



LUND UNIVERSITY

Ascending evacuation in long stairways: Physical exertion, walking speed and behaviour

Ronchi, Enrico; Norén, Johan; Delin, Mattias; Kuklane, Kalev; Halder, Amitava; Arias, Silvia; Fridolf, Karl

2015

[Link to publication](#)

Citation for published version (APA):

Ronchi, E., Norén, J., Delin, M., Kuklane, K., Halder, A., Arias, S., & Fridolf, K. (2015). *Ascending evacuation in long stairways: Physical exertion, walking speed and behaviour*. (TVBB-3192; Vol. 3192). Department of Fire Safety Engineering and Systems Safety, Lund University.

Total number of authors:

7

General rights

Unless other specific re-use rights are stated the following general rights apply:

Copyright and moral rights for the publications made accessible in the public portal are retained by the authors and/or other copyright owners and it is a condition of accessing publications that users recognise and abide by the legal requirements associated with these rights.

- Users may download and print one copy of any publication from the public portal for the purpose of private study or research.
- You may not further distribute the material or use it for any profit-making activity or commercial gain
- You may freely distribute the URL identifying the publication in the public portal

Read more about Creative commons licenses: <https://creativecommons.org/licenses/>

Take down policy

If you believe that this document breaches copyright please contact us providing details, and we will remove access to the work immediately and investigate your claim.

LUND UNIVERSITY

PO Box 117
221 00 Lund
+46 46-222 00 00

Ascending evacuation in long stairways: Physical exertion, walking speed and behaviour

Enrico Ronchi
Johan Norén
Mattias Delin
Kalev Kuklane
Amitava Halder
Silvia Arias
Karl Fridolf

Department of Fire Safety Engineering
Department of Design Sciences
Lund University, Sweden
Lund 2015

Report 3192

Ascending evacuation in long stairways: Physical exertion,
walking speed and behaviour

Enrico Ronchi
Johan Norén
Mattias Delin
Kalev Kuklane
Amitava Halder
Silvia Arias
Karl Fridolf

Lund 2015

Ascending evacuation in long stairways: Physical exertion, walking speed and behaviour

Enrico Ronchi, Johan Norén, Mattias Delin, Kalev Kuklane, Amitava Halder, Silvia Arias, Karl Fridolf

Report 3192

Number of pages: 116

Keywords: ascending evacuation, fatigue, stairs, escalators, physical exertion, walking speed, human behaviour.

Abstract.

This is the final report of the project “Ascending evacuation in long stairways: Physical exertion, walking speed and behaviour”. This project investigated the effects of fatigue on walking speeds, physiological performance and behaviours in case of long ascending evacuation. The report includes a literature review on, at the time when the project began, existing material on ascending evacuation on long stairs and escalators. Experimental research was conducted and the results are presented in the report. This includes two set of experiments on human performance during ascending evacuation in long stairs. In addition, an individual and group experiment was performed to investigate the performance of people during an ascending evacuation on a long stopped escalator. One laboratory experiment was conducted on a stair machine and a methodology to link the laboratory and the field experiments has been presented. Results include walking speeds, physiological measures of physical exertion (oxygen consumption, heart rates and electromyography data), perceived exertion and behavioural observations. Results show that physical work capacity affect walking speeds in case of long ascending evacuation and it should be considered while using long ascending evacuation in engineering design. The analysis of both walking and vertical speeds is recommended since it provides additional insights on the impact of stair configuration on vertical displacement. The novel datasets presented in this report are deemed to provide useful information for fire safety engineers both for assisting fire safety design as well as the calibration of evacuation modelling tools. A new prediction model for the representation of physical exertion in relation to physiological data, i.e., maximal oxygen consumption, has been developed and presented. This model allows predicting the time that a person can walk upwards at a certain pace in relation to physical exertion and human physical work capacity.

© Copyright: Department of Fire Safety Engineering, Department of Design Sciences, Lund University, Lund 2015 & Briab Brand och Riskingenjörerna AB & DeBrand Sverige AB.

Avdelningen för brandteknik
Lunds universitet
P.O. Box 118
221 00 Lund

brand@brand.lth.se
<http://www.brand.lth.se>

Telefon: 046 - 222 73 60
Telefax: 046 - 222 46 12

Department of Fire Safety Engineering
Lund University
P.O. Box 118
SE-221 00 Lund, Sweden

brand@brand.lth.se
<http://www.brand.lth.se/english>

Telephone: +46 46 222 73 60
Fax: +46 46 222 46 12

Acknowledgements

The authors of this report are grateful to the sponsors of the project. This project would not have been possible without the funding received from two Swedish sponsors, namely the Swedish Transport Administration (Trafikverket) and the Swedish Fire Research Board (Brandforsk), who jointly financed about 90% of the project. In addition, co-funding for approximately 10% has been provided by the two engineering firms involved in the project, namely Briab – Brand & Riskingenjörerna AB and DeBrand Sverige AB. The project had a total budget of approximately 2.1 million SEK (which corresponds to approximately € 240 000) and it was carried out during approximately two years (from October 2013 to September 2015).

The authors would like to thank Karin Lundgren and Sofia Månsson for all their help with data collection during the field studies, and Chuansi Gao and Michael Miller for their support on analysis and discussion of electromyographic (EMG) data. The authors also thank Caroline Ericsson Lantz for her help in the data collection in the Ideon Gateway experiment and Ruggiero Lovreglio for proof reading the report.

A special thank goes to the reference group of the project who has provided useful suggestions throughout the entire duration of the project. The reference group included Caroline Cronsioe (Boverket), Jenny Ahlfont (Storstockholms brandförsvär), Per Vedin and Behnam Shahriari (Trafikverket), Per-Erik Johansson (Brandforsk), Tomas Ojala and Ditte Kahlström Jansson (SLL), Ingerid Eknes (Oslo T-banedrift), Axel Jönsson (Brandskyddslaget), Arne Brodin and Johan Häggström (Faveo).

We also thank Vasakronan for the use of Kista Science Tower, SLL (in the person of Tomas Ojala) and MTR for the use of the escalator at Västra Skogen metro station. Especially we would like to thank their staff that put a lot of effort in helping us during the experiments.



Preface

This is the final report of the Swedish research project *Utrymning i långa trappor uppåt: Utmattning, gånghastighet och beteende* [English translation: Ascending evacuation in long stairways: Physical exhaustion (this word has been replaced with “exertion” due to the terminology adopted in this report), walking speed and behaviour]. This project investigated and quantified human performance in case of long ascending evacuation. The egress components under consideration in the projects were stairs and one set of experiments was carried out on a stopped escalator. The overall goal of the project was to increase the current understanding on human performance during ascending evacuation and produce novel data and modelling information for relevant stakeholders (e.g., authorities, fire safety engineers, etc.). In addition, the project investigated the use of a stair machine to collect data on human performance in ascending evacuation on stairs and escalators. Collected data included walking and vertical speeds on stairs and escalators as well as physiological measurements of human exertion.

The approach of the research project was highly multidisciplinary, since researchers and practitioners from different disciplines (fire safety engineering and physiology) have been cooperating towards the common goal to increase the knowledge about ascending evacuation in stairs and escalators. This research area has received little attention at the time the project was initiated. The partners of the research projects included researchers from Lund University and two Swedish companies, namely Briab – Brand & Riskingenjörerna AB, and DeBrand Sverige AB.

The project included five different parts:

- 1) A literature review on the existing material on the topic of ascending evacuation on stairs and escalators.
- 2) Two sets of experiments aimed at investigating individual and group performance of people during ascending long stair evacuation. Behaviours were also studied. Two buildings of different heights (approximately 48 m and 109 m) were considered. Individual experiments involved 47 and 29 test participants, respectively, while group experiments involved 15 and 26 test participants.
- 3) One set of experiments on individual and group performance of people during ascending evacuation in a long stopped escalator (33 m in height). Behaviours were also studied. This experiment involved 34 test participant in the individual experiments and 21 in the group experiment.
- 4) One experiment on the individual evacuation performance in a stair machine. This experiment involved 25 test participants.
- 5) The development and validation of a simple model which predicts human performance during ascending evacuation in relation to different factors such as the impact of physical exertion, human physical work capacity, age, gender, etc.

Table of Contents

Acknowledgements	4
Preface	5
Table of Contents	6
1. Introduction	9
1.1. Outline	10
2. Objectives.....	12
3. Background	14
3.1. Experimental studies	14
3.1.1. Walking paths	15
3.1.2. Walking speed on stairs	17
3.1.3. Walking speeds on escalators.....	18
3.1.4. Flow rates.....	18
3.1.5. The design of steps and handrails.....	19
3.2. Modelling studies	20
4. Methods	21
4.1. Literature review	21
4.2. Experimental equipment and measurement tools.....	21
4.2.1. Video-cameras	22
4.2.2. Borg scale.....	22
4.2.3. Heart rate monitor	23
4.2.4. Oxygen consumption analyser	23
4.2.5. Surface electromyography.....	23
4.2.6. Stair machine	24
4.2.7. Equipment weight.....	25
4.3. Field experiments.....	25
4.3.1. Field experiment procedure.....	28
4.4. Laboratory experiments.....	29
4.5. Data collection and analysis	30
4.5.1. Walking speeds measurements in the field experiments.....	30
4.5.2. Data collection in the laboratory experiments	31
4.5.3. Physiological measurement analysis.....	32
4.5.4. Data synchronization	33
5. Experimental work	35

5.1.	Ideon experiment.....	35
5.1.1.	Experimental layout	35
5.1.2.	Results.....	36
5.2.	Kista experiment.....	45
5.2.1.	Experimental layout	45
5.2.2.	Results.....	46
5.3.	Västra Skogen experiment	55
5.3.1.	Experimental layout	55
5.3.2.	Results.....	57
5.4.	Stair machine experiment	64
5.4.1.	Experimental layout	64
5.4.2.	Results.....	64
5.5.	Comparison of experimental results	67
5.5.1.	Comparison of walking speeds.....	67
5.5.2.	Comparison of vertical speeds	68
5.5.3.	Comparison of physiological data	71
5.5.4.	Comparison of perceived exertion	83
5.5.5.	Qualitative observations	85
5.6.	Modelling fatigue	87
6.	Discussion	91
7.	Future research	95
8.	Conclusions	97
	References	99
	Appendix A – Walking speeds vs gender and age.....	104
	Appendix B - Flow data from the Västra Skogen experiment.....	114
	Appendix C – Publications produced during the project.....	115

1. Introduction

In recent years, the number of underground facilities has been gradually increasing, with a trend of building deeper infrastructures. For example, train and metro stations might be built tens of metres below ground and road and rail tunnels are increasing in number, length and depth. This happens for a number of reasons, such as the optimization of space in urban areas, the enhancement of transportation networks, meeting increased travel demands or environmental concerns.

The main principle for the fire safety design of deep underground facilities is the same as for infrastructures above ground, i.e., people should be able to reach urgently a safe place in case of a fire emergency. However the use of this type of design solution introduces challenges from the fire safety and evacuation perspective. For instance, people may be required to evacuate long ascending vertical distances (in the present work we will refer to ascending evacuation) in case of a fire emergency. During long ascending evacuation (in stairs or escalators), the behaviours of the evacuees can be affected by a series of physical and psychological factors. Among them, physical exertion may play a key role in evacuation performance and needs to be investigated (Pelechano and Malkawi, 2008; Ronchi and Nilsson, 2013).

Current research in the field of stair evacuation is mostly focused on descending stair evacuation (Peacock, Averill, and Kuligowski, 2010). In particular, this subject has received a great deal of attention after the terrorist attacks to the World Trade Center in 2001, in which descending stairs were the main egress components used to evacuate (Averill et al., 2005).

Regarding descending evacuation in stairways, many studies have been performed in order to investigate different variables which may impact the evacuation process such as merging behaviours (Boyce et al., 2012; Ding, Yang, and Rao, 2013; Galea et al., 2008; Hokugo et al. 1985; Proulx, 2002, Takeichi et al., 2005), deference behaviours (Boyce et al., 2012; Melly et al., 2009), stair configuration (Blair and Milke, 2011; Graat et al., 1999; Hyun-seung et al., 2011; Kuligowski et al., 2014; Pauls et al., 2007; Templer, 1974), or the impact of population demographics (Kuligowski et al., 2013; Larusdottir and Dederichs, 2012; Spearpoint and MacLennan, 2012).

In contrast to research on descending stair evacuation, ascending evacuation has received scarce research attention (e.g., Frantzich, 1993). The consequence is that the design of stairways is not generally made to account for the case of ascending evacuation and that the representation of human behaviour in ascending stairs is generally based on assumptions developed and calibrated for descending evacuation. In general, oversimplified assumptions might be used when representing people movement during stair evacuation, such as the adoption of a fixed relationship between walking speeds and population densities (Fruin, 1987; Gwynne and Rosenbaum, 2008; Predtechenskii and Milinskii, 1978) or the use of fundamental diagrams (Burghardt et al., 2013).

The research conducted in the 70ies (Fruin, 1987; Predtechenskii and Milinskii, 1978) to develop the basic principles and models to make calculations on evacuation times on stairs is still in use. Nevertheless, those data-sets present several issues for modern applications. In fact, the population in which those calculations are applied today can be quite different than the one investigated in these studies (where the population under investigation consisted mostly of healthy commuters under normal conditions). In addition, these studies have not researched in detail the issues associated with physical work and physical exertion and the subsequent changes in behavioural activities which might be generated by their effects in long ascending evacuation. Modern

population includes an increasing proportion of physically inactive, overweight and older people which could negatively affect the overall ability of a population to evacuate (Spearpoint and MacLennan, 2012). As a general principle, equal opportunities for satisfactory evacuation in case of fire should be given to the entire population, as a direct consequence of the UN Convention on the rights of people with disabilities (UN, 2006). In this project, this concept is used as a long term guiding principle.

The prediction of walking speeds and human behaviour during ascending evacuation in long stairways is difficult for a number of reasons. Scarce data is available today due to limited research on the topic. In addition, the nature of ascending stair evacuation suggests that psychological and physiological variables (e.g., work capacity, muscle strength) or physical variables (e.g., characteristics of the environment) may affect individual and group walking speeds and the subsequent evacuation (Frantzich, 1993). Also, it is likely that the evacuation behaviour of people climbing a long stairway will differ from the case of a short stairway, as the required workload is expected to be higher with increasing height.

It should be noted that in the present project, the term exertion and fatigue are used to refer to the physical effort associated with a task, while exhaustion is used in the case in which people are not able to continue their task and they need to stop.

Given the lack of research on human performance in case of ascending stair evacuation, as well as the increasing trend to build deeper underground, a multi-disciplinary, holistic approach is required to increase the understanding of the phenomenon. Human performance is here including the impact of physical exertion and work capacity on the performance of a task (in the present case ascending evacuation). To address this issue, a two-year research project was initiated in Sweden in October 2013 to study and quantify evacuation performance and behaviours during ascending evacuation in long stairways (i.e. stairs and stopped escalators and in a stair machine). This report presents the findings of this project.

The project included five different parts, namely:

- 1) A literature review on the existing material on the topic of ascending evacuation on stairs.
- 2) Two sets of experiments aimed at investigating individual and group performance during ascending long stair evacuation, which take into account human behaviour.
- 3) One set of experiments on individual and group performance during ascending evacuation in a long stopped escalator, which takes into account human behaviour.
- 4) One experiment on the individual evacuation performance in a stair machine.
- 5) The development and validation of a simple model to predict human performance during ascending evacuation, which can serve as a base to predict individual and group performance.

1.1. Outline

Within the present report, a description of the activities carried out during the research project and results are presented. The report is divided into the following sections.

Section 1 (*Introduction*) introduces the issues associated with ascending evacuation in long vertical distances, the overall motivation of the present project and the outline of the present report.

Section 2 (*Objectives*) presents the objectives of the research project in relation to the current gaps on existing knowledge on the topic of ascending evacuation on stairs.

Section 3 (*Background*) summarizes the information available at the start of the project on the topic of ascending evacuation in stairs and escalators. This information has been presented in form of a literature review. A dedicated report on this literature review (Delin and Norén, 2014) and an associated research article (Norén et al., 2014) are already publicly available. The information provided in the present report is only a brief summary of that work and interested readers are referred to the specific publications (Appendix C). The complete references of this material are available in the reference list of this report.

Section 4 (*Methods*) introduces the methods employed during the research project, including the description of experimental equipment.

Section 5 (*Experimental work*) presents in detail the four experiments conducted during the research project, namely two sets of (individual and group) experiments on ascending stair evacuation, 1 set of (individual and group) experiments on ascending evacuation in a stopped escalator and 1 individual laboratory experiment on ascending evacuation on a stair machine. Data include walking speeds in relation to height and walked distance, physiological variables (i.e., oxygen consumption, heart rate and electromyography), and human behaviour variables (e.g. handrail usage, subjective estimation of physical exertion and qualitative observations). A simple model to predict human performance in relation to physical exertion is also presented.

Section 6 (*Discussion*) includes a general discussion on the variables affecting ascending evacuation, and the practical uses and implications of the data collected during the project.

The last part of this report, namely Section 7 (*Future Research*), provides suggestions on future research topics that need to be investigated in the subject area.

2. Objectives

The primary goal of the project discussed in this report was to use a multi-disciplinary approach to improve the understanding of human performance during ascending evacuation. This approach studied physical exertion and behaviour in relation to the distance walked during long ascending evacuation on stairways (i.e., stairs and stopped escalators and stair machine) including the data collection of walking and vertical speeds as well as physiological measurements.

The goal was to increase the level of understanding of the phenomenon of ascending evacuation and develop a new simple model which could aid fire safety and evacuation design of stairs in underground facilities and other similar buildings where people are expected to evacuate long vertical distances upwards. This goal could be divided into the following four project sub-objectives:

1. To increase the level of understanding of the emergency evacuation process during ascending evacuation by studying and describing the physical work and exertion effects on walking speed and associated behaviours.
2. To study and describe human performance, and the possible changes in behavioural activities, e.g. travel paths, use of handrails, etc. in relation to the expected impact of physical exertion (both measured with physiological data as well as subjectively estimated) and the height of the stairs.
3. To develop a simple mathematical model that describes human performance during long ascending evacuation including the effects of physical exertion in relation to the height of the stairs. This model can be used as a basis for evacuation design.
4. To develop an experimental method that can be used in a laboratory setting to investigate physical work during long ascending evacuation on stairways. An objective of the laboratory tests was indeed to evaluate if the physical work of real stair climbing could be simulated on a stair machine, and thus, be used in the future for data collection on variety of populations at lower costs, but also on specific populations, e.g. people with disabilities, elderly etc., in a controlled and safer environment. Also, it was expected that by observing the relationship between a) evacuation of a group in a real setting; b) evacuation of an individual in real settings; and c) individual evacuation in a laboratory setting; it might be possible to estimate group evacuation from the laboratory tests.

This report presents the study of ascending evacuation on long vertical distances in order to identify and describe the key variables affecting evacuation movement in deep underground facilities and similar infrastructures. Examples of issues that are addressed in this report are:

- The walking speed and the vertical speed during ascending egress.
- How does physical exertion affect walking speed?
- Is human behaviour of the evacuees affected by the physical work, and to which extent does physical exertion affect people?
- How can the height of the stairs and the physical work be mathematically described in an evacuation model?
- A discussion on how to investigate recommendations on limiting how high a vertical ascending evacuation should be allowed to be.

These questions represent important issues that need to be addressed in order to obtain appropriate engineering design of evacuation from such type of deep infrastructure facilities. To date, existing stairway designs might not account for these specific issues, and there is no clear

understanding on the effectiveness of existing design solutions. In particular, it is not clear whether people with limited physical abilities (e.g. people with disabilities) would be able to walk long ascending vertical distances. For ethical reasons, it is difficult to carry out experimental research in real settings with this type of population since there can be risks for the subjects involved. For this reason, the research presented in this document has mostly been produced by investigating the behaviours of test participants with normal physical abilities, but the knowledge gained (both concerning extrapolating the results with the support from data on different populations physical capacity and concerning the lab experiment method developed in the project) may contribute to an increased understanding also for vulnerable populations.

3. Background

This section presents a brief overview of the first part of the project, a literature review on existing research on long ascending evacuation and it also includes further relevant literature which has been taken into consideration through-out the entire duration of the project. To ensure that the research project's objectives were met, a number of hypotheses were defined. They were then discussed within the project group and reformulated to ensure that the literature review focused on relevant parts. As a result of this process, the following two hypotheses were defined (related to long ascending evacuation):

1. Physical exertion is a descriptive variable of the evacuation process, and it can affect walking speed, flow rates and human behaviour.
2. Stair configuration can affect the evacuation process.

In order to examine whether these hypotheses could be confirmed or not, different sub-questions were defined and addressed in the literature review, namely:

- Can physical exertion affect the evacuation process?
- To which extent does physical exertion (up to the limit of exhaustion, where people need to stop and rest) affect walking speeds and human performance during long ascending evacuation?
- Are there any former research results related to mathematical modelling of ascending evacuation in long stairs?
- Are there any recommendations related to the design of stairs for stairs primarily used for ascending evacuation?

In order to address these questions, a set of relevant material has been analysed concerning:

(1) experimental studies on the impact of physical exertion during stair evacuation as well as ascending stair evacuation and associated recommendations specific to the design of stairways for ascending evacuation (2) modelling studies attempting to represent the impact of physical exertion on human performance.

3.1. Experimental studies

The analysis of the experimental studies collected on the impact of physical exertion on evacuation on stairs and escalators suggests that this variable may influence the evacuation process. Different studies have highlighted this issue in the last 40 years. For example, Egan (1978) highlighted that the effects of physical exertion are expected to appear and have an impact on evacuation in case of evacuations taking longer than five minutes. However, Khisty (1985) stated that this has never been confirmed in any evacuation experiments. In a large data collection effort made by the National Institute of Standards and Technology (NIST) on stair evacuation (Kuligowski et al., 2014), the authors stated that the mean walking speed can decrease in relation to the increasing height of buildings. This change in walking speed can be associated with physical exertion.

The effect of physical exertion was also highlighted in a literature review conducted by Frantzych (1993) in which he concluded that walking speeds would be slower in longer stairwells according to the additional physical work needed to move forward. However, past research has mostly investigated young and fit populations and complete conclusions for a general population have not been fully discussed. In fact, issues concerning physical exertion can be increased by the

changes in occupant demographics, such as the presence of an aging or less fit population (Spearpoint and MacLennan, 2012) or those with health problems (Averill et al., 2005).

Previous research has also shown that people manage to keep up an activity for up to 5 minutes if it is carried out at about 90 % of our maximal oxygen consumption ($VO_2\text{max}$) level (90% for a fit person lays in average around 600 W/m^2) (Holmér and Gavhed, 2007). Work at about 475 W/m^2 ($\approx 70\%$ of $VO_2\text{max}$) can be performed for about 15-20 min (Holmér and Gavhed, 2007). However, oxygen consumption capacity is not the only limiting physiological capacity. At the onset of the exercise, anaerobic energy yielding processes dominate until oxygen transport to the working muscle tissues develops (Costill et al., 2012). Anaerobic processes cause build-up of lactic acid in working muscles that needs to be taken care of by oxygenation processes. The critical time of lactic acid development for performance is 2-3 minutes after onset of exercise. Thus, evacuation that takes 2-3 minutes or more may be affected by either cardiorespiratory capacity or lactate tolerance or both. Reaching any of these limits does reduce ascending speed, and thus, increase evacuation times.

The main data on walking speeds during ascending evacuation available in the literature are presented in this section. The available data-sets are divided into two main groups, namely 1) walking speeds on stairs, and 2) walking speed on escalators. It should be noted that different assumptions regarding the walking paths assumed by people during their movement can affect the calculation of the observed walking speeds (Hoskins and Milke, 2012; Ronchi et al., 2014). For this reason, prior presenting the values of walking speeds in the literature, a brief discussion on possible assumptions regarding walking paths is made. The values derived from the experimental data-sets discussed in this section are here only briefly presented and the authors recommend reading the associate literature to understand the fundamental assumptions in the data collection techniques, population samples, calculation methods for walking speeds, etc.

3.1.1. Walking paths

The studies by Hoskins and Milke (2012) and Ronchi et al. (2014) have provided an in-depth review of the assumptions used to calculate walking speeds on stairs from camera observations, i.e., the methods adopted for the interpretation of data about people movement on stairs and the subsequent generation of the reference equations used for the calculation of occupant travel speeds. The information on the assumptions employed during the analysis of a data-set is crucial to avoid data mis-use during the calibration of evacuation model inputs for the simulation of evacuation on stairs (Hyun-seung et al., 2011). The assumed walking behaviour relate to both the movement path on the actual stair flight as well as the movement on landings.

Hoskins and Milke (2012) consider it reasonable to assume that people walk on stairs side by side in the case of densely crowded situations. Templer (1974) stated that people tend to move to the right and/or take the shortest path in case of individual paths and low density conditions. This was later confirmed by the study by Ronchi et al. (2014). The stay-to-the-right tendency can have different impacts in case of sinistral or dextral stairs. Nevertheless, Hyun-seung et al. (2011) did not observe this behaviour in their stair evacuation experiments.

The approximation in walking speed calculations in relation to the assumed walking paths on a stair flight has been discussed by Kvarnström and Ericson (1980). The walking path is intended here as the theoretical reference path for the calculation of walking speeds. Walking paths might depend on several factors, such as stair configuration (Templer, 1974), the *effective width* concept (Pauls, 1980), population characteristics, etc. Kvarnström and Ericson (1980) recommended measuring the walking line 30 cm far from the handrail. Considering the assumptions adopted in

the hydraulic model of the Society of Fire Protection Engineers (SFPE) based on early Pauls' work and expanded by Gwynne and Rosenbaum (2008), a margin of 150 mm should be considered on each side of the stairs when considering space usage on stairs for calculation (e.g. for flow calculations, walking lines, etc.).

The calculation of the walking speeds from observed data can be done assuming three different lines as reference:

- a. Using as reference the stair slope (a in Figure 1).
- b. Using as reference the horizontal component of the stair flight (b in Figure 1).
- c. Using as reference the vertical component of the stair flight (c in Figure 1).

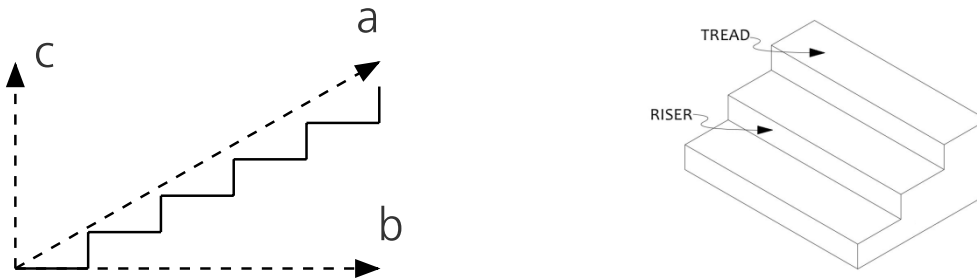

Figure 1. Different reference lines for the calculation of walking speeds on stairs (left).
Illustration on tread and riser on a step of a stair (right)

Similarly, research studies have discussed if the path in the landing should be approximated with a rectangular path (Predtechenskii and Milinskii, 1978) or a semi-circular path (Hoskins and Milke, 2012; Ronchi et al., 2014). To date, researchers seem to agree (Hoskins and Milke, 2012; Kuligowski et al., 2014; Ronchi et al., 2014) that a semi-circular path represents a better approximation for walking paths on landings.

The review shows that the assumed travel paths used to calculate walking speeds can have an impact on the results presented. The review shows that to date the most commonly used paths assume semi-circular paths and they take into account the effective width concept. The review indicates that people tend to walk side by side when the stair width is sufficiently large and tend to take the shortest path in case of individual paths and low people densities.

3.1.2. Walking speed on stairs

Table 1 presents the summary of the mean ascending walking speed on stairs in the data-sets analysed during the review. The table includes a data-set on pedestrian circulation (Fruin, 1971), an experiment in a long stairway (Kretz et al., 2006), a study on the characteristics of commuters in Singapore (Yeo and He, 2009), an evacuation experiment in a high-rise building in Korea (Choi, et al., 2014) and the values in the Swedish building code (Boverket, 2013). In the reviewed material, the walking speeds vary significantly, ranging from 0.27 m/s to 0.75 m/s.

Table 1. Walking speeds upwards stairs from the studied literature.

Mean speed (m/s)	General information	Source	Year	Country
0.67	Men younger than 30 years	Fruin	1971	USA
0.64	Women younger than 30 years			
0.63	Men between 30 and 50 years			
0.59	Women between 30 and 50 years			
0.51	Men over 50 years			
0.49	Women over 50 years			
0.52 ^a	Single person	Kretz et al.	2006	Germany
0.47 ^a	Group of people not affecting each other (low density)			
0.44 ^a	Group of people affecting each other (high density)			
0.27 ^b	Elderly women (> 65 years)	Yeo, S.K., and He, Y.	2009	Singapore
0.28 ^b	Elderly (> 65 years)			
0.29 ^b	Elderly men (> 65 years)			
0.29 ^b	Children (< 13 years)			
0.30 ^b	Adult women			
0.31 ^b	Adults			
0.32 ^b	Adult men			
0.75 ^c	Men floor 1-25 (mean)	Choi, et al.	2014	Korea
0.55 ^c	Men floor 26-50 (mean)			
0.53 ^d	Women floor 1-25 (mean)			
0.42 ^d	Women floor 26-50 (mean)			
0.5	High density (<2 persons per m ²)	Boverket	1994-2013	Sweden
0.6	Low density ^e			

^aThe stair had a slope of 35.1° and it was 35.8 meters high. The speed was measured after 25 meters.

^bVertical speed. Several short stairs at different metro stations were studied. A total of 643 commuters were analysed. The slope of the stairs is not known.

^cThe study involved 30 men in the age 20-28 years (mean 24.6 years).

^dThe study involved 30 women in the age 20-28 years (mean 22.2 years).

^eBased on a low number of observations

Only two of the studied papers involved long ascending evacuation (Choi et al., 2014; Kretz et al., 2006). One experimental study (Choi et al., 2014) addressed explicitly the issue of the impact of physical exertion during ascending stair evacuation. The conclusions of this study were that the effect of physical exertion varies among individuals depending on different variables, e.g., personal factors such as health status, physical condition and previous physical work during the trial. For example, the mean walking speed in floor 26-50 compared to floor 1-25 was reduced by 27% for

men and 21% for women. In that study, the mean walking speed changed after about 90 seconds of ascending evacuation. By that time, men were in the area of floor 12, and women were in the area of floor 9. The walking speed was also affected by whether or not a person was walking alone or in a group. The authors concluded that a reduction in walking speed during ascending stair evacuation might depend on the increased physical effort. This study, however, did not address specifically the physiological factors which do influence the development of fatigue.

The literature review highlighted that the data-sets today available come from different decades and geographical areas. These data-sets involve mostly young and healthy samples.

3.1.3. Walking speeds on escalators

The great majority of research conducted on human factors concerning escalator usage has been conducted during normal circulation conditions (Kinsey, 2011).

Table 2 presents a summary of the data-sets selected for the literature review concerning walking speeds during ascending evacuation in escalators. These data-sets include experiments on a stopped escalator in Japan (Kadokura, et al., 2012) and experiments in a large facility in Japan (Okada, et al., 2009). The values of walking speeds found in the literature under consideration ranged from 0.47 m/s to 0.8 m/s.

Table 2. Ascending walking speed on escalators from the literature.

Mean speed (m/s)	General information	Source	Year	Country
0.8 ^a 0.7 ^a	Single person Group	Kadokura et al.	2012	Japan
0.77 ^b 0.49 ^b 0.54 ^b 0.47 ^b	Single person Single person with obstructing gear ^c Group without obstructing gear Group with some people carrying obstructing gear ^d			
		Okada et al.	2009	Japan

^a The studied group consisted of 79 university students and the escalator had a height of 13.2 meters.

^b The studied group consisted of 35 male and 15 female university students with the mean age 21 years. The escalator had a height of 22 meters.

^c “*Instant senior*” is a young person equipped with obstructing gear to simulate an elderly person concerning moving ability and seeing ability.

^d The persons equipped as “*instant senior*” affected the whole group.

The analysis of the available experimental research shows that the variation in walking speed is large for ascending evacuation (Table 1 and Table 2). Taken into account that the populations under consideration normally are young, healthy people, the variation would be even larger if a wider population is investigated.

3.1.4. Flow rates

The interpersonal distance and the subsequent local densities kept during ascending evacuation plays an important role in the flow rate of people (Burghardt et al., 2013). However, in the studied literature, there is no agreement regarding the interpersonal distance during ascending evacuation in comparison with descending evacuation, i.e., whether this distance is shorter or longer. Only

one study enables a comparison to the interpersonal distance for the same walking speed (Copenhagen fire brigade, 2000), and in that study the interpersonal distance was demonstrated to be longer when walking upward in a stair with the same speed as downward.

Different correlations between walking speeds and densities (also referred as fundamental diagrams) are available in the literature for ascending stair evacuation (Chen, et al., 2010; Fruin, 1987; Predtechenskii and Milinskii, 1978; Seer, et al, 2008; Weidmann, 1992), while no dedicated correlations have been found for escalators.

3.1.5. The design of steps and handrails

The design of steps has been object of research since the late eighteenth-century and different correlations between the riser and tread have been defined (e.g., the correlation by Kvarnström and Ericson, 1980). Lichtneckert (1973), who studied movement on stairs from a physiological perspective, suggests that there are no universal correlations between risers and treads, which will be optimum for all people during both ascending and descending movement. Lichtneckert (1973) also studied the psychological factors affecting upward and downward movement on stairs, concluding that ascending stair movement primarily involves movement in the hip and knee, and that descending movement on stairs primarily involves a movement in which the knee and the ankle are bending. According to this, and the way people move their feet over the tread, Selvik and Sonesson (1974) concluded that when designing stairs for descending movement, the riser should be longer compared to stairs designed for ascending movement. They (Selvik and Sonesson, 1974) also recommended that the dimensions for the tread should be between 25-30 cm, to ensure that the user did not have to take too long strides when walking downwards, and that the riser should not exceed 20 cm. According to the authors, risers over 20 cm would generate a complex muscular and skeletal movement during descent. Others have also recommended the same levels of dimensions; see for example the work by Fruin (1971). Finally, to increase the safety in the stairs, Selvik and Sonesson (1974) concluded that there should not be any variations in risers and treads within a stairwell.

Kvarnström (1977) and Kvarnström and Ericson (1980) have analysed the impact of handrail usage on evacuation movement. According to the authors, the purposes of handrails are to facilitate the use of stairs and make them safer to use. The presented recommendation was that a handrail should be placed 90 cm over the nosing in order to ensure that it could be used for both descending and ascending movement. For ascending movement it was recommended that the handrail was placed higher over the nosing, but no exact recommendations were found.

The findings of the review were that the basis for stair design today is mostly the result of research carried out during the 1970s, and the Swedish design criteria for stairs are primarily based on the results of a major research project in that period (Kvarnström, 1977; Kvarnström and Ericson, 1980). These studies investigated the design of steps, travel paths and the effects of handrail usage. The main focus of the design of stairs in Sweden has been for descending movement due to the fact that the risk of accidents is larger when moving downwards compared to moving upwards (Kvarnström, 1977; Kvarnström and Ericson, 1980). This is an important issue to be taken into account. However, the reviewed literature did not present any clear recommendations on how to design stairs that are primarily intended for ascending movement, and as result from this, no studies have been found that explicitly deal with the design of ascending stairs in relation to physical exertion.

3.2. Modelling studies

This section discusses the modelling studies which have investigated the impact of physical exertion on evacuation movement in general as well as the simulation of evacuation on stairs. This part is an expanded version of the discussion of the literature review (Delin and Norén, 2014) since it includes information which might be useful to evaluate the advantages of the new proposed model to represent physical exertion developed in this project. Evacuation modelling is used in fire safety engineering for the assessment of the life safety performance of a building in case of evacuation (Kuligowski, Peacock, and Hoskins, 2010). To date, more than sixty evacuation models are available on the market, including different features and modelling methods (Ronchi and Kinsey, 2011). The features of those models have been discussed and categorized in several model reviews and application fields such as underground infrastructures and high-rise buildings (Gwynne et al., 1999; Kuligowski et al., 2010; Ronchi, 2013; Ronchi and Nilsson, 2013). Nevertheless, a detailed discussion on the representation of physical exertion is generally not included in these reviews. This is in contrast with the need for inclusion of physical exertion within evacuation models. This issue has been pointed out by different researchers (Mehta et al., 2014; Pelechano and Malkawi, 2008; Ronchi and Nilsson, 2013).

A limited set of modelling studies have explored the impact of physical exertion on evacuation (Denny, 2008; Ding et al., 2000; Koo, Kim, and Kim, 2014). Movement models including physical exertion have been developed in different fields, such as biology (Denny, 2008) and sport science (Elliott and Roberts, 1980; Morgan, Martin, and Krahenbuhl, 1989). The issues associated with the representation of physical exertion on movement models are of crucial importance on calculation accuracy as demonstrated by the study by Koo et al. (2014). This study was based on the experiments conducted by Denny (2008) on running speeds that investigated the impact of physical exertion on different species, including humans.

One of the main limitations of the modelling studies is that they mostly looked at fatigue as a pure physical issue, without accounting for the psychological aspects associated with physical exertion and how these can affect movement speeds. Psychological factors can affect the perception of tiredness and resources available over time during the course of an evacuation (Graat et al., 1999; Pijpers et al., 2013; Warren, 1984). The consequences of the lack of a comprehensive model which includes physical exertion can be the obtainment of optimistic results, with subsequent negative consequences on life safety.

4. Methods

In order to achieve the project objectives, a set of experimental methodologies were adopted. Those methods can be classified in the following categories:

- 1) Literature review
- 2) Field experiments in real settings (three experiments of which the first and second were conducted on stairs and the third experiment on an escalator)
- 3) Laboratory experiments

This section also presents the equipment in use during the experimental research conducted.

In line with the Swedish ethics act (Lag, 2003), research which involves methods and procedure which might be invasive to test participants must be object of a dedicated review by a regional ethics board. This project made no exception. Each experimental plan and other related documentations were reviewed and approved by the Regional ethics board in Lund (Sweden) prior being conducted.

4.1. Literature review

A literature review was conducted in order to investigate the prior studies which have researched the impact of physical exertion on evacuation, and the effects that it may have on the evacuation process in general. The first step was the definition of a number of keywords to ensure a systematic search in databases. The keywords included words such as *evacuation*, *exhaustion*, *fatigue*, *egress modelling*, *fire evacuation*, *stair evacuation*. The literature was retrieved from different online databases and libraries, primarily Google Scholar [<https://scholar.google.com>], ScienceDirect [www.sciencedirect.com], Summon [www.serialssolutions.com/en/services/summon] and Evacmod [www.evacmod.net]. Literature was included in the review in relation to its relevance to the objectives of the project.

The material analysed can be divided into three main categories; (1) experimental studies on ascending evacuation (2) modelling studies attempting to represent the impact of physical exertion and (3) literature on stair design.

The results of the literature review are briefly presented in the background section of this report and more information can be found in the report on the literature review in Swedish (Delin and Norén, 2014) and in an associated research paper in English presented at the Pedestrian and Evacuation Dynamics Conference in 2014 (Norén et al., 2014). The background section of this report also includes further relevant literature which has been taken into consideration throughout the entire duration of the project (e.g. a review of existing modelling work is useful for the understanding of the novelty of the new model on human exertion proposed in this project). This literature combined is deemed to be useful to interpret and evaluate the results of the project.

4.2. Experimental equipment and measurement tools

This section introduces a description of the equipment and measurement tools that were used for data collection during the experiments including video-cameras, the scale used for measuring subjective estimation of physical exertion, heart rate monitor, oxygen consumption analyser, surface electromyography and a stair machine.

4.2.1. Video-cameras

Walking speeds and behaviours were measured in the field experiments using video cameras (Sony Corp, Japan and Drift Innovation). Two different camera settings were used during the field experiments. This was done in order to enhance the quality of the data collected as well as trying to develop a novel method of collecting reliable data and reducing the efforts needed for the post processing of the recorded material. The two settings were (Figure 2):

1. Fixed cameras were placed at every floor in the first field experiment and every third floor in the second experiment and every three meters of height in the third experiment. These were the Drift Innovation X170. The dimensions were 2.54 x 13.3 x 3.3 cm. Maximum framerate supported was 30 fps with a native resolution of 720 x 480.
2. Action cameras were mounted on the test participants (one camera per person). This was an HDR AS30V by Sony. The dimensions of the camera were 4.7 cm x 8.2 cm x 2.4 cm. This camera had 11.9 Mega Pixel, a field view of 120 degrees and a maximum resolution of 1920x1080). The camera had a recording speed for HQ video of 16 Mbps.



a. Wall mounted camera



b. Action camera

Figure 2. Camera mounted on wall (a), action camera mounted on a test participant (b)

During the field experiments the following observations connected to the evacuation movement filmed with the video cameras were observed, namely: 1) The time that it took for a person to move from one position to another; 2) Behaviours, e.g. changes in walking paths, handrail usage, etc. The effects of overtaking and group dynamics were also recorded in the group experiments.

4.2.2. Borg scale

During the field experiments, the subjective estimation of physical exertion was recorded by camera microphones (on each landing in the first experiment, every third floor in the second experiment and every third vertical metre in the third experiment). Test participants were requested to rate their perceived exertion on a scale from 6 to 20 (i.e., the Borg's scale (Borg, 1982)). This scale is a well validated tool which can be used to link the physical effort to complete a task with its subjective estimation. In the present project, the subjective responses of the perceived exertion were recorded in each experiment. Figure 3 shows the Borg scale.

Exertion scale

6	No exertion at all
7	
8	Extremely light
9	Very light
10	
11	Light
12	
13	Somewhat hard
14	
15	Hard (heavy)
16	
17	Very hard
18	
19	Extremely hard
20	Maximal exertion

Figure 3. Borg scale used during the experiment.

4.2.3. Heart rate monitor

Heart rate was recorded with a heart rate monitor (RS400, Polar Electro, Finland for individual and additionally with Polar Team2 logger/transmitter system for the group experiment, Polar Electro, Finland).

4.2.4. Oxygen consumption analyser

Oxygen consumption was measured in terms of oxygen and carbon dioxide content in exhaled air for metabolic rate assessment by a portable oxygen analyser (Metamax II, Cortex Medical GmbH, Germany). As only one oxygen analyser was available, it was not possible to equip each individual subject with the oxygen analyser due to preparation time, and only one test participant was equipped with it during the group experiments.

4.2.5. Surface electromyography

Muscle activity was measured through surface electromyography (sEMG) by using the EMG 'Megawin' system (ME6000-T16 Mega Electronics, Kuopio, Finland). EMG is an electro diagnostic technique for evaluating and recording the electrical activity produced by skeletal muscles (Disselhorst-Klug et al., 2009). To obtain the EMG signals pre-gelled bipolar surface electrodes 'Ambu Neuroline-720' (Ballerup, Denmark) were applied on the skin. The skin was cleaned with 70 % isopropyl alcohol after scrubbing it lightly with fine sand paper in order to remove dead and loose skin layers for best contact.

Instruments were fastened with a strap around the chest and/or waist before climbing the stairs and were carried along with them during climbing. sEMG data were recorded in the buildings and lab experiments but not in all subjects. The measurements were skipped in the escalator experiment due to time constraints as the preparations were time consuming. In order to observe muscle fatigue the following five anti-gravity body weight carrying muscles of the subject's dominant lower limb (Vastus lateralis: thigh and calf) were measured (Figure 4):

1. Vastus lateralis (VL)
2. Vastus medialis (VM)
3. Rectus femoris (RF)¹
4. Gastrocnemius medialis (GM)

¹ VM was measured instead of RF only in the first stair experiment.

5. Gastrocnemius lateralis (GL)

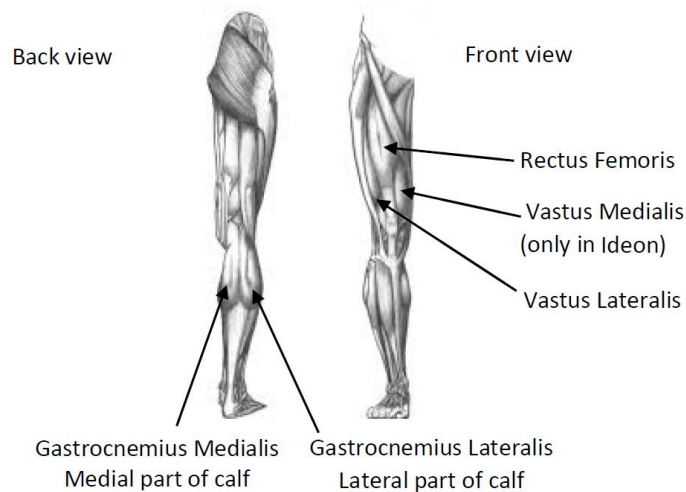

Figure 4: Human lower limb musculature back (posterior) and front (anterior) view (from left to right) highlighted with the muscles measured in the field and laboratory studies.

Figure 5 shows a fully equipped test participant.



Figure 5. A fully equipped test participant before (a) and during the ascending evacuation test (b).

4.2.6. Stair machine

During the laboratory experiment, a stair machine SM5 (StairMaster, USA, Figure 6) was used (dimensions were equal to 147 cm x 86 cm x 226 cm and weight was 156 Kg). This machine included 205 mm high and 250 mm deep steps which replicate the workout of real stair climbing.

The speeds that can be implemented in the machine range from 24 to 162 steps per minute allowing step rate adjustment in 20 levels at about 8 steps per minute intervals.



Figure 6. Stair machine SM5 Stairmaster used in the laboratory experiment (figure taken from the company website)

4.2.7. Equipment weight

Although the effect of clothing and footwear weight on physical effort is known to be strong (Dorman and Havenith, 2009; Duggan, 1988), the present work did not focus on this issue. Footwear and clothing were not standardised, and all the subjects used their own items. Any possible effect was considered to increase both the physiological load and the time to cover the distance. A summary of the weight of the equipment (including belt, cables etc.) is presented in Table 3.

Table 3. Weight of the equipment mounted on people (per piece)

Equipment	Weight [g]
Action camera	355
Oxygen consumption and heart rate measurement systems	1657
Electromyography system	544

4.3. Field experiments

Three sets of field experiments in real settings were performed within this project. The first two experiments were performed in two different stairwells in order to avoid that the evacuation performance is linked to a specific configuration of the staircase. The third experiment was carried out in the longest escalator in Sweden.

The experiments were carried out both by single individuals evacuating upwards one at a time as well as groups of people. This allowed identifying general trends on evacuation behaviour and human performance as well as measure walking speeds and physiological variables associated with physical exertion. Test participants were recruited from the general public in order to include a mixed population in terms of age and gender. The field evacuation experiments were:

- 1) An evacuation experiment conducted in one stair of the Elite Ideon Gateway building located in Lund, Sweden (from now on this experiment is called “Ideon” in this report). The evacuation experiment was conducted on a total of 13 floors (48 m high). This experiment was conducted in April 2014.
- 2) An evacuation experiment conducted in one stair of the Kista Science Tower building located in Stockholm, Sweden (from now on this experiment is called “Kista” in this report). The evacuation experiment was conducted on a total of 31 floors (109 m high). This experiment was conducted in September 2014.
- 3) An evacuation experiment conducted in an escalator located at the Västra Skogen metro station in Stockholm, Sweden (from now on this experiment is called “Västra Skogen” in this report). The escalator had a total height of 33 metres and its length is 66 metres, which makes it to the date of the experiment the longest escalator in Sweden. This experiment was conducted in October 2014.

The main characteristics of the experimental sites are presented in Table 4 (Figure 7 presents photographs of the different experimental locations). The characteristics of the experimental groups are presented in Tables 5 and 6.

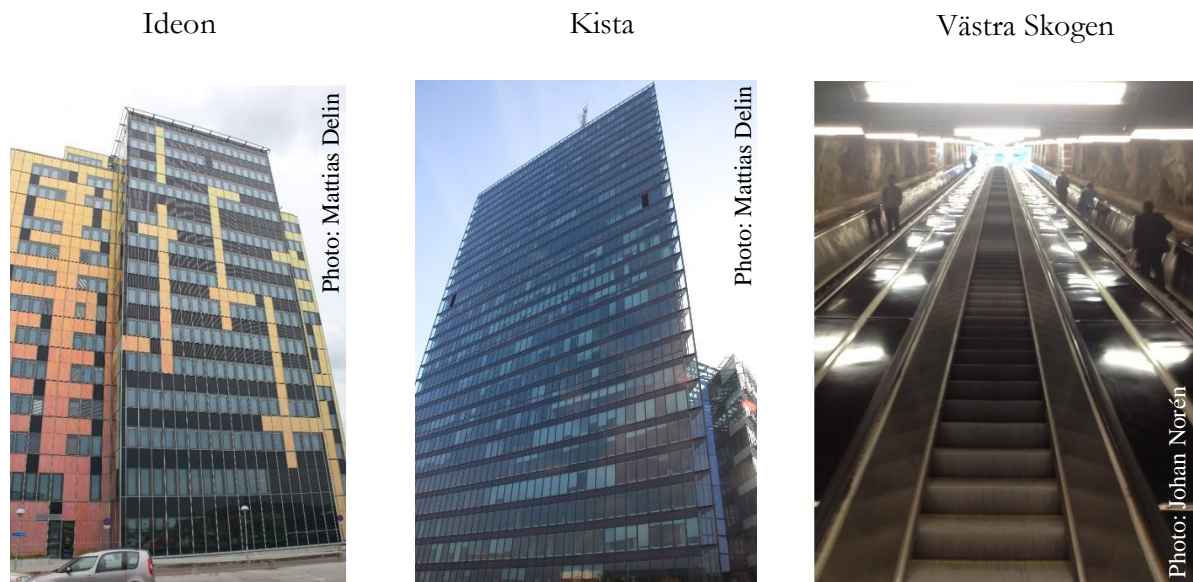

Figure 7. Photographs of the experimental locations.

Table 4. The characteristics of the different experimental settings.

Stairwell	Width [m]	Step riser [m]	Step tread [m]	Height [m]	Floors [#]
Ideon	1.0	0.18	0.26	48	13
Kista	1.6*	0.17	0.27	109	31
Västra Skogen	1.2*	0.20	0.40	33	-

*The width is between the handrails. In Västra Skogen the step width was 1.0 meter.

Table 5. The characteristics of the experimental groups for the individual experiments.

Individual experiment	Number of persons	Men	Women	Age [year]		
				Min	Mean	Max
Ideon	47	27	20	19	33	51
Kista	29	16	13	20	32	46
Västra Skogen	34	21	13	22	38	64

Table 6. The characteristics of the experimental groups for the group experiments.

Group experiment	Number of persons	Men	Women	Age [year]		
				Min	Mean	Max
Ideon	15	9	6	21	32	56
Kista	26	15	11	19	34	59
Västra skogen	21	11	10	20	29	45

Camera recordings were used to measure walking speeds during the evacuation process. In addition, during the experiments, physical work was measured. The measurements included oxygen consumption (VO_2), heart rate (HR) and electromyography (EMG). Only a sub-set of participants were subjected to the more thorough physiological measurements (Table 7). These measurements were performed in order to study the role of the physical work on evacuation performance.

Table 8 summarizes the subjects' age, height, weight and body surface area in each experiment for the participants with oxygen consumption measurement equipment.

Table 7. Number of participating subjects in total and separately in group and individual tests with results of heart rate (HR), oxygen consumption analyser (VO_2) and electromyography measurements (EMG). During the group experiments only one test participant could use the oxygen consumption analyser and EMG, and their results are here included in the individual tests. Heart rate data of some subjects was lost.

Test site	All	HR (group)	HR (indiv)	VO_2 (total)	EMG (total)
Ideon	64*	16	48	32	12
Kista	50*	18	30	18	9
Västra Skogen	54*	19	32	17	-

*Due to a technical problem, some participants have been excluded.

Table 8. Characteristics of test participants with oxygen consumption equipment: mean (SD).

Test site	Age (years)	Height (m)	Weight (kg)	Body area (m ²)
Ideon	32.9 (9.5)	1.76 (0.08)	73.7 (13.8)	1.89 (0.19)
Kista	31.7 (7.0)	1.73 (0.06)	70.0 (13.6)	1.82 (0.18)
Västra Skogen	37.6 (11.4)	1.74 (0.10)	74.9 (13.1)	1.89 (0.20)

Data on handrail usage and the subjective estimation of physical exertion (using the Borg scale (Borg, 1982)) was also collected. In the present report we refer to perceived exertion to describe the subjective estimation of exertion. A qualitative analysis of human behaviour was also performed. This was made in the form of comments to the video observations and interviews by standardized questionnaires of the subjects after the experiments. To summarize, the following data have been collected:

- 1) Walking speeds
- 2) Flow rates (in the escalator experiment)
- 3) Physiological measurements (VO_2 , HR and EMG²)

² It should be noted that muscle fatigue estimation methods based on EMG measurements were made outside the frame of this project on selected subjects only for the purpose of testing out methods for future research.

- 4) Qualitative observations on human behaviour (e.g., handrail usage, subjective estimation of physical exertion, travel paths, etc.)

Based on pre-studies there were the following expectations related to field experiments that set certain limitations:

- If the evacuation time is short, i.e. less than 1.5-2 minutes then a stable and reliable VO_2 would not be reached as during that period both instrument and body are still adjusting to the new conditions (near maximal activity level); also, the lactate development in muscles has not reached the level to affect the performance yet;
- If the evacuation time is above 2 minutes but less than 3-4 minutes, then acquiring stable VO_2 values can be expected, however, time may not be enough to set physical capacity as a limitation for the exercise; simultaneously muscle fatigue develops and lactate effects may start muscle stiffness which may probably not lead to stopping the activity before reaching the top of the stair;
- At evacuation times above 3-4 minutes both VO_2 and muscle fatigue have a possibility to become a limiting factor and the condition would allow studying both effects, and determine which of them depending on specific parameters does lead to exhaustion and limits the ascending evacuation.

Thus on long ascending evacuations, the following hypothetical cases have been formulated:

1. A person reaches stable values in terms of physiological measurements and keeps the pace until the end – no exhaustion can be observed;
2. A person reaches stable values but after some time reduces the pace and values stabilize at a lower level that can be kept until the end, i.e., a person choosing a too high pace at the beginning which gets corrected in time to avoid exhaustion;
3. VO_2 values do not manage to stabilize since a person would slow down, take some breaks for recovery, and VO_2 values would fluctuate depending on work/rest pattern. More breaks may be required towards the top of the stair – exhaustion has been reached but a person could manage to complete the evacuation until the end;
4. A last hypothesis assumes a similar situation to case 3 but a person does not reach the top. The breaks get longer until a person has to quit and gets clearly exhausted.

4.3.1. Field experiment procedure

Test participants arrived on site and they got information on the study and were asked to fill in a questionnaire. This questionnaire included background questions regarding age, height, weight, physical status, exercising habits, use of public transportations, disabilities, and stated level of tiredness before the experiment. After the test participants got the information on the study and filled the questionnaire, they were directed to the station for mounting the equipment. Each subject received an action camera and a heart rate monitor, and a sub-set of participants was equipped with an O_2 and CO_2 analyser for oxygen consumption measurements (VO_2). Heart rate data were recorded every 5 seconds. In the group experiment only one person was equipped with the oxygen analyser. Muscle electromyography (EMG) was measured in a smaller sub-set of test participants who used the oxygen analyser. After completion of preparation and instrumentation, the test participants were lead to the stairs (or escalator). In the stair experiments, test participants were told to move upwards the stair until they met a member of the research team. In all experiments, participants were told to walk with a pace of their choice. During the exercise the subjects were also requested to rate their perceived exertion on a scale from 6 to 20 (i.e., the Borg's scale (Borg, 1982)). Borg scales were fixed on the walls at defined intervals and the test participants had to tell out the rating so that the cameras could record it. After reaching the top floor (or top of the

escalator) the subjects were guided back, the equipment was removed and they filled a second questionnaire on their experience of the evacuation experiment.

In the individual experiments all test participants walked alone and they were not affected by others. Each individual subject was free to start after that the measuring devices were started and synchronized (this consisted of a beep from the pulse watch and the O₂ and CO₂ analyser that was caught by the camera microphone). In the group experiments the participants were placed close together before the start to reproduce a queue close to the stair and maximize the effects of people affecting each other.

4.4. Laboratory experiments

A set of laboratory experiments was carried out on a stair machine, the SM5, with the scope of simulating evacuation at various physical exertion levels. The same physiological data collected during the field experiments were also collected in the laboratory tests (i.e. oxygen consumption, heart rate, EMG). The equipment used during these tests was the same as in the field tests.

Since the step rate of the stair machine was fixed for each individual depending on their maximal work capacity (measured in each subject earlier in a separated test session on a treadmill with increasing inclination (ACSM, 2013)), walking speeds were in this case fixed too. The correlation between the field and the laboratory tests was evaluated to assess how well a stair machine may represent the reality. Vice versa, the tests with controlled step rates at different exercise levels were to provide estimation of vertical distance based on individual physical capacity. The number of participants involved in the laboratory experiments and their characteristics are presented in Tables 9 and 10. Twelve (12) female and 13 male subjects did participate in the study and their data was pooled. EMG data from 2 subjects was lost due to technical problems. The first 19 subjects were used for model development and the last 6 were used for validation. The study involved the following steps: arrival of the subject, fixing the instruments on the subject and walking on the stair machine (Figure 8).

Table 9. Number of test participants and corresponding physiological measurements in the laboratory experiments

All subjects	HR	VO ₂	EMG
25	25	25	23

Table 10. Test participant characteristics in the laboratory experiments: mean (SD).

Age (years)	Height (m)	Weight (kg)	Body area (m ²)
35.3 (12.3)	1.72 (0.07)	74.4 (17.6)	1.86 (0.22)



Figure 8. A fully equipped subject climbing the stair machine in the research-hall at Lund University, Department of Design Sciences.

4.5. Data collection and analysis

This section includes the methods and assumptions in use for the calculation of the walking speeds, the analysis of the physiological data and data synchronization.

4.5.1. Walking speeds measurements in the field experiments

The times at which test participants reached reference points in the camera recordings were noted using manual annotation in video-editing tools (vData in Ideon and Kista experiment and Kinovea in Västra Skogen experiment). Both the walking speed and the vertical speed were calculated and analysed. Local walking speeds were calculated referring to the travel path walked by the test participants divided the time needed to go from a point to another where the cameras were placed.

Vertical speeds were instead calculated referring to the vertical displacement of test participants. This means that the vertical speeds were obtained dividing the vertical distance from a point to another where the cameras were placed and the time spent.

In order to calculate the walking speeds, assumptions were made regarding the travel paths adopted by the test participants. During the individual experiments the participants predominately used the inside route. When calculating the walking speed, the inside route was used to determine the travel path and it was defined as the inclined travel distance on the stairs plus the landing travel distance for each landing. The arc is half a circle with its centre between the stair flights where the stair meets the landing. A sample travel path in Ideon was analysed in more detail. This analysis was made by a wall-mounted camera. In the Ideon experiment, the radius was approximately 0.45 m (measured on floor 6). The measured radius gives a travel path on the landing of 1.41 m. One travel path in the Kista experiment was also analysed in more detail. In the Kista experiment, this analysis was made with a paper placed on one landing to register the foot marks and an estimation of the mean radius was drawn from that. In the Kista experiment the radius was approximately 0.55 m (measured at floor 15). The measured radius gives a travel path on the landing of 1.73 m in the Kista experiment. In the group experiment, the travel path of each participant varied more.

Most of the test participants kept the same travel paths as the participants in the individual experiments. Unlike the case of both experiments described before, Ideon and Kista, in the escalator experiment there was no need to make assumptions about the travel paths used by the participants. Other than an eventual shift from one side of the handrail to the other, the paths along the escalator do not differ much from a straight line, and therefore they were assumed to be a straight line. In the Ideon experiment, it should be noted that the flights have odd number of treads which benefits the rhythm of the walking speed since each person is able to arrive at each landing with the inner foot. Some people decided to take an extra step when they got tired.

4.5.2. Data collection in the laboratory experiments

Oxygen consumption (VO_2) represents oxygen amount that is used to burn energy to carry out a defined task, i.e. move a mass at a specific speed to a defined distance. VO_2 in ml/kg/min considers even the own body mass to be moved. In any case, either knowing the maximal heart rate (HRmax) or maximal oxygen consumption (VO_{2max}) would allow a better prediction/correlation when instead of absolute values one would use percentage of individual maximum (relative heart rate/pulse or relative oxygen consumption). At this stage it was decided to use the VO_2 as the major parameter in prediction development. The multivariate linear regression for best fit confirmed this reasoning (see later on model development). Oxygen consumption to energy expenditure (metabolic rate) and cardio-respiratory capacity and exertion were measured.

A set of pre-tests were performed on 2 subjects for whom VO_{2max} and field results were available in order to finding the best method for simulating ascent. The lab tests were therefore preceded by several pre-tests:

1. walking up at defined pace on downwards moving escalator;
2. doing stepping on a stair high bench at the same rate (up and down) as they did during the evacuation experiment in the Ideon experiment;
3. walking on treadmill with 22.5% inclination at a calculated speed (Givoni and Goldman, 1971) corresponding to the same VO_2 as during the Ideon experiment;
4. walking on a StairMaster (at RehabSyd, Lund) at the same rate as during the Ideon experiment.

However, none of the tested setups was in one or another way considered to simulate field conditions (step rate and VO_2) for both subjects enough accurately. As the use of the stair machine provided the closest results then a new version of stair machine (SM5, StairMaster) was acquired. This machine was expected to simulate climbing the stairs best, especially, the exercise on an escalator.

Based on the field tests, pre-tests and database comparisons (Kuklane and Gao, 2012) it was derived that the subjects in the field reached close to their maximal capacity when climbing the stairs. The load on the stair machine (step rate) was adjusted to generate around 90% of their maximal oxygen consumption when climbing at the highest level, i.e. they would be able to continue at that rate up to 5 minutes. Maximal capacity test (American College of Sports Medicine, 2013; Lee et al., 2013) while running on treadmill with increasing inclination was carried out earlier together with giving study information and acquiring written consent. The subjects' VO_{2max} was measured on a different day at least 24-36 hours before the stair climbing test.

While the subjects were free to choose their speed and strategy during climbing in the field experiments, the laboratory study was designed to measure climbing capacity with pre-selected step rates. The step rate estimation calculations were based on field tests and preliminary lab tests

together with available maximal capacity test results database analysis (Kuklane and Gao, 2012). The step rates were selected to generate the work load corresponding to 50% and 70% of individual VO_2 max. The selected work load levels were kept for 3 minutes each with a 2 minutes resting break in between. The last level at 90% of individual VO_2 max was meant to last for 5 min or until exhaustion and it was preceded by 5 minutes of rest (Table 11). The total testing time was 20 min and it started with 2 minutes of rest for baseline measurements. Such setup allowed studying the effect of pace on oxygen consumption but also the effect of body size and fitness.

Table 11. The timings for the lab exercise. Step rates for each climbing level were calculated from VO_2 max and the intended percentage of maximal effort individually: mean (SD).

Activity	Timings (min)	Step rate (steps/min)	Corresponding SM5 level	Vertical displacement (m/min)
Resting 1	0-2			
Climbing 1	2-5	66.1 (16.3)	7 (2)	13.2 (3.3)
Resting 2	5-7			
Climbing 2	7-10	88.3 (17.0)	10 (2)	17.7 (3.4)
Resting 3	10-15			
Climbing 3	15-20	109.4 (17.8)	13 (2)	21.9 (3.6)

Highly repetitive muscle activities are usually fatiguing the muscle. Stair climbing is such a dynamic cyclic activity for the lower limb muscles and joints. Dynamic movement is a continuous motion involving different muscles and permits co-ordination to produce action to the body biomechanical system. This muscle action can be measured by using the electromyography (EMG) method. The EMG activity provides an estimation of the forces and frequencies given by the measured muscle. In general, there is an established relationship between the EMG, muscle length and isometric or sustained muscle action. Repeated movements recording in EMG may give an estimate of fatigue of the muscles by relative changes that happen in the active muscles of the leg (Asplund and Hall, 1995). This strong statement forms the basis of EMG system that would concluding about local muscle fatigue and establish a relationship to oxygen (VO_2) consumption in such challenging lengthy tasks and simulated evacuation situation. Surface electromyography (EMG) signals have limitations; however, this is the convenient non-invasive method to predict muscle activity (Disselhorst-Klug et al., 2009).

As all subjects would walk at fixed paces (in contrast with the field experiment where they could choose their own pace) results were analysed by various time points, i.e., 1, 2, and 3 minutes and at the end. The comparisons included heart rate, mean and maximal VO_2 , mean VO_2 over a stable measuring period. Statistical evaluation was based on means between the groups and standard deviations. In order to compare individual subjects the data was normalized for time. The laboratory study was also intended to find a correlation between EMG data and VO_2 measurements during stair climbing. In the first two field studies on stairs, different time periods of muscle activity have been compared to observe muscle fatigue.

4.5.3. Physiological measurement analysis

There are various methods available for estimating maximal heart rate (Robergs and Landwehr, 2002). However, the errors in maximal heart rate estimation are still high (Robergs and Landwehr, 2002), and estimated maximal heart rate used in work capacity estimations would lead to even higher errors due to individual variation. Maximal pulse may differ in a range from 180 to 210 b/min, e.g. 1 standard deviation corresponds to about 15 b/min, and thus, at least as high variation

in a recorded pulse under a specific exercise can be expected. Heart rate may also be affected by psychological or thermal impact (International Standards Organization, 2004; Kuklane et al., 2015). As VO_2 in ml/kg/min is a direct measure of individual fitness then VO_2 was selected as the basis for the main analysis and relationship derivation with step rate and vertical displacement.

Muscle fatigue analysis through EMG mainly relies on the median frequencies (MDF) and rectified amplitudes. The increase in frequencies and amplitudes of a specific muscle indicates increased force of the measured muscle. Decrease in both of these parameters proves the force decrease. When the amplitude increases and frequency decreases it is assumed that muscle fatigue occurs. However, the reverse state of that i.e. increasing frequency and decreasing amplitude is a sign of recovery from fatigue (Figure 9) (Cifrek et al., 2009).

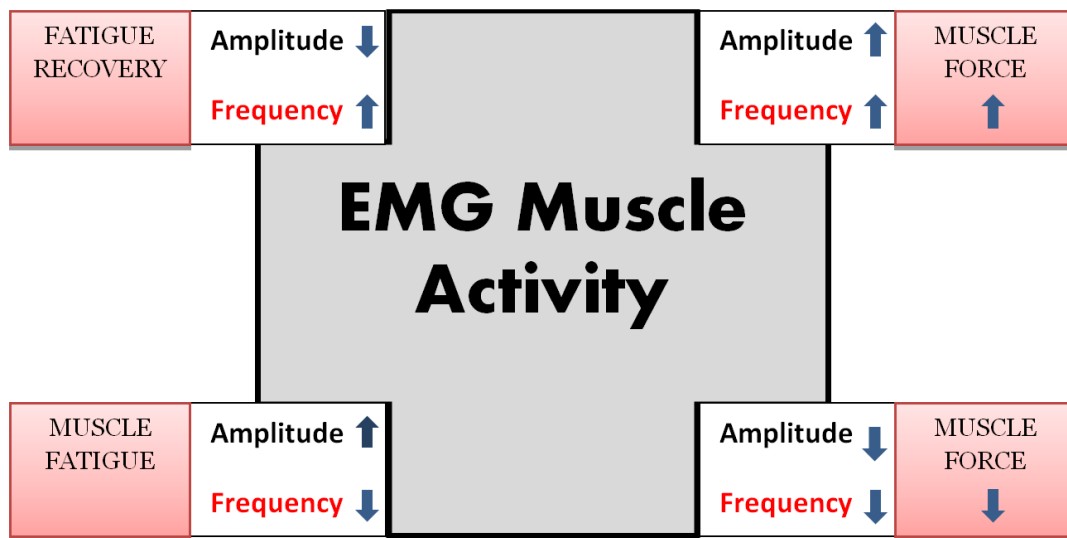

Figure 9: EMG signal interpretation based on Cifrek et al. (2009).

The sEMG signals were filtered using bandpass between 20 to 499 Hz followed by notch filtered between 48–52 Hz to remove any residual and noise which is about 50 Hz in the ‘Megawin’ software version 3.1-b10 (De Luca, 1983; De Luca et al., 2010). EMG median frequencies and root mean square (RMS) rectified amplitudes are a common measure of local muscle fatigue (Bigland-Ritchie et al., 1995; De Luca, 1983). These two parameters were calculated for each duration of selected time period of the starting 10 s, midway 10 s and finishing 10 s in the real stair way of the first two phases of this project. In expecting a better co-relation of VO_2 data with sEMG, total climbing time was normalized with each 10th percentile time period a data point (10%-100%) to observe the gradual or progressive changes of the muscle activity over time in the lab study. Then it was averaged to yield a single median frequency (MDF) and amplitude for each selected duration from each subject. The frequencies and amplitudes changes due to dynamic muscle activities from different time period and over time were observed and compared in the stair and laboratory experiments (Dingwell et al., 2008; MacIsaac et al., 2001).

4.5.4. Data synchronization

Times from speed calculation were matched with the times for oxygen consumption recordings, i.e. walking speeds were averaged to fit the VO_2 recordings that were collected every 10 seconds. As oxygen consumption and metabolic rate values could also vary, e.g. depending on number of breaths, then mean of 3 values around the selected time point was utilized in the analysis.

In order to compare individual subjects, data was analysed by floor levels but also normalized in time. In fact, as all subjects could choose their own pace during the field experiments and in order to compare the results from various experiments, then results were also reported at various time points, i.e., 1, 2, and 3 minutes and at the end. The analysis included heart rate, mean and maximal VO_2 , mean VO_2 over a stable measuring period.

5. Experimental work

This section presents two field experiments concerning ascending evacuation on stairs (Ideon and Kista), one field experiment on ascending evacuation of an escalator (Västra Skogen) and one laboratory experiment made on a stair machine.

The experiments are presented in accordance with the following structure:

- 1) Experimental layout
In this part a description of the characteristics (geometrical or layout) of the site and/or laboratory has been provided.
- 2) Results
This part presents the results of each experiment. This can be presented in terms of numerical values, plots or qualitative comments.

5.1. Ideon experiment

The first field experiment was performed in the Lund Ideon Gateway building (this building is called simply “Ideon” in this report) in April 2014. The experiment was performed in one of the stairwells of the building.

5.1.1. Experimental layout

The stairwell in the Ideon building has a height of 48 m and it is a dog-leg stair. The stair consists of two flights, with 11 or 12 treads at floor 1-3 and with 10 or 11 treads at floor 4 -10 and 12. Floor 11 consists only of one flight (curved instead of a landing) with 29 treads. The distance between each stair flight is 0.15 m and the slope of the flight is 34.7 degrees. On the inner side of the stair, the handrail is mounted above the edge of the step and on the outer side of the stair the handrail is mounted on the wall at a distance of 0.06 m from the edge of the step. The handrail is placed 0.95 m over the nosing. The landings have a depth varying between 0.95 m - 1.25 m and a width of 2.15 meters. Table 12 and Figure 10 and 11 presents the stair characteristics in the Ideon experiment and Figure 12 presents a picture of the stairwell.

Table 12. The characteristics of the Ideon stairwell.

Stairwell	Width	Step height	Step depth	Total height
Ideon	1.0 m	0.18 m	0.265 m	48 m

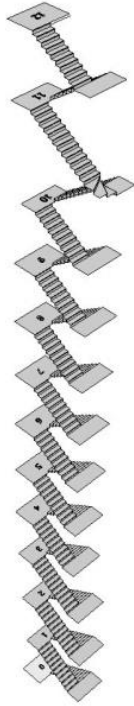

Figure 10. The stairwell in the Ideon experiment.

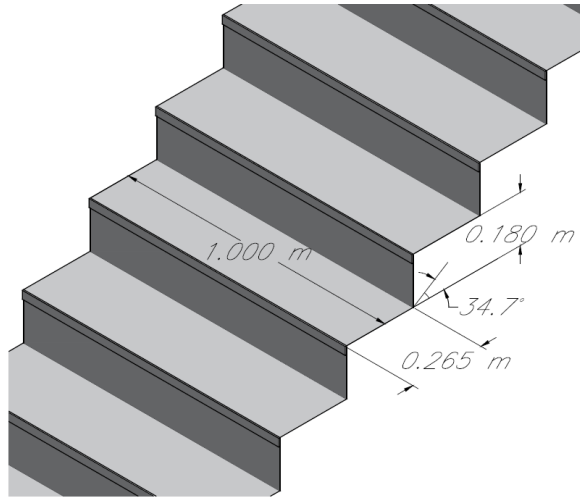

Figure 11. The stairwell (with measures) in the Ideon experiment.



Figure 12. The stairwell in the Ideon experiment.

5.1.2. Results

The results of the Ideon experiments include walking speeds, vertical speeds (refer to the previous section 4.5.1 for the definition of walking speed and vertical speed in this report), physiological data and a linear regression analysis performed to evaluate the impact of demographics on participant's performance.

WALKING SPEEDS

The first set of plots shows the median value of the walking speeds at each level together with minimum and maximum values and the 25th and 75th percentile at different heights (Figure 13 for the individual experiment and Figure 14 for the group experiment). The probability density function and the cumulative density function of walking speeds in the individual experiments are also presented in Figures 15 and 16 respectively. The walking speeds of the median, the slowest and the fastest test participants are presented in Figure 17.

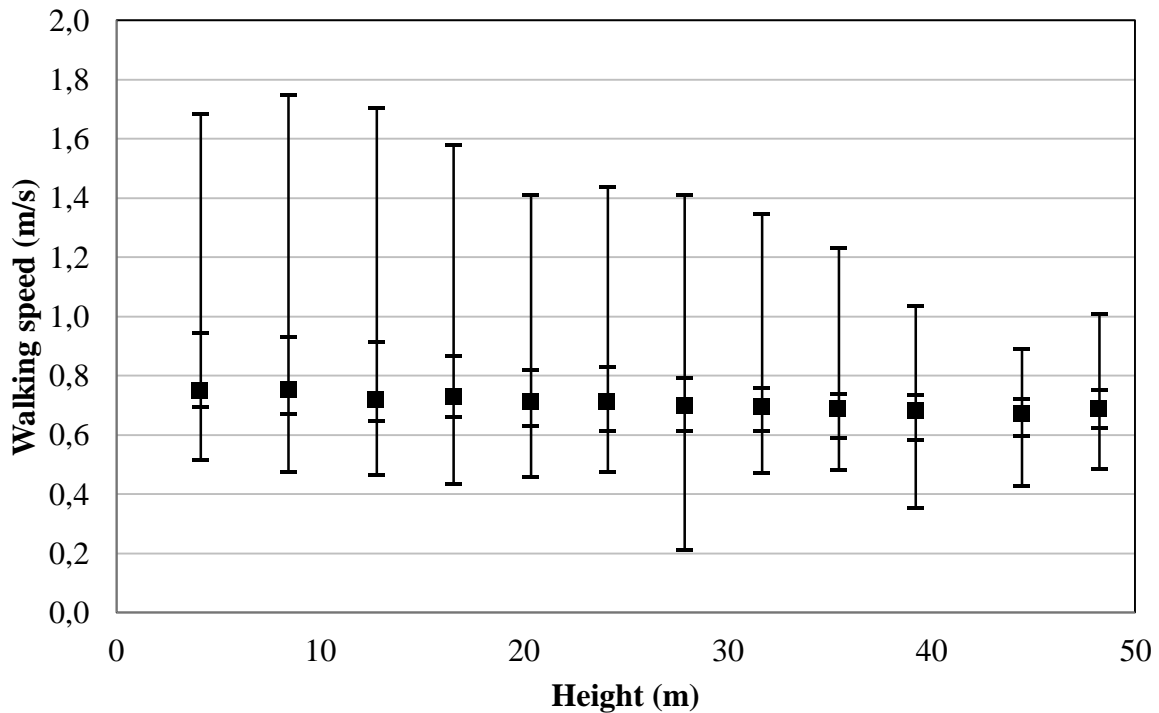

Figure 13. Walking speed for the individual experiments in the Ideon building. The plot shows minimum, 25th percentile, median (represented by the black squares), 75th percentile and the maximum value at different heights.

The median value (50th percentile) of the walking speed in the Ideon individual experiment ranges between 0.75 m/s (first floor, height of 4 m) to 0.67 m/s (floor 11, height of 44 m). The reduction in speed is equal to 10.7 %. The 25th percentile of the walking speed ranges between approximately 0.6 m/s to 0.7 m/s, while the 75th percentile ranges between 0.7 m/s to 0.9 m/s. When comparing the median values for the first half with the last half of the stairwell, it is possible to see that there was a decrease in walking speed of 5.56% the Ideon experiment.

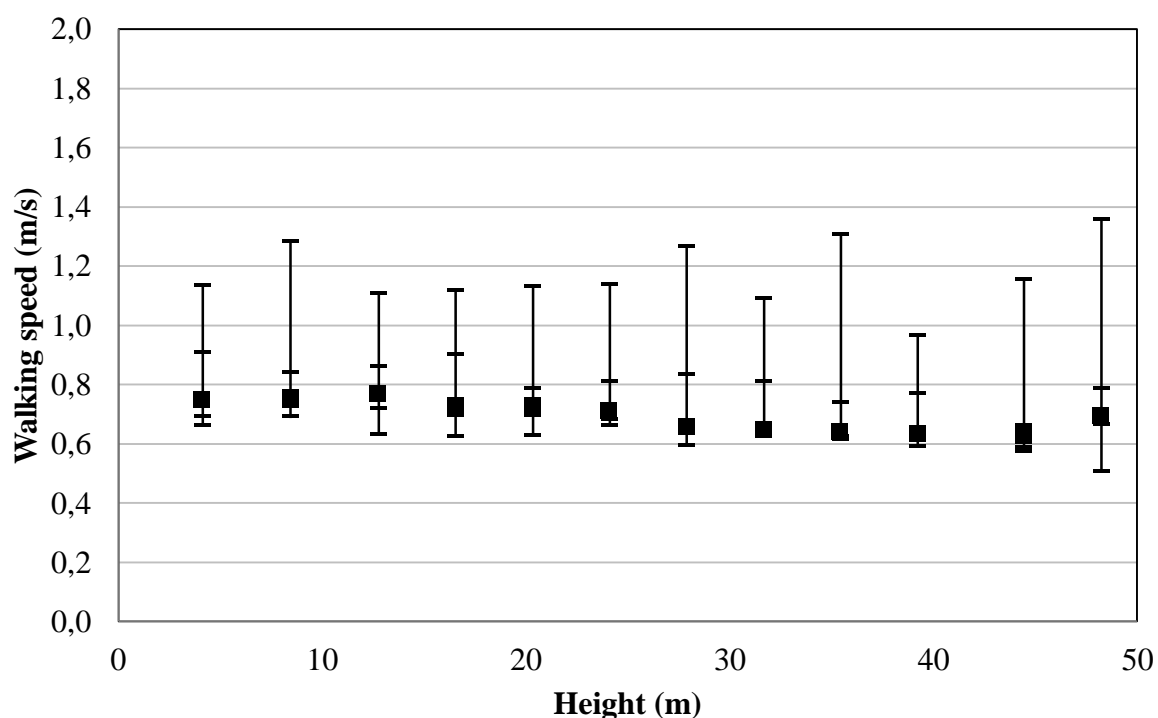

Figure 14. Walking speed for the group experiments in the Ideon building. The plot shows minimum, 25th percentile, median (represented by the black squares), 75th percentile and the maximum value at different heights.

The median value of the walking speed in the group experiment ranges between 0.75 m/s (floor 2 and 3, height of 4-8 m) to 0.62 m/s (floor 11, height of 44 m). When comparing the median walking speed between the first and the second half of the stairwell, the reduction corresponds to approximately 12% (Figure 14). The 25th percentile of the walking speed in the group experiment ranges between just below 0.6 m/s to 0.7 m/s. The 75th percentile starts just above 0.8 m/s but soon decreases to below 0.7 m/s. In general, the variation between the percentiles is quite small and this is probably associated with the presence of the queue.

The probability density function of the walking speeds during the individual experiment is presented in Figure 15. The density functions can be used to evaluate the frequency of a certain walking speed in relation to different heights. The general trend is that the probability distributions are shifted towards higher probability for lower values with increasing height (Figure 15). The same observation can be made in the cumulative density function of the walking speeds in the individual experiments (Figure 16).

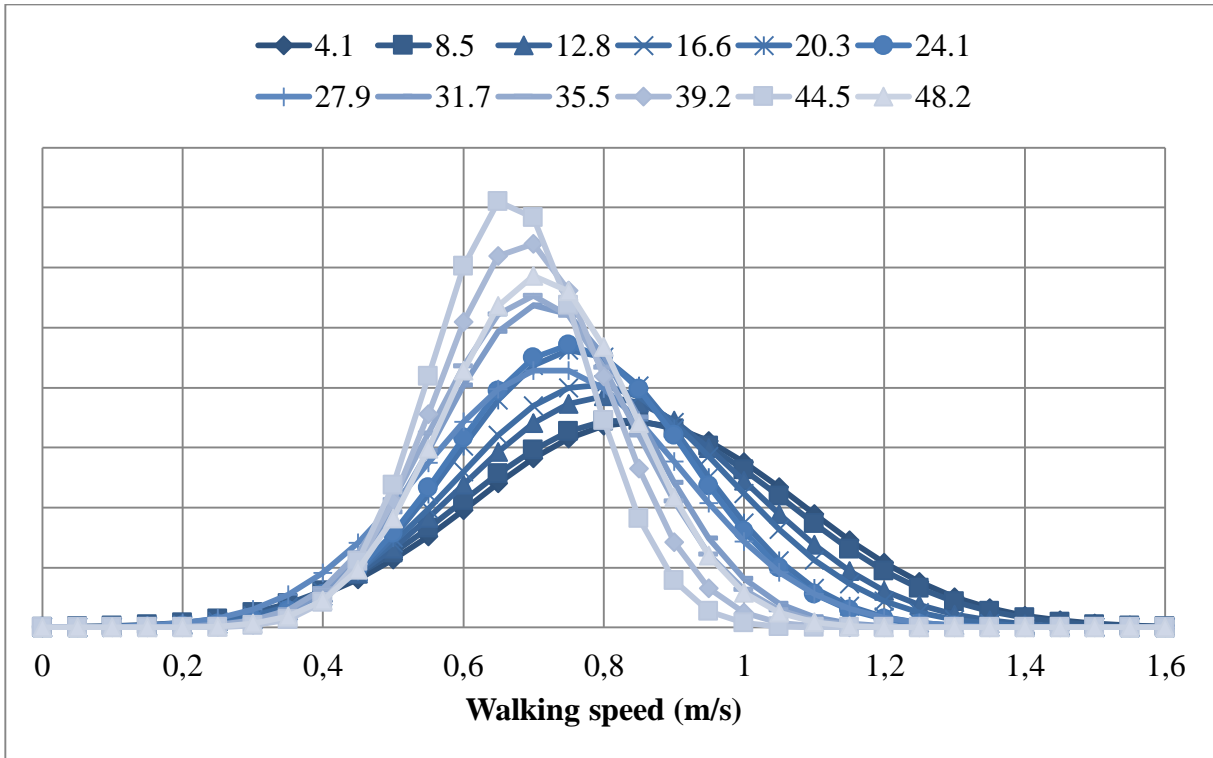

Figure 15. Probability density function of walking speeds at different heights (each number on the top of the figure indicates a height in meters) for the individual experiment in the Ideon experiment.

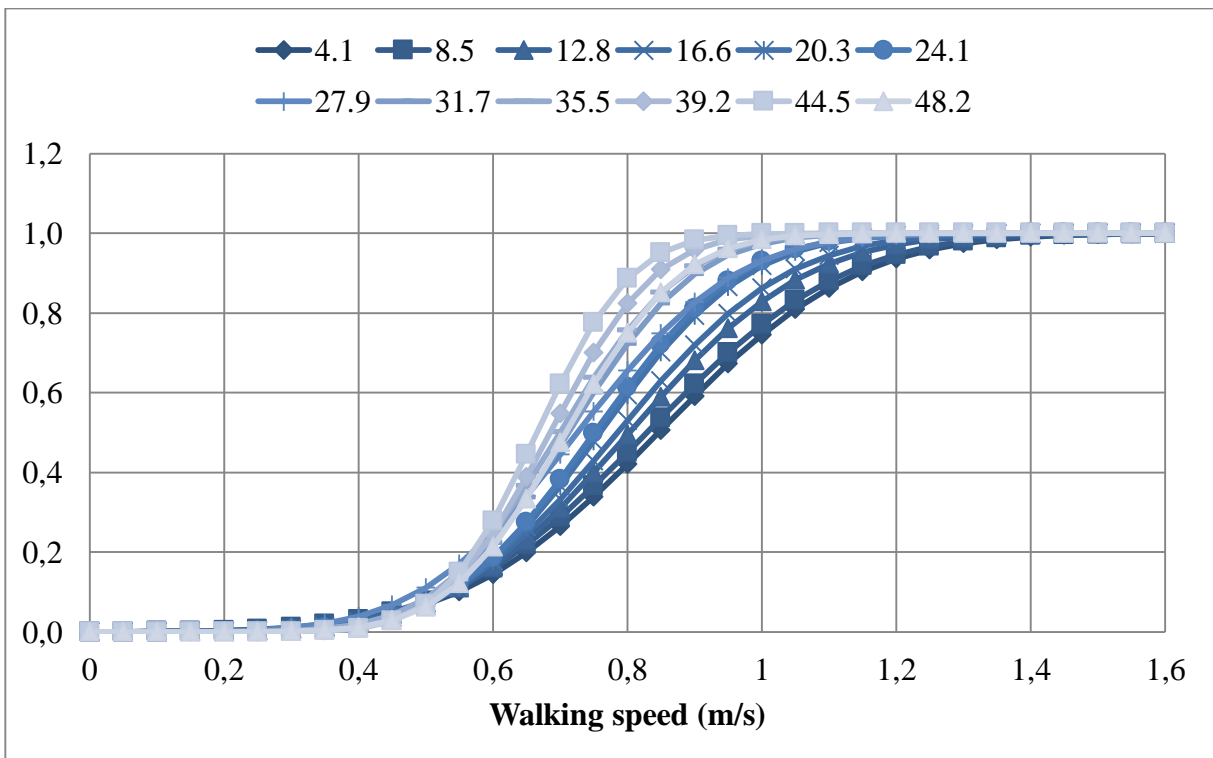

Figure 16. Cumulative density function of walking speeds at different heights (each number on the top of the figure indicates a height in meters) for the individual experiment in the Ideon experiment.

The analysis of the walking speeds of the median, slowest and fastest participant has also been made in order to evaluate the results from an individual perspective. The ascending walking speeds vary substantially between floors, especially over the first half of the ascent, but there is also a wide variation of walking speed between individuals. Figure 17 shows this variation by plotting the fastest, the slowest and the median participant's walking speeds.

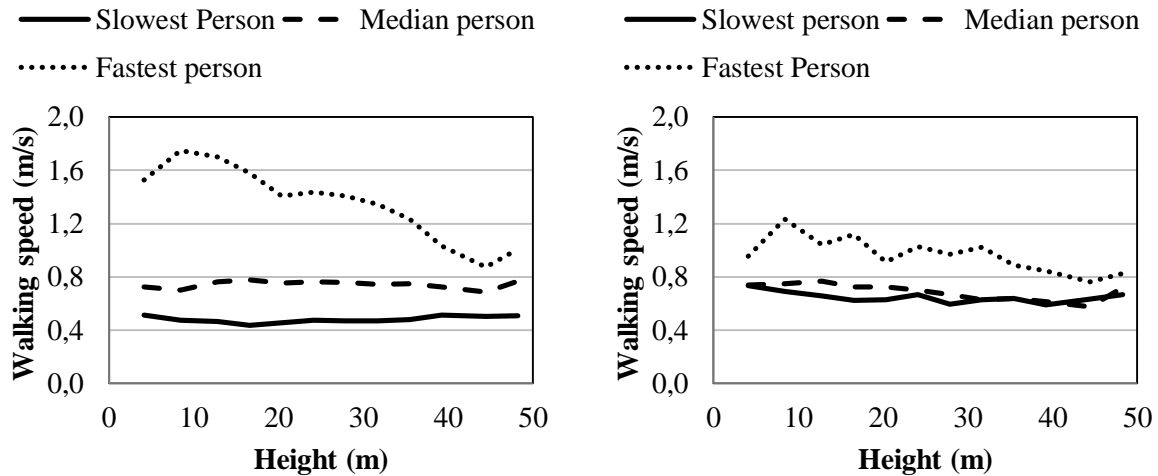

Figure 17(a)-17(b). Walking speed of the slowest, median and fastest test participant for the (a) individual experiment (left) and (b) the group experiment (right).

In the individual experiment at the Ideon building, the fastest participant started with high speed but could not manage that high pace over time and had to reduce the speed dramatically (there is a drop of almost 49% of speed). Both the median and the slowest participant kept a rather constant pace during the ascent. During the Ideon experiment, almost all participants increased their speed on the last floor when they realized that they had almost reached the end of the experiment (Figure 17.a).

As seen during the individual experiments, a similar trend of walking speed reduction also applies to the group experiments, although this trend is less evident (Figure 17.b).

Detailed plots of the walking speeds in relation to gender and age are presented in Appendix A.

VERTICAL SPEEDS

Results of vertical speeds are presented here using the same plots adopted for the description of the walking speeds. The first set of plots shows the median value at each level together with min- and max- value and the 25th and 75th percentile at different heights (Figure 18 for the individual experiment and Figure 19 for the group experiment).

Figure 18 presents the vertical speed for the individual experiments. In the individual Ideon experiment, the most common median value for the vertical speed is 0.28 m/s after a few floors and the maximum vertical speed is 0.36 m/s (at floor one) and lowest median speed is 0.27 m/s (at floor 9, 10 and 12). The 25th percentile of the vertical speed in the individual Ideon experiment ranges between 0.23–0.33 m/s. The 75th percentile of the vertical speed in the individual Ideon experiment ranges between 0.29 m/s and 0.45 m/s during the ascent.

Figure 19 presents the vertical speed values during the group experiment in the Ideon building. The median value of the vertical speed decreases from 0.35 m/s at the beginning of the experiment to 0.28 m/s after a few floors. The maximum median vertical speed corresponds to 0.35 m/s (at floor 1) and the lowest median speed is 0.25 m/s (at floor 9 and 10). The 25th percentile of the

vertical speed in the group experiment ranges between 0.25–0.33 m/s. This value is similar to the corresponding individual experiment. The 75th percentile of the vertical speed is first relatively stable just above 0.34 m/s during the first 25 meters of climb and then reduces to approximately 0.28 m/s. The vertical speed values of the 25th and 75th percentiles are mostly relatively stable within a range of 0.05 m/s (Figure 19).

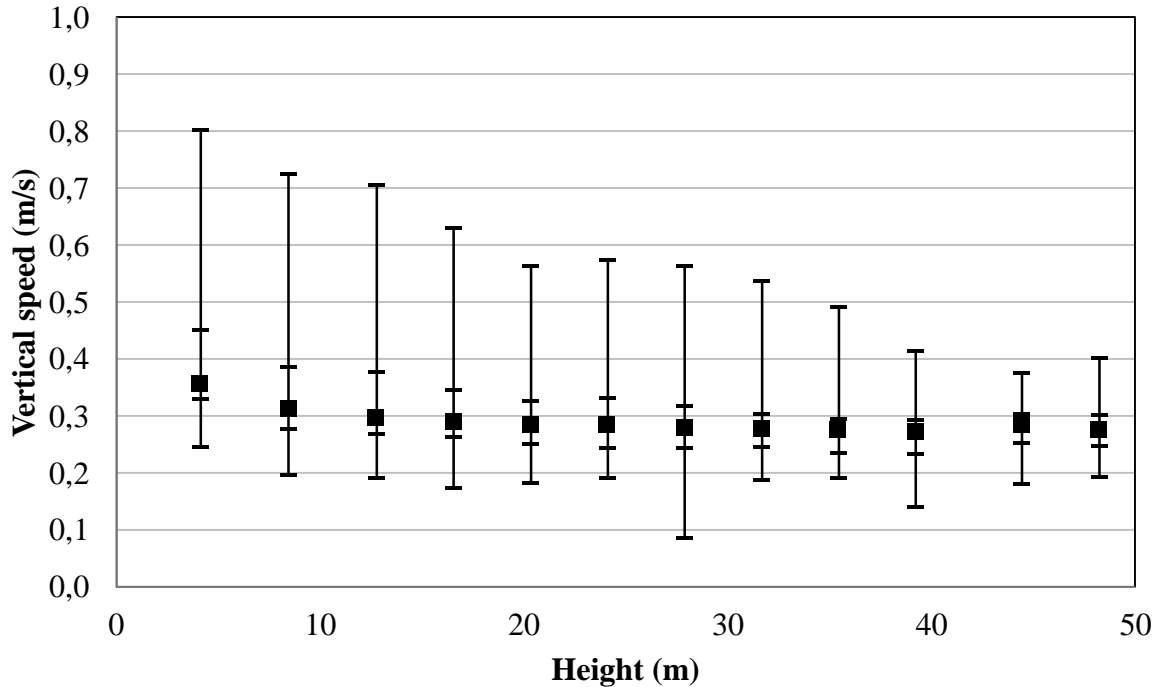

Figure 18. Vertical speed values during the individual experiments in the Ideon building. The plot shows minimum, 25th percentile, median, 75th percentile- and the maximum value at different heights.

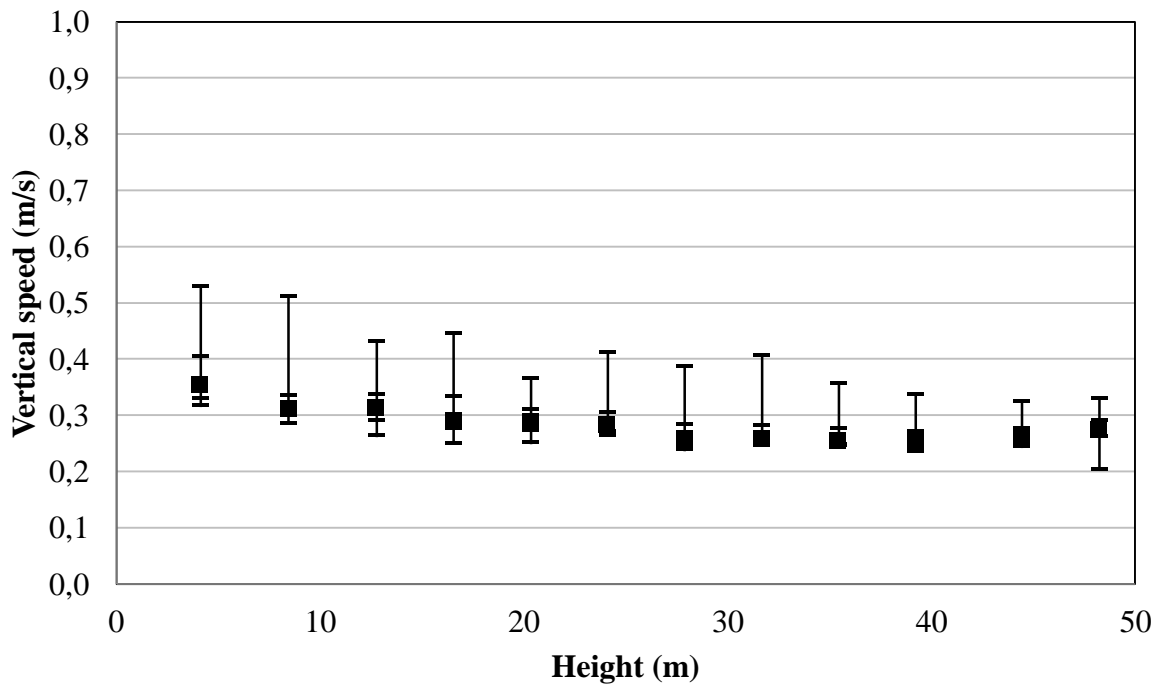

Figure 19. Vertical speed values during the group experiments in the Ideon building. The plot shows minimum, 25th percentile, median, 75th percentile- and the maximum value at different heights.

BACKGROUND VARIABLES VS SPEEDS

In order to evaluate the impact of the sample characteristics with the walking and vertical speeds, a linear regression analysis has been performed for the individual experiment. Independent variables were those collected through the first part of the questionnaire. In addition, the body surface area (BSA) was calculated according to the DuBois formula (DuBois and DuBois, 1916). This variable considers the height and weight of a person together, giving a more comprehensive description of the person's physical characteristics if compared with height or weight only. In this analysis, demographic and descriptive variables such as of body surface area, age, gender, height, weight, level of fitness, tiredness before the experiments, use of public transportation and if rests during the experiment were recorded. The results of those models suggested that no clear influence of those variables can be found on walking speeds. The exact formulation of the linear regression model is not presented here given its low predictive capability. In the Ideon experiment, age and tiredness level were the two variables with the highest predictors of walking speeds, although the adjusted R^2 value remained quite low ($\text{Adj}R^2=0.169$).

PHYSIOLOGICAL DATA

The mean stable heart rate values in the Ideon experiment (both individual and group experiment) are presented in Figure 20. It should be noted that one test participant (subject 48) climbed twice with a half an hour resting break in between as the EMG equipment did not start during the first try, and one test participant was a subject in both individual (subject 47=62) and group (subject 62=47) test. Due to a technical problem, it was not possible to connect the heart rate data of subjects X1-X5 from the group experiment to the correct person.

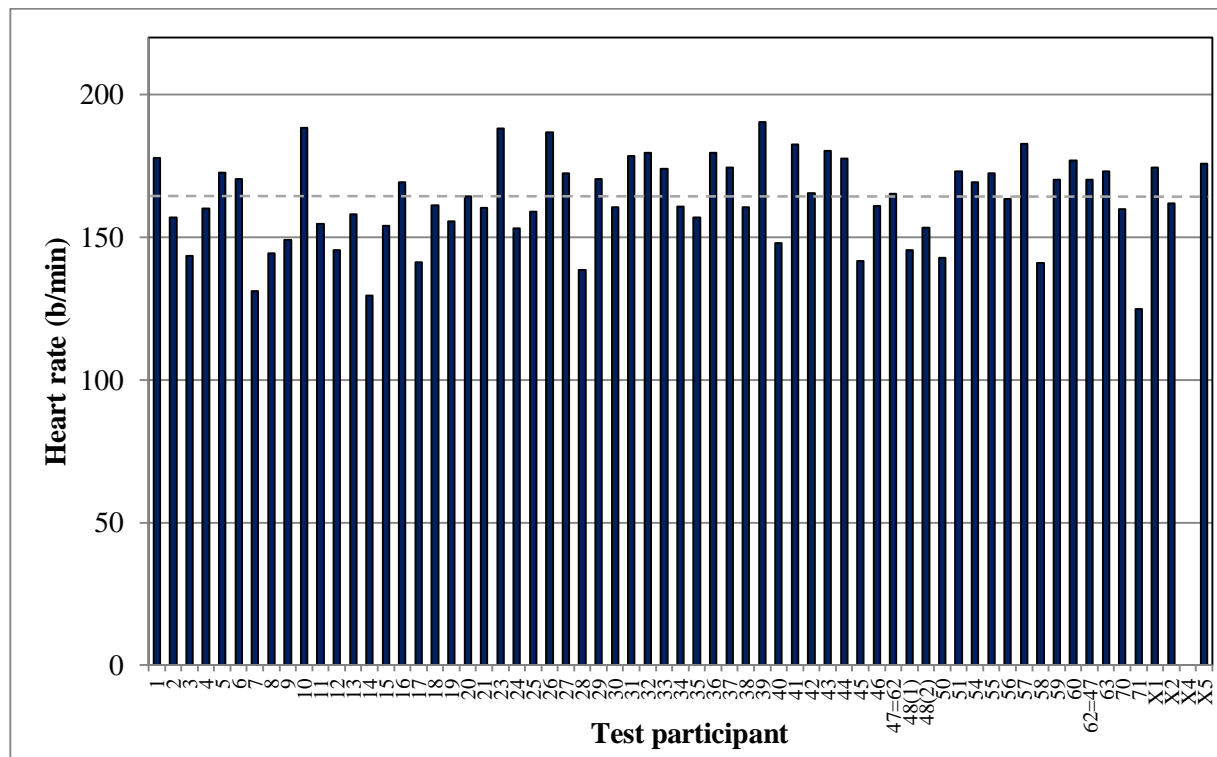

Figure 20. Mean stable heart rate (HR) data from the Ideon experiment. The dashed grey line is the mean HR of this experiment and it corresponds to approximately 170 b/min.

The mean stable state oxygen consumption (VO_2) recordings from the Ideon experiment are presented in Figure 21. As described in the previous sections, not all subjects could have the

measuring equipment, so the results refer to the subjects from the individual tests and one subject (62=47) equipped with an oxygen analyser during the group test.

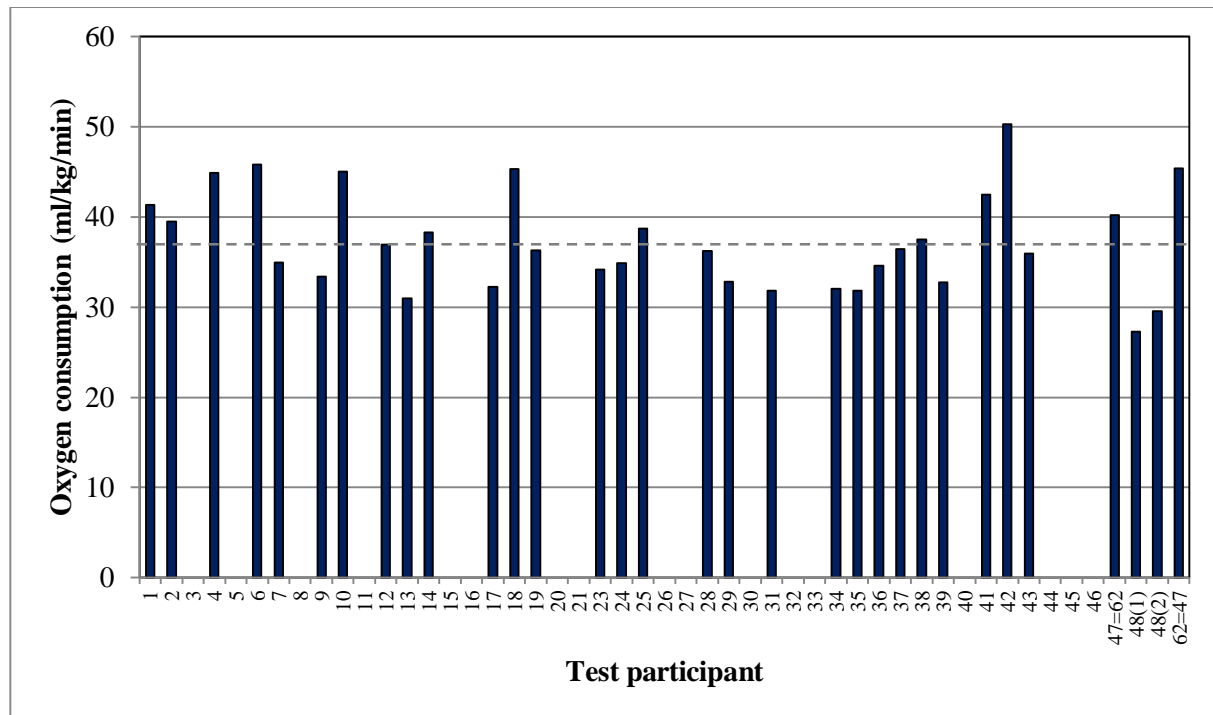

Figure 21. “Stable” VO_2 measurements (see Section 4.3) during the Ideon experiment. The missing bars indicate the participants whose oxygen consumption data have not been collected. The dashed grey indicates the mean stable VO_2 value, which is approximately 38 ml/kg/min.

Muscular median frequency (MDF) results from the selected duration showed that pattern of changes was about the same during ascending the Ideon experiment in the three muscles except the lateral calf (GL) (Figure 22). However, there was no significant difference in the three sub period of start 10s, middle 10s and last 10s duration of MDF of muscle activity. Importantly, there was a significant difference in the calf muscle GM mean ($p=0.02$). The other calf muscle GL median amplitude was in on the verge ($p=0.056$) to be statistically significant.

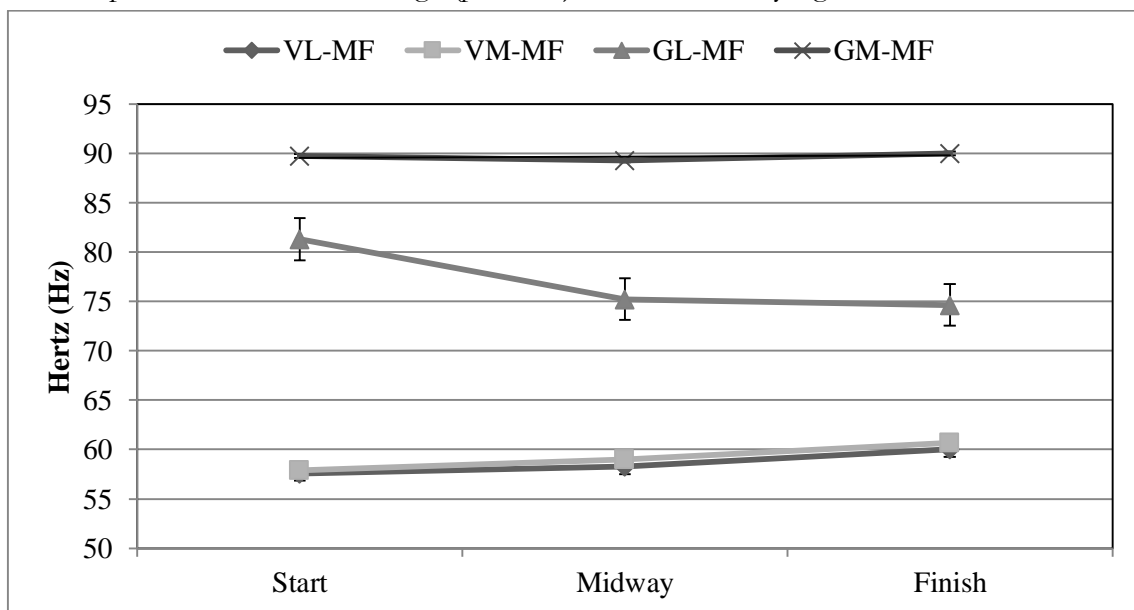

Figure 22. Mean of all subjects' median frequency (MDF) of muscle activity in the Ideon experiment.

Muscle activity mean amplitude root mean square (RMS) figures showed that there was a decrease from starting to the middle period (Figure 23). This gives an indication of the reduction of muscle force production during climbing after few floors in the beginning. This sustained reduced force production supported the speed reduction (Figures 13, 14, 18, 19 and 23). It gives an evidence that there was no statistically significant level of muscle fatigue except the GM muscle. However, subjects compensated their muscular capabilities by reducing force or adopting some postural changes to reach to the top floor to fulfill the task.

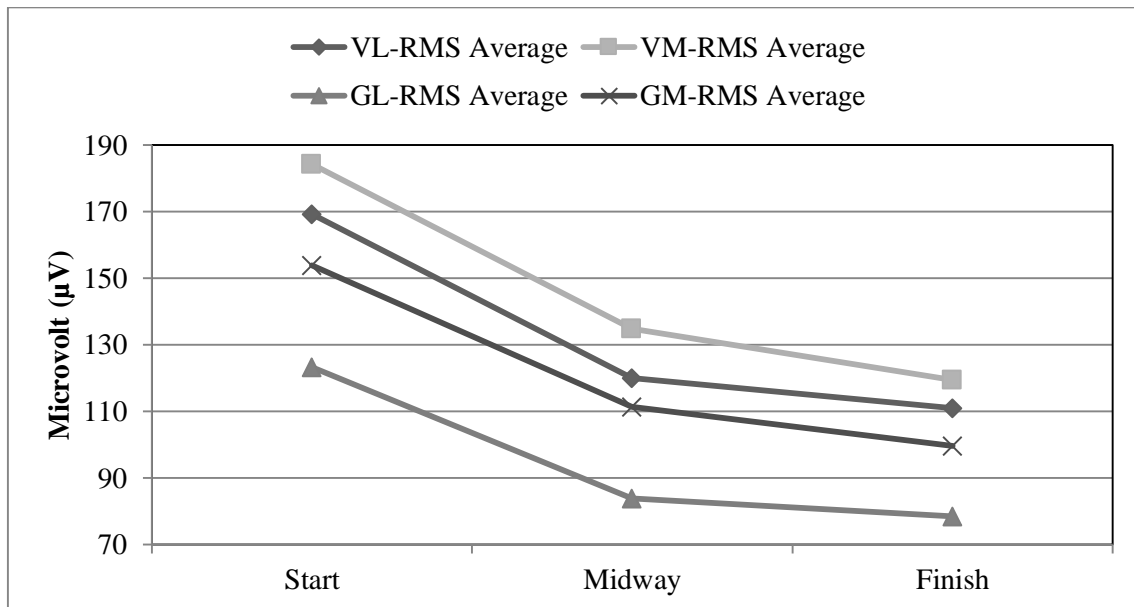

Figure 23. Muscle activity in mean RMS amplitude of all subjects in the Ideon experiment.

5.2. Kista experiment

The second field experiment was performed in the Kista Science Tower building (this building is called simply “Kista” in this report) in September 2014. The experiment was performed in the stairwell of the building.

5.2.1. Experimental layout

The stairwell in Kista Science Tower is a dog-leg stair with 7 treads between each landing except for the last flight which has 9 treads. Each stair connecting two floors consists of three flights, and three landings. The distance between each flight is 0.155 m and the slope of the stair is 32.2 degrees. On the inner side of the stair the handrail is mounted just outside the edge of the step. On the outer side of the stair, the handrail is mounted on the wall 0.075 meters from the edge of the step, reducing the 1.7 m wide step to approximately 1.6 m of width between handrails. Each landing has a depth of 1.60 meter and a width of 3.55 meters. Table 13 and Figure 24 and 25 present the stair characteristics in the Kista experiment and Figure 26 presents a picture of the stairwell.

Table 13. The characteristics of the stairwell in the Kista experiment.

Stairwell	Width	Step height	Step depth	Total height
Kista	1.7 m (1.6 m between handrails)	0.17 m	0.27 m	109 m



Figure 24. The stairwell in the Kista experiment.

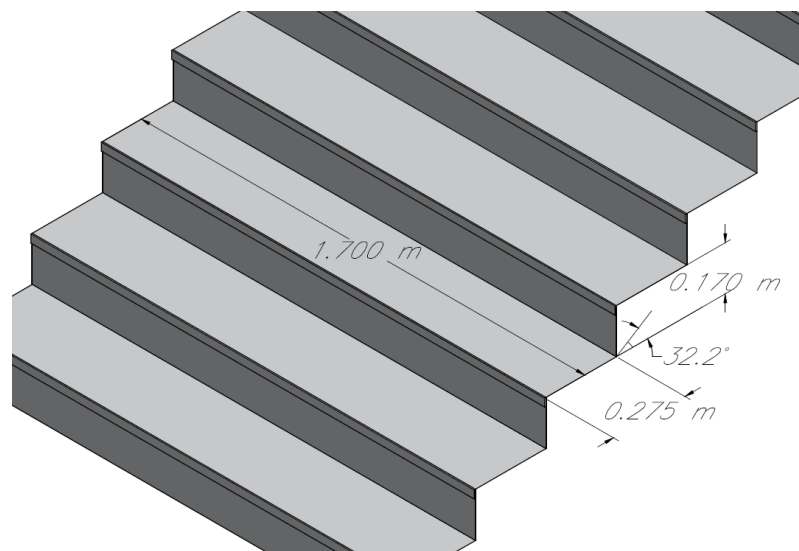

Figure 25. The stairwell (with measures) in the Kista experiment.

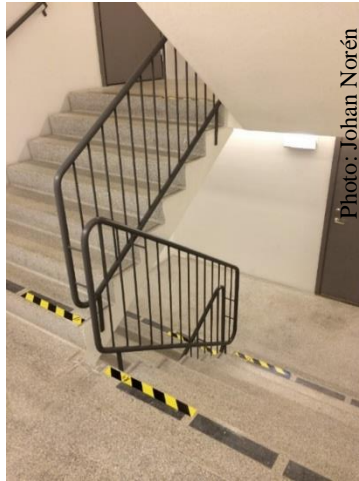

Figure 26. The stairwell in the Kista experiment.

5.2.2. Results

The results of the Kista experiments also include walking speeds, vertical speeds, physiological data and a linear regression analysis.

WALKING SPEEDS

The first set of plots shows the median value at each level together with minimum and maximum value and the 25th and 75th percentiles at different heights (Figure 27 for the individual experiment and Figure 28 for the group experiment). The probability density function and the cumulative density function of walking speeds in the individual experiments are also presented in Figures 29 and 30 respectively. The walking speeds of the median, the slowest and the fastest test participants are presented in Figure 31.

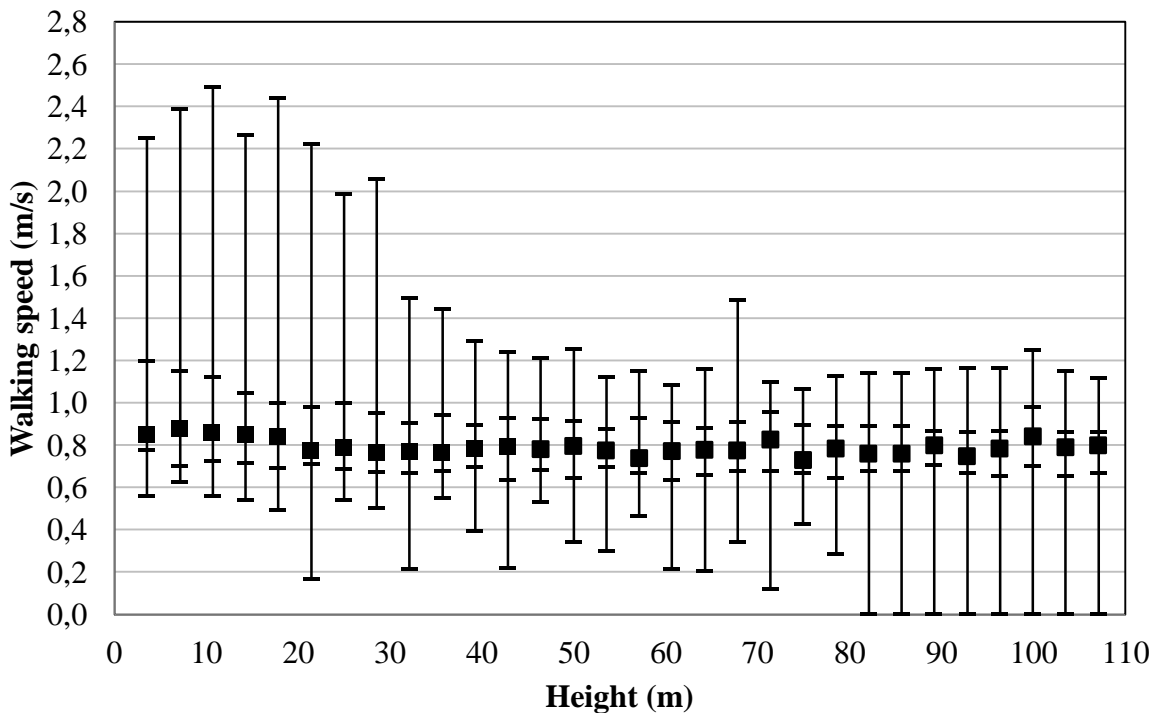

Figure 27. Walking speed for the individual experiments in the Kista building. The plot shows minimum, 25th percentile, median (represented by the black squares), 75th percentile and the maximum value at different heights.

In the individual Kista experiment the median walking speed varies from 0.87 m/s (second floor, height of 7 m) to 0.73 m/s (floor 21, height of 75 m), i.e., corresponding to a reduction in speed equal to 16.1%. The 25th percentile of the walking speed in the Kista experiment ranges between 0.61 m/s and 0.78 m/s. In the Kista experiment the 75th percentile is approximately 0.90 m/s and never exceeds 1.0 m/s above 15 meters height. In the Kista experiment the range changes from being dominant above the median value to be dominant below the median value. In the Kista experiment the minimum speed decreases dramatically after 21 meters (floor 6) due to the slowest subject starting to rest. Higher up in the stairwell, several other subjects also had to rest and after 82 meters (floor 23) the slowest subject had to stop and could not finish the experiment. When comparing the median values for the first half with the last half of each stairwell, in the Kista experiment the decrease in speed corresponds to 3.1%.

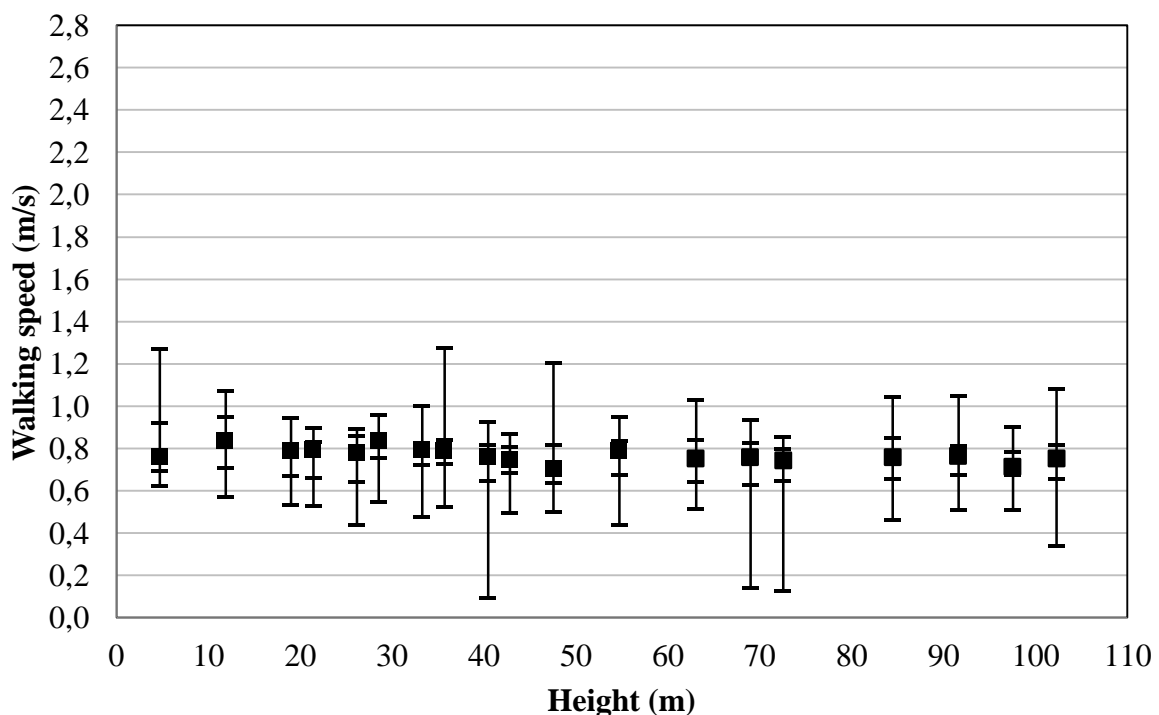

Figure 28. Walking speed for the group experiments in the Kista building. The plot shows minimum, 25th percentile, median (represented by the black squares), 75th percentile and the maximum value at different heights.

In the group experiment in Kista, the median walking speed ranges between 0.83 m/s (floor 3, height of 12 m) and 0.70 m/s (floor 13, height of 47 m). When comparing the median walking speed between the first and second half of the stair, the reduction is 3.4%. The 25th percentile of the walking speed in the Kista experiments ranges between 0.61 m/s and 0.68 m/s. The 75th percentile is approximately 0.9 m/s at the beginning but it soon decreases to around 0.8 m/s.

The probability density function of the walking speeds during individual experiment is presented in Figure 29. As in the experiment carried out in the Ideon building, the same general trend can be observed: the probability distributions are shifted towards higher probability for lower values with increasing height. The same observations can be made in the cumulative density function of the walking speeds in the individual experiment (Figure 30).

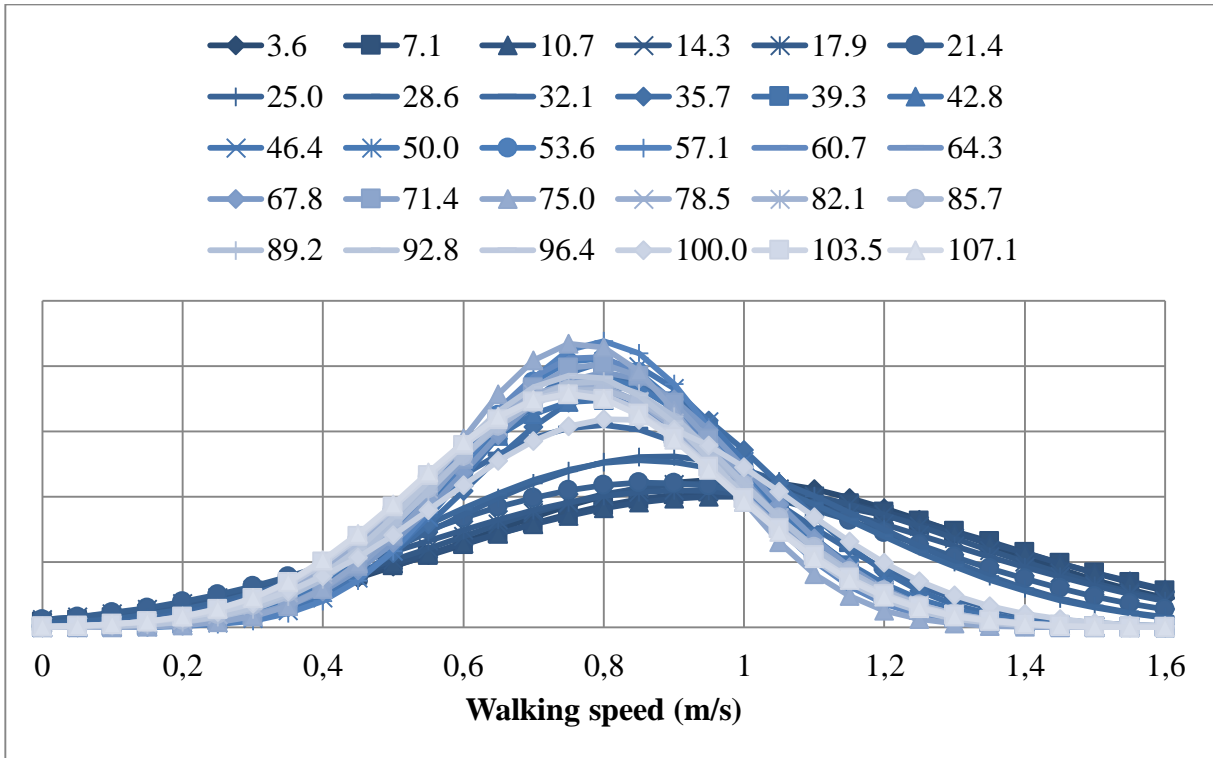

Figure 29. Probability density function of walking speeds at different heights (each number on the top of the figure indicates a height) for the individual experiment in the Kista building.

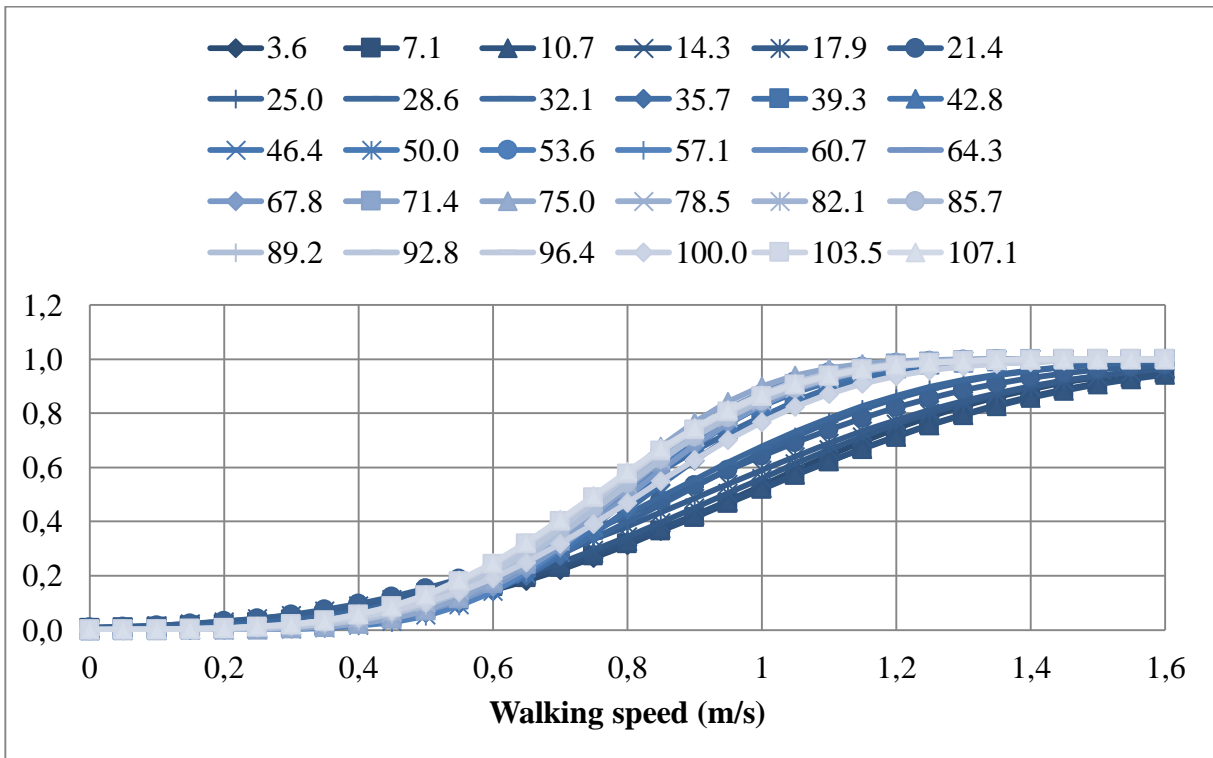

Figure 30. Cumulative density function of walking speeds at different heights (each number on the top of the figure indicates a height) for the individual experiment in the Kista building.

Also in this case, the analysis of the walking speeds of the median, slowest and fastest participant has been made in order to evaluate the results from an individual perspective. The ascending walking speeds can vary substantially between floors in the Kista experiment, especially over the

first half of the ascent, but there is also a wide variation of walking speed between individuals. Figure 31 shows this variation by plotting the fastest, the slowest and the median participant's walking speeds.

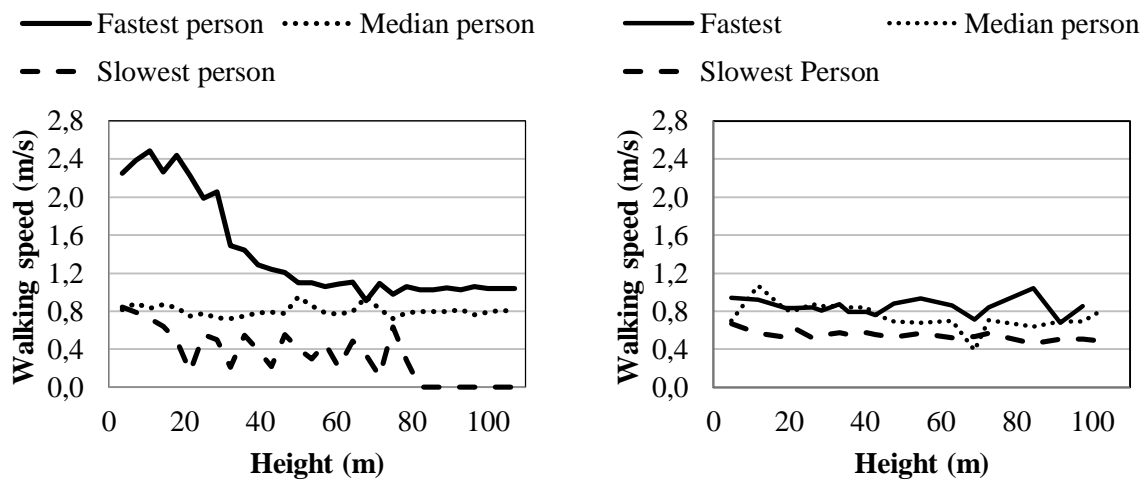

Figure 31(a)-31(b). Walking speed of the slowest, median and fastest test participant for the (a) individual experiment (left) and (b) the group experiment (right).

During the Kista experiment, the fastest participant started with a very high speed but the participant did not manage to keep up the speed and after approximately nine floors (height equal to 30 m) the participant reduced the speed dramatically. The test participant had to reduce the walking speed of over 63% to be able to reach the top of the stairwell. The median person kept a sustainable speed through the experiment. The slowest participant started with a moderate speed but then got tired after 6 floors (height equal to 21 m) and had to rest. The participant rested several times between floor 6 and 21, and eventually on every third or second floor before aborting the experiment at floor 21 (height equal to 75 m). The participant was exhausted and reported pain in the knees.

Also in this case, it is evident that the initial speed affects the total speed reduction. A participant climbing the stairs with a high speed might be forced to reduce the speed substantially to a pace he/she can maintain for the rest of the ascent. This reduction in speed is over 60%. In the Kista experiment, the walking speed tend to become stable at floor 20 (height of 71 m) and then it is relatively constant during the last ten floors. This trend can also be seen in Figure 28 where the variation in walking speed between 25th and 75th percentile is limited between the heights of 70-100 m.

Here a similar trend to the individual experiment of walking speed reduction can be observed in the group experiments (Figure 31.b). In the Kista experiment, the individual ascent movement is sometimes impeded by other participants. This affects the walking speed, although the stair width offers enough space for overtaking slower participants. The median participant starts with a high speed but is getting tired and needs to reduce the speed at a height of 15 m. At 65 meters the participant needs to rest before continuing the climbing. The slowest participant finds a sustainable speed and manages to keep almost that speed all the way to the top of the stairwell.

Detailed plots of the walking speeds in relation to gender and age are presented in Appendix A.

VERTICAL SPEEDS

Results of vertical speeds are presented here using the same plots adopted for the description of

the walking speeds. The first set of plots shows the median value at each level together with minimum and maximum value and the 25th and 75th percentile at different heights (Figure 32 for the individual experiment and Figure 33 for the group experiment).

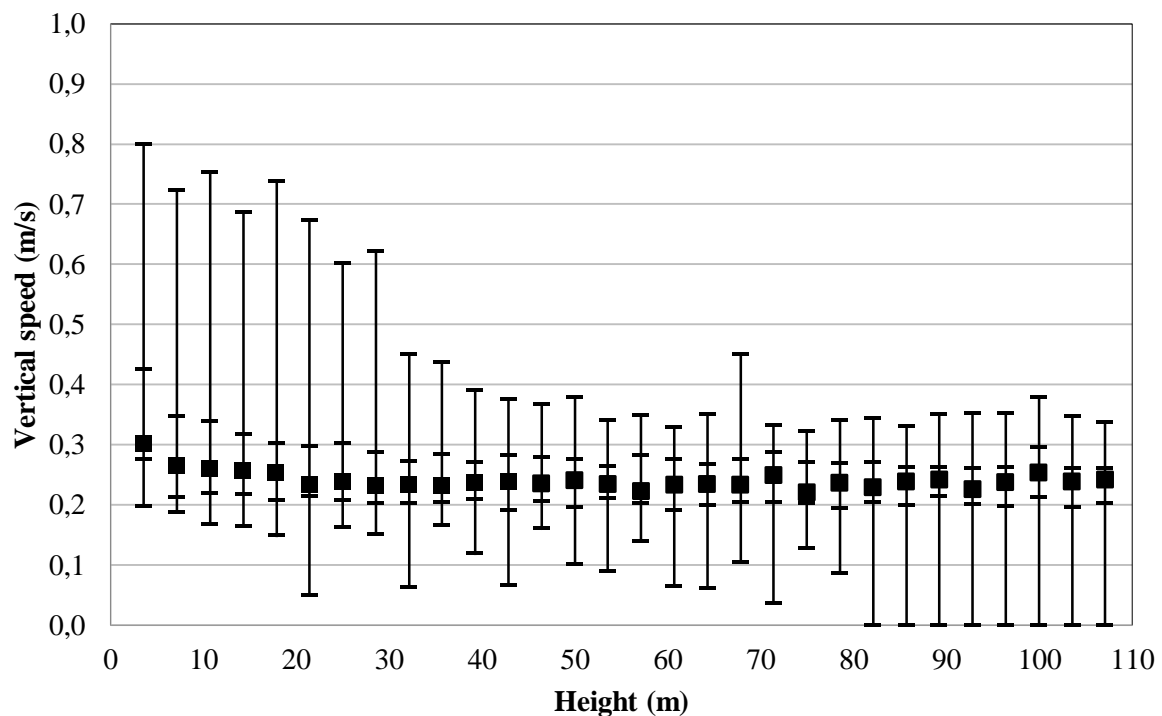

Figure 32. Vertical speed values during the individual experiments in the Kista building. The plot shows minimum, 25th percentile, median (represented by the black squares), 75th percentile and the maximum value at different heights.

Figure 32 presents the vertical speed for the individual experiments. In the Kista experiment, the median vertical speed is typically 0.24 m/s and the maximum vertical speed is 0.30 m/s (at floor 1) and the lowest speed is 0.22 m/s (at floor 16). The 25th percentile of the vertical speed is approximately 0.19 – 0.20 m/s. The 75th percentile of the vertical speed ranges approximately between 0.30 m/s and 0.26 m/s. The range between 25% and 75% decreased during the ascent. The range between the slowest and the fastest was predominantly above the median value in the beginning and below the median value in the end.

Figure 33 presents the vertical speed values during the group experiment. In the Kista experiment, the median vertical speed is typically within the range of 0.22 - 0.24 m/s and the lowest vertical speed is 0.18 m/s (at floor 14, at a height of 50 m). The 25th percentile of the vertical speed is approximately 0.20 m/s. This value is similar to the individual experiments. The 75th percentile decreases from the start to about 0.25 m/s (not vary stable) but stabilizes after approximately 50 meters of climb at that value. The range between 25% and 75% is relatively stable at 0.05 m/s. The range between the slowest and the fastest was predominantly above the median value at the beginning and below the median value in the end.

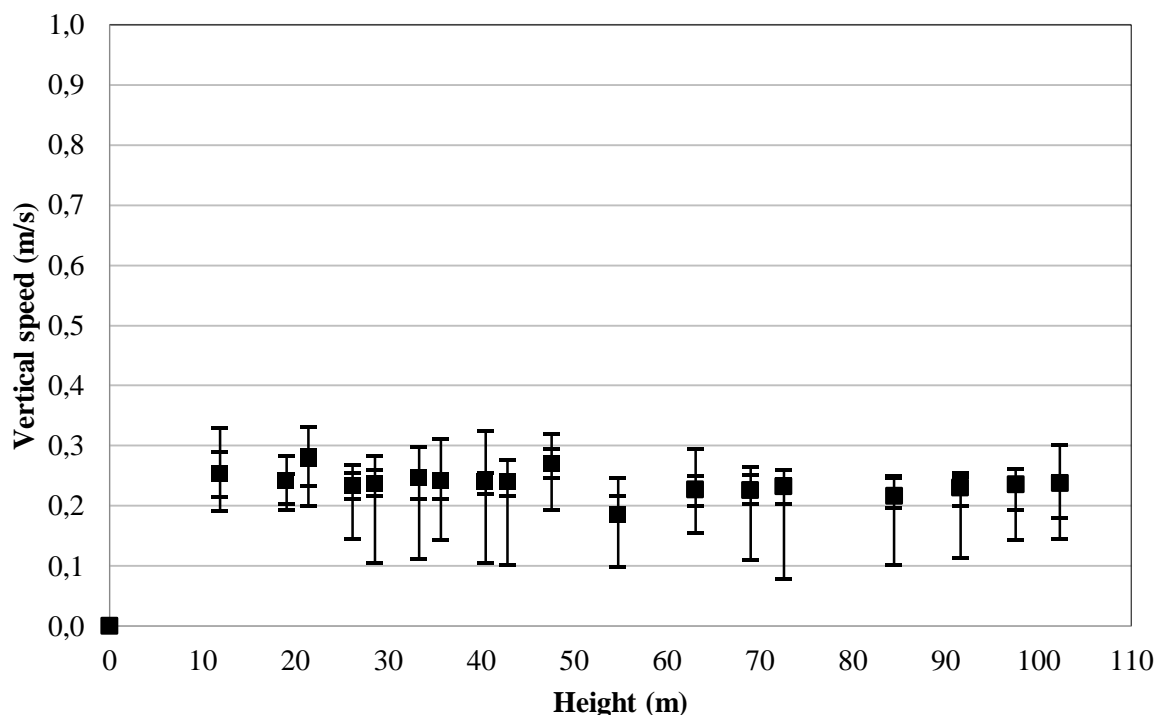

Figure 33. Vertical speed values during the group experiments in the Kista building. Due to a measurement error, the first value has not been included. The plot shows minimum, 25th percentile, median (represented by the black squares), 75th percentile and the maximum value at different heights.

BACKGROUND VARIABLES VS SPEEDS

In order to evaluate the impact of the sample characteristics with the speeds, a linear regression analysis has been performed for the individual experiment. In this analysis, the same demographic and descriptive variables of the Ideon experiment were tested. The results of those models suggested that no clear influence of those variables can be found on walking speeds. The exact formulation of the linear regression model is not presented here given its low predictive capability. In Kista experiment, age and resting (people taking a rest during the experiment) had the highest significant level (age 0.10 and resting 0.028) and the corresponding adjusted R^2 value was the highest ($AdjR^2= 0.307$).

PHYSIOLOGICAL DATA

The mean stable heart rate values in the Kista experiment (both individual and group experiment) are presented in Figure 34. The mean stable state oxygen consumption (VO_2) recordings from the Kista experiment are presented in Figure 35. As described in the previous sections, not all subjects could have the measuring equipment, so the results refer to the subjects from the individual tests and only one subject was equipped with an oxygen analyser during the group test. It should be noted that one test participant repeated the experiment twice (1 (1) and 1 (2) in Figure 35) since there was a technical problem with the EMG equipment.

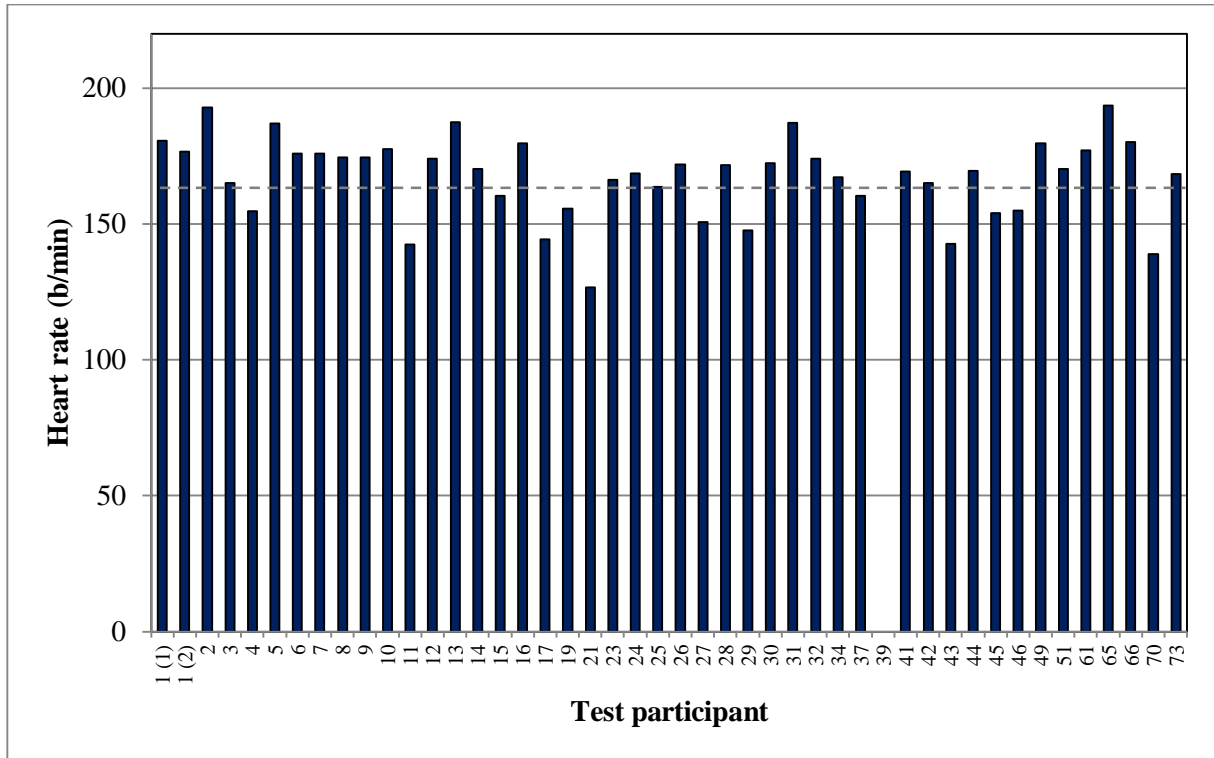

Figure 34. Heart rate (HR) data from the Kista experiment. The dashed grey line is the mean HR value (approximately 165 b/min).

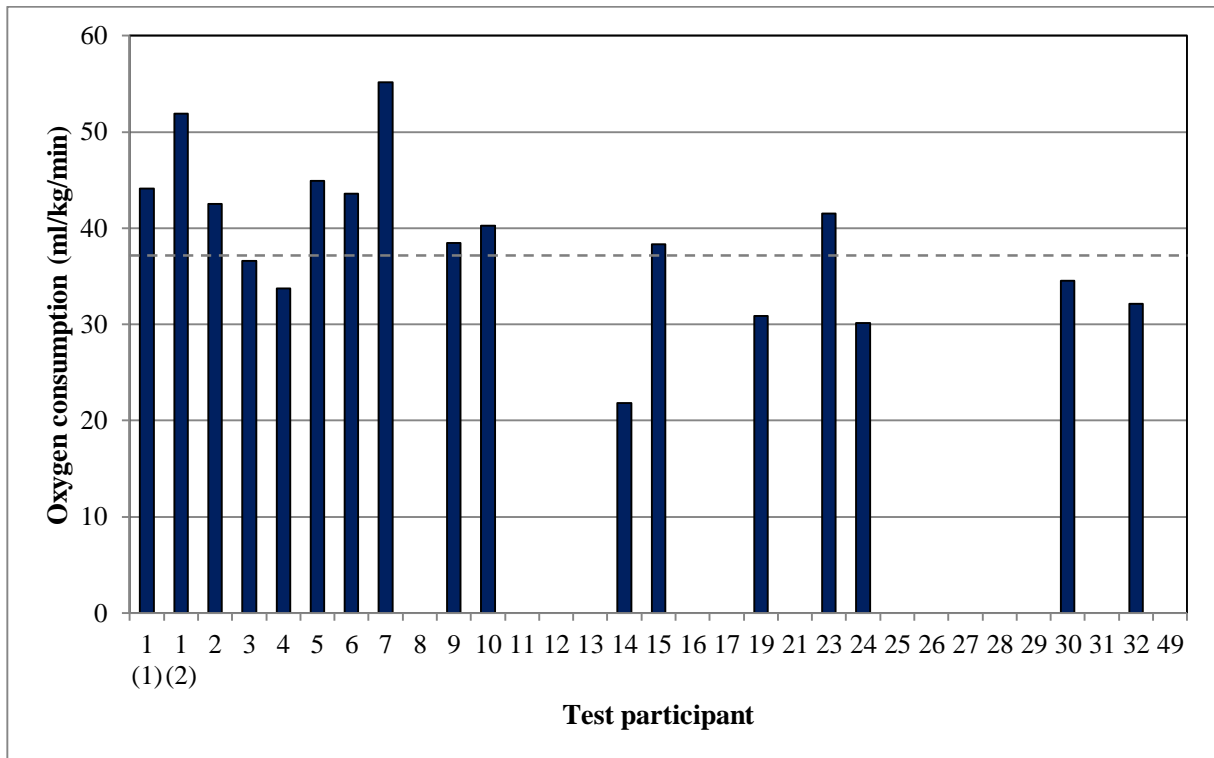

Figure 35. VO₂ measurements during the Kista experiment. The missing bars indicate the participants with no VO₂ measurements. The dashed grey line indicates the mean stable value (approximately 38 ml/kg/min).

The mean climbing time for the 9 subjects equipped with EMG measurement device was approximately 396 s to reach the top floor. Subjects had a relatively high speed (1.12 m/s) in the

first few floors and then a gradual reduction of speed up to middle levels of the tower, where about 0.87 m/s was maintained without further reduction all the way up to reach the top floor. This seems to suggest that at about 0.85 m/s (approximately 0.26 m/s of vertical speed) climbing walking speed on stairs, human can continue for a reasonably long period of time (7-10 min) with tolerable amount of physical exertion that does not force them to stop climbing.

Muscle activity was similar in frequency during the entire stair climbing in the Kista experiment. MDF analysis showed no significant changes during start, midway and 10 s end time periods except for the GL muscle which decreased a little in midway which was not statistically significant (Figure 36). However, there was a sharp decline of all the muscles' EMG mean RMS amplitudes after reaching midway and then the mean RMS amplitudes remain in the same value range towards the end (Figure 37).

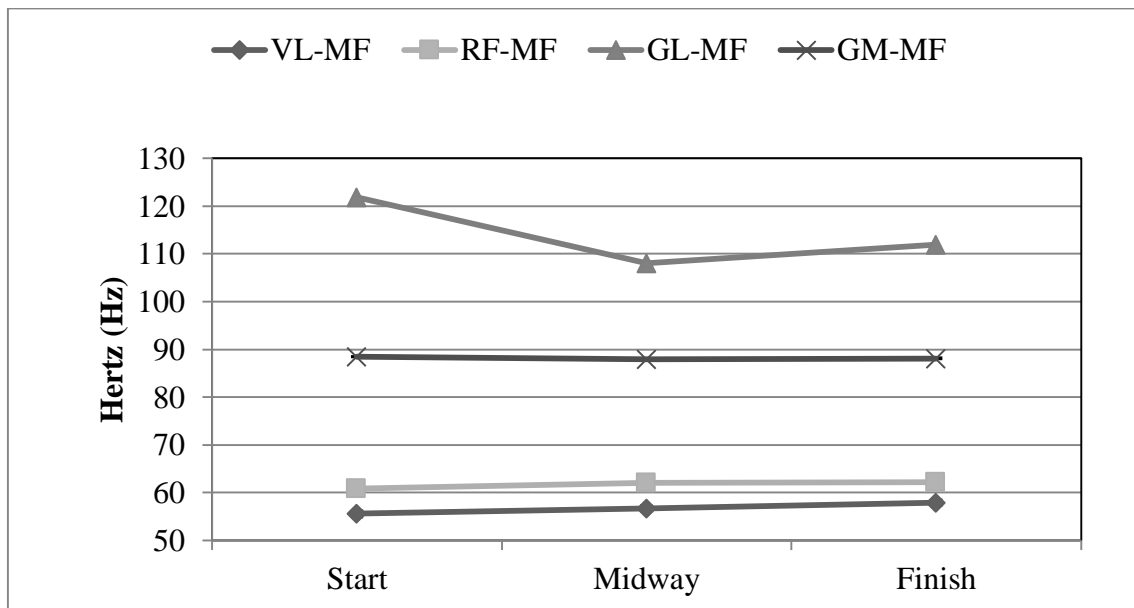

Figure 36. Mean of all subjects' median frequency (MDF) of muscle activity in the Kista experiment.

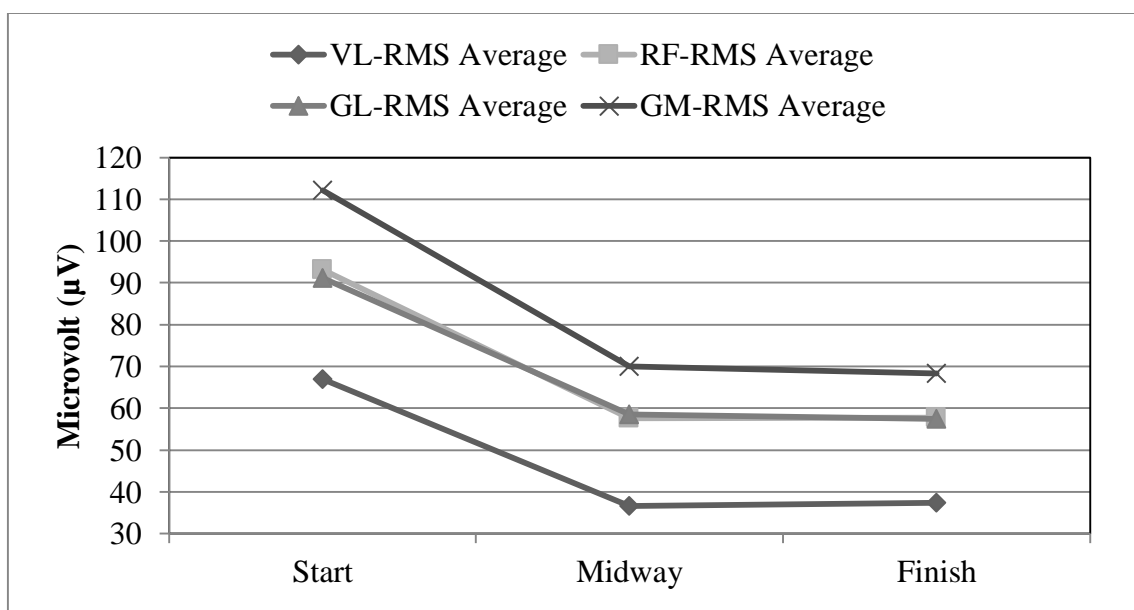

Figure 37. Muscle activity in mean RMS amplitude of all subjects in the Kista experiment.

Interestingly, only GM (calf) muscles mean electrical RMS amplitudes were significantly ($P=0.049$) reduced and median amplitudes were in border line ($P=0.057$) in this long ascending way. Similarly, this EMG RMS amplitude reduction curves figure (Figure 37) seems to agree with the speed reduction curve.

5.3. Västra Skogen experiment

The third field experiment was performed in an escalator at the Västra Skogen metro station (this escalator is called simply “Västra Skogen” in this report), located in Stockholm, in October 2014. The experiment was performed in the tallest escalator in Sweden. The experiment consisted of two parts. In the first part, test participants walked up the escalator individually. In the second part a group of test participants walked up the escalator together.

5.3.1. Experimental layout

The escalator runs in a single flight without breaks or landings, which allows observing the climbing process uninterruptedly. The escalator was 61 m long in the horizontal direction and 32.5 m high (Figure 38). The total width between handrails was 1.2 m, while each step was 1 m wide and 0.345 m deep, and had a 55 mm deep nosing in addition (Figure 39). The slope of the escalator was 29.7 degrees. There were 162 steps in full height (197 mm) and a total of 12 steps with variable height (5 located at the lower end of the escalator, and 7 located at the top) (Figure 40). These steps of variable height were not considered for the calculations to be presented in the results section. In this report, “steps” are the full height steps unless stated otherwise.

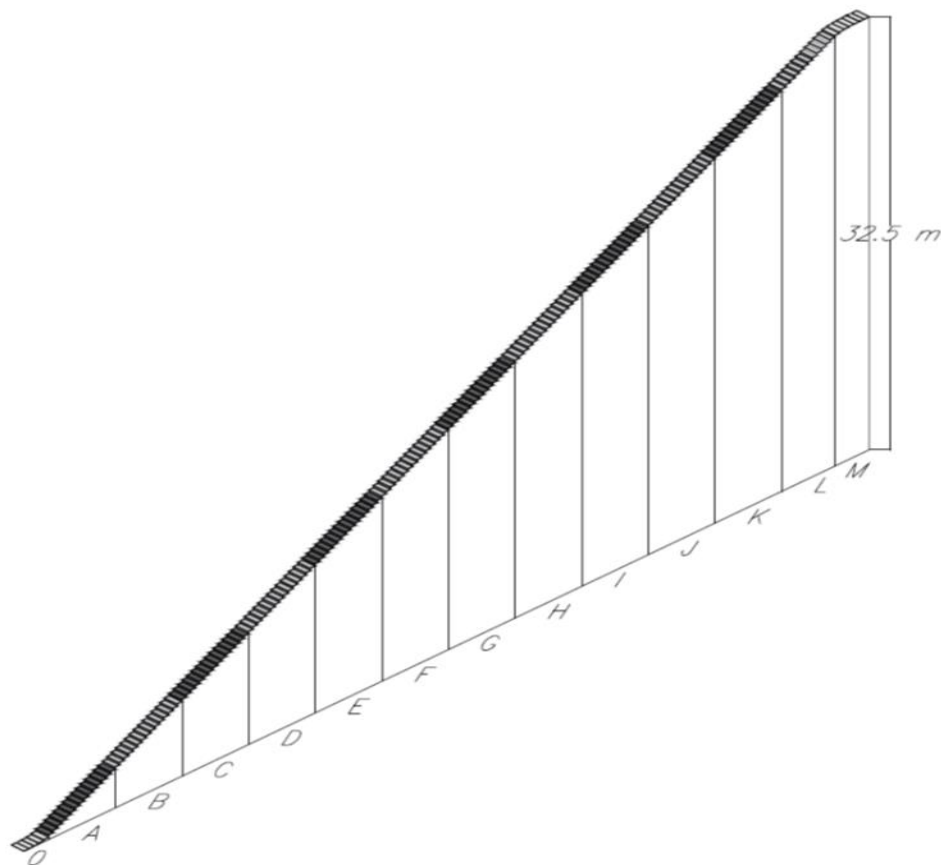

Figure 38. Escalator geometry. The total height reaches 32.5 m while the total horizontal projection covers 61.0 m. The 15-step segments (see explanation below) indicated in white and grey.

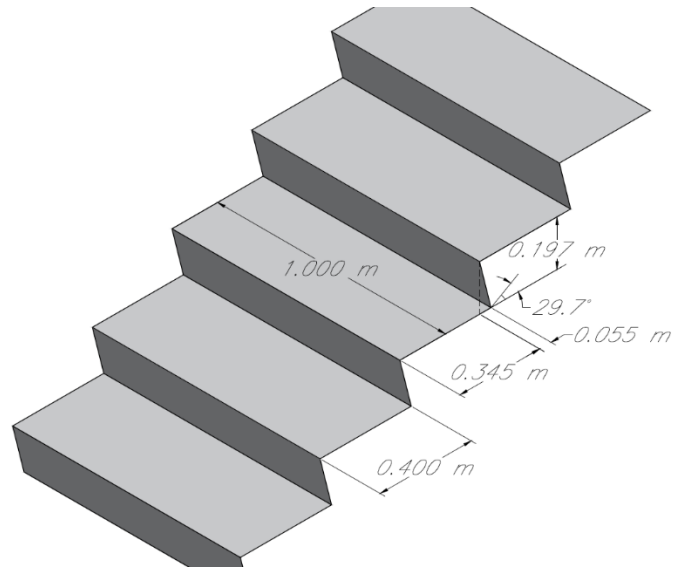

Figure 39. The escalator (with measures) in the Västra Skogen experiment.

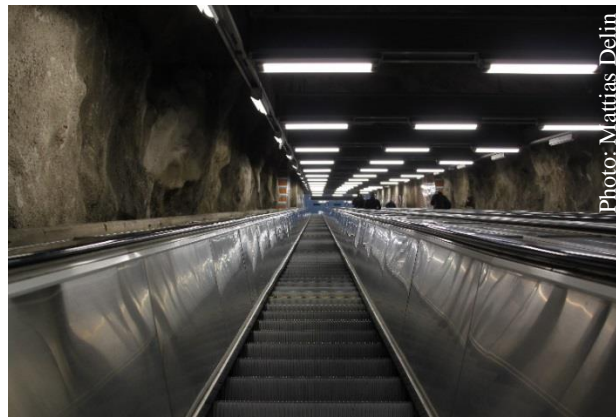

Figure 40. A picture of the escalator in the Västra Skogen experiment.

For experimental purposes the escalator was divided into 11 segments. As shown in Figure 41, the first 10 segments starting from the lower end of the escalator had 15 steps, while the last segment had 12 steps. The beginning of each segment was indicated with a tape along the width of the step. Segments were named after letters of the alphabet, from A to L. The tape indicating the segments did not modify the geometry of the escalator nor did it constitute an obstacle for the participants.



Figure 41. A picture of the segment marker (tape) in the escalator during the Västra Skogen experiment.

5.3.2. Results

Results include walking speeds, physiological data and a linear regression analysis performed to evaluate the impact of the sample characteristics on evacuation performance.

WALKING SPEEDS

The walking speeds are presented in different plots. The first set of plots shows the median value at each level together with minimum and maximum value and the 25th and 75th percentile at different heights (Figure 42 for the individual experiment and Figure 43 for the group experiment). The probability density function and the cumulative density function of walking speeds in the individual experiments are also presented (Figures 44 and 45 respectively). The walking speeds of the median, the slowest and the fastest test participants are presented in Figure 46.

The median value (50th percentile) of the walking speed in the Västra Skogen individual experiment ranges between 0.79 m/s (height of 3 m) and 0.66 m/s (height of 30 m), i.e., the reduction in speed is equal to 16.5%. The 25th percentile of the walking speed ranges between 0.74 m/s and 0.54 m/s, while the 75th percentile ranges between 1.08 m/s and 0.76 m/s, being most of them below 0.92 m/s. When comparing the median values for the first half with the last half of the escalator, the average decrease in walking speed in the Västra Skogen experiment is about 10%.

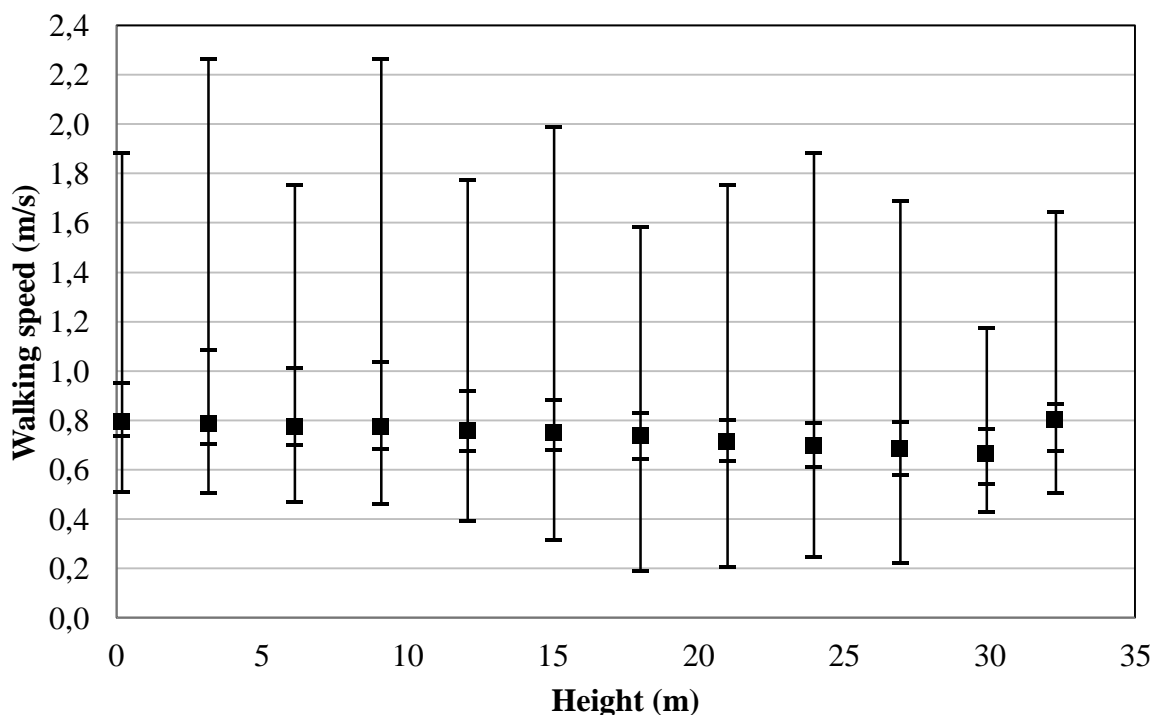

Figure 42. Walking speed for the individual experiments in the Västra Skogen experiment. The plot shows minimum, 25th percentile, median, 75th percentile- and the maximum value at different heights.

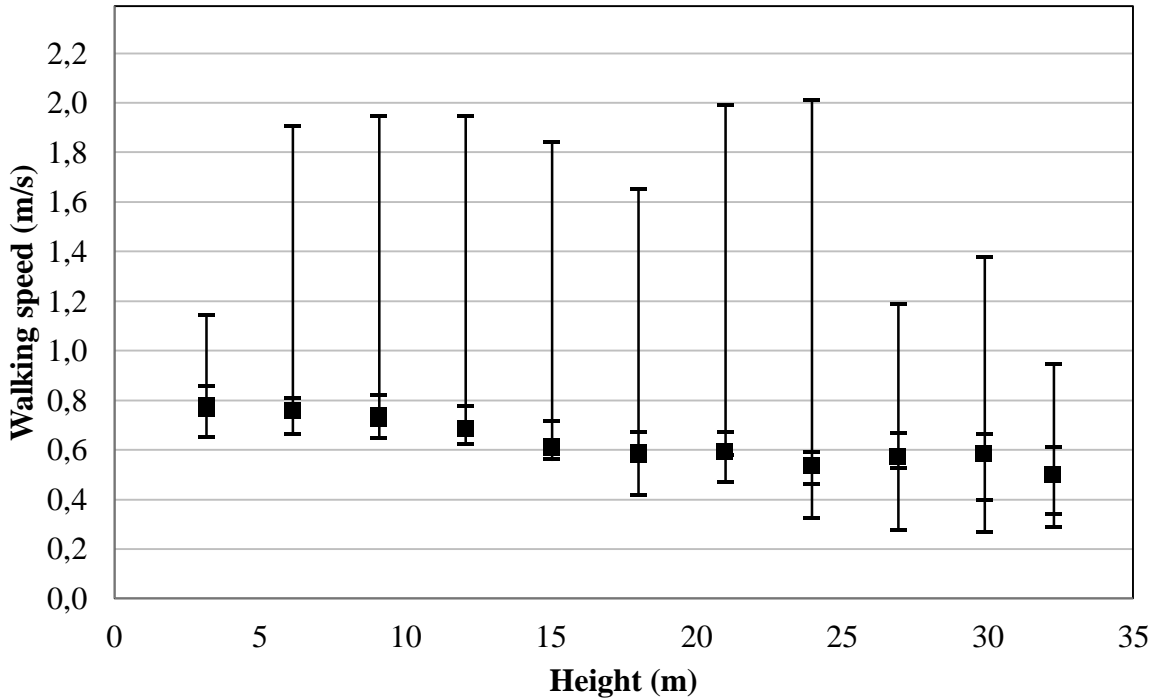

Figure 43. Walking speed for the group experiments in the Västra Skogen station. The plot shows minimum, 25th percentile, median, 75th percentile and the maximum value at different heights.

The median value of the walking speed in the group experiment ranges between 0.80 m/s (height of 3 m) to 0.52 m/s (height of 32 m). When comparing the median walking speed between the first and the second half of the escalator, the reduction corresponds to approximately 15% (Figure 42). The 25th percentile of the walking speed in the group experiment ranges between 0.76 m/s and 0.36 m/s. The 75th percentile starts at 0.88 m/s and decreases until 0.63 m/s (Figure 42). The variation between the percentiles is significant among the 75th percentile. It should be noted that a queue is formed in the escalator and this can significantly affect the results.

The probability density function of the walking speeds during the individual experiment is presented. Similarly to the two previous experiments, the plot shows a general trend in which the probability distributions are shifted towards higher probability for lower values with increasing height (Figure 44). This can also be observed in the cumulative density function of the walking speeds in the individual experiment (Figure 45).

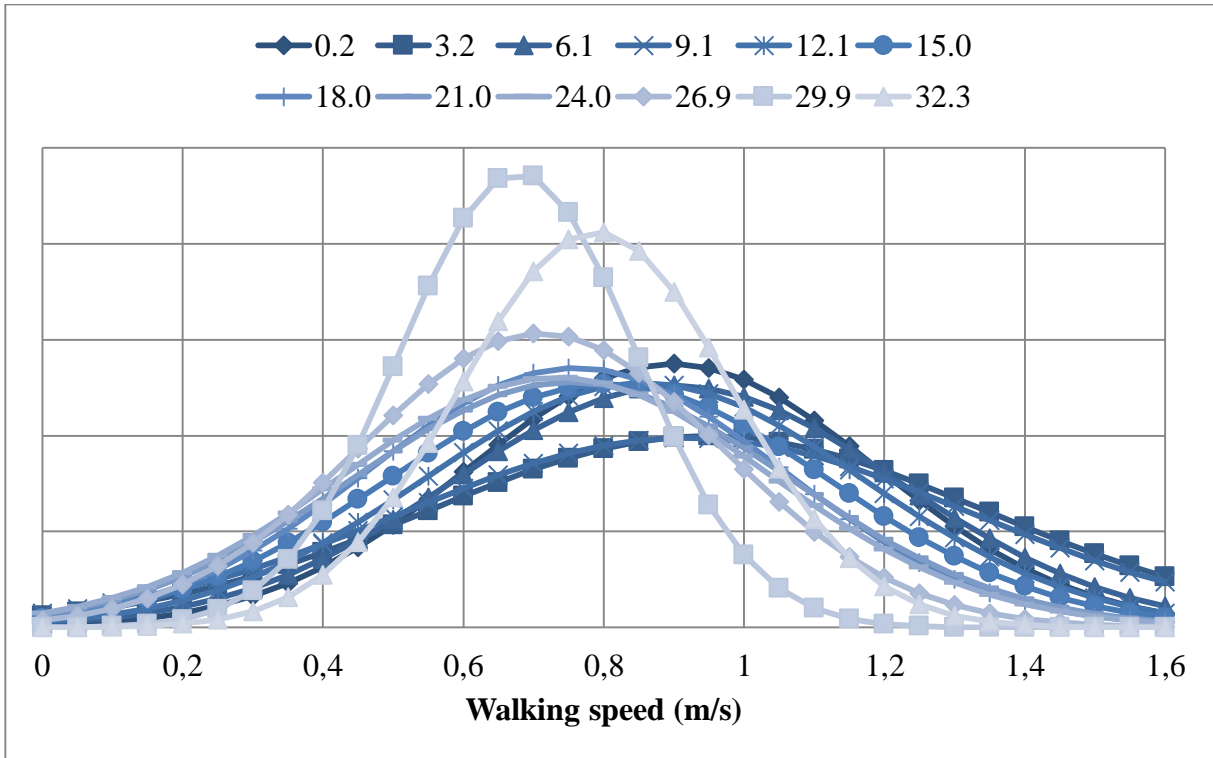

Figure 44. Probability density function of walking speeds at different heights (each number on the top of the figure indicates a height) for the individual experiment in the Västra Skogen experiment.

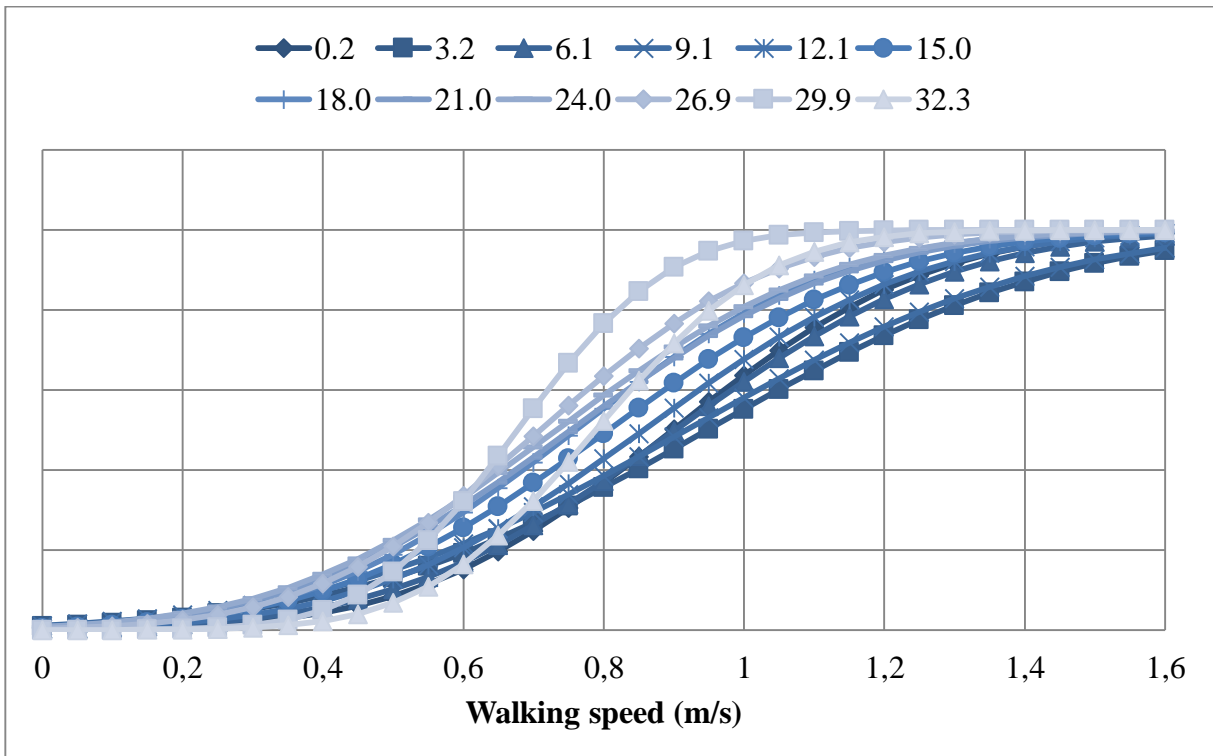

Figure 45. Cumulative density function of walking speeds at different heights for the individual experiment in the Västra Skogen station.

The analysis of the walking speeds of the median, slowest and fastest test participants was made in order to evaluate the results from an individual perspective. The ascending walking speeds did

vary significantly in the last couple of segments. Figure 46 shows the variations between the fastest, the slowest and the median test participant's walking speeds for both the individual and the group experiment.

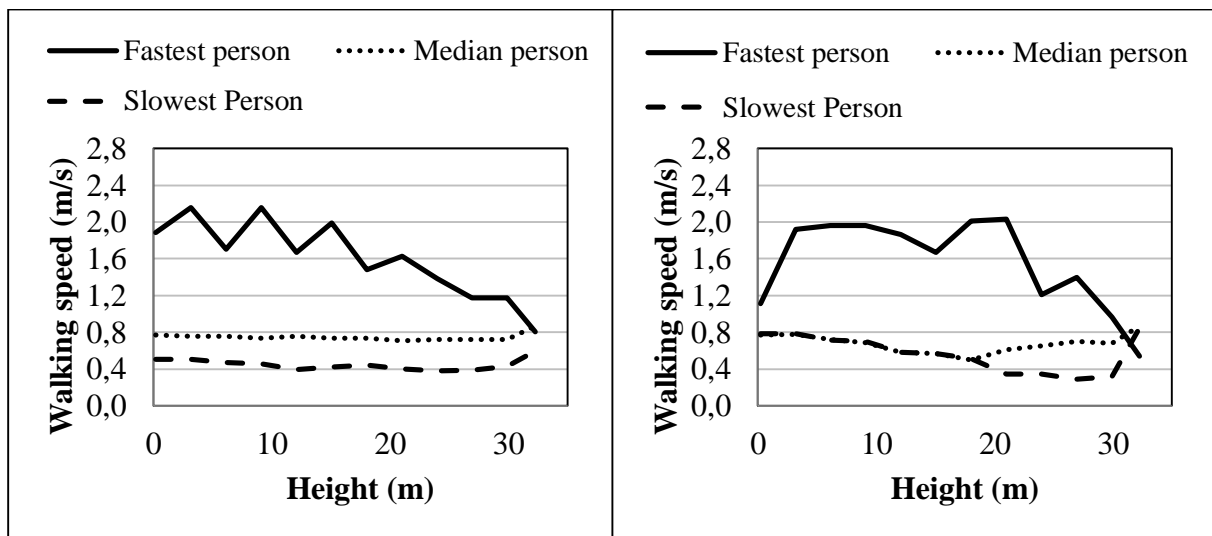

Figure 46(a)- (b). Walking speed of the slowest, median and fastest test participant for the (a) individual experiment (left) and (b) the group experiment (right).

In the individual experiment the fastest test participant shows a variable speed at the beginning, decreasing to about half of the maximal speed by the end of the experiment. The median person showed a steady pace, with a small but constant decrease of the speed. The slowest person also shows variability. The soft peak in the second half is explained by the person restarting movement after a break (Figure 46.a).

In the group experiment the behaviour was different. While the fastest person is clearly much faster than the others, the median and the slowest person seem to have the same pace for more than half of the climbing (Figure 46.b). This is associated with the presence of a queue. It is important to notice that in the case of the escalator, given the reduced width of the stair, the presence of some slow participants at the beginning of the experiment made it hard for the faster participants to overtake. The fastest test participant started the experiment among the first couple of test participants entering the escalator, and therefore they had more space to overtake the few participants in front. In addition, the fastest test participant ran upstairs instead of walking. In the case of the median person, the sudden increase in their speed could be explained by a lower density after the first half, meaning that the median participant had enough room to overtake and reach their preferred speed. The slowest test participant had a relatively steady decrease of speed. Detailed plots of the walking speeds in relation to gender and age are presented in Appendix A. Results of the flows in the group experiments are presented in Appendix B.

VERTICAL SPEEDS

The same trends regarding walking speeds observed in the escalator experiment can be found observing the results of the vertical speeds (Figure 47 and 48). Since no landings are present in the escalator, the results are the same but shifted of a factor depending on the use of vertical displacement as reference for the speed calculation rather than the walked distance.

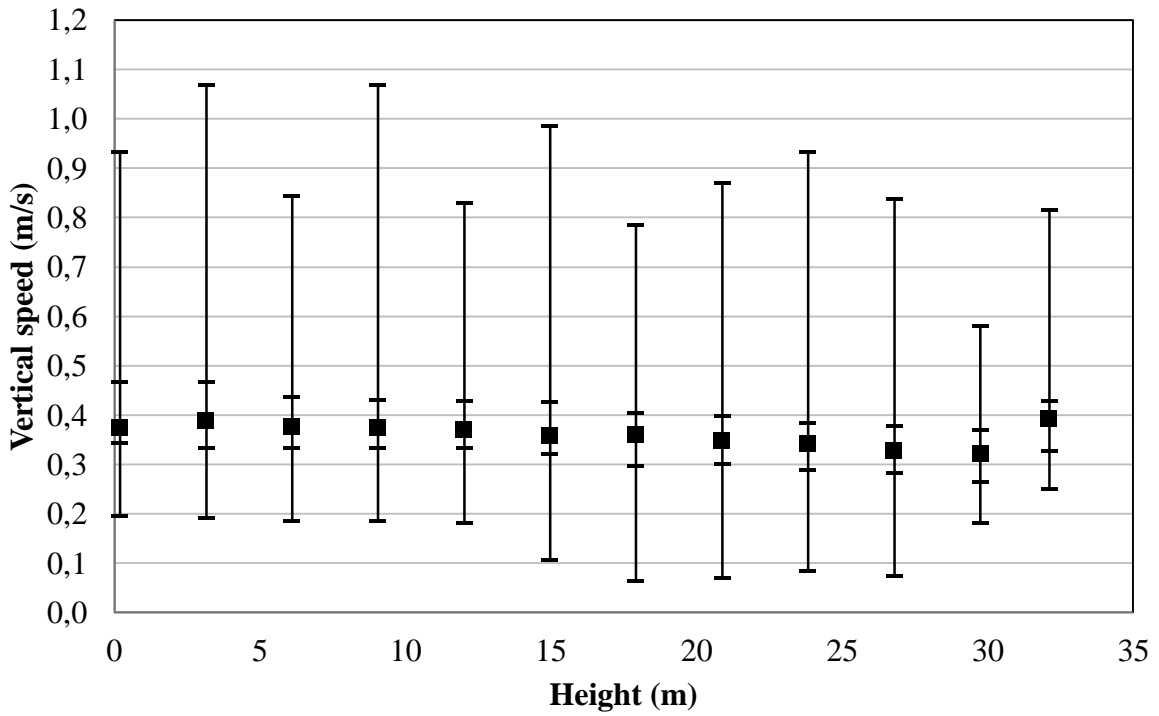

Figure 47. Vertical speed values during the individual experiments in Västra Skogen. The plot shows minimum, 25th percentile, median, 75th percentile- and the maximum value at different heights.

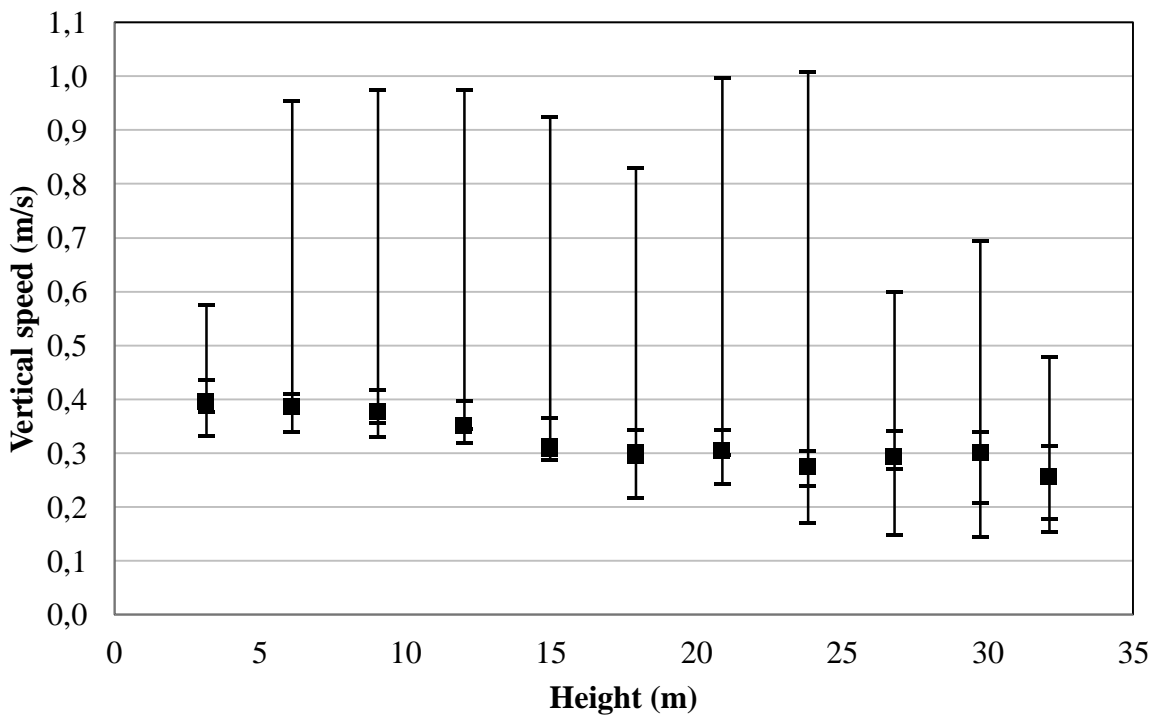

Figure 48. Vertical speed values during the group experiments in Västra Skogen. The plot shows minimum, 25th percentile, median, 75th percentile- and the maximum value at different heights.

The same discussion presented for walking speeds can be made regarding the observed vertical speeds (since results are just shifted given the use of a different reference length for the speed

calculation). Main findings include the fact that the vertical speeds of the 75th percentile are particularly high and when comparing the median values for the first and second half of the escalator, there is a clear trend of decrease in vertical speeds.

FLOW RATES

The time for the whole group to pass each point in the escalator is illustrated in Figure 49. It should be noted that this information refer to the specific number of people involved in the experiment, and they should be therefore interpreted referring to the transition phase between the situation with no queue and the situation with a queue. The experimental conditions reproduce the initial phase of an evacuation with no initial people located in the escalator and a group of people approaching it. For this reason, results are presented as the time to pass each point and suggested flow values based on the measuring points closest to the maximum interval values are presented in Appendix B. Particular attention should be paid to the most restricting flows observed at the top of the escalator, since in a real scenario they might be the one limiting the flow in the entire escalator (i.e. the flow responsible of queue formation).

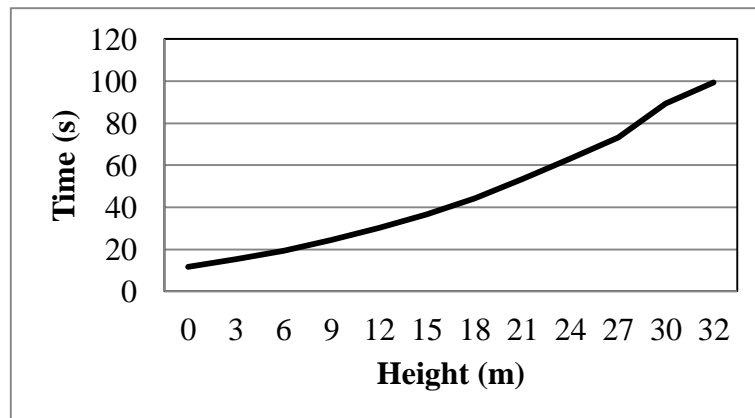

Figure 49. Time for the whole group to pass each mark at different heights.

BACKGROUND VARIABLES VS SPEEDS

In order to evaluate the impact of the sample characteristics with the speeds, a linear regression analysis has been performed for the individual experiment. In this analysis, the same demographic and descriptive variables of the Ideon and Kista experiments were tested. The results suggested no clear influence of those variables on walking speed/vertical speed. The exact formulation of the linear regression model is not presented here given its low predictive capability. In the case of the vertical speed, the parameters age, height, weight and disability explained up to 42% of the observations ($AdjR^2 = 0.424$).

PHYSIOLOGICAL DATA

Since stable heart rate values were not reached, the results are reported only as maximum heart rate reached when test participants finished the task (Figure 50). Further explanations on this issue are provided in the discussion section. Similarly, the maximum oxygen consumption while finishing the task is presented in Figure 51. It should be noted that the walked distance was not long enough to generate stable values for heart rate and oxygen consumption in most of the subjects.

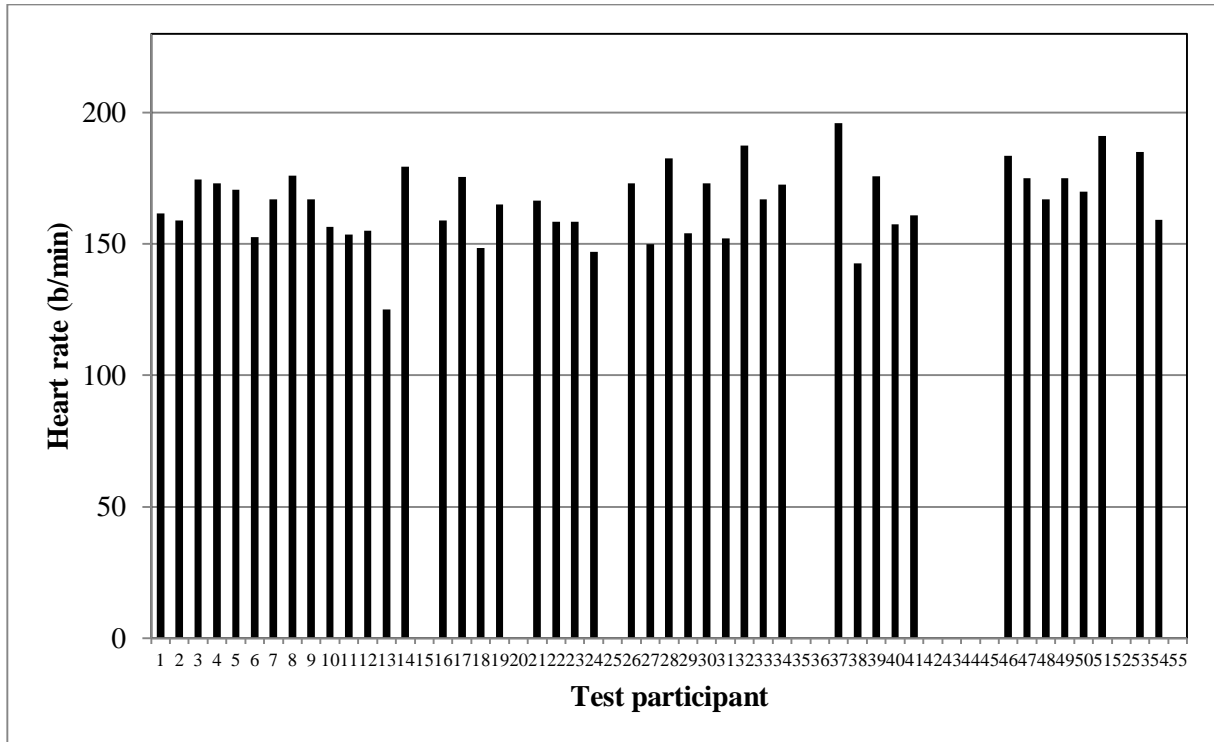

Figure 50. Heart rate (HR) data (i.e., maximum HR after task completion) from the Västra Skogen experiment. The missing bars indicate the participants with no HR measurements. The mean value is approximately 160 b/min.

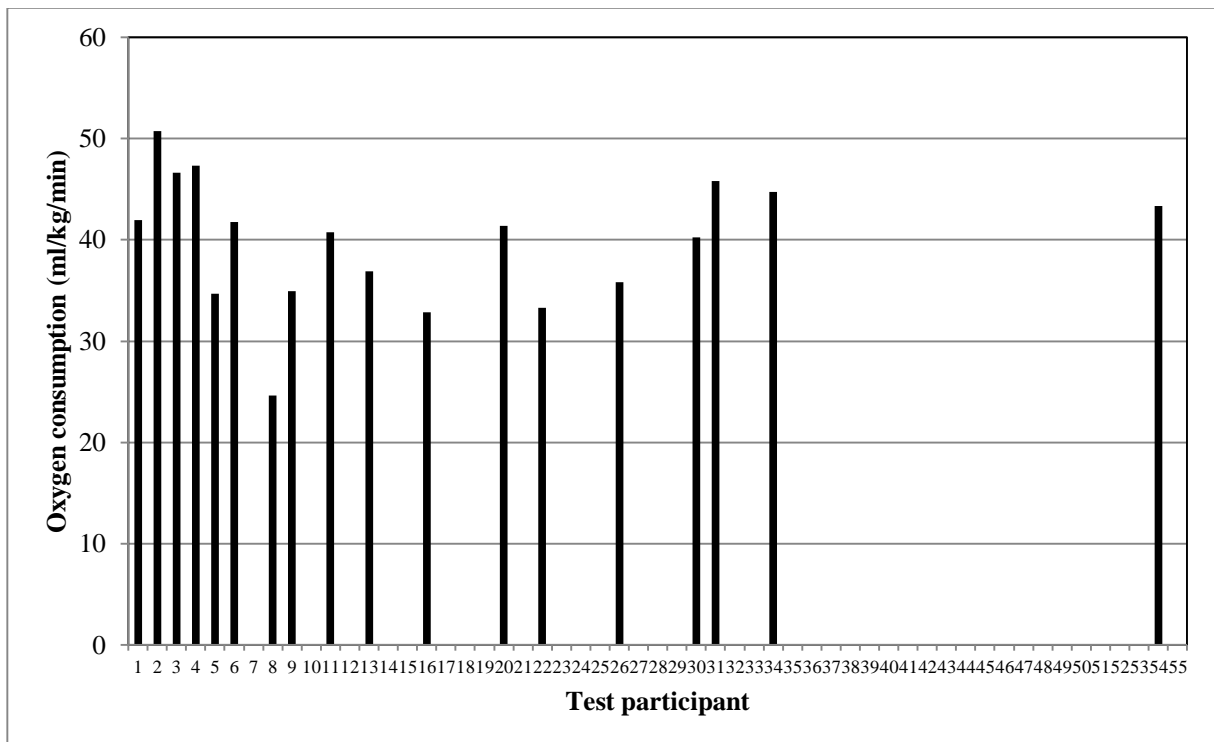

Figure 51. VO_2 measurements during the Västra Skogen experiment. The given VO_2 values are not stable and the maximum levels achieved by the end of the task are expressed in ml/kg/min. The missing bars indicate the participants with no VO_2 measurements.

5.4. Stair machine experiment

This section describes the laboratory experiment conducted with a stair machine located at the Thermal Environment Laboratory under the division of Ergonomics and Aerosol Technology at the Department of Design Sciences at Lund University.

5.4.1. Experimental layout

This experiment made use of the stair machine SM5 (StairMaster, USA). More information about the characteristics of the stair machine can be found in the relevant section on experimental equipment.

5.4.2. Results

The results of the stair machine experiment are presented in this section. Results include physiological data (metabolic rate, heart rate and EMG). It should be noted that it is difficult to walk on the stair machine without holding the handrails. Reasons for this could be:

- a) There were no plane areas (platforms) where one could have slightly lower load or other muscles working;
- b) The pace was fixed by the machine or by study leader – the subject was not able to adjust the pace according to individual needs, e.g. balance loss;
- c) Due to the moving surface it was more difficult to keep balance while climbing – it required more attention towards the walking surface in order to be aware of the steps as both the body and the underfoot surface kept moving.

PHYSIOLOGICAL DATA

The mean stable heart rates at selected time points and the maximum heart rate values in the stair machine experiment are presented in Figure 52. The values of oxygen consumption (VO_2) recordings for the same stages as for heart rates from the stair machine experiment are presented in Figure 53.

As the model development part results ended with higher VO_{2max} percentage at the 2 first levels (around 60 % instead of 50 % and around 75 % instead of 70 %) then the validation part aimed at 60 and 75 % for these levels. The aim for the highest level of 90 % was left the same.

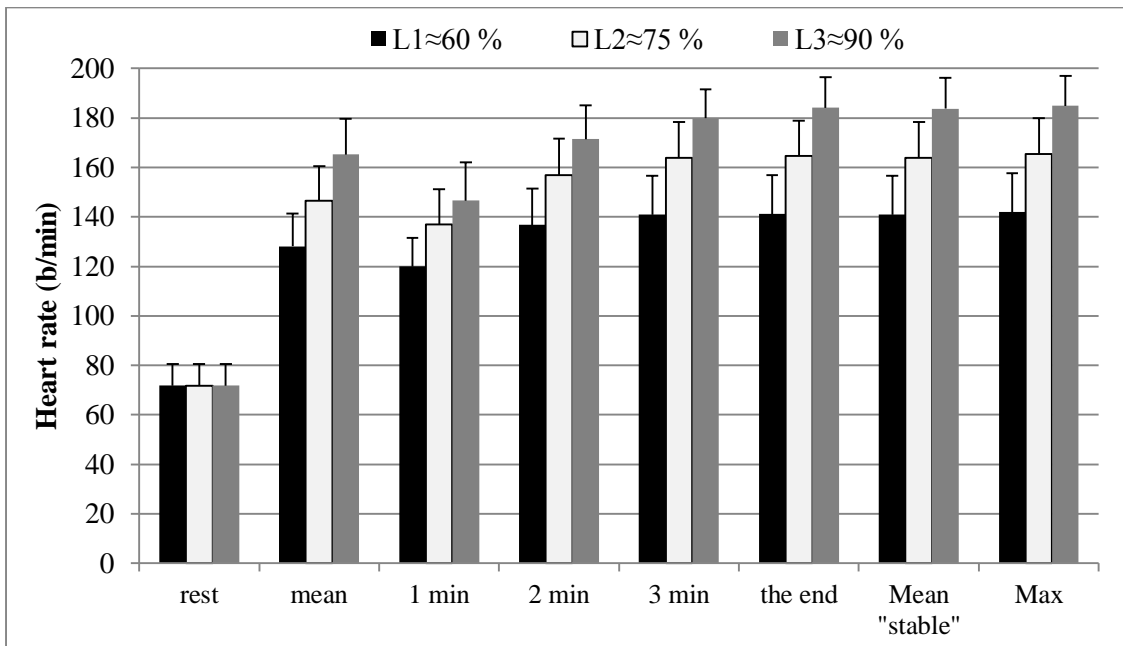

Figure 52. Heart rates in the laboratory at 3 maximal capacity (VO_2max) defined exertion levels (level 1=L1, level 2=L2, level 3=L3).

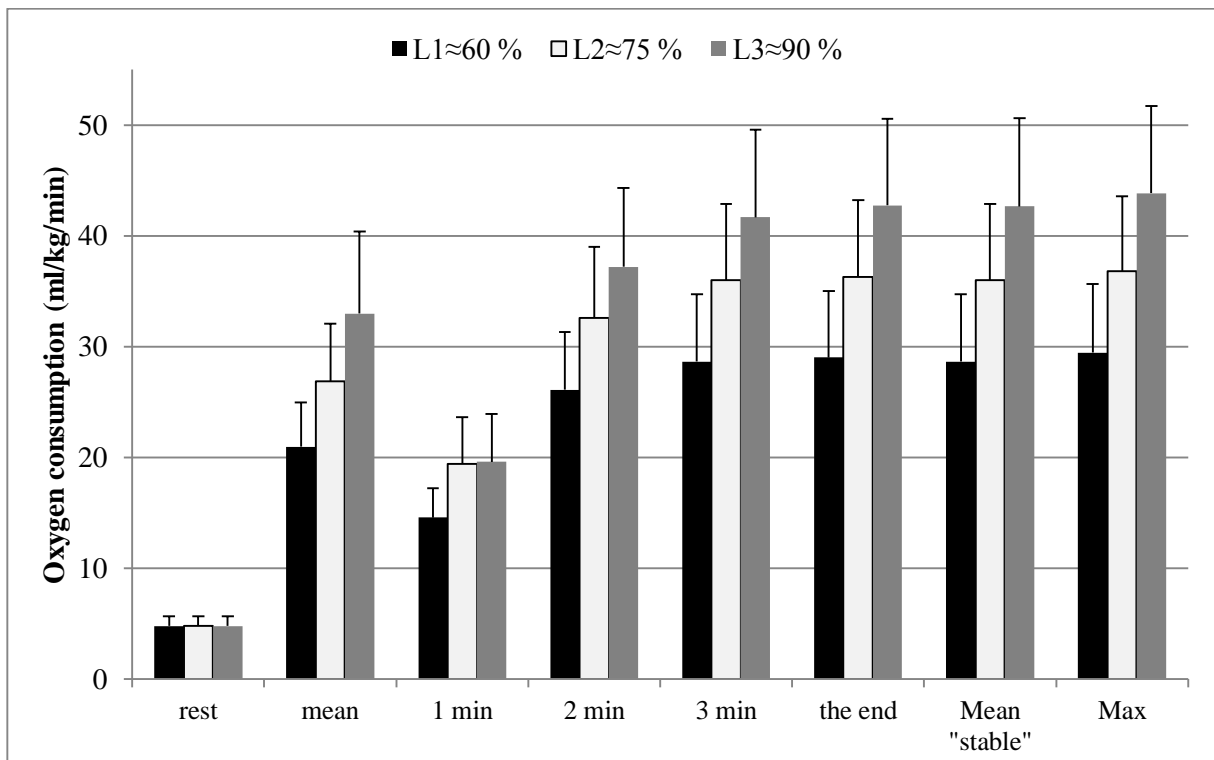

Figure 53. Oxygen consumption in the lab at 3 maximal capacity (VO_2max) defined exertion levels (level 1=L1, level 2=L2, level 3=L3).

Results of EMG data is presented after analysing four subjects with one thigh muscle, Vastus Lateralis (VL) at 90 % of $VO_2 max$ speed level for 5 min is presented in this report (Figure 54).

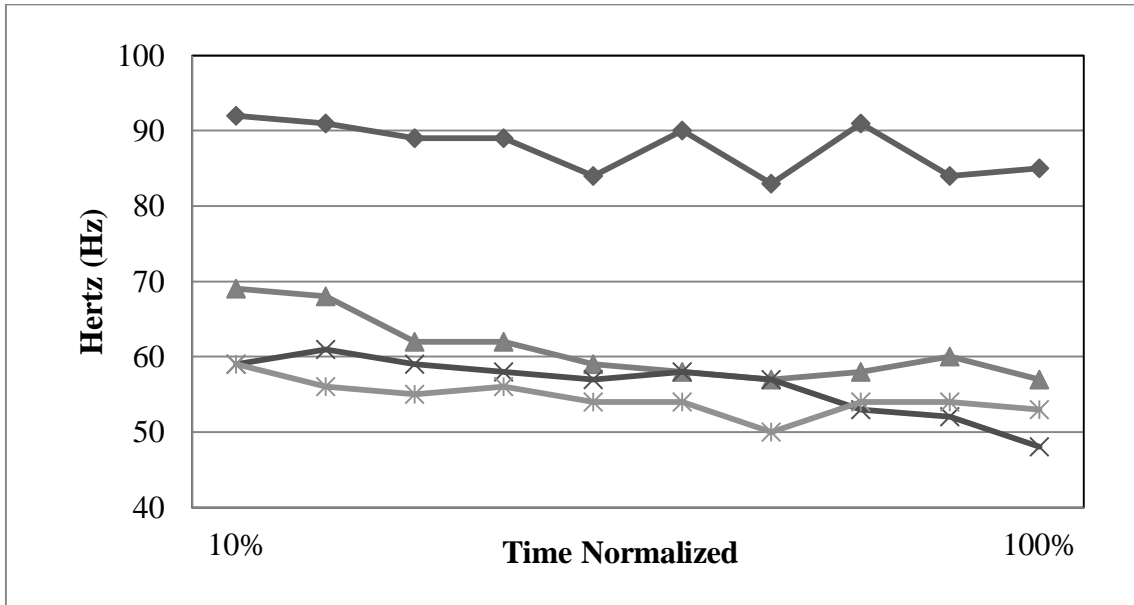

Figure 54. Vastus Lateralis (VL) (thigh) muscle EMG median frequency (MDF) time normalized (10 %-100 %) activity in the laboratory study for four different test subjects.

The results of muscle activity in the laboratory test showed that median frequency (MDF) was gradually decreasing in the time normalized data from 10 %-100 % (Figure 54). This gradual MDF decreasing tendency of the thigh muscle showed that muscular working frequency decreased on those four subjects.

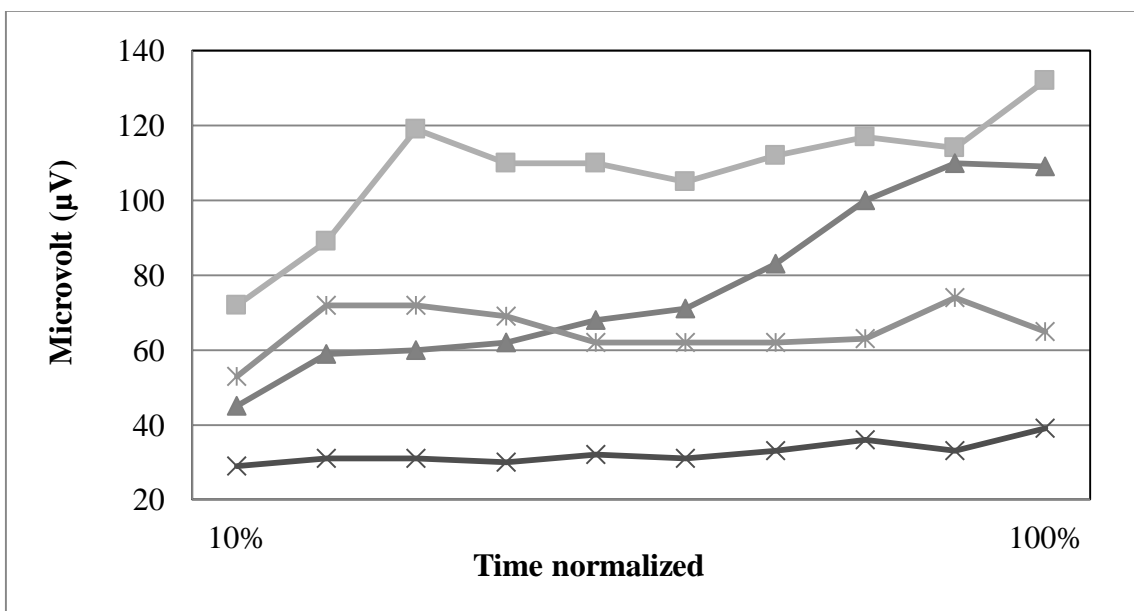

Figure 55. Vastus Lateralis (VL) (thigh) muscle sEMG RMS mean amplitude time normalized (10%-100%) activity in four subjects in the laboratory study.

RMS mean amplitude was increasing in the VL muscle in the same way from beginning to the end of this max speed level of stair climbing on the machine (Figure 55). This supports the appearance of local muscle fatigue in the thigh muscle in this controlled climbing speed and consensus of the muscle fatigue theory of decreasing frequency with increased amplitudes (see Figure 9).

5.5. Comparison of experimental results

This section presents a comparison of all experiments in relation to the observed walking speeds, vertical speeds, physiological data, perceived exertion and qualitative observations (e.g. handrail usage, behaviours, etc.).

5.5.1. Comparison of walking speeds

The box plots including the entire information from the individual and group field experiments are presented in Figure 56 and Figure 57.

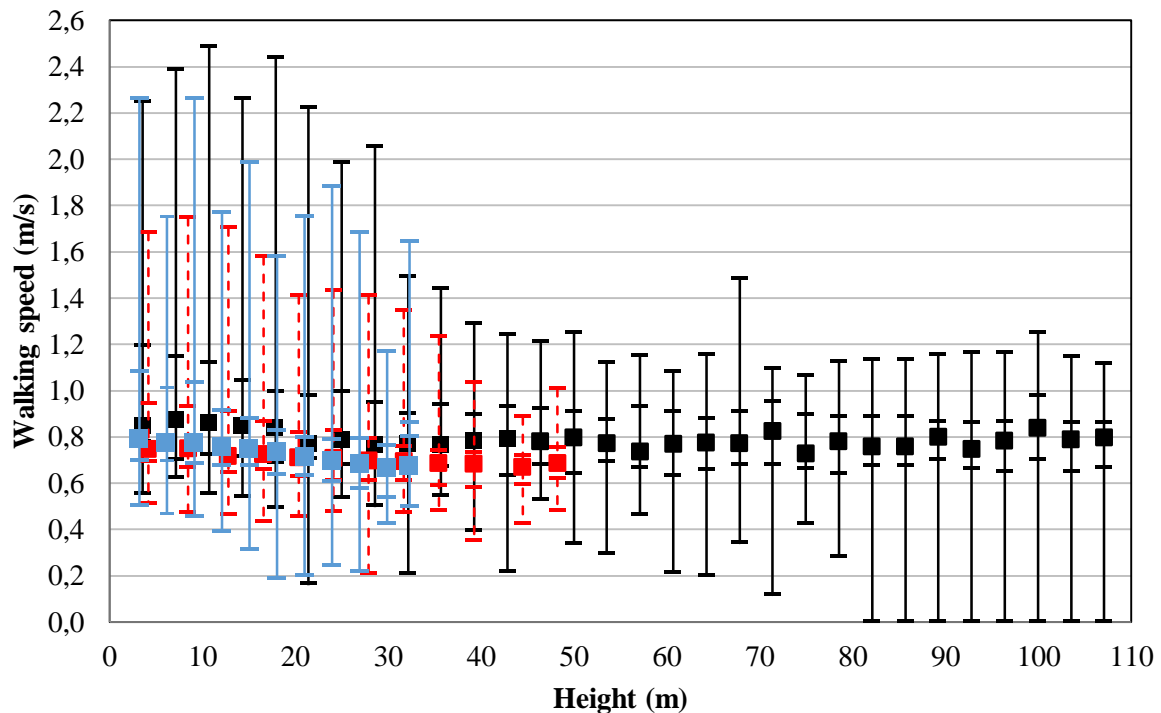

Figure 56. Walking speeds collected in all individual field experiments (including minimum 25th percentile, median, 75th percentile, maximum). Ideon data are presented in red, Kista data are presented in black and Västra Skogen data are presented in blue.

Considering the walking speeds in the individual experiments, it is possible to observe that the median walking speeds in the Kista experiment are higher than the walking speeds in Ideon and Västra Skogen. Västra Skogen has the slowest speeds due to the absence of landing (the presence of landings allows faster walking speeds). The different stair configurations of the two stair experiments (i.e. different number of landings) also affect the walking speeds result, generating higher walking speeds, where more landings are available. In all experiments, walking speeds decrease with height, caused by physical exertion. There is also a clear trend that the 75th percentile of speeds is the one which decreases more in all experiments (in terms of absolute values) along the height of the stairs/escalators.

The data on walking speeds in the group experiments shows that the lowest speeds among the three experiments are observed in the Västra Skogen experiment. This is most likely associated with the absence of landings and the presence of a queue caused by the narrow width of the escalator together with large body sway caused by the larger treads, which makes it difficult to overtake. In the group experiments, the fastest participant is generally affected by the others at the

beginning of the experiment, but during the second part of the stair climbing, the fastest participants' speeds tend to adjust to sustainable unimpeded walking speeds and they are less affected by the obstruction of others.

As a general note, it is possible to observe that by starting the stair ascent with a lower speed, it can be possible to keep a constant speed during the ascent and reduce the impact of physical exertion during the ascending movement. An initial pace which is too high for the participant might lead to a considerable speed reduction during the rest of the ascent.

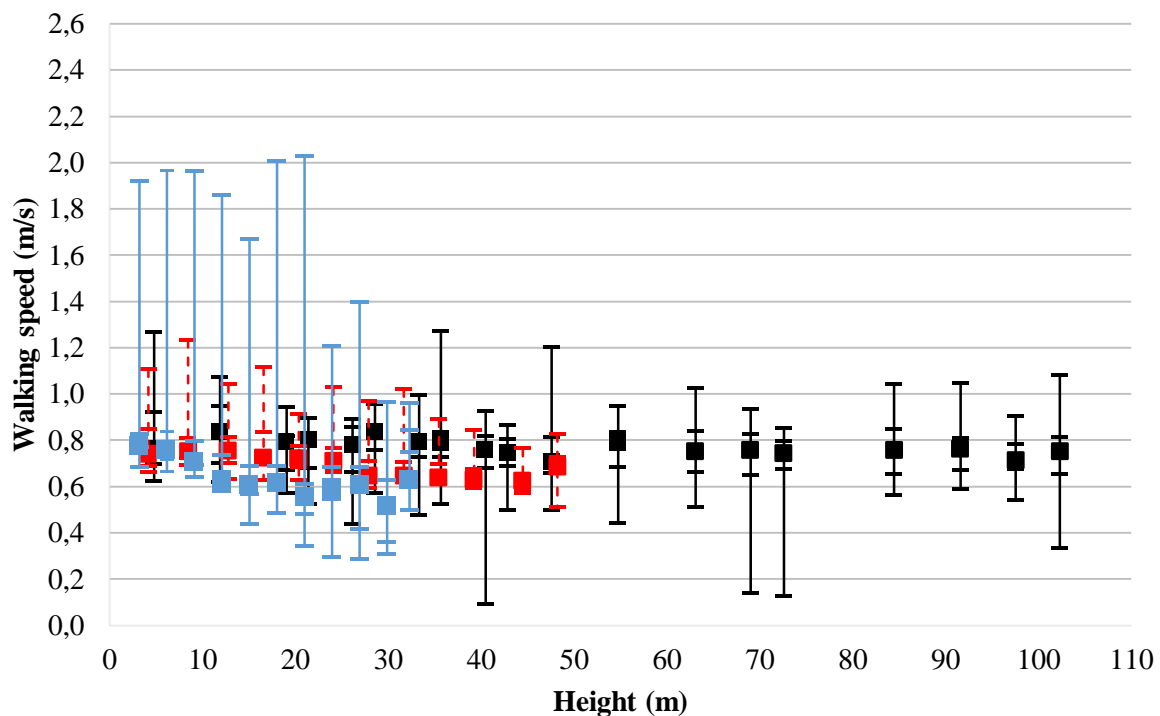

Figure 57. Walking speeds collected in all group field experiments (including minimum 25th percentile, median, 75th percentile, maximum). Ideon data are presented in red, Kista data are presented in black and Västra Skogen data are presented in blue.

The group experiments at Ideon and Västra Skogen have more in common, since the buildings have both quite narrow stairs, making it hard to overtake. This also affects the speed. The difference between the speed in the individual experiments and the group experiments (slower) is a result of impeded speed in the group experiment. In the Ideon experiment, one participant put his hands on both handrails, blocking the stair, with the result that the speed became similar to a large part of the group. In Västra Skogen the group did not keep together in the same way but the slower individuals in the group experiment lost contact with others after about 15 meters of the climb. In the Kista experiment, the differences between the individual experiment and the group experiment are smaller since the stair width, offering good possibilities for overtaking, allowed people choose their desired speed to a greater extent. In addition to that, the group experiment in Kista shows less queuing in the distribution of the walking speed.

5.5.2. Comparison of vertical speeds

Figure 58 and Figure 59 show a comparison between all vertical speed for both the individual and the group experiments. In all experiments, the vertical speed of the group is lower than the vertical

speed for the individual experiments. This is associated with the same reasons discussed in the comparison of walking speeds (i.e. queuing, overtaking, and stair width).

When comparing the vertical speeds of all field experiments, the situation is the opposite than the comparison of walking speeds. In fact, the vertical speed values are higher in the Västra Skogen experiment, followed by the Ideon experiment. This is due to the fact that there are no landings in the escalator and the vertical displacement becomes faster. In the stair experiments, differences in stair design seem to have a strong impact. It should be noted that while considering vertical speed, there is no impact of the travel path assumed in the stairwell since vertical speeds only measures the vertical ascent (i.e. the reference for speed calculation is the progressive height, not the walked distance).

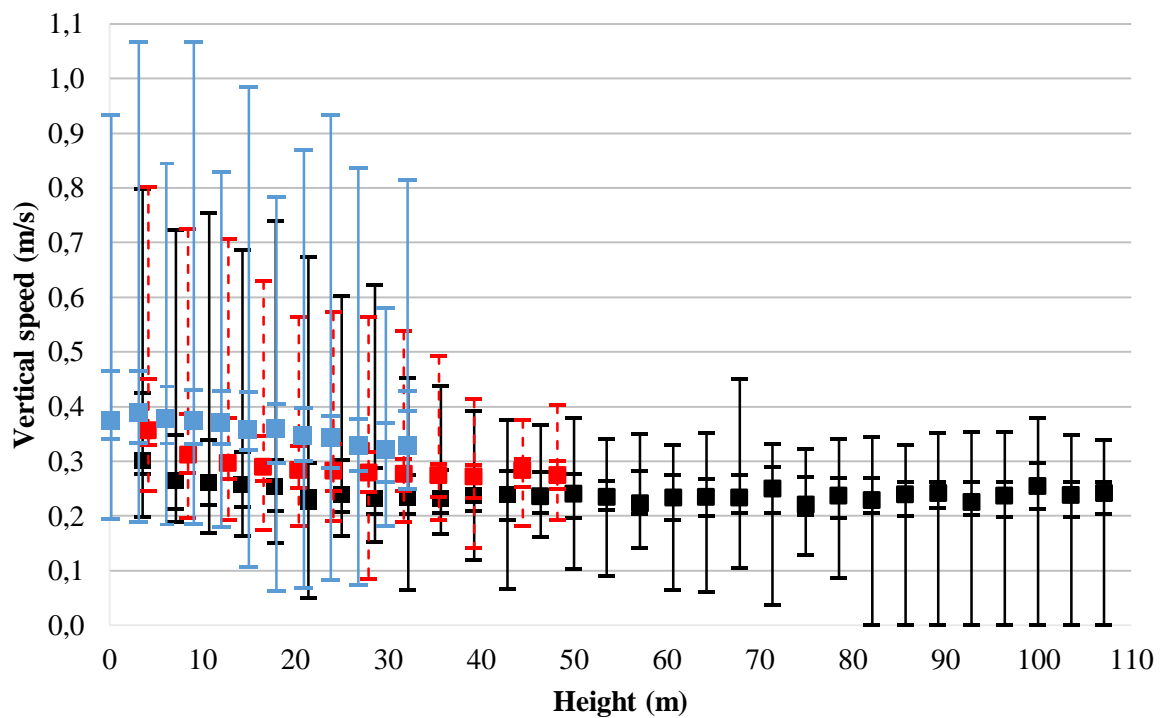

Figure 58. Vertical speeds collected in all individual field experiments (including minimum 25th percentile, median, 75th percentile, maximum). Ideon data are presented in red, Kista data are presented in black and Västra Skogen data are presented in blue.

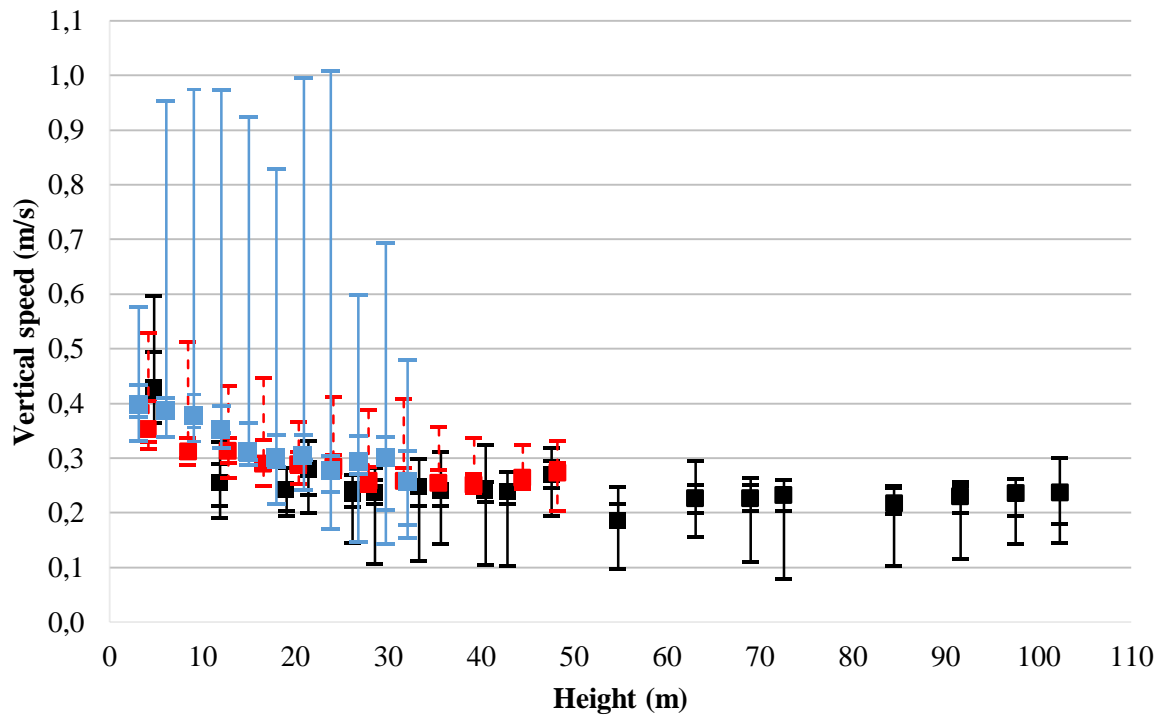

Figure 59. Vertical speeds collected in all group field experiments (including minimum 25th percentile, median, 75th percentile, maximum). Ideon data are presented in red, Kista data are presented in black and Västra Skogen data are presented in blue.

In both the present and previous studies (Lam et al., 2014), it was observed that some subjects in the group experiments impede the movement of others thus affecting the climbing speed of other members of the group. It was also observed that a group may act as a motivation for a higher speed.

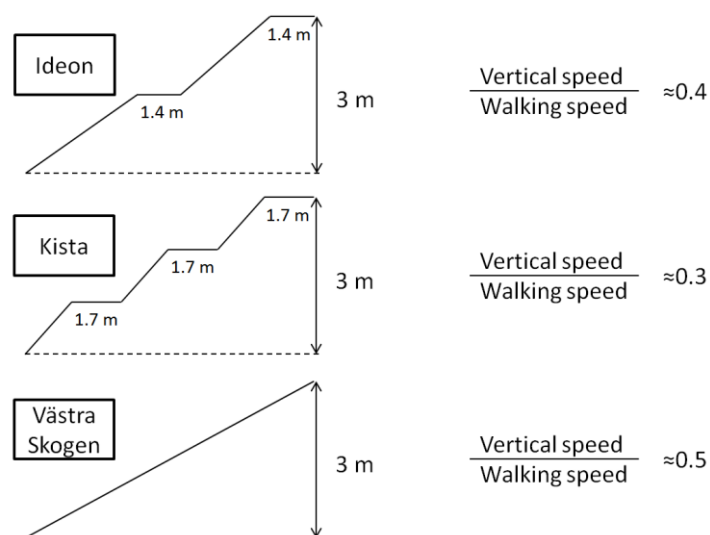

Figure 60. Qualitative illustration of walking paths and vertical displacement in the three field experiments.

The walking path in the field experiments can be compared by observing the three walking lines associated with the walking speed and the vertical speed as shown in Figure 60. The ratio between

the walking speed and the vertical speed is approximately 0.4 in Ideon, 0.3 in Kista, and 0.5 in Västra Skogen.

5.5.3. Comparison of physiological data

As all subjects in field tests could choose their own pace and in order to compare the results from various study locations, the study was split by various time points. This includes 1 minute work to compare the Västra Skogen (33 m height took in average about 1.5 minutes), Ideon and Kista experiments; 2 and 3 minutes work to compare Ideon (13 floors took in average about 2.5 minutes) and Kista experiments, and the first 13 floors at Kista compared to the 31 floors. The comparison was made by heart rate, mean and maximal VO_2 , and mean VO_2 over a stable measuring period. The statistical evaluation was based on means between the groups and standard deviations. In order to compare individual subjects, the data was normalized with time.

HEART RATE AND OXYGEN CONSUMPTION

A series of laboratory exercises carried out at Lund University on 144 students ranging from 18 to 64 years (Kuklane and Gao, 2012) has shown an average maximal heart rate (mean (standard deviation)) of 191 (11) b/min. Their corresponding maximal oxygen consumption was 48.7 (8.9) ml/kg/min with a range from 22 to 67 ml/kg/min. If the students are split by gender, then the corresponding heart rate and oxygen consumption values were 193 (9) and 187 (12) b/min, and 52.0 (8.0) and 44.2 (8.1) ml/kg/min for males and females, respectively. The mean measured maximal pulse and oxygen consumption values were:

- In the Ideon experiment 164 (15) and 168 (14) b/min, and 3.29 (0.78) and 2.29 (0.32) l/min (40.7 (5.5) and 36.9 (5.0) ml/kg/min)
- In the Kista experiment 174 (17) and 176 (11) b/min, and 3.16 (0.61) and 2.53 (0.53) l/min (44.3 (8.9) and 39.5 (7.0) ml/kg/min) for males and females, respectively.

Assuming that the groups cover the same experimental population then it does indicate that the subjects reached very close to their maximal capacity levels: 85-95% of their maximal heart rate and 80-90 % of their $\text{VO}_{2\text{max}}$. In the Västra Skogen experiment, the corresponding variables could not be compared as the time was too short for reaching stable values for most of the subjects.

The results of the field experiments were planned to be used to design the laboratory tests. The controlled exercise in the laboratory was intended to be used to develop ascending evacuation speed estimation model based on human physical capacity.

For the first purpose $\text{VO}_{2\text{max}}$ values of some subjects participating in field tests were measured, and together with VO_2 and anthropometric parameters of the participants of the field tests were compared to the mean values from over 140 students' $\text{VO}_{2\text{max}}$ results. Based on the estimations of $\text{VO}_{2\text{max}}$, the assumed percentage of VO_2 during the field exercise and measured velocity/step rate, the corresponding preliminary step rates were calculated in the lab tests for 50, 70 and 90% of $\text{VO}_{2\text{max}}$ for each individual subject. Based on the results of the first 19 lab subjects the estimation was re-evaluated and modelled with multivariable linear regression analysis (XLSTAT Version 2014.1.01), and a new estimation was validated on the last 6 subjects. This last relationship was converted into an estimation of the vertical displacement prediction for ascending evacuation. The prediction was expected to be usable together with population fitness data, e.g. as presented by Shvartz and Reibold (1990). Other related databases and methods can also be used for estimating population fitness, e.g. Jackson et al. (1990), NHANES (CDC, 2005), Loe et al. (2013).

Oxygen consumption (VO_2) represents the oxygen amount that is used to burn energy to carry out a defined task, i.e. to move a mass at a specific speed to a defined distance. In any case, either

knowing the maximal heart rate (HR_{max}) or maximal oxygen consumption (VO_{2max}) would allow better prediction/correlation if compared with absolute values since it allows calculating the percentage of individual maximum (relative heart rate/pulse or relative oxygen consumption). At this stage it was decided to use the VO₂ as the major parameter in prediction development. If it is used in ml/kg/min then this direct work capacity variable takes also into account the body weight. A multivariable linear regression for best fit confirmed this reasoning.

The expectations on data output discussed in section 4.3 on the field experiments resulted true (Figures 61-64):

1. Mean ascent time of about 2.5 minutes in the Ideon experiment allowed reaching stable VO₂ level both physiologically and in instrument (Figure 61). Muscle fatigue could have an impact in the cases where the ascent took longer time, simultaneously in these cases the step rate was also lower and muscles got micro-breaks for recovery and it could not be observed that muscle fatigue led to exhaustion;
2. In the Kista experiment, the exercise lasted considerably more than 4 minutes (Figure 62 and Figure 64). This did introduce speed reduction due to several factors: cardio-vascular capacity, muscle fatigue and lactate building. Most probably the analysis of the subject VO₂ and EMG data would explain the reasons for each specific case. However, it was already observed that trained people having higher VO_{2max} and better lactate tolerance led to higher speed, and thus, less time spent on landings and less chance for exhaustion.
3. Ascent time in the Västra Skogen experiment was too short (Figure 63); commonly neither the test participants nor instruments had the time to stabilize; VO₂ commonly did not reach maximal levels and lactate development did not reach the levels to affect the performance, yet. Main restrictions for evacuation would be bad fitness level or disabilities, either real or contextual (carrying a child, heavy bag etc.);

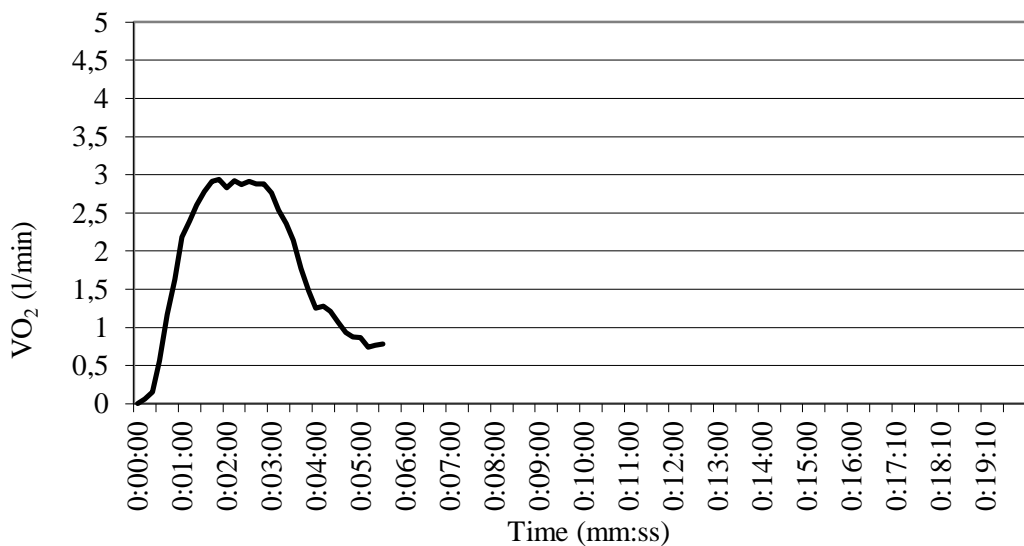

Figure 61. Example of test participant's oxygen consumption over time in the Ideon experiment. The participant managed the task without breaks.

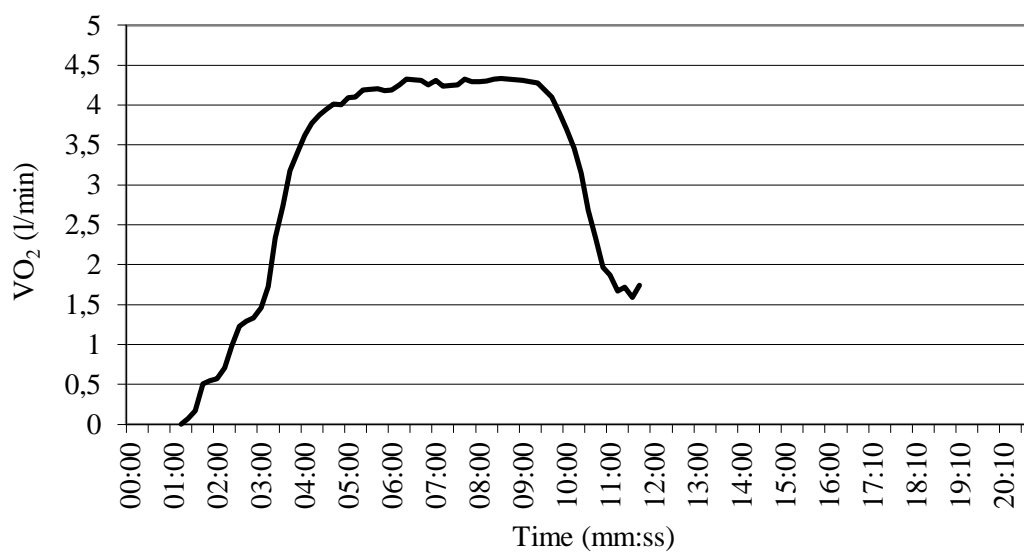

Figure 62. Example of test participant's oxygen consumption over time in the Kista experiment. The participant managed the task without breaks.

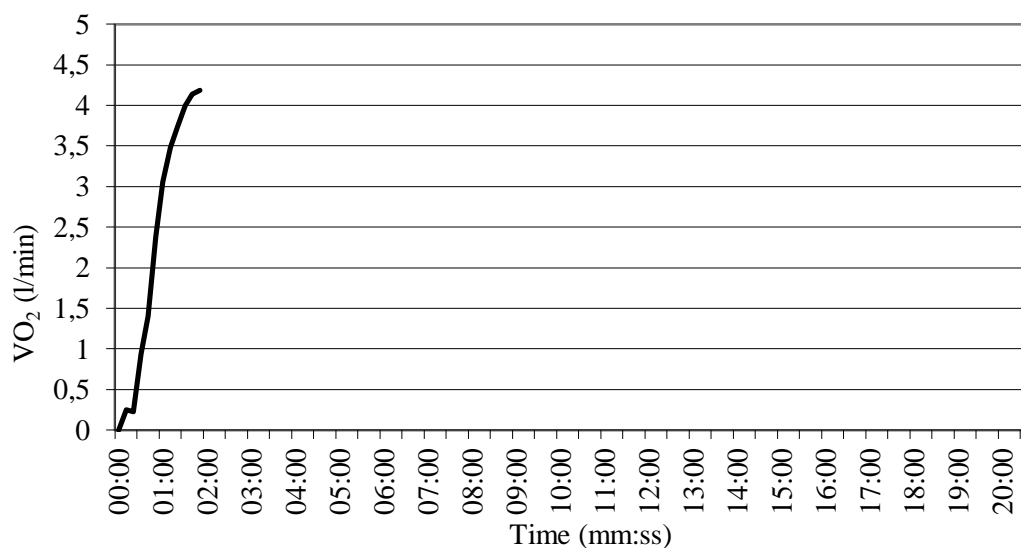

Figure 63. Example of test participant's oxygen consumption over time in the Västra Skogen experiment. The participant managed the task without breaks.

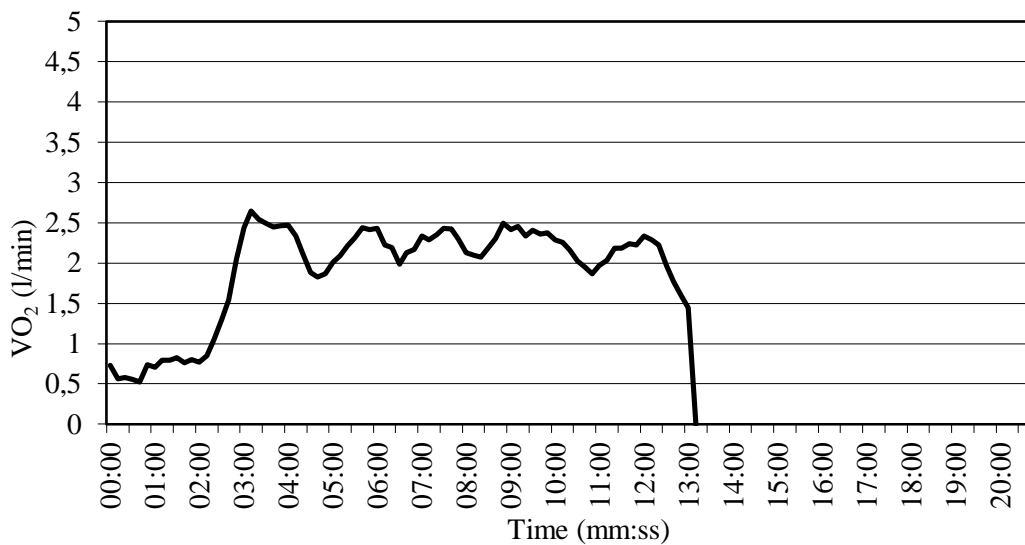

Figure 64. VO₂ development of a test participant from the Kista experiment that got exhausted and required several breaks for recovery in order to manage ascent. The ascent started on the 2nd minute.

Due to the observed limitations in the field, the importance of laboratory experiments did grow. The main limitations of the capability of the field experiments to evaluate work capacity in ascending evacuation were namely, 1) the missing knowledge of the maximal aerobic capacity of subjects and 2) all subjects chose their ascent velocity. During the laboratory experiments, the maximal capacity of each subject was tested on treadmill with increasing inclination. The mean maximum heart rate and VO₂max were 195 and 186 b/min, and 3.77 (0.69) and 3.08 (0.60) l/min - 47.0 (8.6) and 47.2 (9.7) ml/kg/min - for males and females, respectively. Nevertheless, even in this study all subjects did not climb the stairs with the same step rate, then their relative effort was set individually at approximately the same known relative level. Also, any change of the velocity was not possible during the exercise on each level. Figure 65 represents an example of VO₂ curve of a subject under the lab experiment.

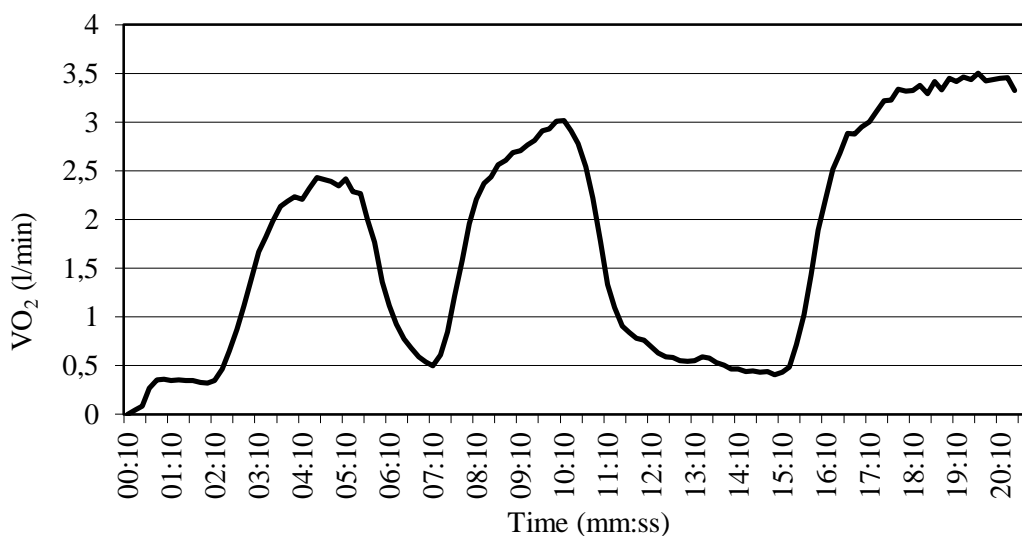

Figure 65. VO₂ curve of one test participant during the lab experiment working at 3 different levels of VO₂max on a stair machine, and with breaks for recovery between different levels.

The ascending walking speeds are shown in Figure 66 and Figure 67 for the field and laboratory experiments in relation to time. These are given here only for comparative purposes. In the laboratory experiment, the walking speeds were lower than in the field. They were fixed for each individual and therefore the variation is not as high as in the field tests. Laboratory speeds at the highest exercise level were close to the results from the Västra Skogen experiment, however, still lower. The step heights at both locations were almost similar (0.197 m vs. 0.205 m in Västra Skogen and on step machine, respectively) and there were no landings, but step depth differed by 15 cm. Thus, the vertical speeds on the step machine were kept at similar or higher level and constant at the highest exercise level while lower levels corresponded to mean stable vertical speeds in the stairwells, i.e. 0.37 (0.06), 0.30 (0.06), 0.23 (0.06) m/s for 90, 75 and 60 % of VO_{2max} , respectively. At the same time it has to be considered that in Västra Skogen most subjects managed the stair climbing in around 1.5 minutes while in the laboratory experiments, most subjects did the exercise for 5 minutes. In case of the longer stairs in Västra Skogen, the mean walking speed could have been reducing even more. The variation in maximal speed (Figure 66) in the experiments shows different strategies but also reflects people overestimating their capacity if compared to the mean speed. The possibility for adjusting the walking speed was not present in the laboratory experiment (Figure 67).

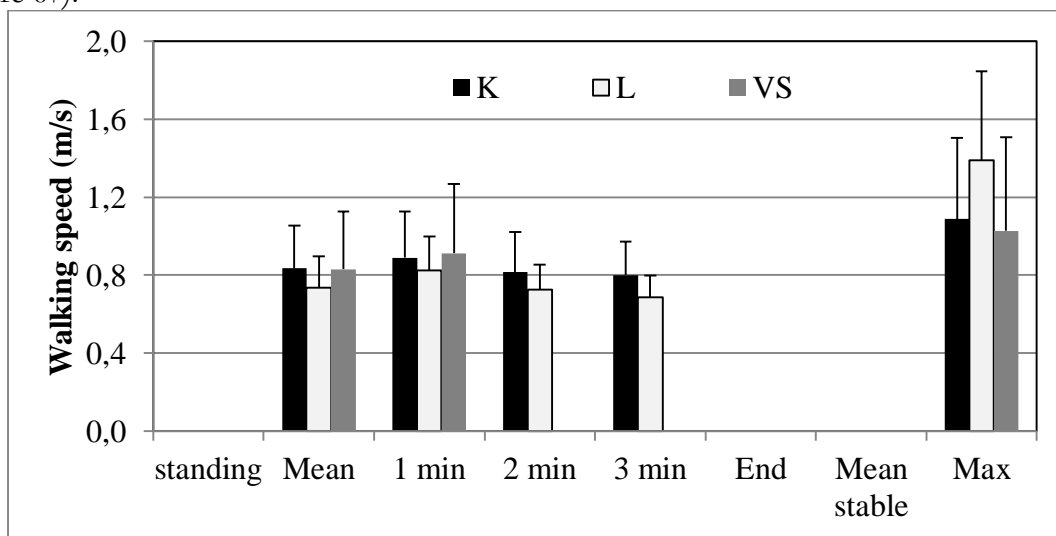

Figure 66. Mean walking speeds in all field experiments, Legend: K=Kista experiment, L=Ideon experiment, VS=Västra Skogen experiment.

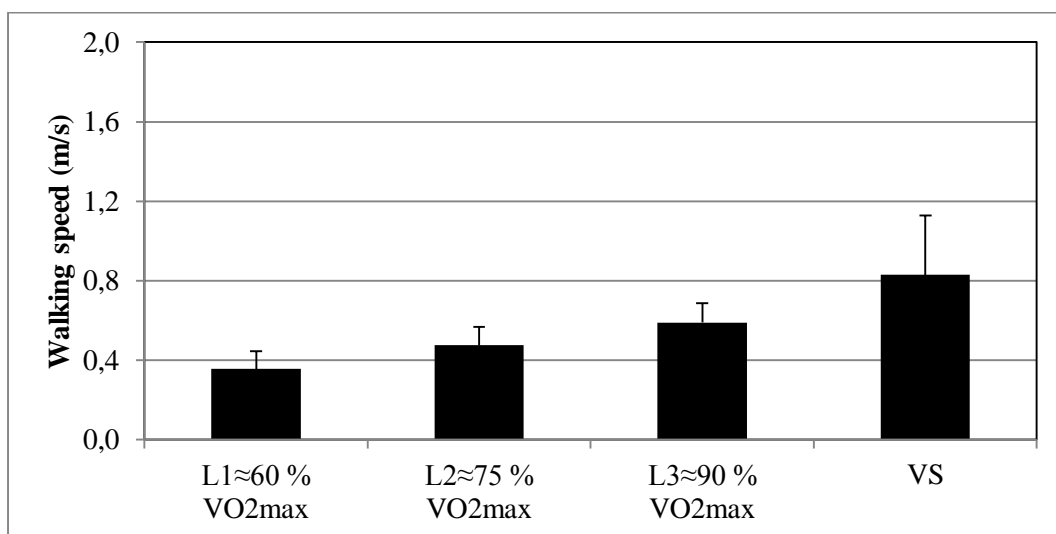

Figure 67. Mean walking speeds in the laboratory experiments and in the Västra Skogen experiment.

From an anthropometric point of view, the field and laboratory experiments had a similar population. No statistically significant differences were found using a two-tailed t-tests assuming equal variances ($p < 0.05$).

Figure 68 shows the half minute average heart rates at various time points and periods of the individual field exercise. Figure 69 shows the same for the group experiments and Figure 70 shows VO_2 for the individual field and laboratory experiments.

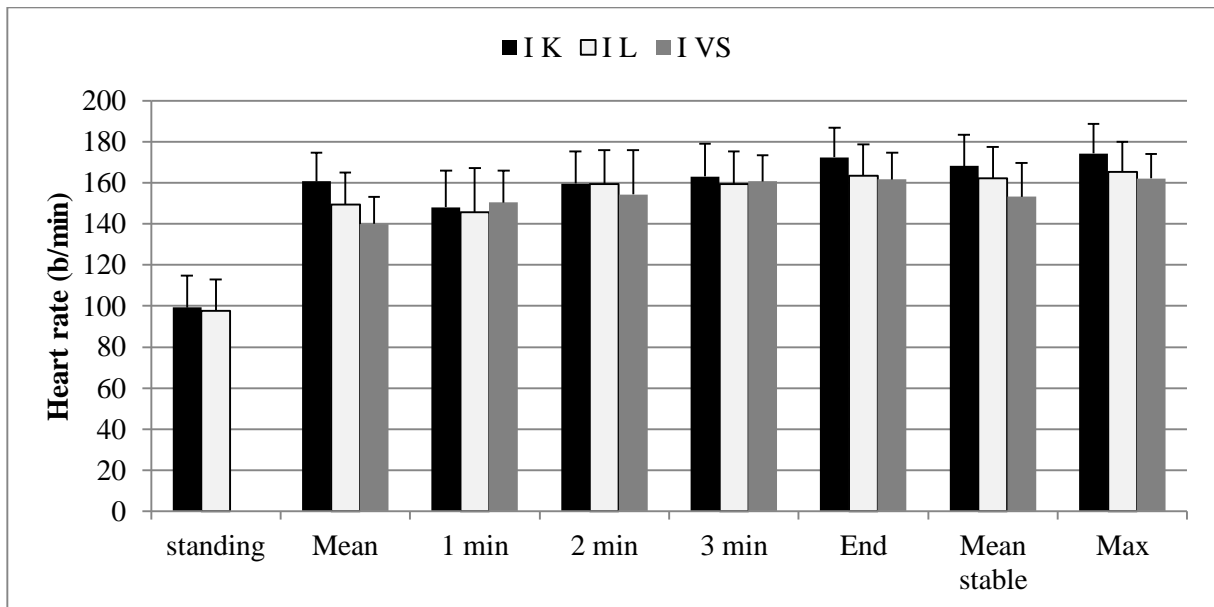

Figure 68. Heart rates from the individual field experiments. Legend: I K=Individual Kista experiment, I L= Individual Ideon Experiment, I VS= Individual Västra Skogen experiment.

When looking at the figures, it should be remembered that only in Kista and in most cases of laboratory tests complete data for all time points were obtained. In the Ideon experiments, most of the subjects had finished the tests within 3 minutes and in Västra Skogen within 2 minutes. Therefore, the means are based on few subjects for whom the task took longer time, and thus, could often be perceived more strenuous, e.g. there was only 1 subject in Västra Skogen who did ascent in about 3 minutes in the group experiment. Vice versa, some subjects did not rush. In any case those values should be considered with care.

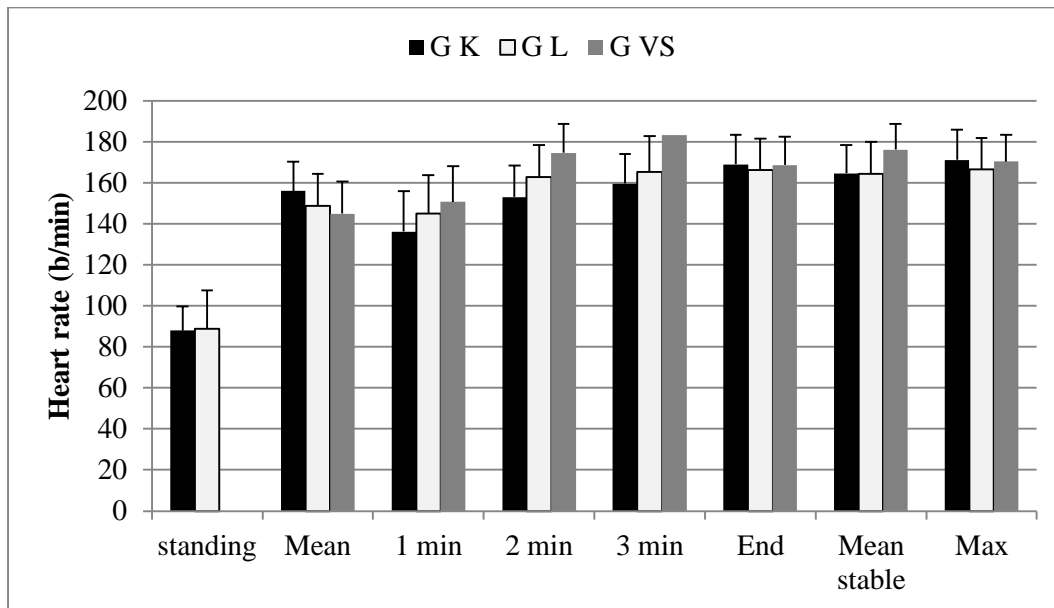

Figure 69. Heart rates from the group field experiments. Legend: G K=Individual Kista experiment, G L= Individual Ideon Experiment, G VS= Individual Västtra Skogen experiment.

The trend seems to be that the longest ascent (Kista) leads to the highest stress. It is logical as in the Kista experiment there is the longest time to develop the heart rate, but also, the chance to reach exhaustion is higher than in the other field experiments. At the same time, the pace in the group experiment was influenced by the group and the results were more even while the shortest exercise (Västtra Skogen) could show the highest values (Figure 69). By excluding the 2nd and 3rd minutes, it is possible to observe that the highest heart rate could be related to the highest stress or fatigue development as there were higher steps and no landings where working muscles could have micro-pauses.

During the laboratory experiments, the heart rates of the selected exercise levels did differ as expected and at the highest level the heart rates were higher than in the field (Figures 50, 68 and 69). From the 2nd minute the differences grew and they became significant at the 3rd minute, at the end and for the stable period if compared to the Ideon and Västtra Skogen experiment, and for the 3rd minute if compared to the Kista experiment (Figures 68 and 69). As in Västtra Skogen, also during the laboratory tests, the step height was higher than in the Ideon and Kista experiment, and test participants had to move without pauses in the landings. In addition, the step rate was fixed and the subjects had no chance to neither slow down nor allow for any mistakes that could lead to the balance loss. A quite large number of the subjects had, therefore, to watch down to ensure the correct placement of the feet. This may explain some of the increase in heart rate during the laboratory experiment. Another, explanation is associated with the vertical speed.

In the experiments presented in this project, heart rate was measured continuously. When comparing the results with an available and extensive ascending related study (Lam et al., 2014) then it is not so easy to evaluate the differences in the pulse. The values “before” and “straight after” would have been to be defined better in time. “Before” is better defined (at least 10 minutes before any exercise or sport started) than “immediately after”. However, it was not clear if the activity before was seated, standing or filling the questionnaire. From that viewpoint, the present study did not focus on the starting pulse. The standing values refer to the pulse that was recorded straight before the exercise started. Nevertheless, the subjects had a period of low activity at the beginning (sitting and filling the forms, standing for being instrumentation), and the recording was

initiated just before the exercise after a walk to the starting point at the bottom of the stairway, i.e., there may be an influence of either instrument delay or previous activity.

Considering the “immediately after” phase, based on this study with continuous heart rate recording, it could be observed that in this phase, the pulse was changing very quickly from near maximal to level of seated, standing or office work level (see all figures concerning VO_2 in this section, i.e., pulse behaves similarly). The change could be related to subjects’ fitness – fit subjects do recover quicker. Lam et al. (2014) do not clearly define the time when blood pressure and pulse were measured, e.g. within a minute after the exercise. Within less than 30 seconds after ceasing the exercise the values could still be relatively stable. Considering stopping, sitting, setting the equipment around the arm, pumping up and measuring, including any other delay may mean 1-1.5 minutes delay after the exercise. In average, it may correspond to a range between 70 and 150 b/min based on the data from this study. With a longer delay, more stable values could have been obtained, i.e., an average of approximately 120 b/min. Therefore, a continuous pulse recording should be recommended during similar experiments.

Figure 70 presents the oxygen consumption (VO_2) values for individual field tests and the laboratory tests. As during each group exercise only 1 subject was measured then these data are not included. The time points and periods for comparison are the same as for the heart rate measurements. The same limitations for data interpretation as for heart rate apply.

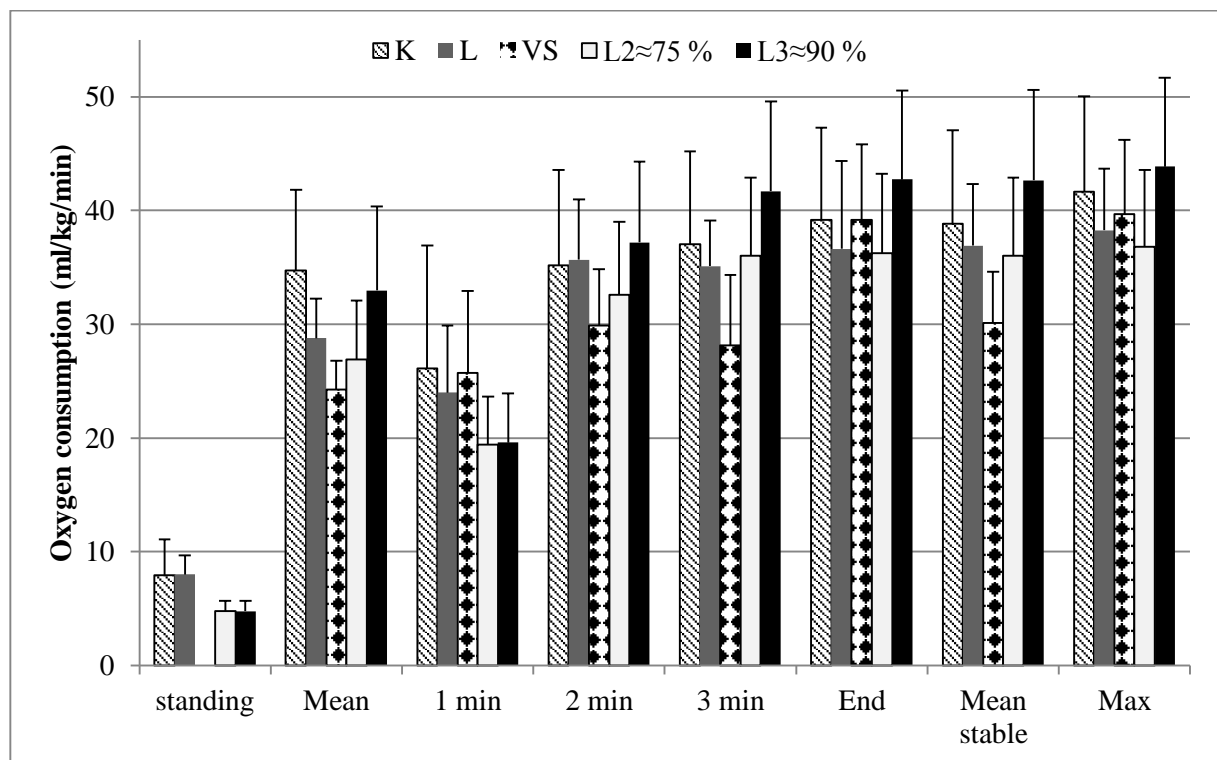

Figure 70. Oxygen consumption from the individual field and laboratory experiments. Legend: K= Kista experiment, L= Ideon Experiment, VS= Västra Skogen experiment, L2≈75% = second exertion level in lab; L3≈90% = third exertion level in lab.

It can be seen that in Västra Skogen the VO_2 values did not stabilize. Based on the 2nd and the 3rd minutes results shown in Figures 70, it can be concluded that people with lower capacity were left to continue climbing: VO_2 is considerably lower while heart rate indicating stress is similar (in relation to recorded VO_2 higher) compared to Ideon and Kista results. On the other hand, values in the Ideon and Kista experiments do not differ significantly except for the “mean” period. However, the “mean” here depends on the exercise time as longer test means also considerably

longer period with high VO_2 . The same can be said about the laboratory tests (see for instance 75% vs. 90% of $\text{VO}_{2\text{max}}$) but there were also different exertion levels present.

Similar heart rate and oxygen consumption values for Ideon (12 floors) and Kista (32 floors) indicate similar stress development (Figures 68-70). Based on physiological data recordings it cannot be stated that people's expectations of the height could have affected their performance.

As all subjects had in field different times to complete the tasks then, in order to compare the results oxygen consumption was normalized for time (Figures 71-73). A few subjects in the laboratory tests did not manage to complete the intended time of 5 minutes at the highest work load. Also these data were normalized for time (Figure 74). Although there was no direct need for normalization within 2 lower activity levels in the laboratory experiments, it was still done for comparison and for future needs to treat the data and co-analyse with walking speeds and EMG. The figures do illustrate the spread of data and in some cases the ascending strategies.

A trend line with best fit was created for all experiments. It has to be considered that the figure for the Västtra Skogen experiment (Figure 73) covers about 15% and for the Ideon experiment (Figure 71) about 30% of the VO_2 development curve in Kista (Figure 72). In the same way, the two lowest step rates in the laboratory experiment (Figure 75) cover about 60% of the one with the highest level (Figure 74). Although the highest level in the laboratory experiment stabilizes at above 40 ml/kg/min compared to Kista that in average stayed below 40 ml/kg/min, the curves have similar shapes. This can be observed considering that the laboratory test took in average approximately 50% shorter time than an average time in Kista (Figures 72 and 74).

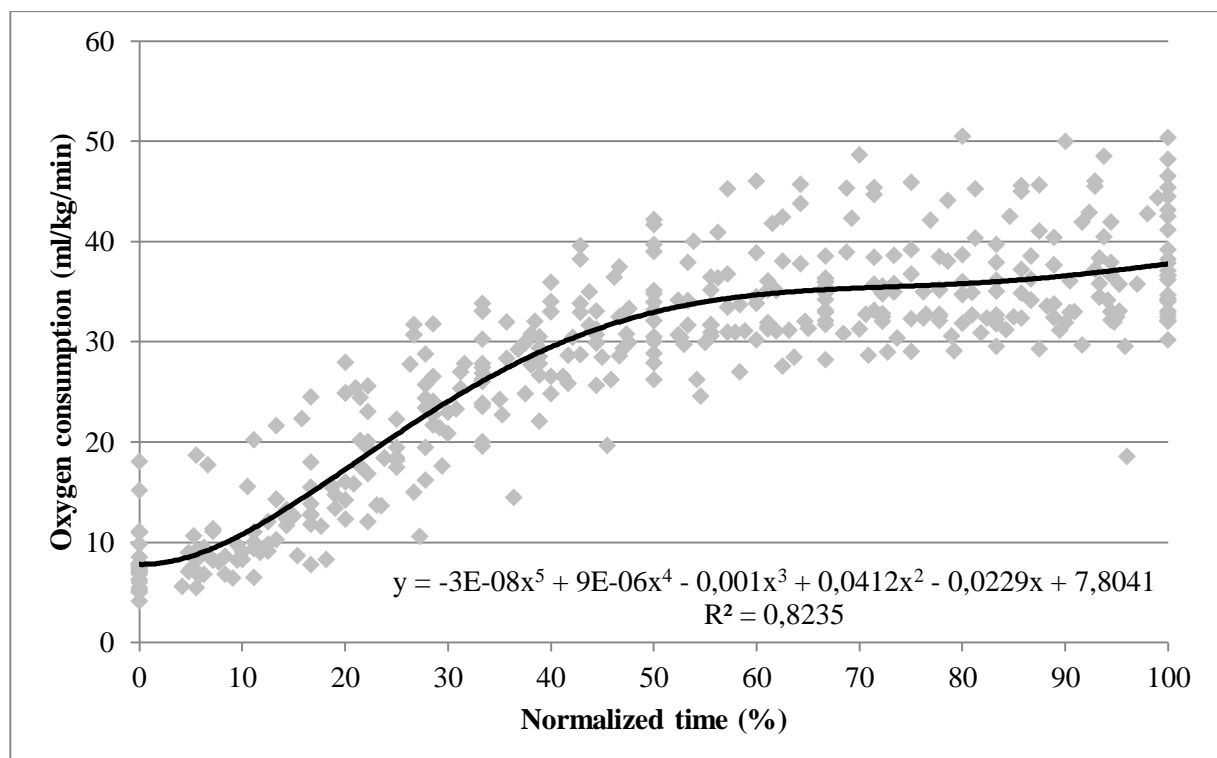

Figure 71. Time normalized development of oxygen consumption in the Ideon experiment. The black line represents a polynomial trend line.

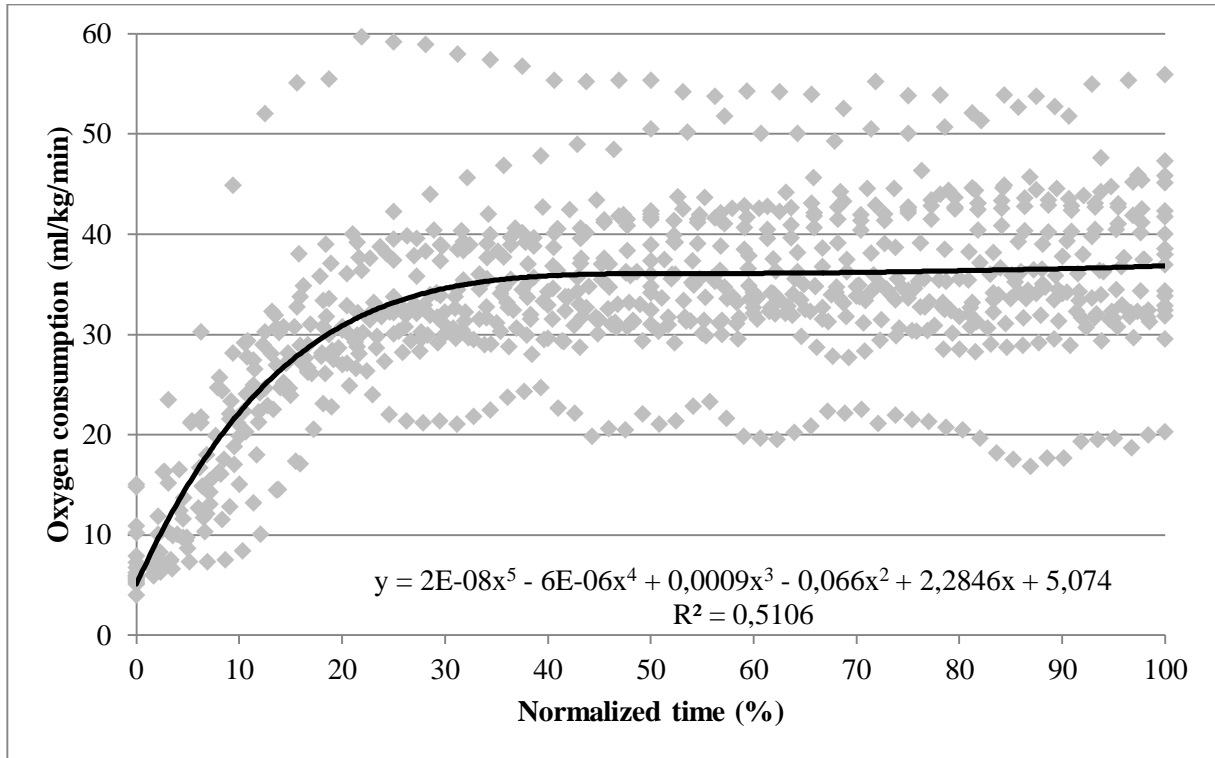

Figure 72. Time normalized development of oxygen consumption in the Kista experiment. The black line represents a polynomial trend line.

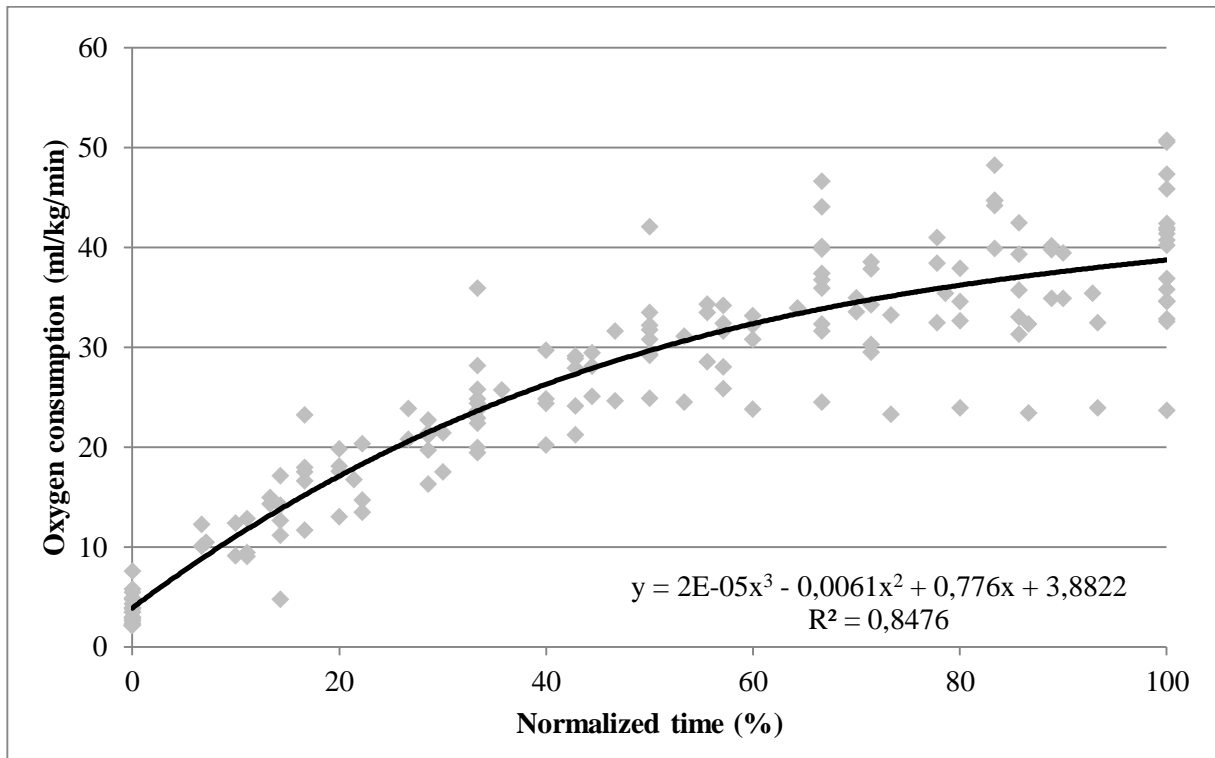

Figure 73. Time normalized development of oxygen consumption in the Västra Skögen experiment. The black line represents a polynomial trend line.

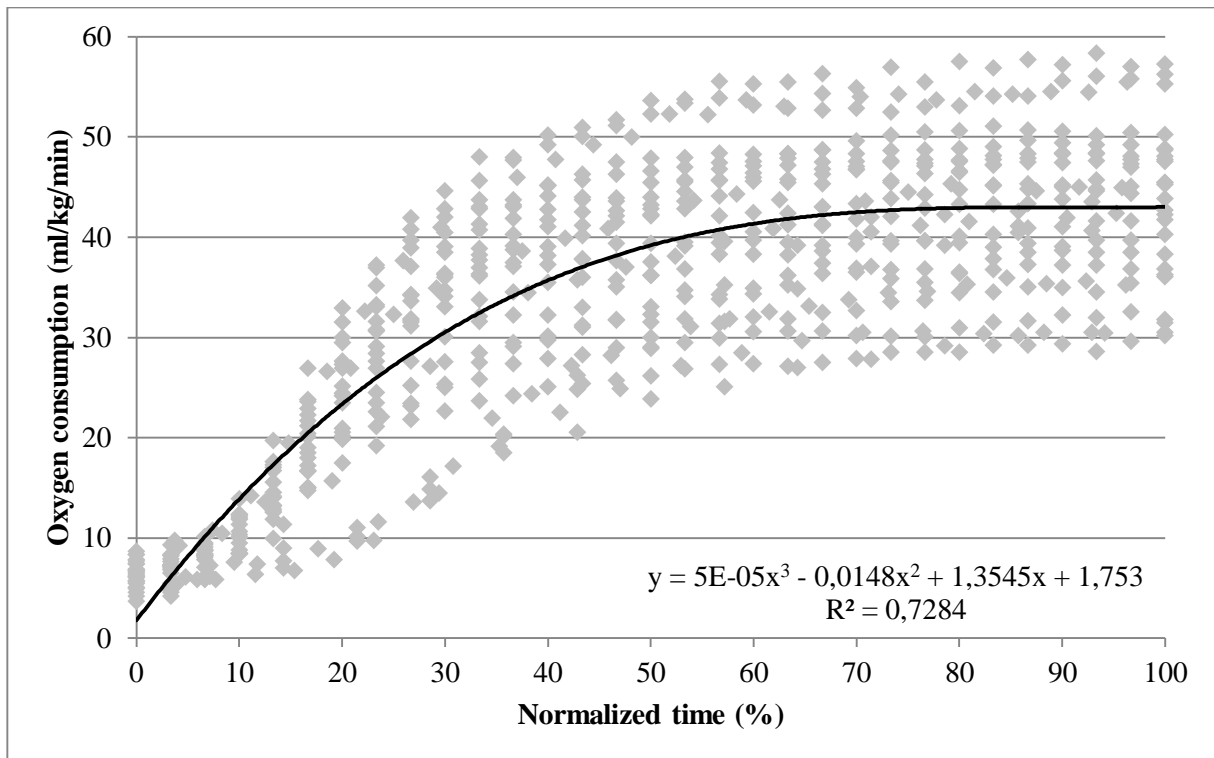

Figure 74. Time normalized development of oxygen consumption in the laboratory experiment at the highest workload (90% of VO_2 max). The black line represents a polynomial trend line.

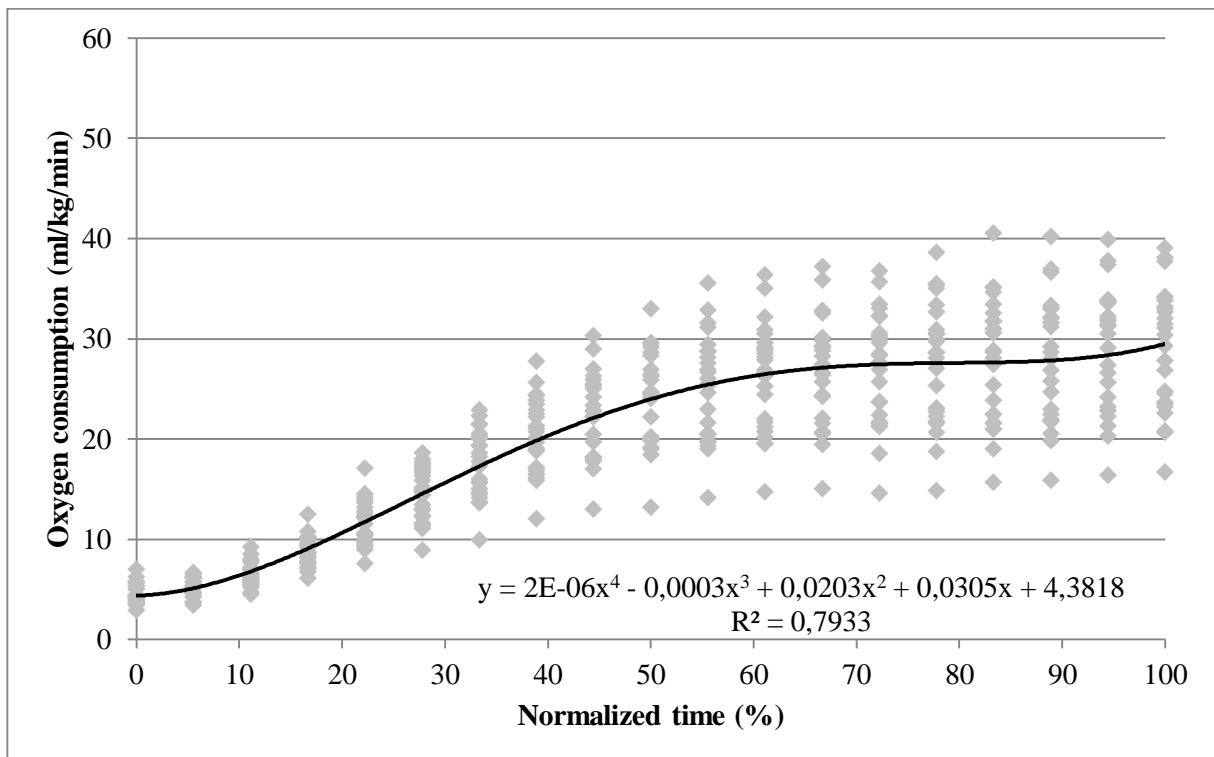

Figure 75. Time normalized development of oxygen consumption in the laboratory experiment at the lowest workload (60% of VO_2 max). The black line represents a polynomial trend line.

EMG

Exploring the complex local muscle fatigue which involves energetic, cardiovascular, neuromuscular, biomechanical and psychological factors during ascending stair evacuation is a

challenge. Several studies have measured fatigue-related changes in dynamic performance and related to mechanical and cardiovascular output during cycling muscular activity. However, very few have examined muscle activity during stair climbing while measuring the VO_2 consumption. Surface electromyography was able to measure exertion by comparing muscle electrical activities in the beginning and progressively towards the end of the climbing to get the idea whether muscle fatigue occurs or not in the leg muscles (Cifrek et al., 2009). Moreover, this part of the study was aimed to build a relationship between oxygen consumption and the muscular system especially of the leg muscles carrying the body weight. It is essential to know the physiological limits to ensure a safe ascending evacuation. More specifically, the aim was to identify the dominance of muscle fatigue locally in the legs' musculature or the cardiovascular system as a limiting factor while ascending stairways.

The results of the field studies suggested that subjects starting with a quicker speed were forced to reduce the speed because of muscular constraints. It was also observed that local fatigue gradually developed after few floors, even from the 3rd or the 4th floor. Subjects compensated muscle fatigue by reducing their climbing pace and maintained lower steady pace till the end. These results support that fatigue persisted gradually with limited cardiovascular capabilities or legs muscle force production. Previous study showed that cycling EMG median frequency changes has a relationship with the movement kinematic changes, which may lead to individual postural adaptation (Dingwell et al., 2008). The present sEMG results of the field study suggested that the muscle activity amplitude was reduced due speed reduction caused by the strategy adopted by the subjects for task completion.

Median frequencies of the muscle activities did not vary because subjects had their own control in choosing the pace and techniques to finish the climbing. In the field studies on stairs, everybody managed to reach the top floor except one female subject who could not continue due to knee pain. From a muscle fatigue perspective, it can be said that people would reach the top floor or manage to escape regardless of the number of floors (whether it is 13 or 32 floors) if sufficient time for escaping is available. This would allow changing climbing body biomechanics, adopting some postural adaptations and/or by minimizing the leg muscle force production capabilities that were all observed in EMG results.

Conversely, in the lab study thigh muscle RMS mean amplitudes were increasing from the beginning to the end of 90% of their VO_{2max} related climbing speed. Another stair climbing study found that calf muscle activity level was significantly higher during ascending (Eteraf et al., 2014). The EMG results from the laboratory study strongly suggested the occurrence of muscle fatigue, which was clearly demonstrated in the decrease of frequencies and increase of amplitudes with the progression of climbing for 5 min at the 90 % VO_{2max} level. It should be noted that this laboratory study method did exclude the subjects' opportunity to control their speed. It was mentioned previously that stair climbing is a dynamic activity and fatigue is expected after a while. In the field experiments the subjects had a full control of their speed and reasonably slowed down their pace of climbing especially when muscle fatigue appeared. Moreover, the task was not a continuous climbing of stairs at a set pace, and landings between flights allowed an obvious recovery from local muscle fatigue to some extent. Additionally, the subjects were not forced to climb as quickly as possible until the end.

5.5.4. Comparison of perceived exertion

Regarding perceived exertion, as expected, the subjective estimation of physical exertion tends to increase in all experiments with the distance walked or the vertical displacement, with a trend of higher scores towards the end of the experiments and lower normalized walking speeds.

The Borg scale recordings in relation to the normalized speeds in the different experiments is presented (Figure 76, 77 and 78). The normalized speeds are the walking speed expressed as the percentage of walking speed reduction in comparison with a person's maximum walking speed. As it can be seen by comparing the three plots, high values of Borg scales are reached in all experiments.

In the Ideon experiment, no test participant reached the maximum level even though the normalized speed was reduced to 20% of a participant's maximum speed. From floor 9 onwards, almost all participants started estimating their subjective physical exertion in the range of 15 - 19, with a majority around 15-17. The same trend can be seen in the Kista experiment where the first test participant estimated 20 on floor 12 while most of the participants estimated their physical exertion between 15 and 18 from floor 12 onwards. The variation in estimated exertion increases on the top floor but it is only one participant on each floor, from floor 12 onwards, that estimated the physical exertion as 20. It is worth noticing that when the first participant needed to rest for the first time, s/he estimated the physical exertion to 13. In the Västra skogen experiment the same trend of Ideon and Kista experiments can be observed, but the spread in estimations is lower than in the other two experiments. From the height of 27 m most of the participants estimated 15 and above. On the height of 32 m, 6 out of 21 of the participants rated their subjective physical exertion as 20 on the perceived exertion scale.

It seems that the participants adjusted their speed due to the physical exertion and aimed to be within 15 – 17 in the Borg scale. But for the Västra Skogen experiment more participants rated higher scores at a lower height compared to Ideon and Kista experiments. There are different reasons which could explain this result. One reason could be the use of handrail, i.e. people in the escalator did not use as much the handrail as in the stairwell experiments. Another reason is the step configuration (taller in the escalator), which could increase the perceived exertion. Also, the vertical displacement and the subsequent vertical speeds recorded in the Västra Skogen experiment were higher, thus it could have affected the level of perceived exertion. As pointed out before, the lack of landings in the escalator resulted in the absence of micro-pauses which allow the climbing muscles to have a short rest while the person walks on the landing in the stairwell experiments.

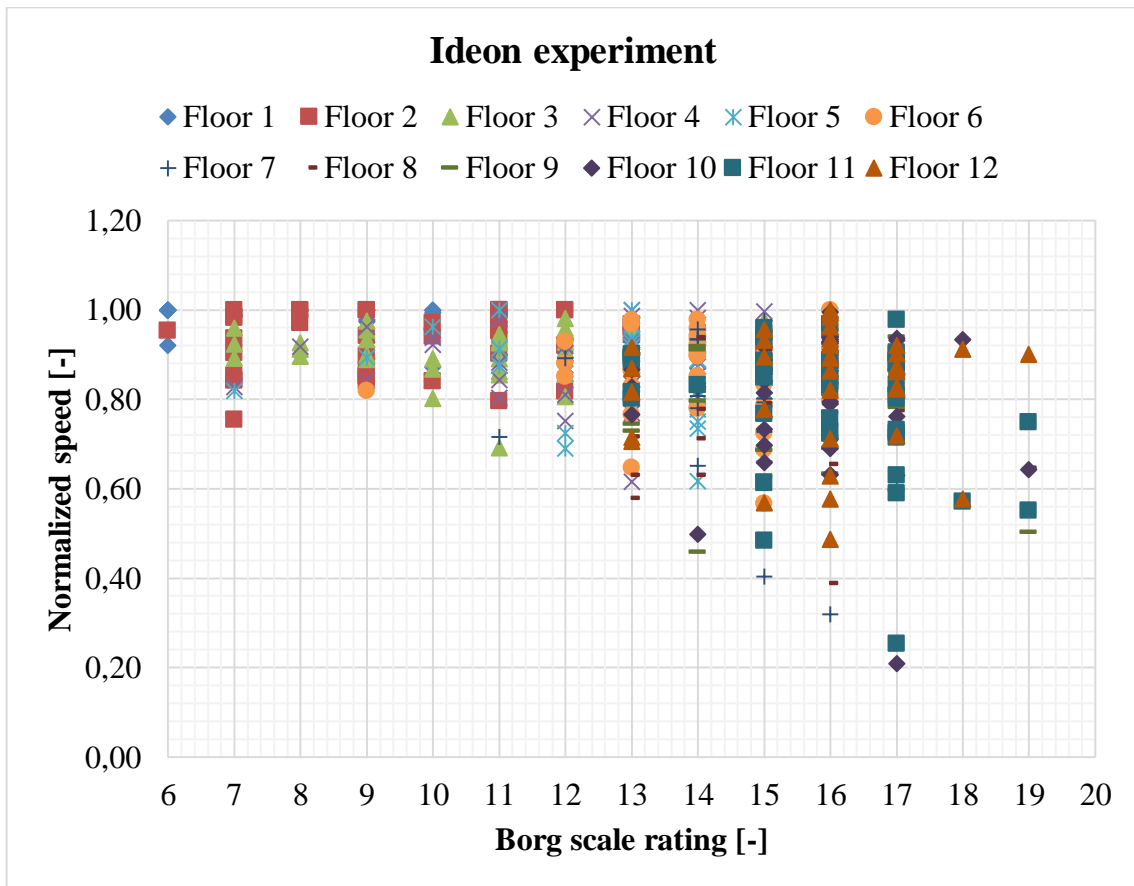

Figure 76. Borg scale ratings in relation to normalized walking speeds in the Ideon experiment.

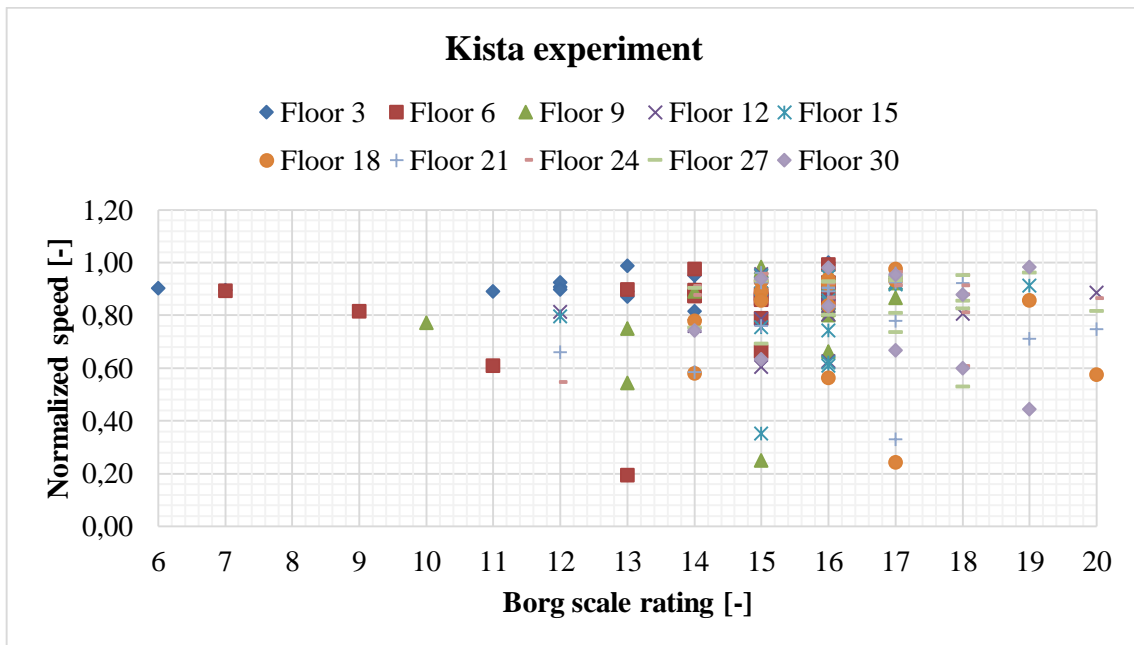

Figure 77. Borg scale ratings in relation to normalized walking speeds in the Kista experiment.

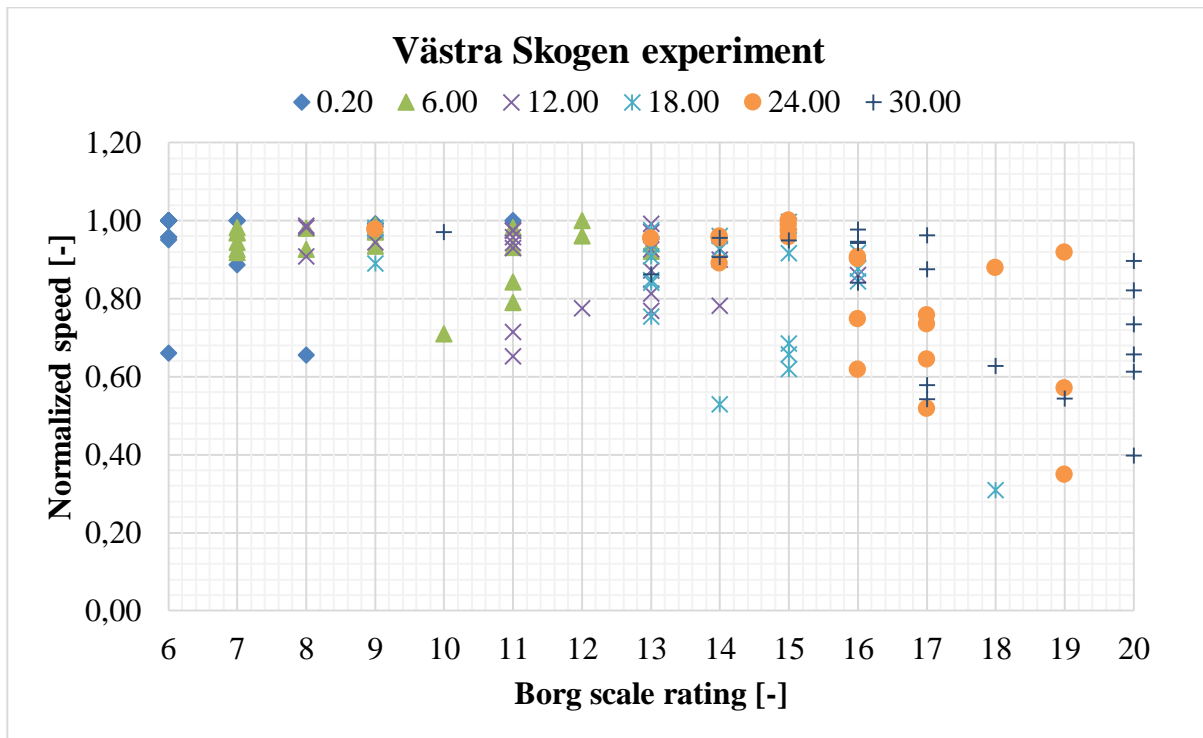

Figure 78. Borg scale ratings in relation to normalized walking speeds in the Västra Skogen experiment.

5.5.5. Qualitative observations

During the field experiments, qualitative video observations tend to show that the use of handrail increases with the physical effort, i.e. with increased physical exertion after long distances. This might be associated with the necessity of using handrails to improve balance in case of reduced physical ability due to tiredness, as well as a redistribution of the weight to other muscles (i.e., to try to reduce the effort produced by the leg muscles by using the arms as support). A similar trend was observed in the laboratory experiments, where the handrails had a significant role in the balance of the test participants during the task. It should be noted that the use of handrail differed among individuals. In the Ideon experiment, over 70% of the participants used the handrail (primarily the right handrail in the beginning of the experiment and after some floor the majority of the people using one handrail started using both handrails). In the Kista experiment, people used the handrail more when they had more people around them. This is probably linked with safety precaution due to the increased risk of falling if getting in physical contact with other people. In general, there was a preference for the handrail on the inner side in the field experiments, and there was not any preference on which side of the handrail to use among the individual test participants in the Västra Skogen experiment. Also, some participants did not use the handrail at all. This could be linked of the habit of commuters to not use handrails in escalators for hygienic reasons. In the group experiments, the use of the handrail was also observed to be different among the participants.

Another important variable which has been observed to have an impact on human behaviour is the design of the stair flights. In the Ideon experiment, the flights have odd number of treads (every other flight there are even numbers of treads and every other flights there are uneven number of treads) which benefits the rhythm of the walking speed. Considering one tread at a time within a flight, a person will be able to arrive at each landing with the inner foot. The variation in the travel path may also depend on the effects of physical exertion and that a person may take

micro pauses on the landing by taking an extra step. In addition, narrow stairs (like in an escalator or in the Ideon experiment) generates difficulty to pass slower participants and reduces the walking speed/vertical speed. This has not been observed in the Kista experiment.

In the individual experiments some test participants took breaks. The breaks were of different length and number, from one individual taking only 1 break, to another one taking up to more than 10 breaks. Breaks were also observed in the group experiments. Some test participant taking a break seemed to be clearly under a very high physical stress level and stopped for more than few seconds. The differences in the resting periods may also be explained by social influence. The individual test participant taking a break could not compare themselves to anybody else; while the group test participants could see they were staying behind. In the individual Västra Skogen experiments 5 people out of 29 took breaks, and those breaks started around the half of the climbing height. These breaks were of different length and number, from a single break, to up to 10 breaks. In the group Västra Skogen experiments 2 people out of 21 were observed to take a break. Those breaks took place in the last fifth of the climbing height. This difference in the number of breaks and their location may be explained by the social influence. An individual test participant taking a break could not compare themselves to anybody else; while the group test participant could see they were being left behind, and this could encourage them to keep the pace. However, this is not conclusive and may be due to the reduced number of participants.

The climbing distance when different participants took rests varied between the experiments. In the Ideon experiment the first rest was after 28 meters of climbing in the individual experiment and after 45 meters in the group experiment. In the Kista experiment the first rest was after 22 meters of climbing in the individual experiment and after 26 meters in the group experiment. In Västra Skogen the first rest was after 15 meters of climbing in the individual experiment and after 25 meters in the group experiment. In Kista the difference was the smallest and it may be explained to a great extent by the fact that people could walk at their desired walking speed in most cases. The small increase in height before the first rest in the group may be due to social influence. In Ideon and Västra Skogen people were more affected by each other, and had to adjust their speed to the others, making them walking slower and getting tired later in the group experiments than in the individual experiments. This could be explained by the differences in height more than social influence. The amount of data and recorded behaviour of test participants in the experiments is low and the conclusions above, from few observations, are highly speculative.

While the group test participants started walking up at the same time, participants did not receive any additional instructions than those given to the individual test participants. They were not instructed to wait for the slower ones, but there were few existing or emerging sub-groups that would move at the speed of the slowest person. At the beginning of the experiments there was a higher density per unit area, but it decreased with the time as the faster individuals started to overtake the slower ones.

Some people in the group experiment walked in the outer walking path almost all the way up, both when they walked alone and when they walked in a group. They then had the handrail on the left side closest to them. None of them was left-handed.

One woman in the group experiment in Kista experiment got tired and stopped. A second woman stopped to check on her and kept together with her all the way up to make sure that she was ok. Some groups in the Kista experiment kept walking together for long periods of time. This seemed to be a group behaviour more than a coincidental harmonisation of walking speed. Some people seemed to prefer to walk alone all the way up, avoiding mixing with the group.

5.6. Modelling fatigue

This section presents a new model to represent the impact of fatigue. This is based on the laboratory experiments performed in this project, which were designed in accordance to the field experiments. In particular, the prediction model was developed based on the first 19 laboratory subjects and it was validated on the 6 last subjects.

A prediction model was developed based on the available maximal capacity recordings of a few subjects who did participate in the field trials and assuming that the tested population would correspond to their maximal capacity to the measured student population and utilizing multivariable linear regression (XLSTAT). The step rate was calculated from VO_2 max and aimed percentage of VO_2 max. According to Holmér and Gavhed and ISO 8996 (Holmér and Gavhed, 2007; International Standards Organization, 2004), a person can manage about 5 minutes at 80-90% of VO_2 max, about 15 minutes at 70-80% of VO_2 max and up to 2 hours at 50-60% of VO_2 max. Thus the predictions were aimed towards 50%, 70% and 90% of each individual's VO_2 max. However, as there was less information on lower workloads then the measured values were quite close at high workload but exceeded the prediction considerably at low workloads (Figure 79). Some subjects had to quit the highest level, too. Presently, however, it is not possible to say if the discontinuation was related to oxygen consumption capacity or muscle fatigue. At the moment, there are just the subjective explanations of the subjects who complained on difficulty to lift the legs, indicating an effect of muscle fatigue that could be caused by high rate of repetitive activity at around the 3rd minute of exercise and the effect of lactate concentration in the muscles.

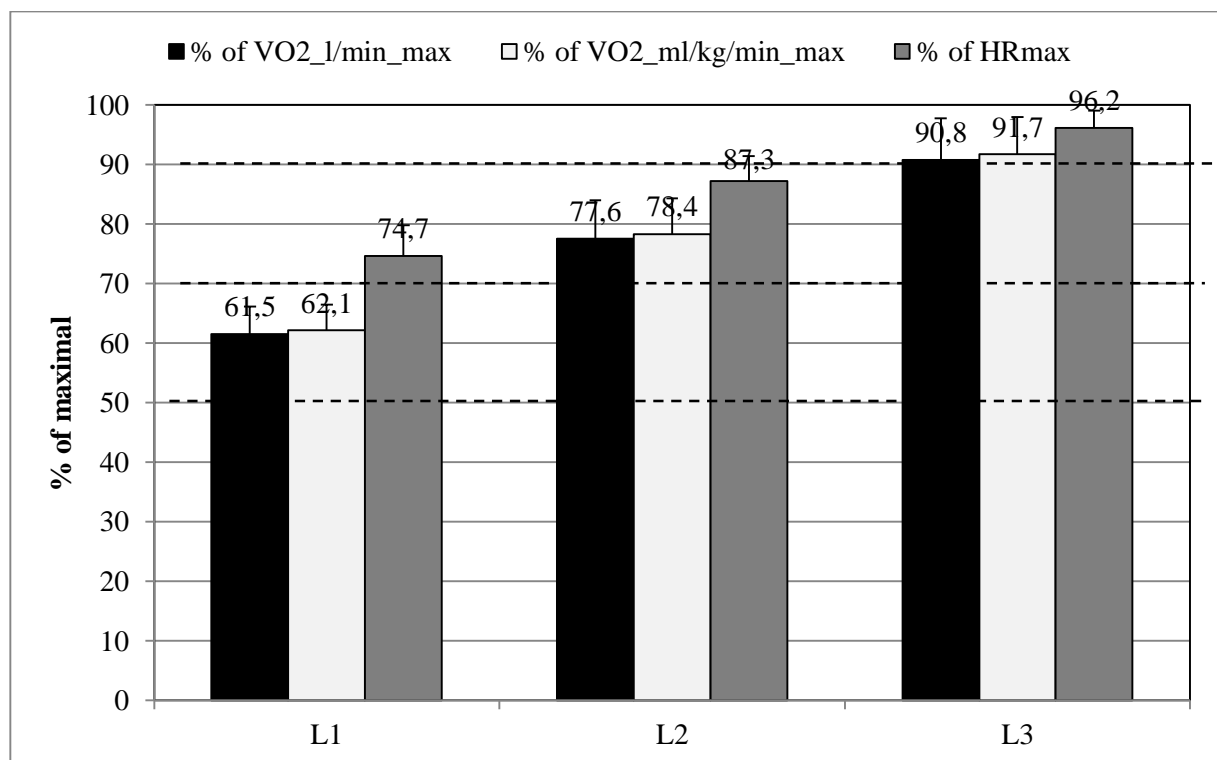

Figure 79. Measured percentage of maximal values of 19 subjects. Prediction was carried out for VO_2 max in ml/kg/min. The dashed black horizontal lines mark the aimed percentages.

As the original prediction underestimated the lower workloads, then the validation at 60%, 75% and 90% of VO_2 max was aimed at matching the previously collected data. Using the new prediction method, no subject did quit, and the aimed percentages stayed within the standard deviation of the measured values (Figure 80). Heart rate values were still closer to the maximal

than VO_2 values indicating that stress could have been caused also by other factors than oxygen consumption capacity.

The prediction equation for the step rate (steps/min) was:

$$\text{Step rate} = -108.8633 + 2.0121 * VO_{2max} + 1.3289 * \%VO_{2max} \quad [\text{Equation 1}]$$

The fitness adjusted R^2 was 0.915. Similar prediction based on heart rate led to a correlation with adjusted R^2 of 0.705.

Considering that the step rate may not be the most useful variable for practical use due to the possible effect of step height etc., an equation for vertical displacement (h_{vert} , m/min) has been developed:

$$h_{vert} = -21.7727 + 0.4024 * VO_{2max} + 0.2658 * \%VO_{2max} \quad [\text{Equation 2}]$$

Pooling the data of all lab subjects increases adjusted R^2 to 0.921, and the equation becomes:

$$h_{vert} = -20.0943 + 0.3989 * VO_{2max} + 0.2480 * \%VO_{2max} \quad [\text{Equation 3}]$$

However, Equation 3 has not been validated in the same way as the previous.

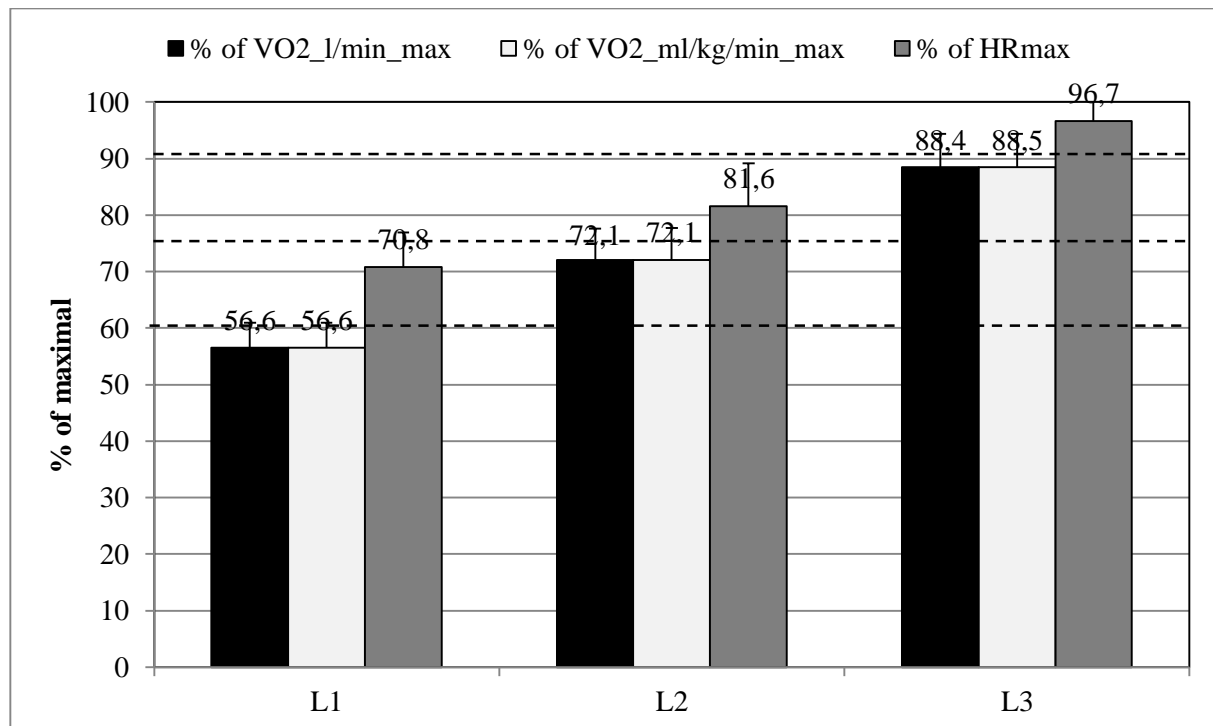

Figure 80. Measured percentage of maximal values of 6 subjects. Prediction was carried out for VO_{2max} in ml/kg/min. The dashed horizontal lines mark the aimed percentages.

In order to plan for ascending evacuation there is a need for physical capacity data of the intended population. Population characteristics, e.g. fitness levels, do define the confidence intervals as VO_{2max} and its percentage is based on individuals. There are available internet-based fitness estimations with different levels of accuracy, however, a population fitness database may be needed to improve the accuracy. This database should be created based on maximal capacity testing, however, it is very costly. Much easier and less costly are various submaximal bench, e.g. Harvard

step test, or bicycle ergometer based tests, e.g. see American College of Sports Medicine (2013) that are enough accurate to evaluate training benefits and where population means are close to the real values (absolute values for an individual may deviate). To date, the diagrams on VO_2 max dependency on fitness, age and gender from Shvartz and Reibold (1990), Jackson et al. (1990) NHANES (CDC, 2005), Loe et al. (2013) or the tables from ACSM (American College of Sports Medicine, 2013) may be used as a guideline.

Example: Calculation related to a 75 year old lady with fitness level at the border between poor and very poor (VO_2 max is about 14 ml/kg/min from the data presented in Shvartz and Reibold, 1990) gives her vertical displacement rate at 75% of her maximal capacity 3.8 m/min. She could keep up at that rate (including micro-breaks but no stops) for 15 minutes allowing her to reach up to about 57 m during that time. If she climbs the stairs at 90% max of her capacity then she would probably last less than 5 minutes but her evacuation rate would be 7.8 m/min, reaching maximally (still considering 5 minutes work) to 39 m/height before exhaustion that requires considerable rest period. Possible effect of muscle fatigue and clothing are not considered here, thus these values above should be considered as upper limits that should never be crossed. In an actual design this methodology should account of these and other factors (e.g. presence of disabilities, etc.), thus more conservative assumptions should be used.

Considering the data from the present project, then it may not be correct to utilize the results fully in this way. However, if for instance the laboratory subject 25 (validation group) is considered, the subject was fully exhausted by 5th minute and kept up only because of cheering at the side – without it, the test subject would probably have given up at 4 minutes. Now the “height” reached was 89 m and calculation gave 88.7 m. The person’s VO_2 max was 38.7 ml/kg/min and in calculation it was counted with 90% max (actual was 91.2%). Would an emergency be a strong enough motivator? If not or where risk is not obvious for people being evacuated then we might consider calculating with 10 and 4 minutes limits for 75 and 90% of maximal capacity, respectively.

Another example from the study is subject 48 in the Ideon experiment (the subject took it calm and used 4-5 min to complete 12 floors in very stable pace and VO_2) who also participated in the laboratory tests. The subject managed only 2 minutes in the lab at one’s own 92.2% of VO_2 max reaching thus to 36 m high instead of expected 77 m. However, already under the predicted medium level she did reach 91% of max for some unclear reason.

Human ability to work at various loads and its time dependence should be considered. The guidelines are available in the text above. More information can be acquired from ISO 8996 (International Standards Organization, 2004). This standard does also provide methods to estimate metabolic rate that can be derived from oxygen consumption. However, a more accurate time dependence chart would be useful, e.g. a 3D plot (Figure 81) where (normalized) time, VO_2 and vertical speed interact; type a relation on people with oxygen consumption from X1 to X2 who can keep up the pace Y for Z minutes or floors.

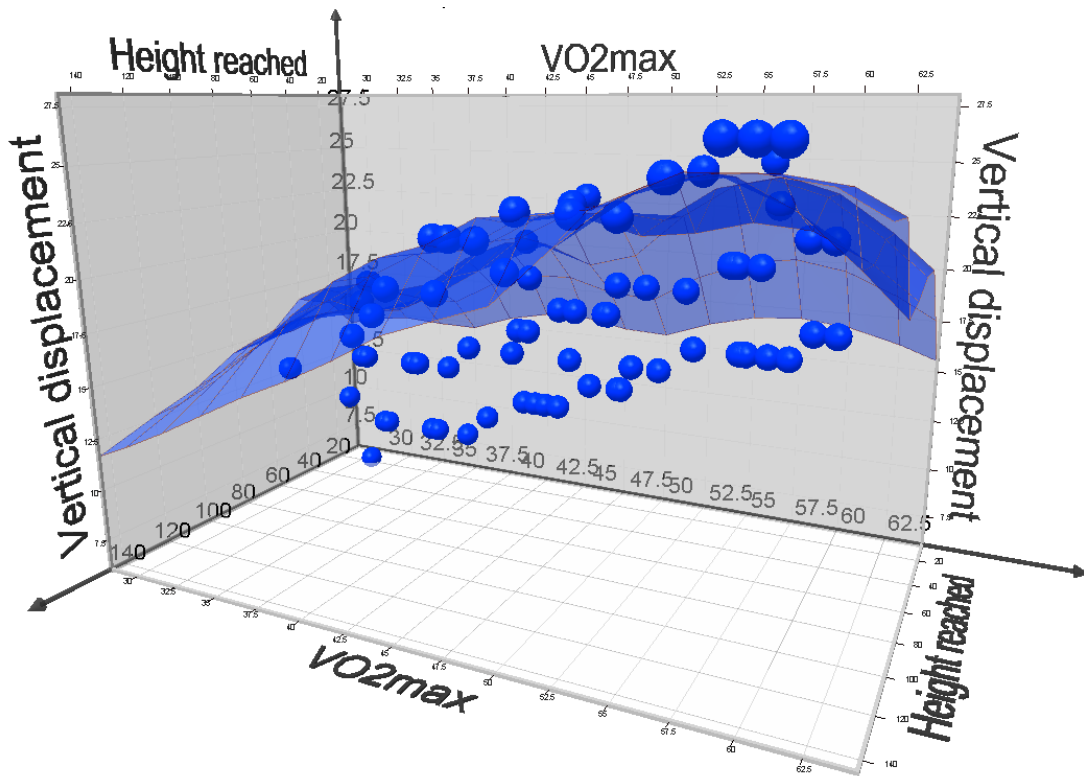

Figure 81. Three-dimensional plot where vertical displacement speed (m/min), VO_2 (ml/kg/min) and reached height (m) interact.

6. Discussion

This section presents a discussion on the results obtained during the field and laboratory experiments. A new model for the representation of the impact of physical exertion on human performance and possible implications in the fire safety engineering world are presented.

From a methodological perspective, the use of different types of cameras resulted beneficial to improve the data collection efficiency. In the Ideon experiment, it was decided to use the recordings from the wall-mounted cameras for transcribing the data and the action camera as a back-up for quality assurance. In the Kista and Västra Skogen experiment, an opposite choice was made and action camera data were the primary source of data. The availability of recordings from different sources allowed an improved accuracy in the data transcription, in particular in cases where data may be not easy to interpret (e.g. audio data in a crowded scene or the identification of the position of an individual in a crowded area). For this reason, the use of multiple sources for data collection is highly advisable in such type of experiments. It should also be noted that the action cameras was much more efficient in the process of transcribing the films to measured data (in particular for individual experiments).

Comparing the data sets from the Ideon and Kista experiments, the walking speeds at Kista are in general higher than Ideon, both when it comes to the individual experiments and the group experiment. But, when comparing the vertical speed the opposite occurs. The vertical speed in Ideon experiment is higher than the vertical speed in Kista experiment. Comparing the median vertical speeds in the first 48 m of height, a difference of just over 12% is observed for both the individual and the group experiments. The difference between walking speed and vertical speed may be explained by looking at the design of the stairwells. Both stairs are “dog leg-stairs” but the proportion between flight and landing differs. The flights in the Ideon experiment is almost 50% longer (more treads in each flight) between each landing and has a steeper inclination than in Kista experiment. The consequence of this is that in Kista experiment, a greater portion of the movement is horizontal, which has a higher speed. The higher vertical speed in Ideon experiment comes from the fact that a greater part of the movement contributes to vertical displacement. Nevertheless, conclusions cannot be drawn on its impact on ascending movement in building as high as the Kista Science Tower since the fewer number of landings in Ideon Gateway gives people less time to recover during the ascending movement. In Västra Skogen the ratio between vertical speed and walking speed is 50 % since the escalator has no landings at all.

When analysing and designing ascending evacuation, both walking speed and vertical speed should be taken into account with the purpose to address specific issues of each stairwell configuration. It may also be that the most optimal stairwell configuration will change over height. A stairwell with the height of 50 m can have one optimal design which does not fit for a stairwell with a height of 100 m. This can partly be seen from the comparison of data from the Ideon and Kista experiments. Further studies concerning the design of stairs are needed to be able to draw specific conclusions on the impact of the design of a stair on the walking speed and the vertical speed.

In Kista experiment there is a trend showing that the walking speed becomes stable at floor 20 (height of 71 m) and remains constant during the last ten floors. Comparing the current data-sets to previous data, it is noted that there are some variations. Fruin (1987), Kretz et al. (2006) and Choi et al. (2014) have all presented their result as walking speed along the ascending plane, while Yeo et al (2009) presented the data as vertical speed. The difference in data set is up to 70 % for the individual experiment and 55 % in the group experiment when comparing the walking speed at the height of 25 m of the Kista experiment with the data from Kretz et al (2006). Comparing data for vertical speed, the difference in data set is smaller. When comparing the vertical speeds of

the Ideon experiment with Yeo et al. (2009) - data for adults (0.31 m/s) - the difference is small but in the Kista experiment the difference is at least 23%. It is still difficult to compare different data-sets with each other due to the differences on data collection methods and assumptions made in the analysis of the data. The methods to perform the measurements and the analysed walking distance may also affect the results. In the current experiments, the walking speed is measured over a normalized floor to reduce local effects but still be able to capture changes in trends. However, previous studies measured the speed in other ways (for example as a mean value over a longer distance), which might affect the result. There are also differences in the studied populations in terms of age and gender, which can affect the result and there is usually scarce information about the configuration of the stairs. Based on the differences in the data, when comparing the Ideon and Kista experiments to the prior results, it seems that the design of stairs and effects of fatigue may have greater impact on walking and vertical speed than previously accounted and both walking speed and vertical speed need to be considered. Regarding the walking speeds in the Västra Skogen experiment, the values obtained in the individual experiments are slightly lower, in average, than those found in the existing literature. The walking speeds for the group experiments are consistent with those of the existing literature.

As found in the literature review, the tread depth should not exceed 30 cm because it would force the pedestrian to take longer steps which will affect body sway and physical exertion. This is demonstrated by for instance the Västra Skogen experiment (in which there is the deeper tread depth) in which the physical demand is overall higher than in the other experiments.

The experience that can be captured when looking at speed of specific individuals, mean speed, median speed and different percentiles of the studied population suggests that mean speed may not be a good value for design purposes.

When people get tired during long ascending evacuation some of them will take pauses. This can affect the total flow of egressing people and the design of the egress route must take this into consideration. There may be a positive correlation between person density, walking speed and the need to rest. High densities tend to decrease walking speed, which makes people endure longer distances before resting. If, on the other hand, the density is low, people may walk faster and getting tired faster, and may need to rest earlier. The consequences of them resting and obstructing parts of the flow are limited since the density is low. The data from this study is not large enough to verify that theory but preliminary observations based on the collected samples seem to indicate this trend. This may be an important topic for further research, which may be addressed in future computer models simulating fatigue. Based on the observations of this study it is suggested that the first climb should not be higher than 20 meters in stairs and 15 meters in escalators. After that height a resting area is suggested (and these areas should be appropriately designed in order to accommodate people queuing). The following climbs must be shorter since the time between the pauses tends also to be shorter (and the speed slower) for the people who need them. Since the stamina after taking breaks cannot be clearly defined in this study, the distance between the resting areas after the first one cannot be predicted.

Looking at the results on physiological data, it seems that an “average” person can reach height up to 12 floors without major breaks if the stairway has landings where muscles can have micro-breaks and recover to some extent. Nevertheless, fire safety design should take into account also the population below the average characteristics, so this value should be considered carefully. In contrast, continuous climbing at high pace that exceeds individual 90% of $VO_2\text{max}$ may lead to exhaustion in less than 3 minutes most probably due to local fatigue in working muscles (as in the case of an escalator with no intermediate stops). Cardiovascular capacity may allow somewhat

longer exposure, especially, if the handrails are available to redistribute some of the load from the legs to the upper body.

The increased breathing volume during ascending movement needs to be considered by engineers if FED (Purser, 2008) is used as a factor during analysis of evacuation scenarios.

The controlled climbing pace in comparison with a real emergency would probably change the whole scenario of stair climbing muscle activity observed during the laboratory experiment. Repetitive force production through leg muscles to ascend stair also depends on the capacity of the cardiovascular system to meet the demand in leg muscles. However, this also depends on the lactate tolerance level of the individual muscular system.

However, even during stair climbing in real situations with controlled speed, the effects of muscle length, mass, and the elastic properties of the muscle tissue, the tendons and the ligaments have to be taken into consideration during EMG analysis (Disselhorst-Klug et al., 2009). This does result in the fact that the EMG and VO_2 relationship differs for each muscle in relation to each subject's own style of climbing, adaptive techniques and the way his/her muscles contraction occurs.

The laboratory study confirmed the development of muscle fatigue on measured lower limb muscles. Results indicate that it might not be possible to sustain or perform climbing in a maximum speed longer than 4-6 min. Individual speed may vary in controlled condition or emergency evacuation situations. The consistency of the muscle EMG frequency and decreased amplitudes in the field studies also indicate that there was a recovery from fatigue.

The analysis of the data collected during the project supports a set of recommendations for fire safety engineering designs involving ascending evacuation. The first interesting recommendation concerns the use and interpretation of the data presented. The project results indicate different levels of physical efforts associated with ascending evacuation on stairs in comparison with ascending evacuation on escalators. This is possibly linked with a different usage of handrails (i.e. handrails were used less in the escalator experiment). In addition, the presence of landings on the stairs allows for some micro-pauses which affect the physiological response of people to the physical effort. For this reason, the use of data-sets collected in stairs (which includes landings) for the design of escalators may not be appropriate, given the different patterns of physiological response (with and without micro-pauses which allows people to rest). For this reason, a mis-use of ascending stair data-sets for the design of escalators might lead to non-conservative design solutions. Engineers should take into account the possibility to include intermediate zones for resting between too long escalators. Nevertheless, this design should be coupled with a detailed analysis of possible congestion issues in these resting zones, i.e. careful attention should be placed on the sizing of the resting zones.

An important issue to be discussed is the ethical viability of designing evacuation routes in which the evacuees arrive almost exhausted in a safe place. The results on perceived exertion (Borg scale) as well as the participants who showed the need to stop and rest during the experiments demonstrate that conservative assumptions are needed when designing the maximum vertical displacement in an ascending evacuation route. From an ethical point of view, even the completion of a successful evacuation might not be considered an optimal engineering solution if the population involved almost reach exhaustion to perform this task. The perceived exertion results show very high values in all experiments performed, thus indicating that these types of ascending evacuations are particularly demanding for the evacuating population and thus, a fire engineering design should be conservative enough to not reach exertion levels very close to exhaustion. This

is also linked with group dynamics, i.e. the group experiments show in some cases the solidarity of existing and emerging groups, i.e. some people waited for the slowest evacuees. This might lead to an increase of risk exposure to a higher number of people, i.e. ascending evacuation design should be made not for the average person, but it should account for the entire population. This should include evacuees with poor physiological abilities or fitness levels and people with different types of impairments (i.e., disabilities or diseases which impair physical abilities).

From the design point of view of the stair, it was observed that the handrail usage increased with the level of physical and perceived exertion. This was also associated with the width of the stair and the crowding conditions in the stair. Results show that handrails represent an important support for long ascending evacuation. For that reason it is recommended that stairs are designed so that all primary walking paths have access to a handrail. Secondary walking paths (e.g. paths used for overtaking only) may have a longer distance to a handrail if, for example, that walking path is in the centre line of a stair. It should be noted that in a stair both sides can become primary walking paths (and both can be slow) and the centre path will be the only area available for takeover. In flow calculations it can be assumed that only the primary paths will have high efficiency (dense flow) and that the centre path will have a small flow but will serve an important purpose as takeover area. During very crowded situations also the centre path can be used to its maximum but then the speed can be expected to very low.

The model presented in this report should be considered a useful tool to calculate for how long time people with different age, gender and fitness levels are able to perform an ascending evacuation. This information could be complemented with fundamental diagrams (Burghardt et al., 2013) which relates walking speeds and crowding conditions in order to obtain an estimation of flows in case of ascending evacuation. In addition, the predictive model allows calculating the maximum vertical displacement that people with different fitness levels, age and gender could perform. This information can be useful for the identification of the order of magnitude of vertical limits that should not be crossed when designing an egress component which involves ascending evacuation. Nevertheless, this information should always be coupled with conservative assumptions. This should be done to account for the variability in the population (i.e. people with very low fitness levels or people with disabilities). A large uncertainty in any calculation with this method is that the decision of speed for each individual is not known but may affect the outcome strongly. The probability of different decisions may therefore be implemented in the calculations. Similarly, the present model does not account for the additional weight that a person could carry during an evacuation (for instance in a metro station people could carry baggage or heavy clothes in the winter).

7. Future research

This section presents possible topics of future research in the area of ascending stair evacuation and physical exertion.

- An important future topic of research is the investigation of the effects of different stair configurations on the ascending evacuation movement. This should be made for different building heights, landing configurations, etc.
- Future additional data collection efforts with different sample characteristics in long stairwells using the same methodology are recommended in order to provide a better characterization of the walking and vertical speeds for a wider population. In particular, the analysis of the slowest percentile would allow more information on the design of stairs for ascending evacuation.
- From a methodological perspective, future measurements of walking speeds should investigate methods for the direct estimation of the actual trajectories adopted by people, e.g. the use of sensor-based techniques for trajectory tracking (Corbetta et al., 2014). This would allow a better accuracy in the estimation of walking speeds and the collection of great data-sets.
- Regarding the model and equations developed to represent physical exertion based on physiological data, it should be noted that they were developed and validated on the stair machine experiments. A further field validation is therefore strongly recommended. It should be noted that the stair machine used in this project was acquired also with future studies in mind. However, this equipment might be unsuitable for testing people with disabilities and elderly whose balance ability may not be excellent.
- The question on the effect of muscle fatigue during evacuation presents several challenges. Based on the results presented and the subjective responses presented in this report, there may be an additional interaction to take into account. Regarding the analysis of muscle activity during stair climbing, future research should focus on the study of a larger sample population in a real stairway. Future research should include all physiological measurements discussed in this work including EMG data with lactate measurements until exhaustion. The study should be performed in a controlled situation in order to generalize the results. Subjects' time normalized EMG activity with progression of climbing relative to the oxygen consumption would give an indication whether local muscle fatigue in the leg muscles or the cardiovascular capacity determines the evacuation capacity. Moreover, the scrutiny of muscle fatigue in challenging work like stair climbing may need to consider the blood lactate concentration in a muscle based on blood samples at predefined time intervals during conducting the lab study and a real stair climbing. It is not yet clear if exhaustion depends on oxygen consumption capacity, cardiovascular capacity (higher pulse due to combined stressors) or muscle fatigue.
- An additional future direction of research would concern the study of people carrying loads/weights (e.g. a parent carrying a child, heavy clothes) and to which extent this could affect the evacuation performance considering the weight in ml/kg/min. Performing a speculation on the effect of carried weight according to the literature (Givoni and Goldman, 1971) then the load most probably can be considered added to the body weight of a person. For example, a person with $VO_2\text{max}$ of 3.0 l/min (assume body weight of 70

kg) carries a load of 10 kg, e.g. a mother with a child, then the VO_{2max} in ml/kg/min for calculations change from $3*1000/70=42.9$ to $3*1000/80=37.5$ ml/kg/min or even less (additional load needed to balance the extra weight outside the line of gravity). This speculation should be confirmed by future dedicated data collection efforts.

- When people get tired during long ascending evacuation some of them will take pauses. This can affect the total flow of egressing people and the design of the egress route must take this into consideration. There may be a beneficial correlation between person density, walking speed and the need to rest. It seems like high densities decrease the walking speed which makes people endure longer distances before resting. The probability of people blocking the flow therefore decreases. If, on the other hand, the density is low, people may walk faster and getting tired faster, and may need to rest earlier. The consequences of them resting and obstructing parts of the flow are limited since the density is low. The data from this study is not large enough to verify this theory but the collected sample data seem to indicate this trend. This is an important topic for further research and it is recommended to be investigated with future computer models able to represent physical exertion.

8. Conclusions

This report presents new data-sets on long ascending evacuation which can be used to inform fire safety engineering design. The results of four experiments are presented and discussed, including two sets of stair evacuation experiments in high-rise buildings (both individual and group experiments), one long escalator experiment (both individual and group experiments) and a laboratory experiment on a stair machine.

In line with the objectives of the project, the following conclusions have been produced:

- ✓ Objective 1) *To increase the level of understanding of the emergency evacuation process during ascending evacuation by studying and describing the physical work and physical exertion effects on walking speed and associated behaviours.*

Four new data-sets on walking speeds, physiological response and behavioural activities (e.g. use of handrail, travel paths, etc.) have been presented in this report and are now available for fire safety practitioners. Results indicate that ascending evacuation on stairs and escalators present different characteristics. The presence of landings allows micro-pauses which allow longer stamina in people. Nevertheless, higher vertical speeds have been observed in the escalator experiments. An important conclusion is that data-sets should be used within their context of application given the different configurations that are generally present (e.g. stair data-sets should not be used for escalator design and vice versa).

Physical exertion can affect walking and vertical speeds in case of long ascending evacuation and it should be taken into consideration. This report also highlights that the analysis of both walking and vertical speeds is recommended in this type of experiments since it provides additional insights on the impact of stair configuration on vertical displacement.

An important issue is the ethical viability of designing evacuation routes in which the population arrives almost exhausted at the end of the stair/escalator. Perceived and physiological fatigue results demonstrate that conservative assumptions are needed when designing the maximum vertical displacement in an ascending evacuation route.

- ✓ Objective 2) *To study and describe human performance, and the possible changes in behavioural activities, e.g. travel paths, use of handrails, etc. in relation to the expected impact of physical exertion (both measured with physiological data as well as subjectively estimated) and the height of the stairs.*

The performance of people in case of ascending evacuation in long stairs and escalators has been observed and analysed, considering both individual and group experiments. The analysis of the walking paths and behaviours during stair ascent has been also presented. Physical exertion has been proved to affect different behavioural aspects during the ascent such as the use of handrails or group dynamics (formation of emerging groups, social influence, etc.). Handrail usage tends to increase with physical exertion and walked distance. Handrails provide an important support for long ascending evacuation. Adopted travel paths are generally in the inner side of the stairs, but group dynamics can have an impact on the assumed travel paths. In addition, the design of the stair is another important aspect to consider which has a major impact on human behaviour.

- ✓ Objective 3) *To develop a simple mathematical model that describes human performance during long ascending evacuation, which includes the effects of physical exertion in relation to the height of the stairs. This model can be used as a basis for evacuation design.*

A novel prediction model for the representation of physical exertion in relation to physiological data has been developed and presented. This model allows calculating the maximum vertical displacement that people can achieve in relation to the climbing pace adopted. This model can also be used to calculate the time a person can maintain a certain pace in relation to his/her age, gender and fitness level. This model can provide useful insights for both the fire safety engineering world (to verify appropriateness of existing designs with long ascending evacuations) as well as regulatory world (the model allows providing recommendations on the maximum heights of stairways/escalators in relation to the population under consideration). A large uncertainty in any calculation with this method is that the decision of speed for each individual is not known but may affect the outcome strongly. In addition, the model could be coupled with the analysis of existing computer evacuation model results to verify how the model account for the impact of individual desired speed and the effects of physical exertion.

- ✓ Objective 4) *To develop an experimental method that can be used in a laboratory setting to investigate physical work during long ascending evacuation on stairways. An objective of the laboratory tests is indeed to evaluate if the physical work of real stair climbing could be simulated on a stair machine, and thus, be used in the future for data collection on variety of populations at lower costs, but also on specific populations, e.g. people with disabilities, elderly etc., in a controlled and safer environment. Also, it was expected that by observing the relationship between a) evacuation of a group in a real setting; b) evacuation of an individual in real settings; and c) individual evacuation in a laboratory setting; it might be possible to estimate group evacuation from the laboratory tests.*

Results from laboratory and field experiments have been linked and analysed. Data collected with the stair machine have been a useful tool to evaluate the physiological abilities of people in case of long ascending evacuation and the results obtained in the laboratory setting were compared with the field data. Based on the laboratory experiments, the newly developed model could be potentially used for the estimation of the evacuation time of a group by combining the model results with existing correlations between walking speeds, evacuation times and flows. The predictive model developed using the results of the laboratory experiments will allow practitioners to have an insight into the maximum vertical displacements that people could reach in relation to their physical abilities, gender and age.

References

- American College of Sports Medicine. (2013). *ACSM's guidelines for exercise testing and prescription*. Lippincott Williams & Wilkins.
- Asplund, D. J. & Hall, S. J. (1995). Kinematics and myoelectric activity during stair-climbing ergometry. *Journal of Orthopaedic & Sports Physical Therapy*, 22(6), 247–253.
- Averill, J., Mileti, D., Peacock, R. D., Kuligowski, E. D., Groner, N., Proulx, G., ... Nelson, H. (2005). *Occupant Behavior, Egress, and Emergency Communication. Federal Building and Fire Safety Investigation of the World Trade Center Disaster* (No. NIST NCSTAR 1-7) (p. 298). Gaithersburg, MD (USA): National Institute of Standards and Technology.
- Bigland-Ritchie, B., Rice, C. L., Garland, S. J., & Walsh, M. L. (1995). Task-Dependent Factors in Fatigue of Human Voluntary Contractions. In S. C. Gandevia, R. M. Enoka, A. J. McComas, D. G. Stuart, C. K. Thomas, & P. A. Pierce (Eds.), *Fatigue* (Vol. 384, pp. 361–380). Boston, MA: Springer US. Retrieved from http://link.springer.com/10.1007/978-1-4899-1016-5_29
- Blair, A. J. & Milke, J. A. (2011). The Effect of Stair Width on Occupant Speed and Flow Rate for Egress of High Rise Buildings. In R. D. Peacock, E. D. Kuligowski, & J. D. Averill (Eds.), *Pedestrian and Evacuation Dynamics* (pp. 747–750). Boston, MA: Springer US. Retrieved from http://www.springerlink.com/index/10.1007/978-1-4419-9725-8_67
- Borg, G. A. (1982). Psychophysical bases of perceived exertion. *Med Sci Sports Exerc*, 14(5), 377–381.
- Boverket. (2013). Boverkets ändring av verkets allmänna råd (2011:27) om analytisk dimensionering av byggnaders brandskydd (BFS 2011:27 med ändringar t.o.m. 2013:12). Boverket, Karlskrona, Sweden.
- Boyce, K. E., Purser, D. A. & Shields, T. J. (2012). Experimental studies to investigate merging behaviour in a staircase. *Fire and Materials*, 36(5-6), 383–398. <http://doi.org/10.1002/fam.1091>
- Burghardt, S., Seyfried, A., & Klingsch, W. (2013). Performance of stairs – Fundamental diagram and topographical measurements. *Transportation Research Part C: Emerging Technologies*, 37, 268–278. <http://doi.org/10.1016/j.trc.2013.05.002>
- CDC (Centers for Disease Control and Prevention) (2005). National Health and Nutrition Examination Survey (NHANES). Cardiovascular Fitness Procedure Manual. January 2005, USA. <http://www.cdc.gov/nchs/nhanes.htm>
- Chen, X., Ye, J. & Jian, N. (2010). Relationships and Characteristics of Pedestrian Traffic Flow in Confined Passageways. *Transportation Research Record: Journal of the Transportation Research Board*, 2198, 32–40. <http://doi.org/10.3141/2198-05>
- Choi, J.-H., Galea, E. R. & Hong, W.-H. (2014). Individual Stair Ascent and Descent Walk Speeds Measured in a Korean High-Rise Building. *Fire Technology*, 50(2), 267–295. <http://doi.org/10.1007/s10694-013-0371-4>
- Cifrek, M., Medved, V., Tonković, S. & Ostojić, S. (2009). Surface EMG based muscle fatigue evaluation in biomechanics. *Clinical Biomechanics*, 24(4), 327–340. <http://doi.org/10.1016/j.clinbiomech.2009.01.010>
- Copenhagen Fire Brigade. (2000). Brand og brandsikkerhet i forsamlingslokaler – et fælles ansvar. Department of Fire Prevention, Copenhagen, Denmark.
- Corbetta, A., Bruno, L., Muntean, A. & Toschi, F. (2014). High Statistics Measurements of Pedestrian Dynamics. *Transportation Research Procedia*, 2, 96–104. <http://doi.org/10.1016/j.trpro.2014.09.013>
- Costill, D. L., Wilmore J. H. & Kenney, W. L., (2012). *Physiology of sport and exercise* (5th ed). Champaign, IL: Human Kinetics.
- Delin, M. & Norén, J. (2014). *Fysisk ansträngning vid utrymning uppför trappor – Kunskapsöversikt* (No. 3179) (p. 26). Lund [Sweden]: Department of Fire Safety Engineering and Systems Safety, Lund University.

- De Luca, C. J. (1983). Myoelectrical manifestations of localized muscular fatigue in humans. *Critical Reviews in Biomedical Engineering*, 11(4), 251–279.
- De Luca, C. J., Donald Gilmore, L., Kuznetsov, M. & Roy, S. H. (2010). Filtering the surface EMG signal: Movement artifact and baseline noise contamination. *Journal of Biomechanics*, 43(8), 1573–1579. <http://doi.org/10.1016/j.jbiomech.2010.01.027>
- Denny, M. W. (2008). Limits to running speed in dogs, horses and humans. *Journal of Experimental Biology*, 211(24), 3836–3849. <http://doi.org/10.1242/jeb.024968>
- Ding, J. W., Anthony S. Binder-Macleod, Stuart A. (2000). A predictive model of fatigue in human skeletal muscles. *Journal of Applied Physiology*, 89(4), 1322–1332.
- Dingwell, J. B., Joubert, J. E., Diefenthaler, F. & Trinity, J. D. (2008). Changes in Muscle Activity and Kinematics of Highly Trained Cyclists During Fatigue. *IEEE Transactions on Biomedical Engineering*, 55(11), 2666–2674. <http://doi.org/10.1109/TBME.2008.2001130>
- Ding, Y., Yang, L. & Rao, P. (2013). Investigating the Merging Behavior at the Floor-stair Interface of High-rise Building Based on Computer Simulations. *Procedia Engineering*, 62, 463–469. <http://doi.org/10.1016/j.proeng.2013.08.088>
- Disselhorst-Klug, C., Schmitz-Rode, T. & Rau, G. (2009). Surface electromyography and muscle force: Limits in sEMG–force relationship and new approaches for applications. *Clinical Biomechanics*, 24(3), 225–235. <http://doi.org/10.1016/j.clinbiomech.2008.08.003>
- Dorman, L. E. & Havenith, G. (2009). The effects of protective clothing on energy consumption during different activities. *European Journal of Applied Physiology*, 105(3), 463–470. <http://doi.org/10.1007/s00421-008-0924-2>
- Du Bois, D. & Du Bois E. F. (1916). A formula to estimate the approximate surface area if height and weight be known. *Archives of Internal Medicine*, XVII(6_2), 863. <http://doi.org/10.1001/archinte.1916.00080130010002>
- Duggan, A. (1988). Energy cost of stepping in protective clothing ensembles. *Ergonomics*, 31(1), 3–11. <http://doi.org/10.1080/00140138808966645>
- Egan, M. D. (1978). *Concepts in building fire safety*. New York: Wiley.
- Elliott, B. C. & Roberts, A. D. (1980). A biomechanical evaluation of the role of fatigue in middle-distance running. *Canadian Journal of Applied Sport Sciences. Journal Canadien Des Sciences Appliquees Au Sport*, 5(4), 203–207.
- Eteraf Oskouei, A., Ferdosrad, N., Dianat, I., Asghari Jafarabadi, M. & Nazari, J. (2014). Electromyographic Activity of Soleus and Tibialis Anterior Muscles during Ascending and Descending Stairs of Different Heights. <http://doi.org/10.5681/hpp.2014.023>
- Frantzich, H. (1993). Utrymningsvägars fysiska kapacitet. Sammanställning och utvärdering av kunskapsläget. *LUTVDG/TVBB–3069–SE*.
- Frantzich, H. (1996). *Study of movement on stairs during evacuation using video analysing techniques* (No. 3079) (p. 44). Departement of Fire Safety Engineering, Lund University.
- Fruin, J. J. (1971). *Pedestrian Planning and Design*. Elevator World, Inc, Mobile
- Galea, E. R., Sharp, G. & Lawrence, P. J. (2008). Investigating the Representation of Merging Behavior at the Floor--Stair Interface in Computer Simulations of Multi-Floor Building Evacuations. *Journal of Fire Protection Engineering*, 18(4), 291–316. <http://doi.org/10.1177/1042391508095092>
- Givoni, B. & Goldman, R. F. (1971). Predicting metabolic energy cost. *Journal of Applied Physiology*, 30(3), 429–433.
- Graat, E., Midden, C. & Bockholts, P. (1999). Complex evacuation; effects of motivation level and slope of stairs on emergency egress time in a sports stadium. *Safety Science*, 31(2), 127–141. [http://doi.org/10.1016/S0925-7535\(98\)00061-7](http://doi.org/10.1016/S0925-7535(98)00061-7)
- Gwynne, S., Galea, E. R., Owen, M., Lawrence, P. & Filippidis, L. (1999). A review of the methodologies used in evacuation modelling. *Fire and Materials*, 23(6), 383–388. [http://doi.org/10.1002/\(SICI\)1099-1018\(199911/12\)23:6<383::AID-FAM715>3.0.CO;2-2](http://doi.org/10.1002/(SICI)1099-1018(199911/12)23:6<383::AID-FAM715>3.0.CO;2-2)

- Gwynne, S. M. V. & Rosenbaum, E. (2008). Employing the Hydraulic Model in Assessing Emergency Movement. In *SFPE Handbook of Fire Protection Engineering* (4th Edition). National Fire Protection Association, Quincy (MA): Di Nenzo P. J.
- Hokugo, A., Kubo, K. & Murozaki, Y. (1985). An Experimental Study on Confluence of Two Foot Traffic Flows in Staircase. *Journal of Architecture, Planning and Environmental Engineering*, 358, 37–43.
- Holmér, I. & Gavhed, D. (2007). Classification of metabolic and respiratory demands in firefighting activity with extreme workloads. *Applied Ergonomics*, 38(1), 45–52. <http://doi.org/10.1016/j.apergo.2006.01.004>
- Hoskins, B. L. & Milke, J. A. (2012). Differences in measurement methods for travel distance and area for estimates of occupant speed on stairs. *Fire Safety Journal*, 48, 49–57. <http://doi.org/10.1016/j.firesaf.2011.12.009>
- Hyun-seung, H., Jun-ho, C. & Won-hwa, H. (2011). Calculating and Verifying the Staircase-length for Evacuation Analysis. In R. D. Peacock, E. D. Kuligowski, & J. D. Averill (Eds.), *Pedestrian and Evacuation Dynamics* (pp. 601–611). Boston, MA: Springer US. Retrieved from http://www.springerlink.com/index/10.1007/978-1-4419-9725-8_54
- International Standards Organization. (2004). ISO 8996:2004 Ergonomics of the thermal environment -- Determination of metabolic rate.
- Jackson A.S., Blair S.N., Mahar M.T., Wier L.T., Ross R.M. & Stuteville J.E. (1990) Prediction of functional aerobic capacity without exercise testing. *Medicine and Science in Sports and Exercise*, 22(6), 863-870
- Kadokura, H., Sekizawa, A. & Takahashi, W. (2012). Study on availability and issues of evacuation using stopped escalators in a subway station: Evacuation Using Stopped Escalators in a Subway Station. *Fire and Materials*, 36(5-6), 416–428. <http://doi.org/10.1002/fam.1097>
- Khisty, C. (1985). *Pedestrian flow characteristics on stairways during disaster evacuation*.
- Kinsey, M. J. (2011). *Vertical Transport Evacuation Modelling*. Greenwich, London, UK.
- Koo, J., Kim, B.-I. & Kim, Y. S. (2014). Estimating the effects of mental disorientation and physical fatigue in a semi-panic evacuation. *Expert Systems with Applications*, 41(5), 2379–2390. <http://doi.org/10.1016/j.eswa.2013.09.036>
- Kretz, T., Grünebohm, A., Kessel, A., Klüpfel, H., Meyer-König, T. & Schreckenberger, M. (2006). Upstairs walking speed distributions on a long stairway. *Physik von Transport und Verkehr, Universität Duisburg-Essen, Duisburg, Germany*.
- Kuklane, K., Dahlqvist, C., Lundgren, K., Lucas, R., Halder, A., Gao, C., Jakobsson, K., & Hansson, G. (2015). Assessment of workload in heat: an approach with accelerometers. Presented at the International Symposium on Firefighters and Heat Strain, Seoul National University.
- Kuklane K. & Gao C. (2012) Lecture materials on laboratory exercise summaries for Human Performance in Extreme Environments course (summarized data for 2006-2012). Division of Ergonomics and Aerosol Technology, Lund University.
- Kuligowski, E. D., Peacock, R. D. & Hoskins, B. (2010). *A Review of Building Evacuation Models, 2nd Edition* (No. Technical Note 1680) (p. 36). Gaithersburg, MD (USA): National Institute of Standards and Technology.
- Kuligowski, E. D., Peacock, R. D., Reneke, P. K., Weiss, E., Hagwood, C. R., Overholt, K. J., Elkin R. P., Averill J., Ronchi E., Hoskins, B. & Spearpoint, M. (2014). *Movement on Stairs During Building Evacuations* (No. NIST TN 1839). National Institute of Standards and Technology. Retrieved from <http://nvlpubs.nist.gov/nistpubs/TechnicalNotes/NIST.TN.1839.pdf>
- Kuligowski, E., Peacock, R., Wiess, E. & Hoskins, B. (2013). Stair evacuation of older adults and people with mobility impairments. *Fire Safety Journal*. <http://doi.org/10.1016/j.firesaf.2013.09.027>

- Kvarnström, L. (1977). Trappor, en sammanställning av delrapporter rörande trappor och trappgåendet. Arkitektur 1 B, Lunds tekniska högskola.
- Kvarnström, L. & Ericson, L. (1980). Spiraltrappan, en diskussion om risker och rörelseer. Arkitektur 1 B, Lunds tekniska högskola.
- Lag. (2003). Om etik prövning av forskning som avser människor [The Act concerning the Ethical Review of Research Involving Humans] Lag(2003:460).
- Lam, J. H. T., Yuen, J. K. K., Lee, E. W. M. & Lee, R. Y. Y. (2014). Experimental study on upward movement in a high-rise building. *Safety Science*, 70, 397–405. <http://doi.org/10.1016/j.ssci.2014.07.011>
- Larusdottir, A. R. & Dederichs, A. S. (2012). Evacuation of Children: Movement on Stairs and on Horizontal Plane. *Fire Technology*, 48(1), 43–53. <http://doi.org/10.1007/s10694-010-0177-6>
- Lee, J.-Y., Bakri, I., Kim, J.-H., Son, S.-Y. & Tochiyama, Y. (2013). The Impact of Firefighter Personal Protective Equipment and Treadmill Protocol on Maximal Oxygen Uptake. *Journal of Occupational and Environmental Hygiene*, 10(7), 397–407. <http://doi.org/10.1080/15459624.2013.792681>
- Lichtneckert, S. (1973). Arbetsfysiologisk undersökning. Fysiologiska institutionen. Lunds Universitet.
- Loe, H., Rognum, Ø., Saltin, B. & Wisløff, U., 2013. Aerobic Capacity Reference Data in 3816 Healthy Men and Women 20–90 Years. PLoS ONE 8, e64319. [doi:10.1371/journal.pone.0064319](https://doi.org/10.1371/journal.pone.0064319)
- MacIsaac, D., Parker, P. A. & Scott, R. N. (2001). The short-time Fourier transform and muscle fatigue assessment in dynamic contractions. *Journal of Electromyography and Kinesiology*, 11(6), 439–449. [http://doi.org/10.1016/S1050-6411\(01\)00021-9](http://doi.org/10.1016/S1050-6411(01)00021-9)
- Mehta, J. P., Lavender, S. A., Hedman, G. E., Reichelt, P. A., Park, S. & Conrad, K. M. (2014). Evaluating the physical demands on firefighters using track-type stair descent devices to evacuate mobility-limited occupants from high-rise buildings. *Applied Ergonomics*. <http://doi.org/10.1016/j.apergo.2014.07.009>
- Melly, M., Lennon, P. & Lennon, R. (2009). Who defers to whom? Deference behaviour on stairs (pp. 135–146). Presented at the Human Behaviour in Fire 2009 Symposium, Interscience Communications.
- Morgan, D. W., Martin, P. E. & Krahenbuhl, G. S. (1989). Factors Affecting Running Economy. *Sports Medicine*, 7(5), 310–330. <http://doi.org/10.2165/00007256-198907050-00003>
- Norén, J., Delin, M. & Fridolf, K. (2014). Ascending Stair Evacuation: What do We Know? *Transportation Research Procedia*, 2, 774–782. <http://doi.org/10.1016/j.trpro.2014.09.087>
- Okada, N., Hasemi, Y., Moriyama, S. & Hirakawa, K. (2009). Feasibility of upward evacuation by escalator – an experimental study. In *HBIF2009*. Cambridge, UK: Interscience Communications.
- Pauls, J. L. (1980). Effective Width Model for Evacuation Flow in Buildings (pp. 215–232). Presented at the Engineering Applications of Fire Technology, Washington DC: National Bureau of Standards.
- Pauls, J. L., Fruin, J. J. & Zupan, J. M. (2007). Minimum Stair Width for Evacuation, Overtaking Movement and Counterflow — Technical Bases and Suggestions for the Past, Present and Future. In N. Waldau, P. Gattermann, H. Knoflacher, & M. Schreckenberg (Eds.), *Pedestrian and Evacuation Dynamics 2005* (pp. 57–69). Berlin, Heidelberg: Springer Berlin Heidelberg. Retrieved from http://link.springer.com/10.1007/978-3-540-47064-9_5
- Peacock, R. D., Averill, J. D. & Kuligowski, E. D. (2010). Stairwell Evacuation from Buildings: What We Know We Don't Know. In W. W. F. Klingsch, C. Rogsch, A. Schadschneider, & M. Schreckenberg (Eds.), *Pedestrian and Evacuation Dynamics 2008* (pp. 55–66). Berlin, Heidelberg: Springer Berlin Heidelberg. Retrieved from http://link.springer.com/10.1007/978-3-642-04504-2_4

- Pelechano, N. & Malkawi, A. (2008). Evacuation simulation models: Challenges in modeling high rise building evacuation with cellular automata approaches. *Automation in Construction*, 17(4), 377–385. <http://doi.org/10.1016/j.autcon.2007.06.005>
- Pijpers, J. R., Bakker, F. C. & Holsheimer, F. (2013). Fatigue and Reachability. In *Studies in Perception and Action IV* (MA Schmuckler and JM Kennedy, eds, pp. 145–148). Hillsdale.
- Predtechenskii, V. M. & Milinskii, A. I. (1978). *Planning for foot traffic flow in buildings*. Amerind Publishing.
- Proulx, G., (2002). *Movement of People: The Evacuation Timing*, in: SFPE Handbook of Fire Protection Engineering. National Fire Protection Association, Quincy, MA (USA), pp. 3–341 – 3–366 (Chapter 3–13).
- Purser, D.A., 2008. Assessment of Hazards to Occupants from smoke, toxic gases and heat, in: SFPE Handbook of Fire Protection Engineering (4th Edition). Di Nenno P. J., Quincy, MA (USA), pp. 2–96 – 2–193.
- Robergs, R. A. & Landwehr, R. (2002). The surprising history of the “HRmax= 220-age” equation. *J Exerc Physiol*, 5(2), 1–10.
- Ronchi, E. (2013). Testing the predictive capabilities of evacuation models for tunnel fire safety analysis. *Safety Science*, 59(0), 141–153. <http://doi.org/10.1016/j.ssci.2013.05.008>
- Ronchi, E. & Kinsey, M. (2011). Evacuation models of the future: insights from an online survey of user’s experiences and needs (pp. 145–155). Presented at the Advanced Research Workshop: Evacuation and Human Behavior in Emergency Situations, Santander, Spain: University of Cantabria.
- Ronchi, E. & Nilsson, D. (2013). Fire evacuation in high-rise buildings: a review of human behaviour and modelling research. *Fire Science Reviews*, 2(1), 7. <http://doi.org/10.1186/2193-0414-2-7>
- Ronchi, E., Reneke, P. A., Kuligowski, E. D. & Peacock, R. D. (2014). An analysis of evacuation travel paths on stair landings by means of conditional probabilities. *Fire Safety Journal*, 65, 30–40. <http://doi.org/10.1016/j.firesaf.2014.02.001>
- Seer, S., Bauer, D., Brandle, N. & Ray, M. (2008). Estimating Pedestrian Movement Characteristics for Crowd Control at Public Transport Facilities (pp. 742–747). IEEE. <http://doi.org/10.1109/ITSC.2008.4732689>
- Selvik, G. & Sonesson, B. (1974). Rörelsemönster vid gång i trappor. En funktionell-anatomisk studie. Byggeforskningens rapportserie, Lund, Sweden.
- Shvartz, E. & Reibold, R. (1990). Aerobic fitness norms for males and females aged 6 to 75 years: a review. *Aviation, Space, and Environmental Medicine*, 61(1), 3–11.
- Spearpoint, M. & MacLennan, H. A. (2012). The effect of an ageing and less fit population on the ability of people to egress buildings. *Evacuation and Pedestrian Dynamics*, 50(8), 1675–1684. <http://doi.org/10.1016/j.ssci.2011.12.019>
- Takeichi, N., Yoshida, Y., Sano, T., Kimura, T., Watanabe, H., & Ohmiya, Y. (2005). Characteristics of Merging Occupants In A Staircase. *Fire Safety Science*, 8, 591–598. <http://doi.org/10.3801/IAFSS.FSS.8-591>
- Templer, J. A. (1974). *Stair Shape and Human Movement*. Phd Dissertation. Columbia University.
- United Nation (2006). Convention on the Rights of Persons with Disabilities, Operation protocol A/RES/61/106.
- Warren, W. H. (1984). Perceiving affordances: Visual guidance of stair climbing. *Journal of Experimental Psychology: Human Perception and Performance*, 10(5), 683–703.
- Weidmann, U. (1992). *Transporttechnik der Fussgänger*. *Transporttechnische Eigenschaften des Fussgängerverkehrs Literaturlauswertung*. Zurich, Switzerland: IVT, Institut für Verkehrsplanung, Transporttechnik, Strassen- und Eisenbahnbau.
- Yeo, S. K. & He, Y. (2009). Commuter characteristics in mass rapid transit stations in Singapore. *Fire Safety Journal*, 44(2), 183–191. <http://doi.org/10.1016/j.firesaf.2008.05.008>

Appendix A – Walking speeds vs gender and age

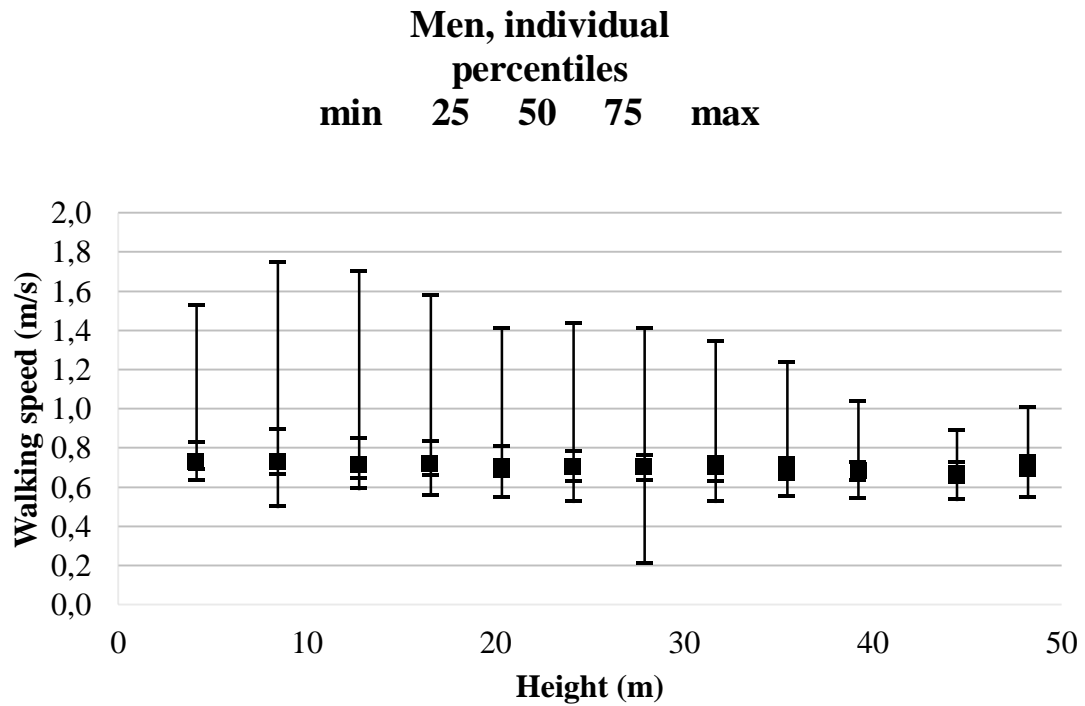

Figure A1. Walking speed in the individual Ideon experiment of the male sample.

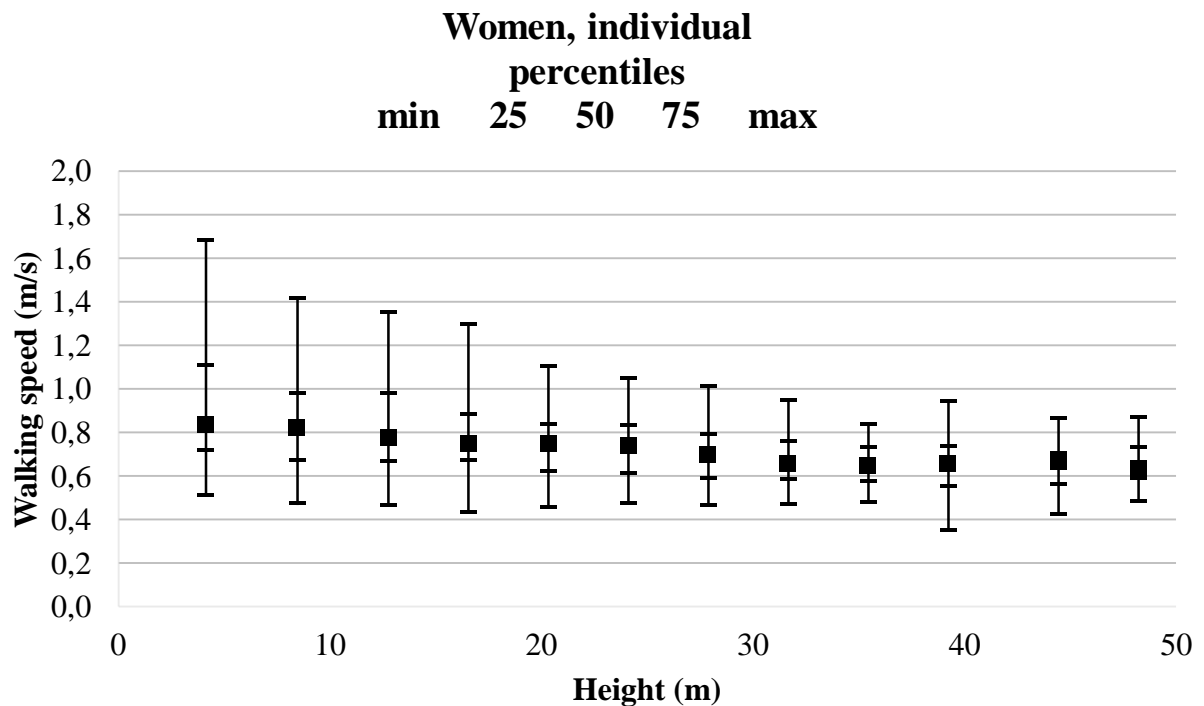

Figure A2. Walking speed in the individual Ideon experiment of the female sample.

More than 40 years old, individual percentiles

min 25 50 75 max

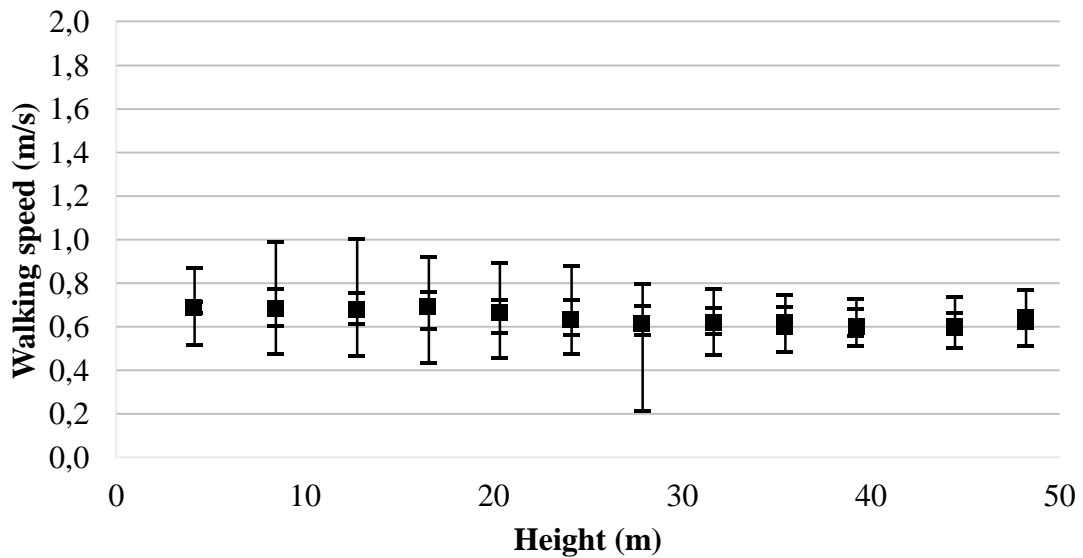

Figure A3. Walking speed in the individual Ideon experiment of the individuals above 40 years old.

40 years old or less, individual percentiles

min 25 50 75 max

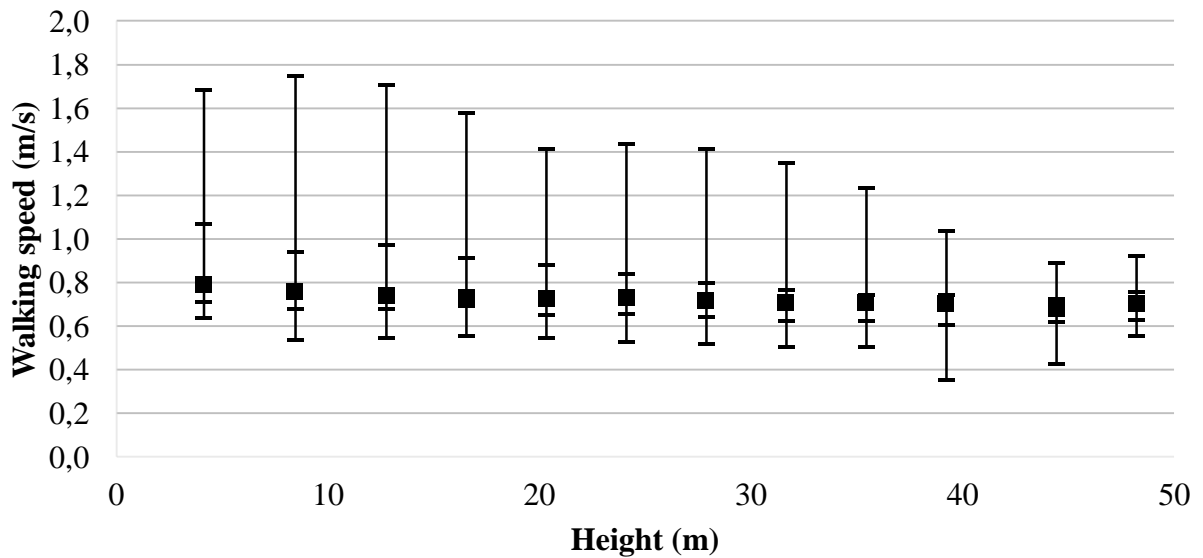

Figure A4. Walking speed in the individual Ideon experiment of the individuals below 40 years old.

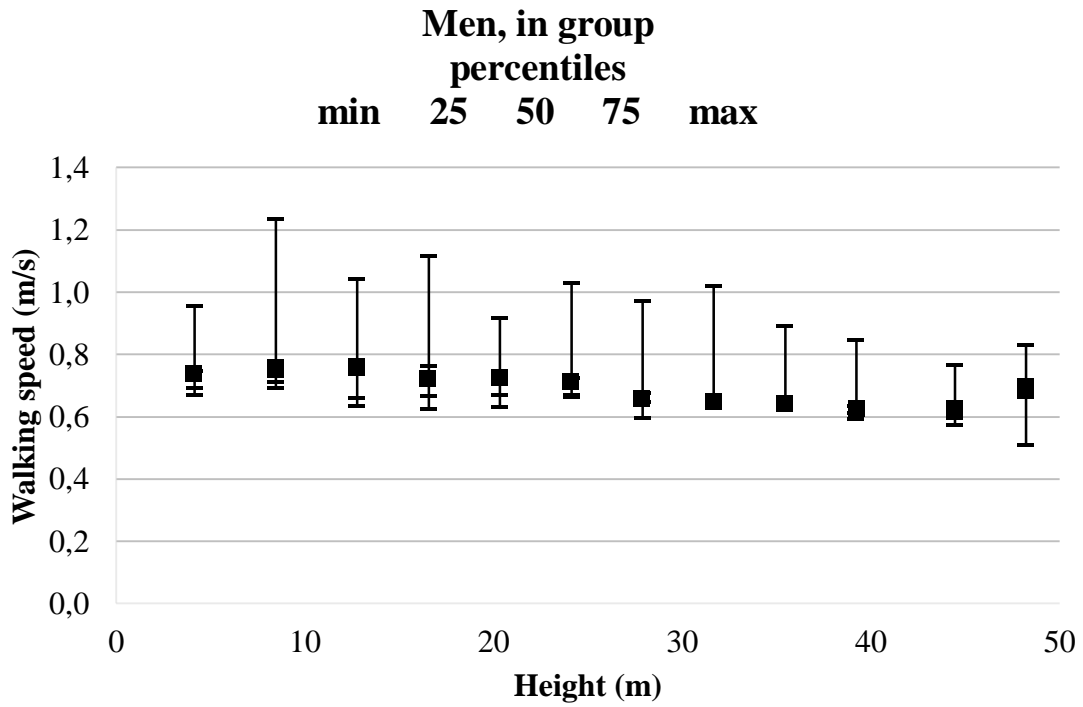

Figure A5. Walking speed in the group Ideon experiment of the male sample.

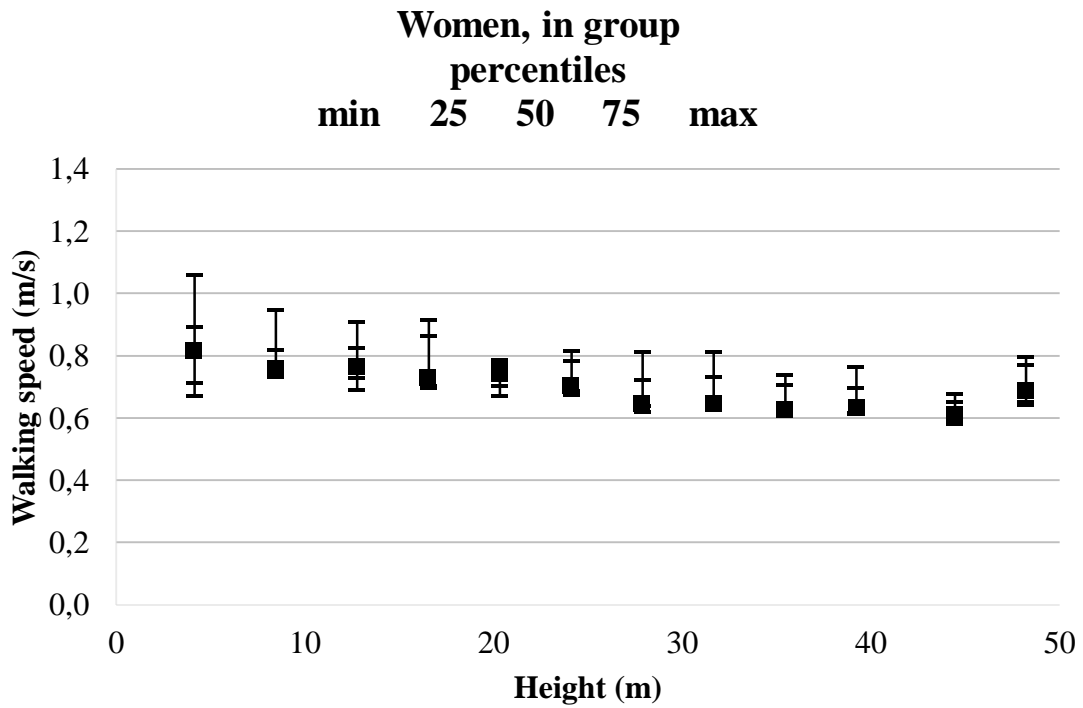

Figure A6. Walking speed in the group Ideon experiment of the female sample.

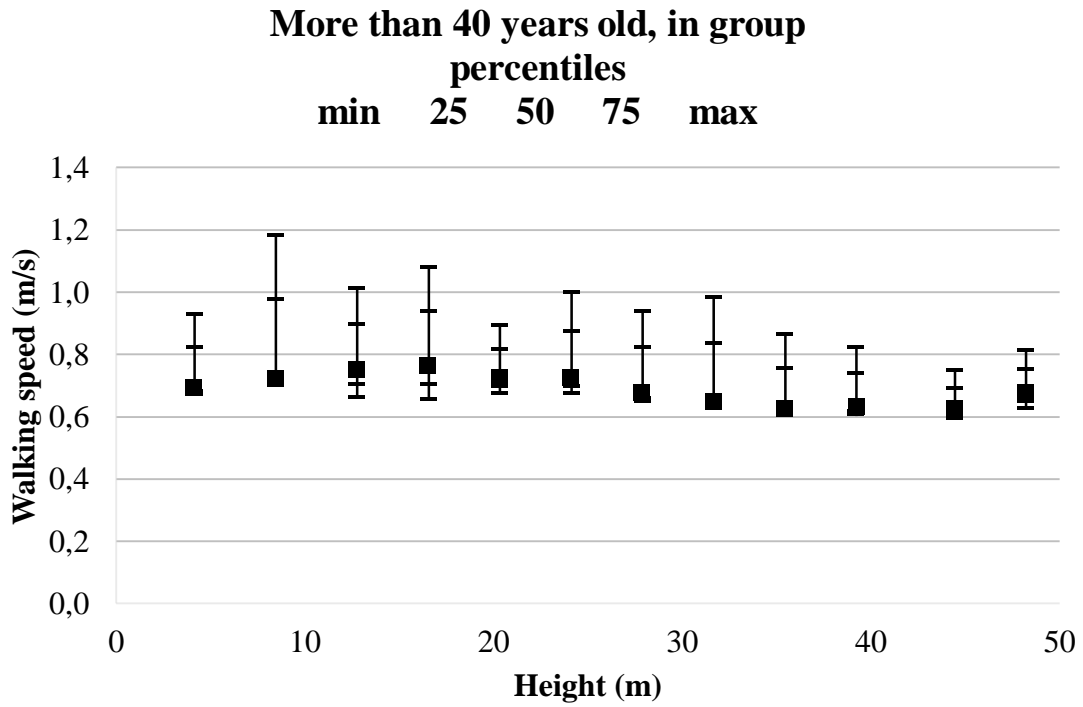

Figure A7. Walking speed in the group Ideon experiment of the group individuals above 40 years old.

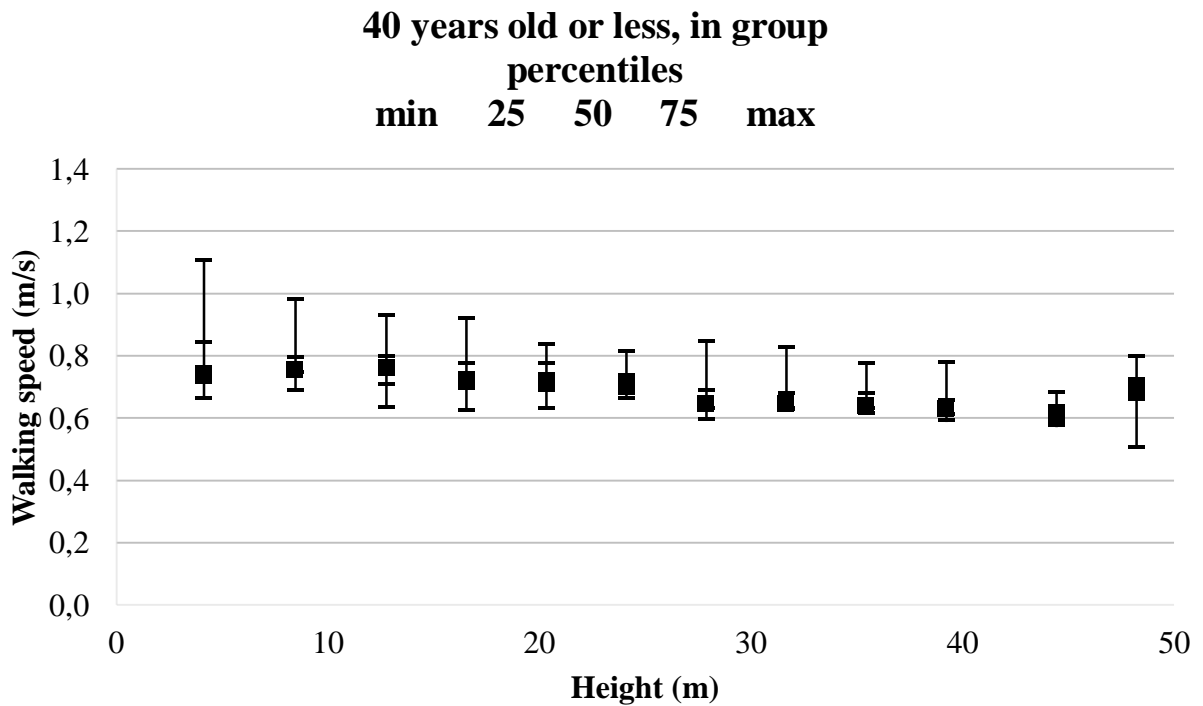

Figure A8. Walking speed in the group Ideon experiment of the group individuals below 40 years old.

**Men, individual
percentiles**
min 25 50 75 max

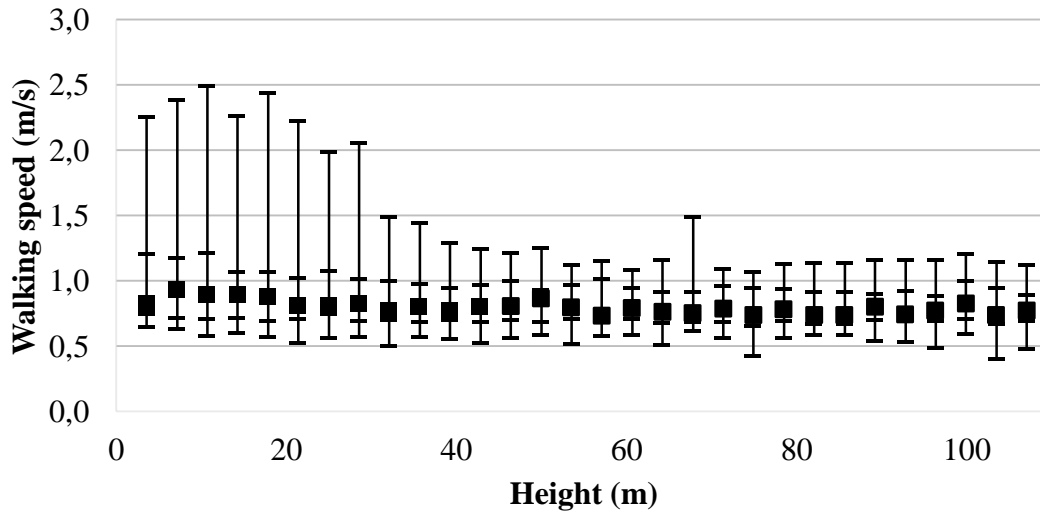

Figure A9. Walking speed in the individual Kista experiment of the male sample.

**Women, individual
percentiles**
min 25 50 75 max

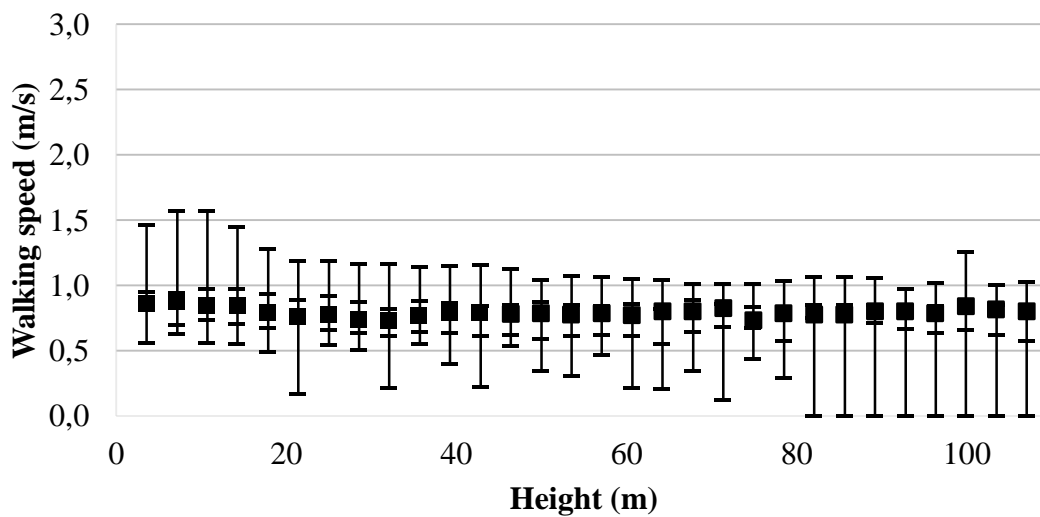

Figure A10. Walking speed in the individual Kista experiment of the female sample.

More than 40 years old, individual percentiles
min 25 50 75 max

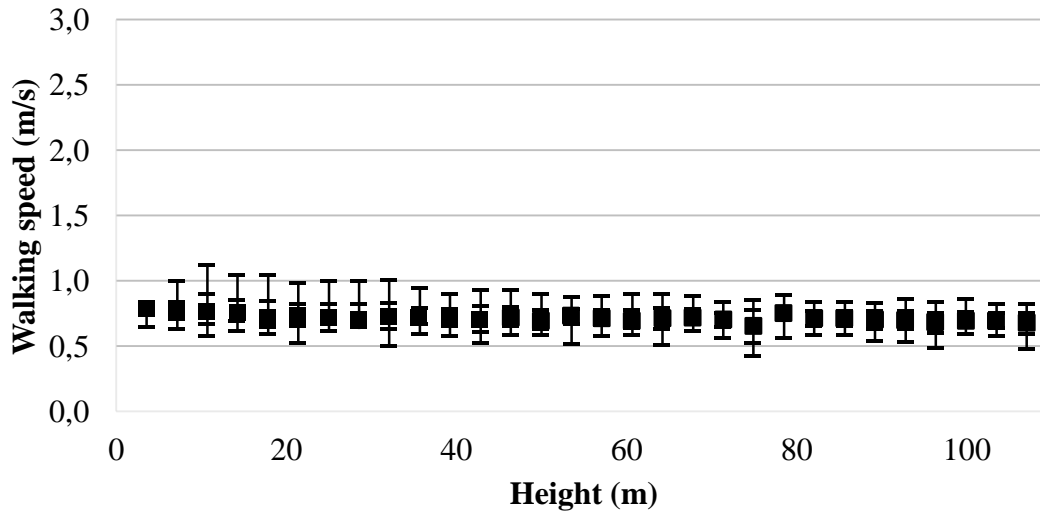

Figure A11. Walking speed in the individual Kista experiment of the individuals above 40 years old.

40 years old or less, individual percentiles
min 25 50 75 max

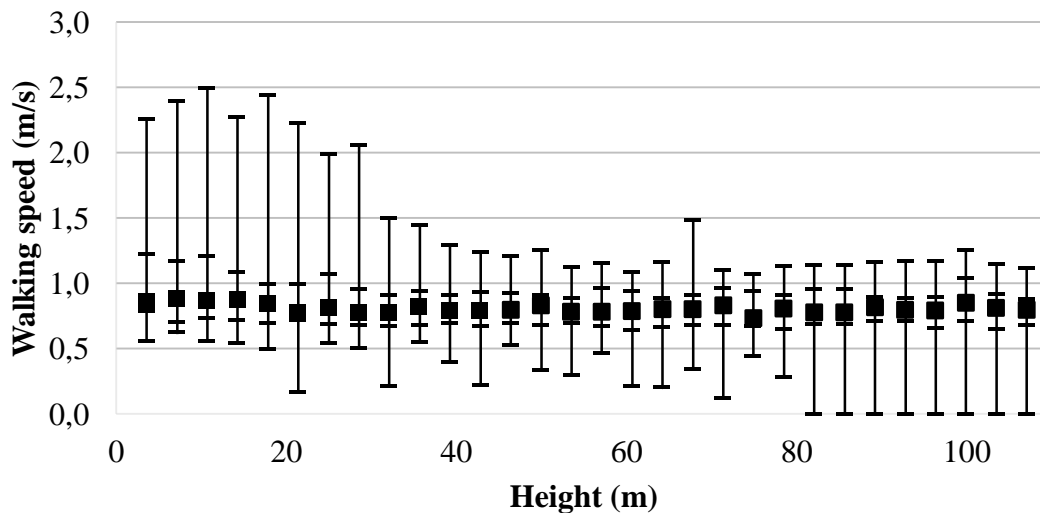

Figure A12. Walking speed in the individual Kista experiment of the individuals below 40 years old.

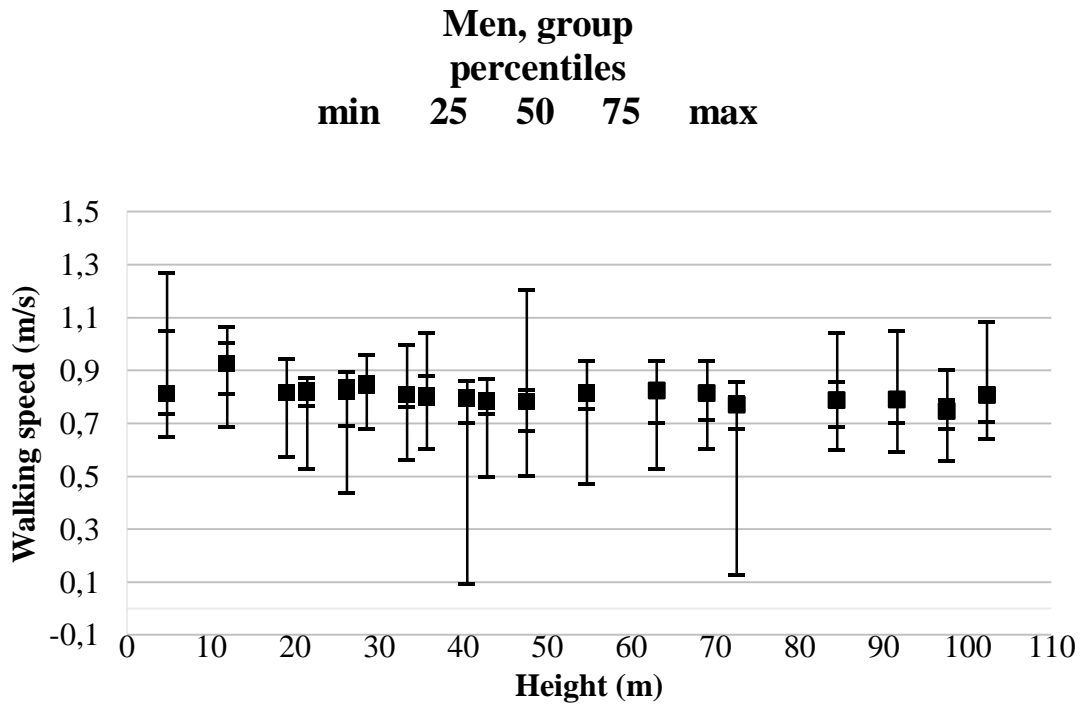

Figure A13. Walking speed in the group Kista experiment of the male sample.

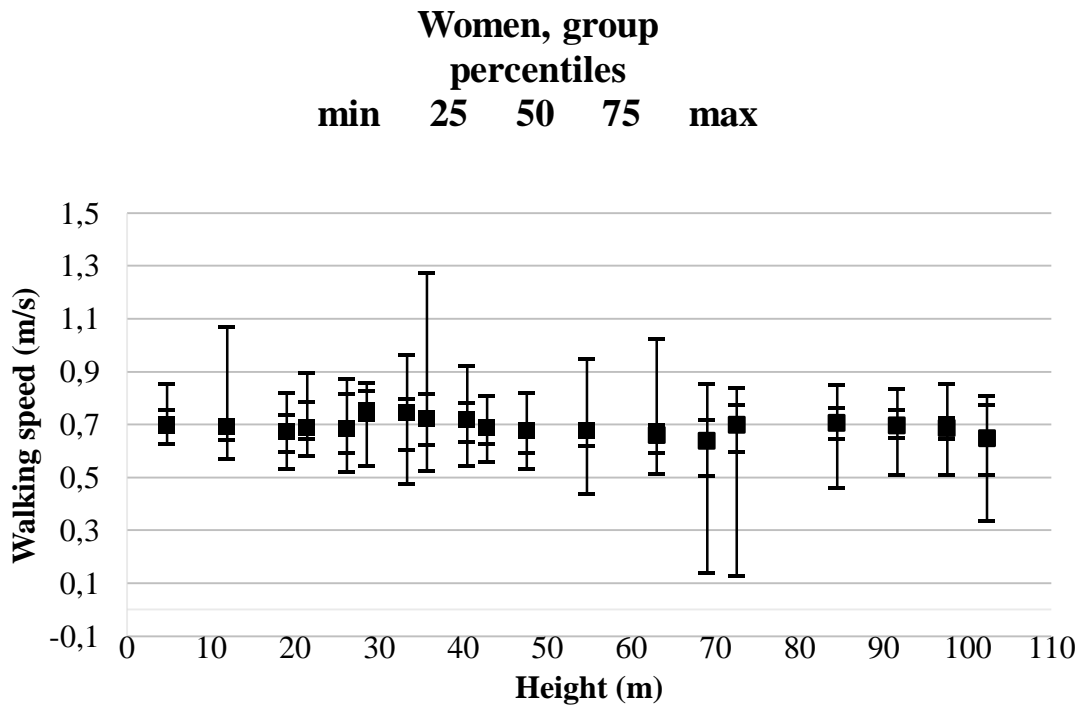

Figure A14. Walking speed in the group Kista experiment of the female sample.

**More than 40 years old, group
percentiles
min 25 50 75 max**

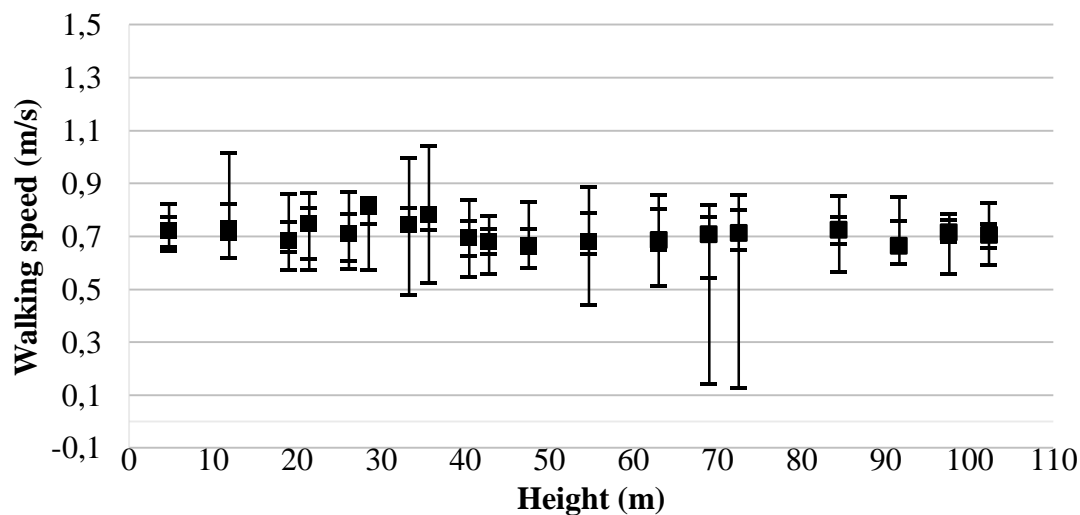

Figure A15. Walking speed in the group Kista experiment of the group individuals above 40 years old.

**40 years old or less, group
percentiles
min 25 50 75 max**

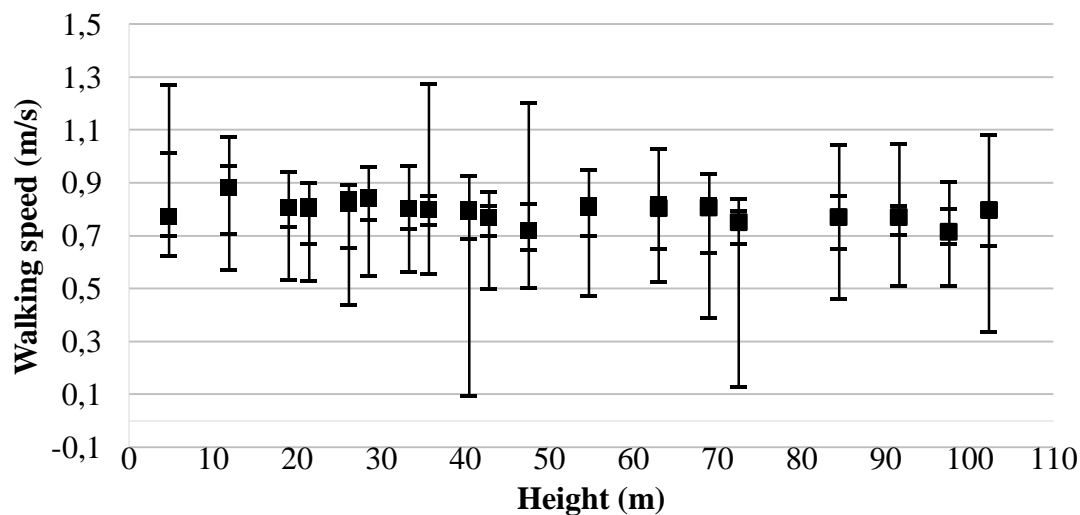

Figure A16. Walking speed in the group Kista experiment of the group individuals below 40 years old.

**Men, individual
percentiles**
min 25 50 75 max

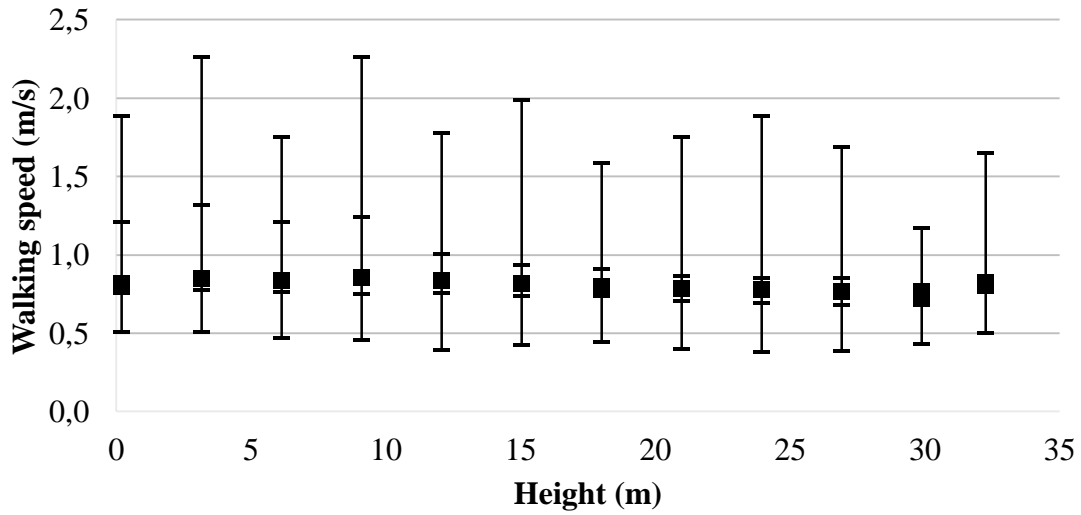

Figure A17. Walking speed in the individual Västra Skogen experiment of the male sample.

**Women, individual
percentiles**
min 25 50 75 max

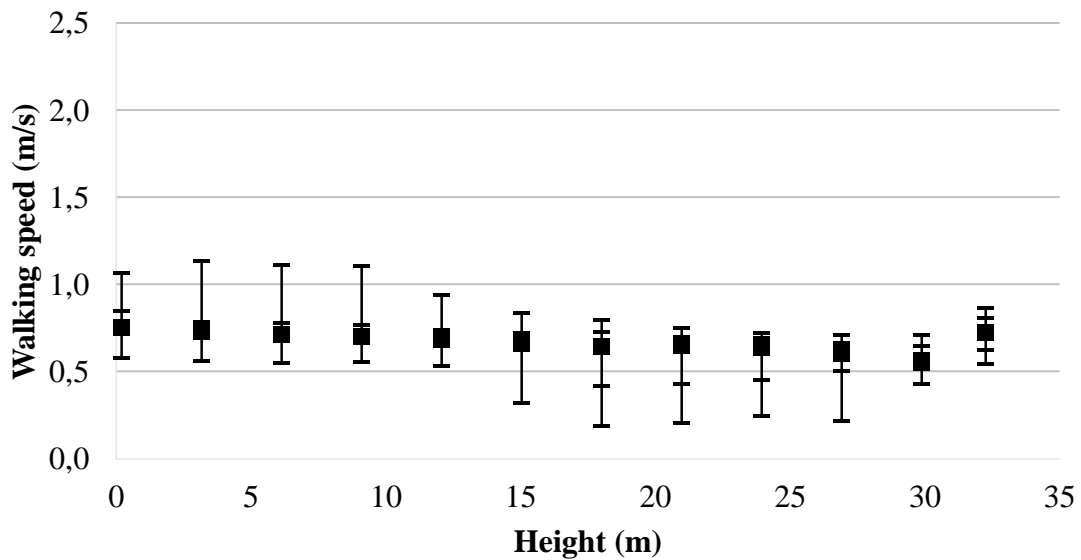

Figure A18. Walking speed in the individual Västra Skogen experiment of the female sample.

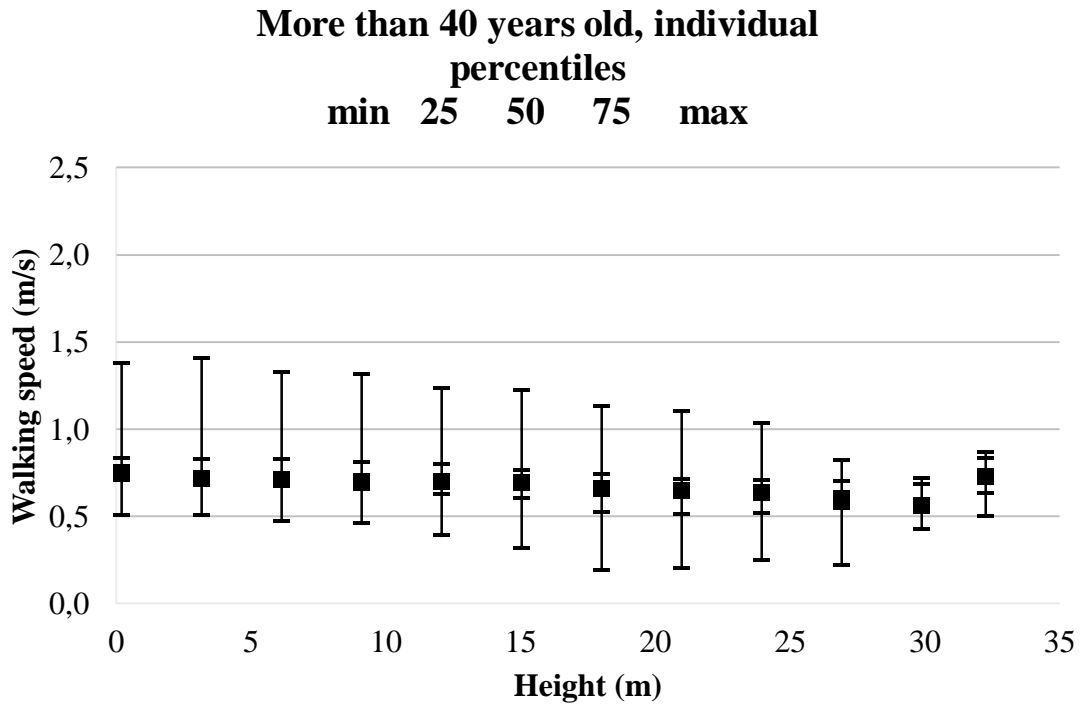

Figure A19. Walking speed in the individual Västra Skogen experiment of the individuals above 40 years old.

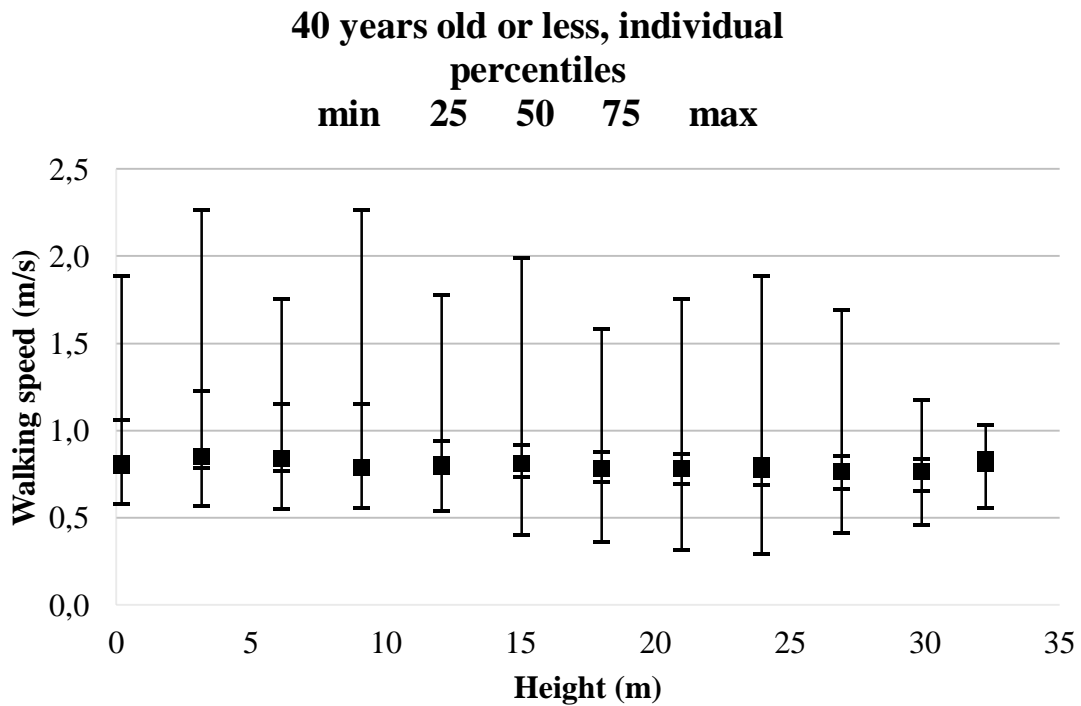

Figure A20. Walking speed in the individual Västra Skogen experiment of the individuals below 40 years old.

Appendix B - Flow data from the Västra Skogen experiment

This section reports the data from the flow recorded in the group experiments performed in the Västra Skogen experiment. Figure B.1 presents the time for the whole group to pass each mark (from A to L). Table B.1 shows the flow values based on the Västra Skogen experiments.

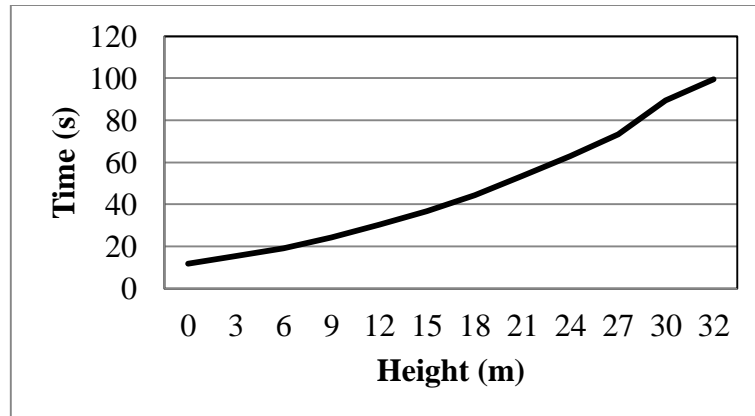

Figure B.1. Time for the whole group to pass each mark at different heights.

Assuming the values corresponding to the flow rate for the measuring points closest to the maximum interval value (10 m, 20 m, 30 m and >30m), the flow values presented in Table B.1 can be derived.

Table B.1. Flow values based on the Västra Skogen experiments.

Height	Flow	Comment
0-10 m	46 people/min	Mean value for point D and E
10-20 m	23 people/min	Value from point H
20-30 m	14 people/min	Value from point K
>30 m	12.5 people/min	Value from point L

Appendix C – Publications produced during the project

The following list refers to the material published during the project at the time the present report has been made public.

Written papers and reports:

- Delin, M., & Norén, J. (2014). *Fysisk ansträngning vid utrymning uppför trappor – Kunskapsöversikt* (No. 3179) (p. 26). Lund [Sweden]: Department of Fire Safety Engineering and Systems Safety, Lund University.
- Halder, A., Kuklane, K., Gao, C., Miller, M., Noren, J., Delin, M., Lundgren, K., Fridolf, K. (2015). Energy costs and leg muscle activities in ascending stairs. Presented at the 20th annual congress of the European College of Sport Science (ECSS), Malmö, Sweden.
- Norén, J., Delin, M., & Fridolf, K. (2014). Ascending stair Evacuation: What do We Know? *Transportation Research Procedia*, 2, 774–782. <http://doi.org/10.1016/j.trpro.2014.09.08>
- Norén, J., Delin, M., Fridolf, K., Kuklane, K., Halder, A., Lundgren, K., Ronchi, E., Arias S. (2015). *Ascending stair evacuation - effects of fatigue, walking speed & human behaviour*. Presented at the Human Behaviour in Fire Symposium 2015, Cambridge UK pp. 155-160.
- Delin, M., Norén, J., Fridolf, K., Kuklane, K., Halder, A., Lundgren, K., Månsson S. (2015). *Ascending stair evacuation - Walking Speed in Stairs as a Function of Height*. Presented at the Human Behaviour in Fire Symposium 2015, Cambridge UK pp. 161-172.

Oral presentations:

- Halder A., (2015) Physiological limitations in ascending stairs during evacuation, Presented at the MetaLund weekly seminar, at the Skåne University Hospital, Auditorium F2, Lund, Sweden.
- Norén, J., Delin, M., Ronchi E., Arias, S., Kuklane, K., Halder, A., Lundgren, K., Fridolf, K. (2015). *Ascending Stair Evacuation – A Research Project on Effects Of Fatigue, Walking Speed & Human Behavior*. Oral presentation at the 1st SFPE Europe conference on Fire Safety Engineering, Copenhagen (Denmark).

