



LUND UNIVERSITY

New Mediators and Novel Mechanisms in Allergic Airway Inflammation

Bryborn, Malin

2008

[Link to publication](#)

Citation for published version (APA):

Bryborn, M. (2008). *New Mediators and Novel Mechanisms in Allergic Airway Inflammation*. [Doctoral Thesis (compilation)]. Department of Otorhinolaryngology, Lund University.

Total number of authors:

1

General rights

Unless other specific re-use rights are stated the following general rights apply:

Copyright and moral rights for the publications made accessible in the public portal are retained by the authors and/or other copyright owners and it is a condition of accessing publications that users recognise and abide by the legal requirements associated with these rights.

- Users may download and print one copy of any publication from the public portal for the purpose of private study or research.
- You may not further distribute the material or use it for any profit-making activity or commercial gain
- You may freely distribute the URL identifying the publication in the public portal

Read more about Creative commons licenses: <https://creativecommons.org/licenses/>

Take down policy

If you believe that this document breaches copyright please contact us providing details, and we will remove access to the work immediately and investigate your claim.

LUND UNIVERSITY

PO Box 117
221 00 Lund
+46 46-222 00 00

New Mediators and Novel Mechanisms in Allergic Airway Inflammation

Malin Bryborn



LUND UNIVERSITY

Laboratory of Clinical and Experimental Allergy Research
Department of Otorhinolaryngology, Malmö University Hospital
Lund University, Sweden

DOCTORAL THESIS

The public defense of this thesis for the degree of Doctor of Medical Science, with due permission from the Faculty of Medicine in Lund, will take place in Lilla Aulan, entrance 59, Medicinskt Forskningscentrum, Malmö University Hospital, Friday, March 7, 2008 at 13:15.

External examiner: Associate professor Mats Lindahl, Division of Occupational and Environmental Medicine, Department of Molecular and Clinical Medicine, Linköping University, Sweden.

New Mediators and Novel Mechanisms in Allergic Airway Inflammation

Malin Bryborn



LUND UNIVERSITY

Laboratory of Clinical and Experimental Allergy Research
Department of Otorhinolaryngology, Malmö University Hospital
Lund University, Sweden

Malmö, 2008

© Malin Bryborn 2008

ISBN 978-91-85897-70-4

TABLE OF CONTENTS

LIST OF PAPERS	7
ABBREVIATIONS	8
ABSTRACT	10
BACKGROUND	12
The respiratory tract	12
The nose	12
Palatine tonsils	13
Lower airways	13
The allergic immune response	13
Allergic airway inflammation	14
Allergic rhinitis	14
Asthma and airway hyperreactivity	15
Link between allergic rhinitis and asthma	15
Allergic rhinitis and genetic variation	15
Proteomics	17
Mediators in allergic inflammation	18
IL-4	18
Bradykinin and des-Arg ⁹ -bradykinin	18
S100A7	19
WNT2B	19
Prolactin-inducible protein	19
PLUNC	20
Charcot-Leyden crystal protein/galectin-10	20
OBJECTIVES	21
METHODS	22
Organ culture model	22
Isometric tension measurements	22
Human study populations	23
cDNA synthesis and real-time PCR	24
Nasal lavage	25
Two-dimensional gel electrophoresis and mass spectrometry	25
Western blot	26
Immunohistochemistry	26
DNA sequencing and SNP genotyping	27
Genetic analysis	28
DNA microarray	28
Cell line and culture conditions	28
Statistical analysis	29
RESULTS AND COMMENTS	30
IL-4 contributes to the development of airway hyperreactivity	30
Comments	32

Novel mediators identified in nasal lavage fluid.....	33
Comments.....	34
Genetic variation associated with allergic rhinitis	36
Comments.....	39
S100A7 expression in the nose and palatine tonsils	40
Comments.....	43
SUMMARY AND CONCLUSIONS.....	45
FUTURE PERSPECTIVES.....	47
SUMMARY IN SWEDISH.....	48
ACKNOWLEDGEMENTS.....	50
REFERENCES	52
APPENDICES: PAPER I-VI.....	63

LIST OF PAPERS

This thesis is based on the following papers, which will be referred to in the text by their roman numerals (I-VI):

- I** **Bryborn M**, Adner M, Cardell LO. Interleukin-4 increases murine airway response to kinins, via up-regulation of bradykinin B₁-receptors and altered signalling along mitogen-activated protein kinase pathways.
Clinical and Experimental Allergy. 2004;34:1291-8
- II** **Bryborn M**, Adner M, Cardell LO. Psoriasin, one of several new proteins identified in nasal lavage fluid from allergic and non-allergic individuals using 2-dimensional gel electrophoresis and mass spectrometry.
Respiratory research. 2005;6:118
- III** **Bryborn M**, Halldén C, Säll T, Adner M, Cardell LO. Comprehensive evaluation of genetic variation in *S100A7* suggests an association with the occurrence of allergic rhinitis.
Submitted
- IV** **Bryborn M**, Halldén C, Säll T, Cardell LO. *CLC*- a novel susceptibility gene for allergic rhinitis?
Manuscript
- V** **Bryborn M**, Fransson M, Benson M, Uddman R, Virtala R, Broberg P, Jansson L, Adner M, Riesbeck K, Cardell LO. S100A7, a novel protein in allergic rhinitis.
Manuscript
- VI** **Bryborn M**, Månsson A, Cardell LO, Adner M. Differentiated S100A7 expression in infected tonsils and tonsils from allergic individuals.
Submitted

Published papers are reproduced by copyright permission.

ABBREVIATIONS

ANOVA	Analysis of variance
BK	Bradykinin
CD	Cluster of differentiation
cDNA	Complementary DNA
CLC	Charcot-Leyden crystal protein
COPD	Chronic obstructive pulmonary disease
Ct	Cycle threshold
des-Arg ⁹ -BK	des-Arg ⁹ -bradykinin
2-DE	Two-dimensional gel electrophoresis
DNA	Deoxyribonucleic acid
dNTP	Deoxyribonucleotide triphosphate
ELISA	Enzyme-linked immunosorbent assay
ERK	Extracellular signal-regulated kinase
GAPDH	Glyceraldehyde-3-phosphate dehydrogenase
HRP	Horse radish peroxidase
HWE	Hardy Weinberg equilibrium
IEF	Isoelectric focusing
IFN	Interferon
Ig	Immunoglobulin
IL	Interleukin
IL-4R	IL-4 receptor
JNK	c-Jun N-terminal kinase
kb	kilo bases
kDa	kilo Dalton
LD	Linkage disequilibrium
LPS	Lipopolysaccharide
MAF	Minor allele frequency
MALDI-TOF	Matrix assisted laser desorption ionization-time of flight
MAPK	Mitogen-activated protein kinase
mRNA	Messenger RNA
NF- κ B	Nuclear factor kappa B
OR	Odds ratio
PCR	Polymerase chain reaction

pI	Isoelectric point
PIP	Prolactin-inducible protein
PLUNC	Palate lung and nasal epithelial clone
PVDF	Polyvinylidene fluoride
RNA	Ribonucleic acid
S100A7	S100 calcium-binding protein A7
SDS-PAGE	Sodium dodecyl sulphate-polyacrylamide gel electrophoresis
SEM	Standard error of the mean
SNP	Single nucleotide polymorphism
Th	T helper
Th1	T helper type 1
Th2	T helper type 2
TNF	Tumor necrosis factor
WNT2B	Wingless-type MMTV integration site family, member 2B

ABSTRACT

Hyperresponsiveness and inflammation are major pathophysiological features of both allergic rhinitis and asthma. The mechanisms behind these are not fully understood. The aims of this thesis were to investigate if cytokines involved in the allergic response can induce airway hyperreactivity by affecting the airway smooth muscle directly and to identify novel mediators involved in allergic airway inflammation.

The effect of the pro-inflammatory cytokine interleukin (IL)-4 on airway smooth muscle contractions was investigated in an organ culture model. Prolonged exposure to IL-4 enhanced contractions induced by des-Arg⁹-bradykinin (dA-BK) and bradykinin (BK). This effect was mediated via an up-regulation of B₁-receptors and through altered signaling along the mitogen-activated protein kinase (MAPK) signal transduction pathways. Thus, IL-4, besides its previously known effects on the allergic phenotype, may also exhibit direct effects on airway smooth muscle cells, contributing to the development of airway hyperreactivity.

Two-dimensional gel electrophoresis (2-DE) was used in combination with mass spectrometry to identify protein patterns in nasal lavage fluid obtained from patients with allergic rhinitis and healthy controls. Six novel proteins, not previously described in the nose, were identified: S100 calcium-binding protein A7 (S100A7), Wingless-type MMTV integration site family, member 2B (WNT2B), galectin-3, alpha enolase, intersectin-2 and hypothetical protein MGC33648. Of these, S100A7 was down- and WNT2B up-regulated among patients.

The previously known role of S100A7 in various forms of skin inflammation, including atopic eczema, made it of special interest to investigate its role in allergic airway inflammation. Thus, further investigations were performed on material derived from the nose, the palatine tonsils and cultured epithelial cells. In the nose, immunohistochemical staining for S100A7 was seen in the epithelium and in seromucous glands. DNA microarray analysis demonstrated increased levels of S100A7 in nasal lavage fluid cells obtained from patients with allergic rhinitis, both during season and following nasal allergen provocation. These results were confirmed in nasal biopsies using real-time PCR. In analogy, cultured nasopharyngeal epithelial cells (Detroit 562) increased their S100A7 mRNA expression after stimulation with the pro-inflammatory cytokine tumor necrosis factor (TNF)- α , an effect mediated via nuclear factor kappa B (NF- κ B) induced transcription. The difference seen between mRNA and protein levels in humans might be related to disease driven consumption or alternatively to an impaired translation of mRNA into protein.

In palatine tonsils, S100A7 protein was detected in the epithelium, germinal centers and T cell zones. S100A7 mRNA expression levels among allergic individuals were generally lower than in healthy control subjects. A similar picture was seen in the nose when patients sampled outside pollen season were compared to healthy controls. In

addition, tonsils with bacterial infections expressed reduced mRNA levels of S100A7 compared to non-infected tonsils.

The gene coding for S100A7 was resequenced in a set of allergic individuals, resulting in the identification of 13 polymorphisms. Single nucleotide polymorphism (SNP) genotyping in allergic and non-allergic individuals revealed an increased minor allele frequency (MAF) for a non-synonymous SNP (rs3014837) in allergic individuals. It was also established that the major haplotype, containing the major allele at all sites, was more common in non-allergic individuals, while the haplotype containing the minor allele at rs3014837 was equally more common among the allergic individuals. Additionally, heterozygotes at this site had significantly higher scores in skin prick tests for 9 out of 11 tested allergens, compared to homozygotes.

Polymorphisms in the genes coding for four other mediator candidates identified through nasal lavage screening; Prolactin-inducible protein (PIP), WNT2B, Palate lung and nasal epithelial clone (PLUNC) and CLC (Charcot-Leyden crystal protein) were investigated for association with allergic rhinitis. All investigated SNPs in *CLC* were polymorphic and eight SNPs, located in the putative promoter region, yielded increased χ^2 -values with respect to genotype frequencies. It appeared that homozygotes for the minor alleles were more common in the allergic group, compatible with a recessive inheritance model. Furthermore, the minor alleles were all located on the same haplotype. None of the investigated SNPs in *PIP*, *WNT2B* and *PLUNC* were found to be associated with the disease.

To summarize, results presented in this thesis demonstrate that prolonged exposure to cytokines, like IL-4, have the ability to affect airway smooth muscle directly, causing hyperreactivity. Six proteins not previously demonstrated in the nose were identified. The expression of one of these, S100A7, was found to be connected with changes caused by allergic airway inflammation. Further, genetic analysis revealed variations in the gene coding for S100A7, which appear to be associated with the occurrence of allergic rhinitis. Genetic association with allergic rhinitis was found also for another recently identified nasal protein, CLC. This renders S100A7 and CLC promising candidates for further investigations regarding their tentative role as diagnostic markers and targets for novel therapeutic strategies.

BACKGROUND

The respiratory tract

The respiratory tract can anatomically be divided into the upper and lower airways. The upper airways consist of the nose, paranasal sinuses, pharynx and larynx while the trachea, bronchi and lung alveoli constitute the lower airways (figure 1).

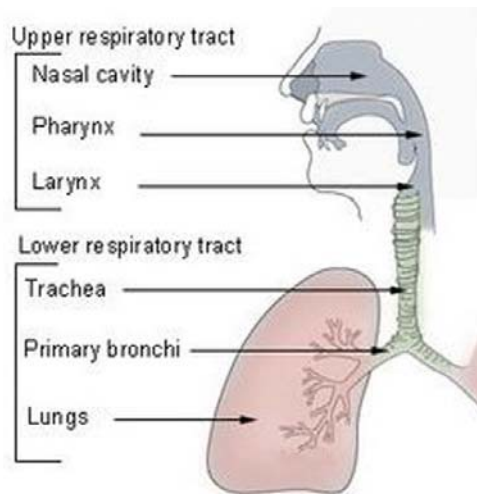

Figure 1. Schematic overview of the human respiratory tract (<http://www.daviddarling.info>).

The nose

The nose consists of the external nose and the nasal cavity which opens into the pharynx. The nasal cavity contains the inferior, middle and superior turbinates which are covered with pseudostratified columnar ciliated epithelium. The turbinates increase the surface of the nasal cavity and facilitate humidification, temperature regulation and filtration of inspired air. The olfactory epithelium, the sensory organ for smell, is situated above the middle turbinate and contains odor-receptor cells (1, 2).

The nasal mucosa consists of the ciliated epithelium, the basement membrane and the submucosa. The submucosa contains serous and seromucous glands, nerves and a complex vasculature. The high degree of vascularisation is one of the key features of the nasal mucosa, allowing rapid changes in the thickness of the mucosa in response to different stimuli (3). Nasal secretions primarily originate from goblet cells in the epithelium, submucosal glands and plasma exudates and contain a variety of proteins which are part of the primary barrier against infections (4, 5). During inflammatory

conditions, like allergic rhinitis, nasal secretion is markedly enhanced and may sustain the inflammatory processes (6).

Palatine tonsils

The palatine tonsils are secondary lymphoid organs located at the transition of the mouth to the oropharynx. They belong to the integrated mucosal immune system of the pharynx, called the Waldeyer's ring (7). They are covered by a nonkeratinized stratified squamous epithelium supported by an underlying capsule of connective tissue containing blood vessels, nerves and lymphatics (8). The subepithelial compartments are formed by lymphoid follicles and interfollicular regions, containing B and T lymphocytes. One important characteristic of tonsils is the tonsillar crypts, increasing the surface area for antigen stimulation (7). The palatine tonsils are, due to their anatomical position, continuously exposed to foreign pathogens and airborne antigens entering the body through the nose and mouth. Recurrent tonsillitis is a common disease mostly caused by bacterial infections or viruses. Group A β -hemolytic streptococci, has long been regarded as the most frequent causative agent of bacterial tonsillitis (9) but there is compelling evidence that *Haemophilus influenzae* is associated with the occurrence of recurrent tonsillitis as well (10). Due to their easy accessibility, the structure and function of palatine tonsils have often been studied, and they are most often used as models for human lymphoid organs.

Lower airways

The trachea and bronchi are covered with a ciliated pseudostratified columnar epithelium similar to that in the nose. Blood vessels, nerves and seromucous glands are found in the submucosa, underneath the epithelium. The walls consist of incomplete cartilage rings, that provide support and prevent the airways from collapsing. A smooth muscle layer is bridging the ends of the incomplete cartilage rings and is involved in regulating the size of the trachea lumen (11).

The allergic immune response

The immune system is traditionally divided into the innate and the adaptive immune system. The innate immune system is present from birth and constitutes the first line of defense against pathogens. The cellular part of the innate immune system consists of dendritic cells, monocytes, macrophages, granulocytes, natural killer cells, as well as epithelial cells. The non-cellular part is diverse and includes e.g. antimicrobial proteins and the complement cascade. The adaptive immune system is mediated by T and B lymphocytes and is in contrast to the innate immune system, specific and able to develop an immunologic memory (12, 13). Innate and adaptive immunity are often described as two separate processes but they are closely linked together and are both essential for an intact and fully active immune response.

The allergic immune response is an immunoglobulin (Ig) E-mediated hypersensitivity reaction towards certain types of antigens, referred to as allergens. During the initial encounter with the allergen, called the sensitization phase, the allergen is recognized as harmful by the immune system and triggers a humoral immune response with IgE production from B lymphocytes. The IgE molecules bind to high affinity Fc-receptors on the cell surface of mast cells. At a second exposure, the allergen crosslinks the cell bound IgE molecules, leading to degranulation of the mast cells and release of pro-inflammatory mediators giving rise to an early phase response, consisting of vasodilatation and increased vascular permeability, stimulation of mucus secretion and stimulation of afferent nerves. A late phase response occurs several hours later and is thought to be caused by recruitment, activation and tissue infiltration of leukocytes, including T lymphocytes, eosinophils, basophils and neutrophils (14, 15).

Although the allergic immune response is primarily mediated by the adaptive immune system, components of the innate immune system are highly involved. Intensive research is focused on determining how the innate immune system participates in shaping the adaptive immune system into an allergic phenotype (16-18). One important characteristic of the allergic immune response is the imbalance in the T helper (Th) lymphocyte response, called the Th1/Th2 paradigm. T helper lymphocytes were previously divided into two different types, T helper type 1 (Th1) and T helper type 2 (Th2) lymphocytes, based on their pattern of cytokine production (19, 20). Th1 lymphocytes secrete cytokines like IL-2 and IFN- γ , while Th2 lymphocytes secrete IL-4, IL-5, IL-9 and IL-13 and are the predominant T lymphocytes in the allergic immune response, favoring IgE production from B lymphocytes. The Th1/Th2 paradigm has long dominated our understanding of the pathophysiology of allergic diseases but the identification of regulatory T lymphocytes has made it apparent that the regulation of the allergic immune response is much more complex. To date at least four different subsets of regulatory T lymphocytes have been identified (21). They function as key regulators of immunologic processes and are thought to be involved in suppressing allergen-specific responses (22). Today it is suggested that the development of an allergic phenotype is the result of a missing immune deviation in early life, from Th2 to Th1, in combination with a lack of immune suppression from regulatory T lymphocytes (23).

Allergic airway inflammation

Allergic rhinitis

Allergic rhinitis is a common global disease, with an estimated prevalence of approximately 10-25% (2, 24-26). During the last two decades there has been an enormous increase in the number of allergic individuals, but in some regions with very high prevalence a plateau may now have been reached (27). There are large geographical differences, with higher prevalence in developed countries (28). The disease is clinically defined as a symptomatic disorder of the nose, induced by an IgE-mediated

inflammation of the nasal mucosal surfaces. The characteristic symptoms upon allergen contact are itching, sneezing, rhinorrhea and nasal congestion. A late phase response is seen after 3-10 hours in approximately 50% of individuals and consists of nasal congestion (14). Allergic rhinitis can be divided into two subtypes, intermittent and persistent allergic rhinitis, previously termed seasonal and perennial allergic rhinitis. According to the ARIA document, intermittent disease means that the symptoms are present less than four days per week or for less than four weeks (e.g. pollen induced), while the disease is persistent when symptoms are present more than four days per week and for more than four weeks (induced by e.g. indoor allergens like dust mites, moulds and animal dander) (2). In Sweden, with fixed pollen seasons, it is still correct to use the older term seasonal allergic rhinitis.

Asthma and airway hyperreactivity

Asthma is a disorder of the lower airways characterized by reversible airway obstruction, chronic inflammation, hyperreactivity and structural alterations of the airways, such as thickening of the airway smooth muscle layer, i.e. remodeling (29). One of the key features is the hyperresponsiveness, exaggerated narrowing of the airways after inhalation of various stimuli. There is convincing evidence that airway inflammation is closely related to the development of hyperreactivity seen in asthma (30). One of the most important cell types involved in hyperreactivity is the airway smooth muscle cell. This cell type is plastic and capable of changing its phenotype in response to different stimuli. Pro-inflammatory cytokines, like IL-1 β and TNF- α , have the ability to increase the contractile response of airway smooth muscle (31, 32).

Link between allergic rhinitis and asthma

There is compelling evidence linking allergic rhinitis and asthma together. Several studies show that allergic rhinitis and asthma often co-occur in the same patients. A majority of patients, approximately 80%, with allergic asthma also suffer from allergic rhinitis (33-35) and patients suffering from allergic rhinitis have a 5-6 fold increased risk of developing asthma (35). There also seems to be an association between the presence of rhinitis and asthma severity. These findings all indicate that allergic rhinitis and asthma are manifestations of the same disease. Hence, the upper and lower airways can be considered as one united airway (2, 27).

Allergic rhinitis and genetic variation

The development of allergic rhinitis is a complex process, involving interactions between several environmental and genetic factors. Twin studies support the genetic impact in that the concordance rate is higher in monozygotic compared to dizygotic twins. The heritability for allergic rhinitis has been estimated to be as high as 70-75% (36, 37). The genetics behind allergic rhinitis has not been as well investigated as for

asthma but the close relationship between asthma and allergic rhinitis indicates that these two atopic phenotypes share some of their genetic background (38). In a recent review, summarizing genetic studies concerning asthma and atopy-related traits, the authors identified 25 genes that have been associated with asthma or atopy in at least six independent studies and 54 genes in 2-5 studies (39). It remains to be explored if this applies to allergic rhinitis as well since only 23 genes in this review were studied for association with allergic rhinitis and only 17 were found to actually be associated with the disease. However, as in other complex diseases it is probable that a large number of genes are involved, each with relatively modest effects on the susceptibility risk.

A large number of variations have been identified in the human genome through the Human Genome Project (40-42). The most common genetic variation is the SNP which is a single base difference at a specific location of the genome, found in $> 1\%$ of the population (43). Today about nine million SNPs are reported in public databases, like dbSNP (44). The average frequency of SNPs is about one per 1000 base pairs, but large variation exists between different parts of the genome (45). Depending on where the SNP is situated it may have different consequences. A SNP situated in the coding region of a gene may give rise to an amino acid shift which in turn may affect the protein structure and function. These SNPs are said to be non-synonymous. SNPs in non-coding regions may also be implicated in susceptibility to disease, including SNPs in promoter regions, introns, and splice sites.

SNPs tend to be linked together in a predictable way, known as haplotypes. A haplotype is a set of SNPs situated on closely linked loci on the same chromosome. The association between SNPs situated on nearby sites can be described using the term linkage disequilibrium (LD). LD is a measure of historical recombination between two sites and is said to exist when SNPs are inherited together more often than expected by chance (46).

To explore if SNPs in a certain candidate gene are associated with the disease of interest, association studies are often performed. A common form of association study is the case-control study where SNPs are genotyped in one patient group and one healthy control group to compare differences in allele and genotype frequencies. If a particular allele or haplotype is seen more often in one of the groups, association with the disease is said to exist. Association studies are hypothesis-driven and are both cheaper and simpler to perform in comparison to linkage analysis, since they do not require the collection of family material. However, the interpretation of results from association studies is not always straightforward. Due to the LD phenomenon it is possible that the identified SNP is not the true disease associated SNP, it might just be situated on the same haplotype as the causal SNP. It is therefore of importance to also study haplotypes and not only individual SNPs.

Proteomics

Proteomics is the study of the protein complement of the genome in a biological system at a given time, also called the proteome. Although the human genome only consists of approximately 30,000 genes (47) there are several hundred thousands of human proteins and peptides, deriving from alternative splicing, post-translational modifications and proteolytic processes (48-50). While the genome has a relatively high stability, the proteome of a cell is dynamic and changes with both time and environment. Hence, in contrast to studies of the genome or transcriptome, proteome studies give a more comprehensive representation of changes in the status of a cell or organism.

To be able to identify and characterize proteins in a complex mixture of thousands of different proteins it is necessary to use a method with high resolving power and sensitivity. Although 2-DE was developed more than thirty years ago it is still one of the most common methods used for separating proteins (51). Proteins are separated in a first dimension using isoelectric focusing (IEF), carried out in gels with a fixed pH gradient. Accordingly, proteins are separated based on their isoelectric point (pI), i.e. the pH where the protein carries no net electric charge. In a second dimension they are separated based on their molecular weight using SDS-PAGE (sodium dodecyl sulphate-polyacrylamide gel electrophoresis). The 2-DE gels are subsequently stained to give a map of the protein pattern which enables analysis of the number of protein spots as well as protein quantity in individual spots (52). Proteins or peptides are extracted from the gels and further analyzed for identification. The key technology used today for identification of proteins is mass spectrometry which is much faster and provides much higher sensitivity compared to the previously used method Edman sequencing (53). The huge amount of data obtained from the mass spectrometry analysis must be interpreted and this is done using various bioinformatics approaches (53, 54).

By comparing the proteome of samples obtained from healthy individuals and patients with a certain disease, proteins that are differently expressed can be identified and possibly used as biomarkers for the disease. The proteomics approach has been successfully used when studying pathophysiological changes both in the upper and lower airways. Evaluation of the bronchoalveolar lavage fluid proteome has been useful in the research of several inflammatory lung diseases, including emphysema, cystic fibrosis, COPD and asthma (55-57). The nasal lavage fluid proteome has also been characterized and changes in this proteome are seen in e.g. smokers and patients with allergic rhinitis, asthma, or sinusitis (58-61). It appears that the nasal lavage fluid proteome changes in response to both upper and lower airway inflammation, supporting the united airway hypothesis.

Mediators in allergic inflammation

Both allergic rhinitis and asthma are complex diseases and a large number of different mediators are involved in the regulation of allergic airway inflammation. The identification and characterization of novel mediators is of importance in the search for therapeutic targets and diagnostic markers. Since the upper airways are relatively easy to access and offer the opportunity for allergen provocation, sampling and measurements with minimum discomfort or risk for the patient, allergic rhinitis is a good experimental model when searching for suitable mediators to target in allergic airway inflammation. A short description of the mediators/genes investigated in this thesis is given below.

IL-4

IL-4 is a Th2 cytokine of particular importance in the pathophysiology of allergic diseases. It was initially described as a differentiation factor for eosinophils (62), but it later became clear that this cytokine has effects on a variety of cell types. It is involved in establishing the allergic phenotype by driving the differentiation of naïve T lymphocytes into Th2 lymphocytes (63) and inducing IgE isotype switch and secretion of IgE by B lymphocytes (64). Furthermore, IL-4 is involved in the effector phase of the allergic reaction by inducing mucus hypersecretion (65) and increasing the production of eotaxin and other inflammatory cytokines (66). There are also findings to suggest that IL-4 can act on resident airway cells, contributing to airway remodeling and hyperreactivity in asthma. The receptor for IL-4 (IL-4R) consists of an IL-4R α chain, which binds IL-4 with high affinity, and a common gamma chain (67). The genes coding for IL-4 and IL-4R α have been investigated for association with asthma and atopy in several studies, but the results are conflicting (39).

Bradykinin and des-Arg⁹-bradykinin

Kinins are produced in blood and tissues in response to inflammation. BK can be formed from the kininogen precursor after cleavage by tissue and plasma kallikrein and can be further converted into dA-BK by carboxypeptidase N (68). A key role for BK in airway inflammation has been suggested. Elevated levels are found in bronchoalveolar lavage fluid from asthmatic patients (69). Inhalation of BK induces a strong bronchoconstriction in asthmatic patients but has minimal effect on non-asthmatics (69, 70). There are findings to suggest that both BK and dA-BK are involved in the development of airway hyperreactivity. Long-term exposure of murine airways to pro-inflammatory cytokines results in enhanced contractions induced by both dA-BK and BK (31, 71, 72). There are two subtypes of receptors for kinins, B₁ and B₂. The B₁ receptor is induced during inflammatory conditions and is the main receptor for dA-BK, while BK preferentially binds to the constitutively expressed B₂ receptor (73).

S100A7

S100A7 belongs to the S100 protein family which is the largest subfamily of calcium-binding EF-hand proteins, consisting of approximately 24 proteins (74, 75). The name S100 originates from the observation that the first identified proteins in this family, S100B and S100A1, were soluble in 100% ammonium sulfate (76). S100 proteins are small, acidic proteins, ranging from 10-12 kDa and they contain two EF-hand motifs (helix-loop-helix) with varying affinity for calcium (77). *S100A7*, 2.7 kilo bases (kb) large, is together with 18 other *S100* genes situated on chromosome 1q21 (75, 78). The interest in S100A7 arose when this protein was found to be highly up-regulated in the psoriatic lesions of psoriasis patients (79, 80), hence the original name psoriasin. The chemotactic activity of S100A7 (81) suggested a key role for this protein in the inflammatory response observed during psoriasis onset but the gene was later ruled out as a psoriasis susceptibility gene (82). More recently, S100A7 was shown to be able to effectively kill *E.coli* through Zn^{2+} sequestering (83). The chemotactic and anti-microbial properties argue for a role in inflammation and the immediate innate immune response to pathogens. The expression of S100A7 is up-regulated in several inflammatory skin diseases, e.g. atopic eczema, further corroborating the involvement of S100A7 in inflammation (84). Other S100 proteins, e.g. S100A8, S100A9, S100A12, are suggested to be involved in inflammatory diseases like inflammatory bowel disease, rheumatoid arthritis and asthma (85-88).

WNT2B

The WNT family is a large family of secreted protein growth factors which during development are implicated in cell proliferation, migration and death and in adults they are important for tissue homeostasis (89). WNT2B, formerly known as WNT13, has been suggested to function as a hematopoietic growth factor. Recently, increased expression was found in patients with inflammatory bowel disease suggesting a role in the inflammatory response (90). The gene coding for WNT2B is situated on chromosome 1p13 and is 53.9 kb large (91).

Prolactin-inducible protein

PIP is a secretory protein expressed in exocrine organs like sweat, salivary and lacrimal glands (92). This protein is found both in saliva and nasal lavage fluid (93, 94) and is thought to play a role in host defense since it has the ability to bind to CD4 and potently inhibits T lymphocyte apoptosis (95). The gene coding for PIP is 7.7 kb large and is situated on chromosome 7q32-q36 (92).

PLUNC

PLUNC, or SPLUNC1 as it is also called, belongs to a multigene family located on chromosome 20q11 (96). PLUNC is highly expressed in the epithelium of the upper airways, nasopharynx and submucosal glands and is secreted into the upper airways (94, 97). The homology between PLUNC and lipopolysaccharide (LPS) binding proteins suggests that this protein is involved in the host defense against bacterial infections (98). Altered expression has been found in patients with allergic rhinitis, suggesting involvement in allergic airway inflammation (59).

Charcot-Leyden crystal protein/galectin-10

CLC belongs to the β -galactoside-binding lectin family and is for this reason also called galectin-10. The function of CLC has not been completely established. Early studies suggested that CLC was a lysophospholipase in eosinophils but it has been revealed that this is not the case. Instead it has been shown to bind to a lysophospholipase inhibitor (99). Due to the abundant levels in eosinophils, CLC has long been regarded as a marker of eosinophilic inflammation and high levels are indeed found in e.g. skin, sputum and nasal lavage fluid in association with allergic diseases (59, 100, 101). The *CLC* gene is 6.8 kb large and is situated on chromosome 19q13.1 (102).

OBJECTIVES

The aims of this thesis were to investigate if cytokines involved in the allergic response can induce airway hyperreactivity by affecting the airway smooth muscle directly and to identify new mediators involved in allergic airway inflammation.

Specific aims were to:

- Investigate if inflammatory mediators implicated in allergy, like IL-4, can affect the airway smooth muscle tone directly, using a murine *in vitro* model, focusing on kinins.
- Identify novel mediators of allergic airway inflammation, by comparing the protein secretion pattern in nasal lavage fluid from patients with allergic rhinitis and healthy controls.
- Describe genetic variation in S100A7, one of the new mediator candidates found during our nasal lavage fluid screening, and determine if this variation is associated with allergic rhinitis.
- Examine if genetic variation in four other mediator candidates, PIP, WNT2B, PLUNC and CLC, found during nasal lavage fluid screening, is associated with allergic rhinitis.
- Analyze the expression of S100A7 in the human nose and palatine tonsils, and determine if this expression is affected by atopic disposition and infectious stimuli.

METHODS

Organ culture model

Most animal models used for evaluation of airway hyperreactivity are very complex, which makes it difficult to control the experimental conditions. Cell cultures on the other hand, are easy to control but lack the tissue architecture with its cell-matrix interactions, known to be important for the smooth muscle cell function. Organ culture can be seen as a link between *in vivo* models and cell cultures. The cell-cell and cell-matrix interactions remains intact and pharmacological effects of various molecules can be assessed during controlled conditions (103).

In paper I, the organ culture technique was used to evaluate the effects of IL-4 on tracheal smooth muscle. BALB/c J mice were killed by cervical dislocation and the whole trachea was rapidly removed and placed into Dulbecco's Modified Eagle's Medium supplemented with penicillin and streptomycin. After adherent tissue had been removed, the trachea was cut into circular segments comprised of three cartilage rings. The segments were either used directly or cultured for 1-4 days at 37°C in 5% CO₂ in absence or presence of IL-4 and various signal transduction pathway inhibitors.

Alternatively, whole tracheae were cultured for 4 days in absence or presence of IL-4 and dexamethasone. After culture, the smooth muscle strips were isolated and stored in RNAlater at -80°C until total RNA extraction.

Isometric tension measurements

Smooth muscle reactivity of tracheal segments was analyzed in temperature controlled (37°C) myograph baths, containing Krebs-Henseleit buffer solution. The solution was continuously equilibrated with 5% CO₂ in O₂, resulting in a pH of 7.4. The tracheal segments were mounted on two L-shaped metal tacks, with a resting tension of 0.8 mN. One tack was connected to a force-displacement transducer for continuous recording of isometric tension. The other tack was connected to a displacement device, allowing adjustment of resting tension by changing the distance between the two tacks. Pharmacological agents were added directly into the baths and their effects, in form of isometric tension changes, were recorded (figure 2).

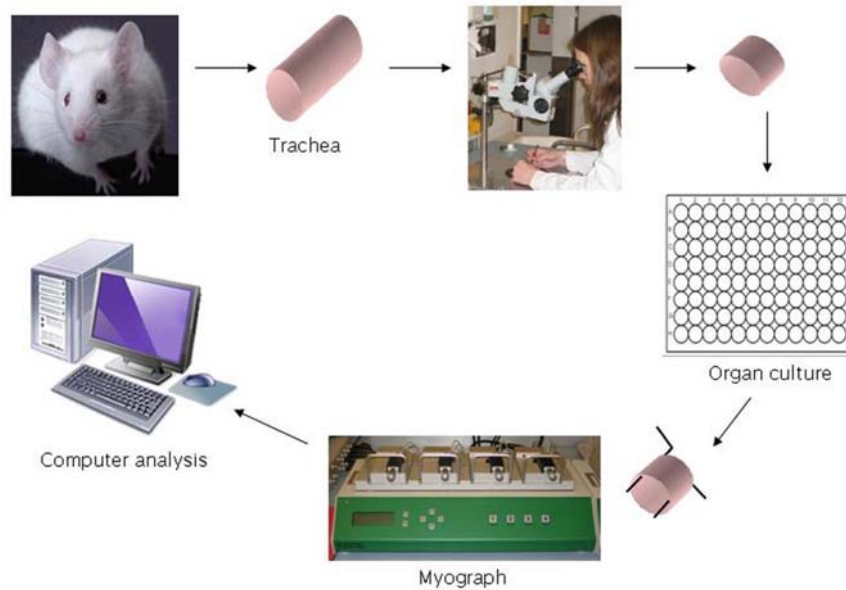

Figure 2. Illustration of the organ culture model.

Human study populations

Patients and healthy volunteers included in paper II-VI:

- In paper II, nasal lavage fluid was collected from 11 patients with symptomatic pollen-induced allergic rhinitis and 11 healthy non-atopic individuals, serving as controls.
- In paper III, peripheral blood samples were obtained from 184 patients with pollen-induced allergic rhinitis and 378 healthy, non-allergic blood donors.
- In paper IV, peripheral blood samples were collected from 251 patients with pollen-induced allergic rhinitis and 386 healthy, non-allergic blood donors.
- Paper V was based on six separate cohorts;
 - 1) Nasal lavage fluid was obtained outside pollen season from six patients with pollen-induced allergic rhinitis before and after nasal provocation with allergen and LPS, respectively.
 - 2) Nasal lavage was performed outside pollen season on another 21 patients with pollen-induced allergic rhinitis before and after allergen provocation.
 - 3) Nasal lavage fluid was collected during pollen season from 15 symptomatic patients with a history of pollen-induced allergic rhinitis. Nasal lavage fluid from 28 healthy, non-allergic individuals served as controls.

- 4) Nasal biopsies were obtained during pollen season from 10 patients with symptomatic pollen-induced allergic rhinitis and 11 healthy individuals.
 - 5) Nasal biopsies were obtained from 14 non-symptomatic patients with a history of pollen-induced allergic rhinitis and 15 healthy controls. Samples were taken after challenge with either LPS or NaCl.
 - 6) Nasal biopsies were obtained from 11 symptomatic patients with a history of non-infectious, non-allergic rhinitis.
- In paper VI, palatine tonsils were obtained from 109 patients undergoing tonsillectomy due to recurrent infections or airway obstruction.

All studies were performed at Malmö University Hospital UMAS after approval from the Ethics committee of the Medical Faculty, Lund University. A written informed consent was obtained from all participants included.

cDNA synthesis and real-time PCR

Real-time PCR can be used for mRNA quantification in cells or tissues. Before performing real-time PCR total RNA has to be extracted from isolated cells or homogenized tissues. The total RNA concentration and quality can be calculated using the wavelength absorption ratio 260/280 nm, measured in a spectrophotometer. mRNA has then to be reversely transcribed into cDNA, in the present thesis by using Omniscript reverse transcriptase kit (Qiagen) with oligo-dT primer.

The real-time PCR system presently used (paper I, V and VI) automatically monitors the binding of a fluorescent dye to double-stranded DNA by real-time detection of the fluorescence during each amplification cycle. The number of cycles when the fluorescence curves reach a pre-determined threshold value or the first turning point, identified by the second derivative method, is called the cycle threshold (Ct)-value. Real-time PCR was performed using either the Light-Cycler FastStart DNA Master SYBR[®] Green 1 kit in the Light-Cyklar detection system (Roche Diagnostics GmbH, Germany) (paper I) or QuantiTect[™] SYBR[®] Green PCR kit (Qiagen) in the SmartCyclerII system (Cepheid, USA) (paper V and VI). Intron over-spanning primers, designed using Primer express[®] 2.0 software (Applied Biosystems, USA) and synthesized by DNA Technology A/S (Aarhus, Denmark), were used to eliminate amplification of genomic DNA. The specificity of obtained PCR products was confirmed by running melting curves. The relative amounts of mRNA were determined by subtracting the Ct value for housekeeping gene β -actin or glyceraldehyde-3-phosphate dehydrogenase (GAPDH) from the Ct values for investigated genes (Δ Ct). In paper I, the Δ Ct value for the control group was then subtracted from the Δ Ct value for the treated group, generating a $\Delta\Delta$ Ct value, and the amount of mRNA was expressed as fold change compared to control ($2^{-\Delta\Delta$ Ct}). In paper V and VI, the amount of mRNA was expressed in relation to

10,000 mRNA molecules of GAPDH ($10,000 \times 2^{-\Delta Ct}$) and 100 mRNA molecules of β -actin ($100 \times 2^{-\Delta Ct}$).

Nasal lavage

Nasal lavage is a non-invasive method, commonly used to study mechanisms involved in inflammatory airway disease. In the design presently used (paper II and V), the nose is first cleared from excess mucus by forceful exsufflation. A room temperature sterile saline solution is then sprayed into both nostrils, alternately. The fluid is allowed to return passively and is collected in a graded tube, kept on ice, until 7 ml has been recovered (104). The derived fluid contains epithelial and inflammatory cells as well as different inflammatory mediators from plasma exudates and gland secretion. After counting the cells, the fluid is centrifuged. The cell pellet is dissolved in RNeasy lysis buffer and both cells and supernatants are stored at -80°C until analysis.

Two-dimensional gel electrophoresis and mass spectrometry

Two-dimensional gel electrophoresis (2-DE) in combination with mass spectrometry is today a commonly used method to identify and quantify proteins in different biological samples. In paper II, 2-DE in combination with mass spectrometry was used to identify and quantify proteins in human nasal lavage fluid. Proteins were separated in the first dimension according to their pI, using IEF. The focused proteins were then further separated in the second dimension according to their molecular weight, using SDS-PAGE. The 2-DE gels were stained (105) and subsequently scanned to give digitalized images over the protein patterns in the investigated samples. The images were analyzed using special software programs where it is possible to compare different gels and quantify protein spots of interest. Selected protein spots were excised from the gels, proteins were degraded into peptides, and the peptides were then extracted from the gel plug and analyzed using mass spectrometry.

In this thesis, matrix-assisted laser desorption/ionization time of flight (MALDI-TOF) mass spectrometry was used. In short, peptides are added to an UV-light absorbing matrix. This solution is added to a target plate, where the peptides co-crystallize with the matrix molecules. A laser pulse is fired at the plate and the laser energy is absorbed by the matrix. The matrix transfers part of its charge to the peptides, resulting in ionization of the peptides. The ions are accelerated in an electric field and thereafter allowed to passively fly in a field-free time of flight analyzer until they reach a detector. Light ions travel faster than heavy ions and the mass-to-charge ratio is determined by measuring the time it takes for the ions to reach the detector. The retrieved peptide masses are compared with theoretical peptide masses in different databases (106) to identify the proteins (figure 3).

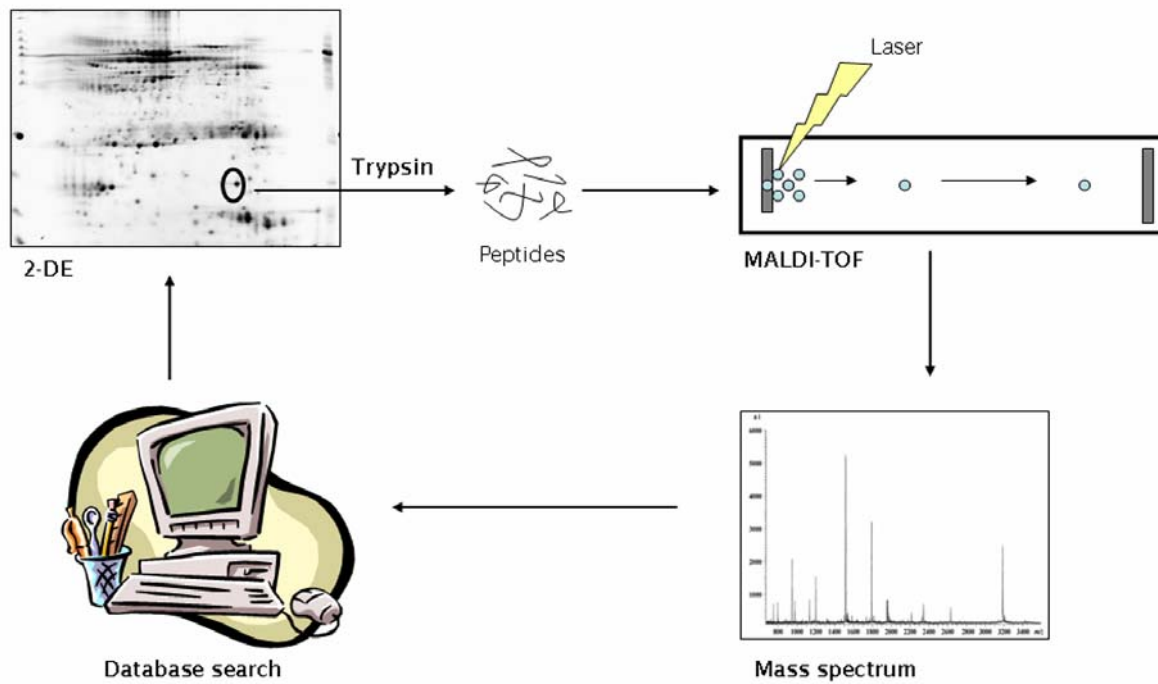

Figure 3. Schematic illustration of 2-DE and mass spectrometry.

Western blot

Western blot is a common method where antibodies are used to identify specific proteins. This procedure was used in paper II to confirm 2-DE findings in nasal lavage fluid and in paper VI to detect S100A7 in human palatine tonsil. In short, samples were mixed with SDS sample buffer to denature the proteins and make them negatively charged. Samples were then heated and centrifuged to separate the proteins from other cell components. Equal amounts of the samples were loaded onto acrylamide gels, separated by electrophoresis, and blotted to PVDF membranes. Membranes were blocked using 5% dry milk solution and then incubated with primary antibody against the protein of interest. Membranes were washed, followed by incubation with horse radish peroxidase (HRP)-conjugated secondary antibody. After several washes, membranes were incubated with a chemiluminescent substrate. The chemiluminescence was detected by exposing the membrane to X-ray film.

Immunohistochemistry

In immunohistochemistry, antibodies are used to detect proteins in tissue slides. In paper V and VI, enzymatic staining was used to detect S100A7 in human inferior turbinate and palatine tonsil, respectively. This method is based on detection of a specific antigen by a primary antibody, followed by incubation with a HRP-labeled polymer conjugated to a secondary antibody, which binds to the primary antibody bound to the tissue. After incubation with a substrate, positive immunoreactivity is identified by bright field microscopy, as a color precipitate.

DNA sequencing and SNP genotyping

DNA sequencing was used in paper III to resequence the *S100A7* gene. Genomic DNA was extracted from whole blood, regions of interest were amplified using PCR and thereafter sequenced using Big Dye Terminator chemistry. This method is based on a normal PCR reaction but with the addition of fluorescently labeled dideoxynucleotides, which are nucleotides lacking their 3'-hydroxyl group. When a dideoxynucleotide is incorporated into the DNA strand the extension of this DNA strand is terminated. At the end of the PCR reaction there are a large number of terminated PCR products of various lengths, each ending with a dideoxynucleotide (ddC, ddT, ddA or ddG). The PCR products are separated by size using capillary electrophoresis, and the fluorescence from each fragment is detected using a laser. In this way the nucleotide sequence is determined. SNPs are identified by comparing the retrieved nucleotide sequence with a known reference sequence.

To be able to identify differences in allele and genotype frequencies, SNPs are often genotyped in larger populations. In paper III and IV genotypes were determined in allergic and healthy individuals using the Sequenom MassARRAY MALDI-TOF system. This system analyzes allele-specific primer extension products using mass spectrometry. In short, SNP-containing regions are amplified with a primary PCR. Unincorporated dNTPs are dephosphorylated and in a second PCR reaction massEXTEND primers are extended into the SNP site. The resulting extension products have different masses, depending on which allele is situated at the polymorphic site. MALDI-TOF is then used to differentiate between the extension products and to determine the genotypes (figure 4).

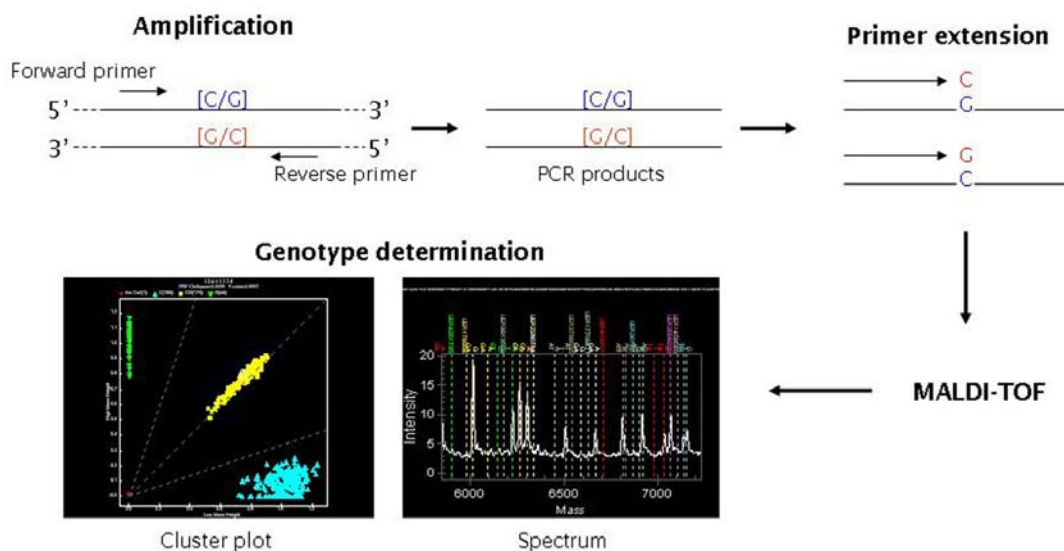

Figure 4. SNP genotyping procedure.

Genetic analysis

The Hardy Weinberg Equilibrium (HWE) equation ($p^2+2pq+q^2=1$, where p is the frequency of the major allele and q the frequency of the minor allele), describes the relationship between allele frequencies and predicted genotype frequencies in a random population. A deviation from HWE exists when the observed genotype frequencies are different from the predicted frequencies. HWE is expected from a randomly mating population in the absence of factors such as migration, selection and sub-population structure. Since genotyping errors also can result in deviations from HWE, all genotype frequencies in paper III and IV were tested for deviations from HWE (107).

Allele and genotype frequencies were tested for association with allergic rhinitis, using a χ^2 -homogeneity test. Haplotypes were estimated for *S100A7* and *CLC*, using the program PHASE (108). The level and pattern of LD in *S100A7* was investigated in paper III.

DNA microarray

DNA microarrays can be used to measure gene expression levels. Briefly, total RNA is extracted, amplified and labeled with biotin. The labeled mixture is hybridized to an array consisting of small DNA fragments. The array is stained with streptavidin-phycoerythrin and the intensity of the resulting signals gives an estimate of the quantity of each transcript in the sample. By comparing patient and control samples it is possible to distinguish genes that are up- or down-regulated. In paper V, HG-U133A, HG-U133B and HG-U133 Plus 2.0 microarrays from Affymetrix were used to measure *S100A7* gene expression levels in cells from nasal lavage fluid, during pollen season as well as before and after nasal provocation with allergen or LPS, respectively. HG-U133A and HG-U133B together contains probes representing more than 39,000 transcripts while the newer HG-U133 Plus 2.0 array represents over 47,000 transcripts.

The large amount of data retrieved from microarrays and the complex analytical process increase the risk of spurious findings. It is therefore important to verify identified gene expression changes with other methods, e.g. real-time PCR.

Cell line and culture conditions

Detroit 562 is an epithelial cell line originating from human nasopharyngeal carcinoma. This cell line was used in paper V to explore the regulation of *S100A7* mRNA expression in epithelial cells. Cells were cultured in complete Minimum Essential Medium in cell culture flasks, at 37°C in 5% CO₂. Before each experiment, cells were plated on 24-well culture plates (250,000 cells/well) and incubated over night.

Statistical analysis

Data were expressed as mean values \pm standard error of the mean (SEM) and n equals the number of subjects or experiments. Normally distributed data were analyzed using parametric methods. For comparison between two sets of data unpaired or paired t-test was performed. For comparison of more than two data sets, one-way analysis of variance (ANOVA), Repeated Measures ANOVA or two-way ANOVA was used. In all cases with multiple comparisons, Dunnett's or Bonferroni post tests were performed. Data not normally distributed were analyzed with nonparametric Mann-Whitney test. P-values ≤ 0.05 were considered statistically significant.

RESULTS AND COMMENTS

IL-4 contributes to the development of airway hyperreactivity

Chronic inflammation is thought to be involved in the induction of airway hyperreactivity, an important characteristic of both allergic rhinitis and asthma (109, 110). IL-4 is a Th2 cytokine involved in the development of allergic inflammation. It promotes an allergic phenotype by driving the differentiation of naïve Th lymphocytes into Th2 lymphocytes and also induces IgE class switch in B lymphocytes (111, 112). However, it is not known if IL-4 has a direct effect on airway smooth muscle. The aim of paper I was to evaluate if prolonged exposure to IL-4 affects the contractile response of murine airway smooth muscle. For this, an organ culture model, developed at our laboratory to study endured effects of inflammatory mediators on airway smooth muscle, was used (103). Kinins are formed during inflammation and there are evidence to suggest a key role in airway inflammation (69, 70). Two related kinins, dA-BK and BK, were used to evaluate the contractile response of murine tracheal segments after culture with IL-4.

dA-BK and BK did not induce any contractions in fresh tracheal segments. However, already after one day of culture the contractile response induced by dA-BK and BK, respectively, was increased in tracheal segments treated with IL-4. Tracheal segments were cultured for two, four and eight days as well. Increased contractile responses in segments treated with IL-4 were seen during all time periods (figure 5). The effect was concentration dependent, with a concentration of 100 ng/ml giving rise to the highest contractions. All contractions were expressed as percentage of a maximum contraction induced by carbachol (103), which was performed at the end of all myograph experiments. The carbachol induced contraction was not affected by culture time or by IL-4 treatment.

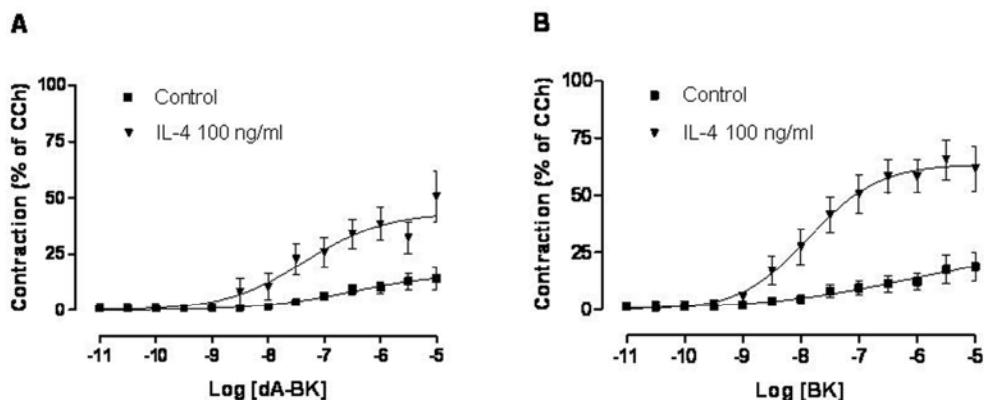

Figure 5. Representative picture of the contractile response induced by dA-BK (**A**) and BK (**B**), after four days of culture in absence and presence of 100 ng/ml IL-4 (n=6-8).

Treatment with IL-4 in combination with the general transcription inhibitor actinomycin D (113) almost completely abolished the induced contractions, suggesting that the IL-4 induced increase of contractions is dependent on transcription. To explore signal transduction pathways, segments were cultured for four days with IL-4 in combination with various MAPK signal transduction pathway inhibitors (114-116). The derived data indicated that the c-Jun N-terminal kinase (JNK) pathway was involved in contractions induced by both dA-BK and BK, whereas the extracellular signal-regulated kinase (ERK) pathway was involved only in BK contractions and the p38 pathway only in dA-BK induced contractions (figure 6).

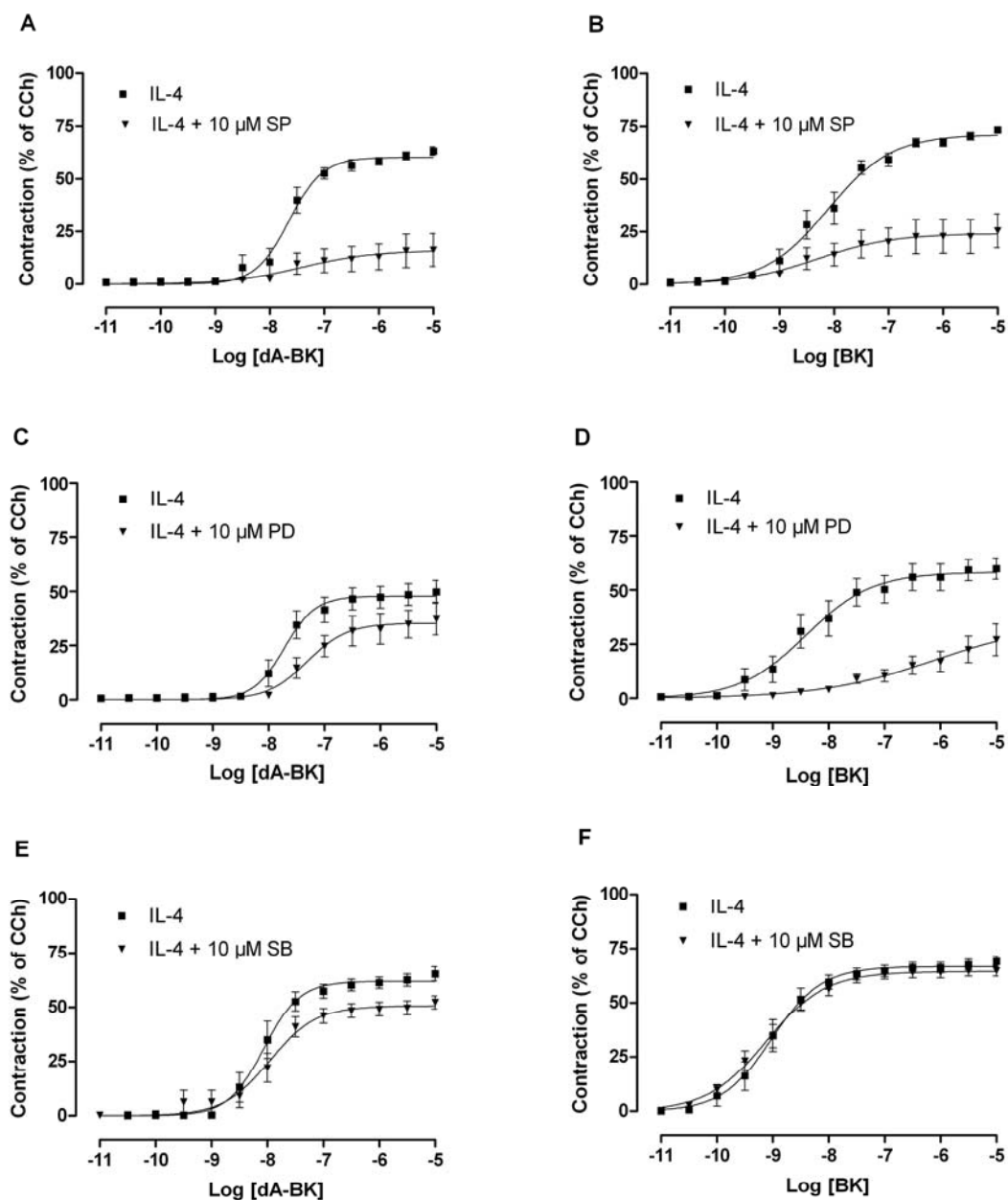

Figure 6. Contractile responses of mouse tracheal segments, induced by dA-BK and BK after four days of culture with IL-4 in combination with various MAPK signal transduction pathway inhibitors; JNK inhibitor SP600125 (**A**, **B**), ERK inhibitor PD098059 (**C**, **D**) and p38 inhibitor SB203580 (**E**, **F**) (n=5-8).

The receptors for dA-BK and BK are B₁ and B₂, respectively (73). To evaluate the effect of IL-4 on the expression of the B₁, B₂ and IL-4 receptor whole tracheae were cultured in presence of IL-4 for four days. Receptor mRNA levels were subsequently determined in isolated smooth muscle strips using real-time PCR. It was seen that the mRNA expression for the B₁ receptor was induced by IL-4. The expression of the B₂ receptor and the IL-4R was not affected by IL-4 treatment (figure 7).

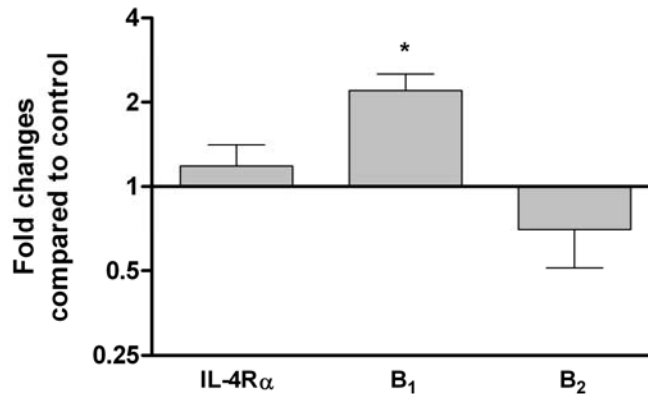

Figure 7. Receptor mRNA expression after four days of culture with IL-4 (n=3, * p <0.05).

Comments

In a murine organ culture model it was shown that IL-4 seems to have direct effects on airway smooth muscle cells, enhancing kinin-induced contractions. Kinins play a central role in airway inflammation; elevated levels are present in bronchoalveolar lavage of asthmatics, inducing bronchoconstriction, vascular dilatation and plasma exudation (117). Under normal conditions both dA-BK and BK are known to be poor bronchoconstrictors (118), which is in accordance with the results from the experiments with fresh tracheal segments in the present study. The receptor for BK (B₂) is constitutively expressed whereas the receptor for dA-BK (B₁) is induced during inflammatory conditions (73). In this study, IL-4 treatment led to increased mRNA expression of the B₁ receptor, leaving the B₂ receptor expression unaffected. The two B receptors also exhibited differences between which signaling pathways that were involved. Apparently, there are different mechanisms regulating the dA-BK and BK induced contractions. In the case of dA-BK, an up-regulation of B₁ receptors is probably involved. It is possible that IL-4 affects the B₁ and B₂ receptor signaling at additional levels, e.g. receptor redistribution, increased translation of the receptors or decreased internalization of receptors. The results in this study imply that IL-4 is not only important for establishing an allergic phenotype. It may also have a direct effect on airway smooth muscle cells and thereby contribute to the development of airway hyperreactivity.

Novel mediators identified in nasal lavage fluid

The upper airways are relatively easy to access and offer the opportunity for allergen provocation, in conjunction with repeated sampling and measurements, with a minimum of discomfort and risk for the patient. This has prompted us to use allergic rhinitis as an experimental model when searching for suitable mediators to target. Pro- and anti-inflammatory mediators are continuously emitted into the nasal lumen as a result of plasma exudation and glandular secretion. During ongoing inflammation, these processes are markedly facilitated (119). Nasal lavage has long been used to investigate the pathophysiologic mechanisms behind allergic rhinitis (120, 121). In paper II, we aimed to map the protein secretion pattern in human nasal lavage fluid and to identify differences between individuals with symptomatic allergic rhinitis and healthy non-atopic individuals, in an attempt to identify novel mediators of importance in allergic inflammation.

Twenty-one different proteins were identified in nasal lavage fluid, using 2-DE in combination with MALDI-TOF (figure 8 and table 1). The majority of proteins had previously been described in nasal lavage fluid by others (5, 58, 59, 94, 122), but six proteins were described in this study for the first time; S100A7 (psoriasin), galectin-3, alpha enolase, intersectin-2, WNT2B and a hypothetical protein MGC33648. We were able to confirm all novel proteins, except for intersectin-2 and MGC33648, using western blot analysis.

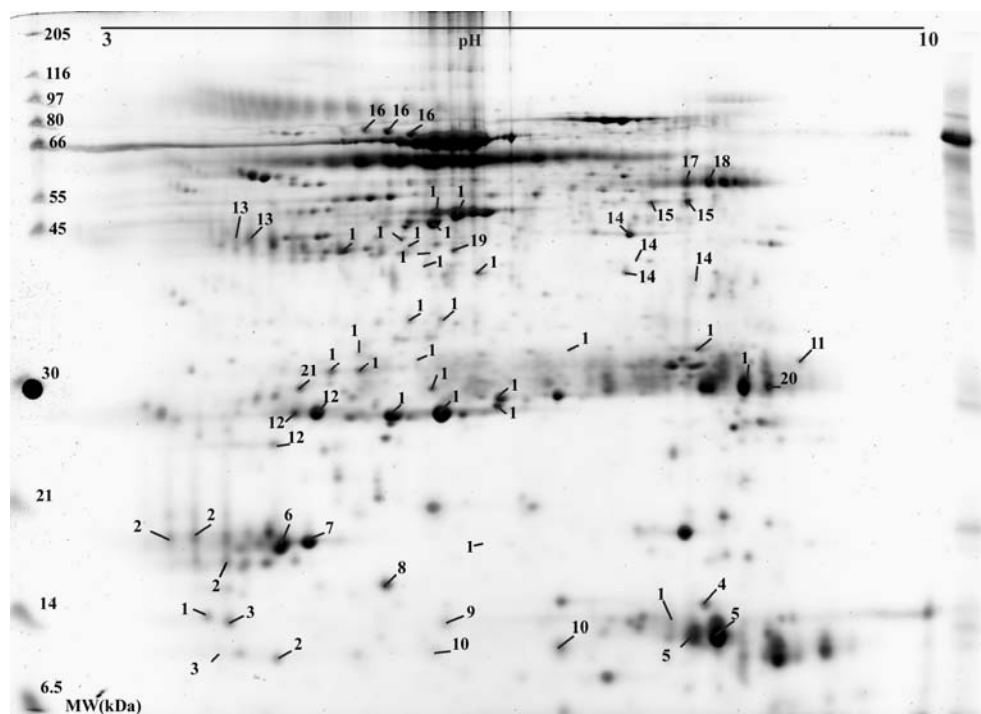

Figure 8. Typical 2-DE protein pattern in nasal lavage fluid. The protein name for each numbered spot is presented in table 1.

Table 1. Identified proteins in nasal lavage fluid

No.	Protein	Accession no. (Swissprot/IPI)
1	Albumin	P02768
2	PIP	P12273
3	Cystatin S	P01036
4	Cystatin SN	P01037
5	Hemoglobin beta chain	P68871
6	Intersectin 2 (splice isoform 2)	Q9NZM3-2
7	Lipocalin-1	P31025
8	Transthyretin	P02766
9	Calgranulin B	P06702
10	S100A7 (Psoriasin)	P31151
11	Galectin-3	P17931
12	Apolipoprotein A1	P02647
13	Alpha-2 glycoprotein 1, zink	P25311
14	Serotransferrin	P02787
15	Alpha enolase	P06733
16	Hemopexin	P02790
17	IgG2 chain c region	P01859
18	Wnt-2B protein (splice isoform 1)	Q93097-1
19	Fibrinogen beta chain	P02675
20	Hypothetical protein MGC33648	IPI00168581
21	Actin, cytoplasmic 1 or 2	P60709

Novel proteins are in bold

When the identified proteins were quantified, it appeared that six proteins differed in quantity when comparing allergic with healthy individuals. Two of these were novel proteins (S100A7 and WNT2B). The levels of S100A7 were decreased in the allergic individuals whereas the levels of WNT2B were elevated. Other proteins up-regulated in allergic individuals were albumin, IgG2 chain c region and transthyretin. In contrast, PIP appeared to be down-regulated. The findings for S100A7 were confirmed with western blot analysis.

Comments

2-DE in combination with mass spectrometry has proven to be one of the most powerful methods for describing and quantifying the proteome of different biological samples. Using this approach we were able to identify 21 different proteins in nasal

lavage fluid, of which six differed in quantity when comparing samples from allergic and non-allergic individuals. Both S100A7 and WNT2B, two of the differentially expressed proteins, were described in the nose for the first time. Since S100A7 has chemotactic properties (81) it can be assumed that the reduced levels found in allergic individuals might be of importance for the outcome of the disease. WNT2B is a developmental protein that has been reported to play a role as hematopoietic growth factor (91, 123). The increased levels in allergic individuals might be related to the increased growth and maturation stimulation of eosinophils and neutrophils often seen in allergic inflammation. PIP, a protein down-regulated in allergic individuals, might also be of interest in relation to airway inflammation since it is a potent inhibitor of T lymphocyte apoptosis (95).

The focus of the present study was to identify proteins that differed in quantity between allergic and healthy individuals, but it should be stressed that it is not only protein level changes that can be of importance for disease development. There are several post-translational modifications that can change the function of proteins, e.g. phosphorylation, glycosylation or acetylation (124-126). Consequently, the other identified proteins should not be discarded as potential biomarkers for allergic rhinitis, until this has been investigated.

It should be emphasized that although 2-DE has a high separation power there are still some limitations with this method. Very hydrophobic proteins, especially membrane proteins, have low solubility and tend to aggregate in aqueous solutions, and are thus more difficult to separate (127). Proteins with extreme pI also tend to be underrepresented and there is limited sensitivity for both high and low molecular weight proteins. Furthermore, low abundant proteins are often masked by high abundant proteins (55). Albumin for instance is present at high concentrations in nasal lavage fluid and represents approximately 15% of the total protein content. In the present study, albumin was not removed from the samples prior to 2-DE analysis, possibly resulting in suppressed separation of low abundant proteins.

Genetic variation associated with allergic rhinitis

The development of allergic rhinitis is dependent on interactions between several environmental and genetic factors (128). Although the increased prevalence of allergic diseases in the developed countries during the last decades has been largely attributed to changes in lifestyle and environment (129), there are studies showing that environment only accounts for 25% and heritability for 75% of the disease risk (36). Which genes that are involved has not yet been established but it is probable that several genes, each with modest effect, play a role in the disease development.

The aim of paper III was to describe genetic variation in the new mediator candidate S100A7 and investigate if this is associated with allergic rhinitis. The gene coding for S100A7 was resequenced in 47 allergic individuals, resulting in the identification of 13 polymorphisms, 12 SNPs and one 8-nucleotide indel. Seven polymorphisms were newly identified whereas six had been previously described (figure 9).

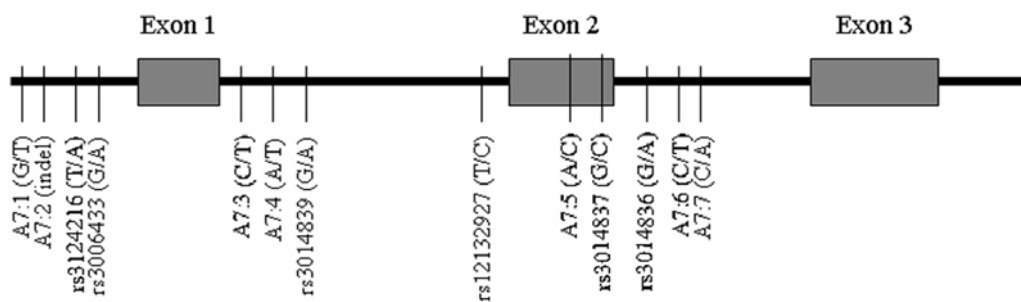

Figure 9. Polymorphic sites identified in *S100A7*. A7:1-A7:7 have not been previously described.

Nine polymorphisms were genotyped in 184 allergic individuals and 378 non-allergic individuals. All polymorphisms produced good quality data and were in HWE, both in the allergic group and the healthy control group. When allele frequencies were analyzed for association with allergic rhinitis, one SNP in the coding region appeared to be associated with the disease (table 2). This SNP, rs3014837, is a non-synonymous SNP situated in the coding region of the gene, giving rise to the amino acid shift Asp→Glu. When estimating the haplotypes in *S100A7*, two haplotypes were identified to differ in frequency between the allergic and healthy groups. The most common haplotype, containing the major allele at all sites, was more common in the healthy group (63.5% of the healthy and 60.1% of the allergic individuals, respectively). In contrast, the minor allele at rs3014837 appeared to be almost completely associated with a haplotype which was equally more common in the allergic group (3.6% of the healthy and 7.1% of the allergic individuals, respectively). Furthermore, skin prick test results were analyzed for association with allergic rhinitis. Also in this analysis rs3014837 showed a significant

association (with the allergen *Alternaria*). It was also seen that heterozygotes for this SNP had higher skin prick test scores for 9 out of 11 tested allergens.

Table 2. Allele frequencies for genotyped polymorphisms in *S100A7*

SNP name	Controls		Patients		Association test χ^2 -value (p-value)
	MAF	HWE	MAF	HWE	
A7:1	0.03	0.25	0.04	1.32	2.79 (0.09)
A7:2	0.14	0.02	0.16	1.20	0.91 (0.34)
rs3006433	0.12	1.09	0.15	1.26	1.44 (0.23)
A7:3	0.10	1.70	0.10	0.01	0.01 (0.93)
rs3014839	0.13	1.00	0.15	1.20	1.28 (0.26)
rs12132927	0.08	1.20	0.10	0.33	0.45 (0.50)
A7:5	0.01	0.03	0.01	0.04	0.45 (0.50)
rs3014837	0.05	1.68	0.08	0.59	5.15 (0.02)
A7:7	0.01	0.06	0.01	0.01	0.33 (0.57)

The positive association found for rs3014837 prompted us to investigate if there was genetic variation associated with allergic rhinitis in genes coding for other differentially expressed proteins in nasal lavage fluid. Consequently, in paper IV, the genes coding for PIP and WNT2B, identified in our own nasal lavage screening, together with PLUNC and CLC, identified by others (58, 94), were investigated for association with allergic rhinitis. None of the investigated SNPs in *PIP*, *WNT2B* and *PLUNC* were found to be associated with allergic rhinitis. In *CLC* however, eight SNPs revealed increased χ^2 -values, of which two were statistically significant when analyzed at the genotype level (figure 10 and table 3). No association was found at the allele level.

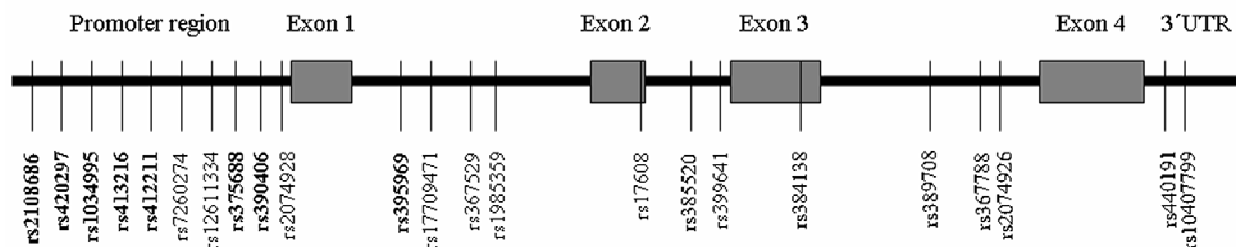

Figure 10. Polymorphic sites in *CLC*. SNPs with increased χ^2 -values are in bold.

Table 3. Genotype frequencies for SNPs with increased χ^2 -values in *CLC*

SNP	Genotype	Controls, n (%)	Patients, n (%)	Association test, χ^2 -value (p-value)	Odds ratio ¹ , 11 vs 12 11 vs 22
rs2108686	CC	288 (74.8)	194 (78.2)		
	CT	96 (24.9)	50 (20.2)		0.77
	TT	1 (0.3)	4 (1.6)	5.22 (0.07)	5.94
rs420297	CC	285 (75.4)	147 (79.9)		
	CT	92 (24.3)	33 (17.9)		0.70
	TT	1 (0.3)	4 (2.2)	7.68 (0.02*)	7.76
rs1034995	TT	269 (81.5)	175 (82.9)		
	CT	60 (18.2)	32 (15.2)		0.82
	CC	1 (0.3)	4 (1.9)	4.25 (0.12)	6.15
rs413216	CC	284 (75.5)	193 (79.1)		
	CT	91 (24.2)	47 (19.3)		0.76
	TT	1 (0.3)	4 (1.6)	5.33 (0.07)	5.89
rs412211	AA	294 (76.8)	195 (78.9)		
	TA	88 (23.0)	48 (19.4)		0.82
	TT	1 (0.26)	4 (1.6)	4.46 (0.11)	6.03
rs375688	TT	284 (75.5)	193 (78.8)		
	TC	91 (24.2)	48 (19.6)		0.78
	CC	1 (0.3)	4 (1.6)	5.05 (0.08)	5.89
rs390406	GG	289 (75.1)	197 (78.8)		
	GA	95 (24.7)	48 (19.2)		0.74
	AA	1 (0.3)	5 (2.0)	7.15 (0.03*)	7.34
rs395969	CC	294 (76.4)	197 (78.8)		
	TC	90 (23.4)	49 (19.6)		0.81
	TT	1 (0.3)	4 (1.6)	4.56 (0.10)	5.97

11: homozygote for major allele, 12: heterozygote, 22: homozygote for minor allele

*p \leq 0.05, 2 degrees of freedom

All SNPs with increased χ^2 -values were situated in the putative promoter region of the *CLC* gene and it appeared that homozygotes for the minor alleles were more common in the allergic group. When this effect was quantified using odds ratios (OR) it appeared that the OR of the homozygote for the minor allele in relation to the homozygote for the major allele was very high, while the heterozygotes were underrepresented in the allergic group (OR $<$ 1). Unexpectedly, seven of the SNPs in this region deviated from HWE in the control group.

The haplotype pattern in the putative promoter region was relatively simple with two very similar haplotypes, differing in one SNP only, representing approximately 50% respectively 30% of all chromosomes. A third haplotype, consisting almost entirely of minor alleles, represented about 12%, and differed in 8-9 SNPs from the other haplotypes. The fourth haplotype, representing about 3%, was very similar to the two major haplotypes (table 4).

Table 4. Estimated haplotype frequencies in the putative promoter region of *CLC*

SNP ¹	1	2	3	4	5	6	7	8	9	10	11	Frequency
Haplotype												
1	C	C	T	C	A	G	C	T	G	C	C	0.51
2	C	C	T	C	A	G	G	T	G	C	C	0.32
3	T	T	C	T	T	G	C	C	A	C	T	0.12
4	C	C	T	C	A	G	C	T	G	T	C	0.03

¹ SNPs are numbered according to their order of appearance in figure 10.
Minor allele in bold

Comments

Genetic variation in both *S100A7* and *CLC* was found to be associated with allergic rhinitis, while no association was found between this disease and *PIP*, *WNT2B* and *PLUNC*. The pattern of genetic variation was not the same in *S100A7* and *CLC*. In *S100A7*, association was found for a non-synonymous SNP at the allele level. The minor allele of this SNP was completely associated with one specific haplotype, which means that the allele frequency difference at the same time was a haplotype frequency difference. Although rs3014837 is situated in the region coding for the N-terminal EF-hand of S100A7 (130, 131) it is difficult to predict if this amino acid shift has any functional effects important for the disease. The reduced levels previously found in nasal lavage fluid in allergic individuals are probably not a result of genetic variation, since amino acid shifts seldom give rise to protein level changes. However, the fact that heterozygotes for rs3014837 had increased skin prick test scores for 9 out of 11 tested allergens further supports S100A7 as a factor involved in allergic inflammation.

In *CLC* on the other hand, eight SNPs situated in the putative promoter region revealed increased χ^2 -values, of which two were statistically significant. The minor alleles of all eight SNPs were situated on the same haplotype, but in this case no haplotype frequency differences were obtained between the two groups. This is in line with the fact that the association was seen at the genotype level. Homozygotes for the minor alleles were more common in the allergic group, which speaks for a recessive inheritance model. This is also compatible with the altered protein levels detected previously in allergic individuals (59). One confusing observation however is that seven

of the SNPs in the putative promoter region were found to deviate from HWE in the control group, as a result of an overrepresentation of heterozygotes. Deviation from HWE is often a sign of technical problems but since all investigated SNPs in the data set gave rise to good quality data and similar deviation was seen for all seven SNPs in the promoter region, we would like to rule out this possibility as an explanation to this result. Due to the high prevalence of allergy, the control group cannot be viewed as a sample of the entire population, since they are selected conditionally on the absence of allergy. Instead, a SNP associated with disease may very well show a deviation from HWE in both groups.

S100A7 and CLC have both previously been suggested to be involved in allergic inflammation. Apart from our own finding that S100A7 protein levels are reduced in allergic individuals during pollen season (132), increased mRNA levels have been described in skin from atopic eczema patients (84, 133). CLC, also called galectin-10, is abundantly expressed in eosinophils and high concentrations are found in e.g. skin, sputum and nasal lavage fluid in association with allergic rhinitis (100, 134). In the present study we also find genetic variation linked to allergic rhinitis in these genes, rendering S100A7 and CLC good candidates for further studies regarding their role in allergic inflammation.

S100A7 expression in the nose and palatine tonsils

Paper II and III identified S100A7 as a new mediator candidate in allergic inflammation. Not much has been written about the functional effects of S100A7 but it has been attributed both chemotactic and antimicrobial properties (81, 83). The aims of paper V and VI were to investigate the expression of S100A7 in nose and palatine tonsils, respectively, and study how this expression is affected by atopic disposition and infectious stimuli.

Immunohistochemical staining for S100A7 in the nose was found in the epithelium and in seromucous glands. In palatine tonsils, staining was detected in the epithelium, in germinal centers and in T cell zones (figure 11). The mRNA expression in tonsillar B lymphocytes (CD19⁺) and T lymphocytes (CD4⁺ and CD8⁺) was assessed with real-time PCR. All cell types expressed S100A7 and the expression appeared to be highest in the CD8⁺ T lymphocyte. The effect of allergen stimulation on the S100A7 mRNA expression in the nose was assessed using DNA microarray analysis on cells obtained from nasal fluid, before and after nasal allergen challenge. In a first set of patients, studied outside pollen season, there was a significant increase of S100A7 mRNA levels six hours after allergen challenge (figure 12A). This was confirmed in a material consisting of pooled samples from a second set of patients, also studied outside pollen season. In this experiment it was also shown that the up-regulation of S100A7 was time dependent. An increased expression was seen one hour after the provocation and this increase was further enhanced five hours later. Effects on the S100A7 expression induced during pollen season were analyzed in a third group of patients, revealing

elevated levels in symptomatic individuals. To confirm these findings, nasal biopsies were obtained from allergic and non-allergic individuals during pollen season and analyzed with real-time PCR analysis. Compatible with the DNA microarray findings, the S100A7 mRNA expression was strongly up-regulated in the patients with on-going symptomatic allergic rhinitis (figure 12B). Interestingly, outside pollen season the situation seemed to be reversed. When comparing all DNA microarray analyses, the gene expression level for S100A7 was lower in allergic individuals (200 ± 80 and 247 , respectively) than in healthy controls (726).

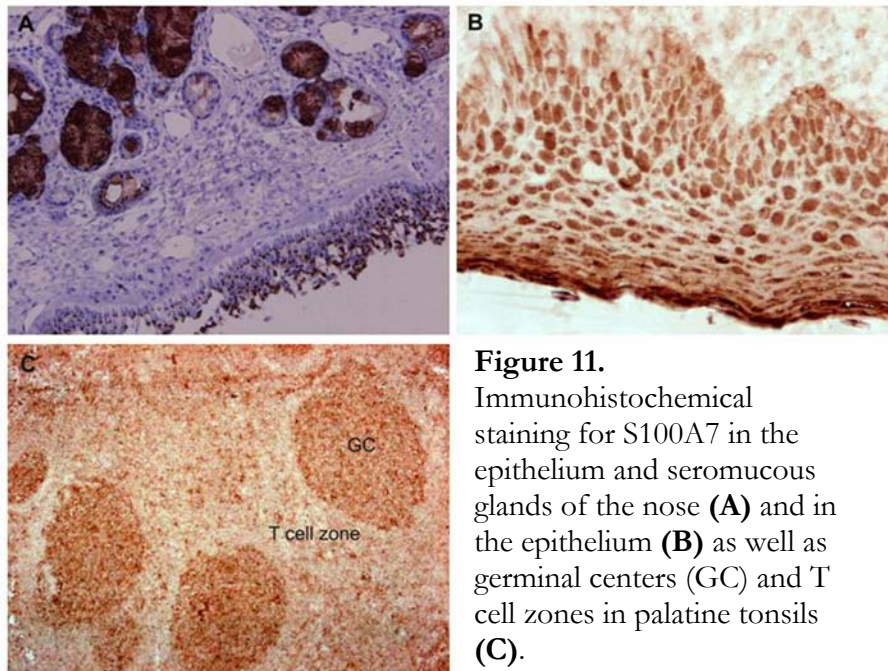

Figure 11. Immunohistochemical staining for S100A7 in the epithelium and seromucous glands of the nose (A) and in the epithelium (B) as well as germinal centers (GC) and T cell zones in palatine tonsils (C).

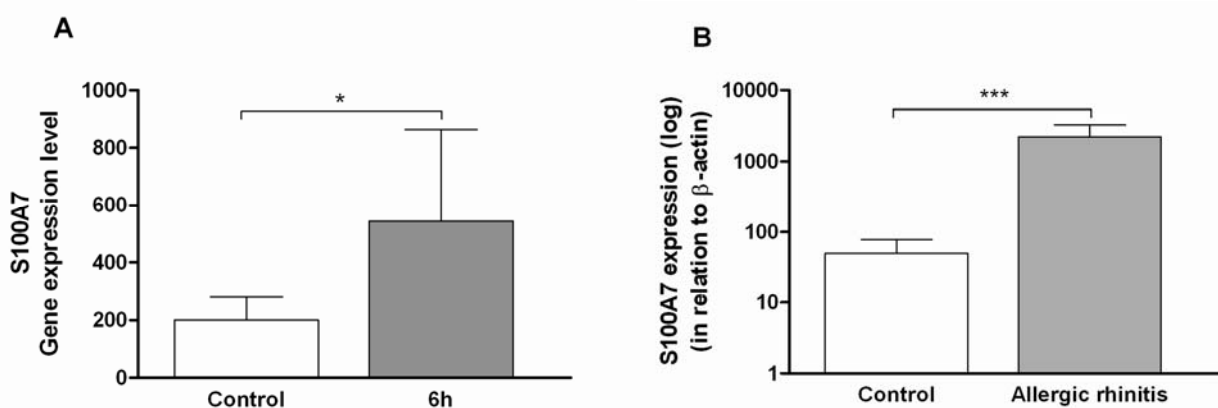

Figure 12. S100A7 mRNA levels in cells obtained from nasal lavage fluid before (control) and six hours (6h) after allergen provocation ($n=6$); data derived using DNA microarrays (A). S100A7 mRNA levels in nasal biopsies obtained during pollen season from healthy (control) and allergic individuals (allergic rhinitis) ($n=10-11$); data derived using real-time PCR (B) (* $p < 0.05$, *** $p < 0.001$).

In the next step, the regulation of S100A7 during inflammatory conditions was analyzed *in vitro* in the nasopharyngeal epithelial cell line Detroit 562. Cells were stimulated with the pro-inflammatory cytokine TNF- α , resulting in an up-regulation of the mRNA levels of S100A7, in a time- and concentration dependent manner (figure 13A). The TNF- α induced S100A7 expression was clearly inhibited by the general transcription inhibitor actinomycin D. To explore which signal transduction pathways that were involved, cells were incubated with TNF- α in combination with various signal transduction pathway inhibitors (135). MG-132, a proteasome inhibitor capable of suppressing I κ B α degradation and subsequent NF- κ B nuclear translocation, significantly decreased the TNF- α induced up-regulation (figure 13B).

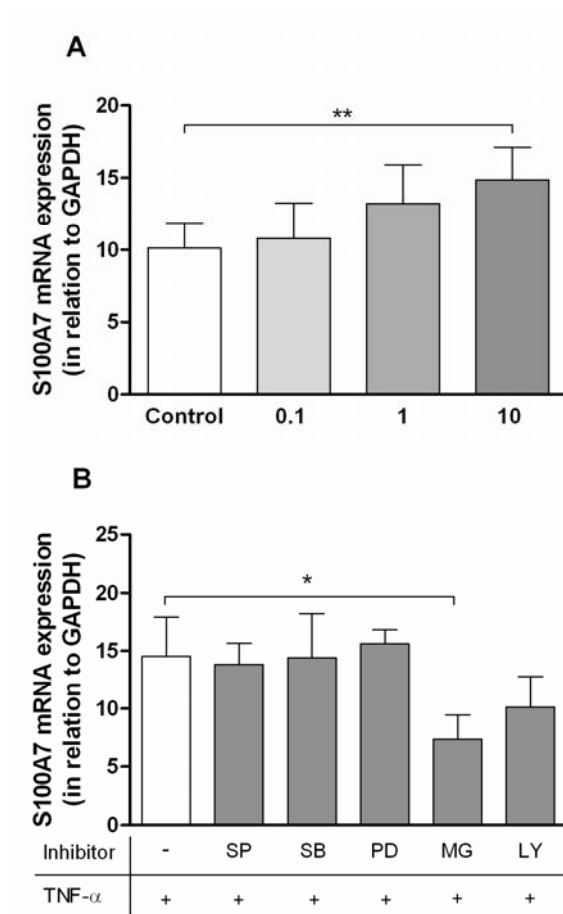

Figure 13. S100A7 mRNA expression in Detroit 562 cells after stimulation with TNF- α (0, 0.1, 1 or 10 ng/ml) for six hours (n=6) **(A)**. Detroit 562 cells treated for six hours with TNF- α (10 ng/ml) in absence or presence of various signal transduction pathway inhibitors (n=4) **(B)**. SP=JNK inhibitor SP600125 (10 μ M), SB=p38 inhibitor SB203580 (10 μ M), PD=ERK inhibitor PD98059 (10 μ M), MG=NF- κ B inhibitor MG-132 (1 μ M), LY=PI3K inhibitor LY294002 (10 μ M), *p<0.05, ** p<0.01.

Tonsils were obtained consecutively from patients undergoing tonsillectomy due to recurrent infections or airway obstruction. All patients were tested for occurrence of allergy using a Phadiatop test with subsequent test for specific IgE antibodies against a standard panel of allergens. Based on these results, the obtained tonsils were divided into one allergic and one non-allergic group, consisting of 41 and 68 tonsils, respectively. S100A7 mRNA levels in the tonsils were subsequently determined using real-time PCR. This analysis revealed that tonsils obtained from allergic individuals expressed reduced S100A7 mRNA levels compared to tonsils obtained from healthy

non-allergic individuals (figure 14A). This is in line with what we have been reporting for S100A7 in the nose, outside pollen season.

Palatine tonsils are continuously exposed to microbes and the secretion of antimicrobial peptides has previously been described as a part of the first line of defense (136). Since S100A7 has been reported to have the ability to kill bacteria we wanted to explore if a history of recurrent tonsillitis had any effect on the S100A7 mRNA expression in tonsils. Tonsils were divided into one infected and one non-infected group based on the results from tonsillar core culture tests. Tonsils with positive core culture test for β -hemolytic streptococci and/or *Haemophilus influenzae* were considered infected and tonsils with negative core culture test were considered non-infected. It appeared that the infected tonsils had lower S100A7 mRNA levels compared to the non-infected ones (figure 14B).

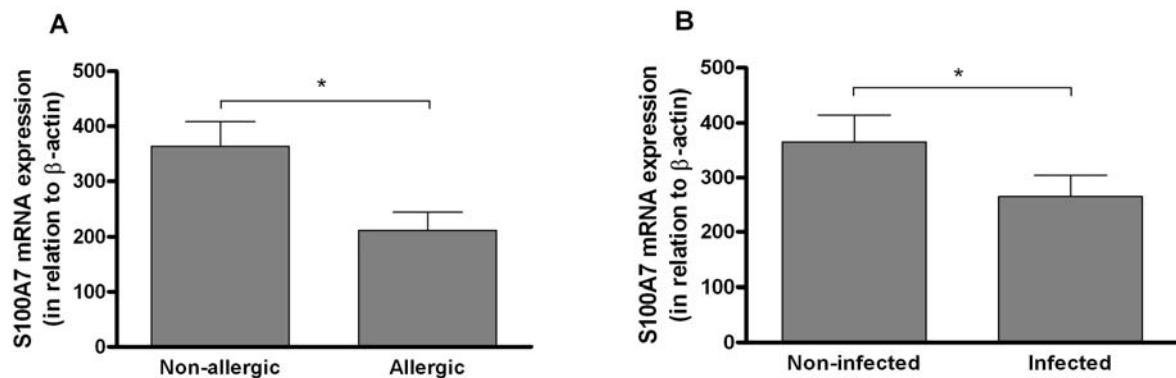

Figure 14. Comparison of S100A7 mRNA levels in tonsils from non-allergic (n=68) and allergic individuals (n=41) (A) and in non-infected (n=46) and infected tonsils (n=63) (B), * p < 0.05.

Comments

S100A7 protein was detected in the epithelium of both nose and palatine tonsils. Nasal biopsies consist primarily of epithelial cells and the main cell types obtained during nasal lavage are leukocytes, primarily neutrophils, and epithelial cells. Since we have not been able to detect S100A7 in neutrophils, the present study suggests that S100A7 primarily originates from epithelial cells. The protein was also found in seromucous glands in the nose and in both T and B lymphocytes in tonsils, which indicates that the epithelial cell is not the only source for S100A7. In the skin for instance, S100A7 is found both in the epithelium (keratinocytes) and in sebaceous glands (83). Both epithelial cells and exocrine glands can rapidly secrete S100A7 in response to stimuli and since S100A7 is chemotactic for inflammatory cells it may very well function as a link between the innate and adaptive immune system. It is well known that airway epithelial cells secrete antimicrobial peptides as an innate defense mechanism against infections (137). However, in the present study we also found S100A7 in tonsillar B and T lymphocytes, both part of the adaptive immune system. This is compatible with the observation that β -defensins, another group of antimicrobial peptides, are present in T

lymphocytes in the respiratory tract (138), and suggests that antimicrobial peptides, including S100A7, have multiple functions in the airway mucosa.

S100A7 mRNA expression in the nose was increased after allergen provocation and a further increase was seen during ongoing pollen season, indicating that S100A7 can be synthesized during inflammatory conditions. The *in vitro* experiments with the nasopharyngeal cell line Detroit 562 also indicate that S100A7 is induced in response to pro-inflammatory stimuli, mediated through NF- κ B induced transcription. A somewhat confusing observation is the discrepancy between high mRNA levels in the nose during inflammatory conditions and reduced protein levels in nasal lavage fluid in symptomatic allergic individuals. One possible explanation is that the mRNA transcription is induced in response to inflammatory stimuli but for some reason the translation or secretion of the protein is repressed in allergic individuals, possibly leading to an accumulation of mRNA molecules in the cells. Another possibility is that there is a disease driven consumption of the protein during the allergic response, leading to reduced protein levels in the lavage fluids. The mRNA expression pattern in tonsils adds another level of complexity to the regulation of S100A7. In contrast to the nose, tonsils obtained from allergic individuals expressed less mRNA for S100A7 compared to healthy controls. It should be emphasized that the patients participating in the tonsil study did not report any allergic symptoms when included in the study. In the nose study, non-symptomatic allergic individuals seemed to have lower expression compared to their non-allergic controls, which is compatible with the results obtained from the tonsils. The tonsillar expression in patients reporting allergic symptoms remains to be explored. Still, the possibility exists that low S100A7 expression results in an altered immunological response, favoring Th2 activity. When comparing infected and non-infected tonsils, the infected tonsils expressed less S100A7 mRNA. In general, the expression of other antimicrobial peptides is up-regulated in response to tonsillar infections (138, 139) but this is obviously not the case for S100A7. Consequently, it is tempting to speculate that individuals with low expression of S100A7 are more prone to develop infections.

SUMMARY AND CONCLUSIONS

- Long-term exposure to IL-4 increased the contractile response induced by dA-BK and BK in cultured murine airways. The effect was mediated via an up-regulation of B₁ receptors and altered signaling along the MAPK pathways. This suggests that IL-4 has a direct effect on airway smooth muscle that may contribute to the development of airway hyperreactivity.
- 2-DE screening identified 21 different proteins in human nasal lavage fluid, of which six, S100A7, WNT2B, galectin-3, alpha enolase, intersectin-2 and hypothetical protein MGC33648 had not been previously described in the nose. Two of these, S100A7, a potent chemotactic factor and WNT2B, a hematopoietic growth factor, appeared to be of special interest for the pathophysiology of the disease. S100A7 was down- and WNT2B up-regulated among patients with symptomatic allergic rhinitis. Another down-regulated protein, PIP, known to be associated with T lymphocyte apoptosis, was also identified as being of potential interest for the development of airway inflammation.
- Genetic analysis revealed 13 polymorphisms in *S100A7*. rs3014837, a non-synonymous SNP, was found to be associated with allergic rhinitis. Heterozygotes for this SNP had increased skin prick test scores for 9 out of 11 investigated allergens. Additionally, the major haplotype, containing the major allele at all sites, was more common in non-allergic individuals, while the haplotype containing the minor allele at rs3014837 was equally more common among the allergic individuals. This further supported the involvement of S100A7 in allergic inflammation and rendered S100A7 a strong candidate for further investigations regarding its functional role in allergic rhinitis.
- Genetic variation in *PIP*, *WNT2B* and *PLUNC* was not associated with allergic rhinitis, but a haplotype in the promoter region of *CLC* was found to be associated with the disease. This haplotype almost entirely consists of minor alleles and individuals homozygous for this haplotype are more common in allergic compared to healthy non-atopic individuals. The pattern of variation is compatible with a recessive inheritance model. The high expression levels previously described in eosinophils promote CLC as a good candidate for future studies regarding its involvement in allergic inflammation.
- Immunohistochemical staining for S100A7 was seen in the airway epithelium of the nose and corresponding mRNA expression could be obtained in nasal biopsies. The mRNA expression increased both after allergen provocation and during pollen season. S100A7 mRNA was also identified in the nasopharyngeal epithelial cell line Detroit 562, and TNF- α stimulation resulted in an up-regulation of the mRNA expression in these cells. Altogether, this suggests an

ability to synthesize S100A7 during inflammatory conditions. In palatine tonsils S100A7 was detected in the epithelium as well as in germinal centers and T cell regions. In contrast to the findings in the nose, the mRNA expression was decreased in individuals with atopic disposition as well as in patients with a history of recurrent tonsillitis.

- The discrepancy between the reduced protein levels of S100A7 in the nasal lavage fluid during symptomatic allergic rhinitis and the increase of mRNA found following various types of inflammatory stimulation may reflect either an increased consumption of S100A7 or a decreased ability to translate the mRNA into protein. The reduced mRNA levels in tonsils during inflammatory conditions appear to increase the complexity of the S100A7 regulation. However, the antimicrobial properties attributed to S100A7 make it tempting to assume that individuals with low expression levels are more prone to develop infections. In the case of atopic disposition, it is possible that the decreased expression levels are partly responsible for an altered immunological response in the tonsils, favoring Th2 activity.

FUTURE PERSPECTIVES

In the present thesis, S100A7 has been identified as a novel mediator candidate in allergic rhinitis. The altered protein levels in allergic individuals during pollen season and the association between a non-synonymous SNP and allergic rhinitis strongly support S100A7 as a factor involved in allergic airway inflammation. Nevertheless, there are some issues that need further attention. The relevance of the increased S100A7 mRNA levels in the nose after allergen stimulation and the discrepancy between mRNA and protein findings needs to be explored. It is well known that mRNA and protein levels do not always converge and consequently additional protein studies are required. During the course of this study no commercial S100A7 ELISA (enzyme-linked immunosorbent assay) has been available and strong efforts have been made to set up an ELISA at our own laboratory, unfortunately without much success. The recent introduction of a S100A7 ELISA on the market seems promising for future protein studies. It is also of importance to characterize the function of S100A7 in more detail. Several of the S100 proteins bind to the RAGE receptor (140, 141) but this does not seem to be the case for S100A7. Identification of the receptor would enable more detailed functional studies. Furthermore, it would be very interesting to investigate the functional effects of the Asp→Glu amino acid shift in the *S100A7* gene, and explore if this is of importance for the pathogenesis of the disease. This could be done by introducing this amino acid shift in a mouse model for allergic airway inflammation. In a larger perspective it would of course also be interesting to evaluate S100A7 as a therapeutic target in allergic airway inflammation, but the pathological mechanisms need to be assessed first.

CLC was also identified as a promising candidate for further studies regarding its role in allergic inflammation. Additional studies are needed to distinguish if the promoter haplotype associated with allergic rhinitis in fact affects the CLC protein levels in allergic individuals. Furthermore, the function of CLC and its relevance in the pathogenesis of the disease needs to be established before one can predict its usefulness as a future therapeutic target.

POPULÄRVETENSKAPLIG SAMMANFATTNING

Allergisk rinit (hösnuva) och astma är två besläktade sjukdomstillstånd som båda försämras av allergenexposition. Det förra karakteriseras av nysningar, snuva och nästäppa samt klåda i näsa och ögon, medan andnöd präglar det senare. Gemensamt för båda tillstånden är att de har sin utgångspunkt i en underliggande luftvägsinflammation samt att luftvägarna hos dessa patienter ter sig hyperreaktiva, dvs. uppvisar en överdriven känslighet för olika typer av stimulering. Mycket talar för att tillstånden utvecklas genom samverkan mellan arv och miljö.

Syftet med föreliggande avhandling är att studera om redan kända inflammatoriska mediatorer med en etablerad roll i det immunologiska systemet kan bidra till utveckling av luftvägshyperaktivitet genom direkt påverkan på den glatta muskulaturen. Vidare var målet att försöka identifiera och karakterisera helt nya mediatorproteiner med en möjlig roll för uppkomst och utveckling av allergisk inflammation.

Delarbete I är en djurexperimentell studie där isolerade luftvägar från mus behandlades med antingen IL-4 eller en kontrollsubstans under fyra dagar. Efter detta mättes luftvägarnas förmåga att dra ihop sig som svar på stimulering med bradykinin. Det visade sig att de luftvägar som behandlats med IL-4 svarade mycket kraftfullare på bradykinin än de som behandlats med kontrollsubstans. Både IL-4, en av många medlemmar i den stora cytokinfamiljen, och bradykinin är välkända mediatorer som bildas i ökad utsträckning under den allergiska inflammationsprocessen. Framkomna data talar för möjligheten av en tidigare icke kartlagd väg för utveckling av hyperaktivitet i lungor via en direkt cytokinpåverkan av luftvägsmuskulaturen.

I delarbete II försökte vi kartlägga vilka proteiner som utsöndras i näsan under pågående pollensäsong samt studera om det fanns några skillnader i mängd mellan friska personer och personer med allergisk rinit. För att komma åt de proteiner som utsöndras sköljdes näsan med koksaltlösning och proteininnehållet identifierades. Av de proteiner som kartlades var sex tidigare inte beskrivna i näsan. Bland dessa återfanns S100A7 och PIP i mindre mängd och WNT2B i större mängd hos patienter med allergisymptom, något som gör deras eventuella roll i den allergiska sjukdomsutvecklingen intressant att studera närmare.

I delarbete V och VI genomfördes fördjupade studier för att se hur S100A7 påverkas av allergisk inflammation och bakteriella infektioner. Vävnadsbitar samlades in från näsa och tonsiller och genuttrycket, så kallat mRNA-uttryck, analyserades. mRNA-nivåerna av S100A7 var förhöjda i näsvävnad från patienter med allergisk rinit både efter att dessa exponerats för pollen före provtagning och under själva pollensäsongen. Orsaken till att proteinmängden minskar (delarbete II) samtidigt som mRNA-mängden här ökade kan bero på att det protein som bildats med mRNA som mall konsumerats under den inflammatoriska processen. En annan förklaring skulle kunna vara att överföringen från mRNA till protein inte fungerar tillfredställande hos patienter med luftvägsallergi. I

tonsiller från allergiska individer var mRNA-nivåerna av S100A7 lägre jämfört med friska kontroller. Samma bild sågs hos patienter som opererats pga. återkommande bakteriella infektioner i sina tonsiller. Det är sedan tidigare känt att S100A7 har antibakteriella egenskaper. Det kan därför inte uteslutas att en bristande förmåga att bilda S100A7 kan bidra till utveckling av kronisk tonsillinflammation.

Delarbete III och IV utgörs av genetiska studier. I kroppens alla celler finns DNA som fungerar som mall för de proteiner som skall bildas. En DNA-sträng är uppbyggd av olika byggstenar, så kallade nukleotider (A, C, G och T). Förändringar i nukleotidmönstret kan leda till att det inte bildas lika mycket eller felaktigt protein. Ett vanligt förekommande fenomen är att enskilda nukleotider på olika ställen i DNA-strängen är utbytta (t.ex. ett A har blivit ett T). Denna genetiska förändring kallas för en SNP. I arbete III beskrivs ett antal sådana förändringar i den gen (del av DNA-strängen) som fungerar som mall för proteinet S100A7. En av dessa förändringar var mer vanligt förekommande i allergiska patienter jämfört med friska icke-allergiska individer. Förekomst av denna SNP skulle kunna påverka proteinets funktion.

Delarbete IV genomfördes med syfte att kartlägga förekomsten av SNPar i gener kodande för andra nasala proteiner. Studien kom att omfatta generna för WNT2B och PIP samt ytterliggare två proteiner: PLUNC och CLC, vars förekomst i näsa nyligen rapporterats av en annan forskargrupp. Ett antal genetiska förändringar i *PIP*, *WNT2B* och *PLUNC* kunde konstateras men ingen av dessa kunde kopplas till förekomsten av allergisk rinit. I *CLC* däremot, återfanns ett antal förändringar i den del av genen som reglerar hur ofta den används för att producera protein. Dessa förändringar var vanligare hos allergiker än hos friska och skulle kunna påverka den mängd CLC protein som produceras under allergisk inflammation.

Sammanfattningsvis kan sägas att studierna som ingår i denna avhandling visar att IL-4 kan bidra till utveckling av luftvägshyperaktivitet genom direkt påverkan på den glatta muskulaturen. Vidare har sex nya proteiner påvisats i näsan. Ett av dessa, S100A7, föreföll speciellt intressant för uppkomst och utveckling av allergisk rinit, då patienter med denna sjukdom uppvisade påtagligt sänkta nivåer. En närmare analys stärkte sambandet med allergisk inflammation och visade att den gen som styr proteinbildningen är nära associerad med förekomst av allergisk rinit. Liknande genetisk sjukdomsassociation noterades för ett annat nytt protein i näsan, CLC. Både S100A7 och CLC är därför kandidater för vidare studier med avsikt att verifiera deras användbarhet som diagnostiska markörer och terapeutiska mål vid allergisk luftvägsinflammation.

ACKNOWLEDGEMENTS

A lot of people have contributed to the work in this thesis and I would like to express my sincere gratitude to everyone who has helped and supported me during my years as a PhD-student. In particular, I would like to thank:

Lars-Olaf Cardell, my supervisor, for introducing me to allergy research. Your profound knowledge in the field, your enthusiasm and dedication to research has been truly inspiring. I really appreciate the support you have given me throughout the years.

Mikael Adner, my co-supervisor, for introducing me to the organ culture model and for always being available in the laboratory during my first years. Thank you for your fine support and encouragement in the beginning, it meant a lot.

Christer Halldén, my co-supervisor during the last two years, for teaching me all that I know about DNA sequencing and SNP genotyping and for systematically guiding me through the world of genetics.

Rolf Uddman, my co-author in paper V, for contributing with immunohistochemical analyses and for taking the time to critically read all my manuscripts.

Torbjörn Säll, my co-author in paper III and IV, for generously performing genetic analyses and valuable contributions to the manuscripts.

My co-authors in paper V, **Mattias Fransson, Mikael Benson, Robert Virtala, Per Broberg, Lennart Jansson** and **Kristian Riesbeck**, for your contributions in this study.

Peter James, manager for the division of Protein technology in Lund, for letting me use your facilities during my proteomics study. **Ulrika Brynnel** and **Anna-Karin Pählman** for your excellent assistance with the 2-DE gels and for always taking the time to help me find a solution to my problems. **Liselotte Andersson** for helping me with the mass spectrometry analysis.

Agneta Sterner, Agneta Östensson, Liselotte Hall and **Maria Sterner** at the DNA laboratory for kindly performing DNA sequencing and SNP genotyping.

My colleagues at the Allergy laboratory: **Ingegerd Larsson**, my “rock”, for helping me with all sorts of things in the lab, your smart practical solutions, nice chats and for putting out with my endless flow of questions. **Ann Reutherborg** for generous help with collecting samples, fun discussions and for taking care of my strange invoices.

Anne Månsson, co-author and roommate, for your contributions to paper VI, helpful suggestions, your positive energy and good friendship. **Anna-Karin Ekman, Camilla Rydberg** and **Yaping Zhang**, roommates, for great company and help in the lab. It has been really nice working with you all.

Ofir Bachar, former colleague at the Allergy laboratory, for helping me in the very beginning.

Anna Karin Bastos, Josefine P Riikonen and **Eva Thylander** at the Allergy unit for collecting patient material and for pleasant dinner company at congresses.

Kristina Erlandsson for always being helpful with the administrative work.

Sven Jönsson, for computer assistance and amusing coffee breaks.

My research colleagues, **Johan Gustafsson** and **Jesper Bogefors** and present personal at the ENT department, for good collaboration.

My friends outside the lab, for many fun moments together and invaluable friendship.

My family for always believing in me and supporting me in everything I do.

Fredrik, the love of my life, for your endless support and encouragement.

This study was supported by the Swedish Medical Research Council, the Swedish Heart Lung Foundation, the Swedish Association for Allergology, the Swedish foundation for Health Care Science and Allergic research, the Royal Physiographic Society in Lund and the Foundation of Ellen, Walter and Lennart Hesselman.

REFERENCES

1. Jones N: The nose and paranasal sinuses physiology and anatomy, *Adv Drug Deliv Rev* 2001, 51: 5-19.
2. Bousquet J, Van Cauwenberge P and Khaltaev N: Allergic rhinitis and its impact on asthma, *J Allergy Clin Immunol* 2001, 108: S147-334.
3. Widdicombe J: Microvascular anatomy of the nose, *Allergy* 1997, 52: 7-11.
4. Kaliner MA: Human nasal respiratory secretions and host defense, *Am Rev Respir Dis* 1991, 144: S52-6.
5. Casado B, Pannell LK, Iadarola P and Baraniuk JN: Identification of human nasal mucous proteins using proteomics, *Proteomics* 2005, 5: 2949-59.
6. Greiff L, Andersson M, Erjefalt JS, Persson CG and Wollmer P: Airway microvascular extravasation and luminal entry of plasma, *Clin Physiol Funct Imaging* 2003, 23: 301-6.
7. Perry M and Whyte A: Immunology of the tonsils, *Immunol Today* 1998, 19: 414-21.
8. Nave H, Gebert A and Pabst R: Morphology and immunology of the human palatine tonsil, *Anat Embryol (Berl)* 2001, 204: 367-73.
9. Lindroos R: Bacteriology of the tonsil core in recurrent tonsillitis and tonsillar hyperplasia--a short review, *Acta Otolaryngol Suppl* 2000, 543: 206-8.
10. Gaffney RJ and Cafferkey MT: Bacteriology of normal and diseased tonsils assessed by fine-needle aspiration: Haemophilus influenzae and the pathogenesis of recurrent acute tonsillitis, *Clin Otolaryngol Allied Sci* 1998, 23: 181-5.
11. Armstrong WB and Netterville JL: Anatomy of the larynx, trachea, and bronchi, *Otolaryngol Clin North Am* 1995, 28: 685-99.
12. Clark R and Kupper T: Old meets new: the interaction between innate and adaptive immunity, *J Invest Dermatol* 2005, 125: 629-37.
13. Chaplin DD: 1. Overview of the human immune response, *J Allergy Clin Immunol* 2006, 117: S430-5.
14. Durham SR: Mechanisms of mucosal inflammation in the nose and lungs, *Clin Exp Allergy* 1998, 28 Suppl 2: 11-6.
15. Fransson M, Benson M, Wennergren G and Cardell LO: A role for neutrophils in intermittent allergic rhinitis, *Acta Otolaryngol* 2004, 124: 616-20.

16. Fransson M, Adner M, Erjefalt J, Jansson L, Uddman R and Cardell LO: Up-regulation of Toll-like receptors 2, 3 and 4 in allergic rhinitis, *Respir Res* 2005, 6: 100.
17. Schnare M, Barton GM, Holt AC, Takeda K, Akira S and Medzhitov R: Toll-like receptors control activation of adaptive immune responses, *Nat Immunol* 2001, 2: 947-50.
18. Mansson A, Adner M, Hockerfelt U and Cardell LO: A distinct Toll-like receptor repertoire in human tonsillar B cells, directly activated by PamCSK, R-837 and CpG-2006 stimulation, *Immunology* 2006, 118: 539-48.
19. Mosmann TR, Cherwinski H, Bond MW, Giedlin MA and Coffman RL: Two types of murine helper T cell clone. I. Definition according to profiles of lymphokine activities and secreted proteins, *J Immunol* 1986, 136: 2348-57.
20. Wierenga EA, Snoek M, de Groot C, Chretien I, Bos JD, Jansen HM, et al.: Evidence for compartmentalization of functional subsets of CD2+ T lymphocytes in atopic patients, *J Immunol* 1990, 144: 4651-6.
21. Akbari O, Stock P, DeKruyff RH and Umetsu DT: Role of regulatory T cells in allergy and asthma, *Curr Opin Immunol* 2003, 15: 627-33.
22. Akdis M, Blaser K and Akdis CA: T regulatory cells in allergy: novel concepts in the pathogenesis, prevention, and treatment of allergic diseases, *J Allergy Clin Immunol* 2005, 116: 961-8; quiz 969.
23. Vandebulcke L, Bachert C, Van Cauwenberge P and Claeys S: The innate immune system and its role in allergic disorders, *Int Arch Allergy Immunol* 2006, 139: 159-65.
24. Janson C, Anto J, Burney P, Chinn S, de Marco R, Heinrich J, et al.: The European Community Respiratory Health Survey: what are the main results so far? European Community Respiratory Health Survey II, *Eur Respir J* 2001, 18: 598-611.
25. Bauchau V and Durham SR: Prevalence and rate of diagnosis of allergic rhinitis in Europe, *Eur Respir J* 2004, 24: 758-64.
26. Nihlen U, Greiff L, Montnemery P, Lofdahl CG, Johannisson A, Persson C, et al.: Incidence and remission of self-reported allergic rhinitis symptoms in adults, *Allergy* 2006, 61: 1299-304.
27. Cruz AA, Popov T, Pawankar R, Annesi-Maesano I, Fokkens W, Kemp J, et al.: Common characteristics of upper and lower airways in rhinitis and asthma: ARIA update, in collaboration with GA(2)LEN, *Allergy* 2007, 62 Suppl 84: 1-41.
28. Strachan D, Sibbald B, Weiland S, Ait-Khaled N, Anabwani G, Anderson HR, et al.: Worldwide variations in prevalence of symptoms of allergic rhinoconjunctivitis in children: the International Study of Asthma and Allergies in Childhood (ISAAC), *Pediatr Allergy Immunol* 1997, 8: 161-76.

29. Maddox L and Schwartz DA: The pathophysiology of asthma, *Annu Rev Med* 2002, 53: 477-98.
30. Cockcroft DW and Davis BE: Mechanisms of airway hyperresponsiveness, *J Allergy Clin Immunol* 2006, 118: 551-9; quiz 560-1.
31. Zhang Y, Adner M and Cardell LO: Up-regulation of bradykinin receptors in a murine in-vitro model of chronic airway inflammation, *Eur J Pharmacol* 2004, 489: 117-26.
32. Zhang Y, Cardell LO and Adner M: IL-1beta induces murine airway 5-HT2A receptor hyperresponsiveness via a non-transcriptional MAPK-dependent mechanism, *Respir Res* 2007, 8: 29.
33. Linneberg A, Henrik Nielsen N, Frolund L, Madsen F, Dirksen A and Jorgensen T: The link between allergic rhinitis and allergic asthma: a prospective population-based study. The Copenhagen Allergy Study, *Allergy* 2002, 57: 1048-52.
34. Sichletidis L, Chloros D, Tsiotsios I, Gioulekas D, Kyriazis G, Spyrtos D, et al.: The prevalence of allergic asthma and rhinitis in children of Polichni, Thessaloniki, *Allergol Immunopathol (Madr)* 2004, 32: 59-63.
35. Leynaert B, Neukirch C, Kony S, Guenegou A, Bousquet J, Aubier M, et al.: Association between asthma and rhinitis according to atopic sensitization in a population-based study, *J Allergy Clin Immunol* 2004, 113: 86-93.
36. Rasanen M, Laitinen T, Kaprio J, Koskenvuo M and Laitinen LA: Hay fever--a Finnish nationwide study of adolescent twins and their parents, *Allergy* 1998, 53: 885-90.
37. van Beijsterveldt CE and Boomsma DI: Genetics of parentally reported asthma, eczema and rhinitis in 5-yr-old twins, *Eur Respir J* 2007, 29: 516-21.
38. Barnes KC: Evidence for common genetic elements in allergic disease, *J Allergy Clin Immunol* 2000, 106: S192-200.
39. Ober C and Hoffjan S: Asthma genetics 2006: the long and winding road to gene discovery, *Genes Immun* 2006, 7: 95-100.
40. Collins FS, Brooks LD and Chakravarti A: A DNA polymorphism discovery resource for research on human genetic variation, *Genome Res* 1998, 8: 1229-31.
41. Collins FS, Morgan M and Patrinos A: The Human Genome Project: lessons from large-scale biology, *Science* 2003, 300: 286-90.
42. Sachidanandam R, Weissman D, Schmidt SC, Kakol JM, Stein LD, Marth G, et al.: A map of human genome sequence variation containing 1.42 million single nucleotide polymorphisms, *Nature* 2001, 409: 928-33.
43. Brookes AJ: The essence of SNPs, *Gene* 1999, 234: 177-86.

44. Sherry ST, Ward MH, Kholodov M, Baker J, Phan L, Smigielski EM, et al.: dbSNP: the NCBI database of genetic variation, *Nucleic Acids Res* 2001, 29: 308-11.
45. Wang DG, Fan JB, Siao CJ, Berno A, Young P, Sapolsky R, et al.: Large-scale identification, mapping, and genotyping of single-nucleotide polymorphisms in the human genome, *Science* 1998, 280: 1077-82.
46. Wall JD and Pritchard JK: Haplotype blocks and linkage disequilibrium in the human genome, *Nat Rev Genet* 2003, 4: 587-97.
47. Baltimore D: Our genome unveiled, *Nature* 2001, 409: 814-6.
48. Roberts GC and Smith CW: Alternative splicing: combinatorial output from the genome, *Curr Opin Chem Biol* 2002, 6: 375-83.
49. Jensen ON: Modification-specific proteomics: characterization of post-translational modifications by mass spectrometry, *Curr Opin Chem Biol* 2004, 8: 33-41.
50. Lopez-Otin C and Overall CM: Protease degradomics: a new challenge for proteomics, *Nat Rev Mol Cell Biol* 2002, 3: 509-19.
51. O'Farrell PH: High resolution two-dimensional electrophoresis of proteins, *J Biol Chem* 1975, 250: 4007-21.
52. Gorg A, Weiss W and Dunn MJ: Current two-dimensional electrophoresis technology for proteomics, *Proteomics* 2004, 4: 3665-85.
53. Mann M, Hendrickson RC and Pandey A: Analysis of proteins and proteomes by mass spectrometry, *Annu Rev Biochem* 2001, 70: 437-73.
54. Vihinen M: Bioinformatics in proteomics, *Biomol Eng* 2001, 18: 241-8.
55. Hirsch J, Hansen KC, Burlingame AL and Matthay MA: Proteomics: current techniques and potential applications to lung disease, *Am J Physiol Lung Cell Mol Physiol* 2004, 287: L1-23.
56. Plymoth A, Lofdahl CG, Ekberg-Jansson A, Dahlback M, Broberg P, Foster M, et al.: Protein expression patterns associated with progression of chronic obstructive pulmonary disease in bronchoalveolar lavage of smokers, *Clin Chem* 2007, 53: 636-44.
57. Wu J, Kobayashi M, Sousa EA, Liu W, Cai J, Goldman SJ, et al.: Differential proteomic analysis of bronchoalveolar lavage fluid in asthmatics following segmental antigen challenge, *Mol Cell Proteomics* 2005, 4: 1251-64.
58. Ghafouri B, Stahlbom B, Tagesson C and Lindahl M: Newly identified proteins in human nasal lavage fluid from non-smokers and smokers using two-dimensional gel electrophoresis and peptide mass fingerprinting, *Proteomics* 2002, 2: 112-20.

59. Ghafouri B, Irander K, Lindbom J, Tagesson C and Lindahl M: Comparative proteomics of nasal fluid in seasonal allergic rhinitis, *J Proteome Res* 2006, 5: 330-8.
60. Lindahl M, Stahlbom B and Tagesson C: Two-dimensional gel electrophoresis of nasal and bronchoalveolar lavage fluids after occupational exposure, *Electrophoresis* 1995, 16: 1199-204.
61. Casado B, Pannell LK, Viglio S, Iadarola P and Baraniuk JN: Analysis of the sinusitis nasal lavage fluid proteome using capillary liquid chromatography interfaced to electrospray ionization-quadrupole time of flight- tandem mass spectrometry, *Electrophoresis* 2004, 25: 1386-93.
62. Sanderson CJ, O'Garra A, Warren DJ and Klaus GG: Eosinophil differentiation factor also has B-cell growth factor activity: proposed name interleukin 4, *Proc Natl Acad Sci U S A* 1986, 83: 437-40.
63. Seder RA, Paul WE, Davis MM and Fazekas de St Groth B: The presence of interleukin 4 during in vitro priming determines the lymphokine-producing potential of CD4+ T cells from T cell receptor transgenic mice, *J Exp Med* 1992, 176: 1091-8.
64. Coffman RL, Ohara J, Bond MW, Carty J, Zlotnik A and Paul WE: B cell stimulatory factor-1 enhances the IgE response of lipopolysaccharide-activated B cells, *J Immunol* 1986, 136: 4538-41.
65. Dabbagh K, Takeyama K, Lee HM, Ueki IF, Lausier JA and Nadel JA: IL-4 induces mucin gene expression and goblet cell metaplasia in vitro and in vivo, *J Immunol* 1999, 162: 6233-7.
66. Doucet C, Brouty-Boye D, Pottin-Clemenceau C, Jasmin C, Canonica GW and Azzarone B: IL-4 and IL-13 specifically increase adhesion molecule and inflammatory cytokine expression in human lung fibroblasts, *Int Immunol* 1998, 10: 1421-33.
67. Nelms K, Keegan AD, Zamorano J, Ryan JJ and Paul WE: The IL-4 receptor: signaling mechanisms and biologic functions, *Annu Rev Immunol* 1999, 17: 701-38.
68. Kaplan AP, Joseph K and Silverberg M: Pathways for bradykinin formation and inflammatory disease, *J Allergy Clin Immunol* 2002, 109: 195-209.
69. Christiansen SC, Proud D, Sarnoff RB, Juergens U, Cochrane CG and Zuraw BL: Elevation of tissue kallikrein and kinin in the airways of asthmatic subjects after endobronchial allergen challenge, *Am Rev Respir Dis* 1992, 145: 900-5.
70. Polosa R and Holgate ST: Comparative airway response to inhaled bradykinin, kallidin, and [des-Arg9]bradykinin in normal and asthmatic subjects, *Am Rev Respir Dis* 1990, 142: 1367-71.
71. Zhang Y, Adner M and Cardell LO: Glucocorticoids suppress transcriptional up-regulation of bradykinin receptors in a murine in vitro model of chronic airway inflammation, *Clin Exp Allergy* 2005, 35: 531-8.

72. Zhang Y, Adner M and Cardell LO: IL-1beta-induced transcriptional up-regulation of bradykinin B1 and B2 receptors in murine airways, *Am J Respir Cell Mol Biol* 2007, 36: 697-705.
73. Couture R, Harrisson M, Vianna RM and Cloutier F: Kinin receptors in pain and inflammation, *Eur J Pharmacol* 2001, 429: 161-76.
74. Marenholz I, Heizmann CW and Fritz G: S100 proteins in mouse and man: from evolution to function and pathology (including an update of the nomenclature), *Biochem Biophys Res Commun* 2004, 322: 1111-22.
75. Marenholz I, Lovering RC and Heizmann CW: An update of the S100 nomenclature, *Biochim Biophys Acta* 2006, 1763: 1282-3.
76. Moore BW: A soluble protein characteristic of the nervous system, *Biochem Biophys Res Commun* 1965, 19: 739-44.
77. Schafer BW and Heizmann CW: The S100 family of EF-hand calcium-binding proteins: functions and pathology, *Trends Biochem Sci* 1996, 21: 134-40.
78. Ravasi T, Hsu K, Goyette J, Schroder K, Yang Z, Rahimi F, et al.: Probing the S100 protein family through genomic and functional analysis, *Genomics* 2004, 84: 10-22.
79. Madsen P, Rasmussen HH, Leffers H, Honore B, Dejgaard K, Olsen E, et al.: Molecular cloning, occurrence, and expression of a novel partially secreted protein "psoriasin" that is highly up-regulated in psoriatic skin, *J Invest Dermatol* 1991, 97: 701-12.
80. Hardas BD, Zhao X, Zhang J, Longqing X, Stoll S and Elder JT: Assignment of psoriasin to human chromosomal band 1q21: coordinate overexpression of clustered genes in psoriasis, *J Invest Dermatol* 1996, 106: 753-8.
81. Jinquan T, Vorum H, Larsen CG, Madsen P, Rasmussen HH, Gesser B, et al.: Psoriasin: a novel chemotactic protein, *J Invest Dermatol* 1996, 107: 5-10.
82. Semprini S, Capon F, Bovolenta S, Bruscia E, Pizzuti A, Fabrizi G, et al.: Genomic structure, promoter characterisation and mutational analysis of the S100A7 gene: exclusion of a candidate for familial psoriasis susceptibility, *Hum Genet* 1999, 104: 130-4.
83. Glaser R, Harder J, Lange H, Bartels J, Christophers E and Schroder JM: Antimicrobial psoriasin (S100A7) protects human skin from Escherichia coli infection, *Nat Immunol* 2005, 6: 57-64.
84. Algermissen B, Sitzmann J, LeMotte P and Czarnetzki B: Differential expression of CRABP II, psoriasin and cytokeratin 1 mRNA in human skin diseases, *Arch Dermatol Res* 1996, 288: 426-30.
85. Luger N, Stoll R, Schmid KW, Kucharzik T, Stein H, Burmeister G, et al.: The myeloid related protein MRP8/14 (27E10 antigen)--usefulness as a potential

- marker for disease activity in ulcerative colitis and putative biological function, *Eur J Clin Invest* 1995, 25: 659-64.
86. Sunahori K, Yamamura M, Yamana J, Takasugi K, Kawashima M, Yamamoto H, et al.: The S100A8/A9 heterodimer amplifies proinflammatory cytokine production by macrophages via activation of nuclear factor kappa B and p38 mitogen-activated protein kinase in rheumatoid arthritis, *Arthritis Res Ther* 2006, 8: R69.
 87. Yang Z, Yan WX, Cai H, Tedla N, Armishaw C, Di Girolamo N, et al.: S100A12 provokes mast cell activation: a potential amplification pathway in asthma and innate immunity, *J Allergy Clin Immunol* 2007, 119: 106-14.
 88. Foell D, Wittkowski H and Roth J: Mechanisms of disease: a 'DAMP' view of inflammatory arthritis, *Nat Clin Pract Rheumatol* 2007, 3: 382-90.
 89. Miller JR: The Wnts, *Genome Biol* 2002, 3: REVIEWS3001.
 90. You J, Nguyen AV, Albers CG, Lin F and Holcombe RF: Wnt Pathway-Related Gene Expression in Inflammatory Bowel Disease, *Dig Dis Sci* 2007.
 91. Katoh M, Hirai M, Sugimura T and Terada M: Cloning, expression and chromosomal localization of Wnt-13, a novel member of the Wnt gene family, *Oncogene* 1996, 13: 873-6.
 92. Myal Y, Gregory C, Wang H, Hamerton JL and Shiu RP: The gene for prolactin-inducible protein (PIP), uniquely expressed in exocrine organs, maps to chromosome 7, *Somat Cell Mol Genet* 1989, 15: 265-70.
 93. Ghafouri B, Tagesson C and Lindahl M: Mapping of proteins in human saliva using two-dimensional gel electrophoresis and peptide mass fingerprinting, *Proteomics* 2003, 3: 1003-15.
 94. Lindahl M, Stahlbom B and Tagesson C: Identification of a new potential airway irritation marker, palate lung nasal epithelial clone protein, in human nasal lavage fluid with two-dimensional electrophoresis and matrix-assisted laser desorption/ionization-time of flight, *Electrophoresis* 2001, 22: 1795-800.
 95. Gaubin M, Autiero M, Basmaciogullari S, Metivier D, Mishal Z, Cullerier R, et al.: Potent inhibition of CD4/TCR-mediated T cell apoptosis by a CD4-binding glycoprotein secreted from breast tumor and seminal vesicle cells, *J Immunol* 1999, 162: 2631-8.
 96. Bingle CD and Craven CJ: Comparative analysis of the PLUNC (palate, lung and nasal epithelium clone) protein families, *Biochem Soc Trans* 2003, 31: 806-9.
 97. Bingle CD and Bingle L: Characterisation of the human plunc gene, a gene product with an upper airways and nasopharyngeal restricted expression pattern, *Biochim Biophys Acta* 2000, 1493: 363-7.

98. Bingle CD and Gorr SU: Host defense in oral and airway epithelia: chromosome 20 contributes a new protein family, *Int J Biochem Cell Biol* 2004, 36: 2144-52.
99. Ackerman SJ, Liu L, Kwatia MA, Savage MP, Leonidas DD, Swaminathan GJ, et al.: Charcot-Leyden crystal protein (galectin-10) is not a dual function galectin with lysophospholipase activity but binds a lysophospholipase inhibitor in a novel structural fashion, *J Biol Chem* 2002, 277: 14859-68.
100. Benson M, Langston MA, Adner M, Andersson B, Torinsson-Naluai A and Cardell LO: A network-based analysis of the late-phase reaction of the skin, *J Allergy Clin Immunol* 2006, 118: 220-5.
101. Dor PJ, Ackerman SJ and Gleich GJ: Charcot-Leyden crystal protein and eosinophil granule major basic protein in sputum of patients with respiratory diseases, *Am Rev Respir Dis* 1984, 130: 1072-7.
102. Mastrianni DM, Eddy RL, Rosenberg HF, Corrette SE, Shows TB, Tenen DG, et al.: Localization of the human eosinophil Charcot-Leyden crystal protein (lysophospholipase) gene (CLC) to chromosome 19 and the human ribonuclease 2 (eosinophil-derived neurotoxin) and ribonuclease 3 (eosinophil cationic protein) genes (RNS2 and RNS3) to chromosome 14, *Genomics* 1992, 13: 240-2.
103. Adner M, Rose AC, Zhang Y, Sward K, Benson M, Uddman R, et al.: An assay to evaluate the long-term effects of inflammatory mediators on murine airway smooth muscle: evidence that TNF α up-regulates 5-HT $_2A$ -mediated contraction, *Br J Pharmacol* 2002, 137: 971-82.
104. Benson M, Strannegard IL, Wennergren G and Strannegard O: Interleukin-5 and interleukin-8 in relation to eosinophils and neutrophils in nasal fluids from school children with seasonal allergic rhinitis, *Pediatr Allergy Immunol* 1999, 10: 178-85.
105. Lamanda A, Zahn A, Roder D and Langen H: Improved Ruthenium II tris (bathophenanthroline disulfonate) staining and destaining protocol for a better signal-to-background ratio and improved baseline resolution, *Proteomics* 2004, 4: 599-608.
106. Kersey PJ, Duarte J, Williams A, Karavidopoulou Y, Birney E and Apweiler R: The International Protein Index: an integrated database for proteomics experiments, *Proteomics* 2004, 4: 1985-8.
107. Hosking L, Lumsden S, Lewis K, Yeo A, McCarthy L, Bansal A, et al.: Detection of genotyping errors by Hardy-Weinberg equilibrium testing, *Eur J Hum Genet* 2004, 12: 395-9.
108. Stephens M, Smith NJ and Donnelly P: A new statistical method for haplotype reconstruction from population data, *Am J Hum Genet* 2001, 68: 978-89.

109. Bousquet J, Jeffery PK, Busse WW, Johnson M and Vignola AM: Asthma. From bronchoconstriction to airways inflammation and remodeling, *Am J Respir Crit Care Med* 2000, 161: 1720-45.
110. Schmidt D and Rabe KF: Immune mechanisms of smooth muscle hyperreactivity in asthma, *J Allergy Clin Immunol* 2000, 105: 673-82.
111. Swain SL, Weinberg AD, English M and Huston G: IL-4 directs the development of Th2-like helper effectors, *J Immunol* 1990, 145: 3796-806.
112. Snapper CM, Finkelman FD and Paul WE: Differential regulation of IgG1 and IgE synthesis by interleukin 4, *J Exp Med* 1988, 167: 183-96.
113. Goldberg IH and Friedman PA: Antibiotics and nucleic acids, *Annu Rev Biochem* 1971, 40: 775-810.
114. Du L, Lyle CS, Obey TB, Gaarde WA, Muir JA, Bennett BL, et al.: Inhibition of cell proliferation and cell cycle progression by specific inhibition of basal JNK activity: evidence that mitotic Bcl-2 phosphorylation is JNK-independent, *J Biol Chem* 2004, 279: 11957-66.
115. Dudley DT, Pang L, Decker SJ, Bridges AJ and Saltiel AR: A synthetic inhibitor of the mitogen-activated protein kinase cascade, *Proc Natl Acad Sci U S A* 1995, 92: 7686-9.
116. Davies SP, Reddy H, Caivano M and Cohen P: Specificity and mechanism of action of some commonly used protein kinase inhibitors, *Biochem J* 2000, 351: 95-105.
117. Barnes PJ: Effect of bradykinin on airway function, *Agents Actions Suppl* 1992, 38 (Pt 3): 432-8.
118. Li L, Vaali K, Paakkari I and Vapaatalo H: Involvement of bradykinin B1 and B2 receptors in relaxation of mouse isolated trachea, *Br J Pharmacol* 1998, 123: 1337-42.
119. Svensson C, Andersson M, Greiff L, Alkner U and Persson CG: Exudative hyperresponsiveness of the airway microcirculation in seasonal allergic rhinitis, *Clin Exp Allergy* 1995, 25: 942-50.
120. Andersson M, Svensson C, Andersson P and Pipkorn U: Objective monitoring of the allergic inflammatory response of the nasal mucosa in patients with hay fever during natural allergen exposure, *Am Rev Respir Dis* 1989, 139: 911-4.
121. Di Lorenzo G, Mansueto P, Melluso M, Candore G, Colombo A, Pellitteri ME, et al.: Allergic rhinitis to grass pollen: measurement of inflammatory mediators of mast cell and eosinophils in native nasal fluid lavage and in serum out of and during pollen season, *J Allergy Clin Immunol* 1997, 100: 832-7.

122. Lindahl M, Stahlbom B, Svartz J and Tagesson C: Protein patterns of human nasal and bronchoalveolar lavage fluids analyzed with two-dimensional gel electrophoresis, *Electrophoresis* 1998, 19: 3222-9.
123. Van Den Berg DJ, Sharma AK, Bruno E and Hoffman R: Role of members of the Wnt gene family in human hematopoiesis, *Blood* 1998, 92: 3189-202.
124. Mumby M and Brekken D: Phosphoproteomics: new insights into cellular signaling, *Genome Biol* 2005, 6: 230.
125. Morelle W, Canis K, Chirat F, Faid V and Michalski JC: The use of mass spectrometry for the proteomic analysis of glycosylation, *Proteomics* 2006, 6: 3993-4015.
126. Clark RS, Bayir H and Jenkins LW: Posttranslational protein modifications, *Crit Care Med* 2005, 33: S407-9.
127. Molloy MP: Two-dimensional electrophoresis of membrane proteins using immobilized pH gradients, *Anal Biochem* 2000, 280: 1-10.
128. Barnes KC: Gene-environment and gene-gene interaction studies in the molecular genetic analysis of asthma and atopy, *Clin Exp Allergy* 1999, 29 Suppl 4: 47-51.
129. Garn H and Renz H: Epidemiological and immunological evidence for the hygiene hypothesis, *Immunobiology* 2007, 212: 441-52.
130. Brodersen DE, Etzerodt M, Madsen P, Celis JE, Thogersen HC, Nyborg J, et al.: EF-hands at atomic resolution: the structure of human psoriasin (S100A7) solved by MAD phasing, *Structure* 1998, 6: 477-89.
131. Wolf R, Mirmohammadsadegh A, Walz M, Lysa B, Tartler U, Remus R, et al.: Molecular cloning and characterization of alternatively spliced mRNA isoforms from psoriatic skin encoding a novel member of the S100 family, *Faseb J* 2003, 17: 1969-71.
132. Bryborn M, Adner M and Cardell LO: Psoriasin, one of several new proteins identified in nasal lavage fluid from allergic and non-allergic individuals using 2-dimensional gel electrophoresis and mass spectrometry, *Respir Res* 2005, 6: 118.
133. Sugiura H, Ebise H, Tazawa T, Tanaka K, Sugiura Y, Uehara M, et al.: Large-scale DNA microarray analysis of atopic skin lesions shows overexpression of an epidermal differentiation gene cluster in the alternative pathway and lack of protective gene expression in the cornified envelope, *Br J Dermatol* 2005, 152: 146-9.
134. Pantanowitz L and Balogh K: Charcot-Leyden crystals: pathology and diagnostic utility, *Ear Nose Throat J* 2004, 83: 489-90.

135. Jang BC, Kim DH, Park JW, Kwon TK, Kim SP, Song DK, et al.: Induction of cyclooxygenase-2 in macrophages by catalase: role of NF-kappaB and PI3K signaling pathways, *Biochem Biophys Res Commun* 2004, 316: 398-406.
136. Weise JB, Meyer JE, Helmer H, Wittrock H and Maune S: A newly discovered function of palatine tonsils in immune defence: the expression of defensins, *Otolaryngol Pol* 2002, 56: 409-13.
137. Bals R: Epithelial antimicrobial peptides in host defense against infection, *Respir Res* 2000, 1: 141-50.
138. Wah J, Wellek A, Frankenberger M, Unterberger P, Welsch U and Bals R: Antimicrobial peptides are present in immune and host defense cells of the human respiratory and gastrointestinal tracts, *Cell Tissue Res* 2006, 324: 449-56.
139. Song JJ, Hwang KS, Woo JS, Chae SW, Cho JG, Kang HJ, et al.: Expression of cathelicidin in recurrent throat infection, *Int J Pediatr Otorhinolaryngol* 2006, 70: 487-92.
140. Hofmann MA, Drury S, Fu C, Qu W, Taguchi A, Lu Y, et al.: RAGE mediates a novel proinflammatory axis: a central cell surface receptor for S100/calgranulin polypeptides, *Cell* 1999, 97: 889-901.
141. Arumugam T, Simeone DM, Schmidt AM and Logsdon CD: S100P stimulates cell proliferation and survival via receptor for activated glycation end products (RAGE), *J Biol Chem* 2004, 279: 5059-65.