



LUND UNIVERSITY

OFDM channel estimation by singular value decomposition

Edfors, Ove; Sandell, Magnus; van de Beek, Jan-Jaap; Wilson, Sarah Kate; Börjesson, Per Ola

Published in:
[Host publication title missing]

DOI:
[10.1109/VETEC.1996.501446](https://doi.org/10.1109/VETEC.1996.501446)

1996

[Link to publication](#)

Citation for published version (APA):
Edfors, O., Sandell, M., van de Beek, J.-J., Wilson, S. K., & Börjesson, P. O. (1996). OFDM channel estimation by singular value decomposition. In [Host publication title missing] (Vol. 2, pp. 923-927) <https://doi.org/10.1109/VETEC.1996.501446>

Total number of authors:
5

General rights

Unless other specific re-use rights are stated the following general rights apply:
Copyright and moral rights for the publications made accessible in the public portal are retained by the authors and/or other copyright owners and it is a condition of accessing publications that users recognise and abide by the legal requirements associated with these rights.

- Users may download and print one copy of any publication from the public portal for the purpose of private study or research.
- You may not further distribute the material or use it for any profit-making activity or commercial gain
- You may freely distribute the URL identifying the publication in the public portal

Read more about Creative commons licenses: <https://creativecommons.org/licenses/>

Take down policy

If you believe that this document breaches copyright please contact us providing details, and we will remove access to the work immediately and investigate your claim.

LUND UNIVERSITY

PO Box 117
221 00 Lund
+46 46-222 00 00

OFDM CHANNEL ESTIMATION BY SINGULAR VALUE DECOMPOSITION

Ove Edfors¹, Magnus Sandell¹, Jan-Jaap van de Beek¹,
Sarah Kate Wilson² and Per Ola Börjesson¹

¹ Division of Signal Processing
Luleå University of Technology
S-971 87 Luleå
SWEDEN

² School of Electrical and Computer Engineering
Purdue University
West Lafayette, IN 47907
U.S.A.

Abstract – A new approach to low-complexity channel estimation in orthogonal-frequency division multiplexing (OFDM) systems is proposed. A low-rank approximation is applied to a linear minimum mean-squared error (LMMSE) estimator that uses the frequency correlation of the channel. By using the singular-value decomposition (SVD) an optimal low-rank estimator is derived, where performance is essentially preserved – even for low computational complexities. A fixed estimator, with nominal values for channel correlation and signal-to-noise ratio (SNR), is analysed. Analytical mean-squared error (MSE) and symbol-error rates (SER) are presented for a 16-QAM OFDM system.

I. INTRODUCTION

Wireless digital communication systems using multi-amplitude modulation schemes, such as quadrature amplitude modulation (QAM), require estimation and tracking of the fading channel. In general, this means a more complex receiver than for differential modulation schemes, such as differential phase-shift keying (DPSK), where the receivers operate without a channel estimate [1].

In orthogonal frequency-division multiplexing (OFDM) systems, DPSK is appropriate for relatively low data rates, such as in the European digital-audio broadcast (DAB) system [2]. On the other hand, for more spectrally-efficient OFDM systems, coherent modulation is more appropriate.

The structure of OFDM signalling allows a channel estimator to use both time and frequency correlation. Such a two-dimensional estimator structure is generally too complex for a practical implementation. To reduce the complexity, separation of the use of time and frequency correlation has been proposed in [3]. This combined scheme uses two separate FIR-Wiener-filters, one in the frequency direction and the other in the time direction.

In this paper we present and analyse a class of block-oriented channel estimators for OFDM, where only the frequency correlation of the channel is used in the estimation. Whatever their level of performance, it may be improved with the addition of a second filter using the time correlation [3], [4].

Though a linear minimum mean-squared error (LMMSE) estimator using only frequency correlation has lower complexity than one using both time and

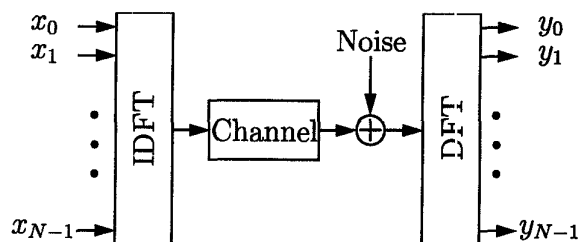

Fig. 1. Base band model of an OFDM system. A cyclic prefix is used, but not displayed here.

frequency correlation, it still requires a large number of operations. We introduce a low-complexity approximation to a frequency-based LMMSE estimator that uses the theory of optimal rank reduction. Other types of low-rank approximations, based on the discrete-time Fourier transform (DFT), have been proposed for OFDM systems before [5], [6], [7]. The work presented in this paper was inspired by the observations in [7], where it is shown that DFT-based low-rank channel estimators have limited performance for non-sample-spaced channels and high SNRs.

After presenting the OFDM system model and our scenario in Section II, we introduce the estimators and their mean-squared error (MSE) performance in Section III. We show that the main limitation on the achieved complexity reduction is an irreducible MSE-floor inherent in low-rank approximations of the LMMSE. Section IV is devoted to symbol-error rate (SER) comparisons.

A summary and concluding remarks appear in Section V.

II. SYSTEM DESCRIPTION

Figure 1 displays the OFDM base-band model used in this paper. We assume that the use of a cyclic prefix [8] both preserves the orthogonality of the tones and eliminates inter-symbol interference between consecutive OFDM symbols. Further, the channel is assumed to be slowly fading, *i.e.*, it is considered to be constant during the transmission of one symbol. The number of tones in the system is N , and the length of the cyclic prefix is L samples.

Under these assumptions we can describe the system as a set of parallel Gaussian channels, shown in Figure 2, with

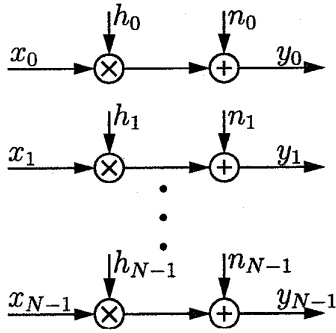

Fig. 2. The OFDM system, described as a set of parallel Gaussian channels with correlated attenuations.

correlated attenuations h_k . The attenuations on each tone are given by

$$h_k = G\left(\frac{k}{NT_s}\right), k = 0 \dots N-1,$$

where $G(\cdot)$ is the frequency response of the channel during the OFDM symbol, and T_s is the sampling period of the system. In matrix notation we describe the system as

$$\mathbf{y} = \mathbf{X}\mathbf{h} + \mathbf{n}, \quad (1)$$

where \mathbf{y} is the received vector, \mathbf{X} is a matrix containing the transmitted signalling points on its diagonal, \mathbf{h} is a channel attenuation vector, and \mathbf{n} is a vector of i.i.d. complex, zero-mean, Gaussian noise with variance σ_n^2 .

We consider a fading multi-path channel model [1], consisting of M impulses. The impulse response of the channel is

$$g(\tau) = \sum_{k=0}^{M-1} \alpha_k \delta(\tau - \tau_k T_s), \quad (2)$$

where α_k are independent zero-mean, complex Gaussian random variables, with power-delay profile $\theta(\tau_k)$, and τ_k is the delay of the k th impulse, normalized with respect to the sampling period T_s .

Two versions of this channel model are used in the paper. The first version is a model of a perfectly time-synchronized OFDM system, where the first fading impulse always has a zero-delay, $\tau_0 = 0$, and other fading impulses have delays that are uniformly and independently distributed over the length of the cyclic prefix. The impulse power-delay profile, $\theta(\tau_k) = Ce^{-\tau_k/\tau_{rms}}$, decays exponentially [9]. The second version is a uniform channel model, where all impulses have the same average power and their delays are uniformly and independently distributed over the length of the cyclic prefix.

Our scenario consists of a wireless 16-QAM OFDM system, designed for an outdoor environment, which is capable of carrying digital video. The system operates at 500 kHz bandwidth and is divided into 64 tones with a total symbol period of 136 μ s, of which 8 μ s is the cyclic prefix. One OFDM symbol thus consists of 68 samples

($N + L = 68$), four of which are contained in the cyclic prefix ($L = 4$). The uncoded data rate of the system is 1.9 MBit/sec. We assume that $\tau_{rms} = 1$ sample in the synchronized channel.

III. ESTIMATOR DESIGN

In the following we present the LMMSE estimate of the channel attenuations \mathbf{h} from the received vector \mathbf{y} and the transmitted data \mathbf{X} . We assume that the received OFDM symbol contains data known to the estimator – either training data or receiver decisions.

The complexity reduction of the LMMSE estimator consists of two separate steps. In the first step we modify the LMMSE by averaging over the transmitted data, obtaining a simplified estimator. In the second step we reduce the number of multiplications required by applying the theory of optimal rank-reduction [10].

A. LMMSE Estimation

The LMMSE estimate of the channel attenuations \mathbf{h} , in (1), from the received data \mathbf{y} and the transmitted symbols \mathbf{X} is [7]

$$\begin{aligned} \hat{\mathbf{h}}_{lmmse} &= \mathbf{R}_{hh} \mathbf{R}_{hls}^{-1} \hat{\mathbf{h}}_{ls} \\ &= \mathbf{R}_{hh} \left(\mathbf{R}_{hh} + \sigma_n^2 (\mathbf{X}\mathbf{X}^H)^{-1} \right)^{-1} \hat{\mathbf{h}}_{ls}, \end{aligned} \quad (3)$$

where

$$\hat{\mathbf{h}}_{ls} = \mathbf{X}^{-1} \mathbf{y} = \begin{bmatrix} y_0 & y_1 & \dots & y_{N-1} \\ x_0 & x_1 & \dots & x_{N-1} \end{bmatrix}^T \quad (4)$$

is the least-squares (LS) estimate of \mathbf{h} , σ_n^2 is the variance of the additive channel noise, and the covariance matrices are

$$\begin{aligned} \mathbf{R}_{hh} &= E\{\mathbf{h}\mathbf{h}^H\}, \\ \mathbf{R}_{hhls} &= E\{\mathbf{h}\hat{\mathbf{h}}_{ls}^H\}, \\ \mathbf{R}_{hls hls} &= E\{\hat{\mathbf{h}}_{ls}\hat{\mathbf{h}}_{ls}^H\}. \end{aligned}$$

In the following we assume, without loss of generality, that the variances of the channel attenuations in \mathbf{h} are normalized to unity, i.e. $E|h_k|^2 = 1$.

The LMMSE estimator (3) is of considerable complexity, since a matrix inversion is needed every time the training data in \mathbf{X} changes. We reduce the complexity of this estimator by averaging over the transmitted data [1], i.e. we replace the term $(\mathbf{X}\mathbf{X}^H)^{-1}$ in (3) with its expectation $E(\mathbf{X}\mathbf{X}^H)^{-1}$. Assuming the same signal constellation on all tones and equal probability on all constellation points, we get $E(\mathbf{X}\mathbf{X}^H)^{-1} = E|1/x_k|^2 \mathbf{I}$, where \mathbf{I} is the identity matrix. Defining the average signal-to-noise ratio as $\text{SNR} = E|x_k|^2/\sigma_n^2$, we obtain a simplified estimator

$$\hat{\mathbf{h}} = \mathbf{R}_{hh} \left(\mathbf{R}_{hh} + \frac{\beta}{\text{SNR}} \mathbf{I} \right)^{-1} \hat{\mathbf{h}}_{ls}, \quad (5)$$

where

$$\beta = E |x_k|^2 E |1/x_k|^2$$

is a constant depending on the signal constellation. In the case of 16-QAM transmission, $\beta = 17/9$. Because \mathbf{X} is no longer a factor in the matrix calculation, no inversion is needed when the transmitted data in \mathbf{X} changes. Furthermore, if \mathbf{R}_{hh} and SNR are known beforehand or are set to fixed nominal values, the matrix $\mathbf{R}_{hh}(\mathbf{R}_{hh} + \frac{\beta}{\text{SNR}}\mathbf{I})^{-1}$ needs to be calculated only once. Under these conditions the estimation requires N multiplications per tone. To further reduce the complexity of the estimator, we proceed with low-rank approximations in the next section.

B. Optimal Low-rank Approximations

The optimal rank reduction of the estimator in (5), using the singular value decomposition (SVD), is obtained by exclusion of base vectors corresponding to the smallest singular values [10]. We denote the SVD of the channel correlation matrix

$$\mathbf{R}_{hh} = \mathbf{U}\mathbf{\Lambda}\mathbf{U}^H, \quad (6)$$

where \mathbf{U} is a matrix with orthonormal columns $\mathbf{u}_0, \mathbf{u}_1, \dots, \mathbf{u}_{N-1}$ and $\mathbf{\Lambda}$ is a diagonal matrix, containing the singular values $\lambda_0 \geq \lambda_1 \geq \dots \geq \lambda_{N-1} \geq 0$ on its diagonal¹. This allows the estimator in (5) to be written

$$\hat{\mathbf{h}}_p = \mathbf{U}\mathbf{\Delta}\mathbf{U}^H\hat{\mathbf{h}}_{ls},$$

where $\mathbf{\Delta}$ is a diagonal matrix containing the values

$$\delta_k = \frac{\lambda_k}{\lambda_k + \frac{\beta}{\text{SNR}}}, k = 0, 1, \dots, N-1 \quad (7)$$

on its diagonal. The best rank- p approximation of the estimator in (5) then becomes

$$\hat{\mathbf{h}}_p = \mathbf{U} \begin{bmatrix} \mathbf{\Delta}_p & \mathbf{0} \\ \mathbf{0} & \mathbf{0} \end{bmatrix} \mathbf{U}^H \hat{\mathbf{h}}_{ls}, \quad (8)$$

where $\mathbf{\Delta}_p$ is the upper left $p \times p$ corner of $\mathbf{\Delta}$.

A block diagram of the rank- p estimator in (8) is shown in Figure 3, where the LS-estimate is calculated from \mathbf{y} by multiplying by \mathbf{X}^{-1} .

Viewing the unitary matrix \mathbf{U}^H as a transform², the singular value λ_k of \mathbf{R}_{hh} is the channel energy contained in the k th transform coefficient after transforming the LS estimate $\hat{\mathbf{h}}_{ls}$. The dimension of the space of essentially time- and band-limited signals leads us to the rank needed in the low-rank estimator. In [11] it is shown that this dimension is about $2BT + 1$, where B is the one-sided bandwidth and T is the time interval of the signal. Accordingly, the magnitude of the singular values of \mathbf{R}_{hh} should drop rapidly

¹Since we are dealing with Hermitian matrices, the λ_k s are also eigenvalues. However, we use the SVD terminology since it is required in the general case of low-rank approximations.

²The transform in this special case of low-rank approximation is the Karhunen-Loeve (a.k.a. Hotelling) transform associated with \mathbf{h} .

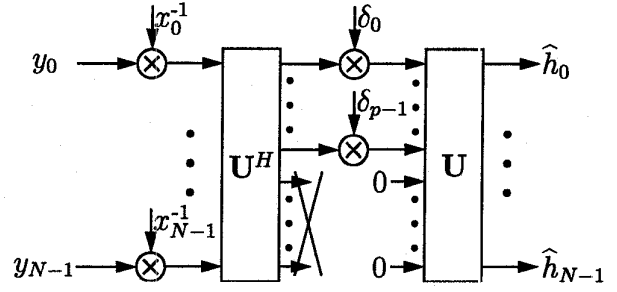

Fig. 3. Block diagram of the rank- p channel estimator.

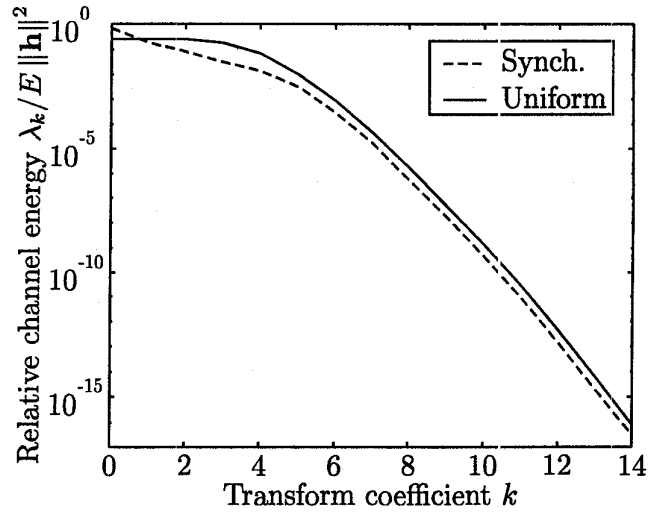

Fig. 4. Relative channel energy in the transform coefficients for the two channels addressed.

after about $L + 1$ large values, where L is the length of the cyclic prefix ($2B = 1/T_s$, $T = LT_s$ and $2BT + 1 = L + 1$).

We present the relative channel energy contained in the first 15 coefficients in Figure 4. The calculations are based on our scenario. The magnitude of the channel energy drops rapidly, in both cases shown, after about $k = 4$, i.e. the fifth coefficient. This is consistent with the observation that the dimension of the space spanned by \mathbf{R}_{hh} is approximately $L + 1 = 5$.

This prompts an analysis of the computational complexity of the rank- p estimator. The implementation we have chosen is based on writing (8) as a sum of rank-1 matrices, which gives us the expression

$$\hat{\mathbf{h}}_p = \left(\sum_{k=0}^{p-1} \delta_k \mathbf{u}_k \mathbf{u}_k^H \right) \hat{\mathbf{h}}_{ls}. \quad (9)$$

The smaller p is, the lower the computational complexity and the larger the approximation error. Further, by assigning $\mathbf{q}_k = \delta_k \mathbf{u}_k$, the rank- p estimator (9) is simplified to

$$\hat{\mathbf{h}}_p = \sum_{k=0}^{p-1} \left(\mathbf{u}_k^H \hat{\mathbf{h}}_{ls} \right) \mathbf{q}_k.$$

The argument in the sum consists of an inner product, $\mathbf{u}_k^H \hat{\mathbf{h}}_k$, scaling the vector \mathbf{q}_k . Each summation term requires $2N$ multiplications, and the sum contains p such terms. The estimation thus requires $2pN$ multiplications and the total number of multiplications per tone becomes $2p$. In comparison with the full estimator (5), we have managed to reduce the number of multiplications from N to $2p$ per tone. As mentioned above, we expect p to be in the range of samples in the cyclic prefix, which is usually much smaller than the number of tones, N .

C. Mean-squared error

The mean-squared error (MSE) of the rank- p estimator is mainly determined by the channel energy contained in the transform coefficients. To get a general expression for the estimator MSE, we derive it under the assumption that the estimator is designed for \mathbf{R}_{hh} and SNR, but the true correlation matrix and signal-to-noise ratio are $\widetilde{\mathbf{R}}_{hh}$ and $\widetilde{\text{SNR}}$, respectively. This allows us to analyse this estimator's sensitivity to design errors. Under these assumptions it can be shown that the MSE, $\text{mse}(p) = E\|\mathbf{h} - \hat{\mathbf{h}}_p\|^2$, of the rank- p estimate (8) is

$$\text{mse}(p) = \sum_{k=0}^{p-1} \left[\tilde{\lambda}_k (1 - \delta_k)^2 + \frac{\beta}{\text{SNR}} \delta_k^2 \right] + \sum_{m=p}^{N-1} \tilde{\lambda}_m \quad (10)$$

where δ_k is given by (7) and $\tilde{\lambda}_k$ is the k th diagonal element of $\mathbf{U}^H \widetilde{\mathbf{R}}_{hh} \mathbf{U}$, cf. (6). The diagonal element $\tilde{\lambda}_k$ is the channel energy contained in the k th transform coefficient, under correlation mismatch. If the channel estimator is designed for correct channel correlation and SNR, we have $\tilde{\lambda}_k = \lambda_k$ and $\widetilde{\text{SNR}} = \text{SNR}$ in (10).

The MSE can be bounded from below by the channel energy in the transform coefficients not used in the estimate, i.e., the last term in (10),

$$\text{mse}(p) \geq \underline{\text{mse}}(p) \triangleq \sum_{m=p}^{N-1} \tilde{\lambda}_m. \quad (11)$$

We call the quantity $\underline{\text{mse}}(p)$ the MSE-floor of the low-rank estimator.

The MSE-floor is the main limitation on the complexity reduction achieved by optimal rank reduction. As an illustration, Figure 5 displays the MSE relative to the channel variance, for three different ranks, as a function of the SNR. The ranks chosen are $p = 5, 6$ and 7 , and the channel used in the example is the synchronized channel. The corresponding MSE-floors are shown as horizontal lines. For $p = 7$, the MSE-floor is relatively small, and the MSE of the rank-7 estimator is comparable to the original estimator (5) in the range 0 to 30 dB in SNR. By choosing the appropriate rank on the estimator, we can essentially avoid the impact from the MSE-floor up to a given SNR. When we have full rank, $p = N$, no MSE-floor exists.

Under correlation mismatch, the energy in the transform coefficients changes from λ_k to $\tilde{\lambda}_k$, as described above.

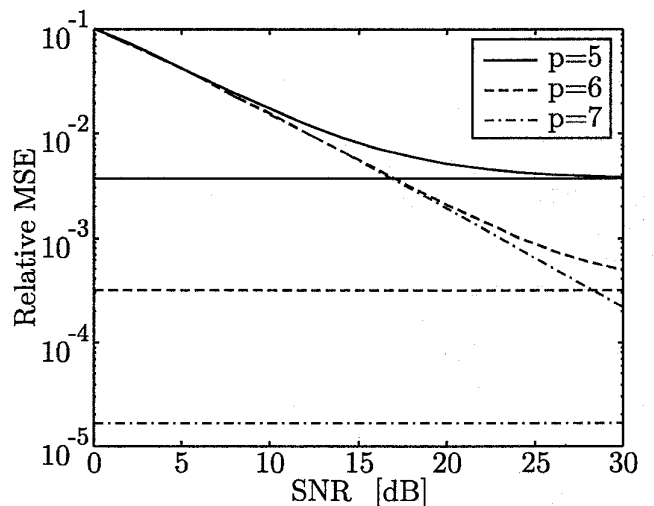

Fig. 5. Low-rank estimator mean-squared error as a function of SNR, with ranks $p = 5, 6$ and 7 . Corresponding MSE-floors shown as horizontal lines. (Synchronized channel)

Since this also affects the MSE-floor, we use $p = 8$ in the following to further suppress the MSE-floor in the SNR range up to 30 dB.

To illustrate the differences between the low-rank estimators designed for different channel correlations, we present the change in MSE, when the true channel alters between synchronized to uniform, in Figure 6. The change in MSE is smaller for the estimator designed for the uniform channel. It should also be noted that the loss in MSE when the uniform design is used on the synchronized channel is relatively small. In terms of 16-QAM symbol error rate, the performance curves are even closer and are hard to distinguish – less than 0.5 dB difference in SNR. We can interpret a uniform channel estimator as one that uses only the knowledge that the channel is time limited. This results in an estimator that is relatively insensitive to variations in the power-delay profile.

If we want a robust generic channel estimator design for OFDM systems, the above analysis suggests the use of the uniform channel correlation. The design of such an estimator only requires knowledge about the length of the cyclic prefix and the number of tones in the system. Based on the target range of SNRs, a fixed design SNR can be chosen. Using an estimator of this type, no tracking of channel correlation and SNR is needed in the receiver.

IV. SYMBOL-ERROR RATE

Using the formulae presented in [12], we have calculated the symbol-error rate (SER) for our scenario, uncoded 16-QAM and all training data. The obtained SER curves are displayed in Figure 7. An uncoded OFDM system using a generic rank-8 estimator, designed for a uniform channel and a nominal SNR of 30 dB, is compared with two references. The first reference is a system using the LS estimator (4). The second reference is a system where the

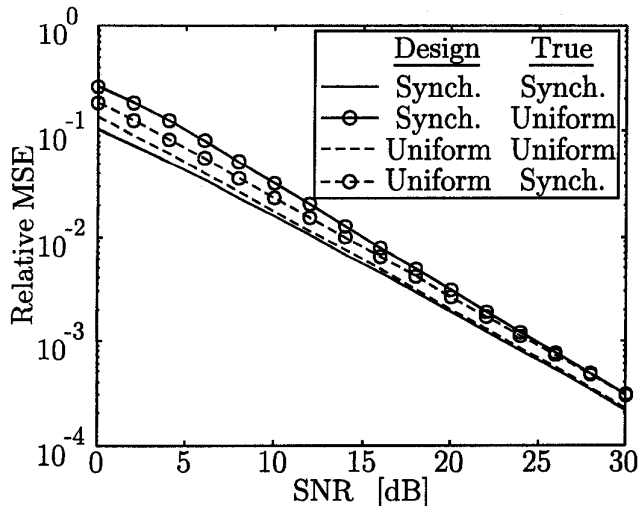

Fig. 6. Change in MSE when channel changes from synchronized to uniform. MSE-curves under correlation mismatch are circled (○). Estimator rank $p = 8$.

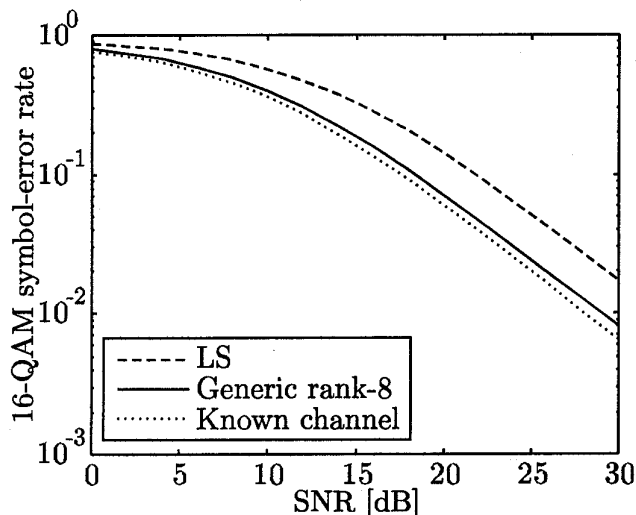

Fig. 7. SER for 16-QAM training data and a synchronized channel. Generic rank-8 estimator, designed for a uniform channel and 30 dB in SNR, is compared to two references: The LS estimator and known channel at the receiver.

channel is known at the receiver.

As seen in Figure 7, the generic rank-8 estimator improves the performance over the LS estimator by about 3.5 dB in SNR. Compared to the case where the channel is known at the receiver, its loss in SNR is only about 1 dB. The generic rank-8 estimator requires $2p = 16$ multiplications per estimated tone.

V. CONCLUSIONS

We have investigated low-complexity low-rank approximations of the LMMSE channel estimator. The investigation shows that an estimator error-floor, inherent in the

low-rank approximation, is the significant limitation to the achieved complexity reduction. We show that a generic low-rank estimator design, based on the uniform channel correlation and a nominal SNR, can be used in our uncoded 64-tone scenario with only a small loss in SNR (about 1 dB) up to a SNR of 30 dB, compared to the case where the channel is known at the receiver – this with 16 multiplications per estimated tone.

One of the appealing properties of the generic estimator design is that it only requires knowledge about the length of the cyclic prefix, the number of tones in the system and the target range of SNRs for the application. No tracking of channel correlation and SNR is needed at the receiver.

In general, when estimating the channel in an OFDM system, we would like to use both time- and frequency correlation. The general theory of low-rank approximations may be applied in these cases too.

REFERENCES

- [1] J.G. Proakis. *Digital Communications*. Prentice-Hall, 3rd edition, 1995.
- [2] Radio broadcasting systems; Digital Audio Broadcasting (DAB) to mobile, portable and fixed receivers. ETS 300 401, ETSI – European Telecommunications Standards Institute, Valbonne, France, February 1995.
- [3] Peter Hoeher. TCM on frequency-selective land-mobile fading channels. In *Proc. 5th Tirrenia International Workshop on Digital Communications*, Tirrenia, Italy, September 1991.
- [4] Sarah Kate Wilson, R. Ellen Khayata, and John M. Cioffi. 16-QAM modulation with orthogonal frequency-division multiplexing in a Rayleigh-fading environment. In *Proc. VTC'94*, volume 3, pages 1660–1664, Stockholm, Sweden, June 1994. IEEE.
- [5] Ahmad Chini. *Multi Carrier Modulation in Frequency Selective Fading Channels*. PhD thesis, Carleton University, Ottawa, Canada, 1994.
- [6] John M. Cioffi. Personal communication, 1994.
- [7] Jan-Jaap van de Beek, Ove Edfors, Magnus Sandell, Sarah Kate Wilson, and Per Ola Börjesson. On channel estimation in OFDM systems. In *Proc. VTC'95*, volume 2, pages 715–719, Rosemont, IL, July 1995. IEEE.
- [8] A. Peled and A. Ruiz. Frequency domain data transmission using reduced computational complexity algorithms. In *Proc. IEEE ICASSP*, pages 964–967, Denver, Colorado, 1980.
- [9] Peter Hoeher. A statistical discrete-time model for the WS-SUS multipath channel. *IEEE Trans. Comm.* 41(4):461–468, November 1992.
- [10] Louis L. Scharf. *Statistical Signal Processing: Detection, Estimation, and Time Series Analysis*. Addison-Wesley, 1991.
- [11] H. J. Landau and H. O. Pollak. Prolate spheroidal wave functions, Fourier analysis and uncertainty – III: The dimension of the space of essentially time- and band-limited signals. *Bell System Tech. J.*, 41:1295, 1962.
- [12] Sarah Kate Wilson. *Digital audio broadcasting in a fading and dispersive channel*. PhD thesis, Stanford University, California, August 1994.