



LUND UNIVERSITY

The Inter-relation between Analytical and Experimental Methods of Structural Fire Engineering Design

Pettersson, Ove

1979

[Link to publication](#)

Citation for published version (APA):

Pettersson, O. (1979). *The Inter-relation between Analytical and Experimental Methods of Structural Fire Engineering Design*. (Report / Lund Institute of Technology, Lund, Sweden, Department of Structural Mechanics; Vol. R79-6). Lund Institute of Technology.

Total number of authors:

1

General rights

Unless other specific re-use rights are stated the following general rights apply:

Copyright and moral rights for the publications made accessible in the public portal are retained by the authors and/or other copyright owners and it is a condition of accessing publications that users recognise and abide by the legal requirements associated with these rights.

- Users may download and print one copy of any publication from the public portal for the purpose of private study or research.
- You may not further distribute the material or use it for any profit-making activity or commercial gain
- You may freely distribute the URL identifying the publication in the public portal

Read more about Creative commons licenses: <https://creativecommons.org/licenses/>

Take down policy

If you believe that this document breaches copyright please contact us providing details, and we will remove access to the work immediately and investigate your claim.

LUND UNIVERSITY

PO Box 117
221 00 Lund
+46 46-222 00 00

LUND INSTITUTE OF TECHNOLOGY · LUND · SWEDEN
DEPARTMENT OF STRUCTURAL MECHANICS
REPORT NO. R79-6

OVE PETTERSSON

THE INTER-RELATION BETWEEN
ANALYTICAL AND EXPERIMENTAL
METHODS OF STRUCTURAL FIRE
ENGINEERING DESIGN

LUND INSTITUTE OF TECHNOLOGY • LUND • SWEDEN

DEPARTMENT OF STRUCTURAL MECHANICS

REPORT NO. R79-6

OVE PETTERSSON

THE INTER-RELATION BETWEEN ANALYTICAL AND EXPERIMENTAL
METHODS OF STRUCTURAL FIRE ENGINEERING DESIGN

Reprinted from *Studies on Concrete Technology*, dedicated to
Professor Sven G Bergström on his 60th anniversary,
December 14, 1979

LUND 1979

THE INTER-RELATION BETWEEN ANALYTICAL AND EXPERIMENTAL METHODS
OF STRUCTURAL FIRE ENGINEERING DESIGN

Ove Pettersson

ABSTRACT

During the last ten years a rapid progress has been made in the development of analytical methods for a fire engineering design of load-bearing structures or structural members. In spite of this, the standard fire resistance test still is internationally predominant as a basis for a fire classification and design. The analytical methods can be categorized as (1) an interpolation or extrapolation of the results of fire resistance tests, (2) a theoretical determination of the fire resistance, (3) an analytical design, directly based on differentiated gas-temperature-time curves of natural fires, and (4) an analytical design, indirectly based on natural fire characteristics over an equivalent time of fire duration, connecting natural fires and the thermal exposure according to the standard fire resistance test.

The paper briefly describes the different approaches and demonstrates how useful input information for the analytical design methods can be derived from the results of standard fire resistance tests. The consistency between the various methods is critically reviewed and, by exemplifying for fire exposed steel structures, one way is indicated for improving this consistency.

Although, the different analytical and experimental design methods have been developed mainly independently and rather frequently have been discussed as contradictory to each other, it is quite clear, that the methods in a long-term perspective will form a well coherent pattern.

Ove Pettersson is Professor in Structural Mechanics at Lund University. His research contributions mainly have reference to instability problems and structural fire engineering design. He has many international commitments within CIB, ECCS, FIP and ISO.

INTRODUCTION. GENERAL BACKGROUND

The internationally predominant fire engineering design of load-bearing structures and structural members is characterized by a schematic procedure, based on results of standard fire resistance tests and connected systems of classification. FIG 1 describes the procedure. The design comprises a proof that the structure has a fire resistance time t_{fr} , determined in a standard fire resistance test, which exceeds the required time of fire duration t_{fd} , specified in building codes and regulations for different applications. The fire resistance and required fire duration concepts, t_{fr} and t_{fd} , are connected to a thermal exposure, which shall vary with time within specified limits according to the relationship:

$$T - T_0 = 345 \log_{10} (8t + 1) \quad (1)$$

where

t = time, in minutes
 T = temperature at time t , in $^{\circ}\text{C}$
 T_0 = temperature at time $t = 0$, in $^{\circ}\text{C}$.

During the last ten years important progress can be noted in the development of computation methods for an analytical structural fire engineering design. For steel structures, this development has arrived at a level which enables an analytical fire engineering design to be carried out in most practical applications (1). Validated material models

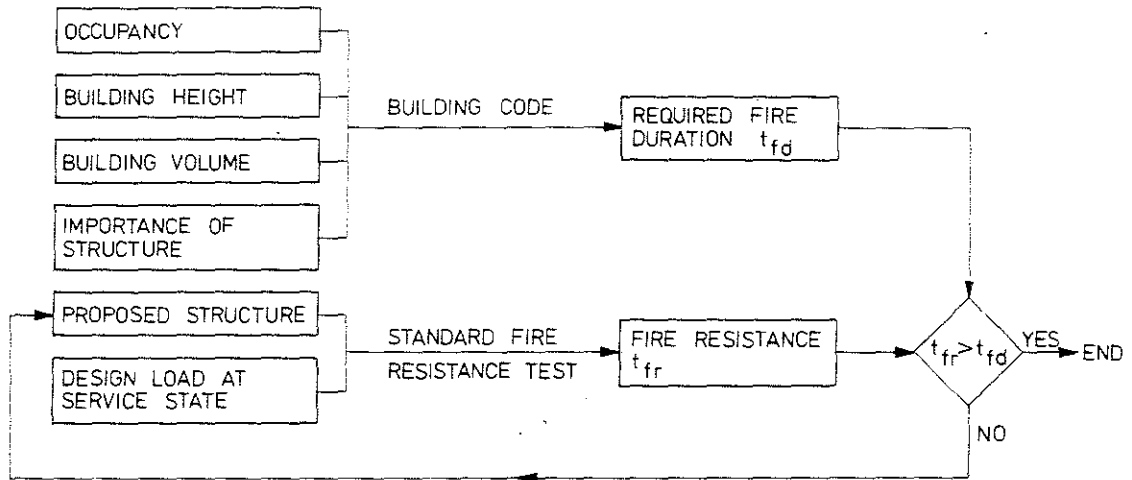

FIG 1. Internationally conventional fire engineering design of load-bearing structures, based on classification and results of standard fire resistance tests.

for the mechanical behaviour of concrete under transient high-temperature conditions (2), (3) and thermal models for a calculation of the time variation of the charring rate in wood at a fire exposure (4), (5), derived during the last years, now are opening the door for an essentially enlarged application of an analytical approach also for fire exposed concrete and wooden structures. (6) gives a rough idea of the present state of knowledge, as far as a systemized design basis is concerned.

Internationally, the analytical approach in connection with a structural fire engineering design can be categorized with reference to the following levels:

- (1) A theoretical interpolation or extrapolation of the results of a standard fire resistance test for a classification of a structure with a modified design in relation to the test specimen,
- (2) a theoretical determination of the fire resistance of a load-bearing structure, based on a thermal exposure according to the standard fire resistance test, Eq (1),
- (3) an analytical design, directly based on differentiated gastemperature-time curves of a real fire development, specified in detail with regard to the influence of the fire load density and the geometrical, ventilation and thermal proper-

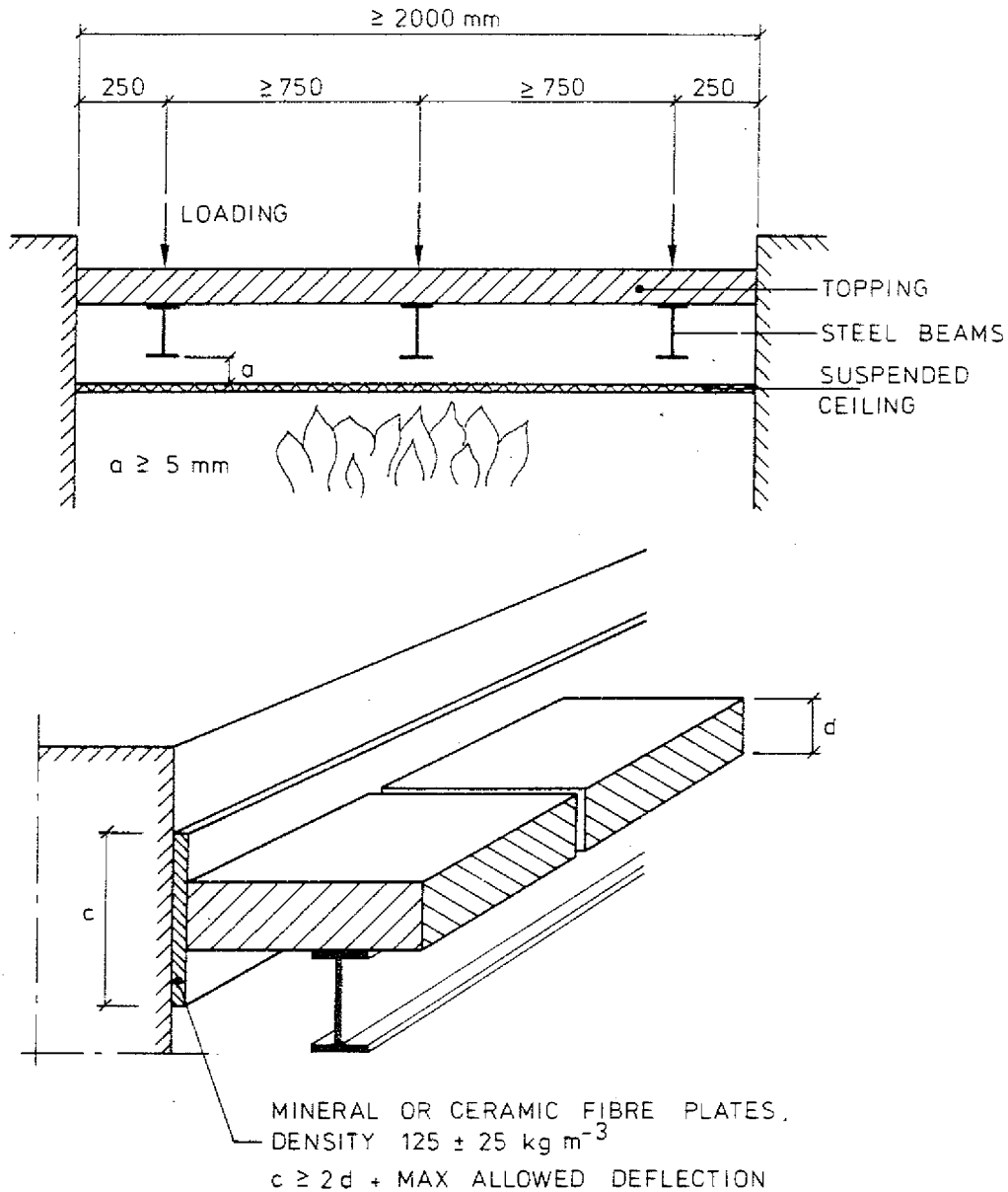

FIG 2. Test assembly for a determination according to draft proposal ISO DP 6167 "Fire resistance test - suspended ceilings" (9), (10) of the contribution of a suspended ceiling to the fire resistance of an unventilated load-bearing floor or roof structure.

ties of the fire compartment (1), (6),

(4) an analytical design, based on differentiated gastemperature-time curves of a real fire development but taken into account indirectly over an equivalent time of fire duration, connected to the heating according to the standard fire resistance test, Eq (1), (1), (6), (7), (8).

The described pattern of methods of structural fire engineering design gives the standard fire resistance test an essential role to produce information which can be used as a basis or as input data for different types of analytical approach. The importance of this role is further supported by the fact that fire resistance tests of load-bearing structures and structural elements have been carried out frequently for more than half a century, having given a very large volume of knowledge and experience.

The present paper exemplifies how results of standard fire resistance tests can be used as basic or input information in different analytical methods of a structural fire engineering design. The exemplification applies to an unventilated, load-bearing floor or roof assembly, composed of a supporting structure of steel beams, a slab of normal or aerated concrete and a suspended ceiling, as shown in FIG 2.

BASIC QUANTITIES, TO BE DERIVED FROM A STANDARD FIRE RESISTANCE TEST

In a fire resistance test of a load-bearing floor or roof assembly according to FIG 2, the time curve of the maximum steel beam temperature T_s is recorded - the dashed and dotted line curve in FIG 3 and 4. The collapse of the supporting structure - normally defined by a deflection or a rate of deflection criterion - determines the critical steel beam temperature $T_{s,crit}$ and the corresponding collapse time $t_{s,crit}$. If the suspended ceiling is damaged in the test, the time of this damage $t_{i,crit}$ is noted.

From the recorded time curve of the maximum steel beam temperature T_s , a derived value $(d_i/\lambda_i)_{der}$ of the tested suspended ceiling can be determined - d_i is a thickness measure and λ_i a thermal conductivity measure for the ceiling. The determination is based on a requirement that the agreement between the maximum steel beam temperature, measured in the test, and the corresponding calculated time curve shall be as close as possible. Such a determination is rendered easily feasible by using sets of diagrams of the type shown by the full line curves in FIG 3 or 4 as presented in (11) for floor or roof assemblies with a slab of alternatively normal concrete or aerated concrete and supporting steel beams with varying U/F values - U is

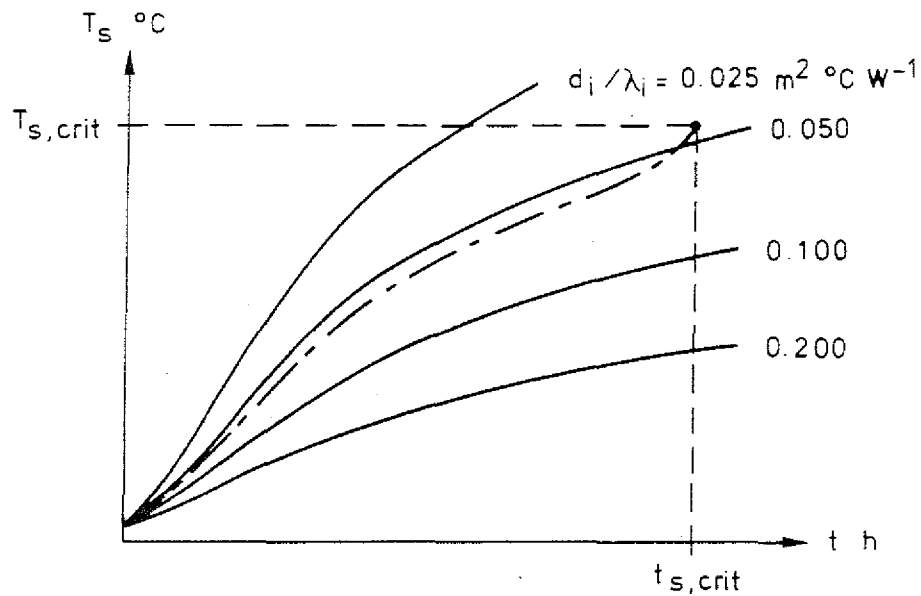

FIG 3. Calculated time curves of the steel temperature T_s of the supporting beams of a floor or roof assembly, as shown in FIG 2, with a suspended ceiling, having different values of d_i/λ_i (full line curves), and a measured time curve of the maximum steel beam temperature, determined in a fire resistance test according to ISO DP 6167 (dashed and dotted line curve).

the heat exposed surface and F the volume of the steel beam per unit length. By this procedure, the suspended ceiling tested is characterized in an integrated way with regard taken to the real structural design and behaviour at a fire exposure, including the influence of initial moisture content, crack formations, disintegration of materials, and partial failure of the ceiling and its fastening devices.

The reference diagrams presented in (11), are based on heat transfer equations, which neglect the influence of the heat stored in the suspended ceiling. If such diagrams are used for a determination of a derived value $(d_i/\lambda_i)_{der}$ of the suspended ceiling tested, the influence of this stored heat will be included in a way which has to be described more as a trick of calculation than as a functionally based procedure. For ordinary types of suspended ceilings, the approximation is reasonable. For suspended ceilings with a large thickness and made of materials of high density, it is recommended in (11) to use a presented and listed computer program for a direct and more accurate characterization of

the suspended ceiling.

For some types of suspended ceilings, the measured time curve of the maximum steel beam temperature can have a form which deviates considerably from the calculated time curves - FIG 4. The criterion for the determination of the value $(d_i/\lambda_i)_{\text{der}}$ of the suspended ceiling then should be that the calculated curve and the curve measured in the test give the same steel temperature $T_{s,\text{crit}}$ at the time $t_{s,\text{crit}}$. For the example, shown in FIG 4, this leads to a $(d_i/\lambda_i)_{\text{der}} = 0.05 \text{ m}^2 \text{ }^\circ\text{C W}^{-1}$. By applying such a criterion, a $(d_i/\lambda_i)_{\text{der}}$ is obtained, from which test results can be extrapolated without giving values of the fire resistance on the unsafe side.

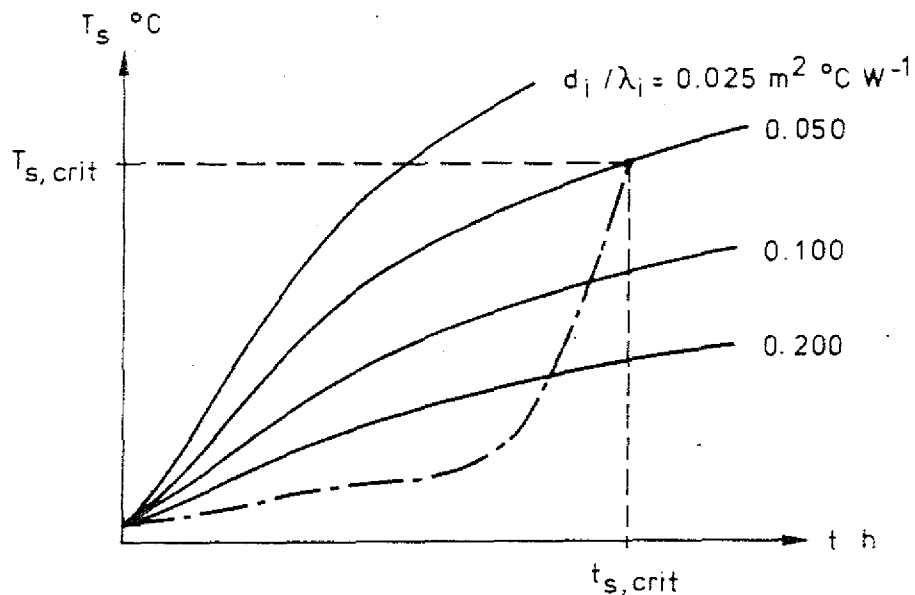

FIG 4. Criterion for the determination of $(d_i/\lambda_i)_{\text{der}}$ of a suspended ceiling, if the forms of the measured and calculated time curves of the steel beam temperature deviate. Notation according to FIG 3.

If the suspended ceiling is damaged in the test, the time for this damage $t_{i,\text{crit}}$ can be transferred to a critical temperature at the centre level of the ceiling $T_{i,\text{crit}}$ by using design diagrams, presented in (11) and exemplified in FIG 5.

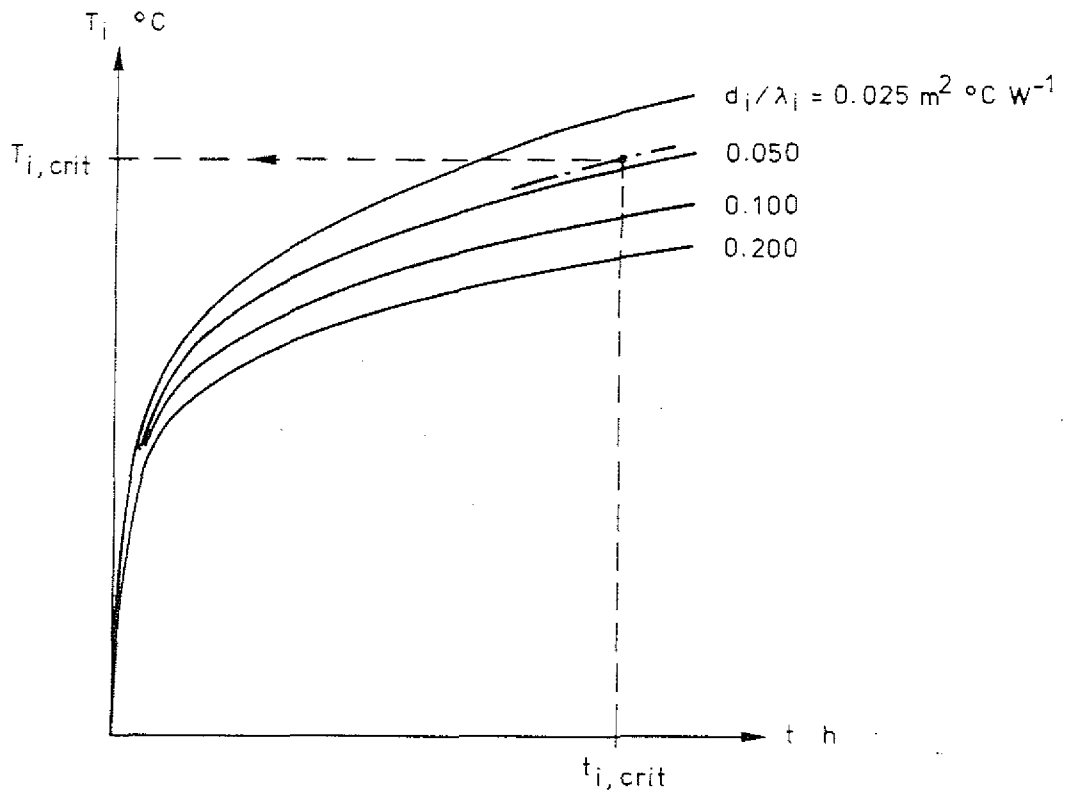

FIG 5. Calculated time curves of the temperature at the centre level of the suspended ceiling T_i in a floor or roof assembly, according to FIG 2, for different values of d_i/λ_i of the ceiling. Dashed and dotted line curve applies to a derived value $(d_i/\lambda_i)_{der}$ of an assembly tested and used for transferring the time for damage of the suspended ceiling $t_{i,crit}$ to a corresponding critical temperature of the ceiling $T_{i,crit}$.

DIRECT INTERPOLATION OR EXTRAPOLATION OF RESULTS OF FIRE RESISTANCE TESTS FOR CLASSIFICATION PURPOSES

Knowing the following quantities of a floor or roof assembly according to FIG 2

- (1) the critical steel beam temperature $T_{s,crit}$ at the collapse of the supporting structure,
- (2) the derived value $(d_i/\lambda_i)_{der}$ of the suspended ceiling, characterizing in an integrated way the real structural design and behaviour of the ceiling and its fastening devices at a fire exposure,
- (3) the critical temperature at the centre level of the suspended ceiling $T_{i,crit}$, corresponding to a failure of the

ceiling, if any,

the results of the fire resistance test can be directly interpolated or extrapolated for a determination of the fire resistance t_{fr} for structural modifications of the tested floor or roof assembly, having a suspended ceiling which is identical with the one tested. The modification then relates to the slab and the supporting steel beams.

A quick carrying through of the interpolation or extrapolation requires that a design basis is available which directly gives the time curves of the steel beam temperature T_s and the temperature at the centre level of the suspended ceiling T_i for varying slab material, steel beam characteristics and $(d_i/\lambda_i)_{der}$ for the suspended ceiling at a fire exposure according to Eq (1). Such a design basis is presented in (11) together with some examples, illustrating the practical application of the interpolation or extrapolation procedure.

If the modified floor or roof assembly is to be classified for the same ratio between the design load Q and the ultimate load at ordinary room temperature Q_u as applied in the test, the critical steel beam temperature $T_{s,crit}$ obtained in the fire resistance test directly constitutes the limiting value for the interpolation or extrapolation. If the classification relates to another ratio Q/Q_u than used in the test, the limiting steel beam temperature of the supporting structure $T_{s,crit}$ must be corrected, for instance, by way of FIG 6 (12).

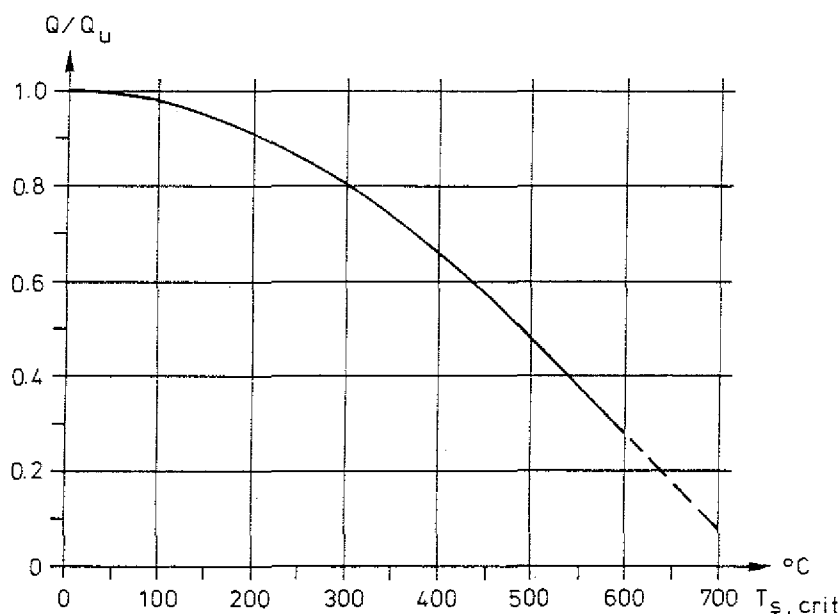

FIG 6. Limiting steel temperature $T_{s,crit}$ as function of ratio between design load Q and ultimate load at ordinary room temperature Q_u .

THEORETICAL DETERMINATION OF FIRE RESISTANCE

More and more countries now are permitting a determination of the fire resistance of load-bearing structures or structural members to be done analytically all through. The European recommendations for the design of fire exposed steel structures, recently drawn up by the European Convention for Constructional Steelwork (13), certainly will stimulate still more countries to approve officially this way of classification as an alternative to the standard fire resistance test.

The components of the design procedure are outlined in FIG 7. The thermal exposure is specified by Eq (1).

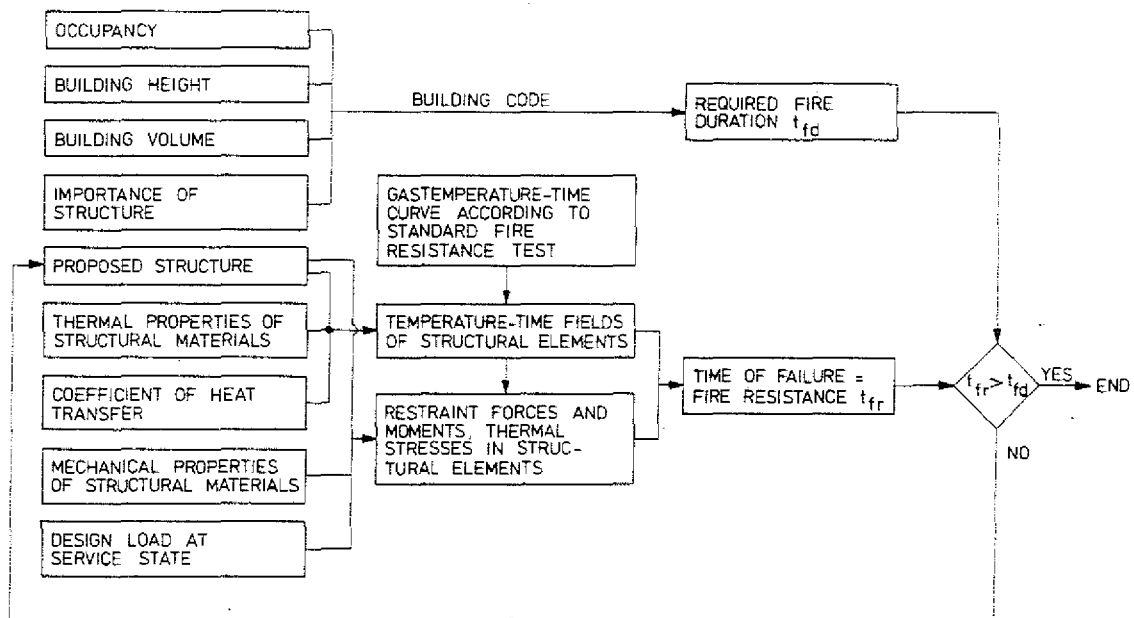

FIG 7. Analytical fire engineering design of load-bearing structures, based on classification and thermal exposure according to Eq (1).

It could be seen as quite natural to base a theoretical determination of the fire resistance of a floor or roof assembly according to FIG 2 on the following assumptions:

- (1) Characteristic values of the mechanical properties of the material of the steel beams at elevated temperatures,
- (2) characteristic values of the geometrical imperfections and residual stresses of the steel beams,
- (3) a uniform temperature distribution across the steel beams,

(4) a uniform temperature distribution along the steel beams.

Fire resistance tests of load-bearing structures or structural members are very expensive and consequently, the number of tests on each prototype ordinarily is limited to only one test - in a few countries, two tests. Hence, there are no possibilities to evaluate the test results statistically.

The actual quality of the structural material in a single test specimen can be considered as a random sample from a wide variety. Therefore, the material quality of a structural element, used in a fire resistance test, will generally be higher than the quality guaranteed by the manufacturer and consequently the mechanical properties of the material better than the characteristic values.

Analogously, the real level of the influence of imperfections for a single test specimen can be considered as a random sample. Hence, a steel beam member generally has a lower level of imperfections than the characteristic level specified in codes and regulations.

Finally, in a fire resistance test, the steel beams in a floor or roof assembly according to FIG 2 will get a considerable temperature variation over the cross section as well as in the longitudinal direction.

These circumstances indicate that considerable discrepancies will arise when the fire resistance of a floor or roof assembly, as shown in FIG 2, is determined on one hand by a standard fire resistance test, on the other by a calculation based on the assumptions, listed above. Generally, then the analytical method gives a lower - frequently essentially lower - value of the fire resistance than the test.

The described discrepancies between an analytical and experimental determination of the fire resistance are discussed and analysed more in detail in (14) for different types of load-bearing steel structures. Alternative methods of correction are briefly outlined for getting an improved consistency between the analytical and experimental approaches and one of these methods is further developed to a design basis, which can easily be applied in practice.

Principally, the method is characterized by a correction of the analytically determined load-bearing capacity R , based on the characteristic values of the mechanical properties of the structural material, the characteristic value of the initial imperfections of the structure and a uniformly distributed steel temperature across and along the structure. FIG 8 reproduces a recommended correction factor f , by which the load-bearing capacity R is to be multiplied in order to get the corrected load-bearing capacity R_c , i.e.

$$R_c = fR \quad (2)$$

The correction factor f then depends on the type of steel structure and on the steel temperature T_s , calculated on the assumption of a uniform distribution across and along the structure.

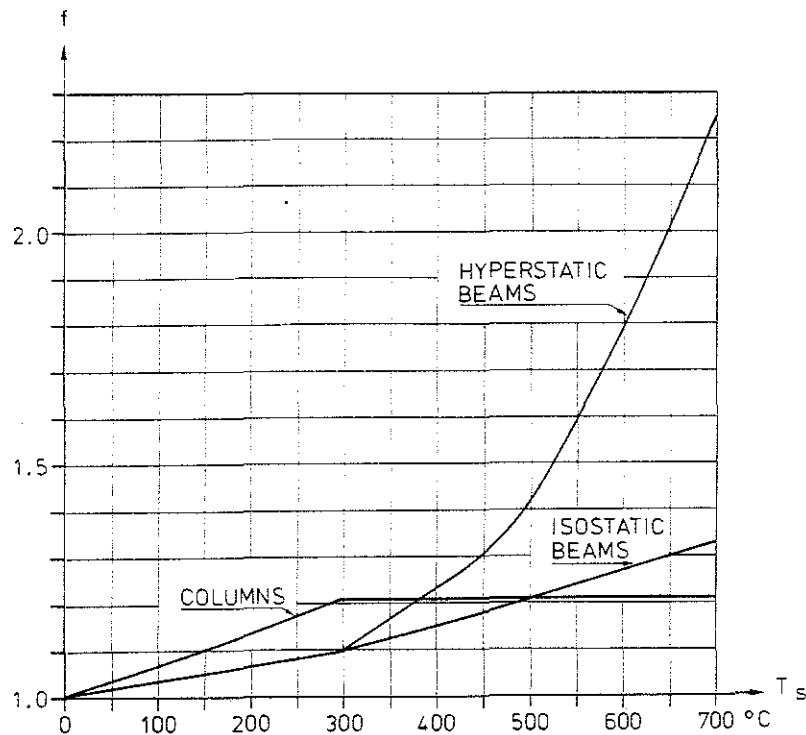

FIG 8. Correction factor f as a function of uniformly distributed steel temperature T_s for columns, isostatic beams and hyperstatic beams with two redundancies. For hyperstatic beams with only one redundancy, f roughly can be taken as the average of the values for isostatic beams and hyperstatic beams with two redundancies.

Applied to a floor or roof assembly with load-bearing steel beams and a suspended ceiling, as shown in FIG 2, an analytical determination of the fire resistance according to FIG 7 normally requires a support from results of a standard fire resistance test, specifying the integrated behaviour of the suspended ceiling, for instance, by the derived value $(d_i/\lambda_i)_{der}$ and the critical temperature at the centre level of the ceiling $T_{i,crit}$. In (1), these quantities are put down for a large number of types of suspended ceilings, obtained in fire resistance tests performed at the National Swedish Institute for Testing and Meteorology in Stockholm.

ANALYTICAL DESIGN, DIRECTLY BASED ON REAL FIRE CHARACTERISTICS

An input information in the form of the quantities $(d_i/\lambda_i)_{der}$ and $T_{i,crit}$ or other equivalent quantities for the suspended ceiling, determined in a standard fire resistance test or in some other test, ordinarily is required also in an analytical design for a real fire exposure, when applied to a floor

FIG 9. Procedure of an analytical fire engineering design of a load-bearing structure, directly based on real fire characteristics. The design scheme comprises an eventual additional requirement on re-serviceability after fire.

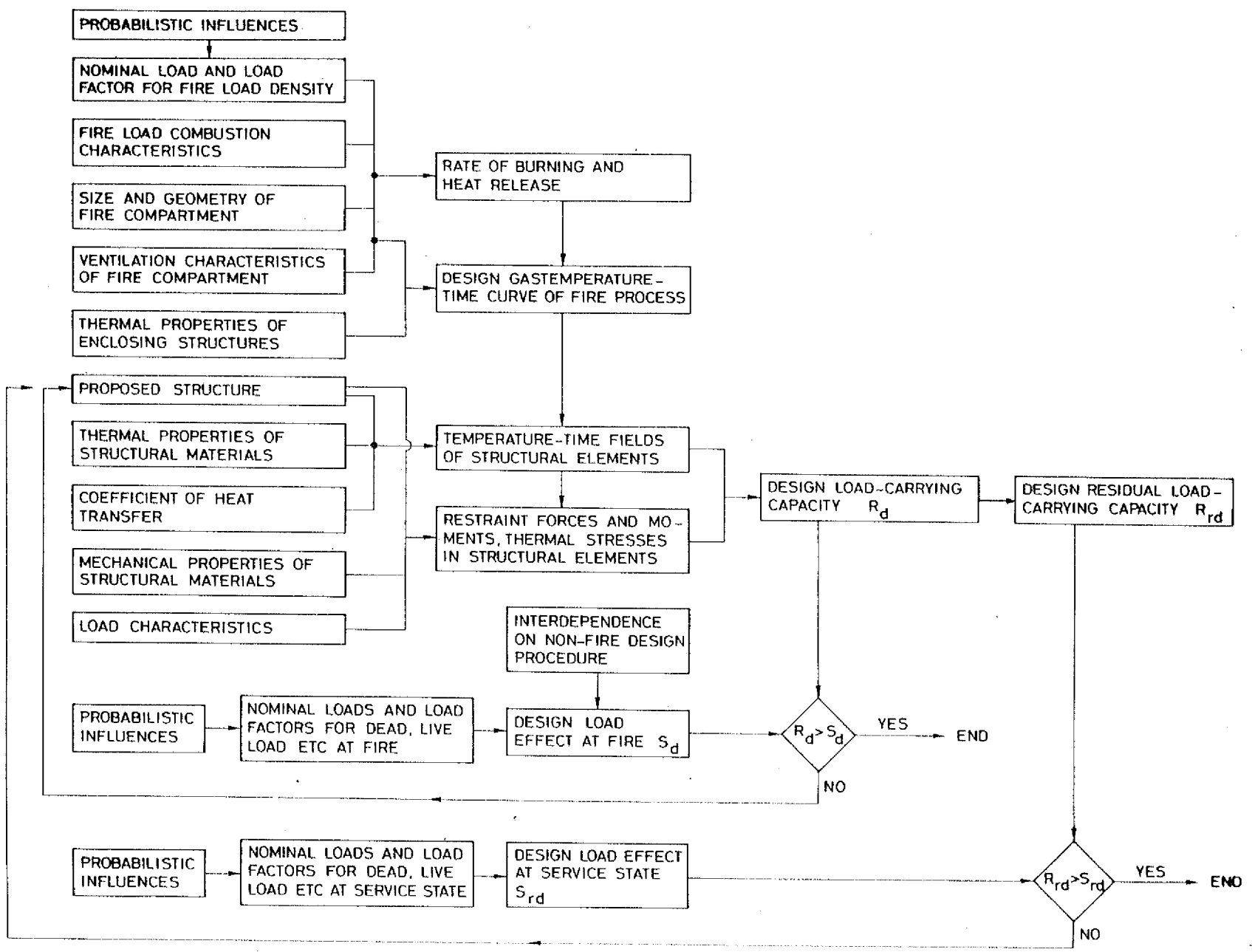

or roof assembly, as shown in FIG 2.

The procedure of an analytical structural fire engineering design, directly based on differentiated gastemperature - time curves of a real fire development, is shown in FIG 9 (1), (6). Decisive quantities for the fire exposure are

- (1) the design fire load density and its combustion characteristics,
- (2) the size and geometry of the fire compartment,
- (3) the ventilation of the fire compartment, and
- (4) the thermal properties of the structures enclosing the fire compartment.

The design criterion requires that the lowest value of the load-bearing capacity R during the fire exposure - the design load-carrying capacity R_d - exceeds the design load effect at fire S_d .

For buildings containing activities, which are particularly important from, for instance, an economical point of view, there may be the motive for requiring that the building can be used again after a fire - either directly or after only very limited repairs - for the current activities in a full extent. If a fire engineering design also includes such a requirement on re-serviceability of the structure after fire, the residual load-carrying capacity R_{rd} must exceed the design load effect at service, non-fire state on the structure S_{rd} .

An analytical design according to FIG 9 is now approved in Sweden for a general practical use by the National Swedish Board of Physical Planning and Building (15). For facilitating the practical application, a comprehensive set of design diagrams and tables have been systematically produced, giving directly, on one hand, the design temperature state of the fire exposed structure, on the other, a transfer of this information to the corresponding design load-bearing capacity of the structure; cf, for instance (1), (6), (16).

Compared with the internationally predominant fire engineering design, based on classification and results of standard fire resistance tests, the analytical design according to FIG 9 has a more logical structure, based on well-defined functional requirements and performance criteria, gives a structural fire design with improved economy, and leads to a more consistent fire safety level.

ANALYTICAL DESIGN, INDIRECTLY CONNECTED TO REAL FIRE EXPOSURE
OVER THE CONCEPT EQUIVALENT TIME OF FIRE DURATION

In those cases, at which the present state of knowledge does not enable a complete analytical fire engineering design according to FIG 9 to be carried out, the concept equivalent time of fire duration can be a useful implement. The concept has been introduced as a means for a direct translation from a real fire exposure to a corresponding heating according to a standard fire resistance test, and vice versa.

In principle, the equivalent time of fire duration is defined as that length of the heating period in a standard fire resistance test which gives the same, most hazardous effect on the structure as the complete fire process of a real fire - e.g., the same maximum temperature for a steel structure. Depending on the type of design problem to be dealt with and the level of accuracy intended, the character of the concept will vary.

If the available design basis permits a theoretical determination to be performed, as concerns the transient temperature fields but not the design load-carrying capacity of a fire exposed structure, it can be motivated to use a differentiated form of the equivalent time of fire duration concept. The equivalent time of fire duration then becomes a function both of the parameters of the fire process and of the quantities which describe the detail design of the actual structure (1), (6).

A more rough form of the concept is necessary to use, when the structural fire engineering design is to be based on real fire exposure characteristics without the prerequisites existing for an analytical determination of the transient temperature fields and the connected load-bearing capacity of the fire exposed structure. Under such circumstances, the equivalent time of fire duration t_e can be differentiated only with respect to the detail properties of the fire process but not with respect to the characteristics of the structural design - FIG 10 (7), (8), (17). For fire exposed steel structures - for instance, a floor or roof assembly according to FIG 2 - then the following approximate formula can be applied (8)

$$t_e = 0.067 \frac{q_f}{\left(\frac{A\sqrt{h}}{A_t}\right)_f^{1/2}} \quad (\text{min}) \quad (3)$$

in which q_f is the fictitious value of the fire load density ($\text{MJ}\cdot\text{m}^{-2}$) and $\left(\frac{A\sqrt{h}}{A_t}\right)_f$ the fictitious value of the opening factor of the fire compartment ($\text{m}^{1/2}$); cf (1), (6). Written in this form, the formula enables that the influence of varying thermal properties of the structures surrounding the fire

compartment can be taken into account.

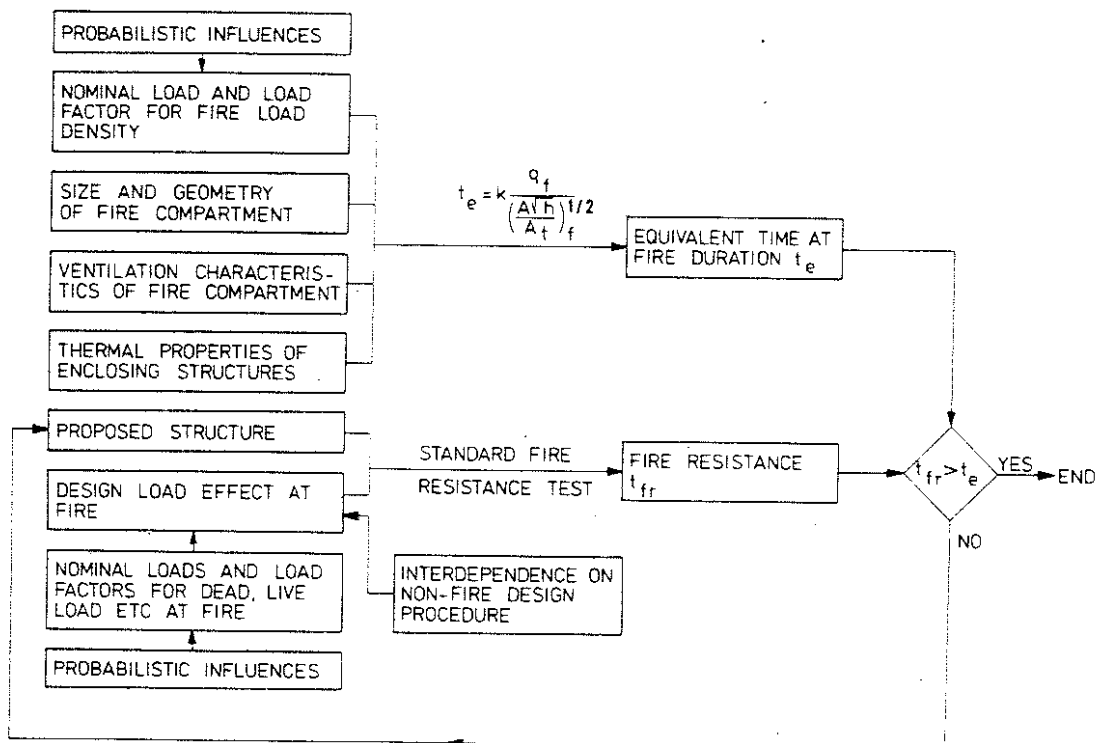

FIG 10. Procedure for a structural fire engineering design, based on a simplified expression for the equivalent time of fire duration t_e and on an experimentally determined fire resistance of the structure t_{fr} .

REFERENCES

- (1) Pettersson, O., Magnusson, S.E. and Thor, J., "Fire engineering design of steel structures", Publication 50, Swedish Institute of Steel Construction, Stockholm, 1976 (Swedish Edition 1974).
- (2) Anderberg, Y. and Thelandersson, S., "Stress and deformation characteristics of concrete at high temperatures. 2. Experimental investigation and material behaviour model", Bulletin 54, Division of Structural Mechanics and Concrete Construction, Lund Institute of Technology, Lund, 1976.
- (3) Schneider, U. and Kordina, K., "Ueber das Vorhalten von Normalbeton unter stationärer und instationärer Temperaturbeanspruchung", 3rd International Conference on Structural Mechanics in Reactor Technology, Vol. 3, Part H, M 1/6, London, 1975.

- (4) Hadvig, S. and Paulsen, O.R., "One-dimensional charring rates in wood", Journal of Fire & Flammability, Vol. 7, October 1976.
- (5) Fredlund, B., "Modell för beräkning av temperaturer och fuktfördelning samt reducerat tvärsnitt i brandpåverkade träkonstruktioner (Analytical model for a determination of temperature and moisture distribution and reduced cross section in fire exposed wooden structures)", Internal Report IR 79-2, Division of Structural Mechanics, Lund Institute of Technology, Lund, 1979.
- (6) Pettersson, O. and Ödeen, K., "Brandteknisk dimensionering - principer, underlag, exempel (Fire engineering design of building structures - principles, design basis, examples)", Liber Förlag, Stockholm, 1978.
- (7) Law, M. and Arnault, P., "Fire loads, natural fires and standard fires", ASCE-IABSE International Conference on Planning and Design of Tall Buildings, Lehigh University, Bethlehem, Pennsylvania, August 21-26, 1972.
- (8) Pettersson, O., "The connection between a real fire exposure and the heating conditions according to standard fire resistance tests," European Convention for Constructional Steelwork, Chapter II, CECM-III-74-2E.
- (9) ISO/TC92, DP 6167 "Fire resistance test - suspended ceilings", Document ISO/TC92 N494, October 1978.
- (10) ISO, "Fire resistance tests - elements of building construction", International Standard 834, 1975-11-01.
- (11) Sandberg, B. och Pettersson, O., "Theoretical evaluation of fire resistance tests of floor and roof assemblies with suspended ceiling", Bulletin 58, Division of Structural Mechanics and Concrete Construction, Lund Institute of Technology, Lund, 1978.
- (12) Witteveen, J., "Brandveiligheid staalconstructies (Fire resistance of steel structures)", Centrum Bouwen in Staal, Rotterdam, 1966.
- (13) European Convention for Constructional Steelwork, Committee 3, "European recommendations for the design of steel structures exposed to the standard fire", Final Draft, July 1979.
- (14) Pettersson, O. and Witteveen, J., "On the fire resistance of structural steel elements, derived from standard fire tests or by calculation", to be published in the Journal of Fire Safety, 1979.

- (15) National Swedish Board of Physical Planning and Building, "Brandteknisk dimensionering (Fire engineering design)", Comments on SBN (Swedish Building Code), No. 1976:1.
- (16) Pettersson, O., "Calcul théorique des structures exposées au feu", Sécurité de la Construction Face à l'Incendie, Séminaire tenu à Saint-Rémy-lès Chevreuse (France) du 18 au 20 Novembre 1975, Editions Eyrolles, Paris, 1977.
- (17) Pettersson, O. and Magnusson, S.E., "Fire test methods - background, philosophy, development trends and future needs", Nordtest Doc Gen 011, Stockholm, 1977.

