



LUND UNIVERSITY

Temperature, genetic and hydroperiod effects on metamorphosis of brown frogs *Rana arvalis* and *R-temporaria* in the field

Loman, Jon

Published in:
Journal of Zoology

DOI:
[10.1017/S0952836902001255](https://doi.org/10.1017/S0952836902001255)

2002

[Link to publication](#)

Citation for published version (APA):

Loman, J. (2002). Temperature, genetic and hydroperiod effects on metamorphosis of brown frogs *Rana arvalis* and *R-temporaria* in the field. *Journal of Zoology*, 258(1), 115-129. <https://doi.org/10.1017/S0952836902001255>

Total number of authors:
1

General rights

Unless other specific re-use rights are stated the following general rights apply:
Copyright and moral rights for the publications made accessible in the public portal are retained by the authors and/or other copyright owners and it is a condition of accessing publications that users recognise and abide by the legal requirements associated with these rights.

- Users may download and print one copy of any publication from the public portal for the purpose of private study or research.
- You may not further distribute the material or use it for any profit-making activity or commercial gain
- You may freely distribute the URL identifying the publication in the public portal

Read more about Creative commons licenses: <https://creativecommons.org/licenses/>

Take down policy

If you believe that this document breaches copyright please contact us providing details, and we will remove access to the work immediately and investigate your claim.

LUND UNIVERSITY

PO Box 117
221 00 Lund
+46 46-222 00 00

Temperature, genetic and hydroperiod effects on metamorphosis of brown frogs *Rana arvalis* and *R. temporaria* in the field

Jon Loman

Department of Animal Ecology, Lund University, SE-223 62 Lund, Sweden

(Accepted 15 October 2001)

Abstract

Time for metamorphosis and metamorph size of moor frogs *Rana arvalis* and common frogs *R. temporaria* were measured in 22 ponds for 1–8 years. Environmental data in these ponds were also measured. Metamorphosis of the frogs took place from the beginning of June to the beginning of August. When both species were found in one pond, the common frogs metamorphosed up to 20 days earlier than the moor frogs. Most variation in time for metamorphosis, among ponds and years, is explained by temperature effects, but a causal relationship was not established. Within a pond, metamorphosis was later in cold summers than in warm summers. Size at metamorphosis was affected by tadpole density; at high densities metamorphs were smaller. Size at metamorphosis was not related to time for metamorphosis. There was an effect of pond drying; if ponds were about to dry up, metamorphosis was accelerated by about 2.4 days. Tadpoles from ponds with a late metamorphosis in the field had tadpoles that metamorphosed early in a common garden experiment, suggesting counter gradient selection.

Key words: competition, counter gradient selection, development, growth rate, tadpoles, *Rana*

INTRODUCTION

The timing of metamorphosis is affected by a multitude of proximate and ultimate factors. Comparisons among species give an indication of how various strategies have evolved (Werner, 1986). Laboratory studies give detailed information about the influence of proximate factors such as temperature, food availability, predators, egg size and hydroperiod (Denver, 1997). To evaluate the factors that actually govern the timing of metamorphosis in natural populations, field studies are necessary. For example, several studies have shown effects of lowered water level on anuran development rate, presumably an adaptation to survive in drying ponds (Loman, 1999; Ryan & Winne, 2001). However, there is little (Newman, 1989) information on whether this happens in nature. Also, competition can have dramatic influences on tadpole development rate and metamorph size in laboratory studies (Wilbur, 1987). Is this an important phenomenon in natural ponds?

There are few data on metamorphosis of anurans in the field. This study presents data from 22 ponds, studied for up to 8 years, and analyses year and pond variation. Data from several other studies, some of which were primarily collected for other purposes but involved the same ponds that were monitored for metamorphs, are used to analyse the effect that several environmental factors have on tadpole metamorphosis.

This study is correlative, in contrast to experimental, which means that it is not possible to conclude anything about causative effects. However, it yields information on factors that may be important in the field and may thus generate hypotheses for further studies.

METHODS

Study ponds

The study is based on data from 1990 to 1997 (Table 1). There were 22 study ponds, monitored for between 1 and 8 years each (Table 2). They were situated in south-western and central Scania, the southernmost province of Sweden (Fig. 1). Most ponds were situated 20–120 m a.s.l. The three north-easternmost ponds, HP25, HP27 and HP33, were situated at 170 m a.s.l. The ponds represent a range of types used by the 2 species. In the first part of the Results, metamorphosis episodes (combinations of year and pond) are related to the physical characteristics of the ponds. For this purpose the ponds are divided according to surroundings (forest ponds and non-forest ponds) and permanency (shallow, medium and deep). Shallow ponds were those that occasionally dried up completely, causing total loss of tadpoles or truncated metamorphosis episodes (only fast developing tadpoles metamorphosed before pond drying). Medium

Table 1. Number of study ponds and degree of metamorphosis success. In some years and ponds, pond drying resulted in no or only partial (truncated) metamorphosis

	Total no. of ponds	Metamorphosis		
		None	Partial	Completed
1990	12	1	1	10
1991	17	0	0	17
1992	19	8	1	10
1993	21	7	1	13
1994	19	0	5	14
1995	11	1	4	6
1996	7	0	2	5
1997	7	2	2	3

ponds had a deep centre but extensive shallow shores. Deep ponds had steep shores and a maximum depth of > 0.5 m throughout the summer. For statistical analysis, pond categories were not used, but values scored for continuous environmental variables were used directly.

Year-specific factors

Air temperatures were recorded at the official meteorological station in Lund (Fig. 1). Monthly air temperature for April–July (AATEMP, MATEMP, JNATEMP and JLATEMP) have only 1 value per year, used for all ponds. Variation among ponds (the pond *

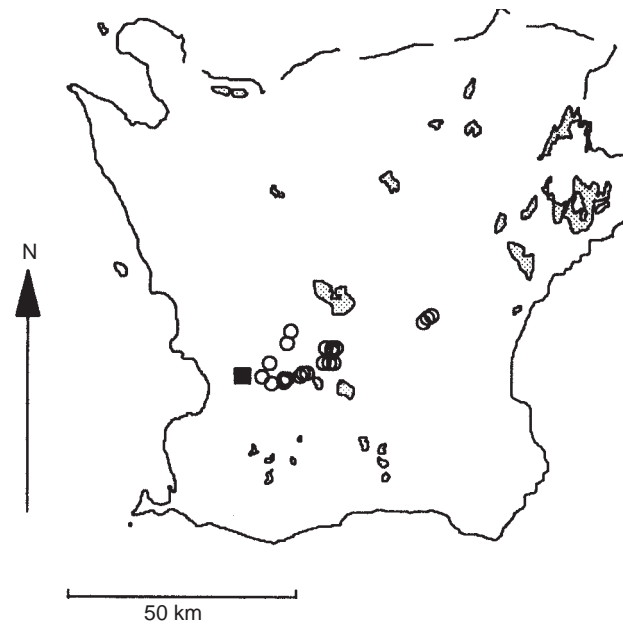

Fig. 1. Map of the province Skåne in southernmost Sweden with pond locations (circles). Filled square, site of the meteorological station used at Lund.

air temperature interaction) is judged minor and not considered. Besides, no pond specific information is available. Also for pond- and year-specific factors (EDENS, HTIME, TDENS, PRED, DRY, see below)

Table 2. Study pond data. 'Total years' is the number of years the pond was monitored during (potential) time for metamorphosis. 'Dry' and 'truncated years' are subsets of those when pond became dry before metamorphosis or during metamorphosis (when some tadpoles were still present). 'Surrounding' is F for ponds in forest and O for ponds in open land. 'Shape' is S for shallow ponds (that occasionally dry up), M for medium ponds (with shallow shores but a permanent centre) and D for deep ponds with steep shores. Abbreviations for other variables recorded are given in Methods. The mean values are based on different number of years for different variables and ponds. This is not always the same as the total number of years that the pond was monitored

Pond	Total years	Dry years	Truncated years	Surrounding	Shape	HTIME	EDENS	TDENS	DRY	ALG	PRED	PTEMP	GEN-TIME	GEN-SIZE	ESIZE
AD17	8	1	1	O	S	49	0.57	106.1	60	0.012	0.62	12.3	18.7	13.1	1.90
AD18	5	2	0	O	M	50	0.07	0.8	51	0.009	0.35	12.9			1.81
AP1	1	0	0	O	M		0.06	0.5			1.80	13.1			
AP4	4	0	0	F	D		0.18	0.9	88	0.007	1.78	10.8			
AP5	5	2	2	F	S	65	0.21	292.5	19	0.016	0.23	11.8			1.83
HL3	4	0	0	O	D		0.02	0.1	96	0.012	1.23	12.1			2.01
HL6	5	0	0	O	D	52	0.33	1.1	95	0.008	0.80	13.4	13.7	12.6	2.06
HL7	4	0	0	O	D	51	0.18	5.7	93	0.021	0.66	12.5			1.88
HL8	5	0	0	O	D	56	0.21	3.2	86	0.027	0.79	11.4	5.8	12.0	1.98
HP25	7	3	2	F	S	60	0.19	52.9	33	0.021	0.12	11.0	12.9	12.6	1.89
HP27	7	1	0	O	M	54	0.18	3.9	51	0.008	0.31	12.7			1.93
HP33	6	3	3	F	S	60	0.13	16.7	42		0.04	10.9	14.2	12.6	1.79
L1	6	3	2	F	S	56	1.12	57.3	53		0.00	12.3	13.7	12.7	1.96
M1	6	0	0	O	M	50	0.09	4.3	84	0.010	0.71	14.0			1.75
M2	6	0	0	O	M	61	0.05	2.4	52	0.016	0.85	14.1			1.86
M3	5	2	2	O	S	58	0.08	1.6	26	0.019	0.28	13.9			2.02
M4	6	0	0	O	D	55	0.03	0.2	54	0.007	1.14	14.0			1.82
R3	8	3	3	O	S		0.15	6.5	43	0.010	0.99	11.8	8.1	11.8	
R4	4	0	0	O	D		0.08	1.2	96	0.006	1.79	14.7			1.84
R5	4	0	0	O	D		0.16	0.1	95	0.005	2.30	13.4			
SK6	3	0	0	O	D	58	0.02	0.1	90		1.10	14.3	16.9	12.4	1.77
SK7	4	0	0	O	D	57	0.17	16.0	93		0.38	14.7	8.6	12.2	1.76

1 value was computed for each year, using the model described later under Pond-specific factors.

Pond- and year-specific factors

Measures of crowding (EDENS, TDENS), hatching time (HTIME), predators (PRED), and of pond drying (DRY) vary both among years and among ponds. This information was recorded for most ponds during most of the years.

Egg crowding (EDENS)

All ponds were monitored at the time of frog spawning. The total number of spawn clumps was counted. The total number of *Rana* spawn clumps divided by pond area was used as an index of early crowding. Tadpoles of the 2 species have been shown to compete, which motivates combining the 2 species into an aggregate index (Lardner, 1995).

Hatching time (HTIME)

Breeding sites were monitored until the first spawn in a pond had hatched. This date was registered. In principle, average hatching date for all spawn had been a more relevant measure. However, this was not registered. In any 1 pond most breeding took place within a few days (Håkansson, 1992) and (because water temperature was usually higher at that time) hatching was even more contracted than breeding. When both species were present in a pond, the first spawn of each usually hatched on the same day or at most 1 day apart. For these reasons, only 1 value is used for each pond: date for the first spawn to hatch, regardless of species.

Tadpole crowding (TDENS)

Later, tadpoles were sampled by a scraper net. This gave a measure of tadpole density. The efficiency probably varied with bottom type but because the measured between-pond variation was very large, it was judged useful as an index of real density variation between ponds. The net samples were taken twice each year, in late May and early June. At each occasion there were 5–20 samples taken, each covering 1 m². The average of the mean monthly sample densities was used in the analyses; data from the 2 *Rana* species were combined for this density index.

Predators (PRED)

The scraper net samples yielded predators as well as tadpoles. Number of predators per sample (representing

1 m² bottom) was used for an index of predators. There were usually 10 samples per pond, year and period. The mean value for all samples during 1 period (May or June) was computed and their mean used for the index. The predators included in the index were water beetles *Dytiscus* sp. (adults as well as larvae), back swimmers *Notonecta* sp., water stick insects *Ranatra linearis*, dragonfly nymphs (Anisoptera), adult newts *Triturus cristatus* and *T. vulgaris*, stickleback *Gasterosteus aculeatus* and crucian carp *Carassius carassius*. Except for stickleback (which was not studied) these were all found to consume *R. temporaria* tadpoles in a study by Lardner & Loman (1995). One could consider various linear combinations of densities of these predators. However, computing a standard value for the density of each predator and pond, there was no significant negative correlation between any pair of predators and only 2 positive ($n = 22$). Being independent estimates of predators and lacking documented information on their relative danger for tadpoles, the sum of all individuals was used as an index of predation risk.

Pond drying (DRY)

In early June, the percentage of the area of pond water remaining (compared to that at breeding time) was estimated. A low value usually indicated that the pond was close to becoming totally dry. However, sometimes this was not the case, but summer rains raised the water level (and saved the tadpoles).

Tadpole growth rate and development

Tadpoles were captured twice each year using a scraper net. Because of the large number of ponds, the captures could not be done on the same day in any 1 year. The total pond and year variation was 12 May–22 May and 27 May–8 June. Within any 1 year, the total span of 1 period was always <7 days. To compute a size measure that was comparable between ponds and years, the following procedure was used (Fig. 2). In each year all tadpoles, from both capture periods, were entered in an analysis of ANCOVA with POND as category and DATE as covariate. The analysis yielded an average slope which was used to extrapolate all measures to a common date, 25 May. The average of these values was used for each pond and year. Growth rate was computed by dividing body length (minus 2 mm, the size of a hatching) with the number of dates from first day of hatching in the pond to 25 May.

Apart from body length, hind leg length was measured on tadpoles captured with a scraper net. Relative leg length was computed as leg length divided by body length. Because the second capture was always at least 7 days before metamorphosis, usually much more, this measure increased continuously during the tadpoles ontogeny. The 2 measures for each pond in a given year were combined into 1 in the same manner as for body

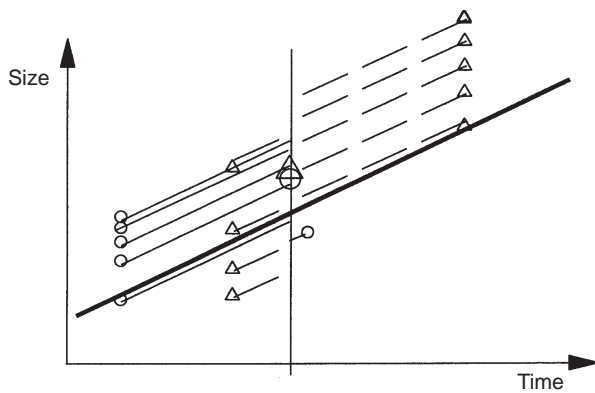

Fig. 2. Fictive example of method used to calculate year- and pond-specific *Rana* tadpole body length and tadpole relative leg length. Small circles and triangles, individual captures from two ponds. In the circle pond there was only one tadpole captured on the second occasion. Thick slope, average slope. This is the effect of TIME from an ANCOVA with TIME as covariate and POND as factor. It is not the regression based on all data points but an average of separate pond regressions. This slope is used to correct all captures to an expected size at the standard date, 25 May (vertical line). These corrected values are used to compute pond means. This method corrects for time when some ponds were sampled earlier than others and it puts equal weight on all captures in a pond. It is assumed that there is growth in all ponds, best estimated by the average growth. In case only one or two exceptionally small or large tadpoles were captured on either of the two capture occasions, this did not bias the data. The method also preserves data if no tadpole was captured on either occasion. Both situations were rare but did occur and were judged unrepresentative. In the example, disregarding growth during the sampling period, or assuming that the single right circle was representative of tadpole size in the circle pond at the late sampling time, had given a smaller tadpole size in the circle than in triangle pond. The model used yields of a similar size. Note that this figure shows the computation of tadpole size. Growth rate, which is used in the analysis, is computed from this value and from information on hatching time.

length (above). This measure is termed tadpole development.

Pond specific factors

Some factors have only 1 value per pond. This could be because between-year variation was not considered relevant, as is true for genetic factors (GEN-). Even if several comparable measures for different years were available for this factor, this could not represent an underlying among-year variation. For some factors, i.e. ESIZE, PTEMP and ALG, an among-year variation, in addition to among-pond variation, is quite probable, but as information was only available for 1 or 2 years, 1 value per pond was computed. This value was only used in analyses of the among-pond variation. The

value was found by fitting the linear model $FAC- T O R = C O N S T A N T + P O N D + Y E A R$. This model was then used to estimate 1 value per pond for a standard year. This year was 1994 for all factors, but for ALG no data were available for any pond in this year, and thus values could not be estimated; 1993 was used instead. The choice of standard year is not important, years will only vary by a constant number, the same for all ponds. As year is not part of these analyses this had no effect on the results. Also for the pond- and year-specific factors (listed above), 1 value was computed for each pond, using the model described above.

Pond temperature (PTEMP)

Temperature was measured in 2 years, 1991 and 1994 in 18 and 15 ponds, respectively. Eleven of the ponds were used both years. Temperature was measured by the sucrose inversion method (Pallman, Eichenberger & Hasler, 1940; Berthet, 1960): 1 ml test-tubes were filled with a solution of sucrose, buffered to pH 1.7 and stored at -18°C . This transforms to a mixture of glucose and fructose, a reaction that is temperature dependent. The progress of the reaction can be measured by polarimetry. At the first day of a test period, the tubes were put in plastic bags with a stone and deposited at 20 cm depth around the shore of the ponds. The bags were checked weekly and moved out if the water level had decreased. There were 4 stations around each pond (2 around 1 small pond and 8 around 1 large pond). In each year, measures were taken in an early period, a late period and a long period covering both the shorter periods. The short periods were 15 May–29 May 1991, 29 May–12 June 1991, 28 April–9 May 1994 and 9 May–19 May in 1994. In 1991 there were 2 tubes per station (in the same bag) during the short periods and 3 tubes per station during the long period. In 1994, when it was known that the repeatability within bags was high, there was only 1 tube per period and station. The total number of measurements (506 and 200 for 1991 and 1994, respectively) was less than that planned by the design because bags were stepped upon by cattle. The solutions were calibrated by placing tubes at the corresponding periods of time at 2 temperatures (8 and 12°C) in 1991 and 3 temperatures (8, 16 and 24°C) in 1994.

Genetic effects (GENTIME, GENSIZE)

Some of the ponds were the source for eggs used in 'common-or-garden' experiments (Fauth, 1998) where tadpoles were raised from egg to metamorphosis in 80-l outdoor tanks (Loman, 2002). This was done in 1992, 1993 and 1994. Eggs from 9 different ponds were used. For each year, the average time for metamorphosis and size at metamorphosis for tadpoles from a pond were considered an index of the innate standard for the population in the pond. A 2-way ANOVA demon-

strated significant year (d.f. = 2:9, $F = 521$, $P < 0.001$) and pond effects (d.f. = 8:9, $F = 4.36$, $P = 0.019$) on time for metamorphosis in these tanks. For size at metamorphosis, the year effect was also significant (d.f. = 8:2, $F = 17.2$, $P < 0.001$) but there was no pond effect (d.f. = 8:2, $F = 0.35$, $P = 0.93$). Yearly pond means for these tadpoles were converted to overall pond means using the method described above. This pond standard value is determined by genetic and maternal factors, exclusive of other pond-specific effects. The values were used for comparison with the corresponding data from the field measurements of time for and size at metamorphosis, respectively.

Egg size (ESIZE)

In 1993 and 1994, eggs were sampled from between 6 and 22 spawn clumps in each of 18 ponds (13 ponds were sampled in both years) (Loman, 2001a). From each clump, the diameter of the eggs in a sample of 15 eggs was measured and the average value used as a measure for the clump. The average for all measured clumps was used as a measure for the pond and year.

Algae (ALG)

In 1991 and 1993, algae growth was measured in 17 ponds. This was done by putting small Perspex chambers in the pond for *c.* 4 weeks and recording the weight of the algae that grew (Loman, 2001b). The chambers had 2 sides covered by a plastic net that permitted free flow of water but excluded grazing tadpoles and snails.

Response variables – time for and size at metamorphosis

Each pond and year was considered as 1 metamorphosis episode. When metamorphosis was expected to start, each pond was visited once every 2–6 days (average 4.1). Visits were more spaced out late in the season when few or no metamorphs were found. When only 1 or no metamorphs was found, a final visit was made before quitting for the pond and season. At each visit as many metamorphs as possible were captured from the shore of the pond. The captures lasted for 2–10 min (average 6.3). The effort was higher (capture time up to 10 min) if few metamorphs were found. This was to secure a sample for measuring. All metamorphs were measured (body and tail length) and released at the capture pond. All animals found on land were considered to have metamorphosed, regardless of tail length, and were captured when possible. Average relative tail size differed between ponds and therefore relative tail length (tail/body length) was used to estimate a standard day of metamorphosis for each individual. For relative tail lengths, a 2–50% capture date was used as the metamorphosis date. For relative tail lengths of 50–100%, 1 day was added to the capture date and for relative tail

lengths > 100%, 2 days were added. At the other end of the development window, only froglets with a remaining tail > 2% of body length were considered metamorphs. Those with shorter tails were not included in the computation of date of metamorphosis. A total of 626 *R. arvalis* and 2403 *R. temporaria* were captured (Appendices 1 & 2).

Because capture visits varied in duration and interval, the following procedure was used to compute mean metamorphosis date for an episode (1 pond in 1 year). Each single metamorph capture was weighed by a score based on 2 factors. The first factor was the inverse of the capture effort for the pond and day. Effort was total capture time (2–10 min) minus a handling time of 10 s per captured metamorph. If a visit lasted for a long time (high effort), each individual capture on that visit carried less weight. The second factor was the time between capture days. If capture intervals were longer, captures had a higher weight than if they were shorter. These scores were scaled to give a mean weight of 1. The average date of capture for all metamorphs, weighed by their score, was used as the date of metamorphosis for the episode.

Size at metamorphosis was total body length, excluding tail. For this measure all froglets with a relative tail length of at least 1% of body length were used. A total of 788 *R. arvalis* and 2648 *R. temporaria* were measured (Appendices 3 & 4).

If a pond dried during the period of metamorphosis, this episode was considered truncated and was not included in the analyses of time for metamorphosis. Including these episodes would have biased the value towards an early date. However, in the following 2 instances, these values, after appropriate corrections, were also used.

First, to analyse the effect of the pond hydroperiod, it was desirable to include truncated episodes because these represented most episodes of potentially critical pond drying. For this analysis, the first date of metamorphosis for each episode was used. To account for pond and year effects (which could mask the drying effect) a residual date for metamorphosis for each episode was computed. This was based on a linear model including pond and year and also the number of metamorphs recorded. This is because episodes with many recorded metamorphs tended to have a longer time from first date of metamorphosis to mean date of metamorphosis than episodes with few metamorphs. Below, this is referred to as residual date of metamorphosis.

Second, to analyse the relation between metamorphosis time and size at metamorphosis for individual episodes another approach was used. In this instance, correcting for year and pond using the method described above would mask the pattern under analysis. Using only completed episodes, the regression between first date for metamorphosis and mean date for metamorphosis was computed, accounting for the effect of the number of metamorphs captured. This estimate was then applied to all episodes, including truncated ones.

Below, this is referred to as estimated mean date of metamorphosis.

Species used for analyses

All dependent variables were measured for both *R. arvalis* and *R. temporaria*. However, *R. temporaria* were present in all 22 ponds while *R. arvalis* were only present in 8 ponds. Also, 2 of the effect variables (ESIZE and GEN-) were only available for *R. temporaria*. Therefore, the full analysis is only carried out for *R. temporaria*. The phenology of *R. arvalis* is described and compared to that of *R. temporaria* but no analysis of the influence of the independent factors was carried out.

RESULTS

Phenology and metamorph size

Within-pond variation

Within a pond and year, most tadpoles metamorphosed within 10 days of the mean date and the distribution of metamorphosis dates was normal (Fig. 3). The total period of metamorphosis lasted up to 50 days (Fig. 4) and was longer the more metamorphs that were counted (*R. arvalis*: $n = 25$, $r = 0.80$, $P < 0.001$; *R. temporaria*: $n = 66$, $r = 0.79$, $P < 0.001$ (log of numbers used); Fig. 4). Also, for *R. temporaria*, it was longer for medium-timed metamorphosis episodes, if metamorphosis was early and late it tended to be shorter (Fig. 4). The Wald 95% confidence interval for the negative second degree term in the fitted model was -0.030 to -0.004 . The corresponding effect was not significant for *R. arvalis*, the interval was -0.046 to 0.015 , thus overlapping zero. The tests are based on episodes weighed by size (Fig. 4).

Among-pond and among-year variation in time for metamorphosis

For *R. temporaria*, mean date of metamorphosis in early ponds was, on average over all years of study, 15–20 June. In later ponds, this was > 1 month later (Fig 5). Metamorphosis was later in forest ponds than in open ponds (two-way ANOVA, d.f. = 1:62, $F = 22.18$, $P < 0.001$), but there was no effect of pond permanency (two-way ANOVA, d.f. = 2:62, $F = 0.00$, $P = 0.99$). Within ponds, among years, mean date of metamorphosis varied by about 20 days, occasionally more. *Rana arvalis* metamorphosed later than *R. temporaria* (Fig. 5), on average 7.2 days ($n = 20$), with extremes -1 to 21 days (Fig. 6). Also, metamorphosis for *R. arvalis* was later in the (single) forest pond (two-way ANOVA, d.f. = 1:16, $F = 12.01$, $P = 0.003$), but there was no effect of pond permanency (two-way ANOVA, d.f. = 2:16, $F = 0.36$, $P = 0.70$).

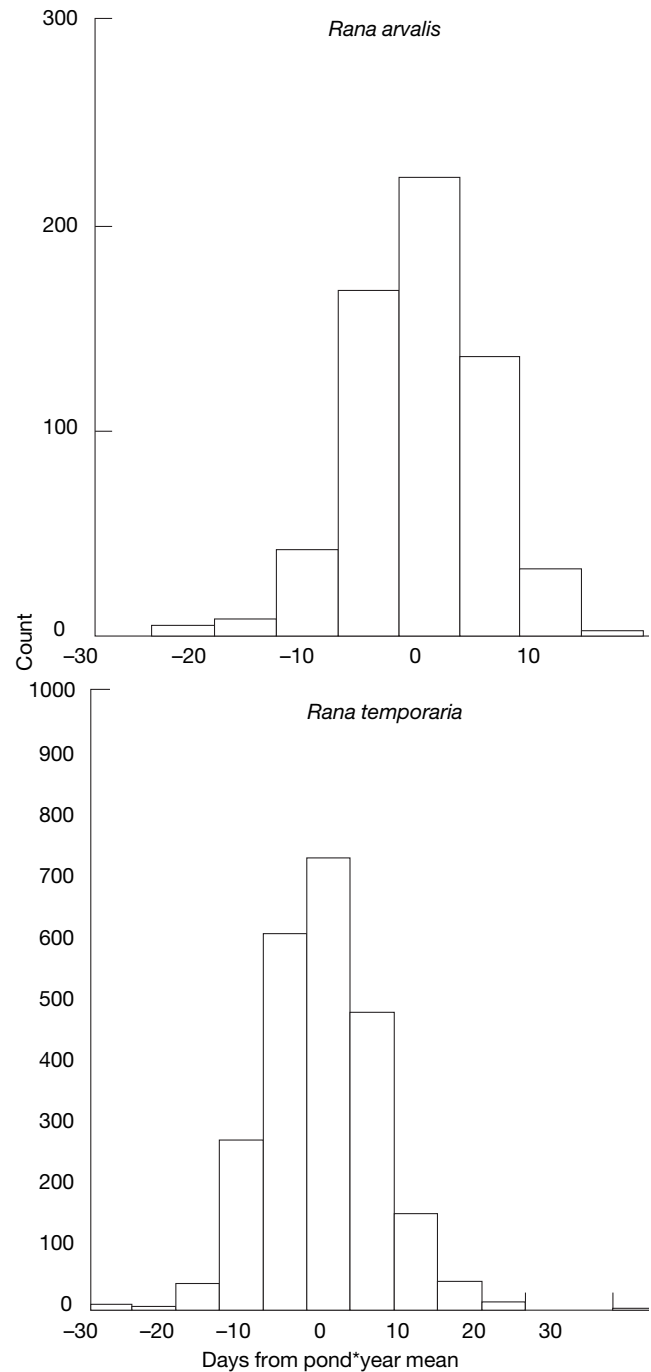

Fig. 3. Deviation in days from episode mean date for metamorphosis of *Rana arvalis* and *R. temporaria*. The figure is based on all metamorphs recorded.

For both species there were significant pond and year effects on time for metamorphosis (Fig. 5). This was tested using the full set of ponds (Table 3). To test for an interaction between pond and year, only fully crossed sets of pond and years could be used. This showed significant interactions between pond and year for *R. temporaria* (Table 3). This means that effects of year differed among ponds, e.g. 1990 was an early year in medium and shallow ponds M1, AD17 and M2, while

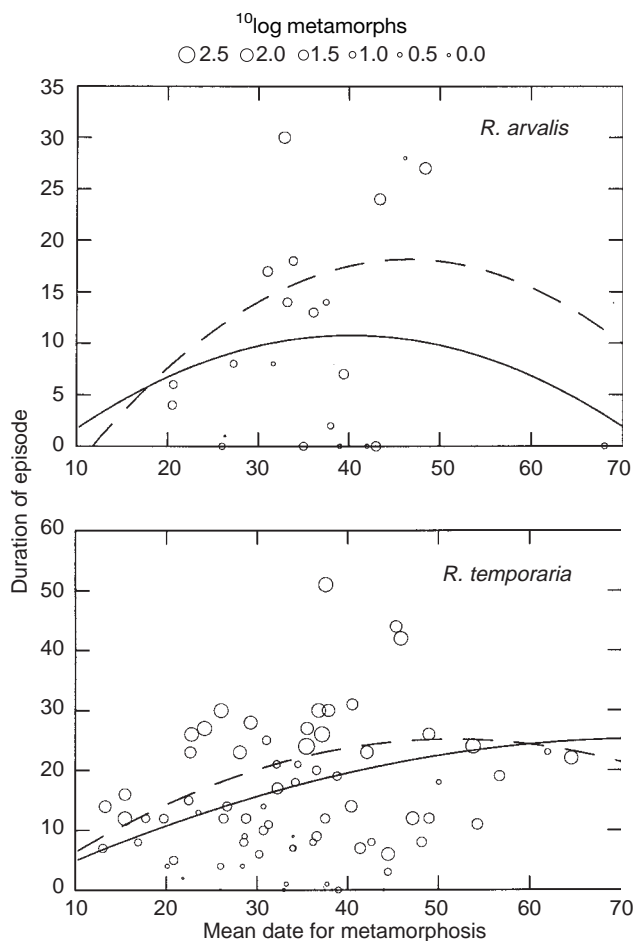

Fig. 4. Duration of metamorphosis episodes of *Rana arvalis* and *R. temporaria* in relation to timing of episodes. Duration is the number of days from the first to the last recorded metamorph. The size of the plot symbols represent the number of metamorphs (transformed to $10\log$) recorded for the episode. Two second degree regressions are fitted. The filled line is based on equal weight for all episodes, the dashed lines weights the episodes by their size ($10\log$ number of metamorphs).

it was a late year in the deep ponds HL3, HL6, HL7 and HL8. The interaction could not be tested for *R. arvalis*.

Among-pond and among-year variation in size at metamorphosis

Size at metamorphosis varied for both species by as much as 4 mm among ponds. Variation within ponds, among years, was for most ponds < 2 mm but occasionally more (Fig. 7). *Rana temporaria* metamorphs were smaller in forest ponds and in shallow ponds (two-way ANOVA, d.f. = 1:79, $F=9.35$, $P=0.003$ and d.f. = 2:79, $F=14.82$, $P<0.001$, respectively). *Rana arvalis* metamorphs were smaller in forest ponds but there was no significant effect of pond permanency (two-way ANOVA, d.f. = 1:26, $F=6.19$, $P=0.020$ and d.f. = 2:26, $F=2.13$, $P=0.14$, respectively). For both species there

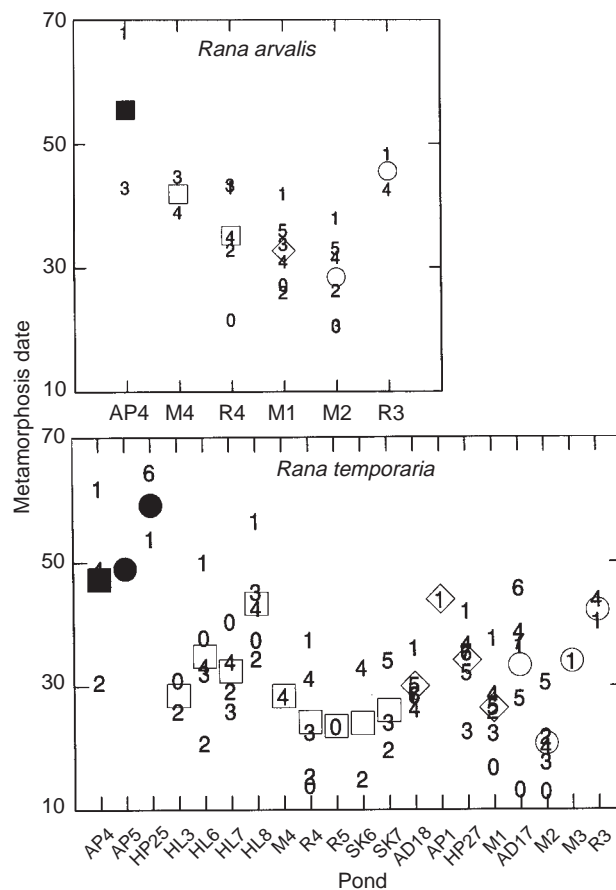

Fig. 5. Timing of all episodes in *Rana arvalis* and *R. temporaria*. Dates are represented by the number of days after 1 June. Individual episodes are represented by the last figure of the respective year. Large symbols, average date for the different ponds. Ponds are ordered by physical type. Square symbols, permanent ponds; diamonds, semi-permanent ponds; circles, temporary ponds; black symbols, forest ponds; open symbols, non-forest (open) ponds. Only complete episodes are included.

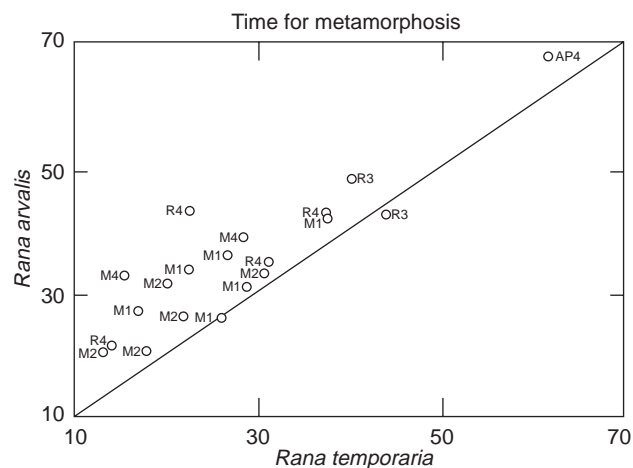

Fig. 6. Relation between time for metamorphosis for *Rana arvalis* and *R. temporaria*. Time for metamorphosis is given as days after 1 June. Abbreviations, names of the ponds; line, same date for both species.

Table 3. Pond and year effects on mean day of metamorphosis of *Rana arvalis* and *R. temporaria* tested by ANOVA. Data used are individual metamorph dates. Truncated metamorphosis episodes are not included. For the test of possible interaction between pond and year, only fully crossed sets of ponds and years could be used. Two alternatives were used: AD17, AD18, HP27 and M1 in 1991, 1994 and 1995 and HL6, HL8, HP27, M1 and R4 in 1991, 1993 and 1994

	<i>R. arvalis</i>			<i>R. temporaria</i>		
	d.f.	F	P	d.f.	F	P
Full set						
Year	7:342	57.3	<0.001	7:2026	123.7	<0.001
Pond	5:342	19.9	<0.001	19:2026	90.5	<0.001
Set 1						
Year				2:426	88.2	<0.001
Pond				4:426	80.7	<0.001
Year*						
Pond				8:426	5.42	<0.001
Set 2						
Year				2:342	39.6	<0.001
Pond				3:342	11.8	<0.001
Year*						
Pond				6:342	6.23	<0.001

Table 4. Pond and year effects on body length at metamorphosis of *Rana arvalis* and *R. temporaria* tested by ANOVA. Data used are individual metamorph sizes. Truncated metamorphosis episodes are not included. For the test of possible interaction between pond and year, only fully crossed sets of ponds and years could be used. Two alternatives were used: AD17, AD18, HP27 and M1 in 1991, 1994 and 1995, and HL6, HL8, HP27, M1 and R4 in 1991, 1993 and 1994

	<i>R. arvalis</i>			<i>R. temporaria</i>		
	d.f.	F	P	d.f.	F	P
Full set						
Year	8:398	44.5	<0.001	7:2255	120.4	<0.001
Pond	5:398	7.30	<0.001	19:2255	114.8	<0.001
Set 1						
Year				2:485	54.2	<0.001
Pond				4:485	50.6	<0.001
Year*						
Pond				8:485	33.3	<0.001
Set 2						
Year				2:399	44.3	<0.001
Pond				3:399	133.1	<0.001
Year*						
Pond				6:399	14.1	<0.001

were significant effects of ponds and year on size at metamorphosis (Table 4) and, when analysed for a restricted set of ponds and years, also significant interactions between pond and year effects.

There was no correlation between pond average time for metamorphosis and pond average size at metamorphosis (Fig. 8; $r = -0.32$, $n = 20$, $P = 0.17$). Also, within pond, among year, there was no effect of estimated mean time for metamorphosis on size at metamorphosis (Fig. 9; tested with an ANCOVA, d.f. = 1:58, $F = 0.14$, $P = 0.72$ for effect of time).

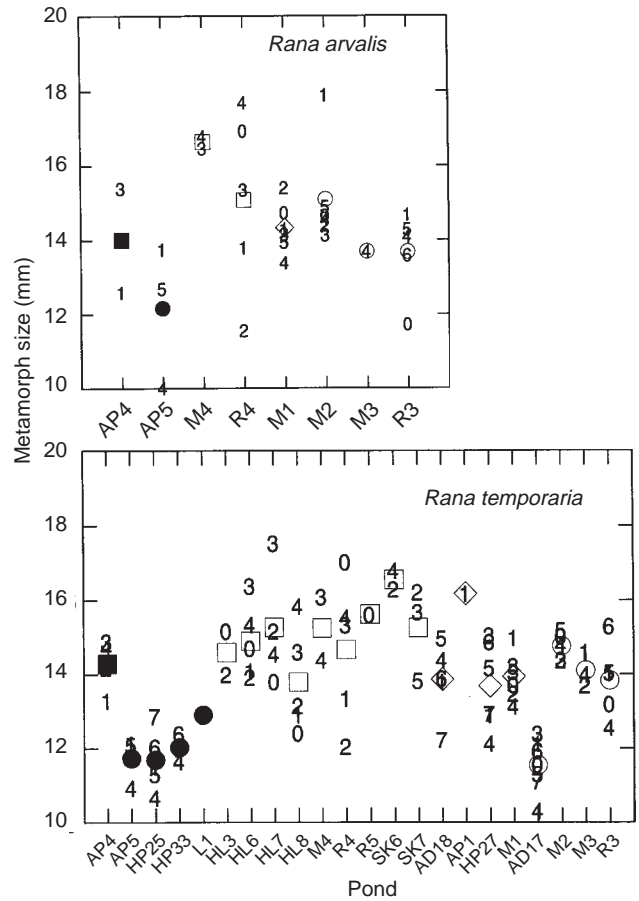

Fig. 7. Size at metamorphosis for *Rana arvalis* and *R. temporaria*. All episodes, including truncated, are included. Symbols as for Fig. 5.

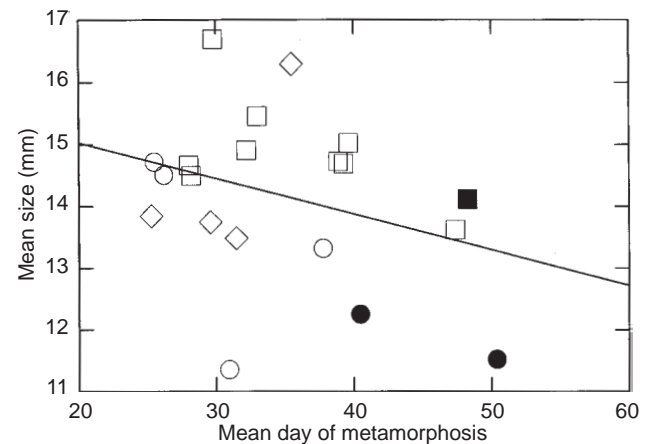

Fig. 8. Relation between time for metamorphosis and size at metamorphosis in *R. temporaria*. Data points represent mean values for ponds. Time for metamorphosis is given as days after 1 June. Only non-truncated metamorphosis episodes were included when computing these means. Pond symbols as for Fig. 5.

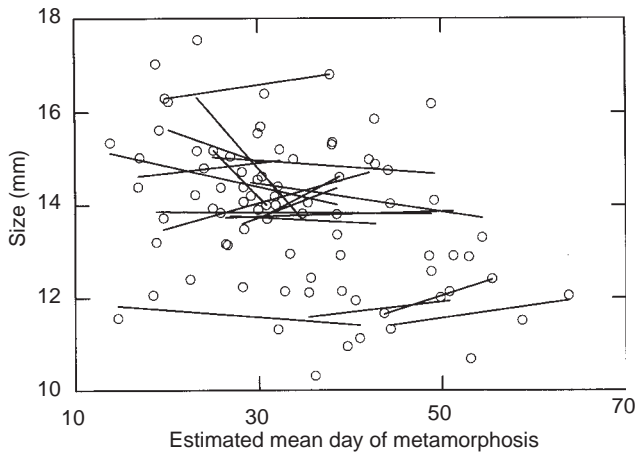

Fig. 9. Relation between estimated time for metamorphosis and size at metamorphosis for *R. temporaria*. Method for estimating mean dates given in Methods. Data points represent metamorphosis episodes. Time for metamorphosis is given as days after 1 June. For each pond the linear regression between size and time is shown.

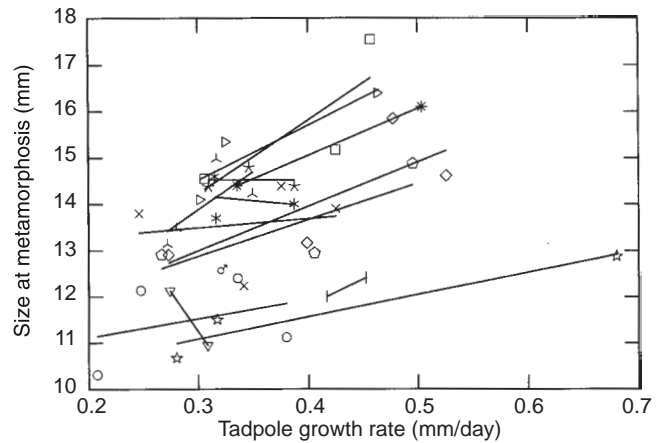

Fig. 11. Effect of tadpole growth rate on metamorph size in *Rana temporaria*. Symbols represent different episodes. Symbols are pond specific. For each pond the linear regression between growth rate and size is shown.

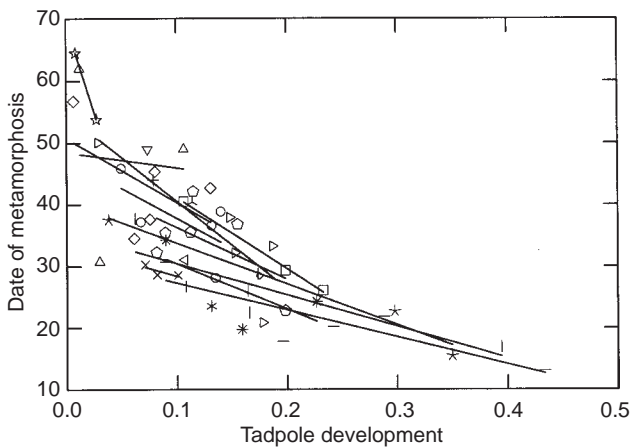

Fig. 10. Relation between time for metamorphosis and tadpole development of *Rana temporaria*. Data points represent metamorphosis episodes. Time for metamorphosis is given as days after 1 June. Tadpole development is measured by relative leg size; hind leg/body length as estimated for 25 May. Symbols are pond specific. For each pond the linear regression between growth rate and size is shown.

Effect of early tadpole development

Metamorphosis was early for episodes with well-developed tadpoles (Fig. 10). This was tested with a three-way ANCOVA (d.f. = 1:33, $F=9.67$, $P=0.004$). The effect of tadpole development was present in addition to significant effects of year (d.f. = 7:33, $F=5.82$, $P<0.001$) and pond (d.f. = 18:33, $F=3.22$, $P=0.002$). The pond effect meant that even if tadpoles were equally developed on 25 May, expected time for metamorphosis could in a late year (relative leg size 10%) vary by as much as 15 days (Fig. 10).

Metamorphs were large if tadpole growth rate was

Table 5. Effects of average monthly temperatures on mean day of metamorphosis and size of *Rana arvalis* and *R. temporaria* at metamorphosis. This was tested with five separate two-way ANCOVAs with the respective temperature and pond as factors. Also, because May and June temperatures were correlated over 8 years ($r=0.57$, $n=8$) of the study, the separate effects of May and June temperatures were tested with a three-way ANCOVA with both months combined, in addition to pond. The interactions were all non-significant and removed before final analysis. Because this is a scan of five plus five tests, only P -values <0.005 should be considered significant

<i>Rana arvalis</i>			<i>Rana temporaria</i>			
d.f.	F	P	d.f.	F	P	
Time						
Five separate tests						
March	1:16	1.17	0.30	1:45	2.18	0.15
April	1:16	3.72	0.072	1:45	0.03	0.88
May	1:16	12.18	0.003	1:45	64.79	<0.001
June	1:16	12.11	0.003	1:45	34.68	<0.001
July	1:16	0.57	0.46	1:45	1.27	0.27
One combined test						
May	1:15	2.16	0.163	1:44	25.32	<0.001
June	1:15	2.12	0.166	1:44	6.31	0.016
Size						
Five separate tests						
March	1:16	0.22	0.65	1:47	2.64	0.11
April	1:16	1.31	0.27	1:47	4.17	0.047
May	1:16	0.06	0.82	1:47	1.57	0.22
June	1:16	0.62	0.44	1:47	0.94	0.34
July	1:16	0.08	0.78	1:47	5.97	0.018

high (Fig. 11; three-way ANCOVA, d.f. = 1:46, $F=11.3$, $P=0.002$). The effect of growth rate was present in addition to significant effects of year (d.f. = 7:46, $F=5.36$, $P<0.001$) and pond (d.f. = 21:46, $F=5.90$, $P<0.001$).

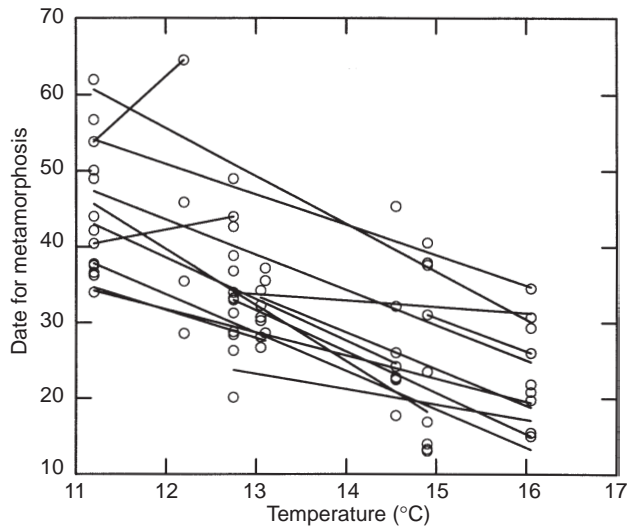

Fig. 12. Effect of early summer temperature on time for metamorphosis of *Rana temporaria*. Symbols represent different episodes. 'Temperature' is average May and June air temperature for the respective year. Time for metamorphosis is given as days after 1 June. For each pond the linear regression between temperature and time is shown.

Development time

Development time for individual tadpoles was not known, but one estimate is the time from the date when the first egg hatched to the date of first metamorphosis. The average for this was 76 days (*R. arvalis*) and 68 days (*R. temporaria*). The span was 56–90 days and 47–91 days, respectively.

Effect of year-specific factors

There were significant effects only of average May and of average June temperature on mean date for metamorphosis for both species (analysed by two-way ANCOVA; Table 5, Fig. 12). Temperatures were not correlated between months (March–July) (Bartlett's $\chi^2 = 6.06$, d.f. = 10, $P = 0.81$). Only for May and June was there a tendency to correlation ($r = 0.57$, $n = 8$, $P = 0.14$). Therefore the separate effects of May and June temperatures were analysed with a three-way ANCOVA (the effect of pond was included in addition to May and June temperatures) (Table 5). This confirmed the separate effects of at least the May temperature for *R. temporaria* but not for *R. arvalis*.

There were no significant effects of monthly temperatures on size at metamorphosis (Table 5, Fig. 13).

Effects of pond-specific factors

These analyses use one value per pond for each factor.

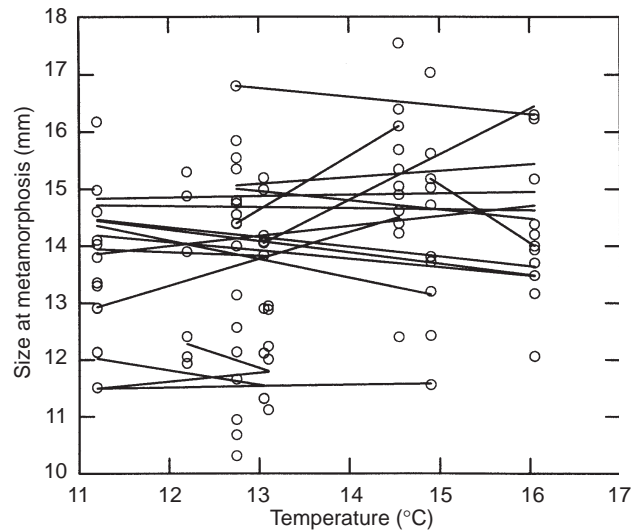

Fig. 13. Effect of early summer temperature on size at metamorphosis of *Rana temporaria*. Symbols and scales as for Fig. 11.

Correlation scan

Average pond time for metamorphosis was inversely correlated to average pond temperature; metamorphosis was earlier in warmer ponds. It was also inversely correlated to the populations genetic component of metamorphosis time; ponds with late metamorphosis in the field yielded eggs and tadpoles that in a common garden experiment metamorphosed early relative to those from other populations (Table 6).

Size at metamorphosis was correlated to pond temperature: the metamorphs were larger in warm ponds. It was also correlated to pond drying and tadpole density; metamorphs were smaller in ponds that on average were almost dry in June and had a high density of tadpoles (Table 6).

Principal components

All pond-specific factors except genetic were used to extract five principal components (Table 7). The genetic information was not used because it was only available for nine ponds while information on all the other factors was available for at least 17 ponds. Time for metamorphosis was correlated ($r = 0.81$, $n = 12$, $P = 0.002$) to PC5 which was negatively correlated to pond temperature. There was also a tendency that time for metamorphosis was correlated to PC2 ($r = -0.57$, $n = 12$, $P = 0.060$). This means that ponds with much algal growth and few predators tended to have an early metamorphosis. Size at metamorphosis was negatively correlated to PC1 ($r = -0.72$, $n = 12$, $P = 0.008$). This means that metamorphs were larger if there was a low density of eggs and tadpoles and if hatching tended to be late in a pond. Also, there was

Table 6. Correlations between field-recorded time for metamorphosis and size at metamorphosis and the pond-specific factors. Pond- and year-specific factors are also used after reduction to one pond specific value. n , number of ponds. Correlations are run as two sets, one for each response factor. Within each set, P -values given are Bonferroni-adjusted to correct for mass significance. GEN- is based the respective measure for the two response factors, time (GENTIME) and size (GENSIZE)

	EDENS	ESIZE	GEN-	HTIME	PTEMP	DRY	TDENS	ALG	PRED
Time for metamorphosis									
r	0.36	0.42	-0.89	0.47	-0.76	0.07	0.09	0.43	-0.14
n	22	18	9	17	22	21	22	17	22
P	0.94	0.73	0.01	0.51	<0.001	1.00	1.00	0.79	1.00
Size at metamorphosis									
r	-0.55	-0.059	-0.49	-0.44	0.64	0.73	-0.68	-0.29	0.46
n	22	18	9	17	22	21	22	17	22
P	0.07	1.00	1.00	0.73	0.011	0.001	0.004	1.00	0.27

Table 7. Rotated loadings for principal components. Explanations for the factor abbreviation are given in Methods

	PC1	PC2	PC3	PC4	PC5
HTIME	0.871	-0.139	0.059	0.008	0.264
EDENS	0.847	0.005	0.240	-0.150	0.064
TDENS	0.683	-0.131	-0.417	-0.415	0.163
ALG	-0.008	-0.890	0.098	0.014	0.353
PRED	-0.185	0.871	0.029	0.339	0.073
ESIZE	0.136	-0.064	0.952	0.041	0.097
JUNPKVAR	-0.148	0.198	0.044	0.938	-0.158
PTEMP	-0.326	0.193	-0.100	0.196	-0.869

a tendency for a negative correlation between metamorph size and PC5 ($r = -0.52$, $n = 12$, $P = 0.081$) resulting in a positive correlation between temperature and metamorph size.

Effect of pond- and year-specific factors

This analysis is motivated by the fact that there was a significant interaction between pond and year on time for metamorphosis. This analysis is only carried out for *R. temporaria*.

The effect of the five pond- and year-specific factors (EDENS, TDENS, PRED, DRY and HTIME) were analysed by an ANCOVA (d.f. = 1:5, $P > 0.10$ for all factors) where they were entered as covariates together with the categorical factors pond and year. This analysis failed to detect any significant effects, either on time for metamorphosis or on size at metamorphosis.

Hydroperiod effects

Two alternative factors signalling a condition when an adaptive increase of development rate can be expected are analysed. In truncated episodes, part of the tadpole population actually developed too slowly to survive until metamorphosis. These episodes are compared to

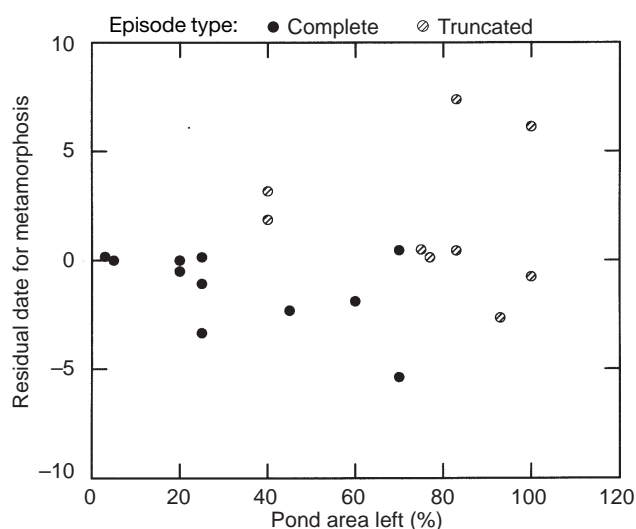

Fig. 14. Effect of pond drying on time for metamorphosis of *Rana temporaria*. Residual date for metamorphosis, first date for metamorphosis of each episode, corrected for effects of pond and year and number of metamorphs found; Pond area left, area of water remaining in the first week of June, compared to that at the time of spawning in April. Truncated episodes were those where late tadpoles were killed as a result of the pond drying. Complete episodes were those where this never happened. Only episodes from ponds with both complete and truncated episodes are included in the figure.

all complete episodes when no tadpoles were killed by drying. Average residual date for metamorphosis for truncated episodes was earlier (residual date: -1.24) than for complete episodes ($+1.14$). The difference, 2.38 days, is significant (d.f. = 21, $t = 2.23$, $P = 0.037$) (Fig. 14). As an alternative factor, the effect of DRY (% pond area left in June) was analysed. This is a continuous variable – the smaller the value, the more likely the pond is to dry up shortly and the more reason for the tadpoles to accelerate development. However, the two factors are not perfectly correlated. Sometimes, a change in weather ‘saved’ the pond, while at other times

(especially in generally late years) a pond dried despite much water in early June. Surprisingly, the percentage of pond area left in the beginning of June was less consistently related to time for metamorphosis ($r = 0.21$, $n = 20$, $P = 0.37$) (Fig. 14).

The first factor was also tested with a three-way ANOVA, including pond, year and episode type (truncated or complete). Even if the correction for metamorph number (used in computing the residuals above) is left out, this shows a significant effect of episode type (d.f. = 1:10, $F = 8.29$, $P = 0.016$). The second factor was tested with a corresponding ANCOVA. This approach also showed no effect of percentage of pond area left (d.f. = 1:7, $F = 1.70$, $P = 0.23$).

DISCUSSION

For both species there was much variation between ponds and years in time for and size at metamorphosis. Surprisingly few corresponding field studies exist. Strömberg (1995) reports first day of metamorphosis for *Rana dalmatina* in a south Swedish pond during 12 years. This varied by >6 weeks, at least as much as in this study. A 4-year study by Diaz-Paniagua (1988) suggests a similar or smaller variation in seven Spanish frog species.

A correlative field study, like this one, cannot tell us whether or not a particular factor actually affects tadpole performance. This is because the effect of a factor may be offset by another factor, having the opposite effect, that is correlated to the first factor. If so, neither of these two factors is correlated nor is there an effect of the principal component to which they may combine. Many correlations potentially present are not found because the range of variation in this set of natural ponds is much less than that used in laboratory studies. This has some interest because it may show that the variable considered is not an important selective force in natural environments. Also, correlations with tadpole performance found may be the result of covariation with another factor that is the actual cause. Thus, correlation does not necessarily imply causation. On the other hand, principal component analysis can show the independent effect of factors, suggesting that there is really an effect. For these basic reasons, the following discussion is limited to discussing those effects found, rather than trying to explain why many effects, shown in laboratory studies, were not detected.

Effect of temperature and other factors

The analysis suggests that the most important proximate factor determining time for metamorphosis was pond temperature. Among-year variation in May and June air temperature (which should have an influence on pond temperature) was strongly related to time for metamorphosis. A difference of 5 °C in the average May

and June temperature that was found between the coldest and the warmest year, was accompanied by a difference of about 3 weeks in average time for metamorphosis. Also among ponds, there was a strong correlation between average pond temperature and average time for metamorphosis. The coolest ponds had a temperature about 3 °C less than the warmest ones during the measuring period in May, and tadpoles in these ponds metamorphosed >3 weeks later than those in the warmest ponds. Furthermore, the principal component analysis showed that this pond temperature effect was largely independent of any correlations between pond temperature and other effect factors. Yearly temperature did not affect variation in metamorph size but pond temperature explained some variation among ponds, suggesting that metamorphs were larger in warm ponds.

The effect of temperature on development is as expected from laboratory studies; a higher rate at high temperatures (Dodd & Dodd, 1976; Smith-Gill & Berven, 1979; Merilä, Laurila, Laugen *et al.*, 2000). On the other hand, laboratory studies show a pattern where tadpoles growing at low temperatures develop more slowly but eventually metamorphose at a larger size (Etkin, 1964; Smith-Gill & Berven, 1979; Hayes, Chan & Licht, 1993). This was not found, rather there was a tendency to the opposite comparing warm and cool ponds. Possibly, pond temperature interacts with other factors, e.g. resource growth, that may act to increase growth rate.

However, it also seemed that development was faster in ponds rich in algae and/or poor in predators. The benefit of the first factor for development has been confirmed by several laboratory studies (Tejedo & Reques, 1992; Semlitsch, 1993; Newman, 1994). Also the second factor promotes feeding rate as it allows tadpoles to feed more openly (Laurila & Kujasalo, 1999) and therefore more efficiently. Indeed, several laboratory studies and experiments in field enclosures have shown a negative effect of predators on development rate (Skelly & Werner, 1990; Skelly, 1992).

There were competition effects on metamorph size; metamorphs were smaller in ponds with a high tadpole density and in ponds that had decreased much in size because of early summer drying. The principal component analysis suggested that the effect was more the result of tadpole density per se and less the result of the indirect effects of pond drying. Competition effects (which may be difficult to separate from resource effects) on metamorph size have repeatedly been found in laboratory experiments (Murray, 1990; Brady & Griffiths, 2000) and also in field experiments (Loman, 1997). Surprisingly, there was no effect of PC2 on metamorph size. PC2 combined algal growth and low predator density (two factors that were correlated in the present set of ponds). Plentiful food has been associated with large metamorph size in laboratory experiments (Murray, 1990; Tejedo & Reques, 1992; Semlitsch, 1993; Newman, 1994). However, it is possible that the present field measurements were too coarse for this analysis.

They yielded a quantitative measure of epi- and periphyton but no information on quality (Kupferberg, 1997), which may differ among ponds.

Surprisingly, no significant effects of time for hatching could be demonstrated. However, the correlation coefficient between time for hatching and time for metamorphosis was 0.47, which by itself (but not when corrected for multiple tests) is significant. My conclusion is that much of the variation in time for metamorphosis includes the variation in time for hatching. The approach of this study does not allow us to say whether this effect is non-random. This pinpoints the fact that the response variable measured is related to, but different from, development time. Note, however, that maximum variation in hatching time between ponds was 16 days (Table 2) but variation in time for metamorphosis was 38 days (Fig. 5).

The general pattern of correlates to year and pond variation in metamorph size and timing is as follows. There is variation among ponds in average metamorph size, which is the result of several factors, the most important probably being competition and pond temperature (open vs forest ponds). There was also variation among ponds in development rate, mainly because of variation in pond temperature and possibly resource level. Among-year variation in early summer temperature strongly affects development rate. Within ponds, development was later in cool summers. However, in any year, regardless of temperature and development rate, tadpoles tended to grow to the size typical for that pond. This gives support to the Werner (1986) model that predicts that in each environment there is an optimal size for metamorphosis.

Pond drying

Much attention has been focused on the ability of tadpoles to increase development rate adaptively when a pond starts drying up. The trait has been shown for several frog species (Tejedo & Reques, 1994; Denver, 1997) including *R. temporaria* (Loman, 1999; Merilä, Laurila, Pakkala *et al.*, 2000) in laboratory studies. Newman (1989) have shown the phenomenon for *Scaphiopus couchii* in the field. The ability was studied here in the field, but the analysis is complicated because measures of pond drying interact with several other factors – pond temperature and tadpole density being the most obvious. Part of these effects were accounted for by using a residual date of metamorphosis as the dependent variable. By analysing metamorphosis date thus corrected for pond, most of the density variation resulting from differences in average population density (here measured as egg density), which affects tadpole density, was accounted for. However, if drying means that tadpole density increases in a particular year, this is not corrected for but part of the ‘drying effect’. Furthermore, temperature effects resulting from differences between years (which partly affects the likelihood of pond drying)

and pond location (forest ponds vs open ponds) were corrected for. However, if pond drying, per se leads to increased temperature, this will also be part of the ‘drying effect’, as analysed here. The analysis does show an effect as truncated episodes were earlier than complete metamorphosis episodes. Note that the dependent variable is based on *first day of metamorphosis*, rather than *average date of metamorphosis*. Thus it is not biased towards an early date by truncation of episodes. Surprisingly, there was no effect of the pond drying in early June (factor DRY) on timing. This may partly be because some ponds that were about to dry by that time eventually filled with water because it rained. This shows that the adaptive response probably is fairly finely geared to the water regime when close to metamorphosis. An advanced metamorphosis date has been demonstrated by manipulating the water levels in tanks *c.* 1 week before the metamorphosis of the earliest developing tadpoles (Loman, 1999). Denver, Mirhadi & Phillips (1998) have shown that the change in development rate is to some extent reversible, should water levels be restored. In conclusion, experimental studies on developmental plasticity in *R. temporaria*, seem to have relevance for the field.

Evidence of countergradient selection

The analysis also showed one mechanism, which rather than explaining the presence of differences in time for metamorphosis tends to level them out. ‘Common-or-garden’ experiments (Loman, 2002) have shown population differences in time for metamorphosis. This differences must be genetic or the result of other maternal effects, e.g. egg size. It seems that *R. temporaria* tadpoles with an innate tendency to metamorphose early come from ponds with a tendency to late metamorphosis. This constitutes an example of countergradient selection (Conover & Schultz, 1995). On an altitudinal and a regional scale, corresponding examples of counter gradient on *R. temporaria* development time have been demonstrated by Martin & Maud (1999) and Merilä, Laurila, Pakkala *et al.* (2000), respectively.

There was no corresponding effect for size at metamorphosis. This may largely be because there was little variation among ponds in the innate size found in the ‘common-or-garden’ experiments.

Acknowledgements

I thank Björn Lardner, Ingegård Ljungblom, Jonatan Loman, Torkel Loman, Gunilla Lundh, Elsa Månsson, Håkan Sandsten, Herman van Steenwijk, and Ralph Tramontano who assisted in the field over the years, and Nils Ryrholm for introducing me to the sucrose method for temperature measurements. I also thank Bo and Marie Stille for help and laboratory facilities when

carrying out the analyses. Björn Lardner's comments greatly improved the text. The work has been financed by Swedish Council for Forestry and Agricultural Research.

REFERENCES

- Berthet, P. (1960). La mesure écologique de la température par détermination de la vitesse d'inversion du saccharose. *Vegetatio* **9**: 197–207.
- Brady, L. D. & Griffiths, R. A. (2000). Developmental responses to pond desiccation in tadpoles of the British anuran amphibians (*Bufo bufo*, *B. calamita* and *R. temporaria*). *J. Zool. (Lond.)* **252**: 61–69.
- Conover, D. O. & Schultz, E. T. (1995). Phenotypic similarity and the evolutionary significance of countergradient variation. *Trends Ecol. Evol.* **10**: 248–252.
- Denver, R. J. (1997). Proximate mechanisms of phenotypic plasticity in amphibian metamorphosis. *Am. Zool.* **37**: 172–184.
- Denver, R. J., Mirhadi, N. & Phillips, M. (1998). Adaptive plasticity in amphibian metamorphosis: response of *Scaphiopus hammondi* tadpoles to desiccation. *Ecology* **79**: 1859–1872.
- Díaz-Paniagua, C. (1988). Temporal segregation in larval amphibian communities in temporal ponds at a locality in SW Spain. *Amphib.-Reptilia* **9**: 15–26.
- Dodd, M. H. I. & Dodd, J. M. (1976). The biology of metamorphosis. In *Physiology of the Amphibia*: 467–599. Lofts, B. (Ed.). New York: Academic Press.
- Etkin, W. (1964). Metamorphosis. *Physiology of the Amphibia*: 427–468. Moore, J. A. (Ed.). New York: Academic Press.
- Fauth, J. (1998). Investigating geographical variation in interspecific interactions using common garden experiments. In *Experimental ecology. Issues and perspectives*. Resatarits, W. J. Jr & Bernardo, J. (Eds). Oxford: Oxford University Press.
- Håkansson, P. (1992). *Communal spawning in the common frog Rana temporaria, female behaviour and egg performance*. Lund: Biologiska Institutionen, Lunds Universitet.
- Hayes, T., Chan, R. & Licht, P. (1993). Interactions of temperature and steroids on larval growth, development, and metamorphosis in a toad (*Bufo boreas*). *J. exp. Zool.* **266**: 206–215.
- Kupferberg, S. (1997). Facilitation of periphyton production by tadpole grazing: functional differences between species. *Freshwater Biol.* **37**: 427–439.
- Lardner, B. (1995). Larval ecology of *Rana arvalis*: an allopatric island population compared with sympatric mainland population. *Amphib.-Reptilia* **16**: 101–111.
- Lardner, B. & Loman, J. (1995). Predation on *Rana* and *Bufo* tadpoles: predator species and tadpole size effects. *Mem. Soc. Fauna Flora Fenn.* **71**: 149.
- Laurila, A. & Kujasalo, J. (1999). Habitat duration, predation risk and phenotypic plasticity in common frog (*Rana temporaria*) tadpoles. *J. Anim. Ecol.* **68**: 1123–1132.
- Loman, J. (1997). Natural density regulation in tadpoles of the moor frog *Rana arvalis* – preliminary report of a field experiment. *Herp. Bonnensis* **1997**: 247–255.
- Loman, J. (1999). Early metamorphosis in common frog *Rana temporaria* tadpoles at risk of drying: an experimental demonstration. *Amphib.-Reptilia* **20**: 421–430.
- Loman, J. (2001a). Local variation in *Rana temporaria* egg and clutch size – adaptations to pond drying. *Alytes* **19**: 45–52.
- Loman, J. (2001b). Effects of tadpole grazing on periphytic algae in ponds. *Wetlands Ecol. Manage.* **9**: 135–139.
- Loman, J. (2002). Microevolution and maternal effects on tadpole *Rana temporaria* growth and development rate. *J. Zool. (Lond.)* **257**: 93–100.
- Martin, R. & Miaud, C. (1999). Reproductive investment and duration of embryonic development in the common frog *Rana temporaria*. *Current studies in herpetology*: 309–313. Miaud, C. & Guyétant, R. (Eds). Le Bourget du Lac: SEH.
- Merilä, J., Laurila, A., Laugen, A. T., Räsänen, K. & Pakkala, M. (2000). Plasticity in age and size at metamorphosis in *Rana temporaria* – comparison of high and low latitude populations. *Ecography* **23**: 457–465.
- Merilä, J., Laurila, A., Pakkala, M., Räsänen, K. & Laugen, A. T. (2000). Adaptive phenotypic plasticity in timing of metamorphosis in the common frog *Rana temporaria*? *Ecoscience* **7**: 18–24.
- Murray, D. L. (1990). The effects of food and density on growth and metamorphosis in larval wood frogs (*Rana sylvatica*). from central Labrador. *Can. J. Zool.* **68**: 1221–1226.
- Newman, R. A. (1989). Developmental plasticity of *Scaphiopus couchii* tadpoles in an unpredictable environment. *Ecology* **70**: 1775–1787.
- Newman, R. A. (1994). Effects of changing density and food level on metamorphosis of a desert amphibian, *Scaphiopus couchii*. *Ecology* **75**: 1085–1096.
- Pallmann, H., Eichenberger, E. & Hasler, A. (1940). Eine neue Methode der Temperaturmessung bei ökologischen oder bodenkundlichen Untersuchungen. *Ber. Schweiz Bot. Ges.* **50**: 337–362.
- Ryan, T. J. & Winne, C. T. (2001). Effects of hydroperiod on metamorphosis in *Rana sphenocephala*. *Am. Midl. Nat.* **145**: 46–53.
- Semlitsch, R. D. (1993). Adaptive genetic variation in growth and development of tadpoles of the hybridogenetic *Rana esculenta* complex. *Evolution* **47**: 1805–1818.
- Skelly, D. K. & Werner, E. E. (1990). Behavioral and life-historical responses of larval American toads to an odonate predator. *Ecology* **71**: 2313–2322.
- Skelly, D. K. (1992). Field evidence for a cost of behavioral antipredator response in a larval amphibian. *Ecology* **73**: 704–708.
- Smith-Gill, S. J. & Berven, K. A. (1979). Predicting amphibian metamorphosis. *Am. Nat.* **113**: 563–586.
- Strömberg, G. (1995). The yearly cycle of the jumping frog (*Rana dalamitina*) in Sweden. A 12 year study. *Sci. herp.* **1995**: 185–186.
- Tejedo, M. & Reques, R. (1992). Effects of egg and density on metamorphic traits in tadpoles of the natterjack toad (*Bufo calamita*). *J. Herpetol.* **26**: 146–152.
- Tejedo, M. & Reques, R. (1994). Plasticity in metamorphic traits of natterjack tadpoles: the interactive effects of density and pond duration. *Oikos* **71**: 295–304.
- Werner, E. E. (1986). Amphibian metamorphosis: growth rate, predation rate and the optimal size at transformation. *Am. Nat.* **128**: 319–341.
- Wilbur, H. M. (1987). Regulation of structure in complex systems: experimental temporary pond communities. *Ecology* **68**: 1437–1452.

APPENDIX 1

Number of *Rana arvalis* metamorphs with size recorded. This is the number froglets found on the shore with a tail at least 2% of body length. 0, none where found, despite searching and water present; blank no search was made; values in parenthesis, no metamorphs were found because the pond dried before (0) or during (> 0), the period of metamorphosis. Note that the number given here is larger than that used in most analyses where metamorphs from truncated episodes were excluded

	1990	1991	1992	1993	1994	1995	1996	Total
AP4		2	0	1	0			3
AP5		2	(0)	(0)	(5)	(2)		9
M1	5	2	5	5	12	19		48
M2	3	3	3	10	16	14		49
M3	(0)	0	(0)	(0)	(6)			6
M4	0	0	0	23	3			26
R3	(10)	89	(0)	(0)	84	(98)	165	446
R4	40	1	22	37	1			101
Total	58	99	30	76	127	133	165	788

APPENDIX 2

Number of *Rana temporaria* metamorphs with time for metamorphosis recorded. Criteria and conventions as in Appendix 1

	1990	1991	1992	1993	1994	1995	1996	1997	Total
AD17	45	15	(0)	79	15	62	79	131	426
AD18		9	(0)	(0)	19	12	14	6	60
AP1		2							2
AP4		7	5	0	28				40
AP5		47	(0)	(0)	(22)	(8)			77
HL3	16	0	1	0					17
HL6	52	5	15	11	4				87
HL7	35		65	90	2				192
HL8	92	29	8	42	11				182
HP25		104	(0)	(0)	(61)	7	70	(60)	302
HP27		60	(0)	84	82	35	162	53	476
HP33			(0)	(0)	(34)	(0)	31	(24)	89
L1		(0)	(0)	(0)	(0)	(10)	(0)	(0)	10
M1	10	4	8	16	22	19			79
M2	15	0	2	13	4	17			51
M3	(0)	1	(2)	(0)	(1)				4
M4	0	0	0	0	4				4
R3	(1)	42	(0)	(0)	(1)	(7)	(3)	(0)	54
R4	1	21	43	36	14				115
R5	5	0	(0)	0					5
SK6			1	0	1				2
SK7			17	99	0	13			129
Total	272	346	167	470	325	190	359	274	2403

APPENDIX 3

Number of *Rana arvalis* metamorphs with time for metamorphosis recorded. This is the number of froglets found on the shore with a tail at least 1% of body length. Other conventions as in Appendix 1

	1990	1991	1992	1993	1994	1995	1996	Total
AP4		2	0	1	0			3
AP5		0	(0)	(0)	(5)	(2)		7
M1	3	2	4	4	12	17		42
M2	3	2	3	6	16	14		44
M3	(0)	0	(0)	(0)	(5)			5
M4	0	0	0	13	3			16
R3	(10)	77	(0)	(0)	82	(95)	164	428
R4	34	1	18	27	1			81
Total	50	84	25	51	124	128	164	626

APPENDIX 4

Number of *Rana temporaria* metamorphs with size recorded. Criteria and conventions as in Appendix 3

	1990	1991	1992	1993	1994	1995	1996	1997	Total
AD17	49	19	(0)	88	21	69	91	139	476
AD18		9	(0)	(0)	22	13	14	6	64
AP1		2							2
AP4		8	5	1	29				43
AP5		51	(0)	(0)	(22)	(8)			81
HL3	18	0	1	0					19
HL6	53	8	18	13	4				96
HL7	36		69	98	2				205
HL8	94	31	8	43	11				187
HP25		107	(0)	(0)	(65)	7	72	(61)	312
HP27		71	(0)	88	95	41	180	62	537
HP33		0	(0)	(0)	(35)	(0)	(31)	(24)	90
L1		(0)	(0)	(0)	(0)	(10)	(0)	(0)	10
M1	12	5	8	26	23	23			97
M2	15	0	2	23	5	20			65
M3	(0)	1	(2)	(0)	(2)				5
M4	0	0	(0)	0	5				5
R3	(1)	51	(0)	(0)	3	(7)	(3)	(0)	65
R4	2	23	49	42	17				133
R5	5	0	0	0					5
SK6			1	0	1				2
SK7			23	113	0	13			149
Total	285	386	186	535	362	211	337	292	2648