



# LUND UNIVERSITY

## Aggrecan fragments as biomarkers in osteoarthritis

Larsson, Staffan

2010

[Link to publication](#)

*Citation for published version (APA):*

Larsson, S. (2010). *Aggrecan fragments as biomarkers in osteoarthritis*. [Doctoral Thesis (compilation), Orthopaedics (Lund)]. Lund University, Faculty of Medicine, Clinical Sciences Lund, Department of Orthopaedics, SE-221 84 Lund, Sweden.

*Total number of authors:*

1

### General rights

Unless other specific re-use rights are stated the following general rights apply:

Copyright and moral rights for the publications made accessible in the public portal are retained by the authors and/or other copyright owners and it is a condition of accessing publications that users recognise and abide by the legal requirements associated with these rights.

- Users may download and print one copy of any publication from the public portal for the purpose of private study or research.
- You may not further distribute the material or use it for any profit-making activity or commercial gain
- You may freely distribute the URL identifying the publication in the public portal

Read more about Creative commons licenses: <https://creativecommons.org/licenses/>

### Take down policy

If you believe that this document breaches copyright please contact us providing details, and we will remove access to the work immediately and investigate your claim.

LUND UNIVERSITY

PO Box 117  
221 00 Lund  
+46 46-222 00 00

# Aggrecan fragments as biomarkers in osteoarthritis

Staffan Larsson

Lund University, Sweden

Thesis  
Lund 2010

## Contact address

Staffan Larsson  
Lund University  
Department of Orthopaedics  
BMC, C12  
SE-221 84 Lund  
Sweden  
Phone: +46 46-222 42 56  
E-mail: Staffan.Larsson@med.lu.se

Cover illustration: Aggrecan aggregate with hyaluronan and link protein visualized by glycerol spraying/rotary shadowing and electron microscopy (courtesy of Matthias Mörgelin).

Copyright © Staffan Larsson  
Tryck Media-Tryck, Lund 2010  
ISSN 1652-8220  
ISBN 978-91-86443-70-2  
Lund University, Faculty of Medicine Doctoral Dissertation Series 2010:55

## To Petra

*Few things are so apt to cause a drowsy despair at a medical meeting as the prospect of an academic discussion on . . . osteoarthritis. The field is so barren, the harvest is small . . .*

John Kent Spender, British Medical Journal, Volume 1, Issue 1424, Pages 781-783, 1888



# Contents

List of papers	7
Description of contribution	8
Definitions and abbreviations	10
Abstract	12
Populärvetenskaplig sammanfattning på svenska	15
Introduction	17
The knee joint	18
Articular cartilage	18
The chondrocyte	19
Collagens	20
Aggrecan	20
Aggrecan turnover by proteolysis	21
Objectives	25
Subjects	26
Methods	29
Results and discussion	35
Paper I	35
Paper II	36
Paper III	39
Paper IV	41
General discussion	43
Aggrecanase versus MMP aggrecanolytic activity in human osteoarthritis	43
Aggrecanase cleavage in the IGD contra the CS2 domain in health and disease	44
Interpretations of SF ARGS levels increased above normal	45
Aggrecan ARGS as a biomarker	46
Aggrecan metabolism in knee injury	48
Conclusions	51
Future perspectives	53
Acknowledgements	55
References	57
Papers I-IV	69



# List of papers

This thesis is based on the following papers, which will be referred to by their Roman numerals in the text:

## I

Human osteoarthritis synovial fluid and joint cartilage contain both aggrecanase- and matrix metalloproteinase-generated aggrecan fragments

André Struglics, **Staffan Larsson**, Michael A. Pratta, Sanjay Kumar, Michael W. Lark and L. Stefan Lohmander

Osteoarthritis and Cartilage, Vol. 14, Issue 2, Pages 101-113, 2006.

## II

Western blot quantification of aggrecan fragments in human synovial fluid indicates differences in fragment patterns between joint diseases

André Struglics, **Staffan Larsson**, Maria Hansson and L. Stefan Lohmander

Osteoarthritis and Cartilage, Vol. 17, Issue 4, Pages 497-506, 2009.

## III

Synovial fluid level of aggrecan ARGS fragments is a more sensitive marker of joint disease than glycosaminoglycan or aggrecan levels: a cross-sectional study

**Staffan Larsson**, L. Stefan Lohmander and André Struglics

Arthritis Research and Therapy, Vol. 11, Issue 3, Pages R92, 2009.

## IV

Synovial fluid levels of aggrecan ARGS fragments show a negative association with progression of joint space narrowing in knee osteoarthritis 18 years after meniscectomy

**Staffan Larsson**, Martin Englund, André Struglics and L. Stefan Lohmander

Manuscript

Reprints were made with the permission of the publishers.



# Description of contribution

## Paper I

Study design:	Stefan Lohmander André Struglics Staffan Larsson
Data collection:	Staffan Larsson André Struglics
Data analysis:	Staffan Larsson André Struglics Stefan Lohmander
Manuscript writing:	André Struglics Staffan Larsson
Manuscript revision:	Stefan Lohmander Sanjay Kumar Michael Lark Michael Pratta

## Paper II

Study design:	Stefan Lohmander André Struglics Staffan Larsson
Data collection:	Maria Hansson Staffan Larsson André Struglics Stefan Lohmander
Data analysis:	Staffan Larsson André Struglics Maria Hansson Stefan Lohmander
Manuscript writing:	Staffan Larsson André Struglics
Manuscript revision:	Stefan Lohmander

## Paper III

Study design:	Staffan Larsson Stefan Lohmander André Struglics
Data collection:	Staffan Larsson Stefan Lohmander
Data analysis:	Staffan Larsson Stefan Lohmander André Struglics
Manuscript writing:	Staffan Larsson
Manuscript revision:	Stefan Lohmander André Struglics

## Paper IV

Study design:	Stefan Lohmander Martin Englund Staffan Larsson André Struglics
Data collection:	Staffan Larsson Martin Englund Stefan Lohmander
Data analysis:	Staffan Larsson Martin Englund Stefan Lohmander
Manuscript writing:	Staffan Larsson
Manuscript revision:	Stefan Lohmander Martin Englund André Struglics



# Definitions and abbreviations

Biomarker (Biological Marker) – A characteristic that is measured and evaluated as an indicator of normal biologic processes, pathological processes, or pharmacologic responses to a therapeutic intervention.

Receiver Operating Characteristic (ROC) curve – A graphical plot of the sensitivity, or true positives, versus (1 – specificity), or false positives, for a binary classifier system as its discrimination threshold, or cut off, is varied. The area under the ROC curve (AUC) is often used as an index of accuracy of a binary diagnostic test (Zweig and Campbell 1993).

ACL	anterior cruciate ligament
ADAMTS	a disintegrin and metalloprotease with trombospondin-like motifs
ARGS	amino acids alanine (Ala; A), arginine (Arg; R), glycine (Gly; G) and serine (Ser; S); N-terminal sequence created by aggrecanase cleavage
AUC	area under receiver operator characteristics (ROC) curve
CS	chondroitin sulphate
CTX-II	C-telopeptides of type II collagen
DMOADS	disease modifying osteoarthritis drugs
ECL	electrochemiluminescence
ECM	extracellular matrix
ELISA	enzyme-linked immunosorbent assay
G1, G2, G3	aggrecan globular domains 1, 2 and 3
HABR	hyaluronan-binding region
IGD	aggrecan interglobular domain
JSN	joint space narrowing
KS	keratan sulphate
MAb	monoclonal antibody
MMP	matrix metalloprotease
MSD	Meso Scale Discovery (company name), immunoassay using electrochemiluminescence (ECL)
OA	osteoarthritis
OST	osteophyte
PIICP	procollagen type II C-terminal propeptide
PCL	posterior cruciate ligament
RA	rheumatoid arthritis
ROA	radiographic OA
ROC	receiver operator characteristics (defined above)
SF	synovial fluid
sGAG	sulphated glycosaminoglycan
TF	tibiofemoral
TIMP	tissue inhibitor of matrix metalloprotease



# Abstract

*Background.* In osteoarthritis (OA) the balance of cartilage matrix synthesis and degradation is disturbed, resulting in a gradual destruction of the articular cartilage. Matrix components released into body fluids by proteolytic cleavage can be used as biomarkers of ongoing processes. This thesis focuses on proteolytic degradation of the proteoglycan aggrecan with the overall aim to study the potential of aggrecan fragments as biomarkers in knee OA.

*Methodology/Principal findings.* Using neoepitope specific antibodies in Western blots, aggrecan fragments were identified in knee cartilage and synovial fluid (SF) pooled from individuals with a wide spectrum of disease. Aggrecanases were found to dominate aggrecan proteolysis in disease, although a contribution of matrix metalloprotease (MMP) activity was noted. Western blot quantification in individual samples showed that the proportion of aggrecan released into SF generated by aggrecanases varied in disease, and was higher in diagnostic groups associated with high disease activity. Quantification by ELISA of SF ARGS showed that SF ARGS better distinguished samples from patients with knee joint disease from samples obtained from knee healthy individuals than aggrecan measures not specific for this neoepitope. In patients meniscectomized 18 years earlier, SF ARGS levels were inversely associated with progression of radiographic OA.

*Conclusions.* Aggrecanase is the dominating protease in human knee OA and its activity toward the aggrecan interglobular domain (IGD) is elevated in disease. SF levels of aggrecan ARGS fragments generated by this IGD activity can be used as biomarkers and has diagnostic as well as prognostic capabilities.



# Populärvetenskaplig sammanfattning på svenska

(Summary in Swedish)

Vid vår vanligaste ledsjukdom, artros, sker en progressiv förstöring av ledbrosk beroende på en störd balans mellan nedbrytning och nybildning av broskets extracellulära matrix. Ledbrosket utsätts för stort slitage och broskceller – kondrocyter – glest positionerade i vävnaden står för både nysyntes av broskmolekyler och för huvuddelen av nedbrytandet av slitna molekyler genom syntes av proteinklyvande enzymer – proteaser. Två familjer av proteaser har visat sig vara viktiga i omsättningen av ledbrosket: matrix metalloproteaser (MMP) och aggrecanaser. Dessa klyver framför allt kollagen II och aggrecan som, förutom vatten, är de två huvudbeståndsdelarna i ledbrosk. Kollagen II utgör ungefär 3/4 av vävnadens torrsvikt, bildar ett fibrillerat nätverk som ger ledbrosket dess draghållfasthet, samt förankrar aggrecan och andra proteiner i vävnaden. Aggrecan utgör ungefär 1/5 av vävnadens torrsvikt och är den molekyl i ledbrosket som ger det dess stötdämpande förmåga, detta genom sin stora negativa laddning vilken attraherar motjoner som i sin tur skapar det osmotiska tryck som håller vatten kvar i brosket.

Det övergripande syftet med denna avhandling var att utvärdera om klyvningsfragment av aggrecan utsläppta från brosket till den omgivande ledvätskan kan användas som indikatorer, eller biomarkörer, för artros. En biomarkör är en biologisk variabel som speglar en fysiologisk förändring till följd av t.ex. sjukdom. Biomarkörer kan användas vid diagnostisering, för att förutsäga vem som löper risk för att drabbas eller förvärras, eller för att följa om en behandling har effekt. De kan också användas för att studera bakomliggande biologiska mekanismer.

I första delarbetet gjordes en noggrann kartläggning av aggrecanfragment i brosk och ledvätska från ett stort antal patienter med varierande grad av artros eller knäskada. Antikroppar specifika för de nya aminosyresekvenser som blottläggs vid proteasklyvning, så kallade neopeptoper, användes i Western blot teknik. Denna teknik vidareutvecklades för att grovt kunna kvantifiera olika fragment. Kartläggningen i kombination med kvantifiering av några huvudfragment av aggrecanmolekylen visar att proteas i aggrecanasfamiljen ADAMTS spelar en huvudroll vid omsättningen av aggrecan i artros, även om aggrecanfragment kluvna av proteas ur familjen MMP också förekom.

Fördelen med kvantifieringsmetoden utvecklad i första delarbetet är att man, till skillnad från den vanligaste antikroppsbaseade kvantifieringsmetoden ELISA, kan särskilja och kvantifiera fragment av olika storlek samtidigt. Detta utnyttjades i andra delarbetet där ledvätskor från ett trettio-tal patienter med olika ledsjukdomar jämfördes med knäfriska individers ledvätskor. Ledvätskenivåer av fragment kluvna av aggrecanas i två olika



domäner av aggrecan jämfördes sinsemellan och med generellt aggrecaninnehåll. Resultaten identifierar fragment med den aggrecanasgenererade neoepitopen ARGS som en potentiell biomarkör och visar att andelen aggrecan med denna neoepitop varierar mellan olika ledsjukdomar och är större vid hög sjukdomsaktivitet.

Kvantifiering i Western blot kräver dock stora provmängder samt tidskrävande upparbetning och lämpar sig därför sämre för större provserier. I tredje delarbetet utökades antalet försökspersoner till 295 och ledvätskenivåer av ARGS-aggrecan mättes med en ELISA. Resultaten visar på mycket förhöjda ledvätskenivåer av ARGS-aggrecan vid ledsjukdom, i synnerhet vid inflammation och kort tid efter knäskada, men även vid knäartros. Lång tid efter knäskada var ARGS-nivåerna låga, men fortfarande förhöjda jämfört med nivåerna hos knäfriska och med mycket större spridning mellan olika individer. Jämfört med andra metoder som mäter generella nivåer av aggrecan oavsett var fragmenten kluvits, är ledvätskenivån av ARGS avsevärt bättre på att särskilja prover från ledsjuka från de från knäfriska. Ledvätskenivåer av ARGS-aggrecan visades alltså vara en god biomarkör för ledsjukdom.

I fjärde delarbetet studerades ARGS-aggrecan i relation till sjukdomsprogress vid artros. I 141 patienter vilka opererats för meniskskada 18 år tidigare, mättes ledvätskekoncentrationen av ARGS-aggrecan och jämfördes med förändring av röntgenologiska kännetecken för artros 7,5 år senare. ARGS-nivåerna i ledvätska 18 år efter operation fanns vara samma som i kontrollindivider som inte opererats. Inom dessa till synes normala nivåer, visade sig risken för röntgenologisk sjukdomsprogress minska med ökande ledvätskenivåer av ARGS-aggrecan, vilket var förvånande då andra studier visat på förhöjda nivåer vid ledsjukdom. En trolig förklaring, som skulle innebära minskad risk för sjukdomsprogress med ökande ledvätskenivåer av ARGS inom det normala spannet, är en ökad nysyntes av aggrecan som till dels inkorporeras i vävnaden, men till dels klyvs av aggrecanas och sipprar ut i ledvätskan.

Sammanfattningsvis visar jag i denna avhandling att proteas tillhörande familjen aggrecanas är dominerande i artros och att aggrecanfragment med neoepitopen ARGS uppkommen genom aggrecanasklyvning är en biomarkör med diagnostisk så väl som prognostisk förmåga.

# Introduction

Osteoarthritis (OA) represents a group of joint diseases distinguished by loss of cartilage, alteration of subchondral bone, formation of osteophytes, and as a consequence thereof, eventually; joint failure with typical symptoms of pain and functional limitations (Flores and Hochberg 2003). Although OA has been part of the history of mankind from the very earliest times – the “Java man”, a *Homo erectus* whose 500 000 to 700 000 year old fossilized femur show signs of OA (Copeman 1964) – it was not until 1888 it was first mentioned as a separate arthritic disease by John Kent Spender (Spender 1888). As a physician at the Royal Mineral Water Hospital in Bath, he noted that most cases of OA could be divided into slow and quick forms based on the velocity and tension of the heart’s action. Research on OA has evolved over the past 122 years, and has shown that the disease is considerably more complex. OA is now not viewed as one disease but rather as a group of multifactorial diseases with a common final stage of joint failure (Dieppe and Lohmander 2005; Martel-Pelletier et al. 2006; Abramson and Attur 2009). Risk factors such as age, sex, overuse, trauma, obesity and genetics can each contribute to or trigger the disease with a different contribution of each factor in each individual. All parts of the joint – cartilage, bone, ligaments and synovium – are involved (Abramson and Attur 2009). Another paradigm that has been shifted due to recent advances in the research is the traditional view of OA as a non-inflammatory arthritis; the inflammatory pathway has been shown to be upregulated, at least in some patients and in some phases of the diseases (van den Berg et al. 2003; Abramson 2004).

In the same year that OA was first described by Spender, Wilhelm Conrad Röntgen became professor of physics at the University of Würzburg. Some years later, in 1895, he discovered what still today is the most commonly used tool in diagnosing osteoarthritis: x-rays (Röntgen 1895). Bertha Röntgen, his wife, volunteered her hand for the first x-ray image – upon examination today, presence of osteophytes indicates that she in fact had hand OA – and in 1901, Wilhelm Conrad Röntgen received the Nobel Prize in physics for his discovery. Today, radiographic changes described by Kellgren and Lawrence (Kellgren and Lawrence 1957) form the basis for radiographic diagnostic criteria for OA. Cardinal radiographic features of OA, such as joint space narrowing (JSN), and the formation of marginal osteophytes (Altman et al. 1995; Altman and Gold 2007), however appear late in disease, and the search for early signs and mechanisms leading to advanced disease has been ongoing for many years. Spender himself, lacking radiography as a tool, tried to find early signs of OA, and found that “pigmentation which goes by the common name of ‘freckles’ is a frequent accompaniment of early osteo-arthritis” (Spender 1888). Even though we may smile at the signs he associated with early OA, Spender tried in 1888 to find what this thesis essentially is about; early ways of diagnosing OA.

Following proudly in the footsteps of John Kent Spender, the work in this thesis aims at both a deeper understanding of the mechanisms involved in pathology and of ways to diagnose and predict future onset or progression of OA. All joints can be afflicted by OA, the most common are knees, hands, hips, and spine (Felson 2003), but the focus of this work is the joint most commonly afflicted – the knee.

## The knee joint

The knee is a weight-bearing joint which functions to allow movement of the leg and is critical to normal walking. It can be divided into three compartments; the femur (thigh-bone) and the tibia (shinbone) joins together to form the lateral and medial compartments of the tibiofemoral (TF) joint, the patella (kneecap), which joins with the femur to form the patellofemoral (PF) joint (Grey 1918). In the normal knee it is mainly the medial TF compartment which is load bearing (Evans 2007).

The joint is stabilized statically by collateral and cruciate ligaments and dynamically by muscles and tendons crossing the knee (Evans 2007). Articular cartilage lines the distal and proximal bone surfaces, absorbs and distributes load and together with the cushioning menisci in the lateral and medial compartments of the TF joint, provide a virtually friction free surface for the joint movements. The joint is enclosed by the joint capsule which inner surface is lined with the synovial membrane, or synovium, which is permeable to water and small molecules and proteins (Simkin 2003), and is the major source of mediators – cytokines, growth factors and enzymes (van den Berg et al. 2003) – as well as of hyaluronan and lubricin. The cavity formed inside the capsule is filled with synovial fluid (SF), which is a viscous fluid rich in hyaluronan and lubricin (Swann et al. 1981). SF serves both as a lubricant, minimizing friction between the articular surfaces (Swann et al. 1984), and a medium for transport of nutrition and waste products between the microvasculature and lymphatic vessels of the synovium and the avascular cartilage (Simkin 1991; Simkin 2003).

## Articular cartilage

Cartilage is classified in three types – elastic, fibrous and hyaline – based on its structure and composition. Articular cartilage is a smooth, hyaline cartilage that contains an extracellular matrix (ECM) in which cells are sparsely positioned. It is an avascular tissue and more than 60% of its content is water (Mankin and Thrasher 1975); the remainder is to the largest part composed of collagens, aggrecan, and other matrix molecules (Heinegård 2007), and only a few per cent of the tissue consists of cells (Gilmore and Palfrey 1988) (Figure 1). The joint cartilage is organized into four zones, ranging from the superficial zone at the articular surface, via the transitional or intermediate zone, to the deep zone which connects to the subchondral bone via the calcified cartilage zone (Martel-Pelletier et al. 2008). The extracellular matrix also has a distinct organization around the cell, which is described as pericellular closest to the cell, territorial and interterritorial.

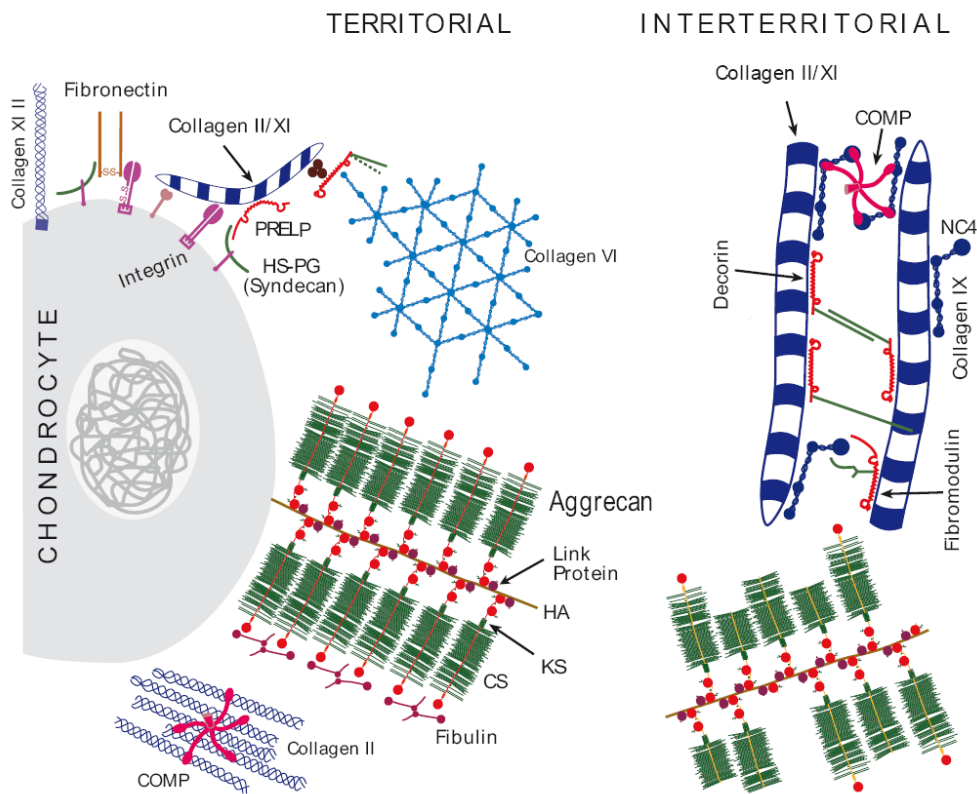

**Figure 1.** A schematic view of the articular cartilage matrix molecules and their interactions and organization around the chondrocyte. CS, chondroitin sulphate; HA, hyaluronan; KS, keratan sulphate. See also cover illustration of aggregate with hyaluronan and link protein. Modified from (Heinegård 2009). Reproduced with kind permission from Pilar Lorenzo and Dick Heinegård.

## The chondrocyte

The only cell type in cartilage is the chondrocyte, which is responsible for the maintenance of the ECM, including both degradation of tissue structures as well as regeneration by synthesis of new matrix molecules. Although its life span is long, it appears to be limited and regeneration is suggested to occur by differentiation of mesenchymal stem cells as well as by mitosis of mature cells in situ (Simkin 2008). Since articular cartilage is avascular, the chondrocyte receives nutrition and oxygen via water transport from the adjacent vascularised tissues, the synovium and the subchondral bone; waste products and degraded matrix constituents are cleared from the joint into the plasma via the lymphatic system (Simkin and Bassett 1995).

# Collagens

The collagens are the major proteins of cartilage and make up about 60% of its dry weight. The fibril-forming collagen type II is the most abundant, and its fibrils act as a scaffold, provide tensile strength to the tissue and maintains its volume (Heinegård 2007). The collagen II fibres are stable with an estimated half-life in the range of 100 years (Heinegård et al. 2003). In the assembly of fibrils, both the N-terminal and the C-terminal propeptides are removed by proteolytic enzymes (Heinegård et al. 2003), which, as discussed below, can be used as markers of collagen II synthesis. The fibres also contain small amounts of collagen XI, which appears to govern the thickness of fibres (Mendler et al. 1989), and bound to its surface, numerous other molecules, including collagen IX (Eyre et al. 1987), fibromodulin (Hedlund et al. 1994) and decorin (Pringle and Dodd 1990), which interact with other collagen II fibres or other molecules such as cartilage oligomeric matrix protein (COMP) to form a collagen network (Heinegård et al. 2003). A second fibrillar network with collagen VI as its major constituent interacts with the collagen type II network and other assemblies in the matrix via molecules bound to the surface of the filaments (Heinegård 2007).

# Aggrecan

The second most abundant molecule in cartilage is aggrecan, a large aggregating proteoglycan (Figure 2 and cover illustration). It is a molecule with an estimated half-life of months to a few years (Maroudas et al. 1998). It consists of a central core protein of more than 2400 amino acids which has glycosaminoglycan chains covalently attached to the core protein (Thyberg et al. 1975; Doege et al. 1991). It is organized into distinct domains of which the functionally most important are the two chondroitin sulphate domains CS1 and CS2 (Watanabe et al. 1998) (Figure 2). They stretch over a large portion of the molecule and carry, in a bottle brush fashion, about 100 CS chains, each of which consists of 20 to 80 disaccharide units, each with two negatively charged groups (Hardingham 1998); the length of the CS chains diminish with the age of the aggrecan (Plaas et al. 1997). The CS domains of aggrecan can thus carry in excess of 10 000 negative charges, which attract counter ions and create an osmotic pressure that hydrates the cartilage. Adjacent to the CS1 domain is the third region rich in glycosaminoglycan, the keratan sulphate (KS) domain. KS chains are, like the CS chains, composed of disaccharide units, albeit smaller in size and charge density. In addition to the CS and KS chains, there are also shorter N- and O-linked oligosaccharides attached to the core protein (Lohmander et al. 1980; Barry et al. 1995).

Aggrecan contains three globular domains (G1, G2 and G3) of which the N-terminal G1 domain, stabilized by link protein, binds to hyaluronan (HA) (Figure 1). HA is a glycosaminoglycan constituted by in excess of 1000 disaccharide units and form huge aggregates of up to 100 aggrecan molecules (Hardingham and Muir 1972; Hascall and Heinegård 1974) (Cover illustration). The G2 domain, is to the major part homologous with the G1 domain, but does not bind hyaluronan and has no known function (Heinegård et al. 2003). The peptide region between G1 and G2 is termed the interglobular domain (IGD)

and contains proteolytic cleavage sites for a variety of proteases (Sandy et al. 1992; Lohmander et al. 1993c; Arner et al. 1998; Sandy and Verscharen 2001; Sandy 2003). The G1 and a large stretch of the IGD domain are sometimes referred to as the hyaluronan binding region (HABR) (Mörgelin et al. 1994; Barry et al. 1995). The C-terminal G3 domain has been shown to interact with other matrix molecules such as fibulin-2 and tenascin-C (Day et al. 2004). This interaction seems important in the formation of aggregates close to the chondrocyte (Heinegård et al. 2003), but with ageing the proportion of aggrecan lacking the G3 through proteolytic activity in the CS domain increases (Paulsson et al. 1987; Vilim and Fosang 1994; Dudhia et al. 1996; Plaas et al. 1997), and the stabilizing interaction by G3 with other matrix molecules thusly decrease. The rate of incorporation of aggrecan into aggregates has been shown to be much slower in mature cartilage than in cartilage of younger individuals (Bayliss et al. 2000).

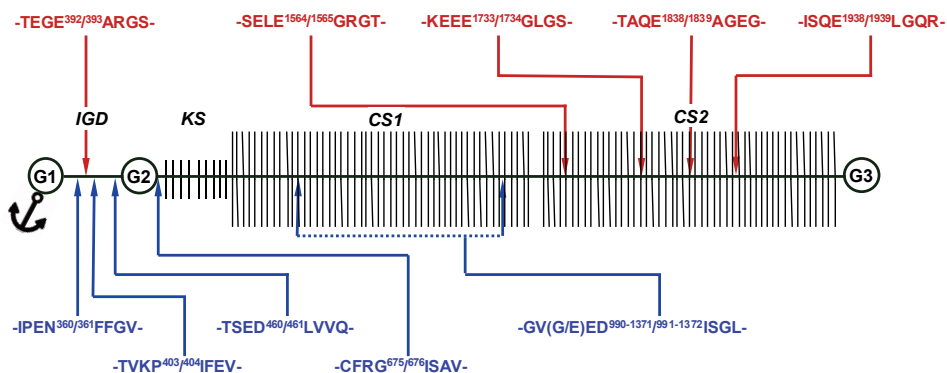

**Figure 2.** Human aggrecan with aggrecanase (above, red) and MMP (below, blue) cleavage sites. In this thesis aggrecanase-generated neopeptides TEGE, ARGS, SELE, KEEE, LGQR and MMP-generated neopeptides IPEN and FFGV are initially investigated and discussed together with the multiple MMP cleavage site in the CS1 region (Paper I). In the following papers the epitopes studied were ARGS and G3 (Paper II) and ARGS alone (Papers III and IV). Amino acid numbering is based on full length human aggrecan starting with the N-terminal <sup>1</sup>MTTL (NCBI accession number P16112).

## Aggrecan turnover by proteolysis

Chondrocytes are the primary cellular source of degradative proteases in healthy turnover as well as in OA (Murphy and Nagase 2008), but also the synovial cells contribute, especially in inflammation (van den Berg et al. 2003). In normal turnover the production and activity of these proteases is controlled and tissue homeostasis maintained (Heinegård et al. 2003), but production of degradative enzymes by the cells increases in response to ageing, mechanical stimuli such as injury, inflammatory cytokines (Lohmander et al. 1994; Lark et al. 1997) and reactive oxygen species (Loeser 2008). The majority of the proteases responsible for degradation of ECM molecules are metalloproteases of the two families MMPs (matrix metalloproteases) and ADAMTS (a disintegrin and metalloprotease with thrombospondin-like motifs (Caterson et al. 2000; Nagase and Kashiwagi 2003; Murphy and Nagase 2008)). MMPs are zinc-dependent endopeptidases that are capable of degrad-

ing all kinds of ECM proteins and include collagenases, gelatinases and stromelysins, which all to some degree cleave aggrecan in the IGD (Sandy 2003) (Figure 2). Collagenase-3 (MMP-13) was proven essential for development of OA in the mouse through its type II collagenolysis (Little et al. 2009).

The first evidence of a human aggrecanase emerged in 1992, when aggrecan fragments cleaved between the Glu<sup>392</sup>-Ala<sup>393</sup> bond of the IGD were identified in human synovial fluid (Sandy et al. 1992; Lohmander et al. 1993c). Aggrecanase was purified and cloned a few years later (Tortorella et al. 1999). **There are now two known aggrecanases, both belonging to the ADAMTS family; aggrecanase-1 and -2, or ADAMTS-4 and ADAMTS-5.** The aggrecanases cleave aggrecan at one site in the IGD domain and at four sites in the CS2 domain (Sandy 2003; Martel-Pelletier et al. 2008) (Figure 2). Other members of the ADAMTS family – ADAMTS-1, -8, -9, -15, -16, and -18 – have a substantially lower level of expression and/or weaker aggrecan-degradative activity *in vivo*, and are not likely functional aggrecanases (Fosang and Little 2008; Tortorella and Malfait 2008). Proteases other than the metalloproteases are capable of aggrecan cleavage, such as the cysteine proteases calpain and cathepsin B, and the aspartic protease cathepsin D, although they appear to play a limited role in OA pathology (Sandy 2003).

### Expression and regulation of ADAMTS-4 and ADAMTS-5

Although ADAMTS-5 has been shown to be essential for development of OA in mice (Glasson et al. 2005; Stanton et al. 2005), both ADAMTS-4 and ADAMTS-5 appear to be involved in human OA (Song et al. 2007). Their gene expression is however very differently regulated; ADAMTS-5 is constitutively expressed in human cartilage and synovium, whereas ADAMTS-4 expression is induced by proinflammatory cytokines (Bau et al. 2002; Naito et al. 2007). This could have implications in drug development aimed at inhibition of both aggrecanases.

The zinc-binding catalytic domain of ADAMTS-4 and ADAMTS-5 is at the N-terminal of the active enzyme and its specificity for cleavage sites is governed by truncation of the C-terminal domain, which modulates substrate binding (Fushimi et al. 2008). Both aggrecanases cleave human aggrecan within the IGD, although ADAMTS-4 much less efficiently than ADAMTS-5 (Roughley et al. 2003; Gendron et al. 2007). Truncation of ADAMTS-5 render a reduced IGD activity (Gendron et al. 2007), whereas truncation of ADAMTS-4 was, by conflicting studies, shown to either reduce (Gendron et al. 2007) or increase (Gao et al. 2002) the IGD activity by the enzyme.

### Inhibition of metalloproteases

There are four tissue inhibitors of matrix metalloproteases (TIMP-1 through -4) expressed in humans that inhibits all MMPs; of those TIMP-3 is also a potent inhibitor of ADAMTS-4 and ADAMTS-5 (Hashimoto et al. 2001; Kashiwagi et al. 2001). In the search for disease modifying osteoarthritis drugs (DMOADs), therapeutic strategies mimicking the TIMPs started more than 30 years ago, but was hampered by unacceptable adverse effects or lack of efficacy (Fosang and Little 2008). With evidence of the aggrecanases emerging in the 1990's (Sandy et al. 1992; Lohmander et al. 1993c), and the subsequent

cloning of aggrecanase-1 (Tortorella et al. 1999), the focus has moved toward aggrecanase inhibitors (Tortorella et al. 2009). One such inhibitor is the AGG-523, which with no or minimal effect on MMPs, has proven effective in inhibition of IGD cleavage of aggrecan in a rat meniscal tear model (Chockalingam, Sun, Rivera-Bermudez, Zeng, Dufield, Larsson, Lohmander, Flannery, Glasson, Georgiadis and Morris; submitted manuscript), suggesting that pharmacological inhibition of aggrecanases may be effective in suppressing cartilage destruction in humans following joint injury. It was in fact recently reported that a clinical phase I study using the AGG-523 inhibitor is soon to be finished (Fosang and Little 2008).

## Biomarkers

Biomarkers are defined as objective indicators of normal biologic processes, pathogenic processes, or pharmacological response to therapeutic intervention (De Gruttola et al. 2001). In OA, plain radiography may be considered a biomarker for OA. But with radiographic changes being associated with late stages of disease, and only measuring cartilage change indirectly as narrowing of the joint space, the need for earlier methods of diagnosing and ways of monitoring early phases of disease are highly desirable. OA biomarkers are now often described using the recently proposed BIPEDS classification scheme which classifies OA biomarkers as Burden of disease, Investigative, Prognosis of disease, Efficacy of interventions, Diagnosis of disease, and Safety of interventions biomarkers (Bauer et al. 2006; Byers-Kraus et al. 2010).

There are various approaches used to study OA biomarkers. One widely used approach is to measure levels of key proteases in synovial fluid or blood. Synovial fluid levels of the collagenase MMP-1 and the stromelysin MMP-3 has, for example, been shown to be elevated in rheumatoid arthritis (RA) and after knee injury (Walakovits et al. 1992; Lohmander et al. 1993b; Lohmander et al. 1994; Lark et al. 1997), and plasma levels of MMP-3 were shown to be predictive of JSN in knee OA (Lohmander et al. 2004). The assays used in these studies however measured both the free protease and the inactivated form complexed with TIMP (Walakovits et al. 1992; Lohmander et al. 2005). That makes the interpretation of the results more difficult and raises the issue whether or not these measures are biologically relevant as regards actual cartilage destruction.

Another approach is to measure cartilage matrix molecules released into synovial fluid and further transported into blood and urine. Using antibodies specific for cartilage proteins or for the neoepitopes that arise upon protease cleavage of cartilage proteins, it is possible to measure protein release from the tissue as well as results of specific protease degradation (Fosang et al. 2010). There are numerous examples of markers of type II collagen synthesis and degradation (Elsaid and Chichester 2006; Charni-Ben Tabassi and Garnero 2007). Of the markers for synthesis, elevated SF levels of procollagen type II C-terminal propeptide (PIICP) has been shown to be associated with early stages of OA (Lohmander et al. 1996; Kobayashi et al. 1997) as well as with progression of OA (Sugiyama et al. 2003). However, PIICP levels in serum and SF do not correlate, and serum levels showed no diagnostic or predictive ability in RA or OA (Nelson et al. 1998), possibly due to a relatively short half life of the PIICP fragment.



Of the collagen degradation markers, C-telopeptides of type II collagen (CTX-II) proteolytically cleaved from the rest of the collagen molecule by MMPs, is one of the most versatile. CTX-II levels in SF and serum has been shown to be elevated in early OA (Lohmander et al. 2003) and in urine in OA of longer disease durations (Garnero et al. 2001; Garnero et al. 2002a). Increased urinary CTX-II has further been shown to be both predictive of progression of OA (Reijman et al. 2004), as well as associated with severity of radiographic knee OA (Atley et al. 2000; Jordan et al. 2006). Urinary CTX-II has also been used to monitor efficacy of intervention in studies of therapeutic intervention of cartilage degradation (Gineyts et al. 2004; Spector et al. 2005). Although shown to associate with joint specific changes, urinary marker levels are however a reflection of the collective systemic production of all joints, rather than a joint specific reflection, which makes the biological interpretation more difficult (Simkin and Bassett 1995).

Aggrecan levels in synovial fluid were proposed as a biomarker already some 25 years ago by Saxne and colleagues when levels were noted to be elevated in patients with various knee joint arthritides (Saxne et al. 1985; Saxne et al. 1986; Saxne et al. 1987); they showed evidence both for its usefulness in monitoring the effects of therapy (Saxne et al. 1986) as well as for potential use as a prognostic factor for future cartilage destruction in RA (Saxne et al. 1987). Also after knee injury SF levels of aggrecan were elevated, albeit only in the first weeks or months after injury (Lohmander et al. 1989; Dahlberg et al. 1992; Lohmander et al. 1993a). These studies, however, used assays specific either for sulphated glycosaminoglycan by dye precipitation, (Björnsson 1993), or for protein core epitopes of aggrecan not specific of protease cleavage (Saxne et al. 1986; Saxne and Heinegård 1992; Möller et al. 1994). **This made deductions impossible as to which protease was involved, and at what cleavage site.** This is something which the work presented herein aims to illuminate.

The chondroitin sulphate (CS) epitope 846 present mostly on newly synthesized aggrecan, has been reported to be elevated in SF in various arthritides and after knee injury (Lohmander et al. 1999). **In contrast to the temporal changes seen after injury for aggrecan release into SF where an initial elevation diminished with time** (Lohmander et al. 1989; Dahlberg et al. 1994; Lohmander et al. 1994; Lohmander et al. 1999), the CS846 epitope remained 2-fold elevated for many years (Lohmander et al. 1999). In patients with RA, the CS846 epitope was increased only in groups with slow joint destruction (Månsson et al. 1995), indicating a potential use of CS846 as a prognostic marker.

# Objectives

## Overall aims

The overall aim of this work was to study the potential of aggrecan fragments as biomarkers of osteoarthritis. My principal hypotheses were that aggrecan fragmentation by proteolysis is different in health and diseases and that aggrecan fragments specific of proteolytic cleavage can be used as biomarkers in OA.

## Specific aims

### Paper I

To identify aggrecan fragments present in knee cartilage and synovial fluid in a wide spectrum of disease, and to compare aggrecan fragment patterns found *in vivo* with those found by *in vitro* digestion by stromelysin (MMP-3) and aggrecanase-1 (ADAMTS-4).

### Paper II

To investigate the balance of aggrecanase proteolysis of the interglobular domain contra the chondroitin sulphate-2 (CS2) domain of aggrecan in patients with knee joint pathology compared with knee healthy individuals.

### Paper III

To quantify synovial fluid levels of ARGS aggrecan in human synovial fluid to determine if fragments specific for this cleavage better identifies joint pathology than previously used aggrecan assays not specific of proteolytic cleavage.

### Paper IV

To determine whether synovial fluid levels of aggrecanase generated ARGS-aggrecan fragments (SF ARGS) distinguish subjects with progressive radiographic knee osteoarthritis (ROA) from those with stable or no ROA, and to investigate if SF ARGS is related to severity of ROA.



# Subjects

Ten patients undergoing total knee joint replacement due to osteoarthritis supplied cartilage used in the first study of this thesis (Paper I).

Knee synovial fluid samples studied were from subjects belonging to:

- A. A cross-sectional convenience cohort (Papers I-III), with diagnoses including knee healthy subjects, acute inflammatory arthritis, acute and chronic knee injury (involving rupture of a cruciate ligament and/or a meniscal tear), and knee osteoarthritis.
- B. A prospective meniscal injury cohort (Paper IV) of patients retrospectively identified to have undergone isolated meniscectomy some 18 years prior to the first examination, with a follow-up examination about 7.5 years later. (Englund and Lohmander 2004)

An overview of the subjects is given in Table 1, and further details on the subjects can be found in the respective papers. Informed consent was obtained from all participants and all procedures were approved by the research ethics review committee of the Medical Faculty of Lund University.

**Table 1.** Tissue and subjects used in the studies.

Tissue and subjects	Paper I	Paper II	Paper III	Paper IV
Cartilage pooled from 10 individuals with end-stage OA	X			
SF pooled from 100 individuals, cross-sectional convenience cohort	X			
SF pooled from 47 patients (OA pool), cross-sectional convenience cohort		X		
SF from 24 patients and 4 knee healthy controls, cross-sectional convenience cohort		X		
SF from 269 patients and 26 knee healthy controls, cross-sectional convenience cohort			X	
SF from 141 meniscectomized patients and 17 un-operated controls, longitudinal meniscal injury cohort				X



# Methods

The main methods used in the papers included in this thesis are listed in Table 2, followed by a brief overview of the methods. Detailed protocols are given in the individual papers.

**Table 2.** The major methods used in the studies.

Methods	Paper I	Paper II	Paper III	Paper IV
GuHCl-extraction of proteoglycan from cartilage	X			
CsCl density gradient centrifugation	X	X		
<i>In vitro</i> digestion of aggrecan by proteases	X			
Western blot	X	X		
Alcian blue precipitation	X	X	X	
1-F21 aggrecan ELISA			X	
KS/OA-1 ARGS ELISA			X	
HABR/OA-1 ARGS MSD				X
Radiography				X

## Extraction of proteoglycan from cartilage (Paper I)

The most commonly used method of extracting proteoglycans from cartilage is by grinding the tissue and then using a strong solvent, 4M guanidinium hydrochloride (GuHCl), to dissociate molecules from one another by breaking the intermolecular noncovalent bonds (Sajdera and Hascall 1969). With aggrecan being the most abundant proteoglycan in articular cartilage (Heinegård et al. 2003), GuHCl-extracts of cartilage are rich in aggrecan.

## Caesium chloride density gradient centrifugation (Papers I & II)

By adding caesium chloride to solutions containing proteoglycans, the positively charged and heavy caesium ions will bind to the negatively charged glycosaminoglycan chains positioned along the aggrecan core protein. In a subsequent ultracentrifugation, a CsCl-density gradient will form and molecules will be separated based on fixed charge density.

The technique was put to common use after first being described in 1969 (Hascall and Sajdera 1969), and can be conducted on cartilage extracts and synovial fluid under associative conditions as well as under dissociative conditions in the presences of GuHCL (Heinegård et al. 1987).

## *In vitro* digestion of aggrecan by proteases (Paper I)

Two of the major protease families involved in the proteolysis of aggrecan *in vivo*, are the aggrecanases (ADAMTS) and the matrix metalloproteases (MMPs) (Caterson et al. 2000; Nagase and Kashiwagi 2003) To investigate their relative contribution to the aggrecan fragments found in cartilage and synovial fluid (Paper I), we digested aggrecan monomers, extracted and purified from human articular cartilage, *in vitro* with aggrecanase-1 (ADAMTS-4) and stromelysin (MMP-3). Both enzymes have the capability of cleaving aggrecan in the IGD; aggrecanase-1 and -2 at the TEGE<sup>392-393</sup>ARGS site, and stromelysin at the IPEN<sup>360-361</sup>FFGV site. An aggrecanase-1 digest was further used as a standard for molar quantification of aggrecan fragments carrying the ARGS neoepitope (Papers II-IV).

## Western blot (Papers I & II)

After separation by sodium dodecyl sulphate polyacrylamide gel electrophoresis (SDS-PAGE) (Shapiro et al. 1967), proteins were transferred to nitrocellulose or polyvinylidene fluoride membranes where they were detected with antibodies specific for protein sequences, glycosaminoglycan epitopes, or neoepitopes created by proteolysis in the Western blot technique (Burnette 1981). Enhanced chemiluminescence was used for detection with registration of emitted light either by film (Paper I) or digitally by a photosensor in a luminescence image analyser (Paper II). In Paper II, ARGS concentrations were quantified against the aggrecanase-1 digested aggrecan standard and relative concentration of the globular domain 3 (G3) of aggrecan was done against the OA pool of 47 SF samples.

## Alcian blue precipitation (Papers I-III)

Specific precipitation of proteoglycans or glycosaminoglycans present in, for example, biological fluids or cartilage extracts was described by Björnsson (Björnsson 1993). The positively charged Alcian blue dye interacts specifically with the negative charges of the sulphates on the glycosaminoglycans of the aggrecan molecule, and the amount of bound dye is quantified in a spectrophotometer against a known standard.

## ELISA

Enzyme-linked immunosorbent assays (ELISA) are used for quantification of substances of immunogenic properties. The assays typically involves at least one antibody specific for a particular antigen. The antibody is directly or indirectly linked to an enzyme catalyzing a biochemical reaction. The most commonly used enzyme is horseradish peroxidase (HRP), which catalyzes a shift in colour which is detected as absorbance in a spectrophotometer. Based on the strategy used for detection, ELISAs are commonly classified in four groups; direct, when the antigen is reacted directly with the antibody, indirect, when the detection is via a secondary antibody specific for the antigenic antibody, sandwich, when one antibody adsorbed to the solid phase is used to capture the antigen and a second antibody is used for detection, and competition ELISA, when two reactants are competing to bind to a third (Crowther 1995).

### 1-F21 aggrecan ELISA (Paper III)

Aggrecan concentration in synovial fluid was analyzed by a competition ELISA using the MAb 1-F21 recognizing a protein sequence within or close to the keratan sulphate (KS) domain of aggrecan (Möller et al. 1994; Lohmander et al. 1999). Chondroitinase digested aggrecan monomers were used as standard for detection and quantification of chondroitinase digested aggrecan fragments present in synovial fluid. The assay is specific for aggrecan fragments carrying the protein epitope in or about the KS domain independent of the proteolytic origin of the fragments. 1-F21 ELISA data previously obtained on synovial fluids from patients included in Paper III was used.

### KS/OA-1 ARGS ELISA (Paper III)

In Paper III, quantification in synovial fluid of aggrecan fragments with the aggrecanase generated <sup>393</sup>ARGS N-terminal was by a sandwich ELISA using an anti-KS antibody to capture aggrecan fragments and the monoclonal antibody OA-1 for detection of specific fragments (Pratta et al. 2006). Human aggrecan monomers digested with aggrecanase-1 (ADAMTS-4) was used as standard.

## MSD immunoassay

The Meso Scale Discovery® (MSD, Gaithersburg, MD, USA) assay is an electrochemiluminescence (ECL) immunoassay using the same principal as an ELISA where the enzyme catalyzing a biochemical reaction is substituted with a reporter molecule, ruthenium(II) tris-bipyridyl [Ru(bpy)<sub>3</sub><sup>2+</sup>], which upon electrical stimulation from electrodes in the bottom of microtitre plates emits light that is recorded by a photosensor (Deaver 1995; Chowdhury et al. 2009).



## HABR/OA-1 ARGS MSD immunoassay (Paper IV)

In Paper IV, quantification in synovial fluid of ARGS aggrecan was by a sandwich MSD immunoassay using a capture antibody directed against the hyaluronan-binding region (HABR) of aggrecan, and the monoclonal anti-ARGS antibody OA-1 (Pratta et al. 2006) for detection. The assay was converted to the MSD format from an ELISA that uses the same anti-HABR capture but a different anti-ARGS antibody, BC-3 (Hughes et al. 1995), for detection of the ARGS neoepitope (Chockalingam et al. 2009).

## Radiography (Paper IV)

In Paper IV, radiographic examination of the meniscectomized patients (described in Subjects) were at first patient examination by standing anteroposterior radiographs of the tibiofemoral (TF) joint in about 15° flexion and tibiofemoral and skyline view of the patellofemoral (PF) joint with the knee in about 50° flexion obtained using a fluoroscopically positioned x-ray beam, using film (Englund and Lohmander 2005). At the second examination some 7.5 years later, a digital x-ray sensor was used instead of film, and posteroanterior and lateral views of the TF joint was obtained using the fixed flexion (SynaFlexer) protocol (Peterfy et al. 2003; Kothari et al. 2004).

Joint space narrowing (JSN) and osteophytes (OST) were graded on a four point scale (0 to 3, where 0 = no evidence of OST or JSN) according to the 1995 atlas of Osteoarthritis Research Society (OARSI) (Altman et al. 1995). Two investigators blinded to clinical data each graded all radiographs. Images were read paired with knowledge of time sequence. If classification differed between the readers, films were reread with adjudication of discrepancies.

Radiographic outcomes based on arthroplasty, osteotomy or the JSN and OST scores were:

1. Radiographic OA (ROA)
2. End-stage OA or arthroplasty
3. Sum score of JSN
4. Sum score of OST
5. Sum score of both JSN and OST; called ROA sum score
6. Progression of JSN
7. Progression of OST
8. Progression of ROA

Detailed definitions are found in Paper IV.

## Statistical methods

For correlation of different marker levels, a Spearman's rank order correlation ( $r_s$ ) (Spearman 1904) was used for continuous variables not normally distributed (Papers II and III) and Pearson's correlation ( $r$ ) (Pearson 1909) was used for normally distributed continuous variables (Paper IV). Group comparisons in Papers II and III were, since the data was not normally distributed, by Mann-Whitney U rank sum test (Mann and Whitney 1947) after an initial Kruskal-Wallis one-way analysis of variance on ranks test (Kruskal and Wallis 1952) to avoid mass significance.

In Paper IV, comparison of SF ARGS in men and women were by analysis of covariance (ANCOVA) with adjustments for age, BMI, time between meniscectomy and examination A, and JSN score. In comparisons between the groups with or without ROA, a Chi-square test was used for categorical values (numbers of progressors) and Mann-Whitney U rank sum test for continuous variables. Longitudinal associations between SF ARGS levels and progression of radiographic features of knee OA were assessed using multivariate logistic regression. Odds ratios (ORs) were calculated to estimate the likelihood for progression of ROA with adjustments for age, gender, BMI, time between examinations A and B, and JSN score at examination A.

All tests were two-tailed and P values below 0.05 were considered significant except in Paper III, where Bonferroni correction for multiple comparisons was used and P below 0.013 were considered significant to retain the 0.05 overall significance level.

Statistical calculations were performed using SPSS for Windows versions 15, 16 and 17 (SPSS, Chicago, IL, USA).



# Results and discussion

This section summarizes the major findings and conclusions of Papers I-IV included in this thesis: further details can be found in the individual papers.

## Paper I – Aggrecan fragments in human OA

In Paper I we made a thorough investigation of which aggrecan fragments are present in human knee OA cartilage and synovial fluid. Using antibodies specific for aggrecan epitopes and neoepitopes we showed in Western blots that, although MMP generated fragments are present, aggrecan fragments in synovial fluid to a major extent are generated by aggrecanases. Fragment patterns seen in synovial fluid showed a high similarity to fragment patterns seen in aggrecanase digested aggrecan (Figure 3).

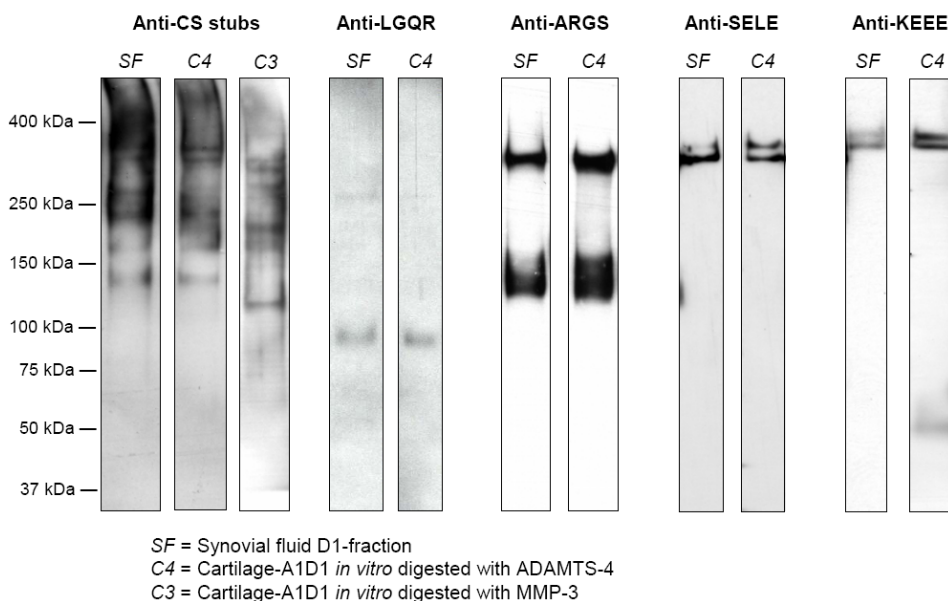

**Figure 3.** Western blots of aggrecan fragments carrying sulphated glycosaminoglycans in synovial fluid (SF) from patients with knee OA and in cartilage aggrecan digested *in vitro* by ADAMTS-4 (C4) or MMP-3 (C3). Strips probed with monoclonal antibody 3-B-3 specific for chondroitin sulphate stubs (Anti-CS stubs), or with antibodies against the aggrecanase generated neoepitopes <sup>1939</sup>LGQR, <sup>393</sup>ARGS, SELE<sup>1564</sup> and KEEE<sup>1733</sup> are shown with molecular weights indicated. (Figure reproduced from Paper I with permission from publisher.)

We further found that OA synovial fluid contained insignificant amounts of the G1-IPEN fragment as compared to the G1-TEGE fragment, while OA cartilage contained significant and approximately equal amounts of both fragments.

OA cartilage contained several glycosaminoglycan-containing aggrecan fragments with N-terminals of G1- or FFGV- but no fragments with an N-terminal of ARGS-. Using a novel technique for quantifying the enhanced chemiluminescence signal in Western blot, we quantified synovial fluid content of large size aggrecan fragments with ARGS and FFGV N-terminals. In the pooled OA synovial fluid we found 107 pmol ARGS and 40 pmol FFGV per ml, out of a total concentration of aggrecan fragments of about 185 pmoles per ml.

Conclusions of Paper I were that both an MMP and an aggrecanase pathway for aggrecan degradation exist in OA, but proteases of the aggrecanase family are to the major part responsible for aggrecanolysis in OA.

## Paper II – Western blot quantification of aggrecan fragments in human synovial fluid

The development of the quantitative Western blot technique in Paper I, prompted us to refine and use the technique for quantification of aggrecan fragments of different sizes sharing the same epitope. Based on the findings in Paper I that the aggrecan fragment pattern in OA synovial fluid to a major part is aggrecanase generated, and knowing that aggrecanase cleavage occur on many different sites of aggrecan (Sandy 2003) (Figure 2), we wanted to explore if aggrecanase cleavage at different sites differ in health and disease. Aggrecan fragments carrying the ARGS neoepitope and fragments including the globular domain-3 (G3) were quantified in a cross-sectional material comprising knee healthy references, and patients with knee OA, knee injury or acute inflammatory arthritis.

The major ARGS and G3 fragments found in all groups were ARGS-SELE and ARGS-CS1, respectively GRGT-G3, GLGS-G3 and AGEG-G3 (Figure 4). In addition to the three G3 fragments detected in all patients, some of the individuals had small but detectable amounts of aggrecanase generated LGQR-G3 bands, and some individuals had a shorter G3-band of unknown cleavage origin.

Quantification of the ARGS neoepitope by Western blot correlated well with the KS capture OA-1 ARGS ELISA used in Paper III. Compared to knee healthy references, acute arthritis and acute injury groups had a 30-fold elevated concentration of ARGS fragments, and the proportion of aggrecan fragments carrying the ARGS neoepitope was higher in both these groups compared to all other groups. We further found that the knee healthy and chronic injury groups had an excess of ARGS-CS1 fragments over ARGS-SELE fragments, while these fragments were more evenly distributed in the groups with knee OA and acute inflammatory arthritis.

The ratio of ARGS to G3 was found to vary between diagnostic groups (Figure 5). ARGS fragments represents a potentially more harmful IGD aggrecanase activity resulting in a great loss of functional aggrecan from the tissue, than G3 fragments representing

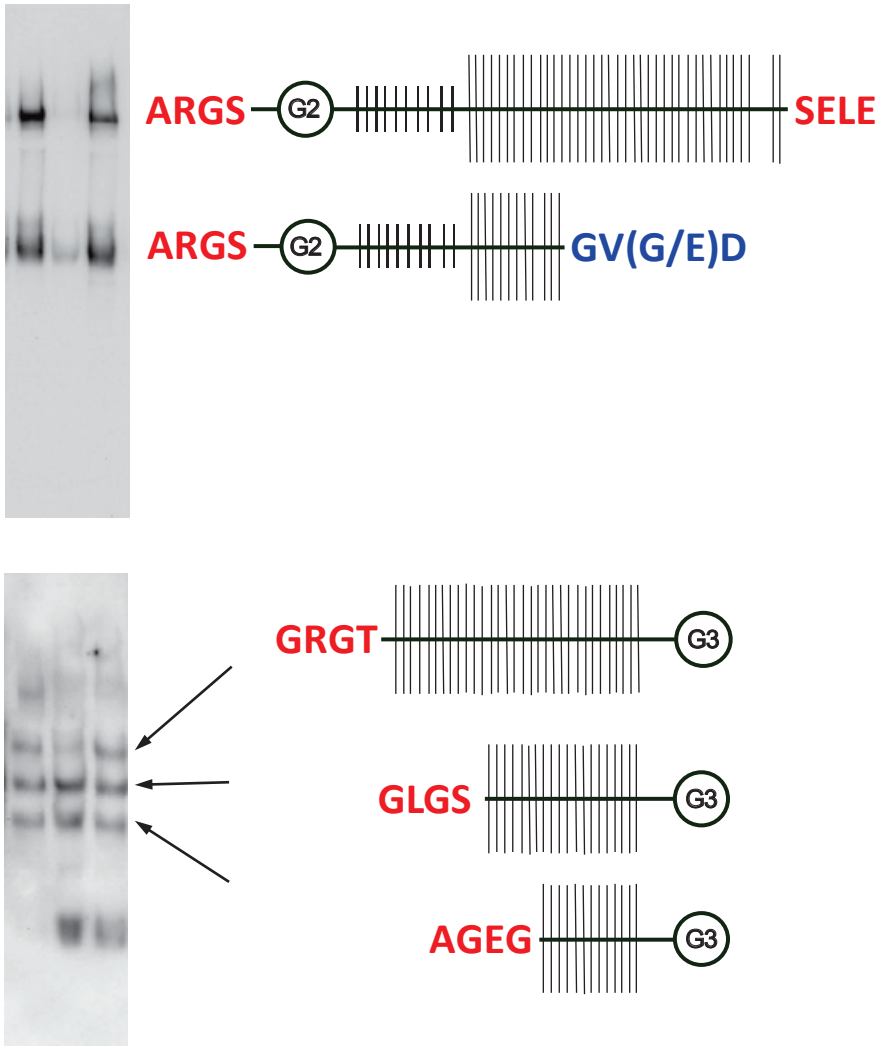

**Figure 4.** Anti-ARGS (top) and anti-G3 (bottom) Western blots of three representative synovial fluid samples with the respective fragments indicated. Red text represents aggrecanase generated neopeptides, blue text represent MMP generated neopeptides. Additional G3 fragments detected in some patients were aggrecanase generated LGQR-G3 and smaller G3 fragments of unknown cleavage origin, visible here in two patients below the AGEV-G3. Samples shown are from acute injury patients 6, 7 and 8; see Paper II for details.

CS2 aggrecanase activity giving a small loss of functional aggrecan. High ARGS to G3 ratios thus indicate a high relative level of pathological aggrecanase degradative activity. Interestingly, such high ARGS to G3 ratios were noted in groups associated with high disease activity (acute arthritis, acute injury and knee OA), and lower in the reference and chronic injury groups, of no or low disease activity.

Conclusions of Paper II were that the proportion of aggrecanase generated aggrecan of all aggrecan in synovial fluid varies between different joint diseases, and are higher with higher disease activity. We further concluded that there are differences in the proportion of cleavage in the IGD and the CS2 region by aggrecanases, with a higher level of pathological IGD cleavage in groups associated with high disease activity.

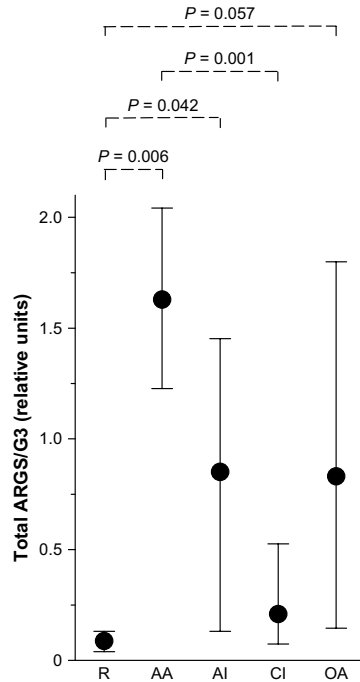

**Figure 5.** Ratios of ARGs to G3 in synovial fluid samples. The total ARGs and total G3 fragment concentrations from the subjects and the OA pool were quantified (amount/ml SF), using Western blot and luminescence image analyzer, and the mean values were calculated for each subject. The subjects' relative ARGs and G3 signals were first calculated against the OA pool, and then divided giving an ARGs/G3 ratio. Median values (circles) and the 25th and 75th percentiles (whiskers) of diagnostic groups knee healthy references (R, n = 4), acute inflammatory arthritis (AA, n = 7), acute knee injury (AI, n = 7) chronic knee injury (CI, n = 6), and knee OA (OA, n = 4). P values for group comparisons by Mann Whitney rank sum tests are given. (Figure reproduced from Paper II with permission from publisher.)

## Paper III – ARGS aggrecan in synovial fluid as a marker of joint pathology

In Paper III, the KS capture OA-1 ARGS ELISA developed in collaboration with Michael Pratta and colleagues (Pratta et al. 2006) was improved for better use in synovial fluids. The assay detects and quantifies aggrecan fragments carrying the ARGS neoepitope generated by aggrecanase cleavage in the IGD, which in Paper II was shown to be associated with high disease activity. Here we use it to determine if this cleavage-site specific method better identifies joint pathology than previously available aggrecan assays not specific for protease-derived neoepitopes.

In a cross-sectional material extended from the one used in Paper II, we found that aggrecan ARGS fragment concentrations in all groups differed from the reference group (Figure 6A), whereas aggrecan content measured as glycosaminoglycan concentrations (Figure 6B) or the 1-F21 protein core epitope (Figure 6C) only differed from the reference in acute inflammatory arthritis and in acute injury.

To investigate the overall ability of the three aggrecan measures to classify diseased and non-diseased individuals correctly, we made area under the curve (AUC) analysis based on receiver operator characteristics (ROC) curves which is commonly used to assess the usefulness of diagnostic markers (McNeil and Hanley 1984; Bauer et al. 2006). The specificity (the proportion of non-diseased correctly identified as such) was above 90% for all three aggrecan measures, whereas the sensitivity (the proportion of diseased correctly identified as such) was for the ARGS neoepitope 67%, compared with sGAG and 1-F21 aggrecan which had lower sensitivities of 40% respectively 32% (Table 3). The synovial fluid level of ARGS aggrecan was thus a better diagnostic marker for distinguishing diseased from non-diseased, as compared to levels of sGAG or 1-F21 aggrecan, which is reflected by the higher AUC for the ARGS measure (Table 3). No diagnostic power was gained by using the ratio of ARGS to sGAG (Table 3).

**Table 3.** Sensitivity and specificity of aggrecan fragments measurements.

Marker	Cut-off	AUC	Sensitivity	Specificity
ARGS neoepitope	1 pmol ARGS/ml	82%	67%	92%
sGAG	88.5 µg sGAG/ml	63%	40%	92%
1-F21 aggrecan	188.5 µg aggrecan/ml	53%	32%	91%
ARGS/sGAG*	5%	83%	65%	96%

\*The molar proportion of aggrecan fragments in SF detected as ARGS neoepitope fragments, measured as sGAG and ARGS, respectively.

Sensitivity: The proportion of diseased correctly identified as such.

Specificity: The proportion of healthy correctly identified as such.

AUC: area under receiver operator characteristics (ROC) curve.

Cut-offs were chosen based on ROC curve analysis at the point which maximized the sum of the sensitivity and the specificity.



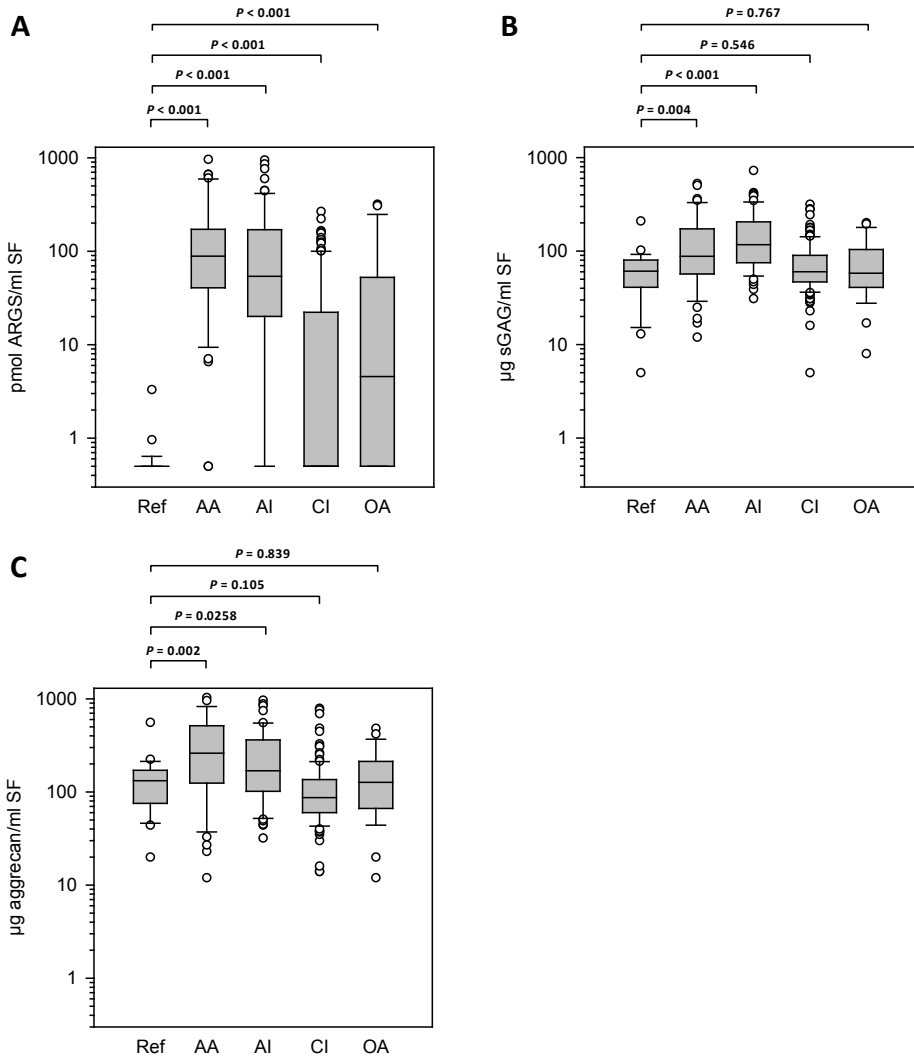

**Figure 6.** Concentrations of (A) ARGs fragments, (B) sulphated glycosaminoglycan (sGAG), and (C) aggrecan by the 1-F21 ELISA in the study groups healthy knee reference (REF, n = 26), acute inflammatory arthritis (AA, n = 48), acute knee injury (AI, n = 69), chronic knee injury (CI, n = 123), and knee osteoarthritis (OA, n = 29). The boxes define the 25th and 75th percentiles with a line at the median, error bars defining the 10th and 90th percentiles and circles represents individual outliers. Note that in (A) the median level of the chronic injury group is the same as the lower limit of the box; 0.5 pmol ARGs/ml. P values for group comparisons by Mann Whitney rank sum tests are given and after Bonferroni correction  $P < 0.013$  is considered significant to retain the 0.05 overall significance level. (Modified from Paper III)

Conclusions in Paper III were that synovial fluid levels of ARGS aggrecan are increased in human arthritis, in knee OA, and after knee injury, and that this likely is explained by an enhanced cleavage by aggrecanases at the Glu<sup>392</sup>-Ala<sup>393</sup> bond in the interglobular domain. As a diagnostic marker, synovial fluid levels of ARGS aggrecan better distinguished joints with pathology from normal joint, than levels of aggrecan or sGAG.

## Paper IV – ARGS aggrecan in synovial fluid and progression of radiographic OA

In Paper IV, we enhanced the sensitivity of the ARGS ELISA used in Paper III by changing capture antibody from an antibody specific for keratan sulphates to one specific for protein epitopes in the hyaluronan-binding region, and by a transition from the ELISA format to the MSD platform. With an assay better suited to quantify samples low in ARGS than the previous ARGS ELISA, we found that SF levels of ARGS aggrecan in patients meniscectomized some 18 years earlier were low and no different from un-operated individuals, and were unrelated to radiographic status at the time of sampling. However, SF ARGS levels were found to have a weak negative association with progression of radiographic features of OA, where an increase in the SF ARGS level was associated with a decreased risk of progression (Table 4). For progression of JSN this association was significant with an odds ratio (OR) of 0.89 (95% CI 0.79-0.99) per increase in ARGS concentration by 1 pmol per ml. This association was stronger in subjects without ROA at the time of sampling with a decrease in likelihood of progression of JSN by 0.76 (95% CI 0.79-0.99) per pmol ARGS/ml, and in subjects with ROA there was no association, OR 0.96 (95% CI 0.81-1.13).

**Table 4.** Multivariate logistic regression analyses of associations between the examination A ARGS aggrecan levels in SF and developments of joint space narrowing (JSN), osteophytes (OST) and either JSN or OST or both (radiographic OA; ROA) from examination A to examination B 7.5 years later. Odds Ratios (ORs) are adjusted for age, gender, BMI, time between examinations A and B, and JSN score at examination A. OST and JSN were scored according to the OARSI atlas.

	No stratification, n = 141	Stratified with or without ROA at examination A	
	OR (95% CI)	- ROA, n = 63 OR (95% CI)	+ ROA, n = 78 OR (95% CI)
Dev. JSN	0.89 (0.79-0.99)	0.76 (0.60-0.95)	0.96 (0.81-1.13)
Dev. OST	0.96 (0.86-1.08)	0.91 (0.75-1.11)	0.99 (0.85-1.15)
Dev. ROA	0.89 (0.78-1.02)	0.87 (0.72-1.05)	0.90 (0.73-1.13)

SF ARGs concentrations were higher in males compared to females with mean (range) values of 7.34 (0.31-15.07) and 5.14 (0.15-10.71) pmol ARGs/ml, respectively (P = 0.005 by ANCOVA when adjusted for age, BMI, time between meniscectomy and examination A, and JSN score). However, progression of radiographic features of OA did not differ between men and women.

The conclusions were that in this study cohort with previous meniscectomy, higher synovial fluid levels of ARGs were weakly associated with less progression of radiographic knee OA, and that there were no association between SF ARGs and severity of radiographic knee OA.

# General discussion

The underlying mechanisms of osteoarthritis involve a disturbed balance between anabolism and catabolism of extracellular matrix molecules in the articular cartilage. Yet, the most common way to diagnose osteoarthritis is by a combination of symptoms – such as pain and morning stiffness – and characteristic radiographic changes of the joint described by Kellgren and Lawrence in 1957 (Kellgren and Lawrence 1957). The focus of this thesis is proteolytic degradation of aggrecan with the aims of both a better understanding of the biological mechanisms involved in aggrecan degradation, and of identifying aggrecan fragments that could be used as biomarkers in knee OA.

## Aggrecanase versus MMP aggrecanolysis in human osteoarthritis (Paper I)

In Paper I we used a large number of antibodies specific for aggrecan neoepitopes created by proteolytic degradation to identify aggrecan fragments generated by the two main protease families, aggrecanases and MMPs. Although we found some aggrecan fragments generated by MMP activity alone, and several fragments generated by a combination of MMP and aggrecanase activity, the overall fragment pattern of osteoarthritic synovial fluid showed high resemblance to the fragment pattern of cartilage aggrecan cleaved *in vitro* by ADAMTS-4 of the aggrecanase family.

MMP-3 cleavage at the Asn<sup>360</sup>-Phe<sup>361</sup> bond in the IGD of human aggrecan was first demonstrated in 1992, and by N-terminal sequencing both IPEN<sup>360</sup> and <sup>361</sup>FFGV fragments were identified (Flannery et al. 1992). **At the same time the first evidence of a human aggrecanase activity emerged through N-terminal sequencing of aggrecan fragments present in human synovial fluid from osteoarthritic or knee injured patients (Sandy et al. 1992), and later also in inflammatory joint disease (Lohmander et al. 1993c).** In both these studies, all fragments found had an N-terminal sequence starting with <sup>393</sup>ARGS, generated through cleavage of the Glu<sup>392</sup>-Ala<sup>393</sup> bond in the IGD; no MMP generated FFGV fragments were found (Sandy et al. 1992; Lohmander et al. 1993c).

Antibodies specific for both the aggrecanase generated ARGS neoepitope (BC-3) (Hughes et al. 1995), and for the MMP-3 generated IPEN (BC-4 and a polyclonal) (Hughes et al. 1995; Singer et al. 1995) and FFGV neoepitopes (AF-28) (Fosang et al. 1995) were developed. The results of the studies using these antibodies were not wholly congruent: The study using the anti-ARGS antibody on culture media of rat and bovine cartilage explants, aggrecanase cleavage of the Glu<sup>392</sup>-Ala<sup>393</sup> bond was shown to be upregulated by inflammatory cytokines, but proteases other than aggrecanase were suggested to be involved in catabolism of aggrecan in normal turnover (Hughes et al. 1995). In support, Lark and colleagues noted presence of both IPEN and TEGE epitopes in

human joint cartilage in OA, RA and in individuals with no known joint disease (Lark et al. 1997). The opposite was suggested to be the case in mice, since the IPEN epitope was undetectable in cartilage of normal mice, but was observed in cartilage of mice with collagen induced arthritis (Singer et al. 1995). And in human synovial fluid from patients requiring either therapeutic or diagnostic aspiration, two species of FFGV fragments were detected (Fosang et al. 1995). When the flora of neoepitope antibodies had grown, a study on human cartilage and synovial fluid of a small number of individuals indicated that aggrecanase activity was responsible for catabolic turnover and loss of whole aggrecan, whereas other protease activity was required for C-terminal processing (Sandy and Verscharen 2001). The results presented in Paper I extend the previous knowledge and support the human findings: In a large pool of more than a hundred OA synovial fluids, we detected both ARGS and FFGV carrying fragments, and found upon quantification by Western blot that aggrecanase generated ARGS fragments were 2.7 times more abundant in OA synovial fluid than MMP generated FFGV fragments. Our results indicate that even though there is an MMP driven aggrecanolysis in OA, aggrecanase activity seems to be the greatest contributor to harmful aggrecan degradation in OA.

## Aggrecanase cleavage in the IGD contra the CS2 domain in health and disease (Paper II)

In Paper II we narrowed our focus to aggrecanase generated fragments carrying either the ARGS neoepitope or the G3 domain. With the three major G3 fragments having C-terminals created by aggrecanase cleavage in the CS2 domain (GRGT-G3, GLGS-G3, and AGEK-G3; Figure 4), we could thus study both IGD activity per se, through the ARGS concentrations, and we could examine the proportional activity of aggrecanases towards the IGD and the CS2 domain, through the ratio of ARGS to G3. We did so in a cross-sectional material comparing patient groups with different diagnoses.

Our findings of elevated levels of ARGS in acute injury and acute inflammatory arthritis showed that the previously noted elevated release of aggrecan into synovial fluid in these groups (Lohmander et al. 1989; Lohmander et al. 1999; Månsson et al. 2001) is in fact to a major part due to aggrecanase proteolysis of the IGD. This was previously indicated by others (Hughes et al. 1995; Sandy and Verscharen 2001). By quantification of ARGS and G3 containing bands, we extended our understanding and found that also the proportion ARGS to G3 was elevated in these two groups, indicating a high relative pathological cleavage of the IGD in these groups. Interestingly, the ARGS to G3 ratio was also elevated in the knee OA group, a group which had SF ARGS levels no different from those in knee healthy references (Paper II), or elevated to a lesser degree than in acute injury or inflammation (Paper III). It appears that in knee OA, where the aggrecanase activity towards the Glu-Ala bond in the IGD is little (Paper III) or no different (Paper II) from knee healthy references, the proportion of cleavage in IGD contra CS2 has shifted towards the relatively more pathological IGD cleavage of the Glu-Ala bond also seen in groups with elevated SF ARGS levels.

What can explain such a shift in preference of cleavage? The literature is far from conclusive: We know that ADAMTS-5 is the primary pathological aggrecanase in mice (Glasson et al. 2005; Stanton et al. 2005). In humans both ADAMTS-4 and ADAMTS-5 appear to be involved (Song et al. 2007), but it is not clear whether one or both are dominating in pathology. It seems that ADAMTS-5 is constitutively expressed in human cartilage, whereas ADAMTS-4 expression is induced by proinflammatory cytokines (Bau et al. 2002; Naito et al. 2007). In bovine cartilage explants the reverse has however been shown to occur after injury, where ADAMTS-5 expression was elevated for a longer time and to a much greater extent than ADAMTS-4 expression was (Lee et al. 2009). Both aggrecanases cleave human aggrecan within the IGD, although ADAMTS-4 is much less efficient than ADAMTS-5 (Roughley et al. 2003; Gendron et al. 2007). Both enzymes are affected by posttranslational truncation; truncation of ADAMTS-5 renders a reduced IGD activity (Gendron et al. 2007), whereas truncation of ADAMTS-4 has, in conflicting studies, been shown to either reduce (Gendron et al. 2007) or increase (Gao et al. 2002) the proteolytic activity against the IGD by the enzyme. It is difficult to draw conclusions from these conflicting studies, other than that both altered expression of, and altered posttranslational truncation of either or both enzymes are likely to be involved. It also appears that different aggrecanases are upregulated in humans in inflammation (ADAMTS-4) and after injury (ADAMTS-5) (Bau et al. 2002; Naito et al. 2007).

Although posttranslational truncation of the ADAMTS was shown to alter the preference of cleavage sites, other explanations are possible. There are, for example, heterogeneities in aggrecan distribution in the ECM, with newly synthesized full length aggrecan in the pericellular zone, and an older pool of aggrecan further away from the chondrocyte that to a higher extent is truncated in the CS2 domain. Aggrecanase IGD activity towards a pool of aggrecan with a high proportion of the aggrecan truncated in the CS2 would yield a higher ARGS to G3 ratio, than IGD activity towards a pool of predominantly intact aggrecan. Plaas and colleagues showed that ADAMTS-5 was predominantly colocalized with HA in association with cells throughout normal cartilage and was markedly increased in OA (Plaas et al. 2007). ADAMTS-4 was not detected in normal cartilage, but was detectable at the surface of the OA cartilage (Plaas et al. 2007). With an apparent heterogeneity in the matrix around the cell of both the aggrecanases and the differently aged pools of aggrecan, an altered balance in expression of the aggrecanases could thus influence the ARGS to G3 ratio.

## Interpretations of SF ARGS levels increased above normal (Papers II and III)

The most straightforward interpretation of the increased SF levels of ARGS seen in acute inflammation, acute injury (Papers II and III) and in knee OA (Paper III), is that it is caused by an enhanced aggrecanase activity towards the IGD. This could for the same reasons as given above, be caused by enhanced expression and altered posttranslational truncation of the aggrecanases. Possibly, reduced levels of TIMP-3, a potent inhibitor of

both aggrecanases (Kashiwagi, Tortorella et al. 2001), could be involved. Additional factors, however, need to be considered.

*Firstly*, not only enhancement of the release of matrix molecules into the joint cavity, but also the clearance kinetics from the joint cavity affects the concentration in synovial fluid. It has been demonstrated that there is an accelerated clearance of albumin from canine osteoarthritic knee joints with a low grade of synovitis (Myers et al. 1996). Also in human inflammatory disease there are indications of accelerated clearance of albumin (Simkin 1999). Taking these findings on clearance rates of albumin into account, we possibly underestimate the release of ARGS aggrecan into the synovial fluid in acute inflammatory arthritis, which is the group with the most elevated levels of ARGS. This could also be the case for the knee OA group, with a presence of inflammation. Regarding acute and chronic injury, a steady state between release of molecules into the joint and clearance from the joint is established after an initial imbalance (Simkin and Bassett 1995). It is therefore possible that the temporal changes in SF ARGS after injury not only are a reflection of temporal changes of release of ARGS aggrecan into the synovial fluid, but also to some part are a reflection of a transition from an imbalance to a steady state of release and clearance.

*Secondly*, enhanced substrate level in the form of enhanced synthesis of aggrecan in combination with a steady state pool of aggrecanases could serve as an alternate explanation for elevated levels of ARGS in synovial fluid. However, as discussed in Paper III, this should result in an elevation of aggrecan G3 domain, which we did not see in any of the groups with levels of ARGS elevated above normal. It can however not be ruled out that this occurs to some extent, and at some stage of disease – a fact which is important for the interpretations of findings in Paper IV, which will be discussed below.

Although these additional factors cannot be completely ruled out, I suggest that increased aggrecanase cleavage in the IGD best explains the elevated levels of SF ARGS seen in these patients, and that there are many possible reasons for this increased activity, including altered expression of, altered posttranslational truncation of, or reduced inhibition of either ADAMTS-4 or ADAMTS-5 or both enzymes.

## Aggrecan ARGS as a biomarker (Papers II, III and IV)

As outlined by Bauer et al., diagnostic markers are defined by the ability to classify individuals as either diseased or non-diseased (Bauer et al. 2006). In Paper II, ARGS aggrecan was identified as a candidate diagnostic marker; in a relatively small number of individuals we found that synovial fluid levels of ARGS aggrecan, measured by quantitative Western blots, were elevated in acute injury and in acute inflammation compared to knee healthy individuals. Many publications have shown similar data for synovial fluid levels of aggrecan without specification of proteolytic cleavage (Saxne et al. 1985; Saxne et al. 1986; Lohmander et al. 1989; Dahlberg et al. 1992; Saxne et al. 1993; Lohmander et al. 1998; Lohmander et al. 1999). We however used a novel quantitative Western blot technique where we could compare levels of different aggrecan fragments, allowing more detailed information on the underlying biology, as discussed above.

In Paper III we narrowed our focus to the ARGS neoepitope, quantified using a newly developed ELISA, increased the number of samples ten-fold, and found elevated levels of ARGS aggrecan not only in acute inflammation and acute injury, but also in chronic injury and in knee OA. Using the assays not specific for this neoepitope, aggrecan levels were elevated above normal only in acute inflammation and acute injury. This was reflected also in the ROC curve analysis where the AUC was 82% for ARGS aggrecan, which was about twice as high as for the glycosaminoglycan or 1-F21 aggrecan (Table 3). Similar high AUCs have been published for urinary levels of the collagen marker CTX-II when studying healthy individuals compared to those with hip (92%) or knee OA (82%) (Jung et al. 2004), and release of this fragment of collagen into synovial fluid is known to be an early event after injury and in knee OA (Lohmander et al. 2003).

Increased levels of ARGS aggrecan in synovial fluid could thus, in similarity with CTX-II, qualify as a diagnostic marker for pathology in the proposed BIPEDS classification of OA biomarkers (Bauer et al. 2006; Byers-Kraus et al. 2010).

In Paper IV, we continued to explore SF ARGS as a biomarker in a cohort of patients meniscectomized some 18 years earlier, and did so with a more sensitive ARGS MSD immunoassay better suited for analyses of samples low in ARGS than the ARGS ELISA used in Paper III. We found that SF ARGS levels did not differ between operated individuals and un-operated control subjects, did not differ in patients diagnosed with or without ROA, and no correlation was seen between SF ARGS and severity of radiographic features alone or in combination. In these patients SF ARGS was thus not a diagnostic marker for meniscectomy or radiographic OA, nor was it a burden of disease marker for severity of radiographic features of OA. We however noted that within these low and seemingly normal SF ARGS levels 18 years after meniscectomy, there was an association between SF ARGS and progression of JSN by one grade or more in the following 7.5 years. The association was however negative, with increasing levels of SF ARGS associated with decreasing risk of progression of JSN. No significant association was found between SF ARGS and progression of the osteophyte (OST) score, but there was a trend for decreasing risk of progression with increasing levels of SF ARGS.

The negative association between SF ARGS and progression of JSN was surprising, since we hypothesized that increasing levels would be associated with increasing risk of radiographic progression of OA, as has been shown for CTX-II (Garnero et al. 2002a; Garnero et al. 2002b; Reijman et al. 2004). The ARGS neoepitope can, however, reflect aggrecanolytic mature and to a large extent truncated forms of aggrecan, as well as newly synthesized full length aggrecan. As discussed above in *Interpretations of SF ARGS levels enhanced above normal (Papers II and III)*, we could by quantification of both ARGS and G3 conclude that the SF ARGS levels above normal seen in acute inflammation and after acute injury to a major part was caused by an enhanced aggrecanolytic of aged aggrecan already truncated in the CS domains. In the meniscectomized patients we quantified only ARGS neoepitope and were thus blinded as to what type of aggrecan – newly synthesized or older and truncated – was degraded. Our group has previously shown that synthesis of aggrecan is 2-fold elevated early after a knee injury and remains elevated at that level for up to 20 years (Lohmander et al. 1999). In Paper IV we therefore propose that within the



normal levels of SF ARGS seen in these patients 18 years after meniscectomy, high levels is a reflection of a tissue repair response involving synthesis of aggrecan in combination with aggrecanase activity. This would explain both a release of ARGS aggrecan into synovial fluid of high within normal levels, and a decreased risk of progression of JSN due to an at least partly successful incorporation of newly synthesized aggrecan into the tissue.

Results presented in this thesis do not support a Burden of disease classification of SF ARGS, since no correlation was seen between SF ARGS and radiographic severity (Paper IV). Interestingly, we have in a co-authored manuscript not belonging to this thesis, noted a significant correlation between SF ARGS and radiographic severity of knee OA in ageing rhesus monkeys supporting a Burden of disease classification in that species (Chockalingam, Sun, Rivera-Bermudez, Zeng, Dufield, Larsson, Lohmander, Flannery, Glasson, Georgiadis and Morris, submitted manuscript). Results from the same study on aggrecanase inhibition in a meniscal tear rat model clearly showed differences in SF ARGS levels with or without inhibition, thus strongly supporting an Efficacy of intervention classification for SF ARGS.

Taken together, SF ARGS qualifies in a number of the BIPEDS categories and has already proven useful in research and development. However, one of its strengths is also one of its greatest weaknesses: Marker levels in SF are more certain to reflect joint processes than marker levels in blood or urine, but with joint fluid being more difficult to obtain than blood or urine, SF markers are unlikely as routine diagnostic tools in the clinic. One also needs to be careful in the interpretation of SF ARGS, since alterations in the level of ARGS, unlike CTX-II, can be reflected by alterations both in synthesis and degradation, which in the section below is proposed to be important in diseases or stages of disease with relatively low levels of SF ARGS, but not in those with high levels of SF ARGS.

## Aggrecan metabolism in knee injury

Using data presented in this thesis in combination with previously published data (Lohmander et al. 1999), Figure 7 is a summary of metabolic release into SF of two types of aggrecan fragments in a cross-sectional cohort of patients with previous knee injury (Figure 7, circles) or meniscectomy (Figure 7, black square). SF levels of the CS846 epitope present on newly synthesized aggrecan represent an anabolic activity, and SF levels of ARGS aggrecan generated by aggrecanase cleavage in the IGD, represents a catabolic activity. It is evident from the data in figure 7 that both anabolism and catabolism is altered after a knee trauma compared to knee healthy references. Synthesis is enhanced early after injury and remains enhanced for many years; this results in a 2-fold enhanced level of the CS846 epitope in the synovial fluid over many years (Lohmander et al. 1999) (Figure 7, grey circles, yellow area). Aggrecanase degradation in the IGD is greatly enhanced in the ten first weeks after injury, and thereafter falls to more moderate levels; this can be seen as an immediate but with time diminishing elevation in the release of ARGS aggrecan into the synovial fluid (Figure 7, black circles, red area). Even so, the levels of ARGS are still altered compared to knee healthy individuals (dotted line, green area), and the range between individuals is substantially greater than in health, and also greater than the range

seen for release of the CS846 epitope of newly synthesized aggrecan. We know that SF ARGS levels 18 years after meniscectomy on the average do not differ from average levels seen in knee healthy, un-operated individuals (Figure 7, black square within green field), and, as discussed above, SF ARGS and progression are negatively associated, where an increase within normal range in SF ARGS is associated with a decreased risk of progression of JSN. We find that the most probable explanation for this negative association is that the high levels within normal range of SF ARGS seen in these patients is a reflection of a tissue repair response involving synthesis of aggrecan in combination with aggrecanase activity.

The coloured areas in Figure 7 are a generalized model of aggrecan metabolism after knee trauma based on the specific findings discussed above. Red area is SF ARGS, yellow area is SF CS846, and green area is SF ARGS in uninjured. I propose: (1) That the red area above the yellow represents a net detrimental aggrecanase activity leading to a net loss of aggrecan from the tissue – the balance of synthesis and degradation is tilted in favour of degradation. (2) That the red area below the yellow represents a net beneficial aggrecan synthesis leading to a net incorporation of aggrecan into the tissue – the balance of synthesis and degradation is tilted in favour of synthesis. According to this model, all individuals have an unbalance in synthesis and degradation in favour of degradation in the first 20 weeks after a knee trauma; thereafter there is heterogeneity with some individuals having an unbalance in synthesis and degradation in favour of degradation, and some in favour of synthesis. In the perspective of therapeutic interventions using aggrecanase inhibitors, all individuals would be aided by intervention in the first 20 weeks, thereafter individuals with an unbalance in favour of degradation would be more likely to be responsive to therapy. Discrimination of individual with an unbalance in favour of degradation from those in favour of synthesis could thus prove important, especially if intervention is expensive or have possible side effects, as are seen with inhibitors used in RA (Murdaca et al. 2009). SF ARGS alone is not likely to have this discriminative power, but the combination of ARGS and CS846 might prove to have this power.

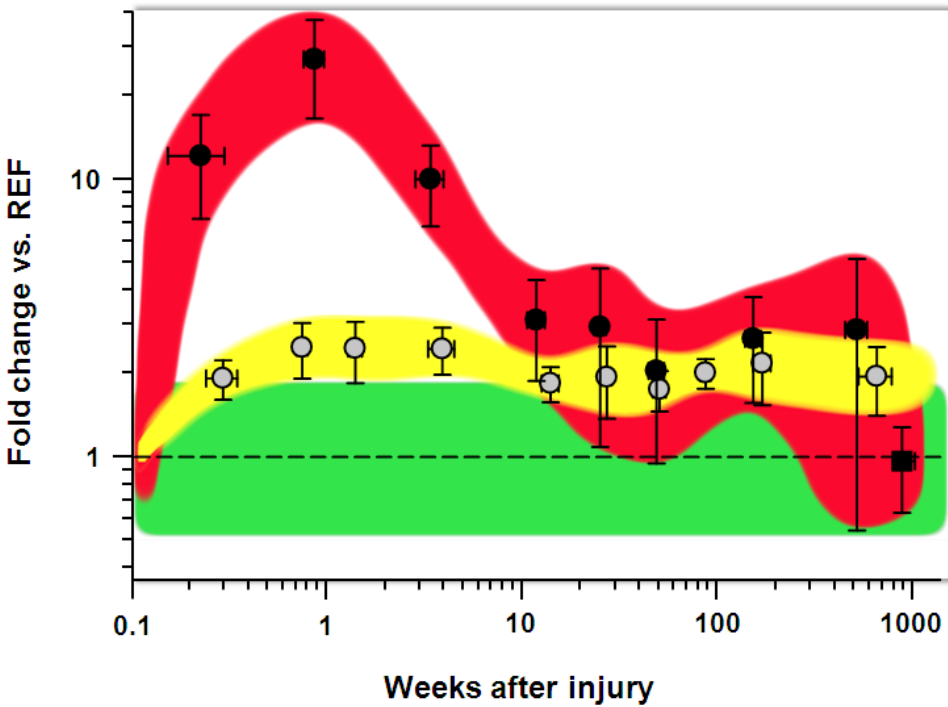

**Figure 7.** A model of aggrecan synthesis and degradation by aggrecanase IGD activity after knee injury.

*Data.*

Circles and square are medians with error bars at the 25<sup>th</sup> and 75<sup>th</sup> percentiles of data compiled from the cross-sectional convenience cohort used in Papers II and III (circles) and the meniscectomized cohort studied in Paper IV (square).

Black circles and square: ARGs aggrecan in SF (fold change versus knee healthy references, REF).

Grey circles: CS846 aggrecan (fold change versus REF).

Green area: The inter-quartile range of ARGs aggrecan in SF of knee healthy references normalized against the median level (dotted line).

Yellow area: The inter-quartile range of release of newly synthesized aggrecan.

Red area: The inter-quartile range of release of aggrecan generated by aggrecanase IGD activity.

*Model.*

1) Red area above the yellow represents a net detrimental aggrecanase activity leading to a net loss of aggrecan from the tissue – the balance of synthesis and degradation is tilted in favour of degradation.

2) Red area below the yellow represents a net beneficial aggrecan synthesis leading to a net incorporation of aggrecan into the tissue – the balance of synthesis and degradation is tilted in favour of synthesis.

Note: This figure is based on data from the papers of this thesis (Black square: SF ARGs by HABR/OA-1 ARGs MSD on the meniscectomy cohort), and also from an earlier publication not part of this thesis (Grey circles: CS846 by ELISA) (Lohmander et al. 1999), and from data on the same patients as published in Paper III, but here analyzed with an HABR/BC-3 ARGs ELISA (Chockalingam et al. 2009).

# Conclusions

We have progressed beyond John Kent Spender, whom 122 years ago started the search for disease mechanisms and for biomarkers helping in diagnosing OA (Spender 1888). The work presented here has contributed some new insights into the biology of OA and expanded the knowledge in the field of OA biomarkers. My main conclusions from this work are:

- Both an MMP and an aggrecanase pathway for aggrecan degradation exist in OA, but proteases of the aggrecanase family are the major proteases responsible for aggrecanolysis in OA.
- The proportion of aggrecan released into synovial fluid carrying the aggrecanase generated ARGS neoepitope is higher in disease compared to in health, and is higher in groups associated with high disease activity.
- The proportion of aggrecanase cleavage in the IGD versus cleavage in the CS2 domain varies between health and disease, with higher proportion of IGD cleavage being associated with high disease activity.
- Quantification of synovial fluid levels of the aggrecanase generated ARGS neoepitope is a better diagnostic marker for knee pathology than aggrecan or glycosaminoglycan concentrations determined by assays not specific for this neoepitope.
- The increased release of ARGS into synovial fluid seen early after a knee trauma is to the major part caused by an increased aggrecanase IGD activity, whereas the moderately increased release of ARGS seen long after knee trauma, likely is reflected by a combination of increased aggrecan synthesis and aggrecanase IGD activity.
- SF ARGS 18 years after meniscectomy is weakly prognostic of radiographic OA, but is unrelated to severity of radiographic OA in the human cohort studied.



# Future perspectives

The utility of a synovial fluid biomarker such as ARGS aggrecan as a clinical diagnostic tool is doubtful, both regarding the difficulty in obtaining the body fluid, and the diagnostic or prognostic value for the individual. The solution of the first part could be to validate ARGS as a serum marker – although this introduces the uncertainty of origin of the ARGS fragments, in OA involving more than one joint. The latter part deserves consideration:

It is unlikely that one biomarker will be able to tell the whole story; there are many parts to the degeneration of cartilage in disease, and there seem to be a clearly defined order in which they appear (Heinegård 2007). I therefore believe that the future lies in the combination of markers, both as a means to better understand the biology involved, and as a means to enhance the diagnostic or predictive powers in the analysis and lift it beyond the group level into the individual and the clinic. With recent evidence of both type II collagenolysis by MMP-13 (Little et al. 2009), and aggrecanolysis by ADAMTS-5 (Glasson et al. 2005; Stanton et al. 2005), being crucial for OA pathology in mice (but most likely acting at different stages of disease) it would be interesting to study post-traumatic temporal changes in aggrecanolysis and type II collagenolysis by combining ARGS and CTX-II. It would, of course, also be interesting to test the hypothesis that the combination of ARGS and CS846 holds better discriminative power than ARGS alone.

Finally, I believe the most important aspect of knee OA in the patients' perspective, symptoms and function of the knee, has only briefly been mentioned, and it would be intriguing to see how they relate to SF ARGS.



# Acknowledgements

I would like to express my deep and sincere gratitude to all those whom in any way have been involved in the making of this work, with special thanks to:

*Stefan Lohmander*, my supervisor, for being a true coach in the ways of science and not always answering my questions, but instead quietly pushing me in the right direction and letting me find out for myself.

*André Struglics*, my co-advisor, for guiding me in the world of protein chemistry and being always patient and a good role model in the laboratory, and for great support and encouragement throughout this work.

*Ewa Roos*, my co-advisor in the beginning of this work; although you may feel that your scientific input in this work was too small for you to stay on as a co-advisor, your input on my way of thinking about science has been profound. I would never have started this work without you onboard.

*Maria Hansson*, my team mate in the laboratory, for always lending a helping hand whenever I needed, for amusing conversation during long sessions in the laboratory, and for spreading joy in our group. With a very special thanks for performing the Western blots in Paper II when I could not.

*Martin Englund*, for a most fruitful and interesting collaboration in Paper IV, for guiding me in the world of meniscectomy, and for teaching me when the likelihood of erroneous usage of the word risk was at risk in the calculations of odds ratios. All remaining mistakes are mine.

*Jan-Åke Nilsson*, for patiently guiding me in world of statistics.

All members, present and past, of the *doctoral student network*; I was invited to join long before I knew that I was going to become a doctoral student (again; the subtleties of good coaching by Stefan and Ewa) and your good spirits and enthusiasm for science and osteoarthritis has been a great inspiration.

All past and present *C12-colleagues*, for great laughs and conversations around the coffee table. Many ideas have been born or tested at coffee and lunch.

*Sanjay Kumar* and *Mikael Pratta*, for all help in the development of the KS/OA-1 ELISA, for giving it to us when it proved not commercially successfully, and for providing us with antibodies, enzymes and peptides.



*Priya Chockalingam*, for so kindly providing detailed knowledge and information on her HABR/BC-3 ARGS ELISA, and for letting me use her data on our samples for Figure 7 in this thesis.

*Magnus Tägil*, for swift evaluation of Berta Röntgens hand x-ray. (The plate was taken 1895, the answer came 2010 – I wonder if Berta knew she had hand OA?)

*Matthias Mörgelin*, for helping me with the cover illustration by providing an EM picture of the main character of this book.

*Pilar Lorenzo*, for so kindly letting me use your iconic picture of articular cartilage.

*Lena Ström*, for leading the way and showing me that this is possible.

My parents, *Björn* and *Elisabeth*, and my brother *Torbjörn*, for both telling me, and showing me with your own actions that “Yes, you can!” long before Barack Obama made it a common phrase.

And finally, but most importantly, my dear family – my wife *Petra*, and my children *Ella*, *Johannes*, *Sara* and *Lisa* – without your support and love this would not have been possible. You have been my lifebuoy throughout this work.

# References

- Abramson, S. B. (2004). "Inflammation in osteoarthritis." *J Rheumatol Suppl* 70: 70-6.
- Abramson, S. B. and M. Attur (2009). "Developments in the scientific understanding of osteoarthritis." *Arthritis Res Ther* 11(3): 227.
- Altman, R. D., M. Hochberg, W. A. Murphy, Jr., F. Wolfe and M. Lequesne (1995). "Atlas of individual radiographic features in osteoarthritis." *Osteoarthritis Cartilage* 3 Suppl A: 3-70.
- Altman, R. D. and G. E. Gold (2007). "Atlas of individual radiographic features in osteoarthritis, revised." *Osteoarthritis Cartilage* 15 Suppl A: A1-56.
- Arner, E. C., C. E. Hughes, C. P. Decicco, B. Caterson and M. D. Tortorella (1998). "Cytokine-induced cartilage proteoglycan degradation is mediated by aggrecanase." *Osteoarthritis Cartilage* 6(3): 214-28.
- Atley, L. M., L. Sharma, J. D. Clemens, K. Shaffer, T. A. Pietka, J. A. Riggins and D. Eyre (2000). "The collagen II CTx degradation marker is generated by collagenase 3 and in urine reflects disease burden in knee OA patients." *Trans Orthop Res Soc* 25: 168.
- Barry, F. P., L. C. Rosenberg, J. U. Gaw, T. J. Koob and P. J. Neame (1995). "N- and O-linked keratan sulfate on the hyaluronan binding region of aggrecan from mature and immature bovine cartilage." *J Biol Chem* 270(35): 20516-24.
- Bau, B., P. M. Gebhard, J. Haag, T. Knorr, E. Bartnik and T. Aigner (2002). "Relative messenger RNA expression profiling of collagenases and aggrecanases in human articular chondrocytes in vivo and in vitro." *Arthritis Rheum* 46(10): 2648-57.
- Bauer, D. C., D. J. Hunter, S. B. Abramson, M. Attur, M. Corr, D. Felson, D. Heinegård, J. M. Jordan, T. B. Kepler, N. E. Lane, T. Saxne, B. Tyree and V. B. Kraus (2006). "Classification of osteoarthritis biomarkers: a proposed approach." *Osteoarthritis Cartilage* 14(8): 723-7.
- Bayliss, M. T., S. Howat, C. Davidson and J. Dudhia (2000). "The organization of aggrecan in human articular cartilage. Evidence for age-related changes in the rate of aggregation of newly synthesized molecules." *J Biol Chem* 275(9): 6321-7.
- Björnsson, S. (1993). "Simultaneous preparation and quantitation of proteoglycans by precipitation with alcian blue." *Anal Biochem* 210(2): 282-91.
- Burnette, W. N. (1981). "'Western blotting': electrophoretic transfer of proteins from sodium dodecyl sulfate--polyacrylamide gels to unmodified nitrocellulose and radiographic detection with antibody and radioiodinated protein A." *Anal Biochem* 112(2): 195-203.

- Byers-Kraus, V., M. Nevitt and L. J. Sandell (2010). "Summary of the OA Biomarkers Workshop 2009 Biochemical Biomarkers: Biology, Validation, and Clinical Studies." *Osteoarthritis Cartilage* In press.
- Caterson, B., C. R. Flannery, C. E. Hughes and C. B. Little (2000). "Mechanisms involved in cartilage proteoglycan catabolism." *Matrix Biol* 19(4): 333-44.
- Charni-Ben Tabassi, N. and P. Garnero (2007). "Monitoring cartilage turnover." *Curr Rheumatol Rep* 9(1): 16-24.
- Chockalingam, P. S., W. Sun, M. Rivera-Bermudez, S. Glasson, J. Lee, S. Larsson, L. S. Lohmander, K. E. Georgiadis and E. A. Morris (2009). "049 Joint injury leads to significantly increased aggrecanase activity in humans and preclinical animal models" *Osteoarthritis Cartilage* 17(Supplement 1): S34-S35.
- Chowdhury, F., A. Williams and P. Johnson (2009). "Validation and comparison of two multiplex technologies, Luminex and Mesoscale Discovery, for human cytokine profiling." *J Immunol Methods* 340(1): 55-64.
- Copeman, W. S. C. (1964). *A short history of the gout and the rheumatic diseases*. Berkeley and Los Angeles, California, University of California Press.
- Crowther, J. R. (1995). "ELISA. Theory and practice." *Methods Mol Biol* 42: 1-218.
- Dahlberg, L., L. Ryd, D. Heinegård and L. S. Lohmander (1992). "Proteoglycan fragments in joint fluid. Influence of arthrosis and inflammation." *Acta Orthop Scand* 63(4): 417-23.
- Dahlberg, L., T. Friden, H. Roos, M. W. Lark and L. S. Lohmander (1994). "A longitudinal study of cartilage matrix metabolism in patients with cruciate ligament rupture-synovial fluid concentrations of aggrecan fragments, stromelysin-1 and tissue inhibitor of metalloproteinase-1." *Br J Rheumatol* 33(12): 1107-11.
- Day, J. M., A. I. Olin, A. D. Murdoch, A. Canfield, T. Sasaki, R. Timpl, T. E. Hardingham and A. Aspberg (2004). "Alternative splicing in the aggrecan G3 domain influences binding interactions with tenascin-C and other extracellular matrix proteins." *J Biol Chem* 279(13): 12511-8.
- De Gruttola, V. G., P. Clax, D. L. DeMets, G. J. Downing, S. S. Ellenberg, L. Friedman, M. H. Gail, R. Prentice, J. Wittes and S. L. Zeger (2001). "Considerations in the evaluation of surrogate endpoints in clinical trials. summary of a National Institutes of Health workshop." *Control Clin Trials* 22(5): 485-502.
- Deaver, D. R. (1995). "A new non-isotopic detection system for immunoassays." *Nature* 377(6551): 758-60.
- Dieppe, P. A. and L. S. Lohmander (2005). "Pathogenesis and management of pain in osteoarthritis." *Lancet* 365(9463): 965-73.
- Doerge, K. J., M. Sasaki, T. Kimura and Y. Yamada (1991). "Complete coding sequence and deduced primary structure of the human cartilage large aggregating proteoglycan, aggrecan. Human-specific repeats, and additional alternatively spliced forms." *J Biol Chem* 266(2): 894-902.

- Dudhia, J., C. M. Davidson, T. M. Wells, D. H. Vynios, T. E. Hardingham and M. T. Bayliss (1996). "Age-related changes in the content of the C-terminal region of aggrecan in human articular cartilage." *Biochem J* 313 ( Pt 3): 933-40.
- Elsaid, K. A. and C. O. Chichester (2006). "Review: Collagen markers in early arthritic diseases." *Clin Chim Acta* 365(1-2): 68-77.
- Englund, M. and L. S. Lohmander (2004). "Risk factors for symptomatic knee osteoarthritis fifteen to twenty-two years after meniscectomy." *Arthritis Rheum* 50(9): 2811-9.
- Englund, M. and L. S. Lohmander (2005). "Patellofemoral osteoarthritis coexistent with tibiofemoral osteoarthritis in a meniscectomy population." *Ann Rheum Dis* 64(12): 1721-6.
- Evans, B. G. (2007). *The knee. Essentials of orthopedic surgery.* S. W. Weisel and J. N. Delahay. New York, Springer New York: 454-471.
- Eyre, D. R., S. Apon, J. J. Wu, L. H. Ericsson and K. A. Walsh (1987). "Collagen type IX: evidence for covalent linkages to type II collagen in cartilage." *FEBS Lett* 220(2): 337-41.
- Felson, D. T. (2003). *Epidemiology of osteoarthritis.* K. D. Brandt, M. Doherty and L. S. Lohmander. Oxford, Oxford University Press: 9-16.
- Flannery, C. R., M. W. Lark and J. D. Sandy (1992). "Identification of a stromelysin cleavage site within the interglobular domain of human aggrecan. Evidence for proteolysis at this site in vivo in human articular cartilage." *J Biol Chem* 267(2): 1008-14.
- Flores, R. H. and M. C. Hochberg (2003). *Definition and classification of osteoarthritis.* K. D. Brandt, M. Doherty and L. S. Lohmander. Oxford, Oxford University Press: 1-8.
- Fosang, A. J., K. Last, P. Gardiner, D. C. Jackson and L. Brown (1995). "Development of a cleavage-site-specific monoclonal antibody for detecting metalloproteinase-derived aggrecan fragments: detection of fragments in human synovial fluids." *Biochem J* 310 (Pt 1): 337-43.
- Fosang, A. J. and C. B. Little (2008). "Drug insight: aggrecanases as therapeutic targets for osteoarthritis." *Nat Clin Pract Rheumatol* 4(8): 420-7.
- Fosang, A. J., K. Last, H. Stanton, S. B. Golub, C. B. Little, L. Brown and D. C. Jackson (2010). *Neoepitope antibodies against MMP-cleaved and aggrecanase-cleaved aggrecan.* Matrix Metalloproteinase Protocols. I. M. Clark. New York, Humana Press; Springer. 622: 312-47.
- Fushimi, K., L. Troeberg, H. Nakamura, N. H. Lim and H. Nagase (2008). "Functional differences of the catalytic and non-catalytic domains in human ADAMTS-4 and ADAMTS-5 in aggrecanolytic activity." *J Biol Chem* 283(11): 6706-16.
- Gao, G., J. Westling, V. P. Thompson, T. D. Howell, P. E. Gottschall and J. D. Sandy (2002). "Activation of the proteolytic activity of ADAMTS4 (aggrecanase-1) by C-terminal truncation." *J Biol Chem* 277(13): 11034-41.

- Garnero, P., M. Piperno, E. Gineyts, S. Christgau, P. D. Delmas and E. Vignon (2001). "Cross sectional evaluation of biochemical markers of bone, cartilage, and synovial tissue metabolism in patients with knee osteoarthritis: relations with disease activity and joint damage." *Ann Rheum Dis* 60(6): 619-26.
- Garnero, P., X. Ayral, J. C. Rousseau, S. Christgau, L. J. Sandell, M. Dougados and P. D. Delmas (2002a). "Uncoupling of type II collagen synthesis and degradation predicts progression of joint damage in patients with knee osteoarthritis." *Arthritis Rheum* 46(10): 2613-24.
- Garnero, P., R. Landewe, M. Boers, A. Verhoeven, S. Van Der Linden, S. Christgau, D. Van Der Heijde, A. Boonen and P. Geusens (2002b). "Association of baseline levels of markers of bone and cartilage degradation with long-term progression of joint damage in patients with early rheumatoid arthritis: the COBRA study." *Arthritis Rheum* 46(11): 2847-56.
- Gendron, C., M. Kashiwagi, N. H. Lim, J. J. Enghild, I. B. Thogersen, C. Hughes, B. Caterson and H. Nagase (2007). "Proteolytic activities of human ADAMTS-5: comparative studies with ADAMTS-4." *J Biol Chem* 282(25): 18294-306.
- Gilmore, R. S. and A. J. Palfrey (1988). "Chondrocyte distribution in the articular cartilage of human femoral condyles." *J Anat* 157: 23-31.
- Gineyts, E., J. A. Mo, A. Ko, D. B. Henriksen, S. P. Curtis, B. J. Gertz, P. Garnero and P. D. Delmas (2004). "Effects of ibuprofen on molecular markers of cartilage and synovium turnover in patients with knee osteoarthritis." *Ann Rheum Dis* 63(7): 857-61.
- Glasson, S. S., R. Askew, B. Sheppard, B. Carito, T. Blanchet, H. L. Ma, C. R. Flannery, D. Peluso, K. Kanki, Z. Yang, M. K. Majumdar and E. A. Morris (2005). "Deletion of active ADAMTS5 prevents cartilage degradation in a murine model of osteoarthritis." *Nature* 434(7033): 644-8.
- Grey, H. (1918). *Anatomy of the human body*. Philadelphia, Lea & Febiger; Bartleby.com 2000.
- Hardingham, T. (1998). "Chondroitin sulfate and joint disease." *Osteoarthritis Cartilage* 6 Suppl A: 3-5.
- Hardingham, T. E. and H. Muir (1972). "The specific interaction of hyaluronic acid with cartilage proteoglycans." *Biochim Biophys Acta* 279(2): 401-5.
- Hascall, V. C. and S. W. Sajdera (1969). "Proteinpolysaccharide complex from bovine nasal cartilage. The function of glycoprotein in the formation of aggregates." *J Biol Chem* 244(9): 2384-96.
- Hascall, V. C. and D. Heinegård (1974). "Aggregation of cartilage proteoglycans. I. The role of hyaluronic acid." *J Biol Chem* 249(13): 4232-41.
- Hashimoto, G., T. Aoki, H. Nakamura, K. Tanzawa and Y. Okada (2001). "Inhibition of ADAMTS4 (aggrecanase-1) by tissue inhibitors of metalloproteinases (TIMP-1, 2, 3 and 4)." *FEBS Lett* 494(3): 192-5.

- Hedlund, H., S. Mengarelli-Widholm, D. Heinegård, F. P. Reinholt and O. Svensson (1994). "Fibromodulin distribution and association with collagen." *Matrix Biol* 14(3): 227-32.
- Heinegård, D., Y. Sommarin and W. C. Leon (1987). [17] Isolation and characterization of proteoglycans. *Methods in Enzymology*, Academic Press. Volume 144: 319-372.
- Heinegård, D., M. T. Bayliss and P. Lorenzo (2003). Biochemistry and metabolism of normal and osteoarthritic cartilage. *Osteoarthritis*. K. D. Brandt, M. Doherty and L. S. Lohmander. Oxford, Oxford University Press: 73-82.
- Heinegård, D. (2007). Cartilage matrix destruction. *Bone and osteoarthritis*. F. Bronner and M. C. Farach-Carson. London, Springer. 4: 81-95.
- Heinegård, D. (2009). "Proteoglycans and more – from molecules to biology." *Int J Exp Pathol* 90(6): 575-86.
- Hughes, C. E., B. Caterson, A. J. Fosang, P. J. Roughley and J. S. Mort (1995). "Monoclonal antibodies that specifically recognize neoepitope sequences generated by 'aggrecanase' and matrix metalloproteinase cleavage of aggrecan: application to catabolism in situ and in vitro." *Biochem J* 305 ( Pt 3): 799-804.
- Jordan, K. M., H. E. Syddall, P. Garnero, E. Gineyts, E. M. Dennison, A. A. Sayer, P. D. Delmas, C. Cooper and N. K. Arden (2006). "Urinary CTX-II and glucosyl-galactosyl-pyridinoline are associated with the presence and severity of radiographic knee osteoarthritis in men." *Ann Rheum Dis* 65(7): 871-7.
- Jung, M., S. Christgau, M. Lukoschek, D. Henriksen and W. Richter (2004). "Increased urinary concentration of collagen type II C-telopeptide fragments in patients with osteoarthritis." *Pathobiology* 71(2): 70-6.
- Kashiwagi, M., M. Tortorella, H. Nagase and K. Brew (2001). "TIMP-3 is a potent inhibitor of aggrecanase 1 (ADAM-TS4) and aggrecanase 2 (ADAM-TS5)." *J Biol Chem* 276(16): 12501-4.
- Kellgren, J. H. and J. S. Lawrence (1957). "Radiological assessment of osteo-arthritis." *Ann Rheum Dis* 16(4): 494-502.
- Kobayashi, T., Y. Yoshihara, A. Samura, H. Yamada, M. Shinmei, H. Roos and L. S. Lohmander (1997). "Synovial fluid concentrations of the C-propeptide of type II collagen correlate with body mass index in primary knee osteoarthritis." *Ann Rheum Dis* 56(8): 500-3.
- Kothari, M., A. Guermazi, G. von Ingersleben, Y. Miaux, M. Sieffert, J. E. Block, R. Stevens and C. G. Peterfy (2004). "Fixed-flexion radiography of the knee provides reproducible joint space width measurements in osteoarthritis." *Eur Radiol* 14(9): 1568-73.
- Kruskal, W. H. and W. A. Wallis (1952). "Use of Ranks in One-Criterion Variance Analysis." *Journal of the American Statistical Association* 47(260): 583-621.

- Lark, M. W., E. K. Bayne, J. Flanagan, C. F. Harper, L. A. Hoerrner, N. I. Hutchinson, Singer, II, S. A. Donatelli, J. R. Weidner, H. R. Williams, R. A. Mumford and L. S. Lohmander (1997). "Aggrecan degradation in human cartilage. Evidence for both matrix metalloproteinase and aggrecanase activity in normal, osteoarthritic, and rheumatoid joints." *J Clin Invest* 100(1): 93-106.
- Lee, J. H., J. B. Fitzgerald, M. A. Dimicco, D. M. Cheng, C. R. Flannery, J. D. Sandy, A. H. Plaas and A. J. Grodzinsky (2009). "Co-culture of mechanically injured cartilage with joint capsule tissue alters chondrocyte expression patterns and increases ADAMTS5 production." *Arch Biochem Biophys*.
- Little, C. B., A. Barai, D. Burkhardt, S. M. Smith, A. J. Fosang, Z. Werb, M. Shah and E. W. Thompson (2009). "Matrix metalloproteinase 13-deficient mice are resistant to osteoarthritic cartilage erosion but not chondrocyte hypertrophy or osteophyte development." *Arthritis Rheum* 60(12): 3723-33.
- Loeser, R. F. (2008). "Molecular mechanisms of cartilage destruction in osteoarthritis." *J Musculoskelet Neuronal Interact* 8(4): 303-6.
- Lohmander, L. S., S. De Luca, B. Nilsson, V. C. Hascall, C. B. Caputo, J. H. Kimura and D. Heinegård (1980). "Oligosaccharides on proteoglycans from the swarm rat chondrosarcoma." *J Biol Chem* 255(13): 6084-91.
- Lohmander, L. S., L. Dahlberg, L. Ryd and D. Heinegård (1989). "Increased levels of proteoglycan fragments in knee joint fluid after injury." *Arthritis Rheum* 32(11): 1434-42.
- Lohmander, L. S., L. A. Hoerrner, L. Dahlberg, H. Roos, S. Björnsson and M. W. Lark (1993a). "Stromelysin, tissue inhibitor of metalloproteinases and proteoglycan fragments in human knee joint fluid after injury." *J Rheumatol* 20(8): 1362-8.
- Lohmander, L. S., L. A. Hoerrner and M. W. Lark (1993b). "Metalloproteinases, tissue inhibitor, and proteoglycan fragments in knee synovial fluid in human osteoarthritis." *Arthritis Rheum* 36(2): 181-9.
- Lohmander, L. S., P. J. Neame and J. D. Sandy (1993c). "The structure of aggrecan fragments in human synovial fluid. Evidence that aggrecanase mediates cartilage degradation in inflammatory joint disease, joint injury, and osteoarthritis." *Arthritis Rheum* 36(9): 1214-22.
- Lohmander, L. S., H. Roos, L. Dahlberg, L. A. Hoerrner and M. W. Lark (1994). "Temporal patterns of stromelysin-1, tissue inhibitor, and proteoglycan fragments in human knee joint fluid after injury to the cruciate ligament or meniscus." *J Orthop Res* 12(1): 21-8.
- Lohmander, L. S., Y. Yoshihara, H. Roos, T. Kobayashi, H. Yamada and M. Shinmei (1996). "Procollagen II C-propeptide in joint fluid: changes in concentration with age, time after knee injury, and osteoarthritis." *J Rheumatol* 23(10): 1765-9.

- Lohmander, L. S., L. Dahlberg, D. Eyre, M. Lark, E. J. Thonar and L. Ryd (1998). "Longitudinal and cross-sectional variability in markers of joint metabolism in patients with knee pain and articular cartilage abnormalities." *Osteoarthritis Cartilage* 6(5): 351-61.
- Lohmander, L. S., M. Ionescu, H. Jugessur and A. R. Poole (1999). "Changes in joint cartilage aggrecan after knee injury and in osteoarthritis." *Arthritis Rheum* 42(3): 534-44.
- Lohmander, L. S., L. M. Atley, T. A. Pietka and D. R. Eyre (2003). "The release of cross-linked peptides from type II collagen into human synovial fluid is increased soon after joint injury and in osteoarthritis." *Arthritis Rheum* 48(11): 3130-9.
- Lohmander, L. S., K. D. Brandt, S. A. Mazzuca, S. Larsson, K. A. Lane, A. Struglics and B. P. Katz (2004). Plasma MMP-3 (stromelysin) levels reflect joint space narrowing in patients with knee osteoarthritis. *Osteoarthritis Cartilage*. 12: S10-S10.
- Lohmander, L. S., K. D. Brandt, S. A. Mazzuca, B. P. Katz, S. Larsson, A. Struglics and K. A. Lane (2005). "Use of the plasma stromelysin (matrix metalloproteinase 3) concentration to predict joint space narrowing in knee osteoarthritis." *Arthritis Rheum* 52(10): 3160-7.
- Mankin, H. J. and A. Z. Thrasher (1975). "Water content and binding in normal and osteoarthritic human cartilage." *J Bone Joint Surg Am* 57(1): 76-80.
- Mann, H. B. and D. R. Whitney (1947). "On a test of whether one of two random variables is stochastically larger than the other." *Annals of Mathematical Statistics* 18(1): 50-60.
- Maroudas, A., M. T. Bayliss, N. Uchitel-Kaushansky, R. Schneiderman and E. Gilav (1998). "Aggrecan turnover in human articular cartilage: use of aspartic acid racemization as a marker of molecular age." *Arch Biochem Biophys* 350(1): 61-71.
- Martel-Pelletier, J., D. Lajeunesse, H. Fahmi, G. Tardif and J. P. Pelletier (2006). "New thoughts on the pathophysiology of osteoarthritis: one more step toward new therapeutic targets." *Curr Rheumatol Rep* 8(1): 30-6.
- Martel-Pelletier, J., C. Boileau, J. P. Pelletier and P. J. Roughley (2008). "Cartilage in normal and osteoarthritis conditions." *Best Pract Res Clin Rheumatol* 22(2): 351-84.
- McNeil, B. J. and J. A. Hanley (1984). "Statistical approaches to the analysis of receiver operating characteristic (ROC) curves." *Med Decis Making* 4(2): 137-50.
- Mendler, M., S. G. Eich-Bender, L. Vaughan, K. H. Winterhalter and P. Bruckner (1989). "Cartilage contains mixed fibrils of collagen types II, IX, and XI." *J Cell Biol* 108(1): 191-7.
- Murdaca, G., B. M. Colombo and F. Puppo (2009). "Anti-TNF-alpha inhibitors: a new therapeutic approach for inflammatory immune-mediated diseases: an update upon efficacy and adverse events." *Int J Immunopathol Pharmacol* 22(3): 557-65.



- Murphy, G. and H. Nagase (2008). "Reappraising metalloproteinases in rheumatoid arthritis and osteoarthritis: destruction or repair?" *Nat Clin Pract Rheumatol* 4(3): 128-35.
- Myers, S. L., B. L. O'Connor and K. D. Brandt (1996). "Accelerated clearance of albumin from the osteoarthritic knee: implications for interpretation of concentrations of "cartilage markers" in synovial fluid." *J Rheumatol* 23(10): 1744-8.
- Månsson, B., D. Carey, M. Alini, M. Ionescu, L. C. Rosenberg, A. R. Poole, D. Heinegård and T. Saxne (1995). "Cartilage and bone metabolism in rheumatoid arthritis. Differences between rapid and slow progression of disease identified by serum markers of cartilage metabolism." *J Clin Invest* 95(3): 1071-7.
- Månsson, B., A. Gulfe, P. Geborek, D. Heinegård and T. Saxne (2001). "Release of cartilage and bone macromolecules into synovial fluid: differences between psoriatic arthritis and rheumatoid arthritis." *Ann Rheum Dis* 60(1): 27-31.
- Möller, H. J., F. S. Larsen, T. Ingemann-Hansen and J. H. Poulsen (1994). "ELISA for the core protein of the cartilage large aggregating proteoglycan, aggrecan: comparison with the concentrations of immunogenic keratan sulphate in synovial fluid, serum and urine." *Clin Chim Acta* 225(1): 43-55.
- Mörgelin, M., D. Heinegård, J. Engel and M. Paulsson (1994). "The cartilage proteoglycan aggregate: assembly through combined protein-carbohydrate and protein-protein interactions." *Biophys Chem* 50(1-2): 113-28.
- Nagase, H. and M. Kashiwagi (2003). "Aggrecanases and cartilage matrix degradation." *Arthritis Res Ther* 5(2): 94-103.
- Naito, S., T. Shiomi, A. Okada, T. Kimura, M. Chijiwa, Y. Fujita, T. Yatabe, K. Komiya, H. Enomoto, K. Fujikawa and Y. Okada (2007). "Expression of ADAMTS4 (aggrecanase-1) in human osteoarthritic cartilage." *Pathol Int* 57(11): 703-11.
- Nelson, F., L. Dahlberg, S. Laverty, A. Reiner, I. Pidoux, M. Ionescu, G. L. Fraser, E. Brooks, M. Tanzer, L. C. Rosenberg, P. Dieppe and A. Robin Poole (1998). "Evidence for altered synthesis of type II collagen in patients with osteoarthritis." *J Clin Invest* 102(12): 2115-25.
- Paulsson, M., M. Mörgelin, H. Wiedemann, M. Beardmore-Gray, D. Dunham, T. Hardingham, D. Heinegård, R. Timpl and J. Engel (1987). "Extended and globular protein domains in cartilage proteoglycans." *Biochem J* 245(3): 763-72.
- Pearson, K. (1909). "Determination of the Coefficient of Correlation." *Science* 30(757): 23-25.
- Peterfy, C., J. Li, S. Zaim, J. Duryea, J. Lynch, Y. Miaux, W. Yu and H. K. Genant (2003). "Comparison of fixed-flexion positioning with fluoroscopic semi-flexed positioning for quantifying radiographic joint-space width in the knee: test-retest reproducibility." *Skeletal Radiol* 32(3): 128-32.

- Plaas, A., B. Osborn, Y. Yoshihara, Y. Bai, T. Bloom, F. Nelson, K. Mikecz and J. D. Sandy (2007). "Aggrecanolytic activity in human osteoarthritis: confocal localization and biochemical characterization of ADAMTS5-hyaluronan complexes in articular cartilage." *Osteoarthritis Cartilage* 15(7): 719-34.
- Plaas, A. H., S. Wong-Palms, P. J. Roughley, R. J. Midura and V. C. Hascall (1997). "Chemical and immunological assay of the nonreducing terminal residues of chondroitin sulfate from human aggrecan." *J Biol Chem* 272(33): 20603-10.
- Pratta, M. A., J. L. Su, M. A. Leesnitzer, A. Struglics, S. Larsson, L. S. Lohmander and S. Kumar (2006). "Development and characterization of a highly specific and sensitive sandwich ELISA for detection of aggrecanase-generated aggrecan fragments." *Osteoarthritis Cartilage* 14(7): 702-13.
- Pringle, G. A. and C. M. Dodd (1990). "Immunoelectron microscopic localization of the core protein of decorin near the d and e bands of tendon collagen fibrils by use of monoclonal antibodies." *J Histochem Cytochem* 38(10): 1405-11.
- Reijman, M., J. M. Hazes, S. M. Bierma-Zeinstra, B. W. Koes, S. Christgau, C. Christiansen, A. G. Uitterlinden and H. A. Pols (2004). "A new marker for osteoarthritis: cross-sectional and longitudinal approach." *Arthritis Rheum* 50(8): 2471-8.
- Roughley, P. J., J. Barnett, F. Zuo and J. S. Mort (2003). "Variations in aggrecan structure modulate its susceptibility to aggrecanases." *Biochem J* 375(Pt 1): 183-9.
- Röntgen, W. C. (1895). "Eine neue art von strahlen." *Sitzungsberichte der Physikalisch-Medizinischen Gesellschaft*.
- Sajdera, S. W. and V. C. Hascall (1969). "Protein-polysaccharide complex from bovine nasal cartilage. A comparison of low and high shear extraction procedures." *J Biol Chem* 244(1): 77-87.
- Sandy, J. D., C. R. Flannery, P. J. Neame and L. S. Lohmander (1992). "The structure of aggrecan fragments in human synovial fluid. Evidence for the involvement in osteoarthritis of a novel proteinase which cleaves the Glu 373-Ala 374 bond of the interglobular domain." *J Clin Invest* 89(5): 1512-6.
- Sandy, J. D. and C. Verscharen (2001). "Analysis of aggrecan in human knee cartilage and synovial fluid indicates that aggrecanase (ADAMTS) activity is responsible for the catabolic turnover and loss of whole aggrecan whereas other protease activity is required for C-terminal processing in vivo." *Biochem J* 358(Pt 3): 615-26.
- Sandy, J. D. (2003). *Proteolytic degradation of normal and osteoarthritic cartilage matrix*. Osteoarthritis. K. D. Brandt, M. Doherty and L. S. Lohmander. Oxford, Oxford University Press: 82-92.
- Saxne, T., D. Heinegård, F. A. Wollheim and H. Pettersson (1985). "Difference in cartilage proteoglycan level in synovial fluid in early rheumatoid arthritis and reactive arthritis." *Lancet* 2(8447): 127-8.
- Saxne, T., D. Heinegård and F. A. Wollheim (1986). "Therapeutic effects on cartilage metabolism in arthritis as measured by release of proteoglycan structures into the synovial fluid." *Ann Rheum Dis* 45(6): 491-7.

- Saxne, T., F. A. Wollheim, H. Pettersson and D. Heinegård (1987). "Proteoglycan concentration in synovial fluid: predictor of future cartilage destruction in rheumatoid arthritis?" *Br Med J (Clin Res Ed)* 295(6611): 1447-8.
- Saxne, T. and D. Heinegård (1992). "Synovial fluid analysis of two groups of proteoglycan epitopes distinguishes early and late cartilage lesions." *Arthritis Rheum* 35(4): 385-90.
- Saxne, T., A. Glennås, T. K. Kvien, K. Melby and D. Heinegård (1993). "Release of cartilage macromolecules into the synovial fluid in patients with acute and prolonged phases of reactive arthritis." *Arthritis Rheum* 36(1): 20-5.
- Shapiro, A. L., E. Vinuela and J. V. Maizel, Jr. (1967). "Molecular weight estimation of polypeptide chains by electrophoresis in SDS-polyacrylamide gels." *Biochem Biophys Res Commun* 28(5): 815-20.
- Simkin, P. A. (1991). "Physiology of normal and abnormal synovium." *Seminars in arthritis and rheumatism* 21(3): 179-183.
- Simkin, P. A. and J. E. Bassett (1995). "Cartilage matrix molecules in serum and synovial fluid." *Curr Opin Rheumatol* 7(4): 346-51.
- Simkin, P. A. (1999). *Fluid dynamics of the joint space and trafficking of matrix products. Dynamics of bone and cartilage metabolism.* M. Seibel, S. Robins and J. Bilezikian, Academic Press: 319-324.
- Simkin, P. A. (2003). *Synovial physiology in the context of osteoarthritis. Osteoarthritis.* K. D. Brandt, M. Doherty and L. S. Lohmander. Oxford, Oxford University Press: 155-161.
- Simkin, P. A. (2008). "A biography of the chondrocyte." *Ann Rheum Dis* 67(8): 1064-8.
- Singer, II, D. W. Kawka, E. K. Bayne, S. A. Donatelli, J. R. Weidner, H. R. Williams, J. M. Ayala, R. A. Mumford, M. W. Lark, T. T. Glant and et al. (1995). "VDIPEN, a metalloproteinase-generated neopeptide, is induced and immunolocalized in articular cartilage during inflammatory arthritis." *J Clin Invest* 95(5): 2178-86.
- Song, R. H., M. D. Tortorella, A. M. Malfait, J. T. Alston, Z. Yang, E. C. Arner and D. W. Griggs (2007). "Aggrecan degradation in human articular cartilage explants is mediated by both ADAMTS-4 and ADAMTS-5." *Arthritis Rheum* 56(2): 575-85.
- Spearman, C. (1904). "The Proof and Measurement of Association between Two Things." *The American Journal of Psychology* 15(1): 72-101.
- Spector, T. D., P. G. Conaghan, J. C. Buckland-Wright, P. Garner, G. A. Cline, J. F. Beary, D. J. Valent and J. M. Meyer (2005). "Effect of risedronate on joint structure and symptoms of knee osteoarthritis: results of the BRISK randomized, controlled trial [ISRCTN01928173]." *Arthritis Res Ther* 7(3): R625-33.
- Spender, J. K. (1888). "On some Hitherto Undescribed Symptoms in the Early History of Osteoarthritis: The So-Called Rheumatoid Arthritis." *Br Med J* 1(1424): 781-783.

- Stanton, H., F. M. Rogerson, C. J. East, S. B. Golub, K. E. Lawlor, C. T. Meeker, C. B. Little, K. Last, P. J. Farmer, I. K. Campbell, A. M. Fourie and A. J. Fosang (2005). "ADAMTS5 is the major aggrecanase in mouse cartilage in vivo and in vitro." *Nature* 434(7033): 648-52.
- Sugiyama, S., M. Itokazu, Y. Suzuki and K. Shimizu (2003). "Procollagen II C propeptide level in the synovial fluid as a predictor of radiographic progression in early knee osteoarthritis." *Ann Rheum Dis* 62(1): 27-32.
- Swann, D. A., R. B. Hendren, E. L. Radin, S. L. Sotman and E. A. Duda (1981). "The lubricating activity of synovial fluid glycoproteins." *Arthritis Rheum* 24(1): 22-30.
- Swann, D. A., K. J. Bloch, D. Swindell and E. Shore (1984). "The lubricating activity of human synovial fluids." *Arthritis Rheum* 27(5): 552-6.
- Thyberg, J., S. Lohmander and D. Heinegård (1975). "Proteoglycans of hyaline cartilage: Electron-microscopic studies on isolated molecules." *Biochem J* 151(1): 157-66.
- Tortorella, M. D., T. C. Burn, M. A. Pratta, I. Abbaszade, J. M. Hollis, R. Liu, S. A. Rosenfeld, R. A. Copeland, C. P. Decicco, R. Wynn, A. Rockwell, F. Yang, J. L. Duke, K. Solomon, H. George, R. Bruckner, H. Nagase, Y. Itoh, D. M. Ellis, H. Ross, B. H. Wiswall, K. Murphy, M. C. Hillman, Jr., G. F. Hollis, R. C. Newton, R. L. Magolda, J. M. Trzaskos and E. C. Arner (1999). "Purification and cloning of aggrecanase-1: a member of the ADAMTS family of proteins." *Science* 284(5420): 1664-6.
- Tortorella, M. D. and A. M. Malfait (2008). "Will the real aggrecanase(s) step up: evaluating the criteria that define aggrecanase activity in osteoarthritis." *Curr Pharm Biotechnol* 9(1): 16-23.
- Tortorella, M. D., A. G. Tomasselli, K. J. Mathis, M. E. Schnute, S. S. Woodard, G. Munie, J. M. Williams, N. Caspers, A. J. Wittwer, A. M. Malfait and H. S. Shieh (2009). "Structural and inhibition analysis reveals the mechanism of selectivity of a series of aggrecanase inhibitors." *J Biol Chem* 284(36): 24185-91.
- Walakovits, L. A., V. L. Moore, N. Bhardwaj, G. S. Gallick and M. W. Lark (1992). "Detection of stromelysin and collagenase in synovial fluid from patients with rheumatoid arthritis and posttraumatic knee injury." *Arthritis Rheum* 35(1): 35-42.
- van den Berg, W. B., P. M. van der Kraan and H. M. van Beuningen (2003). *Synovial mediators of cartilage damage and repair in osteoarthritis*. K. D. Brandt, M. Doherty and L. S. Lohmander. Oxford, Oxford University Press: 147-155.
- Watanabe, H., Y. Yamada and K. Kimata (1998). "Roles of aggrecan, a large chondroitin sulfate proteoglycan, in cartilage structure and function." *J Biochem* 124(4): 687-93.
- Vilim, V. and A. J. Fosang (1994). "Proteoglycans isolated from dissociative extracts of differently aged human articular cartilage: characterization of naturally occurring hyaluronan-binding fragments of aggrecan." *Biochem J* 304 ( Pt 3): 887-94.
- Zweig, M. H. and G. Campbell (1993). "Receiver-operating characteristic (ROC) plots: a fundamental evaluation tool in clinical medicine." *Clin Chem* 39(4): 561-77.



# Paper I



## Human osteoarthritis synovial fluid and joint cartilage contain both aggrecanase- and matrix metalloproteinase-generated aggrecan fragments<sup>1</sup>

A. Struglics Ph.D.†, S. Larsson B.Sc.†, M. A. Pratta M.Sc.‡, S. Kumar Ph.D.‡, M. W. Lark Ph.D.§ and L. S. Lohmander M.D., Ph.D.†\*

† Department of Orthopaedics, Lund University, Lund, Sweden

‡ Department of Musculoskeletal Diseases, GlaxoSmithKline, Collegeville, PA, USA

§ Centocor Inc., Malvern PA, USA

### Summary

**Objective:** To identify the major aggrecanase- and matrix metalloproteinase (MMP)-generated aggrecan fragments in human osteoarthritis (OA) synovial fluid and in human OA joint cartilage.

**Method:** Aggrecan fragments were prepared by CsCl gradient centrifugation. Fragment distributions were compared with aggrecanase-1 (ADAMTS-4) and MMP-3 digested human aggrecan by analysis with neopeptide antibodies and an anti-G1 domain antibody, using Western immuno-blots.

**Results:** The overall fragment pattern of OA synovial fluid aggrecan was similar to the fragment pattern of cartilage aggrecan cleaved *in vitro* by ADAMTS-4. However, multiple glycosaminoglycan (GAG) containing aggrecanase and MMP-generated aggrecan fragments were identified in OA synovial fluid and some of these fragments were produced by the action of both types of proteinases. The synovial fluid content of large size aggrecan fragments with <sup>374</sup>ARGS- and <sup>342</sup>FFGV- N-terminals was about 107 and 40 pmoles per ml, respectively, out of a total concentration of aggrecan fragments of about 185 pmoles per ml. OA synovial fluid contained insignificant amounts of the G1-IPEN<sup>341</sup> fragment as compared to the G1-TEGE<sup>373</sup> fragment, while OA cartilage contained significant amounts of both fragments. OA cartilage contained several GAG-containing aggrecan fragments with N-terminals of G1- or <sup>342</sup>FFGV- but no fragments with an N-terminal of <sup>374</sup>ARGS-.

**Conclusions:** The overall pattern of aggrecan fragments in human OA synovial fluid and cartilage supports an important role for aggrecanase in aggrecan degradation. However, the fragment patterns and their differential distribution between cartilage and synovial fluid are consistent with the existence of at least two proteolytic pathways for aggrecan degradation in human OA, generating both <sup>342</sup>FFGV- and <sup>374</sup>ARGS-fragments.  
© 2005 OsteoArthritis Research Society International. Published by Elsevier Ltd. All rights reserved.

**Key words:** Osteoarthritis, Cartilage, Synovial fluid, Aggrecan, Aggrecanase, Matrix metalloproteinase.

### Introduction

The gradual destruction of joint cartilage is a prominent feature of OA, involving loss from the tissue of the major matrix components type II collagen and aggrecan. Aggrecan depletion in arthritic joints is largely due to fragmentation of the core protein by proteolysis. The involvement of aggrecanase in this process in human arthritis was first shown by the identification in human arthritic synovial fluids of high

molecular weight (Mw) aggrecan fragments bearing the N-terminal sequence <sup>374</sup>ARGS-<sup>1,2a</sup>.

Multiple matrix metalloproteinase (MMP) and aggrecanase cleavage sites in the articular cartilage aggrecan have since been identified by *in vivo* and *in vitro* studies of animal and human samples (Fig. 1). Three MMP cleavage sites are present in the interglobular domain (IGD), Asn<sup>341</sup>-Phe<sup>342</sup> being the predominant MMP cleavage site<sup>4–7</sup>. One MMP cleavage site has been identified between the G2 domain and the keratan sulfate enriched region (KS)<sup>8</sup>, together with several sites in the chondroitin sulfate enriched region one (CS1)<sup>9</sup>. Several aggrecanase cleavage sites have been identified in the aggrecan core protein: one in the IGD<sup>10–12</sup> at Glu<sup>373</sup>-Ala<sup>374</sup>, other sites are located in the chondroitin sulfate enriched region two (CS2)<sup>10,11</sup>.

Only a limited number of studies have used human synovial fluid<sup>1,2,6,13,14</sup> and human joint cartilage<sup>4,6,14,15</sup> to characterize the aggrecan fragments generated in OA. While much of the current data suggest that destructive aggrecanolysis (i.e., in IGD) is due to aggrecanase activity<sup>1,2,6,14</sup>, with ADAMTS-5 playing a lead role in mouse cartilage<sup>16,17</sup>, other studies suggest that variable but quantitatively not well determined proportions of the IGD cleavage may be due to activity of MMP or other proteases<sup>13,15</sup>. Further,

<sup>1</sup>Supported by: The Swedish Research Council, the Swedish Rheumatism Association, the Kock Foundation, the King Gustaf V 80-year Anniversary Foundation, the Faculty of Medicine Lund University, and Region Skåne.

<sup>a</sup>The superscript numbers denote the amino acid residue positions. Human aggrecan residue numbers used in this paper were obtained by subtraction of 19 amino acids (leader sequence) from the total (1–2415 amino acid) sequence of human aggrecan (NCBI accession nr P16112<sup>3</sup>).

\*Address correspondence and reprint requests to: Stefan Lohmander, Department of Orthopaedics, Lund University, Lund University Hospital, SE-22185 Lund, Sweden. Tel: 46-46-171503; E-mail: stefan.lohmander@med.lu.se

Received 1 November 2004; revision accepted 27 July 2005.



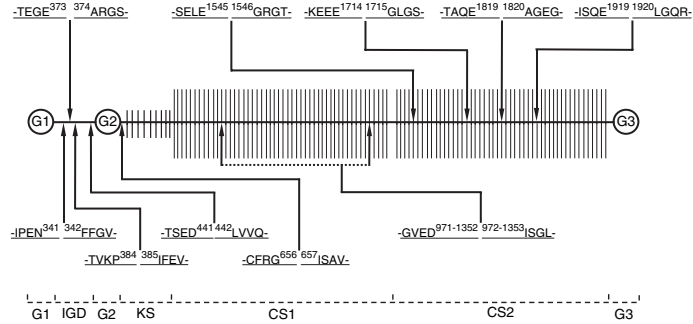

Fig. 1. Schematic illustration of human aggrecan with cleavage sites of aggrecanases (above) and MMP (below). G1, G2 and G3 – globular domains 1–3; IGD – interglobular domain; KS – keratan sulfate enriched region; CS1 and CS2 – chondroitin sulfate enriched region one and two. Amino acid numberings are based on mature human aggrecan starting with the N-terminal sequence <sup>1</sup>VETS- (NCBI accession nr P16112). The cleavage sites represented by arrows were summarized from several publications (see text).

deletion of the ADAMTS-5 catalytic domain in genetically modified mice provided a partial but not complete protection against cartilage destruction and aggrecan loss in OA and arthritis models<sup>16,17</sup>. A better understanding of the relative roles of the different proteolytic pathways is highly relevant for current efforts to develop disease-modifying treatments for human OA.

In the present study, we have identified aggrecan fragments in pooled human OA cartilage and in pooled OA human synovial fluid from a large number of patients with varying stages of OA. A well-characterized set of antibodies was used to detect and quantify both aggrecanase- and MMP-generated aggrecan fragments. We detect for the first time in human samples large glycosaminoglycan (GAG) containing fragments with an MMP-generated N-terminus of <sup>342</sup>FFGV- both in OA synovial fluid and OA cartilage, and propose mechanisms for aggrecan degradation in human knee OA that incorporate the identified degradation patterns.

## Materials and methods

### MATERIALS

Alcian Blue 8GS (C.I. no 742240) was from Chroma-Gesellschaft (Köngen, Germany). 4-(2-Aminoethyl)-benzenesulfonyl fluoride (AEBSF), 6-aminohexonic acid (EACA), benzamidine-HCl, BSA, chondroitin sulfate type C from shark cartilage (C4384), tetrasodium ethylenediaminetetraacetate (Na<sub>4</sub>-EDTA), *N*-ethylmaleimide (NEM), trans-epoxysuccinyl-L-leucylamido-(4-guanidino)butane (E64), iodoacetamide,  $\alpha$ -phenanthroline, pepstatin A and phenylmethylsulfonyl fluoride (PMSF) were from Sigma. Chondroitinase ABC (EC 4.2.2.4), keratanase (EC 3.2.1.103) and keratanase II (from *Bacillus* sp. Ks36) were from Seikagaku. Molecular weight markers 10–250 kDa (Precision Plus Protein Standards) were from BioRad, and for a 400 kDa Mw marker reduced laminin from mouse Engelbreth-Holm Sarcoma (Roche) was used.

Activated recombinant human MMP-3 was provided by Merck. Human recombinant ADAMTS-4 (a disintegrin and metalloproteinase with thrombospondin motifs, aggrecanase-1) was provided by GlaxoSmithKline<sup>18</sup>. ECL Plus detection and Hyperfilm-ECL were from Amersham Biosciences. Mini gels (4–12 and 3–8%), lithium dodecyl

sulfate (LDS) sample buffer, sodium dodecyl sulfate (SDS) running buffers (Tris-acetate and MOPS buffers), and transfer buffer were all NuPAGE<sup>®</sup> from Invitrogen. Poly vinylidene difluoride (PVDF) membranes were from Invitrogen. Non-fat dry milk (Semper) was from the local supermarket. Neo-specific rabbit anti-peptide sera anti-KEEE, anti-FFGV, anti-LGQR, anti-TEGE and anti-IPEN were prepared at Merck. Neo-specific anti-ARGS monoclonal antibody (mab OA-1) was raised in mouse against the synthetic peptide ARGSVILTVK (GlaxoSmithKline). Neo-specific polyclonal anti-SELE antibody was raised in rabbit against the synthetic peptide CASTASELE (GlaxoSmithKline). Anti-G1 antibody (polyclonal rabbit anti-ATEGQV- peptide sera) was a gift from Dr John Sandy (Shriners Hospital and University of South Florida, Tampa). Polyclonal anti-aggrecan-G3 antibody was from Affinity Bio-Reagents (Golden, CO, USA). Anti-chondroitin sulfate (CS) antibody (mab 3-B-3) was from Seikagaku. Peroxidase conjugated secondary antibodies, goat anti-mouse IgG was from Cell Signaling Technology, goat anti-rabbit IgG from KPL and goat anti-mouse IgM from Sigma. Synthetic peptides used in immuno-blocking experiments, neopeptide peptide ARGSVILTVKGGC, neopeptide peptide CASTASELE and spanning peptide DIPENFFGVGGGEEDC, were from GlaxoSmithKline; spanning peptide EVVTASTASELEGRGT, neopeptide peptide FFGVGGGEEDITVC, neopeptide peptide CEVAPTFKEEE and spanning peptide VAPTFKEEEGLGS were from Innovagen (Lund, Sweden); spanning peptide EGARGSVILTVKPIF was from Merck; anti-G1 blocking peptide CATEGQVRVNSIYQDKVSL was a kind gift from Dr John Sandy.

### HUMAN CARTILAGE AND SYNOVIAL FLUID SAMPLES

Knee cartilage was obtained from patients undergoing joint replacement surgery for OA. All remaining cartilage was removed from 10 knee joints, diced and pooled for aggrecan extraction. Samples were stored at  $-80^{\circ}\text{C}$ . Synovial fluid samples from more than 100 patients with advanced knee OA or with varying stages of post-injury cartilage changes were pooled and then stored at  $-80^{\circ}\text{C}$ . The synovial fluids and the cartilage samples were not from the same subjects. All procedures were approved by the ethics review committee of the Medical Faculty of Lund University.

## AGGREGAN ISOLATION FROM SYNOVIAL FLUID

Human synovial fluid pool (in 50 mM Na-acetate, pH 6.8) was cleared by centrifugation (20 400 × g, 35 min, 4°C), and guanidine-HCl (4 M final concentration) and CsCl (starting density 1.5 g/ml) were added to the supernatant. A CsCl density gradient centrifugation was performed (162 000 × g, 48 h, 16°C) and the D1-fraction (bottom two-fifth) was collected, dialyzed against Millipore-water (Type 1, 18.2 MΩ cm), and freeze-dried. This sample, called SF-D1, was stored at -20°C. An associative (without guanidine-HCl) A1-fraction, called SF-A1, was also made from the human synovial fluid pool, using the same method and the same starting density. Both the associative and the dissociative preparations were conducted either in the absence or in the presence of proteinase inhibitors, 10 mM Na<sub>4</sub>-EDTA, 0.4 mM AEBSF, 1 μM pepstatin A, 5 μM E64 and 5 mM o-phenathroline (in gradient centrifugation) and 10 mM Na<sub>4</sub>-EDTA, 0.4 mM PMSF, 1 μM pepstatin A, 100 μM iodoacetamide and 2 mM o-phenathroline (in dialysis).

## AGGREGAN ISOLATION FROM CARTILAGE

Aggrecan from a knee cartilage pool of 10 OA patients was extracted with guanidine-HCl (4 M) in the presence of proteinase inhibitors (10 mM Na<sub>4</sub>-EDTA, 100 mM EACA, 10 mM NEM, 5 mM benzamidine-HCl and 5 mM PMSF) and then isolated by associative-dissociative CsCl density gradient centrifugation, in the presence of the proteinase inhibitors, as described<sup>15</sup>. No hyaluronan (HA) was added. Fractions A1D1 and A1D3 were collected (herein called cartilage-A1D1 and cartilage-A1D3) and finally dialyzed against either Millipore water or against Millipore water containing proteinase inhibitors (5 mM Na<sub>4</sub>-EDTA, 10 mM EACA, 2 mM NEM, 2 mM benzamidine-HCl and 0.4 mM PMSF) prior to freeze drying.

## GAG AND PROTEIN QUANTITATION

The method for quantitation of GAG by Alcian Blue precipitation was modified from Björnsson<sup>19</sup>. Samples and chondroitin sulfate standards (75 μl) were precipitated for 2 h at 4°C with 0.04% w/v Alcian Blue, 0.72 M guanidine-HCl, 0.25% w/v Triton X-100, and 0.1% v/v H<sub>2</sub>SO<sub>4</sub> (0.45 ml). The precipitates were collected as pellets at 16 000 × g 15 min, 4°C and then dissolved in 4 M guanidine-HCl, 33% v/v 1-propanol (0.25 ml) prior to absorbance measurement.

The protein quantitation method was modified from the Pierce Micro BCA™ Assay – microplate procedure. Samples and bovine serum albumin (BSA) standards were incubated with bicinchoninic acid (BCA) on a 96-well microtiter plate at 60°C for 1 h. After room temperature equilibration the absorbance was measured at 570 nm with a plate reader.

PROTEINASE DIGESTION OF CARTILAGE AGGREGAN  
IN VITRO

Human aggrecan cartilage-A1D1 (1.5 nmol) was digested for 16 h at 37°C with recombinant human MMP-3 (0.353 nmol) in proteinase digestion buffer (50 mM Tris-HCl, 100 mM NaCl, 10 mM CaCl<sub>2</sub>, pH 7.5). Human aggrecan cartilage-A1D1 (856 pmol) was digested for 3 h at 37°C with recombinant human ADAMTS-4 (5.13 pmol) in the same buffer. The enzymatic digestion reactions

(1 ml) were stopped by addition of EDTA (18.3 μmol) and were directly deglycosylated (see below). The molar calculations were based on a dry weight molecular mass for human aggrecan assuming 1000 kDa, for MMP-3 the Mw used was 42.8 kDa and for ADAMTS-4 we used an Mw of 60 kDa.

## DEGLYCOSYLATION

Aggrecan in deglycosylation buffer (50 mM Tris-acetate, 50 mM Na-acetate, 10 mM EDTA, pH 7.6) was first digested for 2 h at 37°C with chondroitinase ABC (1 mU/μg GAG), and then digested for another hour at 37°C with the addition of keratanase (1 mU/μg GAG) in the presence of 1 mM AEBSF and 10 mM NEM. Finally, the aggrecan was digested at pH 6.0 for 1 h at 37°C with the addition of keratanase II (0.1 mU/μg GAG). The deglycosylated samples were dried in a vacuum centrifuge and dissolved in 2× concentrated sample buffer.

## WESTERN IMMUNO-BLOT ANALYSIS

Deglycosylated samples (0.5–5 μg GAG per 5 mm well) were denatured in 1× sample buffer under reducing conditions (50 mM DTT) by boiling for 5 min. Samples were separated (according to manufacturer's instructions) by sodium dodecyl sulfate polyacrylamide gel electrophoresis (SDS-PAGE) on either 3–8% Tris-acetate gels or 4–12% Bis-Tris gels. Proteins were electrophoretically transferred at room temperature at 40 V for 70 min (from 3 to 8% gels) or at 35 V for 65 min (from 4 to 12% gels) onto PVDF membranes (0.2 μm). After transfer, membranes were dried completely at room temperature. Immuno-reactions were conducted according to the ECL Plus instruction manual (Amersham Biosciences) using film for detection. Membranes were washed in TBST-150 (20 mM Tris-HCl, 150 mM NaCl, 0.1% v/v Tween 20, pH 7.6) four times at each step using 4 ml/cm<sup>2</sup>. Blocking was conducted in blocking buffer (5% w/v non-fat dried milk in TBST-150), and antibody incubations were done in blocking buffer for 1 h at room temperature. For the anti-G1 immuno-reaction, the washes were conducted in TBST-300 (20 mM Tris-HCl, 300 mM NaCl, 0.1% v/v Tween 20, pH 7.6), blocking was conducted in 3% w/v BSA (in TBST-300), and antibody incubations were conducted in 1% w/v BSA (in TBST-300). The following primary antibodies were used: anti-KEEE (1:2000 or 1:5000 dilution), anti-FFGV (1:1000 or 1:2000 dilution), anti-LGQR (1:500 or 1:1000 dilution), anti-TEGE (1:3000 dilution), anti-IPEN (1:10 000 dilution), anti-ARGS (1:4000 dilution, 2.7 μg/ml), anti-SELE (1:1000 dilution, 1.2 μg/ml), anti-G1 (1:2000 or 1:5000 dilution), anti-G3 (1:500 dilution) and anti-CS stubs (1:3000 dilution). The following secondary peroxidase conjugated antibodies were used: goat anti-mouse IgG (1:50 000 and 1:15 000 dilutions, 2.5 or 0.75 ng/ml), goat anti-rabbit IgG (1:400 000 and 1:75 000 dilutions 2.5 or 13.3 ng/ml) and goat anti-mouse IgM (1:100 000 dilution). In the peptide blocking experiments the peptide and the antibody were incubated simultaneously with the blotted proteins.

## QUANTIFICATION OF FFGV- AND ARGS-FRAGMENTS

The complete conversion of GAG containing G1-fragments to either FFGV- or ARGS-fragments (with corresponding G1-IPEN and G1-TEGE fragments) was achieved by digesting (as described above) cartilage A1D1-fraction for 16 h with MMP-3 or by digesting for 24 h

with ADAMTS-4. These samples were deglycosylated and used as FFGV- or ARGS-standards in the Western blot quantification. The standards were assumed to contain 1 nmol FFGV- or ARGS-fragments per mg aggrecan dry weight, using a Mw of  $1 \times 10^6$  g/mol aggrecan. The synovial fluid sample (D1-fraction) and standards were probed by anti-ARGS or anti-FFGV antibodies as described above. The detection and quantification was conducted in a luminescence image analyzer (Fujifilm LAS-1000) using Image Gauge version 4.0 (Fujifilm) software. Samples and standards were used within a linear range of the imaging system, and the total sum of FFGV- or ARGS- immuno-signal was used in the quantification.

#### IDENTIFICATION OF AGGREGAN FRAGMENTS IN SYNOVIAL FLUID AND CARTILAGE

Most of the CsCl-purified aggrecan fragments were immuno-identified at both N- and C-terminal ends. Fragments that were not immuno-verified at both ends were further characterized by Mw calculations, based on their migration in the PAGE-system, together with a specific calibration constant (A Struglics, S Larsson, LS Lohmander unpublished). The calibration constant ( $K$ ) was generated from several aggrecan fragments identified at both N- and C-terminal ends by dividing the SDS-PAGE Mw ( $m$ ) with the

sum of the total amino acid Mw ( $a$ ) and the total Mw of GAG stubs ( $g$ ):  $K = m/(a + g)$ .

## Results

#### CHARACTERIZATION OF ANTIBODIES USING *IN VITRO* DIGESTED CARTILAGE AGGREGAN AND BLOCKING PEPTIDES

Several aggrecan fragments were detected in the ADAMTS-4 and MMP-3 *in vitro* digested cartilage-A1D1 samples (Fig. 2). The N- and C-terminal sequences of these aggrecan fragments were identified in matching Western immuno-blot experiments (Table I). The anti-ARGS, anti-SELE, anti-KEEE and anti-FFGV neopeptide antibody immuno-reactions were completely blocked by the specific neopeptide peptides [Fig. 2(A–D)]. Little or no blocking of the neopeptide immuno-reactions was observed in the presence of the corresponding spanning peptides [Fig. 2(A–D)]. The anti-G1 immuno-reactions were completely blocked by the corresponding immunization peptide [Fig. 2(E)], and this antibody has been further described<sup>20,21</sup>. The anti-ARGS antibody (mab OA-1) has been further characterized by Western and enzyme linked immunosorbent assay (ELISA) experiments (Pratta *et al.*, unpublished), whereas characterization of anti-TEGE and anti-IPEN neopeptide antibodies was published<sup>22</sup>.

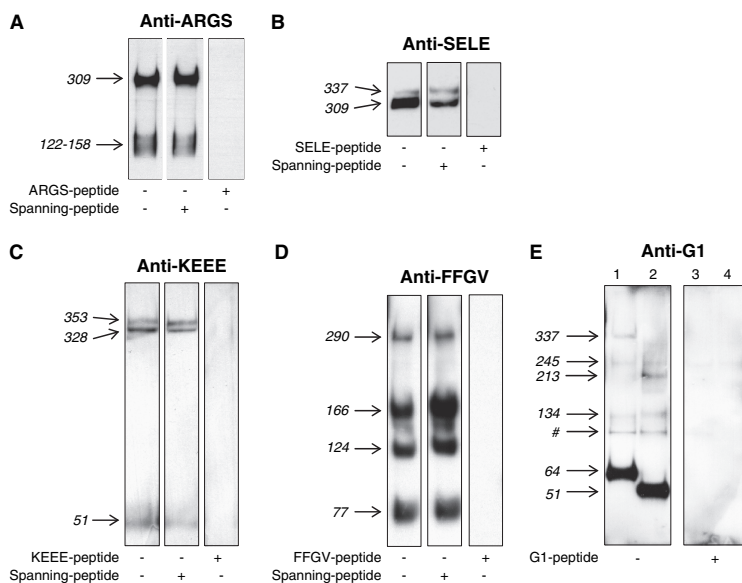

Fig. 2. Western immuno-blot peptide blocking experiment against *in vitro* digested cartilage aggrecan. Human cartilage aggrecan (A1D1) digested *in vitro* with ADAMTS-4 (A, B, C, E lanes 1 and 3) or with MMP-3 (D, E lanes 2 and 4) was SDS-PAGE separated (3–8% gels) and analyzed by Western immuno-blot in the presence or absence of synthetic peptides. (A) Anti-ARGS Western with 1.5  $\mu$ g GAG per lane,  $\pm 10$ - $\mu$ M neopeptide ARGSVILTVKGGC-peptide and  $\pm 10$ - $\mu$ M spanning EGEARGSVILTVKPIF-peptide. (B) Anti-SELE Western with 1.25  $\mu$ g GAG per lane,  $\pm 2$ - $\mu$ M neopeptide CASTASELE-peptide and  $\pm 2$ - $\mu$ M spanning EVVTASTASELEGRGT-peptide. (C) Anti-KEEE Western with 3.6  $\mu$ g GAG per lane,  $\pm 2$ - $\mu$ M neopeptide CEVAPTTFKEEE-peptide and  $\pm 2$ - $\mu$ M spanning VAPTTFKEEEGLGS-peptide. (D) Anti-FFGV Western with 4.2  $\mu$ g GAG/lane,  $\pm 10$ - $\mu$ M neopeptide FFGVGGEEEDITVC-peptide and  $\pm 10$ - $\mu$ M spanning DIPENFFGVGGEEEDC-peptide. (E) Anti-G1 Western with 4.2  $\mu$ g GAG per lane,  $\pm 2$ - $\mu$ M immunization CATEGQVRVNSIYQDKVSL-peptide. Mean values of Mw of aggrecan fragments are given as kDa, and were calculated based on electrophoretic migration. The anti-G1A band, marked with # (E) was identified as the deglycosylation enzyme chondroitinase ABC (results not shown).

Table I  
Aggrecan fragments detected by Western immuno-blot in samples from OA patients

Aggrecan fragments	SF-A1 fraction	SF-D1 fraction	Cartilage-A1D1 fraction	Cartilage-A1D3 fraction	Cartilage-A1D1 fraction <i>in vitro</i> digested with	
					ADAMTS-4	MMP-3
G1-IPEN <sup>341</sup>	52	—	—	52	—	51
G1-TEGE <sup>373</sup>	65	—	—	65	64	—
<sup>342</sup> FFGV-G2-KS	80-95	—	—	—	—	77
<sup>342</sup> FFGV-G2-CS1	—	—	300	—	283	124, 166, 290
<sup>342</sup> FFGV-G2-SELE <sup>1545</sup>	—	310	—	—	312	—
<sup>342</sup> FFGV-G2-KEEE <sup>1714</sup>	341	335	340	—	328	—
<sup>342</sup> FFGV-G2-G3	—	—	411	—	—	—
<sup>374</sup> ARGS-G2-CS1	—	129-159	—	—	122-158	—
<sup>374</sup> ARGS-G2-SELE <sup>1545</sup>	—	311	—	—	309	—
G1-G2-KS	ND	—	—	ND	—	134
G1-G2-CS1	—	200, 252	197, 217	ND	247	173, 213, 245
G1-G2-SELE <sup>1545</sup>	—	340	331	—	337	—
G1-G2-KEEE <sup>1714</sup>	—	354	367	—	353	—
G1-G2-G3	—	—	429	—	—	—
<sup>1192b</sup> LGQR-G3	—	103	—	—	104	—
<sup>1546</sup> GRGT-KEEE <sup>1714</sup>	46	50	—	—	51	—

Mw of detected aggrecan fragments from electrophoresis as mean values in kDa.

—, Not detected; ND, not determined.

Peptide crossover experiments were conducted, testing, e.g., anti-SELE immuno-reaction in the presence of ARGS-VIL-peptide. None of these experiments showed false positive immuno-blocking (results not shown).

The HRP conjugated secondary antibodies used in this paper did not bind directly to the blotted proteins in our Western immuno-blot experiment systems (results not shown). Further, the neopeptide antibodies used did not bind to human IgG, BSA, MMP-3, ADAMTS-4, deglycosylation enzymes or Mw markers (results not shown). The anti-G1 antibody showed immuno-reactivity against a 100 kDa non-aggrecan polypeptide which is marked as # in [Fig. 2(E)].

These findings show that the antibodies used were specific for the neopeptides and sequences examined.

#### THE EFFECT OF PROTEINASE INHIBITORS DURING THE PURIFICATION AND DIALYSIS OF AGGREGAN

It was reported that guanidine-HCl denatured MMPs could be activated during dialysis against distilled water<sup>23</sup>. Therefore, we compared aggrecan purification from human synovial fluid and cartilage in the presence or absence of proteinase inhibitors in (a) the dialysis against distilled water for cartilage aggrecan purifications, and (b) all steps of the purification of aggrecan from synovial fluid (see Materials and methods). The results showed similar immuno-patterns and equal fragment intensities independent of the presence or absence of proteinase inhibitors (result not shown).

These results indicate the absence of proteolysis during preparation of aggrecan fragments from joint cartilage or synovial fluid as done here. The aggrecan fragments detected in this report are thus likely to have originated from *in vivo* aggrecanolysis.

#### SIMILARITIES BETWEEN AGGREGAN SPECIES DETECTED IN HUMAN OA SYNOVIAL FLUID AND AGGREGAN FRAGMENTS PREPARED FROM ADAMTS-4 *IN VITRO* DIGESTED HUMAN JOINT CARTILAGE

Western analysis of unpurified synovial fluid provided little or no information on the aggrecan fragment content

(result not shown), presumably due to the low concentration of GAG-containing aggrecan fragments, together with high concentration of protein and HA in synovial fluid. We therefore purified high density D1 and A1 fractions of aggrecan fragments from pooled human synovial fluid using CsCl density gradient centrifugation. Based on Western analysis using an antibody which detects the products associated with the aggrecan core protein following chondroitinase ABC digestion (mab 3-B-3), the immuno-reactivity patterns of the aggrecan fragments detected in human OA synovial fluid D1-fraction showed a high degree of similarity to the ADAMTS-4 *in vitro* cleaved human cartilage-A1D1 sample, but not with an MMP-3 digested sample (Fig. 3). The aggrecan fragments detected by anti-ARGS, anti-SELE, anti-KEEE and anti-LGQR antibodies in the OA synovial fluid D1-fraction were also observed in the ADAMTS-4 *in vitro* cleaved cartilage-A1D1 sample. Not only did these samples show the same patterns with the different antibodies, but the aggrecan fragments from the two samples also showed similar Mw (Table I). A difference observed in these comparison experiments was that the ADAMTS-4 *in vitro* digested cartilage-A1D1 sample contained a low Mw (51 kDa) anti-KEEE fragment, most likely <sup>1546</sup>GRGT-KEEE<sup>1714</sup>, which is not seen in the synovial fluid D1-fraction (Fig. 3), although this fragment was observed in other preparations of the OA synovial fluid D1-fraction (results not shown). In contrast, the aggrecan fragment pattern of the OA synovial fluid sample differed significantly from the aggrecan fragment pattern of MMP-3 *in vitro* digested cartilage-A1D1 and from the cartilage-A1D1 sample (Table I).

These results suggest that the majority of the aggrecan fragments identified in human OA synovial fluid are generated from *in vivo* aggrecanase activity.

#### AGGREGAN FRAGMENTS DETECTED IN HUMAN OA SYNOVIAL FLUID ARE GENERATED FROM BOTH AGGREGANASE AND MMP ACTIVITIES

GAG-containing aggrecan fragments in the OA synovial fluid (D1-fraction) were identified in Western immuno-blot experiments by using anti-G1 and neopeptide antibodies (Fig. 4). To determine the likely N- and C-terminal

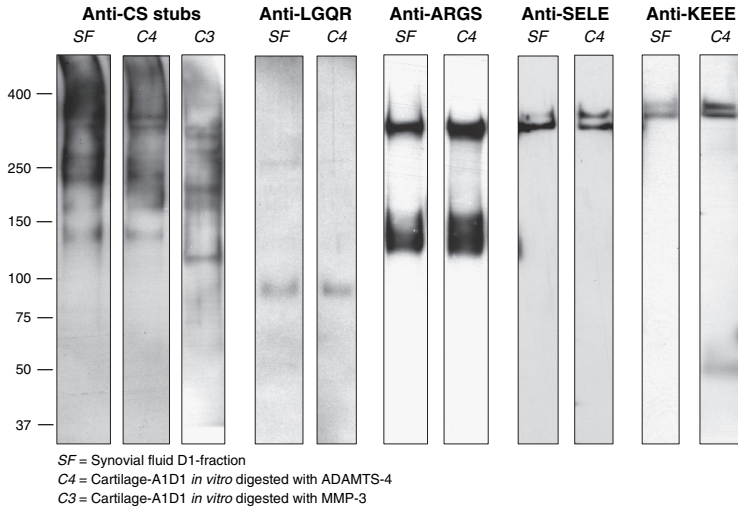

Fig. 3. Aggrecan fragments detected in MMP-3 and ADAMTS-4 *in vitro* digested A1D1-cartilage, and in OA synovial fluid (D1-fraction) by Western immuno-blot. The samples were SDS-PAGE separated (3–8% gel) and analyzed by Western blot with different antibodies as shown. Different amounts of GAG per lane were loaded to facilitate the comparison between the samples. The positions of Mw (in kDa) are indicated.

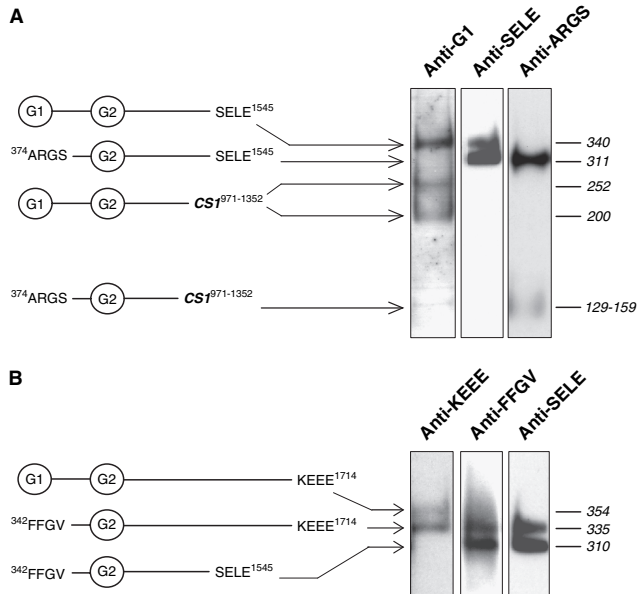

Fig. 4. Detection of high Mw aggrecan fragments in OA synovial fluid. Human OA synovial fluid fraction D1 was SDS-PAGE separated (3–8% gel) and analyzed by Western immuno-blot with the following antibodies: (A) anti-G1, anti-SELE and anti-ARGS; (B) anti-KEEE, anti-FFGV and anti-SELE. Different amounts of GAG per lane were loaded to facilitate comparisons. Mean values of Mw (in kDa) of aggrecan fragments were calculated based on electrophoretic migration.

sequences of the aggrecan fragments, several approaches were used. Firstly, the Western immuno-blot experiments were repeated several times with the different antibodies to give average values for the Mw of the aggrecan fragments. Secondly, the lanes on the PVDF membranes were divided in half after transfer, incubated with different antibodies, and physically realigned before detection.

The neoepitope antibodies verified both aggrecanase and MMP-generated N-terminal fragments in the OA synovial fluid (Fig. 4). Several G1-domain containing fragments including G1-SELE<sup>1545</sup> (340 kDa) and G1-KEEE<sup>1714</sup> (354 kDa) were observed. The two <sup>342</sup>FFGV-fragments observed, 310 kDa and 335 kDa, contained aggrecanase generated C-terminal -SELE<sup>1545</sup> and -KEEE<sup>1714</sup> [Fig. 4(B)].

The faster migrating anti-SELE immuno-band was composed of <sup>374</sup>ARGS-SELE<sup>1545</sup> and <sup>342</sup>FFGV-SELE<sup>1545</sup> fragments having similar Mw (Fig. 4). The multiple <sup>374</sup>ARGS-CS1<sup>971-1352</sup> fragments (129–159 kDa) and two G1-CS1<sup>971-1352</sup> fragments (200 kDa and 252 kDa) had their C-terminal sequences identified as -GVED<sup>971-1352</sup>, from the multiple MMP-3 cleavage site GVED<sup>971-1352</sup>↓<sup>972-1353</sup>ISGL (see Fig. 1). Small amounts of low Mw <sup>342</sup>FFGV-fragments (80–95 kDa) were detected in the SF-A1 fraction, while only trace amounts of these fragments were found in the SF-D1 fraction of OA synovial fluid (results not shown). Such low Mw <sup>342</sup>FFGV-fragments have also been detected in Q-Sepharose purified synovial fluids<sup>13</sup>. A weakly reacting 50 kDa anti-KEEE fragment, most like <sup>1546</sup>GRGT-KEEE<sup>1714</sup>, was detected in SF-D1 and SF-A1 samples of the OA synovial fluid pool (results not shown, Table I). This fragment has previously been detected in normal human synovial fluids<sup>14</sup>.

The <sup>1920</sup>LGQR-G3 fragment detected in SF-D1 samples was N-terminally (Fig. 3) and C-terminally (result not shown) verified, and except for the C-terminals in <sup>374</sup>ARGS- and G1-CS1<sup>971-1352</sup> fragments and the N-terminal of the G1-KEEE<sup>1714</sup> fragment, all the high Mw SF-D1 fragments detected were immuno-verified both N- and C-terminally (Fig. 4).

These results show that OA synovial fluid contains at least nine different GAG-containing aggrecanase and MMP-generated fragments. Several of these fragments were likely produced by the action of both proteinases. In contrast to other reports<sup>6,14</sup>, we detected for the first time large GAG containing <sup>342</sup>FFGV-fragments in OA synovial fluid.

G1-TEGE<sup>373</sup> AND G1-IPEN<sup>341</sup> FRAGMENTS WERE BOTH DETECTED IN HUMAN OA CARTILAGE, BUT ONLY INSIGNIFICANT AMOUNTS OF G1-IPEN<sup>341</sup> AS COMPARED TO G1-TEGE<sup>373</sup> WERE OBSERVED IN HUMAN OA SYNOVIAL FLUID

In order to detect G1-TEGE<sup>373</sup> and G1-IPEN<sup>341</sup> aggrecan fragments we prepared an A1D3 fraction from the OA cartilage pool (cartilage-A1D3) and an A1-fraction from the OA synovial fluid pool (SF-A1). As control samples we used ADAMTS-4 or MMP-3 *in vitro* digested cartilage-A1D1. After *in vitro* digestion of the cartilage-A1D1, a 65 kDa G1-TEGE<sup>373</sup> fragment was detected in the ADAMTS-4 cleaved sample, and a 52 kDa G1-IPEN<sup>341</sup> fragment was observed in the MMP-3 digested sample as verified by the anti-G1, anti-TEGE and anti-IPEN immuno-reactions (Fig. 5). The cartilage-A1D3 sample showed approximately equal immunoreactivities for the 65 kDa G1-TEGE<sup>373</sup> and the 52 kDa G1-IPEN<sup>341</sup> fragments, whereas the SF-A1 sample showed very low amounts of G1-IPEN<sup>341</sup> as compared to the G1-TEGE<sup>373</sup> fragment (Fig. 5). Similar results were obtained from experiments using DE52 cellulose (diaminoethylcellulose) anion exchange<sup>14</sup> purified aggrecan samples prepared from the OA synovial fluid pool (results not shown). Further, when increasing amounts of G1-IPEN<sup>341</sup> fragments were added to SF-A1 samples, there was a corresponding increase in IPEN-neoepitope immuno-reactivity, suggesting that the low amount of G1-IPEN<sup>341</sup> fragment detected in synovial fluid was not due to inhibitory factors (results not shown). The OA cartilage fraction A1D1 and the OA synovial fluid fraction D1 did not contain any G1-TEGE<sup>373</sup> or G1-IPEN<sup>341</sup> fragments (results not shown).

These results, based on the -IPEN and -TEGE neoepitope antibodies together with the G1-antibody, suggest that OA synovial fluid has a very low content of the G1-IPEN<sup>341</sup> fragment compared to the G1-TEGE<sup>373</sup> fragment, but that OA cartilage contains significant amounts of both fragments.

GAG CONTAINING AGGREGAN FRAGMENTS DETECTED IN HUMAN OA CARTILAGE

To detect high Mw GAG containing aggrecan fragments in the pooled OA cartilage an A1D1 fraction was prepared. No fragments with the N-terminal neoepitope ARGS were detected in the cartilage-A1D1 (Fig. 6) or cartilage-A1D3 samples (results not shown). On the other hand, several high Mw fragments with the N-terminal neoepitope FFGV

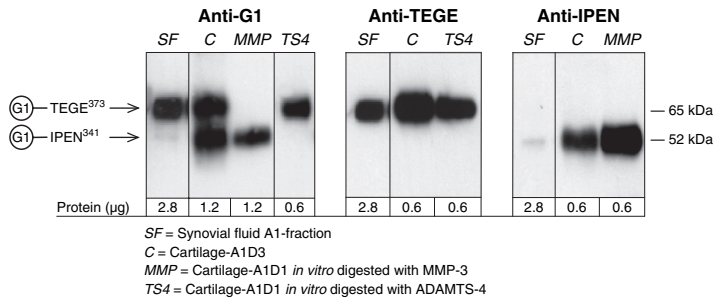

Fig. 5. Detection of aggrecan fragments G1-TEGE and G1-IPEN by Western immuno-blot. The human samples were SDS-PAGE separated (4–12% gel) and analyzed by Western immuno-blot using different antibodies as shown. Amount of protein loaded per lane is shown. Mean values of Mw of aggrecan fragments were calculated based on electrophoretic migration.

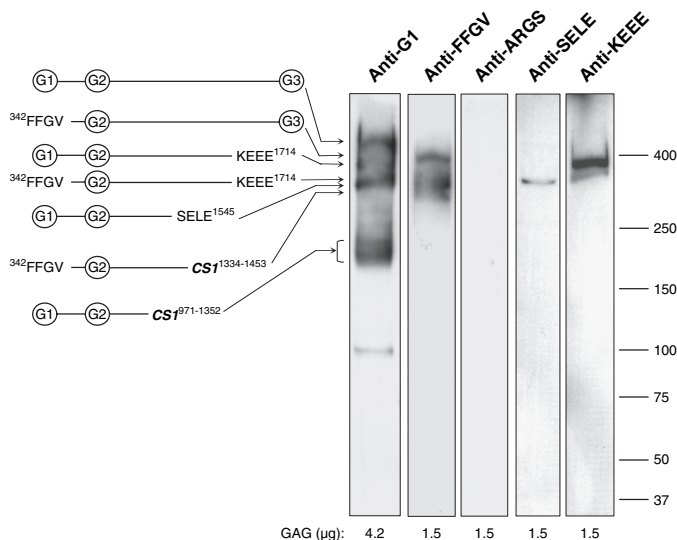

Fig. 6. High Mw aggrecan fragments detected in OA cartilage by Western immuno-blot. Human OA aggrecan cartilage-A1D1 was SDS-PAGE separated (3–8% gel) and analyzed by Western immuno-blot with different antibodies as shown. Amount of GAG loaded per lane, the positions of Mw markers and the aggrecan fragments detected are shown.

were detected by Western immuno-blot in the cartilage-A1D1 sample (Fig. 6). Two FFGV-containing aggrecan polypeptides were identified as a 411 kDa  $^{342}$ FFGV-G3 fragment (also C-terminally verified, results not shown) and as a 340 kDa  $^{342}$ FFGV-KEEE $^{1714}$  fragment (Fig. 6 and Table I). A 300 kDa  $^{342}$ FFGV-fragment had a CS1 located C-terminal identified as -DLS $^{1334-1453}$ , from the calpain-2 site $^{24}$  XDLs $^{1334-1453}$  ↓ $^{1335-1454}$ GLPS (Fig. 6 and Table I). In addition, several high Mw G1-fragments were observed in the cartilage-A1D1 sample. Besides the 429 kDa full length G1-G3 molecule (also verified C-terminally, results not shown), the cartilage-A1D1 sample also contained a 367 kDa G1-KEEE $^{1714}$  fragment, a 331 kDa G1-SELE $^{1545}$  fragment and two (197 and 217 kDa) G1-GVED $^{971-1352}$  (-CS1) fragments (Fig. 6 and Table I). The 100 kDa false positive anti-G1 immuno-band, derived from chondroitinase ABC polypeptide (Fig. 2), was also observed in the cartilage-A1D1 sample (Fig. 6). No N-terminal LGQR-fragments were observed in these cartilage samples (results not shown).

These results show that several high Mw GAG containing fragments with N-terminal sequences of either G1- or  $^{342}$ FFGV-, but not  $^{374}$ ARGS-, are present in the OA cartilage.

#### FFGV- AND ARGS-FRAGMENTS WERE QUANTIFIED IN HUMAN OA SYNOVIAL FLUID

OA synovial fluid (D1-fraction) was quantified for content of FFGV- or ARGS-fragments using FFGV- and ARGS-standards, generated by MMP-3 or ADAMTS-4 total aggrecan cartilage-A1D1 digests [as an example see Fig. 2(A and D)], using Western immuno-blot and a luminescence

imaging system. The OA synovial fluid contained 40.3 pmol FFGV- and 107 pmol ARGS-fragments per ml neat synovial fluid, with an ARGS- to FFGV-fragment molar ratio of 2.7 (Table II). The GAG concentration in the human synovial fluid pool was 140 µg per ml. Based on the assumption that 75% of the aggrecan Mw represents GAG, the total amount of aggrecan fragments per ml SF was 185 µg, or 185 pmoles assuming an Mw for aggrecan of  $1 \times 10^6$  g/mol. Based on this quantification, 20–25% of the GAG-containing aggrecan fragments in pooled human OA synovial fluid carried the FFGV- N-terminal sequence, while the corresponding proportion carrying the ARGS-terminal was 55–60%.

Table II  
Calculated amounts of ARGS and FFGV fragments in synovial fluid from OA patients using Western immuno-blot

	Synovial fluid	
	pmol/ml SF	nmol/mg GAG
ARGS-fragments	107 (17.6)	1.13 (0.2)
FFGV-fragments	40.3 (9.4)	0.42 (0.1)
ARGS/FFGV (mol/mol)	2.7	
Total amount of aggrecan	185 pmol/ml SF	

SF-D1 samples were probed with anti-ARGS or anti-FFGV antibodies. The samples were quantified using total ADAMTS-4 or MMP-3 cartilage-A1D1 digests as standards. Values are expressed as the amount of fragments per volume SF (neat synovial fluid) or amounts of fragments per mg GAG in the SF-D1 fraction. The data show total amounts of respective fragment, standard deviation values are shown in brackets for which  $n = 8$ .

## Discussion

Our understanding of aggrecan degradation pathways *in vivo* in human OA is based on samples from a small number of patients<sup>1,2,6,13,14</sup>. By pooling synovial fluids from more than a hundred OA patients, we have identified the major aggrecan fragments present in knee OA synovial fluid, independent of disease stage, age, and other variables that might influence fragment patterns in the individual patient. Due to ethical constraints the human joint cartilage used was limited to that from knee replacement surgery, and subject origin was separate from the origin of the synovial fluid pool. However, the joint cartilage pool included a range of samples from the macroscopically normal to that with advanced OA pathology. The OA synovial fluid results presented in this paper were obtained from several D1- and A1-fraction preparations, and the OA cartilage data were obtained from two separate A1D1/A1D3 preparations, all providing reproducible results. Using Western immuno-blot, we detected no differences in the aggrecan fragment patterns or intensities of cartilage and synovial fluid samples when the purification was done in the presence or absence of proteinase inhibitors. This contrasts to a previous report, where aggrecanolytic activity by MMPs was observed during the dialysis step in the absence of proteinase inhibitors when guanidine-HCl was removed from extracts of cultured pig cartilage<sup>23</sup>. However, the cartilage explants used in that study were stimulated *in vitro* with IL-1, which would be expected to significantly upregulate protease expression and activity.

All the antibodies used were carefully tested for false positive recognition. We characterized the aggrecan fragments by identification of both N- and C-terminal sequences using Western immuno-blot and by size calculation based on electrophoretic migration.

Although the OA synovial fluid contained several aggrecan fragments generated by both aggrecanases and MMPs, and some that were generated only by MMP (Table I), it is evident from the Western immuno-blot that the aggrecan fragment pattern in OA synovial fluid was mainly generated by aggrecanase activity (Fig. 3; Table I). It has been suggested that ADAMTS-4 at high concentrations *in vitro* may cleave aggrecan at Asn<sup>341</sup>-Phe<sup>342</sup>, in addition to the preferred Glu<sup>373</sup>-Ala<sup>374</sup> site<sup>25</sup>. At the protease concentrations used in the present study we were unable to replicate these findings (Table I).

The differential distribution of aggrecan fragments between OA cartilage and OA synovial fluid (Table I, Fig. 7) may be caused by several different, but not mutually exclusive, processes, including but not limited to those discussed here. *Firstly*, aggrecan structure is variable. For example, newly synthesized molecules are likely to have an intact G3-domain while older aggrecan molecules appear to be increasingly truncated at the C-terminal end. This heterogeneity of the aggrecan core protein will influence the behavior of fragments once cleaved, for example, through interaction of the G3-domain with other matrix components<sup>26</sup>. Further, variability of aggrecan carbohydrate substitution may affect protease susceptibility<sup>27</sup>. It is unclear to what extent aggregation varies, but this may also influence aggrecan fragment behavior. *Secondly*, with more than one protease involved in degradation, there is potential for differential protease activation and substrate specificity, the latter influenced by the order of cleavage. Further potential for variability in aggrecan degradation pathways may be provided by C-terminal processing of ADAMTS-4 which was shown to influence its binding to extracellular matrix

components and substrate specificity<sup>28</sup>. ADAMTS-4 is inhibited by TIMP-3 and by interaction with fibronectin, providing yet other possibilities for protease regulation<sup>29,30</sup>. *Thirdly*, the differential distribution of aggrecan subpopulations and proteolytic activities within the cartilage matrix and synovial fluid will likely play an important role in generating the observed distribution. For example, molecules of different ages may be differentially distributed within the cartilage matrix, and newly synthesized molecules with an intact G3-domain may be preferentially located close to the chondrocytes in the territorial matrix, while older, truncated molecules may dominate in the interterritorial matrix. *Fourthly*, cellular uptake mechanisms may differentiate between different molecular fragments.

Since we detected in human OA cartilage both aggrecanase-generated G1-TEGE<sup>373</sup> and MMP-generated G1-IPEN<sup>341</sup> fragments (Fig. 5), their distal counterparts, carrying the neoepitopes <sup>374</sup>ARGS- and <sup>342</sup>FFGV-, must both have been produced in the tissue. There was, however, a striking difference in the distribution of these fragments between cartilage and synovial fluid. The MMP-generated <sup>342</sup>FFGV-fragments were partly retained in cartilage (Tables I, II; Figs. 6, 7), whereas the aggrecanase-generated <sup>374</sup>ARGS-fragments were not found in the tissue but only in the synovial fluid (Table I; Figs. 4(A), 6, 7). Quantification showed that the OA synovial fluid pool contained 107 pmoles per ml of <sup>374</sup>ARGS-fragments (Table II). This amount corresponds to approximately 60% of the total amount of aggrecan fragments in human OA synovial fluid (estimated to 185 pmoles/ml), and corroborates earlier findings in arthritic synovial fluids<sup>1,2</sup>.

Although the possibility exists that the <sup>374</sup>ARGS-fragments detected in the synovial fluid are the result of aggrecanase activity in the joint cavity, we suggest that these fragments are a product of aggrecanase cleavage of molecules within the cartilage that lack the G3-domain. When such G3-truncated fragments are detached from the HA interacting G1-domain by aggrecanase cleavage, diffusion into the joint cavity may occur. Consistent with this proposal, all the <sup>374</sup>ARGS-fragments detected in the OA synovial fluid lacked the G3-domain (Figs. 4, 7). Cartilage explant experiments have shown that <sup>374</sup>ARGS-fragments readily migrate out into the culture media, resulting in very low <sup>374</sup>ARGS-neoepitope content in the tissue<sup>6,31</sup>. On the other hand, a possible association between the KS enriched regions of aggrecan and type II collagen has been reported<sup>32,33</sup>, which could act to retain these fragments in the cartilage. Endocytosis by chondrocytes of <sup>374</sup>ARGS-neoepitope fragments may also occur, although an HA-G1 complex is required for the endocytosis<sup>34</sup>.

The partial retention in the cartilage of the large <sup>342</sup>FFGV-G3 fragments (Figs. 6, 7), where the G3-domain may interact with fibulin-2 and other matrix molecules<sup>26</sup>, could be explained if aggrecan molecules attacked by MMPs were preferentially those newly synthesized and still retaining their G3-domain. It is more difficult to explain the matrix retention of the G3-truncated FFGV-fragments <sup>342</sup>FFGV-CS1 and <sup>342</sup>FFGV-KEEE<sup>1714</sup> (Fig. 6). Since <sup>374</sup>ARGS-fragments of similar sizes are detected in synovial fluid, but not in the cartilage (Table I; Fig. 6), neither the G2-domain nor the KS and CS enriched regions seem to mediate this tissue retention. The <sup>342</sup>FFGV-neoepitope itself or the N- and O-linked substitutions located between Phe<sup>342</sup> and Glu<sup>373</sup> within the IGD could be the mediators of this retention<sup>35,36</sup>. In support, synovial fluid low Mw <sup>342</sup>FFGV-fragments (80–95 kDa) migrated in the associative CsCl gradient to the bottom A1-fractions (Table I), which indicates an association between



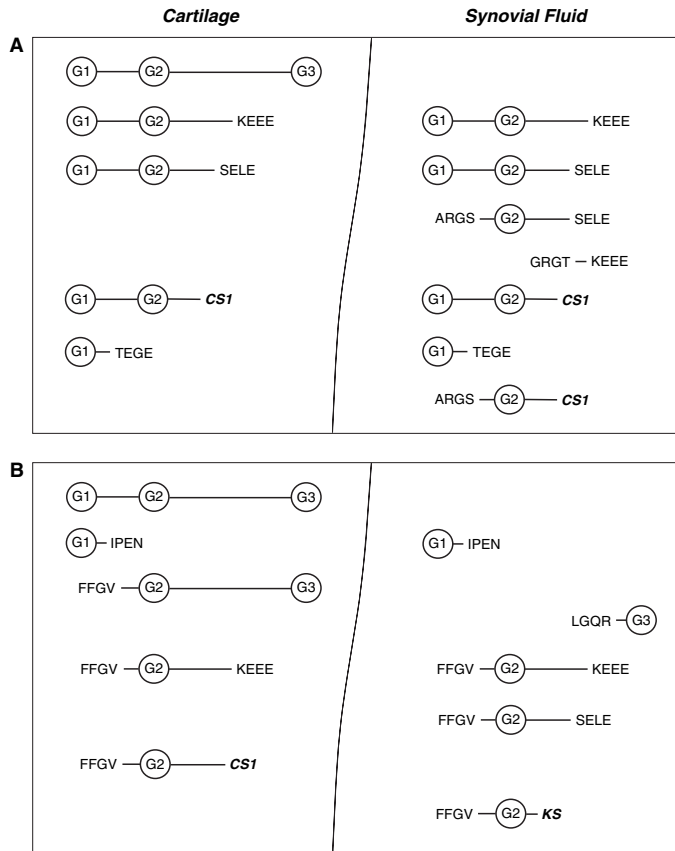

Fig. 7. The main distribution of aggrecan fragments detected by Western immuno-blot in OA cartilage (A1D1 and A1D3 samples) and OA synovial fluid (D1 and A1 samples). Fragments shown are generated by pathways initiated by aggrecanase action (A) and MMP-action (B) as shown in Fig. 8.

these fragments and HA or other molecules binding to HA. Partial matrix retention of G3-truncated <sup>342</sup>FFGV-fragments has been reported<sup>37</sup>. Previously detected FFGV-fragments in human OA synovial fluid<sup>13,38</sup> and in porcine cartilage<sup>37</sup> were a mixture of several smaller peptides ranging between 40 and 200 kDa. In contrast, we detected large (> 300 kDa) <sup>342</sup>FFGV-aggrecan fragments in the OA synovial fluid and OA cartilage [Figs. 4(B), 6]. The level of the large <sup>342</sup>FFGV-aggrecan fragments in the OA synovial fluid pool was about 40 pmol per ml, or 20–25% of the total amount of aggrecan fragments (Table II). This compares with previous findings of 10–20 pmol per ml OA synovial fluid, where a competitive ELISA using the FFGV-epitope mab AF28 was used to detect low Mw FFGV-fragments<sup>13</sup>.

We readily detected both G1-TEGE<sup>373</sup> and G1-IPEN<sup>341</sup> fragments in OA cartilage (Fig. 5), similar to previous reports using Western analysis<sup>6,14,15</sup> or immunohistochemistry<sup>15</sup>. However, we detected insignificant amounts of G1-IPEN<sup>341</sup> fragments in the OA synovial fluid with anti-G1 or

anti-IPEN antibodies, while G1-TEGE<sup>373</sup> was readily detected with both anti-G1 and anti-TEGE antibodies. Even though the sensitivity and affinity of the anti-TEGE and anti-IPEN neopeptide antibodies may differ, these results together with the results based on anti-G1 Western analysis show that there were insignificant amounts of G1-IPEN<sup>341</sup> fragments in the OA synovial fluid pool as compared to the OA cartilage pool (Fig. 5). This contrasts to other reports that have detected both -TEGE<sup>373</sup> and -IPEN<sup>341</sup> neopeptides in some individual OA synovial fluid samples, although the quantity of the -TEGE<sup>373</sup> neopeptide was greater<sup>14</sup>.

There are at least two possible explanations for relative paucity of G1-IPEN<sup>341</sup> fragments in the OA synovial fluid, one not necessarily excluding the other. Firstly, after MMP cleavage at the -IPEN<sup>341</sup> ↓<sup>342</sup>FFGV- site, which could have occurred either in the matrix with subsequent diffusion of the fragments into the joint cavity or within the joint cavity, the G1-IPEN<sup>341</sup> fragments were immediately degraded

within the joint cavity preventing their detection. Secondly, it is possible that the majority of -IPEN<sup>341</sup> ↓<sup>342</sup>FFGV- cleavage takes place within the pericellular or territorial matrix, with prompt internalization of the -IPEN<sup>341</sup> neopeptide by the chondrocytes. Endocytosis of the -TEGE<sup>373</sup> neopeptide has been shown to occur in a porcine cartilage explant system<sup>37</sup>, and a similar process may occur with the -IPEN<sup>341</sup> neopeptide.

With regard to spatial localization of proteinase activities, it was shown by immunohistochemistry that even though both -TEGE<sup>373</sup> and -IPEN<sup>341</sup> neopeptides were present in OA cartilage, the -IPEN<sup>341</sup> neopeptide was reduced or absent from the most superficial parts of the articular cartilage, while the -TEGE<sup>373</sup> neopeptide was present in the same location<sup>15</sup>. This may indicate that aggrecanase cleavage can be spatially distinct within the tissue from MMP cleavage. Early work suggested that in normal mature cartilage there are at least two metabolic pools of aggrecan — an active pool with short-lived aggrecan surrounding the chondrocytes and an inactive pool with long-lived aggrecan in the interterritorial matrix<sup>39–43</sup>. This is consistent with -TEGE<sup>373</sup> ↓<sup>374</sup>ARGS-cleavage occurring in the interterritorial matrix, where fragment diffusion into the joint cavity may dominate, while the majority of cleavage at -IPEN<sup>341</sup> ↓<sup>342</sup>FFGV- takes place in the pericellular or territorial matrix where endocytosis may dominate. Such

separate pathways have been proposed<sup>15</sup>, and are further supported by *in vitro* studies showing that aggrecanases are unable to cleave <sup>342</sup>FFGV-fragments at the -TEGE<sup>373</sup> ↓<sup>374</sup>ARGS- site<sup>37</sup>.

The findings described here provide a basis for a model of aggrecan turnover in OA joint cartilage (Fig. 8). The pathway generating <sup>374</sup>ARGS-fragments is initiated by aggrecanase action in the interterritorial matrix, generating aggrecan with variable C-terminal sequences, but still interacting with HA and link protein. These interterritorially located molecules are further cleaved by aggrecanase within the IGD, generating G1-TEGE<sup>373</sup> fragments bound to HA and free unattached <sup>374</sup>ARGS-fragments. An associated but yet little understood simultaneous degradation of HA may allow the release of G1-TEGE<sup>373</sup> from the matrix<sup>11,44</sup>.

The pathway for the generation of <sup>342</sup>FFGV-fragments is initiated in the vicinity of metabolically active chondrocytes when newly synthesized aggregated proteoglycans are cleaved within the IGD by MMP, generating G1-IPEN<sup>341</sup> and <sup>342</sup>FFGV-G3 fragments. G1-IPEN<sup>341</sup> fragments, bound to HA, are further processed by the chondrocytes. The <sup>342</sup>FFGV-G3 fragments, bound within the matrix by interactions with the N- and C-terminal sequences, are cleaved in the CS2 region by aggrecanase generating <sup>342</sup>FFGV-fragments with variable C-terminals. Finally, the model suggests that the different G3-truncated <sup>374</sup>ARGS- and

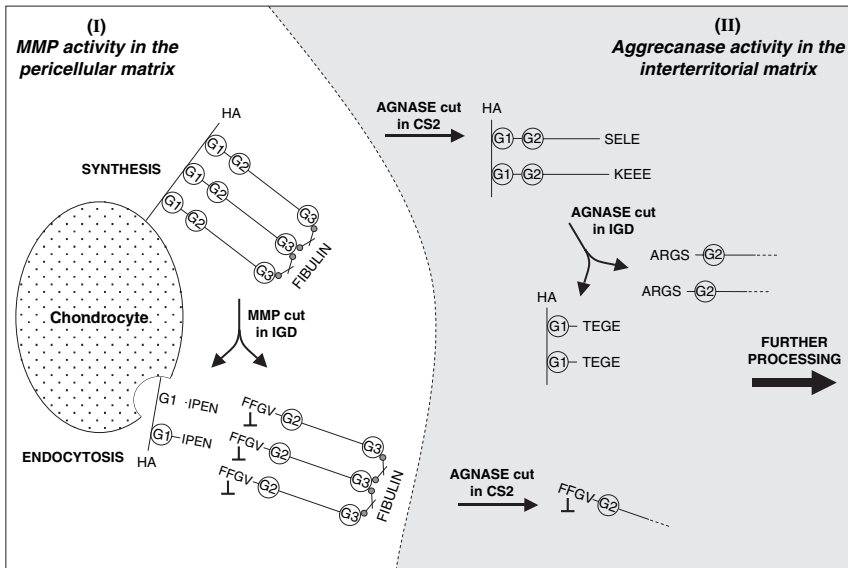

Fig. 8. A hypothetical model of the major proteolysis of cartilage aggrecan in OA joints. ARGS- and FFGV-fragments are generated by two different pathways (I and II). In the pericellular area, full length aggrecan monomers (G1-G2-G3) are expressed and aggregate with HA and link protein; cross-linking of the G3-domain with, e.g., fibulin-2 may also occur. In pathway I, aggrecan turnover in the pericellular area starts by MMP cleavage within the IGD producing G1-IPEN and FFGV-G3 fragments. The HA-bound G1-IPEN fragments are endocytosed by the chondrocytes. The FFGV-G3 fragments are further processed in the CS2 region by aggrecanases, producing FFGV-fragments with various C-terminal sequences (FFGV-G2—), which are partly retained in the tissue by sequence interactions (⊥). In pathway II in the interterritorial area, aggrecan monomers are first cleaved in the CS2 region by aggrecanases (AGNASE) producing HA-bound G1-fragments with various C-terminals. Then the G1-fragments are cleaved by aggrecanase within the IGD, generating HA-bound G1-TEGE fragments and unbound ARGS-fragments having various C-terminals (ARGS-G2—). Finally, in the interterritorial matrix compartment the aggrecan fragments are further processed by aggrecanases and other proteases producing fragments that are released into the synovial cavity.

<sup>342</sup>FFGV-fragments, together with some G1-fragments, are further processed and then diffuse into the joint cavity.

In summary, the results of the present study indicate that the degradation of aggrecan in human knee OA cartilage involves both MMPs and aggrecanases, albeit with an apparent dominant role for aggrecanases. Further examination of individual samples of human OA cartilage and synovial fluid with quantitative methods may provide information on individual variability relating to these pathways, as well as their relationship to age, disease stage and disease activity; information that may be relevant when considering therapies directed towards preventing cartilage matrix breakdown.

## References

- Sandy JD, Flannery CR, Neame PJ, Lohmander LS. The structure of aggrecan fragments in human synovial fluid. Evidence for the involvement in osteoarthritis of a novel proteinase which cleaves the Glu 373-Ala 374 bond of the interglobular domain. *J Clin Invest* 1992;89(5):1512–6.
- Lohmander LS, Neame PJ, Sandy JD. The structure of aggrecan fragments in human synovial fluid. Evidence that aggrecanase mediates cartilage degradation in inflammatory joint disease, joint injury, and osteoarthritis. *Arthritis Rheum* 1993;36(9):1214–22.
- Doegel KJ, Sasaki M, Kimura T, Yamada Y. Complete coding sequence and deduced primary structure of the human cartilage large aggregating proteoglycan, aggrecan. Human-specific repeats, and additional alternatively spliced forms. *J Biol Chem* 1991;266(2):894–902.
- Flannery CR, Lark MW, Sandy JD. Identification of a stromelysin cleavage site within the interglobular domain of human aggrecan. Evidence for proteolysis at this site *in vivo* in human articular cartilage. *J Biol Chem* 1992;267(2):1008–14.
- Fosang AJ, Last K, Knauper V, Murphy G, Neame PJ. Degradation of cartilage aggrecan by collagenase-3 (MMP-13). *FEBS Lett* 1996;380(1–2):17–20.
- Malfait AM, Liu RQ, Ijiri K, Komiya S, Tortorella MD. Inhibition of ADAM-TS4 and ADAM-TS5 prevents aggrecan degradation in osteoarthritic cartilage. *J Biol Chem* 2002;277(25):22201–8.
- Fosang AJ, Last K, Knauper V, Neame PJ, Murphy G, Hardingham TE, *et al.* Fibroblast and neutrophil collagenases cleave at two sites in the cartilage aggrecan interglobular domain. *Biochem J* 1993;295(Pt 1):273–6.
- Flannery CR, Sandy JD. Aggrecan catabolism in cartilage: studies on the nature of a novel proteinase (aggrecanase) which cleaves the Glu373-Ala374 bond of the interglobular domain (Abstract). *Trans Orthop Res Soc* 1993;17:677.
- Bonassar LJ, Frank EH, Murray JC, Pagnio CG, Moore VL, Lark MW, *et al.* Changes in cartilage composition and physical properties due to stromelysin degradation. *Arthritis Rheum* 1995;38(2):173–83.
- Tortorella MD, Pratta M, Liu RQ, Austin J, Ross OH, Abbaszade I, *et al.* Sites of aggrecan cleavage by recombinant human aggrecanase-1 (ADAMTS-4). *J Biol Chem* 2000;275(24):18566–71.
- Tortorella MD, Liu RQ, Burn T, Newton RC, Amer E. Characterization of human aggrecanase 2 (ADAMTS5): substrate specificity studies and comparison with aggrecanase 1 (ADAM-TS4). *Matrix Biol* 2002;21(6):499–511.
- Rodriguez-Manzanique JC, Westling J, Thai SN, Luque A, Knauper V, Murphy G, *et al.* ADAMTS1 cleaves aggrecan at multiple sites and is differentially inhibited by metalloproteinase inhibitors. *Biochem Biophys Res Commun* 2002;293(1):501–8.
- Fosang AJ, Last K, Maciewicz RA. Aggrecan is degraded by matrix metalloproteinases in human arthritis. Evidence that matrix metalloproteinase and aggrecanase activities can be independent. *J Clin Invest* 1996;98(10):2292–9.
- Sandy JD, Verscharen C. Analysis of aggrecan in human knee cartilage and synovial fluid indicates that aggrecanase (ADAMTS) activity is responsible for the catabolic turnover and loss of whole aggrecan whereas other protease activity is required for C-terminal processing *in vivo*. *Biochem J* 2001;358(Pt 3):615–26.
- Lark MW, Bayne EK, Flanagan J, Harper CF, Hoerner LA, Hutchinson NI, *et al.* Aggrecan degradation in human cartilage. Evidence for both matrix metalloproteinase and aggrecanase activity in normal, osteoarthritic, and rheumatoid joints. *J Clin Invest* 1997;100(1):93–106.
- Glasson SS, Askew R, Sheppard B, Carito B, Blanchet T, Ma HL, *et al.* Deletion of active ADAMTS5 prevents cartilage degradation in a murine model of osteoarthritis. *Nature* 2005;434(7033):644–8.
- Stanton H, Rogerson FM, East CJ, Golub SB, Lawlor KE, Meeker CT, *et al.* ADAMTS5 is the major aggrecanase in mouse cartilage *in vivo* and *in vitro*. *Nature* 2005;434(7033):648–52.
- Tortorella MD, Burn TC, Pratta MA, Abbaszade I, Hollis JM, Liu R, *et al.* Purification and cloning of aggrecanase-1: a member of the ADAMTS family of proteins. *Science* 1999;284(5420):1664–6.
- Bjornsson S. Simultaneous preparation and quantitation of proteoglycans by precipitation with Alcian Blue. *Anal Biochem* 1993;210(2):282–91.
- Sandy JD, Plaas AH, Koob TJ. Pathways of aggrecan processing in joint tissues. Implications for disease mechanism and monitoring. *Acta Orthop Scand Suppl* 1995;266:26–32.
- Lemons ML, Sandy JD, Anderson DK, Howland DR. Intact aggrecan and fragments generated by both aggrecanase and metalloproteinase-like activities are present in the developing and adult rat spinal cord and their relative abundance is altered by injury. *J Neurosci* 2001;21(13):4772–81.
- Lark MW, Gordy JT, Weidner JR, Ayala J, Kimura JH, Williams HR, *et al.* Cell-mediated catabolism of aggrecan. Evidence that cleavage at the “aggrecanase” site (Glu373-Ala374) is a primary event in proteolysis of the interglobular domain. *J Biol Chem* 1995;270(6):2550–6.
- Stanton H, Fosang AJ. Matrix metalloproteinases are active following guanidine hydrochloride extraction of cartilage: generation of DIPEN neopeptide during dialysis. *Matrix Biol* 2002;21(5):425–8.
- Oshita H, Sandy JD, Suzuki K, Akaike A, Bai Y, Sasaki T, *et al.* Mature bovine articular cartilage contains abundant aggrecan that is C-terminally truncated at Ala719-Ala720, a site which is readily cleaved by m-calpain. *Biochem J* 2004;382(Pt 1):253–9.
- Westling J, Fosang AJ, Last K, Thompson VP, Tomkinson KN, Hebert T, *et al.* ADAMTS4 cleaves at the

- aggrecanase site (Glu373-Ala374) and secondarily at the matrix metalloproteinase site (Asn341-Phe342) in the aggrecan interglobular domain. *J Biol Chem* 2002;277(18):16059–66.
26. Day JM, Olin AI, Murdoch AD, Canfield A, Sasaki T, Timpl R, *et al.* Alternative splicing in the aggrecan G3 domain influences binding interactions with tenascin-C and other extracellular matrix proteins. *J Biol Chem* 2004;279(13):12511–8.
  27. Poon CJ, Plaas AH, Keene DR, McQuillan DJ, Last K, Fosang AJ. N-linked keratan sulphate in the aggrecan interglobular domain potentiates aggrecanase activity. *J Biol Chem* 2005.
  28. Kashiwagi M, Enghild JJ, Gendron C, Hughes C, Caterson B, Itoh Y, *et al.* Altered proteolytic activities of ADAMTS-4 expressed by C-terminal processing. *J Biol Chem* 2004;279(11):10109–19.
  29. Hashimoto G, Shimoda M, Okada Y. ADAMTS4 (aggrecanase-1) interaction with the C-terminal domain of fibronectin inhibits proteolysis of aggrecan. *J Biol Chem* 2004;279(31):32483–91.
  30. Kashiwagi M, Tortorella M, Nagase H, Brew K. TIMP-3 is a potent inhibitor of aggrecanase 1 (ADAM-TS4) and aggrecanase 2 (ADAM-TS5). *J Biol Chem* 2001; 276(16):12501–4.
  31. Ilic MZ, Mok MT, Williamson OD, Campbell MA, Hughes CE, Handley CJ. Catabolism of aggrecan by explant cultures of human articular cartilage in the presence of retinoic acid. *Arch Biochem Biophys* 1995;322(1):22–30.
  32. Hedlund H, Hedborn E, Heinegård D, Mengarelli-Widholm S, Reinholdt FP, Svensson O. Association of the aggrecan keratan sulfate-rich region with collagen in bovine articular cartilage. *J Biol Chem* 1999;274(9): 5777–81.
  33. Pratta MA, Yao W, Decicco C, Tortorella MD, Liu RQ, Copeland RA, *et al.* Aggrecan protects cartilage collagen from proteolytic cleavage. *J Biol Chem* 2003; 278(46):45539–45.
  34. Embry JJ, Knudson W. G1 domain of aggrecan coin-ternalizes with hyaluronan via a CD44-mediated mechanism in bovine articular chondrocytes. *Arthritis Rheum* 2003;48(12):3431–41.
  35. Barry FP, Rosenberg LC, Gaw JU, Koob TJ, Neame PJ. N- and O-linked keratan sulfate on the hyaluronan binding region of aggrecan from mature and immature bovine cartilage. *J Biol Chem* 1995;270(35): 20516–24.
  36. Fosang AJ, Neame PJ, Last K, Hardingham TE, Murphy G, Hamilton JA. The interglobular domain of cartilage aggrecan is cleaved by PUMP, gelatinases, and cathepsin B. *J Biol Chem* 1992;267(27): 19470–4.
  37. Fosang AJ, Last K, Stanton H, Weeks DB, Campbell IK, Hardingham TE, *et al.* Generation and novel distribution of matrix metalloproteinase-derived aggrecan fragments in porcine cartilage explants. *J Biol Chem* 2000;275(42):33027–37.
  38. Fosang AJ, Last K, Gardiner P, Jackson DC, Brown L. Development of a cleavage-site-specific monoclonal antibody for detecting metalloproteinase-derived aggrecan fragments: detection of fragments in human synovial fluids. *Biochem J* 1995;310(Pt 1):337–43.
  39. Lohmander S, Antonopoulos CA, Friberg U. Chemical and metabolic heterogeneity of chondroitin sulfate and keratan sulfate in guinea pig cartilage and nucleus pulposus. *Biochim Biophys Acta* 1973;304(2): 430–48.
  40. Lohmander S. Turnover of proteoglycans in guinea pig costal cartilage. *Arch Biochem Biophys* 1977;180(1): 93–101.
  41. Mok SS, Masuda K, Hauselmann HJ, Aydelotte MB, Thonar EJ. Aggrecan synthesized by mature bovine chondrocytes suspended in alginate. Identification of two distinct metabolic matrix pools. *J Biol Chem* 1994;269(52):33021–7.
  42. Ilic MZ, Haynes SR, Winter GM, Handley CJ. Kinetics of release of aggrecan from explant cultures of bovine cartilage from different sources and from animals of different ages. *Acta Orthop Scand Suppl* 1995;266: 33–7.
  43. Hascall VC, Sandy JD, Handley CJ. Regulation of proteoglycan metabolism in articular cartilage. In: Archer CW, Caterson B, Benjamin M, Ralphs JR, Eds. *Biology of the Synovial Joint*. Cardiff: Harwood Academic Publishers 1999;101–20.
  44. Chockalingam PS, Zeng W, Morris EA, Flannery CR. Release of hyaluronan and hyaladherins (aggrecan G1 domain and link proteins) from articular cartilage exposed to ADAMTS-4 (aggrecanase 1) or ADAMTS-5 (aggrecanase 2). *Arthritis Rheum* 2004; 50(9):2839–48.
-



## Paper II



## Western blot quantification of aggrecan fragments in human synovial fluid indicates differences in fragment patterns between joint diseases

A. Struglics<sup>a,\*</sup>, S. Larsson<sup>a</sup>, M. Hansson and L. S. Lohmander

Department of Orthopaedics, Clinical Sciences Lund, Lund University, Sweden

### Summary

**Objective:** To develop a Western blot method for quantification of multiple aggrecan fragments in human synovial fluids (SFs).

**Method:** SF aggrecan fragments were prepared from knee healthy (reference), knee injury and arthritis subjects by CsCl gradient centrifugations collecting D1 fractions. Samples were analyzed by Western blot, using antibodies against the N-terminal epitope ARGS and the G3 domain, and fragments were quantified using a digital luminescence image analyzer.

**Results:** The method had a coefficients of variation of 10–30%, and a high correlation ( $r_s = 0.86$ ) with a corresponding enzyme-linked immunosorbent assay (ELISA). The SFs from reference, knee injured and arthritic subjects contained two major ARGS fragments, ARGS-SELE and ARGS-CS1, and three major G3 fragments (GRGT-G3, GLGS-G3 and AGE-G3). Compared to the reference, the acute arthritis and acute joint injury groups had a 30-fold elevated concentration of ARGS fragments, and both groups had a higher proportion of the aggrecan in joint fluid as ARGS fragments compared to the other groups. The reference and chronic injury groups had an excess of ARGS-CS1 fragments over ARGS-SELE fragments, while subjects with acute arthritis or osteoarthritis had a more even distribution between these fragments.

**Conclusions:** We have developed a novel Western blot quantification method for quantification of SF aggrecan fragments which can differentiate fragments of different sizes sharing the same epitope. The anti-ARGS and anti-G3 quantitative Western blots provided information important for a better understanding of the proteolytic pathways in aggrecan breakdown, information that discriminates between different joint diseases, and may aid in identification of new biomarkers.

© 2008 Osteoarthritis Research Society International. Published by Elsevier Ltd. All rights reserved.

**Key words:** Aggrecan, Aggrecanase, Proteolytic fragments, Synovial fluid, Western blot.

### Introduction

A central feature of arthritis and joint injury is the degradation of articular cartilage matrix, involving an early loss of aggrecan fragments into synovial fluid (SF)<sup>1–3</sup>. Although both cathepsins<sup>4–6</sup> and calpains<sup>7,8</sup> cleave aggrecan, the main proteinases responsible for aggrecan degradation are the aggrecanases and matrix metalloproteinases (MMPs)<sup>9</sup>. The involvement of aggrecanases in human arthritis was first shown by the detection of aggrecan fragments with N-terminal sequence<sup>393</sup>ARGS<sup>B</sup> in SF<sup>10,11</sup>. Aggrecanases cleave aggrecan in the inter-globular domain (IGD) at TEGE<sup>392,395</sup>ARGS and in the chondroitin sulfate 2 (CS2) domain at SELE<sup>1564,1565</sup>GRGT, KEEE<sup>1733,1734</sup>GLGS, TAQE<sup>1838,1839</sup>AGEG and ISQE<sup>1938,1939</sup>LGQR sites<sup>12,13</sup>. For MMPs, proteolysis at the IPEN<sup>360,361</sup>FFGV site within the IGD is predominant<sup>14–17</sup>. An important role of the aggrecanase activity in aggrecan degradation in joint disease is established, but

the relative contributions of aggrecanase and other proteolytic activities remain to be defined for different human joint diseases and disease stages<sup>18,19</sup>. Animal models have confirmed the role of aggrecanases in joint cartilage destruction in arthritis, but pointed to a possible role for as yet unidentified proteolytic activities and species differences<sup>20–26</sup>. In the continued work towards a better understanding of cartilage destruction in arthritis, and of the consequences of inhibiting proteolytic pathways as a means of treating human joint diseases, methods are needed that in detail map aggrecan fragment patterns in multiple samples from *in vitro*, animal models or humans.

We have developed a method that combines small scale CsCl density gradient centrifugation with quantitative Western blotting, using antibodies specific for aggrecan proteolytic fragments and domains. It allows a detailed mapping and quantification of aggrecan fragments in multiple samples of human SF. In contrast to ELISA, fragments of different sizes sharing the epitope of detection can be quantified.

<sup>a</sup>These authors contributed equally to the work.

\*Address correspondence and reprint requests to: André Struglics, Department of Orthopaedics, Lund University, Klinikgatan 28, BMC C12, SE-22184 Lund, Sweden. Tel: 46-46-222-0762; Fax: 46-46-211-3417; E-mail: andre.struglics@med.lu.se

Received 28 May 2008; revision accepted 30 September 2008.

<sup>B</sup>All the amino acid numberings in this paper are based on full-length human aggrecan amino acid sequence starting with the N-terminal <sup>1</sup>MTTL – (NCBI accession no. P16112, [www.ncbi.nlm.nih.gov](http://www.ncbi.nlm.nih.gov)).

### Materials and methods

#### MATERIALS

Regular chemicals as described previously<sup>19</sup>. Human recombinant ADAMTS-4 (a disintegrin and metalloproteinase with thrombospondin motifs, aggrecanase-1)<sup>27</sup>, anti-ARGSVILTVK monoclonal neopeptide antibody (mab OA-1)<sup>28</sup> and anti-AGEGPGSI polyclonal neopeptide antibody were provided by M. Pratta (GlaxoSmithKline, Colledgeville). Quick-Seal centrifuge tubes (2 ml no. 344625, 12.5 ml no. 342413), tube sealer (no. 342428), tube sizer (no. 303811) were obtained from Beckman Coulter.



## HUMAN SF SAMPLES

A pool of knee SF from 47 patients with end-stage knee osteoarthritis (OA) or with varying stages of post-injury cartilage changes was made (OA pool control sample). Knee SF was collected from 24 patients with joint injury or different types of joint disease and four knee healthy individuals (Table I). Samples were stored at  $-80^{\circ}\text{C}$  after a brief centrifugation at  $3000 \times g$ . All procedures were approved by the ethics review committee of the Medical Faculty of Lund University.

## AGGREGAN ISOLATION FROM SF

Normal D1 preparation (500–800  $\mu\text{g}$  glycosaminoglycan)<sup>19</sup> was made from the SF OA pool. Mini SF-D1 preparation was made from subjects and from the OA pool: SF was cleared by centrifugation<sup>19</sup> and loaded (30–90  $\mu\text{g}$  glycosaminoglycan/subject) in 2 ml Quick-Seal tubes in the presence of buffer and proteinase inhibitors (final approximate concentrations: 3.5 M guanidinium chloride, 3.1 M CsCl, 52 mM Na-acetate, 10 mM EDTA, 0.41 mM AEBSF, 1.0  $\mu\text{M}$  Pepstatin A, 5.2  $\mu\text{M}$  E64), and fractionated by dissociative CsCl density gradient centrifugation (TLA-120.2 rotor; Beckman Coulter) at  $162,000 \times g$  for 72 h at  $16^{\circ}\text{C}$  with starting density 1.44 g/ml. The D1 fractions were collected from the lower half of the tubes at the density of 1.46–1.54 g/ml and dialyzed against Millipore purified HPLC-grade water containing proteinase inhibitors (0.8 mM EDTA, 0.4 mM PMSF, 1  $\mu\text{M}$  Pepstatin A, 20  $\mu\text{M}$  iodoacetamide, 2 mM  $\alpha$ -phenanthroline). Protein (BCA method) and glycosaminoglycan (Alcian Blue method) content was measured<sup>19</sup> in the SF and D1 samples.

## WESTERN BLOT ANALYSIS

Deglycosylated D1 samples (2–4  $\mu\text{g}$  glycosaminoglycan) and ARGS standards (0.5–3.5  $\mu\text{g}$  glycosaminoglycan) were denatured, reduced<sup>19</sup>, and separated according to manufacturer's instructions by SDS-PAGE on 3–8% Tris-acetate mini-gels (15 wells/gel). Immuno-reactions on polyvinylidene difluoride (PVDF) membranes were done as described<sup>19</sup>, using

anti-ARGS neopeptide (5.3  $\mu\text{g}/\text{ml}$ ) or anti-G3 domain (2  $\mu\text{g}/\text{ml}$ ) antibodies (Affinity BioReagents; Golden, CO, USA) together with peroxidase-conjugated secondary antibodies of goat anti-mouse IgG (20 ng/ml) or goat anti-rabbit IgG (13.3 ng/ml). The immuno-bands were visualized using either ECL Plus (Amersham Biosciences) or ECL SuperSignal (Pierce) with the luminescence image analyzer. Specificity of the anti-ARGS antibody was confirmed<sup>19,28</sup>. Specificity of the G3 antibody was confirmed by blocking of the immuno-reaction using the immunogen peptide CDGHPMQFNWRPNQPDN (results not shown).

## QUANTIFICATION OF AGGREGAN ARGS AND G3 FRAGMENTS

Complete conversion of glycosaminoglycan-containing G1 fragments to ARGS fragments (with corresponding G1-TEGE fragments) was achieved by digesting 0.5 mg dry weight (333 pmol, Mw of  $1.5 \times 10^6$  g/mol) human cartilage A1D1 fraction<sup>19</sup> with 0.5  $\mu\text{g}$  recombinant human ADAMTS-4 (8 pmol, 62.5 kDa as Mw) in buffer (50 mM Tris-HCl, 100 mM NaCl, 10 mM CaCl<sub>2</sub>, pH 7.5) for 24 h at  $37^{\circ}\text{C}$ . The enzymatic reaction (0.5 ml) was stopped by addition of EDTA (12  $\mu\text{mol}$ ) and deglycosylated<sup>19</sup>. The digest was assessed for complete conversion by Western blot using antibodies against the G1, TEGE and ARGS epitopes. The ADAMTS-4 digested and deglycosylated cartilage A1D1 sample was used as ARGS standard in the Western blot quantification, assuming 0.667 nmol ARGS fragments per milligram aggrecan dry weight and aggrecan molecular weight of  $1.5 \times 10^6$  g/mol (i.e., total protein sequence plus glycosaminoglycan). Since no G3 standards were available, the SF D1 OA pool was used as a control for the quantification of G3 fragments, expressing the data as relative units of the control sample. SF D1 samples (from subjects and OA pool) and ARGS standards (three different concentrations/gel) were separated by electrophoresis and transferred to PVDF membranes, and then probed with ARGS or G3 antibodies. Detection and quantification of the ARGS and G3 signals from subjects, control and standard samples was conducted in luminescence image analyzer (Fujifilm LAS-1000) in the linear range of the imaging system. The positioning and analysis of regions of interest of individual bands was done using Fujifilm software Image Gauge version 4.0.

Table I

Characteristics of the subjects providing samples for this study. Twenty-eight individuals provided SF samples. Subject age is indicated in years. M = male; F = female. The joint structure score (OA score) was based on arthroscopic and radiographic assessment as described previously<sup>25</sup>. A score of 1 represents a joint with no arthroscopic or radiographic abnormality, scores 2–5 increasing severity of arthroscopic cartilage changes, and scores 6–10 increasing radiographic changes consistent with osteoarthritis (OA). Time between first diagnosis or joint injury and joint fluid sample aspiration was 0–2 weeks for the acute inflammatory arthritis (AA) group, 1–8 weeks for acute joint injury (AI), 1–11 years for chronic joint injury (CI), and 2 weeks to 1 year for OA. Nd, not done. Na, not applicable

Sample number	Age/sex	Diagnosis groups	Clinical diagnosis	OA score
R1	24/M	Reference (R)	Healthy knee	Nd
R2	21/M			Nd
R3	51/M			Nd
R4	48/M			Nd
AA2	30/F	Acute inflammatory arthritis (AA)	Reactive arthritis	Na
AA3	49/F		Rheumatoid arthritis	Na
AA4	66/M		Pyrophosphate crystal arthritis	1
AA5	65/M		Pyrophosphate crystal arthritis	1
AA6	67/M		Pyrophosphate crystal arthritis	1
AA7	57/M		Pyrophosphate crystal arthritis + OA	8
AA8	68/M		Pyrophosphate crystal arthritis	1
AI1	41/M	Acute joint injury (AI)	Posterior crucial ligament tear	1
AI3	35/M		Anterior crucial ligament tear + medial meniscus tear	1
AI5	30/M		Anterior crucial ligament tear + medial meniscus tear	2
AI6	39/M		Lateral meniscus tear	1
AI7	34/M		Medial meniscus tear	1
AI8	39/M		Medial meniscus tear	1
AI9	37/M		Medial meniscus tear	4
CI1	32/M	Chronic joint injury (CI)	Anterior crucial ligament tear + lateral meniscus tear	1
CI2	38/M		Anterior crucial ligament tear + lateral/medial meniscus tear	2
CI3	42/M		Medial meniscus tear	1
CI4	42/M		Medial meniscus tear	2
CI5	48/M		Lateral meniscus tear + OA	3
CI6	46/M		Medial meniscus tear	2
OA1	61/F	Osteoarthritis (OA)	Primary OA	7
OA2	41/F		Primary OA	2
OA3	70/F		Primary OA	7
OA4	61/M		Primary OA	6

The clinical diagnoses of the subjects providing SF samples were kept blinded during the SF D1 preparations and Western blot analysis. When summarizing the data, the subjects were grouped according to their clinical diagnosis (Table 1).

#### STATISTICS

Kruskal–Wallis one-way analysis of variance on ranks was used to avoid mass significance due to multiple group comparisons. If significances were found, then Mann–Whitney rank sum tests for analysis of unmatched pairs was run. For correlation analysis, Spearman rank order correlation ( $r_s$ ) was used.  $P$  values  $< 0.05$  were considered significant.

## Results

#### MINI-D1 PREPARATION AND WESTERN BLOT SCREENING METHOD

Loading the 2 ml CsCl gradient with  $>20$   $\mu$ g glycosaminoglycan from the OA pool sample resulted in a glycosaminoglycan recovery in the D1 fraction of on average 75% ( $SD = 7$ ,  $n = 9$ ), and recoveries for individual samples were similar. The purification of glycosaminoglycan containing aggrecan fragments in the D1 sample (measured as glycosaminoglycan/total protein) was for the OA pool on average  $1250\times$  ( $SD = 119$ ,  $n = 7$ ). When analyzed by Western blot, there were no qualitative or quantitative differences of aggrecan fragment patterns between normal and mini-D1 preparations (results not shown). As a control of the Western blot quantification method, ARGS Western blot data of SF D1 samples were compared to neat SF samples from the same subjects with a keratan sulfate (KS) capture ARGS ELISA<sup>28</sup>. There was a strong correlation ( $r_s = 0.86$ ,  $n = 18$ ) between results obtained with the Western blot and ELISA quantification methods (Fig. 1). The Western blot method gave on average 44% ( $SD = 23$ ,  $n = 18$ ) of the molar values obtained with the ELISA method.

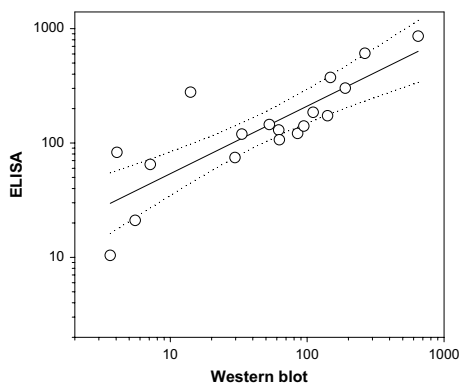

Fig. 1. Correlation between Western blot and ELISA methods in quantification of ARGS fragments. Neat SF from 18 subjects was analyzed by ARGS ELISA as described<sup>28</sup>. D1 samples from the same subjects were quantified by anti-ARGS Western blot. The mean values of the total ARGS concentrations (pmol ARGS/ml SF) are plotted as circles. Solid line shows the first order regression, and broken lines show the 95% confidence intervals. The Spearman rank order correlation between the Western blot and ELISA ARGS concentrations was 0.86 and the  $P$  value was  $< 0.0001$ . Note the logarithmic scales.

Coefficients of variation (CV) for the Western blot screening method were calculated by measuring the total ARGS signal from the OA pool. Analyses of the OA pool from a single D1 preparation showed intra- ( $n = 5$ ) and inter- ( $n = 5$ ) Western blot assay CV of 11% and 16%, respectively, while the intra- and inter-Western blot CV between different D1 preparations ( $n = 10$ ) were both about 30%. The intra-operator CV for applying regions of interest in the image software around the same lane of total ARGS signal was 1% ( $n = 5$ ).

#### QUALITATIVE WESTERN BLOT ANALYSIS OF ARGS FRAGMENTS

Aggrecan fragments were purified from SF of 28 individuals (Table 1) and from the OA pool using the D1 mini-prep method. The D1 samples were separated by SDS-PAGE and probed for ARGS fragments using Western blot (Fig. 2). The SF samples contained two ARGS fragment regions termed A and B [Fig. 2(A)]. The ARGS region A ( $M_w = 280$ – $320$  kDa) contained a 310 kDa ARGS fragment which was detected in all subjects [band a2; Fig. 2(B)], identified previously as a <sup>393</sup>ARGS-SELE<sup>1564</sup> fragment<sup>19</sup>. The ARGS standard and the subjects in the acute arthritis group had an additional 288 kDa ARGS fragment located in region A [band a3 in Fig. 2(B)], while this fragment was missing in the other subject groups. The 288 kDa ARGS fragment had an estimated (using a calculation model<sup>29</sup>) C-terminal of -GTLG<sup>1500</sup> in the CS1 domain, suggesting that the C-terminal was generated by m-calpain cleavage<sup>8</sup> at EDLS<sup>1472</sup>↓<sup>1473</sup>GLPS, corresponding to a <sup>393</sup>ARGS-EDLS<sup>1472</sup> polypeptide. A 367 kDa ARGS fragment [band a1; Fig. 2(B)], had an estimated (using the calculation model<sup>29</sup>) C-terminal of -TQAP<sup>1834</sup> in the CS2 domain, suggesting that it was generated by aggrecanase cleavage at TAQE<sup>1838</sup>↓<sup>1839</sup>AGEG and therefore corresponded to a <sup>393</sup>ARGS-TAQE<sup>1838</sup> polypeptide. This fragment was detected in some of the acute joint injury (AI) subjects (e.g., AI1 and AI8). The broad ARGS-reactive region B ( $M_w = 120$ – $160$  kDa) corresponded to multiple <sup>393</sup>ARGS-CS1 fragments where the C-terminal was estimated<sup>29</sup> to -GV(G/E)D<sup>952</sup>–<sup>1409</sup>, suggesting several MMP cuts in the CS1 region<sup>14</sup>. The anti-ARGS antibody (mab OA-1) showed a similar immuno-pattern in Western blots as the commercially available anti-ARGS antibody BC-3 (results not shown).

#### QUALITATIVE WESTERN BLOT ANALYSIS OF G3 FRAGMENTS

D1 samples were separated by SDS-PAGE and probed for G3 fragments using Western blot (Fig. 3). The majority of the SF samples contained three dominant G3 fragments: band a (214 kDa), b (171 kDa) and c (137 kDa) (Fig. 3). Fragment c was identified as <sup>1839</sup>AGEG-G3 by Western blot using anti-AGEG and anti-G3 antibodies (result not shown); fragments a and b were estimated by the calculation model<sup>29</sup> as putative <sup>1565</sup>GRGT-G3 and <sup>1734</sup>GLGS-G3 fragments, respectively. A weakly reactive G3 fragment, band d (103 kDa), was present in some of the samples (e.g., CI1 and CI2; Fig. 3). This fragment was identified by Western blot as <sup>1939</sup>LGQR-G3 using anti-LGQR and anti-G3 antibodies (our results not shown; Sandy and Verscharen<sup>30</sup>). A G3 fragment, band e (68 kDa), was present in several acute and chronic injury (CI) samples (e.g., AI7, AI8, CI3 and CI4) and in the reference sample R1 (Fig. 3). The N-terminal of fragment e was estimated by the calculation<sup>29</sup> as a sequence starting with <sup>2074</sup>PTAS,

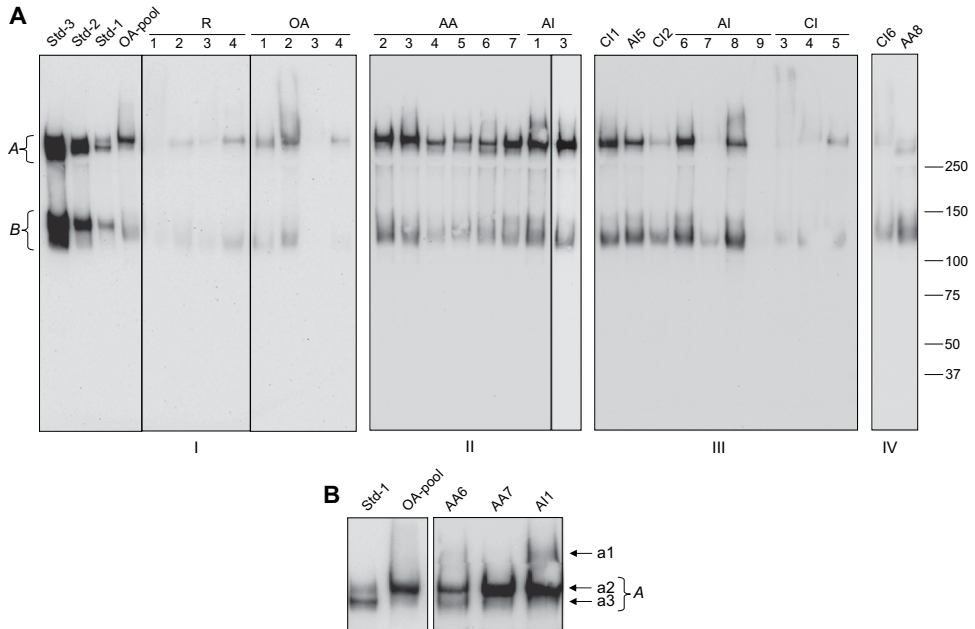

Fig. 2. Anti-ARGS Western blots of SF samples. SF D1 samples from subjects (2 or 4  $\mu$ g glycosaminoglycan) and from the OA pool (2  $\mu$ g glycosaminoglycan), and ARGS standards (Std 1–3; 0.5, 1.5 and 3.5  $\mu$ g glycosaminoglycan) were separated on four SDS-PAGE gels and transferred to PVDF membranes (I–IV). Each of the gels contained the ARGS standards and the OA pool (only shown for membrane I). The membranes were probed by the anti-ARGS antibody and the signal was captured by the luminescence image analyzer. Region A (280–320 kDa) contains two high-Mw ARGS fragments of 288 and 310 kDa. Region B (120–160 kDa) contains multiple ARGS fragments. The position of Mw markers (in kDa) is indicated. (B), an enlargement from (A), shows ARGS polypeptides a3 (288 kDa) and a2 (310 kDa) located in region A, and ARGS polypeptide a1 (367 kDa). Membranes I–III were from one experiment, and membrane IV was from a second Western blot experiment. The images show representative anti-ARGS signals from full size blotted gels. Groups (see also Table I): R (R1–4); AA (AA2–8), AI (AI1, 3, 5–9), CI (CI1–6) and OA (OA1–4).

located approximately 90 amino acids upstream from the end of the CS2 domain.

The G3 fragments a–d were also detected in the OA pool SF sample and were present in aggrecanase *in vitro* digested human A1D1 cartilage samples (not shown). In addition to the G3 fragments a–e, several of the samples also contained high Mw G3 fragments marked region A (370–445 kDa) and B (280–335 kDa) representing G3 fragments with unidentified N-terminals. Their high Mw suggests that some of these polypeptides are full length aggrecan (Fig. 3). Notably, subject OA1 lacked G3 fragments a–e, only containing minor quantities of G3 fragments in region B (Fig. 3).

#### QUANTITATIVE WESTERN BLOT ANALYSIS OF ARGS FRAGMENTS

For Western blot quantification of ARGS fragments each membrane, containing a subset of individual samples, was loaded with three different concentrations of ARGS standards and the OA pool as a control. After subtracting the background signal, an average arbitrary unit (AU)/mol ARGS fragment was calculated from three standard concentrations on each membrane, and used for the calculation

of the ARGS concentration in the samples. Average ARGS concentrations for each subject sample were calculated from 2–5 separate Western blot experiments, and the overall CV for the 28 subjects was 21%. The linear range of the ARGS standards in the luminescence image system was 0.25–6  $\mu$ g glycosaminoglycan ( $R^2 = 0.99$ ), and the ARGS signal of the subject samples was analyzed within this AU range (results not shown).

As shown for aggrecan<sup>31</sup>, there was an individual variation of aggrecan and ARGS concentrations within the diagnostic groups [Table II, Fig. 2(A)]. Comparing group medians showed that the AA and AI groups had the highest total ARGS concentrations, 34- and 38-fold higher than the reference group, and 15- to 29-fold higher than the median levels in the OA and CI groups, while there were only minor non-significant differences between the reference, the CI and the OA groups. (Table II). The concentrations of ARGS fragments in regions A and B showed only minor differences between the reference, CI and OA groups, while for the AA group higher concentrations of ARGS fragments were present in both regions A and B compared to the reference, CI and OA groups [Fig. 4(A,B)].

Comparing the relative distribution of ARGS regions A and B altered the perspective [Fig. 4(C)]; the OA group

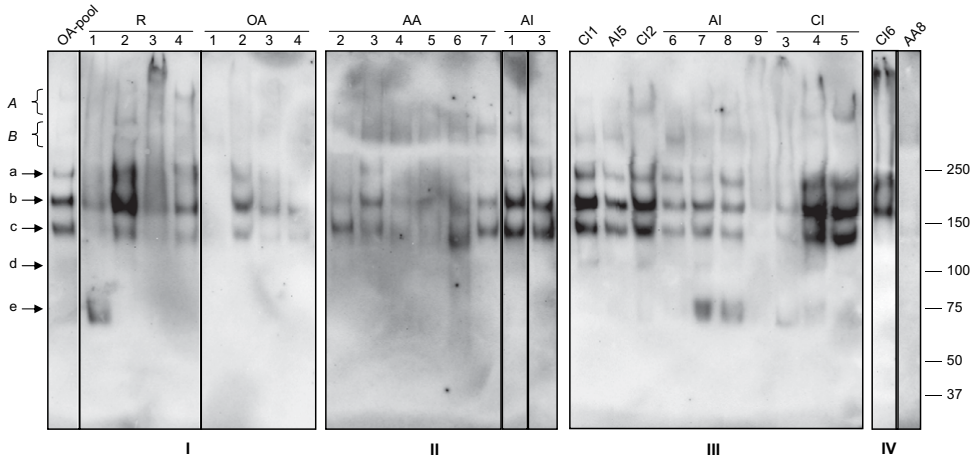

Fig. 3. Anti-G3 Western blots of SF samples. SF D1 samples (4 µg glycosaminoglycan/well) from subjects and from the OA pool were separated on four SDS-PAGE gels and transferred to PVDF membranes (I–IV). Each of the gels contained the OA pool (only shown for membrane I). The membranes were probed by the anti-G3 antibody and the signal was captured by the luminescence image analyzer. G3 fragments a (214 kDa), b (171 kDa), c (137 kDa), d (103 kDa) and e (68 kDa), and G3 region A (370–445 kDa) and B (280–335 kDa) and Mw markers (in kDa) are indicated. Membranes I–III were from one experiment and membrane IV was from a second Western blot experiment. The images show representative anti-G3 signals from full size blotted gels. Groups (see also Table I): R (R1–4); AA (AA2–8), AI (AI1, 3, 5–9), CI (CI1–6) and OA (OA1–4).

showed a 2-fold higher proportion of region A compared to the reference, a similar differential was also suggested for the AA group, without statistical significance [Fig. 4(C)].

Overall, the total SF ARGs concentrations correlated ( $r_s = 0.81$ ) with the SF glycosaminoglycan concentrations determined by Alcian Blue precipitation [Fig. 5(A)]. However, when comparing the molar proportions of ARGs fragments of aggrecan in the groups, approximately half of the aggrecan fragments in the AA and AI SFs carried the ARGs N-terminal sequence, while the corresponding proportions of ARGs fragments for the other groups were lower (Table II). For this comparison, an estimation of the molar amounts of aggrecan in SF was done (Table II) based on sulfated glycosaminoglycan (sGAG) concentrations assuming that: (1) Aggrecan is the predominant proteoglycan carrying sGAG in SF. (2) The average total molecular weight for the aggrecan molecule in SF is  $1.5 \times 10^6$  g/mol and that 75% of this Mw is represented by glycosaminoglycan. For four individuals, who had more than 40% of the aggrecan

as ARGs fragments and the ratio of region A/B was below 1,  $1.2 \times 10^6$  g/mol and 60% was used as an estimated average (this correction changed the median level of the AI group from 59% to 44%). The molar proportions of ARGs of aggrecan in the groups were similar when the amount of aggrecan was estimated from quantification of total aggrecan by ELISA using the monoclonal antibody 1-F21 recognizing a peptide sequence in the keratan sulfate domain<sup>32</sup> (result not shown).

QUANTITATIVE WESTERN BLOT ANALYSIS OF G3 FRAGMENTS

For Western blot quantification of G3 fragments, each membrane, containing a subset of subject samples, was also loaded with the OA pool (Fig. 3). The G3 concentrations of the individual samples, expressed as amount of G3 (in AU) per milliliter SF, were calculated, and related to the G3 signal for the OA pool on the same membrane.

Table II

Concentrations of glycosaminoglycan, aggrecan and ARGs fragments in human SFs. Concentrations of total aggrecan in SF subjects were calculated from sGAG concentrations (Alcian Blue method, see text), and total ARGs fragment concentrations measured in D1 samples using Western blot. Data expressed as median (min–max range) values in diagnostic groups. Median values of ARGs were normalized against the reference group (Norm). P-values, significance analysis (Mann–Whitney) of the AA or AI group vs the rest of the diagnostic groups. ARGs (%), estimated proportion as ARGs fragments out of total amount of aggrecan estimated from sGAG content. Diagnostic groups were according to Table I

Diagnostic groups	n	sGAG (µg/ml SF)	Aggrecan (pmol/ml SF)	Total ARGs (pmol/ml SF)	Norm	P-values		ARGs (%)	P-values	
						vs AA	vs AI		vs AA	vs AI
R	4	81 (59–88)	72 (52–78)	2.5 (1.7–5.2)	1	0.006	0.073	3.9 (2.6–6.7)	0.006	0.109
AA	7	157 (80–425)	140 (71–450)	85.0 (33.3–264.0)	34.3	–	0.902	54.6 (22.5–84.9)	–	0.456
AI	7	224 (61–728)	251 (54–647)	94.5 (1.1–646.9)	38.1	0.902	–	43.6 (2.0–100.0)	0.456	–
CI	6	51 (38–177)	45 (34–246)	3.3 (1.3–62.5)	1.3	0.008	0.073	8.0 (2.5–25.4)	0.002	0.234
OA	4	84 (31–179)	74 (28–159)	5.6 (0.6–29.6)	2.3	0.006	0.164	8.5 (2.3–18.6)	0.006	0.315

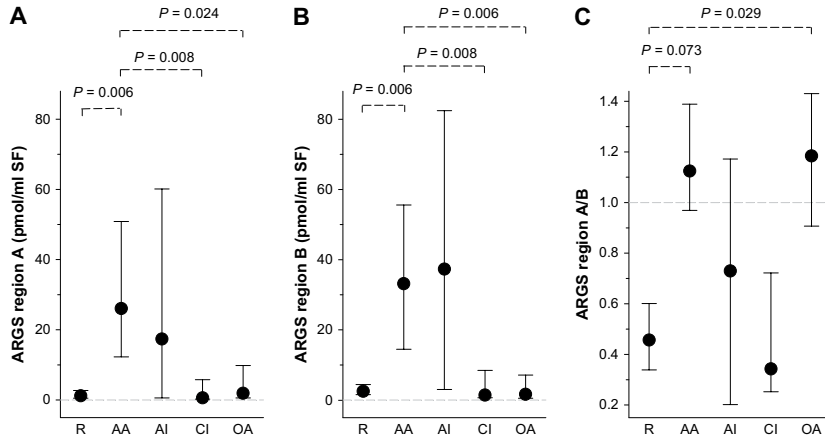

Fig. 4. Concentration of ARGs fragments in region A (310 kDa ARGs-SELE and 288 kDa ARGs-CS1 fragments) and region B (120–160 kDa ARGs-CS1 multiple fragments). ARGs concentrations for fragments in regions A and B were quantified (using D1 samples) by Western blot and luminescence image analyzer and the mean concentrations for the regions of each subject were calculated. Median values (circles) and the twenty-fifth and seventy-fifth percentiles (whiskers) of different diagnostic groups are shown. (A) ARGs concentration in region A. (B) ARGs concentration in region B. (C) The ratio of the ARGs concentration of region A over region B. Diagnostic groups according to Table I: R ( $n = 4$ ), AA ( $n = 7$ ), AI ( $n = 7$ ), CI ( $n = 6$ ) and OA ( $n = 4$ ).

Due to high and uneven G3 background signal, consistent background correction was not possible. Average G3 concentrations were calculated from 2–5 Western blot experiments for each subject, and the overall G3 CV for the 28 subjects was 39%. The linear range of the G3 signal in the luminescence image system was 0.5–8  $\mu\text{g}$  glycosaminoglycan ( $R^2 = 0.97$ ) for the OA pool, and the G3 signal of the subject samples was analyzed within this AU range (results not shown).

The correlation between the total G3 signal in the subject samples and the glycosaminoglycan concentrations was moderate [ $r_s = 0.63$ ; Fig. 5(B)]. Results suggested that the median total G3 signal in the OA diagnostic group was about one third of that in the reference group, while the AA group did not differ from the reference group (Table III).

The major G3 fragments a, b and c corresponding to GRGT-G3, GLGS-G3 and AGE-G3, respectively, constituted 76–100% of the total G3 signal on the diagnostic group level (patient OA1 excluded due to lack of G3 signal) (Fig. 3). The relative contribution of each of these three G3 fragments to their sum (percent a of a + b + c), ranged from 13–53 percent in the individuals, and their relative order of contribution varied between diagnostic groups (result not shown).

#### ARGS/G3 FRAGMENT RATIOS

The total ARGs and total G3 concentrations in the samples, expressed as AU per milliliter SF, were first related to the total ARGs and G3 concentrations in the OA pool sample, and a ratio between the ARGs and G3 signals in relative units was then calculated for each sample. The ARGs/G3 fragment ratio varied between individual subjects, but with a discernible pattern when comparing diagnostic groups (Fig. 6). The median ARGs/G3 ratios for the reference and CI groups were low and did not differ. For the AA and AI groups, the ARGs/G3 ratios were 19- and

10-fold higher than in the reference group, respectively, while the AA group had an 8-fold higher ratio compared to the CI group (Fig. 6).

#### Discussion

Several methods have been presented for quantification of proteinase cleaved aggrecan fragments using neoepitope antibodies in an ELISA format<sup>24,28,31,33–35</sup>. The Western blot quantification method presented here allows the quantitative detection of fragments with the neoepitope ARGs or with the G3 domain. Importantly, it also discriminates between different proteolytic fragments carrying the same epitope, and therefore allows a more detailed quantitative analysis of the products of aggrecan proteolysis than previously achieved. The method allowed the demonstration of quantitative as well as qualitative differences in aggrecan fragment patterns between SF samples obtained from patients with different joint diseases.

The qualitative analysis showed that all the subject SF samples contained ARGs-SELE, the major fragment in region A, and ARGs-CS1 fragments (the multi-ARGs fragments in region B). Only traces of ARGs fragments with Mw below 100 kDa were detected in the SF D1 samples (not shown). Except for the ARGs region A and B fragments, no other ARGs fragments were detected by Western blot amongst aggrecan fragments captured in the plate wells of the KS capture ARGs ELISA, or in aggrecan samples purified from SF by Q-Sepharose anion chromatography (not shown). These results suggest that the ARGs-SELE and the ARGs-CS1 are the dominating ARGs fragments in normal, joint injured and arthritic human SFs. Other groups have described similar high Mw (>250 kDa) ARGs fragments in SFs<sup>30,36,37</sup>, but also significant amounts of low Mw (100–150 kDa) ARGs fragments<sup>36,37</sup>.

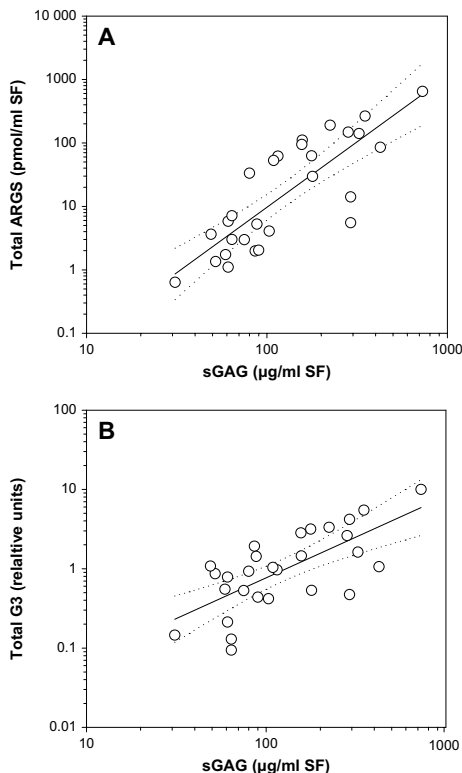

Fig. 5. Correlation between sGAG vs ARGs and G3 fragment concentrations in SF samples. Total ARGs and G3 fragments were quantified from the different subjects and from the OA pool (using D1 samples) by Western blot and luminescence image analyzer, and mean concentrations (in amount/ml SF) for each subject were calculated. The sGAG concentrations were analyzed in neat SF from the same subjects ( $n = 28$ ) using the Alcian Blue method. Solid lines show the first-order regression, and the broken lines show the 95% confidence intervals. Spearman rank order correlation was in (A) 0.81 ( $P < 0.0001$ ), and in (B) 0.63 ( $P < 0.0001$ ). Note the logarithmic scales.

The GRGT-G3, GLGS-G3 and AGE-G3 N-terminals generated by aggrecanase cleavages in the CS2 domain have been identified by others<sup>12,30</sup>, with the same Mw and polypeptide pattern as presented here. These fragments, and the LGQR-G3 fragment, are not present in human cartilage A1D1 fraction, but can be generated by aggrecanase *in vitro* digestion (results not shown). The mini D1 fractions had densities of 1.46–1.54 g/ml. This suggests that also lightly glycosaminoglycan substituted fragments such as the 103 kDa LGQR-G3 and 68 kDa PTAS-G3 fragments (with 11 and 4 potential CS chain substitutions, respectively) migrate to the density of the D1 fraction. These G3 fragments were also detected by Western blot in Q-Sepharose purified SF samples with similar intensities as in the SF D1 samples (not shown). These

Table III

Total G3 concentration in SF samples. G3 concentrations were determined (using D1 samples) by Western blot and luminescence image analyzer. The mean concentration for each subject (based on AU/ml SF) was calculated expressed as relative units against the OA pool sample. Group median values (min–max range) of total G3 signal, in relative units are shown. Median values normalized against the reference group (Norm). P-values, significance analysis (Mann–Whitney) of the R group against the rest of the groups. Diagnostic groups were according to Table I

Diagnostic groups	n	Total G3 (relative units)	Norm	P-values
R	4	0.99 (0.53–1.92)	1	–
AA	7	1.06 (0.93–5.47)	1.1	0.527
AI	7	2.83 (0.21–9.98)	2.9	0.163
CI	6	0.67 (0.13–3.16)	0.7	0.476
OA	4	0.28 (0.09–0.53)	0.3	0.057

results suggest that the GRGT-G3, GLGS-G3, AGE-G3, LGQR-G3 and PTAS-G3 are the dominating G3 fragments in normal, joint injured and arthritic human SFs.

In the choice of ARGs standard, a complete aggrecanase digest of the cartilage A1D1 fraction was found well suited, since the un-digested fraction does not contain any G1-TEGE or ARGs fragments<sup>19</sup>. However, as a standard for molar quantification of G3, the A1D1 fraction prepared from adult human OA cartilage<sup>19</sup> is not suitable since it contains only low amounts of full length monomer (20% G1–G3) and a major proportion C-terminally truncated fragments (60% G1–SELE/KEEE and 20% G1–CS1) (our data, not shown). Instead, we used a control sample (SF D1 OA pool) for the quantification of G3 fragments, expressing the data as relative units of the control sample.

When comparing the ARGs Western blot and ELISA methods using the same antibody and standard, they showed a strong linear correlation indicating that total ARGs fragment content in SF samples by ELISA was reflected by analysis of SF D1 samples with the Western blot method. Although the lower total ARGs values obtained with the Western blot method in part may be due to losses in the CsCl gradient centrifugation step, no additional ARGs fragments were detected by Western blot in aggrecan captured by the KS capture ARGs ELISA (not shown). Only 18 of the 28 SF samples had detectable ARGs concentration in the ELISA, and the 10 subjects (R1-4, OA3, AI7, AI9, CI3, CI4 and CI6) who had non-detectable ARGs concentration by ELISA also showed the lowest concentrations by Western blot [Fig. 2(A)].

Both ARGs and G3 signals correlated overall with the glycosaminoglycan concentration in the SFs. A similar correlation was observed between the concentration of the aggrecan neopeptide fragment<sup>361</sup>FFGV, generated by MMP cleavage in the IGD, and glycosaminoglycan concentrations in SFs from OA patients<sup>33</sup>. This is consistent with previous observations showing that these types of aggrecan fragments make up a significant proportion of the glycosaminoglycan content in human SF<sup>19,24,31,33</sup>.

We previously showed increased concentrations of glycosaminoglycan and different aggrecan epitopes (by ELISA) in SF samples from patients with OA, acute pyrophosphate arthritis, and knee injuries, compared with knee healthy reference subjects<sup>31,38</sup>. Here we show, by a fragment specific quantitative Western blot method, increased concentrations of the aggrecanase generated aggrecan neopeptide ARGs in SF samples from several different joint diseases, again compared with samples from knee healthy reference subjects. We estimated the

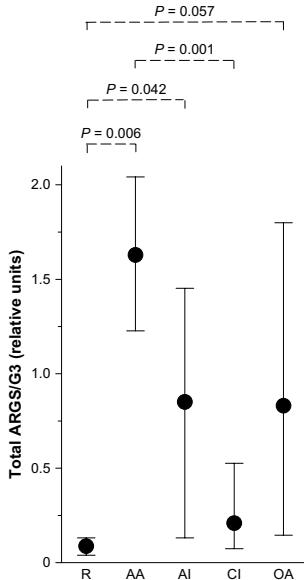

Fig. 6. ARGS/G3 ratios in SF samples. The total ARGS and total G3 fragment concentrations from the subjects and the OA pool were quantified (amount/ml SF), using Western blot and luminescence image analyzer, and the mean values were calculated for each subject. The subjects' relative ARGS and G3 signals were first calculated against the OA pool, and then divided giving an ARGS/G3 ratio. Median values (circles) and the twenty-fifth and seventy-fifth percentiles (whiskers) of different diagnostic groups are shown. Diagnostic groups according to Table 1: R ( $n=4$ ), AA ( $n=7$ ), AI ( $n=7$ ), CI ( $n=6$ ) and OA ( $n=4$ ).

molar content of human ARGS fragments in SF using ARG standard generated by complete aggrecanase digestion of human aggrecan, and also estimated the aggrecan fragment content in SF based on glycosaminoglycan concentrations. Acknowledging the uncertainties in these estimates, our results nevertheless suggest that the diagnostic groups studied here show widely different proportions of the total glycosaminoglycan content of SF detectable as aggrecan ARG fragments. Interestingly, the AA and AI groups both showed a high proportion of glycosaminoglycan in ARG fragments, while the other groups contained much lower proportions, suggesting that a marked release of ARG fragments into human SF is associated with a high joint disease activity.

In a further extension of previous knowledge, our observations suggest an excess of ARG-CS1 (region B) fragments over ARG-SELE (region A) fragments in the reference and CI samples, while the AA and OA samples showed a more even distribution between these fragments [Fig. 4(C)]. These results show that determination of glycosaminoglycan content only, or even total neopeptide content, in, e.g., SF provides an incomplete picture of the cartilage degradation process in human joint disease. Our results further show that there are only minor differences between the disease groups in the total G3 fragment signal in the SF samples. A separate analysis of the three main G3

fragments (GRGT-G3, GLGS-G3 and AGE-G3) suggested variations in the proportions of these fragments between the diagnostic groups (not shown), demonstrating again a significant complexity in aggrecan degradation.

The sum of the detected ARG neopeptide carrying fragments reflects aggrecanase activity directed against the IGD domain of aggrecan. The majority of the detected G3 epitope signal derived from fragments with a size consistent with their N-terminal being located in the aggrecan CS2 domain, and the total G3 signal may thus reflect aggrecanase activity against the CS2 domain. Combining these results into a ratio between ARG and G3 epitope signals could thus provide an indication of the relative activity of aggrecanase against these two aggrecan domains, and or the relative substrate availability. Again, our results showing differences in this particular measure between diagnostic groups emphasize the diversity of fragments released, and how improved analytical techniques may be needed to interpret the physiology and pathology of cartilage matrix degradation.

The CS2 domain proteolysis is believed to represent a process of natural aggrecan turnover and aging, while proteolysis in the IGD, which releases the entire water-binding part of aggrecan from the extracellular matrix, is suggested to be a pathological event associated with cartilage degradation<sup>10,18</sup>. Our results showing variable ratios of ARG to G3 epitope signals between the diagnostic groups could thus indicate a high relative level of pathological aggrecanase degradation activity in the AA, AI and OA groups, and lower in the reference and CI groups. A similar aggrecan degradation index based on aggrecan fragment FFGV/G1-G2 domain ratios was recently reported<sup>24</sup>.

While the discussion above reflects a relatively straightforward interpretation of our results, several alternative interpretations are possible. Firstly, if physiological turnover and aging involve the gradual C-terminal trimming of aggrecan molecules in joint cartilage, then the average available aggrecan substrate may vary with, e.g., the age of the individual. This would influence the pattern of fragments released into the SF following an up-regulated proteolytic activity, confounding interpretations. Secondly, joint cartilage is a major source of aggrecan fragments appearing in SF, but may not be the sole source; they may also to a variable extent originate from, e.g., menisci, ligaments and synovial tissue<sup>39-41</sup>. The synovial cells of the joint capsule contain aggrecanase activities<sup>42,43</sup>. Thirdly, we have assumed that aggrecan fragments appearing in SF are the result of proteolysis of resident, functional matrix molecules. There is evidence for an increased aggrecan synthesis in OA and after joint injury<sup>31</sup>. Some of the aggrecan fragments appearing in SF may therefore be the product of aggrecanase activity directed against newly synthesized aggrecan molecules, not yet fully incorporated into the matrix<sup>44</sup>.

This study has some general limitations. (1) An enrichment of aggrecan fragments is necessary before analysis by SDS-PAGE and Western blot; here we use dissociative CsCl centrifugation assuming that the proportion of aggrecan fragments in the D1 fraction reflects the *in vivo* situation in the SF. (2) Any differences in the affinity of the antibodies for fragments of different size carrying the same epitope would affect the detected ratio of the signals. (3) Although done within the known linear range of both the ARG and G3 quantification systems, extrapolation from a limited set of standards (ARG) or expressing data in relative units (G3) limits the accuracy of the Western blot quantification method. (4) The average aggrecan substrate structure in

joint cartilage may vary with, e.g., age, disease stage and synthesis rate of new molecules, and the diagnostic groups were not matched for age. A more extended analysis of a larger number of patient samples is needed to determine the influence of these potential confounders. With the limited number of samples used, our ability to detect minor differences between diagnostic groups was limited.

We have developed a novel application of small scale CsCl gradient centrifugation and Western blot for quantification of human SF aggrecan fragments. Combined with antibodies detecting the neopeptide ARGS in the IGD, and the G3 domain of aggrecan, the method provides new information on aggrecan fragment patterns in human SF, as well as previously unknown differences in the patterns between groups of patients with different joint diseases. These different fragment patterns may reflect variations in proteolytic activity in the joint in different arthritides. The method allows a detailed mapping of aggrecan fragment patterns in multiple samples from *in vitro* and *in vivo* samples, animal models or humans. This will help determine the relative contributions of aggrecanases and other proteolytic activities in human joint diseases and disease stages. Such information is important for a better understanding of cartilage destruction in arthritis, and of the consequences of inhibiting proteolytic pathways as a means of treating human joint diseases<sup>20–26</sup>.

### Conflict of interest

There is no conflict of interest for the authors of this manuscript.

### Acknowledgement

We greatly appreciate the gift of ADAMTS-4, mab OA-1 and anti-AGEG antibodies from Michael A Pratt and Dr Sanjay Kumar (GlaxoSmithKline, Collegeville). Supported by: The Swedish Research Council, the Swedish Rheumatism Association, the Kock Foundation, the King Gustaf V 80-year Birthday Fund, the Faculty of Medicine, Lund University, Region Skåne, Magnus Bergvalls Foundation, Alfred Österlunds Foundation and Swards/Eklunds Foundations.

### References

- Lohmander LS, Dahlberg L, Ryd L, Heinegard D. Increased levels of proteoglycan fragments in knee joint fluid after injury. *Arthritis Rheum* 1989;32:1434–42.
- Lohmander LS, Hoerner LA, Dahlberg L, Roos H, Bjornsson S, Lark MW. Stromelysin, tissue inhibitor of metalloproteinases and proteoglycan fragments in human knee joint fluid after injury. *J Rheumatol* 1993;20:1362–8.
- Saxne T, Glennas A, Kvien TK, Melby K, Heinegard D. Release of cartilage macromolecules into the synovial fluid in patients with acute and prolonged phases of reactive arthritis. *Arthritis Rheum* 1993;36:20–5.
- Hou WS, Li Z, Buttner FH, Bartnik E, Bromme D. Cleavage site specificity of cathepsin K toward cartilage proteoglycans and protease complex formation. *Biol Chem* 2003;384:891–7.
- Handley CJ, Mok MT, Ilic MZ, Adcock C, Buttle DJ, Robinson HC. Cathepsin D cleaves aggrecan at unique sites within the interglobular domain and chondroitin sulfate attachment regions that are also cleaved when cartilage is maintained at acid pH. *Matrix Biol* 2001;20:543–53.
- Mort JS, Magny MC, Lee ER. Cathepsin B: an alternative protease for the generation of an aggrecan 'metalloproteinase' cleavage neopeptide. *Biochem J* 1998;335(Pt 3):491–4.
- Maehara H, Suzuki K, Sasaki T, Oshita H, Wada E, Inoue T, et al. G1-G2 aggrecan product that can be generated by M-calpain on truncation at Ala709–Ala710 is present abundantly in human articular cartilage. *J Biochem* 2007;141:469–77.
- Oshita H, Sandy JD, Suzuki K, Akaike A, Bai Y, Sasaki T, et al. Mature bovine articular cartilage contains abundant aggrecan that is C-terminally truncated at Ala719–Ala720, a site which is readily cleaved by m-calpain. *Biochem J* 2004;382:253–9.
- Sandy JD. Proteolytic Degradation of Normal and Osteoarthritic Cartilage Matrix. In: Brandt KD, Doherty M, Lohmander LS, Eds. *Osteoarthritis*. Oxford: Oxford University Press; 2003:82–92.
- Sandy JD, Flannery CR, Neame PJ, Lohmander LS. The structure of aggrecan fragments in human synovial fluid. Evidence for the involvement in osteoarthritis of a novel proteinase which cleaves the Glu 373–Ala 374 bond of the interglobular domain. *J Clin Invest* 1992;89:1512–6.
- Lohmander LS, Neame PJ, Sandy JD. The structure of aggrecan fragments in human synovial fluid. Evidence that aggrecanase mediates cartilage degradation in inflammatory joint disease, joint injury, and osteoarthritis. *Arthritis Rheum* 1993;36:1214–22.
- Tortorella MD, Pratta M, Liu RQ, Austin J, Ross OH, Abbaszade I, et al. Sites of aggrecan cleavage by recombinant human aggrecanase-1 (ADAMTS-4). *J Biol Chem* 2000;275:18566–73.
- Tortorella MD, Liu RQ, Burn T, Newton RC, Arner E. Characterization of human aggrecanase 2 (ADAM-TSS): substrate specificity studies and comparison with aggrecanase 1 (ADAM-TS4). *Matrix Biol* 2002;21:499–511.
- Bonassar LJ, Frank EH, Murray JC, Paguio CG, Moore VL, Lark MW, et al. Changes in cartilage composition and physical properties due to stromelysin degradation. *Arthritis Rheum* 1995;38:173–83.
- Flannery CR, Lark MW, Sandy JD. Identification of a stromelysin cleavage site within the interglobular domain of human aggrecan. Evidence for proteolysis at this site *in vivo* in human articular cartilage. *J Biol Chem* 1992;267:1008–14.
- Fosang AJ, Last K, Knauper V, Neame PJ, Murphy G, Hardingham TE, et al. Fibroblast and neutrophil collagenases cleave at two sites in the cartilage aggrecan interglobular domain. *Biochem J* 1993;295(Pt 1):273–6.
- Fosang AJ, Last K, Knauper V, Murphy G, Neame PJ. Degradation of cartilage aggrecan by collagenase-3 (MMP-13). *FEBS Lett* 1996;380:17–20.
- Lark MW, Bayne EK, Flanagan J, Harper CF, Hoerner LA, Hutchinson NI, et al. Aggrecan degradation in human cartilage. Evidence for both matrix metalloproteinase and aggrecanase activity in normal, osteoarthritic, and rheumatoid joints. *J Clin Invest* 1997;100:93–106.
- Struglics A, Larsson S, Pratta MA, Kumar S, Lark MW, Lohmander LS. Human osteoarthritis synovial fluid and joint cartilage contain both aggrecanase- and matrix metalloproteinase-generated aggrecan fragments. *Osteoarthr Cartil* 2006;14:101–13.
- Giasson SS, Askew R, Sheppard B, Carito B, Blanchet T, Ma HL, et al. Deletion of active ADAMTS5 prevents cartilage degradation in a murine model of osteoarthritis. *Nature* 2005;434:644–8.
- Stanton H, Rogerson FM, East CJ, Golub SB, Lawlor KE, Meeker CT, et al. ADAMTS5 is the major aggrecanase in mouse cartilage *in vivo* and *in vitro*. *Nature* 2005;434:648–52.
- East CJ, Stanton H, Golub SB, Rogerson FM, Fosang AJ. ADAMTS-5 deficiency does not block aggrecanolysis at preferred cleavage sites in the chondroitin sulfate-rich region of aggrecan. *J Biol Chem* 2007;282:8632–40.
- Little CB, Meeker CT, Golub SB, Lawlor KE, Farmer PJ, Smith SM, et al. Blocking aggrecanase cleavage in the aggrecan interglobular domain abrogates cartilage erosion and promotes cartilage repair. *J Clin Invest* 2007;117:1627–36.
- Sumer EU, Sondergaard BC, Rousseau JC, Delmas PD, Fosang AJ, Karsdal MA, et al. MMP and non-MMP-mediated release of aggrecan and its fragments from articular cartilage: a comparative study of three different aggrecan and glycosaminoglycan assays. *Osteoarthr Cartil* 2007;15:212–21.
- Naito S, Shiomi T, Okada A, Kimura T, Chijiwa M, Fujita Y, et al. Expression of ADAMTS4 (aggrecanase-1) in human osteoarthritic cartilage. *Pathol Int* 2007;57:703–11.
- Powell AJ, Little CB, Hughes CE. Low molecular weight isoforms of the aggrecanases are responsible for the cytokine-induced proteolysis of aggrecan in a porcine chondrocyte culture system. *Arthritis Rheum* 2007;56:3010–9.
- Tortorella MD, Burn TC, Pratta MA, Abbaszade I, Hollis JM, Liu R, et al. Purification and cloning of aggrecanase-1: a member of the ADAMTS family of proteins. *Science* 1999;284:1664–6.
- Pratta MA, Su JL, Leesnitzer MA, Struglics A, Larsson S, Lohmander LS, et al. Development and characterization of a highly specific and sensitive sandwich ELISA for detection of aggrecanase-generated aggrecan fragments. *Osteoarthr Cartil* 2006;14:702–13.
- Struglics A, Larsson S, Lohmander LS. Estimation of the identity of proteolytic aggrecan fragments using PAGE migration and Western immunoblot. *Osteoarthr Cartil* 2006;14:898–905.



30. Sandy JD, Verscharen C. Analysis of aggrecan in human knee cartilage and synovial fluid indicates that aggrecanase (ADAMTS) activity is responsible for the catabolic turnover and loss of whole aggrecan whereas other protease activity is required for C-terminal processing in vivo. *Biochem J* 2001;358:615–26.
31. Lohmander LS, Ionescu M, Jugessur H, Poole AR. Changes in joint cartilage aggrecan after knee injury and in osteoarthritis. *Arthritis Rheum* 1999;42:534–44.
32. Moller HJ, Larsen FS, Ingemann-Hansen T, Poulsen JH. ELISA for the core protein of the cartilage large aggregating proteoglycan, aggrecan: comparison with the concentrations of immunogenic keratan sulphate in synovial fluid, serum and urine. *Clin Chim Acta* 1994;225:43–55.
33. Fosang AJ, Last K, Maciewicz RA. Aggrecan is degraded by matrix metalloproteinases in human arthritis. Evidence that matrix metalloproteinase and aggrecanase activities can be independent. *J Clin Invest* 1996;98:2292–9.
34. Will H, Dettloff M, Bendzko P, Svshnikov P. A quantitative assay for aggrecanase activity. *J Biomol Tech* 2005;16:459–72.
35. Carter QL, Dotzlaw J, Swearingen C, Brittain I, Chambers M, Duffin K, *et al.* Development and characterization of a novel ELISA based assay for the quantitation of sub-nanomolar levels of neopeptide exposed NITEGE-containing aggrecan fragments. *J Immunol Methods* 2007;328:162–8.
36. Little CB, Hughes CE, Curtis CL, Janusz MJ, Bohne R, Wang-Weigand S, *et al.* Matrix metalloproteinases are involved in C-terminal and interglobular domain processing of cartilage aggrecan in late stage cartilage degradation. *Matrix Biol* 2002;21:271–88.
37. Malfait AM, Liu RQ, Ijiri K, Komiya S, Tortorella MD. Inhibition of ADAM-TS4 and ADAM-TS5 prevents aggrecan degradation in osteoarthritic cartilage. *J Biol Chem* 2002;277:22201–8.
38. Lohmander LS, Hoerner LA, Lark MW. Metalloproteinases, tissue inhibitor, and proteoglycan fragments in knee synovial fluid in human osteoarthritis. *Arthritis Rheum* 1993;36:181–9.
39. McAlinden A, Dudhia J, Bolton MC, Lorenzo P, Heinegard D, Bayliss MT. Age-related changes in the synthesis and mRNA expression of decorin and aggrecan in human meniscus and articular cartilage. *Osteoarthr Cartil* 2001;9:33–41.
40. Valiyaveetil M, Mort JS, McDevitt CA. The concentration, gene expression, and spatial distribution of aggrecan in canine articular cartilage, meniscus, and anterior and posterior cruciate ligaments: a new molecular distinction between hyaline cartilage and fibrocartilage in the knee joint. *Connect Tissue Res* 2005;46:83–91.
41. Verdonk PC, Forsyth RG, Wang J, Almqvist KF, Verdonk R, Veys EM, *et al.* Characterisation of human knee meniscus cell phenotype. *Osteoarthr Cartil* 2005;13:548–60.
42. Ilic MZ, Vankemmelbeke MN, Holen I, Buttle DJ, Clem Robinson H, Handley CJ. Bovine joint capsule and fibroblasts derived from joint capsule express aggrecanase activity. *Matrix Biol* 2000;19:257–65.
43. Vankemmelbeke MN, Ilic MZ, Handley CJ, Knight CG, Buttle DJ. Coincubation of bovine synovial or capsular tissue with cartilage generates a soluble "aggrecanase" activity. *Biochem Biophys Res Commun* 1999;255:686–91.
44. Lohmander LS, Eyre DR. Biochemical markers as surrogate end points of joint disease. In: Reid DM, Miller CG, Eds. *Clinical Trials in Rheumatoid Arthritis and Osteoarthritis*. Springer; 2008:249–74.
45. Dahlberg L, Ryd L, Heinegard D, Lohmander LS. Proteoglycan fragments in joint fluid. Influence of arthrosis and inflammation. *Acta Orthop Scand* 1992;63:417–23.

## Paper III



Research article

Open Access

# Synovial fluid level of aggrecan ARGS fragments is a more sensitive marker of joint disease than glycosaminoglycan or aggrecan levels: a cross-sectional study

Staffan Larsson, L Stefan Lohmander and André Struglics

Department of Orthopaedics, Clinical Sciences Lund, Lund University, SE-221 85 Lund, Sweden

Corresponding author: Staffan Larsson, [staffan.larsson@med.lu.se](mailto:staffan.larsson@med.lu.se)

Received: 8 Feb 2009 Revisions requested: 16 Mar 2009 Revisions received: 19 May 2009 Accepted: 22 Jun 2009 Published: 22 Jun 2009

*Arthritis Research & Therapy* 2009, **11**:R92 (doi:10.1186/ar2735)

This article is online at: <http://arthritis-research.com/content/11/3/R92>

© 2009 Larsson *et al.*; licensee BioMed Central Ltd.

This is an open access article distributed under the terms of the Creative Commons Attribution License (<http://creativecommons.org/licenses/by/2.0>), which permits unrestricted use, distribution, and reproduction in any medium, provided the original work is properly cited.

## Abstract

**Introduction** Aggrecanase cleavage at the <sup>392</sup>Glu-<sup>393</sup>Ala bond in the interglobular domain (IGD) of aggrecan, releasing N-terminal <sup>393</sup>ARGS fragments, is an early key event in arthritis and joint injuries. Here, we use a quantitative immunoassay of aggrecan ARGS neopeptide fragments in human synovial fluid to determine if this cleavage-site specific method better identifies joint pathology than previously available less specific aggrecan assays.

**Methods** Synovial fluid (SF) from 26 people with healthy knees (reference) and 269 patients were analyzed in a cross-sectional study. Patient groups were acute inflammatory arthritis, acute knee injury, chronic knee injury and knee osteoarthritis (OA). Aggrecan ARGS fragments were assayed by ELISA using the monoclonal antibody OA-1. Total aggrecan content was analyzed by an ELISA using the monoclonal antibody 1-F21, and sulfated glycosaminoglycan by Alcian blue precipitation.

**Results** Aggrecan ARGS fragment concentrations in all groups differed from the reference group ( $P < 0.001$ ). The acute inflammatory arthritis group had the highest median level, 177-fold greater than that of the reference group. Median levels (in

pmol ARGS/ml SF) were: reference 0.5, acute inflammatory arthritis 88.5, acute knee injury 53.9, chronic knee injury 0.5 and OA 4.6. In contrast, aggrecan and sulfated glycosaminoglycan concentrations varied much less between groups, and only acute inflammatory arthritis and acute knee injury were found to have a two-fold increase in median levels compared to the reference.

**Conclusions** Levels of aggrecan ARGS fragments in human synovial fluid are increased in human arthritis, OA and after knee injury, likely reflecting an enhanced cleavage at the <sup>392</sup>Glu-<sup>393</sup>Ala bond in the IGD by aggrecanase. An assay that specifically quantified these fragments better distinguished samples from joints with pathology than assays monitoring aggrecan or glycosaminoglycan concentrations. The newly developed ARGS fragment assay can be used to monitor aggrecanase activity in human joint disease and experimental models.

## Introduction

Proteolysis of aggrecan is an early and critical feature of cartilage degradation in arthritis and after knee injury, and is measurable as an elevation of aggrecan release from the cartilage into the synovial fluid (SF) [1-4]. Although proteases, such as matrix metalloproteinases (MMPs), cathepsins and calpains, are

involved [5], aggrecanase plays a major role in aggrecan degradation in murine [6,7] and human [4,8-15] joint disease. There are five known aggrecanase cleavage sites in aggrecan [16]. The most severe aggrecanase cleavage in terms of destructive loss of sulfated glycosaminoglycan (sGAG) from the tissue, is at the <sup>392</sup>Glu-<sup>393</sup>Ala bond in the interglobular

AA: acute inflammatory arthritis; ACL: anterior cruciate ligament; ADAMTS: a disintegrin and metalloproteinase with thrombospondin motifs; AEBSF: 4-(2-aminoethyl)-benzenesulfonyl fluoride; AI: acute knee injury; BSA: bovine serum albumin; CI: chronic knee injury; CV: coefficient of variation; EACA: 6-aminohexanoic acid; EDTA: ethylenediaminetetra acetic acid; ELISA: enzyme-linked immunosorbent assay; H<sub>2</sub>O<sub>2</sub>: hydrogen peroxidase; IGD: interglobular domain; KS: keratan sulfate; mAb: monoclonal antibody; MEN: meniscal injury; MES: 2-(N-morpholino) ethanesulfonic acid; MMP: matrix metalloproteinases; NEM: N-ethylmaleimide; OA: osteoarthritis; PBST: phosphate buffered saline with TWEEN; PMSF: phenylmethylsulfonyl fluoride; PVDF: polyvinylidene difluoride; REF: healthy knee reference; SF: synovial fluid; sGAG: sulfated glycosaminoglycan; TMB: tetramethylbenzidine.

(IGD) domain of aggrecan, releasing N-terminal <sup>393</sup>ARGS neopeptide fragments.

ARGS neopeptide aggrecan fragments released into the SF, as detected by western blot or amino acid sequencing, have been associated with joint diseases [4,8,9,17,18] and have also been detected as a result of normal turnover [4,17]. When quantified by a western blot method, the proportion of aggrecan in SF having the neopeptide ARGS was elevated in arthritis and joint injury compared with individuals with healthy knees [4]. Fragments carrying the same neopeptide were also found in serum from patients with rheumatoid arthritis, but not in healthy controls [15].

Results from several ELISAs have been presented that measure levels of aggrecan neopeptides in medium from human cartilage explants [10,11,13,19]. By measuring neopeptide concentrations, aggrecanase cleavage at the <sup>392</sup>Glu-<sup>393</sup>Ala bond has been confirmed as a major contributor to aggrecan loss from cartilage stimulated by cytokines [10,11,13-15]. However, with the exception of small-scale quantitative western blots [4], only assays of non-specific aggrecan fragments [1,20], of newly synthesized aggrecan bearing the 846 epitope [21] or of sGAG [22] have been reported in studies of human SF.

In this cross-sectional study, comparing people with healthy knees with those with acute inflammatory arthritis, acute knee injury, chronic knee injury, or knee osteoarthritis (OA), we quantified the SF levels of the aggrecan ARGS neopeptide with a modified sandwich ELISA [19], and compared it with aggrecan assays not specific for this neopeptide. We hypothesized that ARGS neopeptide concentrations in SF would differ between these groups and be a more sensitive measure of joint disease than previously used aggrecan or sGAG assays.

## Materials and methods

### Amino acid numbering

All amino acid numbering of aggrecan is herein based on full-length human aggrecan, accession number [Swiss-Prot:P16112], starting with the N-terminal 'MTTL-amino acid sequence.

### Materials

Alcian blue 8GS (C.I. 742240) was from Chroma-Gesellschaft (Köningen, Germany). 4-(2-aminoethyl)-benzenesulfonyl fluoride (AEBSF), 6-aminohexonic acid (EACA), benzamidine-HCl, BSA, chondroitin sulfate type C from shark cartilage (no. C4384), ethylenediaminetetra acetic acid (EDTA), N-ethylmaleimide (NEM), 2-(N-morpholino) ethanesulfonic acid (MES), phenylmethylsulfonyl fluoride (PMSF), and phosphate buffered saline with TWEEN (PBST) buffer (0.01 M sodium phosphate, 0.138 M sodium chloride, 0.0027 M potassium chloride, 0.05% TWEEN 20; pH 7.4) were from Sigma (St. Louis, MO, USA). Cesium chloride and guanidium hydro-

chloride were from Merck (Darmstadt, Germany). Molecular weight markers 10 to 250 kDa (no. 161-0373) were from Bio-Rad (Hercules, CA, USA). Human recombinant ADAMTS-4 (a disintegrin and metalloproteinase with thrombospondin motifs, aggrecanase-1) was from GlaxoSmithKline (Collegeville, PA, USA) [23]. ECL Plus detection was from Amersham Biosciences (Buckinghamshire, UK). Polyvinylidene difluoride (PVDF) membranes, Tris-acetate mini gels (3 to 8%), LDS sample buffer, Tris-acetate SDS running buffer and transfer buffer were from Invitrogen (Carlsbad, CA, USA). Non-fat dry milk by Semper (Sundbyberg, Sweden) was from the local supermarket.

Quick-Seal centrifuge tubes (2 ml no. 344625, 12.5 ml no. 342413), tube sealer (no. 342428), tube slicer (no. 303811) were from Beckman Coulter (Palo Alto, CA, USA). The monoclonal antibody (MAb) OA-1, with or without biotinylation, recognizing the neopeptide sequence ARGSVIL (representing the N-terminus of human aggrecan cleaved between <sup>392</sup>Glu and <sup>393</sup>Ala in the interglobular domain) was kindly provided by Michael Pratta (GlaxoSmithKline, Collegeville, PA, USA) [19]. Tetramethylbenzidine (TMB)-hydrogen peroxidase (H<sub>2</sub>O<sub>2</sub>) solution (no. 50-76-00) and peroxidase labeled streptavidin (no. 14-30-00) were from KPL (Gaithersburg, MD, USA). Hyaluronidase from *Streptomyces hyalurolyticus* (EC 4.2.2.1), chondroitinase ABC protease free (EC 4.2.2.4), keratanase (EC 3.2.1.103) and keratanase II (from *Bacillus* species Ks 36) were from Seikagaku (Tokyo, Japan). Keratan sulfate (KS) capture 96-well plates (no. 42.146.08) were from Biosource International (Camiro, CA, USA).

### Subjects and samples

Knee SF from 26 knee healthy volunteers and 269 patients were obtained from a cross-sectional convenience cohort, where each individual, after informed consent, provided a sample at one time point only. Diagnosis was made by arthroscopy, radiography, assessment of SF and clinical examination [1]. Samples were centrifuged at 3000 g and aliquots of the supernatant were stored at -80°C. All patient-related procedures were approved by the ethics review committee of the Medical Faculty of Lund University.

Diagnostic groups were healthy knee references (REF), acute inflammatory knee arthritis (AA), knee OA, and injured knee (anterior cruciate ligament rupture and/or meniscus tear) grouped as acute knee injury (AI; 0 to 12 weeks after injury) or chronic knee injury (CI; > 12 weeks after injury; Table 1). Joint changes, assessed by arthroscopy and radiography, were scored ranging from 1 to 10, where 1 represents a normal joint by arthroscopy and radiography; 2 to 5 represents an increasing extent and severity of fibrillation and clefts in the joint cartilage by arthroscopy in joints appearing normal on radiographs; and 6 to 10 represents increasing degrees of radiographic joint space narrowing consistent with OA [24].

**Table 1**

Characteristics of the study patients and reference group					OA score	
Study group	Subject number	Male, %	Age, years	Time of sampling, weeks after injury or onset		no.
REF	26	62	27 (17 to 89)	-	1 (1 to 1)	16
AA	48	60	66 (30 to 92)	0.4 (0 to 510)	7 (3 to 9)	31
AI	69	81	27 (16 to 59)	1.4 (0 to 11.9)	1 (1 to 5)	67
CI	123	77	40 (16 to 70)	61 (12.7 to 1926)	2 (1 to 8)	121
OA	29	66	61 (25 to 92)	125 (0 to 772)	7 (2 to 9)	29

Age, time of sampling and OA score in median values (range).

REF = healthy knee reference; AA = acute inflammatory arthritis (46 acute pyrophosphate arthritis/pseudogout, one rheumatoid arthritis and one acute reactive arthritis/Yersinia); AI = acute knee injury (47 anterior cruciate ligament ruptures and one posterior, with or without meniscus tear and meniscus tear alone, 0 to 12 weeks after injury); CI = chronic knee injury (120 anterior cruciate ligament ruptures and three posterior, with or without meniscus tear and meniscus tear alone, > 12 weeks after injury); OA = knee osteoarthritis. The OA score ranges from 1 to 10 where 1 represents a normal joint; see Materials and Methods for a detailed description.

Thirty-one samples lacked arthroscopic and/or radiographic data needed for assessment of OA score.

To study injury-dependent aggrecan fragment release at different times after injury, these samples were grouped as meniscal injury alone (MEN) or cruciate ligament rupture with or without an associated meniscus injury (ACL), stratified by time after injury (0 to 4, 4 to 12, 12 to 26, 26 to 52, or > 52 weeks).

Patient samples were selected from a biobank by one of the authors (LSL) on the basis of clinical diagnosis, without reference to any previously available assay data.

#### Cartilage aggrecan digest as ARGS standard

From the pool of human knee OA cartilage (10 patients) proteoglycans were extracted with guanidinium hydrochloride (4 M) in the presence of proteinase inhibitors (10 mM EDTA, 100 mM EACA, 10 mM NEM, 5 mM benzamide-HCl and 5 mM PMSF) and aggrecan was then isolated by associative-dissociative cesium chloride density gradient centrifugation in the presence of the proteinase inhibitors [25]. Fraction A1D1 was collected and dialyzed against Millipore-water prior to freeze drying [18]. As described, this fraction contains only large aggrecan fragments, containing the IGD, without G1-IPEN and G1-TEGE fragments [18]. Human aggrecan monomers were quantified based on dry weight assuming a molecular weight of  $1.5 \times 10^6$  g/mol.

Full-length human recombinant ADAMTS-4 was cloned, expressed, and purified at GlaxoSmithKline (Collegeville, PA, USA) [23]. ADAMTS-4 (3.1 nM) was incubated with the A1D1 fraction of human aggrecan (346 nM) for 30 hours at 37°C in 50 mM Tris-HCl, 100 mM sodium chloride (NaCl), 10 mM calcium chloride (CaCl<sub>2</sub>), pH 7.5, achieving complete conversion of the G1-containing starting material to G1-TEGE fragments and the corresponding ARGS fragments. The digest was

quenched with 25 mM EDTA and monitored for complete digestion by G1, TEGE, and ARGS western blots (data not shown). The digest was used as an ARGS standard in the aggrecan ARGS ELISA.

#### Aggrecan ARGS ELISA

Quantification in SF of aggrecan fragments with the N-terminal <sup>393</sup>ARGS was by a sandwich ELISA using an anti-KS antibody as capture and the monoclonal neopeptide antibody OA-1 for detection of specific fragments [19]. After modification for use in SF, the assay was conducted as follows:

#### Sample treatment

ARGS standard (ADAMTS-4 digested cartilage A1D1 aggrecan) was treated with chondroitinase ABC as described [18]. SF samples were digested with hyaluronidase (0.01 turbidity reducing unit/μl SF for three hours at 60°C in 50 mM sodium acetate, 10 mM EDTA, 0.25 mM AEBSF, pH 6), treated with chondroitinase ABC (0.8 mU/μl SF for 30 minutes at 37°C in 50 mM Tris-acetate, 75 mM sodium acetate, 15 mM EDTA, 0.125 mM AEBSF, pH 7.6), boiled in a water bath for five minutes, and spun (12,500 g, five minutes) collecting the supernatant.

#### ELISA

Duplicates of 300 μl of ARGS standards (ADAMTS-4 digested cartilage A1D1 aggrecan; 0.02 to 1 nM ARGS) or supernatant of boiled and spun SF samples (final SF dilution 1:50 to 1:6400) were incubated in the presence of 1% w/v BSA, 20 mM MES, 150 mM NaCl, pH 5.3 on KS capture plates coated with an anti-KS antibody (Biosource International, Camiro, CA, USA) over night at 4°C on a plate shaker. Following washes (6 × 400 μl PBST), plates were incubated with biotinylated MAb OA-1 (150 μl/well, 1.5 μg/ml in PBST with 0.1% w/v non-fat dry milk) for two hours at 37°C on a plate shaker. Plates were washed (as above) and incubated

with horseradish peroxidase-conjugated streptavidin (150  $\mu$ l/well, 1  $\mu$ g/ml in PBST) for one hour at room temperature on a plate shaker. Following a wash, a five-minute incubation of TMB-H<sub>2</sub>O<sub>2</sub> solution (150  $\mu$ l/well) and acidification with 1 M phosphoric acid (150  $\mu$ l/well), absorbance at 450 nm was measured spectrophotometrically using a Multiscan Multisoft plate reader (Labsystems, Helsinki, Finland) and the software Ascent 2.4.2 (Thermo Electron, Waltham, WA, USA).

#### Spiking

SF from individuals with ARGES concentrations suited for analysis diluted at 1:50, 1:400, 1:800, and 1:1600 were spiked with equimolar concentrations of ARGES standard (ADAMTS-4-digested cartilage A1D1 aggrecan) and analyzed in the ARGES ELISA.

ARGES neopeptide assays were performed with no knowledge of clinical diagnosis or previous assay data.

#### Aggrecan and sGAG quantification in synovial fluid

Aggrecan content was analyzed by a slightly modified competition ELISA using the mAb 1-F21 recognizing a protein sequence within or close to the KS domain [20,26]. The 1-F21 ELISA differed from the original [20] as follows: concentration of chondroitinase-digested A1D1 was 1.25  $\mu$ g/ml when coating; all washes were 3  $\times$  200  $\mu$ l; plates were blocked after coating (1% BSA, 200  $\mu$ l/well, 30 minutes at room temperature); the primary antibody 1-F21 was diluted to 1:10,000; the secondary antibody (Dakoplat nr. P447) was diluted to 1:2000.

Concentration of sGAG was measured by Alcian blue precipitation modified from Björnsson [22]. Samples and chondroitin sulfate standards (25  $\mu$ l) were precipitated for two hours at 4°C with 0.04% w/v Alcian blue, 0.72 M guanidinium hydrochloride, 0.25% w/v Triton X-100, and 0.1% v/v H<sub>2</sub>SO<sub>4</sub> (0.45 ml). The precipitates were collected after centrifugation (16,000 g, 15 minutes, 4°C), then dissolved in 4 M guanidinium hydrochloride, 33% v/v 1-propanol (0.25 ml), and transferred to 96-well micro-titer plates prior to absorbance measurement at 600 nm.

These data were available from previous studies using these samples [26-28].

For molar comparison of ARGES fragments and aggrecan, conversion from microgram sGAG/ml to pmol aggrecan/ml was made assuming an average aggrecan molecular weight of 1.5  $\times$  10<sup>6</sup> g/mol and assuming that 75% of this weight was sGAG [4].

#### Western blot

Aggrecan fragments captured in the ARGES ELISA by the anti-KS antibodies were analyzed by western blot. Following a completed ARGES ELISA, plates were washed with PBST and

incubated with 4 M guanidinium hydrochloride (150  $\mu$ l/well) for 30 minutes at room temperature on a plate shaker. To obtain enough material for western blot analysis, the well contents of standard wells (74 wells) and wells of SF from 152 patients (152 wells) were pooled separately and dialyzed in 10,000 kDa cut-off dialysis cassettes (Slide-A-Lyzer, Pierce, Rockford, IL, USA) against Millipore water containing protease inhibitors [18]. Samples were freeze dried, dissolved in deglycosylation buffer and digested by chondroitinase, keratanase and keratanase II [18]. Samples were precipitated in ice-cold acetone, and pellets were dissolved in two times concentrated sample buffer.

ADAMTS-4 digested aggrecan (used in the ELISA as standard) and a D1 fraction of pooled SF from 40 OA patients were chondroitinase, keratanase and keratanase II digested [18].

All samples were run on a 3 to 8% Tris-acetate SDS-PAGE gel, transferred to a PVDF membrane and ARGES fragments were visualized using the MAb OA-1 [18].

#### Western blot quantification

Quantification of ARGES fragment in SF by western blot was performed as described [4] using the same mAb for detection (OA-1) and the same standard as in the ARGES ELISA.

#### Statistical analysis

For some patients the available volume of SF was not large enough to perform all assays, which explains the variation in numbers between assays. Of the 295 subjects, 113 had ARGES fragment values below the level of detection (i.e. < 1 pmol ARGES/ml SF). Each was assigned a value of 0.5 pmol ARGES/ml, or half the lower limit of detection. To assess differences among the study groups, either a two-tailed Mann-Whitney U rank sum test with Bonferroni correction was used after Kruskal-Wallis testing, or a Chi-squared test, as appropriate. For correlation analysis Spearman's rank order correlation ( $r_s$ ) was used. *P* values below 0.05 were considered significant unless otherwise noted. Statistical calculations were performed using Statistical Package for the Social Sciences (SPSS, Chicago, IL, USA) for Windows version 15.0.

## Results

#### Technical performance of the ARGES ELISA

SF samples needed to be diluted 1:50 or more for a linear recovery at different dilutions; at dilutions below 1:50 the signal was reduced due to unknown matrix effects (results not shown). With a linear measuring range for the standards of 0.02 to 1 pmol ARGES/ml, and a minimal dilution of SF of 1:50, the lower limit of detection was then recalculated to undiluted SF 1 pmol ARGES/ml SF. Intra assay coefficient of variation (CV) was 6% (n = 10), the inter assay CV for the two groups of KS capture plates used were 12% (n = 5) and 16% (n = 23), respectively, and the total inter assay CV for the control SF sample included on all plates was 20% (n = 28; Table 2).

**Table 2****Technical performance of the KS capture OA-1 ARGs ELISA**

Linear measuring range of standard	0.02 to 1 pmol/ml			
Minimal dilution of SF	1:50			
Minimal detectable concentration in neat SF	1 pmol/ml SF			
Intra assay CV (n = 10)	6.1%			
*Inter assay, intra lot CV (n = 5, 1 <sup>st</sup> lot)	12.2%			
*Inter assay, intra lot CV (n = 23, 2 <sup>nd</sup> lot)	15.6%			
Inter assay, inter lot CV (n = 28)	19.7%			
Dilution of SF	1:50	1:400	1:800	1:1600
Spiking recovery (mean; range)	116%; 109 to 121%	93%; 75 to 104%	81%; 75 to 88%	104%; 98 to 113%

\* Between assay variation in lot numbers (1<sup>st</sup>, #5L21/1; 2<sup>nd</sup>, #7F25/1) of the KS capture plates from Biosource. CV = coefficient of variation; KS = keratan sulfate; SF = synovial fluid.

The mean spiking recovery at dilutions 1:50 to 1:1600 was 99% (range 75 to 121%; Table 2).

Anti-ARGs western blot analysis of aggrecan fragments captured by the ELISA plates, showed that the ARGs fragments present in the standard were also captured by the anti-KS plates (Figure 1). The SF ARGs fragments captured by the plates showed the same fragment pattern as those detected in an SF D1 control sample and in the two standard samples.

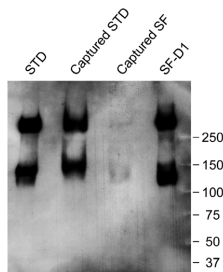
**Figure 1**

Anti-ARGs western blot of ELISA-captured material. Aggrecan fragments captured by the anti-keratan sulfate (KS)-coated plates were extracted after a completed ELISA and analyzed by western blot. Seventy-four wells of captured ARGs standards (STD) and 152 wells of SF from 152 patients were used. The samples were chondroitinase, keratanase, and keratanase II digested, separated on a SDS-PAGE gel, transferred to a polyvinylidene difluoride (PVDF) membrane and probed with the ARGs antibody OA-1. For comparison, the STD (0.5 µg sulfated glycosaminoglycan (sGAG)/well) and an SF D1 sample pooled from 40 osteoarthritis (OA) patients (0.75 µg sGAG/well) were used as controls. The size (kDa) and position of the molecular weight markers are indicated.

**Aggrecan, sGAG, and ARGs fragment concentrations in synovial fluid**

The concentrations of aggrecan measured as 1-F21 reactivity, sGAG, and aggrecan fragments bearing the ARGs neopeptide are summarized in Table 3. As shown [26], there was a strong correlation between aggrecan fragment concentration measured by the 1-F21 ELISA and the concentration of sGAG ( $r_s = 0.82$ , data not shown). The ARGs concentration showed a more moderate correlation with the concentrations of sGAG ( $r_s = 0.69$ ; Figure 2a) and aggrecan ( $r_s = 0.66$ ; Figure 2b).

To validate the identity of the fragments responsible for the signal below the detection limit of the ARGs ELISA, 32 samples, of which 10 were below ELISA detection, were analyzed by western blot quantification [4], using the same mAb for detection, and compared with aggrecan fragment content as measured by sGAG. The molar proportion of aggrecan fragments bearing the ARGs neopeptide (i.e. ARGs/aggrecan) as measured by western blot was calculated. In the 10 samples below the detection limit of the ELISA, the median proportion of ARGs-bearing fragments out of aggrecan was 1.8% (range 1.2 to 6.4%) and in the samples above the detection limit, the median proportion was 23.8% (2.6 to 59.2%). Conversion from µg sGAG/ml to pmol aggrecan/ml is described in Material and Methods.

**Aggrecan ARGs fragments in diagnostic groups**

Concentrations of aggrecan fragments carrying the neopeptide ARGs were elevated in all groups compared with the healthy knee reference group (Figure 3a). The median levels (in pmol ARGs/ml SF) were: REF 0.5 (range 0.5 to 3.3), AA 88.5 (0.5 to 961), AI 53.9 (0.5 to 946), CI 0.5 (0.5 to 266), and OA 4.6 (0.5 to 318). Similarly, all patient groups differed from the reference ( $P < 0.001$ ) regarding the proportion of samples in each diagnostic group with ARGs concentration above the lower limit of detection (1 pmol ARGs/ml) as tested



**Figure 2**

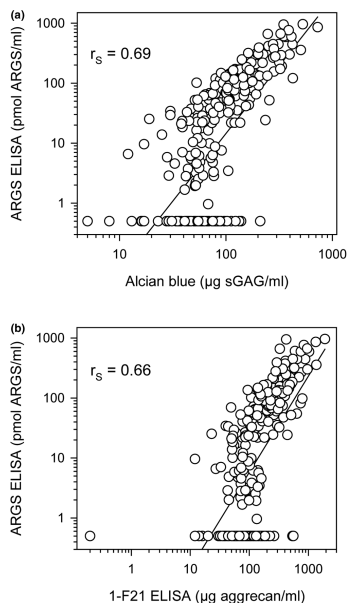

Regression analysis of aggrecan fragment data. The same samples of synovial fluid were analyzed by three different assays (see Material and Methods for details). Concentration of aggrecan fragments carrying the neoepitope ARGES by ELISA versus (a) sGAG concentration by Alcian blue precipitation ( $n = 293$ ) and versus (b) aggrecan concentration by 1-F21 ELISA ( $n = 285$ ). Solid lines show the first-order regression. Note the logarithmic X- and Y-axes. Spearman's rank order correlations ( $r_s$ ) are given for each relationship with  $P < 0.0001$ .

by Chi-squared tests. The percentages of detectable samples were 96% (AA), 87% (AI), 46% (CI), and 62% (OA) compared with 7.7% in REF. The sensitivity of ARGES fragment concentration as a marker for joint disease was 67% with a specificity of 92% (Table 4). We found no significant influence of age or sex on the SF levels of ARGES fragments (data not shown).

**Table 3**

**Synovial fluid aggrecan fragment data in all subjects**

	OA-1 ARGES ELISA (pmol ARGES/ml)	Alcian blue precipitation (µg sGAG/ml)	1-F21 ELISA (µg aggrecan/ml)
n	295	293	285
Mean	75	104	199
Median	10	74	120
Range	0.5 to 961	5 to 728	0.2 to 1912

**sGAG and aggrecan in diagnostic groups**

Median concentrations of sGAG were elevated only in the AA ( $P = 0.004$ ) and AI groups ( $P < 0.001$ ) compared with the REF group (Figure 3b). Similarly, concentrations of aggrecan measured by the 1-F21 ELISA were different from REF only in AA ( $P = 0.002$ ) and AI ( $P = 0.026$ ; Figure 3c). The sensitivities of sGAG and aggrecan fragment concentrations as markers for disease were 40% and 32% with specificities of 92% and 91%, respectively (Table 4). We found no significant influence of sex on the SF levels of sGAG or aggrecan (data not shown). However, age correlated negatively with sGAG concentration in the AA group ( $r_s = -0.292$ ) and aggrecan concentration in the AI and CI groups ( $r_s = -0.335$  and  $r_s = -0.230$  respectively).

**ARGES and aggrecan fragment release in relation to time after injury**

After knee injury involving either a MEN alone (Figures 4a,b), or an ACL injury with or without associated MEN (Figures 4c,d), the SF levels of both sGAG and ARGES fragments were elevated within the first four weeks compared with REF ( $P < 0.001$ ). Notably, the median elevations for MEN and ACL patients were more than 200-fold compared with REF for ARGES, but only two- to three-fold for sGAG. For time spans more than four weeks after injury, the sGAG levels of the MEN and ACL groups were not different from the REF group, whereas the ARGES levels continued to differ from REF (except for 26 to 52 weeks after meniscal injury). At none of the time intervals were there any differences between MEN and ACL groups for ARGES or sGAG in SF.

**Proportion of aggrecan detected as ARGES neoepitope in study groups**

The proportions of aggrecan fragments in SF detected as ARGES neoepitope fragments out of all SF proteoglycan (measured by Alcian blue precipitation) were increased in all study groups compared with REF ( $P < 0.001$ ; Figure 5). The proportion in the AA group was the highest, 111-fold elevated compared with REF, and in the CI group the least increased, two-fold compared with the REF group. The median proportion of ARGES in REF was 1% and ranged in the diagnostic groups from 2% (CI) to 110% (AA). The proportion of ARGES

**Figure 3**

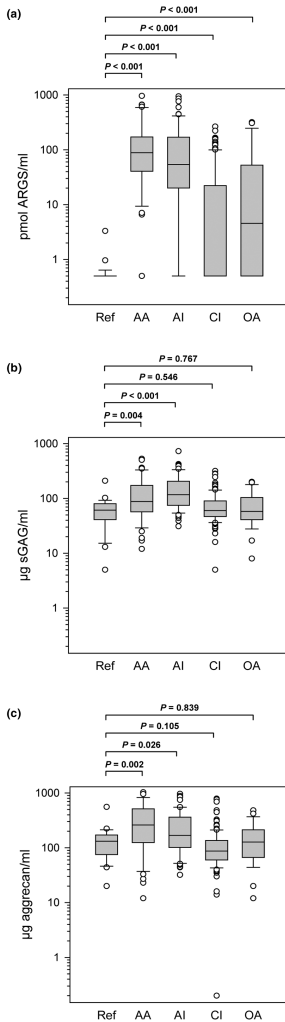

Aggrecan fragment concentrations in the study groups. Concentrations of **(a)** ARGs fragments, **(b)** sulfated glycosaminoglycan (sGAG), and **(c)** aggrecan in the study groups healthy knee reference (REF), acute inflammatory arthritis (AA), acute knee injury (AI), chronic knee injury (CI), and knee osteoarthritis (OA). The boxes define the 25<sup>th</sup> and 75<sup>th</sup> percentiles with a line at the median, error bars defining the 10<sup>th</sup> and 90<sup>th</sup> percentiles and circles represents individual outliers. Note that in panel (a) the median level of the chronic injury group is the same as the lower limit of the box; 0.5 pmol ARGs/ml. After Bonferroni correction, *P* values below 0.013 are considered significant to retain the 0.05 overall significance level.

of all aggrecan as a marker for joint disease had a sensitivity of 65% and a specificity of 96% (Table 4).

## Discussion

Aggrecanase cleavage at the Glu-Ala bond in the IGD is important both in animal [6,7,10,11,13,14] and human [4,9,15,17] joint disease. However, previous analyses of larger series of human samples of serum or SF used assays that were not specific for aggrecan fragments carrying this specific neopeptide [1,3,24,26,29-32]. This limits our ability to interpret the results in terms of activity of specific proteases. The work presented here confirms that aggrecanase cleavage in the IGD is a major contributor to aggrecan degradation in human joint pathology, and extends our understanding of the relative contribution of aggrecanase activity in different human joint diseases. We found greatly increased SF concentrations of aggrecan ARGs fragments in several different joint diseases compared with the healthy knee reference group, differences that were only to a small extent reflected by enhanced concentrations of aggrecan fragments in general or sulfated glycosaminoglycans. We also found that the elevation in SF ARGs concentration was most dramatic early after a knee injury, and then decreased to lower levels 12 weeks after the injury, albeit still significantly different from the healthy knee reference group. This suggests that the enhanced aggrecan cleavage in the IGD by aggrecanase caused by the acute joint insult remains increased for several years. Similar long-term changes after knee injury in SF levels of stromelysin (MMP-3) have been reported [2,28].

## Study design and methodology

The range of ARGs concentrations within each study group was substantial, with the exception of the healthy knee reference group. In part, this can be explained by the cross-sectional study design, with the grouping together of individuals with varying severity of injury and disease activity. However, it is also known that the variability of SF markers is greater than for serum and urine markers [32]. Despite the considerable range observed, we note that all study groups differed significantly from the reference group regarding ARGs concentrations. Based on previous studies it is most likely that the knee injury groups are not homogenous regarding progression of OA, but are comprised of progressors and non-progressors [33,34]. It is plausible that heterogeneities like these also influence the ARGs concentrations, and could partly explain the variations seen in these groups.

The lower limit of linearity of the ARGs ELISA in SF was 1 pmol/ml SF, and samples below this level were assigned half that value to allow statistical analysis. All study groups had significantly lower proportions of samples below the lower limit of detection compared with the knee healthy reference group.

As a validation of the ARGs ELISA, we analyzed a subset of SF samples, purified by dissociative cesium chloride density

**Table 4**

Sensitivity and specificity of aggrecan fragment measurements				
Assay	Cut-off	AUC	Sensitivity	Specificity
OA-1 ARGs ELISA	1 pmol ARGs/ml	82%	67%	92%
Alcian blue precipitation	88.5 µg sGAG/ml	63%	40%	92%
1-F21 ELISA	188.5 µg aggrecan/ml	53%	32%	91%
ARGs/sGAG*	5%	83%	65%	96%

\*The molar proportion of aggrecan fragments in SF detected as ARGs neoepitope fragments, measured by Alcian blue precipitation and the ARGs ELISA respectively.  
 Sensitivity = the proportion of positives (diseased) correctly identified by the test.  
 Specificity = the proportion of negatives (healthy) correctly identified by the test.  
 AUC = area under receiver operating characteristic (ROC) curve.  
 Cut-offs were chosen based on ROC curve analysis where the sum of sensitivity and specificity was highest.

gradient centrifugation, with quantitative western blots using the same ARGs antibody and standard as in the ELISA. The results verified that samples below the detection level of the ARGs ELISA had very low levels of ARGs.

captured by the ELISA plate, compared with fragments captured from the standard, is most likely a reflection of a lower total ARGs concentration in these SFs compared with the standards.

The similarity in the Western blot analysis of loaded and captured aggrecan ARGs fragments show that the ARGs fragments present in the standard and the cesium chloride D1 preparation of an SF sample are captured by the anti-KS plate. The weaker immuno-reaction seen for SF ARGs fragments

The strategy applied in the ARGs ELISA of capturing fragments with the anti-KS antibody limits detection of ARGs fragments to those also containing part of the KS domain. Although there are known cleavage sites for proteases such as MMPs, cathepsins, and calpains between <sup>393</sup>ARGs and

**Figure 4**

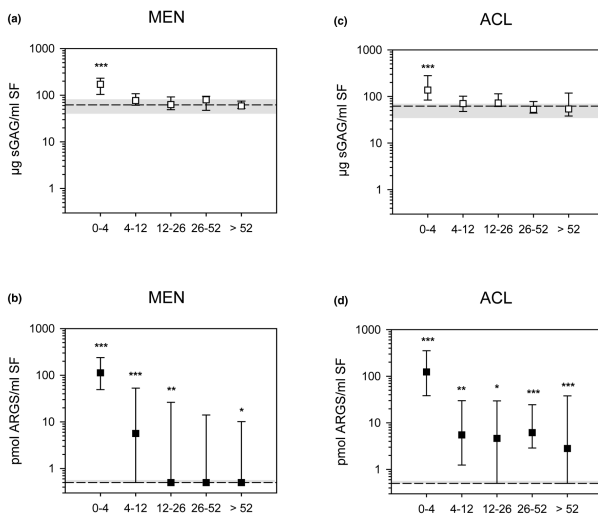

Aggrecan release after knee injury. Samples were ordered by time after knee injury (weeks) and by (a, b) meniscal injury alone (MEN) or (c, d) by anterior cruciate ligament rupture with or without an associated meniscus injury (ACL). Values are median concentrations of sulfated glycosaminoglycan (sGAG; open squares) and ARGs (filled squares) with 25<sup>th</sup> and 75<sup>th</sup> percentiles, compared with the medians (dashed lines) and 25<sup>th</sup> and 75<sup>th</sup> percentiles (shaded area) of the reference group on logarithmic Y-axes. Significant difference against the reference group at the 0.001 (\*\*\*), 0.01 (\*\*) and 0.05 (\*) levels after Bonferroni correction is indicated.

**Figure 5**

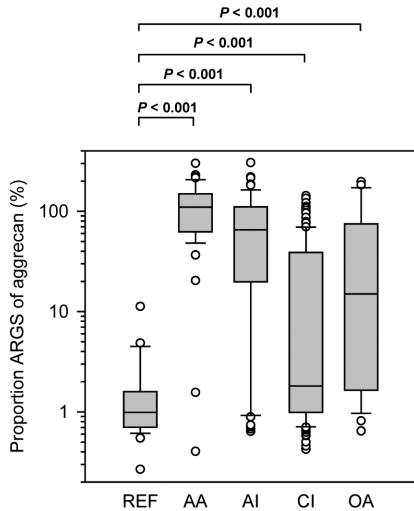

Proportion ARGs of aggrecan in the study groups. The molar proportion of aggrecan fragments in synovial fluid (SF; measured by Alcian blue precipitation) detected as ARGs neopeptide fragments (measured by ARGs ELISA) in the study groups healthy knee reference (REF), acute inflammatory arthritis (AA), acute knee injury (AI), chronic knee injury (CI), and knee osteoarthritis (OA). The boxes define the 25<sup>th</sup> and 75<sup>th</sup> percentiles with a line at the median, error bars defining the 10<sup>th</sup> and 90<sup>th</sup> percentiles and circles represents individual outliers. After Bonferroni correction, *P* values below 0.013 are considered significant to retain the 0.05 overall significance level. Conversion from microgram sulfated glycosaminoglycan (sGAG)/ml to pmol aggrecan/ml was made assuming an average aggrecan molecular weight of  $1.5 \times 10^6$  g/mol and that 75% of this weight was sGAG.

the KS domain stretching from amino acid 676 to 848, these cleavage sites were all confirmed to occur by *in vitro* experiments [5]; Sandy and Verscharen showed in SF the presence of a 100 kDa ARGs band ('Species f') estimated to stretch to amino acids 800 to 900 [17]. We detected small amounts of a similar band in SF purified by chromatography or by associative A1 fractioning which, when deglycosylated, migrated to 50 to 70 kDa; the intensity of the band corresponded to about 3% of the total ARGs signal (data not shown). By use of a calculation model [35], we estimate these <sup>393</sup>ARGs fragments to stretch to amino acids 690 to 750 (data not shown). With the KS domain starting at amino acid 676, these fragments contain part of the domain necessary for capture. We can not, however, completely rule out the presence of SF ARGs fragments not containing the KS necessary for detection.

The inter assay CV for the ARGs ELISA was to a large part caused by the use of two different lot numbers of the KS capture plates supplied by Biosource. The samples were, how-

ever, analysed blinded with diagnostic groups spread evenly, so the change of lot numbers had no effect on the observed group differences in ARGs concentrations.

#### Aggrecan and ARGs fragments as biomarkers in SF

As reported [1,2,24], the group differences in aggrecan content determined by Alcian blue precipitation or by ELISA with the 1-F21 antibody were small with a maximum of a two-fold increase compared with the REF. Only AA and AI were shown to have significantly elevated levels of sGAG and aggrecan compared with REF.

In contrast to the Alcian blue precipitation method and the 1-F21 ELISA, the ARGs ELISA is highly specific regarding neopeptide and presence of KS on the fragments. Even so, the ARGs neopeptide concentrations correlated with both sGAG and 1-F21 aggrecan concentrations in SF, consistent with previous findings showing that a significant portion of the sGAG and aggrecan content in human SF consisted of neopeptide fragments such as the ARGs fragments measured here, or MMP-generated <sup>361</sup>FFGV fragments [18,36]. The differences in group median values of ARGs were, however, much greater than for either sGAG or 1-F21 aggrecan. All disease groups were significantly different from the REF, with as much as 177-fold increased levels of ARGs in the AA group. With specificities of 91 to 92%, the concentration of ARGs neopeptide fragments had a sensitivity of 67% in differentiating diseased from healthy patients, compared with sGAG or 1-F21 aggrecan, which had lower sensitivities of 40% and 32%, respectively. Quantification in SF of ARGs fragments generated by aggrecanases by a neopeptide-specific ELISA is clearly a more powerful tool to distinguish diseased and injured joints from healthy than quantification of aggrecan fragments either by 1-F21 ELISA or by measuring sGAG concentrations.

#### Proportion of aggrecan detected as ARGs neopeptide

Acknowledging that there are uncertainties in our assumptions of molecular weight and degree of glycosylation of the average aggrecan fragment in SF, and of the molecular weight of the standard, uncertainties that make ARGs proportions of aggrecan greater than 100% possible, the diagnostic groups nevertheless showed large differences in the proportion of SF aggrecan fragments generated by aggrecanase IGD activity. In the two groups most strongly associated with high joint disease activity, acute inflammatory arthritis and acute knee injury, a majority of the aggrecan fragments were indeed shown to be the result of aggrecanase IGD activity, whereas the other groups had much lower proportions. These results corroborate those previously obtained by western blots [4].

#### Interpretation of elevated SF levels of ARGs

Based solely on data available in this paper, the elevated SF levels of ARGs in disease, particularly in the acute inflammatory arthritis and acute injury samples, could be explained by

enhanced aggrecanase activity against aggrecan resident in the joint cartilage matrix, or against newly synthesized and secreted aggrecan [37]. ADAMTS-5 (aggrecanase-2) was shown to co-localize with hyaluronan surrounding chondrocytes in both normal and osteoarthritic cartilage [38]. However, if enhanced synthesis of aggrecan in combination with aggrecanase activity were to explain the enhanced SF levels of ARGS, an equal increase in the SF levels of G3 was to be expected. This is not the case; we have in quantitative western blot analysis of 30 of these samples seen no significant difference in SF levels of G3 of any of the diagnostic groups compared with healthy knee references [4]. We therefore suggest that an increased aggrecanase activity against the IGD domain of resident aggrecan best explains the enhanced SF levels of ARGS seen in these diagnostic groups.

### The source of the aggrecan fragments

SF is more proximate to the location of joint cartilage and aggrecan degradation than serum or urine, and may therefore better reflect local pathologic processes in the joint being studied. The observed group differences are thus likely to reflect differences in local knee joint pathology. The fragments observed in SF originate in a major part from the joint cartilage, while minor proportions may be released from menisci and ligaments [39,40].

### Conclusions

Our findings confirm that aggrecanase cleavage at the <sup>392</sup>Glu-<sup>393</sup>Ala bond in the IGD of aggrecan is enhanced in joint pathology, most markedly in acute inflammatory arthritis and early after knee injury, but also in knee OA. The enhanced aggrecanase IGD cleavage is detectable by ELISA as ARGS fragments in the SF. We show that measuring SF concentrations of ARGS is more sensitive in distinguishing diseased and injured joints from healthy ones than methods that do not rely on the specific detection of this aggrecan neopeptide. The ARGS ELISA could be used to monitor aggrecanase activity in joint disease, and to monitor the efficacy of interventions to inhibit this protease activity in joint disease or model systems.

### Competing interests

The authors declare that they have no competing interests.

### Authors' contributions

SL participated in the design of the study, carried out the modification of the ARGS ELISA, the acquisition of data and the analysis and interpretation thereof, and was primarily responsible for writing the manuscript. AS contributed in the design of the study, in the modification of the ARGS ELISA, and helped draft the manuscript. LSL participated in the design of the study, collected samples, provided previous assay data, and helped draft the manuscript. All authors read and approved the final manuscript.

### Acknowledgements

The authors would like to thank Michael Pratta and Sanjay Kumar for the generous gift of ADAMTS-4, the mAb OA-1 and KS capture ELISA plates, Maria Hansson for help in the modification of the ARGS ELISA and data acquisition, Jan-Åke Nilsson for useful comments on the statistical analysis and Ewa Roos for constructive input on the study design. Supported by: The Swedish Research Council (LSL), the Swedish Rheumatism Association (LSL), the Kock Foundation (AS), the King Gustaf V 80-year Birthday Fund (LSL), the Faculty of Medicine Lund University (LSL), Region Skåne (LSL), Magnus Bergvalls Foundation (AS), Alfred Österlunds Foundation (AS), and Swårds/Eklunds Foundations (AS).

### References

- Lohmander LS, Dahlberg L, Ryd L, Heinegard D: **Increased levels of proteoglycan fragments in knee joint fluid after injury.** *Arthritis Rheum* 1989, **32**:1434-1442.
- Lohmander LS, Hoerner LA, Dahlberg L, Roos H, Björnsson S, Lark MW: **Stromelysin, tissue inhibitor of metalloproteinases and proteoglycan fragments in human knee joint fluid after injury.** *J Rheumatol* 1993, **20**:1362-1368.
- Saxne T, Glennas A, Kvien TK, Melby K, Heinegard D: **Release of cartilage macromolecules into the synovial fluid in patients with acute and prolonged phases of reactive arthritis.** *Arthritis Rheum* 1993, **36**:20-25.
- Struglics A, Larsson S, Hansson M, Lohmander LS: **Western blot quantification of aggrecan fragments in human synovial fluid indicates differences in fragment patterns between joint diseases.** *Osteoarthritis Cartilage* 2009, **17**:497-506.
- Sandy JD: **Proteolytic degradation of normal and osteoarthritic cartilage matrix.** In *Osteoarthritis* 2nd edition. Edited by: Brandt KD, Doherty M, Lohmander LS. Oxford: Oxford University Press; 2003:82-92.
- Glasson SS, Askew R, Sheppard B, Carito B, Blanchet T, Ma HL, Flannery CR, Peluso D, Kanki K, Yang Z, Majumdar MK, Morris EA: **Deletion of active ADAMTS5 prevents cartilage degradation in a murine model of osteoarthritis.** *Nature* 2005, **434**:644-648.
- Stanton H, Rogerson FM, East CJ, Golub SB, Lawlor KE, Meeker CT, Little CB, Last K, Farmer PJ, Campbell IK, Fourie AM, Fosang AJ: **ADAMTS5 is the major aggrecanase in mouse cartilage in vivo and in vitro.** *Nature* 2005, **434**:648-652.
- Sandy JD, Flannery CR, Neame PJ, Lohmander LS: **The structure of aggrecan fragments in human synovial fluid. Evidence for the involvement in osteoarthritis of a novel proteinase which cleaves the Glu 373-Ala 374 bond of the interglobular domain.** *J Clin Invest* 1992, **89**:1512-1516.
- Lohmander LS, Neame PJ, Sandy JD: **The structure of aggrecan fragments in human synovial fluid. Evidence that aggrecanase mediates cartilage degradation in inflammatory joint disease, joint injury, and osteoarthritis.** *Arthritis Rheum* 1993, **36**:1214-1222.
- Carter QL, Dotzlaw J, Swearingen C, Brittain I, Chambers M, Duffin K, Mitchell P, Thirunavukarasu K: **Development and characterization of a novel ELISA based assay for the quantitation of sub-nanomolar levels of neopeptide exposed NITEGE-containing aggrecan fragments.** *J Immunol Methods* 2007, **328**:162-168.
- Karsdal MA, Sumer EU, Wulf H, Madsen SH, Christiansen C, Fosang AJ, Sondergaard BC: **Induction of increased cAMP levels in articular chondrocytes blocks matrix metalloproteinase-mediated cartilage degradation, but not aggrecanase-mediated cartilage degradation.** *Arthritis Rheum* 2007, **56**:1549-1558.
- Song RH, Tortorella MD, Malfait AM, Alston JT, Yang Z, Amer EC, Griggs DW: **Aggrecan degradation in human articular cartilage explants is mediated by both ADAMTS-4 and ADAMTS-5.** *Arthritis Rheum* 2007, **56**:575-585.
- Sumer EU, Sondergaard BC, Rousseau JC, Delmas PD, Fosang AJ, Karsdal MA, Christiansen C, Qvist P: **MMP and non-MMP-mediated release of aggrecan and its fragments from articular cartilage: a comparative study of three different aggrecan and glycosaminoglycan assays.** *Osteoarthritis Cartilage* 2007, **15**:212-221.

14. Karsdal MA, Madsen SH, Christiansen C, Henriksen K, Fosang AJ, Sondergaard BC: **Cartilage degradation is fully reversible in the presence of aggrecanase but not matrix metalloproteinase activity.** *Arthritis Res Ther* 2008, **10**:R63.
15. Rousseau JC, Sumer EU, Hein G, Sondergaard BC, Madsen SH, Pedersen C, Neumann T, Mueller A, Qvist P, Delmas P, Karsdal MA: **Patients with rheumatoid arthritis have an altered circulatory aggrecan profile.** *BMC Musculoskelet Disord* 2008, **9**:74.
16. Nagase H, Kashiwagi M: **Aggrecanases and cartilage matrix degradation.** *Arthritis Res Ther* 2003, **5**:94-103.
17. Sandy JD, Verscharen C: **Analysis of aggrecan in human knee cartilage and synovial fluid indicates that aggrecanase (ADAMTS) activity is responsible for the catabolic turnover and loss of whole aggrecan whereas other protease activity is required for C-terminal processing in vivo.** *Biochem J* 2001, **358**:615-626.
18. Struglics A, Larsson S, Pratta MA, Kumar S, Lark MW, Lohmander LS: **Human osteoarthritis synovial fluid and joint cartilage contain both aggrecanase- and matrix metalloproteinase-generated aggrecan fragments.** *Osteoarthritis Cartilage* 2006, **14**:101-113.
19. Pratta MA, Su JL, Leesnitzer MA, Struglics A, Larsson S, Lohmander LS, Kumar S: **Development and characterization of a highly specific and sensitive sandwich ELISA for detection of aggrecanase-generated aggrecan fragments.** *Osteoarthritis Cartilage* 2006, **14**:702-713.
20. Moller HJ, Larsen FS, Ingemann-Hansen T, Poulsen JH: **ELISA for the core protein of the cartilage large aggregating proteoglycan, aggrecan: comparison with the concentrations of immunogenic keratan sulphate in synovial fluid, serum and urine.** *Clin Chim Acta* 1994, **225**:43-55.
21. Poole AR, Ionescu M, Swan A, Dieppe PA: **Changes in cartilage metabolism in arthritis are reflected by altered serum and synovial fluid levels of the cartilage proteoglycan aggrecan. Implications for pathogenesis.** *J Clin Invest* 1994, **94**:25-33.
22. Bjornsson S: **Simultaneous preparation and quantitation of proteoglycans by precipitation with alcian blue.** *Anal Biochem* 1993, **210**:282-291.
23. Tortorella MD, Burn TC, Pratta MA, Abbaszade I, Hollis JM, Liu R, Rosenfeld SA, Copeland RA, Decicco CP, Wynn R, Rockwell A, Yang F, Duke JL, Solomon K, George H, Bruckner R, Nagase H, Itoh Y, Ellis DM, Ross H, Wiswall BH, Murphy K, Hillman MC Jr, Hollis GF, Newton RC, Magolda RL, Trzaskos JM, Arner EC: **Purification and cloning of aggrecanase-1: a member of the ADAMTS family of proteins.** *Science* 1999, **284**:1664-1666.
24. Dahlberg L, Ryd L, Heinegard D, Lohmander LS: **Proteoglycan fragments in joint fluid. Influence of arthrosis and inflammation.** *Acta Orthop Scand* 1992, **63**:417-423.
25. Heinegard D, Sommarin Y, Leon WC: **[17] Isolation and characterization of proteoglycans.** In *Methods in Enzymology Volume 144*. London: Academic Press; 1987:319-372.
26. Lohmander LS, Ionescu M, Jegusur H, Poole AR: **Changes in joint cartilage aggrecan after knee injury and in osteoarthritis.** *Arthritis Rheum* 1999, **42**:534-544.
27. Lohmander LS, Hoerner LA, Lark MW: **Metalloproteinases, tissue inhibitor, and proteoglycan fragments in knee synovial fluid in human osteoarthritis.** *Arthritis Rheum* 1993, **36**:181-189.
28. Lohmander LS, Roos H, Dahlberg L, Hoerner LA, Lark MW: **Temporal patterns of stromelysin-1, tissue inhibitor, and proteoglycan fragments in human knee joint fluid after injury to the cruciate ligament or meniscus.** *J Orthop Res* 1994, **12**:21-28.
29. Saxne T, Heinegard D, Wollheim FA, Pettersson H: **Difference in cartilage proteoglycan level in synovial fluid in early rheumatoid arthritis and reactive arthritis.** *Lancet* 1985, **2**:127-128.
30. Saxne T, Heinegard D, Wollheim FA: **Therapeutic effects on cartilage metabolism in arthritis as measured by release of proteoglycan structures into the synovial fluid.** *Ann Rheum Dis* 1986, **45**:491-497.
31. Saxne T, Wollheim FA, Pettersson H, Heinegard D: **Proteoglycan concentration in synovial fluid: predictor of future cartilage destruction in rheumatoid arthritis?** *Br Med J (Clin Res Ed)* 1987, **295**:1447-1448.
32. Lohmander LS, Dahlberg L, Eyre D, Lark M, Thonar EJ, Ryd L: **Longitudinal and cross-sectional variability in markers of joint metabolism in patients with knee pain and articular cartilage abnormalities.** *Osteoarthritis Cartilage* 1998, **6**:351-361.
33. Englund M, Roos EM, Lohmander LS: **Impact of type of meniscal tear on radiographic and symptomatic knee osteoarthritis: a sixteen-year followup of meniscectomy with matched controls.** *Arthritis Rheum* 2003, **48**:2178-2187.
34. Englund M, Lohmander LS: **Risk factors for symptomatic knee osteoarthritis fifteen to twenty-two years after meniscectomy.** *Arthritis Rheum* 2004, **50**:2811-2819.
35. Struglics A, Larsson S, Lohmander LS: **Estimation of the identity of proteolytic aggrecan fragments using PAGE migration and Western immunoblot.** *Osteoarthritis Cartilage* 2006, **14**:898-905.
36. Fosang AJ, Last K, Maciewicz RA: **Aggrecan is degraded by matrix metalloproteinases in human arthritis. Evidence that matrix metalloproteinase and aggrecanase activities can be independent.** *J Clin Invest* 1996, **98**:2292-2299.
37. Lohmander LS, Eyre DR: **Biochemical markers as surrogate end points of joint disease.** In *Clinical trials in rheumatoid arthritis and osteoarthritis* Edited by: Reid DM, Miller CG. London: Springer; 2008:249-274.
38. Plaas A, Osborn B, Yoshihara Y, Bai Y, Bloom T, Nelson F, Mikecz K, Sandy JD: **Aggrecanolytic in human osteoarthritis: confocal localization and biochemical characterization of ADAMTS5-hyaluronan complexes in articular cartilages.** *Osteoarthritis Cartilage* 2007, **15**:719-734.
39. McAlinden A, Duthia J, Bolton MC, Lorenzo P, Heinegard D, Bayliss MT: **Age-related changes in the synthesis and mRNA expression of decorin and aggrecan in human meniscus and articular cartilage.** *Osteoarthritis Cartilage* 2001, **9**:33-41.
40. Verdonk PC, Forsyth RG, Wang J, Almqvist KF, Verdonk R, Veys EM, Verbruggen G: **Characterisation of human knee meniscus cell phenotype.** *Osteoarthritis Cartilage* 2005, **13**:548-560.



## Paper IV





# The association between synovial fluid levels of aggrecan ARGS fragments and progression of joint space narrowing in knee osteoarthritis

Staffan Larsson<sup>1</sup>, Martin Englund<sup>1, 2</sup>, André Struglics<sup>1</sup>, L Stefan Lohmander<sup>1</sup>

<sup>1</sup>Department of Orthopaedics, Clinical Sciences Lund, Lund University, Lund, Sweden.

<sup>2</sup>Clinical Epidemiology research & Training Unit, Boston University School of Medicine, Boston, MA, USA

## **Corresponding author:**

Staffan Larsson

Lund University

Department of Orthopaedics

BMC, C12

SE-221 84 Lund

Sweden.

Phone: +46 46-222 42 56

Fax: +46 46-211 34 17

E-mail: [staffan.larsson@med.lu.se](mailto:staffan.larsson@med.lu.se)

## **E-mail addresses:**

Staffan Larsson ([staffan.larsson@med.lu.se](mailto:staffan.larsson@med.lu.se))

Martin Englund ([martin.englund@med.lu.se](mailto:martin.englund@med.lu.se))

André Struglics ([andre.struglics@med.lu.se](mailto:andre.struglics@med.lu.se))

L Stefan Lohmander ([stefan.lohmander@med.lu.se](mailto:stefan.lohmander@med.lu.se))