



# LUND UNIVERSITY

## Well Testing, Methods and Applicability

Rosberg, Jan-Erik

2010

[Link to publication](#)

*Citation for published version (APA):*

Rosberg, J.-E. (2010). *Well Testing, Methods and Applicability*. [Doctoral Thesis (compilation), Engineering Geology]. Department of Electrical Measurements, Lund University.

*Total number of authors:*

1

### General rights

Unless other specific re-use rights are stated the following general rights apply:

Copyright and moral rights for the publications made accessible in the public portal are retained by the authors and/or other copyright owners and it is a condition of accessing publications that users recognise and abide by the legal requirements associated with these rights.

- Users may download and print one copy of any publication from the public portal for the purpose of private study or research.
- You may not further distribute the material or use it for any profit-making activity or commercial gain
- You may freely distribute the URL identifying the publication in the public portal

Read more about Creative commons licenses: <https://creativecommons.org/licenses/>

### Take down policy

If you believe that this document breaches copyright please contact us providing details, and we will remove access to the work immediately and investigate your claim.

LUND UNIVERSITY

PO Box 117  
221 00 Lund  
+46 46-222 00 00

# **Well testing, methods and applicability**

**Jan-Erik Rosberg**

**Engineering Geology  
Lund University**

**Doctoral Thesis  
2010**



**LUND UNIVERSITY**

*Author*

Jan-Erik Rosberg 1977-

*Title*

Well testing, methods and applicability

*Keywords*

Well testing, slug tests, pumping tests, injection tests, well development, pneumatic initiation, hydro-jetting, coiled tubing, deep wells, tunnel lining, re-injection, well completion

*Published by*

Engineering Geology, Lund University

*Printed by*

Media-Tryck, Lund 2010

*All rights reserved, © 2010 by the author*

ISBN 978-91-976848-3-5

ISRN LUTVDG/TVTIG-1025-SE

## Acknowledgements

This thesis was completed with help and encouragement from many people. I wish to express my gratitude to these people, some of which deserve greater appreciation than I'm able to fully express here.

First of all I would like to thank my supervisor Leif Bjelm for always being helpful and giving me the opportunity to work with extraordinary well testing projects. I would also like to thank my second supervisor Gerhard Barmen for always having time to answer my questions. Thanks to both of you for all your encouragement, guidance and expertise during the thesis work.

I thank the two oldies Kjell Andersson and Ingvar Svensson. I thank Kjell for helping me during the field campaign and for his excellent guidance in Nicaragua. I thank Ingvar for his help with the design and assembly of the slug testing equipment. I also thank Peter Jonsson for being my mentor in data acquisition and Per-Gunnar Alm for sharing his expertise in borehole logging. Berit Enstedt Danielsen and Conny Svensson are thanked for being good colleagues and for our interesting conversations during coffee breaks. Cecilia Mildner is thanked for her administrative support. All my current and former colleagues at Engineering Geology are also acknowledged.

Thanks to Oskar Aurell, Skanska Vinci for his cooperation during interesting projects over the years. Fridfinnur Danielsen, Derek Howard-Orchard and Virgil Welch are thanked for sharing their great knowledge of drilling and testing during the deep geothermal project in Lund. I also wish to thank the employees at Lunds Energi AB involved during the same project, especially Peter Ottosson and Bengt-Göran Olsson. Drilling crews, mudloggers and staff from various service companies are also thanked.

Banverket at the Hallandsås Project are thanked for giving permission to test their wells and making the reinjection test possible, with a special thanks to Robert Gass. Martin Ekvy is thanked for assistance during the fieldwork at Hallandsås. Helsingborgs stad is also thanked for permitting testing of wells related to the railway tunnel project. E.ON Värmekraft Sverige AB is also acknowledged, with a special thanks to Fredrik Olsson. Thanks to the Swedish International Development Cooperation Agency (Sida) for financially supporting the field campaigns in Nicaragua. CIGEO/UNAN-Managua is also thanked for logistic support during those field campaigns, with special thanks to Gabriela Murillo, Francis Rivera and Walter Espinoza.

Thanks to Bryan Lougheed and Lucy Elvis for correcting the language in my thesis.

And, most importantly, I thank my beloved Anna for her patience and support during drilling projects, travels and the entire thesis work. My beloved Theo and Elias: you are my sunshine, thanks for sharing your energy and giving me happiness. Anna, Theo and Elias: you are my everything.

Lund 2010-03-22  
Jan-Erik Rosberg





## Abstract

Well testing is widely used today in water wells, oil and gas wells, for geothermal applications, within civil engineering projects, thermal storage and CO<sub>2</sub> storage. The overall testing goal is to verify the productivity from a well and/or for characterization of hydraulic and thermal properties, as well as the spatial limitations of an aquifer. There are three major methods for conducting well testing; slug tests, pumping tests and injection tests. The main objective of this thesis is to compare and evaluate the applicability of the three major well testing methods, using experiences gained by active participation in several well testing operations. Testing of shallow and very deep wells as injection tests using a complete tunnel lining are compared and uniquely presented together in the same work. To compare and evaluate the applicability of the three well testing methods, several conditions which govern the selection of hydraulic testing methods are varied and these include, amongst others, the location, depth and diameter of the well. In addition, technical constraints, such as logistics, water handling and external power supply for conducting the testing are also considered. Certain emphasis is also placed on the use and comparison of pneumatic slug testing with other well testing methods, as pneumatic slug testing often complementary to the more expensive and logistically demanding pumping and injection tests. A small diameter slug test equipment was put together for evaluating the applicability of this method and applied in three different geological environments, namely sedimentary deposits, volcanic deposits and the crystalline basement.

It was found that knowledge of the applicability of slug tests, pumping tests and injection tests is essential for selecting the most appropriate method. Two of the methods, namely pumping tests and injection tests, are logistically demanding while the third one, slug tests, is easy to execute. Consequently, it is therefore also an inexpensive test method, which is supported by the fact that several tests can be conducted in different wells during the same day. Slug testing using pneumatic initiation has also been demonstrated as a good alternative to pumping tests, obtaining similar transmissivity estimates. An advantage of slug testing is that the transmissivity is estimated from a series of slug tests and not from one single test, which is often the case for pumping or injection tests. Slug testing using pneumatic initiation is often associated with testing in small diameter wells, but in this work it has been shown applicable in large diameter wells at least up to 12". A major advantage with pneumatic slug testing compared with the other methods is that it can be used for transmissivity mapping, simplified by the method's easy logistics. It is a useful approach if the wells are distributed over a large area. It is suggested that slug testing using pneumatic initiation should be used as a pre-investigation method for civil engineering projects. Further work needs to be carried out for explaining the observed non-linear characteristics in data obtained from some of the slug tested wells.

It has also been demonstrated that well testing methods are not only restricted to drilled wells. The methods can also be applied inside a tunnel with injection through the tunnel lining. The testing was performed as step injection and constant head/pressure tests and, in conjunction, the response from the testing was measured in observation wells drilled from ground level. Analytical solutions developed for vertical wells could be used to interpret hydraulic properties such as transmissivity, using injection tests performed at tunnel level and the pressure response measured in two of the observation wells. Well development was found to be of great importance for any type of well testing and, for deep wells, a hydrojetting system using coiled tubing and simultaneous pumping was found to be applicable, successful and time efficient.

---

---

**Table of contents**

<b>1. INTRODUCTION .....</b>	<b>1</b>
1.1 OBJECTIVES .....	2
1.2 METHODOLOGY .....	2
1.3 LIMITATIONS .....	3
1.4 ORGANISATION OF THE THESIS .....	3
1.5 DESCRIPTION OF THE PAPERS .....	4
<b>2. SLUG TESTS - METHOD &amp; EQUIPMENT.....</b>	<b>5</b>
2.1 SLUG INITIATION METHODS .....	5
2.2 TEST EQUIPMENT AND SELECTED INITIATION METHOD .....	6
2.2.1 <i>Data acquisition system</i> .....	7
2.2.2 <i>Airtight cable inlet</i> .....	8
2.2.3 <i>Airtight coupling between the equipment and the wellhead</i> .....	8
2.2.4 <i>Compressor or scuba tank</i> .....	8
2.3 THE PERFORMANCE OF SLUG TESTING USING PNEUMATIC INITIATION.....	8
2.3.1 <i>Series of slug tests</i> .....	10
2.3.2 <i>Sampling rate</i> .....	10
2.4 DATA PROCESSING.....	11
2.5 METHODS FOR DATA ANALYSIS .....	12
2.5.1 <i>The Cooper et al. solution (1967)</i> .....	12
2.5.2 <i>The Hvorslev (1951) solution</i> .....	13
2.5.3 <i>The McElwee and Zenner (1998) solution</i> .....	14
2.5.4 <i>Solutions for fractured aquifers</i> .....	15
2.6 AREA OF INVESTIGATION.....	15
<b>3. SLUG TESTS - RESULTS .....</b>	<b>19</b>
3.1 RESULTS: CRYSTALLINE BASEMENT.....	19
3.2 DISCUSSION: CRYSTALLINE BASEMENT.....	25
3.3 RESULTS: SEDIMENTARY DEPOSITS .....	27
3.4 DISCUSSION: SEDIMENTARY DEPOSITS .....	35
3.5 RESULTS AND DISCUSSION: VOLCANIC DEPOSITS .....	35
3.6 OVERALL DISCUSSION FOR SLUG TESTING .....	35
<b>4. PUMPING TESTS.....</b>	<b>39</b>
4.1 TEST EQUIPMENT AND PREPARATIONS BEFORE TESTING .....	39
4.1.1 <i>Submersible pump or compressor</i> .....	40
4.1.2 <i>Measuring and data acquisition system</i> .....	42
4.1.3 <i>Disposal of extracted water</i> .....	43
4.1.4 <i>Observation wells</i> .....	44
4.2 DATA ANALYSIS .....	44
4.3 METHODS FOR DATA ANALYSIS .....	46
4.3.1 <i>Horizontal well analysis</i> .....	46
4.4 RESULTS AND DISCUSSION .....	47
4.4.1 <i>Results from deep well testing</i> .....	48
4.4.2 <i>Test pumping as a pre-investigation method</i> .....	52
<b>5. INJECTION TESTS .....</b>	<b>55</b>
5.1 TEST EQUIPMENT AND PREPARATIONS BEFORE TESTING .....	55
5.2 DATA ANALYSIS .....	56
5.3 RESULTS AND DISCUSSION.....	57
<b>6. WELL DEVELOPMENT.....</b>	<b>61</b>
6.1 WELL INTEGRITY .....	63
<b>7. DISCUSSION.....</b>	<b>65</b>
<b>8. GENERAL CONCLUSIONS .....</b>	<b>69</b>
<b>9. RECOMMENDATIONS AND FUTURE WORK .....</b>	<b>71</b>

Table of contents

---

<b>10. REFERENCES .....</b>	<b>73</b>
<b>APPENDIX 1: Air volume calculations</b>	
<b>APPENDIX 2: Slug test and pumping test interpretation</b>	
<b>APPENDIX 3: Turbulent flow</b>	
<b>APPENDIX 4: Pumping test solutions</b>	
<b>APPENDIX 5: Pumping test equations</b>	

## List of papers

- Paper 1 Rosberg J-E. (2010). Pneumatic slug testing in large-diameter wells, Accepted for publication in Hydrogeology Journal
- Paper 2 Rosberg J-E. (2006). Flow test of a perforated deep dual cased well, Proceedings, Thirty-First workshop on geothermal reservoir engineering Stanford University, SGP-TR-179: 123-130
- Paper 3 Rosberg J-E. and O. Aurell (2010). Re-injection of groundwater by pressurizing a segmental tunnel lining with permeable backfill, Tunnelling and Underground Space Technology vol. 25: 129-138
- Paper 4 Rosberg J-E. and L. Bjelm (2009). Well development by jetting using coiled tubing and simultaneous pumping, Ground Water, vol.47, no. 6: 816-821

## Related papers and reports

Rosberg J-E. (2010). An effective well development method for deep screen completed wells, Proceedings World Geothermal Congress, Bali, Indonesia

Bjelm, L. and J-E. Rosberg, 2009. *Test of Carbon dioxide storage in saline aquifers in Malmö*, R&D report, Engineering Geology, LTH, Lund University

Rosberg J-E. (2007). *Testing, well development and evaluation of deep wells completed in Lund 2002-2005*, Licentiate Thesis, ISBN 978-91-976848-0-4, Engineering Geology, Lund University

Bjelm L. and J-E. Rosberg (2006). Recent geothermal exploration for deep seated sources in Sweden, Transactions GRC, vol.30: 655-658

Jonsson P. and J-E. Rosberg (2006). Low-cost, flexible data acquisition system based on commercial off-the-shelf hardware, open source software and radio modem communication, Proceedings, Thirty-First workshop on geothermal reservoir engineering Stanford University, SGP-TR-179: 164-170

---

## 1. Introduction

Well testing today is widely used and there are several methods at hand. However, the purpose of the testing can be quite different since it is applied in a wide range of applications. Well testing is generally applied in water wells, oil and gas wells, for geothermal applications, within civil engineering projects, thermal storage and CO<sub>2</sub> storage. The overall goal is to verify the productivity of a well and/or for the characterization of the hydraulic and thermal properties and the spatial limitations of an aquifer. The well tests can be divided into two different categories, one related to shallow groundwater aquifers and the other to deeper reservoirs. The first is commonly used for groundwater applications and the second is more common for geothermal, oil and gas applications. In practice, the approaches are quite similar, but it can still be difficult to compare them. One explanation can be that groundwater literature uses another technical terminology than the oilfield, using its own units.

The use of well testing in groundwater exploration and exploitation is fundamental. In many areas worldwide, the major fresh water supply is from groundwater. Therefore, in order to avoid overexploitation of aquifers, information obtained from well testing is of major importance. Input data for water budget calculations for the evaluation of possible extraction and future impacts is one such type of information. In addition, well testing is also important for a single user to evaluate the productivity of the well including, for example, the possible influence on or from wells in the vicinity. Well testing is also important in civil engineering projects, such as tunnelling, shafts or other projects involving lowered groundwater, for evaluating the impact of the lowered groundwater. This information can be invaluable for the progress of an entire project in avoiding unwanted delays, damage and environmental conflicts.

In groundwater remediation, well test information is also important for designing an appropriate remediation program and system. However, if contaminated groundwater conditions are present, the selection of a well testing method can depend on environmental restrictions. One such example regards the extraction or injection of water. In that case, it is important to design the well test without handling water, while still having the possibility to get information.

Well testing is also a basic tool in the oil and gas and geothermal industries for evaluating the resources and its productivity. These industries, especially oil and gas, have more money to spend on testing in general, since the fluid produced has a very high value. As a consequence, most of the developments in well tests in deep wells and interpretation of the obtained results nowadays often originate from the oil and gas industry. For geothermal applications, well tests are fundamental for evaluating the amount of energy that can be produced from a specific reservoir, either as heat or as electricity.

Another topical application of well testing related to the oil and gas industry is CO<sub>2</sub>-storage, often expressed as CCS (carbon capture and storage see e.g. IPCC, 2005). It is notable that the technique has been used since the beginning of the 1970s in the oil and gas industry. At that time the technique was referred to as enhanced oil recovery (Haigh, 2009). In CO<sub>2</sub> storage, the information obtained from well testing is used for evaluating the quantity that can be injected into a reservoir and for evaluating whether or not the reservoir is bounded by tight boundaries preventing leakage of CO<sub>2</sub>. Another, rather new concept in well test application, also related to the oil and gas industry, is the extraction of natural gas from shale beds in both old and young sedimentary basins (e.g. Bredehoeft, 2009).



The three major methods for conducting well testing are slug tests, pumping tests and injection tests. The purpose of the well testing will determine which method is appropriate to use. In addition, the method must be applicable both to the well construction and the testing environment. The requirements, logistics and expenses are quite different depending on which well testing method is selected. Therefore, it is of great importance to know the limitations and requirements, as well as which information can be obtained from each method.

There is often a need to have a complementary method to the more logistically demanding and expensive, conventional test pumping methods. In many situations, slug testing can be this method. A consequence of using an expensive and logistically demanding method is that even if many monitoring wells exist, usually only a few of them can be hydraulically tested, due to economic and practical constraints. In other words, hydraulic information that could easily be acquired using slug testing is often ignored. In this thesis, slug testing using pneumatic initiation is evaluated and compared with other methods. This method is of particular interest from a Swedish perspective, since geotechnical and environmental field books (SGF, 1996, 2004) only recommend slug initiation by the removal or addition of water. The use of pneumatic initiation in Sweden has so far only been found in a work by Jansson and Sjölander (1987).

Between 2002 and 2009 I had the opportunity to take part in a number major projects related to geothermal exploration, CO<sub>2</sub> storage in deep wells, as well as test pumping campaigns for civil engineering purposes and groundwater exploration. I also took part in a project involving a full scale injection test of a whole 300 m long TBM railway tunnel segment. The logistical and economic resource sets available in such commercial projects are of an economic magnitude that is very seldom available in a doctoral thesis task. It is perhaps even more uncommon that one person alone has the opportunity to take part in, evaluate and compare an arsenal of testing methods for such diverse applications. Due to the fact that such large scale operations are so logistically demanding and expensive, an attempt has also been made to further promote the low-cost and logistically simpler slug testing method, in this case using pneumatic initiation as a comparison.

### **1.1 Objectives**

The main objective is to compare and evaluate the applicability of three well testing methods, namely slug tests, pumping tests and injection tests, using experiences obtained from a large number of diverse well testing operations. Uniquely, shallow and deep well testing, as well as an injection test carried out using a complete tunnel lining, will be compared and evaluated in the same work. The knowledge from the operations shall also be used for investigating the importance of well development, as well as the additional information that can be obtained from the different well testing methods.

A certain emphasis is devoted to the use and comparison of pneumatic slug testing with other well testing methods, since pneumatic slug testing is often a complement to the more expensive and logistically demanding pumping and injection tests.

### **1.2 Methodology**

To compare and evaluate the applicability of the three well testing methods, several conditions which govern the selection of hydraulic testing methods are varied. These include location, depth and diameter of the well. In addition, technical constraints, such as logistics, water handling and external power supply for conducting the testing, are also considered. The

applicability of the methods is demonstrated via examples from deep well testing as well as from shallow well testing. In addition, examples regarding test equipment and test interpretation are also presented. These are necessary for understanding the limitations and requirements for a well testing method. Additional information obtained from the test data is also emphasised, such as well development needs and the influence of wellbore storage or fractures. In other words, the applicability of the well testing methods is considered from a practical as well as a theoretical perspective. The applicability of an uncommon well testing method, an injection test carried out using a complete tunnel-lining instead of wells, is also presented and evaluated. In this case, the tunnel is considered as a large horizontal well. The test responses measured inside the tunnel, as well as in observation wells drilled from ground level, are used for evaluation.

Small diameter slug test equipment has been put together for evaluating the applicability of slug testing using pneumatic initiation. The method is applied in three different geological environments: sedimentary deposits, volcanic deposits and the crystalline basement. In addition, its applicability is evaluated for large diameter wells, it being a different approach as this method is normally used for small diameter wells. In a couple of cases, the results obtained from the slug testing are compared with data obtained from pumping tests for validating estimates such as transmissivity.

The importance of well development and its impact on the test result are demonstrated with examples from both pumping tests as well as slug tests. In addition, jetting using coiled tubing and simultaneous pumping (suitable for deep wells) is described and evaluated.

### **1.3 Limitations**

One type of well test is to monitor the natural water level fluctuations for a long period, revealing information regarding the aquifer. However, this type of test is not considered in this thesis. The presented injection tests are performed in an open hole and no dual-packer solution has been used during the testing. Therefore, a description of the theory and performance of injection tests using a dual-packer solution is omitted. The slug tests have been performed as rising head tests, meaning that no falling head tests have been performed. It is therefore difficult to evaluate directional dependence during the testing. In general, investments and actual costs for both the testing and the equipment used are omitted.

### **1.4 Organisation of the thesis**

The well testing methods used in this thesis, namely slug tests, pumping tests and injection tests are described in Chapter 2-5. Information about how the testing is carried out and what to measure, as well as solutions used for interpreting the test results, is presented in these chapters. The slug testing is described in Chapters 2 and 3. In Chapter 2, the method and the equipment are described and, in Chapter 3, the results and discussion from the slug testing are included. In general, the description of slug testing is more detailed since a certain emphasis in this thesis is devoted to slug testing using pneumatic initiation. Chapter 2 and 3 supports Paper 1 and Chapter 4 and 5 supports Papers 2 and 3. In Chapter 6, the importance of well development and its influence on the test results are described and is support for Paper 4. In addition, information about the well integrity is also found in Chapter 6. Discussion about the applicability of the different well testing methods is found in Chapter 7. The general conclusions are presented in Chapter 8. Chapter 9 includes recommendations and future work, where a major part is related to the slug test method using pneumatic initiation.

## **1.5 Description of the papers**

### **Paper 1: Pneumatic slug testing in large diameter wells**

The main focus in this paper is on the applicability of small diameter slug test equipment using pneumatic initiation in large diameter wells of up to 12". These are wells with 36 times greater cross-sectional area than the slug test equipment. Due to the diameter difference, it will take a long time for casing depressurization after slug initiation. This time was measured and is presented as a part of the result from the slug testing. The wells with the largest diameter were completed in volcanic clastic deposits. The transmissivity estimates from the slug testing are compared with estimates from pumping tests. Different airtight couplings between the slug test equipment and the casing are also included in this paper.

### **Paper 2: Flow test of a perforated dual cased well**

The main focus in this paper is on deep well testing performed as injection tests and pumping tests. In addition, issues regarding disposal of extracted fluid are also considered, since these directly affected the test time. The testing was initially carried out in an open-hole section in a crystalline basement at a depth greater than 3000 m, and later in sedimentary deposits located at a depth between 1400 m and 1850 m. The production zones in the sedimentary deposits were cased with dual casing and were reopened by using perforation. In the paper, transmissivity estimates from the flow test are compared with estimates from the recovery data.

### **Paper 3: Re-injection of groundwater by pressurizing a segmental tunnel lining with permeable backfill**

In the paper, the applicability of well testing is investigated for a different environment than commonly used. Instead of injection performed by using a well, the injection will be carried out through a tunnel lining. In other words, water is injected through a watertight lining into a section where ungrouted pea gravel was used as backfill. Exactly the same test types and test interpretation methods as for wells will be used and evaluated for the different test environments. In addition, the tunnel is regarded as a horizontal well and a solution developed for horizontal wells is also applied for evaluating the test result. The pressure response was measured both at tunnel level and in observation wells drilled from ground level.

### **Paper 4: Well development by jetting using coiled tubing and simultaneous pumping**

The paper focuses on the importance of well development and a method that is suitable for deep wells is described, namely jetting using coiled tubing and simultaneous pumping. The influence of well development on well test results is considered by comparing well tests before and after well development. In addition, downhole measurements using an impeller flow meter were used for verifying the well improvements.

## 2. Slug tests - Method & Equipment

Slug tests have been used extensively since the beginning of the 1950s to measure hydraulic conductivity. Pioneers included: Hvorslev (1951), Ferris and Knowles (1954) and Skibitzke (1958) (see also Ferris et al., 1962). Hvorslev derived a formula for estimating hydraulic conductivity. Ferris and Knowles (1954) and Skibitzke (1958), derived a formula for transmissibility (nowadays transmissivity) estimation when injecting or bailing out a known volume of water. Cooper et al. (1967) presented a type curve solution for transmissibility estimation and Ramey et al. (1975) incorporated the effects of well skins. Krauss (1974) and van der Kamp (1976) presented solutions for oscillating response or an underdamped response. This was also a new approach since previous solutions were developed for overdamped solutions. Bouwer and Rice (1976) presented a solution for estimating hydraulic conductivity in an unconfined aquifer with a completely or partially penetrating well. This represented a new approach, since previous solutions were developed for completely penetrating wells in confined aquifers. Later, Barker and Black (1983) presented a solution for slug tests conducted in fissured (fractured) aquifers. McElwee and Zenner (1998) presented a non-linear model for slug test responses and showed its applicability on acquired data. Several other solutions have been developed since the start of slug testing; the above was just a selection of some milestones within the history of slug testing.

The popularity of using slug tests has increased since the 1980s (Todd and Mays, 2005). The mechanics behind a slug test are simple. There is a sudden change in head and the return to a static condition is measured. Thereafter, the deviations of head from static conditions are analyzed. A synonym to the slug test is the well response test, but it is not so commonly used in the literature. The well known drill stem test (e.g. Matthews and Russel, 1967; Earlougher, 1977), commonly used by the petroleum industry, is also a type of slug test. A method often applied in deep wells uses initial displacements on the orders of hundreds to thousands of meters of water (Butler, 1998), but, in e.g.: Marinelli and Rowe (1985), the applicability in small diameter boreholes used for groundwater investigations is described. A comparison of conventional slug testing with drill stem testing can be found in e.g. Karasaki (1990). There are two types of slug tests, falling head test and rising head test. During the falling head test there is a sudden rise of the head followed by an outflow from the well. This type of test can also be found in the literature as a slug, slug-in and injection test (Butler, 1998). During the rising head test there is a sudden drop in the head followed by an inflow into the well. Bail-down, bailer, slug-out and withdrawal test are other names for this type of test.

### 2.1 Slug initiation methods

There are several methods for slug initiation, with or without the handling of water. Bailing out, or injecting a known volume of water, are all methods where water is handled that have been used since the start of slug testing (for examples see Ferris et al., 1962). The main disadvantage is that water needs to be handled, which, for example, can be hard to arrange in large diameter wells where large volumes are needed for slug initiation and/or there are great distances to the water table (especially for bailing). It can also be hard to conduct a series of slug tests using different initial displacements (volumes). Health concerns can also be an issue when treating and disposing of water that is contaminated. Furthermore, it can be difficult to preserve the in situ water chemistry when adding water (Shapiro and Greene, 1995).

Another initiation method commonly used is the solid slug method (e.g. Butler, 1998). It is easily manufactured by filling a steel pipe or PVC pipe with sand, with a cap at both ends. A hook with rope is attached to one of the caps and then the solid slug can be introduced into or

## 2. Slug tests - Method & Equipment

---

removed from the well. The advantage of this method is that it is easy to construct and no water needs to be handled. One disadvantage is that it is hard to apply in permeable formations. There is also a risk that the solid slug can either become entangled with or damage the transducer cable. In addition, it is hard to conduct a series of slug tests with different initial displacements and it is hard to apply in wells with a short water column or a long distance to the water table. Butler (1998) also describes problems with noisy early-time data and notes that the solid slug can serve as a vehicle for cross-hole contamination.

The slug initiation method can also be packer based and this test is initiated by either deflating the packer or by opening the flow-through tube of the packer. Patterson and Devlin (1985) described the applicability of deflating a packer for slug initiation. The same principle was later used by Priddle (1989). The principle is that the packer is lowered into the well and inflated. Thereafter, water is added or removed to the well above the packer and finally the slug is initiated by deflating the packer. An alternative to deflating the packer is to open the flow-through tube of the packer (for an example, see Zemansky and McElwee (2005)). It is done by removing a piston plugging off the flow-through tube of the packer, and a similar procedure to the one described above is used. It is common that the application of these methods is described for small diameter wells/piezometers. A major disadvantage with these two packer-based initiation methods is that the water needs to be handled, while a rig may also be needed for installing the packer in large diameter wells. Other disadvantages are that the packer must be cleaned prior to usage in another well and that the flow-through tube of the packer can restrict the flow. In addition, it is also an expensive option (Butler, 1998). Major advantages, according to Butler (1998), are that the slug can be initiated relatively rapidly and a good estimation of the expected initial displacement can be obtained.

Slug testing using pneumatic initiation has been described by many authors e.g.: Prosser (1981), Leap (1984) and Butler (1998) (see also references in Paper1). Compressed air or nitrogen is used to pressurize the air column in a sealed well. The water level will start to decrease since water is pushed out of the well, which will continue until the decrease in water level equals the increased pressure head in the air column. Thereafter, the test is initiated by opening a valve and the air column is depressurized. A more detailed explanation and description will be presented in Chapter 2.3. Major advantages with the method include the fact that no water needs to be handled and the rapid slug initiation. In addition, only the transducer is in contact with the water and therefore this is the only part of the test setup that needs to be cleaned prior to installation in a new well. Another disadvantage is that the pressurization of the air column must occur inside the cased section to avoid air entering the formation. In addition, an airtight coupling between the casing and the equipment is needed, such as an airtight seal around the transducer cable.

### **2.2 Test equipment and selected initiation method**

Pneumatic initiation is the method used during the slug tests described in this thesis. The method was chosen because no water needs to be handled. For example, some of the tested wells are located in remote areas and have large casing diameters and volumes. Therefore, from a practical point of view, slug initiations whereby water needs to be added or removed have been excluded as alternatives. An important design criterion for the equipment is that it should be easy to handle and easy to rig up by one person. In other words, low weight is needed and consequently, restriction of the equipment diameter is necessary.

The equipment is made of steel and the dimension of the pipe and the release valve is 2" (51 mm), see Figure 1. The dimension of 2" was chosen to fulfil the requirement of having a set

of equipment that could be handled by a single person. For example the 2" steel ball valve has a weight of 3.6 kg and the same type of valve for 3" (76 mm) is 11.6 kg. A way around this, of course, is to use plastic instead of steel. Since this was a prototype, steel was chosen as it is not only cheaper but also easier to repair if damaged. The 2" pipe was equipped with one fitting for connection to a scuba tank or a compressor, and one fitting for connection to a digital manometer. At the top of the equipment there is an airtight inlet for the communication cable and, at the bottom, a 2" threaded pin connection for the airtight coupling between the casing and the slug test equipment.

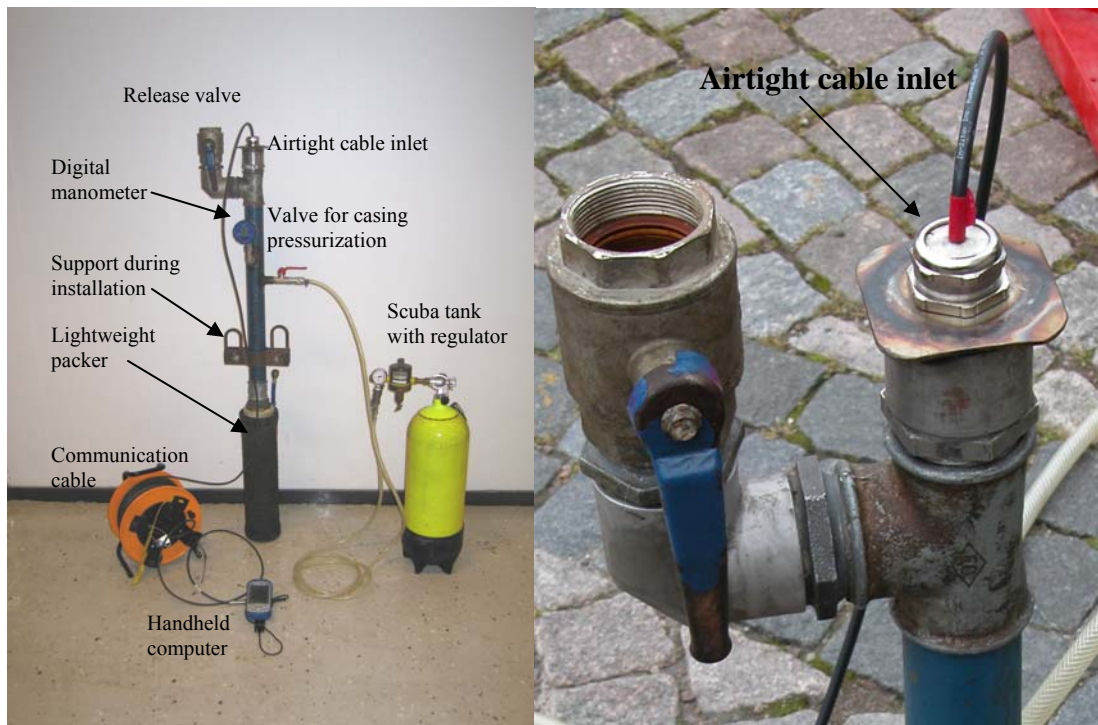

Figure 1. Left: Slug test equipment using pneumatic initiation. Right: The airtight cable inlet.

### 2.2.1 Data acquisition system

Two pressure gauges were used in conjunction with the slug test equipment. A digital manometer with a record function was used for measuring the air pressure inside the casing during the pressurization phase. The other is a vented memory gauge, which is connected to a handheld computer through a communication cable. This was used for data acquisition. This solution is used to avoid external power supplies and have real time data visualization from the submerged sensor, which is of great importance during the testing (see Chapter 2.3). A short specification of the used pressure gauges can be found in Table 1. Included in the table is also a gauge used if there is an observation well in the vicinity of the test well.

Table 1. Short specification of pressure gauges used during slug testing.

Name	Pressure range	Accuracy	Resolution	Fastest sampling rate
LevelTroll700 (Memory gauge)	0-70 m (vented)	35 mm (at 15°C)	> 3.5 mm	4 per second
Leo record (Digital manometer)	0-4 bar (~0-40 m) (absolute)	0.004 bar (~40 mm)	0.001 bar (~10 mm)	1 per second
LevelTroll500 Memory gauge in observation well	0-60.1 m (absolute)	30 mm (at 15°C)	> 3.0 mm	2 per second

## 2. Slug tests - Method & Equipment

---

### 2.2.2 Airtight cable inlet

The inlet for the communication cable must be airtight in order to be able to pressurize the well. A sealing device around the cable had to be manufactured, since it is not an off-the-shelf product. The cable inlet is made by using a cable gland and the PVC sealing insert is divided into two halves adjusted for the cable. The airtight cable inlet can be seen in Figure 1. The size of the cable gland is restricted by the diameter of the submersible pressure gauge, and the hole in the PVC sealing insert is controlled by the cable diameter. Practical advice is to put some grease between the two halves of the PVC sealing insert to improve the sealing capacity.

### 2.2.3 Airtight coupling between the equipment and the wellhead

Another vital part when using pneumatic initiation is the airtight coupling between the slug test equipment and the wellhead. Different airtight couplings are described in Paper 1.

### 2.2.4 Compressor or scuba tank

One practical aspect when conducting a slug test with pneumatic initiation is whether a compressor or a scuba tank should be used for pressurizing the well. It is preferable to bring a scuba tank since it is smaller and easier to handle compared with a compressor. However, an advantage with using a compressor is that there is no restriction regarding available air volume, as is the case for scuba tanks. In Appendix 1, equations are presented for estimating the required air volume during testing. A simple approach, based on Boyle's law, is used to derive the equations. The required air volume during pressurization is dependent upon e.g.: casing size, distance to the static water table from top casing and the initial displacement that will be used for testing.

## 2.3 The performance of slug testing using pneumatic initiation

Before testing, it is important to synchronize the two pressure sensors. After that it is important to install the submerged pressure gauge at an appropriate depth. Therefore, it is important before the testing to determine the maximum initial displacement to be used, avoiding allowing the water level to pass the installation depth of the pressure gauge during the casing pressurization. In high conductivity formations, the installation depth is more important. According to McElwee (2001), the pressure readings have to be corrected if there are significant accelerations and velocities of the water column. To avoid these corrections Butler et al. (2003) suggested that the pressure gauge should be installed as close as possible to the static water level, but including room for the maximum displacement. For all testing, the pressure gauge should generally not be installed at the bottom of a well. This is due to an existing sump containing fines or settling of fines during testing, which can clog the sensor. One piece of advice is to measure the water level in the well both before and after testing using a level tape, for example. This gives additional measurements using an independent method, hereby checking the quality of the measurements from the pressure gauge. In addition, it is recommended to install the pressure gauge at least 10 minutes before testing commences, allowing the sensor to thermally equalize and giving time for the cable to stretch.

The performance of a slug test using pneumatic initiation can be divided into steps A to C. These three steps are visualized in Figure 2. The response during the different steps from the two pressure sensors, a manometer and a submerged pressure gauge are presented in Figure 3. The manometer is placed at wellhead and the submerged pressure gauge is installed at a depth greater than the maximum predetermined initial displacement.

**Step A:** Pre-test conditions and the static conditions are measured, see Figure 2. The manometer measures atmospheric pressure, with an absolute sensor or a relative pressure of

zero if it is a vented sensor (see Figure 3). The submerged pressure sensor measures the water column above the sensor at static conditions.

**Step B:** The casing pressurization is started and the water level will begin to decrease since water is flowing out of the well. This will continue until the decrease in water level equals the increased pressure head in the air column (see Figure 2). The manometer measures the pressure increase in the air column during the pressurization (see Figure 3). The pressure measured by the submerged sensor shall, during ideal conditions, be the same as during Step A. However, a pressure increase can occur due to a slowness effect, meaning that the change in the air pressure occurs faster than the water can flow out of the well.

**Step C:** The casing depressurization phase. The test is initiated by opening the release valve and the air column is depressurized. Following an inflow of water, the rising head test is started (see Figure 2). The head will continue increasing until the water level is stabilized at the initial static conditions. The manometer pressure will drop to zero or to the atmospheric pressure, depending on the sensor type, when the slug is initiated (see Figure 3). The submerged sensor will measure the increase in head with time until initial static conditions are reached.

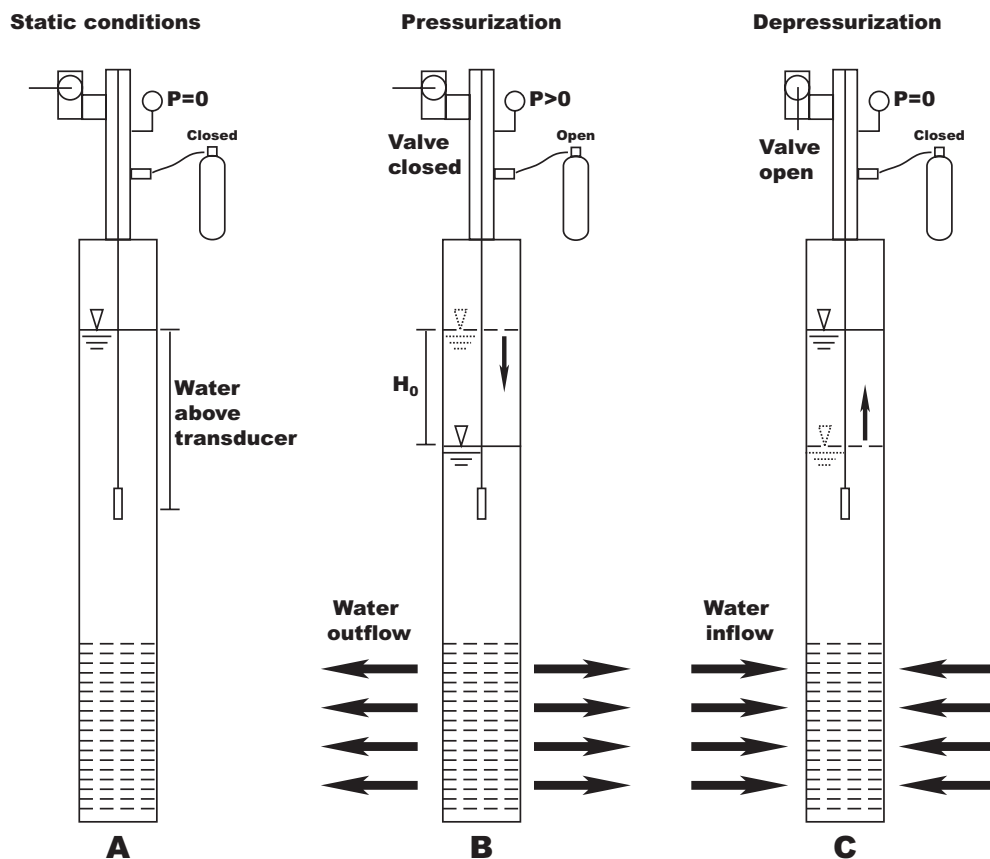
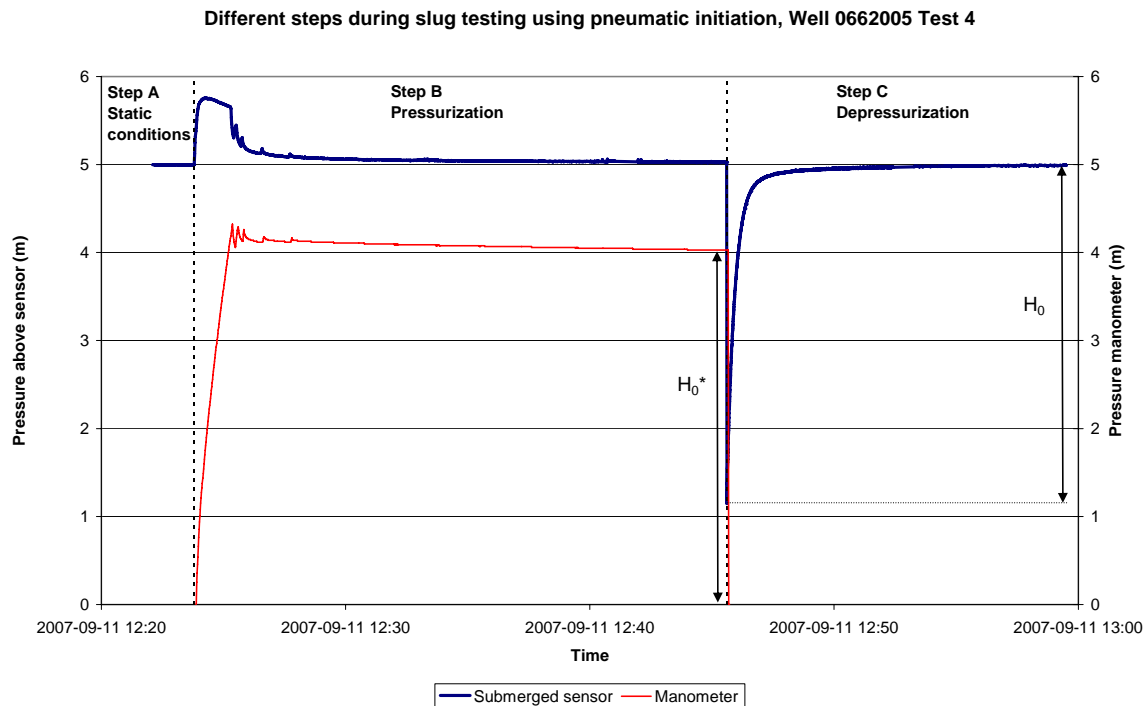

Figure 2. Different steps occurring during slug testing using pneumatic initiation.

In Figure 3, the expected initial displacement ( $H_0^*$ ), measured by the manometer and the initial displacement ( $H_0$ ), measured by the submerged pressure gauge are visualized, showing values that should theoretically be identical. However, if there is a difference between the values, plausible explanations can include non-instantaneous slug initiation, a sampling rate that is too slow, or pressure readings that have to be corrected given significant accelerations and velocities of the water column. According to Butler (1997), in practice, a normalized difference between the expected initial displacement and the actual initial displacement measured in the well being greater than 10% should be of a concern.





**Figure 3.** The response from the manometer and the submerged pressure sensor during slug testing using pneumatic initiation.

### 2.3.1 Series of slug tests

Three or more slug tests should be performed using two or more different initial displacements (Butler et al., 1996). According to conventional theory (e.g. Cooper et al., 1967), measurements from repeat slug tests in the same well should coincide when plotted in a normalized format. It is also important to start and complete the slug testing using the same initial displacement, in order to verify the reproducibility of the testing. A series of slug tests can reveal information about things such as skin effects, non-Darcian flow losses and whether the well is either clogging or hydraulically improved during the testing.

One important design criterion is that the maximum displacement doesn't pass the top of the screen or the top of the open hole. In other words, that air does not enter the formation, which can cause gas clogging of the formation. Therefore, well configuration parameters, such as information about the location of the screen or the open hole, are necessary to consider before testing. One indication of air entering the formation or a leakage in the casing can be a sudden and evident drop in pressure inside the air column.

### 2.3.2 Sampling rate

The sampling rate required during slug testing is dependent on the formation response. A high conductivity formation will respond more rapidly than a low conductivity formation (see Figure 4). The time is calculated using the Cooper et al. (1967) solution and the assumptions are included in the figure. The fastest sampling rate of memory gauges, using a communication cable for real time data display, is today four times per second and the second fastest is two times per second, and so forth. One recommendation is to use the fastest sampling rate during the first test, as the formation response is often unknown. After an evaluation of the first test, a lower sampling rate can be chosen. However, the memory capacity of the memory gauges nowadays does not limit the sampling rate. On the other hand, too many data points can affect the time taken in processing the data. In cases of high

conductivity formations, a sampling rate higher than four per second might be needed. In such cases, a transducer, with 4-20 mA output signals and a data-logger can be used.

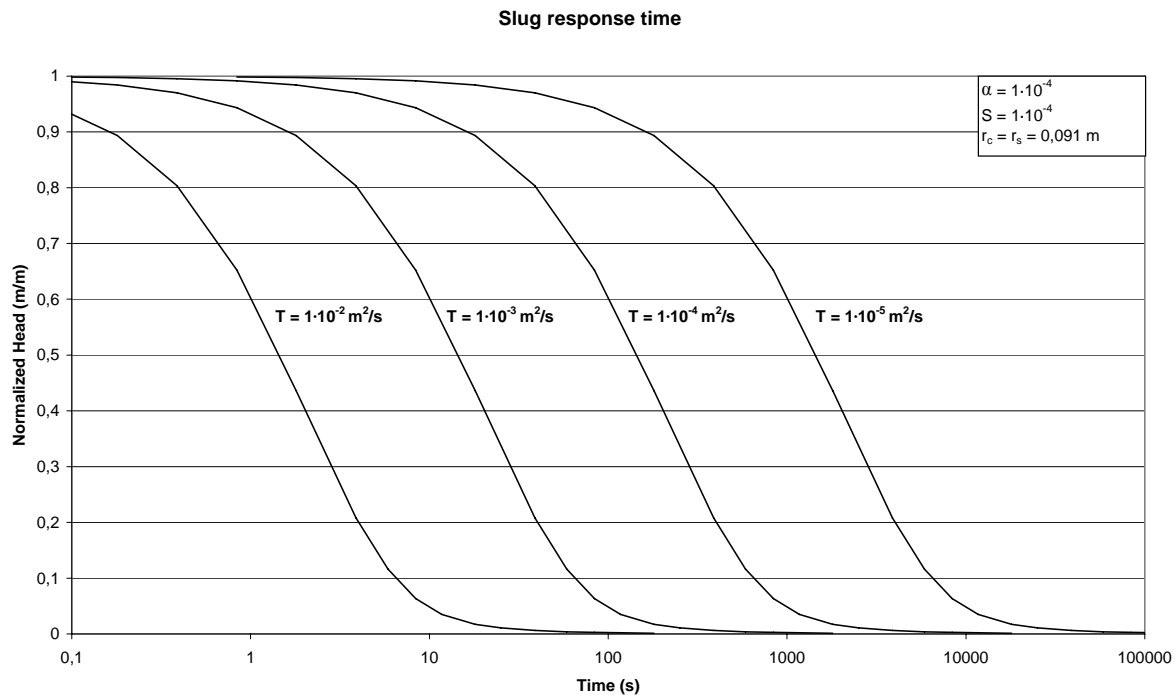

**Figure 4. Response time for different transmissivity values, calculated using the Cooper et al. (1967) solution.**

## 2.4 Data processing

The processing of the acquired data can be divided into four steps (see Figure 5). The first step is a raw data plot from the submerged pressure gauge. The time for the test starts when the slug is initiated. If the slug is initiated instantaneously then the start time for Case A and B will be the same (see Figure 5), as will  $H_0$  and  $H_0^*$ . In the case of a non-instantaneous initiation, the start for Case A will be earlier than for Case B and  $H_0^*$  will be greater than  $H_0$ . If Case A is selected for the data processing, deviation in head is calculated from the time of test initiation and are thereafter normalized using the expected initial displacement  $H_0^*$ .

Case B is the selected method for the data processing in this thesis and is presented in all the steps in Figure 5. This method, the translation method, has been described by Pandit and Miner (1986). The starting time is set to the time where the maximum displacement occurs, marked as the start of test Case B in Figure 5. The deviations in head from static conditions are thereafter normalized using the maximum displacement recorded by the submerged diver. In the last step, a series of slug tests are presented in the same graph. Butler (1998) recommends the translation method in cases of non-instantaneous initiation and has found the method superior to other alternatives. However, drawbacks include, for example, that the method can limit the effectiveness of screening analyses to detect presence of well skins (see Butler, 1998).

## 2. Slug tests - Method & Equipment

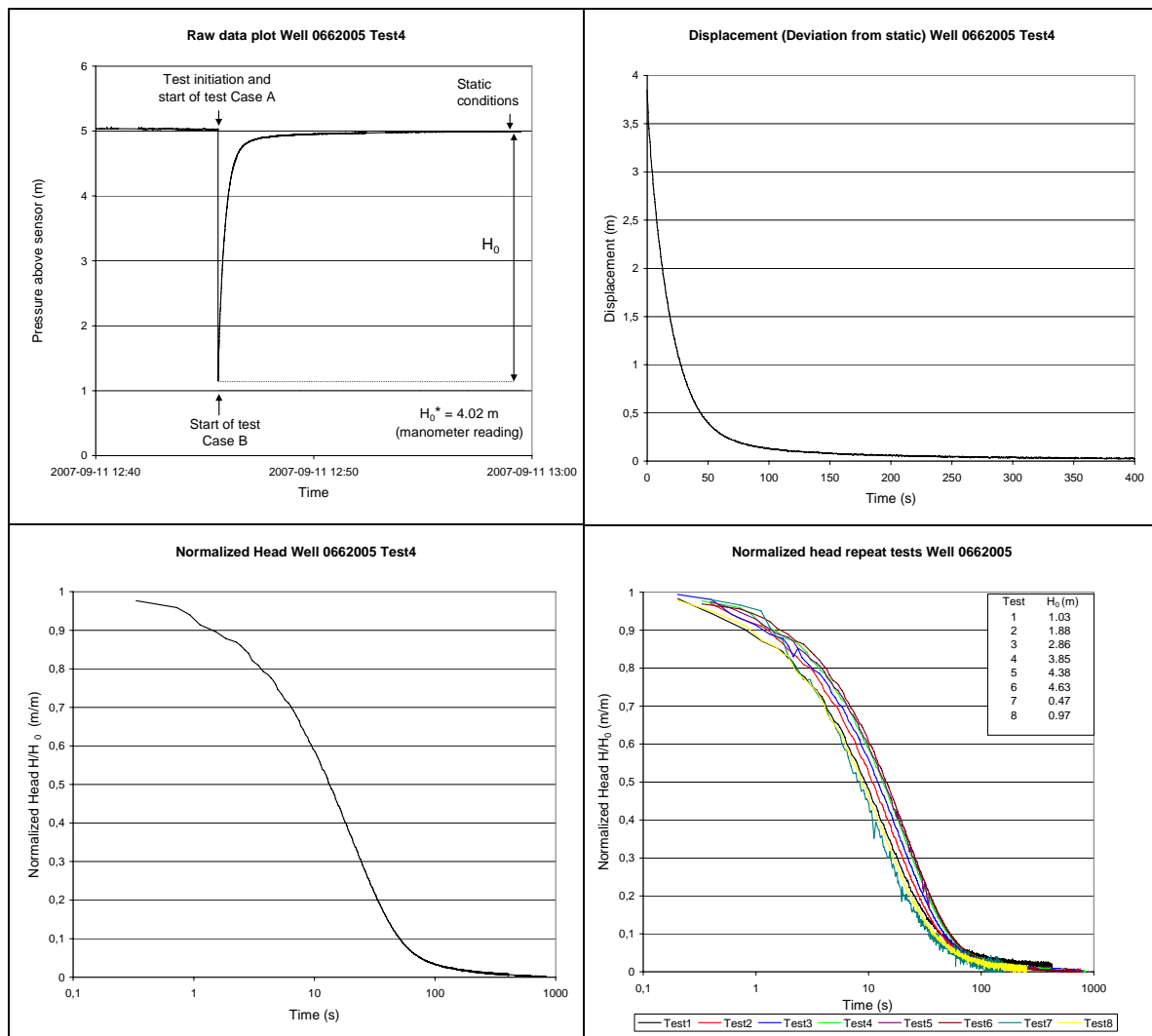

Figure 5. Four steps in data processing. (Note that in the displacement graph only half of the test time is visualized.)

### 2.5 Methods for data analysis

Today there are several solutions for analysing results from slug tests and many of the solutions are implemented in the most common aquifer testing software. The program used for analysing the slug test data presented in this thesis is *Aqtesolv Pro 4.5*, which includes 18 different slug test solutions. The slug test solutions that will be described in this section are the ones that have been used most frequently during the analysis process; Cooper et al. (1967), Hvorslev (1951) and McElwee and Zenner (1998). These solutions were developed for a homogeneous and confined aquifer of infinite areal extent. However, different approaches are used for data analysis and can include a combination of type curve solutions, straight line solutions, linear or non-linear solutions. Barker and Black (1983) developed a solution using a double porosity approach which is also used in this thesis. However, the reader is referred to the original paper for a detailed description.

#### 2.5.1 The Cooper et al. solution (1967)

A type curve solution was presented by Cooper et al. (1967) and updated by Papadopoulos et al. (1973). The solution was derived for a fully penetrating well and an aquifer of uniform thickness. The following equations are used to describe a sudden withdrawal or injection of water, a slug, mathematically:

$$\frac{\partial^2 h}{\partial r^2} + \frac{1}{r} \left( \frac{\partial h}{\partial r} \right) = \frac{S}{T} \frac{\partial h}{\partial t} \quad (r > r_s) \quad \text{(Equation 2.1)}$$

$$h(r_s, t) = H(t) \quad (t > 0) \quad \text{(Equation 2.2)}$$

$$h(\infty, t) = 0 \quad (t > 0) \quad \text{(Equation 2.3)}$$

$$2\pi r_s T \frac{\partial h(r_s, t)}{\partial r} = \pi r_c^2 \frac{\partial H(t)}{\partial t} \quad (t > 0) \quad \text{(Equation 2.4)}$$

$$h(r, 0) = 0 \quad (r > r_s) \quad \text{(Equation 2.5)}$$

$$H(0) = H_0 = \frac{V}{\pi r_c^2} \quad \text{(Equation 2.6)}$$

where  $h$  = deviation of head in the formation from static conditions (m)  
 $t$  = time (s)  $T$  = transmissivity (m<sup>2</sup>/s)  $S$  = storativity (-)  
 $r$  = radial distance (m)  $H$  = deviation in head in the well from static conditions (m)  
 $H_0$  = initial displacement (m)  $r_s$  = effective radius of the screen (m)  
 $r_c$  = effective casing radius (m)  $V$  = volume of added or removed water (m<sup>3</sup>)

Equation 2.1 is the partial differential equation, the diffusion equation, describing non-steady radial flow in a confined aquifer (e.g. Fetter, 2001; Todd and Mays, 2005). Equation 2.2 states that the head in the well is equal to the head at the interface, between the well and the aquifer. In Equation 2.3 it can be seen that as the radial distance approaches infinity, the deviation of head will be zero. Equation 2.4 describes that the rate of inflow or outflow from the aquifer equals the rate of change of the volume of water within the well. Equation 2.5 states that the deviation of head in the aquifer is initially zero. Equation 2.6 states that the slug is initiated instantaneously.

The solution to the mathematical model, Equation 2.1-2.6, is presented in Equation 2.7:

$$\frac{H(t)}{H_0} = F(\beta, \alpha) \quad \text{(Equation 2.7)}$$

$$\beta = \frac{Tt}{r_c^2} \quad \text{(Equation 2.8)}$$

$$\alpha = \frac{r_s^2 S}{r_c^2} \quad \text{(Equation 2.9)}$$

This solution can be expressed as a series of type curves if the normalized head is plotted against the logarithm of  $\beta$ , as in Equation 2.8, and each type curve corresponds to an  $\alpha$ , as in Equation 2.9. The acquired test data are plotted as normalized head versus time and thereafter matched with the type curves, which results in values of transmissivity and storativity. Data requirements for using the Cooper et al. (1967) solution are: normalized head data versus time, effective casing and screen radius, as well as aquifer thickness to express transmissivity as hydraulic conductivity.

### 2.5.2 The Hvorslev (1951) solution

A straight line solution was presented by Hvorslev (1951). The solution was based on a mathematical model, which differs in three aspects from the model described by Cooper et al. (1967) (Equation 2.1-2.6). The first difference is that the right hand side of Equation 2.1 is zero, due to the fact that the storativity is assumed to be negligible. The second is that the slug doesn't need to be introduced instantaneously. Therefore, Equation 2.6 is not used. Finally, Equation 2.3 is changed to a finite instead of an infinite distance. The solution to the mathematical model is presented in Equation 2.10. Equation 2.10 has to be modified if the

## 2. Slug tests - Method & Equipment

---

well screen is in contact with an impermeable boundary, which is done by replacing  $2r_s$  with  $r_s$ :

$$\ln\left(\frac{H(t)}{H_0}\right) = -\frac{2KBt}{r_c^2 \ln\left(\frac{mL}{2r_s} + \sqrt{1 + \left(\frac{mL}{2r_s}\right)^2}\right)} = -\frac{2KBt}{r_c^2 \ln\left(\frac{R_e}{r_s}\right)} \quad (\text{Equation 2.10})$$

Where:  $H$  = deviation in head in the well from static conditions (m)  
 $H_0$  = initial displacement (m)  $t$  = time (s)  $K$  = hydraulic conductivity (m/s)  
 $B$  = formation thickness (m)  $r_c$  = effective casing radius (m)  
 $r_s$  = effective radius of the screen (m)  $L$  = intake length (m)  
 $m$  = transformation ratio  $(K_h/K_v)^{0.5}$   $R_e$  = effective radius of slug test (m)

The solution is a straight line solution. The acquired data is plotted in a semi-logarithmical plot, in the logarithm of normalized head versus time. A straight line is fitted to the data points and the hydraulic conductivity can be estimated by calculating the slope of the line. A common method to calculate the slope is to use the time,  $T_0$ , at which the normalized head of 0.368 (the natural logarithm of which is -1) is obtained and the start of the test. Equation 2.10 can then be expressed as Equation 2.11. The elastic storage is, as previously mentioned, ignored when using the Hvorslev solution. However, if the data points in the plot form an upward-concave curvature, it can be due to the fact that the elastic storage has some influence on the acquired data (Chirlin, 1989). According to Butler (1998), the best approach is to fit a straight line to normalized head data between 0.15 and 0.25, if the upward-concave curvature appears.

$$K = \frac{r_c^2 \ln(R_e / r_s)}{2BT_0} \quad (\text{Equation 2.11})$$

Data requirements for using Equation 2.11 are normalized head data versus time, effective casing and screen radius and aquifer/formation thickness, and an estimate of  $R_e$ , defined as the effective radius of the slug test. According to Butler (1998), it is an empirical parameter and not a parameter describing the actual radius of a slug test. Typically, values of either the length of the well screen, or 200 times the effective radius are used for  $R_e$ .

### 2.5.3 The McElwee and Zenner (1998) solution

In 1998, McElwee and Zenner presented a nonlinear slug test model for a homogenous and confined aquifer. This was based on Navier-Stokes equation, radius changes in the wellbore, nonlinear friction losses, non-Darcian flow, acceleration effects and the Hvorslev model. The solution can be used for both overdamped and for underdamped responses. The McElwee and Zenner (1998) solution is presented in Equation 2.12:

$$(h + z_0 + b + \beta) \frac{d^2h}{dt^2} + A \left| \frac{dh}{dt} \right| \frac{dh}{dt} + \frac{g\pi r_c^2}{FK} \frac{dh}{dt} + gh = 0 \quad (\text{Equation 2.12})$$

where

$h$  = deviation in head in the well from static conditions (m)  
 $z_0$  = static water column above screen (m)  $t$  = time (s)  
 $b$  = screen length (m)  $\beta$  = related to radius changes in the water column (m)  
 $A$  = parameter related to nonlinear head losses (-)  $g$  = gravity of acceleration ( $m^2/s$ )  
 $r_c$  = effective casing radius (m)  $r_s$  = effective radius of the screen (m)  
 $K$  = hydraulic conductivity (m/s)

F = the Hvorslev shape factor:  $F = \frac{2\pi b}{\ln\left(\frac{R_e}{r_s}\right)}$  (m)       $R_e$  = effective radius of slug test (m)

In addition, initial values of the displacement ( $h_0$ ) and of the velocity ( $V_0$ ) must be known. The first term of Equation 2.12 involves acceleration of the water column and the second water velocities in the wellbore. These two terms may be insignificant for low conductivity formations and if ignored Equation 2.12 will be identical to the Hvorslev solution. For a detailed description of the solution and the adherent parameters, see McElwee and Zenner (1998) and McElwee (2001, 2002).

Normalized head versus time is a common way to present the result from the solution. Non-linear effects can be identified by separated curves with a concave-downward curvature, if data from a series of slug tests are plotted in a semi-logarithmic plot, like the one used for Hvorslev's solution (e.g. see McElwee and Zenner, 1998; McElwee, 2002; Zenner, 2009). The McElwee and Zenner solution yields the value of hydraulic conductivity and the three model parameters described above;  $A$ ,  $\beta$  and  $V_0$ . Required data for using the solution are normalized head data versus time, effective casing and screen radius, aquifer/formation thickness, static water column height, depth to top of screen and screen length.

#### 2.5.4 Solutions for fractured aquifers

All the previously described solutions are valid for porous and homogeneous conditions. A fractured medium can be conceptualized as a porous medium if the formation is densely fractured, and if no fluid exchanges between the matrix and the fractures or if the exchange is extremely rapid. In that case, the described standard solutions can be used for data interpretation. Shapiro and Hsieh (1998) showed that standard models for a porous medium can be used for the interpretation of slug testing in a fractured formation. If the formation is sparsely fractured and the flow is restricted to single fractures, standard methods can be applied. However, this is only the case if the flow is radial. If the flow is linear, the standard solutions can be inappropriate (Karasaki et al., 1988; Shapiro and Hsieh, 1998).

Barker and Black (1983) presented a solution using a double porosity model. The double porosity model consists of equally spaced fractures separated by matrix blocks (slab blocks), with primary porosity and low permeability in the matrix, as well as high permeability and low storage capacity in the fractures (Kruseman and de Ridder, 2000). The Barker and Black (1983) solution yields both values of the fracture transmissivity and storativity, as well as the hydraulic conductivity and the specific storage of the matrix. It should be noted that Barker and Black (1983) and Black (1985) stated that the double porosity solution may not be practical because of the non-uniqueness of the data. The same response can be generated using different combinations of model parameters. Instead, they recommended the Cooper et al. (1967) solution for analysing response data in a fractured aquifer.

## 2.6 Area of investigation

Slug testing using pneumatic initiation has been applied in three different geological environments, namely sedimentary rock formations such as sandstone, crystalline basement (mostly gneiss and amphibolites) and volcanic sediments (mostly pyroclastic deposits). The investigated areas can be seen in Figure 6.

## 2. Slug tests - Method & Equipment

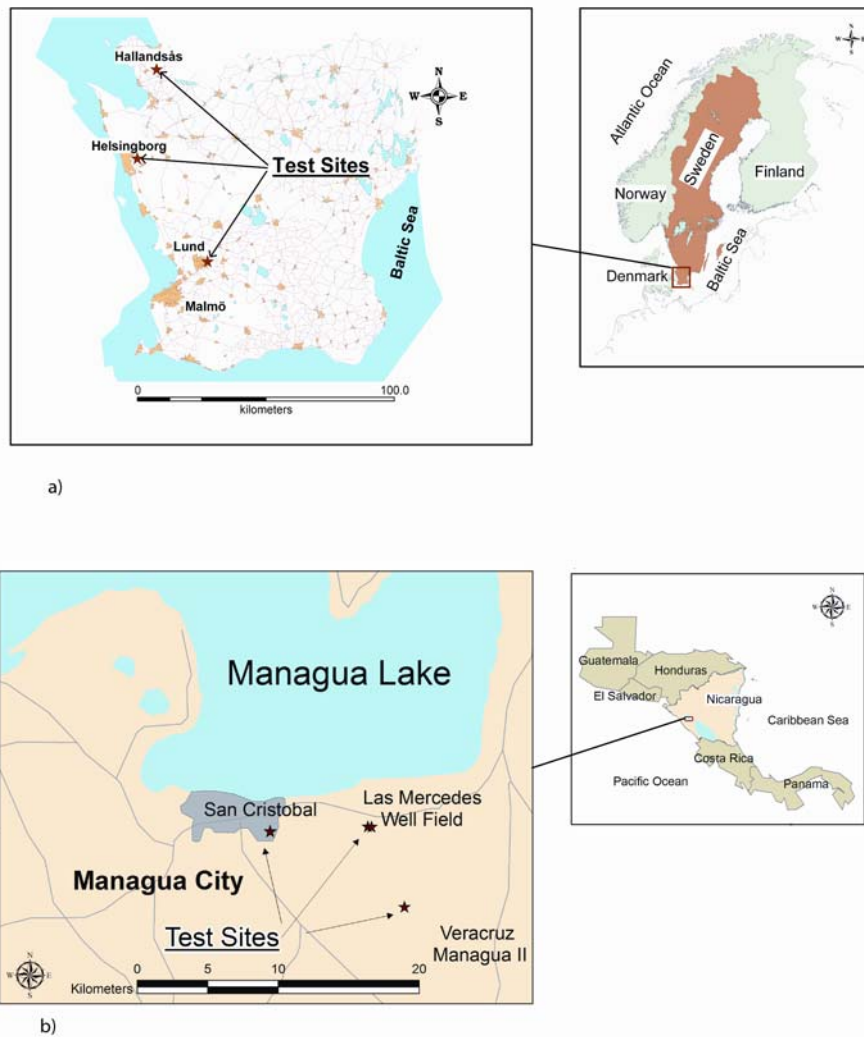

**Figure 6. The test sites used for slug testing.**

Five wells located in the crystalline basement at Hallandsås were tested. The Hallandsås horst is a part of the Tornquist zone, which is one of the major geological structures in northern Europe. The zone has a northwest to southeast orientation and stretches from the North Sea to the Black sea. The dominating fracture and fault systems in the horst are aligned in this direction. Another strongly developed fracture system is located in a north-northeast to south-southwest direction (Wikman and Bergström, 1987). However, the horst has a long and complex geological history and many different fracture systems are present. The fractured basement of the horst is an important groundwater resource with substantial quantities of water. Gneiss is the dominant rock type (80%), followed by amphibolite (15%), with smaller quantities of dolerite and granite. The horst is built up of several tectonic blocks separated by fault zones within the major Tornquist zone. In summary, there is a great variation in rock quality.

Five wells also located within the Tornquist zone, but in a sedimentary environment, were tested. Four of the wells are located in Helsingborg, where the formation down to around 100 m is of early Jurassic or late Triassic age, consisting of alternating layers of sandstone, siltstone, clay, claystone and coal (Erlström, 2007). The fifth well is located in Lund at the LTH campus. The well is also within the Tornquist zone but on the south slope of the Romele horst ridge in the Landskrona basin. The lithology in the upper part consists of Silurian shale and sandstones partly with diabase (Persson, 1985).

Eight wells located in an environment with volcanic deposits, ranging in age from plio-pleistocene to recent, in Managua, Nicaragua were tested. The wells are drilled into the volcanoclastic sediments that constitute the aquifers. According to JICA (1993), there are three different water bearing formations in the area. One is an alluvial deposit with Quaternary pyroclastic sediments, such as volcanic ash and debris. Another formation is the Masaya Group with basaltic lava, pyroclastic sediments, volcanic breccia and ash. The last formation belongs to the Middle Las Sierras group with massive basaltic to andesitic agglomerate with breccia and tuff.





### 3. Slug tests - Results

Slug testing has been applied to both small and large diameter wells located in urban or remote areas. The majority of the testing was conducted as single well testing. In some of the wells, results from an alternative testing method are available, such as pumping tests. However, the methodology for pumping tests in general will be described in Chapter 4.

#### 3.1 Results: crystalline basement

A series of slug tests were conducted at Hallandsås (Figure 6), in well MK20 (see Figure 7). Five tests were conducted, using an initial displacement from around 1 m to 5.6 m. The tested section consists of amphibolite and gneiss rock types. Well data, test data, water capacity data and lithology can also be found in Figure 7. The water capacity measurements were conducted at an earlier stage by a drilling company. Unfortunately, there are no corresponding drawdown measurements during the water capacity measurements, which restricts the use of the measurements. This is a general issue concerning the water capacity measurements in all of the tested wells in the crystalline basement. The longest casing depressurization time for the tests was 1.12 seconds. More than 95% of the expected initial displacement remained after depressurization.

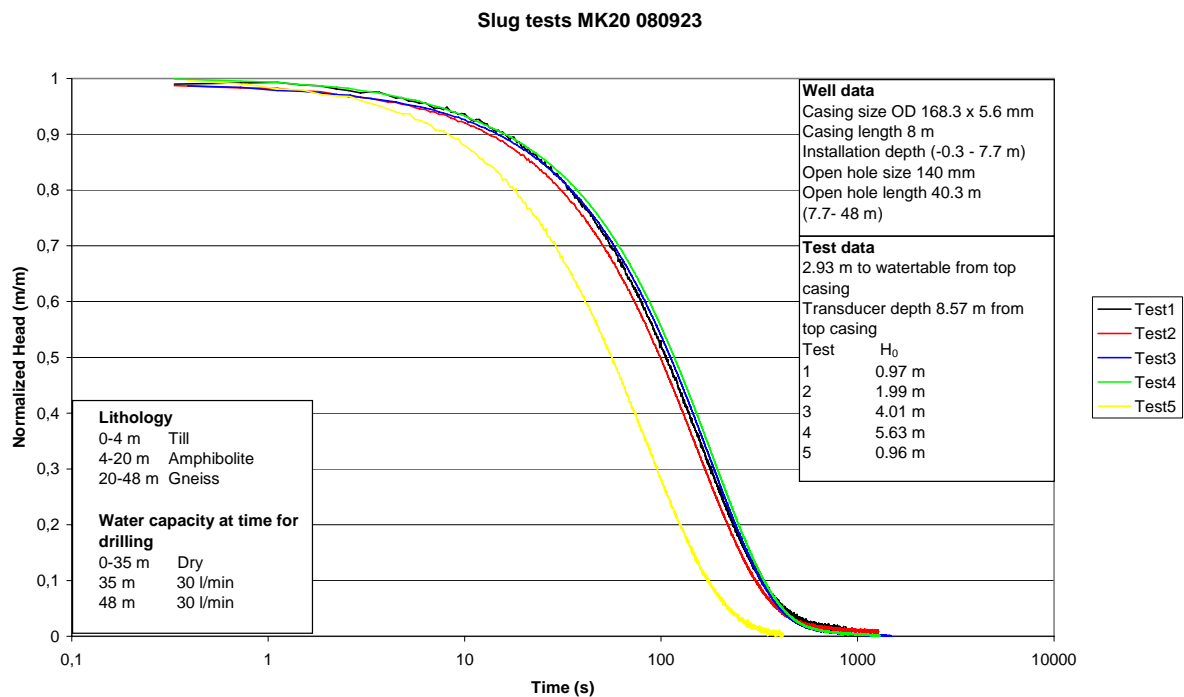

**Figure 7. A series of slug tests in MK20.**

It is notable that, in Figure 7, the well has been hydraulically improved during the slug testing, since the response time for the last test is shorter than the others. In addition, the same initial displacement is used during the first and last tests. In other words, the first test could not have been reproduced. Transmissivity is estimated using the Cooper et al. (1967) solution, the Hvorslev (1951) solution and the Barker and Black (1983) solution (see Figure 8). The length of the open hole section is used for expressing hydraulic conductivity as transmissivity.

### 3. Slug tests - Results

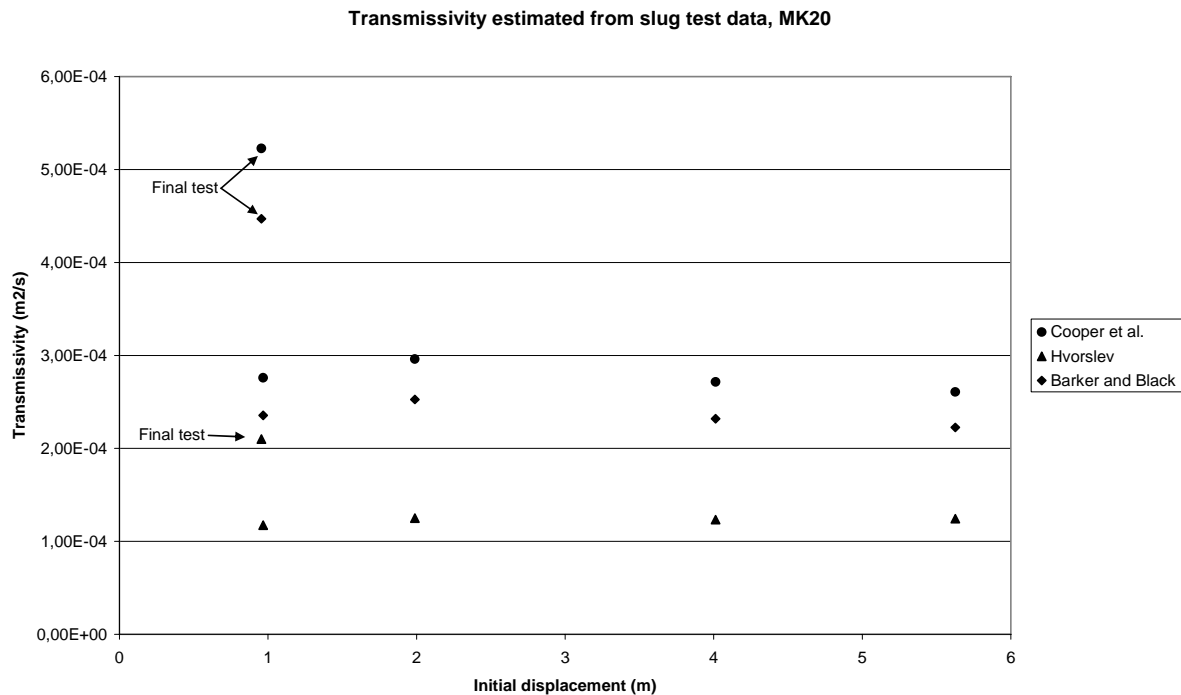

**Figure 8. Transmissivity estimated from a series of slug tests in MK20. Three different solutions are used for the data analysis.**

The highest transmissivity in Figure 8 is obtained from the final test, which also indicates that the well has been hydraulically improved during the testing. Tests 1-4 show great repetition, independent of which solution that was used. The Cooper et al. (1967) solution yielded the highest transmissivity and the Hvorslev (1951) the lowest. In general, the best matching was achieved using the Cooper et al. (1967) and the Hvorslev (1951) solutions. However, a perfect match, with extremely small residuals, wasn't achieved with any of the solutions used. In Appendix 2, data matching using the different solutions is presented for the second test.

A series of slug tests were conducted in well MK24 (see Figure 9). Five tests were conducted, using an initial displacement from around 1 m to 7.8 m. The tested section consists of amphibolite and gneiss. Well data, test data, water capacity data and lithology can also be found in Figure 9. The longest casing depressurization time for the tests was 1.11 seconds. Furthermore, more than 96% of the expected initial displacement remained after depressurization. It is notable that the first and the final test did not start from the same initial conditions. The water level at the start of the first test was 8 cm higher in comparison to the start of the final test. This was due to slow recovery, especially for the last centimetres of the initial displacement. In other words, new tests were conducted before the well was fully recovered.

In Figure 9, good agreement between test 1 and test 2 can be seen. However, test 3 and 4 are shifted in time to the right of the figure, which can be due to non-Darcian flow losses. It can also be seen that the first test cannot be reproduced. Instead, the final test indicates that the well has been hydraulically improved. Transmissivity is estimated using the Cooper et al. (1967) solution, the Hvorslev (1951) solution and the Barker and Black (1983) solution (see Figure 10). The length of the open hole section is used for expressing hydraulic conductivity as transmissivity.

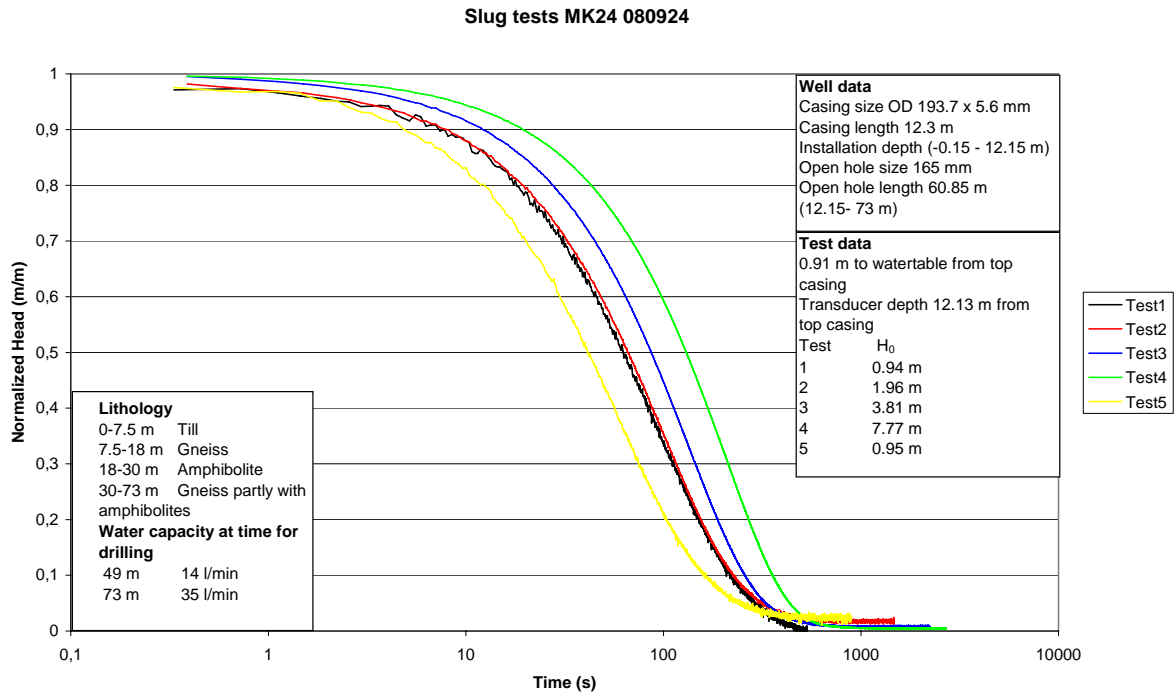

Figure 9. A series of slug test in MK24.

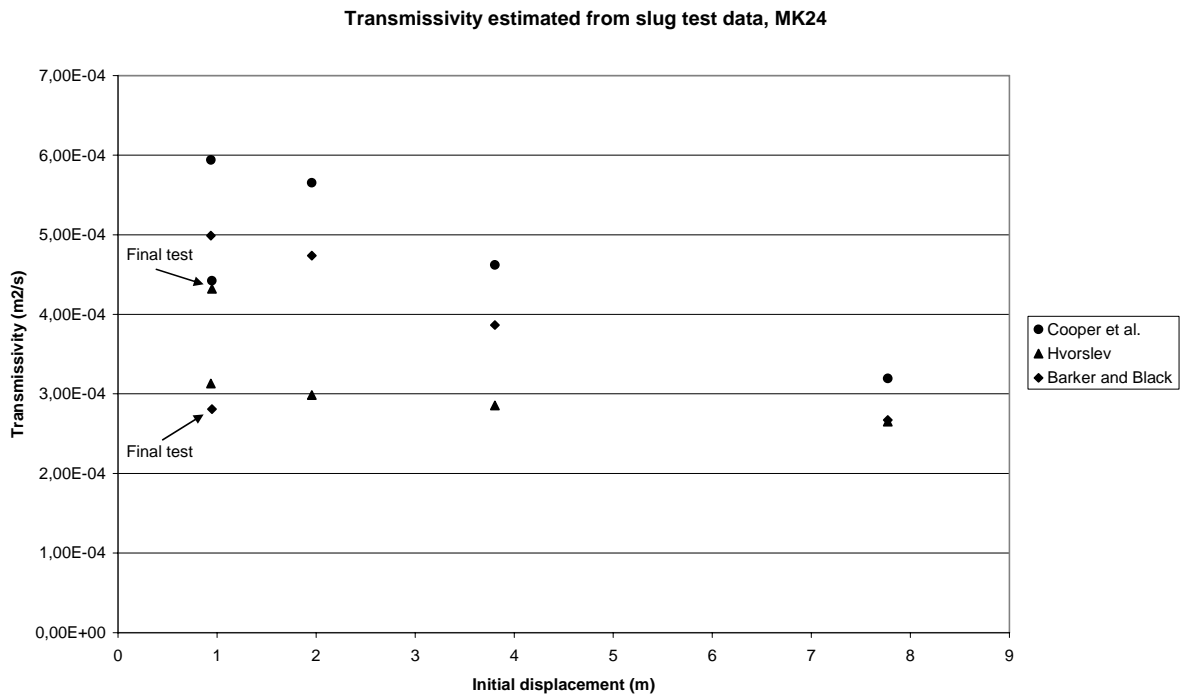

Figure 10. Transmissivity estimated from a series of slug tests in MK24. Three different solutions are used for the data analysis.

The transmissivity estimated using the three solutions decreases with increased initial displacement, which also indicates non-Darcian flow losses (see Figure 10). The greatest transmissivity interpreted using the Hvorslev (1951) solution is in the final test, which indicates that the well has been hydraulically improved. The opposite is obtained from the other two solutions, which yield the lowest transmissivity for the final test. The interpreted transmissivity with the lowest residuals is the one presented in Figure 10. The best match of

### 3. Slug tests - Results

the data for the final test, using e.g. Cooper et al. (1967), was found using a storativity value of  $1.5 \cdot 10^{-5}$ , but for the first test the best match was found using a negligible storativity value of  $1 \cdot 10^{-10}$ . The greatest transmissivity estimate,  $8.4 \cdot 10^{-4} \text{ m}^2/\text{s}$ , will also be achieved from the final test using the Cooper et al. (1967) solution, if the storativity is considered as negligible during the final test. In general, the Cooper et al. (1967) solution yielded the greatest transmissivity values and the Hvorslev (1951) solution the lowest. There is a good match for the test data for tests 1 and 2 as well as for the final test. However, for the remainder, good matches were hard to obtain. In Appendix 2, data matching using the different solutions is presented for the final test.

A series of slug tests were conducted in well MK28 (see Figure 11). Five tests were conducted, using an initial displacement from around 0.9 m to 5.0 m. The tested section consists of gneiss partly with amphibolite and aplite. Well data, test data, water capacity data and lithology can also be found in Figure 11. The longest casing depressurization time for the tests was 1.5 seconds. More than 90 % of the expected initial displacement remained after depressurization.

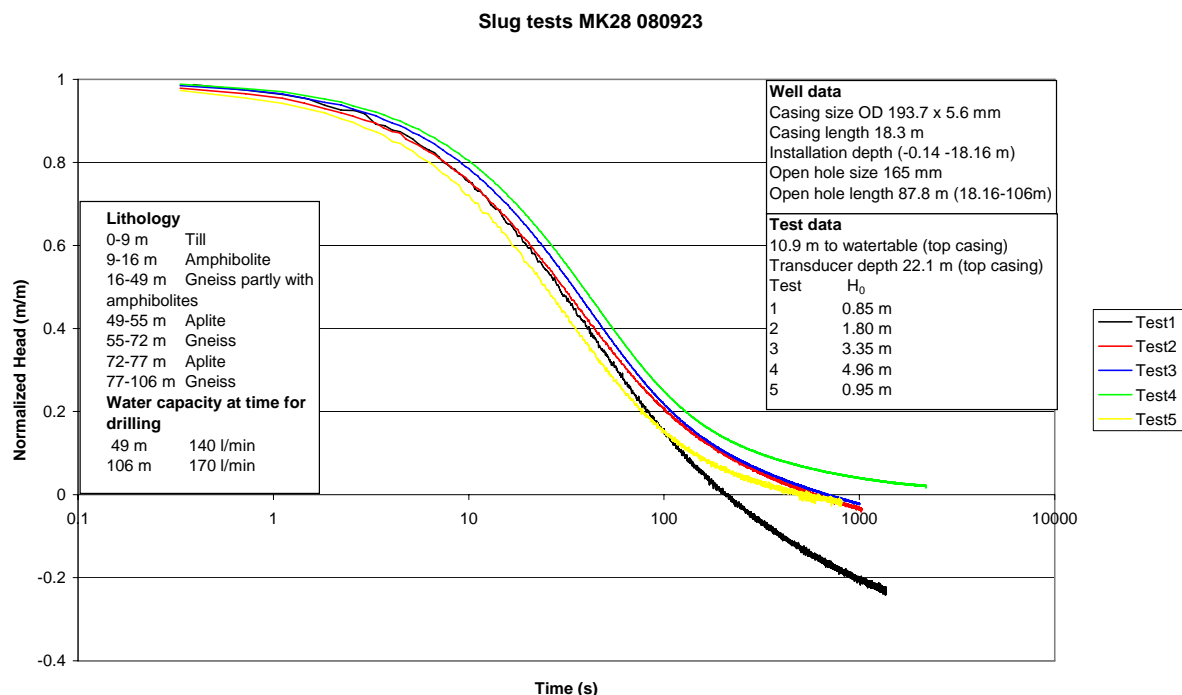

**Figure 11. A series of slug test in Mk28.**

The negative normalized head values obtained at four of the five tests are notable in Figure 11. This is due to the fact that the well is recovering to a water level that is higher than the initial conditions. A water level difference of as much as 30 cm was measured after the testing. Due to these increased levels it is difficult to compare the results from the tests. A possible explanation is that the well is located in the border zone between two different aquifers (Banverket, 2009) with different potential. The initial measured potential in the well corresponds to the aquifer with the lowest potential. However, during testing contact is established with the aquifer with a higher potential, causing the increased level in the well. In other words, the test response is a combined response from the two aquifers. Influence from the TBM-drilling can be omitted, since there was no ongoing activity during the testing (Banverket, 2009). Due to the uncertainties introduced in the acquired data, transmissivity estimations are avoided.

A series of slug tests were conducted in well MK39 (see Figure 12). Four tests were conducted, using initial displacement from around 0.9 m to 4.1 m. The tested section consists of amphibolite and gneiss rock types. Well data, test data, water capacity data and lithology can also be found in Figure 12. The longest casing depressurization time for the tests was 0.78 seconds and more than 94% of the expected initial displacement remained after depressurization.

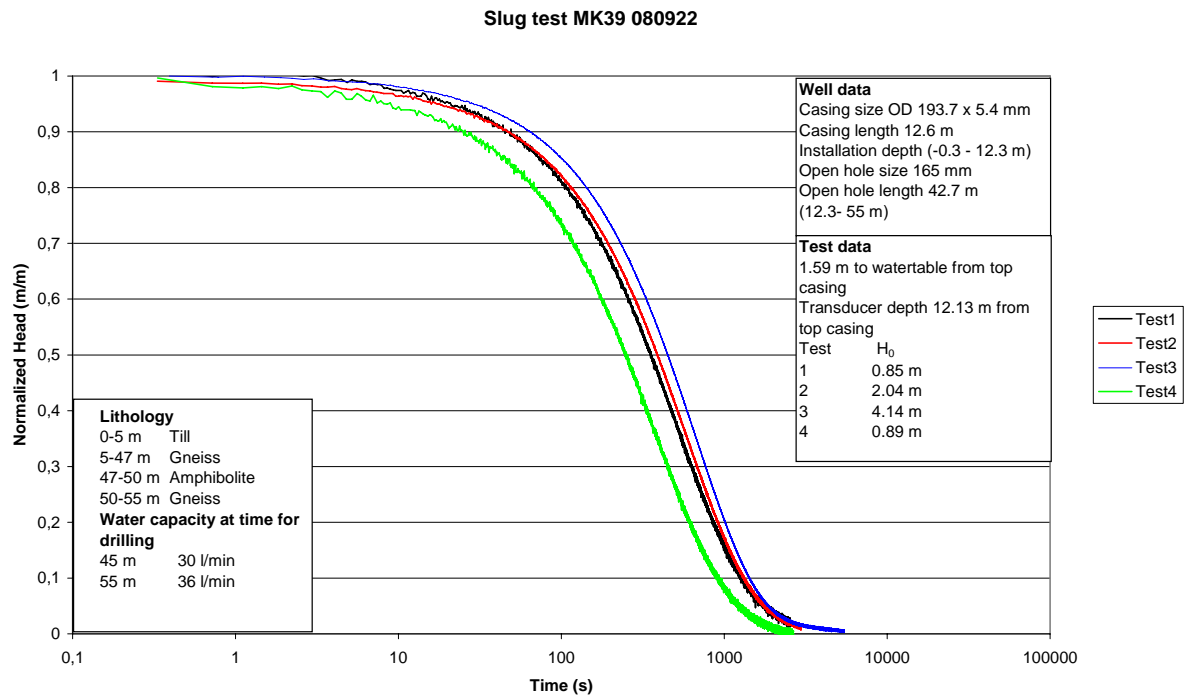
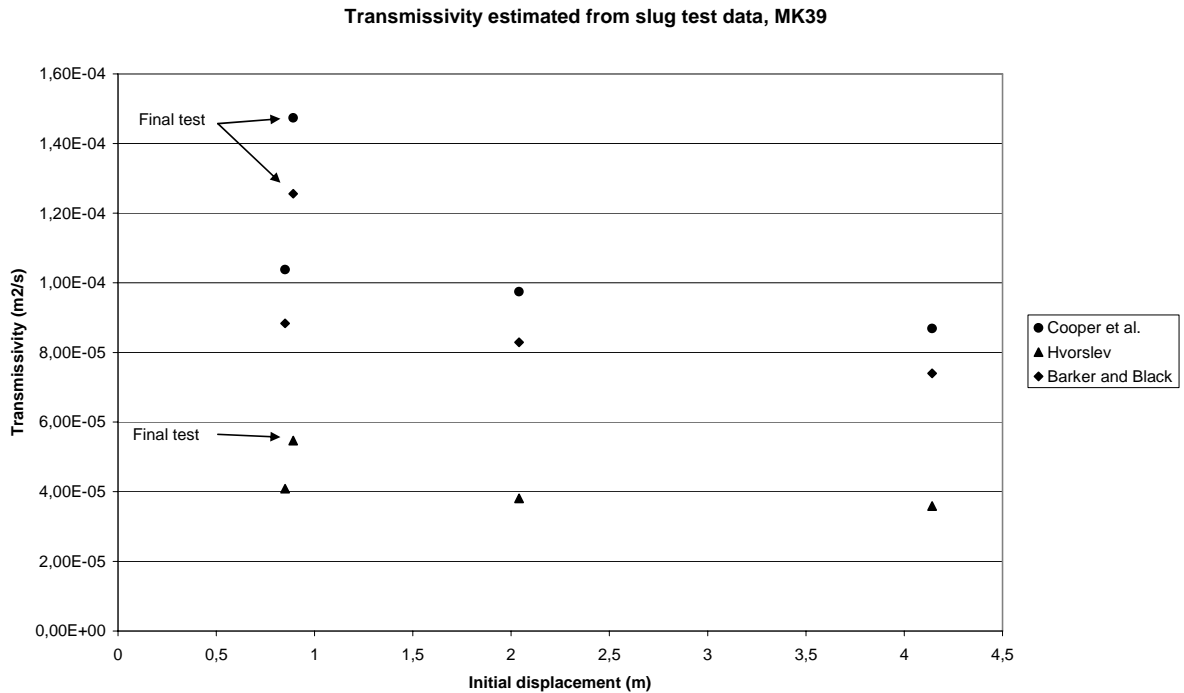

**Figure 12. A series of slug tests in MK39.**

In Figure 12 the fact that the well has been hydraulically improved during the slug testing can be noted, since the response time for the last test is shorter than the others. MK39 is also the well with the longest response time compared with the other tested wells in the crystalline basement. Transmissivity is estimated using the Cooper et al. (1967) solution, the Hvorslev (1951) solution and the Barker and Black (1983) solution (see Figure 13). The length of the open hole section is used for expressing hydraulic conductivity as transmissivity.

The highest transmissivity in Figure 13 is obtained from the final test, which also indicates that the well has been hydraulically improved during the testing. Tests 1-3 show good repetition, despite the small decrease in transmissivity with increased initial displacement, regardless of which solution was used. The Cooper et al. (1967) solution yielded the highest transmissivity and the Hvorslev (1951) solution the lowest. In general, the best matching was achieved using the Cooper et al. (1967) and the Hvorslev (1951) solutions. In Appendix 2, data matching using the different solutions is presented for the final test.

### 3. Slug tests - Results



**Figure 13. Transmissivity estimated from a series of slug tests in MK39. Three different solutions are used for the data analysis.**

A series of slug tests were conducted in well MK48 (see Figure 14). Six tests were conducted, using initial displacement from around 0.5 m to 8.0 m. The tested section consists of dolerite. Well data, test data, water capacity data and lithology can also be found in Figure 14. The longest casing depressurization time for the tests was 2.23 seconds and more than 97% of the expected initial displacement remained after depressurization.

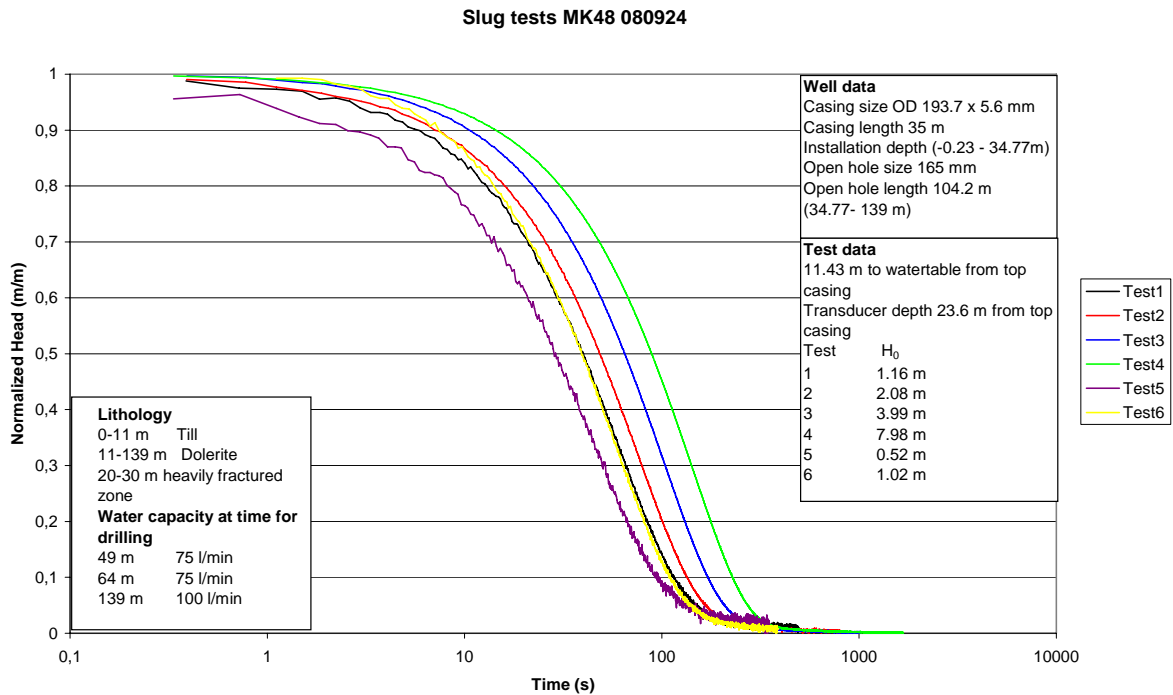

**Figure 14. A series of slug tests in MK48.**

In Figure 14, it can be seen that the result from first test can be reproduced during the last test. Furthermore, it can be seen that as the initial displacement increases the curves will be shifted in time towards the right of the figure. This is an indication that non-Darcian flow losses are occurring during testing. A dynamic skin appearing during the testing can be excluded since the first test is reproduced. Transmissivity is estimated using the Cooper et al. (1967) solution, Hvorslev (1951) solution, the Barker and Black (1983) solution and the McElwee and Zenner (1998) solution (see Figure 15). The latter is used as an attempt to consider possible non-Darcian flow losses in the data set, since it is a non-linear solution. The length of the open hole section is used for expressing hydraulic conductivity as transmissivity.

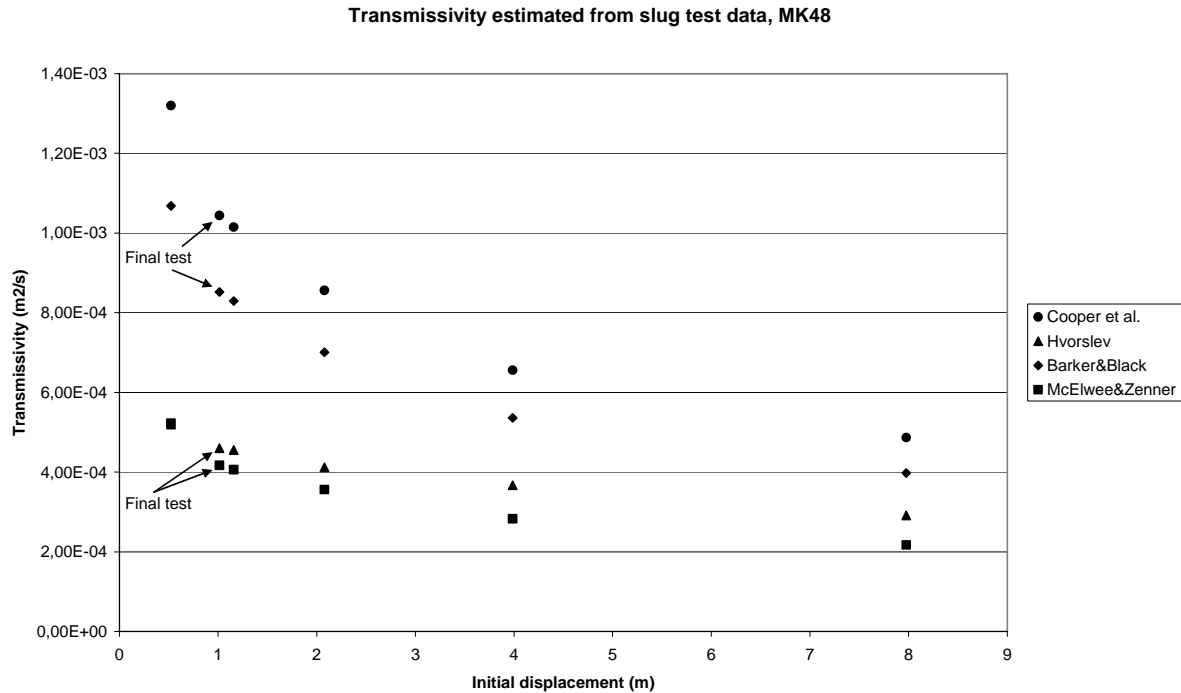

**Figure 15. Transmissivity estimated from a series of slug tests in MK48. Four different solutions are used for the data analysis.**

In Figure 15, the fact that the transmissivity decreases with increased initial displacement for all of the four used solutions, even for the non-linear McElwee and Zenner (1998) solution, should be noted. In other words, non-linear flow losses can't be the only explanation for the decreased transmissivity with increased displacement. However, a downward-concave curvature can be observed in a semi-logarithmic plot, like the one used for Hvorslev's solution. This is an indication of non-linearity. In general, the highest transmissivity is obtained by the use of the Cooper et al. (1967) solution. However, no good matching, high residuals, were obtained by this solution or the Barker and Black (1983) solution. The best match and the lowest residuals were found with the Hvorslev (1951) solution and, especially, the McElwee and Zenner (1998) solution. The smallest difference between highest and lowest transmissivity estimated from the series of slug tests was also obtained from those solutions. In Appendix 2, matching using the different solutions is presented for the last test.

### 3.2 Discussion: crystalline basement

An issue during the slug testing in the crystalline basement was well development occurring during the testing. Gneiss and amphibolite were the dominating rock types in the wells where well development occurred. It was seen as a shorter response time and higher transmissivity during the last test than during the first test. Despite this, almost the same initial displacement



### 3. Slug tests - Results

---

was used during the two tests. One possible explanation is that not so much effort in terms of well development action has been undertaken since the wells were drilled. Another possible explanation for the improvement of the wells is fracture cleaning, meaning that precipitation of minerals such as iron is removed during the slug testing. The observed improvements during the testing highlight the importance of conducting a series of slug tests. In the case of a single slug test, the transmissivity would have been underestimated if only the first test had been carried out. In that case the transmissivity estimate would have been underestimated by a factor of between 1.3 and 1.8, using the Hvorslev solution (1951), when compared to the last test in the series.

With well development occurring during the testing, the transmissivity estimate from the last test seems to be the most representative for describing the formation properties in the vicinity of the well. However, no information is available on whether or not the well was fully developed after the testing, or if it could be improved further. The only way to determine this is to carry out more tests. One recommendation is to evaluate and compare the results from the first and the last test at the test site. Following this, if the well has been hydraulically improved, more tests would verify if it is still improving or not. This is also valid where different hydrostatic levels are obtained during the testing, as has been described for MK28.

The results from the testing of MK48 were different from the others, with an evident influence of non-linearity. A decrease in transmissivity with increased initial displacement was observed. However, it is important that the first test could be reproduced, which excludes influence of dynamic skin. The non-linearity was considered by applying the non-linear McElwee and Zenner (1998) method, but there is still a decrease in transmissivity with increased displacement. One major difference between MK48 and the other wells is that the test section consists of dolerite, compared with the gneiss and amphibolite rock types dominating in the other wells. The observed casing depressurization times were less than 2.2 seconds during the testing, and can only have a minor affect on the results due to the relatively short times. One possible explanation is that turbulence is occurring in the formation during testing. If the flow is restricted to a few fractures, an increased initial displacement can increase the turbulence. Therefore, the most representative transmissivity estimates must, in this case, be those interpreted from the tests using the smallest initial displacements. However, further data analysis and another model of approach other than the solutions used here are required for obtaining confident estimates. These can include validation using an alternative hydraulic test method.

In general, the Cooper et al. (1967) solution yielded the highest value of the transmissivity and the Hvorslev (1951) solution the lowest for the wells tested. A better match was also obtained from these two solutions than from Barker and Black (1983). The fact that a more accurate solution can be obtained using the Cooper et al. (1967) solution has been observed by Barker and Black (1983), Shapiro and Greene (1995) and Butler (1998). However, the lack of additional information from alternative hydraulic test methods makes it difficult to evaluate which of the solutions used is the most accurate for estimation of transmissivity/hydraulic conductivity. One way to validate this issue is to carry out short term pumping tests in the tested wells, in combination with flow meter loggings to verify the flow contribution zones in the wells. This is useful information for expressing transmissivity as hydraulic conductivity or the opposite. There are water capacity measurements in the wells, but unfortunately there are no corresponding drawdown measurements during the water capacity measurements, which restrict the use of these measurements. Otherwise, specific capacity could have been used for calculating transmissivity from empirical formulas (for an example, see Kasenow, 2001).

However, the transmissivity estimates obtained from the slug testing are within the range of  $4 \cdot 10^{-5} - 1 \cdot 10^{-3} \text{ m}^2/\text{s}$ , in the case similar to the estimates obtained from pumping tests carried out in other wells at the Hallandsås horst (VBB VIAK, 1998).

### 3.3 Results: sedimentary deposits

A series of slug tests were conducted in Helsingborg (Figure 6), in Well 0662005 (see Figure 16). Eight tests were conducted, using an initial displacement from around 0.5 m to 4.6 m. The tested section consists of sandstone rock types. Well data, test data and lithology can also be found in Figure 16. The longest casing depressurization time for the tests was less than 1s and more than 93 % of the expected initial displacement remained after depressurization.

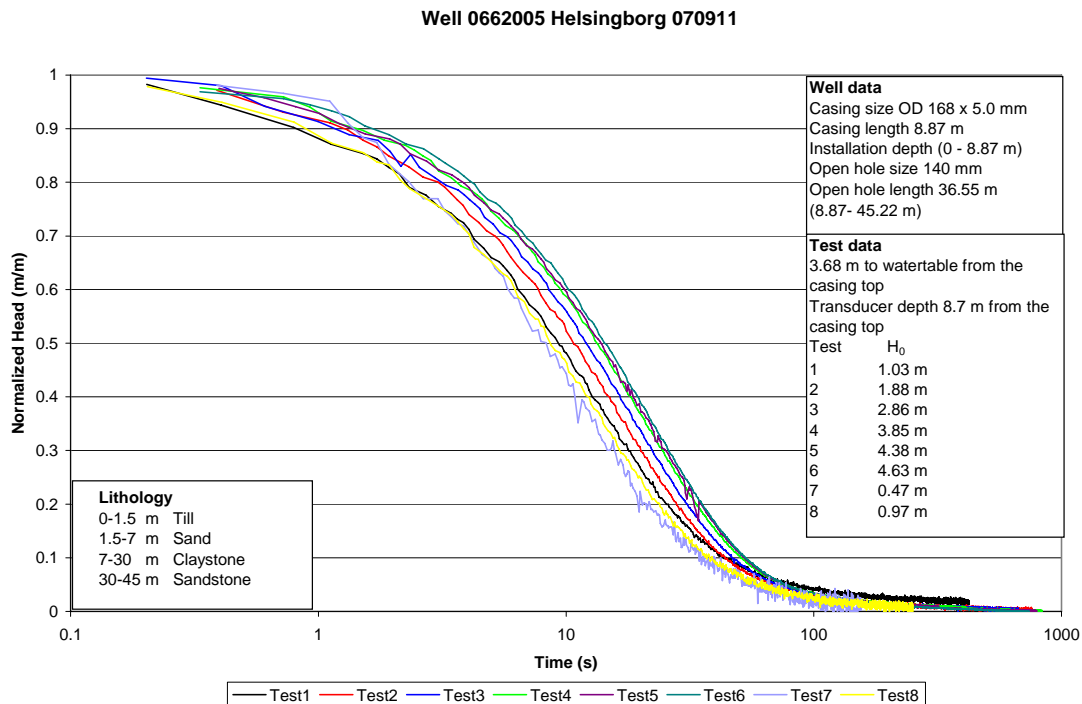

**Figure 16. A series of slug test in well 0662005.**

In Figure 16 it is apparent that the result from first test can be reproduced by the last test. Furthermore, it illustrates that as the initial displacement increases the curve will be shifted in time towards the right of the figure. Transmissivity is estimated using the Cooper et al. (1967) solution, seeing as good matching was achieved with the solution (see Figure 17). The Hvorslev (1951) solution is not used in this case since the data forms an upward-concave curvature when plotted in the semi-logarithmic plots used for the solution. This is an indication of the influence of elastic storage, which is neglected for the Hvorslev solution. Transmissivity estimated from a pumping test and recovery data is also presented in Figure 17. The pumping test lasted around 7 days, using an average flow rate of 245 l/min, and was followed by around 8 days of recovery. The drawdown data was evaluated using the Cooper and Jacob solution. The recovery data was evaluated using Theis recovery method and by using Agarwal equivalent time in combination with the Theis solution. In Appendix 2, the data matching using the solutions is presented. Data matching from the last slug test is also presented.

### 3. Slug tests - Results

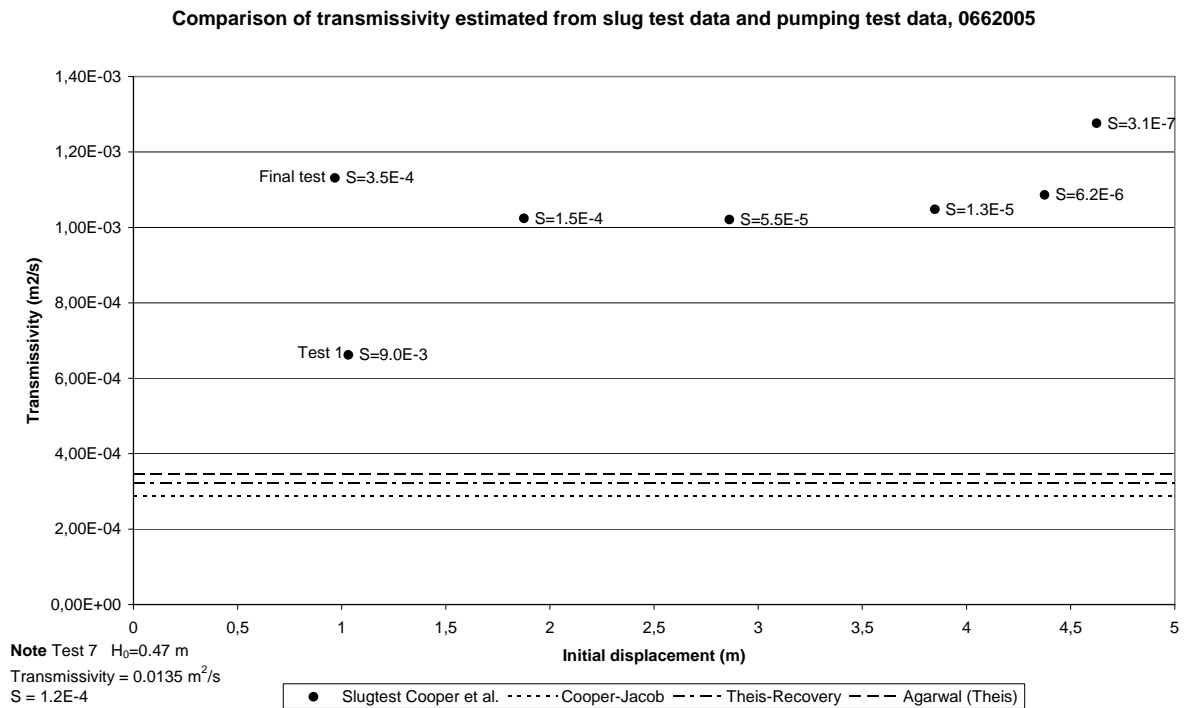

**Figure 17. Transmissivity estimated from slug test (dots) and pumping test (lines) data.**

The transmissivity values estimated from the series of slug tests are in good agreement, except for in the case of tests 1 and 7. The explanation for the different value obtained from test 1 can be due to the fact that there was some trouble in fully opening the release valve during the initiation of the test. The highest transmissivity was estimated from test 7, where the lowest initial displacement, 0.47 m, was used. It is notable that the transmissivity from this test is more than ten times greater than the transmissivity estimated from the other slug tests. The estimates from the pumping and recovery tests are also in good agreement, but the estimates are around three times less than the estimates obtained from the slug testing.

The slug testing was conducted as a multi-well test. This means that the response was also measured in an observation well located at a radial distance of around 8.2 m from the test well. Pressure response measured in the observation well is presented in Figure 18. It can be seen that, during the pressurization phase in the test well, the pressure increases in the observation well. During the depressurization phase the opposite is true. The response in the observation well is most evident during tests 2-6. Around 0.7-1% of the initial displacement used in the test well is measured in the observation well.

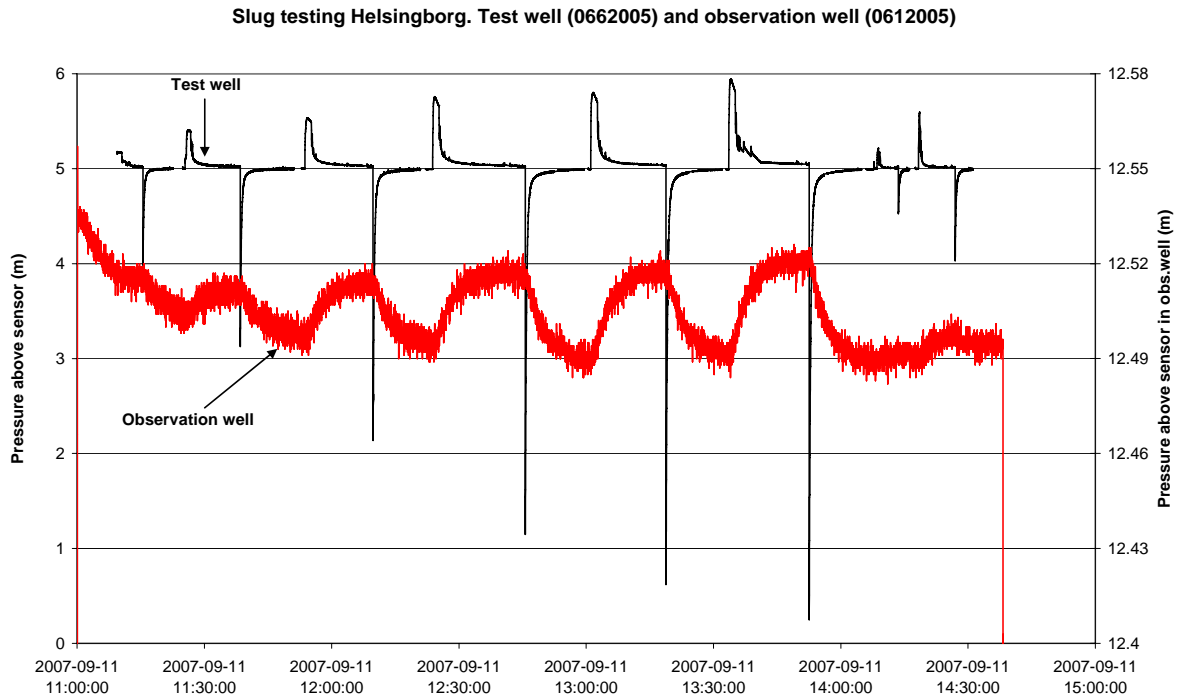

**Figure 18. Response measured during slug testing in an observation well located around 8.2 m from the test well.**

A series of slug tests were conducted in Well 0662002 (see Figure 19). Seven tests were conducted, using an initial displacement from around 0.4 m to 4.6 m. The tested section consists of sandstone. Well data, test data and lithology can also be found in Figure 19. The longest casing depressurization time for the tests was less than one second and more than 84% of the expected initial displacement remained after depressurization.

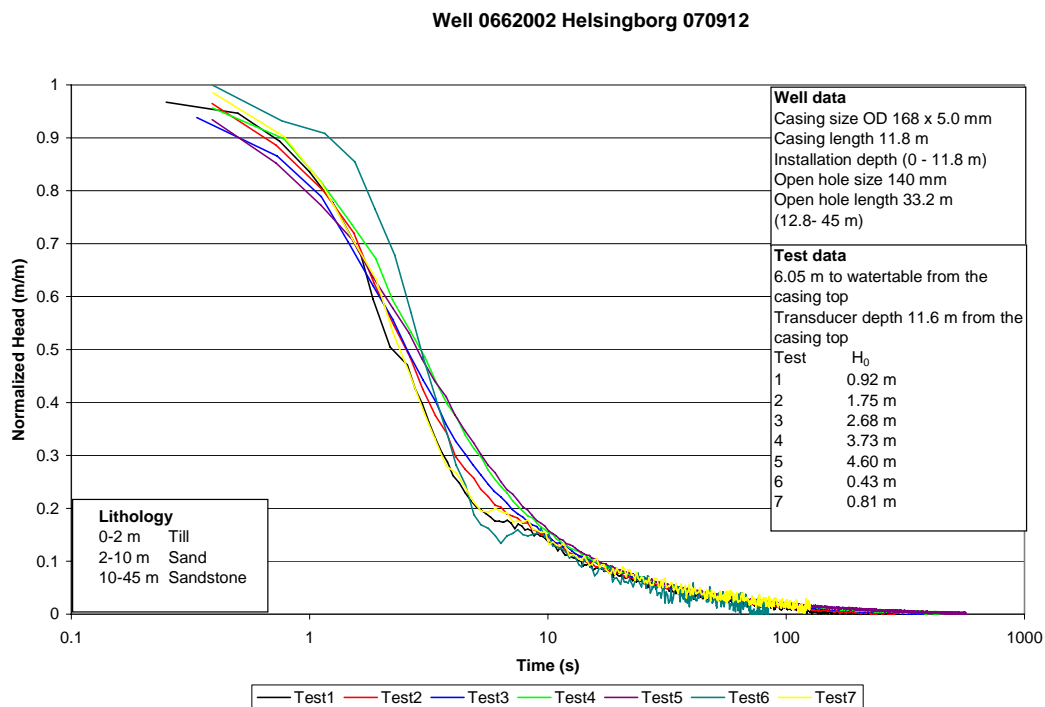

**Figure 19. A series of slug tests in Well 0662002.**

### 3. Slug tests - Results

In Figure 19 it can be noted that two different segments occur in the test data. The first segment dominates before 10 seconds and the second segment after this. The segments can be seen as a double-straight line effect in a  $\log(H/H_0)$  against time plot. Bouwer (1989) discussed this effect, which occurs if there is a highly permeable zone around the well, such as a gravel-pack completion. In this case, there is sandstone and sand above the tested section (open hole), which contribute inflow to the well after slug initiation. The second segment is interpreted as the response from the tested formation response. In addition, the curves from the tests coincide at the second segment. In Figure 19, it can also be seen that the first test can be reproduced by the last test. Hydraulic conductivity is estimated using the Hvorslev (1951) solution and the open hole section of 35 m is used for expressing it as transmissivity (see Figure 20). The solution was chosen due to the fact that it was easy to apply and resulted in a good match. Transmissivity estimated from a pumping test and recovery data is also presented in Figure 20. The pumping test lasted around 7 days, using an average flow rate of 300 l/min. This was followed by around 8 days of recovery. The drawdown data was evaluated using the Cooper and Jacob solution, the recovery data using the Theis recovery method and by using the Agarwal equivalent time in combination with the Theis solution. Data matching using the solutions is presented in Appendix 2, along with the data matching from the last slug test.

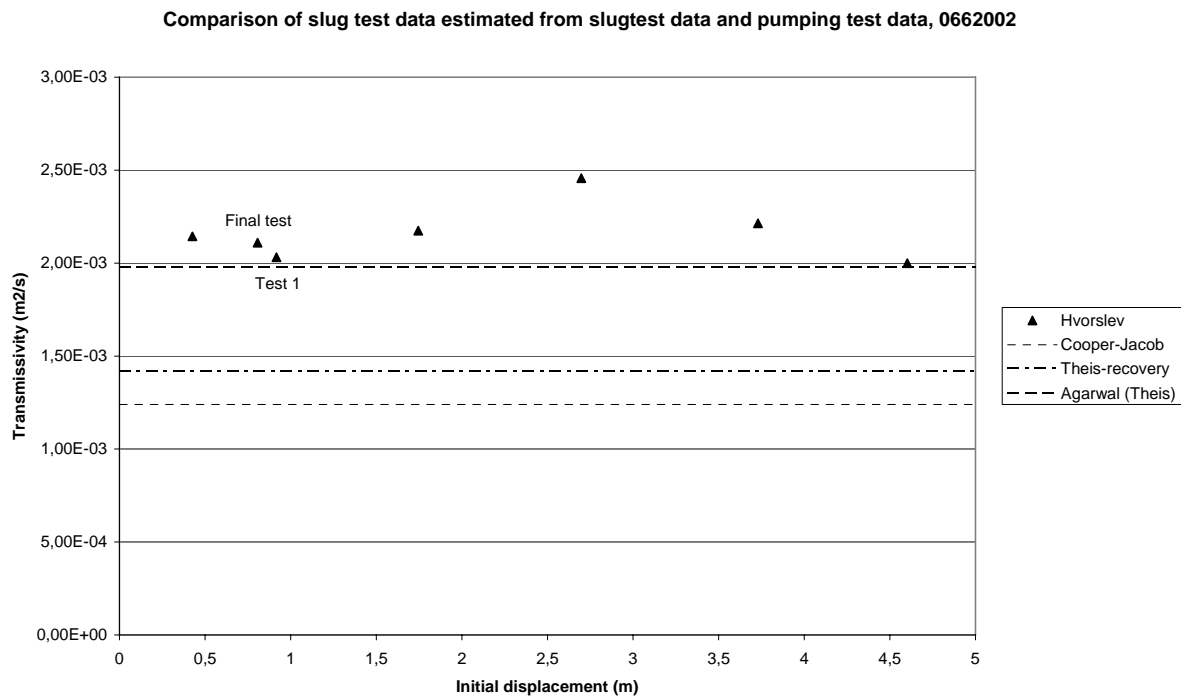
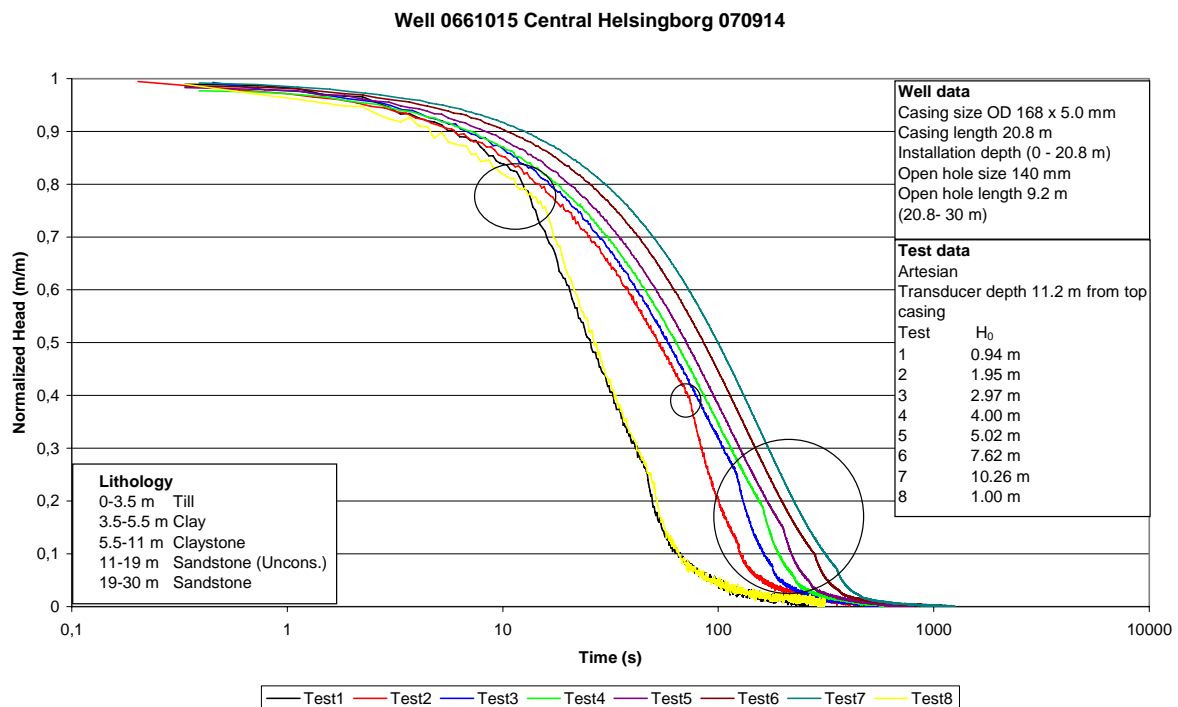

**Figure 20. Transmissivity estimated from slug test (dots) and pumping test (lines) data.**

The transmissivity estimated from the series of slug tests are in good agreement (see Figure 20) but higher than the estimates from the pumping and recovery test. However, the transmissivity estimated from the slug testing can be overestimated, since it is assumed that the entire open hole section contributes to inflow during the testing. In Appendix 2 it can be noted that there are different alternatives for carrying out data matching, regarding both the slug test data and the drawdown and recovery data. These also have to be considered when comparing estimates from different test methods.

A series of slug tests were conducted in Well 0661015 (see Figure 21). Eight tests were conducted, using an initial displacement from around 0.9 m to 10.3 m. The tested section consists of sandstone. Well data, test data and lithology can also be found in Figure 21. The

longest casing depressurization time for the tests was less than one second and more than 98% of the expected initial displacement remained after depressurization. It is notable that the tests are carried out in an artesian well.



**Figure 21. A series of slug tests in Well 0661015.**

It is notable in Figure 21 that a bend appears in the normalized head curves, which has been marked with circles. The bend shape occurs due to a rising water level entering the packer, which is used as an airtight coupling and has a smaller diameter than the casing. In other words, the occurrence of the bend is not related to the formation. It can also be seen in Figure 21 that the result from first test can be reproduced after the occurrence of the curve bend. Also, it can be seen that as the initial displacement increases, the curves will be shifted in time towards the right of the figure. Transmissivity is estimated using the Cooper et al. (1967), Hvorslev (1951) and McElwee and Zenner (1998) solutions (see Figure 22). An estimation window is used during the matching so only the data obtained before the bend appears is used. The result from the Hvorslev (1951) solution is the only one presented for the first and last test in Figure 22, since the other solutions yielded unreliable estimates. This was probably due to the few data points that were available for matching. Transmissivity estimated from recovery data is also presented in Figure 22. The pumping test lasted around 3.8 days, using an average flow rate of 86 l/min, and the well recovered after 2.6 days. The drawdown data is not used for transmissivity estimation, due to bad data quality. Transmissivity was estimated using the Theis recovery method and by using Agarwal equivalent time in combination with the Theis solution. In Appendix 2, the data matching using the solutions is presented. The data matching from slug test number five, where an estimation window from 0 to 202 seconds is used, is also presented.

### 3. Slug tests - Results

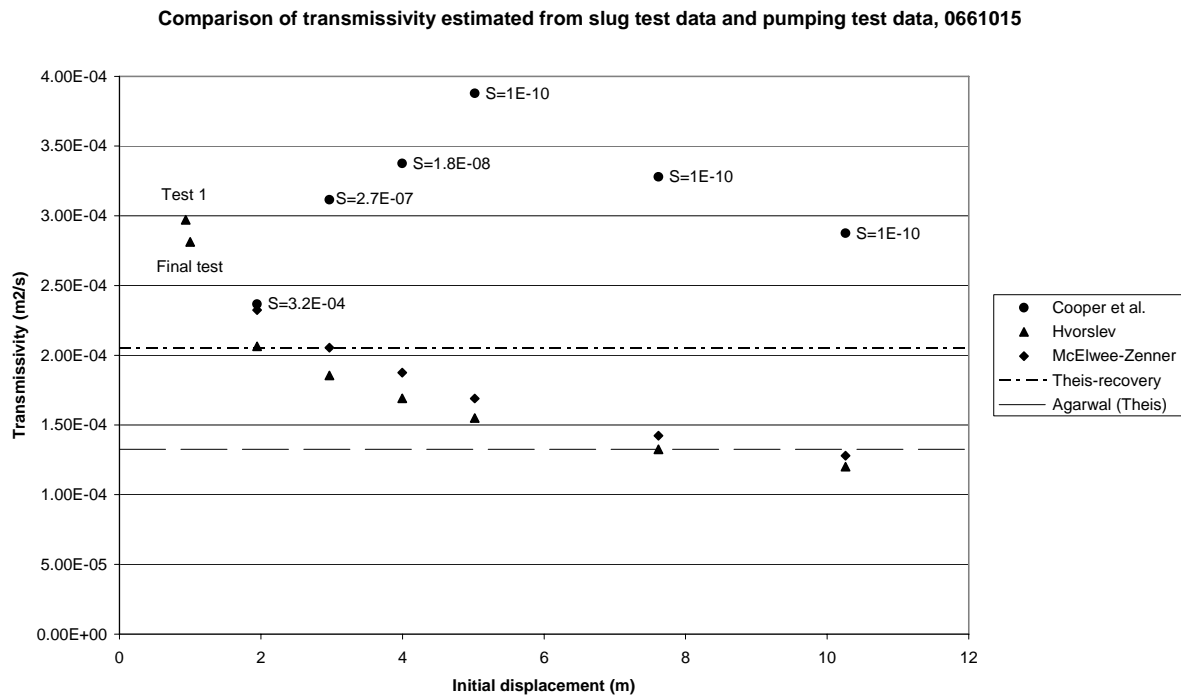

**Figure 22. Transmissivity estimated from slug test (dots) and pumping test (lines) data.**

The highest transmissivity estimates are obtained from the Cooper et al. (1967) solution, but the estimates from the tests are not in good agreement. It is notable that, in the case of the Hvorslev (1951) and the McElwee and Zenner (1998) solutions, the transmissivity decreases with increased initial displacement. This is a typical indication of non-linear flow losses, which are taken into account in the McElwee and Zenner (1998) solution, but, despite of that, it is also occurring for this solution. Therefore, there must be an alternative explanation for the decreasing transmissivity with increased initial displacement that is not considered in any of the used solutions. The transmissivity estimates from the two solutions are close to estimates from the recovery test, where the Theis recovery method yielded the best match. It is interesting that the average transmissivity obtained using McElwee and Zenner (1998) is  $1.8 \cdot 10^{-4} \text{ m}^2/\text{s}$ , and  $1.6 \cdot 10^{-4} \text{ m}^2/\text{s}$  using the Hvorslev (1951) solution. These values are close to the estimate from the Theis recovery method, which is  $2.0 \cdot 10^{-4} \text{ m}^2/\text{s}$ . The estimates from the first and last slug test are of less importance than the other estimates, since only a few data points were available before the bend appeared in the data set, as explained earlier.

A series of slug tests were conducted in LTH-1 (see Figure 23), a well located in Lund (Figure 6) and in different sedimentary rock deposits than the wells previously described. Eleven tests were conducted, using an initial displacement from around 1.2 m to 17.6 m and the tested section consisted of shale and dolerite rock types. Well data, test data and lithology can also be found in Figure 23. The longest casing depressurization time for the tests was less than three seconds, but less than 1.5 seconds for small displacements up to 5 m, and more than 91% of the expected initial displacement remained after depressurization.

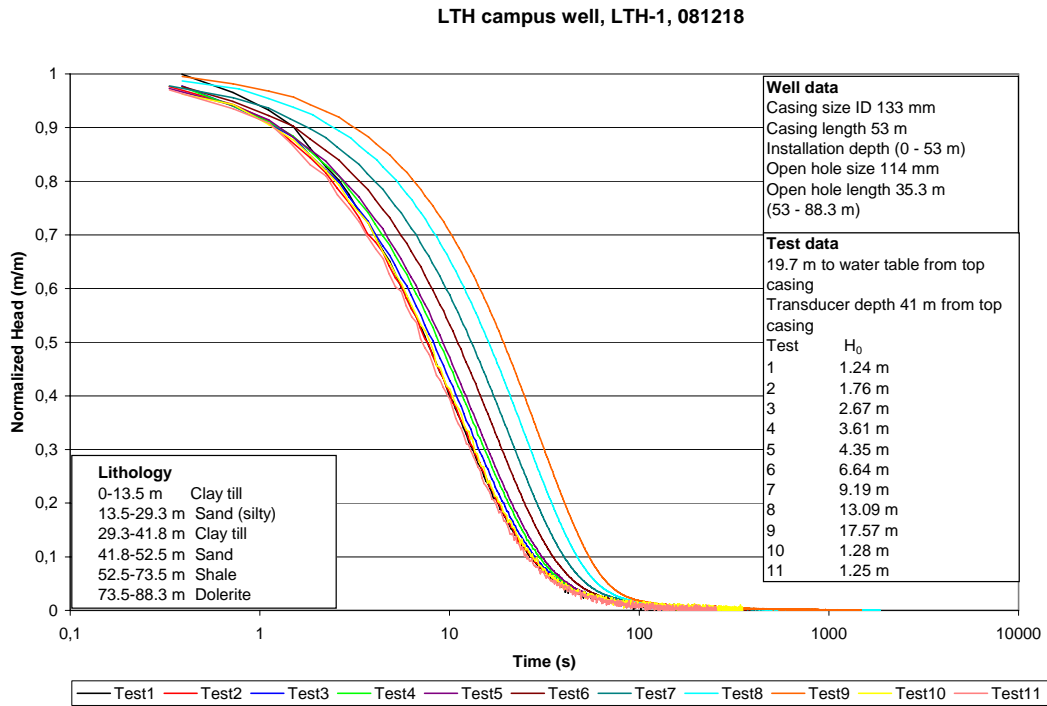

**Figure 23. A series of slug tests in LTH-1.**

In Figure 23 it can be seen that, as the initial displacement increases, the curves will be shifted in time towards the right of the figure, an indication of non-Darcian flow losses. In addition, the first test can be reproduced at the end of the testing (see Figure 24), which eliminates the possibility of the influence of a dynamic skin. It is notable in Figure 23 that the separation of the curves starts to become evident at the curve corresponding to Test 6, indicating that a smaller initial displacement than the one used for Test 6 should be used to avoid the separation of the curves or, in other words, to minimize non-linear flow losses.

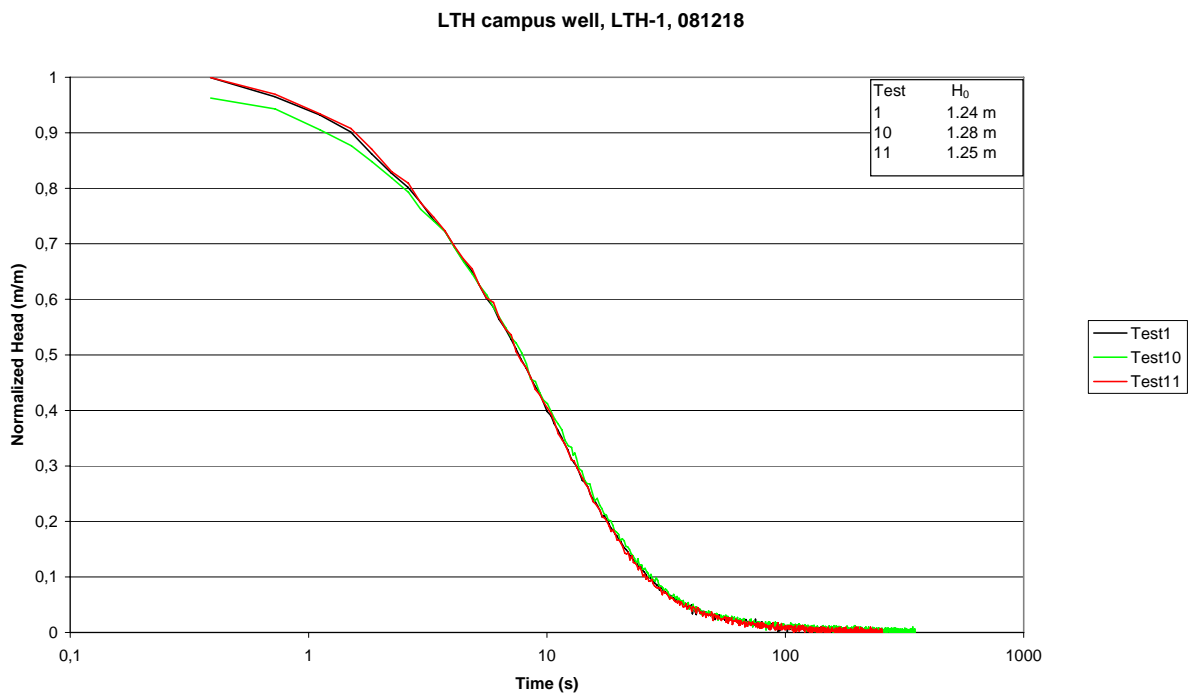
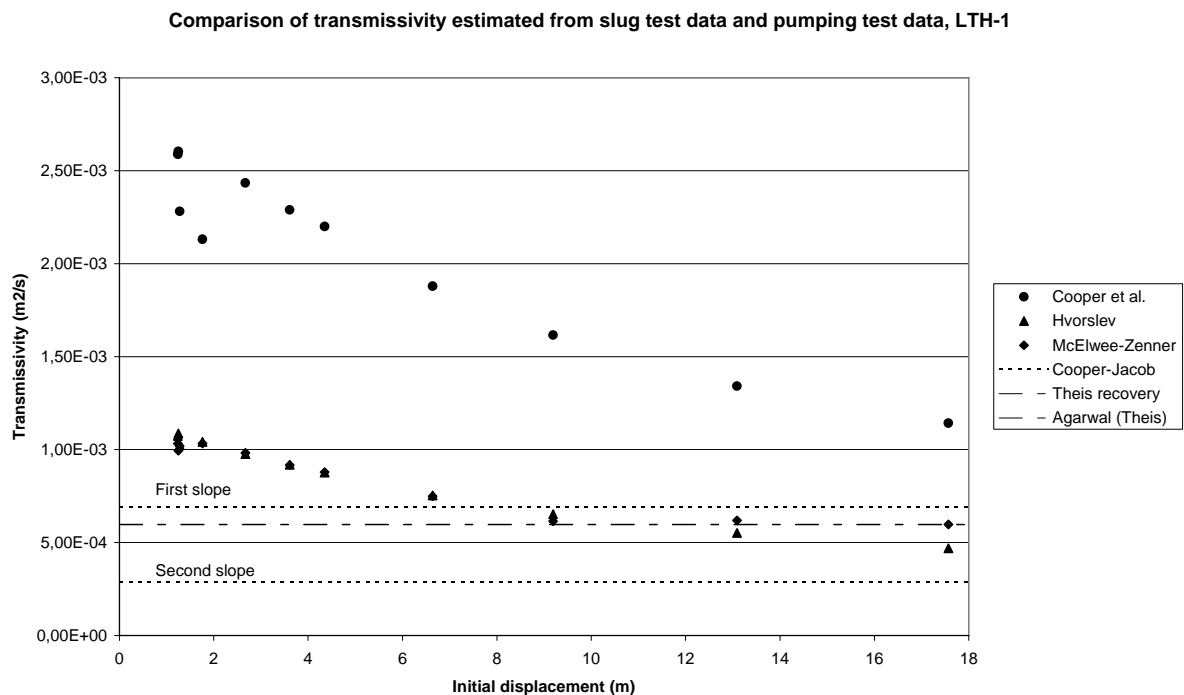

**Figure 24. Great reproducibility of the acquired data for LTH-1.**



### 3. Slug tests - Results

Transmissivity is estimated using the Cooper et al. (1967), Hvorslev (1951) and McElwee and Zenner (1998) solutions (see Figure 25). In Figure 25, transmissivity estimated from drawdown and recovery data is also presented. The pumping test lasted around 11 hours, using an average flow rate of 33 l/min, and the well recovered after around 3 days. The drawdown data was evaluated using the Cooper and Jacob solution and the recovery data using the Theis recovery method, using Agarwal equivalent time in combination with the Theis solution (see Appendix 2). The pumping test data was generally more difficult to interpret and two different slopes, one dominating before and one after 20 minutes, can be used for the estimation. The corresponding transmissivity estimate using the respective slope is presented in Figure 25. Also included in Appendix 2 is the data matching from slug test number 9, using the three slug test solutions mentioned above. An interpretation of slug test number 10 using the Cooper et al. (1967) solution is presented for comparison in Appendix 2, since a good match could be achieved for tests like test 10 using small displacements. The opposite was obtained from a test such as test 9, using great displacements.



**Figure 25. Transmissivity estimated from slug test (dots) and pumping test (lines) data.**

The different slug test solutions yield similar transmissivity estimates from the tests using a small initial displacement of less than 6 m (see Figure 25). At initial displacement values greater than 6 m, transmissivity decreases more evidently with increased initial displacement, except for the estimates obtained from the McElwee and Zenner (1998) solution. This solution yields almost the same transmissivity for the three tests with the highest initial displacements. The highest transmissivity estimates are generally obtained using the Cooper et al. (1967) solution, but estimates from the other two slug test solutions are in better agreement with transmissivity estimates obtained from pumping test data. The McElwee and Zenner solution (1998) yields almost the same transmissivity estimate from the three tests with the highest initial displacement, as does the estimate from the Theis recovery and Agarwal method.

### 3.4 Discussion: sedimentary deposits

The tested wells located in sedimentary deposits have transmissivity estimates from an alternative hydraulic test method. In other words, transmissivity estimates from a series of slug tests can be compared with estimates from conventional pumping tests including recovery. In general, there is good agreement between estimates from one or more of the slug test solutions used, except for one of the wells. In this well, transmissivity estimates three times greater were obtained from the slug testing when compared with pumping test estimates. The slug test solution that yielded similar values as the pumping test is the one by Hvorslev (1951) and/or McElwee and Zenner (1998). However, identical values can be difficult to obtain since a different volume is influenced during the respective testing. For example, the cone of depression created during a pumping test propagates further away from the well as the duration of test increases. In general, the Cooper et al. (1967) solution yielded the highest transmissivity estimates and is also a solution which is less applicable when non-linear flow losses occur in the acquired data set.

For wells in the sedimentary deposits, the first test was generally reproducible, indicating that there was no influence of a dynamic skin. However, in some of the wells, the transmissivity decreased with increased initial displacement, which is an indication of non-linear flow losses. This was also the case when using the McElwee and Zenner solution for transmissivity estimation in one of the wells, a solution that considers non-linear influence. Despite this, the average transmissivity from a series of slug tests was close to the estimates obtained from the pumping tests. In LTH-1, great initial displacement of up to 17.6 m was used. The indication of non-linear flow losses became evident when the initial displacement was greater than 6 m. The increase of non-linear flow losses influences the interpretation, since more effort and time is required for the transmissivity estimation. This is an indication that a too high initial displacement should be avoided. However, a general maximum displacement is difficult to determine, since it will be different from well to well.

### 3.5 Results and discussion: volcanic deposits

The results and discussions concerning the testing in the large diameter wells located in volcanic deposits are presented in Paper 1. Transmissivity estimates from a series of slug tests in three different wells are presented in Paper 1, but only one figure showing the data matching is included in the paper. Therefore, as complementary information, an evaluation of transmissivity/hydraulic conductivity from the last slug test in each well is presented in Appendix 2. Three solutions were used for evaluating the data acquired in Las Mercedes 12: Cooper et al. (1967), Hvorslev (1951) and McElwee and Zenner (1998). The tests in the San Cristobal well were evaluated using the Hvorslev (1951) solution and Cooper et al. (1967) was used for the interpretation of tests conducted in Veracruz Managua II.

### 3.6 Overall discussion for slug testing

Slug testing using pneumatic initiation was applicable in the three tested geological environments, sedimentary deposits, crystalline basement and volcanic clastic deposits. In general, promising results were obtained from a series of slug tests of small and large diameters, located in urban or remote areas. On average, two wells were tested during each day with up to eight tests in each well. More wells, except for those from low conductivity formations, can be tested during a day if the number of tests in each well is reduced, but a minimum value is that at least three tests shall be performed: two tests using the same initial displacement for checking the reproducibility and one using a higher displacement. Testing of several wells per day makes the method cost effective compared with other methods such as, for example, the conventional pumping test. In addition, slug testing is logistically easier to

### 3. Slug tests - Results

---

carry out, which also makes it more cost effective. The use of small diameter slug testing equipment makes it possible, in most cases, for one person to conduct the test.

A major advantage with slug testing using pneumatic initiation is that no water needs to be handled. This is a major issue at contaminated sites where it is hard to get permits for extracting or injecting water. For remediation purposes it is valuable to have information regarding hydraulic properties. In that case, pneumatic initiation will be suitable. Another issue is when large diameter wells are tested, for example, as in the 12" wells described in Paper 1. Great volumes of water would have been needed to carry out the testing if the series of slug tests in Las Mercedes 12, described in Paper 1, should be carried out by removing or adding water. In this case, a total volume of around 2.74 m<sup>3</sup> would have been required. This would have been a great volume of water to handle, which can be avoided by the use of pneumatic initiation. In addition, pneumatic initiation is also more applicable in large diameter wells than the commonly used solid slug, since a long slug will be required. For example, a solid slug with a diameter of 0.22 m and a length of 2 m is required for creating an initial displacement of one meter in a 12" well. Another advantage is that the pneumatic initiation method is also easier to apply in wells with a long distance from the top of the casing to the water table than the solid slug, or by removing or adding water.

One limitation with pneumatic initiation is that the water table must appear within the cased section to be able to pressurize the well. In other words, the method can't be used if the water table is located in the open part of the well or if the water table is located across a screened section. However, a small leakage in the casing or at the wellhead can often be compensated for by increasing the pressure from the scuba tank or the compressor. Another constraint is that an airtight coupling is needed between the slug test equipment and the well. Several airtight couplings are presented in Paper 1. However, this would not be such a major issue if the drilled wells are completed with a threaded casing at the top. In such a case, the coupling is just a threaded lid, thereby improving the suitability of the method. In other words, it would be simple to gain information regarding hydraulic properties but also important information about the casing integrity, i.e. if the casing or the casing joints are tight or not.

A series of slug tests or repeat tests have proved to be an important part of the testing. It will reveal information about the quality of the testing, such as, for example, if the series of slug tests yield similar results or not. The accuracy of the transmissivity estimate, for example, will increase if the same value is interpreted from several tests using different displacements. The importance of repeat tests were also seen during the testing of some of the wells located in the crystalline basement, where the first test couldn't be reproduced by the last test, despite the same initial displacement being used. This was an indication that the well has been hydraulically improved during the testing. Therefore, by the use of repeat tests, the influence of dynamic skin can be evaluated, or in other words, the well can be improved or clogged during the testing (e.g. McElwee and Zemansky, 2005). One issue during the testing, which was independent of the geological environment, was the occurrence of non-linear flow losses such as turbulence. It could be seen that, as the initial displacement was increased, the normalized head curve was separated in time and had a downward curvature in a semi-logarithmic plot, like the one used for Hvorslev's solution (see e.g. McElwee and Zenner, 1998; McElwee, 2002; Zenner, 2009). In other words, the normalized curves from a series of slug tests don't coincide, and the calculated transmissivity from a series of slug tests decreases with increased initial displacement, if evaluated with conventional theory such as Cooper et al. (1967). In addition, the first test could be reproduced with the last test and, due to this, the influence of a dynamic skin can be rejected as a possible explanation. In Appendix 3, it is

shown that turbulence can occur in three of the tested wells located in different geological environments and with different well construction. In the calculation it is assumed that non-Darcian flow will occur if the Reynolds number exceeds 10 (Freeze and Cherry, 1979). These are rough calculations, due to uncertainties including the fact that there are no additional measurements such as flow meter logging, revealing information about the downhole flow distribution. In other words, is the entire screen section or open hole section contributing to the flow, or is the flow restricted to a few intervals, which will yield higher formation/screen velocities.

The influence of the non-linear flow losses has been considered during the data analysis by applying the McElwee and Zenner (1998) non-linear solution. In general, a good match was found using the solution, but decreasing transmissivity with increased initial displacement was found even using this solution and comparing estimates from a series of slug tests, but this was not so pronounced as for the other solutions. Therefore, there must be additional parameters that are not considered by the McElwee and Zenner (1998) solution. The observed long casing depressurization times after slug initiation, especially for the large diameter wells, can be that kind of parameter with long casing depressurization times and non-instantaneous initiation of the slug. The start time of the test is selected after depressurization, meaning the selected start time doesn't coincide with the real start time. However, it is hard to distinguish the impact from the long casing depressurization times during the data analysis. Further work is needed to explain the observed non-linear characteristics in the data and there is ongoing research about non-linear influence. For example, according to a recently published paper by Zenner (2009), the impact of non-linear phenomena on slug tests is still not completely understood. In some cases, the non-linear flow losses can be ignored, if small initial displacements are used, which was shown for one of the tested wells, such as LTH-1 (Figure 23, Page 33), where non-linear influence became evident for displacements greater than 6 m. However, it is difficult to predict the maximum initial displacement that can be used during testing without the occurrence of non-linear flow losses. In practice, it is evaluated from the acquired data post-testing.

In general, the Cooper et al. (1967) solution, when applicable, yielded the highest value for transmissivity, independent of which geological environment the slug tested well was located in. The transmissivity estimate was also higher than estimates from pumping tests conducted in the same well. The other two commonly used solutions in this thesis, Hvorslev (1951) and McElwee & Zenner (1998) yielded estimates close to the estimates obtained from pumping tests, but often somewhat higher. This is notable as, in the case of Butler and Healey (1998), it can be found that estimates from pumping tests are generally higher than the ones from the series of slug tests. One possible explanation can be the uncertainties when converting transmissivity to hydraulic conductivity or vice versa. For example, the transmissivity estimated from Hvorslev (1951) and McElwee & Zenner (1998) is calculated by assuming that the entire screen or open hole is contributing to the inflow. In practice, this is not the case, as the transmissivity is overestimated due to the length contributing to the flow being less than what is used for the calculation. Another aspect when comparing estimates from pumping tests with slug tests is that different aquifer volumes are involved during testing, and therefore the same estimates can't be interpreted from the two tests. In addition, the slug test is more sensitive for near well disturbances than, for example, in a pumping test. As explained by Butler (1990), the influence from near well disturbances (e.g. skin) can be removed if the Cooper-Jacob (1946) semi-logarithmic method is used. Rovey and Cherkauer (1995) discussed the scale dependence in the estimates from pumping test and slug tests, but Butler and Healey (1998) reduced the scale dependence and explained the difference in the estimates as an artefact related to well installation and development.

### 3. Slug tests - Results

---

It is notable that transmissivity estimates from a series of slug tests influenced by non-linear flow losses are within the range of estimates from pumping tests, if the appropriate solution is chosen. In those cases, the best matching was obtained from the McElwee and Zenner (1998) solution, but even the Hvorslev (1951) solution revealed quite good estimates. Sometimes it is better use the simpler Hvorslev solution, since the McElwee and Zenner (1998) solution can be time consuming, especially when evaluating test data with vague non-linear impacts. For example, a match using the Hvorslev (1951) method can take in the order of seconds, compared with 30 minutes to 1 hour for a single test using the McElwee and Zenner (1998) solution.

The quality of the obtained data is important to add to the discussion regarding transmissivity estimates obtained from a series of slug tests compared with estimates from pumping tests. For some of the tested wells, the drawdown data couldn't be used for interpretation of transmissivity, due to bad data quality. The bad data quality can be caused by the fact that the flow rate was not kept constant. In addition, just a single flow rate value is available for the entire test duration. This value will be used later when interpreting the transmissivity from the recovery data. Another issue is, for example, related to the data acquisition and the resolution of the measurements. In the slug tested wells presented in Paper 1, step drawdown tests had been carried out with varying quality and many of the tests were omitted due to bad quality data. Therefore, it is important to consider the quality of the data before comparing two different hydraulic test methods and before evaluating which method reveals the most accurate and representative value for transmissivity. In addition, a major advantage with the slug tests is that a series of slug tests are conducted, compared with a single pumping test. The agreement of the estimates from the series of slug tests is a direct measurement of the quality of the testing. Another advantage is that a slug test is not as sensitive as pumping tests to external influences such as variations in barometric pressure, tides and nearby running pumping wells, due to the short duration of the test. Therefore less effort is needed to correct the displacement data obtained from slug testing.

The slug testing was conducted as a multi-well test at two different test sites, meaning that the response was also measured in an observation well. At one of the sites the observation well was located at a radial distance of around 8.2 m from the test well and at the other site the distance was around 15.5 m. Around 0.7-1% of the initial displacement used in the test well was measured in the corresponding observation well and the response was more evident for tests using the highest displacements. The screen/open hole diameter of the tested wells was different corresponding to the test wells with the shortest and longest distance to the observation wells, 0.14 m and 0.30 m, respectively. A ratio of 1.9 is obtained if the longest radial distance is divided by the shortest. A ratio of 2.1 is obtained if the largest diameter is divided by the smallest. In addition, the same magnitude response was measured in the different observation wells, specifically around 1% of the used initial displacement in the test well. By comparing ratios it seems like the influence of the slug test is proportional to the well screen diameter. This is shown in Sageev (1986), for example, where the normalized head is plotted against the dimensionless radius (radius of influence/screen radius) for different dimensional storage values (the same as  $\alpha$  in the Cooper et al. (1967) solution, see Equation 2.9). A similar approach is also presented in Karasaki et al. (1988). However, this means that if the dimensional storage is the same, the radius of influence is proportional to the screen/open hole radius. In the cases described above, there is a lack of information regarding the storativity. Therefore, a more detailed evaluation regarding the screen and the influence radius cannot be carried out at this stage.

## 4. Pumping tests

Pumping tests have been used for more than a century for aquifer evaluation (Butler, 2009). The first formulas presented for the evaluation of pumping tests were based on steady state conditions (Dupuit, 1863; Thiem, 1906) and are used for transmissivity evaluation. In 1935, Theis presented the first transient solution which also included storativity, an analogy of the heat flow theory used for the evaluation of pumping tests and recovery data in a confined aquifer. This was later called the founder of modern well hydraulics by, for example, Davis and DeWiest (1966). The Theis recovery method would at a later stage be known as the Horner method (1951) in the petroleum industry, used for the evaluation of build up data. However, the practical use of the Theis method was improved by Wenzel (1942), who also explained that the Thiem method could be used for transient steady state situations. In 1946, Cooper and Jacob presented an approximation of the Theis method which could be used for small  $u$  values. In 1955, Hantush and Jacob presented a solution for a leaky confined aquifer without aquitard storage and, in 1960, Hantush also included aquitard storage. In 1962, Ferris et al. described the image well theory used for hydraulic boundaries and, in the same year, Walton presented a curve-fitting method for leaky confined aquifers. In 1967, Papadopoulos and Cooper presented a solution that considered casing storage in large diameter wells. In 1972, Neuman presented a solution based on delayed water table response for unconfined aquifers, which was pioneered by Boulton (Freeze and Cherry, 1979), a method that, as recently as 2007, was expanded by Tartakovsky and Neuman to include the influence of, for example, unsaturated flow. In addition to the classic mentioned pumping test evaluation methods there are several more methods at hand, including, for example, partially penetrating wells, heterogeneity, multi-layered wells and skin effects. For more information about different solutions, the following the books about groundwater hydraulics are recommended; Brown et al. (1963), Bear (1979), Todd (1980), Heath (1983), Walton (1988), Kruseman and de Ridder (2000), Fetter (2001), Kasenow (2001) and Todd and Mays (2005). The petroleum industry's commonly used solutions can be found in, to name a few examples, Matthews and Russell (1967), Earlougher (1977) and Horne (1995).

The purpose of conducting pumping tests can be for the characterisation of hydraulic properties, such as transmissivity and storativity, as well as the spatial limitations of an aquifer. In other words, identifying hydraulic boundaries will reveal information on whether or not the aquifer is laterally bounded, as well as information on the layer above the aquifer being a confining or a leaky confining unit. However, pumping tests can also be carried out just for evaluating the conditions at the pumping well, often related to the productivity of the well. The mechanics behind a pumping test are the pumping of the well and the creation of a change in the water level, while measuring the change, drawdown or recovery in the pumping well and, if possible, in observation wells. Thereafter, the drawdown/recovery measurements are analysed.

### 4.1 Test equipment and preparations before testing

The preparations before a pumping test is carried out can be time-consuming and logistically complex. The necessary systems include a suitable pump or an air-compressor, a system for measuring the flow rate, as well as a system for measuring the displacement during the testing. In addition, requirements include a place where extracted water can be expelled during the testing, as well as observation wells if the purpose of the test is to estimate storativity.

## 4. Pumping tests

### 4.1.1 Submersible pump or compressor

A submersible pump is commonly used for conducting pumping tests and can be applied to both shallow and deep wells. In addition to the pump, a power supply is needed, which, depending on the required pumping power, can vary from a smaller generator to a power supply housed in a small container. It is preferable to use a speed-controlled pump for controlling a constant flow rate during the pump tests by varying the speed/frequency of the pump. Installation procedures become more complicated as the installation depth of the pump increases and a mobile crane is often needed for deep, large diameter wells. A detailed description regarding pump selection through, amongst others, the use of pump performance curves can be found in Driscoll (1986), Roscoe Moss Company (1990) and Culver and Rafferty (1998). However, an important consideration when selecting the pump and power supply is that it should be capable of operating continuously at a constant discharge for a period of at least a couple of days.

An alternative to a pump is an air-compressor and so-called airlifting. The procedure of airlifting involves an air-sub or an open-ended pipe being installed at a specific depth below the water table in the well (see Figure 26), with a compressor connected at the other end of the tubing from the air-sub. Thereafter, the water column is aerated, the water column becomes lighter and an outflow from the well occurs when the aerated water column reaches the top of the well. A more detailed description and information about required air-flows during testing can be found in Driscoll (1986). However, the operator must have some experience since it can be difficult to adjust the pressure and the airflow for obtaining a continuous outflow from the well, as opposed to removing slugs of water. The installation depth of the air-sub is dependent upon the maximum delivery pressure of the compressor, which must also include the friction losses in the pipe system.

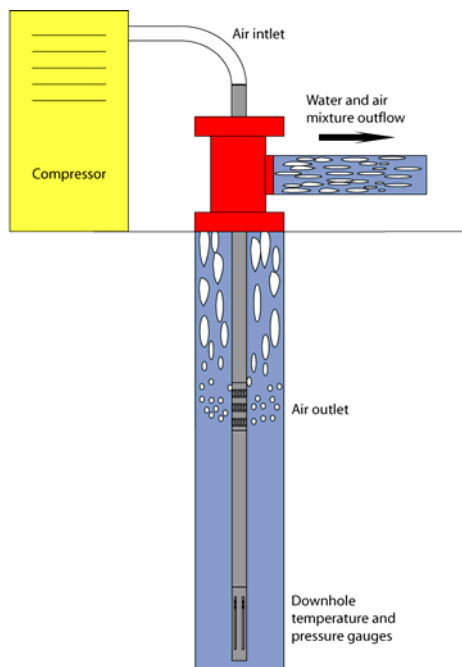
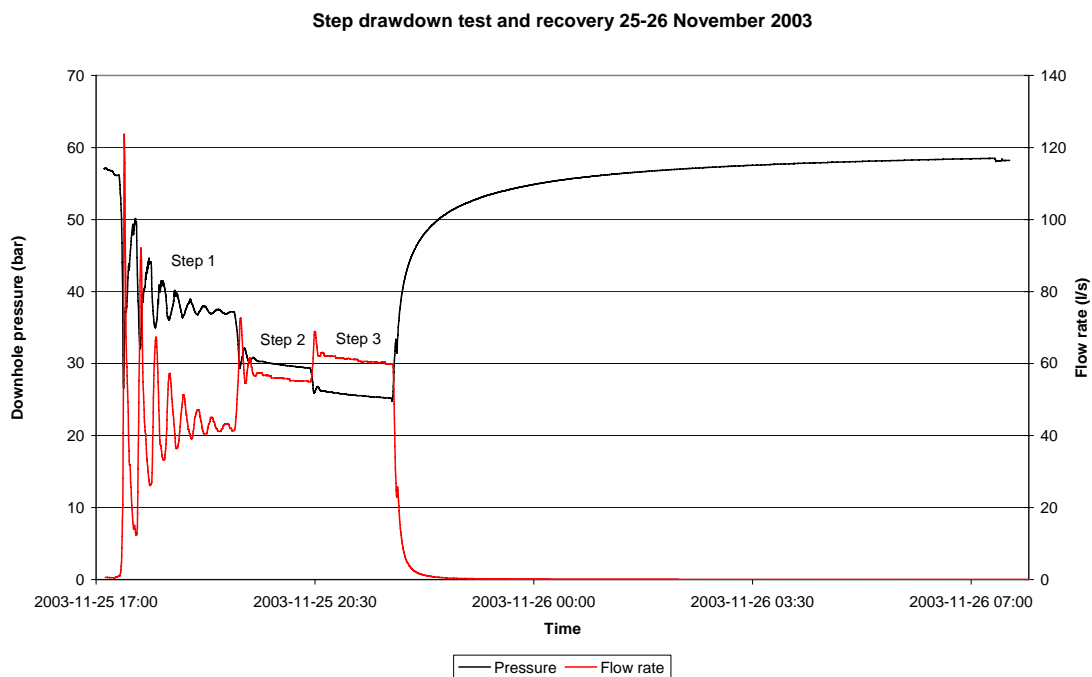

**Figure 26. Principle of the airlifting setup, including downhole temperature and pressure gauges.**

There is one advantage with airlifting when compared with using a pump, which occurs if the test is carried out directly after the completion of the well with a compressor being used during the drilling (e.g. rotary air or percussion drilling). In that case, the compressor can be used for conducting the airlift operation and consequently it is a cheaper option than renting a

pump. Airlifting can also be a useful tool in deep, large diameter wells as an initial hydraulic test method and thereafter the results from the testing can be used for selecting an appropriate pump if there is a need to, for example, conduct long term pumping tests.

Hydraulic tests using airlifting were used with satisfactory results during the testing of a deep well in Lund (Rosberg, 2007). The test setup used during the airlift operation is described in Rosberg (2007) and in Paper 2. In Rosberg (2007) there is also a comparison of tests using airlifting and conventional pumping. Airlifting was used in one of the wells (DGE#1) and a submersible pump was used during the testing of a second well (DGE#2). It was found that airlifting created a rapid drawdown in the well and needed sensitive adjustment of the air inflow, which resulted in undulations in the pressure and flow rate, before the optimal air inflow was found (e.g., see data acquired during first step in Figure 27). Thereafter, during step 2 and step 3, the pressure and flow rate measurements are more stable. The drawdown while using the submersible pump in DGE#2 was smoother and the pump was set for a constant working speed. In general, there are more perturbations in the data acquired during the airlifting than during pumping. Figure 28 shows an example of a well test using airlifting compared to a pumping test, with the corresponding flow rate fluctuating for the airlift but remaining more or less constant during the pumping test. The same conclusions regarding an airlifting and pumping test can be made from deep well testing in Malmö (DONG, 2003; DONG, 2006a; Bjelm and Rosberg, 2009). The aforementioned examples are from deep well testing, but the same evaluation could have been made in shallow wells with a smaller diameter.



**Figure 27. Downhole pressure and flow rate acquired during a step-drawdown test using airlifting.**



## 4. Pumping tests

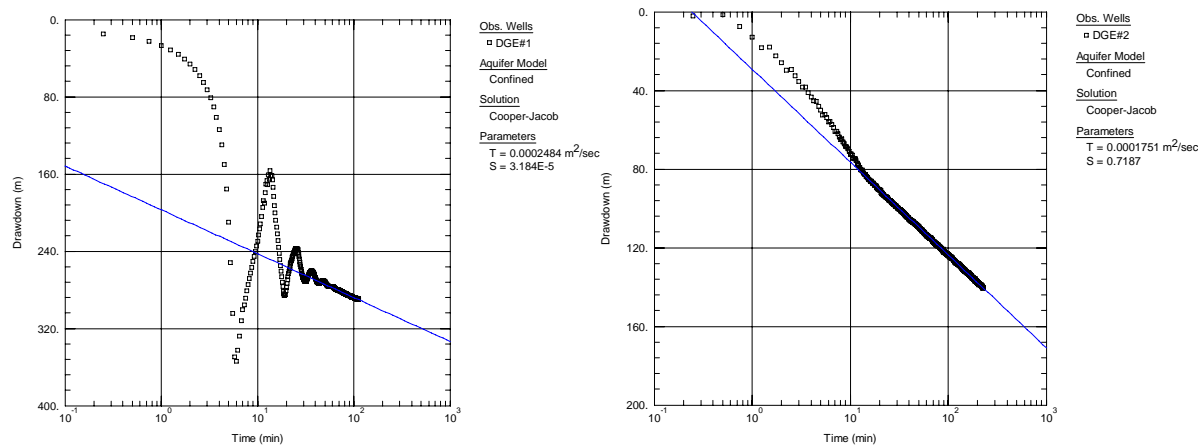

**Figure 28. Drawdown measured during an airlift (left figure) and drawdown measured during pumping test (right figure).**

### 4.1.2 Measuring and data acquisition system

The flow rate during a pumping test can be measured in several ways, ranging from a simple method measuring the required time to fill a tank with a specific volume, to more advanced flow meters with an electrical output based on different principles such as, for example, electromagnetism, mass or ultra sonic methods. There are several other intermediate methods using orifices, weirs and flumes or simple water meters. Basic books in hydromechanics are recommended for a more detailed description of the working principles and how to measure the flow rate; e.g. Franzini and Finnemore (1997), Vennard and Street (1982) and French (1994). In Rosberg (2007) two different setups for flow rate measurements are described. One is designed for airlift operation and the other one for a conventional pumping test. In addition, a system for measuring the flow rate is important when designing the airlift operation, stressing that the flow rate is measured at an appropriate position. The outflow from the well includes formation particles, water and air and, therefore, the flow rate measurements should be carried out at a point after which the formation particles have settled and the air has been released from the water.

It is preferable to use a constant flow rate during the testing, since it will simplify data analysis. However, in practice it can be difficult to employ a constant rate during testing. In such cases there are data analysis methods which consider a variable flow rate, such as the method by Birsoy and Summers (1980). In addition, continuous measurement of the flow rate during testing is recommended, which can be helpful for data analysis of the displacement data when separating formation influences from human induced flow rates due to, for example, adjustment of the flow rate. In some cases only a single value of the flow rate is presented for the entire test, obtained by dividing the extracted volume during the test by the duration of the test.

There are numerous methods at hand to measure the displacement during pumping tests, ranging from simple manual methods such as chalked steel tape, poppers and electrical tape to more advanced methods such as pressure transducers and memory gauges. The latter are preferred to the manual methods. However manual measurements shall not be ignored, since they form a good backup system and are useful for checking the accuracy of data acquired by the transducers or memory gauges. The advantage of a transducer is that real-time data from the testing can be displayed if a computer is connected to the data logger and, in addition, a gauged pressure sensor can be used. A disadvantage is that an external power and data logger are needed, so the setup is not always suitable for fieldwork. Advantages with a memory

gauge include the lack of need for an external power supply or data logger, but the disadvantages include no real-time display of the test data, data acquisition being restricted by the gauge memory capacity, as well as only absolute pressure readings being available. Another disadvantage is the fact that the proper functioning of the memory gauge can only be confirmed after the gauge has been removed from the well and the data downloaded. Today both methods can be combined, namely a memory gauge using a communication cable that can be connected to a handheld computer for displaying pressure readings. The acquired data is stored in the memory of the gauge, but during testing the values can be downloaded to the handheld computer. Another advantage is that the sampling rate can be adjusted during the test without removing the gauge, and that either absolute values or gauged values can be obtained if the communication cable is vented. Memory gauges with or without communication cable and pressure transducers can both be used for shallow wells, but for deep wells it is common to use memory gauges, which are installed at the reservoir level for measuring the actual reservoir pressure. However, the other measuring devices can also be used, if they are installed at shallower levels in the deep well, but, in that case, the displacement values have to be corrected for the non-isothermal conditions. These conditions occur when a reservoir is pumped with a higher temperature than the lower formation temperature at the installation point of the gauge (e.g. Follin, 1984). The temperature corrections for the displacement data are most critical in the beginning of the test, when the wellbore is warming up and, at the end of the recovery, when the wellbore is cooling down.

The sampling rate during a pumping test is not an issue nowadays, since great memory capacity is available. However, a general rule is to use a fast sampling rate during the beginning of the pumping test and during the beginning of the recovery, when the greatest displacement changes are occurring. The sampling rate is easy to change if a pressure transducer or a memory gauge with communication cable is used, allowing for adjustments during testing. When deciding the sampling rate, it is often better to have many measurements than too few, since the values can be reduced at a later stage. This requires less time than conducting a new test. Different sampling rate intervals during a pumping test can be found in, for example, Kruseman and de Ridder (2000), also used during the recovery. Another way to select the sampling rate is to acquire an equal number of values in each time log cycle, as time is plotted on a logarithmic scale during the analysis process (e.g. Boonstra, 1999).

#### **4.1.3 Disposal of extracted water**

Disposal of extracted water can be an overlooked issue. In urban environments the extracted water can be disposed into existing wastewater systems, assuming the groundwater is of good quality. However, this can be a time consuming procedure, as permits need to be obtained from authorities and/or the owners of the wastewater system. Permits are also needed for disposing of water in remote areas such as rivers or lakes. A common attribute for the different water disposal alternatives is to avoid disposing of water into the tested aquifer, which will have a negative effect upon the test data. However, in some cases the water quality differs markedly from the recipient, or the wastewater treatment plant may refuse to treat the water. One example of this is a case in Lund during the deep geothermal project, where the salinity of the fluid was around 14%, and the problems related to water disposal are described in Paper 2. The only option for disposing the extracted water from the flow testing of the first well was to dispose into pits at the drill site and, after completion of the test, inject it back into the different production zones. In other words, testing time was restricted by the available space in the pits. When the pits were full the test had to be terminated and no long term pumping test could be carried out.

## 4. Pumping tests

---

### 4.1.4 Observation wells

Observation wells are required if the purpose of the test is to estimate the storativity of an aquifer. In a case involving a single well (only the pumping well) test, the estimation of the storativity is difficult due to possible skin effects (see Appendix 4). A common situation is that wells near to the pumping wells are used as observation wells during testing. However, in that case the location of the wells will not be the best for the well testing, which can be an issue if, for example, the purpose of the testing is to verify the directional dependence of hydraulic properties within the aquifer. Another option, which is more expensive, is to drill new observation wells and make it possible to find the best location for the wells. Information on finding the ideal location for observation wells can be found in Kruseman and de Ridder (2000).

### 4.2 Data analysis

The first step in the data analysis is to identify different characteristic flow periods that occurred during the testing by using different time-drawdown plots. For example, in the case of radial flow three different flow periods can be identified. The first one is wellbore storage dominating during the earliest time response from a well test and the second is infinite-acting radial flow occurring as an intermediate time response. The third and final one involves the influence of hydraulic boundaries that can occur as a late time response of the well test. In Table 2, the graphical characterization of different flow periods are presented. The table is modified after Horne (1995) and, in addition, the characteristic of a specific flow period on a pressure/drawdown derivative plot is also included. Several diagrams can be found in Horne (1995), illustrating what is described in Table 2. However, Table 2 is an example of additional information that can be obtained from well testing. Information that can be useful for the latter part of the data analysis can include, for example, the selection of an appropriate solution for hydraulic property estimations.

Here follows a short explanation regarding the different flow periods in Table 2: *Infinite acting radial flow* is one of the most common flow regimes and is the basis for many of the well testing interpretation methods. In other words, the flow contribution during testing is radially distributed. *Wellbore storage*, an early time response, dominates part of the flow contribution and is from the storage in the well and not from the tested aquifer. *Bilinear flow regime* means that there is a linear flow within a fracture and linear flow into the fracture from the formation. *Linear flow regime* can be described like bilinear, but without the linear flow within the fracture. *Dual or double porosity behaviour* is a mixed response from, for example, porous matrix blocks and from fractures. *Spherical flow regime* can occur if the flow is concentrated towards a point, which can be the case for partially penetrating wells or limited entry completions. A *closed boundary* means that the aquifer is closed on all sides, and when the cone of depression reaches all the sides pseudosteady state conditions will occur. In the case with an *impermeable boundary* there is a single boundary acting as a barrier, while in the case of a *constant pressure boundary* the boundary will act as a recharge boundary and steady state conditions will occur.

**Table 2. Schematic representation of flow periods that can occur during flow testing (Modified after Horne, 1995).**

<b>Flow period</b>	<b>Characteristic</b>	<b>Plot used</b>
Infinite-acting radial flow (drawdown data)	Semilog straight line (A flat region on the derivative plot)	Drawdown versus logarithm of time (s vs. log t)
Infinite-acting radial flow (recovery/build-up data)	Straight line (The derivatives trends against zero)*	Residual drawdown (or pressure if Horner plot) versus logarithm of time ratio (s' versus log ((t <sub>p</sub> +Δt)/ Δt))
Wellbore storage	Unit slope (A unit slope line plus a hump on the derivative plot)	Logarithm of drawdown versus logarithm of time (log s vs. log t)
Finite conductivity fracture (Bilinear flow)	Straight line slope ¼ (1) Unit slope (2) (Same on derivative plot)	(1) Logarithm of drawdown versus logarithm of time (log s vs. log t) (2) Logarithm of drawdown versus time <sup>1/4</sup> (log s vs. t <sup>1/4</sup> )
Infinite conductivity fracture (Linear flow)	Straight line slope ½ (1) Unit slope (2) (Same on derivative plot)	(1) Logarithm of drawdown versus logarithm of time (log s vs. log t) (2) Logarithm of drawdown versus square root of time (log s vs. t <sup>1/2</sup> )
Dual porosity behaviour	S-shaped transition between parallel semilog straight lines (As a minimum on a derivative plot)	Drawdown versus logarithm of time (s vs. log t)
Spherical flow (E.g. can occur for partially penetrating wells or limited entry completions)	Straight line slope -½ (1) Negative unit slope (2) (Same on derivative plot)	(1) Logarithm of drawdown versus logarithm of time (log s vs. log t) (2) Logarithm of drawdown versus inverse square root of time (log s vs. 1/t <sup>1/2</sup> )
Closed boundary	Pseudosteady state, pressure linear with time (As a steep rising straight line of unit slope on a derivative plot)	Drawdown versus time (s vs. t) Cartesian plot
Impermeable boundary	Doubling of slope on semilog straight line (As a second flat region on a derivative plot)	Drawdown versus logarithm of time (s vs. log t)
Constant pressure boundary (Recharge boundary)	Constant drawdown, flat line on all drawdown vs. time graphs (As a continuous decreasing line on a derivative plot)	Any

\* See comments in Horne (1995) regarding build-up data, e.g. it can be found that “build-up tests presents something of a challenge when it comes to interpreting derivative plots”.

### 4.3 Methods for data analysis

Today there are several solutions for analysing results from pumping and recovery tests, and many of these solutions are implemented in the most common aquifer testing software. The program used for analysing the pumping test data presented in this thesis is Aqtesolv Pro 4.5, which includes 35 different pumping test solutions. In Appendix 4 and 5 pumping and recovery solutions can be found that have been used most frequently during the analysis process; Theis (1935), Cooper and Jacob (1946), Hantush and Jacob (1955), Papadopoulos and Cooper (1967). The solutions developed are for homogeneous and confined or leaky confined aquifers of infinite areal extent. In addition, the skin effect, step-drawdown analysis and Agarwal equivalent time are also mentioned in Appendix 4 and 5. In general, the descriptions are summarized and, for a detailed description, the original papers or the earlier recommended books regarding well hydraulics (see Page 39) are recommended. The pressure derivatives have been used in this thesis to identify the flow regimes and, in that aspect, improved the matching of the drawdown data. However, a combined matching using drawdown type curves and derivative type curves hasn't been used (e.g. see Bourdet et al., 1989).

#### 4.3.1 Horizontal well analysis

According to Horne (1995), the most significant advance in the petroleum industry over the past decades has been the development of horizontal drilling techniques and it has therefore become important to interpret well tests in horizontal wells. Initially, horizontal well tests were analysed with conventional techniques designed for vertical wells (Kuchuk, 1995). However, horizontal wells differ from vertical wells and this is important to consider during well test interpretation. For example, the interval where the fluid enters the wellbore can be very long and the vertical permeability can be of importance since a considerable flow in the vertical direction, as well as different flow regimes, can occur during the testing (Horne, 1995). Different flow regimes are *Early and Late time radial flow*, *Linear flow* and *Hemiradial flow* (see Figure 29). The first flow regime is the *Early time radial flow*, during which there is no influence from the upper and lower boundary of the aquifer. This regime may not occur if the aquifer thickness is small or the anisotropic ratio ( $k_v/k_h$ ) is small. At Late time the upper and lower boundary is influencing the testing and the flow will be radial in the horizontal plane. Between the radial flow periods a Linear flow regime can occur. The flow regime may not occur in an aquifer with a great thickness. The last flow regime described in Figure 29 is the *Hemiradial flow regime*, when the well is located close to the upper or the lower boundary. It will occur between the early and late time radial flows. The pressure derivatives can be a useful tool for verifying the different described flow regimes (see Figure 30). However, in a real well test it is unusual to see all the flow regimes (Horne, 1995).

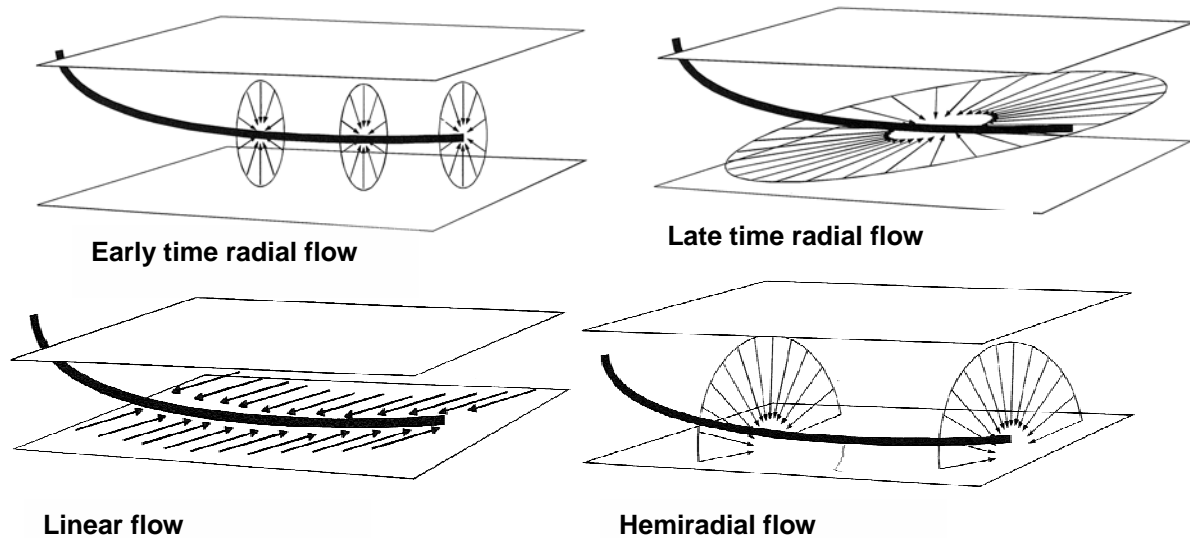

Figure 29. Different flow regimes that can occur during flow testing of a horizontal well (Horne, 1995).

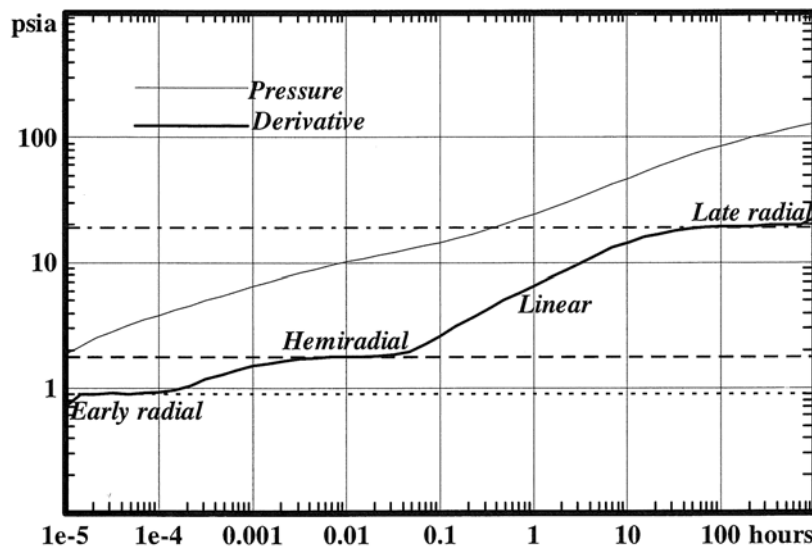

Figure 30. Example of pressure and derivatives from well testing of a horizontal well. The different flow regimes can be distinguished from the derivatives. In a real well test it is unusual to see all the flow regimes (Horne, 1995).

Transmissivity and storativity estimations can be made using the Daviau et al. (1988) solution. The original paper is recommended for a detailed description of the complicated equations, but in this paper the nomenclature commonly used in the petroleum industry is used. However, in Duffield (2007) the equation is expressed in the nomenclature commonly used in groundwater hydraulics. The required parameters for the solution are time drawdown data, flow rate, thickness of the aquifer, length of the horizontal well, position of the well and the location of an observation well. In Kuchuk (1995), the application of semilog analysis is described and it can be found that the transmissivity estimation for the late time radial flow is made by the same formula as for Cooper-Jacob (1946).

#### 4.4 Results and discussion

Results from pumping tests in shallow wells are included in Chapter 3. In this section results from deep well testing will be presented. Paper 2 is a part of this section. Results from deep well testing of two wells located in Lund have previously been described in Rosberg (2007). Therefore, in this thesis only new information concerning deep well testing will be presented.

## 4. Pumping tests

---

Results will also be presented supporting the use of a pumping test also as a pre-investigation method for different engineering purposes.

### 4.4.1 Results from deep well testing

In Paper 2, results are presented from well testing of a deep perforated well, DGE#1, with the issue being that transmissivity estimates from the drawdown data were around 1.7 to 2.8 times greater than the estimates from the recovery data. This issue was further described in Rosberg (2007), with additional information regarding a second deep well, DGE#2, which is a gravel-packed and screen completed well. However, in this well the transmissivity estimated from drawdown data was less than from the recovery data. This is a common situation since the flow rate during the recovery is often overestimated. There are two differences regarding the wells and the well testing conducted in each well, which can be used to evaluate the difference in the transmissivity estimates from the first well. The first major difference is the well completion; perforated or screened and gravel-packed. As mentioned earlier, the perforated well was the one yielding different estimates. The second difference is the fact that airlifting was used for DGE#1, the first well, and for the other well a submersible pump was used for testing. In order to distinguish the most likely explanation, other well tests were needed with information regarding well completion and well testing data. An attempt was also made to interpret the recovery data using another method than the previously used Theis recovery method. An Agarwal equivalent time and Theis type curve was used, but similar estimates were obtained as the ones presented in Paper 2 using Theis recovery method.

Additional information has been obtained from two deep perforated wells located in another part of Scania (DONG, 2003, 2006a, 2006b, 2006c). The wells are around 2100 m deep with production zones located below 1600 m consisting of sandstone belonging to early Cretaceous, early Jurassic (Zone A) and early/middle Triassic (Zone B). The flow testing was conducted using both airlifting and a submersible pump. The estimated transmissivity from the flow testing (drawdown data) and build-up (recovery data) carried out at the two wells are summarized in Table 3. More detailed descriptions of the parameters included in Table 3 as well as for the conducted tests can be found in Bjelm and Rosberg (2009). The estimated values of permeability have been compared with permeability values presented in Dong (2003, 2006a) and the estimates were generally in good agreement, with the exceptions often due to the selection of parameters such as, for example, the contributing thickness used for the permeability calculations. In other words, an independent quality control of the data analysis used for the flow testing and build up. In Table 3 alternating pumping + build up can be found in the test type column, meaning that pumping and build up were alternated three times during the test sequence. The maximum and minimum transmissivity obtained from the three pump tests are also presented. Only a single transmissivity value is presented for the corresponding build up tests, seeing as the different tests yielded similar results.

In Table 3 it can be seen that the transmissivity estimates from the flow test (drawdown data) are greater than the estimates from the build up (recovery data). In other words, that estimates are between 1.6 and 3.3 times greater than the estimates from the build up data. It is notable that a difference between the estimates is obtained, despite a submersible pump having been used for testing. Flow testing data obtained from the airlift operations was generally of bad quality, and consequently the data hasn't been used for transmissivity estimations.

**Table 3. Transmissivity and permeability estimation using flow test and build-up data from testing of two deep perforated wells.**

Well and Zones	Test type	T (m <sup>2</sup> /s) Flow test	K (mD) Flow test	T (m <sup>2</sup> /s) Build up	k (mD) Build up	Contributing thickness (m)	Test duration Flow
						Major production intervals	Test duration Build up
Well 1 Zone B	Airlifting+ Build up	Bad data quality	Bad data quality	$9.4 \cdot 10^{-5}$	133	42 m	12 hours
						1862-1890 m & 2050-2058 m	18 hours
Well 1 Zone A	Pumping+ Build up	$1.3 \cdot 10^{-3}$	7800	$7.9 \cdot 10^{-4}$	4800	10 m	14 days
Well 2 Zone A&B Test 1	Alternating Pumping + Build up (3+3)	$2.5 \cdot 10^{-4}$	214	$1.1 \cdot 10^{-4}$	94	69.5 m	Total 16 days
		- $3.7 \cdot 10^{-4}$	- 317			*	
Well 2 Zone A&B Test 2	Pumping + Build up	$1.8 \cdot 10^{-4}$	154	$9.5 \cdot 10^{-5}$	81	69.5 m	21 days
						*	14 days
Well 2 Zone A&B Test 3	Alternating Pumping + Build up (3+3)	$1.8 \cdot 10^{-4}$	154	$1.1 \cdot 10^{-4}$	94	69.5 m	Total 23 days
		- $1.9 \cdot 10^{-4}$	- 163			*	

\*Three major intervals seem to contribute to the flow in Zone A (2235-2255 m, 2345-2355 m and 2371-2375 m) and three major intervals contributing to the flow in Zone B (2518-2547.5 m, 2623-2625 m and 2696-2700 m).

From three of the four deep wells studied, transmissivity estimates from the flow testing are greater than estimates from the build up data. A common attribute for those wells is that a perforated well completion is used. Whether or not airlifting or a submersible pump was used for the testing can be excluded as an alternative explanation for the observed difference between the estimates. In other words, the most likely explanation is related to the perforated well completion. A possible explanation can be that the aquifer is compressed during the flow testing, and that some of the perforation tunnels located in the aquifer collapse. This causes the near-well permeability to decrease. Instabilities of perforation tunnels are attributed to the erosion of grains and/or chips from the perforation wall and from failure of the surrounding rock (Antheunis et al., 1976). In the case of unconsolidated sands, no perforation tunnels will be generated (Walton et al., 2002). For the studied deep well testing, great drawdown has generally been employed, in the order up to as high as 420 m of drawdown. The great drawdown directly affects the stress situation in the aquifer, with the associated reduction of the pore pressure leading to an equal increase of the effective stresses and therefore a compaction of the aquifer. According to Freeze and Cherry (1979), the volume reduction due to increased effective stresses in granular materials is entirely due to the rearrangement of the grains. However, if the perforation tunnels are collapsing during the flow test due to compaction, with rearrangement of the grains, the build up data will be obtained under



#### 4. Pumping tests

changed conditions in the aquifer, compared to when the flow test data was gathered. This can be a possible explanation for the difference in the transmissivity estimates obtained from flow test and build-up data. Collapsing of perforation tunnels are often described in the literature as in conjunction with sand production, where the stability of the perforation tunnels will decide if the well is to be sand-free during its productive life or not (Antheunis et al., 1976). Sand production is a major issue, since 90 % of the world's oil and gas wells are drilled in sandstone aquifers and 25 to 35% of the well will experience some degree of sand production (Walton et al., 2002). However, the collapse of perforation tunnels related to flow tests and build up data as described above is hard to find. Finally, the discussion regarding transmissivity estimates can be used to evaluate which of the estimates should have the highest priority; the one from the flow test or the one from the build up? In that case it should be transmissivity estimated from the build up data, as it is a measure obtained after a possible compaction of the aquifer and thereby yields a value more representative for the actual conditions within the aquifer. Additionally, there is no influence of pump induced fluctuations, for example.

New information about deep well testing is also the result of the communication test between the two deep perforated wells described in Table 3, for example. A communication test between deep wells is not so common, since it is more common for a single well test for deep wells. Additional information concerning the storativity can be obtained from the test, a parameter that is more often obtained from assumptions and calculations than from undisturbed measurements in an observation well during a well test.

A final communication test using the submersible pump was performed for Well 2 and Well 1, with both zones A and B open for communication during the testing. Well 2 was used as the pumping well and Well 1 was used as an observation well. The final communication test consisted of three pumping periods and three build up periods (see Figure 31). The average flow rate was 26.5 l/s.

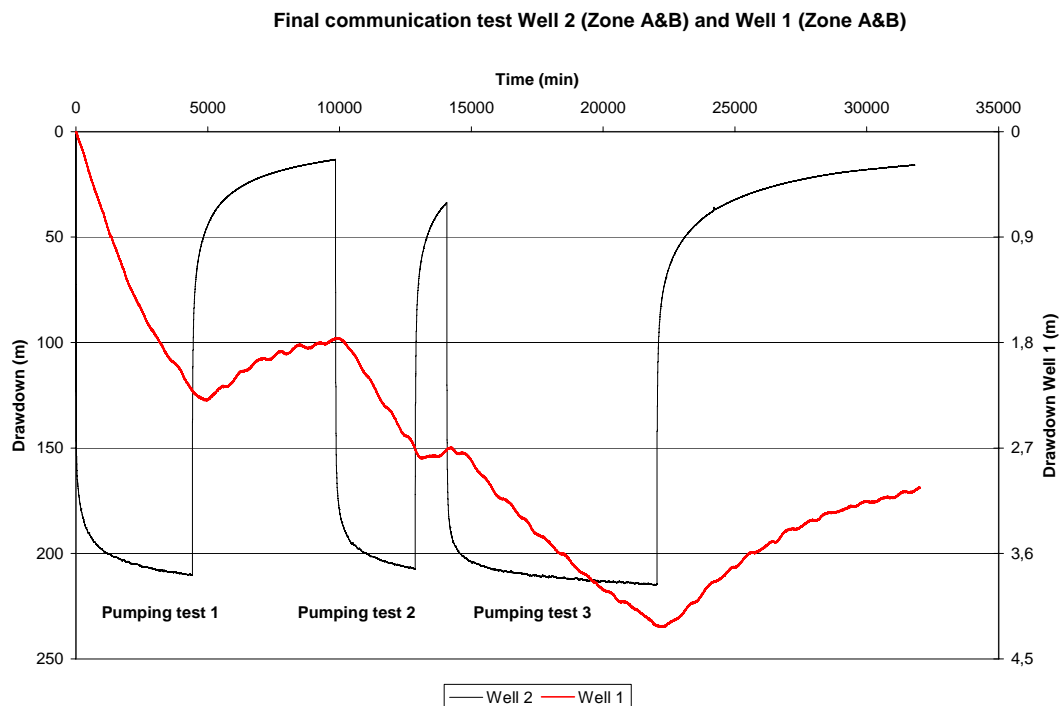

**Figure 31. Communication test between two deep perforated wells.**

In Figure 31 it can be seen that there was a response in the observation well during the testing. The radial distance between the production zones in each well is estimated to be around 1300 m. The estimated transmissivity from the pumping well, Well 2, is presented in Table 3 and called test number 3. Estimation of transmissivity and storativity from data acquired during the first pumping test is presented in Figure 32. The first pumping test is superior, since the test was conducted in a fully recovered aquifer. This wasn't the case for the two other tests. Tests initiated before an aquifer is fully recovered introduce uncertainties in the data analysis.

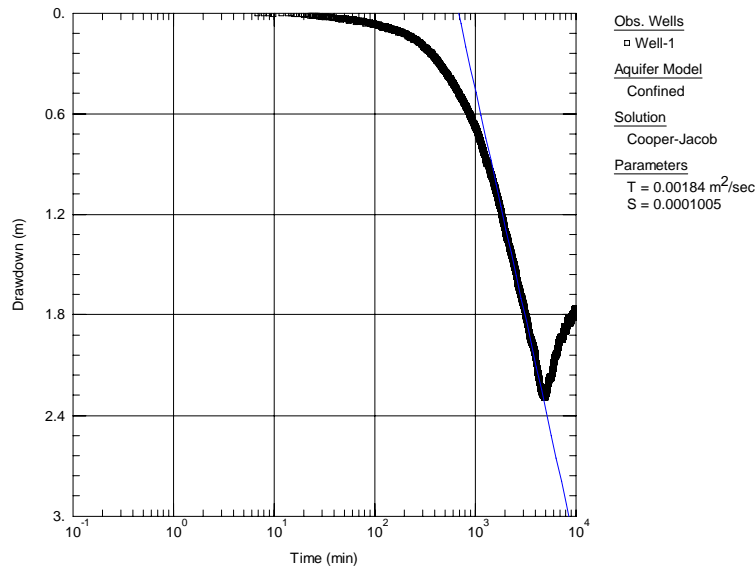
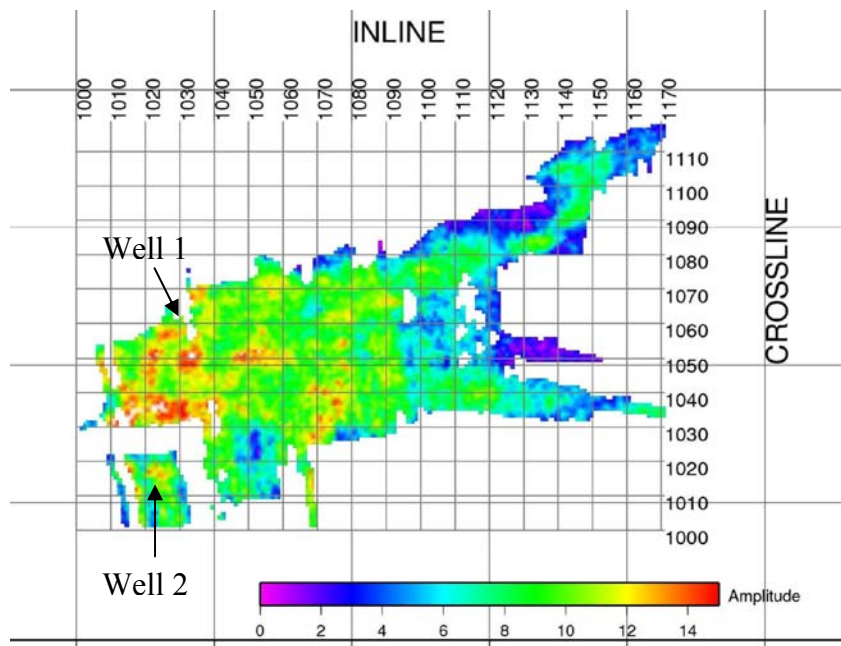

**Figure 32. Estimation of transmissivity and storativity from drawdown data acquired in a deep observation well.**

The transmissivity is estimated as  $1.8 \cdot 10^{-3} \text{ m}^2/\text{s}$  and the storativity as  $1 \cdot 10^{-4}$  from the data acquired in the observation well. A transmissivity that is much higher than the transmissivity estimated at  $1.1 \cdot 10^{-4} \text{ m}^2/\text{s}$  from the build up data is obtained in the pumping well. However, in the case of the single well testing of Well 1, high transmissivity values were obtained from the flow test and build up data compared with the data obtained in Well 2 (see Table 3). A possible explanation for the difference in transmissivity is heterogeneities within the aquifer. This explanation is hard to verify in deep wells using alternative methods. The only additional method that is available is the use of reflection seismic investigations carried out in the area by Juhlin (2009). In that report, 3D processing of the data was carried out and amplitude maps were presented. In Figure 33 an amplitude map shows the top of the tested reservoir. In the map, the highest amplitudes are obtained in the western part of the area, suggesting a higher porosity in this area (Juhlin, 2009). It can also be seen that there is a weak trend of increasing amplitude from Well 2 against Well 1, but there are gaps in the data close to Well 2, which introduces some uncertainties. However, the trend supports the higher transmissivity obtained from Well 1 than from Well 2.

The obtained storativity value of  $1 \cdot 10^{-4}$  is of the same magnitude as the one obtained in the Lund project, around  $2 \cdot 10^{-4}$  (e.g. Paper 2 and Rosberg (2007)). The main difference is that those values were estimated from an empirical formula and not interpreted from test data.

## 4. Pumping tests



**Figure 33. Amplitude map of the picked horizon at the top of the reservoir (modified from Juhlin (2009), with wells locations added).**

### 4.4.2 Test pumping as a pre-investigation method

In engineering projects such as, for example, tunnelling, pre-investigation is of vital importance for future progress of the tunnelling. There are several geophysical methods at hand with different limitations, but all of these methods must be verified from drillings. In other words, several wells will be drilled and therefore stratigraphic information will be obtained, as well as information concerning different water-bearing layers. However, information regarding hydraulic communication and the rock volume between the wells will not be obtained from the drillings. However, if pumping tests are conducted, additional information about hydraulic properties and boundaries can be obtained by using the existing wells. In other words, important information for precautionary efforts and modelling of possible impacts from the future tunnelling project can be obtained.

In the Swedish city of Helsingborg, a pumping test was carried out as part of the pre-investigation for new railway tunnels (Tyréns, 2007). At one site (Söder 1) five wells were used, namely pumping well PW (06.6.2002) and the four observation wells OW1 (06.1.2002), OW2 (06.6.2001), OW3 (06.6.2003) and OW4 (06.1.2009) (see Figure 34). The details about the tests and the pumping well have been described previously on Page 29. The results from the pumping test are presented in Figure 35, in the form of time drawdown data for the different observation wells.

In Figure 35 it can be seen that only two of the four observation wells responded during the testing, namely the closest well (OW1) and the well located to the north of the pumping well OW2. None of the wells located south of the pumping well respond during the testing, which indicates a barrier between the pumping well and the observation well to the south. In other words, valuable information is obtained just by studying the pressure response in the different wells. Thereafter, additional information about the hydraulic properties as transmissivity and storativity will be obtained from the interpretation of the acquired test data. Useful information for future tunnelling is gathered from the pumping test.

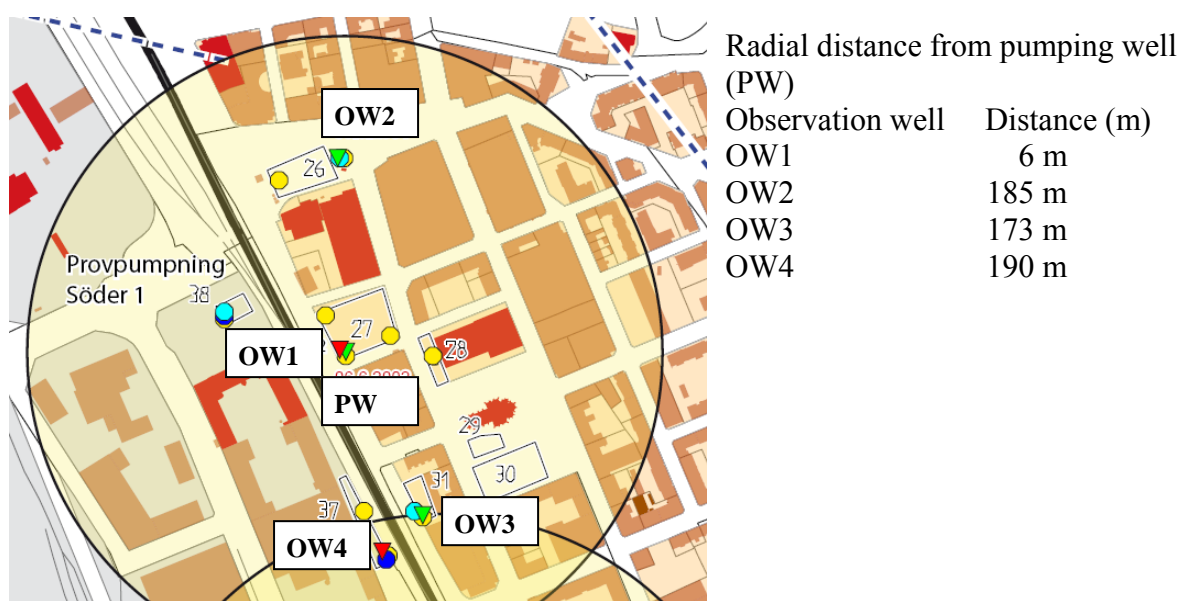

Figure 34. Test site including the pumping well and four observation wells. Wells indicated by triangles.

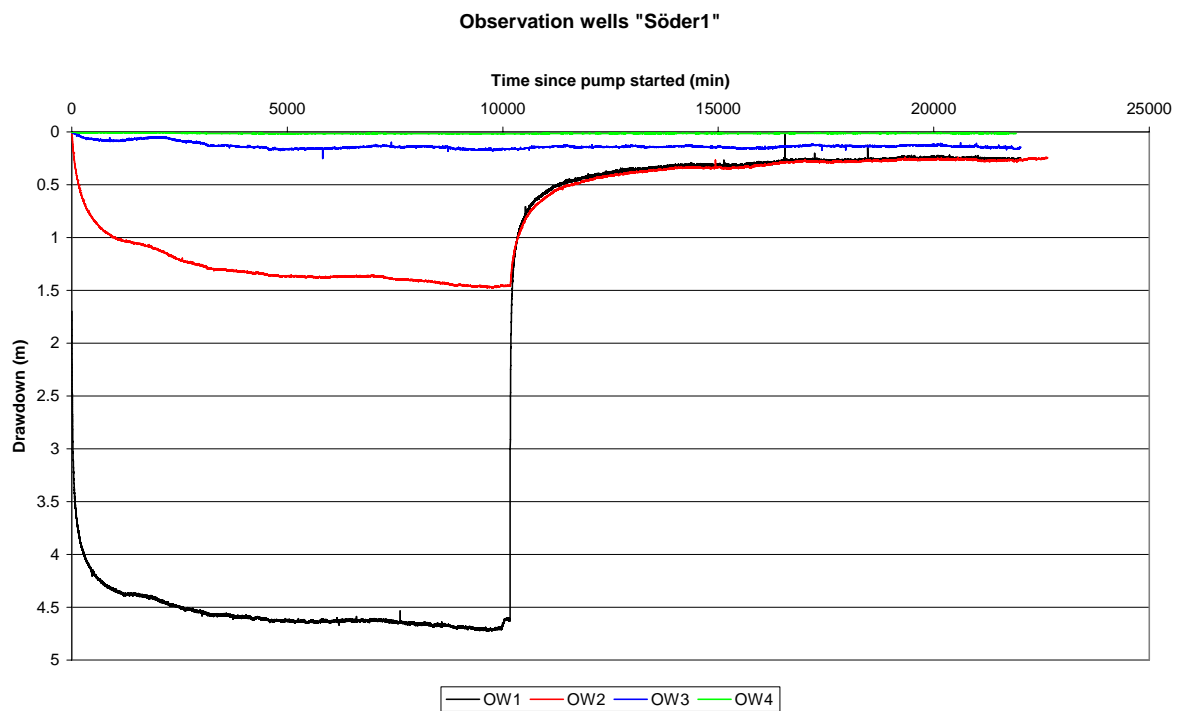

Figure 35. Measured pressure response in the observation wells during the well testing.



## 5. Injection tests

Injection tests have many similarities with pumping tests. The main difference is that water is injected instead of extracted. Injection wells can be used for different purposes, encompassing some of the following; water supply, groundwater control, solution mining, waste disposal and geothermal energy (Driscoll, 1986). However, the disposal of waste into an aquifer is of course dubious, but Hundley and Matulis (1963) have, for example, investigated disposal of chemical waste water into deep wells while avoiding contamination of a nearby river and the groundwater reservoir. A contemporary topic is the use of wells for the injection of CO<sub>2</sub> into deep aquifers. The purpose of the injection wells used in this thesis was for geothermal energy and for underground injections related to a tunnel project. All the injection tests have been conducted as open hole injection, meaning that no double packer setup has been used for the testing. In Gustafson (1986, 2009), information can be found regarding injection tests using packers.

The purpose of conducting injection tests can be the same as described for pumping tests, that is to hydraulically characterize the aquifer, such as the estimation of large scale hydraulic properties including transmissivity and storativity, and identifying the spatial limitations of the aquifer. However, injection tests can also be carried out simply for evaluating the conditions at the injection well, often related to the injectivity of the well. The mechanics behind an injection test is to inject fluid into a well and create a pressure change and to measure the changed pressure in the injection well and, if possible, in observation wells. Thereafter the pressure increase/pressure fall-off measurements are analyzed.

### 5.1 Test equipment and preparations before testing

The preparations before an injection test is to be carried out can be time consuming and logistically complex. A suitable injection pump, a system for measuring the injection rate and a system for measuring the displacement during the testing are all needed. Additionally, it can be necessary to design a system for treatment of the water before it is injected, avoiding clogging or precipitation in, for example, the screen or in the formation. Observation wells can also be used as a part of the test setup for evaluating the impact of the injection. The fluid can be injected directly through the wellhead or through a specific formation interval sealed off by packer(s). In both cases it is important that the wellhead or the packer(s) can resist the injection pressure during the testing and, therefore, these components have to be included in the test design.

Parts of the description for the pumping tests can also be applied for the injection tests. This can include, for example, information regarding the sampling rate and data acquisition system, with some exceptions, including pressure measurements, which are often conducted in a closed system such as in the case of measurements of the injection rate. However, if the injection pump is connected to a water tank, the decrease in the water level with time can be used for calculating the injection rate. The inflow to the tank must therefore also be considered in the calculations.

An example of an injection setup used for deep well testing is presented in Figure 36 and a more detailed description can be found in Rosberg (2007). Settling ponds were used for removing fine particles before the fluid was injected. A feed pump was used to get the required net production suction head (NPSH) for the injection pump. Another common way to obtain the NPSH is to create a pressure difference between the intake at the pump and the water level in the connected water tank. Ordinary flow meters were used for measuring the

## 5. Injection tests

injection rate and pressure transducers were connected to the wellhead and annulus. It is notable that the measured pressure in the wellhead also includes the friction losses in the casing, etc. However, in this case there was a large diameter casing and therefore the friction losses were low and could be ignored. In other words, the friction losses are inversely proportional to the casing diameter to the power of four ( $d^4$ ) and, therefore, it is more critical when the same injection rate is used in the case of small diameter casings. A memory pressure gauge installed at the reservoir level can also be used for measuring the injection pressure and, in that case, the friction losses will not be included. However, there are disadvantages associated with a memory gauge. For example, a long wire is needed for installation purposes and a lubricator or something similar is required at the well head for avoiding leakage around the wire inlet. In large diameter wells it is often common that the different casing dimensions are used for reaching the target depth and the spacing between two casing sizes is called the annulus. It is worth considering if it is possible to measure the pressure in the annulus during injection tests, since it is often a part that is sealed off from the tested reservoir. In other words, if the pressure is increased in the annulus it can be an indication of leakage along or through the casing (casing joints) and injection can therefore be carried out in other reservoirs besides the intended one.

### DGE#1 injection test system

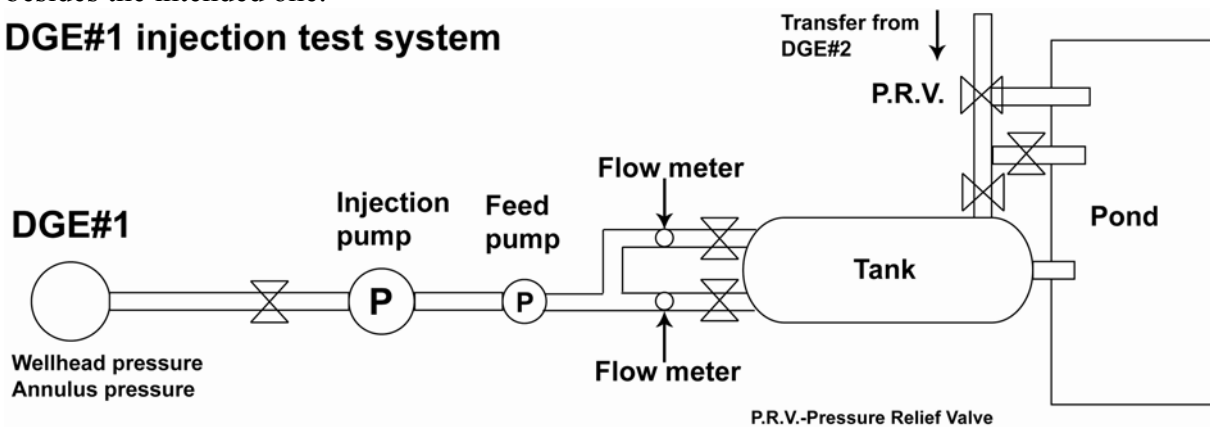

Figure 36. Example of an injection test setup designed for deep wells. It can also be applied to shallow wells.

In Paper 3 there is a description of an injection test setup used for underground environments. The different components for measuring the flow and pressure are included, as well as precautions using check valves for avoiding a backward flow from the formation. A major difference with an injection test in an underground environment compared with the surface is that a pressure higher than the aquifer pressure must be used for injecting the water. The system described in Paper 3 can easily be adapted to wells drilled from, as in this case, tunnel level, which have been verified in practice.

### 5.2 Data analysis

The equations presented previously for drawdown data and recovery data (see Appendix 4) can be used for data acquired during injection tests. The drawdown is substituted with injection pressure/pressure increase and the flow rate with injection rate. When the injection stops, the fall off of the injection pressure can be recorded - in the analyses the residual drawdown is substituted by the fall off of the injection pressure and the Theis recovery (1935) solution can be applied, for example. The equation described for the step drawdown testing can also be applied for evaluating step injection testing.

A disadvantage related to the data analysis is that solutions developed for pumping tests are used for evaluating injection tests, meaning that there are not so many solutions developed

directly for the evaluation of injection tests. When applying a solution developed for a pumping test evaluation to an injection test, it can be equivalent to say that the compression of the aquifer during pumping is equal to the expansion of the aquifer during injection. This is an assumption that is not always valid, since the values of compressibility and expansion can be different and in practice it can be more difficult to inject water than to extract it, such as in the case of a porous medium. In a fractured medium the opposite can be true, however.

### 5.3 Results and discussion

Paper 3 shows the results from an injection test carried out in an underground environment, namely inside a tunnel. A tunnel can be considered as a long horizontal well with a large diameter. The applicability of different test types and solutions for interpretation of the acquired data is described.

In Paper 2, as well as in Rosberg (2007), injection tests carried out in deep wells are described. However, new information concerning applicability and issues obtained during the testing and evaluation will be emphasized in this thesis. Generally, deep well testing methodology can also be applied to shallow wells.

An advantage with an injection test when compared with a pumping test is that it can be easier to apply to testing of a tight formation or a low permeability formation. In such cases it can be difficult to maintain a low pumping rate. One such example is the testing of the crystalline basement between 3198 and 3701.8 m in Lund (see Rosberg (2007) for details). The first flow test in the crystalline basement was carried out as an airlift operation, whereby the airlifting was conducted from two different depths and 19 airlifts were done in total (see Figure 37). The first part of the airlift operation was made from a depth of about 3690 m in the open hole section and the second part was made from a depth of 3100 m in the cased section. The variation in the standpipe pressure (SPP) in the air line and the responding water flow rate after each airlift has been plotted in Figure 37. No downhole pressure gauges were used during the operation.

It can be seen in Figure 37 that no consistent flow rate was achieved during the different airlifts, with slugs of aerated water lifted out of the well instead. The average flow rate produced during a specific airlift can be seen in Figure 37. It was calculated as the volume of water produced during each airlift divided by the time between the actual airlift and the previous airlift. The most common time between two airlifts was around 5 hours and 30 minutes. The total volume of water that was produced during the airlift operation was approximately 664 m<sup>3</sup>. However, the interpretation of hydraulic properties such as transmissivity is difficult using the acquired data.

The next testing of the crystalline basement was instead carried out as injection testing, applying an average injection rate of 2.75 l/s (see Figure 2 in Paper 2). By using injection instead of pumping, a consistent flow rate can be accomplished, which simplifies the estimation of factors such as transmissivity. The transmissivity could be interpreted from the fall off data using the Theis recovery solution, resulting in  $4.7 \cdot 10^{-7}$  m<sup>2</sup>/s for the first and  $5.2 \cdot 10^{-7}$  m<sup>2</sup>/s for the second fall-off test. Due to perturbations during the injection, only the fall off data were used for the transmissivity estimation. However, by changing the well testing method, additional information concerning hydraulic properties could be obtained for the low permeable formation.



## 5. Injection tests

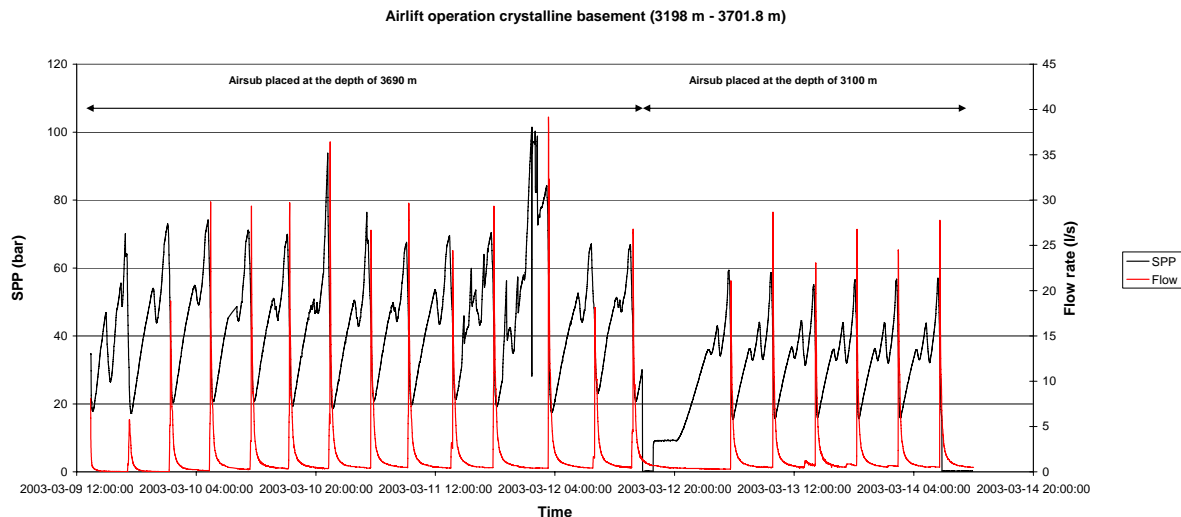

**Figure 37. Measured standpipe pressure (SPP) and flow rate during an airlift operation in a deep well. Note no consistent flow can be obtained during the testing, instead slugs of water are lifted out of the well.**

An issue that was described in Rosberg (2007) occurred during the injection tests carried out in the sandstone reservoirs of Cretaceous age. It could be observed that the injection pressure decreased and the injection rate increased during testing. Another observation was obtained by the data from the step injection test, whereby the specific capacity increased with an increased injection rate. A theory presented in Rosberg (2007) for the observations is that it was related to fractures in the formation. Further investigations were necessary to support or reject the theory. In this thesis, support for the fracture theory is considered through the use of a rock mechanical approach.

In the case of non-deformable fractures the employed injection rate will decrease with time if a constant injection pressure is applied. However, the opposite can occur if the fractures are deformable, as the fluid pressure is penetrating into the fractures. This decreases the effective normal stresses and leads to joint opening and a corresponding increased injection rate (Rutqvist, 1995). In Rutqvist et al. (2000), a classic hydraulic fracturing measurement is described with illustrations of the horizontal stresses occurring during testing (see Figure 38A). A common test yielding similar results can be found in drilling and completion technology. This is called a leak-off test or pressure integrity test/formation integrity test (Lin et al., 2008). The test is often carried out after the casing cementation and the casing shoe is drilled out, with the purpose of determining the least principal stress (minimum horizontal stress) (Zoback et al. 2003), and with a practical purpose for the borehole stability. A schematic of the extended leak-off test is presented in Figure 38. The maximum injection pressure is called the formation breakdown pressure, which is followed by the fracture propagation pressure and, when the injection is terminated, the pressure fall-off begins, which yields information concerning the fracture closure pressure. Methods for calculating the horizontal stresses from the injection test data can be found in, for example; Rutqvist et al. (2000), Haimson and Cornet (2003), Zoback et al. (2003) and Raaen et al. (2006). One way of finding the minimum horizontal stress is to use the shut-in pressure (see Figure 38A).

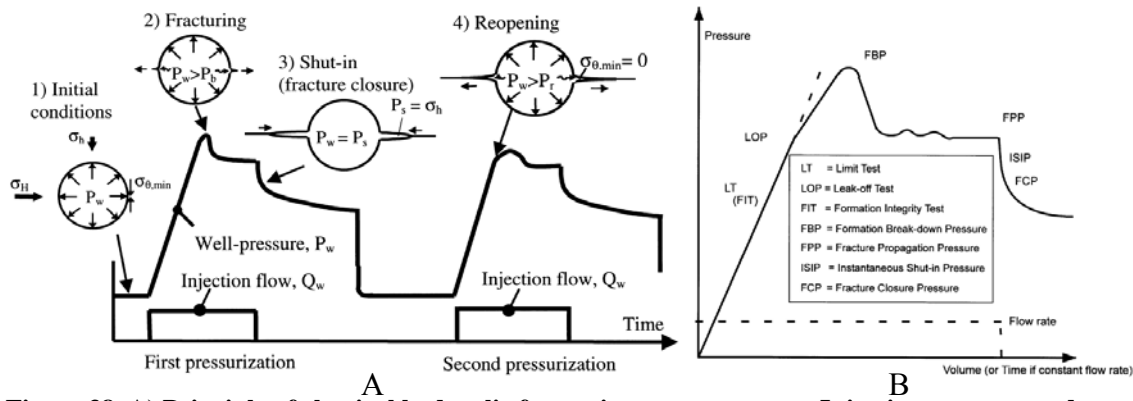

**Figure 38. A) Principle of classical hydraulic fracturing measurements. Injection pressure and rate plotted against time, as well as illustrations of the interaction between the well and a fracture including the horizontal stresses (Rutqvist et al., 2000). B) Schematic illustration for a leak-off test, including the nomenclature describing the different steps. Injection pressure plotted against time using a constant injection rate (Zoback et al., 2003).**

The theory described above can be applied to the injection test data presented in Rosberg (2007) and can be used for supporting the theory that fractures are opened during testing (see Figure 39). A formation breakdown pressure of around 68 bar (6.8 MPa) and a fracture closure pressure (minimum horizontal stress) of around 5 bar (0.5 MPa), a rough value, can be found in Figure 39.

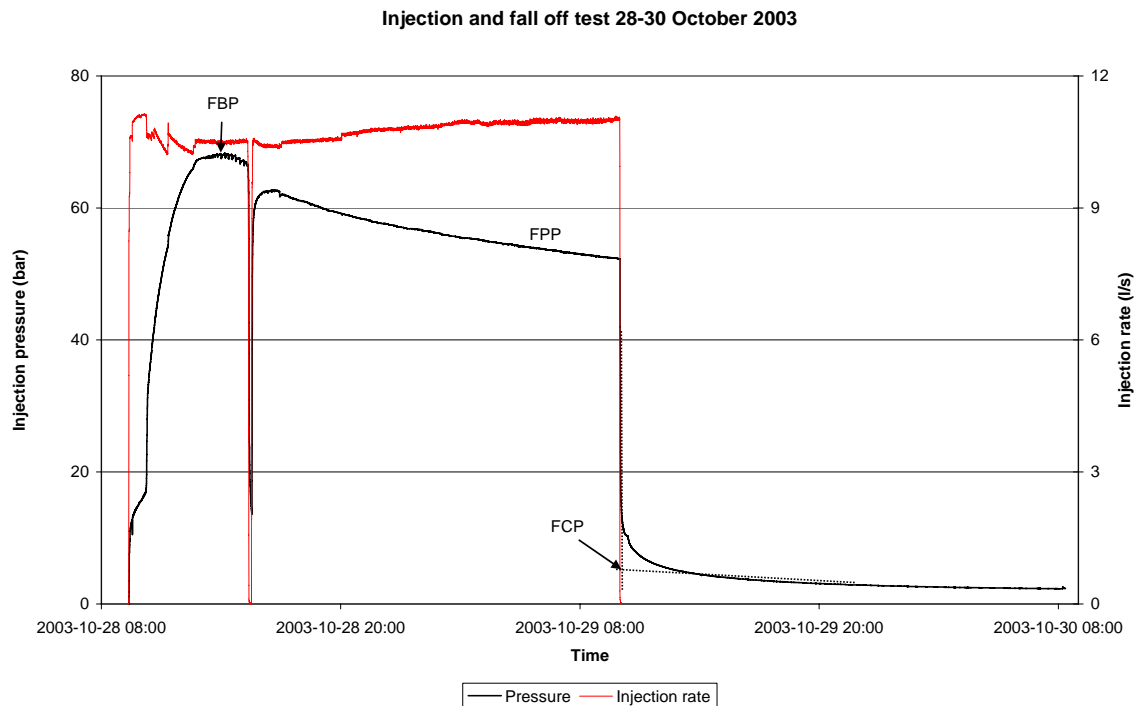

**Figure 39. The recorded injection pressure and injection rate during the injection and fall off test of the early Cretaceous sandstones at 1827-1840 m and 1895-1905 m. Formation breakdown pressure (FBF), fracture propagation pressure (FPP) and fracture closure pressure (FCP).**

The rock mechanical approach can also be used for explaining the observation during a step injection test, whereby the specific capacity (injection rate/injection pressure) increases with increased injection rate. The data from the step injection test is presented in Figure 40, and during the test both the early and the late Cretaceous sandstones were tested (see also Rosberg (2007)).

## 5. Injection tests

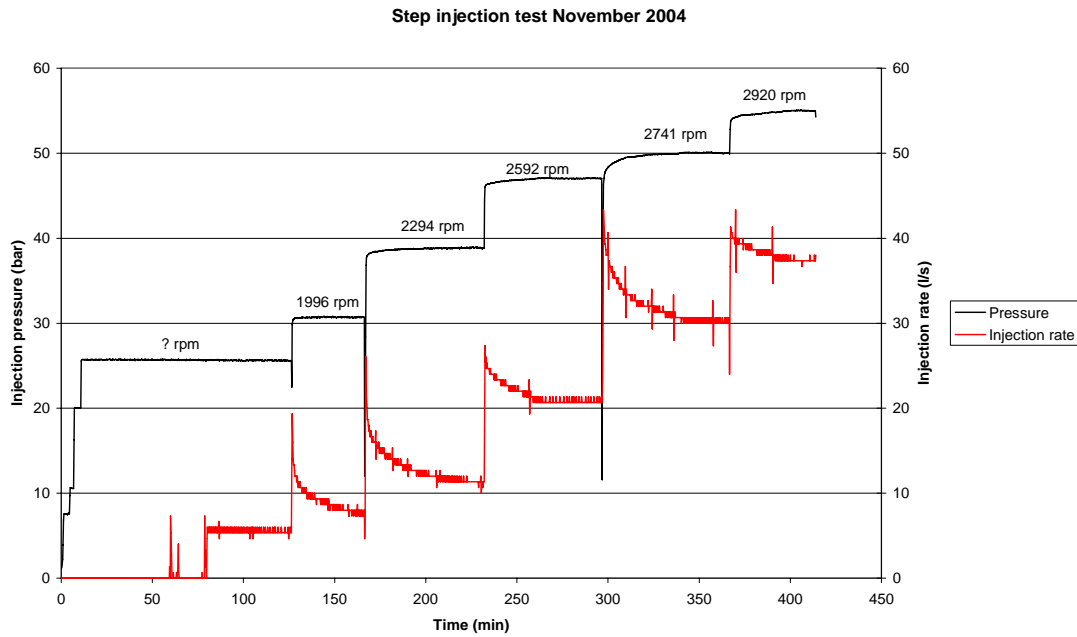

**Figure 40. Injection pressure and injection rate recorded during the different steps of the step injection test of the Early and Late Cretaceous sandstones.**

It is interesting to note the injection pressure and the injection rate recorded during the last four steps (especially the last three) in Figure 40. There is an increase in the injection rate of around 7-10 l/s and an increase of the injection pressure of around 3-9 bar. The extreme value is found between the fourth and the fifth step when the injection rate increases by 10 l/s, but the pressure increase is only around 3 bar. These observations support the theory that the injection rate increases due to influence of fractures that are opened during the testing. The pressure increase obtained during the last steps can be due to the fact that the friction losses are primarily increased through the perforations. A similar example as the one presented in Figure 40 can be found in Rutqvist (1995) for a hydraulic jacking test, with the explanation that the fractures are opening during the testing due to reduced effective stresses.

## 6. Well development

Well development is an important part of well completion and should not be ignored. In Tolman (1937) it can be found that "Proper treatment and development of a well often results in a safe production of 25 to 50 per cent than would hasty methods of development and in addition safeguard the future of the well, whereas careless or hurried work might result in a relatively early collapse of the casing". In the same book the following quotation from Meinzer (1929) can be found:

"If the water is obtained from hard rocks, the driller may have performed his entire duty when he has sunk the hole to required depth. If, however, the water occurs in beds of sand or other incoherent material the driller's work is not complete when he has made the hole, but only when he has far as possible, developed or finished the well in such a manner that it will yield a water supply without inflow of sand, silt, or clay and will remain in good period of years. The process of developing or finishing the well requires quite as much skill as the process of making the hole and if properly done, it may consume much time. A reliable driller will not leave a well in an unfinished condition or in a condition that will cause trouble in the future. However, if he is paid only a certain rate per foot for making the hole, he can hardly afford to spend much time in developing the well, and if he does so he is at a great disadvantage with his less scrupulous competitors." It is notable that today, around 80 years later, lack of well development is still an issue.

The term "well development" includes all procedures carried out to achieve the maximum flow rate at the highest specific capacity with minimum production of particulate matters. Well development has two objectives according to Driscoll (1986): 1. Repair damage done to the formation by the drilling operation so that natural hydraulic properties are restored. 2. Alter the basic physical characteristics of the aquifer near the borehole so that water will flow more freely to a well. There are several methods that can be used for well development, for example overpumping, backwashing, mechanical surging (includes swabbing), air development methods (include surging, blowing and airlift pumping), lifting with nitrogen and jetting. Techniques such as the use of acid, explosives and hydrofracturing are other well development methods, but are primarily used to stimulate the aquifer. A description of the development methods and their applicability can be found in Driscoll (1986) and Roscoe Moss Company (1990).

The need for well development is generally important to consider before conducting the final flow test of a well, especially when conducting a single well test, where the influence of nearby well disturbances can make the interpretation of the aquifer properties more difficult. Therefore, whether it is a pumping test or a slug test the interpretation of the data will be more difficult due to incomplete or ignored well development. Well testing methods can also be considered as being well development methods, since fine formation particles or drilling-induced particles can be removed during the testing by the inflow towards the well. However, this is not valid for a falling-head slug test, since there is an outflow from the well.

Well development and its importance is described in Paper 4. The applicability of the well development method used, jetting using coiled tubing and simultaneous pumping, is described for a deep gravel-packed and screen completed well. In addition, the interpretation of aquifer and well parameters before and after well development is also considered in Paper 4. It can be seen that it is of great importance to have a fully developed well before conducting the final test in order to avoid misinterpretations, and for obtaining a representative estimate of the

## 6. Well development

aquifer properties. Information presented in Paper 4 can also be used for shallow wells. In general, well development in shallow wells is easier to execute than in deep wells.

It is also worth mentioning that there are several indicators obtained from the interpretation of pumping test data useful for identifying the need for well development. The influence of wellbore storage and a high positive skin factor are such indicators. Another indicator is if the drawdown starts to decrease during the testing (see Figure 41). An example of this is a well that is being cleaned during the testing. A fluid containing formation particles or residues from the drilling operation is also an indication that well development is needed.

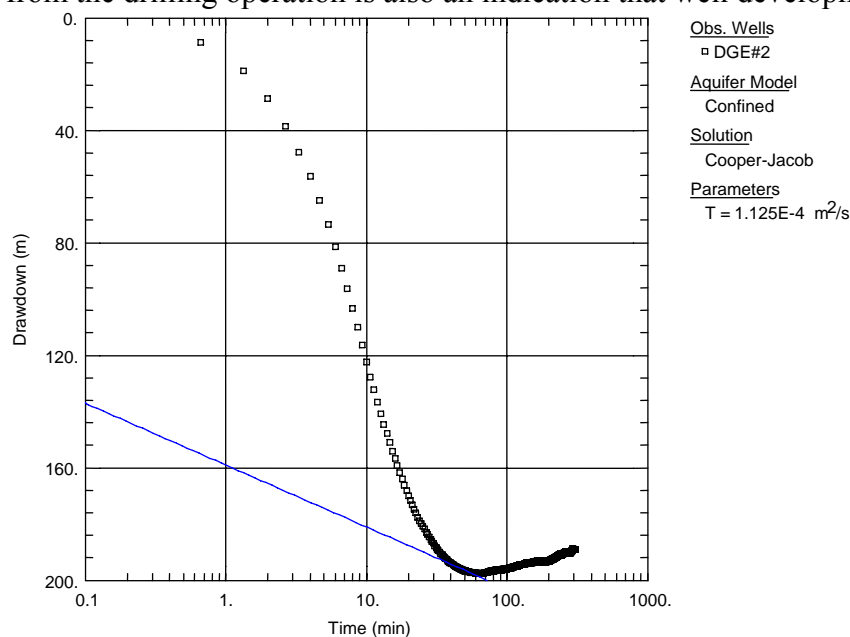
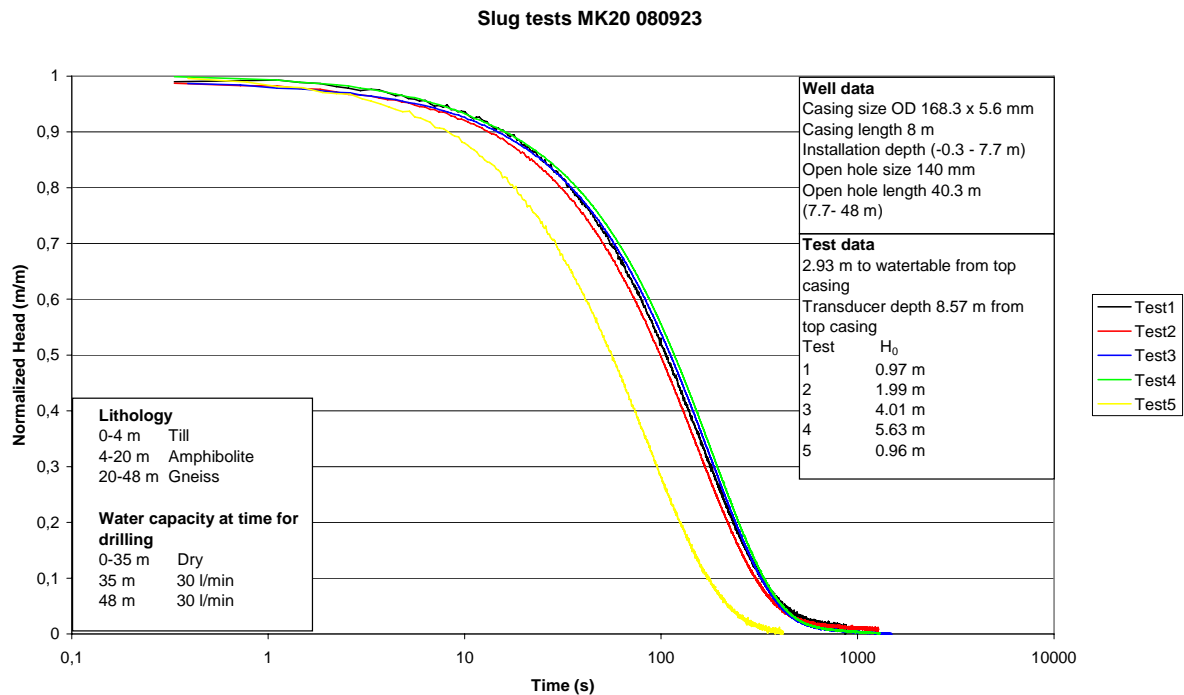

**Figure 41. Example of cleaning during a pumping test using a constant flow rate.**

In Figure 41 it can be seen that the drawdown curve is very steep in the beginning of the testing, indicating the influence of skin and wellbore storage. The presented transmissivity is estimated at  $1.1 \cdot 10^{-4} \text{ m}^2/\text{s}$  using the Cooper-Jacob (1946) solution, without considering the influence of wellbore storage. However, if the influence of wellbore storage is evaluated from the unit slope in a logarithmic diagram and a  $1 \frac{1}{2}$  log cycle rule applied, it will be found that the influence will last for around 250 minutes. In other words, any transmissivity value estimated earlier than this should not be regarded as a representative value for the aquifer. The conclusion is that the data should not be used in the well test analysis, but that the data can be used to evaluate well development needs. A general indication should be evidence of cleaning during the well testing. In such a case, well development should be considered before a new pumping test is conducted, in order to obtain properties representative for the aquifer.

It is well known that slug tests are sensitive for near-well disturbances (e.g. Butler (1998)). The need for well development can be found from repeat tests, as previously shown in Chapter 3 (see Figure 42). A series of slug tests are conducted and the same initial displacement is used for the first and the last test. Despite this, a faster test response is found for the last test when compared with the first one. In other words, the well has been hydraulically improved during the testing. This shows that the slug test method using pneumatic initiation is a type of well development method, since there will first be an outflow from the well during the pressurization and thereafter there will be an inflow to the well, after slug initiation. The improvement of the well directly influences the estimation of the

transmissivity, since a much higher transmissivity is obtained from the last test when compared with others (see also Figure 8 on Page 20).



**Figure 42. Example of hydraulic improvement of a well during slug testing.**

Well development is as important for injection wells as for other types of wells, from both a testing and production point of view. The major difference with an injection well compared with a pumping well is that impurities, fine material, organic matter and air are brought to the formation (Bear, 1979). Fine material can settle in the formation, thus reducing the permeability and dissolved contaminants can interact with the formation and create clogging. The air can also create clogging, as well as organic material which can start to grow on the well screen. Possible clogging during a constant rate injection test can be seen as a sign of continuously increasing injection pressure. However, an indication that must be separated from other likely explanations is, for example, negative hydraulic boundaries. A similar well development method, as described in Paper 4, can also be applied to deep screen completed injection wells. In some cases, simple methods such as conventional pumping or airlifting can be used, since there will be an inflow towards the well, removing fine material, et cetera. In other words, it can be described as a type of backwashing operation. However, it is important to consider well development before an injection well will be used for the first time. It is important to remove drilling induced particles and mud, which will otherwise be transported deeper into the formation during injection. In such a case, a possible consequence can be clogging.

## 6.1 Well integrity

The well integrity plays an important role for well testing and for later monitoring or production purposes. In other words, the well is a vital part of any well testing since the aquifer is accessed through the well. It is therefore important to check the final drilling report or other documents describing the drilling and completion of the well. This includes checking for information such as if the drilling operation has damaged potential production zones, such as that caused by mud invasion due to the fact that too great a mud weight was used passing these production zones. Useful information related to the casing installation and cementation

## 6. Well development

---

work can also be found from drilling reports, such as if the casing was damaged during the installation and if the entire casing completion was cemented or just partly cemented. In other words, can possible leakage through the casing and/or in the annulus occur during well testing? In such a case, other zones can be involved during the testing, additional to those usually expected. Information about the well completion can also be found, namely if it is an open hole, a screen or a perforated completion. The perforated well completion is the most common completion for deep wells. An issue with this completion is that the casing can be perforated over long distances besides the intervals contributing to the majority of the flow. In other words, possible leakage pathways can have a negative influence on the well testing, since the well test data can be a combined response of several intervals besides the one intended.

An interference test can be carried out to verify if there is communication between different production intervals having different geological origin, by, for example, using a packer for separating the intervals. Pressure gauges are installed above and below the packer and, by comparing the result, conclusions can be made about whether there is communication along the casing between the intervals or not. In other words, if the upper interval is tested there should not be any pressure response in the interval below the packer.

In addition, it is important to find the initial use of the well. For example, it could have been used as a production or a monitoring well. Generally, less well developing actions are carried out in a monitoring well when compared to a production well, in which well development is used to obtain a high production rate. Knowledge about the initial use of the well is also important if the well will be used for something else than for which it was initially drilled and finished. An interesting issue today is the use of wells for CO<sub>2</sub> injection (e.g. Haigh, 2009), such as in the case of wells initially designed for geothermal use or oil production. In such a case, information regarding the metallurgy and the cement used is important for evaluating possible corrosion or degradation caused by another fluid, such as CO<sub>2</sub>.

For abandoned wells that will be reused for another purpose differing from the initial use, the well integrity is of major importance. Information obtained from documentation as described above is important, but, in addition, the actual condition of the well may be even more important. To name but a few issues, the well could have collapsed, filled with formation material from earlier production or the casing can be corroded. To verify the actual condition of a well, borehole logging is useful. As a precaution it is advisable to use a dummy for the initial run, since one purpose is to find out if there are any obstacles in the well and tracking the actual depth of the well. Thereafter, calliper logging can be done to measure the diameter of the well, which can indicate corrosion or scaling or other damage in the well. In addition, there are numerous different probes that can be used for logging, but the selection will be based on the purpose of the logging operation (for more information, see e.g. Serra (1984)). Well design information important for well test interpretation will also be obtained from the logging, which is useful for a well with unclear or non-existing documentation about the well completion.

## 7. Discussion

The first issue in well testing is to determine the purpose of the testing, an important aspect for enabling the selection of the most suitable well testing method. The applicability of well testing methods for different situations and conditions are summarized in Table 4, as well as comments regarding limitations or requirements for each method. Technical constraints for applying the well testing methods are also included in Table 4. It is notable that several of the conditions have to be considered for selecting the most appropriate well testing method. For example, four aspects from Table 4 have to be considered when an appropriate well testing method is to be selected for a deep, small-diameter well located in a remote area which is to be used for estimating the transmissivity.

In Table 4 it can also be seen that the three well testing methods are applicable and that all the methods are easier to apply in urban environments than in remote areas. The accessibility of the well, use of the existing power supply, waste water system or water supply are all examples which simplify testing in urban environments. However, in remote areas slug testing is most appropriate if properly designed, due to the fact that it is logistically easy to handle mobile and lightweight equipment compared with other methods. In addition, no water needs to be handled and no electricity is needed.

For some of the conditions in Table 4 one well test method alone is the most appropriate. For example, in the case of aquifer characterization the pumping test is assessed as the most appropriate method, since it provides information about hydraulic properties such as transmissivity, storativity, as well as information about the spatial limitations of the aquifer. The same information can be obtained from an injection test, but those tests are not as commonly used as pumping tests. A likely explanation is that the injection test is more complex, since great volumes of water are required for long term tests, as well as the use of a wellhead, a packer and often large, heavy duty pumps are necessary for conducting the test.

Information that is also important to consider when discussing the applicability of the methods is, for example, the slug initiation method or if a pumping test is conducted using a submersible pump or by using airlifting. These details are not included in Table 4, where the three well testing methods are presented in general terms.

A certain emphasis in this thesis is placed on slug testing using pneumatic initiation. This method is applicable for most of the conditions presented in Table 4. The method has a great advantage when compared both to other slug testing methods using an alternative slug initiation mechanism, as well as with other well testing methods, since no water needs to be handled. Additionally, the method is easy to use and can be handled by a single person, due to a design involving small diameter slug test equipment. The equipment is even easier to handle if the lightweight packer is used as an airtight coupling. Testing of several wells per day also makes the method cost effective when compared with other well testing methods. However, referring to some of the conditions presented in Table 4, the applicability of the method can be restricted in large diameter wells located in high conductivity formations. A consequence of such a case can be that long depressurization times influence the majority of the acquired data, making the data useless for further interpretation. Long casing depressurization times can also restrict the use of the method in deep wells.



## 7. Discussion

**Table 4. Applicability of three well testing methods for different conditions and constraints.**

Conditions	Slug tests	Pumping tests	Injection tests
Aquifer characterization	No information regarding spatial limitations	Most appropriate	Applicable
Transmissivity estimation	Applicable	Applicable	Applicable
Civil engineering projects	Applicable. Most appropriate, if wells distributed over a large area	Applicable, especially if conducted as a multi-well test	Applicable
Well status control	Applicable if repeat tests are used. Information about casing leakage*	Applicable as a step drawdown test. Flowmeter logging useful support	Applicable as a step injection test Flowmeter logging useful support
Underground environment (e.g. Tunnels)	Not applicable **	Not applicable **	Applicable
Urban environment	Applicable Easy to apply	Applicable Facilitated by existing power supply and sewage systems	Applicable Facilitated by existing power and water supply systems
Remote areas	Applicable Appropriate initiation method important	Applicable Demands power supply and disposal of water	Applicable Demands power and water supply
Large well diameter	Applicable Appropriate initiation method important	Applicable, but often influence of wellbore storage	Applicable. Wellhead or packer design important
Small well diameter	Applicable Appropriate initiation method important	Applicable, but limits the selection of pumps	Applicable
Shallow wells	Applicable	Applicable	Applicable
Deep wells	Applicable Appropriate initiation method is important	Applicable Demanding installation of equipment. In general more complicated as the distance to the watertable is increased	Applicable Easy if injection through well head, more complicated if using packers
Tight formations/ Low conductivity	Applicable	Can be difficult to obtain a low pumping rate	Applicable
High conductivity formations	Applicable, requires high speed data acquisition	Applicable	Applicable
<b>Technical constraints</b>			
External Power supply	Not required	Required	Required
Water handling	Not required	Required	Required
Cost	Cheap	Expensive	Expensive
Logistics	Easy	Demanding	Demanding
Contaminated groundwater conditions	Most appropriate, since no water needs to be handled	Applicable, but dependent upon environmental conditions	Applicable, but dependent upon environmental conditions
Well development	Important	Important, especially single well test	Important, especially single well test
Availability of solutions for data analysis	Great variety	Great variety	Limited, but a great variety of solutions for pumping test are applicable
Corrections for external influences (e.g. variations in barometric pressure)	Can often be ignored, except for extremely slow formation response	Required	Required

\* Information about possible casing leakage if applying pneumatic initiation

\*\* The surrounding aquifer head level is higher than, for example, the tunnel level.

It is preferable to use a submersible pump when compared with airlifting for conducting a pumping test, since in general there are more perturbations in the data acquired from the airlifting. This is due to the fact that it is difficult to adjust the airflow from the compressor to obtain a constant flow rate. Influence from hydraulic boundaries, for example, can be difficult to identify in a time-drawdown plot, as a consequence of the perturbations in the acquired data.

The selection of a well completion method governs testing results, especially in deep wells. In a project with perforated well completion it was found that transmissivity estimates from the drawdown data were clearly greater than those estimates interpreted from the recovery data. In one case with a deep, gravel-packed, screen completed well, the opposite was observed. A possible explanation is that the perforations collapse during the testing and, because of that, different transmissivity estimates are obtained. In the case of deep well testing it is also obvious that the disposal of water can be a critical issue, which will finally limit the accessible time for testing. Water from deep wells often has high salinity, much higher than the freshwater recipients or aquifers used for water supply, making it difficult to dispose and treat at wastewater treatment plants.

Finally, Table 4 is useful for selecting the most appropriate method, as well as being useful for different disciplines. Well testing is often omitted based on erroneous assumptions such as the one that expensive and logistically demanding methods have to be used, despite the fact that simpler and cheaper methods are at hand. In general, costs for well testing are small in comparison with the costs of project delays, environmental impacts and damage. In other words, civil engineering projects can benefit from well tests and use the information for preventing unwanted delays, environmental impact and damage. This avoids costs that are essentially higher than the cost of the testing itself. Well testing also forms a basis for sustainability evaluation of groundwater resources. A critical issue in many countries is the overexploitation of the resources and a general lack of well test information. Information from new well tests is therefore beneficial and part of the solution for reducing the risk of overexploitation. Knowledge of the applicability of different well testing methods is also important and beneficial when designing deep well testing. This testing is often performed by an oil and gas service company at extremely high cost. In this case it is important to be able to evaluate whether or not the well testing solution suggested is the most appropriate and cost effective one for fulfilling the purpose of the testing.



## 8. General conclusions

It can be concluded that knowledge regarding the applicability of slug tests, pumping tests and injection tests, is essential for selecting the most appropriate method. The table of applications (Table 4) is a useful outcome of the thesis providing the engineering society with a set up of hands on conclusions and observations. In general, the well testing methods are applicable for different conditions (see Table 4) concerning well construction and the testing environment. However, it is necessary to compare advantages and disadvantages of the different methods for the actual conditions, in order to find the most appropriate well testing method. Two of the methods, namely pumping tests and injection tests, are logistically demanding, while the third one, slug testing, is easy to execute. Consequently, it is therefore also an inexpensive testing method, which is supported by the fact that several tests can be conducted in different wells during the same day.

Slug testing using pneumatic initiation has also been demonstrated as a good alternative to pumping tests, obtaining similar transmissivity estimates. An advantage of slug testing is that the transmissivity is estimated from a series of slug tests and not only from one single test, commonly used for a pumping or injection test. Slug testing using pneumatic initiation is often associated with testing in small diameter wells, but in this work it has been shown to be applicable in large diameter wells of at least up to 12" and, consequently, a suitable alternative to the other methods. A major advantage with pneumatic slug testing, when compared with the other methods is that it can be used for transmissivity mapping, simplified by the method's simple logistics. This is a useful approach if wells are distributed over a large area. Another advantage with the method, since no water handling is taking place, is its usefulness in cases involving contaminated ground or groundwater environments where water extraction or injection is prohibited.

Well development is also of great importance for any type of well testing, due to the removal of mud residues and debris from the drilling operations. Misinterpretation and underestimation of data and the use of non-representative values for the hydraulic properties of the aquifer can be a consequence of ignored well development. Well development is more complex and demanding in deep wells, but a hydrojetting system using coiled tubing with simultaneous pumping was found applicable, successful and time efficient for deep wells. When using slug testing, repeat test information can reveal well development needs. These needs are indicated when the result from a test can't be reproduced, despite identical initial displacements.

It has also been demonstrated that well testing methods are not only restricted to drilled wells. The methods can also be applied inside a tunnel with injection through the tunnel lining. The testing was performed as step injection and constant head/pressure tests and, in conjunction, the response from the testing was measured in observation wells drilled from ground level. Analytical solutions developed for vertical wells could be used to interpret hydraulic properties such as transmissivity, using injection tests performed at tunnel level, along with the pressure response measured in two of the observation wells.

Interdisciplinary values can also be obtained from a well test, found in this work through some of the injection tests. From such tests, groundwater engineers can interpret properties such as transmissivity, while rock mechanical engineers can interpret properties such as the minimum effective stress. Drilling engineers can use the information in a similar way for evaluating rock mass integrity, which can be valuable for planning new drillings. Another

## 8. General conclusions

---

spinoff example is the determination of the appropriate mud weight and mud pressure that can be used during the drillings without causing formation fracturing. One consequence of fracturing is unwanted mud losses and deeper mud invasion, resulting in formation damage.

## 9. Recommendations and future work

Due to practical and economical constraints, both deep well testing and testing by the pressurization of a complete tunnel-lining are uncommon. Consequently, the majority of the recommendations and future work that will be presented are related to slug testing using pneumatic initiation, since this method, in most cases, will be the easiest to perform for obtaining additional information.

I would like to propose the inclusion of slug testing using pneumatic initiation in Swedish geotechnical and environmental handbooks, such as SGF (1996, 2004). It is an initiation method that is often more suitable than methods currently included in the handbooks. I also suggest that slug testing using pneumatic initiation should be used as a pre-investigation method for different civil engineering projects such as tunnelling and cut and cover, amongst others. During civil engineering projects, several wells are drilled during the pre-investigation, but it is common for only a few of the wells to be test pumped. Using slug testing with pneumatic initiation is therefore an obvious opportunity for gathering information regarding hydraulic properties. This information is valuable for the conceptualization of the rock mass properties, which is subsequently useful for increasing the tunnelling progress. In addition, we can obtain useful information for flow modelling used for predicting impacts from the tunnelling.

In addition, the slug test method can be used in running projects, for example the Hallandsås railway tunnel project, where there today are around 400 groundwater monitoring wells, of which only a few have been test pumped. An advantage with the method in that case is that it can be used for transmissivity mapping of the area, which is useful input data for flow modelling. The test response time can be used instead of the transmissivity if, for example, the transmissivity is difficult to interpret for some reason. A long response time will indicate a formation of low permeability and a short time will indicate the opposite.

The pneumatic slug method could be put to even better use if drilled wells were to be completed with a threaded casing at the top, thus making it easy to connect the slug test equipment. In that case the coupling would just consist of a threaded lid. It would not only be easier to gain information regarding hydraulic properties of the well, but also important information about the casing integrity, such as tight casing joints. A consequence of a major leakage in the casing, within or above the casing interval where the water table is displaced, is the inability to conduct the casing pressurization. A possible improvement of the small diameter slug test equipment would be to add a small needle valve, used especially in tight formations. In that case it takes a while after pressurization to obtain readings corresponding to the initial conditions. Therefore, by opening the needle valve, the small overpressure can be adjusted and the readings corresponding to the initial conditions will be obtained faster. However, the usefulness of a needle valve must be investigated in practice.

Another recommendation regarding slug testing is to already compare results from the first and last tests in the field. No further testing is necessary if the first test can be reproduced by the last using the same initial displacement. However, if there is no reproducibility then additional testing can be necessary, since the well can have been hydraulically improved during the testing. The need for additional testing for obtaining a useful transmissivity estimate is more beneficial to verify before demobilization than after. In practice, this verification can be made using a handheld computer and/or a graphical procedure made by hand.

In this line of work there is generally a lack of hydraulic data obtained from an alternative well testing method for the slug tests conducted in the crystalline basement. Therefore, for comparative reasons, it is of great interest to conduct pumping/injection tests in the wells for evaluating the applicability of the slug test method used. It is also of interest to conduct new slug tests in the hydraulically improved wells, for verifying when the wells are fully developed. The new transmissivity estimate can then be compared with the previous obtained estimates. The accuracy of previous estimates can be evaluated from that comparison.

An issue in some of the slug tested wells, which was independent of the geological environment, was the occurrence of non-linear flow losses such as turbulence. Further work needs to be carried out for explaining the observed non-linear characteristics in the obtained data. This can be done by applying alternative non-linear solutions for the estimation of transmissivity, including the influence of long casing depressurization times or by using a new model approach. Finding a solution revealing consistent transmissivity estimates from a series of slug testing will also support the applicability of the slug test method.

It is also of interest to make use of the pressurization data acquired during the slug testing. In this thesis only data from “after slug initiation” has been used for transmissivity estimation, since it is a straightforward and simple procedure. However, uninterpreted data acquired from the pressurization is still at hand, which can reveal additional information of directional dependence of the estimated parameters. The flow direction during the pressurization is different from the direction after slug initiation, outflow from respectively inflow to the well.

No slug tests have been conducted in the deep wells still available in Lund, but several alternative tests, such as pumping and injection tests, have been carried out. Therefore it is of great interest to see if slug testing using pneumatic initiation is applicable in those deep wells. However, great volumes of air are needed because of the large casing diameter, which can cause long casing depressurization times. In practice, instantaneous slug initiation is difficult to obtain in large diameter wells.

Further investigations of the long term effects of injection through a tunnel lining are of great interest, revealing information about the injection pressure and rate possible for conducting a long-term injection operation. Another interesting long term is whether or not the injected fluid will re-enter into the tunnel. However, in reality it is difficult and expensive to perform additional tests as long as the TBM is in operation. It would also be of interest to evaluate how effective this method is for reinjecting groundwater compared with a more common injection method, such as injection through wells drilled from tunnel level.

---

## 10. References

- Agarwal, R.G., 1980. A new method to account for producing time effects when drawdown type curves are used to analyze pressure buildup and other test data, SPE Paper 9289
- Antheunis, D. Vriezen P.B., Schipper B.A. and A.C. van der Vlis, 1976. Perforation collapse: Failure of perforated friable sandstones, SPE Paper 5750
- Banverket, 2009. Personal communication regarding MK28.
- Barker J.A. and J.H. Black, 1983. Slug test in fissured aquifers, *Water Resources Research*, vol. 19, no. 6: 1558-1564
- Bear, J., 1979. *Hydraulics of groundwater*, McGraw-Hill, New York
- Bierschenk, W.H., 1963. Determining well efficiency by step-drawdown test, *International Association of Scientific Hydrology*, Publication 64: 493-507
- Birsoy, Y.K. and W.K. Summers, 1980. Determination of aquifer parameters from step tests and intermittent pumping data, *Ground Water*, vol. 18, no. 2: 137-146
- Bjelm, L. and J.-E. Rosberg, 2009. *Test of Carbon dioxide storage in saline aquifers in Malmö*, R&D report, Engineering Geology, LTH, Lund University
- Black, J.H., 1985. The interpretation of slug tests in fissured rocks, *Quarterly Journal of Engineering Geology*, vol.18:161-171
- Boonstra, J., 1999. *Well hydraulics and aquifer tests, The handbook of groundwater engineering*, Editor-in-chief Delleur, J.W., CRC Press LLC Boca Raton, Florida
- Bourdet, D. Ayoub, J.A. and Y.M. Pirard, 1989. Use of pressure derivative in well-test interpretation, *SPE Formation evaluation*: 293-302
- Bouwer, H., 1989. The Bouwer and Rice slug test-An update, *Ground Water*, vol. 27, no. 3: 304-309
- Bouwer, H. and R.C. Rice, 1976. A slug test for determining hydraulic conductivity of unconfined aquifers with completely or partially penetrating wells, *Water Resources Research*, vol. 12, no. 3: 423-428
- Bredehoeft, J., 2009. Maintaining high fluid pressures in older sedimentary basins, *Geofluids*, vol. 9: 179-181
- Brown, R.H., Ferris, J.G., Jacob, C.E., Knowles, D.B., Meyer, R.R., Skibitzke, H.E. and C.V. Theis, 1963. Methods of determining permeability, transmissibility and drawdown, Compiled by R. Bentall, U.S. Geological Survey, Water-Supply Paper 1536-I
- Butler, J.J., Jr., 1990. The role of pumping tests in site characterization: Some theoretical considerations, *Ground Water*, vol. 28, no. 3: 394-402
- Butler, J.J. Jr., 1997. Theoretical analysis of impact of incomplete recovery on slug tests, *Kansas Geological Survey*, Open-File report no. 97-59
- Butler, J.J. Jr., 1998. *The design, performance and analysis of slug tests*, Lewis Publishers CRC Press LLC, Boca Raton Florida
- Butler, J.J., Jr., 2009. Pumping tests for aquifer evaluation-time for a change?, *Ground Water*, vol. 47, no. 5: 615-617
- Butler, J.J., Jr., McElwee, C.D. and W. Liu, 1996. Improving the quality of parameter estimates obtained from slug tests, *Ground Water*, vol. 34, no. 3: 480-490



## 10. References

---

- Butler, J.J. Jr. and J.M. Healey, 1998. Relationship between pumping-test and slug-test parameters: Scale effect or artefact?, *Ground Water*, vol. 36, no. 2: 305-313
- Butler, J.J., Jr., Garnett, E.J. and J.M. Healey, 2003. Analysis of slug tests in formations of high hydraulic conductivity, *Ground Water*, vol. 41, no. 5: 620-630
- Chirlin, G.R., 1989. A critique of the Hvorselv method for slug test analysis: The fully penetrating well, *Ground Water Monitoring & Remediation*, vol. 9, no. 2: 130-138
- Cooper, H.H. Jr., Bredehoeft, J.D. and I.S. Papadopoulos, 1967. Response of a finite-diameter well to an instantaneous charge of water, *Water Resources Research*, vol. 3, no. 1: 263-269
- Cooper, H.H. and C.E. Jacob, 1946. A generalized graphical method for evaluating formation constants and summarizing well field history, *Transactions American Geophysical Union* vol 27, no.4: 526-534
- Culver, G. and K.D. Rafferty, 1998. *Well pumps, Geothermal direct-use engineering and design guidebook*, Editor Lund J.W., Geo-Heat Center, Klamath Falls, Oregon
- Daviau, F., Mouronval, G., Bourdarot, G and P. Curutchet, 1988. Pressure analysis for horizontal wells, *SPE Formation Evaluation* (Dec. 1988), SPE Paper 14251:716-724
- Davis, S.N. and R.J.M. DeWiest, 1966. *Hydrogeology*, John Wiley & Sons, Inc. New York, US
- DONG, 2003, *Final Testing Report FFC-1*, Geothermal project Malmö, Internal project report
- DONG, 2006a, *Final Testing Report FFC-2*, Geothermal project Malmö, Internal project report
- DONG, 2006b, *Final Well Report FFC-1*, Geothermal project Malmö, Internal project report
- DONG, 2006c, *Final Well Report FFC-2*, Geothermal project Malmö, Internal project report
- Driscoll, F.G., 1986. *Groundwater and Wells 2<sup>nd</sup> edition*, Johnson filtration systems Inc., St. Paul, Minnesota
- Duffield, G.M. 2007. AQTESOLV for Windows Version 4.5 User's Guide, Reston, Virginia: HydroSOLVE, Inc. Available at: <http://www.aqtesolv.com> (accessed December 7, 2009)
- Dupuit, J., 1863. *Études théoriques et pratiques sur le mouvement des eaux dans les canaux découverts et à travers les terrains perméables 2d ed.*, Paris, France
- Earlougher, R.C., 1977. *Advances in well test analysis*, Society of Petroleum Engineers of AIME, Henry L. Doherty Series, Monograph 5
- Erlström, M., 2007. *Uppdaterad konceptuell geologisk modell för Helsingborg*, Dnr 08-712/2007, Geological Survey of Sweden, (in Swedish)
- van Everdingen, A. F., 1953. The skin effect and its influence on the productive capacity of a well, *Transactions, AIME* 198: 171-176
- Ferris, J.G. and D.B. Knowles, 1954. The slug test for estimating transmissibility, U.S. Geological Survey, Groundwater note 26
- Ferris, J.G., Knowles, D.B. Brown, R.H. and R.W. Stallman, 1962. Theory of aquifer tests, U.S. Geological Survey, Water-Supply Paper 1536-E
- Fetter, C.W., 2001. *Applied hydrogeology 4<sup>th</sup> edition*, Prentice Hall, New Jersey
- Follin, S., 1984. *The application of well tests in a low-enthalpy reservoir*, Licentiate Thesis, LUTVDG, TVTG-1002:1-72, Lund Institute of Technology Department of Engineering Geology

- 
- Franzini, J. and J.Finnemore, 1997. *Fluid Mechanics with engineering applications 9<sup>th</sup> edition*, McGraw-Hill, Belfast
- Freeze, R. and J.A. Cherry, 1979. *Groundwater*, Prentice Hall, Englewood cliffs, New Jersey
- French, R.H., 1994. *Open-channel hydraulics*, McGraw-Hill, New York
- Gustafson, G., 1986. *Geohydrologiska förundersökningar i berg*, BeFo84:1/86 (in Swedish)
- Gustafson, G., 2009. *Hydrogeologi för bergbyggare*, Forskningsrådet Formas (in Swedish)
- Haigh, M.J., 2009. Well design differentiators for CO<sub>2</sub> sequestration in depleted reservoirs, SPE Paper 124274
- Haimson, B.C. and F.H. Cornet, 2003. ISRM suggested methods for rock stress estimation-Part 3: hydraulic fracturing (HF) and/or hydraulic testing of pre-existing fractures (HTPF), *International Journal of Rock Mechanics and Mining Sciences*, vol. 40: 1011-1020
- Halford, K.J., Weight, W.D. and R.P. Schreiber, 2006. Interpretation of transmissivity estimates from single-well pumping aquifer tests, *Ground Water*, vol. 44, no. 3: 467-471
- Hantush, M.S. and C.E. Jacob, 1955. Non-steady radial flow in an infinite leaky aquifer, *Transactions American Geophysical Union*, vol. 36 no.1: 95-100
- Hantush, M.S., 1960. Modification of the theory of leaky aquifers, *Journal of Geophysical Research*, vol. 65, no. 11: 3713-3725
- Heath, R.C., 1983. *Basic ground-water hydrology*, U.S. Geological Survey, Water-Supply Paper 2220
- Horne, R. N., 1995. *Modern well test analysis 2<sup>nd</sup> edition*, Petroway Inc., Palo Alto, California
- Horner, D.R., 1951. Pressure build-up in wells. *Proceedings ThirdWorld Petroleum Congress*, Sec II: 503-523
- Hundley, C.L. and J.T. Matulis, 1963. Deep well disposal, *Ground Water*, vol.1, no.1: 15-17(33)
- Hvorslev, M.J., 1951. Time lag and soil permeability in groundwater observations, U.S. Army Corps of Engineers Waterway Experimentation Station, Bulletin 36
- IPCC, Intergovernmental Panel on Climate Change, 2005. *Carbon dioxide capture and storage*, edited by Metz, B., Davison O., de Coninck, H., Loos M. and L. Meyer, Cambridge University press, New York
- Jacob, C.E., 1947. Drawdown test to determine effective radius of artesian well, *Transactions, American Society of Civil Engineers*, vol. 112, Paper 2321: 1047-1064
- Jacob, C.E. and S.W. Lohman, 1952. Nonsteady flow to a well of constant drawdown in an extensive aquifer, *Transactions American Geophysical Union* vol 33: 559-569
- Jansson, T. and P. Sjölander, 1987. *TPM-metoden för in situ mätningar av hydraulisk konduktivitet*, Student report in Hydrogeology, Uppsala University (in Swedish)
- JICA, Japan International Cooperation Agency Instituto Nicaraguense de Acueductos y Alcantarillados INNA, 1993. *The study on water supply project in Managua*, Main Report, Kokusai Kogyo Co., Ltd., Tokyo
- Juhlin, C., 2009. 3D Processing of the Malmö harbor Geothermal 2000 seismic lines, Internal report
- Kamp van der, G., 1976. Determining aquifer transmissivity by means of well response test: The underdamped case, *Water Resources Research*, vol. 12, no. 1: 71-77
-

## 10. References

---

- Karasaki, K., 1990. A systematized drillstem test, *Water Resources Research*, vol. 26, no. 12: 2913-2919
- Karasaki, K., Long J.C.S. and P.A. Witherspoon, 1988. Analytical models of slug tests, *Water Resources Research*, vol. 24, no. 1: 115-126
- Kasenow, M., 2001. *Applied ground-water hydrology and well hydraulics 2nd edition*, Water Resources Publication, LLC
- Krauss, I., 1974. Die bestimmung der transmissivität von grundwasserleitern aus dem einschwingverhalten des brunnen-grundwasserleitersystems, *Journal of Geophysics* vol. 40:381-400
- Kruseman, G.P. and N.A. de Ridder, 2000, *Analysis and evaluation of pumping test data 2<sup>nd</sup> Edition*, Publication 47 International Institute of Land Reclamation and Improvement, The Netherlands
- Kuchuk, F.J., 1995. Well testing and interpretation for horizontal wells, *Journal of Petroleum Technology* (Jan. 1995): 36-41
- Leap, D.I., 1984. A simple pneumatic device and technique for performing rising water level slug tests, *Ground Water Monitoring Review*, vol. 4, no. 1:141-146
- Lin, W., Yamamoto, K., Ito, H., Masago, H. and Y. Kawamura, 2008. Estimation of minimum principal stress from an extended leak-off test onboard the Chikyu Drilling vessel and suggestions for future test procedures, *Scientific Drilling*, no.6: 43-47
- Marinelli, F. and J.W. Rowe, 1985. Performance and analysis of drillstem tests in small-diameter boreholes, *Ground Water*, vol. 23, no. 3: 367-375
- Matthews, C.S. and D.G Russel, 1967, *Pressure buildup and flow tests in wells*, Society of Petroleum Engineers of AIME, Henry L. Doherty Series, Monograph 1
- McElwee, C.D., 2001. Application of a nonlinear slug test model, *Ground Water*, vol. 39, no. 5, pp. 737-744
- McElwee, C.D., 2002. Improving the analysis of slug tests, *Journal of Hydrology* 269:122-133
- McElwee, C.D. and M.A. Zenner, 1998. A nonlinear model for analysis of slug-test data, *Water Resources Research*, vol. 34, no. 1: 55-66
- McElwee, C.D. and G.M. Zemansky, 2005. Effect of a mobile fraction on slug test results, *Natural Resources Research*, vol. 14, no. 1: 31-37
- McWhorter D.B. and D.K.Sunada, 1977. *Ground-water hydrology and hydraulics*, Water Resources Publications, Fort Collins, Colorado
- Meinzer, O.E., 1929. Problems of the Soft-water supply of the Dakota sandstone, U.S. Geological Survey, Water-Supply Paper 597
- Neuman, S. P., 1972. Theory of flow in unconfined aquifer considering delayed response of the water table, *Water Resources Research*, vol. 8, no. 4: 1031-1045
- Pandit, N.S. and R.F. Miner, 1986. Interpretation of slug test data, *Ground Water*, vol. 24, no. 6:743-749
- Papadopoulos, I.S., Bredehoeft J.D. and H.H. Jr Cooper, 1973. On the analysis of 'slug test' data, *Water Resources Research*, vol. 9, no. 4: 1087-1089
- Papadopoulos, I.S. and H.H. Cooper, 1967. Drawdown in a well of large diameter, *Water Resources Research*, vol. 3, no. 1: 241-244

- 
- Patterson, R.J. and J.F. Devlin, 1985. An improved method for slug tests in small-diameter piezometers, *Ground Water*, vol. 23, no. 6: 804-805
- Persson P.-G., 1985. *The temperature log as an indicator of permeable zones and fractures in wells*, Licentiate Thesis, Lund Institute of Technology Department of Engineering Geology
- Priddle, M., 1989. A slug test packer for five centimeter (two-inch) wells, *Ground Water*, vol. 27, no. 5: 713-714
- Prosser, D.W., 1981. A method of performing response tests on highly permeable aquifers, *Ground Water*, vol. 19, no. 6: 588-592
- Raaen, A.M., Horsrud P., Kjørholt, H. and D. Økland, 2006. Improved routine of the minimum horizontal stress component from extended leak-off tests, *International Journal of Rock Mechanics and Mining Sciences*, vol. 43: 37-48
- Ramey, H. J. Jr., Agarwal, R.G. and I. Martin, 1975, Analysis of “slug test” or DST flow period data, *Journal of Canadian Petroleum Technology*, vol. 14: 37-47
- Rorabaugh, M.J., 1953. Graphical and theoretical analysis of step-drawdown test of artesian well, *Proc., American Society of Civil Engineers*, vol. 79, separate no. 362
- Rosberg, J-E., 2007. *Testing, well development and evaluation of deep wells completed in Lund 2002-2005*, Licentiate Thesis, ISRN LUTVDG/TVTGT-1022-SE, ISBN 978-91-976848-0-4, Engineering Geology Lund University
- Roscoe Moss Company, 1990. *Handbook of Ground Water Development*, John Wiley & Sons, New York
- Rovey, C. W. II and D.S. Cherkauer, 1995, Scale dependency of hydraulic measurements, *Ground Water*, vol. 33, no. 5: 769-780
- Rutqvist, J., 1995. Determination of hydraulic normal stiffness of fractures in hard rock from well testing, *International Journal of Rock Mechanics and Mining Sciences & Geomechanics Abstracts*, vol 32., no.5: 512-523
- Rutqvist, J., Tsang C.-F. and O. Stephansson, 2000. Uncertainty in the maximum principal stress estimated from hydraulic fracturing measurements due to the presence of the induced fracture, *International Journal of Rock Mechanics and Mining Sciences*, vol. 37: 107-120
- Sageev, A., 1986. Slug test analysis, *Water Resources Research*, vol. 22, no. 8: 1323-1333
- Serra, O., 1984. *Fundamentals of well-log interpretation: 1. The acquisition of logging data*, Elsevier science publishers B.V., Amsterdam, Netherlands
- SGF, 1996. *Geoteknisk fälthandbok*, Swedish geotechnical society, Report 1:96, (in Swedish)
- SGF, 2004. *Fälthandbok Miljötekniska markundersökningar*, Swedish geotechnical society, Report 1:2004, (in Swedish)
- Shapiro, A.M. and Greene E.A., 1995. Interpretation of prematurely terminated air-pressurized slug tests, *Ground Water*, vol. 33, no. 4: 539-546,
- Shapiro, A.M. and P. A. Hsieh, 1998. How good are estimates of transmissivity from slug tests in fractured rocks?, *Ground Water*, vol. 36, no. 1: 37-48
- Skibitzke, H. E., 1958. An equation for potential distribution about a well being bailed, U.S. Geological Survey, *Ground Water Note* 35
- Tartakovsky, G.D. and S.P. Neuman, 2007. Three-dimensional saturated-unsaturated flow with axial symmetry to a partially penetrating well in a compressible unconfined aquifer, *Water Resources Research*, vol. 43, W01410
-

## 10. References

---

- Theis, C.V., 1935. The relation between the lowering of the piezometric surface and the rate and duration of discharge of a well using groundwater storage, Transactions, American Geophysical Union, vol 16: 519-524
- Thiem, G., 1906. *Hydrologische Methoden*, Leipzig, Germany
- Todd, D.K. and L.W. Mays, 2005. *Groundwater hydrology 3<sup>rd</sup> edition*, John Wiley & Sons, UK
- Todd, D.K., 1980. *Groundwater Hydrology 2<sup>nd</sup> edition*, John Wiley & Sons, US
- Tolman, C.F., 1937. *Ground Water*, McGraw-Hill Book Company, Inc., New York
- Tyréns, 2007. Tekniska PM för project Järnvägstunnlar i Helsingborg, Internal report, (In Swedish)
- VBB VIAK, 1998. Banverket, Södra banregionen Skottorp-Förslöv, Ny järnväg, Tunnlar genom Hallandsås, Fortsatt tunneldrivning Miljöanalys, Internal report (in Swedish)
- Vennard, J.K. and R.L. Street, 1982. *Elementary fluid mechanics 6<sup>th</sup> edition*, John Wiley & Sons, Singapore
- Walton, W.C., 1962. *Selected analytical methods for well and aquifer evaluation*, Illinois State Water Survey Bulletin 49
- Walton, W.C., 1988. *Practical aspects of ground water modelling 3<sup>rd</sup> edition*, National ground water association, Westerville, Ohio
- Walton, I.C., Atwood D.C., Halleck P.M. and L.C.B. Bianco, 2002. Perforating unconsolidated sands: An experimental and theoretical investigation, SPE Drilling and completion (September), SPE Paper 79041:141-150
- Wenzel, L.K., 1942. Methods for determining permeability of water-bearing materials with special reference to discharging-well methods, U.S. Geological Survey, Water-Supply Paper 887
- Wikman, H. and J. Bergström, 1987. *Beskrivning till berggrundskartan Halmstad SV*, Swedish Geological Survey, Uppsala (in Swedish)
- Zenner, M.A., 2009. Near-well nonlinear flow identified by various displacement well response testing, Ground Water, vol. 47, no. 4: 526-535
- Zemansky, G.M. and C.D. McElwee, 2005. High-resolution slug testing, Ground Water, vol. 43, no. 2: 222-230
- Zoback, M.D., Barton, C.A., Brudy, M., Castillo, D.A., Finkbeiner, T., Grollmund, B.R., Moos, D.B., Peska, P., Ward, C.D. and D.J. Wiprut, 2003. Determination of stress orientation and magnitude in deep wells, International Journal of Rock Mechanics and Mining Sciences, vol. 43: 1049-1076

## Appendix 1: Air volume calculations

When designing slug tests using pneumatic initiation, it is important to estimate the required air volume for pressurization. Whether a compressor or scuba tanks will be used can be based on this estimate, but it will also reveal additional information about the air volume that will be released after slug initiation, which is important when discussing the size of the release valve.

A simple approach, based on Boyle's law, is used to derive an equation that can be used to estimate the air volume. Two scenarios during a slug test, namely before and after casing pressurization, are described in Figure A1. Isothermal conditions within the wellbore are assumed and therefore Boyle's law is applied (see Equation A1.1).

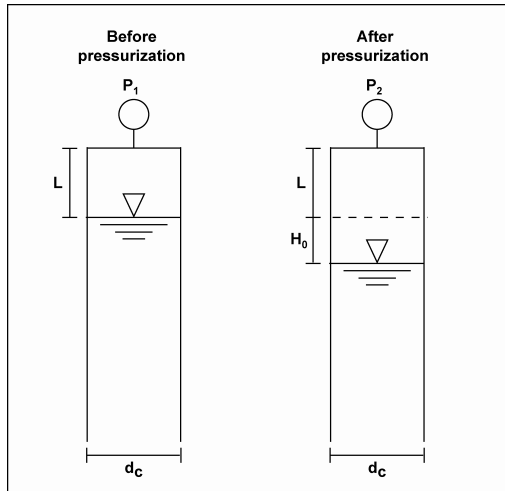

**Figure A1. Two conditions during a slug test, before and after pressurization.  $P_1$  and  $P_2$  are pressures measured at the wellhead,  $L$  is the distance from top of the casing/equipment to the water level,  $H_0$  is the initial displacement and  $d_c$  is the casing diameter.**

Boyle's law

$$P_1 \cdot V_1 = P_2 \cdot V_2 \quad (\text{Equation A1.1})$$

where

$P_1$  = Pressure measured at the wellhead before pressurization (Pa).

$P_2$  = Pressure measured at the wellhead after pressurization (Pa).

$V_1$  = Air volume at  $P_1$  ( $\text{m}^3$ )       $V_2$  = Air volume at  $P_2$  ( $\text{m}^3$ )

$P_1$  equals atmospheric pressure if an absolute sensor is used, and zero if a gauged sensor is used.

$$P_2 = P_1 + (H_0 \cdot \rho \cdot g) \quad (\text{Equation A1.2})$$

where

$H_0$  = initial displacement (m)       $\rho$  = water density ( $\text{kg}/\text{m}^3$ )

$g$  = acceleration of gravity ( $\text{m}/\text{s}^2$ )

$$V_2 = \frac{\pi \cdot d_c^2 \cdot (L + H_0)}{4} \quad (\text{Equation A1.3})$$

where

$L$  = distance to static water table from top casing/equipment (m)

$d_c$  = diameter of the casing (m)

If Equation A1.1-A1.3 are combined, then  $V_1$  can be expressed as Equation A1.4.

$$V_1 = \frac{P_1 + (H_0 \cdot \rho \cdot g)}{P_1} \cdot \frac{\pi \cdot d_c^2 \cdot (L + H_0)}{4} \quad (\text{Equation A1.4})$$

## Appendix 1

---

The supply or the air volume ( $V_{\text{release}}$ ) that will be released through the valve at slug initiation is expressed in Equation A1.5. The last term in the equation is expressing the air volume in the wellbore before pressurization.

$$V_{\text{release}} = \frac{P_1 + (H_0 \cdot \rho \cdot g)}{P_1} \cdot \frac{\pi \cdot d_c^2 \cdot (L + H_0)}{4} - \frac{\pi \cdot d_c^2 \cdot L}{4} \quad (\text{Equation A1.5})$$

If an absolute sensor is used then the measurement unit is bar. Equation A1.5 can be simplified if it is assumed that  $P_1$  equals 1 bar (a reasonable value for atmospheric pressure). In addition, it can be further simplified that 1 bar equals 10 m of water column, meaning that  $H_0 \rho g$  can be replaced by  $0.1H_0$ . Using these simplifications Equation A1.5 can be rewritten as Equation A1.6.

$$V_{\text{release}} = \frac{\pi \cdot d_c^2}{4} (H_0 + 0.1 \cdot H_0 \cdot L + 0.1 \cdot H_0^2) \quad (\text{Equation A1.6})$$

## Appendix 2: Slug test and pumping test interpretation

### MK20, Test number 2.

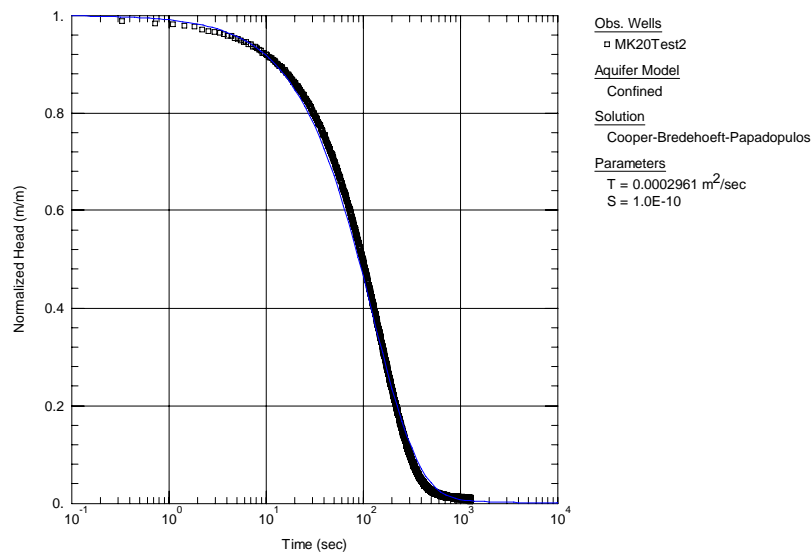

Figure A1. Transmissivity estimated using the Cooper et al. (1967) solution, RSS 2.70 m<sup>2</sup>.

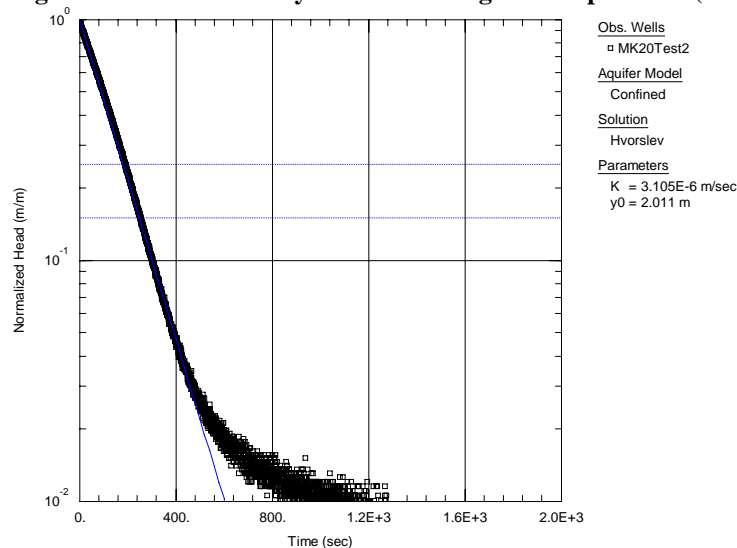

Figure A2. Hydraulic conductivity estimated using the Hvorslev (1951) solution, RSS 2.70 m<sup>2</sup>.

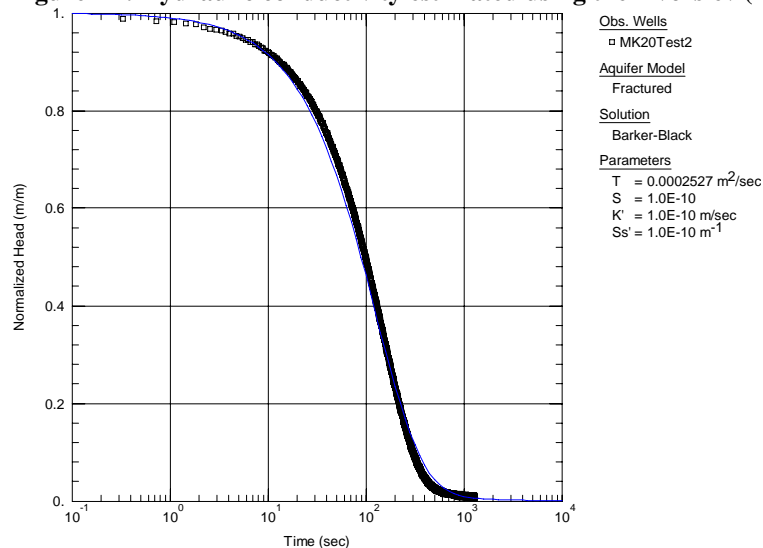
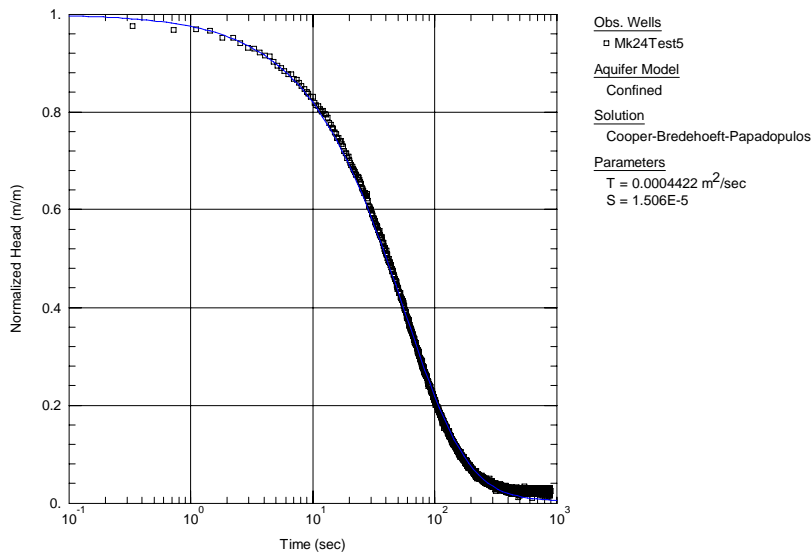

Figure A3. Transmissivity estimated using the Barker and Black (1983) solution, RSS 3.31 m<sup>2</sup>.



**MK24, Test number 5 (final test).**



**Figure A4. Transmissivity estimated using the Cooper et al. (1967) solution, RSS 0.11 m<sup>2</sup>.**

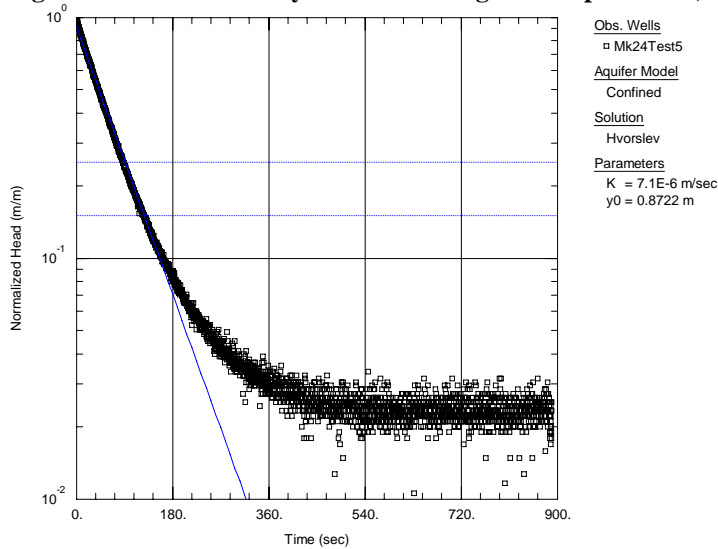

**Figure A5. Hydraulic conductivity estimated using the Hvorslev (1951) solution, RSS 0.28 m<sup>2</sup>.**

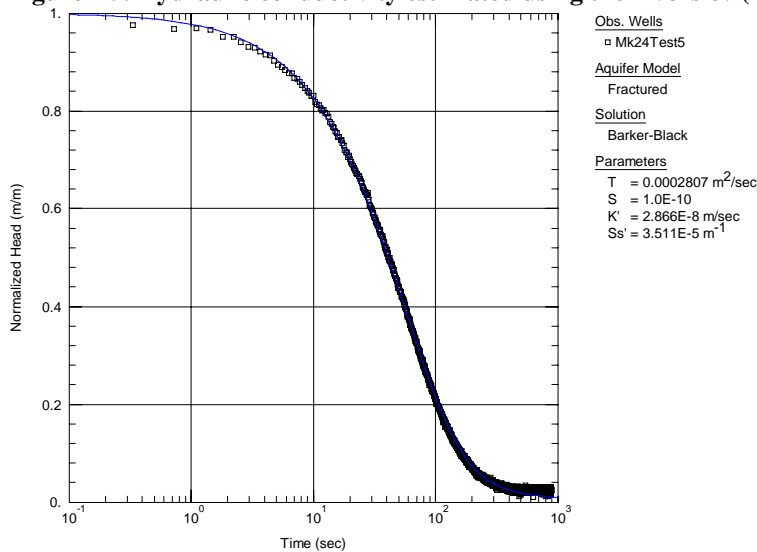

**Figure A6. Transmissivity estimated using the Barker and Black (1983) solution, RSS 0.04 m<sup>2</sup>.**

## MK39, Test number 4 (final test).

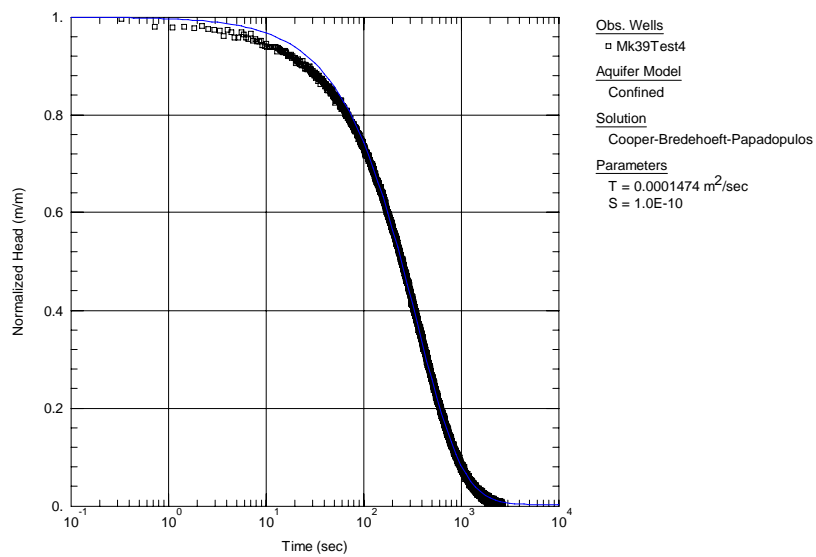

Figure A7. Transmissivity estimated using the Cooper et al. (1967) solution, RSS  $0.25 \text{ m}^2$ .

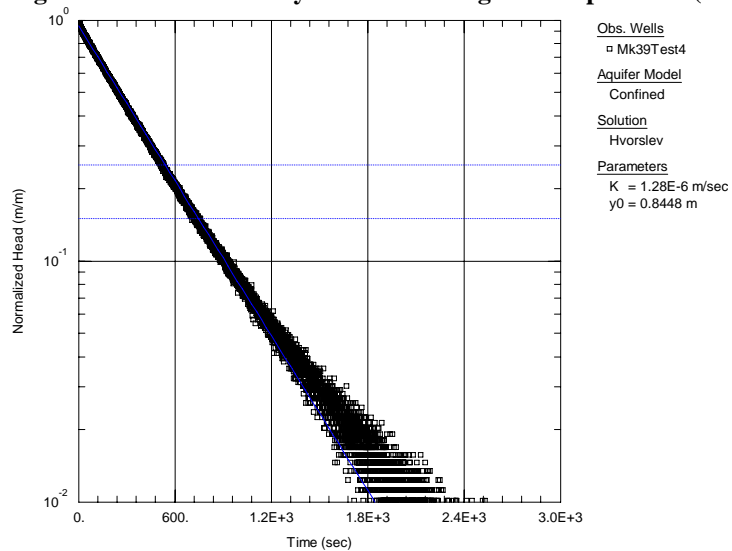

Figure A8. Hydraulic conductivity estimated using the Hvorslev (1951) solution, RSS  $0.25 \text{ m}^2$ .

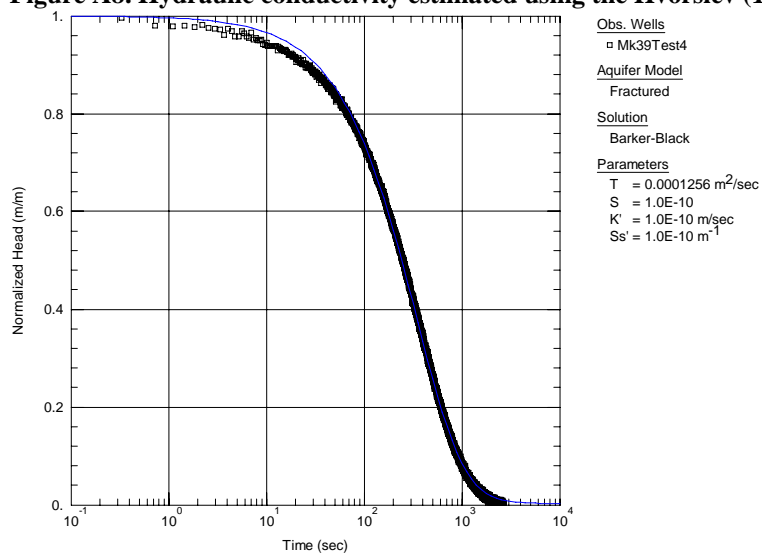
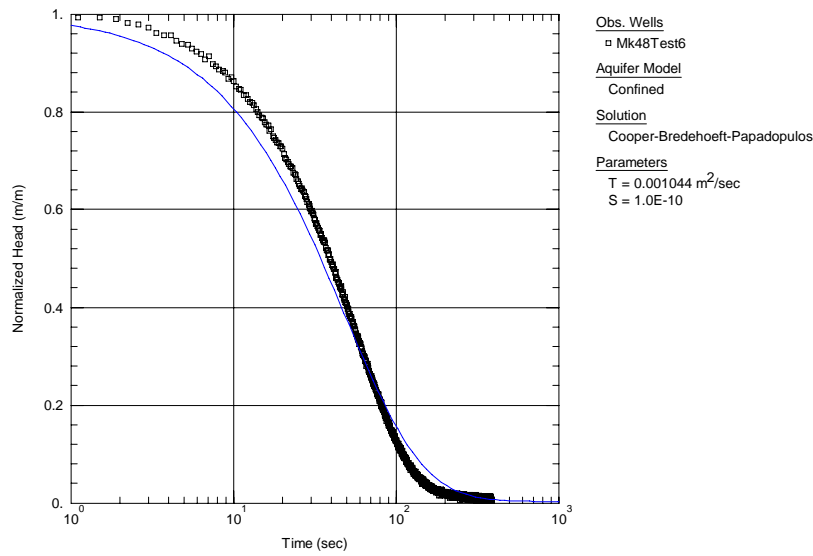
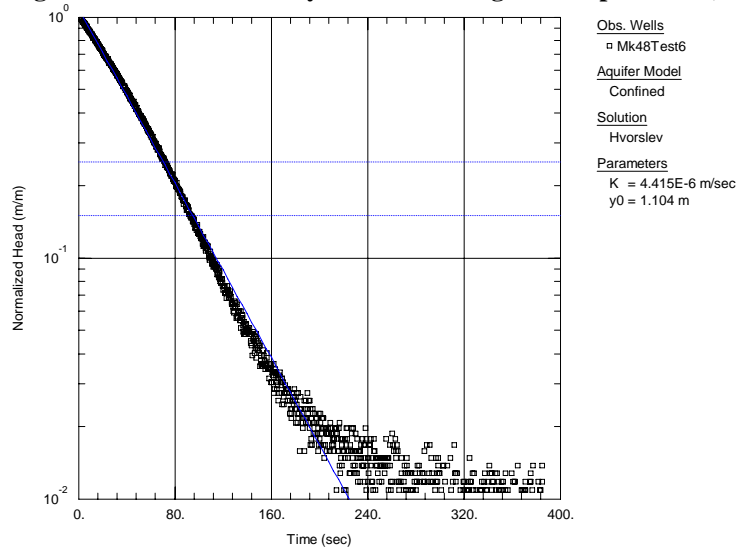

Figure A9. Transmissivity estimated using the Barker and Black (1983) solution, RSS  $0.33 \text{ m}^2$ .

**MK48, Test number 6 (final test).**



**Figure A10. Transmissivity estimated using the Cooper et al. (1967) solution, RSS 0.68 m<sup>2</sup>.**



**Figure A11. Hydraulic conductivity estimated using the Hvorslev (1951) solution, RSS 0.68 m<sup>2</sup>.**

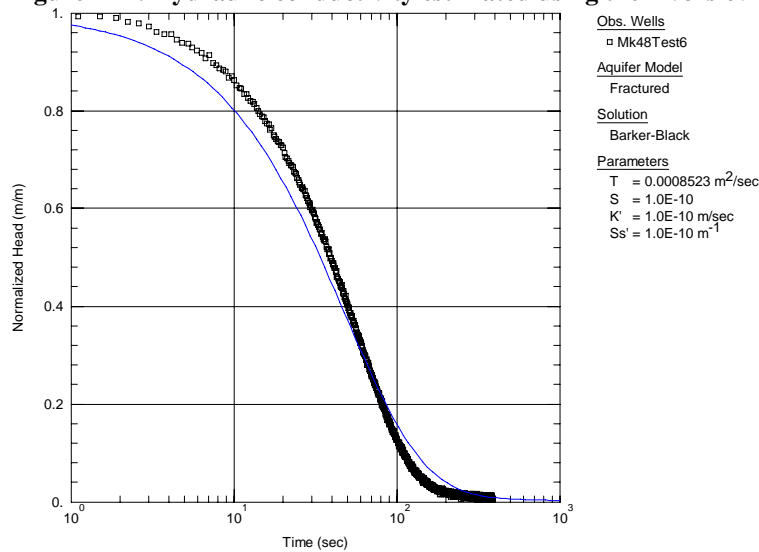

**Figure A12. Transmissivity estimated using the Barker and Black (1983) solution, RSS 0.82 m<sup>2</sup>.**

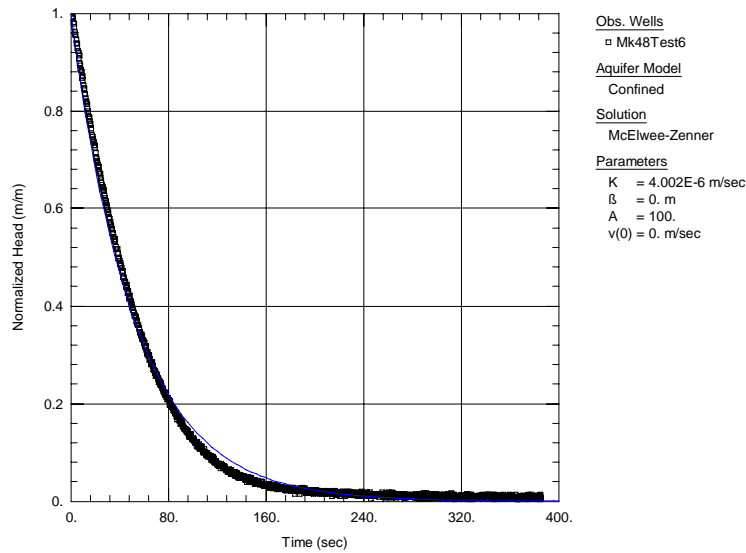

Figure A13. Hydraulic conductivity estimated using the McElwee and Zenner (1998) solution, RSS 0.26 m<sup>2</sup>.

**Well 0662005, Test number 8 (final test) and pumping and recovery tests.**

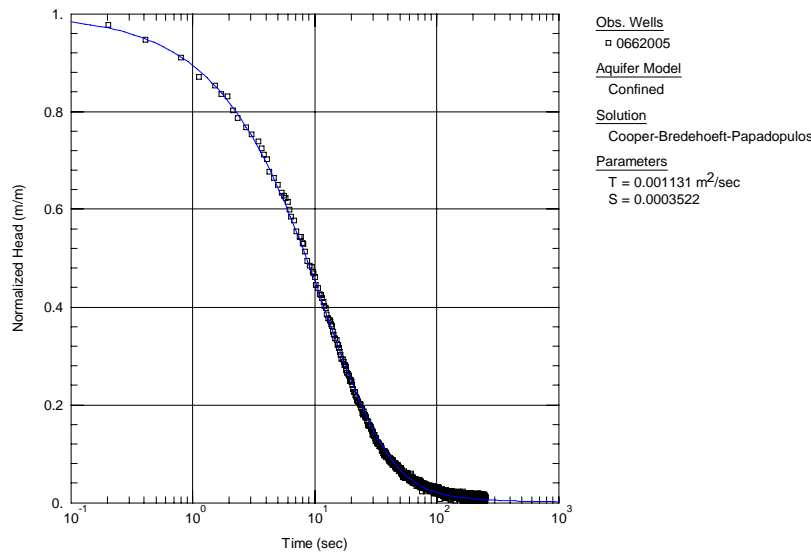

Figure A14. Transmissivity estimated using the Cooper et al. (1967) solution, RSS 0.03 m<sup>2</sup>.

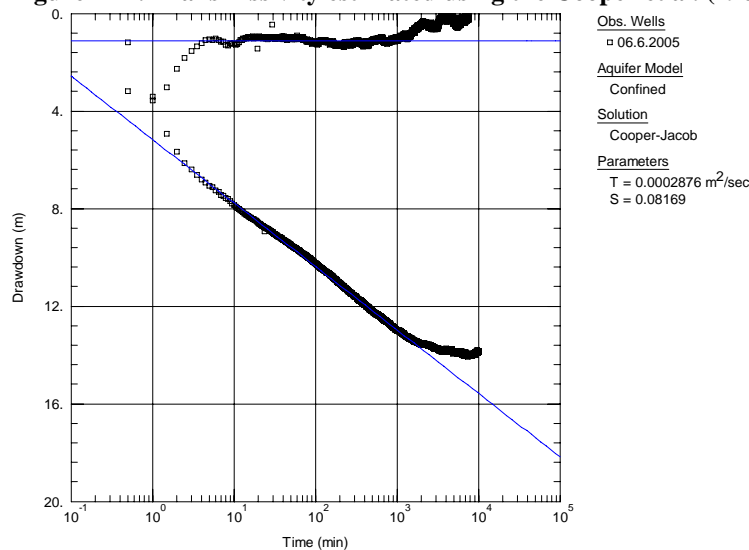
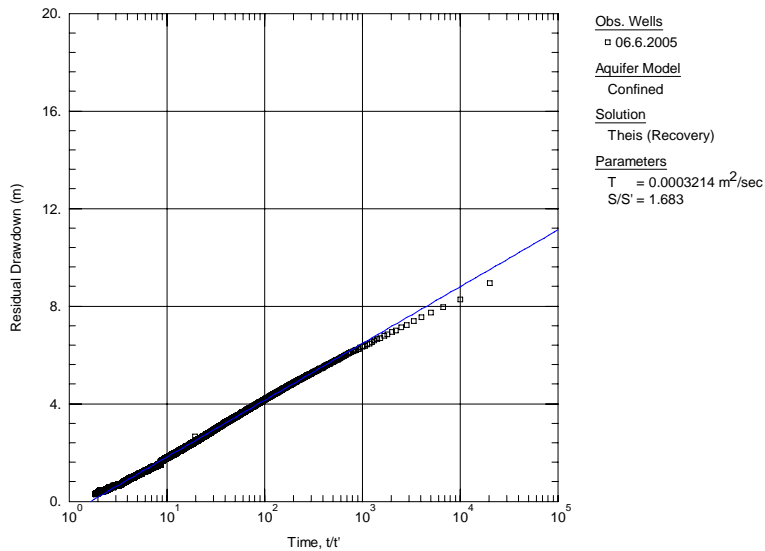
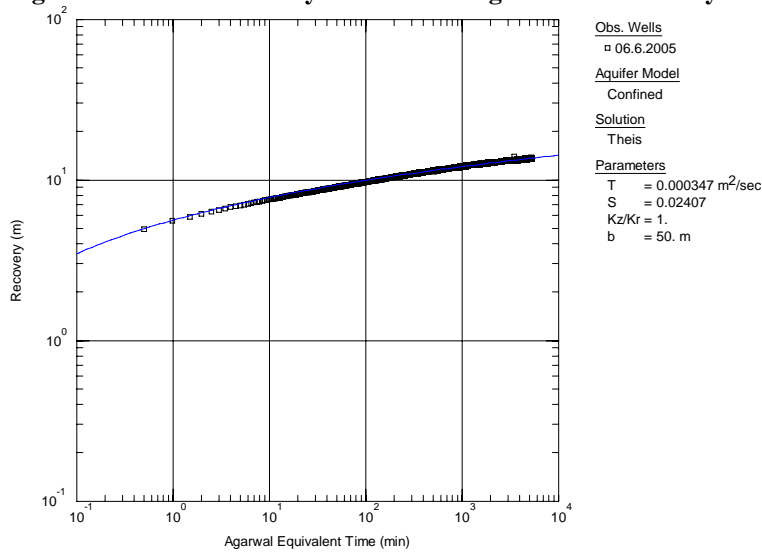

Figure A15. Transmissivity estimated using the Cooper-Jacob (1946), the derivatives are also presented.

## Appendix 2

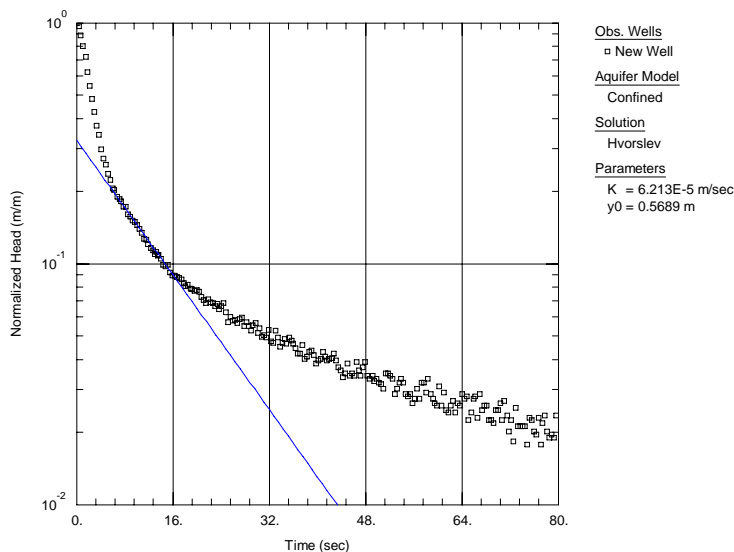

**Figure A16. Transmissivity estimated using the Theis recovery method (1935).**



**Figure A17. Transmissivity estimated using the Agarwal equivalent time and Theis type curve.**

## Well 0662002, Slug Test number 2 and pumping and recovery tests.



**Figure A18. Hydraulic conductivity estimated using the Hvorslev (1951) solution, RSS  $0.47 \text{ m}^2$ .**

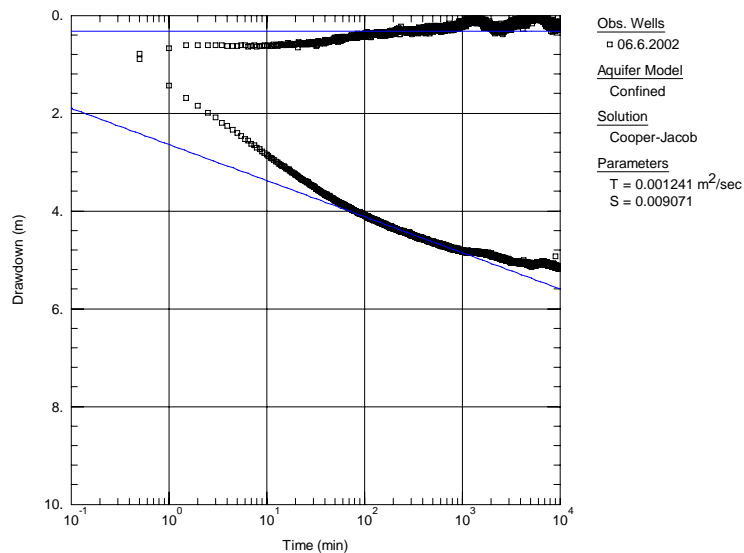

Figure A19. Transmissivity estimated using the Cooper-Jacob (1946), the derivatives are also presented.

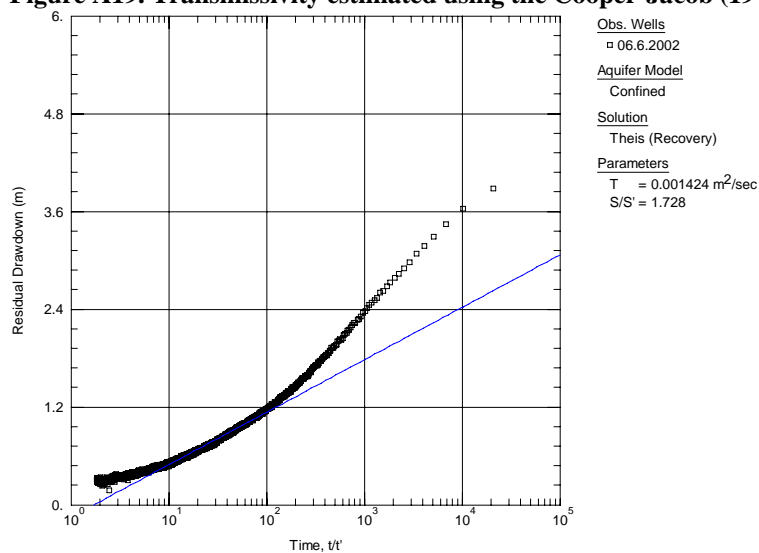

Figure A20. Transmissivity estimated using the Theis recovery method (1935).

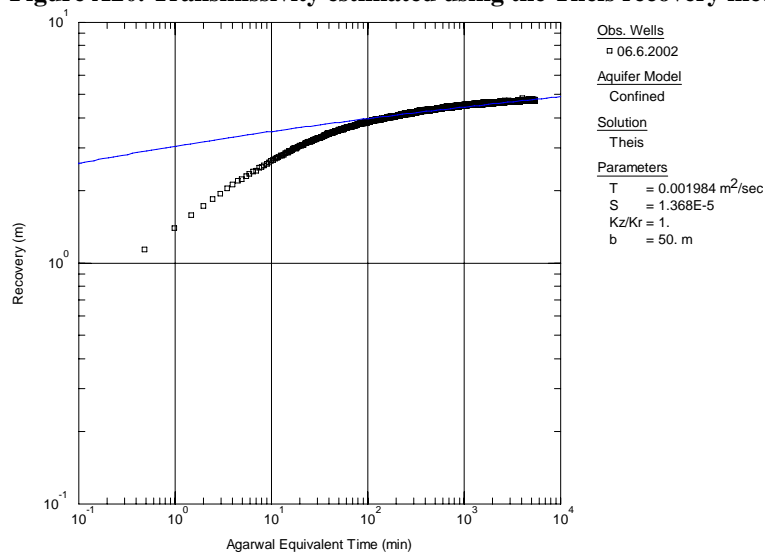
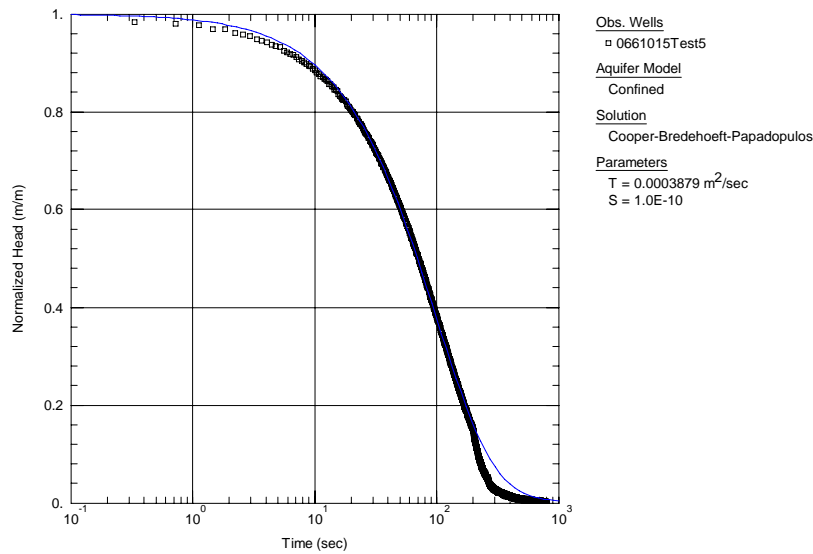
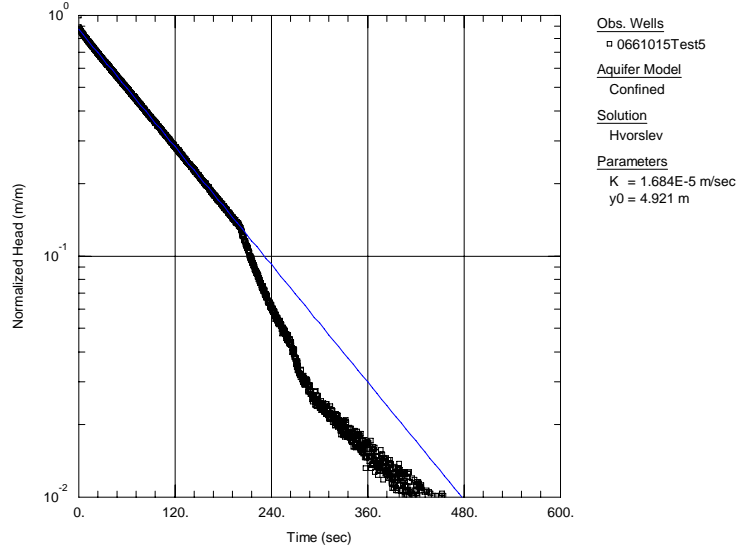

Figure A21. Transmissivity estimated using the Agarwal equivalent time and Theis type curve.

**Well 0661015, Slug Test number 5 and recovery test.**



**Figure A22. Transmissivity estimated using the Cooper et al. (1967) solution, RSS 0.60 m<sup>2</sup>.**



**Figure A23. Hydraulic conductivity estimated using the Hvorslev (1951) solution, RSS 0.09 m<sup>2</sup>.**

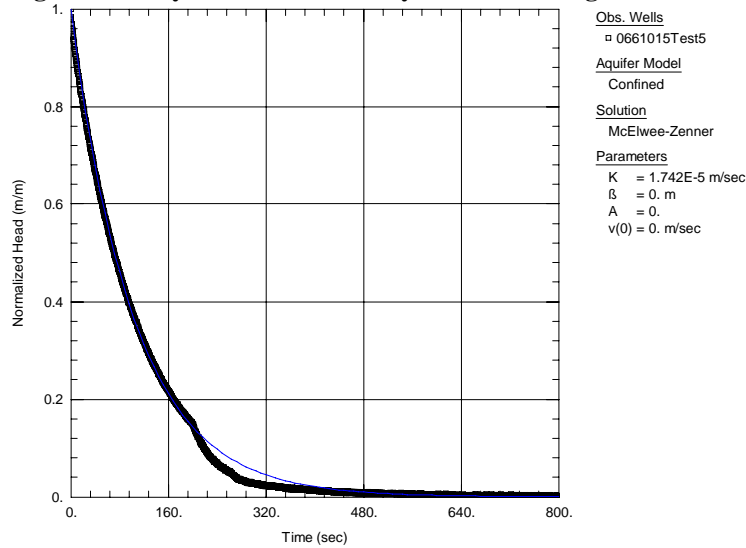

**Figure A24. Hydraulic conductivity estimated using the McElwee and Zenner (1998) solution, RSS 1.23 m<sup>2</sup>.**

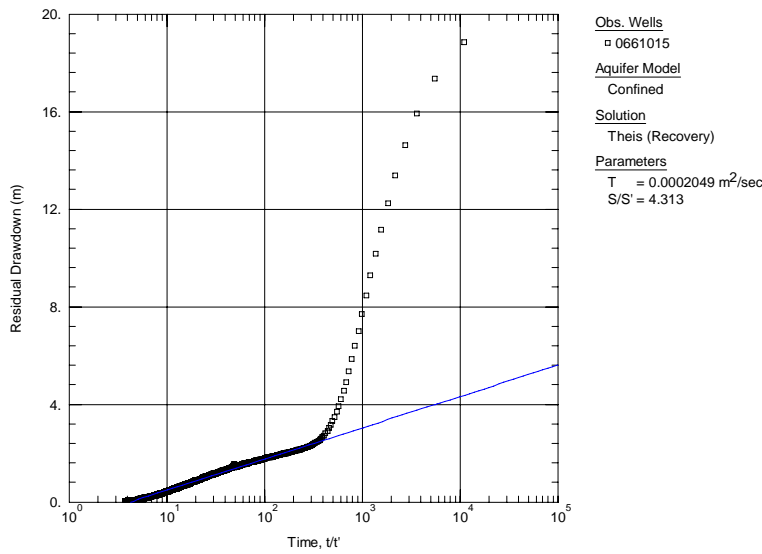

Figure A25. Transmissivity estimated using the Theis recovery method (1935).

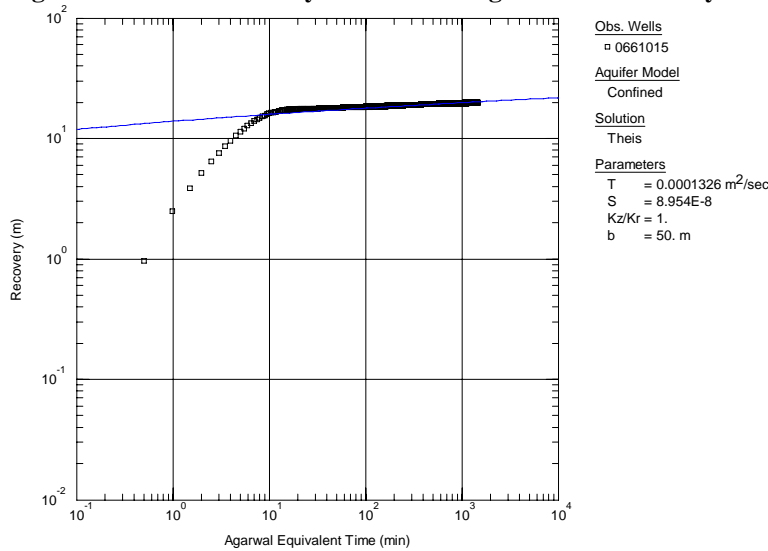

Figure A26. Transmissivity estimated using the Agarwal equivalent time and Theis type curve.

### LTH-1, Slug Test number 9 and 10 and pumping and recovery test.

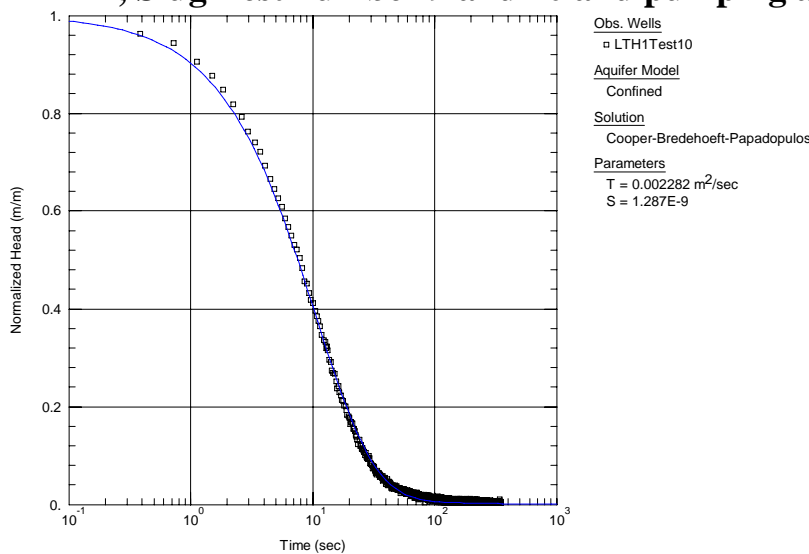
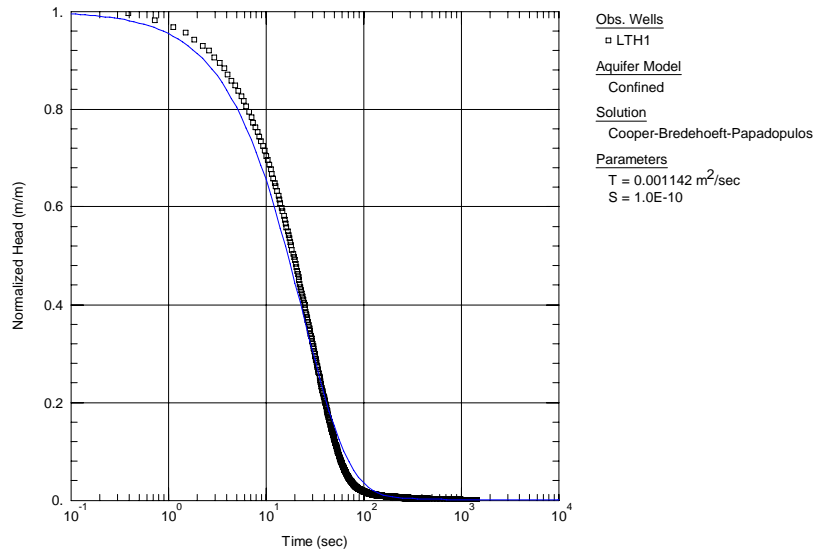

Figure A27. Transmissivity estimated using the Cooper et al. (1967) solution, RSS 0.04 m<sup>2</sup>. Test 10 a low initial displacement was used around 1.3 m.



## Appendix 2



**Figure A28. Transmissivity estimated using the Cooper et al. (1967) solution, RSS 83.7 m<sup>2</sup>. Test 9 a high initial displacement was used around 17.6 m.**

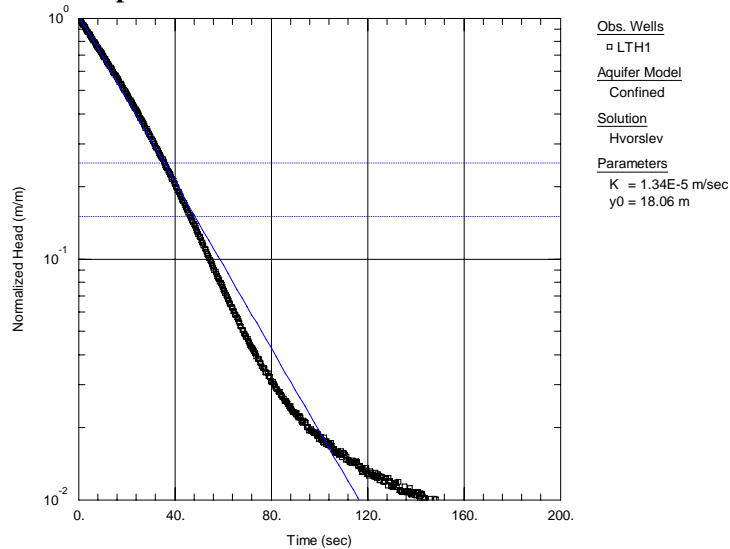

**Figure A29. Hydraulic conductivity estimated using the Hvorslev (1951) solution, RSS 14.8 m<sup>2</sup>. Test 9 a high initial displacement was used around 17.6 m.**

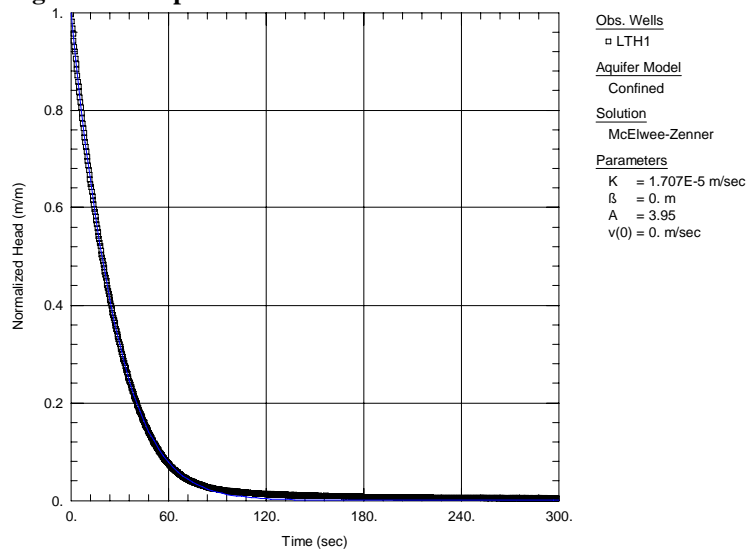

**Figure A30. Hydraulic conductivity estimated using the McElwee and Zenner (1998) solution, RSS 0.91 m<sup>2</sup>. Test 9 a high initial displacement was used around 17.6 m.**

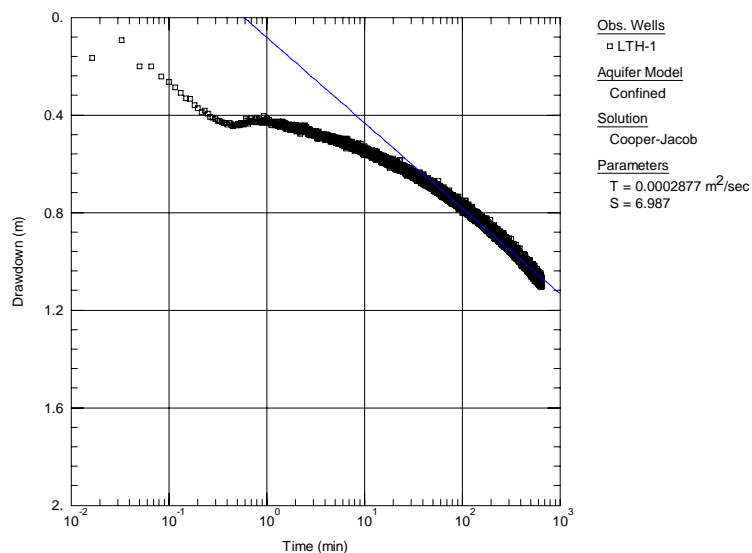

Figure A31. Transmissivity estimated using the Cooper-Jacob (1946) solution. The second slope is used in this example.

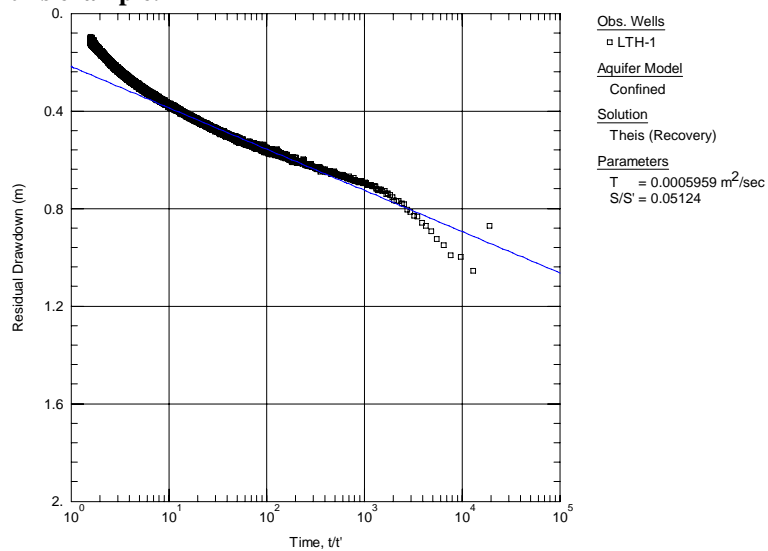

Figure A32. Transmissivity estimated using the Theis recovery method (1935).

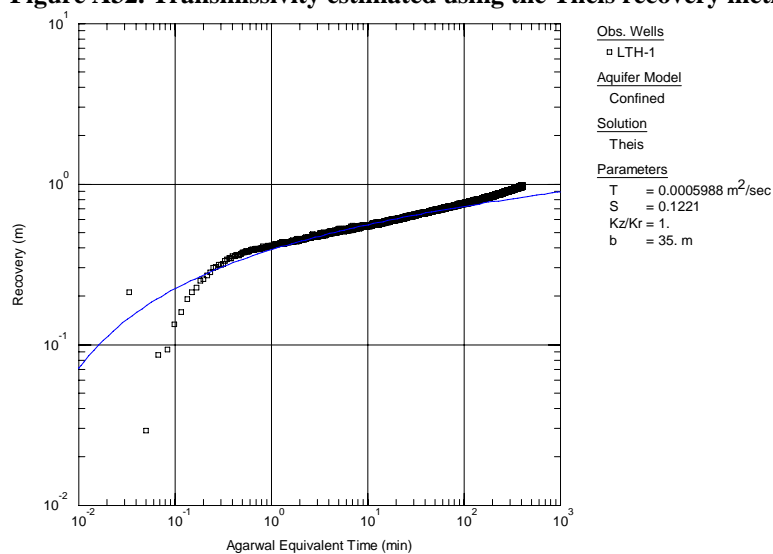

Figure A33. Transmissivity estimated using the Agarwal equivalent time and Theis type curve.

Las Mercedes 12, Slug Test number 8 (final test).

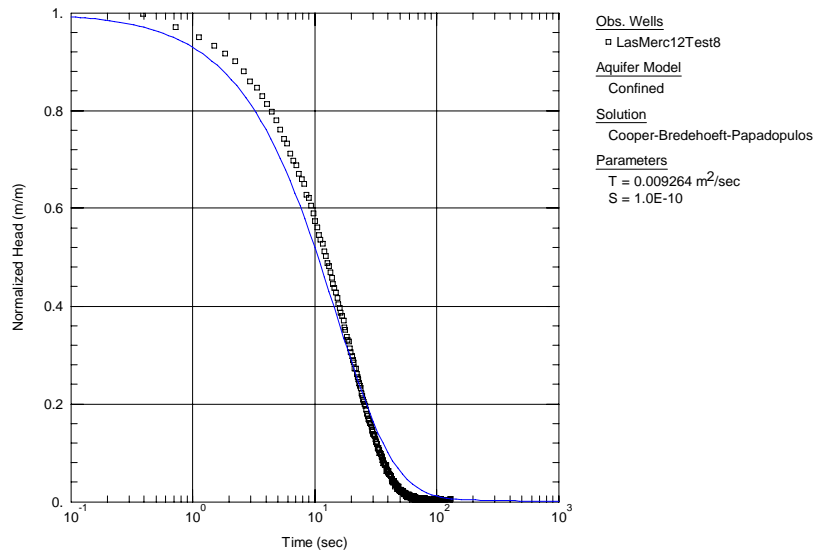

Figure A34. Transmissivity estimated using the Cooper et al. (1967) solution, RSS 0.48 m<sup>2</sup>.

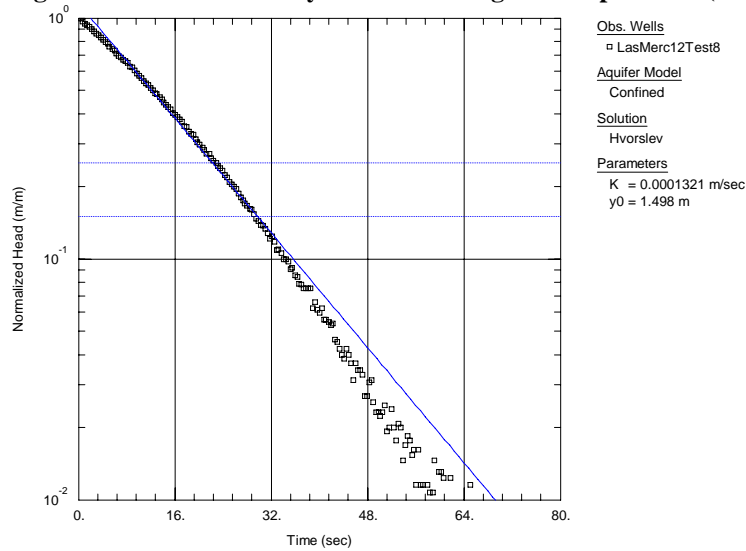

Figure A35. Hydraulic conductivity estimated using the Hvorslev (1951) solution, RSS 0.03 m<sup>2</sup>.

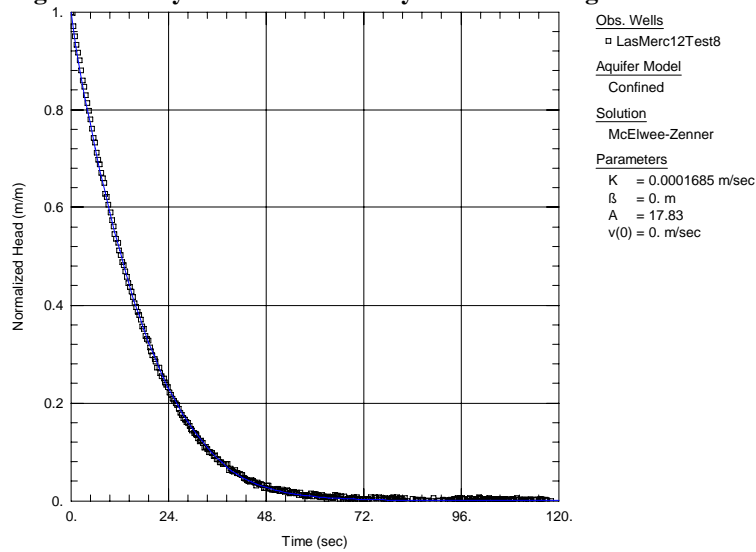

Figure A36. Hydraulic conductivity estimated using the McElwee and Zenner (1998) solution, RSS 0.01 m<sup>2</sup>.

### San Cristobal, Slug Test number 7 (final test).

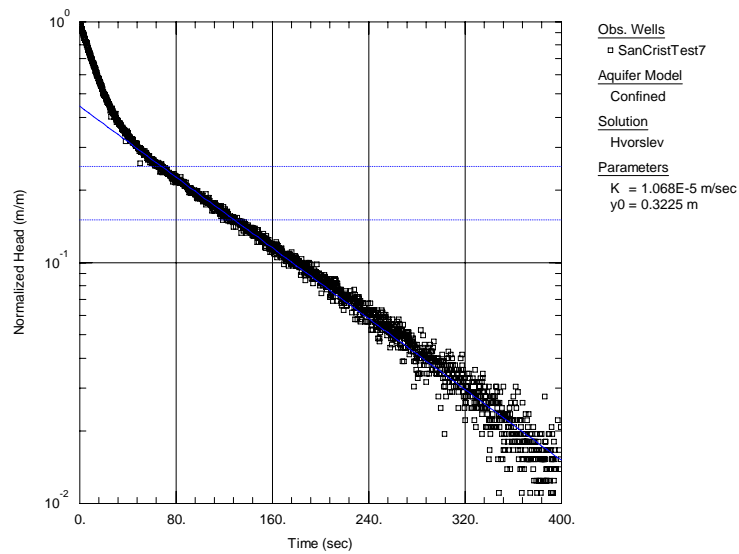

Figure A37. Hydraulic conductivity estimated using the Hvorslev (1951) solution, RSS 0.31 m<sup>2</sup>. Note the double straight line effect.

### Veracruz Managua II Slug Test number 4 (final test).

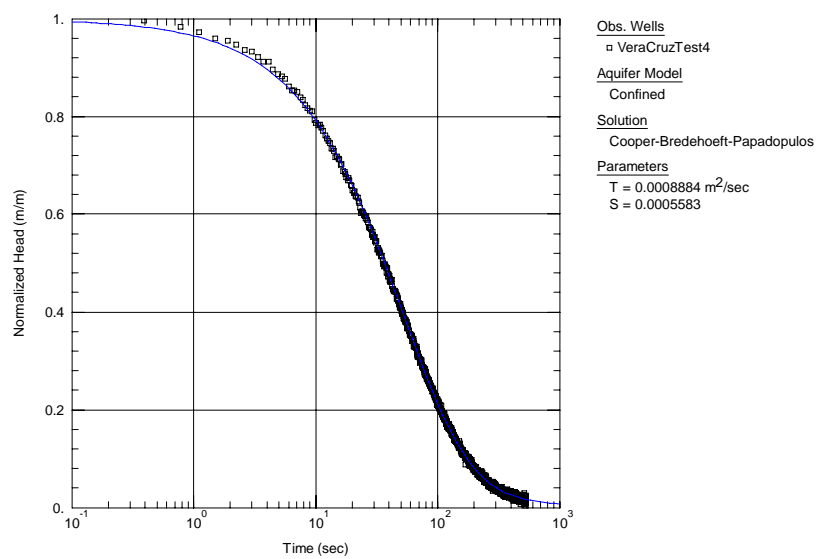

Figure A38. Transmissivity estimated using the Cooper et al. (1967) solution, RSS 0.01 m<sup>2</sup>.



### Appendix 3: Turbulent flow

In some of the tested wells, the influence of non-linear flow losses was evident, and therefore it is of interest to see if turbulent flow can occur in the formation during slug testing. In one of the tested wells (Las Mercedes 12) the impact from non-linear flow was evident and, for evaluating the possibilities for turbulent flow, the velocities inside the casing are calculated for three of the slug tests (see Figure A1). It can be seen that the velocities decrease with time and increase with larger initial displacement. An average velocity of around 0.25 m/s is measured at the beginning of the test using the greatest initial displacement.

Velocity inside casing after slug initiation Las Mercedes 12

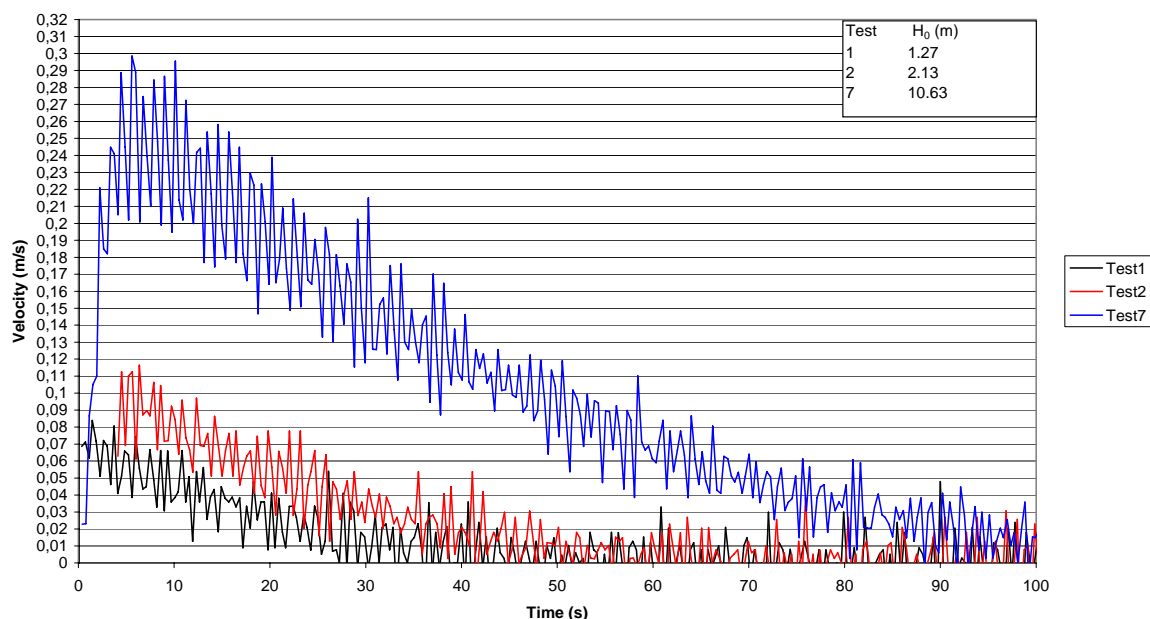

Figure A1. Velocities inside casing after slug initiation in Las Mercedes 12.

In one of the wells (Veracruz MangualI) the normalized head curves from the different tests coincide, and there was no indication of non-linear flow in the acquired data. The calculated velocities inside the casing for this well are very low, less than 0.03 m/s, a value that is below the resolution of the diver. Low velocities are, however, expected from this well compared with the Las Mercedes 12, since the response time for the well to recover was much longer.

The occurrence of turbulent flow will be evaluated for three different cases for measured a velocity inside the casing of 0.25 m/s ( $v_{casing}$ ). It is assumed that if the Reynolds number is less than 10 that a Darcian flow will occur, otherwise it will be turbulent (e.g. Bear, 1979; Freeze and Cherry, 1979). The first case will be the Las Mercedes 12 well with a 12" casing ( $d_{casing}$ ). The inner diameter of the screen is 12" ( $d_{screen}$ ) with slot size 60 (1.5 mm) and the length is 32 m ( $L_{screen}$ ). From Driscoll (1986) it can be found that a 12" no 60 mill slotted screen has an open area of 5% ( $n$ ). The velocity through the screen ( $v_{screen}$ ) can be calculated by using Equation A3.1.

$$v_{screen} = \frac{Q}{A_{screen\_open}} = \frac{v_{casing} \cdot d_{casing}^2}{4 \cdot d_{screen} \cdot L_{screen} \cdot n} \quad (\text{Equation A3.1})$$

The screen velocity equals 0.01 m/s, which is less than the recommended maximum velocity through a screen, which is 0.03 m/s (Driscoll, 1986), meaning that no turbulence will occur in the screen. What if the screen velocity equals the formation velocity? To verify if there can be turbulence in the formation it is assumed that the Reynolds number is less than 10 and that the

## Appendix 3

---

medium grain size diameter ( $d_{\text{grain}}$ ) is calculated and evaluated. A density ( $\rho$ ) of 996.232 kg/m<sup>3</sup> and viscosity ( $\mu$ ) 8.36·10<sup>-4</sup> kg/(s·m) are used since the water temperature during the testing was 28°C (Fetter, 2001). The maximum grain size for laminar flow conditions is 0.7 mm according to Equation A3.2.

$$\text{Re} = \frac{v_{\text{formation}} \cdot \rho \cdot d_{\text{grain}}}{\mu} < 10 \Rightarrow d_{\text{grain}} < \frac{\mu \cdot 10}{v_{\text{formation}} \cdot \rho} \quad (\text{Equation A3.2})$$

A medium grain size of less than 0.7 mm is possible without the occurrence of turbulent flow conditions, but larger grain sizes are possible in the tested formation, meaning that turbulence can occur in that case.

Another possible scenario for evaluating the occurrence of turbulent flow conditions is to calculate the required open area of the screen, without exceeding the critical velocity of 0.03 m/s through the screen. It can be done by rearranging Equation A3.1 and calculating "n" in the equation. The same values are used as above, except that  $v_{\text{screen}}$  equals 0.03 m/s. The slotted open area of the screen (n) must be greater than 2%, using Equation A3.1, in order to avoid turbulence, which is less than the earlier mentioned 5% for this screen. However, the occurrence of turbulence is still possible, since the well can be clogged and, in addition, the entire screen section may not be active. For example, if 50 % of the screen is clogged then it is almost equivalent to an open area of the screen of around 2 %, which, as shown, is critical for turbulent flow. Clogging of the well is a possible scenario, since the well has been abandoned due to low productivity. In addition, if it is assumed that the formation velocity also equals the critical velocity of 0.03 m/s, it can be found from Equation A3.2 that the medium grain size must be less than 0.3 mm for avoiding turbulence in the formation.

The second case is Well 0662005, located in the sedimentary deposits in Helsingborg, but it is not screen completed and turbulent flow behaviour was not so evident either. The length of the open hole is 8.67 m ( $L_{\text{open}}$ ) with a diameter of 0.14 m ( $d_{\text{open}}$ ) and the casing diameter is 0.158 m. A measured velocity inside the casing of 0.25 m/s ( $v_{\text{casing}}$ ) could also be obtained during some of the tests for this well. The formation velocity ( $v_{\text{formation}}$ ) can be calculated by using Equation A3.1, by simply replacing the notations of screen with open hole/formation and where n is replaced by the effective porosity, which is assumed to be 20 %. The formation velocity is calculated as 6.4·10<sup>-4</sup> m/s by using Equation A3.1. The corresponding medium grain size must be less than 2 mm according to Equation A3.2, in order to avoid turbulent flow in the formation. A density ( $\rho$ ) of 999.849 kg/m<sup>3</sup> and viscosity of ( $\mu$ ) 1.386·10<sup>-3</sup> kg/(s·m) are used since the water temperature during the testing was 8°C. A grain size of less than 2 mm is reasonable for the tested sandstone and, therefore, the occurrence of turbulence is limited in this case.

The third case is a well in a fractured basement with an open hole completion, similar to the one presented in the thesis. The length of the open hole is 10 m ( $L_{\text{open}}$ ) with a diameter of 0.14 m ( $d_{\text{open}}$ ) and the casing diameter is 0.158 m. The casing velocity is assumed to be 0.25 m/s ( $v_{\text{casing}}$ ). The formation velocity ( $v_{\text{formation}}$ ) can be calculated by using Equation A3.1, by simply replacing the notations of screen with open hole/formation and where n is replaced by the effective porosity, which is assumed to be 1 %. The formation velocity is calculated as 8.9·10<sup>-2</sup> m/s by using Equation A3.1. The corresponding medium grain size/fracture aperture must be less than 0.15 mm according to Equation A3.2, in order to avoid turbulent flow in the formation. The same density and viscosity are used as for case two (see previous paragraph). Turbulent flow can occur in this case, since grain sizes/fracture apertures can be greater than 0.15 mm and, in addition, if the flow is restricted only to a small portion of the open hole the occurrence of turbulence can increase due to the fact of a higher fluid velocity.

---

## Appendix 4: Pumping test solutions

### Solutions for drawdown analysis

In order to interpret drawdown data in a confined aquifer, Equation A4.1 can be used, which is the Cooper-Jacob solution (Cooper and Jacob, 1946). The skin factor is also taken into account in this equation which is a small modification of the original equation. The derivation of the equation can be seen in Appendix 5. In the field, drawdown is often measured as a change in pressure. To convert pressure measured in bar or Pascal to meters of water column, the density must be known. Use of a constant density value can only be done if the flow can be considered as isothermal and with a constant TDS.

$$s = \frac{p}{\rho \cdot g} = 0.183 \cdot \frac{Q}{T} \cdot \left( \log \left( \frac{135 \cdot T \cdot t}{r_w^2 \cdot S} \right) + \frac{\xi}{1.15} \right) \quad (\text{Equation A4.1})$$

where

$s$ = drawdown (m)	$p$ = drawdown (Pa)	$\rho$ = density (kg/m <sup>3</sup> )
$g$ = acceleration of gravity (m/s <sup>2</sup> )		$Q$ = flow rate (m <sup>3</sup> /s)
$T$ = transmissivity (m <sup>2</sup> /s)	$t$ = time (min)	$r_w$ = radius of the well (m)
$S$ = storativity	$\xi$ = skin factor	

The solution is commonly used and also frequently used in this thesis, due to its simplicity in use, while still obtaining reliable results (e.g. Butler, 1990; Halford et al., 2006). In single well tests, the solution is superior when compared to alternatives (Halford et al., 2006). In order to calculate the transmissivity, the drawdown ( $s$ ) is plotted versus the logarithm of the time ( $\log(t)$ ). This will give a straight line. Then, from the slope of the line ( $\Delta s$ ) and the flow rate ( $Q$ ), the transmissivity ( $T$ ) can be calculated by using Equation A4.2. A further description can be seen in Appendix 5. The transmissivity is the product of the hydraulic conductivity ( $K$ ) and the saturated thickness of the aquifer ( $z$ ). The best fit of the data to a straight line can easily be obtained with, for example, linear regression. The data from the beginning of a pump test can be affected by skin and wellbore storage, which must be taken into account when the line to calculate the transmissivity is fitted to the data. On a longer time perspective, the data might also be affected by hydraulic boundaries.

$$T = \int K \cdot dz = 0.183 \cdot \frac{Q}{\Delta s} \quad (\text{Equation A4.2})$$

where

$K$ = hydraulic conductivity (m/s)	$z$ = saturated thickness (m)
$\Delta s$ = drawdown per log cycle of time (m)	

The storativity ( $S$ ) can also be calculated using the above described plot and if an observation well is used Equation A4.3 can be used.

$$S = \frac{135 \cdot T \cdot t_0}{r^2} \quad (\text{Equation A4.3})$$

where

$t_0$ = time when the drawdown is zero (min)
$r$ = radial distance between pumping and observation well (m)

In the case with a single well test, the estimation of storativity is difficult due to possible skin effects. There can be a difference between the drawdown measured in the well and the drawdown in the aquifer next to the well. The difference is defined as skin. A positive skin factor means that the drawdown is larger in the well than in the aquifer next to the well, which can be caused by, for example, clogging of the well construction. A negative skin factor



## Appendix 4

---

means that the drawdown is less in the well than in the aquifer next to the well, which can be caused by fractures in the formation or from stimulation activities. Equations and assumptions related to the skin factor can be seen in Appendix 5. Calculation of storativity from drawdown data from only one pumping well requires that the skin factor ( $\xi$ ) is known (see Equation A4.4). The correlation between the two parameters of storativity and skin factor introduces uncertainty into the calculations, since assumptions have to be made for one of the parameters in order to calculate the other one. Therefore, the correct way to evaluate the storativity or the skin factor is to evaluate drawdown data from observation wells and compare it with the data from the pumping well.

$$\xi = 1.15 \cdot \log\left(\frac{r_w^2 \cdot S}{135 \cdot T \cdot t_0}\right) \quad (\text{Equation A4.4})$$

The data requirements for using the Cooper and Jacob (1946) solution are time-drawdown data, flow rate, screen radius or radial distance to the observation well, as well as aquifer thickness to express transmissivity as hydraulic conductivity. In the case of influence of wellbore storage (see e.g. Table 2) it is characterized by a unit slope fitted to the early drawdown data in a logarithmic diagram. In that case, the evaluation of the transmissivity was carried out considering the 1 ½ log cycle rule (Horne, 1995), specifically that the semilog straight line shall be expected 1 ½ log cycles after the end of the unity slope fitted to the data.

The Cooper-Jacob is an approximation of Theis (1935) solution, a satisfactory approximation if the  $u$  value is less than 0.01 (McWhorter and Sunada, 1977). The definition of  $u$  can be found in Appendix 5. The Theis solution is a type curve used for a confined aquifer (see Equation A4.5). For data requirements see the above Cooper and Jacob (1946) solution. In addition, in the case of a partially penetrating well, information regarding saturated thickness and data regarding the screen installation are also needed.

$$s = \frac{Q}{4 \cdot \pi \cdot T} \cdot \int_u^\infty \frac{e^{-y}}{y} dy = \frac{Q}{4 \cdot \pi \cdot T} W(u) \quad (\text{Equation A4.5})$$

where

$s$  = drawdown (m)

$Q$  = flow rate (m<sup>3</sup>/s)

$T$  = transmissivity (m<sup>2</sup>/s)

$W(u)$  = Theis well function

In order to consider that water can be stored in the well during testing, ignored by previously described solutions, the Papadopulos-Cooper solution (Papadopulos and Cooper, 1967) can be used (see equation A4.6 and A4.7). This type curve solution takes into account the radius of the casing where the water level changes. Storage in the well is more evident for large diameter wells. The data requirements are the same as described for Cooper and Jacob, with the addition of the casing radius.

$$s = \frac{Q}{4 \cdot \pi \cdot T} \cdot F(u, \alpha) \quad (\text{Equation A4.6})$$

$$\alpha = \frac{r_w^2}{r_c^2} \cdot S \quad (\text{Equation A4.7})$$

where

$F(u, \alpha)$  = Papadopulos function

$r_w$  = effective radius of the well screen (m)

$r_c$  = radius of the casing where the water level is changing (m)

The previously described solutions are developed for confined aquifers, but, to estimate aquifer parameters from a test carried out in a leaky confined aquifer without storage in the aquitard, the Hantush-Jacob (1955) solution can be used (see Equation A4.8). The equation

---

has the same form as the Theis equation but the well function is different. When using the type curve family for leaky aquifers this method is called Walton's method (Walton, 1962).

$$s = \frac{Q}{4 \cdot \pi \cdot T} \cdot \int_u^{\infty} \frac{1}{y} e^{\left(-y - \frac{r^2}{4L^2 y}\right)} dy = \frac{Q}{4 \cdot \pi \cdot T} W(u, r/L) \quad \text{(Equation A4.8)}$$

where

$W(u, r/L)$  = Hantush well function       $r$  = distance to observation well or well radius (m)

$L$  = leakage factor (m) =  $\sqrt{\frac{Tb'}{K'}}$        $b'$  = thickness of aquitard (m)

$K'$  = hydraulic conductivity of aquitard (m/s)

In Equation A4.8, it can be seen that if the second exponential term approaches zero the equation approaches the Theis well function (see Equation A4.5). In addition to aquifer properties such as transmissivity and storativity, information regarding the hydraulic properties of the aquitard can also be obtained from the Hantush-Jacob (1955) solution. The data requirements are the same as for Cooper-Jacob, with some additional information regarding the aquitard required. In addition, for a partially penetrating well, information regarding saturated thickness and data regarding the screen installation are also needed.

The above described methods for interpreting drawdown data are all presented for a constant flow rate. However, in order to consider a variable flow rate during a pumping test, Birsoy and Summers solution (Birsoy and Summers, 1980) can be used (see Appendix 5).

### Solutions for recovery analysis

Recovery data collected after the well is shut in can also be used to calculate the transmissivity. This type of analysis excludes the influence from, for example, turbulence, which can affect the analysis of drawdown data. The Theis recovery method (Theis, 1935) can be used to estimate the aquifer parameters (see Equation A4.9).

$$s' = \frac{Q}{4 \cdot \pi \cdot T} \ln\left(\frac{t}{t'}\right) = 0.183 \frac{Q}{T} \log\left(\frac{t}{t'}\right) \quad \text{(Equation A4.9)}$$

where

$s'$  = residual drawdown (m)

$Q$  = flow rate (m<sup>3</sup>/s)

$T$  = transmissivity (m<sup>2</sup>/s)

$t$  = time since pumping begun (s)

$t'$  = time since pumping stopped (s)

To calculate the transmissivity, the residual drawdown ( $s'$ ) is plotted versus the logarithm of the ratio  $t/t'$ , and then a straight line can be fitted to the data under ideal conditions. The slope of the line  $\Delta s'$  and the flow rate ( $Q$ ) during pumping can be used to calculate the transmissivity by using Equation A4.2. In other words, the data requirement is time-residual drawdown data and flow rate. The skin factor can also be estimated from recovery data by adopting the methodology described by Kruseman and de Ridder (2000).

In 1980, Agarwal presented an alternative method for analysing the recovery data by applying type curves and by using the Agarwal equivalent time. The Agarwal equivalent time is defined in Equation A4.10 for a constant pumping rate. By plotting the Agarwal time against the recovery on a logarithmic plot such as the Theis type curve, it can be used for the matching and transmissivity evaluation.

$$t_{equiv} = \frac{t_p \Delta t}{t_p + \Delta t} \quad \text{(Equation A4.10)}$$

where  $t_p$  = pumping time (s)

$\Delta t$  = time since pumping stopped (s)

### Constant head analysis

A straight line method, similar to the Cooper-Jacob (1946) solution, for analysing data obtained from a constant head test was presented by Jacob and Lohman (1952). A constant head test can, for example, be used for evaluating artesian wells/free flowing wells. During the test the flow rate is varying but the head is kept constant. The Jacob-Lohman (1952) solution can be written as Equation A4.11, which is just another way to present the Cooper and Jacob (1946) solution, compared with Equation A4.1 if the skin factor is ignored. The solution is valid if  $u < 0.01$ .

$$\frac{s}{Q} = \frac{0.183}{T} \cdot \log\left(\frac{135 \cdot T \cdot t}{r_w^2 \cdot S}\right) \quad (\text{Equation A4.11})$$

see Equation A4.1 for parameter definition.

The same methodology as for Cooper-Jacob (1946) can be used for estimating transmissivity and storativity. To calculate the transmissivity, the specific drawdown ( $s/Q$ ) is plotted versus the logarithm of time ( $\log(t)$ ). This will give a straight line. Then, from the slope of the line ( $\Delta(s/Q)$ ) the transmissivity ( $T$ ) can be calculated by using Equation A4.12. The storativity can be calculated using Equation A4.3.

$$T = 0.183 \cdot \frac{1}{\Delta(s/Q)} \quad (\text{Equation A4.12})$$

### Step-drawdown analysis

In a step-drawdown test the flow rate is increased in steps and the drawdown during each step is recorded. Using this data, the aquifer loss coefficient and the well loss coefficient can be estimated. These coefficients can then be used to predict a drawdown corresponding to a certain flow rate. In other words, a method used for investigating the performance of a single well using different flow rates.

The total drawdown can be divided into two parts; the drawdown caused by laminar flow and the drawdown caused by turbulent flow. According to Jacob (Jacob, 1947) the total drawdown can be divided into one linear laminar part and one non-linear part (see Equation A4.13).

$$s = B \cdot Q + CQ^2 \quad (\text{Equation A4.13})$$

where

$s$  = total drawdown (m)

$Q$  = flow rate ( $\text{m}^3/\text{s}$ )

$B$  = aquifer loss coefficient ( $\text{s}/\text{m}^2$ )

$C$  = well loss coefficient ( $\text{s}^2/\text{m}^5$ )

The aquifer loss coefficient can be divided into two parts. Linear aquifer coefficient and linear well loss coefficient, where the latter is due to for example skin. When evaluating data from a step-drawdown test only the combination of the two expressed as aquifer loss coefficient can be evaluated. The parameters included in the aquifer loss coefficient can be seen in Appendix 5, where it also can be seen that the aquifer loss coefficient is time dependent. Rorabaugh (1953) modified Jacob's method to account for changes of the order of the non-linear well loss, whereby instead of the second order, a value from 1.5 to 3.5 can be used.

The method for Jacob in combination with a graphical procedure developed by Bierschenk (Bierschenk, 1963) will be described briefly. A more detailed description can be found in Kruseman and de Ridder (2000). The specific drawdown ( $s/Q$ ) for each step, at a specific time ( $\Delta t$ ), is plotted against the corresponding flow rate and a line is fitted to these points. The slope of the line is the well loss coefficient ( $C$ ) and the intercept with  $Q=0$  is the aquifer loss coefficient ( $B$ ) at a specific time ( $\Delta t$ ). When a straight line can't be fitted to the points then the order of the well loss coefficient is not equal to two and Rorabaugh's method has to be used.

---

The method for using Rorabaugh's method isn't described in this thesis but is described in, for example, Kruseman and de Ridder (2000).

The Theis equation, Equation A4.5, can be modified to include a linear and a non-linear part and thereby be used in a step test analysis (see Equation A4.14). A value from 1.5 to 3.5 can be used for the order of the non-linear well loss.

$$s = \frac{Q}{4 \cdot \pi \cdot T} (W(u) + 2\xi) + C \cdot Q^P \quad (\text{Equation A4.14})$$

for parameter definitions see equation 3.5 and 3.13.

Equation A4.8, the Hantush-Jacob solution, can also be modified in the same manner as Equation A4.14 and be used for step-drawdown analysis.

---



## Appendix 5: Pumping test equations

The Cooper and Jacob (1946) equation:

$$s = 0.183 \cdot \frac{Q}{T} \cdot \log\left(\frac{135 \cdot T \cdot t}{r_w^2 \cdot S}\right) \quad (\text{Equation A5.1})$$

where

$s$  = drawdown (m)

$Q$  = flow rate (m<sup>3</sup>/s)

$T$  = transmissivity (m<sup>2</sup>/s)

$t$  = time (min)

$r_w$  = radius of the well (m)

$S$  = storage coefficient

The equation is an approximation of the Theis well function and is valid for  $u < 0.01$  (McWhorter and Sunada, 1977).

$$u = \frac{r^2 \cdot S}{4 \cdot T \cdot t} \quad (\text{Equation A5.2})$$

The drawdown caused by skin can be defined as in Equation A5.3 (van Everdingen, 1953). Equation A5.3 even shows how it can be approximated.

$$s_s = \frac{\xi \cdot Q}{T \cdot 2\pi} \approx \frac{0.183 \cdot Q}{T} \left(\frac{\xi}{1.15}\right) \quad (\text{Equation A5.3})$$

where

$s_s$  = drawdown caused by skin (m)

$\xi$  = skin factor

The skin factor can be used to calculate the effective radius of the well according to Equation A5.4 (Matthews and Russel, 1967).

$$r_{wf} = r_w \cdot e^{-\xi} \quad (\text{Equation A5.4})$$

where

$r_{wf}$  = effective radius of the well (m)

If the drawdown caused by skin is substituted to Equation A5.1, it can be written as Equation A5.5.

$$s = 0.183 \cdot \frac{Q}{T} \cdot \left( \log\left(\frac{135 \cdot T \cdot t}{r_w^2 \cdot S}\right) + \frac{\xi}{1.15} \right) \quad (\text{Equation A5.5})$$

Equation 5 can be expressed as a straight line in semi-log diagram (see Equation A5.6), where  $\Delta s$  is the slope of the line.

$$s = \Delta s \cdot \log t + s_1 \quad (\text{Equation A5.6})$$

where

$$\Delta s = 0.183 \cdot \frac{Q}{T}$$

$$s_1 = \Delta s \cdot \left( \log\left(\frac{135 \cdot T}{r_w^2 \cdot S}\right) + \frac{\xi}{1.15} \right)$$

$\Delta s$  = drawdown per log cycle of time (m)

$s_1$  = drawdown (m) at  $t = 1$  min

## Appendix 5

---

The time when the drawdown is zero can be calculated with Equation A5.7.

$$t_0 = 10^{-\frac{s_1}{\Delta s}} \quad (\text{Equation 5.7})$$

where

$t_0$  = time (min) when drawdown is zero

By combining Equations A5.6 and A5.7, the skin factor can be calculated using Equation A5.8.

$$\xi = 1.15 \cdot \log\left(\frac{r_w^2 \cdot S}{135 \cdot T \cdot t_0}\right) \quad (\text{Equation A5.8})$$

If the head loss due to turbulence is to be considered, a non-linear term will be added to Equation A5.5 (see Equation A5.9).

$$s = 0.183 \cdot \frac{Q}{T} \cdot \left( \log\left(\frac{135 \cdot T \cdot t}{r_w^2 \cdot S}\right) + \frac{\xi}{1.15} \right) + C \cdot Q^2 \quad (\text{Equation A5.9})$$

where

$C$  = well loss coefficient ( $\text{s}^2/\text{m}^5$ )

Equation A5.10 is another way to express Equation A5.9, which is used for analysing step-drawdown data.

$$s = B \cdot Q + C \cdot Q^2 \quad (\text{Equation A5.10})$$

where

$$B = \frac{0.183}{T} \left( \log\left(\frac{135 \cdot T \cdot t}{r_w^2 \cdot S}\right) + \frac{\xi}{1.15} \right)$$

$B$  = Aquifer loss coefficient ( $\text{s}/\text{m}^2$ ) (time dependent)

To consider a variable flow rate during a pumping test, the Birsoy and Summers (1980) method can be used (see Equations A5.11 and A5.12).

$$\frac{s_n}{Q_n} = \frac{2.3}{4 \cdot \pi \cdot T} \log\left(\frac{135 \cdot T}{r^2 \cdot S} \beta_{n(t)}(t - t_n)\right) \quad (\text{Equation A5.11})$$

where

$s_n$  = drawdown at a particular time within step  $n$  (m)     $Q_n$  = flow rate during step  $n$  ( $\text{m}^3/\text{s}$ )

$T$  = transmissivity ( $\text{m}^2/\text{s}$ )

$r$  = radius of the well/observation well distance (m)

$S$  = storativity

$\beta_{n(t)}(t - t_n)$  adjusted time (min)

$$\beta_{n(t)} = \prod_{i=1}^n (t - t_i)^{\Delta Q_i / Q_n} \quad (\text{Equation A5.12})$$

$t$  = time when  $s_n$  was measured within step  $n$  (min)

$t_i$  = time at which  $i$ -th flow rate started (min)

$\Delta Q_i$  = the increment of flowrate beginning at  $t_i$  ( $\text{m}^3/\text{s}$ )

---

The transmissivity and storativity are estimated using a semi-logarithmic graph with the specific drawdown ( $s/Q$ ) on the vertical axis and the adjusted time on the horizontal axis. Equation A5.11 and a procedure similar to the Cooper-Jacob semi-logarithmic method are used to calculate the parameters.

---



---

---

# **Paper 1**

**Rosberg J-E. (2010)**

**Pneumatic slug testing in large-diameter wells**

**Accepted for publication in Hydrogeology Journal**

**(After the technical review this version has also been technically edited)**



# Pneumatic slug testing in large-diameter wells

Jan-Erik Rosberg  
Engineering geology, LTH, Lund University  
P.O. Box 118 SE-22100 Lund, Sweden  
e-mail: Jan-Erik.Rosberg@tg.lth.se  
Tel.: +46462224086; fax:+46462229127

## Abstract

There is a need for an alternative method to conventional pumping tests that is logistically easier and faster to use and which can be handled by only one person. The well known slug test fulfils those requirements if the equipment is properly designed. The applicability of small-diameter slug-test equipment using pneumatic initiation in large diameter wells, up to 12" (0.3 m), is discussed. In wells with 36 times greater cross-sectional area than the slug-test equipment, it will take a long time for casing depressurization after slug initiation. The casing-depressurization time was measured for each slug test and is presented as a part of the results. The small-diameter equipment was found to be applicable and the long casing-depressurization times did not generally affect the transmissivity estimates. The series of slug tests yielded transmissivity estimates that were in good agreement with each other and also when compared with estimates from pumping tests. However the slug-test results from wells completed in more permeable formations were harder to interpret, and may be an effect of long casing-depressurization times; further investigations are needed. There is a description of the design of several airtight couplings between the slug-test equipment and the casing.

**Keywords** Slug testing, equipment/field techniques, hydraulic testing, Sweden, Nicaragua

## 1. Introduction

In general there is a need for an alternative method to conventional pumping tests, a method that is logistically easier, faster to use, requires less experience, and can be handled by only one person. The well known *slug test*, developed since Hvorslev (1951), fulfils those requirements. The Department of Engineering Geology at Lund University, Sweden, has recently investigated the applicability of slug testing using pneumatic initiation in large-diameter wells. Several tests have been carried out in Sweden and Nicaragua, see Fig. 1. In both countries there is a need to find a complement to the more logistically demanding and expensive conventional test pumping to gather information about the hydraulic properties of the aquifers. In Sweden there are a couple of ongoing tunnelling projects, where a lot of observation wells have been drilled for monitoring impacts of the tunnelling. Only a few of those wells have been test pumped. In the western part of Managua, in Nicaragua, there is an ongoing project to carry out numerical modelling of groundwater flow conditions. A major problem is the lack of data on hydraulic parameters, like transmissivity, despite numerous wells located within the study areas. In common for the wells is their large casing diameter. In Sweden the most common casing sizes are between internal diameter (ID) 5.1" (0.13 m) and ID 7.2" (0.18 m), but in Nicaragua a common casing size is 12" (0.30 m). In practise this means that greater volumes than usual must be discharged in order to initiate a suitable initial displacement during a slug test.

A piece of slug test equipment with pneumatic initiation was designed and tested with respect to its applicability in large-diameter wells. Slug tests with pneumatic initiation have been described by many authors (e.g. Krauss 1974; Prosser 1981; Leap 1984; Spane et al. 1996; Butler 1998; McElwee 2002; Zurbuchen et al. 2002; Ostendorf et al. 2005, 2007) and this method was found to be the most suitable for this work. The main reason is that some of the

wells were located in remote areas and had large casing diameters and volumes, and thus slug initiation (by removing/adding water or using a packer-based system) had to be excluded as a viable method from a practical point of view. The restrictions of the well owners meant that the use of a solid slug was also not possible. An important design criterion for the equipment was that it should be easy to handle by a single person and easy to rig up. In other words, the equipment needed to be low weight; consequently restrictions on the equipment diameter were necessary. As a consequence, when using equipment with a smaller diameter than the casing diameter, the casing depressurization after slug initiation (slug initiation being the *release* of compressed air from the wellbore, not its injection into the wellbore) would not be instantaneous (see e.g. McElwee 2002).

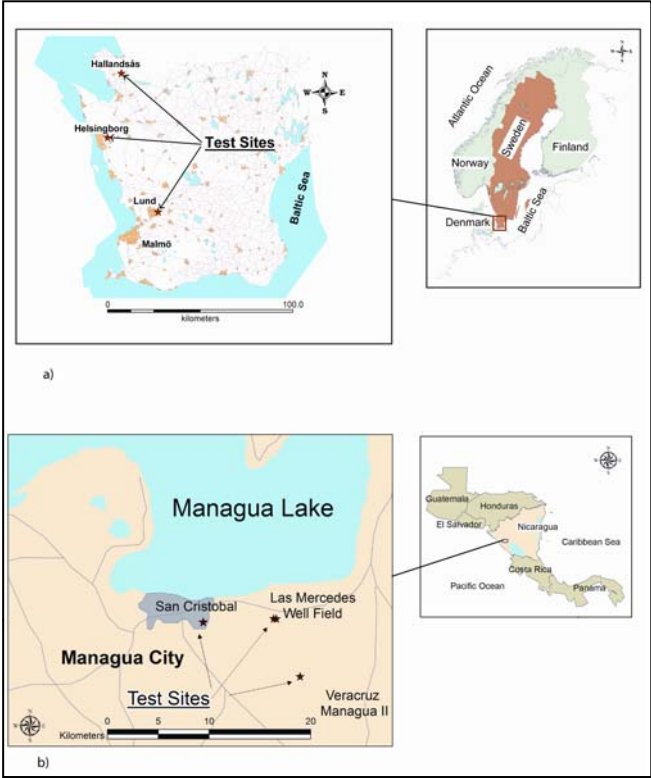

**Fig. 1** The test sites located in (a) Sweden and (b) Nicaragua.

The main focus in this paper will be on the applicability of small-diameter slug-test equipment in large-diameter wells, especially focussing on wells with the largest diameter, 12" (0.30 m), which are all located in Nicaragua. Measurements of the time for casing depressurization, ie. the time for the compressed air to be released from the wellbore after the slug is initiated, will be presented. A comparison of transmissivity values obtained from slug tests will in some cases be compared with values from pumping tests to support or reject the applicability of the slug test equipment. A major concern when conducting the tests was the need for an airtight coupling between the casing and the slug test equipment. Such an airtight coupling is of vital importance for the application of the pneumatic initiation. A great variety of well-top completion arrangements were considered; different airtight couplings had to be constructed and will also be presented in this paper.

**2. Test equipment and airtight couplings**

The equipment is made of steel and the dimension of the pipe and the valve is 2" (0.05 m), see Fig. 2. The dimension of 2" was chosen to fulfil the requirement of having equipment that could be handled by one person. For comparison, the 2" steel ball valve has a weight of 3.6 kg and the same type of valve for 3" (0.08 m) is 11.6 kg. One way to get around this problem is,

of course, to use plastic instead of steel. Since this was a prototype, steel was chosen as it is cheaper and also because it is easier to repair if it is damaged. The 2" pipe was equipped with one fitting for connecting a scuba tank or a compressor and one fitting for a digital manometer. At the top of the equipment there is an airtight inlet for the transducer cable and at the bottom a 2" threaded pin connection for the airtight coupling between the casing and the slug test equipment. A memory gauge connected to a handheld computer through a communication cable was used for data acquisition. This solution was used for avoiding external power supplies and having real time data visualization from the submerged sensor. The digital manometer, with a record function, was used for measuring the air pressure inside the casing during the pressurization phase.

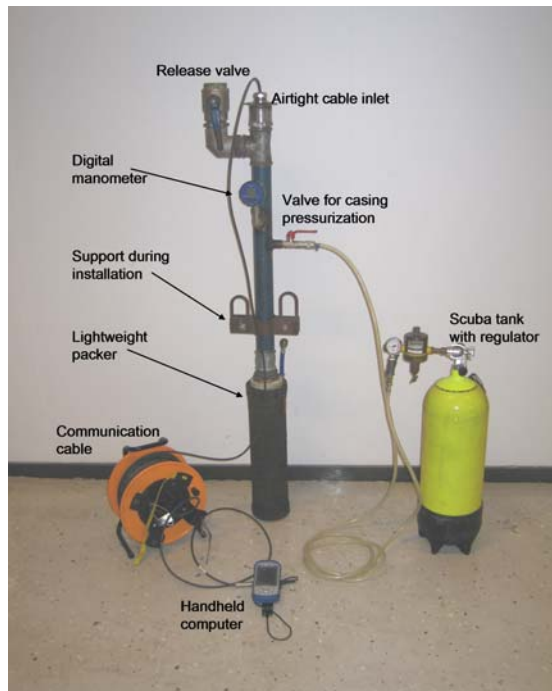

**Fig. 2 Slug test equipment with scuba tank and the lightweight packer.**

Another matter to consider when constructing the airtight coupling between the slug test equipment and the top of the casing is the upward force created during casing pressurization. To calculate this force, multiply the air pressure inside the casing with the cross-sectional area of the casing. For example, if 1 bar overpressure is used in a 10" (0.25 m) casing, it will cause an upward force of around 5 kN; in other words, around 500 kg is necessary as a counterweight to secure the slug test equipment. To have an airtight coupling that stands the upward force may seem fundamental, but on the other hand, it could be very dangerous to operating staff if ignored.

Two different airtight couplings were used in Sweden and found to be suitable for the most common casing sizes. The first coupling was a lightweight packer solution and the second was a clamp-on device. The lightweight packer can be seen in Fig. 2. The packer is 0.56 m long and weights 4.8 kg, and could be used for casing sizes between 6 and 10" (0.15-0.25 m). The by-pass dimension inside the packer is 4" (0.1 m) and at the top there is a threaded box connection, which is used for connecting the slug test equipment. The major differences compared with a more conventional packer (for example, used for cementing/grouting) are the weight and the by-pass dimension inside the packer. Packers used for cementing/grouting often are heavy (more than 20 kg), longer and with a low by-pass dimension (less than 1"). A conventional packer can be used for higher pressure than the used lightweight packer. A

maximum overpressure of 1 bar and 0.6 bar is allowed for a casing diameter of 6" (0.15 m) and 10" (0.25 m), respectively, for the used lightweight packer.

The lightweight packer is easy to handle and install. It can be inflated by a hand pump or by using the scuba tank. It can also be useful to have a support, larger than the casing diameter, for example, a clamp-on device attached to the bottom of the slug test equipment to make the installation procedure easier and to avoid dropping the equipment into the well. This slug test set-up with the lightweight packer can easily be handled by only one person and can be rigged up/down very quickly. One disadvantage is that this airtight coupling solution cannot be used if there is a welded wellhead with restricted diameter or obstacles inside the casing. A similarity with many other airtight coupling devices for pneumatic slug testing is that it is hard to find a packer that covers a wide range of casing sizes.

The second airtight coupling used for slug testing with pneumatic initiation was a clamp-on device. The device consists of steel structures (in two halves) that are clamped on the outside of the casing. There are also two vertical bolts attached to the clamp-on device, which are used for installation of a steel plate on top of the casing, see Fig. 3. In addition a rubber plate is placed on top of the casing as a seal before the steel plate is mounted with washers and nuts. On top of the plate there is a threaded fitting for attaching the slug test equipment. This device must be pre-fabricated and easy to install by one person only. This construction can withstand higher pressures than is needed during pneumatic slug testing, which is decided by the tensile strength in the vertical bolts or the shear strength in the bolts. The airtight coupling has been tested up to 2 bar without any air leakage. A disadvantage with this type of coupling is that it cannot be used if the top of the casing is at the same level as the ground, which can be a quite common situation especially in urban environments. Another disadvantage is that this type of clamp-on device only fits one casing size.

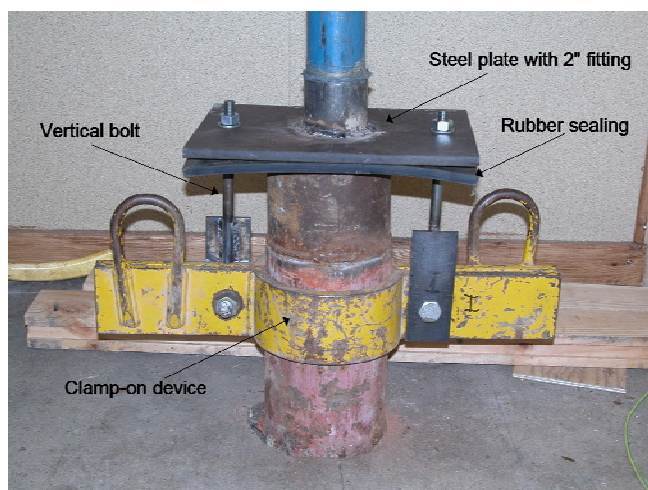

**Fig. 3** A clamp-on device used as an airtight coupling. 2" = 5.1 cm.

During field campaigns in Nicaragua different airtight coupling solutions were designed and tested. The dominating casing size of tested wells was 12", but the completion at the top of the casing was different in different locations. A common completion is a well that is placed in the centre of a rectangular concrete pad, with the top of the casing levelled with the top of the concrete pad. The concrete pads can be equipped with vertical embedded bolts, which could be used for attaching an airtight coupling. For this type of completion the previously mentioned lightweight packer would have been the optimal and fastest coupling to use and install. However, this type of packer fitting for a 12" casing could not be delivered in time for

the field work and at a reasonable price. Therefore focus was set on different coupling solutions that were pre-fabricated before starting the field work, so that most of the field work time was spent on testing instead of installation of equipment. Coupling solutions based on welding were, therefore, avoided; a welding solution can be useful in many situations, but is time consuming and requires additional equipment such as a welding unit, generator, grinder etc. and a welder. Another practical aspect is that welding can not be applied if it is a plastic casing, which was the case at some of the sites.

One airtight coupling solution, that can be applicable for many of the wells in Managua, is the one used for wells placed in the centre of a concrete pad with four embedded bolts. The coupling was constructed by using a circular steel plate with a greater dimension than the actual casing size, see Fig. 4. In the centre of the plate there is a threaded fitting for the slug test equipment. To make it airtight a rubber plate is installed between the concrete and the plate. The plates are firmly installed against the concrete using four iron flat bars; two of the flat bars are equipped with holes fitting the embedded bolts, see Fig. 4, and tightened by nuts. The airtight coupling has been tested with pressurization up to 1.5 bar without any air leakage. To get the coupling airtight it is important that the concrete surface is even. The coupling must be pre-fabricated and is then easy to install. The size of the steel plate is decided by the casing size and the diagonal of the rectangle/square formed by the four embedded bolts, meaning that for different casing sizes different plate sizes are required.



**Fig. 4** Airtight coupling using a steel plate and flat bars.

Another coupling solution was developed for wells similar to the wells described above, but without embedded bolts. The coupling was designed as a circular steel plate with eight holes evenly spaced, similar to a flange, with a threaded fitting for the slug test equipment in the centre, see Fig. 5. To make it airtight a rubber plate with the same shape as the steel plate is placed as a seal between the concrete and the steel plate. Out in the field eight holes, matching the holes in the plates, are drilled in the concrete and expansion anchors are installed. An expansion anchor is a type of bolt with a part that expands when tightened with a nut. Then the plates are mounted on the eight expansion anchors and nuts are used for tightening the coupling against the concrete, in other words to seal off the well. This coupling was airtight



and was tested up to 0.5 bar during pressurization without any leakage. A disadvantage with this method is that one has to drill eight holes for the expansion anchors during the field work, which can be time consuming. In addition, after testing there are eight permanent installed expansion anchors, which can not be reused at another well site.



**Fig. 5 Airtight coupling using a steel plate installed on a concrete pad.**

The easiest airtight coupling used was the one for wells with threaded casing at the top. The coupling was a lid fitting the actual casing size with a threaded fitting for the slug test equipment at the centre, see Fig. 6. The installation time for this coupling is very fast for one person. A practical piece of advice is to use Teflon tape or similar on the casing thread to make it airtight. This type of coupling can stand higher pressures than necessary for slug testing. A disadvantage with this coupling is that a specific coupling can only be used for a specific casing size. In addition very few wells are completed with a threaded casing at the top, which is a limiting fact.



**Fig. 6 Airtight coupling using a casing cap with a fitting for the slug test equipment in the centre. Pen for scale.**

A practical aspect to consider when conducting a slug test with pneumatic initiation is the use of an air compressor or a scuba tank for pressurizing the well. It is preferable to bring a scuba tank compared with a compressor (including required power supply), since it is smaller and easier to handle. However, an advantage with using a compressor is that there is no restriction regarding available air volume, as for scuba tanks. The required air volume during pressurization is dependent on casing size and the air column inside the well pre-testing and the initial water-column displacement that will be used as a testing criterion. For example, a 12" well requires four times greater air volume than a 6" well if the other parameters are identical. To manage a series of slug tests with different initial displacement in the 12" wells in Nicaragua a compressor was required and used. In Sweden for the wells with ID 5.1" (0.13 m) and ID 7.2" (0.18 m), a scuba tank was used. The air column in the Swedish wells was often less than 10 m long.

### 3. Evaluation of casing depressurization time

The effect of using a 2" release valve on the slug test equipment, smaller than the casing size of the tested wells, has been investigated. The slug will not be initiated instantaneously due to this difference in diameter, which will create a delay before the air pressure is evacuated from the wellbore when the slug is initiated. This time for casing depressurization has been measured (by use of the digital manometer at the wellhead, see Fig 2). The remaining water-column displacement after the time for casing depressurization has also been considered by comparing the pressure results from the digital manometer (placed at the wellhead) with the pressure results from the submerged sensor. In other words the air pressure measured at the wellhead before slug initiation is equivalent to the expected initial water-column displacement (in meters), but due to a non-instantaneous slug initiation the same displacement can not be obtained from the submerged sensor. In practice when the slug is initiated the used air pressure is bleeding off simultaneously as the water level starts to rise. During the time for casing depressurization the pressure readings from the submerged sensor will include a combined response from the water column above the sensor and the remaining pressure from the compressed air. The maximum deviation from static conditions (in meters of water column) that can be recorded from the submerged sensor is obtained directly after the time for casing depressurization (since there is no remaining pressure from the compressed air). This deviation will be called the initial water-column displacement ( $H_0$ ) and is the measurement that is compared with the *expected* initial water-column displacement ( $H_0^*$ ). In addition the initial displacement ( $H_0$ ) will be used later in the data analysis for normalizing the head values. The ratio of ( $H_0/H_0^*$ ) will be used for evaluating the remaining part of the expected displacement (used air pressure) after the time for casing depressurization.

Most of the wells tested in Nicaragua have a casing diameter of 12", which provides 36 times greater cross-sectional area than the release valve on the slug test equipment. Fig. 7 shows the time for casing depressurization versus initial displacement ( $H_0$ ) measured during testing of a 12" well with around 22 meters from the top of the casing to the water table. The same figure shows the ratio of the initial displacement measured by the submerged sensor ( $H_0$ ) and the pressure measured at wellhead ( $H_0^*$ , the expected initial displacement if instantaneous slug initiation) against initial displacement. The well is a water-well drilled into an aquifer of volcano-clastic origin and is screened and gravel-packed at five different levels. The volcano-clastic deposits in the well area are a stratified sequence of ash with different layering and grain size properties. Interlayering of basalt and tuff can not be excluded.

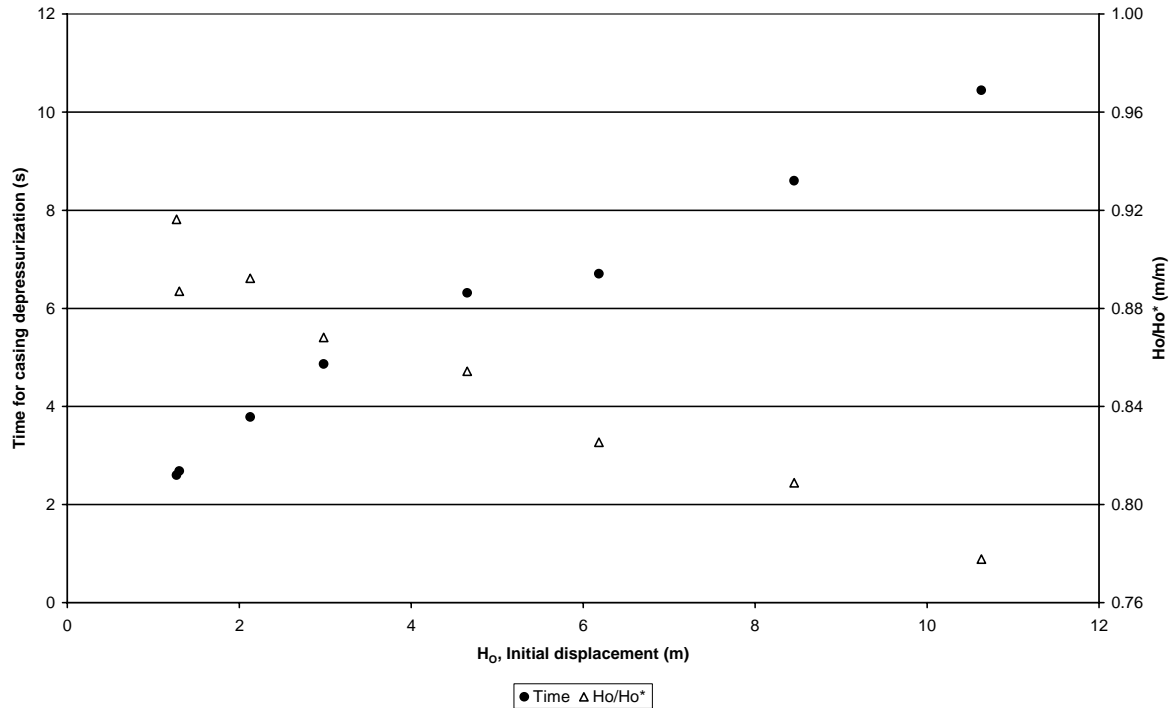

**Fig. 7 Time for casing depressurization and the ratio of initial displacement ( $H_0$ ) and used air pressure (expected initial displacement  $H_0^*$ ), measured during slug testing of well Las Mercedes 12 – a 12" (0.30 m) diameter well. Eight tests were conducted using different initial displacement ( $H_0$ ).  $H_0^*$  is the expected initial water-column displacement (used air pressure) and equates to the reading from the digital manometer directly before the slug is initiated.  $H_0$  is the initial displacement and equates to the reading from the submerged sensor after the time required for casing depressurization.**

The time for casing depressurization increases with increased initial water-column displacement, around 2.5 seconds for the lowest initial displacement and around 10 seconds for the highest, see Fig. 7. Between 78% and 92% of the expected initial displacement is remaining after casing depressurization, which is the same as the maximum displacement measured by the submerged pressure sensor. Similar results have been observed in the other tested wells with a casing size of 12". The time for depressurization is dependent of the air volume that shall be evacuated from the wellbore, which is decided by the casing size, depth to water table, and the initial displacement. In addition it is also dependent of the transmissivity of the aquifer, where a higher transmissivity will shorten the time for casing depressurization.

Time for casing depressurization was often less than 1 second for nine tested wells with smaller diameters in the range between ID 5.1" (0.13 m) and ID 7.2" (0.18 m), in different geological environments. Depth to the water table from the top of the casing was often less than 5 m. The initial displacements were less than 5 m. More than 94% of the used air pressure (expected initial displacement) was remaining after casing depressurization for the majority of the smaller diameter wells. Four of the wells are located in a confined sandstone aquifer and five of the wells are located in a fractured aquifer, dominated by gneiss and dolerite.

The most important part in the evaluative process of long casing-depressurization time is the actual influence on the results from the slug testing. To demonstrate this three wells with large diameter (12") in Nicaragua are discussed. As previously shown it took a long time for casing depressurization when small-diameter slug-test equipment was used for testing large-

diameter wells. The results from a series of slug tests at Las Mercedes well field are presented in Fig. 8; the logarithm of the normalized head ( $H(t)/H_0$ ) is plotted against time for eight different tests. These are the same tests as previously shown in Fig. 7. The start of each test is set to the time after casing depressurization and the initial water-column displacement used for normalizing the head values equates to the maximum displacement measured by the submerged sensor after the depressurization. This method, the translation method, has been described by Pandit and Miner (1986).

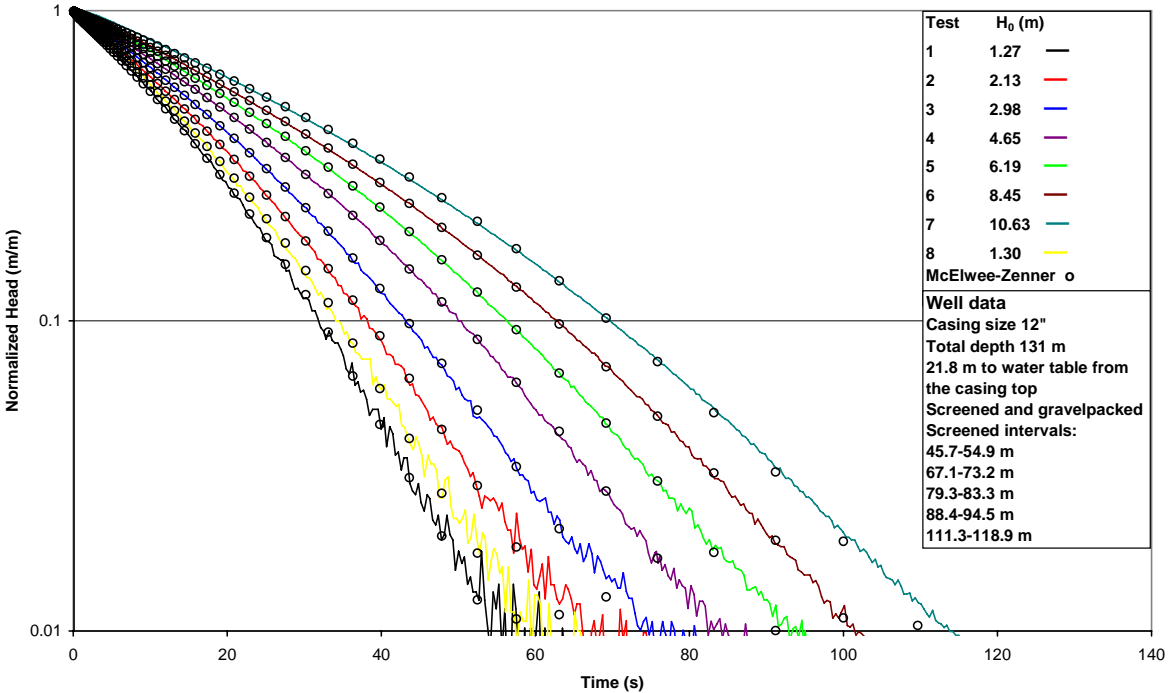
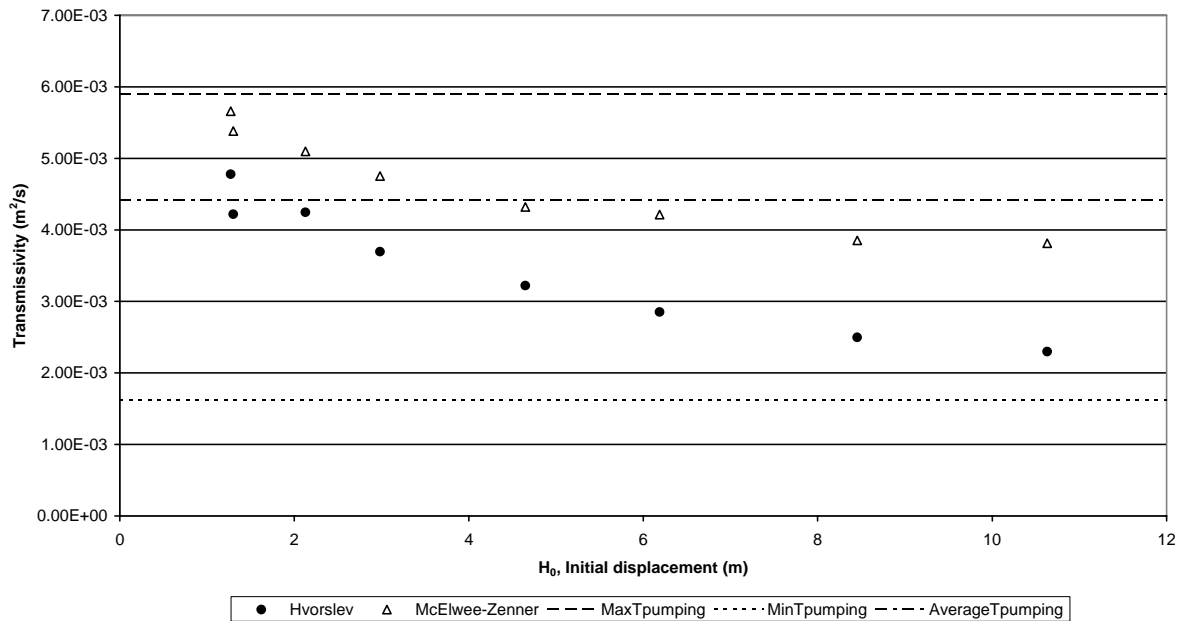

**Fig. 8 Normalized head versus time for eight tests carried out in a 12" diameter well (Las Mercedes 12) using 2" slug-test equipment. Matching using the McElwee and Zenner (1998) solution is also presented.**

Notable in Fig. 8 is that tests lasted between 60 and 120 seconds and time for casing depressurization varied between 2.5 and 10 seconds, see Fig. 6. In other words 4 to 8% of the time after slug initiation is occupied by the time for casing depressurization. It can also be seen in Fig. 8 that with increased initial displacement the corresponding curve is moved in time to the right in the figure. This indicates that lower transmissivity values are obtained if the initial displacement is increased, a parameter that should be constant. The separation of the curves and the downward curvature indicate non-linear influence (McElwee and Zenner 1998; Zenner 2008, 2009).

Transmissivity values estimated from the slug testing are presented in Fig. 9 and compared with values estimated from pumping test data. Transmissivity is estimated using the Hvorslev solution (Hvorslev 1951) and it is assumed that the effective screen length is the same as the actual screen length. Transmissivity is also estimated by using the McElwee and Zenner non-linear solution (McElwee and Zenner 1998; McElwee 2001). Strictly, the solutions above yield a hydraulic conductivity estimate, but the value is expressed as transmissivity for comparison with estimates from pumping tests. Unfortunately there are no pumping test data available for this well, but the well is located in a well field where pumping test data are available for 14 wells. The pumping tests were conducted as step-drawdown tests (e.g. see Kruseman and de Ridder 2000; Todd and Mays 2005), with variable quality of the data. Two different step-drawdown solutions have been used by modifying the Theis solution (Theis

1935) and Hantush-Jacob solution (Hantush and Jacob 1955) to include linear and non-linear flow losses (Jacob 1947). The maximum, minimum and average transmissivity estimates from the different pumping tests are presented in Fig. 9.



**Fig. 9 Transmissivity (T) estimated from slug testing (Las Mercedes 12 well) and 14 pumping tests within the Las Mercedes well field (performed as step-drawdown tests).**

The best match with acquired slug test data was achieved by applying the McElwee and Zenner non-linear solution (McElwee and Zenner 1998), see Fig. 8. In addition the matching was obtained by empirical curve fitting and is performed after the time for casing depressurization. In other words the physics regarding water level retardation associated with a pressurized and slowly relaxing gas cap is not considered. Two of the parameters in the solution  $\beta$  (related to radius changes in the water column) and  $V_0$  (initial velocity) were set to zero — for full parameter definition see McElwee (2001). Parameter A (related to non-linear head losses) was empirically estimated and varied between 13.8 and 17.8 to obtain the best match. A slight decrease of the transmissivity with increased initial displacement can be found in Fig. 9, when using this solution. However the values are close to the average transmissivity value estimated from the test pumpings.

In Fig. 9 it can be seen that the transmissivity estimated using the Hvorslev solution is decreasing markedly with increasing initial displacement, which is a parameter that shall be more or less constant. Other linear solutions, for example the one presented by Cooper et al. (1967), were also tested for interpreting transmissivity, but it was hard to get a good match. Hvorslev's solution (Hvorslev 1951) was easier to apply, since there is a straight line segment that is repeated at the different tests. The transmissivity estimates using the Hvorslev solution are in general lower than the ones from the McElwee and Zenner solution. Despite the decreasing transmissivity, indicating that a non-linear theory should be applied, the values obtained from Hvorslev are within the range of transmissivity values,  $1.6\text{-}5.9 \cdot 10^{-3} \text{ m}^2/\text{s}$  estimated from pumping tests.

Interpretation from seven slug tests conducted in another screened and gravel-packed 12"-well (San Cristobal 2) are presented in Fig. 10. The distance from the casing top to the water table was around 50 m. The Hvorslev solution is used for estimating transmissivity from the

slug tests and these estimated values are compared with a transmissivity value estimated from a pumping test, see Fig. 10. No pumping test data are available for the slug-tested well; instead data from another well (San Cristobal 3) located at a radial distance of around 15 m from the slug-tested well were used. The pumping test was performed as a step-drawdown test and the Theis step-drawdown solution was used for estimating transmissivity. The transmissivity values estimated from the slug testing are in good agreement (shown in Fig. 10), except for the values from the first two tests. A possible explanation is that the well was developed during the first two tests. Transmissivity estimated from the slug testing is around 1.5 times greater than the one estimated from the pumping test.

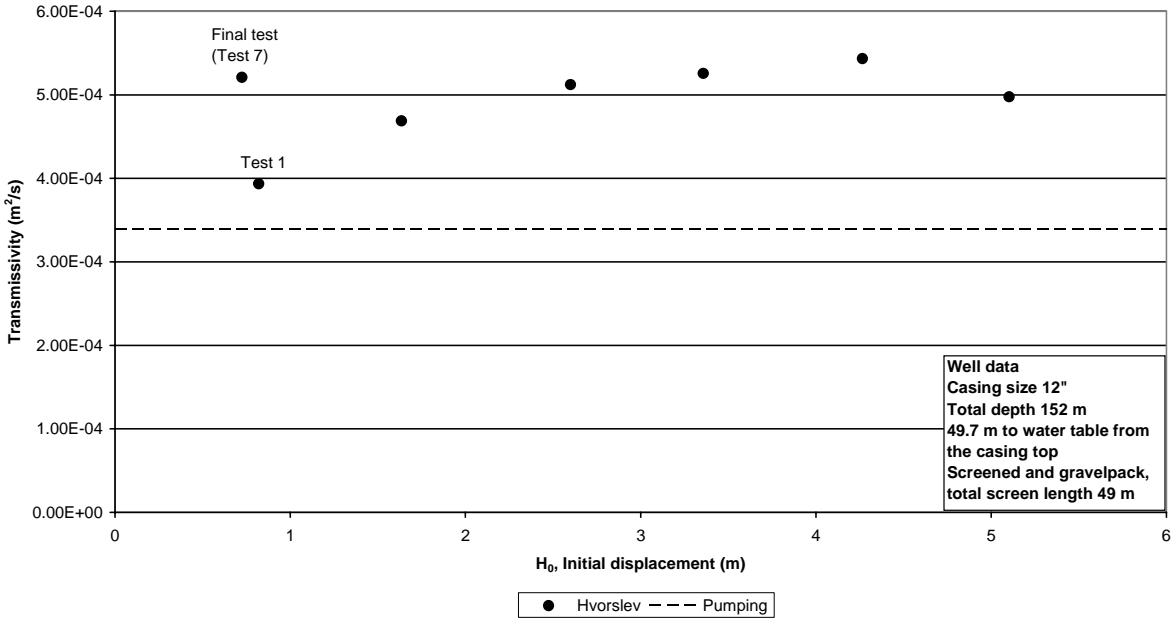

**Fig. 10** Transmissivity estimated from slug testing (San Cristobal 2 well) and a pumping test (in San Cristobal 3, performed as a step-drawdown test).

A third example from slug testing conducted in a screened and gravel-packed 12"-well with plastic casing (well Veracruz Managua II), but where conventional theory could be applied directly on the acquired data, is presented in Fig. 11. The distance from the top of the casing to the water table was around 46 m. The head measurements from the four slug tests are normalized in the same manner as described previously. Long casing-depressurization times were required for this well. It took, for example, around 10 seconds for the test using the highest initial displacement. Transmissivity values estimated using the Cooper et al. (1967) solution are also included in Fig. 11 and a good match was achieved with this solution.

The transmissivity values in Fig. 11 estimated from the slug testing are in good agreement with each other. In addition the first and last tests (Tests 1 and 4) yielded similar results, which indicate a good repetivity. No pumping test data were available for this well or other wells in the vicinity, so no comparison with transmissivity values estimated from pumping tests could be made.

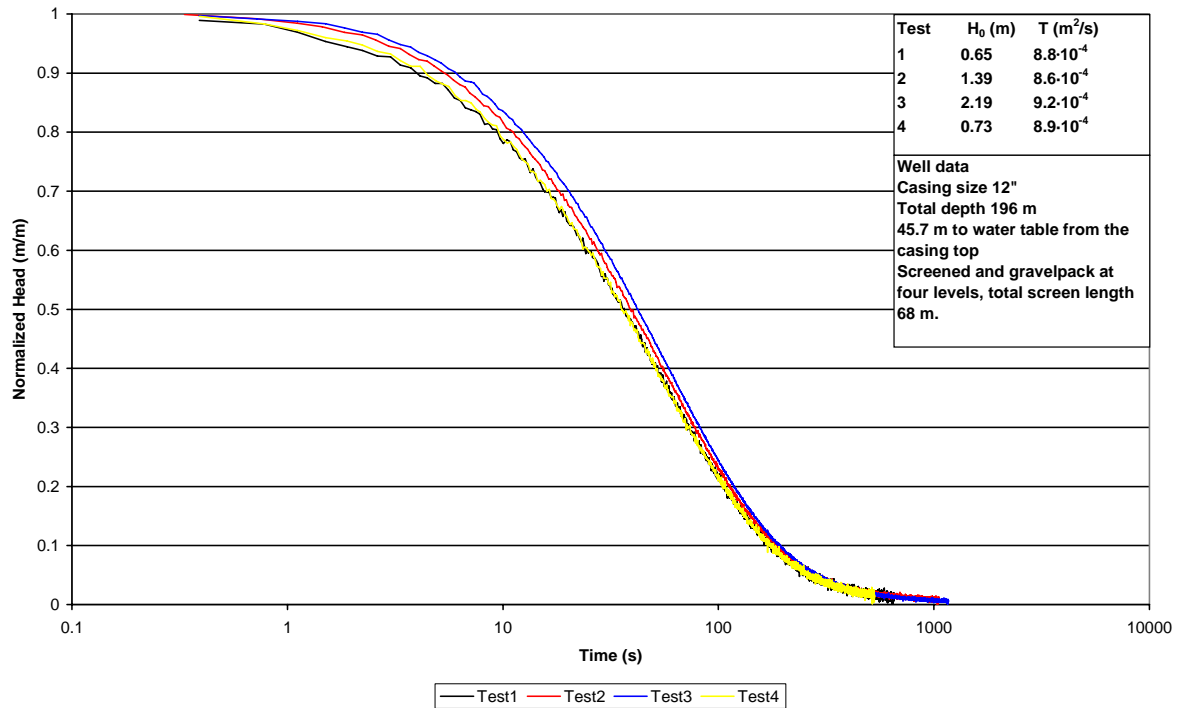

**Fig. 11 Normalized head versus time for four slug tests carried out on a 12" well (Veracruz Managua II), using 2" slug test equipment. Transmissivity data for each test, estimated using Cooper et al. (1967), are also presented.**

#### 4. Discussion

For two of the 12" wells described above the series of slug tests conducted yielded similar transmissivity estimates. In other words there is an evident repetivity of the test data, although small-diameter slug-test equipment is used in wells with a 36-times greater cross-sectional area than the equipment. In one of the wells transmissivity estimated from slug testing is around 1.5 times greater than transmissivity estimated from a pumping test in a well close by, which is not so different taking into consideration that the tests were conducted in different wells and a smaller portion of the aquifer was tested during the slug test than during the pumping test, which directly affects the transmissivity estimate. The determination of aquifer thickness is also important when converting hydraulic conductivity into transmissivity or vice versa. In addition, uncertainty in estimating transmissivity also has to be considered. Several possible explanations for the differences in parameter estimation from slug tests and pumping tests can be found in Butler and Healey (1998).

Decreasing transmissivity with increasing initial displacement has also been observed, especially when applying linear solutions for transmissivity determination, a parameter that shall be more or less constant. This phenomenon has been observed in two wells located within the same well field (Las Mercedes). Results from a series of slug tests are presented for one of the wells in this paper (see Fig. 8). The major difference between The Las Mercedes wells and the other two wells (San Cristobal 2 and Veracruz Managua II) described in this paper, is that the Las Mercedes wells recovered faster to static conditions after slug initiation and thereby higher transmissivity estimates were obtained, from  $3.8 \cdot 10^{-3} \text{ m}^2/\text{s}$  to  $5.6 \cdot 10^{-3} \text{ m}^2/\text{s}$  (non-linear solution). In the other wells values from around  $4.0 \cdot 10^{-4} \text{ m}^2/\text{s}$  to  $8.9 \cdot 10^{-4} \text{ m}^2/\text{s}$  were obtained. Common for all of the tested wells (12" ID) is that a long time was required for casing depressurization after slug initiation, which of course increased when increasing the initial displacement. However data obtained in wells with a rapid response after slug initiation seem to be more sensitive for long depressurization times. A possible explanation for

decreasing transmissivity with increased initial displacement is the long depressurization times. However, in Zurbuchen et al. (2002) and McElwee (2002) the influence of non-instantaneous initiation was considered and found to be of minor importance for their experiments, but in general the casing depressurization time was much shorter than the ones presented in this work. McElwee (2002) also found that there can be influence from non-instantaneous slug initiation if small valves are used with large casing volumes/diameters, as has been described in this work. Another possible explanation is the relation between the transmissivity and the initial displacement as a result of non-Darcian flow losses (Butler et al. 1996), since the first test is reproducible (see Tests 1 and 8 in Fig 8). This is also supported by the non-linear solution from McElwee and Zenner (1998), which resulted in the best match with acquired data. An evolving (dynamic) skin, improvement or clogging of the well during the testing, is not likely in this case, proven by the reproducibility of Test 1. However the estimates from the series of slug tests are within the range of transmissivity estimated from the 14 pumping tests in other wells located in the same well field (see Fig. 9).

The non-linearity, indicated by the diagnostic technique described by McElwee and Zenner (1998) and Zenner (2008, 2009) as well as by the good empirical type-curve matching using the McElwee and Zenner (1998) solution, is difficult to explain. Possible explanations could be that a non-linear flow occurs in the formation, since fractures cannot be excluded (see e.g. Zenner 2009), or a non-linear flow through the screen. The contributing part of the screen during the testing is difficult to evaluate, but if only a minor part of the screen is active non-linear flow cannot be excluded. The above possible explanations are more likely than, for example, friction losses inside the well, which are minor due to the large-diameter casing. The observed long casing depressurization times is also a possible explanation for the observed non-linearity, either as an explanation on its own or combined with the previous explanation. However further work and additional measurements are needed for explanation of the observed indication of non-linearity.

A small-diameter piece of equipment is applicable for slug testing in large wells in this case, located in western Managua, Nicaragua. In this area, there are lots of abandoned wells, but the lack of information regarding those wells is an unfortunate fact. It is hard to find wells with information regarding stratigraphy, well design and pumping tests. Therefore all new information that can be obtained by testing those wells is of importance, especially when considering the spatial variation of the hydraulic properties of the aquifer, an important aspect for conceptualization of the aquifer and upcoming groundwater flow modelling. In spite of the fact that precise transmissivity values could not be obtained for some of the wells the formation response during the slug testing will anyway reveal additional information about that specific part of the aquifer. The lack of well design data is, of course, critical when using slug testing with pneumatic initiation, since air can enter the formation. To overcome this difficulty, the borehole should be logged before slug testing and also for deciding the length of screen or open hole, later used for hydraulic conductivity/transmissivity estimation.

Different air-tight couplings between the slug test equipment and the casing have been tested. Some of the solutions were constructed in conjunction with the field work and can most likely be improved. However most of the different air-tight couplings fulfilled their purpose and can be re-used for other wells. The easiest airtight coupling to install is the lightweight packer and it is highly recommended due to its simplicity. Another advantage is that the packer can cover a range of different casing sizes.



## 5. Conclusions

A small diameter (2") piece of slug-test equipment, using pneumatic initiation, can be applicable in wells of diameter up to at least 12". Wells with 36 times greater cross-sectional area than the slug test equipment can be tested. The equipment was also found to be a good complement to the more logistically and expensive conventional pumping test. The equipment can be handled by one person and is easy to install due to its low weight. Estimated transmissivity data derived from the slug testing also support the applicability of the used equipment. A series of slug tests yielded transmissivity values that were in good agreement with each other, and also when compared with transmissivity estimates from pumping tests in wells close by. Long casing-depressurization times after slug initiation were observed during the tests, but did not generally affect the transmissivity estimates. However, for wells located in formations with higher transmissivity than  $3 \cdot 10^{-3} \text{ m}^2/\text{s}$ , the long casing-depressurization times may have influenced the results. In those wells non-linear solutions had to be applied for evaluating the series of slug tests; despite this, a slight decrease in transmissivity with increased initial displacement can be found. If this is an effect of long casing-depressurization times or being related to non-linear flow in the formation or through the screen needs to be further investigated.

## 6. Acknowledgements

The author would like to acknowledge J.M. Healey, the Associate Editor, one anonymous reviewer and S. Duncan for their useful comments.

## 7. References

- Butler JJ Jr (1998) The design, performance and analysis of slug tests. Lewis Publishers CRC Press LLC, Boca Raton Florida
- Butler JJ Jr, Healey JM (1998) Relationship between pumping-test and slug-test parameters: Scale effect or artefact? *Ground Water* 36 (2):305-313
- Butler JJ Jr, McElwee CD, Liu W (1996) Improving quality of parameter estimates obtained from slug tests. *Ground Water* 34 (3):480-490
- Cooper HH Jr, Bredehoeft JD, Papadopoulos IS (1967) Response of a finite-diameter well to an instantaneous charge of water. *WaterResources Research* 3 (1): 263-269
- Hantush MS, Jacob CE (1955) Non-steady radial flow in an infinite leaky aquifer. *Transactions American Geophysical Union* 36(1): 95-100
- Hvorslev MJ (1951) Time lag and soil permeability in groundwater observations. U.S. Army Corps of Engineers Waterway Experimentation Station, Bulletin 36
- Jacob CE (1947) Drawdown test to determine effective radius of artesian well. *Transactions, American Society of Civil Engineers* 112 (Paper 2321): 1047-1064
- Krauss I (1974) Die bestimmung der transmissivität von grundwasserleitern aus dem einschwingverhalten des brunnen-grundwasserleitersystems (The determination of the transmissibility of aquifers from the transient motion of the well-aquifer system). *Journal of Geophysics* 40:381-400
- Kruseman GP, de Ridder NA (2000) Analysis and evaluation of pumping test data 2<sup>nd</sup> Edition. Publication 47 International Institute of Land Reclamation and Improvement, The Netherlands
- Leap DI (1984) A simple pneumatic device and technique for performing rising water level slug tests. *Ground Water Monitoring Review* 4 (4):141-146
- McElwee CD (2002) Effect of non-instantaneous release of air pressure on pneumatic slug tests. *Kansas Geological Survey Open File Report* 2002-73
- McElwee CD (2001) Application of a nonlinear slug test model. *Ground Water* 39 (5):737-744

McElwee CD, Zenner MA (1998) A nonlinear model for analysis of slug-test data. *Water Resources Research* 34(1): 55-66

Ostendorf DW, DeGroot DJ, Dunaj PJ (2007) Water hammer dissipation in pneumatic slug tests. *Water Resources Research* 43 , W02413, doi:10.1029/2005WR004817

Ostendorf DW, DeGroot DJ, Dunaj PJ, Jakubowski J (2005) A closed form slug test theory for high permeability aquifers. *Ground Water* 43 (1):87-101

Pandit NS, Miner RF (1986) Interpretation of slug test data. *Ground Water* 24 (6):743-749

Prosser DW (1981) A method of performing response tests on highly permeable aquifers. *Ground Water* 19 (6): 588-592

Spane FA Jr, Thorne PD, Swanson LC (1996) Applicability of slug interference tests for hydraulic characterization of unconfined aquifers: (2) Field test examples. *Ground Water* 34 (5): 925-933

Theis CV (1935) The relation between the lowering of the piezometric surface and the rate and duration of discharge of a well using groundwater storage. *Transactions American Geophysical Union* 16:519-524

Todd DK and Mays LW (2005) *Groundwater hydrology* 3<sup>rd</sup> edition. John Wiley & Sons, Inc, UK

Zenner MA (2009) Near-well nonlinear flow identified by various displacement well response testing. *Ground Water* 47 (4):526-535

Zenner MA (2008) Experimental evidence of the applicability of Colebrook and Borda Carnot-type head loss formulas in transient slug test analysis. *Journal of Hydraulic Engineering* 134 (5): 644-651

Zurbuchen BR, Zlotnik VA, Butler JJ Jr (2002) Dynamic interpretation of slug tests in highly permeable aquifers. *Water Resources Research* 38 (3), 1025. doi:10.1029/2001WR000354



# **Paper 2**

**Rosberg J-E. (2006)**

**Flow test of a perforated deep dual cased well**

**Proceedings, Thirty-first workshop on geothermal reservoir engineering  
Stanford University, Stanford, California, January 30-February 1, 2006.**

**SGP-TR-179**



## FLOW TEST OF A PERFORATED DEEP DUAL CASED WELL

Jan-Erik Rosberg

Engineering Geology, Lund University  
P.O. Box 118  
Lund, S-22100, Sweden  
e-mail: Jan-Erik.Rosberg@tg.lth.se

### **ABSTRACT**

An example of well testing when there are limitations in available fluid storage capacity reducing the testing time. Flow tests were carried out in a deep geothermal well in the southernmost province of Sweden. The well is 3701.8 m deep with production zones located in a low temperature reservoir consisting of Cretaceous sandstone. The potential production zones were cased with dual casing, which was cemented into position. Perforation was used to reopen the production zones between 1425 m and 1950 m, followed by airlifting to clean out the debris. The production zones were flow tested separately as well as combined. The hydraulic parameters are evaluated applying groundwater well tests equations. One problem during the flow tests was the limited storage capacity at the drillsite, which affected the testing time. Because of this limitation no hydraulic boundaries were reached during the flow tests. Injection took place after running out of storage capacity and the water was injected back into the sandstone formation. To treat the geothermal water in the municipal wastewater plant was a too expensive option, because of the high salinity of the water. Direct disposal was prohibited due environmental restrictions.

Keywords: Well testing, perforation, dual casing, airlifting, storage capacity.

### **INTRODUCTION**

The city of Lund, located in Scania the southernmost province of Sweden, has a long history when studying the use of geothermal energy in Sweden. Here is the only geothermal plant, which has been in operation since 1984. The plant is a result of the research efforts by the Department of Engineering Geology, Lund Institute of Technology, carried out in cooperation with the local energy company.

The plant consists of 4 production wells and 5 injection wells, which are 500-700 m deep. The

geothermal reservoir is a low temperature reservoir, which is located in the Campanian Sandstone from Late Cretaceous. The plant is extracting 500-600 l/s of approximately 20°C water and heat pumps are used to increase the temperature before it enters the district heating network. The temperature is around 4-5°C when it is injected back into the reservoir. The Lund geothermal heat pump plant stands for 30-35 % of the distributed energy in the district heating system.

In the beginning of 2000 the Department of Engineering Geology initiated a project to investigate the tectonised basement within the Tornquist deformation zone close to the city of Lund. The aim was to extract hot water from deep-seated fractures in the basement created by tectonic activities in the deformation zone. An estimation was done that temperatures around 110-125°C could be at hand at a depth around 3500 m. This was based on the results from years of studying of the temperature gradient in the region.

The local energy company, Lunds Energi AB, found the concept interesting with a possibility to cover more of the energy demand by using geothermal resources. The higher temperatures also make it possible to direct heat exchange the energy into the district heating system, without using heat pumps.

Reflection seismic was used to investigate the deformation zone and to select the best location of the exploration well. Towed array reflection seismic was used on the roads which made it possible to cover large areas in a time effective way compared to conventional seismic surveys. Some of the seismic survey lines were complemented with conventional reflection seismic to get a deeper penetration. In all cases a vibro energy source was used.

Comparing the result from the seismic surveys with data from other geophysical measurements like magnetometry and gravity and the distribution of the existing district heating system a drill site was located. The site for the exploration well is located in

Stora Råby south-east of the city of Lund. The name of the well is DGE#1, which stands for Deep Geothermal Energy and well number one.

The drilling operation started in October 2002 and became the second deepest drilling project in Sweden, with a depth of 3701.8 m. The aim with the drilling project was as mentioned above to investigate the possibility to extract hot water from deep seated fractures in the basement. Another task was to investigate different drilling methods and their applicability in basement rock drilling.

The fall-back of the project was the different types of sandstones that can be found in the sedimentary sequence, around 1950 m thick, resting on the basement.

Flow tests and injection tests were carried out both in the crystalline basement and in the sandstones in the sedimentary deposits. A decision to drill a second well was made after evaluating the results from the flow- and injection tests of the sedimentary deposits.

The second well, DGE#2, was drilled during the summer 2004 to a total depth of 1927 m. The wellcompletion consists of around 138 m wire-wrapped screen located in the sandstone formation. This well was thought to be the production well and the first well DGE#1 should be the injection well.

DGE#2 was flow tested and stimulated during the autumn 2004. The flow rate was too low to fullfill the energy demands of the local energy company, why the project was abandoned. The flow test and the stimulation of DGE#2 will not be presented in this paper.

### **DRILLING OF DGE#1**

The drilling operation started in October 2002 and was finished in March 2003. The total depth of the hole is 3701.8 m and it is cased down to 3200 m. The drilling was performed in both sedimentary rock and in the basement. In this paper the drilling operation is just described briefly to give an understanding of the history of DGE#1. All the depth is measured from kelly bushing, which was located 7.1 m above the ground level.

Rotary drilling with clay based or polymer based mud was used from surface down to 2119 m. Thereafter air drilling with air or aerated water was used as drilling method down to total depth, except for two sections. The section between 2878 m and 2972 m was drilled as percussion drilling with a 12 ¼" percussion bit. Another section between 3666 m and 3675 m was shortly tested with a 8 ½" bit on a Wassara Mud Hammer.

The sizes and the installation depths of the casings in DGE#1 has been summarised in table 1.

*Table 1. Summary of the sizes and installation depths of the casings used in DGE#1.*

<b>Casing size</b>	<b>Top of the casing</b>	<b>Depth of the casing shoe</b>
30"	0 m	155 m
20"	0 m	1005 m
13 ⅝"	0 m	1975 m
9 ⅝"	900 m	3198 m*
<b>Open hole size</b>	<b>Starts</b>	<b>Ends</b>
8 ½"	3198 m	3701.8 m

\*The casing shoe is installed at 3310 m, but due to the whipstock installation the cased section ends at 3198 m.

The top of the 9 ⅝" casing was first installed at 1880 m, but due to collapse of the 13 ⅝" casing at 1030 m a 9 ⅝" tie-back casing was installed to 900 m. The casing collapse is the reason why the potential production zones in the sedimentary rock were cased with a dual casing.

At the depth of 3365 m the driller failed to clean the hole when the penetration rate got very high for a longer time. 38 m of the drilling assembly was left in the hole. An open-hole whipstock was first installed but due to a bad cementing job it started to move and was abandoned. Instead a casing whipstock was installed between 3191 m and 3198 m, which made it possible to reach the final depth.

### **GEOLOGY**

The investigated area is a part of the Tornquist zone (also called Tornquist-Teisseyre zone), which is one of the major geological structures in northern Europe. The Tornquist zone is a major tectonic deformation zone stretching from the North Sea into Poland continuing south-east to the Black Sea (Lindström et al., 1991). The Tornquist zone is also a part of the Fennoscandian border zone, which is the border zone between the Baltic shield and the Danish-Polish embayment.

This border zone is of great importance when studying the geology of Scania, the southernmost part of Sweden. The north-east part of the zone, the Baltic shield, consists of basement rocks and the south-west part of the zone, the Danish-Polish embayment, consists of sedimentary rocks resting on basement rocks. Along the zone there are a lot of block faults including the Scanian horst ridges, which stretch along this zone in a north-west to south-east trend.

The city of Lund is situated close to one of the Scanian horst ridges, the Romele horst ridge. The faulting along the Romele horst ridge is both normal

and reverse faulting. The vertical displacement in this area can be as much as 1500-2000 m.

### **Stratigraphy for well DGE#1**

DGE#1 is located within the fault zone running along the Romele horst ridge. The wellsite is in Stora Råby south-east of Lund. The total depth of the well is 3701.8 m and about 1900 m was drilled in sedimentary rocks and the last 1756 m in basement rocks. A simplified stratigraphy for DGE#1 is presented in table 2 for more detail information see (Erlström and Sivhed, 2003).

*Table 2. Simplified stratigraphy for DGE#1.*

<b>Depth (mKb)</b>	<b>Geological formation</b>	<b>Lithology</b>	<b>Remarks</b>
7-47 m	Quaternary	Till, sand	
47-211 m	Late Cretaceous	Sandstone	
211-223 m	Late Cretaceous	Mixed lithologies	Fault and fracture zone, unconformity
223-1058 m	Early Jurassic	Claystone, siltstone, mudstone	
1058-1425 m	Late Triassic	Mudstone, claystone, sandstone	
1425-1531 m	Late Cretaceous	Claystone, sandstone	Repeated stratigraphy
1531-1946 m	Early Cretaceous	Claystone, sandstone	Repeated stratigraphy
1946-1985 m	Precambrian	Gneiss	
1985-2050 m	Precambrian Early Cretaceous	Claystone, sandstone, gneiss	Faulted zone, mixed sedimentary and basement rocks
2050-3154 m	Precambrian	Gneiss, dolerite, metabasite	
3154-3520 m	Precambrian	Granite, metabasite	
3520-3701.8 m	Precambrian	Gneiss granite, metabasite	

Different potential production zones were located by comparing the lithology with results from different electrical logs. Two of the potential production zones in the sedimentary rock section are described more detailed with respect to the lithology (Erlström and Sivhed, 2003).

The lowermost is the section between 1827 and 1853 m, consists of well sorted fine- and medium grained sandstone, hard and dolomite and silica cemented. There is also hard to very hard and poorly cemented sandstone. The sandstones belong to Valanginian/Ryazanian, which are subdivisions within Early Cretaceous.

The upper is the section between 1427 and 1530 m, which can be divided into four subsections. The first one between 1427 and 1463 m consist of silty clay/claystone, sandy claystone and soft-hard, carbonate cemented sandstone/siltstone. The second one between 1463 and 1477 m consists of fine- and coarse-grained, poorly sorted, soft to hard and carbonate cemented sandstone. The section between 1477 and 1490 m is similar to the lithology between 1427 and 1463 m. 1490-1530 m consist of fine- to coarse-grained, poorly sorted, soft to hard and carbonate cemented sandstone. Except a section between 1501 and 1504 m, this section's lithology is similar to the lithology between 1427 and 1463 m. The lithologies described above belong to Santonian or Turonian which are subdivisions within Late Cretaceous.

### **TEST SET UP USED DURING THE TESTING OF DGE#1**

The well DGE#1 was flow tested during two different periods. The first was in March 2003 and the second was between September and December 2003. The first test was carried out to evaluate the hydraulic properties of the basement rock formation and the second was to evaluate the hydraulic properties in the basement rock and in the sedimentary rock formation. The test set up for those two attempts was in general the same.

The test set up for flow tests was designed for airlift operations. The test set up consisted of air compressors, a booster unit, a system to measure the flow rate and storage pits. The total storage capacity at the drillsite was around 3000 m<sup>3</sup>.

The system to measure the flow rate included one muffler unit and two tanks of 86 m<sup>3</sup> each. The muffler worked as a separator during the airlifting. The air went out through the top of the muffler and coarse particles settled in the muffler and the water flowed to the first tank. The first tank worked as a settling tank and was connected to the muffler. Two pipes were used to connect the settling tank with the second tank. The second tank, the weir tank, was the tank where the flow rate was measured. The weir tank consisted of a Thomson weir, a still well and baffles.

The still well was used to get undisturbed measurements of the head above the V-notch. The



aim with the installation of baffles was to get an almost laminar flow through the Thomson weir. A drawing of the test set up is presented in figure 1.

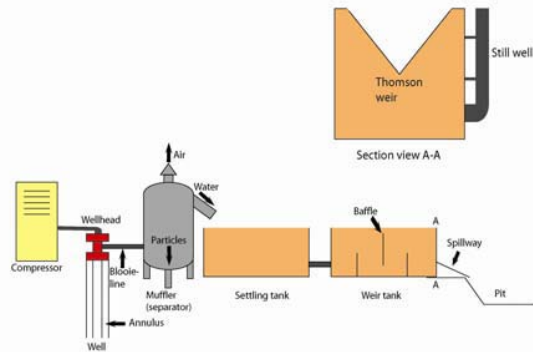

Figure 1. The test set up used during the airlift operations.

The flow rate through a triangular weir can be calculated by using Equation 1:

$$Q = C_e \cdot \frac{8}{15} \cdot \sqrt{2 \cdot g} \cdot \tan\left(\frac{\alpha}{2}\right) \cdot h^{5/2} \quad (\text{Eq.1})$$

where

Q = flow rate (m<sup>3</sup>/s)

C<sub>e</sub> = weir coefficient (depending on the weir angle)

g = gravitational acceleration (m/s<sup>2</sup>)

α = weir angle

h = head above the V-notch (m)

If the weir angle is 90° the weir is called a Thomson weir and then the weir coefficient C<sub>e</sub> = 0,578. The head shall be measured upstream of the weir at a distance of at least 3-4 h<sub>max</sub> (French, 1994).

High resolution downhole sensors were installed in the well to measure the pressure and the temperature during the flow tests. The sampling rate was every 15 second.

Different injections were made using mudpumps. The water was transferred from the pits to the mudpumps and from here through the mudline into the well. The water was injected directly through the well head or through a packer installed at a certain level in the well.

The injection rate was calculated from pump strokes and the injection pressure was measured at the wellhead.

### WELL TESTING PARAMETERS

Equations developed for groundwater hydraulic have been applied to evaluate the well test data. The temperature of the pumped fluid is higher than ordinary groundwater, but as a geothermal fluid defined as a low temperature fluid. Earlier

geothermal projects in Sweden have used the same type of application of groundwater equations for evaluation of well test data (Follin, 1984) and (Gustafson and Andersson, 1979).

Estimation of the transmissivity and the skin factor from the drawdown data has been done by using a modification of Cooper-Jacob solution (Cooper and Jacob, 1946) see equation 2.

$$s = \frac{p}{\rho \cdot g} = 0.183 \cdot \frac{Q}{T} \cdot \left( \log\left(\frac{135 \cdot T \cdot t}{r_w^2 \cdot S}\right) + \frac{\xi}{1.15} \right) \quad (\text{Eq.2})$$

where

s = drawdown (m)

ρ = density (kg/m<sup>3</sup>)

(m/s<sup>2</sup>)

Q = flow rate (m<sup>3</sup>/s)

t = time (min)

S = storage coefficient

p = drawdown (Pa)

g = acceleration of gravity

(m/s<sup>2</sup>)

T = transmissivity (m<sup>2</sup>/s)

r<sub>w</sub> = radius of the well (m)

ξ = skin factor

Estimation of the transmissivity from the recovery data has been done by using Theis recovery solution (Theis, 1935) see equation 3.

$$s' = \frac{Q}{4 \cdot \pi \cdot T} \ln\left(\frac{t}{t'}\right) = 0.183 \frac{Q}{T} \log\left(\frac{t}{t'}\right) \quad (\text{Eq.3})$$

where

s' = residual drawdown (m)

Q = flow rate (m<sup>3</sup>/s)

T = transmissivity (m<sup>2</sup>/s)

t = time since pumping begun (s)

t' = time since pumping stopped (s)

The transmissivity is the product of the hydraulic conductivity (K) and the saturated thickness of the aquifer (z) see equation 4.

$$T = \int K \cdot dz \quad (\text{Eq.4})$$

where

K = hydraulic conductivity (m/s)

z = saturated thickness (m)

The equations presented above for drawdown data and recovery data can be used for data acquired during injection tests. The drawdown is substituted with injection pressure and the flow rate with injection rate. When the injection stops the fall off of the injection pressure can be recorded and substituting the residual drawdown with the fall off of the injection pressure equation 3 can be used.

There are several equations and rule of thumbs to estimate the storage coefficient for a confined aquifer. In this paper Hall's estimation (Hall, 1953), see equation 5, has been used to estimate the storage coefficient.

$$S = \Phi \cdot (c_w + c_f) \cdot h \quad (\text{Eq.5})$$

where

$S$  = storage coefficient       $\Phi$  = porosity (-)  
 $c_f$  = formation pore-volume compressibility ( $m^{-1}$ )  
 $c_w$  = fluid compressibility ( $m^{-1}$ )  
 $h$  = formation thickness (m)

## **RESULTS FROM THE TESTING OF THE CRYSTALLINE BASEMENT**

The first flow test in the crystalline basement was made in March 2003, directly after the well was unloaded. The water in the well was unloaded by using air. The airlift operation was conducted from two different depths and lasted from 2003-03-09 to 2003-03-14. During this period 19 airlifts were done and the airflow rate varied between 19.8 and 31.1  $m^3/min$  (700-1100 cfm).

The first part of the airlift operation was made from the depth of about 3690 m in the open hole section. From this depth 13 airlifts were made during the period from 2003-03-09 to 2003-03-12. The second part of the airlift operation was made during the period 2003-03-12 to 2003-03-14 from the depth of 3100 m in the cased section. 6 airlifts were made during this period. No consistent flow rate was reached during the different airlifts, instead slugs of aerated water were lifted out of the well.

The average flow rate was calculated as the produced volume of water during each airlift divided by the time between the actual airlift and the previous airlift. The most common time between two airlifts was around 5 hours and 30 minutes. The average flow rate was around 1.8 l/s. The density was around 1200  $kg/m^3$ .

One short injection test of the open hole basement section was made 2003-03-15, the test only lasted for 70 minutes. The average injection rate was around 2.2 l/s and the needed injection pressure was approximately 120 bar.

After completion of the test in March the well was shut in until October 2003. In the meantime the well had 6 months to recover. The first effort that was made in October was a bottom hole temperature measurement. A maximum temperature of 85.1°C was recorded.

To improve the inflow to the well the open hole was treated with acid (HCl) to remove potential precipitated carbonates in the rock mass fissures. The acid treatment didn't improve the inflow to the well, which was verified by airlifting. No consistent flow was reached during the airlifting, only slugs of water were lifted out of the well.

Two injection and fall off tests were carried out during three days time. The recorded injection/fall off pressure and the injection rate can be seen in figure 2.

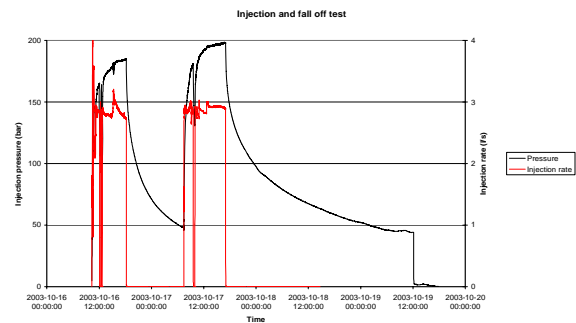

Figure 2. Variation in injection/fall off pressure and variation in injection rate.

The perturbations in the injection rate and the corresponding pressure drops are due to that the mudpump went down. The average injection rate was 2.75 l/s with an increasing injection pressure. During the second injection test the injection pressure almost reached 200 bar before the test was shut down. The shut down was a forced action as the maximum pressure rating of the mudpump was 205 bar.

Due to the perturbations during the injection, only the data from the fall off have been used to get a rough estimation of the transmissivity of the basement. The fall off is evaluated with Theis recovery method and the pressure is converted to meters of water column. The estimation of the transmissivity from the first test is  $4.7 \cdot 10^{-7} m^2/s$  and  $5.2 \cdot 10^{-7} m^2/s$  from the second fall off test. The difference between the two values of the transmissivity is approximately 10%.

Using the average transmissivity of  $5.0 \cdot 10^{-7} m^2/s$  and a thickness of the open hole of 504 m the hydraulic conductivity can be estimated to  $9.9 \cdot 10^{-10} m/s$ . This is the minimum value of the hydraulic conductivity, because of the assumption that the whole thickness of the open hole is contributing to the flow. More likely is that only parts of the open hole are contributing, if that is the case the value of the hydraulic conductivity will be larger. The low values of the transmissivity and hydraulic conductivity can be compared with a deep well in Germany with similar conditions as DGE#1. The well is 4 km deep located in crystalline basement, with an open section of 150 m (Stober and Bucher, 2005). The transmissivity is  $6.1 \cdot 10^{-6} m^2/s$  and the hydraulic conductivity is  $4.07 \cdot 10^{-8} m/s$ . Showing for example a 12 times greater transmissivity than the one estimated from DGE#1.

An attempt to improve the inflow to the well was to perforate the cased section of the basement between 3125 m and 3135 m. Potential contribution to the inflow from this section was evaluated from a PLT (Production Logging Tool) log carried out in March 2003. The log shows peaks on the temperature curve over this section and some flow activity is also at hand. The section was perforated underbalanced,

with 180 charges. Airlifting was used to clean the perforations and to lift out the debris. There was no evident improvement in the flow rate and no consistent flow was reached.

Due to the result from the different airlift operations and from the different injection tests, the crystalline basement was abandoned as being a non-potential production or injection zone. The efforts were instead focussed on water production from the sandstones in the upper part of the well.

**RESULTS FROM THE TESTING OF THE LATE AND EARLY CRETACEOUS SANDSTONE.**

To establish contact with the potential production zones in the sedimentary section perforation of the casings was done. The charges were optimized to penetrate the cemented dual casing and to make flow pipes into the formation. The first perforation runs were done underbalanced, which force the fluid into the well. The last perforation runs were perforated balanced. Directly after each perforation run the debris were cleaned out using airlifting.

The different intervals that were perforated are presented in table 3.

Table 3. The perforated intervals and number of shoots per foot (SPF) used during the specific perforation run.

Perforated intervals	SPF	Reperforation of
1895-1905 m	6	
1827-1840 m	6	
1472-1525 m	6	
1827-1853 m	6	1827-1840 m
1685-1717 m	6	
1427-1472 m	6	
1427-1530 m	6	1427-1525 m

The intervals are from top presented in chronological order in table 3 as they were perforated. The minimum order of number of shoots that were used was 6 SPF (shoot per foot). Two intervals 1827-1840 m and 1427-1525 m were perforated with 12 SPF, because these intervals were reperforated. The chose to reperforate these intervals was to reduce the flow resistance through the perforations.

Every interval that was perforated was flow tested separately, but the well was also flow tested with all the perforated intervals in cooperation.

The potential production zones were the interval between 1827 and 1853 m and between 1427 and 1530 m. The most productive section of the latter one was the lower part between 1472 and 1525 m. These intervals were interpreted by well testing and

temperature logging carried out during production tests.

The well test was performed with airlifting followed by a recovery period. The transmissivity has been estimated both from drawdown data during production and from pressure build up data from the recovery.

Data from the flow test of the interval 1427-1530 m will be presented as an example of the methodology which is used to evaluate the flow tests when airlifting. A retrievable bridge plug (a type of packer) was set at 1610 m to make it possible to flow test only the Late Cretaceous sandstone between 1427 and 1530 m. The downhole pressure and temperature gauges were installed at 1356 m and the airsub was placed at 884 m. Three compressors and one booster were used. The flow test lasted for almost 5 hours and was followed by a 13 hours 30 minutes recovery period.

The transmissivity is estimated to  $1.1 \cdot 10^{-4} \text{ m}^2/\text{s}$  from the drawdown data from the flow test and an average flow rate of 55.7 l/s is used, see figure 3.

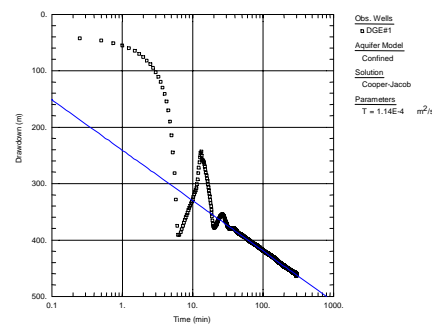

Figure 3. Estimation of the transmissivity from the drawdown data.

The transmissivity is estimated to  $5.0 \cdot 10^{-5} \text{ m}^2/\text{s}$  from the recovery data, see figure 4.

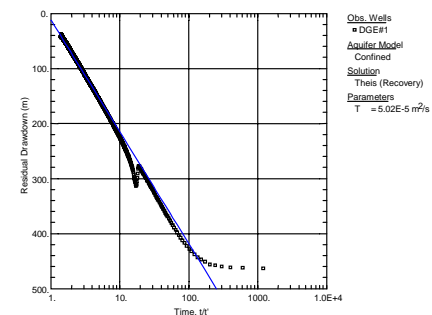

Figure 4. Estimation of the transmissivity from the recovery data.

The transmissivity estimated from the flow test is 2.2 times greater than the one estimated from the recovery.

The transmissivity values for the potential production zones and from the flow test of all perforated intervals involved can be seen in table 4.

Table 4. The transmissivity values estimated from drawdown data and from recovery data.

Section	Transmissivity (m <sup>2</sup> /s) Airlifting	Transmissivity (m <sup>2</sup> /s) Recovery
1827-1840 m	1.6·10 <sup>-4</sup>	9.5·10 <sup>-5</sup>
1472-1525 m	9.6·10 <sup>-5</sup>	3.4·10 <sup>-5</sup>
1472-1525 m	1.4·10 <sup>-4</sup>	5.3·10 <sup>-5</sup>
1427-1530 m	1.1·10 <sup>-4</sup>	5.0·10 <sup>-5</sup>
1827-1853 m 1427-1530 m	2.5·10 <sup>-4</sup>	
1827-1853 m 1427-1530 m	2.2·10 <sup>-4</sup>	1.0·10 <sup>-4</sup>

Worth noting in table 4 is that the transmissivity estimated from the drawdown data is from 1.7 to 2.8 times greater than the transmissivity estimated from the recovery data. The transmissivity values should be almost the same (Kruseman and de Ridder, 2000).

The values of the hydraulic conductivities for each potential production zone and for all the zones combined can be seen in table 5.

Table 5. Hydraulic conductivity estimated from drawdown data and recovery data.

Section	Hydraulic conductivity (m/s) Airlifting	Hydraulic conductivity (m/s) Recovery
1827-1840 m	1.2·10 <sup>-5</sup>	7.3·10 <sup>-6</sup>
1472-1525 m	1.8·10 <sup>-6</sup>	6.4·10 <sup>-7</sup>
1472-1525 m	2.6·10 <sup>-6</sup>	1.0·10 <sup>-6</sup>
1427-1530 m	1.1·10 <sup>-6</sup>	4.9·10 <sup>-7</sup>
1827-1853 m 1427-1530 m	2.3·10 <sup>-6</sup>	
1827-1853 m 1427-1530 m	2.0·10 <sup>-6</sup>	9.0·10 <sup>-7</sup>

In table 4 and 5 it can be seen that the zone between 1827 and 1840 m has the highest transmissivity and hydraulic conductivity. The transmissivity values calculated using data from airlifting when testing the Late Cretaceous sandstone between 1472 and 1525 m are not equal. The difference is a factor of 1.46. This

is probably due to that the first flow period was directly after the perforation and the perforations were cleaned during this flow test. The second flow test started when the well was almost free from the debris from the perforation and therefore gave a higher transmissivity value.

A representative transmissivity value for the whole well is around 2.4·10<sup>-4</sup> m<sup>2</sup>/s and 2.2·10<sup>-6</sup> m/s being the average values of the transmissivity and the hydraulic conductivity. The skin factor was around 1. The storage coefficient estimated using Hall's formula is 2.4·10<sup>-4</sup>. The density of the fluid is around 1140 kg/m<sup>3</sup> with salinity around 14 %. The water temperature was around 31°C measured during the flow test. This is a disturbed measurement of the temperature because the fluid was a mix of cold injected water and formation water.

#### **TEST LIMITATIONS DUE TO STORAGE CAPACITY AND ENVIRONMENTAL RESTRICTIONS**

A major problem during the flow tests was the available storage capacity at the drillsite. The available storage volume directly controlled the length of testing. When the pits were full the pumping was terminated and to be able to carry out further flow tests the fluid had to be injected or transferred elsewhere. The fluid was injected back into the formation.

This means that the flow tests were only short term tests. The longest lasted for 12.5 hours, but the most common time was around 5 hours. To say something about the aquifer and about potential production is hard using these data. The duration of the tests was too short, which means that the long term effects such as boundary conditions could not be evaluated. The boundary effects must be known to say if the aquifer is suitable for production and injection. A major reason is for example spatial limitations of the aquifer.

Another problem with a limited storage capacity was to all the time keep space enough for the flow test. If such conditions were accomplished less flow time than required was at hand to clean the perforations before the next flow test began. This can be maybe the explanation why the transmissivity values for the interval 1472-1525 m, see table 4 differs with 46%.

It can also be discussed if mechanical cleaned and settled mud and formation water that has been oxidised or otherwise altered should be injected back into the formation. But during the circumstances the way it was done was the only solution at that time. The coarse particles in the produced formation water were of course allowed to settle before injection took place and top suction was always used when

transferring the water from the storage pits. However no decrease in the injectivity has been confirmed after those injections.

There was only one option to avoid injection of the fluid into the perforated zones in DGE#1. It was an old geothermal well in Flackarp located around 5 km from the drillsite. Transferring of the water to this well was done with trucks, which was not an economical or environmental friendly way to solve the problem. A typical truck that was used could load 30 m<sup>3</sup> of water and a trip with unloading and loading took at least 1 hour. This is the same as 8.3 l/s of the produced fluid can be transferred with one truck instead of being stored in the pits

Other existing wells in the area are wells used for drinking water. The produced water was saline, which means that it can't be mixed with the groundwater used for drinking water or the surface water. To protect the drinking water the produced saline water had to be injected at great depths.

The water was also too saline to be transferred in the sewage system and to be treated at the wastewater-treatment plant in the city. The wastewater-treatment plant isn't designed for water with high salinity and the treated water's outlet is a freshwater recipient.

The decision to drill a second well was dependent on the results from the short term flow tests carried out. This means to drill a second well before the flow tests were carried was never an option.

To make longer flow tests with the available storage capacity at the drillsite is of course to use a lower pumping rate. However the Energy Company was only interested in which maximum consistent flow rate being available.

### **THE CONTINUATION OF THE PROJECT**

The results from the flow test were enough for the energy company's board to make a decision to drill a second well. This decision was only made from the result from the short term tests, without information about hydraulic boundaries. The second well DGE#2 was drilled during the summer 2004 and flow tested and stimulated during the autumn 2004. The flow rate was too low to fulfill the energy demands of the local energy company, why the project was abandoned.

### **ACKNOWLEDGEMENT**

Special thanks to the drilling manager Virgil Welch and the reservoir engineer Derek Howard-Orchard for sharing their great knowledge of drilling and testing.

### **REFERENCES**

- Cooper, H.H. and Jacob, C.E. (1946), "A generalized graphical method for evaluating formation constants and summarizing well field history", *Transactions, American Geophysical Union*, Vol 27, 526-534.
- Erlström, M. and Sivhed, U. (2003), "Well site report, DGE-1/1b", Dnr: 08-1112/2002, Geological Survey of Sweden, 49 pp.
- Follin, S. (1984), "The application of well tests in a low-enthalpy reservoir", Licentiate Thesis, Lund Institute of Technology Department of Engineering Geology, 71pp.
- French, R.H. (1994). "Open-channel hydraulics", McGraw-Hill Inc., 739 pp.
- Gustafson, G. and Andersson, O. (1979), "Drilling and pumping at Höllviksnäs 1", NE-project 4560 062-063, Viak, Malmö, Sweden, 88 pp.
- Hall, H.N. (1953), "Compressibility of reservoir rocks", *Transactions, AIME* 198, 309-311.
- Kruseman G.P. and de Ridder, N.A. (2000), "Analysis and evaluation of pumping test data 2<sup>nd</sup> edition", International Institute of Land Reclamation and Improvement, The Netherlands, Publication 47, 377 pp.
- Lindström, M., Lundqvist, J. and Lundqvist, Th. (1991), "Sveriges geologi från urtid till nutid", Studentlitteratur, 398 pp.
- Stober. I. and Bucher. K. (2005), "The upper continental crust, an aquifer and its fluid: hydraulic and chemical data from 4 km depth in fractured crystalline basement rocks at the KTB test site", *Geofluids*, Vol 5, 8-19.
- Theis, C.V. (1935), "The relation between the lowering of the piezometric surface and the rate and duration of discharge of a well using groundwater storage", *Transactions, American Geophysical Union*, Vol 16, 519-524.

# **Paper 3**

**Rosberg J-E. and O. Aurell (2010)**

**Re-injection of groundwater by pressurizing a segmental tunnel lining  
Tunnelling and Underground Space Technology**





## Re-injection of groundwater by pressurizing a segmental tunnel lining with permeable backfill

Jan-Erik Rosberg<sup>a,\*</sup>, Oskar Aurell<sup>b</sup>

<sup>a</sup> Engineering Geology, LTH, Lund University, P.O. Box 118, SE-22100 Lund, Sweden

<sup>b</sup> Hallandsås Project, Skanska-Vinci HB, P.O. Box 10 (Vistorpsvägen 94), SE-26091 Förslöv, Sweden

### ARTICLE INFO

#### Article history:

Received 9 June 2009

Received in revised form 14 October 2009

Accepted 22 October 2009

Available online 17 November 2009

#### Keywords:

Re-injection

Well testing

Permeable backfill

Segmental lining

Hallandsås project

### ABSTRACT

Recently, within a tunneling project, a method for reinjecting discharged groundwater at tunnel level has been investigated. The method was performed by pressurizing a long section of the lining with un-grouted pea gravel as backfill, in a rock mass with low hydraulic conductivity. Water was reinjected through watertight lining into a section where un-grouted pea gravel was used as backfill. The pressure response was measured both behind the lining and in the rock mass, the latter by means of several observation wells drilled from ground level. Reinjecting water into a rock mass by pressurizing a lining with a permeable backfill (such as un-grouted pea gravel) was found to be possible and feasible. Well testing methods developed for vertically drilled wells, such as a step injection test and constant head/pressure tests, were used and found to be applicable, even for testing at tunnel level. It was also found that well known analytical solutions, developed for vertically drilled wells, can be used for interpretation, e.g. transmissivity from tests performed at tunnel level and from the pressure response in two of the observation wells.

© 2009 Elsevier Ltd. All rights reserved.

### 1. Introduction

Most underground projects must conform to restrictions concerning the amount of permitted groundwater discharge arising from the project. This is the case at the Hallandsås tunnel project in Sweden, where the water permit is set at a 30 day rolling average of 100 l/s. This permit is based on an assumption of the environmental impact caused by temporary groundwater drawdown. In this case, the water permit governs the tunneling project and different treatments are carried out at the Tunnel Boring Machine (TBM), in order to control the amount of water discharge from the project. TBM lining with grouted backfill is an initial design to avoid an overly large influx of groundwater. Recently, within the project, a method to reinject the discharged groundwater has been investigated. This was done in order to reduce the importance of the strict permit limit of 100 l/s, thereby increasing the rate of tunneling progress. The method was performed by pressurizing a long section of the lining with un-grouted pea gravel as backfill, in a rock mass with low hydraulic conductivity. The water was reinjected through the watertight lining into a section where un-grouted pea gravel was used as backfill. The pressure response was measured, both in the backfill and in several observation wells in the surrounding rock mass. The observation wells are drilled from

ground level. Un-grouted pea gravel was used as back fill material only during the production of the tunnel; the section has now been grouted.

The main goal of this feasibility study was to evaluate the applicability of the method for re-injection of discharged groundwater. In addition, the applicability of well testing methods adopted from the groundwater industry, such as the constant head test and the step injection test were evaluated for a tunnel environment. A different approach is also used for the evaluation of the testing, where well known interpretation methods for displacement and time data are used for the interpretation of transmissivity. Methods like Cooper and Jacob (1946) and Jacob and Lohman (1952) are applied, these methods having been developed for vertical wells. Another approach used was to consider the tunnel as a horizontal well and use a solution developed by Daviau et al. (1988) for the interpretation of transmissivity. Transmissivity is estimated by using data obtained from pressure sensors in the tunnel and measuring the pressure outside of the lining, as well as using data acquired from observation wells.

The method for re-injection of water through the lining was tested during a TBM maintenance stoppage. Consequently, the method's applicability during TBM operational conditions still remains an issue. However, the pump installation did not interrupt logistical operations in the tunnel. Another remaining issue is how to collect and treat water for re-injection. For permanent re-injection, water from the tunnel process needs proper treatment

\* Corresponding author. Tel.: +46 462224086; fax: +46 462229127.

E-mail address: [Jan-Erik.Rosberg@tg.lth.se](mailto:Jan-Erik.Rosberg@tg.lth.se) (J.-E. Rosberg).



before being injected. During the injection tests, clean water from a reservoir located outside the tunnel was used.

### 1.1. Hallandsås project and geology

The Hallandsås project is an ongoing project consisting of two 8.6 km long single track railway tunnels through the Hallandsås Horst in southern Sweden. The tunnels are constructed using a Tunnel Boring Machine (TBM). The TBM has a diameter of 10.6 m and the tunnels are lined with segmental lining. The lining has an outer diameter of 10.12 m, creating an annulus of 24 cm between the rock tunnel and the lining. This annulus volume is filled with backfill material. During the first stage of production the backfill consists of mortar and un-grouted pea gravel. The pea gravel is grouted at a later stage. A detailed description of the project can be found at e.g. (Banverket, 2009). The Hallandsås horst is a part of the Tornquist zone, which is one of the major geological structures in northern Europe. The zone has a north-west to south-east orientation and stretches from the North Sea to the Black Sea. The dominating fracture and fault systems in the horst are aligned in this direction. The tunnels are built sub-perpendicular to these structures. Another strongly developed fracture system is located in a north-northeast to south-southwest direction (Wikman and Bergström, 1987). However, the Horst has a long and complex geological history and many different fracture systems are present. The fractured basement of the horst is an important groundwater resource with substantial quantities of water. Gneiss is the dominating rock type (80%), followed by amphibolite (15%), with smaller quantities of dolerite and granite also present. The horst is built up of several tectonic blocks separated by fault zones within the major Tornquist zone, so there is a great variation in rock quality. As the tunneling propagates from one tectonic block to another, separated by a tectonic zone, the rock mass quality varies from unweathered to completely weathered and from solid to highly fractured.

### 1.2. The selected test section

The selected test section for re-injection of groundwater was situated between concrete Rings #818 and #972 (see Fig. 1). The total length of the section is around 350 m and the backfill consisted of un-grouted pea gravel only. The section is confined to the north-east and southwest by tunnel sections with mortar as backfill. The test section is located between two major dolerite dikes. These dikes limit the aquifer unit affected by this test (see Fig. 1). The dolerite dikes in Hallandsås constitute an almost watertight rock unit with slightly increased permeability in the upper part. During the test, the TBM was standing at the mid-adit (Ring #1160) north-east of the dolerite dike shown in Fig. 1. Hence, drainage around the TBM was mainly affecting the aquifer unit north-east of the test section and the pressure recorded in this unit was 10 bar. The measured groundwater pressure at tunnel level in the test section was 13.1 bar, and the aquifer was still slowly recovering from the drainage caused by the tunneling. The pressure will increase to approximately 14 bar when the aquifer unit is fully recovered.

The test section from Ring #818 to Ring #972 was relatively dry during TBM excavation and the dominating rock type is gneiss. Typically the rock mass was unweathered and had a block size of 20–60 cm (RQD: 50–75), corresponding to Hallandsås rock class 2. Pea gravel consisting of an equal mixture of 3–10 mm and 8–16 mm was used as backfill. The pea gravel is of glacial fluvial origin and the well rounded gravel had been sieved and washed. The dominating rock type in the gravel was high strength gneiss.

The observation wells used during the testing can be seen in Fig. 1 and also on the map in Fig. 2. The wells were drilled down to the tunnel level and are used for observations of the groundwater levels within the Hallandsås project's ecological control program.

### 1.3. Test setup

For this test, water from the clean water pond and a well outside the tunnel was used, with both sources analyzed and found to be comparable with the natural ground water at Hallandsås. The clean water was fed into a tank inside the tunnel and connected to the injection pump (see Fig. 3). The pump was connected to the tank at the intake side and, through a bypass system, to the discharge side (see Fig. 3). A valve attached to the bypass system was used for regulating injection pressure during testing. The manifold was equipped with check valves in order to prevent groundwater flowing backwards into the pump and the bypass system. As an extra mitigatory measure, pressure relief valves were mounted on the manifold. Pressure sensors and flow meters were attached along the manifold (see Fig. 3). The manifold was connected to eight injection hoses, which were connected to injection sockets in the lining, thus establishing communication with the formation. The injection points were equally spaced in pairs over a distance of around 30 m (one on each side of the tunnel ring).

Main components in the test setup were:

- Multistage pump 135 kW, 50 l/s at 20 bar (MULTITEC, MTC A 100/03-08.1).
- 5 m<sup>3</sup> water tank.
- Eight injection hoses (1.5 in.) with injection sockets and valves.
- Steel manifold (4 in.).
- Bypass system including high precision regulation valve.
- Flow meters and pressure sensors.
- Pressure relief valves, 15 and 18 bar.
- Check valves, preventing pea gravel and water from outside the lining entering the system.
- Pipes from clean water line to tank, with regulation valve.

In order to monitor this test flow meters and pressure sensors were installed on the manifold. In addition, six pressure sensors were installed along the lining, measuring the pressure distribution behind the lining (see Fig. 4). Pressure sensors were placed both inside and outside of the test section (see Fig. 4). Pressure data was also acquired during testing from observation wells in the vicinity (see Fig. 2). All the collected data was automatically logged. However, manual readings were carried out continuously as a back up during the tests.

From a mechanical point of view, the lining is sensitive to an asymmetric load so, for safety reasons, as well as to gain experience in the matter, the segmented lining was carefully monitored during testing. Monitoring was carried out using a combination of inclinometers and traditional convergence measurements. The traditional convergence measurement gives the horizontal diameter. Inclinometer measurements reveal both the shape of the ring (ovalisation) and the convergence of the ring (diameter). The inclinometer measurements were performed continuously and the convergence measurements after every injection pressure increase.

## 2. Results and interpretation

Three injection tests were carried out to evaluate the possibility of reinjecting water by pressurizing a tunnel section with un-grouted pea gravel backfill. The first test was conducted in order to check the test setup. The second test performed was a step injection test and the third a constant pressure test.

### 2.1. Step injection test results

The step injection test was performed in three different steps using pressure increases of approximately 0.5 bar, 0.8 bar and

Rock mass affected by reinjection of groundwater  
Sketch, not to scale

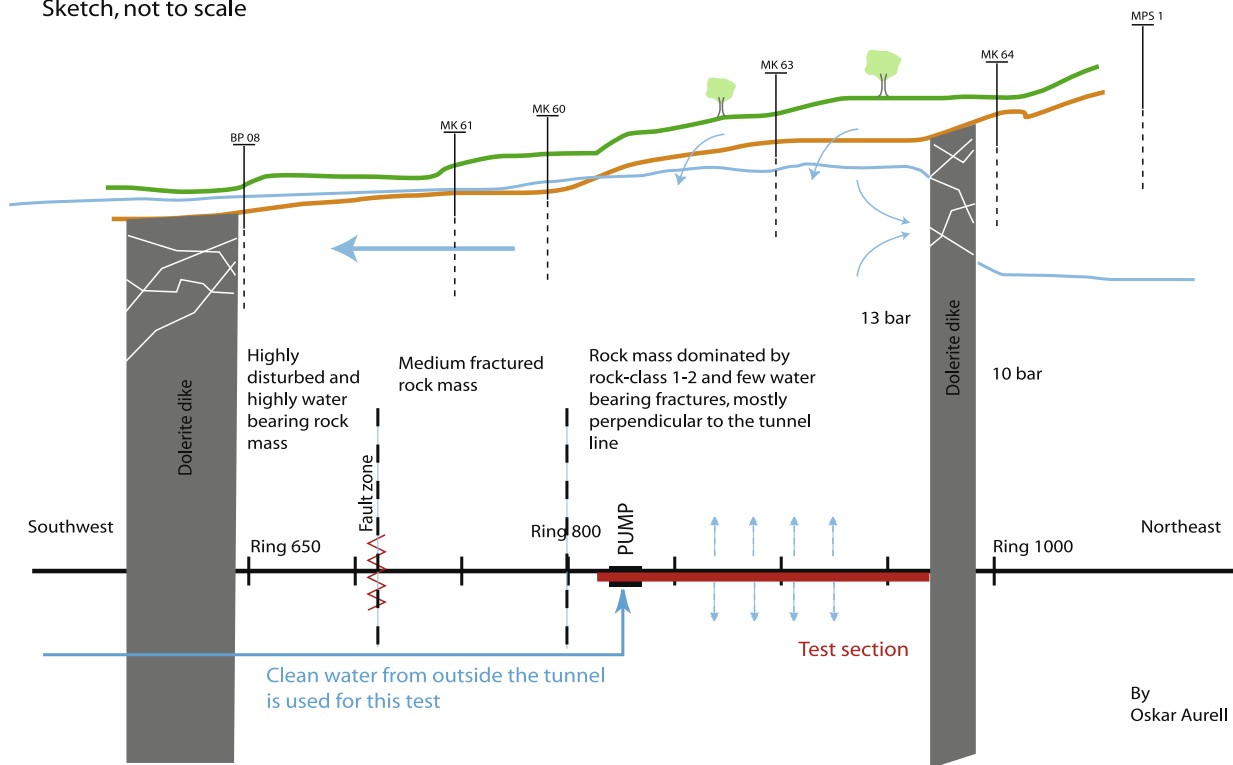

**Fig. 1.** A side view of the test section with pea gravel back fill, in red. Some of the wells monitored during the test (BP08, MK61, MK60, MK63, MK64 and MPS1) can be seen in the sketch. All wells extend down to tunnel level. The dolerite dikes act as barriers limiting the aquifer unit. However, the upper parts of the dikes are probably fractured. The aquifer unit north-east of the test section is drained due to TBM tunneling.

1.1 bar, as measured in the manifold. Each step lasted around 70 min. The injection rate and measured pressure increase along the lining can be seen in Fig. 5. A 10 point moving average is used to visualize the data acquired from both the sensor placed on the manifold and the sensor attached to the injection valve in Ring #836. The highest injection pressure was obtained from the sensor attached to the manifold. This is due to the fact that the measured pressure also includes friction losses in the manifold. The second highest pressure increase is measured at one of the points where the fluid is injected, namely Ring #836 (see Fig. 5). It can also be seen that the pressure decreases as the distance from the source increases, for example in the case of the pressures measured at Ring #851 and Ring #932 (Fig. 5). However, there is a very short pressure increase response time between the pressure sensors in the pea gravel section. The distance between sensor #851 and #932 is #211 m. A pressure increase during each step can also be seen in data acquired from the sensor placed to the south of Ring #790, indicating a leakage through the mortar section south of the test section. No such indications were found at the pressure sensor placed to the north of the test section at Ring #995. In addition it can be mentioned that a pressure response was observed in two of the observation wells at locations MK31 and MK63 (see Fig. 2).

2.2. Step injection test interpretation

Since small pressure changes were used during the step injection test, from a production point of view it is interesting to estimate possible injection rates at higher pressure changes. The estimation has been carried out by using step injection analysis,

evaluating the pressure data from the sensor placed at Ring #836 and the data regarding the injection rate used. The records from the sensor at Ring #836 have been chosen, as the highest pressure increase along the lining will occur at the water injection location. An analysis analog using a step-drawdown modified analysis (e.g. Jacob, 1947; Bierschenk, 1963; Roscoe Moss Company, 1990) was used for data interpretation. The specific injection pressure (injection pressure divided by the injection rate) at the end of each step is plotted against the injection rate and a straight line is fitted to the points (see Fig. 6). A moving average has been used on the injection rate data in order to produce representative values for the analysis.

The slope of the line and the intercept with the vertical axis is used in Eq. (1) to predict injection pressure for different injection rates. In a step-drawdown analysis, the coefficient in front of the squared term is the well loss coefficient and the coefficient in front of the linear term is the aquifer loss coefficient. For the injection tests, the pressure increase restriction was set to 5 bar, which yields an injection rate of 19.3 l/s in accordance with Eq. (1). In other words, this is the maximum usable injection rate that does not exceed the pressure increase restriction. It is important to stress is that this value is valid for 70 min. Therefore, in order to estimate injection pressures and/or injection rates for a longer injection duration, the result from a step injection test has to be combined with result from a long-term injection test. The latter test reveals essential additional information about the spatial limitations of the aquifer.

$$P = 0.0089Q^2 + 0.0878Q \tag{1}$$

where  $P$  = injection pressure (bar)  $Q$  = injection rate (l/s).

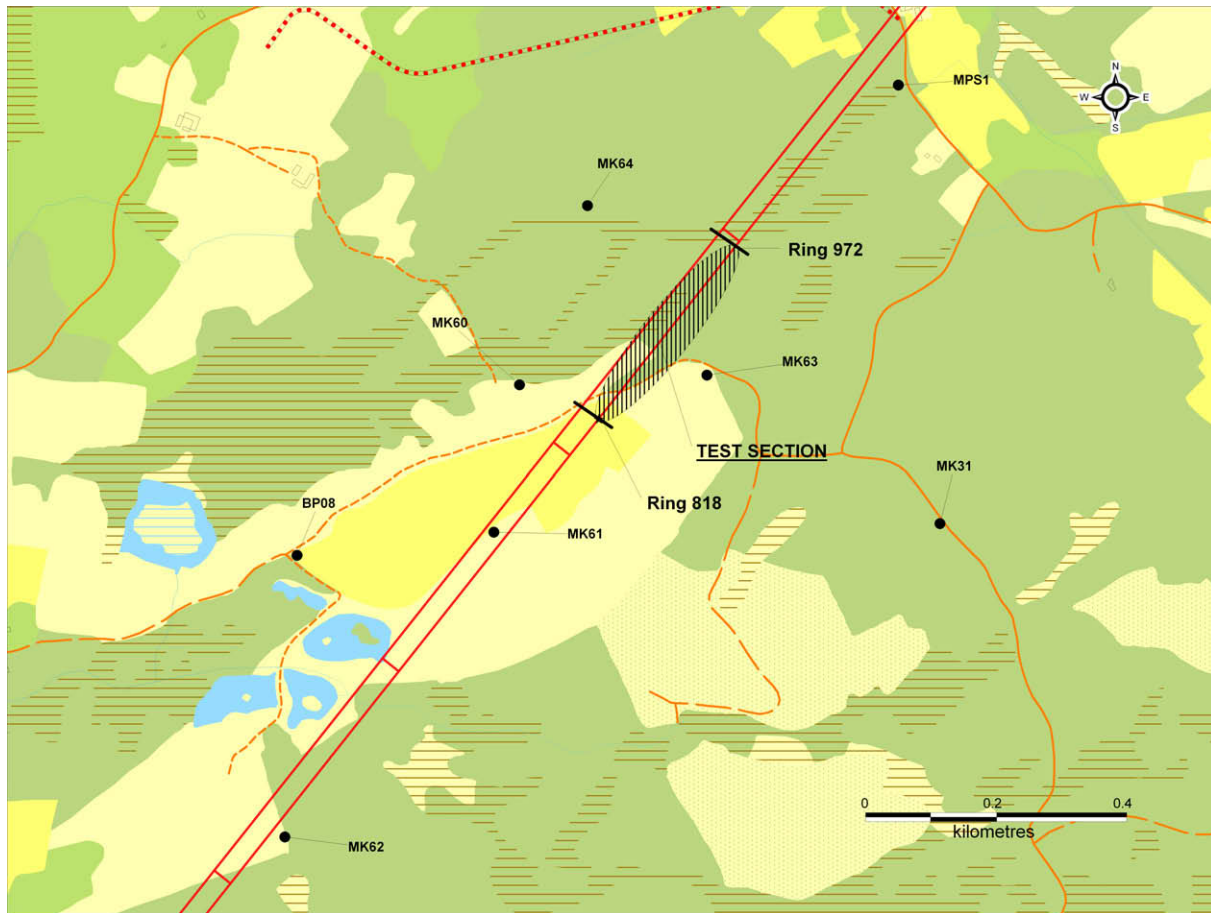

Fig. 2. The map shows observation wells used during testing.

### 2.3. Constant pressure test results

The constant pressure test lasted for approximately 9 h, and was carried out with an injection pressure of about 1 bar, as measured on the manifold (including friction losses in the pipe). The measured pressure increase along the lining, as well as the injection rate, can be seen in Fig. 7. The highest pressure increase was obviously obtained from the sensor attached to the manifold, which is due to the fact that the measured pressure also includes friction losses in the manifold. The second highest pressure increase, around 0.8 bar, is measured at one of the fluid injection points, namely Ring #836 (see Fig. 7). It can also be seen that pressure decreases with increased distance from the injection points, such as in the case of the pressures measured at Ring #851 and Ring #932 in Fig. 7. A pressure increase can also be found from the data acquired from the sensor placed south of the test section (Ring #790), indicating a small leakage through the mortar section to the south of the test section. No such indications were found at the pressure sensor at Ring #995, to the north of the test section. After the termination of the test, the pressure fall off was measured. The pressure fell off to a higher pressure than the initial pressure measured before the test. This is probably due to the fact that the test was conducted in an aquifer recovering tunneling induced drawdown. The time from the termination of the injection test until the pressure fall off levels out was about 2000 min. The pressure fall off time is approximately four times greater than the time used for the injection test. The fall off data was not used for any further analysis, such as estimating transmissivity.

A pressure increase was recorded in two of the observation wells (MK63 and MK31) during the constant pressure test. As men-

tioned previously, the wells are drilled from ground level and their location can be seen in Fig. 2. MK63 is located at a radial distance of around 147 m from Ring #836 and MK31 at a radial distance of 534 m. The most evident response was found in MK63, with around 4.3 m of displacement at the end of test compared with 0.45 m of displacement in MK31 (see Fig. 8).

### 2.4. Constant pressure test interpretation

Interpretation of transmissivity and storativity from the constant pressure test data has been done using the following solutions; Jacob and Lohman (1952), Cooper and Jacob (1946) and Daviau et al. (1988), all of which are unsteady state solutions derived for a porous medium. There are several assumptions and conditions underlying the solutions, i.e. that the aquifer is confined, homogeneous and of an infinite areal extent. The solution by Daviau et al. (1988) is derived for a horizontal pumping/injection well and the other two solutions are derived for a vertical pumping/injection well, but all solutions share the assumption that storage in the wells is negligible.

The data from the sensor attached to Ring #836 (see Fig. 7) is used to estimate the transmissivity, and was chosen due to it being located at a water injection point. The Jacob and Lohman (1952) solution is used to estimate the transmissivity, which is a straight line method used for constant head tests. Data acquired after 100 min is used for the interpretation of transmissivity, a duration after which the approximation of using a straight line solution is valid. Transmissivity is estimated as  $4.4 \times 10^{-4} \text{ m}^2/\text{s}$  using the Jacob and Lohman (1952) solution (see Fig. 9) or as  $1.5 \times 10^{-6} \text{ m/s}$  expressed as hydraulic conductivity. The calculation is based on

### Tank, pump, regulation system and pipes

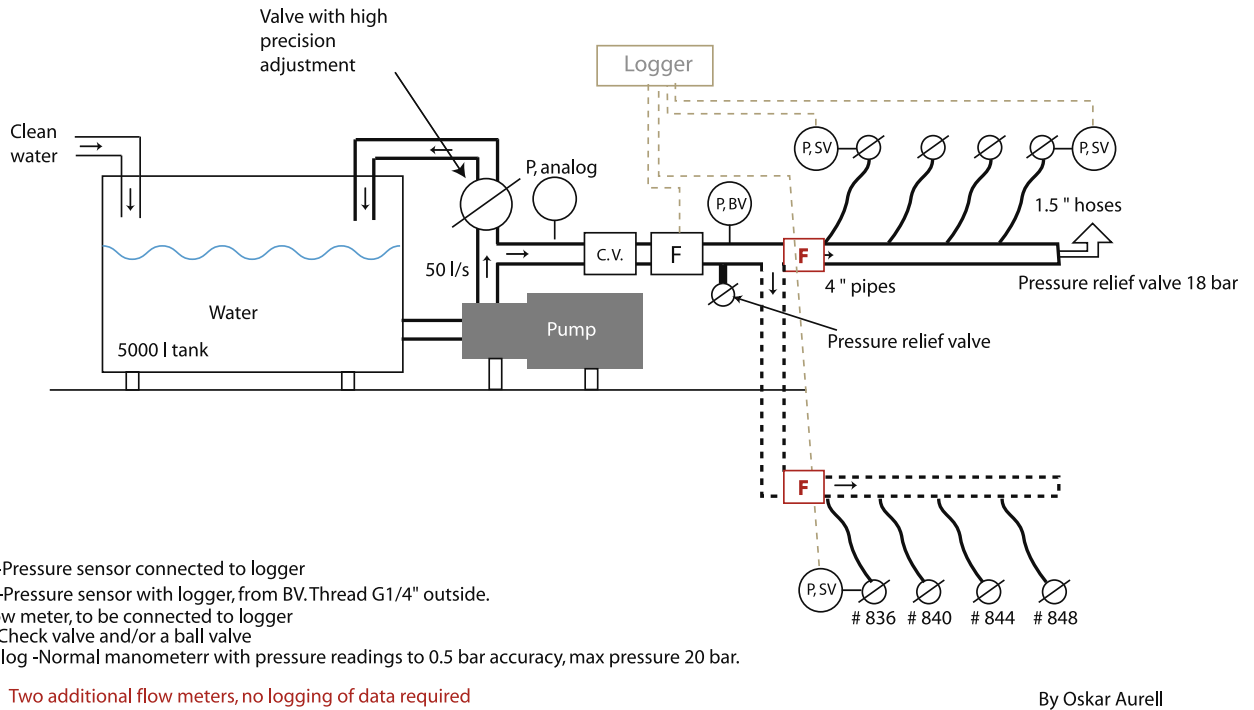

Fig. 3. The pump station with tank, pump, pressure regulation system and pipes. Clean water was fed into the tank. The pump circulated the water during testing and the injection pressure was adjusted using the valve on the bypass system. Water was injected through the lining at eight points.

### Monitoring system, flow and pressure

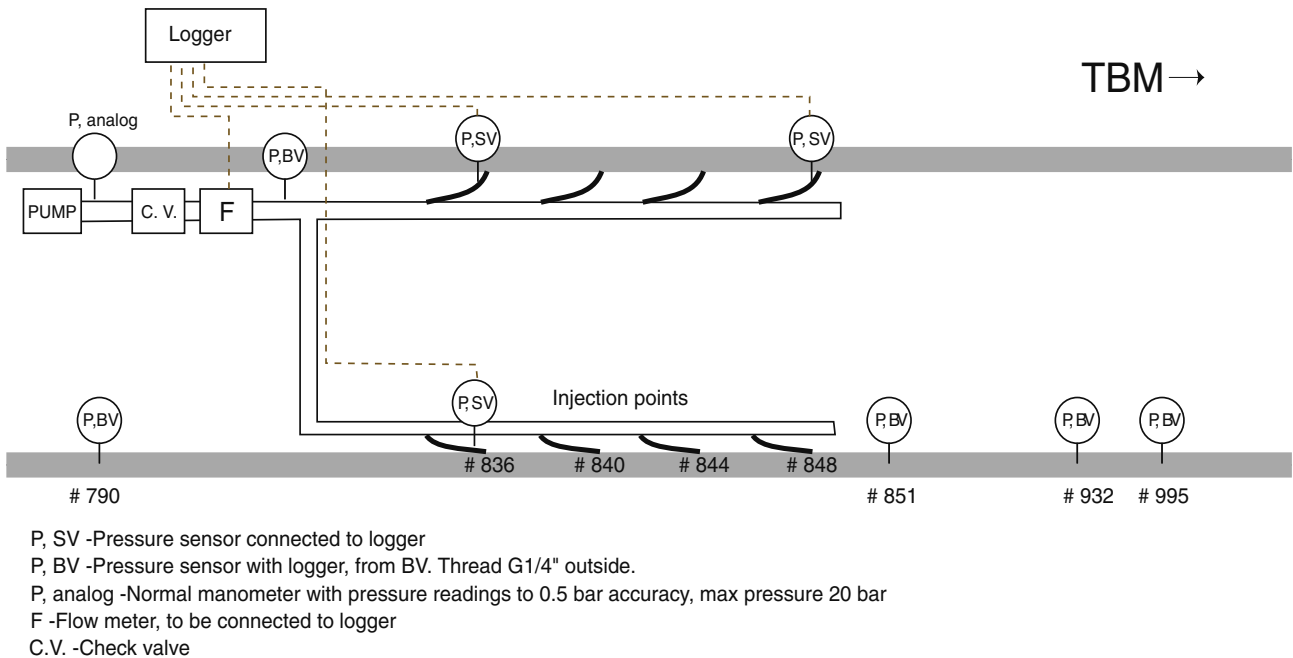

Fig. 4. The monitoring system used in the tunnel during the re-injection test.

the assumption that water is transmitted along the entire test section of around 350 m. There are some uncertainties in the data

used for estimation of transmissivity. Neither the amount of water leaving the test section through the mortar sections nor the water



Fig. 5. Pressure increase and injection rate measured during the step injection test.

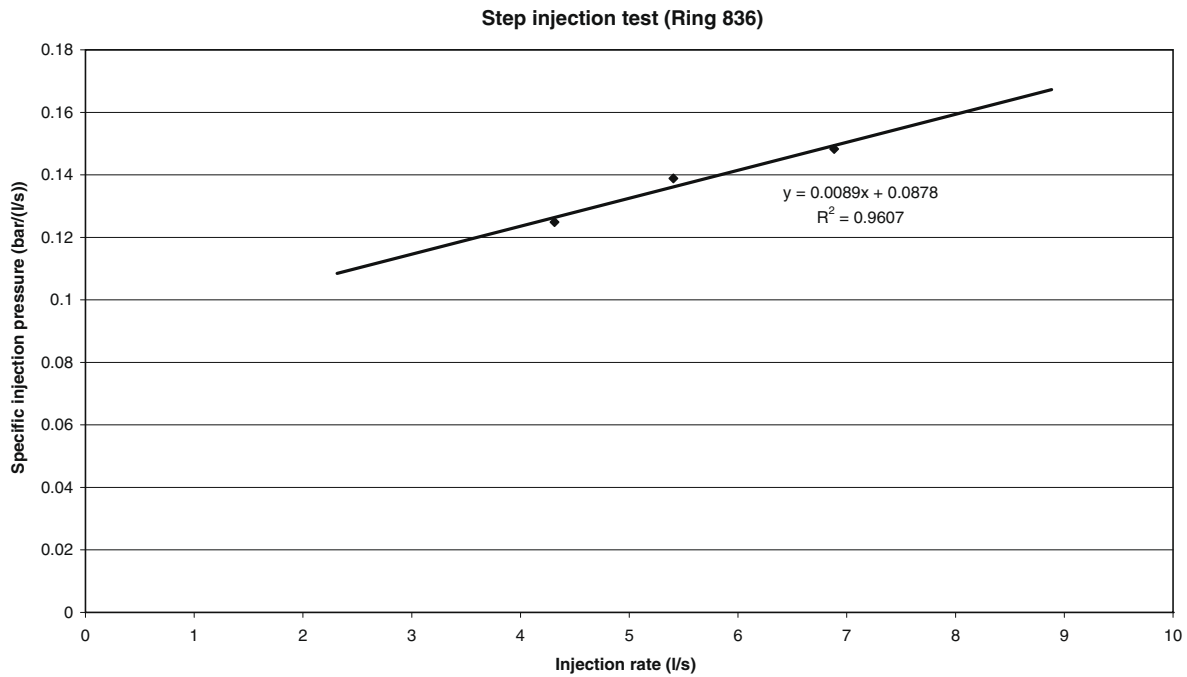

Fig. 6. Specific injection pressure against injection rate measured at Ring #836. The values are measured after 70 min for each step.

re-entering the tunnel could be measured. The above estimated values are based on the approximation that the fluid is only transmitted into the surrounding rock mass, which of course is dubious. However, if 90% of the fluid was to be transmitted into the surrounding rock mass and 10% (a high value) was to re-enter the tunnel, then the transmissivity will be accordingly reduced by 10%.

Transmissivity is estimated as  $5.7 \times 10^{-4} \text{ m}^2/\text{s}$  from the data acquired in observation well MK63 using the Cooper and Jacob (1946) method (see Fig. 10). The average injection rate from the

constant pressure test is used for the interpretation. The storativity is estimated at  $9.1 \times 10^{-6}$ . Lower values of transmissivity are obtained if the variable injection rate is considered but, on the other hand, the match is not as good as in Fig. 10. In addition, there is an uncertainty regarding the injection rate value, due to a lack of information regarding how much water re-entered the tunnel during the test. Transmissivity is also estimated by using a solution presented by Daviau et al. (1988), which was developed for horizontal wells. It is assumed that the tunnel is a horizontal well with

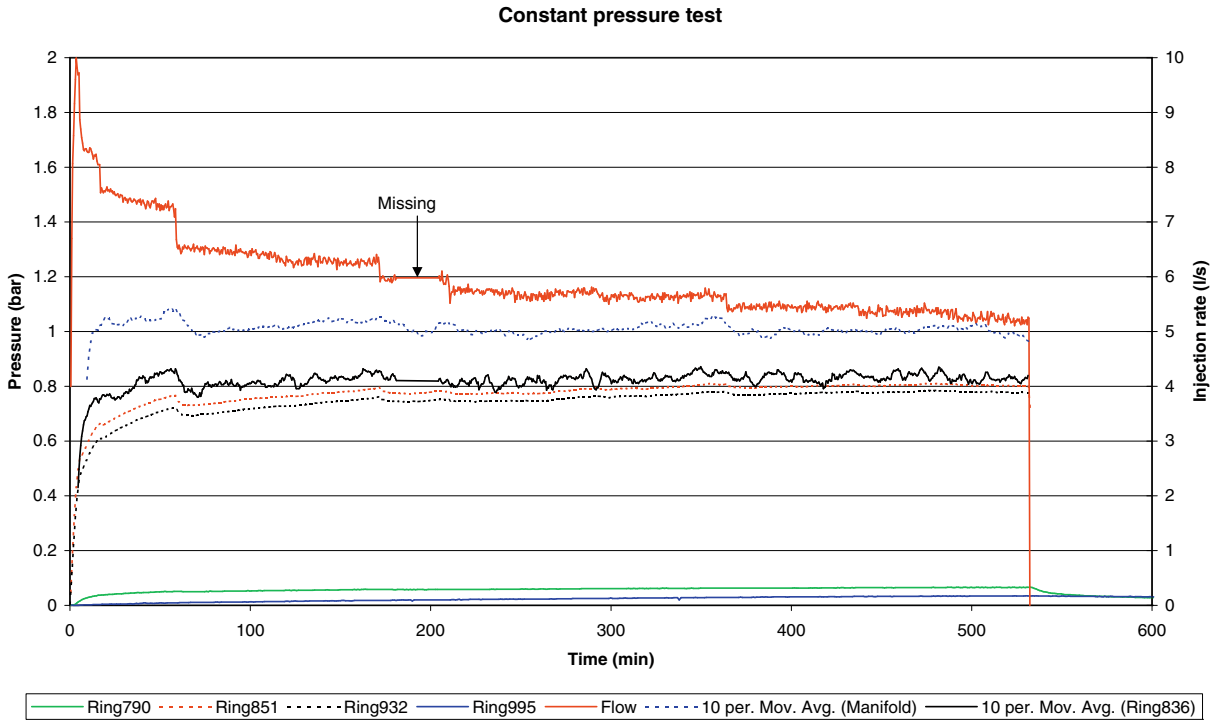

Fig. 7. Measured pressure increase and injection rate during the constant pressure test. The pressure is shown as pressure above ground water pressure prior to test. Injection rate data and pressure data is missing for Ring #836 for the period between 180 and 205 min.

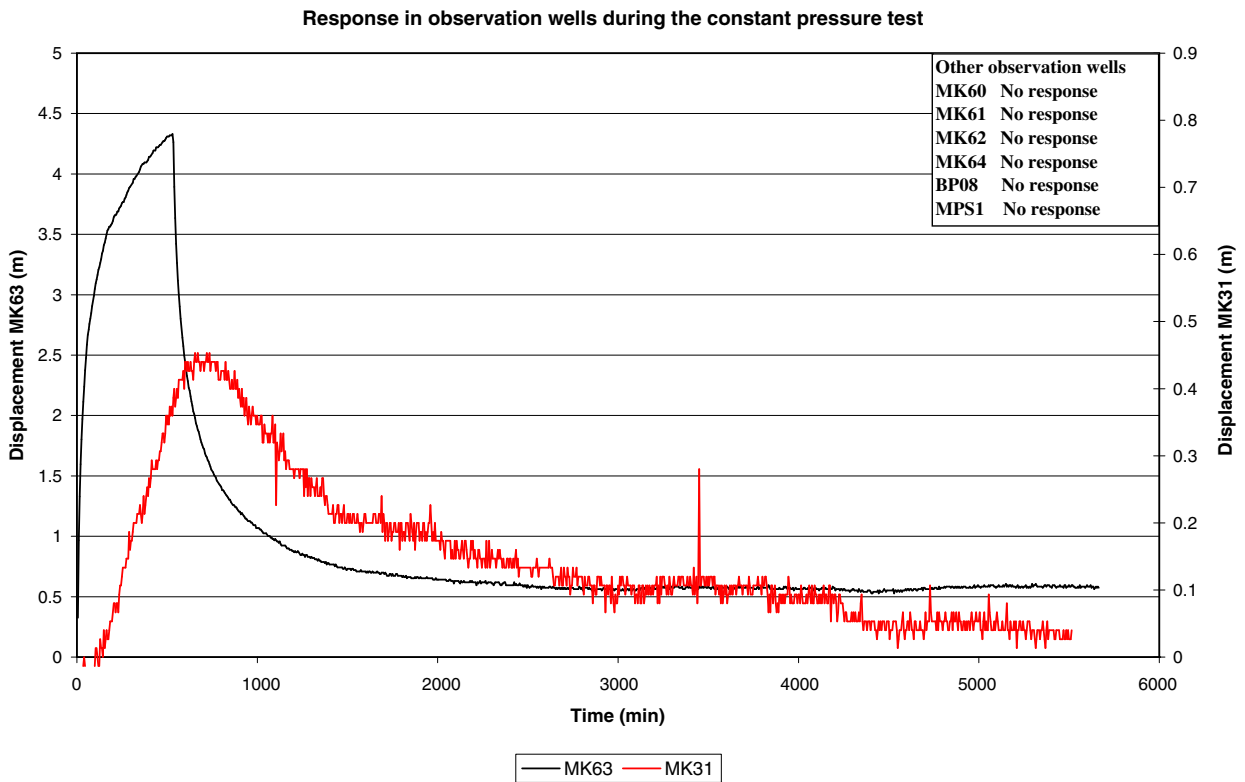

Fig. 8. Measured pressure increase in the observation wells during the constant pressure test.

a diameter of 10.12 m (i.e., the outside diameter of the lining) and the length of the well is assumed to be 30 m (i.e., the length of the section where water was injected). MK63 is considered as an observation well. A transmissivity value of  $5.6 \times 10^{-4} \text{ m}^2/\text{s}$  is esti-

mated using the solution from Daviau et al. (1988), with a storativity value of  $1.1 \times 10^{-5}$  (see Fig. 11).

It is generally more difficult to estimate transmissivity from the data obtained in MK31. There are fluctuations in the

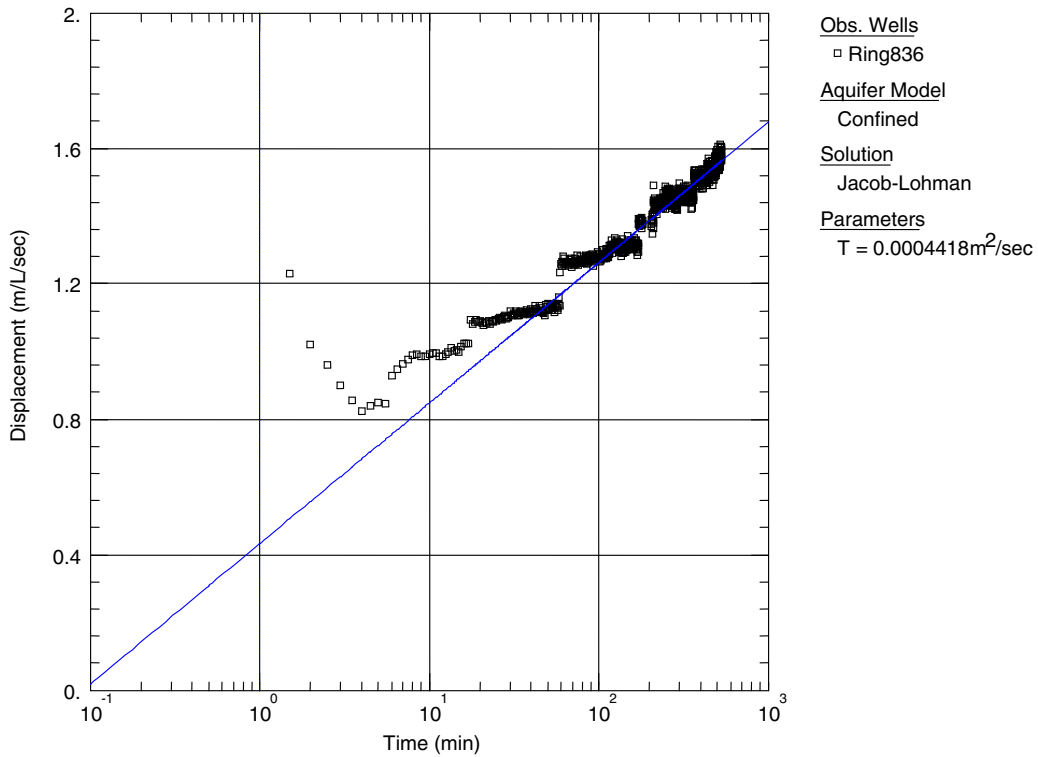

Fig. 9. Estimation of transmissivity using data from the constant pressure test.

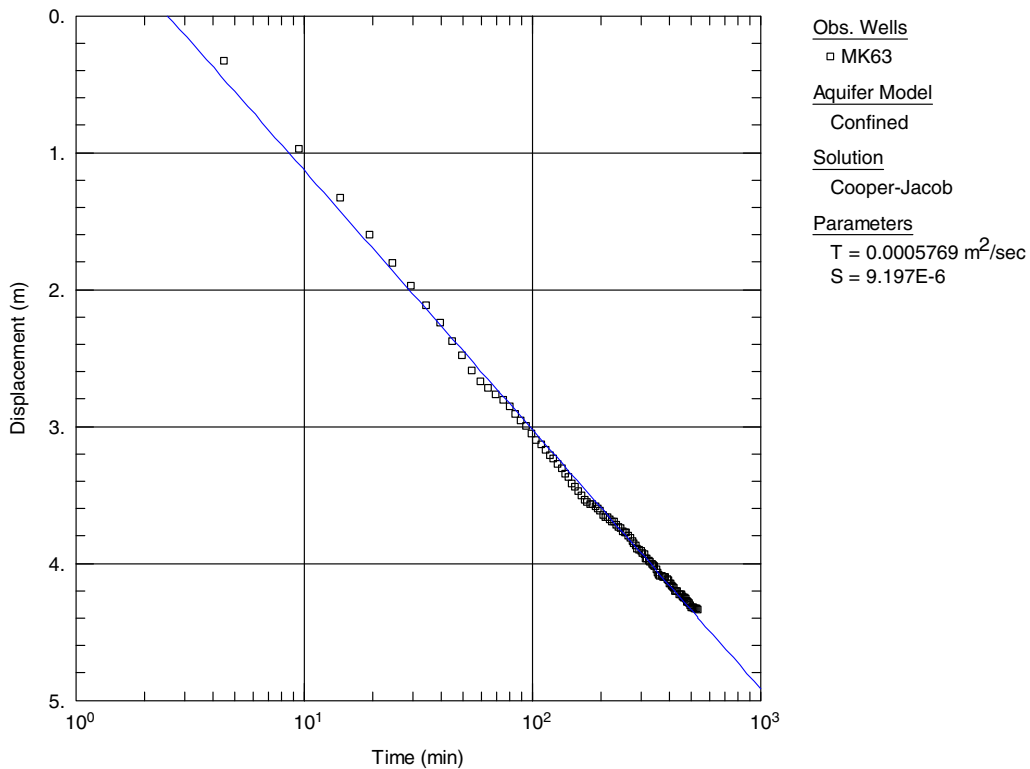

Fig. 10. Transmissivity estimated from displacement data in MK63 using the Cooper and Jacob (1946) method.

measured pressure response, which can be attributed to the precision of the diver. The uncertainties associated with this noisy data means that an interpretation of transmissivity could not be carried out.

### 3. Discussion

Re-injection of groundwater through the TBM lining at a pea gravel backfilled section proved to be a method that can be used



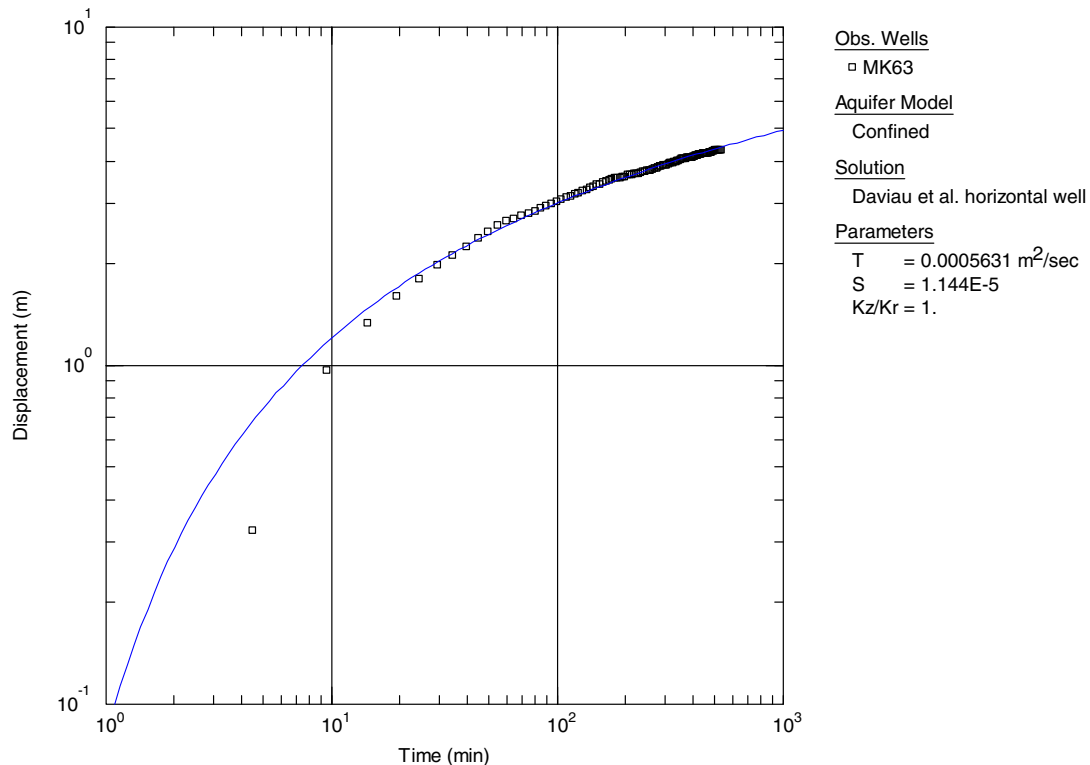

Fig. 11. Transmissivity estimated from displacement data in MK63 using the Daviau et al. (1988) method.

and developed for future re-injection needs. The tests were generally successful, but uncertainties regarding the inflow back into the tunnel were a major disadvantage. However, the inflow back into the tunnel was estimated to be a minor portion of the total injection rate. It is certain that water was injected to the surrounding rock mass, which is also supported by the pressure response in different observation wells. Additional information about the completion of the mortar barriers limiting the test section was also gathered during testing. For example, it was found that there was a small leakage through the mortar to the south of the test section. As a safety precaution, low injection pressures were used during the entire test period and the lining convergence was negligible.

Well testing methods developed for vertical drilled wells can also be applied to injection testing at tunnel level. A promising result was obtained from both the step injection test and the constant head/pressure test. Since the result from the step injection test includes both aquifer losses and well losses, it can be used for predicting injection rates at different pressures than the pressures used during testing. Complementary information about spatial limitations of the aquifer can be obtained from the constant pressure test. After termination of the different injection tests, the subsequent pressure fall off can be used as a fall off test, which can then be used for analyzing aquifer parameters such as, for example, transmissivity. During the different tests, pressure fell off to a value that was greater than the initial pressure measured before the testing. Theoretically, the pressure after the fall off test should be the same as the initial value before testing. The discrepancy in this case can be explained by the injection and fall off tests being conducted in an aquifer recovering from earlier drainage due to TBM tunneling through the area. No further analysis of the fall off data such as, for example, transmissivity estimation, has been done within this study.

Analytical solutions developed for vertical wells can be used for interpreting data acquired from tests performed at tunnel level.

The lowest transmissivity of  $4.4 \times 10^{-4} \text{ m}^2/\text{s}$  was estimated from the data acquired at tunnel level using the Jacob and Lohman (1952) solution. Higher transmissivity was calculated from data acquired in MK63, an observation well drilled from ground level. Specifically,  $5.7 \times 10^{-4} \text{ m}^2/\text{s}$  was calculated using the Cooper and Jacob (1946) solution and  $5.6 \times 10^{-4} \text{ m}^2/\text{s}$  using the Daviau et al. (1988) solution. There is an interesting similarity in the results from the Cooper and Jacob (1946) solution, developed for infinitesimal vertical wells, and the results from Daviau et al. (1988), developed for horizontal wells. One explanation could be the different flow regimes that can occur when testing a horizontal well; the tunnel is considered as a horizontal well in this case. For example, Kuchuk (1995) and Horne (1995) describe different flow regimes; early time radial flow, late time radial flow, hemiradial flow and linear flow. In the case of late time radial flow regime, transmissivity estimated from the solution developed for a horizontal well is estimated in the same manner as with the Cooper and Jacob (1946) solution. Flow regimes, except late time radial, were generally difficult to distinguish in the acquired data. There was also good agreement between the estimated values of storativity obtained from Cooper and Jacob (1946) and Daviau et al. (1988). The two solutions both use the same boundary condition involving an aquifer of infinite areal extent. This is an appropriate assumption, since no influence from hydraulic boundaries could be deduced from the acquired test data. In addition, isotropic conditions are assumed for both solutions. However, analytical solutions developed for vertical wells seem to be applicable for testing at tunnel level. The water is injected in a small portion of the aquifer and it does not seem to matter whether this is done by injection through a vertical well (or several infinitesimal wells) or from tunnel level, analogous to a horizontal well, especially if the response is measured in observation wells. An exception can be that vertical permeability may play an important role in a horizontal well, since there is likely to be considerable flow in the vertical direction. This is analogous to a vertical well where



the horizontal permeability may be dominating due to horizontal flow direction.

There are some general uncertainties in the data used for the estimation of transmissivity, for example the amount of the injected fluid that re-enters the tunnel or leaves the test section through the mortar and barrier sections. The estimated values of transmissivity and storativity are based on the assumption that the fluid is transmitted only into the surrounding rock mass, which of course is not certain. Therefore, the obtained transmissivity values could have been overestimated. However, it is more important to consider that different solutions are applicable for analyzing data obtained during re-injection tests at tunnel level, as well as data from vertically drilled observation wells. Estimating the exact value of, for example, transmissivity is another issue.

#### 4. Conclusions

It can be concluded that re-injection of water by pressurizing a part of the lining with a permeable back fill (un-grouted pea gravel) is possible and feasible. Both the technical setup and monitoring system used were suitable for this type of testing and are consequently suitable for similar re-injection operations.

Based on the response in two of the vertically drilled observation wells, it can be concluded that a large portion of the water was infiltrated into the surrounding rock mass. The wells have good hydraulic contact with the tunnel and are located on a line

parallel with the dominating fractures of the horst, namely north-west to south-east.

Well testing methods, such as step injection and constant head/pressure tests developed for vertical wells, can also be applied for testing at tunnel level. Analytical solutions developed for vertical wells could be used to interpret hydraulic properties such as transmissivity, using tests performed at tunnel level and the pressure response in two of the observation wells.

#### References

- Banverket, 2009. <<http://www.banverket.se/sv/Amnen/Aktuella-projekt/Projekt/1869/Hallandsas.aspx>> (confirmed 29.04.09).
- Bierschenk, W.H., 1963. Determining well efficiency by step-drawdown test. *International Association of Scientific Hydrology* 64, 493–507 (Publication).
- Cooper, H.H., Jacob, C.E., 1946. A generalized graphical method for evaluating formation constants and summarizing well field history. *Transactions American Geophysical Union* 27 (4), 526–534.
- Daviau, F., Mouronval, G., Bourdarot, G., Curutchet, P., 1988. Pressure analysis for horizontal wells. *SPE Formation Evaluation*, 716–724 (December 1988).
- Horne, R.N., 1995. In: *Modern Well Test Analysis*, 2nd ed. Petroway Inc., Palo Alto, California, p. 257.
- Jacob, C.E., 1947. Drawdown test to determine effective radius of artesian well. *Transactions American Society of Civil Engineers* 112 (2321), 1047–1064.
- Jacob, C.E., Lohman, S.W., 1952. Nonsteady flow to a well of constant drawdown in an extensive aquifer. *Transactions American Geophysical Union* 33, 559–569.
- Kuchuk, F.J., 1995. Well testing and interpretation for horizontal wells. *Journal of Petroleum Technology* 24, 36–41 (January 1995).
- Roscoe Moss Company, 1990. *Handbook of Ground Water Development*. John Wiley & Sons, New York. p. 493.
- Wikman, H., Bergström, J., 1987. *Beskrivning till berggrundskartan Halmstad SV*. Swedish Geological Survey, Uppsala (in Swedish).

# **Paper 4**

**Rosberg J-E. and L. Bjelm (2009)**

**Well development by jetting using coiled tubing and simultaneous pumping  
Ground Water**



## Well Development by Jetting Using Coiled Tubing and Simultaneous Pumping

by Jan-Erik Rosberg<sup>1</sup> and Leif Bjelm<sup>2</sup>

---

### Abstract

During flow testing of a deep, 1927-m, gravel packed screen completed well, it became apparent that well development was needed to increase productivity. A hydrojetting system using coiled tubing in combination with simultaneous pumping was developed and tested and found to be successful. To verify whether the jetting improved the well, the results of a pumping test conducted before and after the jetting operation are compared. In addition, flowmeter logging and hydraulic properties obtained from pumping tests conducted during the jetting operation were also used to verify the improvements. Hydrojetting in combination with simultaneous pumping proved to be an effective cleaning method. After 100 min of pumping, around 110 m less drawdown and 15 L/s higher average flow rate were obtained compared to the values before the jetting operation. The skin factor was positive before the jetting operation and negative thereafter, thus providing additional evidence of improvements of the well. The flowmeter data also confirmed the improvements and were valuable in optimizing the jetting operation. It was also found, from the short-term pumping tests conducted during the jetting operation, that the Hantush–Jacob method for leaky confined aquifers is a valuable indicator of the well development. The combination of methods used for the well development in this case can easily be applied on other deep well projects to obtain a controlled and time-efficient well development.

---

### Introduction

The need for well development is always important to consider before conducting the final flow test of a well, especially when conducting a single-well test, where near-well disturbances can affect and make the interpretation of the aquifer properties more difficult. Well development is quite easy to conduct in shallow wells, but for deep wells it is more complicated and more time consuming. Deep wells are often associated with the oil and gas industry and geothermal applications, but can also be relevant for

groundwater applications. The cost for well development is often a critical issue. One way to decrease the cost for well development is to increase the down- and up-hole transportation of the required equipment and to have a system to verify the improvements of the cleaning.

A cost-effective and successful well development method was used in a deep geothermal well project in Lund, Sweden. Hydrojetting using coiled tubing in combination with simultaneous pumping was used and later verified by flowmeter logging—a method that can easily be applied for other deep wells. Coiled tubing is adopted from the petroleum industry and is a long continuous length of pipe wound on a spool, which is straightened before entering the well. It is time efficient to use coiled tubing instead of conventional tubing, where a stop is required at every 9 to 27 m (depending on the rig height) to remove or add a drill pipe or tubing. Coiled tubing provides rapid transportation of the jetting tool, which is of great importance in deep wells, where the transport time to get into position is time consuming and

---

<sup>1</sup>Corresponding author: Department of Engineering Geology, LTH, Lund University, P.O. Box 118, SE-22100 Lund, Sweden; Jan-Erik.Rosberg@tg.lth.se

<sup>2</sup>Department of Engineering Geology, LTH, Lund University, Lund, Sweden

Received October 2008, accepted April 2009.

Copyright © 2009 The Author(s)

Journal compilation © 2009 National Ground Water Association.

doi: 10.1111/j.1745-6584.2009.00588.x

expensive. The well development of one of the deep wells in Lund, DGE#2, will be described in detail in this paper.

### Background

The well, DGE#2, was drilled to a total depth of 1927 m aiming for deep-seated sandstones. Rotary drilling with potassium chloride (KCl) polymer mud was used at the actual production zones. A dual screen completion was used in DGE#2 (Figure 3). The formation where the upper screen is installed, at 1507 to 1539 m, consists of fairly homogenous sandstone (Erlström 2004). The formation where the lower screen is installed, at 1569 to 1673 m, consists of unconsolidated or poorly consolidated quartz sand (Erlström 2004). A more detailed description of the project can be found in, for example, Bjelm and Rosberg (2006); Bjelm (2006), and Rosberg (2006).

### Methods for the Well Development

The jetting operation was carried out using coiled tubing equipment (OD 2 3/8in. [60.3 mm]), which consists of a coiled tubing reel of 2000 m, jetting tools, an electrical submersible pump, piston pumps, settling ponds, transfer pumps, and cyclones—a system designed for reusing the produced fluid. The transfer pumps placed in the pond transferred the formation water to the cyclones placed next to the piston pumps, thus allowing for separation of fine particles from the water. After the cyclones, the piston pumps forced the water through the coil and the jetting tool. Simultaneously the electrical submersible pump was used to lift out the debris and the water was transferred to the settling ponds. A tubing (ID 131.7 mm) was attached

to the column riser pipe to guide the jetting equipment and logging tools past the pump. The nonrotational jetting tool consisted of eight nozzles with diameters of 4.5 mm, oriented horizontally. The tool was equipped with two extra nozzles pointing downward for cleaning the sump from settled formation material.

Numerous jetting runs were carried out to improve the inflow to the well. Recommendations from Driscoll (1986) were used to design the jetting velocity, nozzle pressure, and the pulling speed of the jetting tool. Recommended jetting velocity in our case was 30.5 to 91.5 m/s, maximum nozzle pressure around 27 bar, and pulling speed of the jetting tool 1.2 to 3.7 m/h. The different jetting runs and jetting velocity used and speed of the jetting tool are presented in Table 1. Deviations from the recommended pulling speed can be found in Table 1, which were more of an economical issue than a technical issue. However, the entire screen was jetted once with the recommended pulling speed. Nozzle pressure used varied between 20 and 27 bar, with an average pressure around 20 bar. The maximum pressure was only used at the upper screen, where the formation was supposed to be more resistant against high-pressure jetting compared to the formation at the lower screen. The movement of the jetting tool was always upward while jetting. To minimize settling of debris in the wellbore, the electrical submersible pump was not shut down until 1 h or more after the jetting was terminated. During all jetting runs, the outgoing water was visually inspected for formation particles—a method to evaluate of the cleaning of the well. The effect of the jetting operation was also verified by impeller flowmeter measurements. In other words, the flowmeter logging was used as verification of the jetting operation. Data acquired

**Table 1**  
**The Different Jetting Runs in DGE#2**

Date	Jet Velocity (m/s)	Pulling Speed (m/h)	Cleaned Interval	Remarks
12-02-2004			Sump	Cleaning the sump
12-04-2004	31	4	1673–1652 m	Lower screen
12-05-2004	31	3.9	1652–1613 m	Lower screen
12-06-2004	31	4	1613–1569 m	Lower screen
12-07-2004				
Run 1	77	15	1539–1507 m	Upper screen
Run 2	88	20	1539–1507 m	Upper screen
Run 3	88	15	1539–1507 m	Upper screen
Run 4	77	15	1673–1656 m	Lower screen
12-08-2004	77	8	1673–1569 m	Lower screen
12-09-2004	80	20	1673–1569 m	Lower screen
			1539–1507 m	Upper screen
12-10-2004	85		Sump	Cleaning the sump
12-12-2004	90	4.5	1539–1507 m	Upper screen
12-13-2004		8	1539–1507 m	New jetting tool with larger diameter
12-14-2004	77	10	1673–1640 m	Lower screen
12-15-2004	90		Sump	Cleaning sump

Note: Short-term pumping tests were conducted 10 h or more after the jetting was finished to evaluate the cleaning effect of the jetting operation. The pump was a speed controlled submersible pump and the same frequency was used for all tests; see Rosberg (2007) for more details.

from a flowmeter logging carried out before the stimulation were used as reference data. The flowmeter logging was easy to perform due to the tubing attached to the pump column pipe.

Well-known interpretation methods Cooper and Jacob (1946), Hantush and Jacob (1955), Papadopulos and Cooper (1967) were used to evaluate the test pumping data. The storativity was estimated as  $1.8 \cdot 10^{-4}$  by a formula presented by Hall (1953). The Theis recovery method (Theis 1935) was used for the interpretation of recovery data. Skin factor and influence of wellbore storage were estimated to verify the efficiency of well development.

## Results

To verify whether the jetting improved the well performance, pumping test data acquired before and after the jetting operation were compared (Figure 1). Figure 1 shows that the drawdown has decreased and the flow rate has increased markedly after the jetting operation, for example, around 110 m less drawdown and 15 L/s higher flow rate are obtained after 100 min of pumping. The shape of the drawdown curve has also changed. The curve before the jetting has a steeper shape compared with the curve from after the jetting, which indicates longer effects of wellbore storage and larger skin before the jetting than after. The same pump speed was used on both occasions.

A unity line was fitted to the early drawdown data, at the test conducted before jetting, and, applying the 1 1/2 log cycle rule (Horne 1995), the influence of wellbore storage was estimated to be 225 min. Transmissivity was estimated as  $1.8 \times 10^{-4} \text{m}^2/\text{s}$  and skin factor was 1.9 using the Cooper–Jacob method. Influence of wellbore storage was negligible during the test conducted after the termination of the jetting. Transmissivity was estimated as  $1.4 \times 10^{-4} \text{m}^2/\text{s}$  and skin factor as  $-3.6$  using

the Cooper–Jacob method. The different values of transmissivity and skin factor from the test before and after jetting can be found in Figure 2, such as estimations using recovery data.

Hydraulic properties obtained from the short-term pumping tests, conducted during the jetting operation, were of great importance in evaluating the improvement of the well after each jetting run. The transmissivity has been estimated using three different methods Cooper–Jacob, Papadopulos–Cooper (casing radius 0.22 m), and Hantush–Jacob; see Figure 2. The date, the duration, and the skin factor from each short-term pumping test can also be found in Figure 2.

Impeller flowmeter measurements also confirmed that the well had improved by the jetting. Data acquired from flowmeter logging carried out before the jetting operation started are used as reference values. The values are compared with logging data collected after the operation; see Figure 3. There are three curves plotted in Figure 3, the black curve is the reference curve, and the red and the green curves are from two different logging runs performed after the jetting operation. The pump speed was the same for the logging run, resulting in the black and the red curves and higher for the logging run, resulting in the green curve. Comparing the logging runs before and after the jetting operation, it can be seen that the total flow rate has increased, which was also confirmed earlier by test pumping. A major part of the contribution to the increased flow rate seems to come from the bottom section of the lower screen up to around 1620 m. It can be seen as an increased slope of the red curve compared with the reference curve. The upper screen section has not been improved (Figure 3). The curves show a constant value over this section, proving that there is no further contribution from the upper screen.

The produced fluid was a mix of formation water and deteriorated mud polymer with fines from sand and

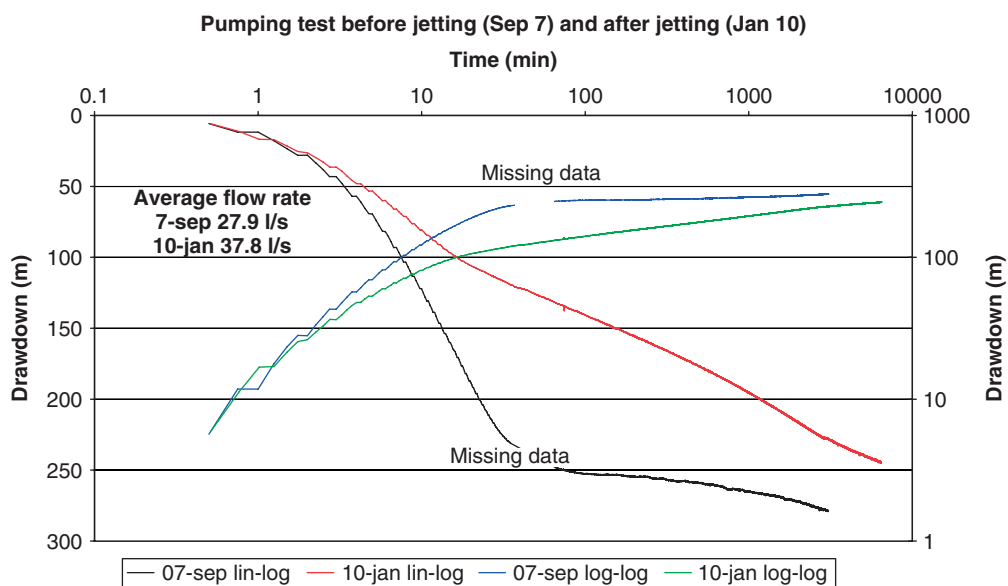

Figure 1. Comparing drawdown recorded before and after jetting.

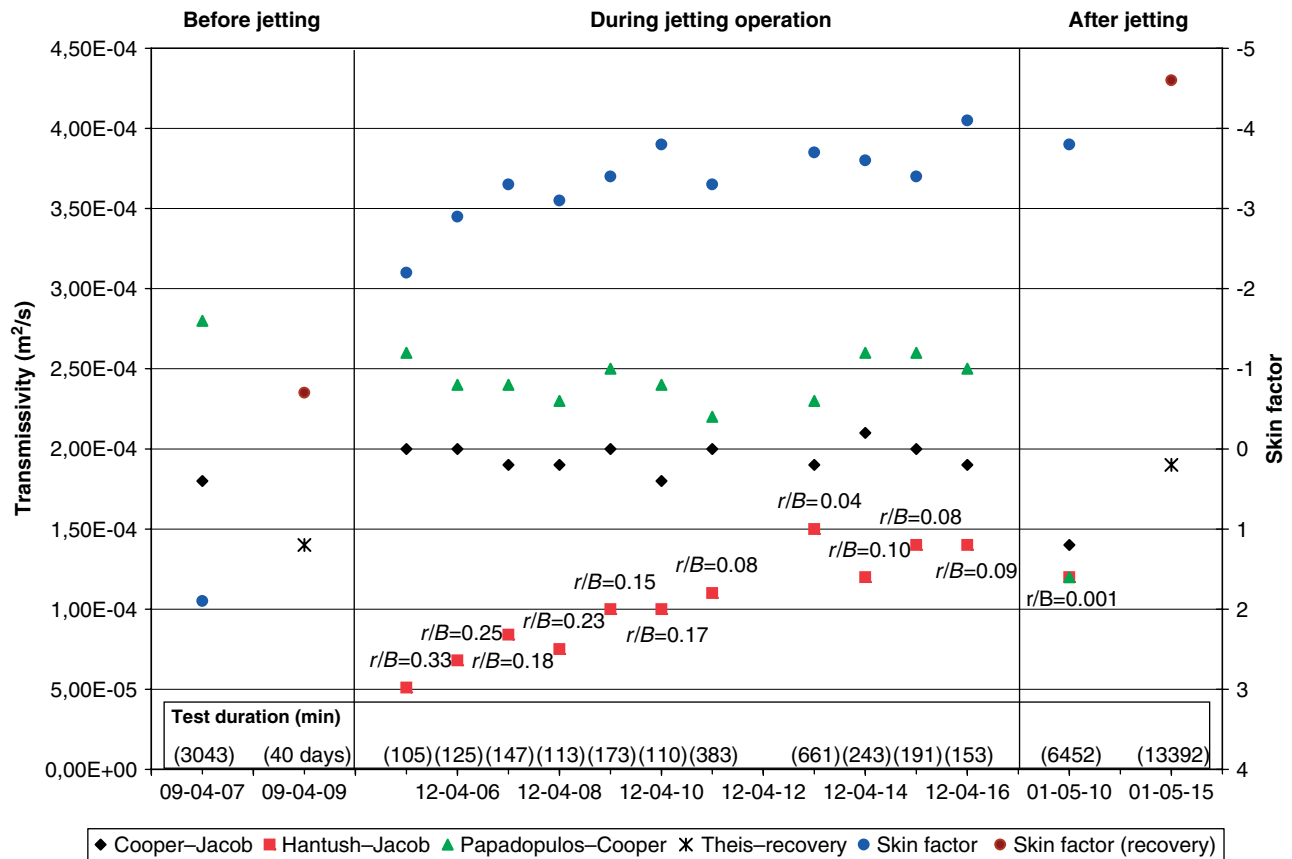

Figure 2. Transmissivity values estimated by four different methods: Cooper–Jacob, Hantush–Jacob, Papadopulos–Cooper, and Theis (recovery). The date and the duration in minutes, presented in brackets, of the different tests are also presented, as is the skin factor (estimated using the Cooper–Jacob method or from recovery data).

claystone formations. Thus, in the beginning of the well development, the dominating part of the debris was residues from the drilling operation. Thereafter the debris consisted mainly of fragments from the formation. At the end of the well development, the fluid became clear and production of formation particles ceased.

## Discussion

The use of jetting led to less drawdown and higher flow rate after the jetting operation and also led to an improved skin factor and less influence of wellbore storage. The slope of the drawdown curves also changed, which is probably a result of removal of formation material from the nearby screen space. This interpretation is supported by a change of the skin factor revealed in pumping test data, which was positive before the jetting operation started and became negative thereafter. This change in skin factor shows that the well has been hydraulically improved by the jetting, probably due to removal of fines clogging the gravel pack and the screen. A positive skin factor is common for a clogged well, as a negative skin factor is common for a well with improved hydraulic conductivity (Horne 1995). Evaluation of the influence of wellbore storage before and after jetting also supports that the well has been improved. Before jetting,

influence of wellbore storage was evident but was almost nonexistent after jetting.

Transmissivity should not change during development and as shown it is easier to interpret from a fully developed well. Different values of transmissivity were obtained when using different interpretation methods while evaluating the data from the pumping test conducted predevelopment. One explanation is of course that skin effects are not considered in all of the methods. But in general the data were hard to interpret and it was also hard to distinguish if the change in the drawdown originated from an undeveloped well or from the aquifer itself. But for the fully developed well the different interpretation methods almost yielded the same value of transmissivity. It is also notable that the transmissivity values estimated from recovery data acquired before jetting are close to the value of a fully developed well. This wasn't the case with the transmissivity values obtained from pumping tests conducted before the jetting.

It was also found that the Hantush–Jacob method for a leaky aquifer is a valuable indicator of the progress of well development. Relatively high  $r/B$  type curves are used in the beginning of well development, resulting in low transmissivity values. At the end of the well development transmissivity values estimated with Hantush–Jacob are close to Theis solution. On the other

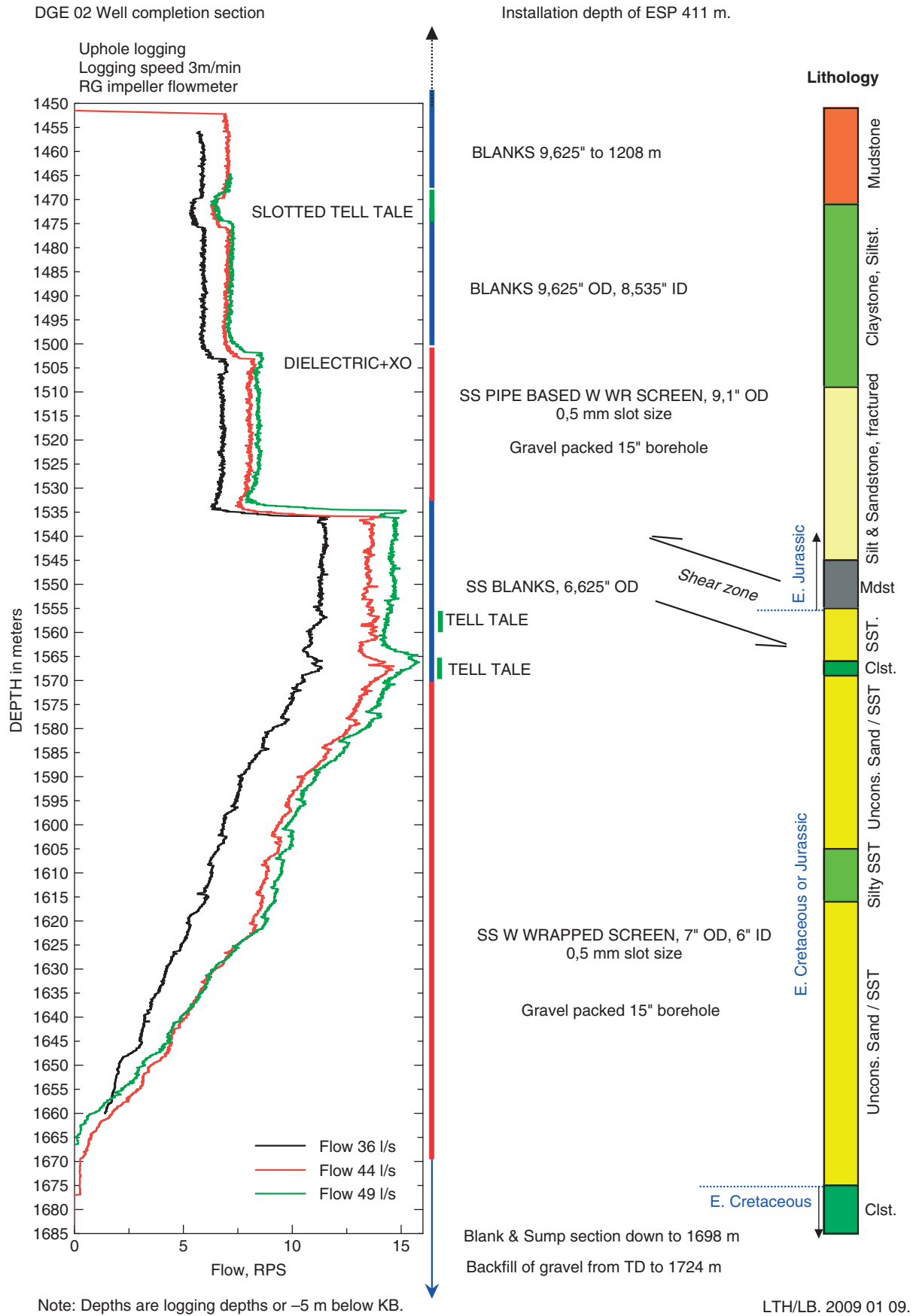

Figure 3. Result from impeller flowmeter logging. The black curve is the reference curve, and the red and the green curve are from two different logging runs performed after the jetting operation.



hand misinterpretation of transmissivity can occur if the Hantush–Jacob method is used for a nondeveloped well. In this case a perfect fit of the type curves to the recorded data has been achieved on several occasions, resulting in low transmissivity values compared to the value of transmissivity estimated for the fully developed well.

In DGE#2 it was confirmed by flowmeter logging that the one of the potential production zones, located at the upper screen section, was totally inactive. It was possible to perform the logging runs time-efficiently by using the innovative construction of the tubing attached to the pump column pipe. Time-consuming failures such as the logging-cable becoming entangled with the pump installations were thereby eliminated.

## Conclusions

Hydrojetting in combination with simultaneous pumping proved to be a time-effective cleaning method, in particular when used with coiled tubing and most certainly thereby a cost-effective method as well. Hydrojetting with pumping contributed to the major part of the cleaning of the well and can be applied to deep wells in general. Around 110 m less drawdown and 15 L/s higher flow rate (after 100 min of pumping). The effectiveness of the coiled tubing unit was confirmed by numerous jetting runs carried out during the entire stimulation period. The main advantages of the method are the rapid transportation of the jetting tool to get into position as well as the possibility of continuous jetting of the screen without any interruptions.

It was invaluable to have pumping test data from tests conducted pre-, during, and postdevelopment to verify the cleaning. A positive skin factor was obtained before the well development, which became negative thereafter. Influence of wellbore storage was evident during tests conducted before jetting, but was of minor importance for tests after development. Downhole measurements such as impeller flowmeter logging were also invaluable for verifying the improvements downhole and can therefore

be used as a tool to locate zones that need further treatment.

## References

- Bjelm, L. 2006. Under balanced drilling and possible well bore damage in low temperature geothermal environments. Thirty-First Workshop on Geothermal Reservoir Engineering Stanford University, California, SGP-TR-179, 67–72.
- Bjelm, L., and J.-E. Rosberg. 2006. Recent geothermal exploration for deep seated sources in Sweden. GRC. Annual Meeting, San Diego, California. *Transactions* 30, 655–658.
- Cooper, H.H., and C.E. Jacob. 1946. A generalized graphical method for evaluating formation constants and summarizing well field history. *Transactions-American Geophysical Union* 27, no. 4: 526–534.
- Driscoll, F.G. 1986. *Groundwater and Wells*, 2nd ed. St. Paul, Minnesota: Johnson Filtration Systems Inc.
- Erlström, M. 2004. Composite litho-log and stratigraphy of DGE#2. Geological Survey of Sweden Report 08-663/2004.
- Hall, H.N. 1953. Compressibility of reservoir rocks. *Transactions, AIME* 198: 309–311.
- Hantush, M.S., and C.E. Jacob. 1955. Non-steady radial flow in an infinite leaky aquifer. *Transactions-American Geophysical Union* 36, no. 1: 95–100.
- Horne, R.N. 1995. *Modern Well Test Analysis*, 2nd ed. Palo Alto, California: Petroway Inc.
- Papadopoulos, I.S., and H.H. Cooper. 1967. Drawdown in a well of large diameter. *Water Resources Research* 3, no. 1: 241–244.
- Rosberg, J.-E. 2007. Testing, well development and evaluation of deep wells completed in Lund 2002–2005. Licentiate Thesis, Department of Engineering Geology, Lund University, Lund, Sweden, ISBN 978-91-976848-0-4.
- Rosberg, J.-E. 2006. Flow test of a perforated deep dual cased well. Thirty-First Workshop on Geothermal Reservoir Engineering Stanford University, California, SGP-TR-179, 123–130.
- Theis, C.V. 1935. The relation between the lowering of the piezometric surface and the rate and duration of discharge of a well using groundwater storage. *Transactions-American Geophysical Union* 16: 519–524.