



LUND UNIVERSITY

Diluted Operation of a Heavy-Duty Natural Gas Engine - Aiming at Improved Efficiency, Emission and Maximum Load

Kaiadi, Mehrzad

2011

[Link to publication](#)

Citation for published version (APA):

Kaiadi, M. (2011). *Diluted Operation of a Heavy-Duty Natural Gas Engine - Aiming at Improved Efficiency, Emission and Maximum Load*. [Doctoral Thesis (monograph), Combustion Engines]. Tryckeriet i E-huset, Lunds universitet.

Total number of authors:

1

General rights

Unless other specific re-use rights are stated the following general rights apply:

Copyright and moral rights for the publications made accessible in the public portal are retained by the authors and/or other copyright owners and it is a condition of accessing publications that users recognise and abide by the legal requirements associated with these rights.

- Users may download and print one copy of any publication from the public portal for the purpose of private study or research.
- You may not further distribute the material or use it for any profit-making activity or commercial gain
- You may freely distribute the URL identifying the publication in the public portal

Read more about Creative commons licenses: <https://creativecommons.org/licenses/>

Take down policy

If you believe that this document breaches copyright please contact us providing details, and we will remove access to the work immediately and investigate your claim.

LUND UNIVERSITY

PO Box 117
221 00 Lund
+46 46-222 00 00

Diluted Operation of a Heavy-duty Natural Gas Engine

Aiming at Improved Efficiency, Emissions
and Maximum Load

Mehrzhad Kaiadi

Doctoral Thesis

Division of Combustion Engines
Department of Energy Sciences
Faculty of Engineering
Lund University



LUND UNIVERSITY

To My Family!

ISBN 978-91-7473-082-1

ISRN LUTMDN/TMHP--11/1077-SE
ISSN 0282-1990

Division of Combustion Engines
Department of Energy Sciences
Faculty of Engineering
Lund University
P.O. Box 118
SE-22100 Lund
Sweden

© 2011 by Mehrzad Kaiadi, All rights reserved
Printed in Sweden by Tryckeriet E-huset, Lund, January 2011

Abstract

Most heavy-duty engines are diesel operated. Severe emission regulations, high fuel prices, high technology costs (e.g. catalysts, fuel injection systems) and unsustainability in supplying fuel are enough reasons to convince engine developers to explore alternative technologies or fuels. Using natural gas/biogas can be a very good alternative due to the attractive fuel properties regarding emission reduction and engine operation.

Heavy-duty diesel engines can be easily converted for natural gas operation which is a very cost effective process for producing gas engines. However, due to the high throttle losses and low expansion ratio the overall engine efficiency is lower than the corresponding diesel engines. Moreover the lower density of natural gas results in lower maximum power level.

In this thesis key features and strategies which may result in improved efficiency, increased maximum power and improved transient capability of a heavy-duty natural gas engines have been identified, validated and suggested.

High EGR rates combined with turbocharging has been identified as a promising way to increase the maximum load and efficiency of heavy-duty gas engines. With stoichiometric conditions a three way catalyst can be used and thus regulated emissions can be kept at very low levels. Obtaining reliable spark ignition is difficult however with high dilution and there will be a limit to the amount of EGR that can be tolerated for each operating point.

Extending the dilution limit of the engine and developing closed-loop control to operate the engine at its dilution limit has been the main method to reduce throttle losses. A new method for calculating cyclic variation was developed that significantly improved the transient capability of the engine control system. The method consequently applied on a closed-loop dilution limit control. Only applying closed-loop control

to operate the engine at its dilution limit resulted in at least 4.5% improvement in specific fuel consumption at 1200 RPM. The dilution limit can also be extended by replacing the combustion chambers with high turbulence pistons which enhances the combustion. By extending the dilution limit the gain in efficiency will be even higher.

In summary the key features to improve the performance of a stoichiometrically operated natural gas engine are identified as: right amount of EGR at different operating regions, right compression ratio, Variable Geometry Turbocharger (VGT), high turbulence pistons, long route EGR system and model-based control.

List of Papers

Paper I

Closed-Loop Combustion Control for a 6-Cylinder Port-Injected Natural gas Engine

SAE Technical Paper 2008-01-1722

By Mehrzad Kaiadi, Per Tunestål, Bengt Johansson

Presented by Mehrzad Kaiadi at the SAE 2008 International Powertrains, Fuels and Lubricants Congress, Shanghai, China, June 2008

Paper II

Closed-Loop Combustion Control Using Ion current Signals in a 6-Cylinder Port-Injected Natural gas Engine

SAE Technical Paper 2008-01-2453

By Mehrzad Kaiadi, Per Tunestål, Bengt Johansson

Presented by Mehrzad Kaiadi at the SAE 2008 International Powertrain, Fuels and Lubricants congress, Chicago, IL, USA, October 2008

Paper III

Using Hythane as a Fuel in a 6-Cylinder Stoichiometric Natural gas Engine

SAE Technical Paper 2009-01-1950

By Mehrzad Kaiadi, Per Tunestål, Bengt Johansson

Presented by Mehrzad Kaiadi at the SAE 2009 International Powertrain, Fuels and Lubricants congress, Florence, Italy, May 2009

Paper IV

Transient Control of Combustion Phasing and Lambda in a 6-Cylinder Port-Injected Natural gas Engine

ASME Technical Paper, ICES2009-76004

By Mehrzad Kaiadi, Magnus Lewander, Patrik Borgqvist, Per Tunestål, Bengt Johansson

Presented by Mehrzad Kaiadi at ASME 2009 Internal Combustion Engine Division Fall Technical Conference, Milwaukee, WI, USA, September 2009

Paper V

How Hythane with 25% Hydrogen can affect the Combustion in a 6-Cylinder Natural gas Engine

SAE Technical Paper 2010-01-1466

By Mehrzad Kaiadi, Per Tunestål, Bengt Johansson

Presented by Mehrzad Kaiadi at the SAE Brazil 2010 International Powertrain, Fuels and Lubricants congress, Rio de Janeiro, Brazil, June 2010

Paper VI

Improving Efficiency, Extending the Maximum Load Limit and Characterizing the Control-related Problems Associated with Higher Loads in a 6-Cylinder Heavy-duty Natural gas Engine

ASME Technical Paper ICES2010-35012

By Mehrzad Kaiadi, Per Tunestål, Bengt Johansson

Presented by Mehrzad Kaiadi at ASME 2010 Internal Combustion Engine Division Fall Technical Conference, San Antonio, TX, USA, September 2010

Paper VII

Reducing Throttle Losses Using Variable Geometry Turbine (VGT) in a Heavy-Duty Spark-Ignited Natural Gas Engine

Draft JSAE 20119022 has been submitted

By Mehrzad Kaiadi, Per Tunestål, Bengt Johansson

Other publications

Unburned Hydro Carbon (HC) Estimation Using a Self-Tuned Heat Release Method

SAE Technical Paper 2010-01-2128

By Mehrzad Kaiadi, Per Tunestål, Bengt Johansson, Karl Hedrick (UC Berkeley)

Presented by Mehrzad Kaiadi at the SAE 2010 International Powertrain, Fuels and Lubricants congress, San Diego, CA, USA, October 2010

Acknowledgment

I would like to express my gratitude to all the people and organizations that have helped me carry out this work. This work had not been possible without their help and support.

Special thanks to my main supervisor Associate Professor *Per Tunestål* for his precious guidance throughout this project, I have always been impressed with his knowledge and ideas. His knowledge is not only limited to control of combustion engines but much more than that. *Per* is not only a knowledgeable supervisor but also a good friend.

Thanks to Professor *Bengt Johansson* my co-supervisor and head of the division for introducing me to this project and his invaluable guidance during the project. His successful career has always inspired me to work harder. During these years you made it economically possible for us to travel around the world to attend different conferences and doing international internships. These travels were not only valuable in terms of gaining knowledge in combustion engines but they were great sources of learning about life. Thanks for the opportunities.

I would also like to dedicate a word of thanks to our technicians who helped keep the engine running. Thank You! *Tom, Kjell, Everitt, Tommy, Bertil, Bert* and *Mats*. Special thanks go to *Krister Olsson* for all his help with computers and measurement systems.

Lots of people from industry were also involved who deserve a word of thanks. Special thanks to *Petter Strandh* and *Arne Olsson* at Volvo Powertrain located in Gutenberg. *Arne* was my contact person at Volvo who helped me a lot to get everything related to the engine very quickly. *Petter* has helped me a lot with the engine control system called “*dapmeas*”. I would also like to thank *Maria Karlsson* at the Department of Automatic Control for her help and long discussions about *dapmeas*. Thanks to *Corfitz Nelson* at the Swedish Gas Center for his good cooperation during the project. Thanks to *Jakob Ängeby* and *Tomas*

Carlson at Hoerbiger for fruitful discussions and answering all questions I had about the Ignition and Injection system developed by them.

I would also like to dedicate a word of thanks to other seniors and all my present and former PhD student colleagues who have contributed to a pleasant atmosphere at work. Thank you all for all discussions and laughter during the coffee breaks. In particular I want to mention *Sasa* for not only being a colleague but a true friend who has been always available to help me. *Claes-Göran* is a very kind, helpful and sympathetic person. *Claes* was kind enough and accepted to proof-read this thesis. *Magnus* my roommate during the past 4 years, we shared the same office, the same office phone number “2227900”, the same dyno and the same control PC which worked out really well. Thanks to *Kent* and *Martin* my other roommates for nice discussions. Thanks to *Hans*, he taught me how to respect him. Thanks to *Ida* for making my office green by the birthday present. My travel mates: *Thomas* in Rio, *Uwe* in Chicago, and *Vittorio* in San Francisco... I have to finish this list otherwise I can make the list much longer. I am not less thankful to the rest of PhD students.

I feel very lucky, proud and honoured that I have had the opportunity to work with you guys at the division of combustion engines. To all of you guys I want just to say “*Thank You*”.

Special thanks to my better half *Tina* and my daughter *Nicole* for all their understanding, patience, support and love. *Tina!* During the past 10 years we have been sharing good and hard times together and all the time I appreciated your patience, thanks for that. Thanks to my sister *Zhila* who has always encouraged me throughout my studies. Thanks to my other brothers and sister *Toomaj*, *Mehrdad* and *Solmaz* for all their love.

Last but not least, thanks to my parents who have always been great sources of inspiration, love and support throughout my studies.

20110109

Mehrzad Kaiadi

Nomenclature

ABDC	After Bottom Dead Centre
AFR	Air Fuel Ratio
ANG	Adsorbed Natural Gas
ATDC	After Top Dead Centre
BDC	Bottom Dead Centre
BMEP	Brake Mean Effective Pressure
CAD	Crank Angle Degree
CAN	Control Area Network
CCM	Cylinder Control Modules
CI	Compression Ignition
CO ₂	Carbon Dioxide
CNG	Compressed Natural Gas
CO	Carbon monoxide
COV	Coefficient Of Variation
EIA	Energy Information Administration
EGR	Exhaust Gas Recirculation
EU	European Union
GUI	Graphical User Interface
HC	Unburned Hydro Carbon
HCCI	Homogeneous Charge Compression Ignition
HP	High Pressure
LHV	Lower Heating Value
LNG	Liquid Natural Gas
LP	Low Pressure
IMEP	Indicated Mean Effective Pressure
ICE	Internal Combustion Engines
MBT	Maximum Brake Torque
MEP	Mean Effective Pressure
MPC	Model Predictive Control
NGV	Natural Gas Vehicles
NO _x	Nitrogen Oxides
OBD	On Board Diagnostic
PI	Proportional Integral
PID	Proportional Integral Derivative
PM	Particulate Matter
PMEP	Pumping Mean Effective Pressure
PRBS	Pseudo-Random Binary Sequence
RPM	Revolutions Per Minute

SCR	Selective Catalytic Reduction
SI	Spark Ignition
SFC	Specific Fuel Consumption
TDC	Top Dead Center
VGT	Variable Geometry Turbocharger
VVT	Variable Valve Timing
WOT	Wide Open Throttle

Contents

Abstract.....	I	
List of Papers	III	
Acknowledgment	V	
Nomenclature	VII	
1	Introduction..... 1	
1.1	Background..... 1	
1.1.1	Energy-related issues	1
1.1.2	Natural gas	4
1.1.3	Natural gas engines.....	5
1.2	Thesis contributions	10
1.3	Objectives	9
1.4	Scope of the thesis	9
1.5	Approach	10
1.6	Outline of the thesis	11
2	Experimental work	12
2.1	Experimental engine	12
2.1.1	Multi-port injection system	13
2.1.2	Ignition and Injection modules	14
2.2	The engine control system	14
2.3	Measurement instruments.....	15
2.3.1	High resolution data	16
2.3.2	Low resolution data	17
2.3.3	Emissions	17
2.4	Measurement uncertainties	17
2.5	Experimental work issues	18
3	Data processing	19
3.1	Efficiency	19
3.1.1	Combustion efficiency	20

3.1.2	Thermodynamic efficiency	20
3.1.3	Gross-indicated efficiency	21
3.1.4	Gas-Exchange efficiency	22
3.1.5	Mechanical efficiency	22
3.1.6	Brake efficiency	22
3.2	Heat release	23
3.2.1	Combustion Phasing and Duration	24
4	Dilution Limit Control	25
4.1	Improving Efficiency at Low/Part load.....	25
4.2	Combustion Stability.....	27
4.2.1	Combustion Stability Parameter Based on In-Cylinder Pressure	27
4.2.2	New Method for Calculation of Cyclic Variations.....	27
4.2.3	Combustion Stability Parameter Based on Ion current Signals	29
4.3	Closed-Loop dilution limit control.....	35
4.3.1	Closed Loop Lambda Control.....	36
4.3.2	Closed Loop EGR Control.....	37
4.3.3	Closed Loop Load Control.....	37
4.3.4	Closed loop Ignition Timing Control.....	38
4.3.5	Experimental Results.....	39
4.3.6	Control performance.....	44
4.4	Concluding remarks.....	46
5	Model Predictive Control of Lambda	48
5.1	Background.....	48
5.2	Lambda control	49
5.3	Model Predictive Control	50
5.4	System identification and modeling.....	50
5.5	Design of lambda controller.....	52
5.6	Control performance.....	53
5.6.1	Throttle disturbance.....	53
5.6.2	Engine speed disturbance	55

5.6.3	EGR disturbance	56
5.6.4	PI versus MPC	57
5.7	Concluding remarks	58
6	Engine Modification to Improve Efficiency and Extend the Maximum Load limit	60
6.1	Background.....	60
6.2	Combustion chamber	61
6.2.1	Combustion duration	62
6.2.2	Efficiency	63
6.2.3	Maximum load.....	64
6.3	Variable Geometry Turbocharger	66
6.3.1	Extending the maximum load	66
6.3.2	Reducing throttle losses by means of VGT	68
6.4	EGR system.....	75
6.4.1	Dilution limit	76
6.4.2	Midrange control	77
6.4.3	Short route versus Long route EGR System	78
6.5	Concluding remarks	79
7	Extending the Dilution Limit and Studying the Effect of Hythane on Combustion	82
7.1	Background.....	82
7.2	Gas data	84
7.3	Experiments.....	85
7.4	Results	86
7.4.1	Lambda response	86
7.4.2	EGR response	90
7.4.3	Map	92
7.5	Concluding remarks	94
8	Conclusions & Discussion	96
9	Future Work.....	98
10	Bibliography	100
11	Summary of Papers	104

11.1	Paper I.....	104
11.2	Paper II	105
11.3	Paper III	105
11.4	Paper IV	106
11.5	Paper V	107
11.6	Paper VI.....	107
11.7	Paper VII.....	108
11.8	Other publications	108

Chapter 1

Introduction

This chapter starts by discussing the general energy issues and specifying the share of the transport sector. The importance of alternative fuels such as natural gas and biogas as an attractive solution to energy issues are discussed to some extent. Natural gas as engine fuel is discussed and different natural gas operation concepts are presented. The motivations to perform research on heavy-duty natural gas engines are highlighted and a review of the previous contribution is presented followed by presenting the main objective of this thesis, discussing method and limitations. The focus of this work is on heavy-duty engines which should be kept in mind when reading this thesis.

1.1 Background

The next three subsections try to answer questions such as: Why natural gas engines are needed? Which engine technology is suitable for natural gas operation? Why and how heavy-duty natural gas engine performance should be improved?

1.1.1 Energy-related issues

The energy-related issues can be divided and discussed in two categories i.e. global and local.

Global issue

Since the advent of the industrial revolution, the worldwide energy consumption has been growing steadily. According to the Energy Information Administration (EIA), world energy consumption is expected to increase by 50 percent over the next 20 years. The increase in energy

1.1 Background

consumption and the share of different fuels from 1980 to 2030 is illustrated in Figure 1 [1]. Fossil fuels (Liquids, Coal and Natural gas) are expected to dominate the energy consumption in the projected years. Fossil fuels are of great importance since their combustion produces significant amounts of energy; however they have a severe impact on the environment. Carbon Dioxide (CO₂) is a greenhouse gas that contributes to the climate change which is an issue of growing international concern. CO₂ emission increases as energy consumption increases (see Figure 2).

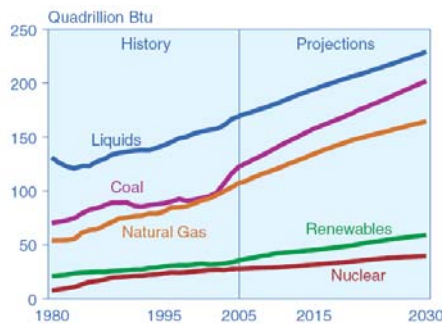

Figure 1 World-wide energy use by fuel 1980-2030 [1]

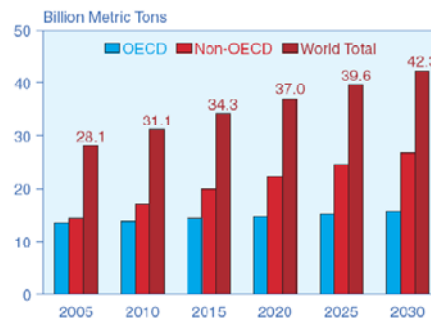

Figure 2 World-wide carbon dioxide 2005-2030 [1]

According to EIA, the transportation sector is the biggest sector in liquid fuel consumption (see Figure 3). Road transportation is the main part in the transportation sector. The fuels mainly used in Internal Combustion Engines (ICE) are oil products i.e. gasoline and diesel. Oil resources are gathered only in a few countries, mainly in the Middle East, which is recognized as a politically unstable region (Figure 4). This means unsustainability in energy supply and price.

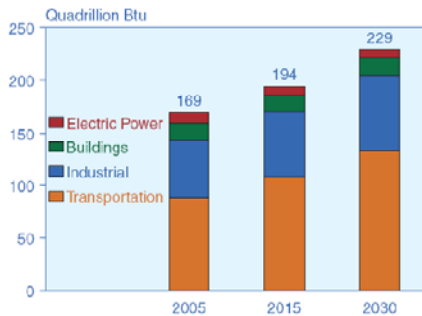

Figure 3 World-wide liquids consumption by end sector 2005-2030[1]

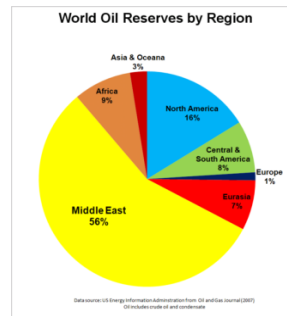

Figure 4 World oil resources [2]

In summary global concerns about climate change (i.e. global warming) and unsustainably in oil supply and price has been recognized as the major global energy issues. Moreover; the share of the transport sector for energy consumption is identified as significant.

Local issues

Due to several factors combustion in ICEs is not “ideal” and apart from carbon dioxide and water vapor harmful products can be released into the environment. These harmful products are mainly Carbon Monoxide (CO), unburned Hydro Carbons (HC), Nitrogen Oxides (NO_x) and Particulate Matter (PM) or soot. These emissions have mainly local impacts on environment and public health. Emission standards were set by different governments to limit the amount of pollutants. Table 1 presents the European emission standards from 2000 to 2013 for heavy-duty diesel and gas engines and it is clear that the standards become more stringent with time. The main emissions are NO_x and PM for diesel engines which are the most dominating heavy-duty engines in the market. Table 1 shows that the most significant limitations are on NO_x and PM emissions. Diesel engines need more complex and costly emission control technology to pass the emission requirements. Increasing diesel engine cost can make them less attractive in the future.

Table 1 Emission Standards for Diesel and Gas Engines, ETC Test, g/kWh [3]

Tier	Date	Test	CO	NMHC	CH ₄ ^a	NO _x	PM ^b
Euro III	<i>1999.10, EEVs only</i>	ETC	3	0.4	0.65	2	0.02
	2000.1	ETC	5.5	0.78	1.6	5	0.16
Euro IV	2005.1		4	0.55	1.1	3.5	0.03
Euro V	2008.1		4	0.55	1.1	2	0.03
Euro VI	2013.01		4	0.16 ^d	0.5	0.4	0.01
a - for gas engines only (Euro III-V: NG only; Euro VI: NG + LPG) b - not applicable for gas fueled engines at the Euro III-IV stages c - for engines with swept volume per cylinder < 0.75 dm ³ and rated power speed > 3000 min ⁻¹ d - THC for diesel engines							

1.1 Background

Demand for cost effective engines that meet emission standards together with increased concern for climate change force engine developers to investigate more efficient alternative engine management.

Using alternative fuels e.g. natural gas/biogas instead of conventional fuels is a good way to reduce the energy-related problems. Natural gas has very attractive fuel properties which makes it a suitable fuel for ICE application. Very low carbon content, high octane number, low fuel price, availability and sustainability of fuel resources are some of the attractive properties of natural gas. Furthermore natural gas is a natural bridge to the “*hydrogen society*” and future vision of transportation systems.

1.1.2 Natural gas

Natural gas is a gaseous fossil fuel consisting predominantly of methane (CH₄) (about 90% depending on origin) and including small quantities of ethane, propane, butane and inert gas. Natural gas has lower carbon content per energy unit which results in lower CO₂ production compared to the conventional fuels. Natural gas is colourless and odourless in its pure form. Natural gas can be stored in different forms as described below:

- Compressed Natural Gas (CNG) is a form of natural gas storage that is stored at a high pressure around 200 bar.
- Liquid Natural Gas (LNG) is liquefied under pressure of 10-20 bar at -162 degrees Celsius. The density of LNG is roughly 410-500 kg/m³ which give it a volume that is approximately 1/600 of the gaseous volume at atmospheric conditions [4] or one third of the volume of CNG. This property is very advantageous since the possible travel distance is much greater than with CNG; however the liquefaction process and the tanks are very energy consuming and expensive.
- Adsorbed Natural Gas (ANG) is another technique to store natural gas. ANG applies adhesion of molecules of natural gas, to the surface of a solid. The ability of a solid to adsorb depends on the chemical makeup of the solid and its physical structure [5].

CNG and LNG are commercially available but ANG has only been used in laboratories so far. CNG is the most dominating fuel storage method for natural gas vehicles.

Biogas

Besides fossil natural gas, biogas is a very important gas which has very similar properties to natural gas. Gaseous fuel manufactured from organic material through biochemical breakdown is called biogas. The organic material can be various crops (e.g. sugar cane, corn) or residuals from e.g. food, wood, plant or manure. At the right temperature and in an oxygen-free environment, bacteria break down the organic material to methane and carbon dioxide which consequently can be upgraded to pure methane. Biogas significantly reduces greenhouse gases in comparison with conventional fuels i.e. gasoline or diesel. A life-cycle assessment has been performed by the energy and environment group at Lund University to quantify the greenhouse reduction with biogas produced from different sources. According to Table 2, depending on the source of the biogas the greenhouse gas reduction is different. The highest reduction can be gained from manure. The reason for the results over 100% is the indirect calculations effects [6]. Manure is potentially pure methane which is an important greenhouse gas with a global warming potential of 25 compared to CO₂. Manure is collected (i.e. greenhouse gas reduction) and converted to bio methane which consequently is combusted and CO₂ and water vapour are produced.

Table 2 Biogas reduces greenhouse gases significantly in comparison with conventional fuels. The reduction can be very different based on the source of biogas production

Biogas source	Greenhouse gas Reduction
Manure	148%
Food Waste	119%
Sugar	85%
Corn	75%

Due to the very similar fuel properties of natural gas and biogas the required engine technology is essentially the same.

1.1.3 Natural gas engines

Spark Ignition (SI) operation has been identified as a suitable engine technology for natural gas operation due to the high octane number of natural gas (about 120). The combustion concept is the same as for gasoline engines but the higher octane number of natural gas gives an

1.1 Background

advantage over gasoline. The compression ratio is limited in gasoline engines because of the low knock resistance. The compression ratio can be increased somewhat in natural gas engines without knocking combustion which results in increased efficiency and peak power. The effect of compression ratio on power and efficiency is shown in Figure 5. Increased compression ratio, raises the expansion ratio which results in higher efficiency; however there is a limit when the compression ratio reaches 16:1.

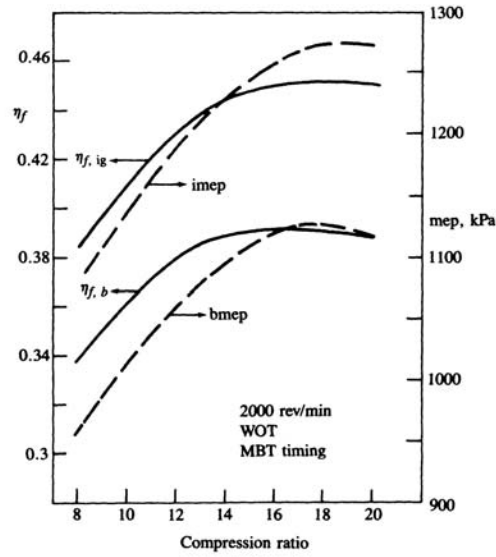

Figure 5 Effect of compression ratio on efficiency and IMEP [7]

Natural gas can be operated either lean or stoichiometric. Lean operation means operating the engine with excess air (i.e. lambda is greater than one) and stoichiometric operation means that lambda is equal to one. Lambda (λ) is defined as:

$$\lambda = \frac{\left(\frac{\text{Air}}{\text{Fuel}} \right)_{actual}}{\left(\frac{\text{Air}}{\text{Fuel}} \right)_{Stoichiometric}} \quad (1.1)$$

The basics, benefits and drawbacks of these two operation concepts are described briefly as follows.

Lean burn natural gas engines

Lean operation of a natural gas engines increases the total efficiency since the engine operates with more open throttle (in some cases without any throttle at all) resulting in less pumping losses. Due to the excess of air, the combustion will be “*complete*” and very high fuel to heat conversion efficiency (i.e. combustion efficiency) can be achieved. Higher λ means higher specific heat ratio during expansion resulting in higher efficiency. Lean operation keeps the exhaust gas temperatures low and there will not be hard limitations on construction materials. The main drawback with lean burn natural gas engines is NO_x emissions since a three-way catalyst cannot be used and a separate more complex and expensive NO_x reduction catalyst must be used.

Stoichiometric natural gas engines

A stoichiometric engine operates at λ equal to one. The main reason for operating stoichiometric is that a three-way catalyst can be used and in this case all emissions are reduced simultaneously. In comparison with lean operation lower efficiency will be reached, mainly due to more throttling and heat losses. Throttling losses can to a great extent be compensated for by using the optimum amount of Exhaust Gas Recirculation (EGR). In some operating points stoichiometric operation of the engine results in increased exhaust gas temperature which can also be reduced with EGR.

Fuel economy and emissions are the two central parameters in heavy-duty engines. There is a trade-off to be made since highest efficiency is obtained with lean operation whereas stoichiometric operation with a three-way catalyst provides lowest emissions at lowest cost.

Heavy-duty natural gas engines versus Diesel engines

So far it has been established that natural gas is an important and suitable fuel for engine applications. Most heavy-duty engines are diesel engines. For this reason most of the heavy-duty natural gas engines are diesel engines converted for SI operation sharing a majority of the components with the original diesel engine. Engine block, cylinder liners,

1.1 Background

pistons, cooling and lubrication systems are the same as for the diesel engine. Converting diesel engines for natural gas operation involves changing the compression ratio, intake geometry (more swirl), combustion chamber, fuel delivery and ignition system. For various reasons the overall efficiency and power density of natural gas engines are lower than for diesel engines.

Normally natural gas engines use a throttle to regulate demanded power. Use of a throttle introduces pumping losses which are particularly significant at low loads. Diesel engines do not use a throttle and pumping losses are very low also at low loads.

The high octane number and high auto-ignition temperature of natural gas makes Compression Ignition (CI) an ill suited concept. Normally SI operation is used which results in use of lower compression ratio compared to diesel engines. As shown in Figure 5 lower compression ratio means lower engine efficiency.

Furthermore, since diesel engines operate lean, the exhaust gas temperature is low and the construction materials do not tolerate high exhaust gas temperatures. The converted engines have more stringent limitations in terms of high exhaust gas temperatures than dedicated SI engines.

In summary, *throttle losses*, *lower compression ratio*, *sensitivity to high exhaust gas temperature* and *lower fuel density* are main parameters which results in lower heavy-duty natural gas engine performance compared to diesel engines.

State of the art of natural gas engines research

Heavy-duty natural gas engines are mostly applied in power plants and also in relatively small numbers for urban transport. In compare with diesel engine research, natural gas engines are relatively speaking ignored due to the low market demand and lack of necessary infrastructure for Natural Gas Vehicles (NGV).

The trend is changing, however, and the demand and interest in NGVs start to increase and more research for more efficient technologies is needed. Today there are about 12 million NGVs worldwide. In Europe, Italy and Russia have the largest fleets and in Germany the fleet is developing rapidly. The European Union (EU) has set a target of

replacing petroleum fuel use in the transport sector with 20% alternative fuels by the year 2020 and will issue a Directive on the use of alternative fuels. This could mean 10% of the market for natural gas by 2020 [8].

Due to the lack of focus on natural gas engine research, great potential exists for optimization of the existing technologies.

1.2 Objectives

The main objective of the thesis is to develop and apply new strategies to improve the *overall engine efficiency*; extend the *maximum power level* and improve the *transient capability* of the engine. Comparing a heavy-duty natural gas engine to a corresponding diesel engine shows that:

- *Overall engine efficiency* is lower due to throttle losses and lower compression ratio.
- *Maximum power level* of a natural gas engine is lower due to the lower gas density and knock phenomena.
- *Transient capability* of the engine is limited due to the diluted operation of the engine and the small lambda window.

1.3 Scope of the thesis

The scope of this project is as follow:

- Use stoichiometric operation with three-way catalyst
- Explore diluted operation with large EGR fraction in order to increase efficiency and suppress knock
- Employ in-cylinder sensing and control to limit cyclic, cylinder-to-cylinder and lambda variations
- Explore engine modification to improve efficiency and extend the maximum load level
- Explore Hythane as an alternative fuel to natural gas

1.4 Approach

This work is an experimental work and the studies presented in this thesis were conducted following a methodology as below:

- As introduction, literature studies on fundamentals, concepts and applications were performed to review previous work and experience in the field.
- Planning and designing of experiments
- Performing experiments
- Evaluating the experimental data

1.5 Thesis contributions

The gas engine project at Lund University has previously explored extending the performance, fuel efficiency and stability of SI natural gas engines. The first NG engine activities started in the beginning of the 1990s. In the first and second phase of the natural gas engine project a lot of time was spent to measure turbulence and to investigate how the combustion chamber design influenced combustion parameters and emissions [9], [10] and [11]. Those experiments were applied on a single-cylinder Volvo engine TD102 (6-cylinder engine with one of the cylinders operational and the other 5 motored). In the third phase of the natural gas engine activities a new engine was supplied by Volvo (6-cylinder turbocharged Volvo engine TG103) for performing some research on a multi-cylinder engine. Different experiments were performed including investigating different locations for fuel injection, investigation of cylinder-to-cylinder and cycle-to-cycle variations in a Lean Burn natural gas engine and a study to compare Lean Burn natural gas engine versus stoichiometric operation with EGR [12], [13] and [14].

The existing project is the fourth phase of the natural gas engine project at Lund University. The previous results show that the stoichiometric operation is a better choice than lean operation since by using a 3-way catalyst the emissions level can be kept at very low levels and differences in efficiency are not significant. Based on the previous results the engine operates stoichiometric and the thesis focuses mostly on the problems associated with this type of operation.

Extending the dilution limit of the engine and developing closed-loop control to operate the engine at its dilution limit has been the main method to improve throttle losses. A new method for calculating cyclic variation was developed that significantly improved the transient capability of the engine control system. The method consequently applied on a closed-loop dilution limit control which resulted in improvement in specific fuel consumption with acceptable transient capability. Ion current signals were studied at different operation condition. Cyclic variation of ion current integral was found to be a robust combustion stability parameter which can be used as more economical alternative to cyclic variation derived from pressure sensors.

Moreover, the key features to improve the engine performance are identified as, right amount of EGR at different operating regions, right compression ratio, Variable Geometry Turbocharger (VGT), high turbulent pistons, long route EGR system and model-based control.

1.6 Outline of the thesis

Chapter one supplies a background to subjects presented in the thesis, outlines the previous work performed at the department, objectives, scopes for these studies and describes the methodologies used. In chapter two the experimental engine, measurement system and control system are discussed. In chapter three definitions for different types of efficiencies are discussed. In Chapter four a dilution limit control was designed and evaluated and the importance of using model-based control strategy is highlighted. In chapter five a model-based control for lambda was developed and evaluated by experimental data. In chapter six the needed engine modification to improve engine performance is discussed. In chapter seven the effect of Hythane on combustion is discussed. The main conclusions of this thesis are discussed in chapter eight. In chapter nine suggested future work is listed followed by references and summary of the publications by author.

Chapter 2

Experimental work

This chapter gives an overview of the experimental apparatus and some experimental methods that were used for the research presented in this thesis. It starts by presenting the engine setup i.e. specifications of the engine, its control system and measurement system. Measurement uncertainties and design of experiments are very important subjects in experimental work. These subjects are discussed briefly in separate subsections. The chapter ends by highlighting some important issues associated with experimental work.

2.1 Experimental engine

The experimental engine was originally a heavy-duty diesel engine from Volvo Trucks which has been converted for natural gas operation; see Table 3 for engine specification. The engine is equipped with a short-route cooled EGR system and a turbocharger with wastegate.

Table 3 Specification of the engine

Number of Cylinder	6
Displacement	9,4 Liter
Bore	120 mm
Stroke	138 mm
Compression ratio	10,5 :1
Fuel	Natural gas

Some engine modifications were performed and new features were installed on the engine for more flexible engine operation especially during transients. The modifications are mainly on the injection system, ignition and injection modules which are presented as follows.

2.1.1 Multi-port injection system

Originally the engine is equipped with a single-point injection system, with four injectors at the fuel injector assembly. The single-point injection system was replaced by a multi-port injection system shown in Figure 6. The main reasons for using a multi-port injection system are the possibility of adjusting injection for each cylinder individually (i.e. cylinder balancing) and faster response to throttle changes (i.e. better transient capability). The original fuel pressure system supplies gas at a pressure of approximately 10 bar. The test-bench engine is supplied with natural gas at a pressure of 4 bar, thus the port injection system is equipped with 12 injectors (2 per cylinder) to compensate the lower pressure and cover the whole load range, see Figure 6. This also makes it possible to operate the engine with two different gaseous fuels simultaneously, in case it is desired.

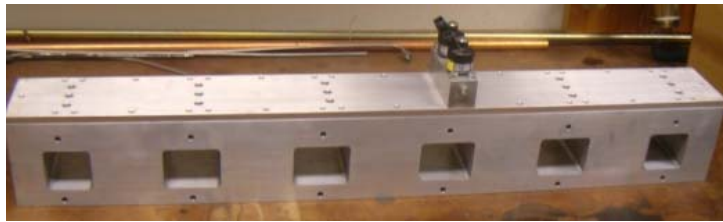

Figure 6 Multi-Port Fuel Injection design

In order to prevent cross breathing of natural gas between cylinders, six mouthpieces were designed for each cylinder and mounted on the injector units to pass the gas flow in the same direction as the cylinder (Figure 7).



Figure 7 Designed injector mouthpiece

Changing the injection system from single-point to multi-port injection system resulted in severe cylinder to cylinder variation. Individual lambda sensors for each cylinder were installed and it was founded that each

2.1 Experimental engine

injector has an individual offset that must be calibrated carefully. Adjusting the injectors offset removed the cylinder to cylinder variations.

2.1.2 Ignition and Injection modules

Cylinder-individual control of fuel injection and ignition is possible with a new platform developed by Hoerbiger Control Systems. Three Cylinder-Control-Modules (CCM) are designed especially for cylinder-individual control of ignition and fuel injection as well as ion current measurements.

The modules use the well-known message-based protocol Control Area Network (CAN) for communication. The engine setup is shown in Figure 8. The three CCMs can be seen below the inlet part and the three boxes on top are ion current modules.

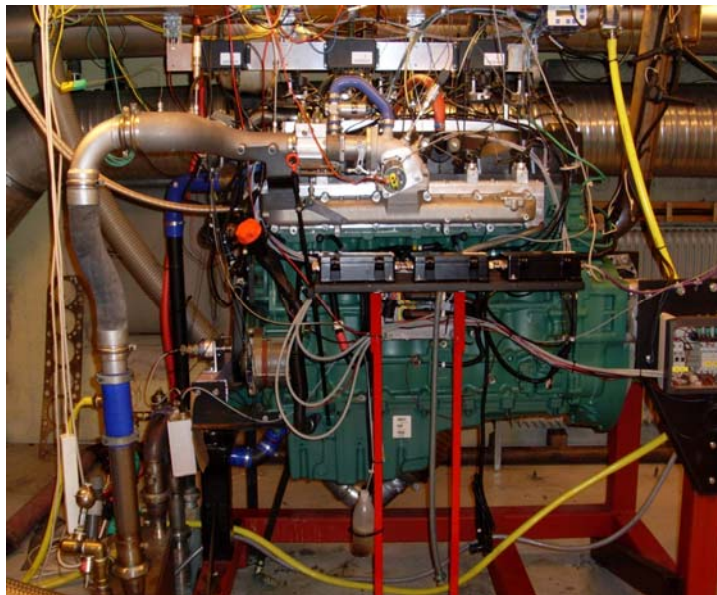

Figure 8 The experimental engine is connected to a dynamometer.

2.2 The engine control system

A master PC based on GNU/Linux operating system is used as a control system. The main program is written in C++ which communicates with

the three CCMs for cylinder-individual control of ignition and fuel injection via CAN communication, see Figure 9.

Crank and cam information are used to synchronize the CCMs with the crank rotation. Flexible controller implementation is achieved using Simulink and C-code is generated using the automatic code generation tool of Real Time Workshop. The C-code is then compiled to an executable program which communicates with the main control program. The program fullfills the requirements for realtime application.

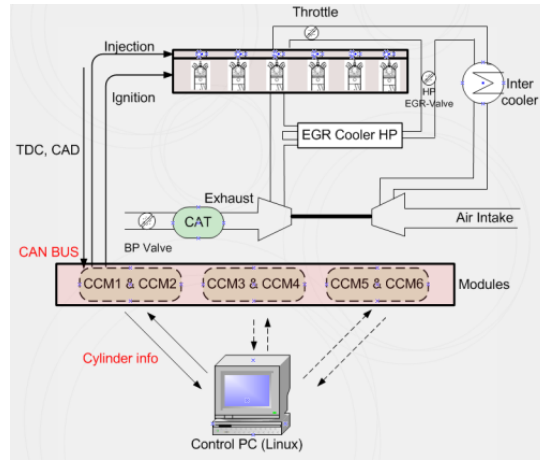

Figure 9 Engine setup structure. A master PC based on GNU/Linux operating system is used as a control system

2.3 Measurement instruments

Different parameters were measured from the engine. Some of them such as crank and cam information and throttle position were needed to operate the control system and the engine. Lots of parameters such as in-cylinder pressure, ion-current, emissions, torque, different flows and temperatures etc. were measured to analyze and evaluate the performance of the engine. Data was sampled with different units, data acquisition cards and with different sample resolution. The master control PC communicates with two other PCs which sample emissions and some other parameters (i.e. slow sampled data) via TCP/IP communication protocol. Figure 10 shows the data flow and communications between PCs and the engine units.

2.3 Measurement instruments

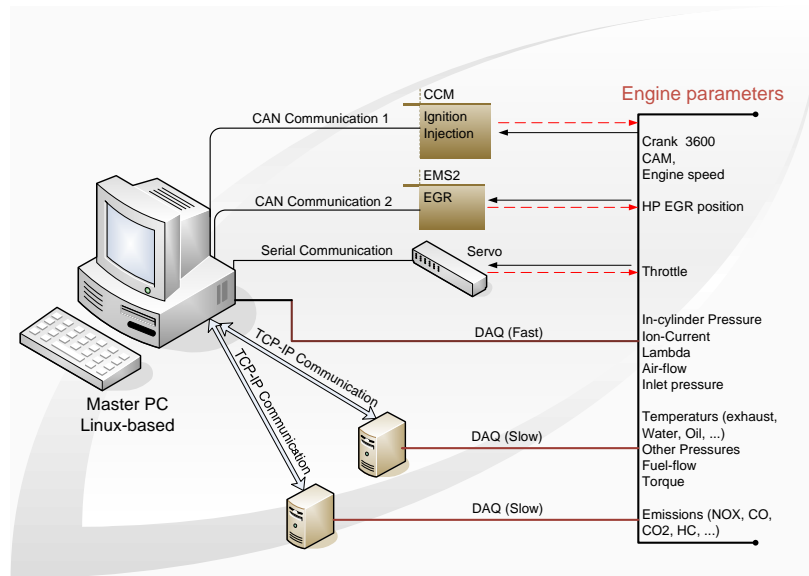

Figure 10 Different parameters were measured from the experimental engine. These parameters are such as in-cylinder pressure, cam and crank position, EGR valve position, throttle position, emission, fuel and air flow etc.

2.3.1 High resolution data

The cylinder head is equipped with piezo electric pressure transducers of type Kistler 7061B to monitor cylinder pressures for heat release calculations. The ion-currents are sampled by CCMs using the spark plugs as sensors. In-cylinder pressure and ion current data are sampled by a Microstar 5400A (DAP 5400A) data acquisition processor which is able to measure 1.25 MS/second (with 8 channels) [15]. To determine the crank shaft position a Leine & Linde encoder is used which provides five pulses per crank angle degree giving a resolution of 0.2 CAD. The in-cylinder pressure and ion current data were sampled with a resolution of 0.2 CAD. Three other parameters, lambda, inlet pressure and air flow were also sampled with DAP 5400A but with lower resolution.

Controlling lambda is one of the objectives of this work; thus fast lambda measurement and fuel calculation is essential. To measure lambda a broadband sensor from ETAS is used to provide a faster response than the lambda calculated from exhaust analysis. To measure air flow a

Bronkhorst F-107A is used to provide accurate and fast response data for lambda control.

2.3.2 Low resolution data

All temperatures were measured by Pentronic Type K thermocouples. Torque is measured from a load cell and fuel flow was measured by F type Bronkhorst flow-meter. All these data were sampled by a HP 3852A data acquisition unit which gives a sample rate of 0.5 Hz.

2.3.3 Emissions

Emissions such as HC, CO, CO₂, NO₂, NO_x and O₂ are measured before and after catalyst. Different analyzers were used to measure the emissions. A summary of the measurement techniques are presented in Table 4.

Table 4 Measurements technique for different emissions

Emission	Measurement technique	Range
NOX	Chemiluminescence Detector (CLD)	0.10000 ppm
HC	Flame Ionization Detector (FID)	0-10000 ppm
CO ₂ , CO	Non-Dispersive Infrared Detectors (NDIR)	0-10%,0.16%
O ₂	Paramagnetic Detector (PMA)	0-25%

EGR was calculated by measuring CO₂ at inlet and exhaust. The latter a NO_x/Oxygen sensor is used to measure oxygen content and the amount of EGR was estimated based on that.

2.4 Measurement uncertainties

The experimental work consists of two main processes i.e. measurement and data processing. Each of these processes will inevitably introduce errors which consequently result in uncertainty of the processed data. The error sources can be very different such as calibration errors, effects of different operating conditions on different sensors, assumptions, estimations and models. The approximate size of the uncertainty should be known to allow a fair judgment and conclusion. A study was performed

2.4 Measurement uncertainties

in [16] to quantify the measurement uncertainty in a 6-cylinder heavy duty engine. The author encourages the reader of this thesis to keep this fact in mind when reviewing the results.

2.5 Experimental work issues

Maybe one of the biggest challenges during these roughly 4.5 years of PhD research work was experimentally related issues. It took less than one year to make the engine, its control system and all other communication equipment ready for the first experiments. Installing the engine, fitting it with all measurements equipment, making a compatible and operational control system with functional communication are some practical parts of the work. Apart from the time needed to prepare the engine and computers for measurements, different mechanical and electrical failures of various parts such as engine units, actuators, signals and computers may occur. Diagnosis of failures together with the time needed for troubleshooting and finding a relevant solution and fixing the failures can be considered as one of the most time consuming moments in the project.

The author wants just to highlight the difficulty and the time consuming process of the experimental work. This means that the effective research time is much less than the project duration.

Chapter 3

Data processing

Most of the results in this thesis are evaluated and presented in terms of various efficiencies and combustion timings and durations. This chapter gives an introduction about the energy cascade and heat release in ICEs and discusses some important aspects of them.

3.1 Efficiency

Mean Effective Pressure (MEP) is a normalized measure of work output from an engine that can be compared regardless of its size. The fuel conversion process to mechanical work during a combustion cycle can be broken down into different processes as illustrated in Figure 11 .

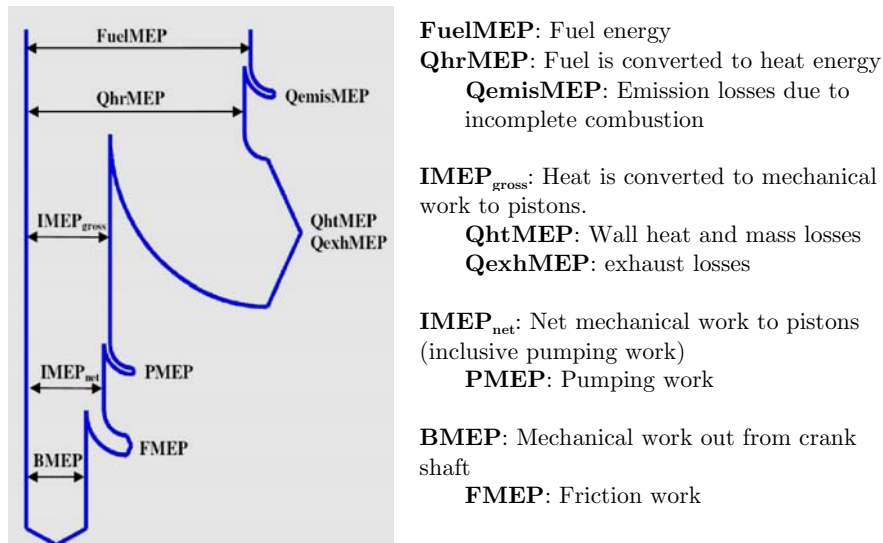

Figure 11 Energy cascade in internal combustion engines. The Sankey diagram is copied from [27]

3.1 Efficiency

The diagram visualizes the entire process from fuel conversion to thermal energy and thermal energy to mechanical work. Different losses during the process are visualized and described briefly in the figure. All terms are normalized by engine displacement.

3.1.1 Combustion efficiency

In the first step the injected fuel per cycle should be converted to thermal energy. The fuel is oxidized and as result a certain amount of energy will be released. If the combustion is not complete, a small part of the fuel is not converted to heat and comes out in forms of different emissions mostly HC and CO which has a heating value. Combustion efficiency is a measure to show how well the fuel energy (FuelMEP) is converted to heat (QhrMEP) expressed as (3.1):

$$\eta_c = \left(\frac{Q_{hrMEP}}{FuelMEP} \right) = 1 - \left(\frac{Q_{emisMEP}}{FuelMEP} \right) \quad (3.1)$$

$$FuelMEP = \left(\frac{m_f Q_{LHV}}{V_D} \right) \quad (3.2)$$

$$Q_{hrMEP} = \left(\frac{Q_{hr}}{V_D} \right) \quad (3.3)$$

m_f is the fuel mass per cycle, Q_{LHV} is the lower heating value of the fuel and V_D is displacement volume. Normally the combustion efficiency is calculated from exhaust gas analysis which gives a more accurate result.

3.1.2 Thermodynamic efficiency

After combustion and when the heat is released, the next step is the conversion of the heat to mechanical work. This conversion usually involves the biggest loss in the entire process. The heat losses in form of heat transfer to cylinder walls, crevices and mass losses (QhtMEP) are relatively high. A large amount of heat can also be lost in the form of exhaust enthalpy (QexhMEP).

Mechanical work for the whole cycle is calculated by measuring in-cylinder pressure together with estimation of cylinder volume from the crankshaft position. Mechanical work calculated for the entire combustion cycle is called $IMEP_{net}$ and excluding the gas-exchange process gives $IMEP_{gross}$.

$$IMEP_{gross} = \frac{\int_{-180}^{180} p dv}{V_D} \quad (3.4)$$

$$IMEP_{net} = \frac{\int_{-360}^{360} p dv}{V_D} \quad (3.5)$$

Thermodynamic efficiency is a measure to evaluate the heat conversion to mechanical work ($IMEP_{gross}$) and is expressed as (3.6).

$$\eta_{th} = \left(\frac{IMEP_{gross}}{Q_{hr}MEP} \right) = 1 - \left(\frac{Q_{ht}MEP + Q_{exh}MEP}{Q_{hr}MEP} \right) \quad (3.6)$$

3.1.3 Gross-indicated efficiency

This efficiency is the product of the thermodynamic efficiency and combustion efficiency. Normally combustion efficiency is calculated based on exhaust gas analysis, sometimes the exhaust gas data is not available, and in this case it is more appropriate to use gross-indicated efficiency instead of combustion and thermodynamic efficiency. It can be expressed as (3.7).

$$\eta_{GI} = \eta_c \times \eta_{th} = \left(\frac{IMEP_{gross}}{FuelMEP} \right) = \left(\frac{IMEP_{gross}}{\left(\frac{m_f Q_{LHV}}{V_D} \right)} \right) \quad (3.7)$$

3.1 Efficiency

3.1.4 Gas-Exchange efficiency

Gas-exchange efficiency is a measure to evaluate the pumping losses in internal combustion engines which is expressed as (3.8)

$$\eta_{GE} = \left(\frac{IMEP_{net}}{IMEP_{gross}} \right) \quad (3.8)$$

Pumping losses can be expressed in terms of Pumping Mean Effective Pressure (PMEP). PMEP is expressed as (3.9)

$$PMEP = IMEP_{gross} - IMEP_{net} \quad (3.9)$$

3.1.5 Mechanical efficiency

Mechanical efficiency is a measure to evaluate the mechanical losses, consisting of friction losses, drive losses in oil, water and fuel supply pumps. The mechanical efficiency is expressed as (3.10) the ratio between the brake work or Brake Mean Effective Pressure (BMEP) and the indicated work. In BMEP calculation T is the measured torque and n_T is the stroke factor which is 2 for a four stroke engine.

$$\eta_m = \left(\frac{BMEP}{IMEP_{net}} \right) \quad (3.10)$$

$$BMEP = \frac{2\pi n_T T}{V_D} \quad (3.11)$$

3.1.6 Brake efficiency

Brake Efficiency or total efficiency is the ratio between brake work and supplied fuel energy which is the same as product of all part efficiencies listed below.

$$\eta_b = \left(\frac{BMEP}{FuelMEP} \right) = \eta_C \times \eta_{in} \times \eta_{GE} \times \eta_m \quad (3.12)$$

3.2 Heat release

Heat release is the most important method to analyze combustion in ICEs. In this section heat-release calculation and some important parameters to analyze and diagnose combustion are discussed. During the combustion in ICEs the inlet and exhaust valves are closed. This means that only heat is transferred and mass transfer is negligible. Hence, the combustion can be modelled as a closed system. The first law of thermodynamics states

$$dQ = dU + dW \quad (3.13)$$

dQ, dU, dW are changes in heat transfer, internal energy and work. Applying the internal energy definition, differentiating that and applying the ideal gas law will result in a new expression for the internal energy.

$$dU = \frac{C_v}{R}(Vdp + Pdv) \quad (3.14)$$

Where C_v the specific heat capacity at constant volume, R is the ideal gas constant, P is pressure and V is volume. Change in mechanical work is given by

$$dW = pdV \quad (3.15)$$

Expressing the new terms for dU and dW yields a new expression for dQ

$$dQ = \frac{C_v}{R}(Vdp + pdv) + pdV \quad (3.16)$$

An expression for the gas constant can be obtained from

$$\left\{ \begin{array}{l} R = C_p - C_v \\ \gamma = \frac{C_p}{C_v} \end{array} \right\} \Rightarrow \left\{ \begin{array}{l} C_p = \frac{\gamma R}{\gamma - 1} \\ C_v = \frac{R}{\gamma - 1} \end{array} \right\} \quad (3.17)$$

This yields a new equation for the changes in heat transfer or heat release

$$dQ = \frac{\gamma}{\gamma - 1} pdv + \frac{1}{\gamma - 1} Vdp \quad (3.18)$$

3.2 Heat release

There are also some losses which should be accounted for in the heat release calculation. dQ_{ht} , dQ_m are changes in wall heat transfer losses and mass (blow-by). Since the heat release is calculated for an internal combustion engine, it is very convenient to represent it as a crank angle derivative.

$$\frac{dQ}{d\alpha} = \frac{\gamma}{\gamma-1} p \frac{dv}{d\alpha} + \frac{1}{\gamma-1} V \frac{dp}{d\alpha} + \frac{dQ_{ht}}{d\alpha} + \frac{dQ_m}{d\alpha} \quad (3.19)$$

Heat losses can be calculated or estimated with empirical and mathematical methods.

3.2.1 Combustion Phasing and Duration

Accumulated heat release can be calculated from the heat release derivative. A typical accumulated heat release as a function of crank angle degree can be seen in Figure 12. Two important parameters are defined to analyze and control the combustion in a more sophisticated way (i.e. combustion duration and combustion phasing). Combustion duration is calculated as the crank angle difference between 10% and 90% (i.e. CA10 and CA90) mass fraction burned. Combustion phasing is defined as the crank angle degree where 50% of the total heat is released (i.e. CA50). The reason for choosing 50% location is the favourable signal to noise ratio [17]. Normally CA50 is used for combustion control or combustion diagnostics.

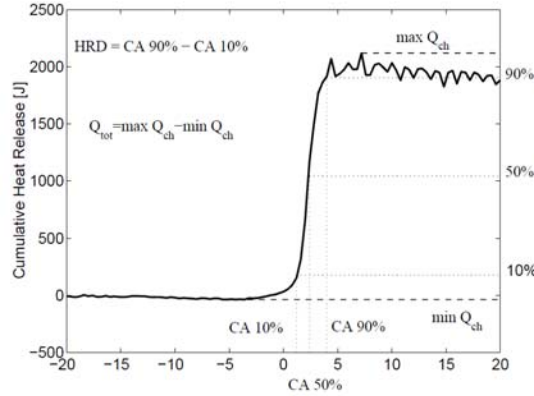

Figure 12 Combustion timing when 10%, 50% and 90% of the total heat is released contains useful information both for combustion analysis and combustion control [17]

Chapter 4

Dilution Limit Control

In this chapter an introduction about throttle losses and their effects on part/low load efficiency is presented. Operating an engine at its maximum dilution limit is suggested as a practical solution to decrease the throttle losses and improve the efficiency. To ensure the combustion stability at these operating conditions robust control is necessary. Details about the control structure, experiments and the evaluation of the control performance at steady-state and transient conditions are reported. Moreover a new method to calculate the combustion stability is developed and discussed in this chapter.

4.1 Improving Efficiency at Low/Part load

By operating natural gas engines stoichiometrically a three way catalyst can be used which results in very low emissions however these types of engines suffer from poor gas-exchange efficiency at part or low loads due to high throttling losses. EGR is a well-known practice to improve engine fuel economy, decrease knock tendency and reduce raw NO_x emissions in certain operating regimes. Using EGR results in improved fuel economy due to the following facts:

- *Reduced throttling losses* (low/part loads): The addition of inert exhaust gas into the intake system means that for a given power output, the throttle plate must be opened further, resulting in increased inlet manifold pressure and reduced throttling losses (see Figure 13).

4.1 Improving Efficiency at Low/Part load

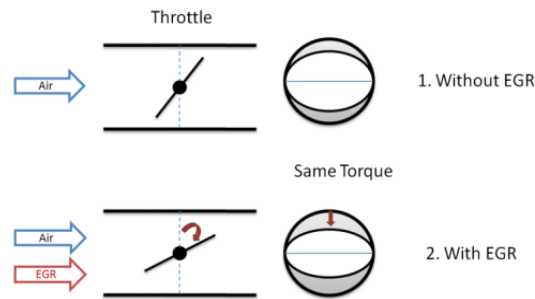

Figure 13 Adding EGR means that for a given power output, the throttle plate must be opened further which results in lower throttle losses

- *Reduced heat rejection:* Lowered peak combustion temperatures not only reduce NO_x formation, it also reduces the loss of thermal energy to combustion chamber surfaces, leaving more energy available for conversion to mechanical work during the expansion stroke. Increased EGR rate makes the combustion colder and the combustion duration longer but it can be compensated somewhat through advanced ignition timing.
- *Reduced chemical dissociation:* The lower peak temperature result in more of the released energy remaining as sensible energy near Top Dead Center (TDC), rather than being expended (early in the expansion stroke) on the dissociation of combustion products. This effect is relatively minor compared to the first two.

The experimental engine is a standard production engine and is equipped with a short route EGR system which is mainly used to suppress knock and not for improving fuel efficiency. When taking into account the advantages of EGR in improving efficiency it is desired to operate the engine at its dilution limit at low/part load operation regions. The dilution limit is imposed by increased cyclic variation of the combustion intensity that reduces the drivability. Thus, there will be a limit to the amount of EGR that can be tolerated for each operating point. However, closed loop control of EGR based on combustion stability parameters can be a good means to improve the efficiency and preserve the engines stability at the same time.

On the way to reach this goal different methodologies and combustion stability parameters are used. Pressure/Ion current based dilution limit control is applied on the EGR separately in order to maximize EGR rate as while preserving combustion stability. Furthermore, standard closed loop lambda control for controlling the overall air/fuel ratio is applied in order to keep the catalyst efficiency at its highest level all the time.

4.2 Combustion Stability

Different combustion stability parameters can be used to measure the roughness of the engine operation. In the following subsections a new method for calculating cyclic variation and combustion stability parameters derived from pressure signals and Ion current signals are discussed.

4.2.1 Combustion Stability Parameter Based on In-Cylinder Pressure

One important and well-known measure of cyclic variability and combustion stability, derived from pressure data, is Coefficient of Variation (COV) of the Indicated Mean Effective Pressure (IMEP) [18], [19]. It is defined as the standard deviation of IMEP divided by the mean value based on e.g. 100 cycles. The following equations express cyclic variations where N is the number of the cycles.

$$COV(IMEP) = \frac{\sigma_{IMEP}}{IMEP} \times 100 \quad (4.1)$$

$$COV(IMEP) = \left(\frac{\sqrt{\frac{\sum (IMEP_{net} - \overline{IMEP})^2}{N}}}{\overline{IMEP}} \right) \times 100 \quad (4.2)$$

4.2.2 New Method for Calculation of Cyclic Variations

Using the traditional method for calculating COV(IMEP) during transient operation produces erroneous results. A gradual deterministic change in

4.2 Combustion Stability

IMEP results in a mean value that is not representative for the entire evaluation interval and the change in operating point will be interpreted as cyclic variation. This means that COV calculations based on mean values are not suitable for transient operations.

It is desired to calculate and update the cyclic variations continuously and smoothly over a fixed number of cycles i.e. 100 cycles. It is also desired to calculate COV(IMEP) in a way that transient operation of the engine does not affect the calculations too much. To achieve this goal a new method is suggested which update the dataset continuously and uses a sort of low pass filter instead of mean value in order to eliminate the deterministic errors.

It is assumed that the mean value of IMEP is based on a dataset of 100 cycles (4.3). The dataset is desired to be updated continuously. This means that, the vector of IMEP updates each cycle by replacing the oldest value by the newest one i.e. $IMEP_1$ is replaced by $IMEP_{101}$ (4.4).

$$\overline{IMEP} = \frac{[IMEP_1 + IMEP_2 + IMEP_3 + \dots + IMEP_{100}]}{100} \quad (4.3)$$

$$\overline{IMEP}_{New} = \frac{[IMEP_2 + IMEP_3 + \dots + IMEP_{100} + IMEP_{101}]}{100} \quad (4.4)$$

During step changes and transients there are still risks to get deterministic changes. The definition of Low-Pass Filter was helpful to calculate a filter set of COV(IMEP). A new variable is defined and named $IMEP_{filtered}$ and is calculated according to (4.5) where k is the cycle number and λ is a predefined weight that can be selected between [0 1]. Selecting λ is a trade-off between accuracy and transient performance. λ was chosen equal to 0.3 in this study. The final expression for calculating the cyclic variation of IMEP is expressed(4.6).

$$IMEP_{filtered}(k+1) = \lambda_m IMEP_{filtered}(k) + (1 - \lambda_m) IMEP_{net}(k) \quad (4.5)$$

$$COV(IMEP) = \left(\frac{\sqrt{\frac{\sum (IMEP_{net} - IMEP_{filtered})^2}{N}}}{IMEP_{filtered}} \right) \times 100 \quad (4.6)$$

To evaluate the performance of the new method a simulation is performed in Simulink environment and the filter-based calculation was compared to the mean based calculation. The comparison is performed in two stages, first under steady-state condition where the IMEP data are not varied and in the second step a transient condition is provided by varying IMEP between 5 and 15 bars. The results for steady-state and transient cases are presented in Figure 14 and Figure 15 respectively. Figure 14 shows that under the steady-state conditions the methods work well and COV(IMEP) calculations are smooth and reliable. Figure 15 demonstrates comparison between the two methods under simulated transient conditions. The figure shows that the filter-based method can easily catch the transient and remove the deterministic changes due to the lower weighting on the older IMEP values. The mean based method is, however, unreliable and cannot be used during transients.

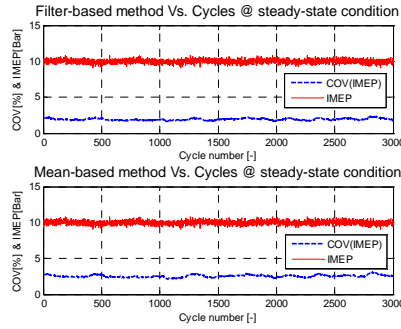

Figure 14 COV(IMEP) calculations with different methods at steady-state conditions

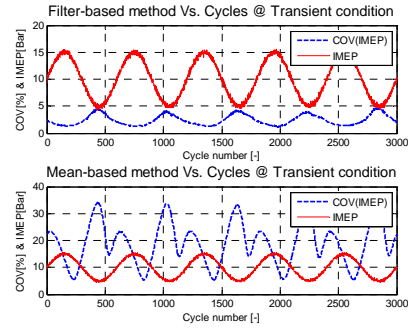

Figure 15 COV(IMEP) calculations with different methods under transient condition

4.2.3 Combustion Stability Parameter Based on Ion current Signals

COV(IMEP) is a combustion stability parameter derived from pressure signals. Direct measurement of in-cylinder pressure can be implemented

4.2 Combustion Stability

with pressure sensors although their use in production vehicles is very expensive, not only in their capital cost but in their required precision fitting and machining procedures. The ion current technique is a method of measuring in-cylinder combustion information in a non-intrusive and economical manner. A lot of researchers have shown interest in ion-sensing in recent years concerning measurement techniques and its possible applications [20], [21], [22], [23], [24], [25]. The following subsections try to explain very briefly the basics of ion current and finally aim to find a compatible ion current based combustion stability parameter to COV(IMEP). The parameter should be robust enough to be used for diagnostic purposes.

Ion-Current

Chemical reactions during the combustion process produce ions and electrons and the motion of these charged particles can be measured by applying a voltage (≈ 100 V DC) over the spark plug which is used as an ion sensing probe. One proposal is to divide the ion current into three parts: the ignition phase, the chemical-ionization phase and the thermal-ionization phase [26]. Figure 16 shows a typical ion current trace and a pressure signal of an average of 400 cycles from the test engine. The ignition phase starts with charging the ignition coil and ends with the coil ringing after the spark. The chemical-ionization phase reflects the early flame development in the spark gap and thermal-ionization phase appears in the burned gases behind the flame front. The peak position often appears close to the position of maximum cylinder pressure.

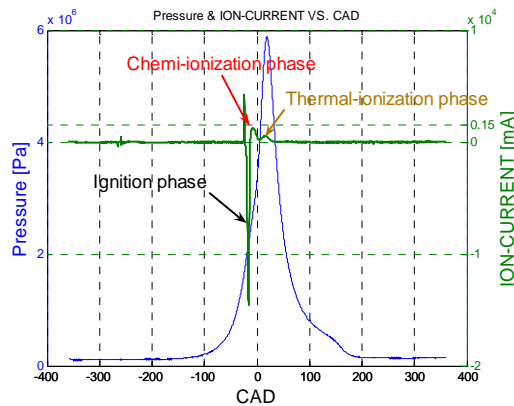

Figure 16 Typical Pressure and Ion current signals Vs. Crank Angle Degree (CAD)

Deriving a Combustion Stability index

In order to find a proper ion current based combustion stability parameter, the behaviour of the ion current signal at different operating conditions was investigated. The engine was operated with different air/fuel ratios and different EGR rates.

Figure 17 shows ion current signals with different air/fuel ratios. According to the figure the strongest ion current signal is achieved when operating the engine somewhat lean (i.e. $\lambda = 1.1$) but as the engine operates leaner or richer the ion current amplitude decreases.

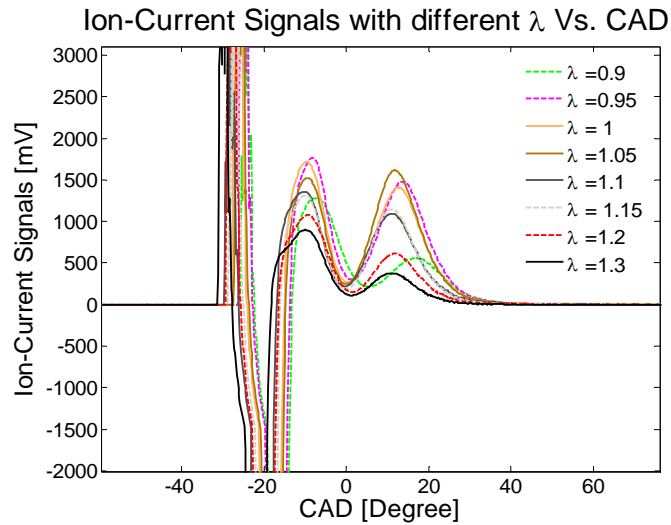

Figure 17 Ion current signal decreases when operating the engine too rich or lean

Figure 18 shows the ion current signal behaviour with different amounts of EGR. By increasing the EGR rate the amplitudes of the first and the second peaks decrease. This effect is strongest on the second peak which almost disappears at highly diluted operating conditions. The ion current signal is highly depended on the combustion temperature i.e. the colder the combustion the weaker the ion current signal.

4.2 Combustion Stability

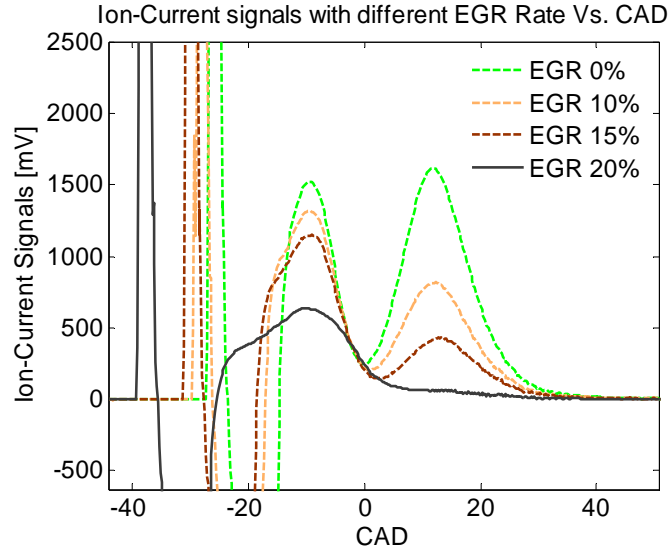

Figure 18 Ion current signal decreases when increasing the amount of EGR

For combustion diagnostic purposes, reliable signals and parameters are requirements. It is demonstrated in Figure 17 and Figure 18 that the signals from the first and the second peak (especially second peak) becomes very weak as the combustion becomes colder. For this reason, the information from the peaks may not be robust enough for diagnostic purposes especially during very lean or diluted operation. However, the area created by the first and the second peak contains useful and reliable information even at low combustion temperature that can be used for combustion diagnostic and control purposes. The area under the first and second peak can be expressed as a new parameter as in (4.7) where $U_{ion}(\theta)$ is the voltage produced by the ion current interface. The ion-integral limits θ_1 and θ_2 must be chosen so that the ignition phase is not a part of the integral and also such that it includes the entire first and the second peaks (see Figure 19).

$$Ion_{Integral} = \int_{\theta_1}^{\theta_2} U_{ion}(\theta) d\theta \quad (4.7)$$

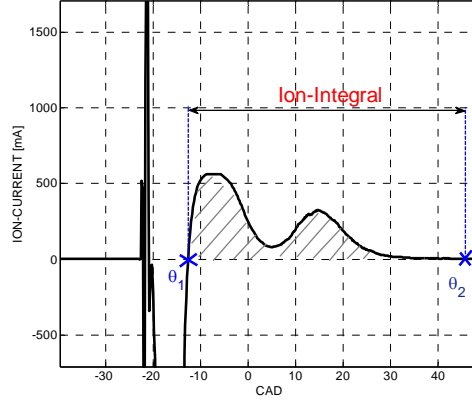

Figure 19 Ion-integral includes both the first and the second peak of the ion current signals

An experiment according to Table 5 is performed. The aim of this experiment is to find out if there is any correlation between $COV(\text{ion-integral})$ and $COV(\text{IMEP})$.

Table 5 Test matrix to capture the correlation between $COV(\text{Ion-Integral})$ and $COV(\text{IMEP})$

Speed (RPM)	EGR Rate (%)
800	0-4-8-10-12-15
1000	0-4-8-10-12-15-20
1200	0-4-8-10-12-15-20
1400	0-4-8-10-12-15-20

To compute the cyclic variation 100 cycles of the data were used. Figure 20 shows $COV(\text{ion-integral})$ correlation with $COV(\text{IMEP})$. It can be seen that $COV(\text{ion-integral})$ depends linearly on $COV(\text{IMEP})$ with different slopes at different engine speeds. Figure 20 also shows that the level of $COV(\text{ion-integral})$ is much higher than the $COV(\text{IMEP})$. The slopes indicate that with increasing EGR the COV increases due to the colder and longer combustion. At low engine speed, $COV(\text{ion-integral})$ is much higher than at high engine speed.

Figure 21 shows mean values of ion current signals for 400 cycles at different engine speeds. It shows that the chemical-ionization phase of the ion current signal becomes stronger with higher engine speed. One possible

4.2 Combustion Stability

explanation is the better establishment of the early flame with higher engine speed. The thermal-ionization phase remains unchanged as engine speed varies. Better signal establishment at higher engine speed results in lower COV(ion-integral) level.

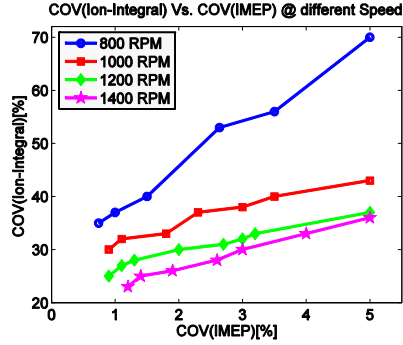

Figure 20 COV(Ion-integral) seems to be a function of speed

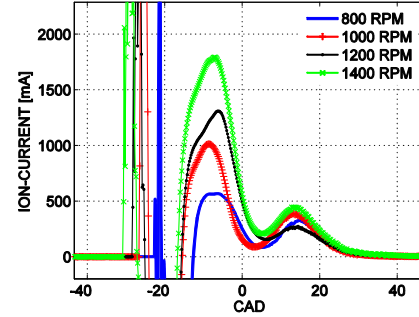

Figure 21 Ion current signals become stronger with higher speed

A new parameter named COV(INDEX) is introduced as a combustion stability parameter which is based on COV(ion-integral) and the product of engine speed and COV(ion-integral). This parameter is introduced as a compatible parameter to COV(IMEP).

A multiple regression is performed which takes into account both effects from COV(Ion-integral) and the product of engine speed and COV(ion-integral) and calculates the statistics for a line that best fits the data. Expression (4.8) is derived which describes the correlation line.

$$\text{COV(INDEX)} = 0.000238 \times (\text{Speed} \times \text{COV(Ion-integral)}) - (0.007 \times \text{COV(Ion-integral)}) - 5.97 \quad (4.8)$$

COV(INDEX) is calculated for the experimental data. Figure 22 shows how COV(INDEX) correlates with COV(IMEP) of the experimental data. The standard deviation for the residuals was calculated to 0.42 which assure the accuracy of the estimation equation.

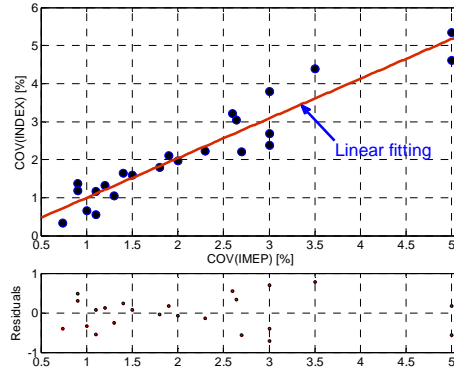

Figure 22 COV(INDEX) is derived based on a multiple regression from ion-integral and engine speed data and correlates well with COV(IMEP)

4.3 Closed-Loop dilution limit control

One of the objectives of this work is to develop a tool for mapping the best positions of the throttle and EGR valve where the engine has the lowest pumping losses and the combustion stability index is still less than 5%. The combustion stability indicator can be either COV(IMEP) or COV(INDEX), both give the same information and the only difference between them is that COV(IMEP) is derived from pressure signals and COV(INDEX) is derived from ion current signals. The solution applied here is to develop separate controllers for load (throttle), combustion stability (EGR) and lambda (fuel injection). The control structure is shown in Figure 23.

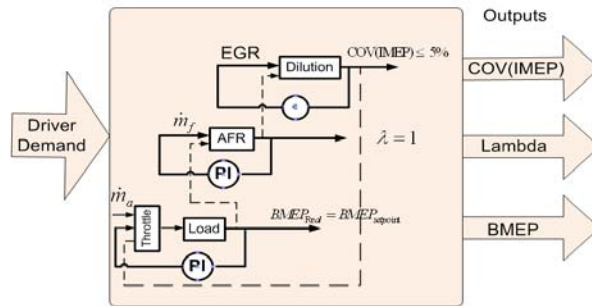

Figure 23 Closed-Loop Combustion Control

4.3.1 Closed Loop Lambda Control

To keep the 3-way catalyst efficiency at its highest possible level a feedback controller is needed. Closed loop lambda control evaluates the signal from the broadband lambda sensor. The sensor measures the oxygen content in the exhaust gas, and thus provides information about the mixture composition. The closed-loop lambda control strategy uses the injected fuel quantity as the manipulated variable and compensates for the lambda error. The error signal is based on the difference between the measured lambda and a desired set-point lambda and a Proportional Integral (PI) controller was used to generate a fuel-offset based on the error.

PID Control

The Proportional Integral Derivative (PID) controller is the most common form of feedback controller which has been widely used in industry. The P term determines the reaction to the current error, the I term determines the reaction based on the sum (integral) of past errors, and the D term determines the reaction based on the rate at which the error is changing. The PID control algorithm is expressed in (4.9) where the controller parameters are proportional gain K , integral time T_i , and derivative time T_d [30]. By tuning the control parameters, the required control action to the specific process can be provided. The D part of the controller is very sensitive to the measurement noise, which can be improved by adding a relevant filter. In this study PI controllers have been developed and used and the D part was avoided due to the mentioned fact.

$$u(t) = k \left(e(t) + \frac{1}{T_i} \int_0^t e(\tau) d\tau + T_d \frac{de(t)}{dt} \right) \quad (4.9)$$

Bump-less transfer and Anti-Windup algorithms were applied during the design of the regulator.

Anti-Windup

Windup refers to the phenomenon which is caused by interaction between the physical limitation of the actuators (i.e. actuator saturation) and integral action of the controller. In the case that the actuator reaches its upper limit, and if integrator action is used in the control loop, the error

continues to be integrated and accumulated to a very large value (it winds up). This means the error will have to spend considerable time with the opposite sign before the integral can reach zero. Different solutions exist to avoid windup when actuators saturate such as setting set-point limitation which may influence the performance of the controller. A back-calculation and tracking method is used here to avoid windup. When the output saturates, the integral term in the controller is recomputed so that its new value gives an output at the saturation limit [31].

Bump-less Transfer

The engine can be operated in manual mode or with the controllers. Switching between these two modes should be smooth i.e. the control signal should not make a large change. The reasonable assumption for this transition is that the error is zero and constant. This implies that the P and D parts should be zero but the integral part must be updated continuously [31].

4.3.2 Closed Loop EGR Control

The regulator always attempts to operate the engine at the maximum dilution limit. COV of IMEP or “INDEX” is set as the limitation indicator and the level is set to 5 percent. The closed loop EGR control evaluates the calculated combustion stability parameter to control the EGR valve. The error signal is based on the differences between the calculated COV(IMEP) and a set-point COV(IMEP) for 5%. The EGR valve opens more as long as the COV(IMEP) is less than 5%, and if COV(IMEP) exceeds 5% the regulator starts to close the EGR valve.

4.3.3 Closed Loop Load Control

The increase in EGR ratio that follows from activating the combustion stability controller decreases the amount of air and thus, with fixed lambda, the load. Thus, a Load controller is designed to adjust the throttle position to keep the load at a predefined level. It was also desired to have an automatic tool to find the best positions of throttle and EGR based on the drivers load demand. The load controller fulfils this requirement.

4.3 Closed-Loop dilution limit control

The engine is connected to an electric dynamometer, and the torque is measured with a load cell. Brake Mean Effective Pressure (BMEP) is calculated from the measured torque according to equation 3.11 [27].

Closed loop load control evaluates the signal from the load cell. The error signal is based on the difference between the measured BMEP and the demanded BMEP and a throttle offset is generated from that. The throttle is adjusted by the regulator to keep the measured BMEP at the same level as the desired BMEP. A PI controller with Bump-less transfer and Anti-Windup algorithms was selected for the task.

4.3.4 Closed loop Ignition Timing Control

For each operating condition optimal spark timing can be obtained. The optimal spark timing is called Maximum Brake Torque (MBT) timing that yields to maximum output load, highest efficiency and thereby lowest fuel consumption for each operating point. A common rule says that MBT timing results if 50% of the fuel is burned at about 10 CAD ATDC (i.e. CA50=10 ATDC) [7]. A simple experiment was performed to verify the statement. Figure 24 shows how changes in CA50 position affect load, efficiency and fuel consumption. MBT is obtained roughly when CA50 is 10 degrees ATDC which is in line with the statement.

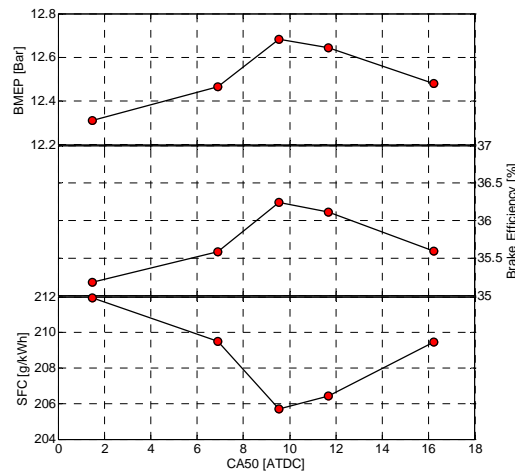

Figure 24 Effect of ignition timing on Brake efficiency and SFC

CA50 is almost unique for each operating condition, meaning different ignition timing is needed to obtain MBT at different loads and engine speeds. The ignitions timing needed to achieve MBT at different load and engine speeds are presented in Figure 25. Traditionally MBT timing is implemented as an open-loop control where the ignition timing is found by using a static lookup tables. In this study a feed-forward map together with a PI controller is designed and used to achieve MBT for each cylinder individually. The error signal is based on the differences between the calculated CA50 and the set-point value. The ignition timing is subsequently adjusted.

In multi-cylinder engines there are always variations in the performance of different cylinders which has negative impacts on the overall performance of the engine. The ignition timing was controlled individually for each cylinder. Figure 26 shows that using a feedback controller improve the combustion phasing balance in all cylinders. The engine was operated at engine speed 1200 RPM and 8 bar BMEP in this experiment.

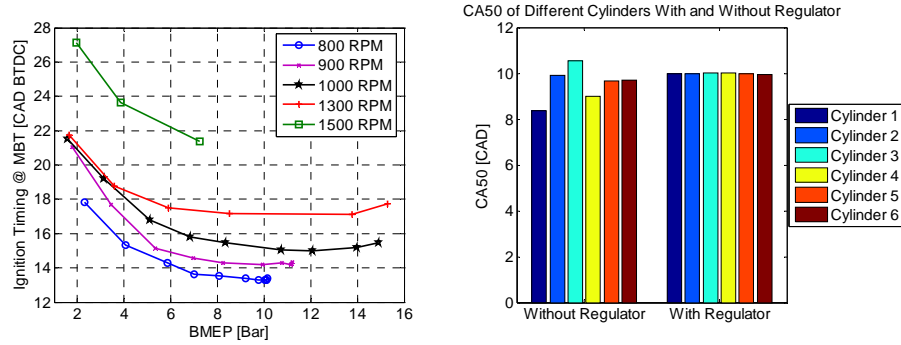

Figure 25 MBT timing for different loads and speeds Figure 26 CA50 of all 6 cylinders with and without MBT controller

4.3.5 Experimental Results

The engine was tested for a variety of speed/loads at steady-state condition. Since the throttling losses are more critical at lower loads, it was decided to operate the engine in this region. Three different loads (i.e. 2.5, 4 and 5.5 bar BMEP) are chosen to be operated with different engine speed levels i.e. 800, 1000, and 1200 RPM (see Table 6). The start of injection was fixed for all cases.

4.3 Closed-Loop dilution limit control

To provide a basis for fair comparison, experiments were conducted in two steps, first without adding EGR and no regulator was activated. In the second step by activating the controllers the engine was operated at its maximum dilution limit, at the demanded load with MBT timing and $\lambda=1$. The results are evaluated in terms of Brake Efficiency, pumping losses, fuel consumption and stability. Engine runs at stoichiometric operating condition with a 3-way catalyst. Since the results for different engine speeds were similar, only the results from one of the engine speed (1200 RPM) tests at 3 different loads are shown here (results from all engine speeds and loads can be found in [28] and [29]).

Table 6 Test matrix of the operating conditions

Engine Speed (RPM)	BMEP (Bar)	Strategies
800	2,5	NO EGR
	2,5	With regulator
	4	NO EGR
	4	With regulator
	5,5	NO EGR
	5,5	With regulator
1000	2,5	NO EGR
	2,5	With regulator
	4	NO EGR
	4	With regulator
	5,5	NO EGR
	5,5	With regulator
1200	2,5	NO EGR
	2,5	With regulator
	4	NO EGR
	4	With regulator
	5,5	NO EGR
	5,5	With regulator

Brake Efficiency is a product of different efficiencies as it is discussed in chapter 3.1. Gross-indicated, gas-exchange and mechanical efficiency for the three loads at 1200 RPM are plotted in Figure 27. The dashed lines represent the results when the controllers are not activated (i.e. without EGR) and the solid lines represent the results with activated controllers.

Since the emissions were measured after catalyst in this experiment the data was not proper to calculate the combustion efficiency. Gross-indicated efficiency which is the product of the thermodynamic and the combustion efficiency is presented for the experiments.

Figure 27 shows slightly higher gross-indicated efficiency in the cases with activated controller. By increasing EGR rate the combustion is somewhat colder and combustion duration will be longer but it can be compensated somewhat by advancing the ignition timing. The combustion efficiency can increase somewhat however since the exhaust gas has a second chance to be combusted in the cylinder. The net result shows a slight increase in gross indicated efficiency.

The figure shows that the gas-exchange efficiency is higher when the controllers are activated since using EGR lets the throttle open even further to keep the load at the same level. More open throttle means higher inlet pressure which results in higher gas-exchange efficiency. Table 7 shows how the inlet pressure increases from using EGR. The effect is stronger at higher loads since the turbulence is higher and the engine tolerates more EGR than at lower loads. The effect on mechanical efficiency is neglectable which was expected.

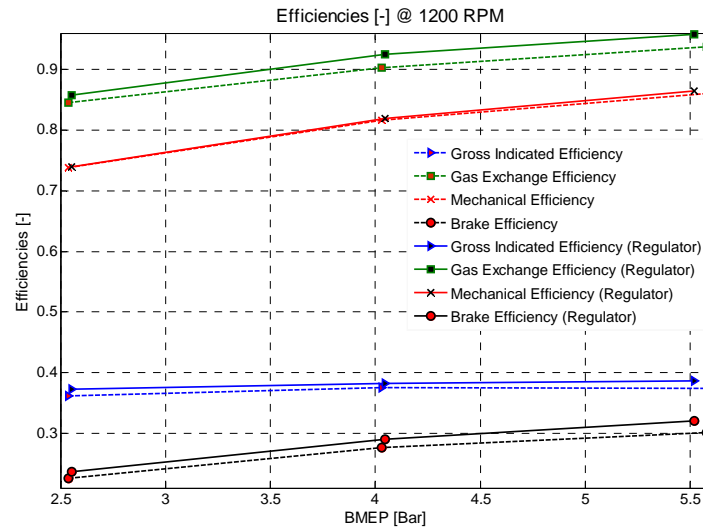

Figure 27 Due to the use of the regulators gas-exchange efficiency will be improved which results in improvement of the total efficiency

4.3 Closed-Loop dilution limit control

Table 7 Inlet pressures for different cases

Engine Speed (RPM)	BMEP (Bar)	Strategies	Inlet Pressure (Bar)
800	2,5	NO EGR	0,48
	2,5	With regulator	0,51
	4	NO EGR	0,61
	4	With regulator	0,71
	5,5	NO EGR	0,75
	5,5	With regulator	0,92
1000	2,5	NO EGR	0,47
	2,5	With regulator	0,51
	4	NO EGR	0,62
	4	With regulator	0,73
	5,5	NO EGR	0,75
	5,5	With regulator	0,89
1200	2,5	NO EGR	0,49
	2,5	With regulator	0,54
	4	NO EGR	0,62
	4	With regulator	0,75
	5,5	NO EGR	0,77
	5,5	With regulator	0,91

The dilution limit and the stable operating region (i.e. region where COV(IMEP) is lower than 5%) for different loads at 1200 RPM are plotted in Figure 28. X-axis shows BMEP in bar, Y-axis shows the rate of EGR in percentage and the colored region shows the level of COV(IMEP). As load and speed increases, more EGR can be tolerated in the engine because of lower residual fraction and higher turbulence level. The figure also verifies the effect of EGR on cyclic variations.

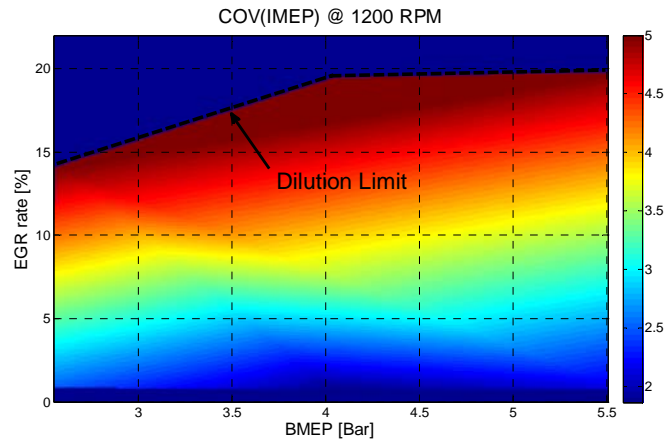

Figure 28 The maximum dilution limit is specified at 1200 RPM. In this study the stable operating region is defined as the operating region where COV(IMEP) is lower than five percent

Pumping losses are calculated and presented in form of PMEP. Figure 29 shows PMEP for the three evaluated loads (2.5, 4, and 5.5 bar BMEP) at 1200 RPM. The X-axis shows the EGR valve opening position in percentage and the Y-axis shows the throttle opening position in percentage. The triangle shows the stable region for the three loads. A certain throttle opening is needed to achieve a certain load. As the EGR valve opens more the throttle must be opened more to achieve the same amount of load. As an example in Figure 29, the case at 5.5 bar can be considered. When the EGR valve is closed the throttle is 34% open but as the EGR valve opens more the throttle opens up to 42% to keep the load at the same level. The throttle opening results in almost 0.15 bar reduction in PMEP which corresponds to over 6% reduction of the **Specific Fuel Consumption** (SFC) (see Figure 30). Figure 30 shows the same type of plot as Figure 29, but it shows SFC as a function of throttle and EGR valve position for the three loads at 1200 RPM.

4.3 Closed-Loop dilution limit control

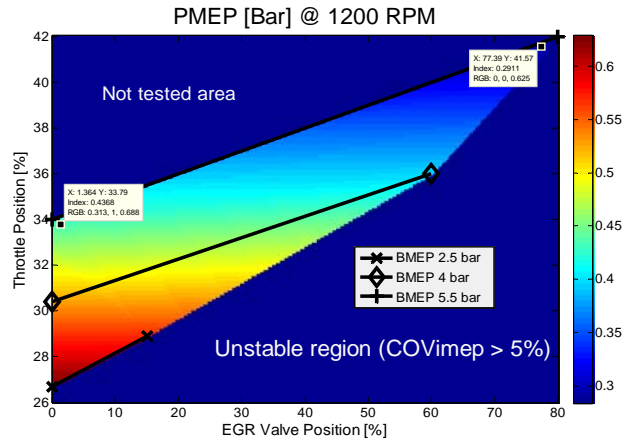

Figure 29 PMEP [bar] decreases as the throttle opens more.

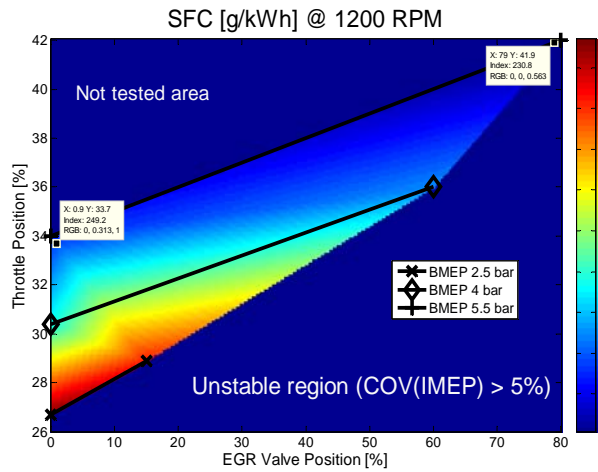

Figure 30 SFC reduces as a result of more throttle opening

The same experiment was performed by using COV(INDEX) instead of COV(IMEP) as combustion stability indicator in the EGR regulator. The results and the control performance were as good as with COV(IMEP).

4.3.6 Control performance

Figure 31 illustrates a typical performance of the different controllers. At the top of the figure CA50 is plotted as a function of cycle number. CA50 is tuned around 10 CAD ATDC by adjusting the ignition timing which is

plotted below CA50 in the figure. Lambda is adjusted by controlling the injection duration and the cyclic variation is controlled by regulating the amount of EGR.

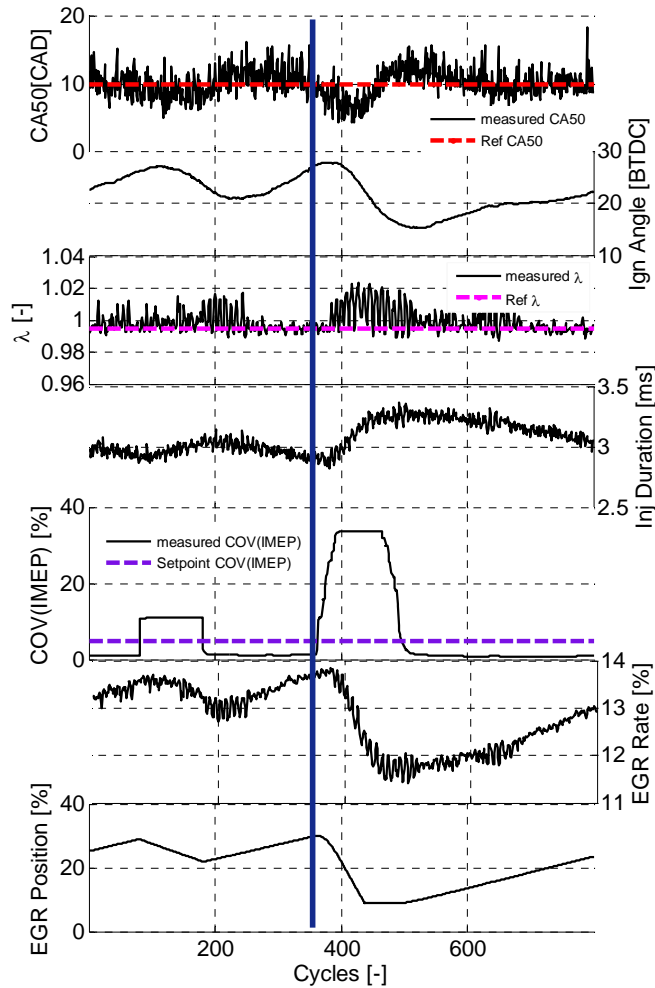

Figure 31 Controllers performance. As COV(IMEP) increases from the predefined limit (i.e. 5%) EGR, Lambda and ignition timing are adjusted

A disturbance resulted in increase in cyclic variation, as it increases over the predefined value (i.e. 5%) the EGR valve starts closing and EGR rates decreases. As result of this change, injection duration and ignition timing should be adjusted to achieve high catalyst efficiency and MBT. The

4.3 Closed-Loop dilution limit control

overall steady-state performance was very good however the transient performance of the lambda controller was limited. However it should be mentioned that the developed dilution limit control should be applied for steady-state operation or light transients and not sharp transient operations.

Only PI feedback controllers were used in this study but a combination of PI controllers and feed-forward maps or model-based controllers will further improve the performance. PID type controllers do not perform well when applied to systems with time delays. Model-based controller overcomes the problem of delayed feedback by using predicted future states of the output for control. Later in this thesis some results about model-based lambda controller are presented.

4.4 Concluding remarks

The conclusions obtained from this study assure that by relatively small efforts, large amount of fuel can be saved. Using the filter-based COV calculation, in combination with high performance dilution limit controller will result in at least 4.5% fuel saving at 1200 RPM. The following conclusions can be highlighted from this study:

- New method for COV calculations was developed which removes the deterministic errors during transients
- Controlling Lambda, MBT, Load and EGR was found to work well. The controller made it possible to have the maximum amount of EGR in the cylinder while preserving the combustion stability
- Very good steady-state and limited transient performance were achieved.
- The results verified 1.5-2.5% points improvement in Brake Efficiency at low/part loads by using the dilution limit controller.
- The proposed controllers can be used as a tool for mapping the best positions of the throttle and EGR valve in terms of efficiency.

The map created by the tool can subsequently be used as a feed-forward map combined with a feedback controller for faster response

- The combustion stability parameter COV(INDEX) which is based on COV(Ion-Integral) derived from ion-integral is proportional to COV(IMEP)

Chapter 5

Model Predictive Control of Lambda

This chapter gives an introduction to the “*lambda window*” and the importance of controlling lambda to stay within the lambda window. Model Predictive Control (MPC) was suggested as a relevant strategy to control lambda and the essential steps for MPC such as system identification, modelling and design of the controller are discussed in details. Finally the control performance was evaluated on the experimental engine by imposing different disturbances. The purpose of this study is to apply MPC and verify it as a new candidate to control lambda and not to develop a new control algorithm.

5.1 Background

As mentioned in the introduction chapter, the chosen engine operation concept is stoichiometric. The main reason for stoichiometric operation is the possibility to use a 3-way catalyst to reduce simultaneously all three regulated emissions (i.e. CO, HC and NO_x) to very low levels and at relatively low cost. Generally the reactions to oxidize CO and HC and reduce NO_x occur most efficiently when the engine operates very close to the fuel’s stoichiometric air/fuel ratio. For the experimental engine the catalyst yields the absolute lowest emissions when lambda is equal to 0.995. A narrow range of lambda offset 0.995 ± 0.009 can be considered as a “*lambda window*” where the catalyst works very effectively. Engine operation outside the lambda window results in poor conversion efficiency. The emissions before and after catalyst, conversion process and lambda window are specified in Figure 32. Because of the narrow range of lambda a closed-loop control is vital to regulate the fuel supplied with respect to

the air flow. Different feedback lambda control alternatives are discussed in the next subsection.

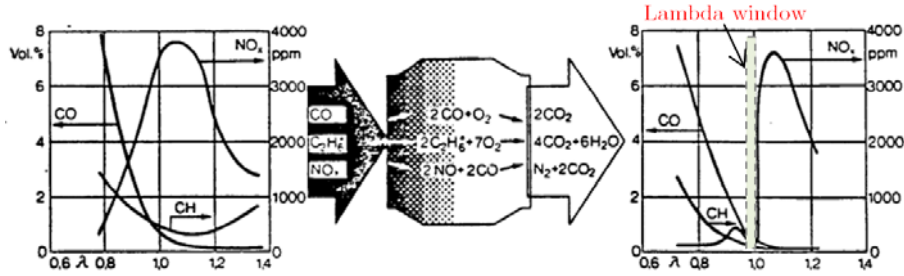

Figure 32 The regulated emissions before and after catalyst. The lambda window is specified in the figure to the right [32]

5.2 Lambda control

Normally a PID control strategy has been used to control lambda. PID control is the most common strategy to control linear processes without time delays. Normally an oxygen sensor is installed downstream of exhaust manifold to measure the oxygen content and calculate the lambda value. The sensor¹ is located a relatively long distance from the cylinders which produces a time delay. Moreover, various disturbances during transients make the process non-linear. Due to the time delay and nonlinearity a PID controller may not be the optimal choice. One way to overcome these problems is to use a model-based controller. An ideal model-based control block diagram is illustrated in Figure 33.



Figure 33 Ideal model-based control block diagram

¹ A broadband lambda sensor (i.e. linear lambda sensor) is used to measure lambda. This linear lambda sensor issues a signal proportional to the residual oxygen content of the exhaust.

5.2 Lambda control

It means that if an accurate model of the process is available, and if the model is invertible, then process dynamics can be cancelled by the inverse model and provide perfect control [33]. However, it should be emphasized that the accuracy of the model is an essential factor for good control performance. Different approaches exist to model a process. Since the purpose of this work is only control and not the characterization of the process “black-box” models are more appropriate than the “white-box” or physical models. Different model-based control approaches are available and can be used to control lambda. Some of them are reported in [34] and [35]. In this study due to the relevance of MPC, it is suggested to control lambda. Use of MPC to control lambda was not reported previously.

5.3 Model Predictive Control

MPC is a model-based control strategy that uses prediction to optimize future control actions with respect to a cost function [36]. The optimization cost function is given by (5.1):

$$J = \sum w_x (r_i - x_i)^2 + \sum w_u \Delta u_i^2 \quad (5.1)$$

Where x_i is the control variable, r_i the reference variable, u_i the manipulated variable and w_x and w_u are weights. MPC has the capability to handle multivariable control problems and account for actuator and output constraints.

5.4 System identification and modeling

A dynamic model is essential for an MPC controller to capture the dynamics of lambda and to predict the future behavior of the system based on that. The main parameters affecting the lambda value are the amount of fuel and air. Injection duration and throttle position are chosen as input variables and lambda is an output variable for the model.

System identification is used to obtain an empirical model. The system was excited with Pseudo-Random Binary Sequence (PRBS) signals for injection duration and throttle position and data was collected. The injection duration varied between 3.8 and 4.2 ms and the throttle position between 35 and 65% of its maximal opening position at 900 RPM. The

changes in throttle position and injection duration resulted in IMEP variation from roughly 7 bar to over 9 bar. The changes in throttle position, injection duration and the resulted variations in IMEP and lambda are presented in Figure 34.

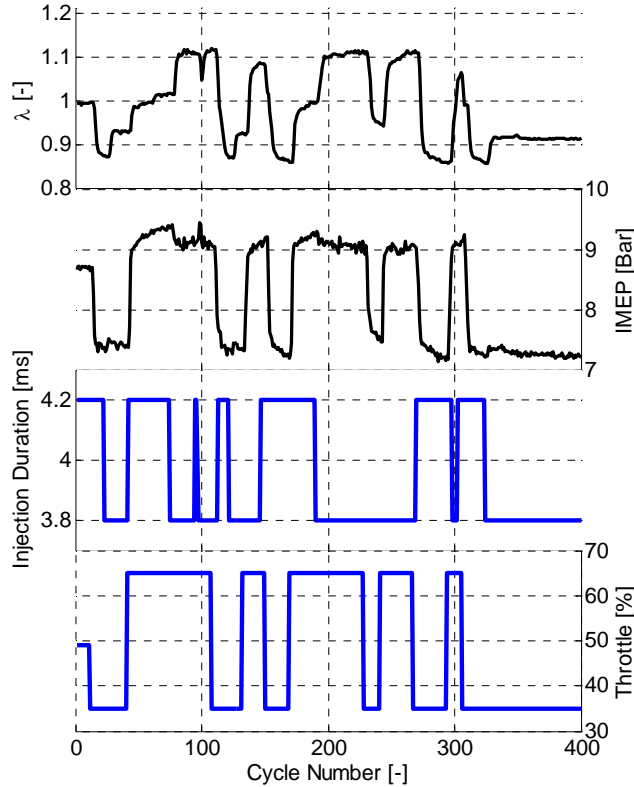

Figure 34 The system was excited with PRBS signals for throttle position and injection duration at 900 RPM to identify the dynamics of lambda

The system Identification Toolbox in Matlab named *Ident* was used to construct a model for the dynamic system from the measured input-output data. It uses a combination of subspace-based identification and optimization of prediction error which proved to generate a good model. A 3rd order discrete time state space model was identified. Figure 35 shows the simulated and measured lambda. The model precision was calculated to 82.8%. Offset has been removed from the data in Figure 35.

5.5 Design of lambda controller

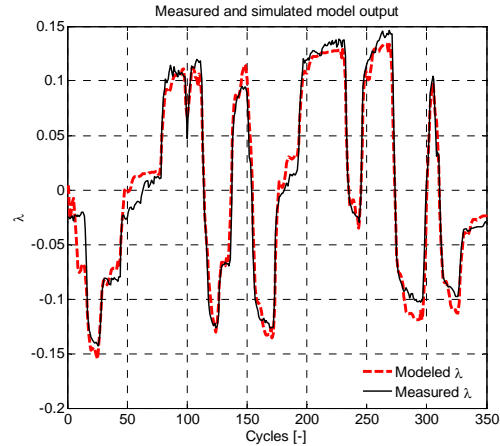

Figure 35 A 3rd order discrete time state space model was identified. Simulated lambda fits the measured lambda with very good precision. The model has 2 inputs (i.e. throttle position and injection duration)

5.5 Design of lambda controller

Throttle position is used as a “*measured disturbance*” and injection duration as “*manipulated variable*” (see Figure 36). When a variable is defined as a measured disturbance it means that the controller should provide feed-forward compensation based on the measurement. A manipulated variable is a signal that will be adjusted by the controller, i.e. in this case injection duration which will be controlled by the injectors. An input variable in Figure 36 named “*Unmeasured Disturbance*” is a disturbance for which the controller will provide feedback compensation. *Unmeasured Disturbances* can be variables such as engine speed or EGR rate.

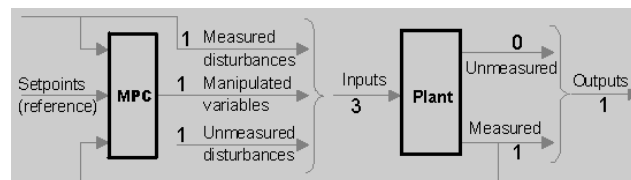

Figure 36 MPC Lambda controller structure

When designing an MPC controller, a number of tuning parameters should be tuned carefully to improve the controller quality. The tuning parameters are weights, constraints, estimation gain etc. As pointed out previously there are two types of constraints in MPC control design: hard and soft constraints. The hard constraints are e.g. actuator constraints and the soft constraints are output constraints which as the name implies can be violated. The output constraints for lambda were set to $[-0.04 \ 0.03]$ from the set-point value which is 0.995. This interval was chosen in order to prevent high levels of NO_x or HC emissions. In order to avoid instability of the controller, no stringent constraints were chosen.

5.6 Control performance

The performance of the MPC lambda control was evaluated by imposing different disturbances on the engine. These disturbances were in the form of step and ramp changes in throttle position i.e. load transients, engine speed and EGR changes. The lambda controller was also evaluated inside and outside of its designed model range. The reference lambda was set to 0,995 which represent the best catalyst conversion efficiency. The results with different disturbances are presented in separate subsections below.

5.6.1 Throttle disturbance

Different step and ramp changes in throttle position were applied inside and outside of the model range and the performance of the MPC controller was analyzed. The throttle was varied (stepwise and ramp changes) inside the model range and the resulting injection duration and lambda are plotted in Figure 37. IMEP was also plotted to give an indication of the load variations.

The controller tracks lambda very quickly and accurately with step and ramp changes. In order to highlight the control performance, the highest variation in lambda is zoomed in and presented at the top of the figure.

5.6 Control performance

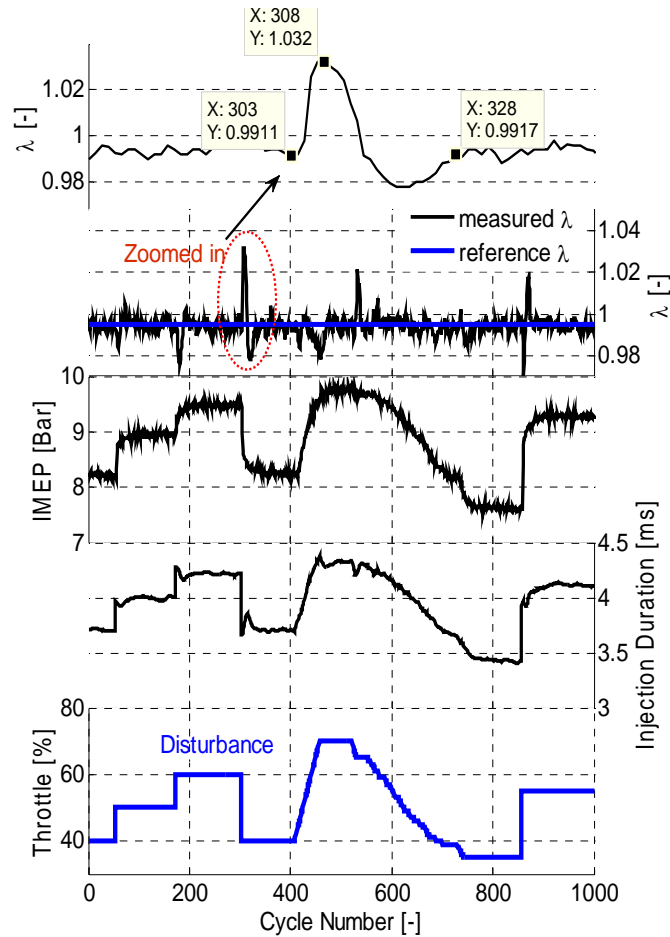

Figure 37 Control performance with throttle step change inside the model range (35-65%)

Different steps and ramps changes outside the model range were applied and the resulting control performance is illustrated by Figure 38. The control is quick and stable however in comparison with Figure 37, shows larger overshoot. The highest overshoot has been zoomed in at the top of the figure.

This simple example shows that the performance of MPC relies highly on models. Either wider ranges of data should be used during modelling or different models for different data range should be provided and switched between during control.

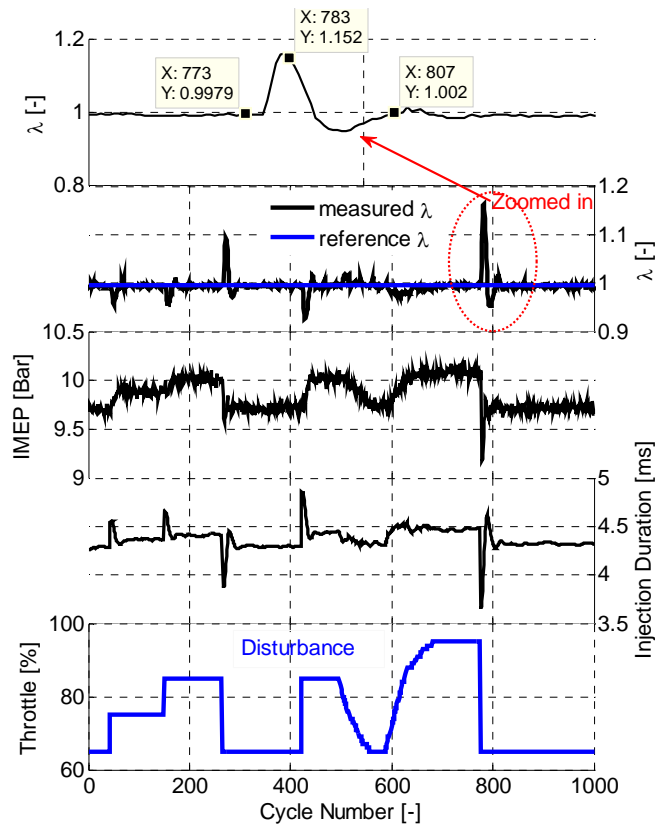

Figure 38 Control performance with throttle step change outside the model range

5.6.2 Engine speed disturbance

Rapid increase, decrease and ramp changes in engine speed were applied and the control performance was evaluated (see Figure 39). With relatively small step changes and ramp changes the controller tracks lambda changes fairly quickly and accurately. However, with big step changes the variations in lambda will be relatively high which can be improved by including engine speed in the model. Consequently, during the MPC control design process, engine speed can be introduced as a measured disturbance.

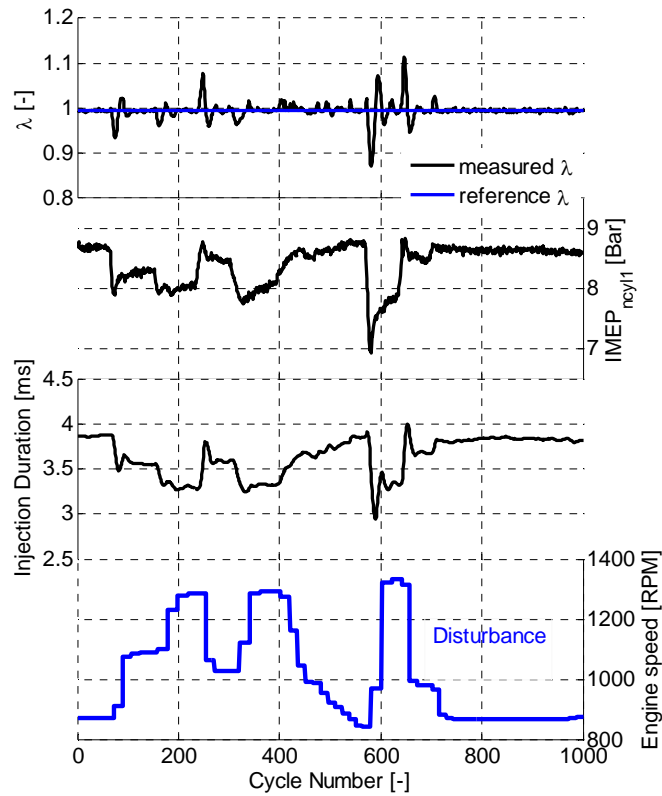

Figure 39 Control performance with disturbance in engine speed

5.6.3 EGR disturbance

Another parameter which can be introduced as disturbance to the system is the variation in EGR rate. Rapid step changes in EGR level are applied and the control performance is observed (see Figure 40). The change in EGR valve position results in roughly 12 or 14% increase in EGR rate. Lambda is adjusted quickly but with relatively large overshoots. In order to decrease the amplitude of the overshoots a new model could be designed including the EGR valve position as a measured disturbance. The model can subsequently be used in an MPC controller to decrease the amplitude of the overshoots.

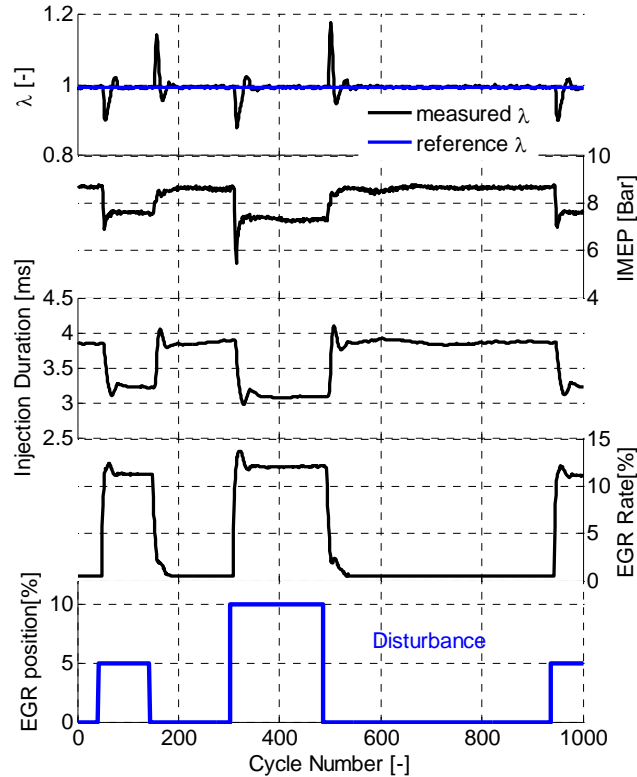

Figure 40 Control performance with step changes in EGR position

5.6.4 PI versus MPC

Before using the MPC lambda controller a traditional PI lambda controller was used for controlling the overall air/fuel ratio. In this part the same tests which were performed with the MPC controller are applied with the PI controller. In Figure 41 the same throttle change as performed in Figure 37 is applied. With the PI controller lambda goes up to 1.1, and takes a longer time to converge to the set-point lambda which results in a big increase in NO_x emissions. With the MPC controller the feed-forward compensation helps find the right amount of fuel injection faster. Of course, by adding a feed-forward part to the PI controller its performance could be improved a lot.

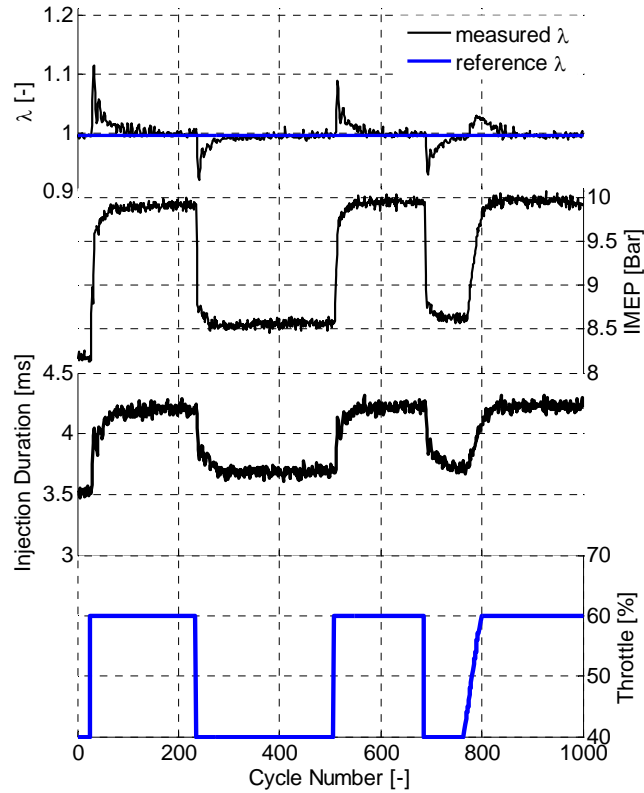

Figure 41 Lambda PI control with step change of the throttle

5.7 Concluding remarks

Model Predictive Control is used to control the overall air/fuel ratio. The main conclusions obtained from this study are as follows:

- System identification made it possible to make a reliable dynamic model of lambda. Injection duration and throttle position were the two input variables of this model. Injection duration was used as control signal and throttle position was introduced as a “measured disturbance” during model design.
- The controller performance inside the model range is very good however it becomes poorer outside the model range. It means that

a wide range model which includes the operating region is an essential element for a high performance MPC controller. Instead of wide range model, a number of small range models can be also used.

- The results show that rapid increases in engine speed and EGR rate (i.e. unmeasured disturbances) can be compensated quickly by the MPC controller however the quality of lambda control was somewhat deteriorated. Including engine speed and EGR rate as input variables to the model and introducing them as “measured disturbances” can improve the controller performance.
- Model Predictive Control was shown to be a suitable method for controlling lambda as long as appropriate input variables for the model are chosen.
- The MPC lambda controller is compared with a PI lambda controller and MPC showed to be a better choice than a pure PI for controlling lambda. It can be added that if a PI controller were combined with a feed-forward part the transient performance would improve significantly.

Chapter 6

Engine Modification to Improve Efficiency and Extend the Maximum Load limit

In this chapter the reasons for the lower overall efficiency and the lower maximum load limit of heavy-duty natural gas engines in comparison with the corresponding diesel engines are highlighted. Possible strategies in terms of engine modifications which may result in efficiency improvement and maximum load extension have been identified. These modifications are applied on the engine pistons, the turbocharging system and the EGR system which is discussed in detail in the respective subsections. Furthermore an innovative strategy to reduce throttle losses by means of a Variable Geometry Turbocharger (VGT) is reported.

6.1 Background

As already mentioned in the introduction there are mainly two reasons for natural gas engines to have lower efficiency than the corresponding diesel engines: first the lower compression ratio which is limited due to knock and second, the use of a throttle for load control which causes severe pumping losses.

A fuel's octane number is a measure of its knock resistance [38]. Normally natural gas engines use the same combustion technology as gasoline engines due to the similarity in fuel properties. However natural gas has a higher octane number than gasoline and thus natural gas operated engines can have higher compression ratio without experiencing severe knock problems. The experimental engine has, originally, a conservative

compression ratio at 10.5 which is quite low and can be increased to higher levels (e.g. 12).

Another reason mentioned for the lower efficiency was throttle losses². It was established in chapter 4 that by operating the engine at its dilution limit, throttle losses will be reduced drastically. It means that the extension of the dilution limit can be another strategy to improve the fuel economy. As the engine operates more diluted the combustion will be colder and as a result the combustion duration becomes longer. Increasing the turbulence level is one of the strategies that can enhance the combustion process and shorten the combustion duration. Thus, high turbulence level during the combustion is favourable especially with highly diluted mixture. One parameter which highly affects the turbulence level in internal combustion engines is the shape of the combustion chambers.

The main objective of this chapter is to discuss the details of some engine modifications which resulted in improving the overall engine efficiency and extending the maximum load limit of the engine. The compression ratio of the engine was increased and the piston shape was designed to reduce the combustion duration. The new piston modification resulted in some changes in the exhaust gas characteristics. This was the motivation to replace the turbocharger with a well-matched VGT to adjust the boost pressure level and extend the maximum load. The engine's EGR system is modified in a way to deliver more EGR and also to control it in a faster and more robust way. Each of the performed modifications and the following results in terms of engine performance are discussed in detail in the following subsections.

6.2 Combustion chamber

The first modification to the engine is to redesign the combustion chamber to achieve higher compression ratio and to increase the turbulence level. The compression ratio can be increased by reducing the compression volume, however to increase the turbulence level the bowl

² Natural-gas engines can be operated stoichiometric or lean. Some of the lean operated natural-gas engines does not use throttle. The statement is only valid for the engines which uses throttle.

6.2 Combustion chamber

shape should be designed in different way. In [37], [39] and [40] the effects of different combustion chambers designs on gas flow, combustion and emissions have been studied. One of the designs, named “Quartette”, that offers the highest turbulence level with good performance has been chosen from [37]. Figure 42 illustrates the measured turbulence level, mean velocity and the rate of heat release together with the shape of the original piston and Figure 43 contains the same information for the Quartette piston. The turbulence measurements are not from this study but since the shapes of the pistons and the engine configurations are very similar, it can be assumed that the results with the experimental engine will be also very similar. In the figures the green lines represents the mean velocity data, the red lines represent the turbulence in the cylinder and the blue lines represent the rate of heat release. Laser Doppler Velocimetry (LDV) was used to measure the turbulence and mean velocity in two directions and 5 mm below the spark plug. Figure 43 shows that the turbulence is much higher with Quartette and peaks close to top dead center which result in much faster combustion than the original piston. A set of new pistons were machined according to the “Quartette” design. The compression volume was calculated to achieve a compression ratio of 12. The results with the new pistons are presented in the following subsections.

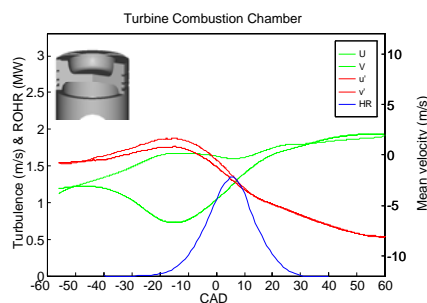

Figure 42 The original piston shape, turbulence measurements, mean velocity and heat release rate [37]

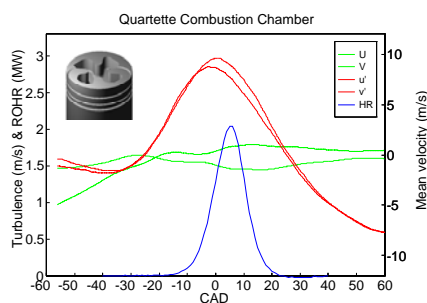

Figure 43 The Quartette piston shape, turbulence measurements, mean velocity and heat release rate [37]

6.2.1 Combustion duration

Combustion duration is calculated as the crank angle difference between 10% and 90% mass fraction burned. Figure 44 shows the combustion

duration when the engine was operated at different engine speeds with Wide Open Throttle (WOT). Due to the higher turbulence level generated by the Quartette piston, the combustion duration is shortened by almost 40% which is a significant reduction. Figure 44 confirm the results reported in [37] about the high turbulence generation with the Quartette design

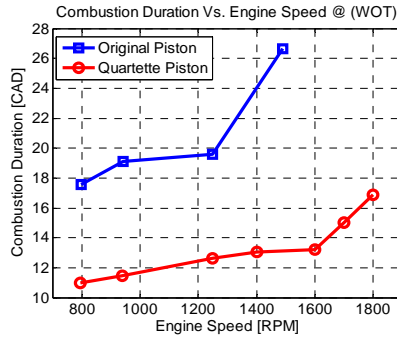

Figure 44 Combustion duration (CA10-CA90) at different engine speed (WOT)

6.2.2 Efficiency

The gross-indicated efficiency data for the same operating points and for the two pistons are compared in Figure 45. The gross-indicated efficiency is improved by at least two percentage points with the Quartette pistons due to faster burn and higher compression ratio. The new pistons' shape resulted in increasing the turbulence level which consequently enhances the burn rate. The shorter combustion duration minimizes the heat transfer losses to the cylinder walls which improves the efficiency. Furthermore, increasing the compression ratio results in a higher effective expansion ratio meaning more thermal energy is used in the cylinder rather than left in the exhaust (i.e. lower exhaust loss). At these operating points (WOT) the changes in gas-exchange efficiency and the mechanical efficiency were negligible and thereby no data are presented. At lower loads the gas-exchange efficiency can be improved. Since the throttle is not fully open, EGR can be used to reduce the throttle losses and since, with the Quartette piston, more EGR can be tolerated the throttle can be more open, for a certain load, and with more open throttle the pumping losses are lower.

6.2 Combustion chamber

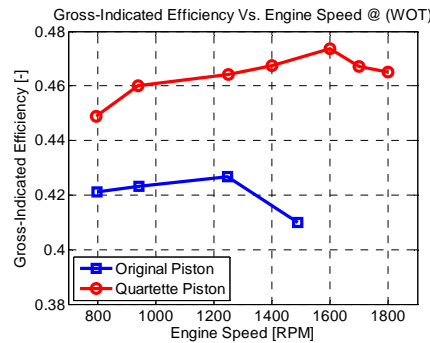

Figure 45 Gross-indicated efficiency at different engine speed (WOT)

6.2.3 Maximum load

Apart from efficiency improvement, extending the maximum load limit of the engine was another objective of this study. In order to find out the influence of the piston modification on the maximum load of the engine, maximum BMEP at different engine speeds are plotted in Figure 46. It shows that the maximum BMEP achieved by Quartette is somewhat lower than with the original pistons.

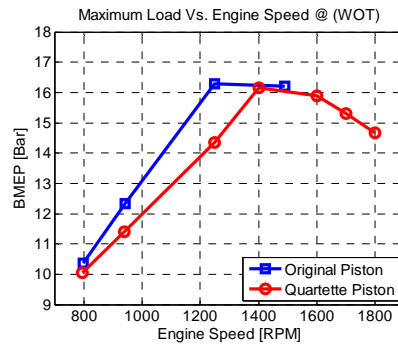

Figure 46 Maximum Load at different engine speed (WOT)

The new piston modification results in some changes in the exhaust gas characteristics and since the engine is equipped with a turbocharger with wastegate, the changes in exhaust gas characteristics may have direct influence on the boost pressure. The pressure after the compressor is plotted in Figure 47 for the same operating points as in Figure 46. The absolute boost pressure with Quartette pistons is lower which results in lower maximum BMEP. Turbine work is performed by the flow which

6 Engine Modification to Improve Efficiency and Extend the Maximum Load limit

turns the turbine and the shaft. From the conservation of energy, the turbine work per mass of airflow, W , is equal to the change in the specific enthalpy, h , of the flow from the entrance to the exit of the turbine as expressed in (6.1). Specific enthalpy means enthalpy per mass of airflow. By expressing the definition for enthalpy and taking into account parameters such as efficiency, η , pressure ratio, P_r , and specific heat ratio, a new expression for the turbine work is derived according to (6.2) [43].

$$W = h_{in} - h_{out} \quad (6.1)$$

$$W = (c_p \times \eta \times T_{in}) \times \left[1 - P_r^{\left(\frac{\gamma-1}{\gamma}\right)} \right] \quad (6.2)$$

From (6.2) it is clear that the inlet temperature of the turbine will affect the amount of work done by the turbine. Figure 48 shows the exhaust gas temperature which is the same as the inlet temperature of the turbine. With the Quartette pistons the exhaust gas temperature is lower than with the original pistons. This is due to the higher compression ratio of the Quartette pistons which results in more expansion. More expansion means that more heat is converted into mechanical work in the cylinder and less energy in the form of exhaust gas enthalpy is available. Lower exhaust temperature means lower exhaust energy and thereby less charging from the turbocharger.

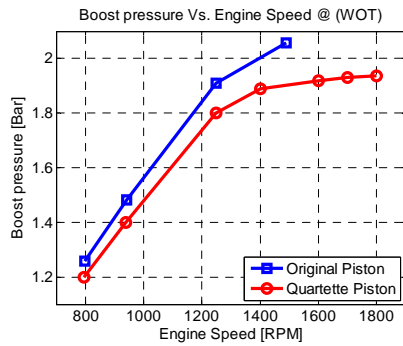

Figure 47 Pressure after compressor at different engine speed (WOT)

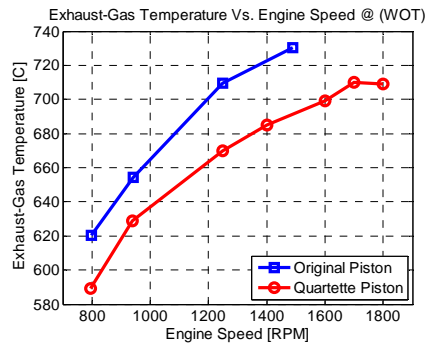

Figure 48 Exhaust gas temperature at different engine speed (WOT)

6.3 Variable Geometry Turbocharger

As noted in the introduction, the exhaust gas temperature from this type of natural gas engines (i.e. diesel converted engines) must be kept low. According to the manufacturer the exhaust gas temperature should be lower than 760°C . The lower exhaust gas temperature obtained with higher compression ratio is beneficial in two ways. First, there is a higher margin to the highest allowable exhaust gas temperature and second, there is potential to extend the maximum load limit by replacing the turbocharger with a better matched unit.

6.3 Variable Geometry Turbocharger

A VGT has the ability to change the turbine geometry in order to obtain the desired boost pressure. VGT offers attractive properties such as high flexibility, minimal amount of lag and wide operating range. VGT technology is extensively used in diesel engines; however the use of VGT is very much ignored in gasoline engines due to their relatively high exhaust temperatures. Ordinary VGT materials and designs cannot withstand temperatures over 890°C [42]. The exhaust gas temperature of gasoline engines could, however, reach up to 1000°C , versus 650°C in diesel engines [41].

Normally natural gas engines use the same combustion technology as gasoline engines due to similar fuel properties. In heavy-duty applications, since the engine speed does not exceed 2000 RPM, the exhaust gas temperature is not very high. As an example, the maximum allowable exhaust gas temperature for the experimental engine that operates stoichiometrically is 760°C which is tolerable for VGT material. Traditionally heavy-duty natural gas engines use the same turbocharging technology as gasoline engines. They are equipped with a turbocharger with wastegate but it is quite simple and advantageous to replace the bypass turbocharger with a well-matched VGT to achieve the required boost pressure.

6.3.1 Extending the maximum load

After consulting with the R&D group at Volvo a VGT was designed and mounted on the engine. The engine is operated at the same engine speeds with WOT and by altering the geometry of the turbine housing the boost

6 Engine Modification to Improve Efficiency and Extend the Maximum Load limit

was increased until either knock occurred or the pumping losses started to increase. To suppress knock, EGR was added and the ignition timing was adjusted accordingly. Figure 49 shows the boost pressure achieved by the VGT in comparison with the by-pass turbocharger with original and Quartette pistons. The boost pressure was increased up to much higher levels with VGT without sacrificing gas-exchange efficiency. The increase in boost pressure resulted in increased maximum load as presented in Figure 50 compared to previous configurations. The peak load increased by 18 percent from 16 to 19 bar BMEP with maintained gas-exchange efficiency and exhaust gas temperature limitation.

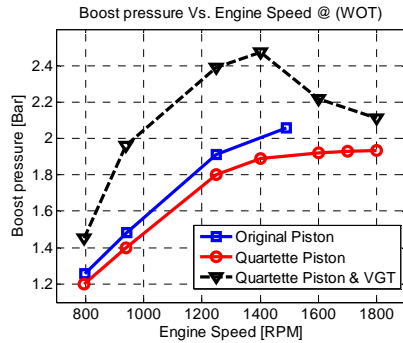

Figure 49 Boost pressure achieved after replacing the turbocharger with a VGT in compared to the other configurations.

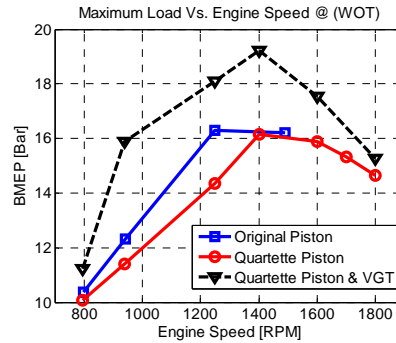

Figure 50 Maximum load achieved after replacing the turbocharger with a VGT compared to the other configurations

By increasing the compression ratio the knock tendency of the engine increases. The knock tendency increases even more when the boost pressure increases. EGR has been used as a remedy to suppress knock. When adding EGR, the ignition timing was adjusted to achieve MBT; of course, MBT was not achieved in some operating points. Figure 51 shows the amount of EGR needed with different engine configurations. The needed EGR rate is obtainable in the entire operating region with all configurations.

6.3 Variable Geometry Turbocharger

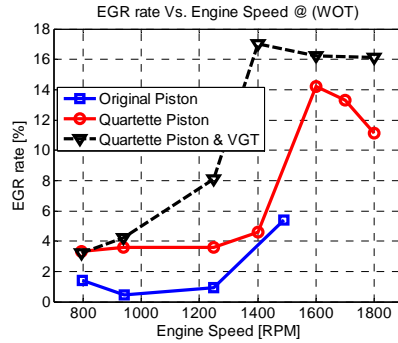

Figure 51 Amount of EGR used to suppress the knock with different configuration viz. Quartette piston and VGT, Quartette/original piston with by-pass turbocharger

6.3.2 Reducing throttle losses by means of VGT

Using a throttle always leads to pumping losses. The gas-exchange efficiency for the whole operating regime of the experimental engine is presented in Figure 52. As BMEP decreases at each engine speed, the gas-exchange efficiency also decreases due to the more closed throttle which results in more pumping losses. Some strategies have been reported to reduce the throttling losses. In [44], [28] and [29] EGR is used together with closed loop dilution limit control to reduce the throttling losses. With this strategy the benefits are limited to the dilution limit of the engine; the transient performance of the engine is also limited. In [45] a technology called Waste Energy Driven Air Conditioning System (WEDACS) is developed to recover throttling losses. In [46], [47] and [48] the new and efficient strategy viz. Variable Valve Timing (VVT) is introduced which results in higher efficiency in a wider operating range. However these strategies are associated with complexity, more components and higher cost.

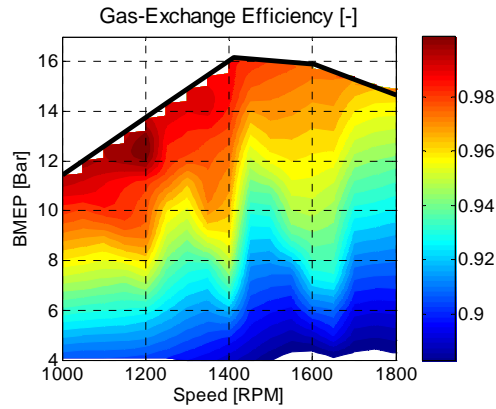

Figure 52 Gas-exchange efficiency as a function of Load and Engine speed for the experimental engine equipped with by-pass turbocharger. More closed throttle at low loads results in lower gas-exchange efficiency

This subsection presents an innovative strategy where a VGT is used to reduce the throttling losses in large operating region. In [49] the feasibility of using VGT for the heavy-duty natural gas engine is established. Normally a throttle is used to control the desired torque in the engines, but it is also possible to use a VGT instead of the throttle in a large operating range to control the desired torque. This is possible due to the flexibility of the VGT to adjust the inlet pressure by altering the geometry of the turbine housing. In this operation region the throttle is kept fully open and the VGT is used to adjust the inlet pressure and finally control the demanded torque. This means that the throttle will not be used in a large part of the operating region and no throttle use means no throttle losses.

The boost threshold for the experimental engine is specified in Figure 53. VGT start producing boost only with enough amount of exhaust mass flow rate. Figure 53 shows the inlet pressure as a function of engine speed and BMEP after installing a VGT on the engine. The VGT operating region is above the boost threshold and is specified with the dashed lines. The covered operating region is roughly 60% of the total operating region of the engine.

6.3 Variable Geometry Turbocharger

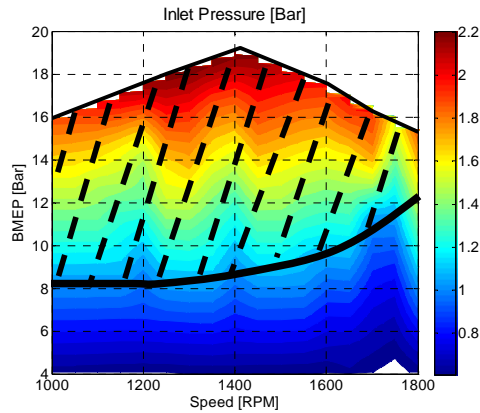

Figure 53 Inlet pressure as a function of Load and Engine speed for the experimental engine equipped with VGT. Operating range with VGT is specified with the dashed lines

The feasibility of reducing losses by means of VGT is studied and quantified in detail and is reported in the following three subsections. In the first subsection the possible gains with VGT in terms of gas-exchange efficiency is discussed. The time constants of load transients when using VGT or throttle are calculated and compared in the second subsection and in the third subsection the achieved results are validated by performing the same experiments at other operation points.

Improvement in Gas-Exchange Efficiency

To quantify the gain in gas-exchange efficiency, IMEP was altered between 10 and 14 bar at 1000 RPM once by using the throttle and once by using the VGT. First the throttle is used to change the load. In this case the VGT position is fixed (i.e. 60% closed) and the throttle was altered between 40 and 100% opening to achieve the desired load. The results are evaluated in terms of gas-exchange efficiency (see Figure 54). The Y-axis to the left shows the throttle position and the Y-axis to right illustrate the gas-exchange efficiency. The X-Axis indicates the number of cycles. Once the throttle was fully opened, the gas-exchange efficiency increased from roughly 98 percent to almost 100 percent. It confirms that the throttling losses results in roughly 2 percent unit losses in gas-exchange efficiency at this operating point.

In the second experiment the throttle was kept fully open and the VGT is used to alter the desired load at the same engine speed. The VGT position is altered between 0 and 60% to adjust the desired boost and subsequently to achieve the desired IMEP. The load was altered in the same range as it was altered by the throttle. Figure 55 shows the gas-exchange efficiency as the VGT is used to control the load. The Y-axis to the left shows the VGT position and the Y-axis to right illustrates the gas-exchange efficiency. Since no throttling has occurred to adjust the desired load, no losses are introduced and the gas-exchange efficiency is kept at its highest level all the time i.e. almost 100%. During the transient (i.e. step responses) some wave pulses are generated which result in overshoots in the opposite direction (see Figure 55). For instance when opening the VGT, exhaust backpressure decreases, but it takes a while before the inlet pressure falls, thus lower pumping loss and higher gas-exchange efficiency for some cycles can be achieved. In the same way higher pumping loss is achieved for some cycles when closing the VGT. The duration of these overshoots corresponds to the turbochargers lag at this operating point.

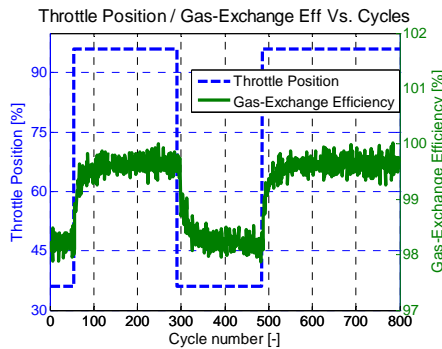

Figure 54 Gas-Exchange efficiency as throttle used to control the desired load at 1000 RPM

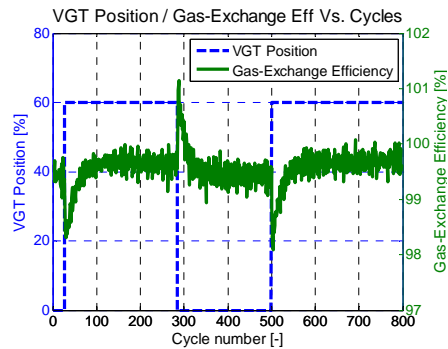

Figure 55 Gas-exchange efficiency as VGT used to control the desired load at 1000 RPM

Dynamics of VGT versus Throttle

Another important parameter that should be considered is the response time of the engine to the changes in VGT. The response time should be fast enough to make the VGT a viable alternative to the throttle. The time constants for the experiments i.e. load variation by VGT or throttle are calculated and compared. Time constant is defined as the time

6.3 Variable Geometry Turbocharger

required for a system output to change from its previous state to 63% of the final settled value [50].

As discussed in the previous subsection, two different experiments were performed one with throttle and one with VGT. The results in terms of gas-exchange efficiency were evaluated and discussed. Figure 56 and Figure 57 show the rise and fall of IMEP in response to throttle or VGT changes for the same experiments. The time constant during rise and fall of IMEP for both experiments are calculated and presented in Table 8.

The time constant for the system during the rise is somewhat longer with VGT but during the fall it is much shorter. The VGT was about 10 cycles slower in rising but almost 25 cycles faster in falling. 10 cycles corresponds to 1.2 seconds at 1000 RPM and 25 cycles corresponds to 3 seconds at 1000 RPM. These results indicate that the dynamics of the VGT are fast enough to be an alternative to the throttle.

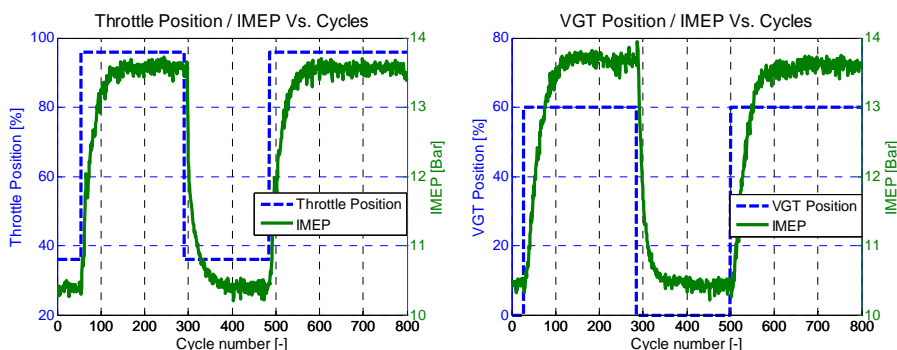

Figure 56 IMEP as Throttle used to control the desired load at 1000 RPM

Figure 57 IMEP as VGT used to control the desired load at 1000 RPM

Table 8 Time constant of the system with Throttle and VGT

Sensor	Direction	Time Constant (Cycle)
Throttle	Rise	45
	Fall	60
VGT	Rise	55
	Fall	35

Validation

The previous experiments were performed at 1000 RPM and gains of about 2 percent units in gas-exchange efficiency were observed. According to Figure 52 the largest operating region of the VGT is at 1400 RPM. To validate the achieved results and also to investigate the VGT performance at some other operating points, the same experiments were performed at 1400 RPM. The IMEP was altered between 11 and 21 bar, once with the throttle and once with the VGT. Figure 58 and Figure 59 show the gas-exchange efficiency as the load was altered with the throttle and VGT respectively. The gas exchange efficiency decreases from approximately 98 % to 95 % when throttle is used to change the load (i.e. IMEP) from 21 to 11 bar at 1400 RPM. In the second experiment the throttle is kept fully open and the VGT is used to achieve the same amount of IMEP. As Figure 59 shows the gas-exchange efficiency is kept at its highest level all the time. This confirms 3 percentage points improvement in gas-exchange efficiency by using VGT instead of throttle at those operating points. The dynamics were also in the same range as reported for the 1000 RPM case. Similar experiments at other engine speeds were performed which were in line with the presented results.

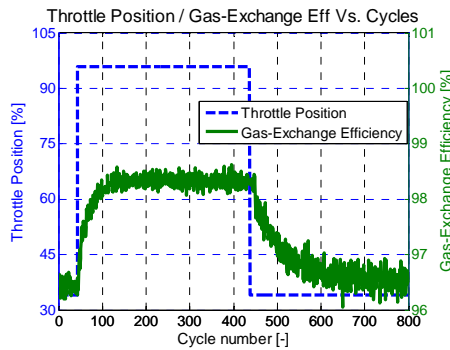

Figure 58 Gas-Exchange efficiency as throttle used to control the desired load at 1400 RPM

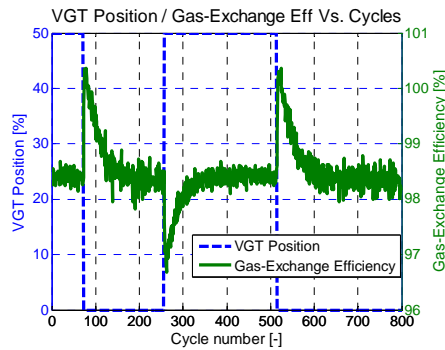

Figure 59 Gas-Exchange efficiency as VGT used to control the desired load at 1400 RPM

Suggested control strategy for lowest possible throttle losses (Fuel-efficient driving)

To avoid the throttle losses as much as possible a control strategy is suggested. It gives two options to the driver to control the desired load. The driver will be able to drive either in the conventional way i.e. with

6.4 EGR system

throttle or in a fuel-efficient mode. With the fuel-efficient strategy, the throttle is avoided as much as possible. With this mode, to control the load mainly VGT, partly EGR and partly a combination of throttle and EGR is used.

The whole operating region of the engine is divided into three main regions. The biggest operating region, located above the boost threshold, can be covered by the VGT. In this region, as already discussed in the previous subsection, the throttle is fully open and the load is totally controlled by altering the geometry of the turbine housing. This results in adjusting the boost pressure which consequently decides the torque. This region is specified in Figure 60. 60 percent of the total operating region can be covered by VGT. The second region is located under the boost threshold. The throttle can still be fully open and by adding EGR the amount of load is decreased. This means that in this region the EGR valve is the main actuator for controlling the desired load. Since the throttle is still fully open in this operating region there will not be any throttle losses. There is a limit for the amount of EGR with the fully open throttle. Increasing cyclic variation in IMEP can be a good indication of this limit. The throttle is used combined with the optimal amount of EGR in the third region. Figure 60 demonstrates the three discussed operating regions and Figure 61 describes the suggested control strategy.

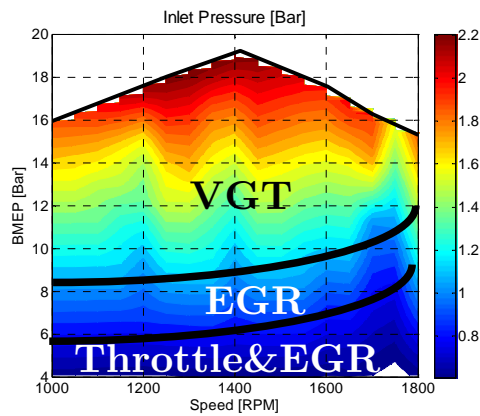

Figure 60 The economical driving requires different strategies in different operating regions.

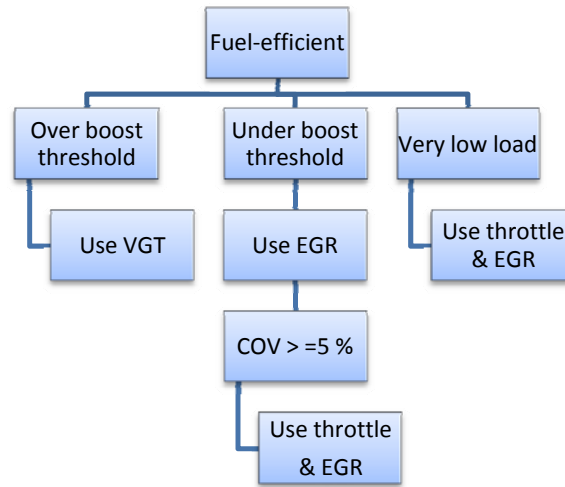

Figure 61 The suggested control strategy for fuel-efficient driving results in the lowest possible throttling losses.

6.4 EGR system

The engine is equipped originally with a short route EGR system also called High Pressure (HP) EGR system. It was established in chapter 3 that high dilution is very advantageous at part load. Since the engines' pistons are replaced with high turbulence pistons the engine will be more tolerant to higher EGR rates. However the HP EGR configuration can deliver only up to 20% EGR. To increase the engine's ability to deliver more EGR and also to control the EGR rate in a faster and more robust way a long route EGR system, so called Low Pressure (LP), is added to the engine (see Figure 62). Moreover a back pressure valve was installed after the catalyst to increase the exhaust pressure when needed in order to deliver the desired EGR rate. This type of double EGR configuration (HP + LP) is previously presented in [51].

6.4 EGR system

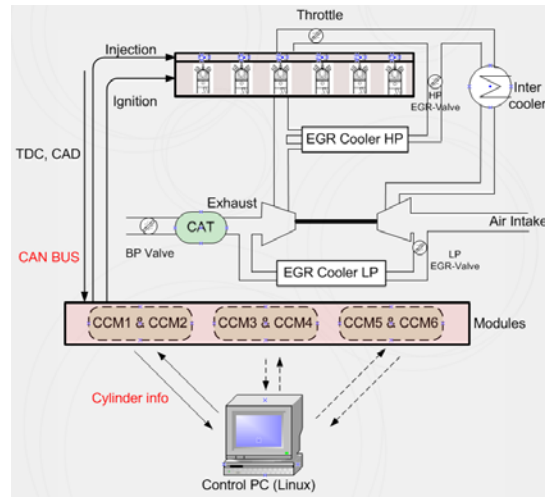

Figure 62 The engine setup with both short and long-route EGR systems.

6.4.1 Dilution limit

After installing the new EGR configuration, an EGR test was made mainly for two reasons. First, to investigate the maximum level of EGR rate that can be delivered by the new EGR configuration and second, to find out how much the dilution limit is extended with the Quartette combustion chambers. The engine was able to deliver about 20% EGR with the original short route system but with the long route EGR system this amount is only limited by the dilution tolerance of the engine. Figure 63 and Figure 64 illustrate the dilution limit of the engine with the original and the Quartette pistons respectively. The sudden increase in cyclic variation of IMEP is used as an indication of the dilution limit. The dilution limit is extended from about 18% EGR to about 24 % EGR with the Quartette pistons at the engine speed of 1000 RPM.

6 Engine Modification to Improve Efficiency and Extend the Maximum Load limit

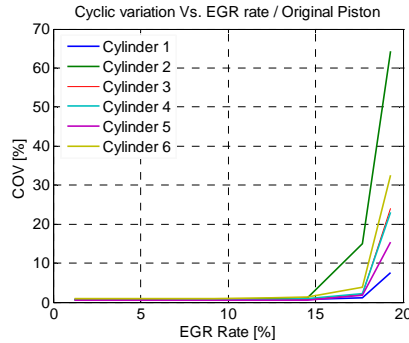

Figure 63 Cyclic variation vs. EGR rate for the original pistons

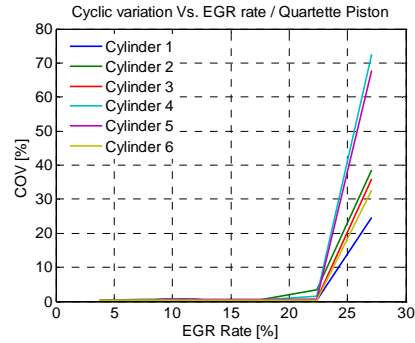

Figure 64 Cyclic variation vs. EGR rate for the Quartette pistons

6.4.2 Midrange control

EGR has been identified as a very important factor for the engine durability and fuel economy. At higher loads, the high boost pressure results in increased knock tendency. Knock can be avoided by adding EGR and adjusting the ignition timing accordingly. At part/low loads the throttling losses can be minimized by operating the engine with optimal amount of EGR. Considering these facts, the need for a fast and robust EGR control is clear. The new configuration of the EGR system (LP+HP) plus fast measurement of the EGR rate are the right tools to fulfil these requirements. Measurement of EGR has to be done in a very fast way to reduce the measurement lag.

Midrange control of EGR is suggested as an appropriate strategy to control the two EGR valves. Traditionally, the mid-range control structure is used for processes with two inputs and only one output [52]. A classical application of this type of controllers is valve position control. Figure 65 demonstrate a mid-range control block diagram. The faster process input u_1 should be used for a small range valve and then the slower process input u_2 should be used for the large range valve. The controllers should have separate time scales to avoid interactions. The hypothesis was that the short route EGR system would give faster response than the long route due to its shorter distance to the cylinder. The main EGR rate could be decided by the long route system and the short route EGR system could be used to make the small adjustments very quickly.

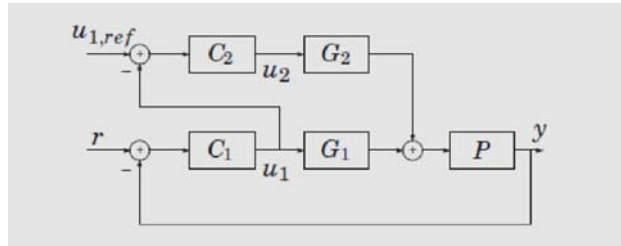

Figure 65 Mid-range control block diagram.

6.4.3 Short route versus Long route EGR System

In order to compare the dynamics of the two EGR configurations, a step response was made to vary the rate of EGR between roughly 1-2% and 15% at 1000 RPM. This experiment was done once with the short route EGR position and once with the long route EGR position. The results from these experiments are presented in Figure 66 and Figure 67 for the short route and long route EGR system respectively. The Y-axis to the left belongs to the EGR valve position and the Y-axis to the right shows the measured EGR rate over 800 combustion cycles. The operating conditions such as load, engine speed etc. were the same for both experiments. Surprisingly the dynamics with the long route EGR system are much faster than with the short route EGR system which was in contrast to our hypothesis. The dynamics of the short route EGR system relies on the dynamics of the turbocharger and its lag. The other reason for the faster dynamics with the long route EGR system rather than the short route is the better pressure difference.

Apart from the faster dynamics, the long route EGR system is advantageous in several other ways. First of all, engine operation is more stable due to better distribution and mixing of the EGR with air and fuel (i.e. the longer distance the more time for mixing). Secondly, the EGR goes through an intercooler and the mixture becomes colder and consequently the engine becomes more knock resistant. Third, due to the higher pressure difference more EGR can be delivered than with the short route EGR system. The only drawback with the long route EGR system is that more water will be produced in the intake which should be systematically drained.

By taking into account all the discussed facts, it can be easily concluded that mid-range control of EGR is not needed since by only using the long route EGR system, the requirements for robust EGR control can be fulfilled (i.e. the short route EGR system is not needed at all).

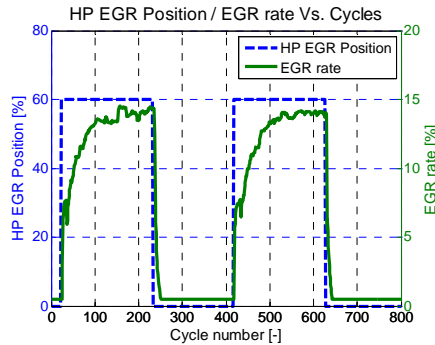

Figure 66 The dynamics of the short route (i.e. HP) EGR system.

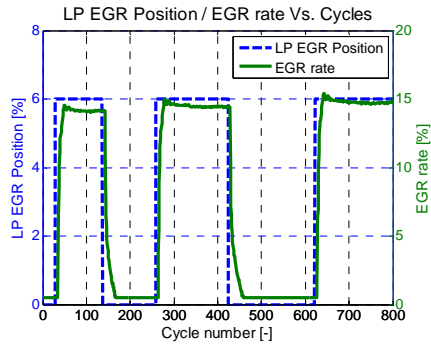

Figure 67 The dynamics of the long route (i.e. LP) EGR system.

6.5 Concluding remarks

The main objective of this chapter was to show which engine modifications are needed to improve the overall efficiency and extend the maximum load limit of the engine. Modifications were performed on the combustion chambers, the turbocharging system and the EGR system. The summary and conclusions from each modification are listed below.

Combustion chamber

- The piston shapes were modified to increase the turbulence level and also the compression ratio from 10.5 to 12.
- The gross-indicated efficiency was improved by at least 2 percent units. Higher compression ratio results in more expansion and consequently less loss in terms of exhaust enthalpy. More turbulence results in faster combustion meaning, less losses in term of wall-heating losses.
- Higher compression ratio results in lower exhaust gas temperature.

6.5 Concluding remarks

- Lower exhaust gas temperature is good since there is more margin with respect to the highest tolerable exhaust temperature of the engine. It can be recalled that since the engine is diesel converted, there is low tolerance for exhaust temperature.
- Since the engine is equipped with a by-pass turbocharger (i.e. turbocharger with wastegate), the lower exhaust gas temperature means lower exhaust energy and lower boost pressure which results in lower maximum load.
- The dilution limit of the engine is extended thanks to the faster combustion chamber meaning the throttle losses can be reduced.

Variable Geometry Turbocharger

- The heavy-duty natural gas engines have higher exhaust gas temperature than the diesel engines but it is still low enough to be tolerable for a VGT. So there is no limitation to use VGT on the natural gas engine.
- Using VGT resulted in significant improvement in maximum achievable load without sacrificing gas-exchange efficiency
- VGT can be used instead of throttle to adjust the desired load in at least 60% of the operating range of the engine. This results in at least 2 percent units' improvement in gas-exchange efficiency. VGT showed comparable dynamics to throttle.

EGR System

- With higher compression ratio and high boost pressure the knock intensity of the engine increases, meaning a fast and robust EGR control is needed. A long route EGR was installed on the engine so that the engine had two EGR routes i.e. short and long route

6 Engine Modification to Improve Efficiency and Extend the Maximum Load limit

- A comparison between short route and long route was performed and long route showed much better performance than the short route EGR system in terms of
 - Much faster dynamics due to the better pressure difference and also not relying with its dynamic on the turbocharger which is the case with the short route
 - Better mixing due to the longer distance to the cylinder
 - Colder mixture meaning less knock intensity
 - More EGR delivery compared to the short route EGR system
- Short route EGR is not needed. As a result mid-range control is not needed.

Chapter 7

Extending the Dilution Limit and Studying the Effect of Hythane on Combustion

This chapter gives an introduction about the importance of adding hydrogen to natural gas. Due to the attractive properties of Hythane such as higher H/C ratio and the lower ignition requirement, this fuel is suitable and has potentials to reduce emissions and increase efficiency. Different experiments were designed and performed to quantify the gains and also identify the possible drawbacks with Hythane. Since natural gas engines mainly operate stoichiometric or lean, a comparison was performed to investigate the Hythane benefits with these two combustion concepts. Natural gas was blended two times with hydrogen once with 10% and once 25% by volume. Basically only the results with 25% hydrogen addition are presented in this chapter.

7.1 Background

Extending the dilution limit has been identified as a beneficial strategy to improve efficiency and decrease emissions in stoichiometrically operated natural gas engines. However the dilution limit is limited mainly due to the lower burn rate of natural gas. One way to extend the dilution limit in a natural gas engine is to operate the engine with a natural gas which is enriched with hydrogen.

Hydrogen and methane are complimentary fuels in some ways. Natural gas consists mainly of methane (~90%) which has a relatively narrow flammability range. This is especially a problem when a natural gas engine is operated close to its lean or dilution limit. Methane has a slow laminar flame speed, especially in lean or diluted operation, while hydrogen has a

much faster laminar flame speed [53] and [54]. Figure 68 shows flame propagation velocity for methane and hydrogen versus air-fuel ratio. Methane is a fairly stable molecule that can be difficult to ignite, but hydrogen has an ignition energy requirement much lower than methane. In [56], [57], [58] and [59] some benefits of using Hythane are reported. In [60] benefits of hydrogen addition to a lean burn natural gas engine are investigated. In the work the hydrogen addition was varied from 5 to 20% (by volume) while the engine was operated lean. Some small improvements in efficiency and unburned hydrocarbon emissions are reported in the work. In [61] a study was performed by the author of this thesis to investigate the effect of Hythane on a stoichiometrically operated multi-cylinder natural gas engine.

The main objective of the work was to investigate the knock sensitivity and possible gain in dilution limit, lean limit, emissions and efficiency of the engine by enriching the natural gas with 10% hydrogen. No significant differences in terms of knock margin, efficiency and emissions levels between the blended natural gas and the pure natural gas were observed in the study. From the results it was concluded that when the engine is operated stoichiometrically the combustion characteristics are already good with short enough combustion duration and the Hythane shows no improvement compared to natural gas. Since no significant results were achieved with 10% hydrogen addition, a complementary study was performed with 25% hydrogen addition. The main objective of this work was to investigate the effects of the hydrogen addition on knock margin, efficiencies, emissions and dilution limit of a stoichiometrically operated natural gas engine. It was also desired to compare the possible advantages with Hythane in diluted operation versus the lean operation natural gas engines.

One important parameter which should be addressed and kept in mind during the reading of this section is the importance of the recent piston modification. The pistons of the engine were replaced by highly turbulent pistons which speed up the combustion rate. This characteristic of the piston has similar effects as Hythane on the combustion process. This means that the effects of the Hythane could be more obvious with the original pistons rather than the new pistons. It should also be mentioned that during these experiments VGT was not mounted on the engine.

7.2 Gas data

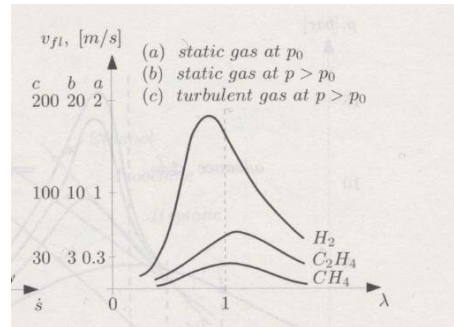

Figure 68 flame propagation velocity over air-fuel ratio [55]

7.2 Gas data

The compositions of the natural gas and the Hythane are presented in Table 9 and Table 10 respectively. The main change in the gas properties is the percentage of Methane which is reduced by 25% and replaced by hydrogen. All the percentages reported in the tables are volume based. Some important properties of the fuels such as H/C ratio, stoichiometric AFR value, lower heating value and density of the Hythane and natural gas are presented in Table 11.

Table 9 Natural Gas composition

Composition	%	Structure
Methane	89.8	CH ₄
Ethane	5.87	C ₂ H ₆
Propane	2.23	C ₃ H ₈
I-Butane	0.37	C ₄ H ₁₀
N-Butane	0.51	C ₄ H ₁₀
I-Pentane	0.13	C ₅ H ₁₂
N-Pentane	0.08	C ₅ H ₁₂
Hexane	0.06	C ₆ H ₁₄
Nitrogen	0.3	N ₂
CO ₂	0.63	CO ₂

Table 10 Hythane composition

Compositions	%	Structure
Methane	67.4	CH ₄
Ethane	4.3	C ₂ H ₆
Propane	1.7	C ₃ H ₈
I-Butane	0.2	C ₄ H ₁₀
N-Butane	0.4	C ₄ H ₁₀
I-Pentane	0.11	C ₅ H ₁₂
N-Pentane	0.09	C ₅ H ₁₂
Hexane	0	C ₆ H ₁₄
Nitrogen	0.3	N ₂
CO ₂	0.5	CO ₂
Hydrogen	25	H ₂

Table 11 More properties of the fuels

Property	Natural Gas	Hythane
H/C Ratio	3.7	4.32
Stoichiometric AFR	16.9	17.56
LHV (MJ/kg)	48.4	50.76
Density (Kg/Nm ³)	0.82	0.638

7.3 Experiments

The experiments were performed in three different stages. Since the objective was to compare the effects of the natural gas and the Hythane respectively on engine operating parameters; the engine is operated twice at each stage, once with natural gas and once with Hythane. Details about the experiments are as follows:

- **Lambda response:** in this experiment the engine operated at 1000 RPM. The sweep is started at $\lambda=0.8$ and λ was subsequently increased until the lean limit was reached. In this experiment the air flow is constant and the fuel flow is varied to achieve the desired λ value. The ignition timing was adjusted to achieve Maximum Brake Torque (MBT) timing.
- **EGR response:** In this experiment the engine was operated stoichiometrically at 1000 RPM. The EGR ratio was increased until the dilution limit is reached.
- **Map:** The engine was operated stoichiometrically at different loads and engine speeds to study the overall performance of the engine in the entire operating region. It was of particular interest to investigate the knock margin of the engine. The test matrix is shown in Table 12. It should be kept in mind that in this experiment EGR was only used to suppress knock and not to increase efficiency³.

Since the stoichiometric value is not the same for both fuels, this value was calculated for each fuel and the lambda sensor was calibrated once

³ EGR can also be used to improve the efficiency by reducing the throttling losses

7.4 Results

the fuel was changed. For each operating point measurements from 300 cycles were collected and an average of the collected data is presented in Table 12.

Table 12 The test matrix for the “Map” experiment

Engine Speed (RPM)	BMEP (Bar)
1000	Maximum
	8
	4
1250	Maximum
	11
	8
1400	Maximum
	12
	8
1600	Maximum
	11
	8
1700	Maximum
	11
	7
1800	Maximum
	11
	8
	4

7.4 Results

The results from the experiments are discussed in three parts and in the same order as it is mentioned in the experiment section.

7.4.1 Lambda response

In the first experiment the lean limit of the engine was investigated. The lean limit of the engine at 1000 RPM was extended from 1.6 to 1.8 by using the Hythane as fuel (see Figure 69). The sudden increase in cyclic variation of IMEP due to misfire in some cycles is used as an indication to identify the lean limit of the engine. The combustion duration becomes

7 Extending the Dilution Limit and Studying the Effect of Hythane on Combustion

longer as the engine operates leaner. Extension of the lean limit is due to faster burn rate and lower energy requirement for ignition of Hythane. For comparison it can be mentioned that the lean limit with the original pistons was 1.4 and was extended to 1.6 with the new pistons.

Average of combustion duration for all 6 cylinders is calculated and plotted over a lambda range for both fuels in Figure 70. Combustion duration is defined as the difference between the Crank Angle (CA) where 10% of the total heat is released (CA10) and the CA where 90% of the total heat is released (CA90). Combustion duration is shorter with Hythane due to the faster flame speed.

The difference is not much as the engine operates close to stoichiometric but as the engine operates leaner, the combustion duration increases and the difference is more obvious. Due to the higher burn rate of Hythane, the ignition timing is retarded to achieve MBT timing.

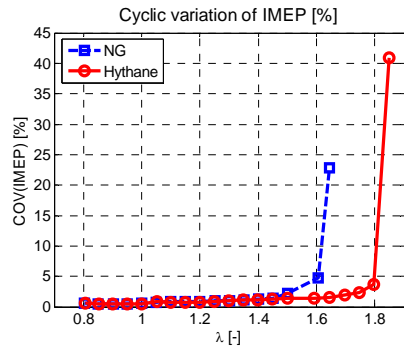

Figure 69 COV(IMEP) versus lambda

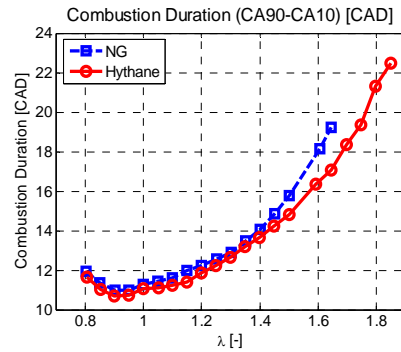

Figure 70 Combustion duration versus lambda

CA10 and CA90 for both fuels over the lambda range are plotted in Figure 71 and Figure 72. CA10 is retarded as a consequence of the retarded ignition timing but CA90 is the same for both fuels.

7.4 Results

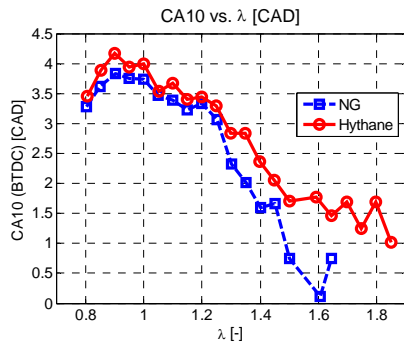

Figure 71 CA10 over lambda range for Hythane and natural gas

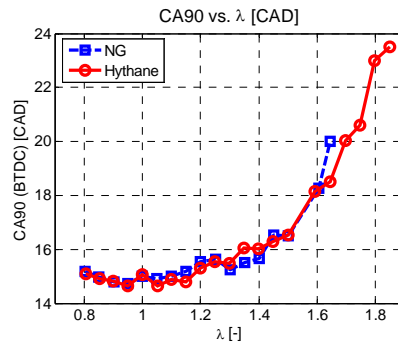

Figure 72 CA90 over lambda range for Hythane and natural gas

Unburned Hydro Carbon (HC) and Nitrogen Oxides (NO_x) are measured and calculated in form of specific emissions.

Specific NO_x versus Lambda

Figure 73 shows the specific NO_x over the lambda range. As the engine operates close to stoichiometric and goes up to lambda equal to 1.2, the in-cylinder temperature increases and as the engine operates leaner and leaner the in-cylinder temperature decreases. The fact that points to the proportional relation between temperature and NO_x generation can explain the trend in NO_x generation in Figure 73. The peak temperature in this experiment is close to lambda 1.2 which is the peak for NO_x generation. Due to the higher burn rate of Hythane, there will be higher peak in-cylinder temperature and consequently somewhat higher NO_x generation. NO_x emission reduces drastically as the engine operates leaner and as the lean limit extends from 1.6 to 1.8 the NO_x will be reduced to very low levels. The region close to the lean limit of the engine is zoomed in and showed in the same figure to the right. It shows that by operating the engine on its lean limit the NO_x emissions can be reduced by 90% (i.e. to 0.33 g/Kwh) with hythane compared to natural gas which is significant. This factor is especially important in lean operated natural gas engines where a Selective Catalytic Reduction (SCR) system is needed to reduce the NO_x emissions to lower levels. By operating the engine on Hythane it seems that it may not be necessary to use SCR. It is still a trade-off between NO_x emissions, HC emissions and efficiency, since by extending the lean limit the combustion becomes colder which reduces the

7 Extending the Dilution Limit and Studying the Effect of Hythane on Combustion

efficiency. A study should be performed to quantify the gains and the losses.

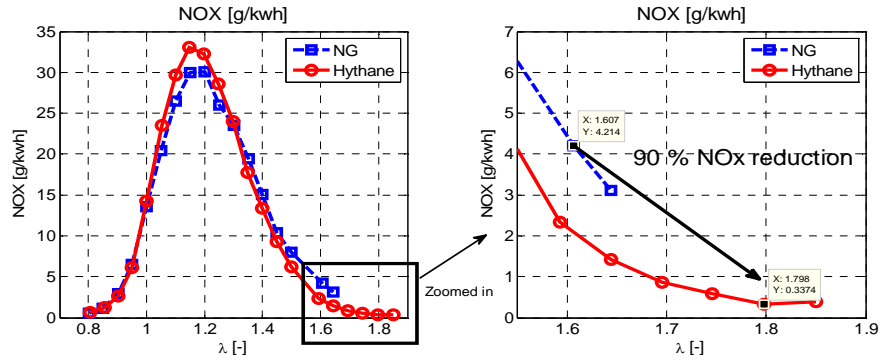

Figure 73 Specific NO_x emissions over lambda range for Hythane and natural gas are compared. NO_x emissions for operating points close to the lean limit is zoomed in, to clarify the benefits in NO_x reduction

Specific HC versus Lambda

As it is stated in Table 11 the H/C ratio of the natural gas is about 16% lower than for Hythane. Specific HC emissions for natural gas and Hythane are plotted over a lambda range see Figure 74. The figure shows almost 15% reduction in HC emissions which corresponds well to the higher H/C ratio of Hythane.

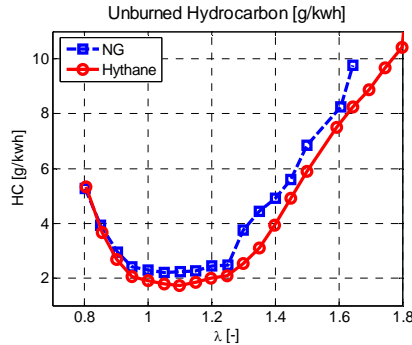

Figure 74 Specific HC over lambda range for Hythane and natural gas are compared.

Specific CO versus Lambda

Specific CO over a lambda range is presented in Figure 75 which shows almost a constant CO reduction with Hythane. The CO reduction is expected since Hythane contains lower carbon atoms than the natural gas.

7.4 Results

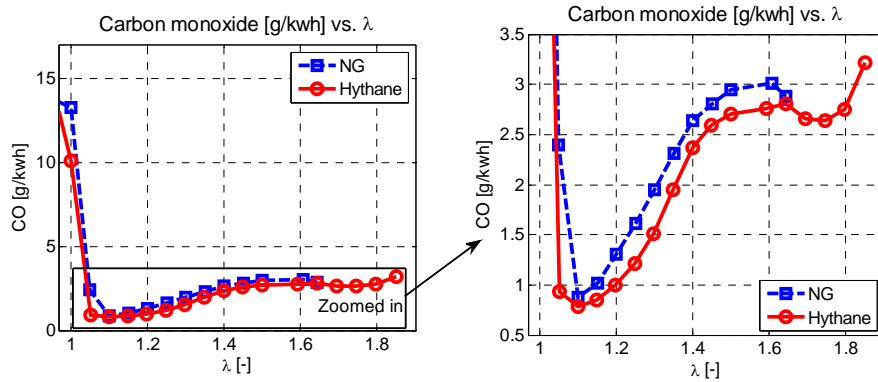

Figure 75 Specific CO emissions over lambda range for Hythane and natural gas are compared. New plot is generated to the right which shows the zoomed in area.

7.4.2 EGR response

In the second stage of the experiment, the dilution limit of the engine is investigated. By adding EGR the combustion becomes colder and combustion duration longer. The combustion duration over the EGR range of the engine is shown in Figure 76. With very high EGR rate, it gets difficult to ignite the mixture which results in misfire in some cycles and consequently a sudden increase in cyclic variation. Due to the lower ignition requirement of Hythane the dilution limit of the engine is extended from 26 to 30 percent compared to natural gas at 1000 RPM. This is shown in Figure 77 where the cyclic variation is plotted over the EGR range.

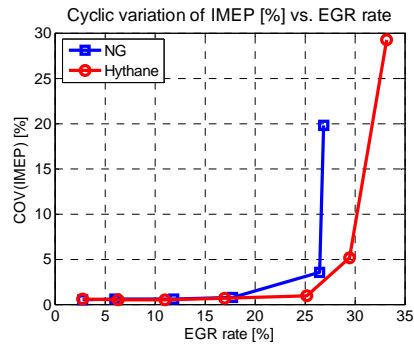
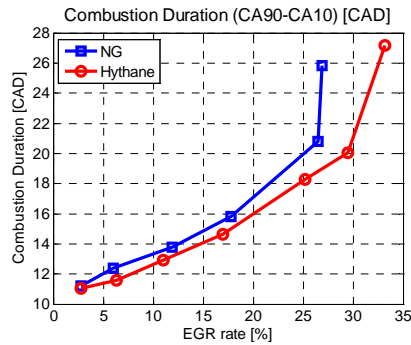

Figure 76 Combustion duration versus EGR rate
 Figure 77 COV(IMEP) versus EGR rate

7 Extending the Dilution Limit and Studying the Effect of Hythane on Combustion

It should be mentioned that the dilution limit of the engine with the original pistons at the same operating point was about 23 percent which was extended to 26% with the new pistons.

Specific NO_x versus EGR rate

By adding EGR the combustion temperature and oxygen concentration are reduced which results in lower NO_x generation. Since the dilution limit is extended by Hythane, the reduction in NO_x emissions at the dilution limit will be higher than with natural gas. The NO_x emissions over the EGR range is plotted in Figure 78. The operating region close to the dilution limit region in Figure 78 is zoomed in and presented in the same figure to the right. By extending the dilution limit from 26 to almost 30 percent EGR at this operating point, the NO_x emissions can be reduced by 34% which is a remarkable reduction. Normally it is beneficial to dilute stoichiometrically operated engines to improve efficiency and control knock. The engine uses a three-way catalyst to reduce all the three emissions i.e. NO_x , HC and CO simultaneously, so reduced engine-out NO_x emissions may result in using a cheaper 3-way catalyst. The NO_x reduction by extending the dilution limit can be compared to the NO_x reduction at the lean limit. The NO_x reduction by extending the lean limit was much greater but it should be kept in mind that stoichiometric operation allows the use of a 3-way catalyst.

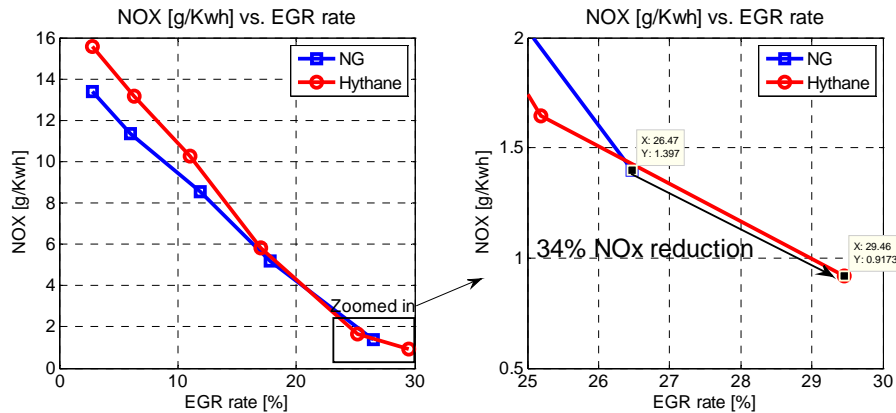

Figure 78 Specific NO_x emissions over EGR range for Hythane and natural gas are compared. The operating region close to dilution limit is zoomed in to the right, to clarify the benefits in NO_x reduction.

7.4 Results

The same trend for HC was observed as reported in the Lambda response section. HC emissions were reduced as Hythane was used since the H/C ratio is higher for Hythane.

7.4.3 Map

In the third stage of the experiments, the engine was operated from low to high load for a range of engine speeds. During this experiment the lambda was kept constant and equal to one i.e. stoichiometric operation. The ignition timing was adjusted to achieve MBT timing and EGR is only used to suppress knock when needed.

The main objective of this experiment was to investigate the knock sensitivity of the engine and also study the overall performance of the engine. The results are evaluated in terms of knock margin, emissions and efficiencies.

Knock Margin

The engine was equipped with a bypass turbocharger (i.e. turbocharger with wastegate) and due to that the knock occurs only at higher loads and engine speeds. To suppress the knock, EGR was added and the ignition timing was adjusted. The amount of EGR to suppress the knock is measured and plotted. Figure 79 shows this amount when the engine is operated with natural gas and Figure 80 shows the EGR amount when the engine is operated with Hythane. In these figures the EGR rate is plotted as a function of BMEP and engine speed. By operating the engine on Hythane, about 2 percent more EGR was used to suppress the knock.

The intent was to keep the inlet temperature constant at 42 degrees Celsius during the experiments. The control of the inlet temperature was performed manually by controlling the water flow in the intercooler. Since the control is manual, some variations (between 38-45⁰ C) in inlet temperature may occur especially at higher loads and engine speeds. Small variations in inlet temperature result in changes in the amount of air and consequently the fuel flow. This results in minor changes in the load. This may be the reason why the maximum load with hythane showed in Figure 80 is higher at some engine speeds than the corresponding point for natural gas in Figure 79. Normally when the engine operates on Hythane, due to the lower density of Hythane the maximum load achieved should be somewhat lower than the load achieved with natural gas. The lower

density is, to some extent compensated by the higher heating value of hythane.

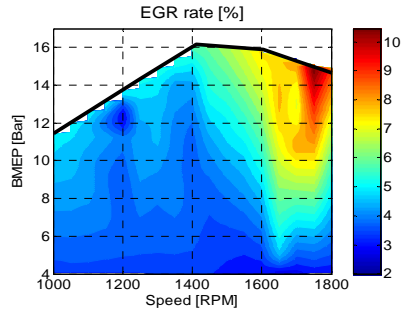

Figure 79 EGR requirement to suppress knock when the engine is operated with natural gas

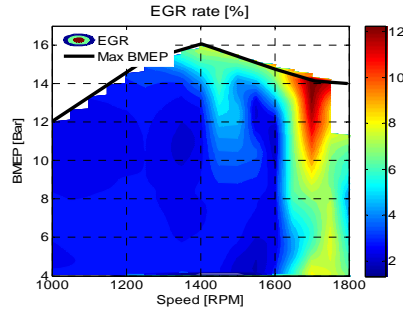

Figure 80 EGR requirement to suppress knock when the engine is operated with Hythane

Gas-exchange Efficiency

Gas-exchange efficiency is a measure to evaluate the pumping losses. Figure 81 and Figure 82 shows the Gas-exchange efficiency of the engine when it is operated with natural gas and Hythane respectively. The plots show that the gas-exchange efficiency is somewhat higher when the engine is operated with Hythane. This is due to the lower density of the Hythane which results in more throttles opening for the same amount of load. As mentioned in the Experiment section, EGR was only used to suppress knock and not to increase efficiency. If EGR were used, the Gas-exchange efficiency would be even higher for Hythane due to extended dilution limit.

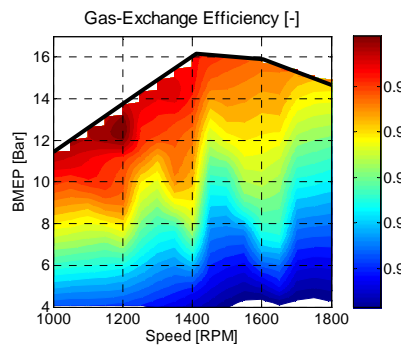

Figure 81 Gas-Exchange efficiency map with natural gas operation

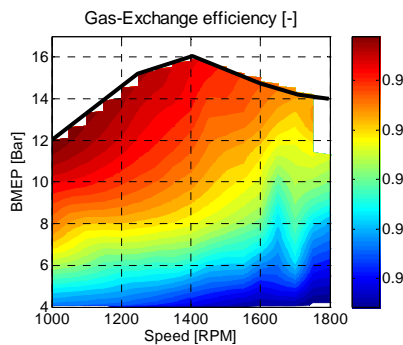

Figure 82 Gas-Exchange efficiency map with Hythane operation

7.4 Results

Gross-indicated Efficiency

Gross-indicated efficiency is a measure to evaluate losses in the form of exhaust energy, wall heat transfer, crevices and blow-by losses. According to Figure 83 and Figure 84 the Gross-Indicated efficiency is somewhat higher with natural gas. This can be explained by the fact that stoichiometric Hythane operation results in higher peak in-cylinder temperature and consequently higher heat losses. Figure 73 also confirms the fact that close to stoichiometric condition the higher peak temperature results in higher NO_x emissions. NO_x emissions for all operating points at stoichiometric operation for the fuels were obtained which support the statement (see Figure 9 and 10 in [62]). The statement which describes the reason for the lower gross-indicated efficiency with Hythane is not correct (In [62] on page 10) and the statement is corrected here.

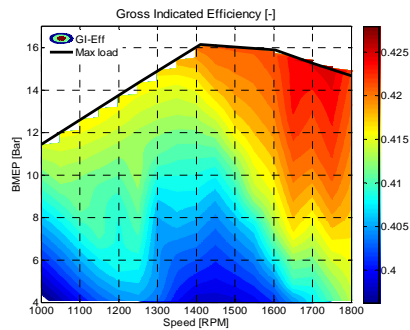

Figure 83 Gross-Indicated efficiency with natural gas

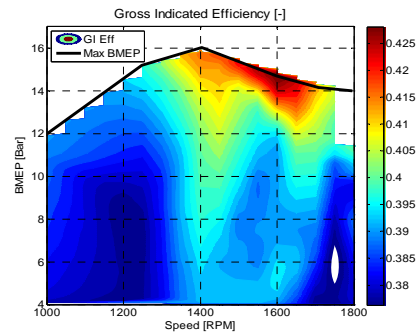

Figure 84 Gross-Indicated efficiency map with Hythane

No remarkable changes in the other efficiencies i.e. combustion and mechanical efficiency were observed. During the “Map” experiment, as mentioned previously, the engine was operated stoichiometrically. The NO_x emissions were higher and the HC emissions were lower with hythane than with natural gas. These results together with some other important results such as combustion duration, exhaust gas temperature, CA50 and boost pressure can be studied in detail in [62].

7.5 Concluding remarks

10 percent hydrogen was added to the natural gas in order to investigate the effect of hydrogen addition to some combustion parameters such as

knock margin, dilution limit, lean limit, emissions and efficiencies. Since no significant effects on the combustion were observed, a complementary study was performed with 25% hydrogen addition. Different experiments were designed and performed to study the mentioned combustion parameters. The following conclusions were obtained from the experiments:

- Lean limit of the engine is extended from 1.6 to 1.8 at 1000 RPM
- Dilution limit of the engine improved from tolerating 26% EGR to more than 30% EGR at 1000 RPM
- NO_x emissions are increased near stoichiometric operation due to higher combustion temperature with Hythane
- HC emissions are reduced due to the higher H/C ratio of Hythane
- Small changes are observed in knock margin of the engine due to the low ignition energy of Hythane.
- The gas-exchange efficiency of the engine is improved somewhat due to the lower density of Hythane. To achieve the same load level with Hythane the throttle should be opened more which results in lower throttling losses and thereby higher gas-exchange efficiency. The gas-exchange efficiency will be improved further with Hythane if EGR is used in the operating points with high pumping losses since the dilution limit is extended with Hythane.
- The gross-indicated efficiency was somewhat better with natural gas due to the lower peak temperature which results in lower heat losses.

By increasing the percentage of Hydrogen the gains in reduce HC and CO emissions and losses in terms of increased NO_x emissions are more obvious. By extending the lean and dilution limits of the engine the NO_x emissions will be reduced dramatically to very low levels. This is especially very advantageous for the lean operated natural gas engines due to the fact that they may not need to use any SCR.

Chapter 8

Conclusions & Discussion

A number of studies have been performed mainly to improve the performance of a heavy-duty 6-cylinder natural gas engine that operates stoichiometrically.

To reduce throttling losses at part load operation regions, the concept of closed-loop dilution limit control was developed. A new method to compute cyclic variation was developed which is well suited for transient operation. The dilution limit control coupled with the new method to compute cyclic variation resulted in very simple and cheap strategy to save fuel. Excellent steady-state performance was achieved as well as limited transient functionality.

A Model-based control strategy was suggested to improve the transient performance. State of the art System Identification was used to obtain an empirical model which subsequently was used in a Model Predictive Control structure. Model Predictive Control was shown to be a suitable method for controlling lambda as long as appropriate input variables are chosen for the model.

Since operating the engine at its dilution limit (at part load operation regions) reduces fuel consumption it is advantageous to extend the dilution limit. Increasing turbulence by replacing the combustion chamber resulted in much more turbulence and thereby faster combustion.

The compression ratio used in this type of engine is very conservatively chosen and can be substantially increased without risk of knocking. By increasing the compression ratio from 10.5 to 12, more energy is used in the cylinder rather than left in the exhaust which results in higher efficiency. The higher compression ratio results in lower exhaust gas

temperature and more margins for boost pressure and to the highest tolerable temperature by the engine.

The heavy-duty natural gas engines have higher exhaust gas temperature than diesel engines but it is still low enough to be tolerable for a VGT. A well-matched VGT will provide desired boost pressure and extend the maximum achievable output power. Load control using the VGT instead of the throttle was also successfully applied in a large operating region (due to its low boost threshold). This resulted in reduced throttle losses and thus increased efficiency.

With higher compression ratio and high boost pressure the knock tendency of the engine increases and there is need for fast and robust EGR control. A comparison between short route and long route EGR was performed and long route showed much better performance in terms of EGR rate, dynamics, mixing, and knock tolerance of engine.

These results show that by mixing different technologies and applying relatively small modifications, significant improvement in engine performance can be gained.

In summary the key features to improve the natural gas engine performance are identified as: Right amount of EGR at different operating regions, Right compression ratio, Variable Geometry Turbocharger, fast burn combustion chambers, Long route EGR system and model-based control.

Moreover, different experiments were designed and performed to identify and quantify the gains and possible drawbacks with Hythane. From the results it was concluded that Hythane is a more appropriate fuel for lean burn operation engines. By extension of the lean limit, NO_x emissions will decrease significantly which could make the NO_x aftertreatment redundant.

Chapter 9

Future Work

The main focus in this study has been on highlighting the potentials to improve the performance of a heavy-duty stoichiometrically operated natural gas engine. The key features for a high-performance natural gas engine were identified and state of the art controllers were developed. Lots of improvements were achieved however there is still room for more.

The author would like to suggest the following subjects of study for more improvements in engine efficiency and reliability:

- An efficient driving strategy was suggested in section 6.3.2. A control system which operates the engine with lowest possible throttle losses should be developed. The system should have a high performance at both steady-state and transient operation.
- The Miller-cycle is a well-known strategy to boost the efficiency by reducing the effective compression ratio while maintaining a high expansion ratio. It can be applied with different methods but due to the simplicity the variable valve actuation method is suggested here. A GT-power model for the engine is already developed. A good start is to quantify the gains in efficiency by simulating the Miller-cycle for the engine.
- LNG is liquefied natural gas at a pressure of 10-20 bars and a temperature of -162 degrees Celsius. To investigate the use of the cold energy is a very interesting subject. Theoretically there is a big potential to improve the engine performance (efficiency and maximum power level) by correct use of LNG. If it is injected at the right place (after compressor maybe) the mixture will be cold

resulting in increased knock resistance and consequently higher compression ratio can be used. The power density will also be increased.

- The engine uses multi-port injection strategy today. The natural step is to shift to direct injection for further improvement in transient performance, engine efficiency and engine power output.
- Dual-fuel (Natural gas/Diesel) is another interesting research area which deserves further investigation. Degree of freedom for choosing high compression ratio, adjusting the ratio of the fuels makes this concept very interesting.

Bibliography

- [1] Energy Information Administration (EIA), International Energy Annual 2005 (June-October 2007), web site www.eia.doe.gov/iea. Projections: EIA, World Energy Projections Plus (2008).
- [2] "World Proved Reserves of Oil and Natural Gas" US Energy Information Administration (2007). Retrieved on 2008-08-19
- [3] Internet source, Emissions standard
"http://www.dieselnet.com/standards/eu/hd.php#stds" 20101211
- [4] Internet source, LNG information "http://www.ch-iv.com/links/lng_information.html" 20101218
- [5] Internet source, ANG information
"http://www.energtek.com/solutions/adsorbed_natural_gas_technology" 20101218
- [6] P. Börjesson, L. Tufvesson & M. Lantz "Report 70 *Livscykelanalys av svenska biodrivmedel*" Department for Environment and Energy Lund University, 2010
- [7] J.B. Heywood, "Internal Combustion Engine Fundamentals", International edition, McGraw-Hill, New York, 1988
- [8] Internet source "http://www.iangv.org/" 20101218
- [9] B. Johansson, K. Olsson: "Combustion Chambers for Natural Gas SI Engines, Part 1: Fluid Flow and Combustion", SAE paper 950469, 1995
- [10] K. Olsson, B. Johansson: "Combustion Chambers for Natural Gas SI Engines, Part 2: Combustion and Emissions", SAE paper 950517, 1995
- [11] Patrik Einewall and Bengt Johansson "Combustion chamber for supercharged Natural Gas Engines" SAE Paper 970221
- [12] Patrik Einewall and Bengt Johansson "Cylinder to Cylinder and Cycle to Cycle variations in a Dix Cylinder Lean Burn Natural Gas Engine" SAE Paper 2000-01-1941
- [13] Patrik Einewall, Per Tunestål and Bengt Johansson "Lean Burn Natural Gas Operation vs. Stoichiometric Operation with EGR and a Three Way Catalyst" Lund Institute of Technology, SAE Paper 2005-01-0250
- [14] Patrik Einewall, Doctoral Thesis "Study and Development of Techniques to Improve Engine Stability and Reduce Emissions from Natural Gas Engines" Sweden, Lund, 2003

-
- [15] Internet source, Microstar Laboratories
“<http://www.mstarlabs.com/dataacquisition/5400/5400spec.html>” 20101207
- [16] Jan-Ola Olsson “The HCCI Engine – High Load Performance and Control Aspects” PhD Thesis, Lund University, Lund, Sweden 2004
- [17] P. Tunestål. “Estimation of the In-Cylinder Air/fuel Ratio of an Internal Combustion Engine by the Use of Pressure Sensors” PhD Thesis, Lund University, Lund, Sweden 2001
- [18] Younis, A. F. and Raine R.R., (2000), “Application of a New Technique for the Evaluation of Cycle-by-Cycle Variation of Completeness of Combustion to Changes of Compression Ratio”, SAE Paper 2000-01-1213.
- [19] Han, S.B. and Chung, Y.J.,(1999), “The Influence of Air-Fuel Ratio on Combustion Stability of a Gasoline Engine at Idle”, SAE Paper 1999-01-1488.
- [20] Jürgen Förster, Achim Gunther, Markus Ketterer, and Klaus-Jurgen Wald, “Ion current sensing for spark ignition engines”, SAE Paper 1999-01-0204.
- [21] André Saitzkoff, Raymond Reinmann, and Fabian Mauss, “In cylinder pressure measurements using the spark plug as an ionization sensor”. SAE paper No. 970857, pages 187– 197
- [22] M. Hellring, T. Munther, T. Rögnvaldsson, N. Wickström, C. Carlsson, M. Larsson, and J. Nytomt, “Robust AFR estimation using the ion current and neural networks”, SAE 1999-01-1161
- [23] A. Abdel-Rahim, N. Henein, E. Vandyne, “Ion current in a spark ignition engine using negative polarity on center electrode”, SAE 2007-01-0646
- [24] I. Andersson, L. Eriksson, “Ion sensing for combustion stability control of a spark ignited direct injected engine”, SAE 2000-01-0552
- [25] I. Haskara, G. Zhu, Ch. Daniels, J. Winkelman. “Closed loop maximum dilution limit control using in-cylinder ionization signal”, SAE 2005-01-3751
- [26] Lars Eriksson, Lars Nielsen, and Jan Nytomt, “Ignition control by ionization current interpretation”, SAE SP 1149, (SAE paper No. 960045):73–79, 1996.
- [27] Johansson, Bengt. “Förbränningsmotorer”, Book, Lund, Sweden 2004
- [28] M Kaiadi, P Tunestål, B Johansson: “Closed-Loop Combustion Control for a 6-Cylinder Port-Injected Natural gas Engine” SAE Technical Paper 2008-01-1722
- [29] M Kaiadi, P Tunestål, B Johansson: “Closed-Loop Combustion Control Using Ion current Signals in a 6-Cylinder Port-Injected Natural gas Engine” SAE Technical Paper 2008-01-2453
- [30] K-E Årzen, “Real Time Control Systems” Book, Lund, Sweden 2008
- [31] K-J Åström, “Control System Design” Book, Sweden 2002

10 Bibliography

- [32] 117 M. Heilig, "Kolvmaskiner AK", Avd. Strömmingsmaskiner, Lunds Tekniska Högskola, 1988
- [33] Mark J. Willis & Ming T. Tham "ADVANCED PROCESS CONTROL" Newcastle University, Newcastle upon Tyne, NE1 7RU, UK.
- [34] Aquino, C. F. (1981) "Transient a/f control characteristics of the 5 litre central fuel injection system SP-487". SAE 810494.
- [35] P. Andersson, L. Eriksson, L. Nielsen "Modeling and Architecture Examples of Model Based Engine Control" Linköping University, Sweden
- [36] Maciejowski, J. M. "Predictive Control with Constraints", Pearson Education, Essex, 2002.
- [37] P. Einewall, B. Johansson "Combustion Chambers for Supercharged Natural Gas Engine" SAE Technical Paper 970221
- [38] C. A. Amann "History of the Internal Combustion Engine" page 36, ICE--volume 8, New York, ASME 1989
- [39] B. Johansson, K. Olsson "Combustion Chambers for Natural Gas SI Engines Part 1: Fluid Flow and combustion" SAE Technical Paper 950469
- [40] K. Olsson, B. Johansson "Combustion Chambers for Natural Gas SI Engines Part 2: Combustion and Emissions" SAE Technical Paper 950517
- [41] R. Bosch GmbH "Automotive Handbook" Book, 6th edition, 2004
- [42] K. Miller "Turbo: Real-World High-Performance Turbocharger Systems (S-A Design)", 2004
- [43] H.H. Saravanamuttoo, G.F.C. Rogers, H. Cohen "Gas Turbine Theory" Book, 5th edition, 2001
- [44] I. Haskara, G. Zhu, Ch. Daniels, J. Winkelman. Closed loop maximum dilution limit control using in-cylinder ionization signal, SAE 2005-01-3751
- [45] R.H.L. Eichhorn, M.D. Boot, C.C.M. Luijten "Throttle Loss Recovery using a Variable Geometry Turbine" SAE 2010-01-1441
- [46] Alvon C. Elrod, Michael T. Nelson "Development of a Variable Valve Timed Engine to Eliminate the Pumping Losses Associated with Throttled Operation" SAE 860537
- [47] Allen J., Law D "Production Electro-Hydraulic Variable Valve-Train for a new Generation of I.C. Engines", SAE Paper Number 2002-01-1109, 2002.
- [48] D. Nehmer, L. Flueckiger, S. Bohac, C. Cowland, "Development of a Fully Flexible Hydraulic Valve Actuation Engine Part I: Hydraulic Valve Actuation System Development", Global Powertrain Congress, 2002
- [49] M. Kaiadi, P. Tunestal, B. Johansson "Improving Efficiency, Extending the Maximum Load Limit and Characterizing the Control-related Problems

-
- Associated with Higher Loads in a 6-Cylinder Heavy-duty Natural gas Engine” ASME, ICES2010-35012
- [50] Lennartson B. “Reglerteknikens Grunder” Holmbergs Malmö AB, Sweden 2008
- [51] M. Kobayashi, Y. Aoyagi, T. Adachi, T. Murayama, A. Noda, Y. Goto, H. Suzuki “Effect of High Boost and High EGR on the Super Clean Diesel Engine” COMODIA 2008, OS-A1
- [52] T. Glade, L. Ljung “Control Theory — Multivariable and Nonlinear Methods” Book, English edition, 2000
- [53] W. C. Strahle “An Introduction to Combustion”, Combustion Science and Technology Book Series, Vol. 1, Gordon and Breach Publishers, Amsterdam, 1993
- [54] N. Apostolescu and R. Chiriac “Optimum Control of S.I. Engine with a Lambda Capability” SAE Paper 960603
- [55] U. Kiencke, L. Nielsen “Automotive Control Systems, For Engine, Driveline, and Vehicle” end edition, 2004
- [56] K. Collier, R. L. Hoekstra, N. Mulligan, C. Jones and D. Hahn “Untreated Exhaust Emissions of a Hydrogen Enriched CNG Production Engine Conversion”, SAE Paper 960858
- [57] S. Munshi, C. Nedelcu, J. Harris, T. Edwards, J. R. Williams, F. Lynch, M. R. Frailey, G. Dixon, S. Wayne, and R. Nine “Hydrogen-Blended Natural Gas Operation of a Heavy-Duty Turbocharged Lean-Burn Spark Ignition Engine”, SAE Paper 2004-01-2956
- [58] G. Pede, E. Rossi, M. Chiesa, and F. Ortenzi “Test of Blends of Hydrogen and Natural Gas in a Light-Duty Vehicle”, SAE Paper 2007-01-2045
- [59] I. Saanum, M. Bysveen, P. Tunestål, S. Trajkovic “HCCI Combustion of Natural Gas and Hydrogen Enriched Natural Gas Combustion Control by Early Direct Injection of Diesel Oil and RME” SAE Paper 2008-01-1657
- [60] P. Tunestål, M. Christensen, P. Einewall, T. Andersson, B. Johansson “Hydrogen Addition for Improved Lean Burn Capability of Slow and Fast Burning Natural Gas Combustion Chamber” SAE Paper 2002-01-2686
- [61] M. Kaiadi, P. Tunestål and B. Johansson “Using Hythane as a Fuel in a 6-Cylinder Stoichiometric Natural gas Engine” SAE Paper 2009-01-1950
- [62] M. Kaiadi, P. Tunestål and B. Johansson “How Hythane with 25% Hydrogen can affect the Combustion in a 6-Cylinder Natural gas Engine” SAE Paper 2009-01-1950

Summary of Papers

11.1 Paper I

Closed-Loop Combustion Control for a 6-Cylinder Port-Injected Natural gas Engine

SAE Technical Paper 2008-01-1722

By Mehrzad Kaiadi, Per Tunestål, Bengt Johansson

High EGR rates combined with turbocharging has been identified as a promising way to increase the maximum load and efficiency of heavy duty spark ignition engines. With stoichiometric conditions a three way catalyst can be used which means that regulated emissions can be kept at very low levels. Open loop operation based on steady state maps is difficult since there is substantial dynamics both from the turbocharger and from the wall heat interaction. The proposed approach applies standard closed loop lambda control for controlling the overall air/fuel ratio for a heavy duty 6-cylinder port injected natural gas engine. A closed loop load control is also applied for keeping the load at a constant level when using EGR. Furthermore, cylinder pressure based dilution limit control is applied on the EGR in order to keep the coefficient of variation at the desired level of 5%. This way confirms that the EGR ratio is kept at its maximum stable level all times. Pumping losses decrease due to the further opening of the throttle, thereby the gas exchange efficiency improves and since the regulator keeps track of the changes the engine all the time operates in a stable region. Our findings show that excellent steady-state performance is achieved.

The first author designed the controllers, did the experiments, evaluated the data, wrote and presented the paper. During the process, active discussions were performed with other authors.

The paper approved and published in SAE International Journal of Fuel and Lubrication, ISSN Number: 1946-3960, Product Code: V117-4EJ

11.2 Paper II

Closed-Loop Combustion Control Using Ion current Signals in a 6-Cylinder Port-Injected Natural gas Engine

SAE Technical Paper 2008-01-2453

By Mehrzad Kaiadi, Per Tunestål, Bengt Johansson

In this paper a combustion stability parameter was derived from ion current signals which have been used for controlling the dilution limit of the engine. 6-Cylinder natural gas engine was the experimental engine which was operated stoichiometric. Operating engine stoichiometrically results in more throttling losses at lower loads. The proposed approach applies standard closed loop dilution limit control on the EGR in order to maximize EGR rate as long as combustion stability is preserved. Furthermore, lambda closed-loop control was applied for controlling the overall air/fuel ratio for keeping the catalyst working optimal. The proposed control strategy has been successfully tested on a heavy duty 6-cylinder port injected natural gas engine and our findings show that 1.5-2.5 % units (depending on the operating points) improvement in Brake Efficiency can be achieved.

The first author designed and performed the experiments, evaluated the data, wrote and presented the paper. During the process, active discussions were performed with other authors.

11.3 Paper III

Using Hythane as a Fuel in a 6-Cylinder Stoichiometric Natural gas Engine

SAE Technical Paper 2009-01-1950

By Mehrzad Kaiadi, Per Tunestål, Bengt Johansson

This paper gives an introduction about the importance of adding hydrogen to natural gas. Due to the attractive properties of Hythane such as higher H/C ratio and the lower ignition requirement, this fuel is suitable and has potentials to reduce emissions and increase efficiency. In

this study 10 percent hydrogen (by volume) was added to the natural gas. Different experiments were designed and performed to investigate the knock margin of the engine. It was also desired to quantify the gains and also identify the possible drawbacks with Hythane. With Hythane no significant differences on the engine performance were observed in this study.

The first author designed and performed the experiments, evaluated the data, wrote and presented the paper. During the process, active discussions were performed with other authors.

The paper approved and published in SAE International Journal of Fuel and Lubrication, ISSN Number: 1946-3960, Product Code: V118-4

11.4 Paper IV

Transient Control of Combustion Phasing and Lambda in a 6-Cylinder Port-Injected Natural gas Engine

ASME Technical Paper, ICES2009-76004

By Mehrzad Kaiadi, Magnus Lewander, Patrik Borgqvist, Per Tunestål, Bengt Johansson

This paper basically discussed the two different control designs to control combustion phasing and lambda. It is desirable to keep catalyst efficiency as high as possible which put demand on well-functional lambda control as lambda window is very narrow. Due to the time delay and the nonlinearity of lambda, a model predictive control strategy was suggested to control the lambda. The controller is designed and validated by experimental data. Moreover a feed-forward map combined with PI feedback controller was developed to assure MBT timing during transients.

The first author did the experiments, evaluated the data, wrote and presented the paper. During the control design process support discussions were performed with other authors.

The paper approved and published in ASME Journal of Engineering for Gas Turbines and Power, GTP-09-1196

11.5 Paper V

How Hythane with 25% Hydrogen can affect the Combustion in a 6-Cylinder Natural gas Engine SAE Technical Paper 2010-01-1466

By Mehrzad Kaiadi, Per Tunestål, Bengt Johansson

This paper is basically the continuation work on paper 3. Since no significant differences were observed in paper 3, more hydrogen was added (i.e. 25% by volume) and the experiments repeated. Since natural gas engines mainly operate stoichiometric or lean, a comparison was also performed to investigate the Hythane benefits with these two combustion concepts. The dilution and lean limit was extended, however the gains for lean operation natural gas engines are more.

The first author designed and performed the experiments, evaluated the data, wrote and presented the paper. During the process, active discussions were performed with other authors.

The paper approved and published in SAE International Journal of Fuel and Lubrication, ISSN Number: 1946-3944, Product Code: V119-4

11.6 Paper VI

Improving Efficiency, Extending the Maximum Load Limit and Characterizing the Control-related Problems Associated with Higher Loads in a 6-Cylinder Heavy-duty Natural gas Engine ASME Technical Paper ICES2010-35012

By Mehrzad Kaiadi, Per Tunestål, Bengt Johansson

This paper highlights the reasons for the lower overall efficiency and the lower maximum load limit of heavy-duty natural gas engines in compare with the corresponding diesel engines. Possible strategies in terms of engine modifications which may result in efficiency improvement and maximum load extension have been identified. These modifications are applied on engine pistons, turbocharging system and EGR system which is discussed in details. The efficiency is improved by at least 2 points percent and the maximum load were boosted from 16 bar BMEP to 19 bar.

The first author did the experiments, evaluated the data, wrote and presented the paper. During the process, active discussions were performed with other authors.

11.7 Paper VII

Reducing Throttle Losses Using Variable Geometry Turbine (VGT) in a Heavy-Duty Spark-Ignited Natural Gas Engine Draft JSAE 20119022 has been submitted

By Mehrzad Kaiadi, Per Tunestål, Bengt Johansson

Normally a throttle is used to control the desired torque in the engines, but it is also possible to use a VGT instead of the throttle in a large operating range to control the desired torque. This is possible due to the flexibility of using VGT to adjust inlet pressure by altering the geometry of the turbine housing. In this operation region the throttle is kept fully open and VGT is used to adjust the inlet pressure and finally control the demanded torque. This means that the throttle will not be used in a big operating region of the engine and no throttle use means, no throttle losses. This paper illustrates the feasibility of using VGT instead of throttle, in terms of efficiency gain and dynamics.

The first author did the experiments, evaluated the data and wrote the draft.

11.8 Other publications

Unburned Hydro Carbon (HC) Estimation Using a Self-Tuned Heat Release Method

SAE Technical Paper 2010-01-2128

By Mehrzad Kaiadi, Per Tunestål, Bengt Johansson, Karl Hedrick (UC Berkeley)

This paper is a result of 2 months internship work at UC Berkeley. The project is in scope of a cold-start project which is a co-operation between UCB and Toyota. This paper gives an introduction about the need for fast and online estimation of unburned hydrocarbon during cold-start. A model which uses a self-tuned heat release algorithm to estimate the emissions explicitly has been developed and validated by experimental

data. Moreover the relations between HC, CO and hydrogen has been investigated and presented.

The first author developed the model, evaluated the data, wrote and presented the paper. During the process, active discussions were performed with other authors.