



# LUND UNIVERSITY

## Thermal models of buildings : determination of temperatures, heating and cooling loads : theories, models and computer programs

Källblad, Kurt

1998

[Link to publication](#)

*Citation for published version (APA):*

Källblad, K. (1998). *Thermal models of buildings : determination of temperatures, heating and cooling loads : theories, models and computer programs*. [Doctoral Thesis (monograph), Building Science]. Department of Building Science, Lund Institute of Technology.

*Total number of authors:*

1

### General rights

Unless other specific re-use rights are stated the following general rights apply:

Copyright and moral rights for the publications made accessible in the public portal are retained by the authors and/or other copyright owners and it is a condition of accessing publications that users recognise and abide by the legal requirements associated with these rights.

- Users may download and print one copy of any publication from the public portal for the purpose of private study or research.
- You may not further distribute the material or use it for any profit-making activity or commercial gain
- You may freely distribute the URL identifying the publication in the public portal

Read more about Creative commons licenses: <https://creativecommons.org/licenses/>

### Take down policy

If you believe that this document breaches copyright please contact us providing details, and we will remove access to the work immediately and investigate your claim.

LUND UNIVERSITY

PO Box 117  
221 00 Lund  
+46 46-222 00 00

# **THERMAL MODELS OF BUILDINGS**

Determination of Temperatures,  
Heating and Cooling Loads.  
Theories, Models and Computer Programs.

Kurt Källblad

# Keywords

Building Physics	Energy	Thermal Models
Buildings	Heating Loads	Ventilation
Climate	Indoor Climate	Walls
Comfort	Infiltration	Windows
Cooling Loads	Rooms	
Computer Programs	Temperatures	

© Copyright Kurt Källblad and Department of Building Science,  
Lund University, Lund Institute of Technology, 1998.

Printed by KFS AB, Lund 1998

Report TABK--98/1015

THERMAL MODELS OF BUILDINGS, Determination of Temperatures,  
Heating and Cooling Loads. Theories and Computer Programs  
Lund University, Lund Institute of Technology, Department of Building Science

ISSN 1103-4467

ISRN LUTADL/TABK--1015--SE

Lund Institute of Technology  
Department of Building Science  
P.O. Box 118  
SE-221 00 LUND  
Sweden

Telephone: + 46 46 222 73 45  
Fax: + 46 46 222 47 19  
E-mail: [bk1@bk1.lth.se](mailto:bk1@bk1.lth.se)  
Homepage: <http://www.bk1.lth.se>

# Abstracts

The need to estimate indoor temperatures, heating or cooling load and energy requirements for buildings arises in many stages of a buildings life cycle, e.g. at the early layout stage, during the design of a building and for energy retrofiting planning. Other purposes are to meet the authorities' requirements given in building codes. All these situations require good calculation methods.

The main purpose of this report is to present the authors work with problems related to thermal models and calculation methods for determination of temperatures and heating or cooling loads in buildings.

Thus the major part of the report deals with treatment of solar radiation in glazing systems, shading of solar and sky radiation and the computer program JULOTTA used to simulate the thermal behavior of rooms and buildings. Other parts of thermal models of buildings are more briefly discussed and included in order to give an overview of existing problems and available solutions.

A brief presentation of how thermal models can be build up is also given and it is a hope that the report can be useful as an introduction to this part of building physics as well as during development of calculation methods and computer programs.

The report may also serve as a help for the users of energy related programs. Independent of which method or program a user select to work with it is his or her own responsibility to understand the limits of the tool, else wrong conclusions may be drawn from the results.

# Acknowledgment

For the help with the work presented here, I want to express my thanks to all people who have supported this work, those not mentioned below really not forgotten.

My supervisors, professor emeritus Bo Adamson and professor Bertil Fredlund, head of the department, for their great assistance and interest in my work. Dr Bengt Efrting who took part in the original development of the JULOTTA program as well as Dr Johan Claesson and Dr Wolfgang Feist for their valuable ideas and interesting discussions during the years.

My research fellows at our department, those at the School of Civil Engineering and the School of Architects in Lund and friends in different international research projects, especially within the IEA have all given many opportunities for constructive discussions.

The Swedish Council of Building Research, without their financial support some of the work had not been carried out.

Finally, I want to address a great thank to my wife Junia and my children for their support and understanding during the years.

Lund, April 1998

Kurt Källblad

# Contents

Abstracts	3
Acknowledgment	4
Contents	5
Nomenclature	7
1 Preface	9
1.1 Background	9
1.2 Methodology	10
1.3 Limitations	10
1.4 Contribution and Relation to Previous Work	11
1.5 Some Historical Notes	11
2 Introduction	16
2.1 Some Definitions	16
2.2 Comfort Parameters	17
2.3 Energy Flows in Buildings	19
2.4 Elements of Thermal Models	20
2.4.1 Temperature Nodes	21
2.4.2 Heat Flow between Nodes	22
2.5 Thermal Models of Building Components	24
2.5.1 Room air	24
2.5.2 Windows	25
2.5.3 LW radiation Exchange in a Room	25
2.5.4 Walls and Slabs	26
2.6 Thermal Model of a Room, an Example	27
3 Thermal Components	29
3.1 Volumes	29
3.2 Surfaces	31
3.3 Walls and Slabs	33
3.4 Windows	34
4 Solar Radiation	38
4.1 Solar Radiation at a Building	38

4.2	Co-ordinate Systems and Solar Angles	40
4.2.1	The Global Co-ordinate System	40
4.2.2	The Local Co-ordinate System	43
4.3	Radiation at Opaque Surfaces without Shading	44
4.3.1	Incident Beam Radiation	44
4.3.2	Incident Diffuse Radiation	45
4.3.3	Absorbed and Reflected Radiation	46
4.4	Radiation at Windows without Shading	47
4.4.1	Properties for a single pane	47
4.4.2	Properties for a multiple pane window	50
4.5	Shading of Beam Radiation	55
4.6	Shading of Diffuse Radiation	58
4.6.1	Opaque Surfaces	58
4.6.2	Windows	59
4.7	Distribution of Reflected Radiation	62
5	The JULOTTA Program	64
5.1	Background	64
5.2	Building Model	64
5.3	Input Data	64
5.4	Characteristics of JULOTTA	65
5.5	Applications of the JULOTTA Program	67
5.6	Conclusions	68
6	Conclusions and Further Developments	69
	References	70
	Appendix 1 Psychometrics	74
	Appendix 2. Solar Position Formulas	79

# Nomenclature

The most commonly used symbols are given here, other symbols are defined in the chapters they are used.

## Roman symbols

A	Area ( $m^2$ )
C	Heat Capacitance (J/K)
G	Heat Conductance (W/K)
G	Global irradiance or solar flux density ( $W/m^2$ )
$G_b$	Beam irradiance ( $W/m^2$ )
$G_d$	Diffuse sky irradiance on horizontal ( $W/m^2$ )
L	Radiance or radiant intensity ( $W/m^2, sr$ )
R	Thermal Resistance (K/W)
T	Temperature (K)
V	Volume ( $m^3$ )
Q	Heat flow (W)
c	Specific Heat (J/kg,K)
$c_p$	Specific Heat for Air at Constant Pressure (J/kg,K)
d	Thickness (m)
e	East-co-ordinate in a local system
$h_{eot}$	Equation of Time (h)
$h_{stt}$	Standard Time for a time zone (h)
$h_{tst}$	True Solar Time for a site (h)
q	Heat flow per unit area ( $W/m^2$ )
s	South co-ordinate in a local system
t	Time (s) or (h)



## Greek symbols

$\alpha$	Altitude
$\beta$	Tilt angle of a surface
$\gamma$	Azimuth, Orientation
$\delta$	Declination
$\varepsilon$	Emissivity
$\varphi$	Spherical co-ordinate, Longitude , Time Median
$\phi$	Angle
$\lambda$	Latitude, Thermal Conductivity (W/m,K)
$\theta$	Spherical co-ordinate
$\omega$	Hour angle
$\rho$	Density (kg/m <sup>3</sup> )

## Subscripts

aux	Auxiliary
c	Convective
i	Inner, Incident
il	Internal load
m	Mass
o	Outer
r	Room
s	Site
sun	Sun
v	Ventilation

# 1 Preface

The main purpose of this report is to present the authors work with problems related to thermal models and calculation methods for determination of temperatures and heating or cooling loads in buildings. Thus the major part of the report deals with treatment of solar radiation and heat transfer in glazing systems, shading of solar and sky radiation and the computer programs JULOTTA and DEROB-LTH. Other parts are more briefly discussed and included in order to give an overview of existing problems and available solutions.

A brief presentation of how thermal models can be build up is also given and it is a hope that the report can be useful as an introduction to this part of building physics as well as during development of calculation methods and computer programs.

The report may also serve as a help for the users of energy related programs. Independent of which method or program a user select to work with it is his or her own responsibility to understand the limits of the tool, else wrong conclusions may be drawn from the results. This is an increasing problem as so many programs nowadays are available on the market and only few of them are well verified and documented. During the last years more interest seems to be paid to the user's interface and less in the methods used. This is in a way a dangerous trend as when the programs get easier to use they are more often used by people without knowledge about the limits of used methods.

## 1.1 Background

The need to estimate indoor temperatures, heating or cooling load and energy requirements for buildings arises in many stages of a buildings life cycle.

At the early layout stage, the builder and his architect may need some basic ideas of the thermal behavior of the building. At this stage, very few data about the building may exist, thus simplified calculations methods may, or must, be used.

During the design of a building, more and more data are available, thus enable more and more sophisticated calculations. In the final design stage, the HVAC consultant must be sure that he can meet the builders requirements about indoor climate, energy consumption etcetera, thus good calculation methods are required.

In the early lifetime of a building the disagreements between estimated and used energy might be examined, especially if legal actions are taken against the consultants. Later, it can be of interest to use calculations to check the operation of the building, energy retrofitting may be considered etcetera. All these situations require good calculation methods.

Other purposes are the authorities' requirements. Building codes often require the use of prescribed methods to show that a building will meet the code. These

methods are seldom elaborate, but some codes allow that more complex methods may be used.

Within the building research establishments there are some important use of this type of calculations. One is generalization of results from experimental buildings and another is to perform parametric studies in order to get a broader understanding of different designs. Both situations arise as experimental building is rather expensive, thus it is not always possible to test ideas e.g. in different climate conditions with real buildings.

## **1.2 Methodology**

Within the field covered by this report it is rather difficult to define strict hypotheses and then test them. In many cases the hypotheses will look curious and only constructed in order to follow the scientific tradition instead of being useful to structure the work. One reason for this is that the report deals with applied physics rather than pure science, a common situation at an Institute of Technology.

E.g. if two programs deal with the same problem it might be important to discuss the limits for each of them and then conclude in which cases one of them is better or worse than the other. This should lead to a whole set of hypothesis like program A is better in case 1, program B in case 2 etcetera. I do not think this should make the presentation more clear.

Instead a systematic presentation is chosen where different parts of thermal models, calculation methods and computer programs are discussed. For each part advantages and disadvantages of used approaches are discussed and finally some conclusions are drawn.

## **1.3 Limitations**

The major part of the report deals with treatment of solar radiation in glazing systems, shading of solar and sky radiation and the computer program JULOTTA used to simulate the thermal behavior of rooms and buildings. Other parts of thermal models of buildings are more briefly discussed and only included in order to give an overview of existing problems and available solutions.

Of interest for simulation with the models discussed are periods from days to years with boundary conditions normally known at time steps of one hour.

The report is more focused on complex dynamic models of buildings than on simplified calculation methods. The latter was partly discussed in the author's licentiate thesis.

The report deals with net energy requirements for heating or cooling of buildings. Thus HVAC systems are not discussed in more details than necessary for including them in total models of rooms or buildings, e.g. performance of boilers, ventilation systems, cooling coils etcetera are excluded.

Special problems may occur when more extreme buildings or part of buildings as glazed courtyards or industrial halls should be examined. These problems are not covered in the report.

The basic physics, mathematics and numerical methods involved in various parts of thermal models of rooms and buildings are assumed as known from general textbooks and not included in the report.

## **1.4 Contribution and Relation to Previous Work**

The author's contribution within the aim of this report may be described without any specific order as follows.

- A systematic presentation of thermal models.
- Shading of solar and sky radiation.
- Some historical notes
- Treatment of solar radiation in windows.
- Use of an illustration technique for thermal models.

There are of course a lot of relations between the work presented here and previous and present work within this area of building physics. Contributions from the author as well as from others direct related to this report are referred to in each chapter.

## **1.5 Some Historical Notes**

These notes will mainly refer to my own experience and the situation in Sweden but similar experience and developments have of course occurred on other sites and in other countries.

In Sweden we can look back on two specific breakpoints in the developments of building codes and design tools during the last half century. In the 60:th the architects, influenced from US, started to design office buildings with much larger windows than used before and the oil crisis in 1973 influenced peoples thoughts about energy used for heating and cooling.

Other things that have influenced the development of design tools may be more specific for Sweden than for other countries. The earlier rather detailed building codes and the rules for governmental loans have forced the builders to particular designs. These codes and rules have been radically changed in later years.

The development of computers has also played an important role for development of more advanced design tools and the number of researchers working with programs for different building physic problems has increased, especially since the introduction of personal computers.

### **The Swedish Building Codes**

The Swedish building code was earlier aimed to force the builders to produce safety and healthy buildings and did not discuss the use of energy in any details as the cost of energy was low. Questions related to indoor temperatures were

focused on lowest acceptable air and inner surface temperatures, the later solved by setting a maximum allowed U-value for building components as windows and walls.

As a result of the code the consultants had to calculate the U-values by use of strict rules in the code in order to show the authorities that there constructions followed the code. The calculation of operative temperatures was also required and solved by use of diagrams.

Partly due to the code and partly to the costs the builders did not pay much attention in the use of energy, thus the calculation methods for heating systems where rather simple, sometimes only roles of the thumb.

In order to estimate the heating power required for a building some more serious consultants used steady state calculations built on the U-values of the building's envelope. But even more simple rules was used, e.g. in 1970 I rebuilt an old one family house situated in Malmö (in the South of Sweden) and the consultant designed the direct electrical heating system only on the bases of 200 W/m<sup>2</sup> living area. I changed the design.

The ventilation and air conditioning consultants were normally more advanced, especial when they dealt with cooling systems. But they often estimated the heating or cooling loads with the U-values and did not used dynamic calculations.

The annual energy requirement for heating was commonly calculated by the Degree Day method where the influence of solar radiation and internal loads was assumed to increase the indoor temperature by 3 C°.

After the oil crises in 1973 rules for efficient use of energy was included in the code and in the code from 1980 the use of more elaborate calculations was mentioned, e.g. for direct electrical heated buildings the code required 40% less energy use than a similar building with another heating system and this could be shown by using the BKL-Method, Källblad (1978).

In the newer building codes, NR (1989) and BBR 94 (1993), the energy use has been paid more attention and the requirements are formulated more as functions of the whole building than properties of single components. The builder may more freely choose different methods when to show that the requirements are met which also has influenced the development of new methods and computer programs.

### **Analogue Computers**

Before the digital computers was available a quit different technique was sometimes used, the active and passive analogue computers.

An active analogue computer was built with operation amplifiers and mainly used for solving differential equations, thus able to use in studies of dynamic heat transfer in e.g. walls and slabs. However, these computers were mainly used for simulation of industrial processes etcetera. An example from Kockum's shipyard in Malmö in the beginning of the 1960th was the simulation of a new submarine's reactions on rudder movements.

The passive analogue computers were built on the analogue between temperatures and heat flow with electrical voltage and current in a network of resistors and capacitors. At the Danish Institute of Technology a passive analogue computer was built and used for design of heating and cooling systems for buildings. At our department I designed one aimed to be used for education and another used to estimate optimal insulation of cold storage houses. However, the development of the digital computers made the analogue computer less interesting.

### **Program Developments in Sweden**

The changes in architecture during the 60:th gave buildings with larger windows and problems was noticed when some high raised buildings was built in the city of Stockholm and a clear need of dynamic models was observed in order to design solar shading and cooling equipment. At this time the main frame computers also became more common available in Sweden and the development of dynamic thermal models of buildings begun.

One of the first dynamic computer programs for determination of indoor climate, heating and cooling loads was developed by Brown, G. (1963). The program, named BRIS, used first principles of physics including non linear heat transfer phenomena and performed the calculations hour by hour for typical days. The program was written in a dialect of Algol developed for the experimental computer TRASK at the Royal Institute of Technology, KTH, in Stockholm. The program is still used but translated to a more modern programming language and is implemented on newer computers. Bring and Isfält at the Royal Institute of Technology (KTH) in Stockholm have also to a great extent been involved in the work with BRIS.

Another pioneer work in Sweden which should be mentioned was carried out at Svenska Fläkt AB where Sune Larm played a leading role developing the program VENTAC, partly in cooperation with KTH and our department. This program has been frequently used by Svenska Fläkt for design of HVAC systems in many different countries.

Professor Bo Adamson, the former head of our department, had an early interest in the development in this field. An experimental building with one room equipped with 500 thermocouples was built at the department in order to validate computer programs and some comparisons between the BRIS program and measurements was carried out. He also worked with simplified methods to predict indoor temperatures, Adamson, (1968).

In the end of 1968 I was employed at the department in order to maintain measurement equipment but became rather soon involved in the development of simulations models and programs as the BKL-Method mentioned above and the more elaborate program JULOTTA which will be discussed later in this report.

Our department has participated in several research project within the International Energy Agency (IEA), e.g. the very first one, Load Energy Determination of Buildings 1977-1980, U.S. Department of Energy (1981), in which Professor Adamson and I were engaged.

Later the modular programs have been of interest, e.g. IDA under development at the Institute of Applied Mathematics in Stockholm. The main idea of this project is briefly to have a library of modules e.g. a wall, a heater or a heat exchanger described both as a numerical model and as a graphical symbol. The user can build up more complex modules by connecting the graphical symbols on the screen thus forming an elaborate thermal model. After a total model has been finished the program will connect the corresponding numerical models and the user will be asked for necessary parameters where after the included solver can perform the required calculations.

### **Program Developments in some other Countries**

In the United States Mitalas (1967) and Stephenson (1967) were some of the pioneers with their work with response factors, the numerical method most program developers in US adopted for the building energy analysis. The response factors for heating and cooling load as functions of outdoor temperatures, solar radiation etcetera at constant indoor temperature was used, thus requiring linearization of all heat transfer phenomena. In many cases the main interest was to determine heating and cooling load at constant indoor temperatures.

Among other pioneers in the US Kusuda, T. (1978) and Lokmanhekim, M. (1971) should be mentioned. Both have carried out a lot of work within this field. Lokmanhekim was involved in several programs but especially known through his work with the program CAL-ERDA, later renamed to DOE, a program which more or less became a standard in the US. Use of weighting factors has also been added to this program and allows it to handle floating indoor temperatures.

Some programs in the US are built on the first principles of physics and allow non linear treatment of heat transfer problems. Among these is the BLAST program rather well known as well as the DEROB program from the University of Texas, Arumi-Noa, F., (1979). The DEROB program has been used on several sites and exists in many versions. One version, DEROB-LTH, was adopted at our department and has been further developed.

Most programs use a rather fixed thermal model of the building but the program TRNSYS, mainly developed at the University of Wisconsin with contributions from many others is somewhat different. The program consists of several modules, e.g. a room, a solar collector, a storage tank etcetera. The user has to build a thermal model for the whole building using these modules and describe how these are connected to each other.

Another modular approach is taken at Berkeley where the Energy Kernal System (EKS) is under development. Some of this work was done in connection with the development of IDA in Sweden.

The first Norwegian program, BYVOK, was written by Larsen, B. (1970) at the Norwegian University of Science and Technology in Trondheim after the principles used by Mitalas and Stephenson. Later, when I showed some serious errors when using BYVOK on heavy buildings, Børresen, B. started the development of DEBAC, a program build on the first principles of physics. Most European program developers also seem to have chosen this approach. Among later work in Norway related to this field is the study of atria by Bryn, I. (1992).

Aittomäki, A. (1971) gave the principles used in the Finnish program TASE which later has been further developed by Kalema, T. (1991). This program uses response factors to solve the heat flow through walls and slabs but uses non-linear equations for heat balance of the surfaces and air volumes thus enable non-linear treatment of e.g. convective film coefficients. As a curious detail it can be mentioned that the program used a differential method to calculate the response factors for the walls.

In Denmark the main development has been concentrated on the program TEMPFO, Andersen, B. (1972), later further developed and now known as TSBI. They also made an early work on climate data and produced a reference year for Denmark rather early, Andersen, B. et al (1974). The idea behind this reference year has later been adopted by the European Community.

An extensive study on thermal models of buildings has been carried out by Feist, W. (1994) in Germany and another study was done by Clarke, J. A. (1985) who developed the ESP program in the UK. Their reports are valuable sources for those interested in the field.



## 2 Introduction

The aim of this chapter is to give a brief introduction to the problems related to thermal behavior of buildings. Some used terms will be explained, some comments on comfort parameters and a brief overview of the energy flows in a building are given. How a thermal model of a room or a building can be built up and illustrated is also presented.

### 2.1 Some Definitions

A *Model*, as the term is used in this report, is a description of a real physical process. One can formulate a model as equations, a mathematical model, or illustrate it by a Figure, e.g. as discussed later in this chapter. A *Thermal model* is in this report used to describe heat transfer phenomena in and around a room or a building. A model may be an almost exact description of the real process, e.g. the Fourier's heat transfer equation in three dimensions used for a wall, but is often an approximation. The approximations can be of different levels, e.g. the Fourier's equation approximated by difference equations with different number of layers and different time steps. A model may be very simplified, e.g. a U-value approximately describing the heat flow through a wall in a steady state case.

The term *Simulation Method* is used for different ways to simulate a real process, e.g. calculation methods, studies of air movement in wind tunnels and water tanks or studies of heat transfer problems by use of analogue electrical networks or analogue computers.

A *Calculation Method* is build up with a mathematical model and the formats, numerical methods, algorithm etc. used to solve the equations in the model. This report will focus on calculation methods for heat transfer in rooms and buildings.

A *Computer Program* contains a calculation method and the program code used to carry out the calculations. As any model can be used, a computer program not necessarily includes a detailed model.

Heat flow between two points may be given as *Specific heat flow (Heat flow per unit area)* in  $W/m^2$ , or as total flow in W. It is common to use the further in e.g. the Fourier's equation and the later in e.g. a heat balance for the air in a room. However, when a thermal model for a room is build up, this will e.g. lead to that the convective heat transfer at an inner surface is represented by one value in the heat balance for the surface and by another value in the heat balance for the room air. The ratio between the values is of course only the area, but to clearly indicate that it is the same flow, the total heat flow will mainly be used throughout this report.

Heat transfer by radiation is commonly divided into two groups according to the wavelength. Radiation mainly within the visible spectra is in this report called *Short Wave Radiation (SW radiation)* or, if the source of the radiation is important, *Solar Radiation, Artificial Light* etcetera. For radiation with a wavelength above the visible spectra, as emitted from building surfaces, the ground or the sky, the term *Long Wave Radiation (LW radiation)* will be used.

Other common terms for LW radiation are infrared radiation and low temperature radiation.

## 2.2 Comfort Parameters

One of the main purposes of a building is to provide a suitable indoor climate. For dwellings and offices are different comfort parameters of interest and in storage houses mainly the room air temperature. Some commonly used comfort parameters are summarized in this paragraph. A more complete investigation of thermal comfort indices and heat stress indices can be found in Wang (1992, TABK--92/3004).

*The air temperature* is the simplest comfort parameter. However, as the human body reacts on both the air temperature as well as radiation exchange with the surrounding the air temperature is not sufficient to judge the humans comfort but never the less used in many cases. E.g. heating and cooling load are often calculated with a given indoor air temperature as the only requirement.

*The operative temperature* is a better comfort parameter as it includes the inner surface's temperature and thus takes into account that a human exchanges heat with the surrounding both by convection and radiation.

ISO 7730 (1994) gives following formula for the operative temperature.

$$v_o = A \cdot v_a + (1 - A)v_r \quad (^\circ\text{C}) \quad (2.2.1)$$

where  $A = 0.5$  for  $v < 0.2$  m/s

0.6 for  $v = 0.2$  to  $0.6$  m/s

0.7 for  $v = 0.6$  to  $1.0$  m/s

$v =$  Air velocity around the person (m/s)

$v_o =$  Operative temperature ( $^\circ\text{C}$ )

$v_r =$  Mean radiant temperature ( $^\circ\text{C}$ )

The air velocity is seldom known and a common way to calculate operative temperature is to use the arithmetic mean, i.e.  $A = 0.5$  is chosen.

*"The mean radiant temperature* in relation to a person in a given body posture and clothing placed in a given point in a room, is defined as that uniform temperature of black surroundings which give the same radiant heat loss from a person as the actual case under study", Fanger 1970. This definition leads to rather elaborate calculations and the result depends not only on the surface temperatures but also of clothing, air velocity and the placing in the room. A commonly used simplified formula is

$$v_r = \frac{\sum_j v_j A_j}{\sum_j A_j} \quad (2.2.2)$$

where  $A_j$  = Area of surface j ( $m^2$ )

$v_j$  = Temperature of surface j ( $^{\circ}C$ )

The *directed operative temperature* is sometimes used, e.g. in the Swedish building code SBN 80 where it is defined as the arithmetic mean of the room air temperature and the directed mean radiant temperature given by

$$v_{dr} = \sum_j \varphi_j v_j \quad (2.2.3)$$

where  $\varphi_j$  = View factor from an infinitesimal area to surface j

$v_{dr}$  = Directed radiant temperature ( $^{\circ}C$ )

$v_j$  = Temperature of surface j ( $^{\circ}C$ )

The directed operative temperature is often used to examine the asymmetry of the indoor climate and the Swedish building code had requirements on this temperature e.g. one meter from a window.

The most elaborate comfort parameters are the *Predicted Mean Vote (PMV)* and the *Predicted Percentage of Dissatisfied (PPD)* defined by Fanger (1970) and also accepted as an international standard, ISO 7730, 1994. These parameters require elaborate calculations and the result depends not only on the temperatures but also of clothing, air velocity and the placing in the room, thus normally not used in thermal models of rooms and buildings.

From the above it is obvious the at least the room air and the surface temperatures are needed in order to estimate the indoor climate. When these have been determined the comfort can be studied in more details. E.g. the PMV can be examined by the FRES program, Rømen, B.&Frydenlund. F. (1992), who uses the simplified Eq 2.2.2 to determine the mean radiant temperature.

A more detailed study about the determination of the PMV was carried out by Källblad (1996), where the COMFORT program also is documented. This program calculates the PMV according to Fanger's definitions and in the report some comparisons between different ways to examine the radiant temperature are carried out.

It is obvious from the above overview that knowledge about the indoor air temperature, the temperatures of the inner surfaces and solar radiation inside the room are needed in order to determine the indoor comfort. Thus many simplified thermal models are not sufficient for comfort determination.

## 2.3 Energy Flows in Buildings

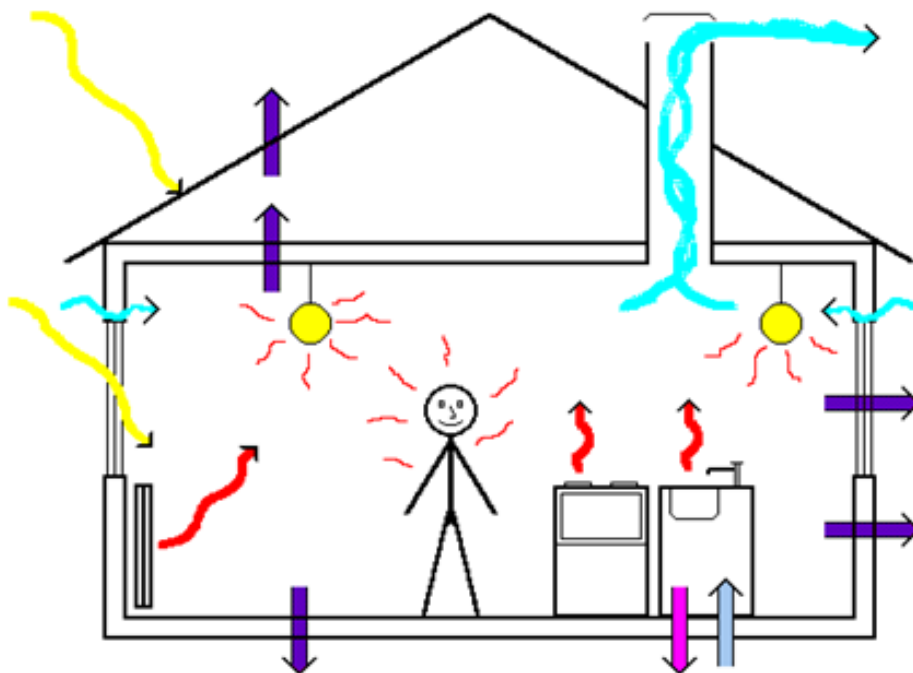

Figure 2.1 Main Energy Flows in a Building

The main energy flows within a building are schematically illustrated in Figure 2.1 where the total supplied energy can be divided into following areas.

- From Persons
- From Solar Radiation
- From Lighting, Electrical Equipment etcetera
- From Heating Systems
- From Hot Tap-water Systems

Energy from persons and solar radiation are often referred to as free heat. Sometimes the energy from lighting, hot tap water system etcetera also is considered as free heat, especially when heating loads are discussed.

The supplied net energy may be convective heat flow to the indoor air or radiation absorbed in building surfaces or furniture.

The energy losses are of three types:

Transmission Losses

Ventilation Losses

Sewage Losses

Transmission losses depend on the heat flows through the building envelope and include heat transfer phenomena as conduction, convection and radiation.

The ventilation losses are mass transfer phenomena and depend primarily on how much the inlet air must be heated or cooled. These losses are commonly

divided into infiltration due to leakage in the envelope and forced ventilation through the HVAC system.

The sewage losses depend on the amount of water used and the temperatures of the inlet and outlet water.

In order to calculate temperatures, heating or cooling loads for a building one have to create a mathematical model of the heat transfer phenomena in the building. This model can be very simple as e.g. in the Degree Day Method, when all losses are lumped together and the energy used for heating is described by a single equation. On the other hand, a very complex model with hundreds of differential equations and non linear equations coupled together can be used.

To make a complete model of all involved details in a building is almost impossible. Not only because of the elaborate calculations this will lead to, but also as a lot of necessary parameters for a complete model are more or less unknown, e.g. use of furniture, equipment etcetera. In order to overcome some of these problems, existing models often use one or more of the following assumptions.

- Uniform air temperature in each room/zone
- Uniform surface temperature on each wall or part of wall
- One-dimensional heat transfer in each wall or part of wall
- Diffuse distribution of solar radiation within rooms
- Diffuse gray surfaces according to LW radiation exchange
- All heat transfer treated as linear phenomena

The assumptions mentioned for walls also include slabs, roofs etcetera. Two- or three-dimensional heat transfer are sometimes included by approximations of different levels.

## 2.4 Elements of Thermal Models

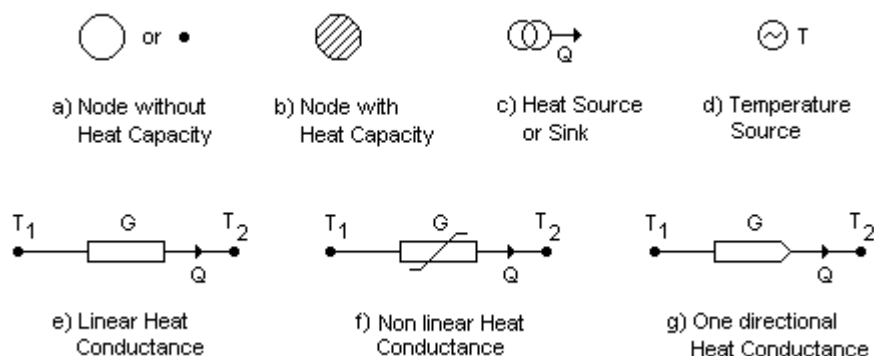

Figure 2.2 Illustrations of Thermal Model Elements

The symbols used in this report, of which the symbol for one directional heat flow is adopted from Claesson, J. (1990), are shown in Figure 2.2 and these will be discussed in following paragraphs.

## 2.4.1 Temperature Nodes

Each point of interest in a thermal model, e.g. the room air, an isothermal part of a wall surfaces or a window pane is referred to as a temperature node, or shortly a node. In a node, the heat capacity may be neglected and the node is then illustrated as in Figure 2.2a. If the heat capacity is taken into account the symbol in Figure 2.2b will be used.

Into each node heat flows from or to other nodes due to conduction, convection, radiation or mass transfer may occur. Furthermore, heat sources or sinks may be attached to a node. If all these flows are defined positive into the node, the heat balance of the node is, due to the fundamental laws of thermodynamics,

$$\sum_i Q_i = Q_c \quad (2.4.1)$$

where  $Q_i$  = Heat flow into the node (W)

$Q_c$  = Net heat flow stored in the node (W)

In cases when the heat capacity is neglected the net heat flow becomes zero, thus

$$\sum_i Q_i = 0 \quad (2.4.2)$$

For a node with heat capacity the change in temperature by time is described by

$$C(T) \frac{dT}{dt} = Q_c \quad (2.4.3)$$

where  $C(T)$  = Heat capacitance (J/K)

$T$  = Temperature of the node (K)

$t$  = Time (s)

E.g. a node representing a layer in a solid wall has the heat capacitance

$$C = c(T)\rho(T)d_{wl}A \quad (\text{J/K}) \quad (2.4.4)$$

where  $c(T)$  = Specific heat (J/kg,K)

$\rho(T)$  = Density (kg/m<sup>3</sup>)

$d_{wl}$  = Thickness of the wall layer (m)

$A$  = Area of the layer (m<sup>2</sup>)

Nodes within solids are, when the heat capacity is included, sometimes called mass nodes. The temperature dependency of the specific heat and density are often neglected for mass nodes.

### Heat Sources and Sinks

Solar radiation absorbed in surfaces, internal heat loads, auxiliary heat from heating systems etcetera represent different heat sources and are illustrated as in Figure 2.2.c. where the arrow indicates the positive flow direction. With the

arrow in the opposite direction, or with a negative value of  $Q$ , the symbol will represent a heat sink, e.g. a cooling fan-coil.

The main characteristic of a heat source or sink is that the heat flow is not dependent on the components connected to it. However, the heat flow may be limited in size or controlled by a temperature in the model.

### Temperature Sources

An independent temperature, e.g. the outdoor air temperature, is sometimes called a temperature source and represented with the symbol in Figure 2.2.d. The symbol is often used to distinguish nodes representing boundary variables from those representing unknown variables in the model.

The main characteristic of a temperature source is that the given temperature is not influenced by the components connected to it, but the temperature may be controlled by a temperature in the model.

## 2.4.2 Heat Flow between Nodes

Between two nodes different heat transfer phenomena may occur. In cases where the direction of heat flow only depends on the temperatures of the nodes, the heat flow can be described by the equation

$$Q_{1-2} = G(T_1, T_2)(T_1 - T_2) \quad (\text{W}) \quad (2.4.5)$$

where  $G(T_1, T_2)$  = Heat conductance (W/K)

$T_i$  = Temperatures of the nodes (K)

The reciprocal value of the heat conductance is called the heat resistance and given by

$$R = \frac{1}{G} \quad (\text{K/W}) \quad (2.4.6)$$

Figure 2.2.e illustrates a heat conductance connecting two nodes. The arrow in the figure defines the positive direction of heat flow and should not be mixed up with the real direction of the flow. In cases when  $T_1 < T_2$  Eq 2.4.5 will give a negative flow indicating that the flow in fact is toward  $T_1$ .

In cases of non linear heat transfer, the conductance will depend on  $T_1$  and/or  $T_2$  as showed below in some examples. The heat conductance can in this case be illustrated as in Figure 2.2.f in order to indicate that the conductance is non linear but also as in Figure 2.2.e if it is obvious that a non linear phenomena is described.

### Example 1, Conduction

E.g. between two nodes in a solid wall, the heat transfer may be assumed as linear and the conductance is then given by

$$G = \frac{\lambda A}{d} \quad (\text{W/K}) \quad (2.4.7)$$

where  $\lambda$  = Conductivity (W/m,K)

A = Area (m<sup>2</sup>)

d = Distance between the nodes (m)

### Example 2, LW radiation

The LW radiation between two nodes may be described by

$$Q = \sigma \varepsilon_{res} A_1 F_{1,2} (T_1^4 - T_2^4) \quad (\text{W}) \quad (2.4.8)$$

where  $\sigma$  = Stefan Boltzmanns constant

$\varepsilon_{res}$  = Resulting emissivity of the surfaces

$A_1$  = Area of surface 1

$F_{1,2}$  = View factor (depends on the geometry)

In this case we get

$$G(T_1, T_2) = \sigma \varepsilon_{res} A_1 F_{1,2} (T_1^2 + T_2^2)(T_1 + T_2) = Q / (T_1 - T_2) \quad (2.4.9)$$

### Example 3, Mass flows

In ventilation systems as well as between rooms in a building, air is often moved in a specific direction between rooms and/or the outdoor air. If air is taken from one room to another and no air is flowing in the opposite direction, a conductance cannot be used in order to represent the situation. Here, the symbol in Figure 2.2.g is used in order to indicate that the heat flow only influences the node T<sub>2</sub>. The heat flow can still be described by e.g. Eq 2.4.5 but should only be included in the heat balance for the node T<sub>2</sub>.

E.g. air exchange (same amount of air going in both directions) between two nodes (T<sub>1</sub> and another T<sub>2</sub>) may be described as

$$Q = c_p \rho(T_1) v(T_1) (T_1 - T_2) \quad (\text{W}) \quad (2.4.10)$$

where  $c_p$  = Specific heat at constant pressure (J/kg)

$\rho(T_1)$  = Density of air (kg/m<sup>3</sup>)

$v(T_1)$  = Volume flow (m<sup>3</sup>/s)

In this case, the conductance becomes

$$G(T_1, T_2) = c_p \rho(T_1) v(T_1) \quad (2.4.11)$$



## 2.5 Thermal Models of Building Components

Using the elements discussed above more complex thermal models of building components can be build up. In this paragraph some example will be given in order to illustrate the technique.

In the models solid lines are used to show how different elements are connected. If lines are connected with a dot they represent connections to the same node.

### 2.5.1 Room air

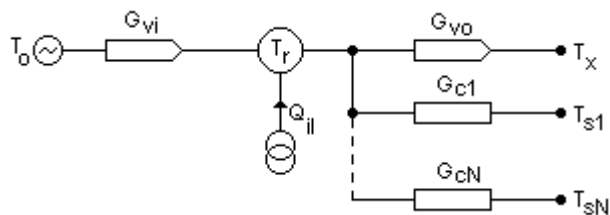

Figure 2.3 Thermal model of the Room Air

It is normally assumed that the building does not influence the outdoor air, thus this temperature is represented as a temperature source ( $T_o$ ).

The room air is assumed to be at an uniform temperature, thus represented by a single node ( $T_r$ ), and the heat capacity of the air is neglected. The heat from convective internal loads is given by  $Q_{il}$  and connected to the room air node.

The inlet air from the outdoor air is represented by  $G_{vi}$  and the outlet air by  $G_{vo}$ . As both these are directional only the first will influence the heat balance of the studied room. The node  $T_x$  may e.g. be another room.

The inner surfaces are represented by the nodes  $T_{si}$  and the convective heat transfer to these are represented by the conductance  $G_{c1}$  through  $G_{cN}$ .

As the heat capacity of the room air is neglected, the heat balance equation becomes

$$Q_{il} + G_{vi}(T_o - T_r) + \sum_i G_{ci}(T_{si} - T_r) = 0 \quad (2.5.1)$$

Here it can be noted that  $G_{vo}$  and  $T_x$  are not included as there is no air going from the node  $T_x$ .

If the room air is divided into temperature zones each zone has to be represented by a node and the heat flows between the zones by additional conductances.

## 2.5.2 Windows

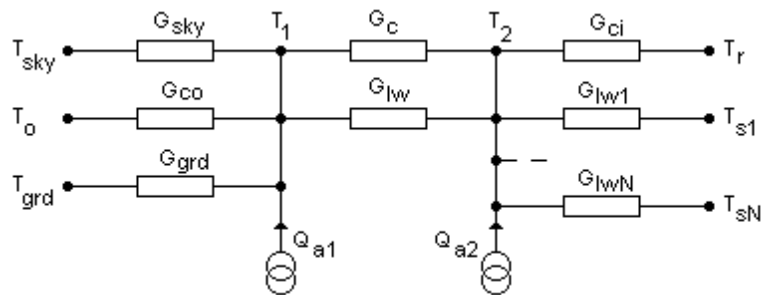

Figure 2.4 Thermal Model of a Double Pane Window

The double pane window is in Figure 2.4 modeled with one node for each pane ( $T_1$  and  $T_2$ ). The heat capacities of the panes are neglected.

On the outside the window is connected to the outdoor air with a conductance  $G_{co}$  representing the convective exchange with the outdoor air. The LW radiation exchange with the sky ( $T_{sky}$ ) and the ground ( $T_{grd}$ ) are represented by  $G_{sky}$  and  $G_{grd}$ .

Between the panes and on the inside the convection is modeled with the conductance  $G_c$  respective  $G_{ci}$ .

The LW radiation exchange with the other inner surfaces is represented by  $G_{lwi}$ .

The absorbed solar radiation absorbed in the panes are represented by the heat sources  $Q_{a,i}$  as the absorbed radiation is not dependent on the temperatures of the panes.

The heat balances of the panes in the window are thus

$$Q_{a,1} + G_o(T_o - T_{w1}) + (G_{LW} + G_c)(T_{w2} - T_{w1}) = 0 \quad (2.5.2)$$

$$Q_{a,2} + (G_{LW} + G_c)(T_{w1} - T_{w2}) + G_{ci}(T_r - T_{w2}) + \sum_i G_{LW,i}(T_{s,i} - T_{w2}) = 0 \quad (2.5.3)$$

## 2.5.3 LW radiation Exchange in a Room

The LW radiation exchange between four surfaces ( $T_{si}$ ) is illustrated in Figure 2.5 where  $G_{ij}$  represent the heat flow between surface  $i$  and  $j$ . Each of these conductances may be determined according to Eq. 2.4.9.

The figure also illustrates that it sometimes is necessary to allow lines representing different temperatures to cross each other in which case they are not connected by a dot.

When more complex models are used all LW radiation may be illustrated as in the right part of Figure 2.5.

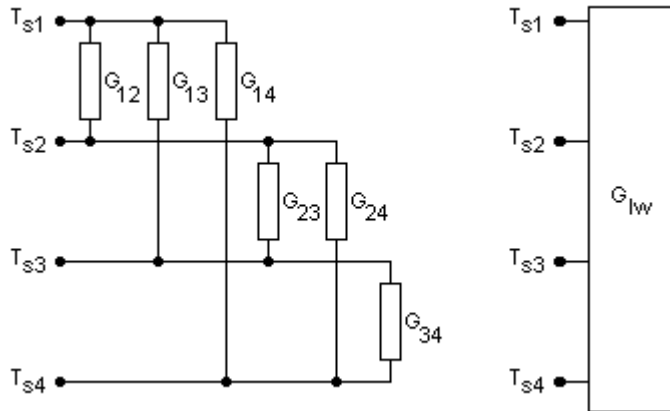

Figure 2.5 Thermal Model of LW Radiation Exchange in a Room

### 2.5.4 Walls and Slabs

For the heat transfer by conduction in walls and slabs the heat capacity must in most cases be taken into account and the Fourier's heat transfer equation be used. In most cases this equation must be treated by differential approximations where the heat capacity e.g. is lumped into a finite number of internal nodes as illustrated in this paragraph. It is also possible to use an approximation that gives surface nodes with heat capacity. Both approximations give the Fourier's equation for one dimensional heat transfer if the number of internal nodes goes to infinity.

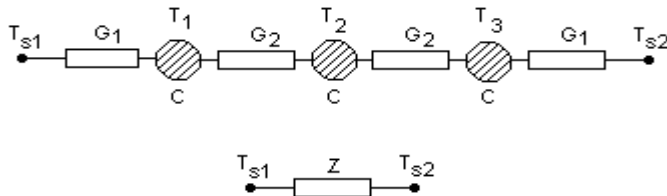

Figure 2.6 Thermal Model of a Wall

An one-dimensional model for a wall with uniform surface temperatures is shown in Figure 2.6. In the upper part of the figure the details in the model are shown. In more complex models the details may be hidden and the wall illustrated by a single impedance ( $Z$ ) as shown in the lower part of the figure.

In this example a homogenous wall is assumed and the wall is modeled by three layers of equal thickness. The heat capacity in each layer is placed in the center of the layer. Using Eq. 2.4.4 and 2.4.7 we obtain for a wall with the thickness  $d_w$ .

$$G_1 = \frac{6A\lambda}{d_w} \quad (\text{W/K}) \quad (2.5.5)$$

$$G_2 = \frac{3A\lambda}{d_w} \quad (\text{W/K}) \quad (2.5.6)$$

$$C = \frac{Ac\rho d_w}{3} \quad (\text{J/K}) \quad (2.5.7)$$

Assuming the same surrounding for the wall as for the window in Figure 2.4 the heat balance for the surfaces ( $T_{s1}$  and  $T_{s2}$ ) became

$$Q_{a1} + G_o(T_o - T_{s1}) + G_1(T_1 - T_{s1}) = 0 \quad (2.5.8)$$

$$Q_{a2} + G_1(T_3 - T_{s2}) + G_{ci}(T_{s2} - T_r) + \sum_j G_{lw,j}(T_{sj} - T_{s2}) = 0 \quad (2.5.9)$$

According to Eq. 2.4.3 and 2.4.5 the heat balances of the mass nodes are

$$C \frac{dT_1}{dt} = G_1(T_{s1} - T_1) + G_2(T_2 - T_{m1}) \quad (2.5.10)$$

$$C \frac{dT_2}{dt} = G_2(T_1 - T_2) + G_2(T_3 - T_2) \quad (2.5.11)$$

$$C \frac{dT_3}{dt} = G_2(T_2 - T_3) + G_1(T_{s2} - T_3) \quad (2.5.12)$$

## 2.6 Thermal Model of a Room, an Example

The models of different building components described above can now be used to build up models of rooms or buildings. As an example a model of a room will be illustrated in this paragraph and some parts of the model are shown in Figure 2.7. The room in question is very simple and contains four walls, a roof, a floor and a double pane window.

The room air ( $T_r$ ) as well as each surface ( $T_{so}$  and  $T_{si}$ ) are assumed to be at uniform temperature, thus each represented by a single node

The impedances  $Z_1$  through  $Z_5$  represent the roof and the walls which on outside are connected to the outdoor air ( $T_o$ ) and the sky ( $T_{sky}$ ). The LW radiation exchange between these outer surfaces and the ground is neglected. The floor  $Z_6$  is on the outside connected to an independent ground temperature ( $T_{grd}$ ).

The double pane window is modeled as illustrated in the last paragraph but the LW radiation between the outer pane and the ground is neglected.

Between all inner surfaces heat exchanged by LW radiation is taken into account and illustrated by the network  $G_{lw}$  which is a simplified illustration of the 21 conductances needed to give a full illustration.

The convective heat transfer between the room air and the inner surfaces are represented by the conductances  $G_{ci}$ , the ventilation losses by  $G_v$  and the heat source  $Q_{ij}$  illustrates convective internal loads to the room air.

In order to formulate a mathematical model of the thermal model in this example six differential equations coupled with six equations for the outer surfaces and an equation system with nine unknown variables (inner surfaces,

the room air and the outer pane) are needed. Furthermore the equations and the equation system normally are non linear.

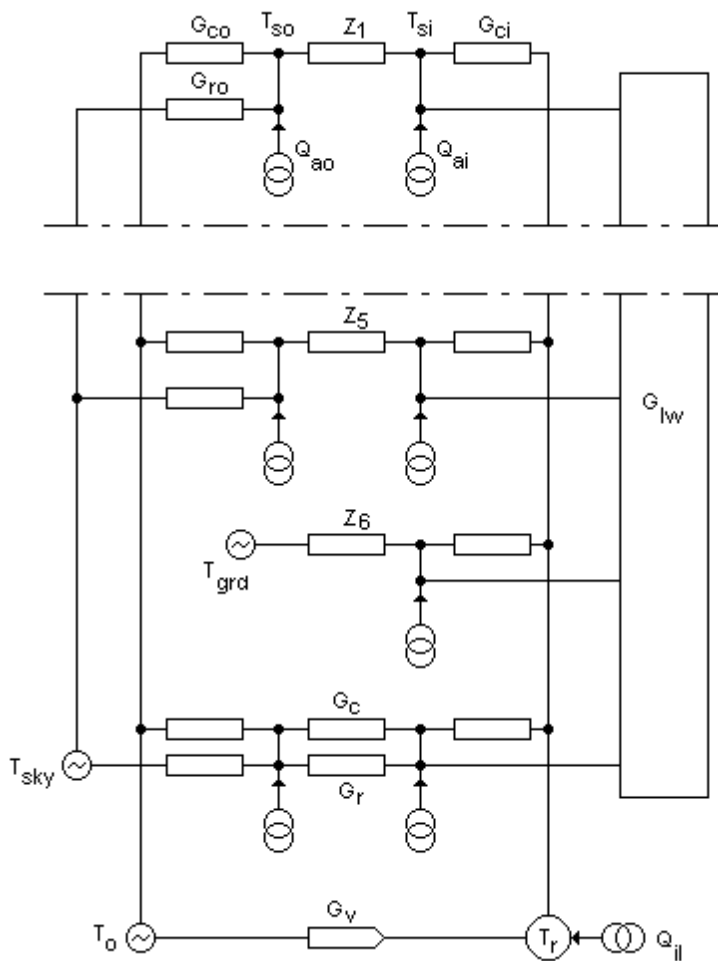

Figure 2.7 Part of a Thermal Model of a Room

When the model then should be used, the differential equations have to be approximated e.g. with difference equations and all equations must be solved simultaneously for each time step. The boundary conditions as outdoor air temperature, solar radiation and internal heat load must be given for each time step. Furthermore, solar angles, shading and distribution of the solar radiation must also be calculated for each time step.

When studying the thermal behavior of a building it is often necessary to simulate periods of up to a whole year's usage with a time step of one hour or less. A computer program is obvious needed even with a simple model as in this example.

## 3 Thermal Components

In this chapter thermal model components will be discussed. The major aim of the chapter is to point out some problems that occur when a thermal model of a building is created and to give references where the reader can find solutions to these problems. The paragraphs are chosen in order to get a systematic presentation but, due to the interactions between different parts of a building, this is not always possible.

### 3.1 Volumes

Detailed treatment of air movements in a volume leads to elaborate calculations with the use of Navier-Stokes' equations. With programs like PHENIX and FLOVENT and a fast PC it can take several hours to solve the equations for one room at a single time step. These calculations are thus too complex to include in a model for energy calculations as we normally want to treat longer periods as heating seasons or years. Thus, the first step is to approximate the enclosures into one or more zones, each with uniform temperature represented by a single node.

Typically one zone for each room is used for residential buildings and in large offices several zones may be defined. Then the heat balance of each zone is used to build up the thermal model for the volume.

Even if a room is treated as a single zone it might be important to treat the temperature differences at different height levels in a room. The Swedish building code SBN1980 gives different slopes depending on the used heating systems which might be used.

In Figure 2.3 a thermal model of a single air node is illustrated. If the heat capacity of the air,  $C_r$ , is taken into account and we assume internal heat load,  $Q_{il}$  and auxiliary heat from a convective heater,  $Q_{aux}$ , we get the heat balance at the node as

$$C_r \frac{dT_r}{dt} = Q_{il} + Q_{aux} + \sum_{i=1}^{N_s} G_{ci} (T_{si} - T_r) + \sum_{i=1}^{N_v} G_{vi} (T_{vi} - T_r) \quad (3.1.1)$$

where the first sum represents the convective heat flows from the room's surfaces and the second the air inlet from other rooms or from the outdoor air. The equation is also valid for cooling in which case  $Q_{aux}$  represents the cooling load.

The equation is used in two different situations, namely if the room air temperature is unknown or if the heating (or cooling) load is unknown. In the first case the auxiliary heat is zero or e.g. controlled by an outdoor thermostat and thus a function of the known outdoor air temperature. In the other case the room air temperature is assumed to be known, e.g. controlled by an indoor thermostat.

## Heat Capacity

If the ventilation losses are neglected the time constant for the room air can be defined as

$$\tau = \frac{C_r}{\sum_{i=1}^{N_s} G_{ci}} \quad (3.1.2)$$

The heat capacity of the room air is rather low, e.g. in a room with a volume of 50 m<sup>3</sup> about 15 Wh/K. If the area of the room surfaces is 45 m<sup>2</sup> and the convective film coefficient 3 W/m<sup>2</sup>,K the time constant will be around 7 minutes. Taking the ventilation into account will give a much shorter time constant. Thus the heat capacity can be neglected as the periods of interest here are much longer.

Jóhannesson, (1981), studied the possible inaccuracy when this approximation was used and draw the conclusion “The approximation holds down to a period of 2 hours which is quite sufficient if input data are given by hourly values.”

Furthermore, when heating or cooling is studied the indoor temperature is controlled in some way. If the control system is assumed to be perfect the temperature variation is zero. With a real indoor thermostat the temperature will vary some degrees but the average value over the periods of interest may still be assumed as constant. Thus the left hand side of Eq. 3.1.1 can be set to zero in these cases independent of the heat capacity.

## Internal Loads

The internal loads consist of heat from e.g. people and electrical appliances as lighting etcetera. The metabolic rate from a person is between 80 to 140 W depending on type of activity and the convective part of this heat is included here. Heat from lighting, TV sets etcetera are mainly convective loads but more difficult is to estimate heat from e.g. washing machines where a lot of hot water is wasted.

## Auxiliary Heat

A commonly used approximation of the heating system is to assume pure convective heat sources. However, the auxiliary heat is, at least in residential buildings, most often supplied by radiators from which the heat transfer is partly radiative. The problem to model the convective part and the interaction between the thermal plumes and the inner surface of a window has been discussed by Kalema, T. (1991).

## Convective Heat Transfer

The convective heat conductance depends on the film coefficient  $h_c$  and the area of the surface.

$$G_{ci} = h_{ci} \cdot A \quad (\text{W/K}) \quad (3.1.2)$$

The film coefficient depends on several parameters as the orientation of the surfaces, temperature differences, laminar or turbulent flow etcetera but will not be discussed in this report. An extensive study on convective heat transfer in models of buildings has been carried out by Feist, W., (1993). That report is a valuable source for further studies.

## Ventilation

Air flows in a building occur from infiltration, airing and/or forced ventilation through the ventilation system. Air is primarily taken from the outdoor air into the building and is heated or cooled to achieve a required indoor climate. The air may also be heated by internal loads. The outdoor air contains water vapor and moisture production can occur in the building, e.g. evaporation from inhabitants, cooking or technical processes. In some cases, the air has to be dried or humidified to fulfill special requirements.

A priori, designed air flows, moisture production and some properties of the outdoor air are known. Air flows are commonly given as volume flows but as the volume of air varies significantly with the temperature it is convenient to use mass and enthalpy balances when dealing with these problems. Commonly available climate data includes values on dry-bulb temperature, static pressure and humidity. The later may be given as relative humidity, wet-bulb temperature, dew-point temperature, humidity by mass or volume or partial water vapor pressure.

The treatment of air flows in buildings requires the use of psychometric definitions and formulas and a summary of the most important is given in appendix 1.

## 3.2 Surfaces

The heat balance of an surface involves conduction, convective heat transfer, absorbed SW radiation and LW radiation exchange with other surfaces. The heat balance of a surface where no heat capacity is assumed is given by

$$Q_{abs} + G_m (T_m - T_s) + G_{ci} (T_r - T_s) + \sum_{i=1}^N G_{LWi} (T_{si} - T_s) = 0 \quad (3.2.1)$$

The heat source ( $Q_{abs}$ ) represents the absorbed solar radiation, radiation from people, radiators and lighting. The major part is the solar radiation which will be discussed in a later chapter.

The conduction ( $G_m$ ) into the first mass node, ( $T_m$ ), in the wall will be discussed in next paragraph.



The convection ( $G_{ci}$ ) between the surface and the surrounding air was briefly discussed above. On an outer surface the wind speed can have a rather high influence and some experimental data is given by Kimura (1977).

The LW radiation exchange between surfaces is represented by the conductance  $G_{LW}$  which can be determined e.g. by Eq. 2.4.9. One way to determine the needed view factors is discussed in chapter 4 and there are several books available in this field, e.g. Siegel and Howell. (1981).

At an outer surface the LW radiation may instead be treated as emitted and absorbed radiation in following way.

All LW radiation is assumed to be diffuse and all involved surfaces are assumed to be optical diffuse-gray, i.e. all emitted and reflected radiation is diffuse and the surface properties are independent of the wavelength. This allows the use of view factors when the LW radiation exchange is studied. The view factor  $F_{i,j}$  gives the part of the total radiation emitted from the whole surface  $i$  that will be incident at the whole surface  $j$  before any reflections has been taken into account.

If no other buildings are in the surrounding of the studied one, the building is facing the sky and the ground. The LW radiation from each of the three "surfaces" will be reflected between the surfaces and finally absorbed. The radiation emitted from the sky, the ground and the building are thus

$$E_{sky} = \sigma \varepsilon_{sky} T_{sky}^4 A_{sky} \quad (3.2.2)$$

$$E_{grd} = \sigma \varepsilon_{grd} T_{grd}^4 A_{grd} \quad (3.2.3)$$

$$E_s = \sigma \varepsilon_s T_s^4 A_s \quad (3.2.4)$$

where  $\sigma =$  Stephan Boltzman's constant ( $5.7 \cdot 10^{-8} \text{ W/m}^2, \text{K}^4$ ).

The radiation emitted from the building and primarily reflected at the ground is

$$E'_{grd} = \sigma \varepsilon_s T_s^4 A_s F_{s,g} (1 - \varepsilon_{grd}) \quad (3.2.5)$$

It is obvious even for a very big building that  $A_s \ll A_{grd}$ . Furthermore, the emissivities and the temperatures of the building and the ground are about the same and  $F_{s,grd} (1 - \varepsilon_{grd}) < 1$ . Thus is  $E'_{grd} \ll E_{grd}$  and can be neglected. In a similar way it can be shown that radiation from the building reflected at the sky can be neglected.

If the influence of the building is neglected the sky and the ground can be seen as two parallel infinite surfaces with  $F_{sky,grd} = F_{grd,sky} = 1$ . The radiation emitted from the ground is reflected between these surfaces and the total radiation from the ground is thus

$$E'_{grd} = \frac{\varepsilon_{grd} E_{grd} + (1 - \varepsilon_{grd}) E_{sky}}{1 - (1 - \varepsilon_{grd})(1 - \varepsilon_{sky})} \quad (3.2.5)$$

The emissivity is typically around 0.9 and thus an error of around 1% is introduced if the denominator is set to 1.

The sky emissivity is seldom available and available climate data is often measurements of the sky radiation. Thus the sky emissivity can be set to 1 and the measured values be used to estimate the sky temperature as

$$T_{sky} = (E_{measured} / \sigma)^{0.25} \quad (3.2.6)$$

As the ground radiation reflected at the sky is included in the measured radiation it is also included in the sky temperature and is thus not needed to be taken into account in any other way.

The LW radiation absorbed in the outer surface can now with  $A_{sky} = A_{grd}$  and as  $A_i F_{i,j} = A_j F_{j,i}$  be written as

$$Q_{abs} = \sigma \varepsilon_s A_s (\varepsilon_{sky} F_{s,sky} T_{sky}^4 + \varepsilon_{grd} F_{s,grd} T_{grd}^4 + (1 - \varepsilon_{grd}) F_{s,grd} \varepsilon_{sky} T_{sky}^4) \quad (3.2.7)$$

### 3.3 Walls and Slabs

Heat transfer in solids is well treated in the literature and in this paragraph only some few aspects on methods to handle one dimensional heat flow will be given. Discussions about two and three dimensional heat flow in e.g. cold bridges can be found in Jóhannesson (1981) and Hagentoft (1988) has studied the heat losses from buildings through slabs on ground.

The expression for one dimensional heat conduction in solids is given by the Fourier equation

$$\frac{\partial T(x,t)}{\partial t} = a \frac{\partial^2 T(x,t)}{\partial^2 x} \quad (3.3.1)$$

$$a = \frac{\lambda}{c\rho} \quad (3.3.2)$$

where  $a$  is the thermal diffusivity. Numerical treatment of this equation requires that the derivatives are approximated by finite differences which can be done in different ways. Two commonly used methods are the forward difference method and the Crank-Nicholson's method. In both methods the left hand side is approximated by

$$\frac{T(x,t + \Delta t) - T(x,t)}{\Delta t} \quad (3.3.3)$$

where  $\Delta t$  is the chosen time step. The right hand side is approximated by dividing the solid into layers of finite length,  $\Delta x$ , and is in the forward difference method given by

$$\frac{a}{(\Delta x)^2} [T(x + \Delta x, t) + T(x - \Delta x, t) - 2T(x, t)] \quad (3.3.4)$$

The equation represents the situation at the beginning of the time step. In Crank-Nicholson's method the average heat flow during the time step is used and the right hand side becomes

$$\begin{aligned} & \frac{a}{2(\Delta x)^2} [T(x + \Delta x, t) + T(x - \Delta x, t) - 2T(x, t)] + \\ & \frac{a}{2(\Delta x)^2} [T(x + \Delta x, t + \Delta t) + T(x - \Delta x, t + \Delta t) - 2T(x, t + \Delta t)] \end{aligned} \quad (3.3.5)$$

Given the initial temperatures, the successive use of the difference equations give the new temperatures step by step.

The forward difference has the advantage of simplicity but the increments cannot be chosen arbitrarily. The expression  $a\Delta t/(\Delta x)^2$  must be less than 0.5, else the results will diverge to infinitive. This means that the time step has to be chosen less than the stability time step

$$\Delta t_s = \frac{c\rho(\Delta x)^2}{2\lambda} \quad (3.3.6)$$

The Crank-Nicholson's method is stable for any time step but has the disadvantage that all temperatures have to be solved simultaneously.

Adams (1970) showed that the best accuracy was achieved with a time step of  $0.5\Delta t_s$  for the forward difference and  $2\Delta t_s$  for the Crank-Nicholson's method. Thus the required amount of calculations is about the same for both methods.

### 3.4 Windows

In this paragraph the heat transfer between panes in a window will be discussed. The presented work is mainly the author's implementation of a new window model in the DEROB-LTH program.

A thermal model with one temperature node in each pane is used. The heat resistance of window panes is neglected. This might to some degree influence the results for single pane windows but for multiple pane windows the errors introduced by this approximation can be neglected. The LW radiation exchange between the panes and the convective heat transfer are determined by the first principles of physics. The total conductance in a gap is thus given by

$$G_{gap} = (h_r + h_c)A_w \quad (3.4.1)$$

where  $A_w$  = area of the window

$h_r$  = radiative heat transfer coefficient

$h_c$  = convective heat transfer coefficient

## LW Radiation

The radiative conductance between two panes can be given by Eq. 2.4.9 and as the gap between two panes is small compared with the window area the view factor between the panes can be set to 1. Thus the resulting emissivity will be

$$\varepsilon_{res} = \frac{1}{1/\varepsilon_1 + 1/\varepsilon_2 - 1} \quad (3.4.2)$$

The heat transfer coefficient is thus

$$h_r = \sigma \varepsilon_{res} (T_1^2 + T_2^2)(T_1 + T_2) \quad (3.4.3)$$

## Convection

The convective heat transfer coefficient is determined as

$$h_c = \frac{Nu\lambda}{d} \quad (3.4.4)$$

$$Nu = f(Ra, H, d, \Phi) \quad (3.4.5)$$

$$Ra = Pr g\beta\rho^2 d^3 \Delta T / \mu^2 \quad (3.4.6)$$

where H = Hight of the window (m)

Nu = Nusslet number

Pr = Prandtl number

Ra = Rayleigh number

T<sub>m</sub> = Average temperature in the gap (K)

ΔT = Temperature differance over the gap (K)

g = Gravitational acceleration (9.82 m/s<sup>2</sup>)

d = Distance between the panes (m)

β = Thermal expansion approximated as 1/T<sub>m</sub> (1/K)

Φ = Tilt angle of the window

λ = Conductivity (W/m,K)

μ = Viscosity (kg/m,s)

ρ = Density (kg/m<sup>3</sup>)

The tilt angle is defined as

0° Horizontal window with the warmest side downwards

90° Vertical window

180° Horizontal window with the warmest side upwards

The temperature dependency of Pr, λ, μ and ρ are approximated with linear functions of T<sub>m</sub>. Some examples of gas data can e.g. be found in Arasteh et al (1989). For calculations of the Nusslet number following chose has been done.

Formulas from ElSherbiny et al (1982) for 90° (vertical) and 60° tilted windows, shown to be valid for a wide range of Rayleigh numbers. They also suggested a linear interpolation between these values.

Hollands et al (1976) give a relation for tilt angles between 0° and 60° and for Ra < 10<sup>5</sup>, thus valid for a wide range of normal windows.

The Nusselt numbers according to ElSherbiny and Holland differs slightly at a tilt angle of 60°. In order to avoid this step the numbers are slightly changed for 0° ≤ Φ < 60°. Compared with measured values shown by ElSherbiny (1982) this correction seems acceptable.

For windows tilted between 90° and 180° following relation from Ferguson and Wright (1984) is used with ElSherbiny's value for Nu<sub>90</sub>.

$$Nu = 1 + (Nu_{90} - 1) \sin \Phi \quad (3.4.7)$$

In order to study the use of the above formulas some calculations have been carried out. The results and some conclusions are given in this paragraph. All examples are for air filled gaps with air properties according to Arasteh (1989).

Table 3.1 Nusslet numbers for different air gaps with ΔT = 10 °C

A	T <sub>m</sub>	Ra	Φ (°)				
			0	25	50	60	90
(-)	(°C)	(-)					
167	-40	.716E+3	1.001	1.001	1.001	1.001	1.000
	0	.311E+3	1.000	1.000	1.000	1.000	1.000
	40	.147E+3	1.000	1.000	1.000	1.000	1.000
83	-40	.573E+4	2.021	2.021	2.021	1.272	1.083
	0	.249E+4	1.466	1.466	1.466	1.015	1.004
	40	.117E+4	1.003	1.003	1.003	1.003	1.000
50	-40	.265E+5	2.863	2.863	2.863	2.279	1.899
	0	.115E+5	2.456	2.456	2.456	1.710	1.366
	40	.543E+4	2.004	2.004	2.004	1.241	1.064
20	-40	.415E+6	6.306	6.306	6.306	5.435	4.603
	0	.180E+6	4.867	4.867	4.867	4.181	3.592
	40	.849E+5	3.886	3.886	3.886	3.302	2.852

The aspect ratios A (=h/d) has been chosen in order to enable comparisons with the results reported by ElSherbiny (1982) and cover a wide range of windows. The results in Table 3.1 are close to those reported by ElSherbiny.

At larger gap width (A = 20) the Rayleigh numbers are relative high. Thus caution must be taken as some of the used formulas are not validated for these

Rayleigh numbers. However, this ratio corresponds e.g. to a 50 mm gap in a window with a height of 1 m which is not so often used.

Finally some values of the convective heat transfer coefficient calculated with the formulas above are shown in Table 3.2.

Table 3.2 Convective coefficients for different air gaps,  $\Delta T = 10 \text{ }^\circ\text{C}$

A	T <sub>m</sub>	Ra	Φ (°)				
			0	25	50	60	90
	(°C)	(-)					
167	-40	.716E+3	3.513	3.513	3.513	3.513	3.510
	0	.311E+3	4.017	4.017	4.017	4.017	4.017
	40	.147E+3	4.523	4.523	4.523	4.523	4.523
83	-40	.573E+4	3.548	3.548	3.548	2.233	1.900
	0	.249E+4	2.944	2.944	2.944	2.038	2.016
	40	.117E+4	2.268	2.268	2.268	2.268	2.262
50	-40	.265E+5	3.015	3.015	3.015	2.400	1.999
	0	.115E+5	2.959	2.959	2.959	2.061	1.646
	40	.543E+4	2.719	2.719	2.719	1.684	1.443
20	-40	.415E+6	2.656	2.656	2.656	2.289	1.939
	0	.180E+6	2.346	2.346	2.346	2.015	1.732
	40	.849E+5	2.109	2.109	2.109	1.792	1.548

## 4 Solar Radiation

Solar radiation absorbed in building surfaces is one of the major heat sources in a building, thus important to treat in a proper way in thermal models. In this chapter the calculations according to solar radiation at and within buildings will be discussed.

The beam radiation from the sun is sometimes called normal or direct radiation. When this radiation is passing the atmosphere absorption as well as scattering, diffraction, reflection and refraction will occur. The beam radiation reaching the earth will thus be decreased and have a slightly different direction than outside the atmosphere. It will also result in light travelling in all directions, at the ground level called diffuse sky radiation. This radiation should not be mixed up with LW radiation from the sky.

It is in this chapter assumed that the solar radiation at the building site is known, thus details of the impact from the atmosphere etcetera found in e.g. Robinson (1966) will not be discussed.

It is also assumed that the beam radiation originates from a point source. This is an acceptable approximation as the maximum apparent radius of the sun is about  $16'17''$ , Robinson (1966), p31. Furthermore, the change of direction of the beam radiation due to refraction within the atmosphere is only briefly discussed.

The properties of the solar radiation as well as material properties related to solar radiation are almost ever dependent on the wavelength of the light. This must be taken into account e.g. when some types of windows and daylight within a building is treated. When dealing with heat models of buildings it is often enough to use average properties for the short wave radiation, as assumed in this chapter if nothing else is mentioned.

### 4.1 Solar Radiation at a Building

The total solar radiation at a building site is given by the *global irradiance*, i.e. the energy flow per unit time per horizontal unit area caused by the beam and the diffuse sky radiation.

$$G = G_d + G_b \sin(\alpha) \quad (\text{W/m}^2) \quad (4.1.1)$$

where  $G$  = Global irradiance

$G_b$  = Beam irradiance

$G_d$  = Diffuse irradiance ( $\text{W/m}^2$ )

$\alpha$  = Solar altitude

The *beam irradiance* is the energy flow per unit time per unit area perpendicular to the beam and the *diffuse irradiance* is the energy flow per unit time per unit horizontal area caused by the diffuse sky radiation.

*Radiant intensity* is defined as the energy flow per unit time in a single direction per unit area normal to the flow direction into a unit solid angle centered around the direction, i.e. in W/sr,m<sup>2</sup>.

The sky radiation is often assumed to be *isotropic*, i.e. the intensity is independent of the direction. This assumption is here used if nothing else is mentioned.

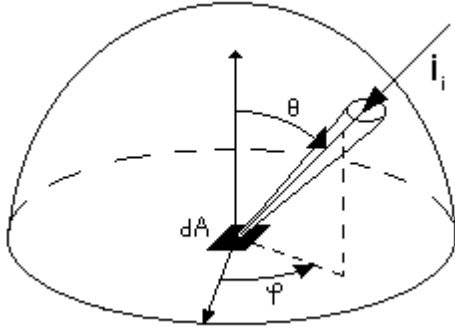

Figure 4.1 Isotropic sky radiation

The relation between diffuse irradiance and the intensity for isotropic sky radiation is illustrated in Figure 4.1. As the intensity is independent of the direction we have

$$G_d = \frac{1}{dA} \int_{\Omega} i_i dA_p(\theta) d\omega \quad (\text{W/m}^2) \quad (4.1.2)$$

where  $dA$  = Infinitesimal horizontal area (m<sup>2</sup>)

$dA_p(\theta)$  = The projection of  $dA$  normal to  $i_i$

$i_i$  = Intensity of incident radiation (W/sr,m<sup>2</sup>)

$\Omega$  = The hemisphere above  $dA$

$\omega$  = Solid angle (sr)

The projection of  $dA$  and the solid infinitesimal angle are given by

$$dA_p(\theta) = dA \cdot \cos\theta \quad (\text{m}^2) \quad (4.1.3)$$

$$d\omega = \sin(\theta) d\theta d\varphi \quad (\text{sr}) \quad (4.1.4)$$

Thus the diffuse sky radiation on horizontal becomes

$$G_d = \int_{\varphi=0}^{2\pi} \int_{\theta=0}^{\pi/2} i_i \cos(\theta) \sin(\theta) d\theta d\varphi = \pi i_i \quad (\text{W/m}^2) \quad (4.1.5)$$



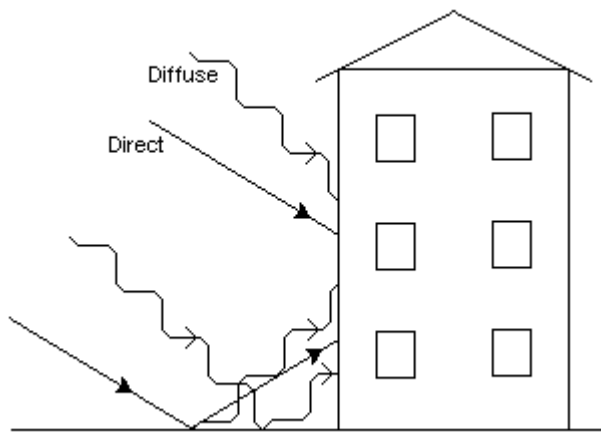

Figure 4.2 Solar radiation at a building

The solar radiation at an outer surface of a building is schematically illustrated in figure 4.2. Beam and diffuse radiation will fall onto the building as well as on the surroundings.

From the surroundings some radiation will be reflected onto the building. The reflection of the beam radiation may be specular or diffused but in this chapter, as well as in most thermal models and programs, all reflected radiation is assumed to be isotropic. In some cases, e.g. a calm sea surface or ice covered ground, specular reflection might be necessary to consider.

At an opaque outer surface some radiation will be absorbed and some reflected and at a window some will be transmitted into the building. The transmitted radiation will partly be absorbed in the inner surfaces and partly undergo multiple reflections before it is absorbed or transmitted out through the windows. As for the ground reflected radiation, all reflected beam radiation is assumed to be isotropic if nothing else is mentioned.

## 4.2 Co-ordinate Systems and Solar Angles

In order to carry out calculations concerning beam radiation we need the solar position related to a site and to the building surfaces. The used co-ordinate systems and equations are described in this paragraph where the earth is assumed to be spherical.

### 4.2.1 The Global Co-ordinate System

*The global co-ordinate system* is a positive orientated, spherical system defined by the equator plane and the axis from the center through the Greenwich median and the North pole as illustrated in figure 4.3.

A site's situation is traditionally given by its latitude and longitude. The *latitude* ( $\lambda_s$ ) is counted from the equator plane, positive to the North and negative to the South. Thus we get the first spherical co-ordinate as

$$\theta_s = \frac{\pi}{2} - \lambda_s \quad (4.2.1)$$

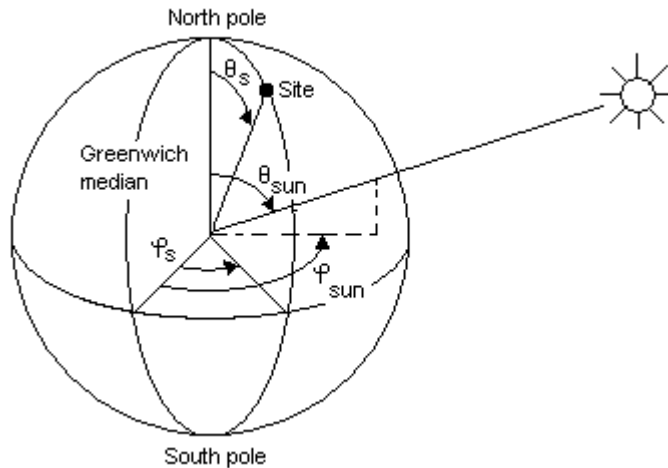

Figure 4.3 Global co-ordinate system

The *longitude* or *median* ( $\varphi_s$ ) is counted positive to the East of the Greenwich median thus equal to the second spherical co-ordinate. However in e.g. in the US it is common to define the longitude for a site positive to the West.

### Position of the sun

The sun's position varies due to the earth's ellipsoidal orbit, its tilt from the ecliptic and its rotation. In the global system is the position at a given day and hour defined by a unit vector pointing toward the sun, here called the *sun vector*.

$$\bar{r}_{sun} = (1, \theta_{sun}, \varphi_{sun}) \quad (4.2.2)$$

It is common to use the *declination* ( $\delta$ ) to describe the angle between the equator plane and the sun vector. The declination is defined positive to the North and we have

$$\theta_{sun} = \frac{\pi}{2} - \delta_{sun} \quad (4.2.3)$$

The eccentricity of the earth's orbit is small (0.01673) so the declination varies almost sinusoidal with the amplitude of about  $23.45^\circ$  and with its maximum at midsummer. Exact values can be found in e.g. nautical calendars and a numerical formula is given in appendix 2. The maximum variation over 24 h is about  $0.40^\circ$ , thus daily values is accurate enough for our calculations.

The angle  $\varphi_{\text{sun}}$  depends on the hour of the day and the day of the year. The situation is illustrated in figure 4.4, a projection on the equator plane seen from the North. The angles indicated in clockwise direction are defined this way according to the definitions of time.

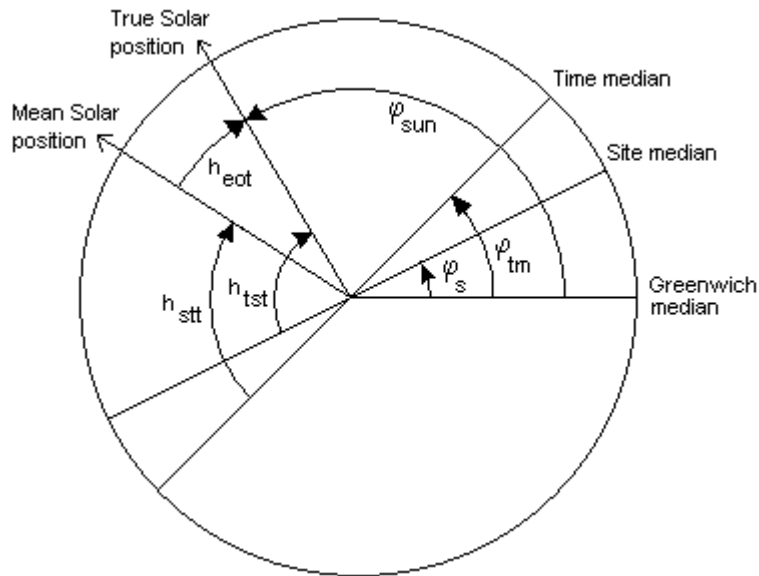

Figure 4.4 Hour angles in the global co-ordinate system

The *standard time* ( $h_{\text{stt}}$ ) in a time zone is referred to the yearly mean solar position at the zone's *time median* ( $\varphi_{\text{tm}}$ ). Some time zones and corresponding time medians are listed in appendix 2.

The *true solar time* ( $h_{\text{tst}}$ ) is referred to each site's median ( $\varphi_{\text{s}}$ ) and the true solar position.

The *Equation of Time* ( $h_{\text{eot}}$ ) depends on the ellipsoidal orbit of the earth around the sun and gives the difference between true solar and standard time on the time median. It is common to give the equation of time in minutes and the variation during the year is between  $-14.2'$  and  $+16.4'$ . Exact values can be found in e.g. nautical calendars and a numerical formula is given in appendix 2. The maximum variation over 24 h is about  $29''$  ( $0.12^\circ$ ), thus daily values is accurate enough for our calculations. From figure 4.4 we get following relations.

$$h_{\text{tst}} = h_{\text{stt}} + h_{\text{eot}} + \varphi_{\text{s}} - \varphi_{\text{tm}} \quad (4.2.4)$$

$$\varphi_{\text{sun}} = \varphi_{\text{s}} - h_{\text{tst}} + \pi \quad (4.2.5)$$

Sometimes the *hour angle* ( $\omega$ ) is used and defined as

$$\omega = h_{\text{tst}} - \pi \quad (4.2.6)$$

## 4.2.2 The Local Co-ordinate System

The local co-ordinate system at a site is defined as a positive orientated, Cartesian co-ordinate system with its axis toward South, East and Zenith. In e.g. the US it is instead common to use West, South and Zenith.

The unit vectors for the axis in the local system are given by

$$\hat{s} = (1, \theta_s + \pi/2, \varphi_s) \quad (4.2.7)$$

$$\hat{e} = (1, \pi/2, \varphi_s + \pi/2) \quad (4.2.8)$$

$$\hat{z} = (1, \theta_s, \varphi_s) \quad (4.2.9)$$

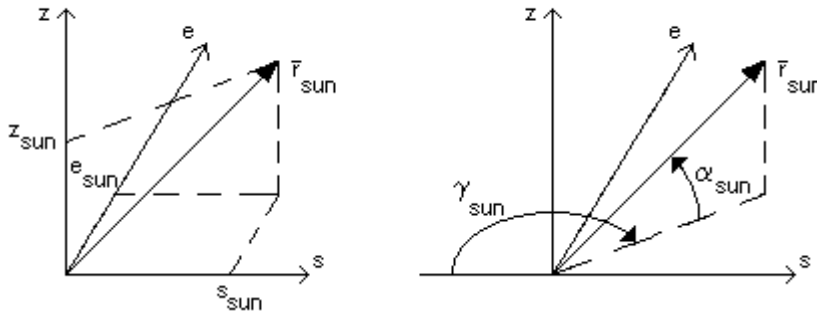

Fig 4.5 Solar position in the local system

The local system is strictly not defined on the poles. However, no formulas in this chapter will fail at the poles but we might want to name the axis as something else than South and East.

The solar position in the local system is illustrated in figure 4.5 and the components of the sun vector in the local system are achieved by the scalar products with the unit vectors of the axis:

$$s_{sun} = \bar{r}_{sun} \cdot \hat{s} = \cos(\omega) \cos(\delta) \sin(\lambda_s) - \sin(\delta) \cos(\lambda_s) \quad (4.2.10)$$

$$e_{sun} = \bar{r}_{sun} \cdot \hat{e} = -\sin(\omega) \cos(\delta) \quad (4.2.11)$$

$$z_{sun} = \bar{r}_{sun} \cdot \hat{z} = \cos(\omega) \cos(\delta) \cos(\lambda_s) + \sin(\delta) \sin(\lambda_s) \quad (4.2.12)$$

Traditionally the sun's position is given by the *altitude* ( $\alpha_{sun}$ ), the angle between the sun vector and the horizontal plane, and the *azimuth* ( $\gamma_{sun}$ ), the angle counted positive clockwise from North to the projection of the sun vector on the horizontal plane. In some literature is the azimuth counted from the South.

If the altitude and azimuth are known, the components of the sun vector can be achieved by

$$s_{sun} = -\cos(\alpha_{sun}) \cos(\gamma_{sun}) \quad (4.2.13)$$

$$e_{sun} = \cos(\alpha_{sun}) \sin(\gamma_{sun}) \quad (4.2.14)$$

$$z_{sun} = \sin(\alpha_{sun}) \quad (4.2.15)$$

When dealing with the inverse relations the computer function atan2 is useful. This function gives the angle ( $-\pi \leq \gamma \leq \pi$ ) according to the values and signs of its arguments and we get

$$\gamma_{sun} = \text{arctg}(-e_{sun} / s_{sun}) = \text{atan2}(-e_{sun}, s_{sun}) \quad (4.2.16)$$

Special care must be taken if the sun is close to zenith where the azimuth is not defined. E.g. the function atan2 is normally undefined if both argument are zero.

## 4.3 Radiation at Opaque Surfaces without Shading

### 4.3.1 Incident Beam Radiation

A non shaded part of an outer surface is illustrated in figure 4.6. The beam irradiance is given for the unit area  $dA$  perpendicular to the beam direction and will hit the area  $dA_s$  of the wall.

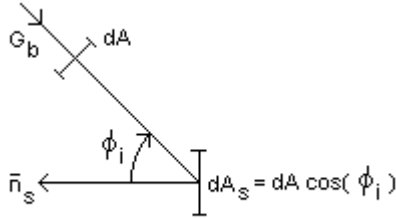

Figure 4.6 Beam radiation incident at a surface.

The *incident angle* ( $\phi_i$ ) is defined as the angle between the sun vector and the vector normal to the surface. Thus the energy flow per time unit and unit area of the surface is equal to

$$E_{ib,s} = G_b \cos(\phi_i) \quad \text{if } \phi_i > 0, \text{ else } 0 \quad (\text{W/m}^2) \quad (4.3.1)$$

If we know the unit vector normal to the surface

$$\vec{n}_s = (s_s, e_s, z_s) \quad (4.3.3)$$

the cosine for the incident angle can be achieved by the scalar product between this vector and the sun vector

$$\cos(\phi_i) = \vec{n}_s \cdot \vec{r}_{sun} = s_s s_{sun} + e_s e_{sun} + z_s z_{sun} \quad (4.3.4)$$

The position of a surface may be specified in many ways, e.g. by the wall azimuth as the angle to the South, counted positive to West, and to define the tilt angle as zero for an upward horizontal surface. However, it seems more naturally to use the compass orientation and let a normal vertical wall have a zero tilt angle, i.e. the same convention for the surface's normal vector as for the sun vector. Thus the position of a surface is here defined by its *azimuth* or *orientation* ( $\gamma_s$ ) counted positive clockwise from the North and its *tilt angle* ( $\beta_s$ ) defined as the angle between the horizontal plane and the surface's normal vector, i.e. zero for a

vertical surface and positive for an upward tilted surface, e.g. a roof. The components of the normal unit vector of the surface are then

$$s_s = -\cos(\gamma_s)\cos(\beta_s) \quad (4.3.5)$$

$$e_s = \sin(\gamma_s)\cos(\beta_s) \quad (4.3.6)$$

$$z_s = \sin(\beta_s) \quad (4.3.7)$$

## 4.3.2 Incident Diffuse Radiation

### Sky radiation

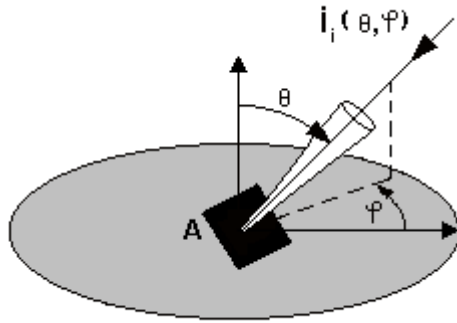

Figure 4.7 Radiation at a tilted surface

For a tilted surface only a part of the sky can be seen from the surface, thus the intensity of the sky radiation at the surface can be written

$$i_i(\theta, \varphi) = \frac{G_d}{\pi} \text{ if } \theta < \pi/2 \text{ and } \phi_i < \pi/2, \text{ else } 0. \quad (4.3.10)$$

where  $\phi_i$  is the incident angle for radiation from the direction  $(\theta, \varphi)$ . The energy flow incident at a tilted surface (A) is thus

$$E_{id,sky,s} = \frac{1}{dA} \int_{\Omega} i_i(\theta, \varphi) \cos(\phi_i) d\omega \quad (\text{W/m}^2) \quad (4.3.11)$$

Solving the last equation gives

$$E_{id,s} = F_{s,sky} G_d \quad (\text{W/m}^2) \quad (4.3.12)$$

with the view factor from the surface to the sky given by

$$F_{s,sky} = \frac{(1 + \sin \beta)}{2} \quad (4.3.13)$$

The isotropic approach can sometimes be avoided even if only  $G_d$  is known. Threnkeld (1962) gives for clear sky the following relation for the incident sky radiation on a vertical, non shaded surface.

$$E_{d,v} = 0.45G_d \text{ if } \cos(\theta_i) < -0.2, \text{ else} \\ E_{d,v} = [0.55 + 0.437\cos(\theta_i) + 0.313\cos(\theta_i)|\cos(\theta_i)|]G_d \quad (4.3.14)$$

If radiation according to Brown and Isfält (1974) for Malmö, Sweden (55.6°N, 13.06°E), March 21 at noon is used we have

$$G = 589, G_d = 93 \text{ W/m}^2, G_b = 882 \text{ W/m}^2 \text{ and } \cos(\theta_i) = 0.824.$$

If an isotropic sky radiation is assumed and the ground reflectance is set to 0.2 and all reflected radiation is assumed to be diffuse the total irradiance on the vertical south facing surface is 833 W/m<sup>2</sup>. If we instead use Threnkeld's formula we get 890 W/m<sup>2</sup>.

The total incident radiation is in this case increased by about 7 per cent indicating that the isotropic approach can underestimate the irradiance. However, in many situations we have to deal with cloudy sky and shading and thus Threnkeld's formula is of limited use.

### Ground reflected radiation

If the beam radiation reflected at the ground is assumed as isotropic, the intensity of all ground reflected radiation will be

$$i_{grd} = \rho_{grd} G / \pi \quad (\text{W/m}^2, \text{sr}) \quad (4.3.14)$$

In a similar way as for the sky radiation the view factor from the surface to the ground can be determined. The result is

$$F_{s,grd} = \frac{(1 - \sin \beta)}{2} \quad (4.3.14)$$

and the energy flow incident at a tilted surface caused by ground reflected radiation becomes

$$E_{id,grd,s} = F_{s,grd} \rho_{grd} G \quad (\text{W/m}^2) \quad (4.3.15)$$

### 4.3.3 Absorbed and Reflected Radiation

The incident radiation at an opaque surface will partly be absorbed and partly reflected according to the properties of the surface.

The absorptance and reflectance are often dependent on the incident angle but might be assumed as constants for common opaque building materials, further details can be found in e.g. Siegel (1981). It is also common to assume that all radiation reflected at opaque building surfaces is isotropic.

With the properties independent of the incident angle the same properties are valid for both beam and diffuse radiation and we have

$$E_{a,s} = \alpha(E_{ib,s} + E_{id,sky,s} + E_{id,grd,s}) \quad (\text{W/m}^2) \quad (4.3.8)$$

$$E_{r,s} = \rho(E_{ib,s} + E_{id,sky,s} + E_{id,grd,s}) \quad (\text{W/m}^2) \quad (4.3.9)$$

where  $E_{a,s}$  = Absorbed radiation (W/m<sup>2</sup>)

$E_{r,s}$  = Reflected radiation (W/m<sup>2</sup>)

$\alpha$  = The absorptance

$\rho$  = The reflectance

## 4.4 Radiation at Windows without Shading

### 4.4.1 Properties for a single pane

In this paragraph a single pane without any interactions with other panes is discussed. The word pane is used for all kind of layers in a window, e.g. normal panes, curtains etcetera.

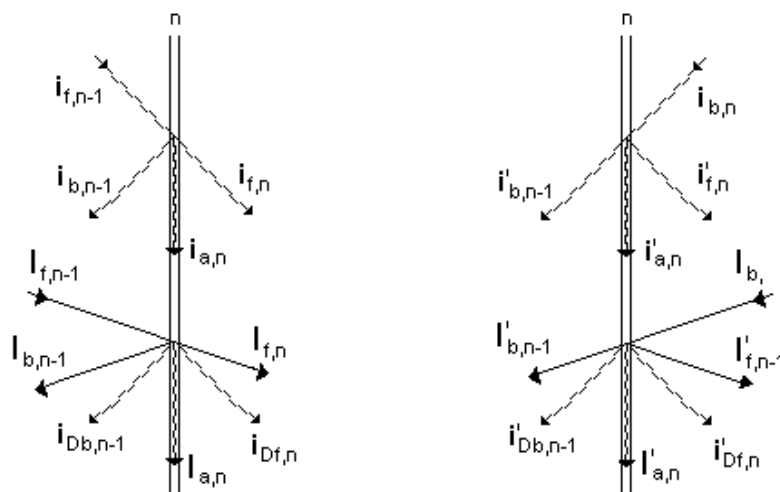

Figure 4.8 Solar radiation at a single pane

Symbols	$I$	Direct radiation	$\alpha$	Absorptance
	$i$	Diffuse radiation	$\rho$	Reflectance
	$i_D$	Diffused radiation	$\tau$	Transmittance

#### Indices

a	Absorbed
D	Direct incident, direct reflected or transmitted
b	Backward
Dd	Direct incident, diffused reflected or transmitted
f	Forward
d	Diffuse incident, diffuse reflected or transmitted
w	Window property



Table 4.1 Single pane properties according to Figure 4.8

Forward incident radiation		
	Direct	Diffuse
Boundary conditions	$I_{f,0} > 0$ $i_{f,0} = I_{b,n} = i_{b,n} = 0$	$i_{f,0} > 0$ $I_{f,0} = I_{b,n} = i_{b,n} = 0$
Reflectance	$\rho_{Df} = I_{b,n-1} / I_{f,n-1}$ $\rho_{Ddf} = i_{Db,n-1} / I_{f,n-1}$	$\rho_{df} = i_{b,n-1} / i_{f,n-1}$
Transmittance	$\tau_{Df} = I_{f,n} / I_{f,n-1}$ $\tau_{Ddf} = i_{Df,n} / I_{f,n-1}$	$\tau_{df} = i_{f,n} / i_{f,n-1}$
Absorptance	$\alpha_{Df} = i_{a,n} / I_{f,n-1}$	$\alpha_{df} = i_{a,n} / i_{f,n-1}$

Backward incident radiation		
	Direct	Diffuse
Boundary conditions	$I_{b,n} > 0$ $I_{f,0} = i_{f,0} = i_{b,n} = 0$	$i_{b,n} > 0$ $I_{f,0} = i_{f,0} = I_{b,n} = 0$
Reflectance	$\rho_{Db} = I'_{f,n} / I_{b,n}$ $\rho_{Ddb} = i'_{Df,n} / I_{b,n}$	$\rho_{db} = i'_{f,n} / i_{b,n}$
Transmittance	$\tau_{Db} = I'_{b,n-1} / I_{b,n}$ $\tau_{Ddb} = i'_{Db,n-1} / I_{b,n}$	$\tau_{db} = i'_{b,n-1} / i_{b,n}$
Absorptance	$\alpha_{Db} = i'_{a,n} / I_{b,n}$	$\alpha_{db} = i'_{a,n} / i_{b,n}$

### Homogeneous (i.e. uncoated) glass

When thickness, refraction index and absorption coefficient for a homogeneous glass is given Fresnel's equations and Snell's law can be used in order to get the properties for a single pane. These can be formulated as

$$\begin{aligned}
 b &= \sqrt{n^2 + \cos^2(\theta) - 1} \\
 t &= e^{-\alpha d n / b} \\
 r_1 &= \left( \frac{\cos(\theta) - b}{\cos(\theta) + b} \right)^2 \\
 r_2 &= \left( \frac{n^2 \cos(\theta) - b}{n^2 \cos(\theta) + b} \right)^2 \\
 \tau_i &= \frac{t(1 - r_i)^2}{1 - t^2 r_i^2} \\
 \rho_i &= r_i(1 + t\tau_i)
 \end{aligned} \tag{4.4.1}$$

where  $n$  = Real part of the refractive index

$\theta$  = Incident angle

$t$  = Transmission for a single path through the glass

$\alpha$  = Absorption coefficient

$d$  = Thickness of the glass

$r$  = Reflection at the surfaces

$\tau$  = Transmittance for the panes

$\rho$  = Reflectance for the pane

$i$  = 1, 2 for perpendicular resp. parallel polarization

When the thickness, the reflectance and transmittance at normal incident are given the refraction index and absorption coefficient are achieved with following formulas obtained from the equations above.

$$\begin{aligned}
 b &= \tau^2 - \rho^2 + 2\rho + 1 \\
 r &= \frac{b - \sqrt{b^2 + 4\rho^2 - 8\rho}}{4 - 2\rho} \\
 n &= \frac{1 + \sqrt{r}}{1 - \sqrt{r}} \\
 \alpha &= \ln\left(\frac{\tau r}{\rho - r}\right) / s
 \end{aligned} \tag{4.4.2}$$

where  $\tau$  = Transmittance for the glass at normal incident.

$\rho$  = Reflectance for the glass at normal incident

## Coated and tinted glass

Modern glazing systems often use coated or tinted glass and in these cases a more elaborate approach must be taken e.g. in order to handle optical thin layers where interference occurs.

Pfrommer et al (1995) discuss a method to handle the calculations in these cases and give a good introduction to the problems.

Roos (1997) suggests instead a simple polynomial with only two terms to predict the angular variations because of the low precision of experimental results and the complex nature of exact Fresnel calculations.

### 4.4.2 Properties for a multiple pane window

In order to get the solar radiation absorbed in each pane of a glazing system the absorptivities for direct and diffuse incident radiation from both sides of the window are needed. This paragraph describes how these properties can be determined when the single pane properties are known.

The method was primarily used in the JULOTTA program and is later also implemented in the DEROB-LTH program..

A glazing system with  $N$  panes and direct and diffuse incident radiation on both sides is illustrated in Figure 4.9 where all radiation are totals after all reflections etcetera has been taken into account. These are used in Table 4.2 where the window properties are defined.

In order to determine the window properties all radiation in all gaps must be known and different methods can be used to calculate these. Below one method is described for forward incident radiation as the application on backward incident radiation then is trivial.

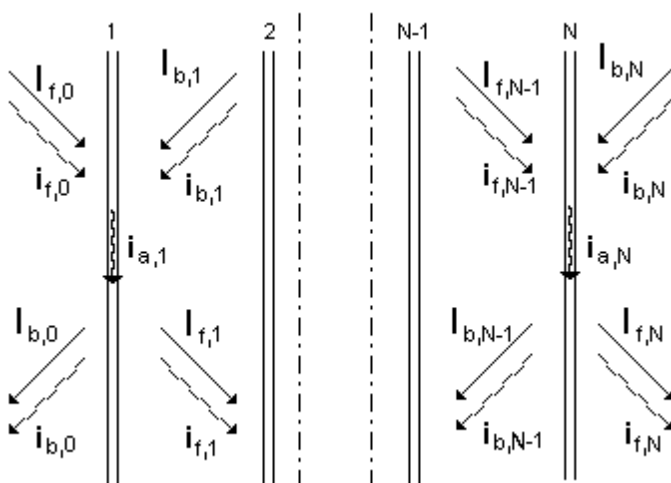

Figure 4.9 Total radiation in a glazing system

Table 4.2 Window properties according to Figure 4.9

Forward incident radiation		
	Direct	Diffuse
Boundary conditions	$I_{f,0} > 0$ $i_{f,0} = I_{b,N} = i_{b,N} = 0$	$i_{f,0} > 0$ $I_{f,0} = I_{b,N} = i_{b,N} = 0$
Reflectance	$\rho^{wDf} = I_{b,0} / I_{f,0}$ $\rho^{wDdf} = i_{b,0} / I_{f,0}$	$\rho^{wdf} = i_{b,0} / i_{f,0}$
Transmittance	$\tau^{wDf} = I_{f,N} / I_{f,0}$ $\tau^{wDdf} = i_{f,N} / I_{f,0}$	$\tau^{wdf} = i_{f,N} / i_{f,0}$
Absorptance	$\alpha^{wDf,n} = i_{a,n} / I_{f,0}$	$\alpha^{wdf,n} = i_{a,n} / i_{f,0}$

Backward incident radiation		
	Direct	Diffuse
Boundary conditions	$I_{b,N} > 0$ $I_{f,0} = i_{f,0} = i_{b,N} = 0$	$i_{b,N} > 0$ $I_{f,0} = i_{f,0} = I_{b,N} = 0$
Reflectance	$\rho^{wDb} = I_{f,N} / I_{b,N}$ $\rho^{wDdb} = i_{f,N} / I_{b,N}$	$\rho^{wdb} = i_{f,N} / i_{b,N}$
Transmittance	$\tau^{wDb} = I_{b,0} / I_{b,N}$ $\tau^{wDdb} = i_{b,0} / I_{b,N}$	$\tau^{wdb} = i_{b,0} / i_{b,N}$
Absorptance	$\alpha^{wDb,n} = i_{a,n} / I_{b,N}$	$\alpha^{wdb,n} = i_{a,n} / i_{b,N}$

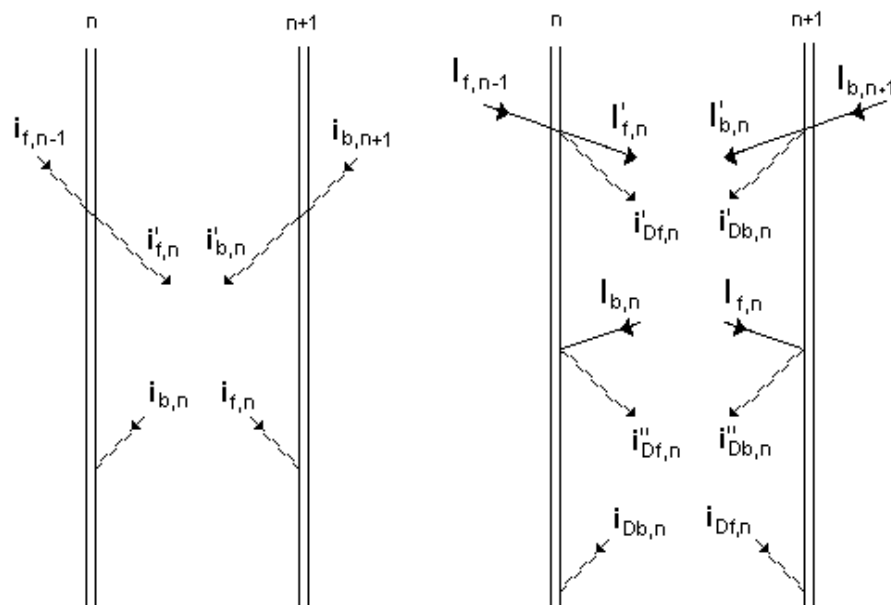

Figure 4.10 A pane together with a fictive pane

Figure 4.10 illustrates a part of a glazing system where all panes to the left of pane n are totally neglected. All panes to the right of pane n form a fictive pane n + 1. All reflections etcetera in those panes are included in the properties of the fictive pane. With forward incident radiation there will be no backward radiation to the right of the fictive pane, thus the illustrated radiation only depends on the properties of pane n and the fictive pane.

### Properties for diffuse incident radiation

The primarily through pane n transmitted radiation is reflected between the panes and decreased by  $\rho_{db,n}$  respective  $\rho'_{df,n+1}$  (the reflectance of the fictive pane) at each reflection. The total diffuse radiation in the gap is thus

$$i_{f,n} = \tau_{df,n} i_{f,n-1} / (1 - \rho_{db,n} \cdot \rho'_{cf,n+1}) \quad (4.4.3)$$

$$i_{b,n} = \rho'_{cf,n} \cdot i_{f,n} \quad (4.4.4)$$

Totally reflected from the combination and totally absorbed in pane n are

$$i_{b,n-1} = \rho_{df,n} \cdot i_{f,n-1} + \tau_{db,n} \cdot i_{b,n} \quad (4.4.5)$$

$$i_{a,n} = \alpha_{df,n} \cdot i_{f,n-1} + \alpha_{db,n} \cdot i_{b,n} \quad (4.4.6)$$

The properties for diffuse radiation incident on the new fictive pane n are then defined as

$$\tau'_{df,n} = i_{f,n} / i_{f,n-1} \quad (4.4.7)$$

$$\rho'_{df,n} = i_{b,n-1} / i_{f,n-1} \quad (4.4.8)$$

$$\alpha'_{df,n} = i_{a,n} / i_{f,n-1} \quad (4.4.9)$$

With  $n = N$  (the last pane in the window) these properties are obvious equal to the pane's properties. For  $n = N - 1$  the properties can be determined with the above equations. This is then repeated until the first pane where the reflectance is equal to the window's reflectance.

$$\rho_{df}^w = \rho'_{df,1} \quad (4.4.10)$$

Then the forward incident radiation can be set to an arbitrarily positive value (e.g. 1) and traced through the window. At each pane the window's absorptivity and the total forward radiation in next gap can be determined.

$$\alpha_{df,n}^w = \alpha'_{df,n} \cdot i_{f,n-1} / t_{f,0} \quad (4.4.10)$$

$$i_{f,n} = \tau'_{df,n} \cdot i_{f,n-1} \quad (4.4.11)$$

Finally the window's transmittance is achieved.

$$\tau_{df,n}^w = i_{f,N} / i_{f,0} \quad (4.4.12)$$

### Properties for direct incident radiation

The same method as for diffuse radiation is here used but as the direct radiation may be diffused at any pane the calculations are more elaborate. The primarily transmitted direct radiation through pane n is reflected between the two panes and decreased by  $\rho_{Db,n}$  respective  $\rho'_{Df,n+1}$  at each reflection.

The total direct radiation in the gap is thus

$$I_{f,n} = \tau_{Df,n} \cdot I_{f,n-1} / (1 - \rho_{Db,n} \cdot \rho'_{Df,n+1}) \quad (4.4.13)$$

$$I_{b,n} = \rho'_{Df,n} \cdot I_{f,n} \quad (4.4.14)$$

If some of the radiation is diffused there may be three sources of diffuse radiation in the gap.

$$i'_{Df,n} = \tau_{Ddf,n} \cdot I_{f,n-1} \quad (4.4.15)$$

$$i''_{Df,n} = \rho_{Ddb,n} \cdot I_{b,n} \quad (4.4.16)$$

$$i'_{Db,n} = \rho'_{Ddf,n+1} \cdot I_{f,n} \quad (4.4.17)$$

The total diffused radiation in the gap is thus

$$i_{Df,n} = (i'_{Df,n} + i''_{Df,n} + \rho_{db,n} \cdot i'_{Db,n}) / (1 - \rho_{db,n} \cdot \rho'_{df,n+1}) \quad (4.4.18)$$

$$i_{Db,n} = \rho'_{df,n+1} \cdot (i'_{Df,n} + i''_{Df,n}) + i'_{Db,n} / (1 - \rho_{db,n} \cdot \rho'_{df,n+1}) \quad (4.4.19)$$

Direct and diffused reflected radiation from the combination become

$$I_{b,n-1} = \rho_{Df,n} \cdot I_{f,n-1} + \tau_{Db,n} \cdot I_{b,n} \quad (4.4.20)$$

$$i_{Db,n-1} = \rho_{Ddf,n} \cdot I_{f,n-1} + \tau_{Ddb,n} \cdot I_{b,n} + \tau_{db,n} \cdot i_{Db,n} \quad (4.4.21)$$

and the totally absorbed radiation in pane n

$$\begin{aligned} I_{a,n} &= I'_{a,n} + I''_{a,n} + I'''_{a,n} \\ &= \alpha_{Df,n} \cdot I_{f,n-1} + \alpha_{Db,n} \cdot I_{b,n} + \alpha_{db,n} \cdot i_{Db,n} \end{aligned} \quad (4.4.22)$$

The properties for direct radiation at the fictive pane n are then defined as

$$\tau'_{Df,n} = I_{f,n} / I_{f,n-1} \quad (4.4.23)$$

$$\rho'_{Df,n} = I_{b,n} / I_{f,n-1} \quad (4.4.23)$$

$$\alpha'_{Df,n} = I_{a,n} / I_{f,n-1} \quad (4.4.24)$$

$$\tau'_{Ddf,n} = i_{Df,n} / I_{f,n-1} \quad (4.4.25)$$

$$\rho'_{Ddf,n} = i_{Dbf,n-1} / I_{f,n-1} \quad (4.4.26)$$

With  $n = N$  these properties are obvious equal to the pane's properties and for  $n = N - 1$  the properties can be determined with the above equations.

This is then repeated until the first pane where the reflectance is equal to the window's reflectivities.

$$\rho_{Df}^w = \rho'_{Df,1} \quad (4.4.27)$$

$$\rho_{Ddf}^w = \rho'_{Ddf,1} \quad (4.4.28)$$

Then the forward incident direct radiation can be set to an arbitrarily positive value (e.g. 1 to avoid some divisions) and the forward incident diffused radiation to zero. These are then traced through the window. At each pane the absorbance and the total forward radiation in next gap can be determined.

$$\alpha_{Df,n}^w = (\alpha'_{Df,n} \cdot I_{f,n-1} + \alpha'_{df,n} \cdot i_{Df,n-1}) / I_{f,0} \quad (4.4.29)$$

$$i_{f,n} = \tau'_{Ddf,n} \cdot I_{f,n-1} + \tau'_{df,n} \cdot i_{f,n-1} \quad (4.4.30)$$

$$I_{f,n} = \tau'_{Df,n} \cdot I_{f,n-1} \quad (4.4.30)$$

Finally the windows transmittances are achieved.

$$\tau_{Df,n}^w = I_{f,N} / I_{f,0} \quad (4.4.31)$$

$$\tau_{Ddf,n}^w = i_{f,N} / I_{f,0} \quad (4.4.32)$$

### Numerical considerations

Numerical problems can arise in some equations above if  $(1 - \rho_{db,n} \cdot \rho'_{df,n+1})$  or  $(1 - \rho_{Db,n} \cdot \rho'_{Df,n+1})$  are close to zero. This can only be the case if  $\rho_{db,n} \approx 1$  or  $\rho_{Db,n} \approx 1$  and the problems can be avoided with following considerations.

If  $\rho_{db,n} \approx 1$  must  $\tau_{db,n}$  be close to zero. This implies that all transmission of diffuse radiation through the pane can be neglected. Neither can any direct radiation be transmitted as diffuse radiation consists of direct radiation with all incident angles. Thus all radiation in the gap can be set to zero and the divisions with  $(1 - \rho_{db,n} \cdot \rho'_{df,n+1})$  and  $(1 - \rho_{Db,n} \cdot \rho'_{Df,n+1})$  are not needed.

Even with  $\rho_{db,n} < 1$  may  $\rho_{Db,n}$  be close to 1. But this require that  $\tau_{Db,n} \approx 0$  which implies that all direct radiation in the gap can be neglected and set to zero and the division with  $(1 - \rho_{Db,n} \cdot \rho'_{Df,n+1})$  is not needed.

### Dependencies on wavelength, polarization and incident angle

In order to take these dependencies completely into account when the properties for a window are determined following calculations are needed.

For each incident angle (or interval), each wavelength (or interval) and two polarization directions all the above calculations for direct radiation have to be carried out.

For each incident angle (or interval) the averages of the properties for the two polarization directions must then, weighted with the wavelength dependent intensity of the solar radiation, be integrated (or summed) over the whole solar

spectra to give the window properties for direct incident radiation at that incident angle.

The window properties for diffuse radiation are finally achieved by integration of the properties for direct incident radiation over the hemisphere.

The importance of treating the polarization in a correct way is shown in Figure 4.11 where some properties for a triple pane window with 3 mm clear glass are illustrated.

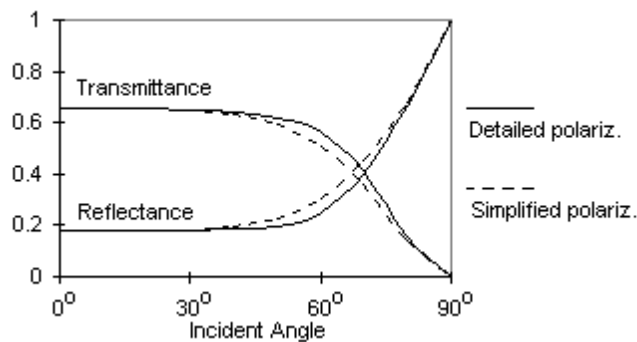

Figure 4.11 Properties calculated with different polarization considerations

In the first case (Detailed polarization) calculation is carried out as above. In the other case the properties for each pane have first been achieved as the average of the two polarization directions and then these values have been used to determine the window properties.

Often it's not possible to get the data needed for all the above calculations. Furthermore, if some direct radiation is diffused in a glazing system, the properties for diffuse radiation are needed before the direct properties are determined. This may be solved with a much more elaborate calculation than shown above.

## 4.5 Shading of Beam Radiation

Detailed calculation of shading is elaborate. In order to reduce the calculation efforts it is convenient to separate objects far away from the building from those close to it as far objects can be treated in a simplified way. The term horizon shading is used for shading by far objects and for close objects ray tracing and geometrical methods will be discussed.

### Horizon shading

If the whole building can be assumed as shaded when the solar altitude is below a certain value we talk about horizon shading. The horizon line may in this case be described as a horizon angle ( $\alpha_h$ ) as a function of solar azimuth so that

$$G_b = 0 \text{ if } \alpha_{sun} < \alpha_h(\gamma_{sun}) \quad (4.5.1)$$

If the beam irradiance is measured on site, this type of shading should not be necessary as no beam radiation will be detected when the sun is below the horizon. However, many times we need to work with climate data from meteorological stations some distance away from the building site or we work



with theoretical values for the solar radiation, thus this type of shading occurs. There is also the situation when the radiation is measured on the roof of the building and lower parts of the building are shaded.

In some cases a surface in a building may be assumed as totally shaded or not shaded at all, e.g. by a hill or a large building far away compared with the dimensions of the surface in question. In these cases a special horizon line for that surface and can be used in order to avoid more elaborate calculations

### Ray tracing

A common technique to deal with shading screens is to divide the receiving area into grids and then trace the ray from the sun to the center of each grid. If a ray is shaded by any screen the whole grid is assumed to be shaded and vice versa.

If each surface that the ray passes is transparent with the transmittance  $\tau_k(\theta_{i,k}) > 0$  where the incident angle ( $\phi_i$ ) can be different at different surfaces, the irradiance on the grid can be expressed as

$$E_{i,s} = G_b \cos(\theta_{i,s}) \prod_k \tau_k(\theta_{i,k}) \quad (\text{W/m}^2) \quad (4.5.2)$$

The disadvantages of this method are the rather elaborate calculations involved if the accuracy is important and the extreme error that can occur if we try to reduce the calculation work by using too few grids. E.g. if we want to have an accuracy of 1%, we need 100 grids and for each of these we have to examine if the beam is passing inside or outside the surfaces that might shade the receiving area.

A typical example of error that can arise with this approach is found in some versions of the DEROB program. Each surface is divided into nine grids and a very small surface which shades the center of one grid gives the result that about 11 % of the surface is shaded. In the same way could a very small window result in beam radiation on 11 % of an inner surface, thus the solar heat gain is considerably overestimated. In DEROB-LTH the situation is to some extent improved, 25 grids are used and the solar radiation absorbed at the inner surfaces is adjusted according to the radiation transmitted through the windows.

### Geometrical methods

Better accuracy and faster calculations than with ray tracing technique can sometimes be achieved by geometrical methods.

An early example of a geometrical method is the shading routine in TRNSYS, the subroutine type 34, where two side wings and an overhang are treated.

To get a more general procedure to deal with shading screens, the following method was suggested by the author. The method has been implemented in the DEROB-LTH program and seems to work satisfactory. A similar method is also described by Johnsen, K., (1996).

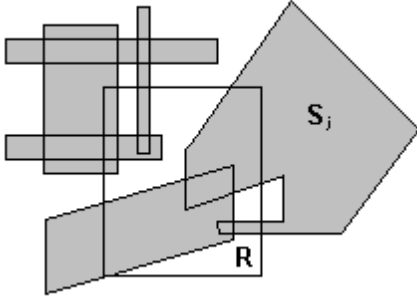

Figure 4.12 A shaded surface

Figure 4.12 illustrate a plane with a receiving area  $R$  shaded by screens giving the shadows  $S_j$ . The shadows are projections of the screens for a given direction of radiation and an incident angle on the receiving area less then  $\pi/2$ . The shaded part of the receiving area is the intersection between the area and the union of the shadows. If  $N$  shadows are considered, the *sunlit area* can be expressed by

$$SLA(R, S_N) = A(R) - A(R \cap \bigcup_{j=1}^N S_j) \quad (\text{m}^2) \quad (4.5.3)$$

where  $A(X)$  is the area of the region  $X$ . The union of the shadows may be complex to represent. As seen in figure 4.12 the union can consist of several regions of which some can contain holes.

In order to avoid unions, the last term can be developed as follows.

$$\begin{aligned} & A(R \cap \bigcup_{j=1}^N S_j) \\ &= A \left[ (R \cap S_N) \cup (R \cap \bigcup_{j=1}^{N-1} S_j) \right] \\ &= A(R \cap S_N) - A \left[ (R \cap S_N) \cap (R \cap \bigcup_{j=1}^{N-1} S_j) \right] + A(R \cap \bigcup_{j=1}^{N-1} S_j) \\ &= SLA(R \cap S_N, S_{N-1}) + A(R \cap \bigcup_{j=1}^{N-1} S_j) \quad (\text{m}^2) \end{aligned} \quad (4.5.4)$$

Repeated development of the last term gives the final result

$$SLA(R, S_N) = A(R) - \sum_{j=1}^N SLA(R \cap S_j, S_{j-1}) \quad (4.5.5)$$

where, as  $S_0$  is empty

$$SLA(X \cap S_1, S_0) = A(X \cap S_1) \quad (4.5.6)$$

We can also observe the following two relations, which are useful when the recursive formula should be used.

$$SLA(X \cap S_j, S_{j-1}) = 0 \quad \text{if} \quad X \cap S_j = 0 \quad (4.5.7)$$

$$SLA(R, S_N) = 0 \quad \text{if} \quad R \cap S_j = R \quad \text{for any } j. \quad (4.5.8)$$

In order to get a simple representation of all intersections between two regions it is useful to allow only convex polygons, i.e. polygons with all inner angles less than  $180^\circ$ . This restriction is not critical, most building parts are of convex shape. In some cases however, a surface may be divided into two or more regions to fulfill this requirement. In other cases we have a receiving area with holes, e.g. a facade wall with windows. Here, the windows can be treated as shadows on the wall.

It is obvious that the shadow from a convex screen is convex, thus a shadow like  $S_j$  in figure 4.12 cannot exist with this restriction. It is also obvious that a non empty intersection between two convex regions is convex.

Following strategy can thus be used in order to determine the intersection between two regions. If the intersection is not determined by one test, the next test must be carried out.

1. If the maximum x-value (y-value) for the vertices in one region is less than or equal to the minimum x-value (y-value) for the vertices in the other, the intersection is empty.
2. If all vertices of one region are placed on or outside the same side, or its extension, of the other region, the intersection is empty.
3. If all vertices of one region are interior or boundary points of the other region, the intersection is equal to the first region.
4. If any vertex in one region is an internal or boundary point of the other region, this vertex is chosen as the first vertex of the intersection. Else the sides of one polygon are checked one by one until an intersection between that side and the boundary of the other polygon is found, thus giving the first vertex. Then the leftmost way of the boundaries are followed in the positive direction until the intersection is closed.

There are no major problems with the recursive formula, the maximum recursive levels needed is equal to the number of shadows. For each level it is only necessary to stack one area and one polygon and if all shadows falling totally outside the receiving area are excluded, the numbers of shadows is normally small.

## 4.6 Shading of Diffuse Radiation

### 4.6.1 Opaque Surfaces

A common method to deal with shading of diffuse radiation is to use view factors to estimate the incident radiation.

*The view factor* is defined as the fraction of the diffuse radiation leaving a surface that arrives at another surface when no reflections are assumed. If a spherical coordinate system is related to surface 1 the view factor between this surface and another can be written

$$F_{1-2} = \frac{1}{\pi A_1} \int_{A_1} \int_{\Omega} \cos(\theta) d\omega dA_1 \quad (4.6.1)$$

where  $A_1$  = Area of surface 1 ( $m^2$ )

$F_{1-2}$  = View factor between surface 1 and 2

$\Omega$  = The angle over  $dA_1$  where surface 2 can be seen (sr)

The sky radiation incident at a surface is then given by

$$E_{id,s} = F_{s,sky} G_d \quad (W/m^2) \quad (4.6.2)$$

where  $F_{s,sky}$  is the view factor between the surface and the sky.

The absorbed and reflected radiation can be determined with Eq. 4.3.8 and 4.3.9 if the absorption and reflection is assumed to be independent of the incident angle.

## 4.6.2 Windows

When the radiation at a window is treated it is common to calculate the incident radiation as in the last paragraph and then use the properties determined for a not shaded, vertical or horizontal window.

A problem with this method is illustrated for two horizontal windows shaded by a cone as illustrated in Figure 4.13. In the first case the window is placed below the cone and in the other inside the cone. In both cases the window area is infinitesimal, thus no shading is assumed in the first case when  $\theta > \pi/4$  or in the other when  $\theta < \pi/4$ .

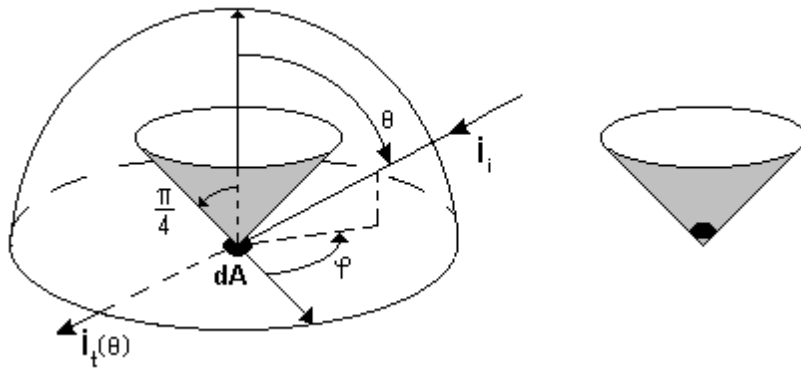

Figure 4.13 Incident isotropic sky radiation at two shaded windows

With use of Eq 4.6.1 the view factors become

$$F_{1,sky} = \frac{1}{\pi} \int_{\varphi=0}^{2\pi} \int_{\theta=\pi/4}^{\pi/2} \cos(\theta) \sin(\theta) d\theta d\varphi = 1/2 \quad (4.6.3)$$

$$F_{2,sky} = \frac{1}{\pi} \int_{\varphi=0}^{2\pi} \int_{\theta=0}^{\pi/4} \cos(\theta) \sin(\theta) d\theta d\varphi = 1/2 \quad (4.6.4)$$

For a single pane window with clear 3 mm glass having a refraction index of 1.52 and an absorption coefficient of  $19.6 \text{ m}^{-1}$  the diffuse transmittance determined for a not shaded horizontal window is 0.790. Thus the estimated flow transmitted through each of the windows will be

$$q_t = 0.790 \cdot 0.5 \cdot I_{dH} = 0.395 \cdot I_{dH} \quad (\text{W/m}^2) \quad (4.6.5)$$

However, all incident angles in the first case are greater than  $\pi/4$  and in the second less than  $\pi/4$ . This indicates that less radiation is transmitted in the first case than in the other and the result seems to be erroneous. In order to examine the error, a more exact calculation is performed.

The energy flow transmitted through a window in Fig. 4.13 can be written

$$q_t = \int_{\Omega} i_t(\theta) \cos(\theta) d\omega = \int_{\Omega} i_t \tau_D(\theta) \cos(\theta) d\omega \quad (\text{W/m}^2) \quad (4.6.6)$$

where  $i_t(\theta)$  = The intensity of transmitted radiation ( $\text{W/sr,m}^2$ )

$\tau_D(\theta)$  = The transmittance for direct radiation

A numerical solution of Eq. 4.6.6 for the two cases with the same type of window as above gives

$$q_{t,1} = 0.361 \cdot I_{dH} \quad (\text{W/m}^2) \quad (4.6.7)$$

$$q_{t,2} = 0.429 \cdot I_{dH} \quad (\text{W/m}^2) \quad (4.6.8)$$

The errors when using Eq. 4.6.5 are in these examples around 9%. The result shows that it is not enough to establish the fraction of diffuse radiation reaching a shaded window, the direction is also important even when the sky radiation is assumed to be isotropic.

The same type of error will, to a less degree, occur for a not vertical or horizontal window.

The shading calculations for diffuse radiation are only needed to be carried out once for each window and the results can then be used at each time step during a simulation. Thus elaborate calculations are not important to avoid and in order to improve the calculations following method can be used.

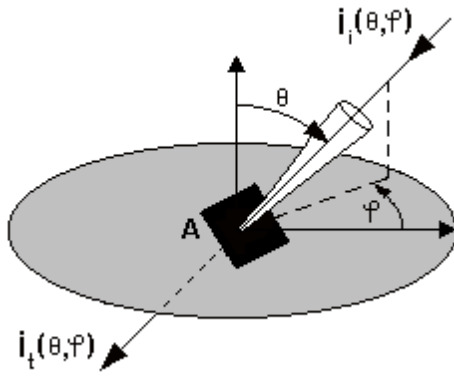

Figure 4.14 Diffuse sky radiation at a tilted window

An eventually shaded and tilted window is illustrated in Figure 4.14. The intensity of the diffuse sky radiation now depends on the direction as it may be shaded or not.

$$i_i(\theta, \varphi) = \frac{G_d}{\pi} \text{ if } \theta < \pi/2, \phi_i < \pi/2 \text{ and non shaded, else } 0. \quad (4.6.9)$$

where  $\phi_i$  is the incident angle. The energy flow incident at the window can thus be written

$$Q_i = \int_A \int_{\Omega} i_i(\theta, \varphi) \cos(\phi(\theta, \varphi)) d\omega dA \quad (\text{W}) \quad (4.6.10)$$

where  $A$  The area of the window ( $\text{m}^2$ )

$\phi$  The incident angle for radiation from the direction  $(\theta, \varphi)$  (rad)

$\Omega$  The part of the sky from where radiation can reach the window

The radiation transmitted through the window becomes

$$Q_t = \int_A \int_{\Omega} i_i(\theta, \varphi) \tau(\phi(\theta, \varphi)) \cos(\phi(\theta, \varphi)) d\omega dA \quad (\text{W}) \quad (4.6.11)$$

where  $\tau(\phi(\theta, \varphi))$  is the transmittance of the window for direct radiation. If  $A_s(\theta, \varphi)$  is the sunlit area as defined in paragraph 4.5 Eq 4.6.11 can be written

$$Q_t = \frac{G_d}{\pi} \int_{\varphi=0}^{2\pi} \int_{\theta=0}^{\pi/2} A_s(\theta, \varphi) \tau(\phi(\theta, \varphi)) \cos(\phi(\theta, \varphi)) \sin(\theta) d\theta d\varphi \quad (4.6.12)$$

The reflected and absorbed radiation can be determined in similar ways and the equations can be used for any surface, shaded or not. E.g. an non shaded window has  $A_s(\theta, \varphi) = A$  if  $\theta < \pi/2$  and  $\phi < \pi/2$ .

The method has been implemented in the DEROB-LTH program and seems to work satisfactorily.

## 4.7 Distribution of Reflected Radiation

For each building surface, all other surfaces may be assumed as shading screens, eventually partly transparent. Thus the primarily incident beam radiation on all surfaces can be determined by the methods described above.

In order to determine the distribution within a building, we also have to deal with the radiation reflected from the surfaces. It is common to assume all reflected radiation as diffuse and use the treatment discussed in the following paragraphs. In many cases, this approximation is acceptable, but caution has to be taken in some cases, e.g. a room glassed on more than one side. If the solar altitude is low, most of the radiation will obvious be transmitted out from the building but assuming diffuse reflection leads to the conclusion that most will remain inside the room. The treatment of specular reflections in a room will not be discussed in this report but is partly discussed in e.g. Siegel and Howell (1981).

If all surfaces are assumed to opaque and optically black or diffuse-gray, i.e. all emitted or reflected radiation is assumed to be diffuse following method from Gebhert (1971) can be used to determine the distribution of the reflected radiation.

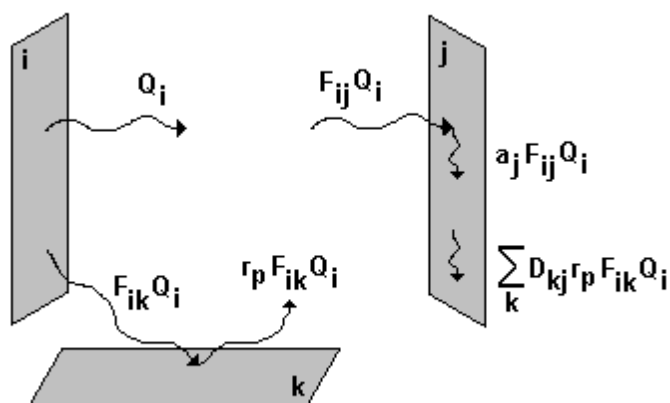

Figure 4.15 Reflections between surfaces

Figure 4.15 illustrates the distribution of the total radiation  $Q_i$  from surface *i* to other surfaces. This radiation may be sky radiation primarily reflected at the surface or emitted LW radiation and will after all reflections be absorbed in different surfaces. The *distribution factor*  $D_{ij}$  is defined as the fraction of  $Q_i$  that after all reflections is absorbed in surface *j*. This factor can be determined in the following way.

$Q_i$  will before any reflections has been taken into account reach other surfaces but not necessarily all. The view factors can be used in order to determine how much will reach each surface, thus  $F_{ij}Q_i$  respective  $F_{ik}Q_i$  will reach surface *j* and *k*.

The radiation reaching a surface is partly absorbed and partly reflected. At surface  $j$  is  $\alpha_j F_{ij} Q_i$  absorbed and at surface  $k$  is  $\rho_k F_{ik} Q_i$  reflected. Here is  $\alpha$  the absorptance and  $\rho$  the reflectance at the surfaces.

The part of the radiation reflected at surface  $k$  will finally after all reflections at all surfaces be absorbed in surface  $j$ . According to the definition of the distribution factor is this absorbed radiation equal to  $D_{kj} \rho_k F_{ik} Q_i$ . If there are  $N$  surfaces (including surface  $i$ ) is the amount of  $Q_i$  primarily reflected at the other  $N-1$  surfaces and finally absorbed in surface  $j$  equal to

$$\sum_{k=1}^N D_{kj} \rho_k F_{ik} Q_i \quad (\text{W}) \quad (4.7.1)$$

The summation can be carried out over all surfaces,  $F_{ii} = 0$  as no radiation primarily will reach the surface it comes from. The totally absorbed radiation in surface  $j$  becomes

$$Q_{aj} = \alpha_j F_{ij} Q_i + \sum_{k=1}^N D_{kj} \rho_k F_{ik} Q_i \quad (\text{W}) \quad (4.7.2)$$

which according to the definition is equal to  $D_{ij} Q_i$  and we get

$$D_{ij} = \alpha_j F_{ij} + \sum_{k=1}^N D_{kj} \rho_k F_{ik} \quad (4.7.3)$$

Gebhart also showed following useful relations.

$$\alpha_i A_i D_{ij} = \alpha_j A_j D_{ji} \quad (4.7.4)$$

$$\sum_{j=1}^N D_{ij} = 1 \quad (4.7.5)$$

The last relation is obvious if all surfaces are opaque, all radiation must be absorbed somewhere. In other cases, e.g. when examine the radiation outside a window, the absorptance in Eq. 4.7.3 and 4.7.4 must be replaced with

$$1 - \rho - \tau \quad (4.7.6)$$

where  $\rho$  and  $\tau$  are the reflectance and transmittance for the window. For the sky a similar substitution must be done.

Eq. 4.7.3 - 4.7.5 is used to set up an equation system for each surface in order to get the distribution factors.



## 5 The JULOTTA Program

### 5.1 Background

The JULOTTA program has been developed at the Department of Building Science (BKL) at the Lund Institute of Technology in Sweden. The study of heat balance and energy use in buildings has been a long-term interest at the department. A need was generated in the mid 1970th for a program able to calculate indoor temperatures and heating/cooling loads for buildings within BKL. The program is documented in Swedish, Källblad, (1986) and a summary of the documentation will be given in this chapter.

When work was begun on JULOTTA, the approach taken was to utilize first principles of physics insofar as possible, and to make the program extremely flexible so that virtually any building's thermal situation could be simulated. The program was conceived as a research tool and never envisioned as eventually developing into any sort of public domain program. Thus, JULOTTA was both core and execution time expensive for users. In addition to this, the flexibility of the program has made input rather elaborate and time-consuming as well.

### 5.2 Building Model

JULOTTA is basically a RC-circuit analysis algorithm. This means that while the user must ordinarily manually create a network analog of the building to be simulated, JULOTTA gives him at the same time the ability to easily manipulate the network and to deal with a wide variety of different problems in extreme detail. The program has no Heating Ventilating and Air Conditioning (HVAC) system modeling capabilities included; however, a special subroutine, SYSTEM, allows the user to build his own HVAC and control routine and access the simulation with appropriate alterations of modeling conditions while it is actually underway.

### 5.3 Input Data

When a user wishes to build up model to be simulated with JULOTTA, he must deal with five basic types of input:

#### **Zero Capacity Nodes**

The first type of input describes the network for rooms. This network includes nodes which are temperature points without heat capacity, for example, wall surface, room air, window panes, curtains, and light panels. To specify a room model, the user has to describe the type of thermal resistors that are connected between the nodes. A complex room can be described with an average of 50 to 60 resistors and 20 nodes. Simple rooms and spaces (such as plenums) can be described with as few as three resistors and three nodes.

#### **Walls**

Walls are described as T-links each having two thermal resistors and a thermal capacity. Each wall can be described as consisting of one or more such T-links

depending on its mass. This description is not restricted to walls alone, but is also applicable to any massive surface such as floor or ceiling slabs and furniture.

### **Outer Surfaces**

Outer surfaces are described by their connection with thermal resistors to the outer air and to the background surfaces such as the surrounding ground and sky. The orientation and absorptance for short-wave radiation must be specified for such surfaces.

### **Direct Room Connections**

This type of input describes direct thermal connections between rooms. These can be, for example, air exchange between two rooms or doors where heat capacity can be neglected.

### **Connection Tables**

The final part of the network description is the connection tables, which associate parts of the model. These tables also connect excitation, such as internal loads and solar radiation, to the model.

## **5.4 Characteristics of JULOTTA**

Thermal resistors utilized within the JULOTTA network scheme are extremely varied in type. Among the types available are:

- constant value
- functions of the square root of temperature differences (e.g. convective film coefficients)
- functions of the fourth power of temperatures (e.g. long-wave radiation exchange between surfaces)
- functions for the dry-bulb air temperature (e.g. ventilation losses)
- special broken functions, (e.g. convective heat film coefficients)

Each resistor must be explicitly specified. For rectangular rooms, however, a geometric description of the surfaces can be converted by JULOTTA into the resistor network describing the long-wave radiation exchange within the room. These are calculated according to the long-wave emissivity of the surfaces and the view factors; and assume gray, diffuse surfaces.

JULOTTA modeling also requires the following assumptions:

- each node describes a surface or air zone with uniform temperature
- each surface has one dimensional heat flow

The solution approach of JULOTTA allows a variety of levels of network solution precision. The user can prescribe a fully linear, or a fully non-linear model solution, or a variety of shades of variation between. He is also free to make the model as complex as he pleases, as long as the available computer configuration allows him sufficient core space and his budget sufficient computer time. However, the program may also be run on a PC.

### **Calculation of Solar Radiation**

JULOTTA ordinarily requires hourly values of direct and diffuse, radiation for its operation. However, when work was started on the program in the late 70's, little such data was available in Sweden. The program was therefore given an optional routine which splits daily horizontal radiation totals into hourly values. The latitude, longitude and building orientation are also required as input. JULOTTA then calculates hourly solar position and incidence angle for each surface. Shading screens and ground reflectance are also taken into account in the calculation. With windows, details calculations using such basic physical principles as Fresnel's law are carried out to determine the amount of radiation absorbed and transmitted by each pane. Transmitted radiation is then treated as totally diffuse within the rooms and is either absorbed by the various internal surfaces or re-radiated out through the windows again. Room radiation distribution is calculated in two steps; view factors are calculated and then used together with the short-wave reflectance for each surface.

### **Independent Temperatures**

Independent temperatures necessary for the calculation are hourly values of outdoor dry-bulb air temperatures. These are normally supplied by the same weather data file as is used for solar radiation. In addition, the program allows the user to specify a number of schedules for temperatures. These schedules can be altered for weekend and weekday regimes and are used either as independent temperatures connected to the model or specifically as set-point temperatures for room air.

### **Internal Loads**

Internal loads can be described by input as constant values, step functions or hourly values. These schedules can also be altered between weekends or weekdays.

### **The SYSTEM Routine**

As was mentioned earlier, the program deals only with the building itself and has no implicit HVAC system modeling capability. For each node in a room model, the user can only specify whether the temperature and/or the load should be calculated. (Of course, no more unknown variables than the number of nodes are possible.) To describe a pure convective heat transfer system, the room air temperature is known but the auxiliary heat to the node is unknown. In the case of a ceiling heating system, the node for the room air is fixed to a set-point, but the ceiling surface node is unknown for both temperature and auxiliary heat. However, in order to be able to put in HVAC and control system, and to manipulate the program itself, a special routine, SYSTEM, with any entry points into the solution routine of JULOTTA, has been included. This routine is called in many different parts of the program; for example, after all of the normal inputs have been read, after all excitations for next time step have been calculated and after the room temperatures have been calculated.

By using the SYSTEM routine, the user can write his own control systems and HVAC systems routines for a particular modeling exercise. Furthermore, he can interact in the modeling of the building. The routine allows the user to include or exclude external resistors, etcetera, thus making it completely possible to model

the physical moving of walls in and out of a room. With this technique, for example, maneuvering of curtains, moving of cars in and out of a garage, and any other transient conditions can be modeled. The structure of this routine to manipulate JULOTTA has been seen by users to be astonishingly successful.

### **Solution Techniques**

The user may choose any positive number of time steps per hour but must provide a sufficient number to meet the stability requirement, necessary for the forward difference method used to solve the differential equations for the walls. The main advantage to the forward difference method is the possibility of calculating the internal temperatures of the walls for one time step without involving the rest of the model of the building, thus giving uncomplicated program flow and easy handling of non-linear performance of the walls. The disadvantage of a shorter time step compared with stable methods are normally well-compensated by the simplified flow and smaller amount of calculation work.

The calculation of the temperatures and/or loads in the rooms is done in the following steps for each room:

The equation system describing the room is linearized around the last calculated temperatures. This linearization is only done if the last known temperatures differ more than a limit given by the user.

The equation system is then solved by a Gaussian elimination technique. The matrix triangulation is done only if it is required by a new linearization or a change in the model. Thus, if working with a full linear and fixed model or with a large limit for linearization, there is very little work for calculation of new temperatures.

If the new temperatures and the limit require a new solution, the program jumps back to the first point above.

When all rooms have been treated separately in the above way, eventually direct connections are checked. A direct connection may require a new solution for one or more rooms depending on the type of couplings. This iteration is done until a user-specified limit is reached.

The SYSTEM routine gives a possibility to introduce control systems by using the obtained temperatures and/or loads to eventually require a new solution for the same time step

## **5.5 Applications of the JULOTTA Program**

The program has been used in a variety of applications at and outside the department. For purposes of demonstration some will be briefly mentioned.

Several parametric studies has been undertaken at the department, see e.g. Adamson, (1987) where different factors influencing the energy consumption in a two-story terrace house situated in Guangzhou, China are studied.

Under the International Energy Agency (IEA), a group of 19 different computer programs for energy modeling of buildings were compared. In order to explain some of the differences in predicted energy use from program to program for a

set building and weather data, a study of the split between radiative and convective film coefficients for inner room surfaces was carried out by the author and later incorporated into a more general report published by U.S. Department of Energy (1981). It was shown that different assumptions about the split between radiative and convective coefficient, can result in significant variations in program simulation results. With a totally combined film coefficient, 48% higher peak load was predicted than with a more realistic split between the coefficients. This indicates that the often used method of combining the film coefficient into only one convective coefficient can overestimate peak loads and thereby equipment size by a great deal.

Another study within the IEA where the JULOTTA program was used is reported by Källblad, (1983). In this study a comparison against measurements from an experimental single family building was carried out.

## **5.6 Conclusions**

JULOTTA has proved, over the years, to be a very successful research tool at the BKL. While its demand for computer resources is high and its input requirements are awkward and lengthy, it has proved to be quite cost-effective when matched against the sorts of non-typical research questions which are posed by projects under way at the department. Use of JULOTTA requires an intimate knowledge of the mechanisms; of heat transfer in buildings and how such mechanisms are combined into reasonable models of the physical performance of buildings. At BKL, where simulations by JULOTTA are readily comparable against experiments under way, the program is an extremely valuable research tool. In a consulting environment, however, where direct comparison of simulations and physical reality are rare at best, it could be a double-edged blade in the hands of any except those with a long experience with building heat transfer processes.

JULOTTA is, perhaps, unique among the several building energy balance programs available and has been a very useful tool for the investigation of sources of difference between other user-oriented programs.

## 6 Conclusions and Further Developments

A method to determine the reflectance, absorptance and transmittance of solar and sky radiation in glazing systems has been presented. The method has been tested through frequent use in the building simulation programs JULOTTA and DEROB-LTH and is well suited to handle different types of glazing combinations. The lack of measured values for many modern types of coated and tinted glass indicates needs for further research efforts.

The method to treat shading of direct and diffuse solar and sky radiation discussed in the report has in the same way as above been shown valuable for use in simulation programs. Distribution of diffuse solar and sky radiation through windows and transparent shading screens, e.g. awnings, is at the moment handled by use of distribution factors for opaque surfaces as described in the report. The method might be further developed in order to include transparent components and thus improve the treatment of diffuse radiation within buildings.

During the work with heat transfer in window systems it has been difficult to find general formulas able to handle a wide range of window sizes. This is more a problem when such calculations should be included in commonly available programs than for programs aimed for use by experts. Further research in this field seems necessary to carry out.

The program JULOTTA has during the years been used in several research project and is shown to be a valuable tool when special and unique heat transfer problems in buildings not able to model in more common programs should be examined.

## References

- Adamson, Bo, (1968), *Värmebalans i rum och byggnader* (Raport BKL 1968:1), Department of Building Science, Lund Institute of Technology, University of Lund, Sweden. (In Swedish)
- Adamson, Bo, (1970), *Byggnadstekniska värmeproblem*, Department of Building Science, Lund Institute of Technology, University of Lund, Sweden. (In Swedish)
- Adamson, Bo, (1987), Passive climatization of residential houses in tropical and subtropical climates in People's Republic of China. 1. Parametric study of a simplified residential house in the Guangzhou climate (Report BKL 1987:2(E), Department of Building Science, Lund Institute of Technology, University of Lund, Sweden.
- Andersen, Bo (1972), *Bygningers Värmebalance*, Faget for Opvarmning og Ventilation, Danmarks Ingeniørakademi, Bygningsafdelningen, Kopenhagen, Denmark. (In Danish)
- Andersen, Bo et al, (1974), *Meteorological Data for Design of Building and Installation: A Reference Year*, Statens Byggeforskningsinstitut, SBI-Rapport 89, Köpenhamn, 1974, ISBN 87 563 0116 2, UDK 551.506:696/697. (In Danish with English summary)
- Aittomäki, A., (1971), A Model for Calculating Heat Balance of Room and Building, Technical Research Centre of Finland, Publication No. 168, Helsinki, Finland.
- Arasteh, D.K., Reilly M.S. and Rubin, M.D. (1989), A Versatile Procedure for Calculating Heat transfer through Windows, *ASHRAE Transactions*, Vol. 95 (2), 1989, p. 755-765.
- Arumi-Noa, Francisco, (1979) *DEROB, The DEROB system, Explanatory Notes and Theory, Volume I and II*, Numerical Simulation Laboratory, School of Architecture, University of Texas, Austin, Texas, July 1979
- ASHRAE, *Handbook of Fundamentals*, American Society of Heating, Refrigerating and Air Conditioning Engineers, Inc. Atlanta G.A., current edition.
- BBR 94, (1993), *Boverkets Byggregler, Föreskrifter och allmänna råd*, BFS 1993:57, ISSN 1100-0856, ISBN 91-38-12851-9, Nordstedts Tryckeri, Stockholm, Sweden. (In Swedish)
- Brown, G. (1963), *A method for calculating heat and light radiation in rooms by digital computer*, VVS 34 (1963), No 10, p 356-367.UDC 518.5/536.3/697.001. (In Swedish with English and German summary)
- Brown, G. (1963), *A method for calculating heating and cooling loads with the aids of a digital computer*, VVS 34 (1963), No 11, p 401-410.UDC 518.5/697.97. (In Swedish with English and German summary)
- Bryn, I., (1992), An Energy Information System for Atria Design, Dissertation at Norwegian University of Science and Technology, Trondheim.
- Clarke, J. A. (1985), *Energy Simulation in Building Design* (ISBN 0-85274-797-7) Adam Hilger Ltd, Bristol.
- Cleasson, J., (1990), *The Mathematical Theory of Building Physics*, Contribution to 2nd Symposium Building Physics in the Nordic Countries, Trondheim, Norway, August 1990.

- U.S. Department of Energy (1981), *Comparison of Load Determination Methodologies for Building Energy Analysis Programs*, Prepared for IEA Energy Conservation in Building and Community Systems, DOE/CE/20184-1, U.S.
- ElSherbiny, S.M., Raithby, G.D. and Hollands, K.G.T. (1982), Heat transfer by Natural Convection Across Vertical and Inclined Air Layers, *Journal of Heat Transfer*, February 1982, Vol.104, p. 96-102.
- Fanger, P. O. (1970), *Thermal Comfort, Analysis and Application in Environmental Engineering*, Danish Technical Press, Copenhagen, Denmark.
- Feist, W., (1993), *Passivhäuser in Mitteleuropa*, Institut Wohnen und Umwelt, Darmstadt, Germany, Dissertation at the University of Kassel, Department of Architecture. (In German)
- Feist, W., (1994), *Thermische Gebäudesimulation, Kritische Prüfung unterschiedlicher Modellansätze*, Verlag C.F. Müller GmbH, Heidelberg, Germany, ISBN 3-7880-7486-8. (In German)
- Ferguson, J.E. and Wright, J.L. (1984), *Vision: A computer program to evaluate the thermal performance of super windows*, Solar Energy Program, National Research Council Canada, Report No Passive-10, June 1984.
- Fowles, G.R., (1968) *Introduction to Modern Optics*. Holt, Rinehart and Winston Inc., N.Y.
- Gebhart, B. (1971), *Heat Transfer*, 2nd edition, McGraw-Hill Book Company, New York, USA.
- Hagentoft, C-E., (1988), *Heat Loss to the Ground from a Building – Slab on Ground and Cellar*, Lund Institute of Technology, Department of Building Technology, Report TVBH-1004, Lund, Sweden.
- Hollands, K.G.T., Unny, T.E., Raithby, G.D. and Konicek, L. (1973), Free Convective Heat Transfer Across Inclined Air Layers, *Journal of Heat Transfer*, May 1976, p. 189-193.
- ISO 7730, 2nd edition, 1994-12-15. Moderate thermal environments - Determination of the PMV and PPD indices and specification of the conditions for thermal comfort, Reference number ISO 7730:1994(E).
- Isfält, E. (1974), *Optiska och termiska egenskaper hos fönster och solskydd*, Dissertation at the Royal Institute of Technology, Stockholm. (In Swedish)
- Jóhannesson, G., (1981), *Active Heat Capacity, Models and Parameters for Thermal Performance of Buildings*, LUTVDG/(TVBH-1003)/1-165/1981, ISSN 0349-4950, Studentlitteratur, Lund, Sweden.
- Jonsson, B. (1982), *Heat transfer through windows*, Department of Building Science, Lund Institute of Technology, University of Lund, Sweden.
- Kalema, T., (1991), *Thermal Analysis of Buildings, Verification and Further Development of the TASE program*, Tampere University of Technology, Department of Mechanical Engineering, Thermal Engineering, Tampere, Finland.
- Kimura, Ken-Ichi, (1977), *Scientific Bases of Air Conditioning*, ISBN 0 85334 732 8, Applied Science Publishers Ltd., London, UK.
- Källblad, K. (1973), *Strålning genom glaskombinationer, Principer och datorprogram (Rapport 1973:12)*, Department of Building Science, Lund Institute of Technology, University of Lund, Sweden (In Swedish).



- Källblad, K. (1983), *Calculation Methods to Predict Energy Savings in Residential Buildings*, Document D4:1983, ISBN 91-540-3885-5, Swedish Council for Building Research, Stockholm, Sweden.
- Källblad, K. (1986), *JULOTTA Datorprogram för beräkning av värmebalans i byggnader* (Computer program for calculation of heat balance in buildings). (Rapport 1986:28), Department of Building Science, Lund Institute of Technology, University of Lund, Sweden (In Swedish).
- Källblad, K. (1992), *KGKPREP, Version 1.0, Datorprogram för menyhantering, Användarbeskrivning* (ISSN 0281-6318, ISRN LUTADL/ TABK-92/3009), Department of Building Science, Lund Institute of Technology, University of Lund, Sweden (In Swedish).
- Källblad, K. (1993), *THE JULOTTA PROGRAM, Formats of the Input Data File and the Weather Data File*, (ISSN ???, ISRN LUTADL/ TABK-93/7009), Department of Building Science, Lund Institute of Technology, University of Lund, Sweden.
- Källblad, K. (1993), *DEROB-LTH, User Manual*, (ISSN 1103-4467, ISRN LUTADL/TABK-93/7007), Department of Building Science, Lund Institute of Technology, University of Lund, Sweden.
- Larsen, B., (1970), *BYVOK, Regnemaskinprogram for berekning av bygningers varme og kjølebehov*, Institutt for Varma- Ventilations- og Sanitærtteknikk, Norwegian University of Science and Technology, Trondheim. (In Norwegian)
- Lokmanhekim, M., (1971), Procedures for Determining Heating and Cooling Loads for Computerizing Energy Calculations, Algorithms for Building Heat Transfer Subroutines, ASHRAE Task Group on Energy Requirements for Heating and Cooling of Buildings, ASHRAE, Inc., New York, USA.
- Mitalas and Stephensen (1967), *Room Thermal Response Factors*, ASHRAE Transaction 73, Part 1, Paper 2019.
- NR, (1989), Boverkets Nybyggnadsregler , *Föreskrifter och allmänna råd*, BFS 1988:18, ISBN 1100-0856, ISBN 91-38-09758-3, Allmänna Förlaget, Stockholm, Sweden (In Swedish).
- Pfrommel, P., Lomas, K.J., Seal, C. and Kupe, Chr., *The Radiation Transfer through Coated and Tinted Glazing*, Solar Energy, Vol. 54, No 5, 1995, Elsevier Science Ltd., USA.
- Roos, A., (1997), Optical characterization of coated glazing at oblique angles of incidence: measurements versus model calculations, *Journal of Non-Crystalline Solids* 218, Elsevier Science B.V.
- Rømen, B., Frydenlund. F. (1992), *Thermal Comfort Simulation Using FRES*, Report STF15 A92014, SINTEF, Trondheim, Norway.
- SBN 1980, *Svensk Byggnorm*, Statens planverks författningssamling, PFS 1983:2, ISSN 0348-1441, ISBN 91-38-07565-2, LiberTryck, Stockholm, Sweden (In Swedish)
- Siegel, R. and Howell, J.R., 1981, *Thermal Radiation Heat Transfer*, Hemisphere Publishing Corporation, Washington, New York, London and MacGrow-Hill Book Company, New York, ISBN 0-07-057316-6.
- Spencer, J.W., (1971), *Fourier Series Representation of The Position of the Sun*, Search, Vol.2, No. 5, May 1971.
- Stephensen and Mitalas (1967), Cooling Load Calculation by Thermal Response Factor Method, ASHRAE Transaction 73, Part 1, Paper 2018.

- Threnkeld, J.L., (1962), *Thermal Environmental Engineering*, Prentice-Hall Inc., Englewood Cliffs, N.Y.
- Wang, Zhiwu (1992) *Thermal performance of ventilated roofs* (Report TABK--92/3004), Department of Building Science, Lund Institute of Technology, University of Lund, Sweden, ISRN LUTADL/ TABK--92/3004--SE.
- Wang, Zhiwu (1992) *Indoor Thermal Environment of Residential Buildings in Subtropical Climates in China* (Report TABK--92/3007), Department of Building Science, Lund Institute of Technology, University of Lund, Sweden, ISRN LUTADL/ TABK--92/3007—SE.
- Wexler, A. and Hyland, R.W. (1980), *A formulation for the thermodynamic properties of the saturated pure ordinary water-substance from 173.15 to 473.15 K*, Final report, ASHREA Research Project PR 216, 1980, Pt1.

# Appendix 1 Psychometrics

The treatment of air flows in buildings requires the use of psychometric definitions and formulas and a summary of the most important are given below. All definitions and formulas are here valid for a given sample of moist air if nothing else is stated.

## Nomenclature

M	Mole weight (kg/mole),
R	The universal gas constant (J/mol,K)
T	Temperature (K)
$T_d$	Dew point temperature (K)
$T_{db}$	Dry-bulb temperature (K)
$T_{wb}$	Wet-bulb temperature (K)
V	Total volume of a sample ( $m^3$ )
$c_p$	Specific heat of dry air at constant pressure (J/kg,K)
$c_v$	specific heat of water vapor (J/kg,K)
$c_w$	Specific heat of fluid or solid water (J/kg,K)
f	Relative humidity
$h_a$	Specific enthalpy of dry air (J/kg dry air)
$h_e$	Specific latent enthalpy of evaporation or condensation(J/kg)
$h_v$	specific enthalpy of water vapor (J/kg water vapor)
$h_w$	specific enthalpy of liquid or solid water(J/kg water)
h	enthalpy of moist air (J/kg dry air)
$m_a$	Mass of dry air (kg)
$m_v$	Mass of water vapor (kg)
n	Total number of moles
$n_a$	Number of moles of dry air
$n_v$	Number of moles of water vapor
p	Total pressure (Pa)
$p_a$	Partial pressure of the dry air (Pa)
$p_v$	Partial pressure of the water vapor (Pa)
sat	Saturation
x	Humidity by mass

*Some Constants from ASHRE.*

$M_a = 28.9645$  (kg/mole) Mole weight of dray air

$M_v = 18.0153$  (kg/mole) Mole weight of water vapor

$R = 8.3144$  (J/mole,K) The universal gas constant

$c_p = 1.0$  (kJ/kg,K) Specific heat of dry air at constant pressure

$c_v = 1.805$ (kJ/kg,K)	Specific heat of water vapor
$c_w = 4.186$ (kJ/kg,K)	Specific heat of liquid or solid water
$h_e = 2501$ (kJ/kg)	Specific latent enthalpy of evaporation or condensation

### *The perfect gas relations*

ASHREA states that "the perfect gas relations are sufficiently accurate for most engineering calculation in air-conditioning practice". Thus a sample of moist air is a mixture of independent dry air and water vapor, each assumed to obey the perfect gas equations:

For the dry air

$$p_a V = n_a RT \quad (\text{A1.1})$$

For the water vapor

$$p_v V = n_v RT \quad (\text{A1.2})$$

For the whole sample of moist air:

$$n = n_v + n_a \quad (\text{A1.3})$$

$$p = p_v + p_a \quad (\text{A1.4})$$

$$pV = nRT \quad (\text{A1.5})$$

$$(p_v + p_a)V = (n_v + n_a)RT \quad (\text{A1.6})$$

$$\frac{p_1 V_1}{T_1} = \frac{p_2 V_2}{T_2} \quad (\text{A1.7})$$

### *Humidity definitions*

*By mass*

$$x = m_v / m_a \quad (\text{kg water vapor/kg dry air}) \quad (\text{A1.8})$$

*By volume*

$$v = m_v / V \quad (\text{kg water vapor/m}^3 \text{ moist air}) \quad (\text{A1.9})$$

*Relative humidity*

$$\phi = v / v_{sat} \quad (\text{A1.10})$$

The humidity definitions above follow SiS (SS024203) and the perfect gas relations give following formulas. Sometimes the pressure ratio in the first formula is used as definition of the relative humidity.

$$\phi = \frac{n_v M_v / V_v}{n_{sat} M_v / V_{sat}} = \frac{p_v RT}{p_{sat} RT} = \frac{p_v}{p_{sat}} \quad (\text{A1.11})$$

$$x = \frac{n_v M_v}{n_a M_a} = \frac{M_v p_v}{M_a p_a} = \frac{M_v p_v}{M_a (p - p_v)} \approx 0.62198 \frac{p_v}{p - p_v} \quad (\text{A1.12})$$

$$x = \frac{M_v}{M_a} \cdot \frac{\phi \cdot p_{sat}}{p - \phi \cdot p_{sat}} \approx 0.62198 \frac{\phi \cdot p_{sat}}{p - \phi \cdot p_{sat}} \quad (\text{A1.13})$$

## Enthalpy

Here specific enthalpy is approximately defined, with constant specific heat of air and water as well as the specific latent enthalpy of evaporation or condensation, by following formulas:

Dry air

$$h_a = c_p T \quad (\text{J/kg dry air}) \quad (\text{A1.14})$$

Fluid or solid water

$$h_w = c_w T \quad (\text{J/kg water}) \quad (\text{A1.15})$$

Water vapor

$$h_v = h_e + c_v T \quad (\text{J/kg water vapor}) \quad (\text{A1.16})$$

The enthalpy of moist air is related to the mass of dry air in the sample, thus we have

$$h = h_a + \frac{m_v}{m_a} \cdot h_v = c_p T + x(h_e + c_v T) \quad (\text{J/kg dry air}) \quad (\text{A1.17})$$

## Density of moist air

Due to the definition of density we have

$$\rho = \frac{m_a + m_v}{V} = \frac{1 + m_v / m_a}{V / m_a} = \frac{(1 + x)}{V / m_a} \quad (\text{A1.18})$$

By use of the perfect gas relations we get

$$V / m_a = \frac{(n_a + n_v)RT}{pn_a M_a} = \frac{(1 + n_v / n_a)RT}{pM_a} = \left(1 + \frac{M_a}{M_v} x\right) \frac{R}{M_a} \frac{T}{p} \quad (\text{A1.19})$$

$$\rho = \frac{(1 + x)p}{(R / M_a + xR / M_v)T} \approx \frac{(1 + x)p}{(0.28705 + 0.46152x)T} \quad (\text{A1.20})$$

We can then get the mass of vapor and dry air by

$$m_v = x\rho V \quad (\text{A1.21})$$

$$m_a = (1 - x)\rho V \quad (\text{A1.22})$$

If the partial water vapor pressure is known, it might be more convenient to use following formulas obtained by the perfect gas formulas.

$$m_v = n_v M_v = \frac{p_v VM_v}{RT} \approx 2.1668 \frac{p_v V}{T} \quad (\text{A1.23})$$

$$m_a = n_a M_a = \frac{p_a \cdot VM_a}{RT} = \frac{(p - p_v) \cdot VM_a}{RT} \approx 3.4837 \frac{(p - p_v)V}{T} \quad (\text{A1.24})$$

### Total pressure

The total pressure of the outdoor air is sometimes given, else we have to work with an assumption, e.g. the normal pressure of 101.3 kPa at sea level or a standard pressure as given in ASHREA for different altitude. If the normal pressure at sea level is used, this pressure has to be adjusted according to the altitude. The following formula may be used for this purpose.

$$p = p_0 \cdot e^{-1.219755 \cdot 10^{-4} \cdot a} \quad (\text{A1.25})$$

where  $p_0$  = Pressure at sea level

$a$  = Altitude (m)

The pressure differences in a building are small compared to the static pressure above. E.g. a difference of 50 Pa (around 0.05 per cent of the static pressure) is often used in order to get an extreme difference when the leakage in a building envelope is tested. Smaller ventilation system works with pressure differences of up to some hundreds Pa, even that is small compared to the static pressure. Thus, in many cases, the pressure in a building can be assumed equal to the outdoor static pressure.

### Partial water vapor pressure at saturation

This quantity is a function only of the temperature and needed in many situations. It can be calculated by the formula given by Wexler (1980).

$$p_{v,sat} = e^{c_1/T + c_2 + c_3 T + c_4 T^2 + c_5 T^3 + c_6 T^4 + c_7 \ln T} \quad (\text{Pa}) \quad (\text{A1.26})$$

where following constants are used for evaporation over ice between -100°C and 0°C and over liquid water between 0°C and 200°C

	Over ice	Over water
c <sub>1</sub>	-5.6745359*10 <sup>3</sup>	-5.8002206*10 <sup>3</sup>
c <sub>2</sub>	6.3925247	1.3914993
c <sub>3</sub>	-9.677843*10 <sup>-3</sup>	-4.8640239*10 <sup>-2</sup>
c <sub>4</sub>	6.2215701*10 <sup>-7</sup>	4.1764768*10 <sup>-5</sup>
c <sub>5</sub>	2.0747825*10 <sup>-9</sup>	-1.4452093*10 <sup>-8</sup>
c <sub>6</sub>	-9.484024*10 <sup>-13</sup>	0.0
c <sub>7</sub>	4.1635019	6.5459673

### Dew point temperature

The dew point temperature  $T_d$  is the temperature at which the sample of moist air will reach saturation when cooled at constant pressure. This may be expressed by

$$p_{v,sat}(T_d) = p_v(T) \quad (\text{A1.27})$$

If the dew point temperature is known, Eq. A1.24 direct gives the partial pressure for the water vapor in a sample. The equation can also be used in a numerical method in order to get  $T_d$  when  $p_v$  is known.

### Wet-bulb temperature

The wet-bulb temperature is the equilibrium temperature for a psychrometer. The differences between this temperature and the thermodynamic wet-bulb temperature defined below, is usually small. Here they are assumed to be equal and  $T_{wb}$  is used for both of them.

The thermodynamic wet-bulb temperature,  $T_{wb}$ , is the temperature at which liquid or solid water at temperature  $T_{wb}$ , through an adiabatic process at constant pressure, may be evaporated into a sample at temperature  $T$  and bring it to saturation at  $T_{wb}$ . The adiabatic process require conservation of the enthalpy, thus the definition can be expressed by

$$h(T) + h_w(T_{wb}) \cdot [x_{sat}(T_{wb}) - x(T)] = h_{a,sat}(T_{wb}) \quad (\text{A1.28})$$

In many sets of weather data, the dry and wet bulb temperatures and the total pressure are given. In these cases, the humidity by mass can be established by the above equation that together with the equations in A1.4 give

$$x(T) = \frac{x_{sat}(T_{wb}) \cdot [h_e - (c_w - c_v)T_{wb}] - c_p(T - T_{wb})}{h_e + c_v T - c_w T_{wb}} \quad (\text{A1.29})$$

# Appendix 2. Solar Position Formulas

## Solar declination and Equation of Time

Formulas (in radians) given by Spancer, J.W., (1971).

$$\begin{aligned} \delta = & 0.006918 \\ & +0.070257\sin(\gamma) + 0.000907\sin(2\gamma) + 0.001480\sin(3\gamma) \\ & -0.399912\cos(\gamma) - 0.006758\cos(2\gamma) - 0.002697\cos(3\gamma) \end{aligned} \tag{A2.1}$$

$$\begin{aligned} h_{eot} = & 0.000075 \\ & -0.032077\sin(\gamma) - 0.040849\sin(2\gamma) \\ & +0.001868\cos(\gamma) - 0.014615\cos(2\gamma) \end{aligned} \tag{A2.2}$$

with

$$\gamma = 2\pi(\text{daynumber}-1)/\text{days per year.}$$

## Some Time Zones and Time Medians

Greenwich Mean Time	0°
Central European	15° E
East European	30° E
US, Alaska-Hawaii	210° E
US, Yukon	225° E
US, Pacific	240° E
US, Mountain	255° E
US, Central	270° E
US, Eastern	285° E