



LUND UNIVERSITY

Realising full-scale control in wastewater treatment systems using in situ nutrient sensors

Ingildsen, Pernille

2002

[Link to publication](#)

Citation for published version (APA):

Ingildsen, P. (2002). *Realising full-scale control in wastewater treatment systems using in situ nutrient sensors*. [Doctoral Thesis (monograph), Division for Industrial Electrical Engineering and Automation]. IEA, LTH, Box 118, SE-221 00 Lund, Sweden,.

Total number of authors:

1

General rights

Unless other specific re-use rights are stated the following general rights apply:

Copyright and moral rights for the publications made accessible in the public portal are retained by the authors and/or other copyright owners and it is a condition of accessing publications that users recognise and abide by the legal requirements associated with these rights.

- Users may download and print one copy of any publication from the public portal for the purpose of private study or research.
- You may not further distribute the material or use it for any profit-making activity or commercial gain
- You may freely distribute the URL identifying the publication in the public portal

Read more about Creative commons licenses: <https://creativecommons.org/licenses/>

Take down policy

If you believe that this document breaches copyright please contact us providing details, and we will remove access to the work immediately and investigate your claim.

LUND UNIVERSITY

PO Box 117
221 00 Lund
+46 46-222 00 00

Realising Full-Scale Control in Wastewater Treatment Systems Using In Situ Nutrient Sensors

Pernille Ingildsen



LUND UNIVERSITY

Doctoral Dissertation in Industrial Automation
Department of Industrial Electrical Engineering and
Automation

Department of
Industrial Electrical Engineering and Automation
Lund University
Box 118
SE-221 00 Lund
Sweden

<http://www.iea.lth.se>

ISBN: 91-88934-22-5
CODEN: LUTEDX/(TEIE-1030)/1-365/(2002)

© Pernille Ingildsen
Printed in Sweden by Media-Tryck, Lund University
Lund, 2002

Clatter, crash, clack
Racket, bang, thump
Rattle, clang, crack
Thud, whack, bam...
Clatter, crash, clack
Racket, bang, thump
Rattle, clang, crack
Thud, whack, bam...

The clatter machine
They greet you and say
We tap out a rhythm
And sweep you away
A clatter machine
What a musical sound
A room full of noises
That spins us around

Björk, *Dancer in the Dark*, 1997.

Dedicated to wastewater treatment plant operators all over
- taming the machines to protect our aquatic nature.

Abstract

A major change in paradigm is taking place in the operation of wastewater treatment plants as automatic process control is becoming feasible. This change is due to a number of different reasons, not least the development of online nutrient sensors, which measure the key parameters in the biological nutrient removal processes, i.e. ammonium, nitrate and phosphate.

This thesis is about realising full-scale control in wastewater treatment systems using in situ nutrient sensors. The main conclusion of the work is that it is possible to significantly improve the operational performance in full-scale plants by means of relatively simple control structures and controllers based on in situ nutrient sensors. The in situ location should be emphasised as this results in short dead time, hence making simple feedback loops based on proportional and integral actions effective means to control the processes.

This conclusion has been reached based on full-scale experiments, where various controllers and control structures for the biological removal of nitrogen and the chemical removal of phosphorous have been tested. The full-scale experiments have shown that it is possible to provide significant savings in energy consumption and precipitation chemicals consumption, reduction in sludge production and improvement of the effluent water quality.

The conclusions are supported by model simulations using the COST benchmark simulation platform. The simulations are used for investigating issues regarding the interactions between the main control handles working in the medium time frame (relative gain array analysis). The simulations have also been used for testing various control structures and controllers. Controllers for the following types of control are suggested and tested:

- Control of aeration to obtain a certain effluent ammonium concentration;
- Control of internal recirculation flow rate to obtain maximum inorganic nitrogen removal;
- Control of external carbon dosage together with internal recirculation flow rate to obtain a certain effluent total inorganic nitrogen concentration;
- Optimisation of the choice of sludge age.

Additionally, a procedure for implementing new control structures based on nutrient sensor has been proposed. The procedure involves an initial analysis phase, a monitoring phase, an experimenting phase and an automatic process control phase. An international survey with the aim to investigate the correspondence between ICA (instrumentation, control and automation) utilisation and plant performance has been carried out. The survey also gives insight into the current state of ICA applications at wastewater treatment plants.

Acknowledgements

Many people have given me valuable help during my Ph.D. project. I owe them much thank and I hope that I will meet them again in my future career.

My greatest thanks goes to Professor Gustaf Olsson – my supervisor – for being a good teacher, inspirer and friend. We have had a great time together during the project, in Australia and when writing our book “*How to get more out of your wastewater treatment plant – complexity made simple*” together. I would also like to thank his wife Kirsti for welcoming me and enduring hours of discussions about control of wastewater treatment plants. Also great thanks to Dr. Ulf Jeppsson, my co-supervisor, for always being attentive to both my writings and explanations. I appreciate the high standards that you have set for me, which I would never have reached without your help. Thanks also for letting me use the code for the Benchmark implementation in Matlab/Simulink. Thanks also to Dr. Christian Rosén for interesting discussions and for helping me getting the layout right. Also thanks to everyone at IEA for accepting me benevolently. I have also enjoyed good conversations with Professor Jes la Cour Jansen, while travelling forth and back over Øresund.

I also owe much gratitude to my industrial supervisors at Danfoss Analytical. To Business Development Manager Theiss Stenstrøm for believing in me and helping me initiating this project, but most of all for being a highly valued mentor and sparring partner. Special thanks also to President of Danfoss Analytical Mads Warming, who took over the industrial supervisor role in the middle of the project, for providing the project with a huge knowledge of market related issues and for posing difficult but focused questions. I am also grateful to him and Mr. Henrik Wendelboe for trusting me to write a book together with Professor Gustaf Olsson.

At Danfoss Analytical, I owe Mrs. Susanne Bruland and Mr. Hans Christian Soerensen special thanks for helping me out when standing in blizzards, rain or sunshine at the Källby wastewater treatment plant with broken down sensors. Thanks also to the rest of my colleagues at Danfoss Analytical. I have enjoyed working together with such a group of competent, inspiring and energetic people.

At the Källby wastewater treatment plant I am grateful to the entire staff, especially Jan, who taught me “*lugn och fin*” (take it nice and easy), Laila, Ann-Marie, Kenth, Richard, Lars-Göran, Michael and not least to the manager Christer Jonasson, who entrusted me to carry out the experiments at the plant.

Thanks to M.Sc. Anders Lynggaard Jensen at DHI Water and Environment, who has served as a third party sparring partner for the project. I am especially grateful to him for sharing his large practical knowledge on full-scale plant experiments by pinpointing pitfalls and thereby preventing me from falling into (most of) them.

During the project, I spend three valuable months at Advanced Wastewater Management Centre in University of Queensland. This was a great experience and I would like to thank everyone at the institute for taking good care of me. I especially enjoyed the cooperation with Dr. Zhiguo Yuan, Dr. Paul Lant and Dr. Linda Blackall.

Thanks also to the people at the Lindau wastewater treatment plant, especially Mr. Friedrich Hutter and Dr. Günter Lorenz. It was interesting to be part of the control project at the plant.

The project was financially supported by the Danish Industrial Ph.D. Fellowship Programme led by the Danish Academy of Technical Sciences (ATV). I am grateful for the support and I have enjoyed working on the board of directors for the fellowship club.

Thanks also to my family and friends for support during the project.

Finally, I would like to thank Ole Alm for all that he is to me.

Pernille Ingildsen
Frederiksberg, April 9, 2002

Contents

Part I Introduction	1
Chapter 1 Project Description	3
1.1 Motivation.....	3
1.2 Scope.....	5
1.3 Contribution.....	9
1.4 Outline of the thesis	9
1.5 Publications.....	10
Chapter 2 Introduction to Wastewater Treatment.....	13
2.1 Wastewater treatment processes.....	13
2.2 Modelling of wastewater treatment processes.....	19
2.3 The benchmark wastewater treatment plant	20
Part II Potential for Process Control	23
Chapter 3 Progress of ICA in wastewater treatment systems.....	25
3.1 A change in paradigm.....	25
3.2 Historical introduction	27
3.3 Development within sensor technology	28
3.4 Development of a model	36
3.5 Full-scale implementations.....	38
3.6 Outlook	41
3.7 Small case stories	44
3.8 Conclusions	47

Chapter 4 International Survey.....	49
4.1 Background.....	49
4.2 Method of investigation	53
4.3 The design aspect	57
4.4 Operational expenditures	59
4.5 Level of ICA usage.....	65
4.6 Principles of benchmarking.....	70
4.7 Simple key performance indicators	73
4.8 ICA utilisation and performance	79
4.9 Conclusions	82
Chapter 5 The Implementation Process	85
5.1 Introducing the Lindau wastewater treatment plant.....	86
5.2 Initial analysis phase	89
5.3 Monitoring phase.....	96
5.4 Experimenting phase	102
5.5 Automatic control phase.....	105
5.6 Conclusions	109
Part III Control System Design Aspects.....	111
Chapter 6 Control Goal Translation.....	113
6.1 Goal formulation	113
6.2 Disturbances.....	115
6.3 Effluent quality criteria	118
6.4 Balancing effluent quality, economy and robustness.....	124
6.5 Conclusions	132

Chapter 7 Control Structure Selection	135
7.1 <i>Control structure selection</i>	<i>136</i>
7.2 <i>Couplings in the system</i>	<i>137</i>
7.3 <i>Control authority</i>	<i>152</i>
7.4 <i>Conclusions</i>	<i>159</i>
Chapter 8 Selection of Controllers	161
8.1 <i>DO setpoint control</i>	<i>162</i>
8.2 <i>Internal recirculation flow rate control.....</i>	<i>174</i>
8.3 <i>External carbon dosage control</i>	<i>181</i>
8.4 <i>Sludge age control</i>	<i>183</i>
8.5 <i>Conclusions</i>	<i>186</i>
Part IV Full-Scale Experiments	189
Chapter 9 Experimental Set-Up	191
9.1 <i>The lay-out of the Källby WWTP</i>	<i>191</i>
9.2 <i>The biological lines.....</i>	<i>194</i>
9.3 <i>Variation into the plant.....</i>	<i>198</i>
9.4 <i>Sensors.....</i>	<i>202</i>
9.5 <i>Laboratory analyses</i>	<i>208</i>
9.6 <i>Quality verification of sensors.....</i>	<i>211</i>
9.7 <i>Energy consumption of actuators</i>	<i>218</i>
9.8 <i>Automation system</i>	<i>220</i>
9.9 <i>Conclusions</i>	<i>222</i>

Chapter 10 Control of Nitrogen Removal	223
10.1 DO control	225
10.2 Feedforward control based on a hydraulic model	231
10.3 Slow floating controller.....	239
10.4 Combined feedback and feedforward control	249
10.5 In situ controller.....	257
10.6 Conclusions.....	271
Chapter 11 Control of Phosphate Precipitation.....	273
11.1 Chemical precipitation at the Källby WWTP	273
11.2 Controller options for precipitation	274
11.3 Flow proportional feedforward control	276
11.4 Load proportional feedforward control	279
11.5 Feedback control.....	281
11.6 Conclusions.....	287
Part V Discussion and Conclusions.....	289
Chapter 12 Discussion	291
12.1 How to control full-scale plants using nutrient sensors	291
12.2 What are the benefits?	293
12.3 Future development of sensors.....	298
12.4 Topics for further research	299
Chapter 13 Conclusions	301

Appendices.....	303
Appendix A Nomenclature and Abbreviations	305
Appendix B Questionnaire	309
Appendix C Stationary Analysis using EES	321
Appendix D Microbiological Investigations.....	331
References.....	337

Part I Introduction

Chapter 1 Project Description

For a long time process control beyond control of dissolved oxygen (DO) in biological nutrient removal wastewater treatment plants has been an issue for researchers and the most advanced plants in the world. However, due to the growing availability of easy-to-use nutrient sensors the interest is increasing at full-scale plants all over. The increasing dissemination of sensors for the online measurements of ammonium, nitrate and phosphate yields a need for easy-to-implement control strategies at full-scale wastewater treatment plants. These control strategies should satisfy local requirements with regard to effluent criteria, energy and chemicals savings. With the development of in situ sensors for online measurements of ammonium, nitrate and phosphate, it is possible to develop simple control strategies, which make it possible to closely monitor and control the biological and chemical nutrient removal processes. This thesis is about such control strategies.

1.1 Motivation

This thesis is based on the work in an industrial Ph.D. project¹ called “Nutrient removal process control in wastewater treatment plants using new sensor technology”. The project is carried out in cooperation between Danfoss Analytical (DK), Lund University (S) and DHI Water and Environment (DK). The starting point for the project was the development of a new generation of nutrient sensors for the in situ measurements of ammonium, nitrate and phosphate. The word “In situ” means “in its original place” or “in its right place”. Here it is taken to mean directly in the

¹ An industrial Ph.D. project is carried out in collaboration between an industrial and an academic partner. The projects are partly sponsored by the Danish Industrial Ph.D. Fellowship Programme led by the Danish Academy of Technical Sciences (ATV).

activated sludge mixture. This is quite different from a location of the sensor in the clean effluent stream. The in situ location makes the sensor considerably better suited for process control. InSitu[®] is also the trade name of the nutrient sensor series developed by Danfoss. The development of the Danfoss InSitu[®] sensor series was started in 1990 and marked the entering of Danfoss into the analytical business area. By 1992, the first working prototype was ready and in 1996, the sensor series was introduced to an international forum in the International Water Association (IWA) (Lynggaard *et al.*, 1996). At the beginning of this Ph.D. project, the sensors were being sold nationally (in Denmark). Since then, the market has increased and the sensors are now being sold in several countries inside and outside of Europe.

The industrial Ph.D. project was initiated because there was a need to understand how to use the sensors for process control, primarily in order to be able to advice customers and to prove the potential benefits associated with process control. The research society (especially IWA) had pointed out the need for nutrient sensors for several years, see e.g. Andrews and Briggs (1973). However, this need did not seem quite as obvious to professionals working at wastewater treatment plants. Part of the explanation for this was that the research to date had to a large extent been based on mathematical models and only a few papers described real full-scale plant implementations (exceptions are for example Ammundsen *et al.* (1992), Clausen and Önnnerth (2000), Nielsen and Önnnerth (1995), Thornberg *et al.* (1998) and Schmitz *et al.* (2000)). This low amount of full-scale experiments is still a problematic issue (Olsson, 2002).

Hence, this industrial Ph.D. research project was started as a means to overcome some of the barriers that still exist after the development of a truly in situ sensor. The identified barriers were:

1. Lack of understanding and documentation of benefits of applying control based on nutrient sensors;
2. Lack of understanding of which control structure to apply in wastewater treatment plants;
3. Lack of understanding of the practical implications of control in full-scale plants.

1.2 Scope

To ensure a solid basis for the project in real life, it was decided that the backbone of the project should be comparative experiments at a full-scale wastewater treatment plant. Carrying out control experiments in a full-scale plant would give insight into the difficulties and limitations of practical implementation, as well as an understanding of the process of implementing control. This knowledge would be valuable when discussing control solutions with customers. Secondly, full-scale tests were also believed to have higher credibility than model simulations among professionals working at full-scale wastewater treatment plants. At the same time, successful experiments would prove to the sceptics that this type of control is practically realisable. The experiments would also give a good indication of the possible benefits of process control in wastewater treatment plants; including economic benefits as well as more “soft” benefits, such as consistent effluent quality, reduction in needed operator intervention, etc. The pre-denitrification system, being one of the most applied systems for biological nutrient removal worldwide, was chosen as the experimental platform for the project.

Performing comparative experiments in full-scale wastewater treatment plants is a time-consuming task of several reasons. First, there is a certain threshold before a specific plant is understood to the extent that good experiments can be designed and carried out. The training period of newly employed operators at wastewater treatment plants are often in the range of a couple of years. Similarly, it took some time before the opportunities for control were understood both with regard to hardware and software and before tools were developed to manipulate the plant. At the specific plant, there were initially difficulties in controlling the DO setpoint, which is a pre-requisite for higher-level process control. An extensive analysis of the equipment and current operating practice was needed to solve this problem. Secondly, the requirements for comparability pose high demands on the parallel lines and several investigations were carried out to ensure this. Thirdly, control experiments, which potentially may influence sludge properties, need to be carried out for an extended period, at best several times the average sludge retention time. On top of that, various types of hardware and software breakdowns that delay or impair the experiments always occur in this type of experiments. However, all these issues constituted an important learning process and gave insight into the problems that operators face every day.

During the project, all the experiments were carried out at one wastewater treatment plant only. This naturally poses some problems regarding generality. In the worst case, this plant could, for one reason or another, be a total outlier among wastewater treatment plants. To gain a better generality of the findings the experiments were supplemented with three types of investigations: A) mathematical modelling experiments, B) an international survey on wastewater treatment plants and C) a sparring partner project with an additional wastewater treatment plant.

- A. The mathematical modelling is based on the benchmark platform defined by COST Action 682 and 624 (see Copp (2002) and the COST 624 homepage). The aim of these investigations was in particular to gain a better understanding of which control structures to use. This included answering the following questions:
1. What types of goals for operation exist at full-scale wastewater treatment plants? In control literature there is a widespread use of multicriteria goals with some weighting factors defining the importance of various aspects, such as concentrations of ammonium, nitrate, organic matter, energy consumption, etc. The plant operation is then aimed at optimising this multicriteria goal. However, this is usually not the way “success” is defined at full-scale plants, rather it is often defined as e.g. complying to effluent permits while minimising operational costs. The definitions in the permits are of major importance to what type of control is needed and the different national energy prices to some extent determine the commitment to which energy savings are sought. The goals have to be pursued with consideration to slowly changing effects that may alter the behaviour of the whole process.
 2. Is the best control system a coupled multiple input – multiple output (MIMO) system or can a simpler decoupled single input – single output (SISO) system perform just as well or at least satisfactorily? Simplicity of the needed control is of major importance for a wide dissemination of process control (i.e. to many plants).
 3. Should model based feedforward control be applied or are simple feedback controllers able to perform just as well or nearly just as well? There is a challenge in finding control structures and controllers that perform sufficiently well. Within the well-established field of dissolved oxygen control, “advanced” methods

for control exist; see e.g. Holmberg (1986) for an adaptive controller or Lindberg and Carlsson (1996) for a non-linear controller. Even so, most wastewater treatment plants use reasonably simple controller set-ups, i.e. on/off -, single PI - or cascaded PI controllers. These may not perform as well as the advanced controllers nevertheless they may perform “sufficiently well”.

4. How important is the “in situ” location of nutrient sensors? At Danfoss Analytical an in situ sensor was developed. It was to be investigated if this type of sensor gave advantages compared to the “traditional” automated analyser type, typically located in the effluent from sedimentation tanks. See further explanations of the differences in Section 3.3.

B) An international survey was conducted to gain insight into the variability in performance of plants and in the current application of ICA (Instrumentation, Control and Automation) equipment. The investigation built on an Australian investigation carried out in 1998 (Lant and Steffens, 1998). The method was extended to include information that went into greater detail in issues regarding ICA usage, consumption of resources and achieved effluent quality. Additionally, the survey included plants from several countries rather than exclusively Australian plants.

C) To gain a broader understanding of the implementation process a sparring partner control implementation project was carried out with a German plant. Based on the experience from this project and the comparative experiments at the Swedish plant, a framework for the implementation of new control strategies in wastewater treatment plants was set up and examples of the different steps were documented.

Participants

To perform the research work Danfoss Analytical teamed up with the Department of Industrial Electrical Engineering and Automation at Lund University headed by Professor Gustaf Olsson. Gustaf Olsson has been involved in the application of ICA in wastewater treatment plants almost since the forming of the field, see e.g. Olsson (1977; 1985; 1993), Olsson and Andrews (1978), Olsson *et al.* (1985), Olsson *et al.* (1998) and not least the recent and comprehensive book called “Wastewater treatment systems –

Modelling, Diagnosis and Control” (Olsson and Newell, 1999). At the beginning of the project Professor Gustaf Olsson was head of the IWA specialist group of ICA, culminating with the 1st ICA conference organised by IWA in Malmö, Sweden, 2001 (IWA, 2001). Dr. Ulf Jeppsson from the Department also played an important role with his extensive knowledge of wastewater treatment models (Jeppsson, 1996) and his involvement in the development of the COST benchmark platform (Copp, 2002).

As a third party in the project, the acknowledged DHI Water and Environment (Denmark) was involved with M.Sc. Anders Lynggaard-Jensen, head of the Department of Monitoring and Information Technology (MIT), as a key resource person. Anders Lynggaard-Jensen is especially known for his involvement in sensor technology R&D (see e.g. Lynggaard-Jensen (1994; 1995), Lynggaard and Harremöes (1996), Lynggaard *et al.* (1996) and Nielsen *et al.* (2001)), and was closely involved in the development of the Danfoss InSitu[®] sensor series. The Department has a strong practical basis in the control of wastewater treatment plant and was involved in the development of STAR (Superior Tuning and Reporting), see e.g. Thornberg (1988) and Thornberg *et al.* (1992), Lynggaard and Nielsen (1993), Jørgensen *et al.* (1995) Önerth *et al.* (1996) and Isaacs *et al.* (1999). This involvement has led to the Department’s own development of DIMS (Dynamic Integrated Monitoring System, see the DHI-MIT homepage) – a software package with a similar purpose.

The Källby wastewater treatment plant was selected as the experimental platform for several reasons. Technically, it was important that the plant would have parallel identical lines (as described in Ingildsen *et al.* (2000; 2001a; 2002b)) so that comparative experiments could be carried out in order to determine the effect of the application of control based on nutrient sensors. It was also important that the plant was well equipped with sensors, making it possible to quantify the improvements due to control; of major importance was also the fact that each of the parallel lines were monitored by effluent nutrient sensors and that flows in the recirculation streams and the airflows were measured by flow and airflow sensors. The plant also featured a well-run laboratory making it possible to perform supplementary analyses such as microscopic investigations and measurements of nitrate uptake rates. The high motivation of the operators for process control was also important.

The results of the research project are documented in this Ph.D. thesis. It is the hope that it may work to promote the application of process control at full-scale wastewater treatment plants, by demonstrating that it is possible

and feasible as well as by suggesting adequate control structures and controllers. The commercial value of the technique is also discussed.

1.3 Contribution

The main results of the research work is summarised in Part V. The most distinguishing feature of the work is the strong commitment to full-scale wastewater treatment plants. The solutions are compared to a lower level of control by various means, i.e. survey results, modelling and full-scale experiments. The major contributions are within the areas (in order of appearance in the thesis):

- Obtaining an indication of current state-of-art in full-scale wastewater treatment plants internationally with regard to the used types and numbers of sensors and to which extent these sensors are used for process control purposes;
- Suggesting a number of simple key performance parameters in wastewater treatment plant operation and comparing the performance of various plants in the survey based on their level of applied ICA;
- Identifying a framework for the implementation process of new systems for process control in full-scale plants;
- Translating different types of effluent criteria from various countries into control goals useful for determining which controllers to apply;
- Proposing a method to balance economy, effluent criteria and robustness of operation;
- Analysing aspects of control structure selection including process interactions, sensor location and control authority in pre-denitrification systems;
- Suggesting a simple control structure involving simple controllers that may comply with various types of plant goals;
- Testing and documenting the effect of different types of controllers for biological nitrogen removal and chemical phosphorous removal in a comparative study at a full-scale wastewater treatment plant.

1.4 Outline of the thesis

The thesis is organised in five parts:

Part I: Introduction (Chapters 1-2)

Chapter 1 gives a general introduction to the project. Chapter 2 gives a short description of the field of wastewater treatment that allows professionals from other fields to get a quick introduction.

Part II: Potential for Process Control (Chapters 3-5)

This part consists of three rather different chapters. Chapter 3 gives a historical introduction to the application of ICA in wastewater treatment plants. Chapter 4 summarises the results from an international survey on the application of ICA in full-scale wastewater treatment plants. Chapter 5 outlines a method for implementation of control in full-scale wastewater treatment plants (WWTPs).

Part III: Control System Design Aspects (Chapters 6-8)

In this part, three aspects of control system design are discussed. Chapter 6 is on goal translation, i.e. the translation of effluent criteria into control goals. Chapter 7 is on control structure selection with focus on interaction and control authority in pre-denitrification systems. In Chapter 8, various simple controllers are proposed and tested by means of simulation.

Part IV: Full-Scale Experiments (Chapters 9-11)

This part describes the full-scale experiments carried out at the Källby WWTP. Chapter 9 describes the plant and its design, instrumentation and automation. Chapter 10 describes experiments with the biological nitrogen removal process while Chapter 11 describes experiments with the chemical phosphorous removal process.

Part V: Discussion and Conclusion (Chapters 12-13)

This part provides an aggregated discussion of the results obtained in the thesis as well as a summary of the main conclusions.

1.5 Publications

During the project the following papers and books have been published:

Books:

Ingildsen, P. and Olsson, G. (2001). *Get more out of your wastewater treatment plant - complexity made simple*. ISBN 87-87411-01-6 (225 pages).

Papers:

Ingildsen, P., Olsson, G. and Jeppsson, U. (2000). Using nutrient sensors for estimation and control of a full scale activated sludge process. *Proc. WaterTech Enviro 2000*, Sydney, April 9-13, 2000.

Ingildsen, P., Olsson, G. and Yuan, Z. (2002). A hedging point strategy – balancing effluent quality, economy and robustness in the control of wastewater treatment plants. *Wat. Sci. Tech.* Vol. 45, No. 4/5, pp. 317-324.

Ingildsen, P., Jeppsson, U. and Olsson, G. (2002). Dissolved oxygen controller based on on-line measurements of ammonium combining feedforward and feedback. *Wat. Sci. Tech.* Vol. 45, No. 4/5, pp. 453-460.

Ingildsen, P. and Olsson, G. (2001). Exploiting online in situ ammonium, nitrate and phosphate sensors in full-scale wastewater treatment plant operation. *Proc. second IWA World Congress*, Berlin, Germany, October 15-19, 2001.

Ingildsen, P., Lant, P. and Olsson, G. (2001). Benchmarking plant operation and instrumentation, control and automation in the wastewater industry. *Proc. second IWA World Congress*, Berlin, Germany, October 15-19, 2001.

Yuan, Z., Oehmen, A. and Ingildsen, P. (2002). Control of nitrate recirculation flow in predenitrification systems. *Wat. Sci. Tech.* Vol. 45, No. 4/5, pp. 29-36.

Olsson, G., Newell, B., Rosen, C and Ingildsen, P. (2002). Application of Information Technology to Decision Support in Treatment Plant Operation. *Proc. from the third IWA world conference*, Melbourne, Australia, April 7-12, 2002.

Chapter 2 Introduction to Wastewater Treatment

This chapter contains a short description of wastewater treatment processes and wastewater treatment plants. The aim is to introduce the area for the person unfamiliar with wastewater treatment. The chapter also contains an introduction to modelling of wastewater treatment processes and to the simulation benchmark model, which is used extensively in the thesis.

2.1 Wastewater treatment processes

Wastewater treatment is just one component in the water cycle (see Figure 2.1). However, it is an important component as it ensures that the environmental impact of human usage of water is significantly reduced. Wastewater treatment consists of several processes: biological, chemical and physical processes. Wastewater treatment aims to reduce: nitrogen, phosphorous, organic matter and suspended solids. To reduce the amount of these substances wastewater treatment plants consisting of (in general) four treatment steps have been designed. The steps are: a primarily mechanical pre-treatment step, a biological treatment step, a chemical treatment step and a sludge treatment step.

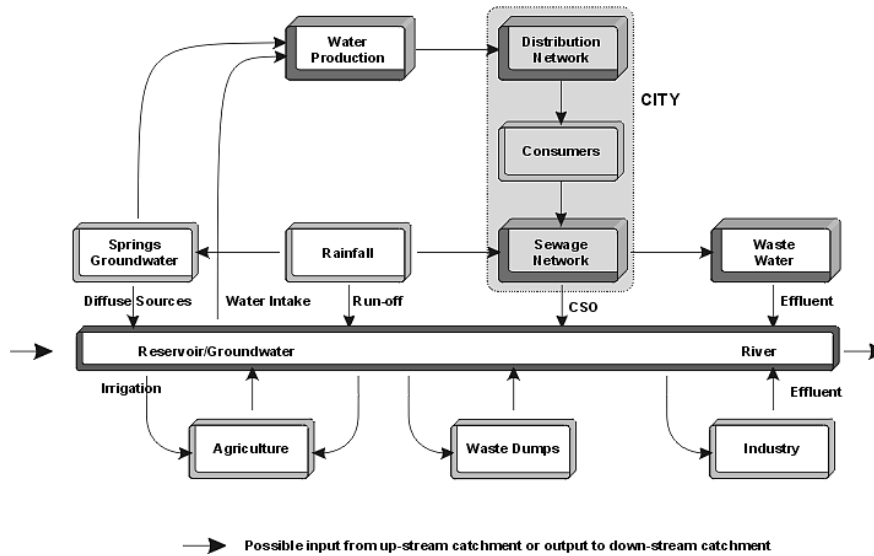

Figure 2.1 The urban water cycle (Indaqua, 1998-1999).

The mechanical pre-treatment step

The purpose of the mechanical pre-treatment step is to remove various types of suspended solids from the incoming wastewater. To a large extent this step is meant to protect the following steps from various types of grits and larger particles. Typically, the step consists of grids that remove larger objects in the wastewater, an aerated sand filter that removes sand and a primary sedimentation unit that reduces the content of suspended solids in the wastewater by means of sedimentation. The primary sedimentation may also remove considerable amounts of organic matter in the particulate form and, hence, reduce the need for aeration later in the process.

The biological treatment step

The aim of the biological treatment step has originally been solely to remove organic matter. However, today many wastewater treatment plants are also designed for the biological removal of nitrogen and phosphorous. The most common type of biological treatment step is based on the activated sludge process. The simplest type of an activated sludge wastewater treatment system is illustrated in Figure 2.2. The biological

reactor contains a mixture of microorganisms suspended in wastewater; called activated sludge. The microorganisms degrade the content of organic matter in the wastewater aerobically, i.e. when air is supplied to the biological reactor. To retain the sludge in the system, the biological reactor is followed by a sedimentation unit that separates the clean effluent wastewater from the sludge. The sludge is then recycled into the biological reactor. Due to the growth of the microorganisms, sludge has to be removed from the system “continuously” via the sludge outtake. In this simple system, the main control handles are: aeration, sludge outtake and sludge recirculation. These variables should be controlled to ensure a suitable treatment efficiency of the process, which includes maintaining a correct amount of sludge in the system.

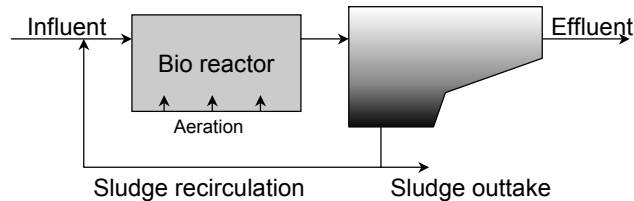

Figure 2.2 Simple activated sludge system

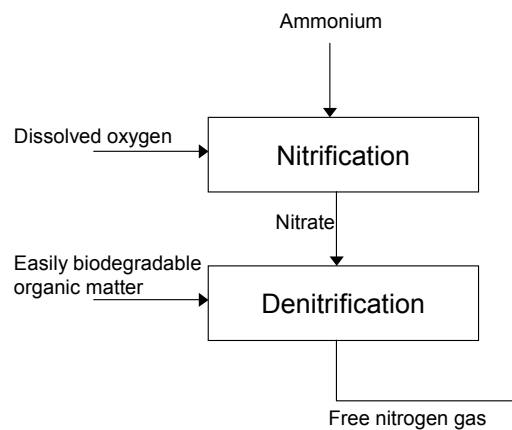

Figure 2.3 Nitrogen removal process

The nitrogen removal process is somewhat more complicated as the process requires both aerobic and anoxic (i.e. instead of dissolved oxygen, nitrate is available in the water) conditions. A simplified process diagram of the whole process can be seen in Figure 2.3. The first step is an aerobic nitrification process where nitrifiers (i.e. microorganisms able to perform nitrification) convert ammonium to nitrate. This is followed by an anoxic process, known as denitrification, where nitrate is converted to free gaseous nitrogen, which leaves the water through the surface into the air. For this process, the denitrifying microorganisms use easily biodegradable organic matter.

Several types of wastewater treatment plants can perform the nitrogen removal processes, see an overview in e.g. Henze *et al.* (1992). One of the most widespread plant designs is the pre-denitrification system, which is depicted in Figure 2.4. To satisfy the need for easily degradable organic matter in the denitrification process the denitrifying biological reactor is located so that it can use the organic matter in the influent wastewater. To ensure the presence of nitrate in this reactor, the wastewater from the following nitrifying biological reactor is recycled via the internal recirculation. To maintain the sludge in the system there is also a sludge recirculation stream, which further supplements the internal recirculation by recycling more nitrate to the denitrification biological reactor. The denitrification reactor is kept anoxic, while the nitrification reactor is supplied with air. The main control handles are: aeration, internal recirculation, sludge outtake and sludge recirculation.

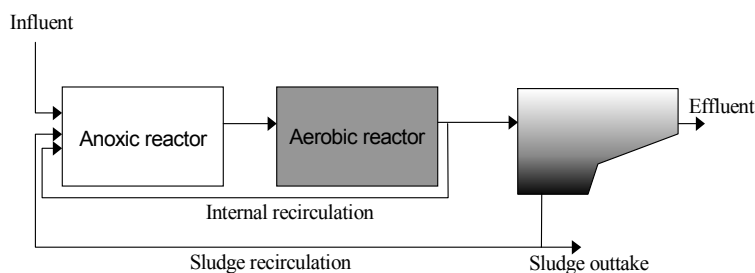

Figure 2.4 Pre-denitrification plant design

Phosphorous removal can be performed biologically or chemically. The chemical process is described later. The enhanced biological phosphorous removal is a fairly new process in the history of wastewater treatment. The process is performed by phosphorous accumulating organisms (PAOs). The PAOs release phosphate during anaerobic conditions (i.e. neither nitrate nor dissolved oxygen present) and take up phosphate during aerobic or anoxic conditions. As the uptake is larger than the release, it leads to a net uptake of phosphorous. The process depends on the presence of volatile fatty acids (VFA), which are easily degradable organic matter. Wastewater treatment plant designs for biological phosphorous removal are typically similar to designs with nitrogen removal. Additionally, the plants are supplied with an anaerobic biological phosphorous release reactor (BIO-P reactor) preceding the nitrogen removal system, see Figure 2.5.

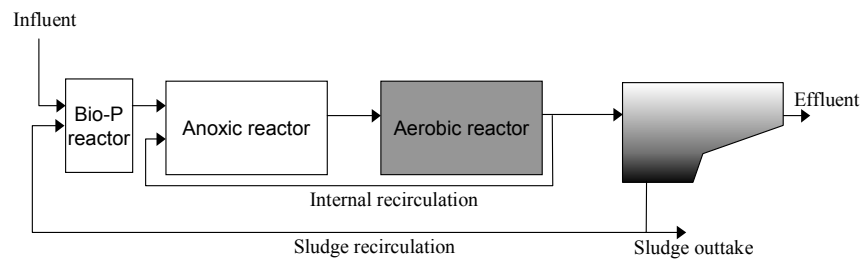

Figure 2.5 Activated sludge system designed for biological phosphorous removal.

The chemical treatment step

Before the biological phosphorous removal process was developed, the common procedure to remove phosphorous was by chemical precipitation. This is a well-proven technology that is still the dominating way of removing phosphorous.

The purpose of the chemical treatment step is chemical removal of phosphorous. The process consists of dosing of a chemical (typically an iron or aluminium salt) that binds phosphate molecules and forms flocs that can be removed by sedimentation. Hence, the phosphorous is removed via a chemical sludge. The process is depicted in Figure 2.6.

For the chemical precipitation process to function two reactors are needed: a flocculation chamber where the chemicals are added and the flocs are formed and a sedimentation unit, which separates the flocs from the

water. The precipitation process may take place at several locations in the wastewater treatment plant. In pre-precipitation plants, the process is carried out in the mechanical pre-treatment step. In simultaneous precipitation the precipitation is performed in the biological step and in post-precipitation plants the process is carried out in a separate chemical step following the biological step. These are the basic options, but others exist. Often a combination of two of these structures is used.

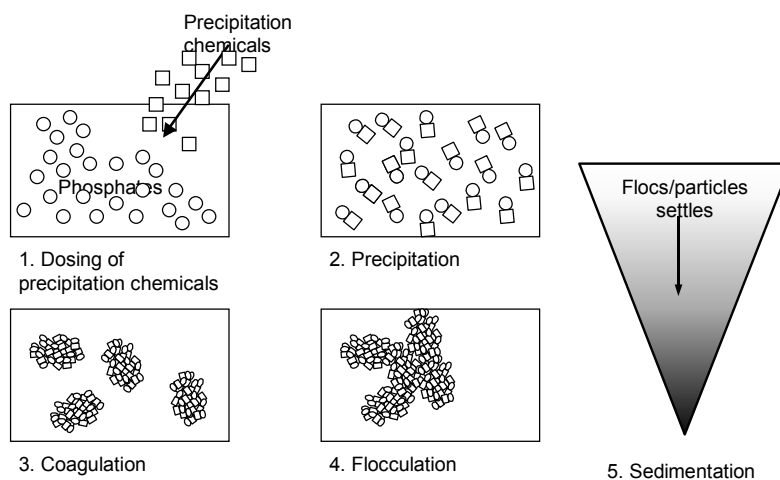

Figure 2.6 The process of phosphorous precipitation.

The sludge treatment step

The purpose of the sludge treatment step is to prepare the sludge for end disposal. Anaerobic digestion is probably one of the most used processes for reducing the amount of sludge. At the same time, the digestion process produces gas, providing a significant source of energy, which is usually used at the WWTP. Sludge treatment also includes various dewatering processes, which reduce weight and volume of the sludge. Sludge treatment is gaining in importance as it becomes increasingly difficult to dispose of the sludge. Sludge disposal is in many countries becoming one of the large costs of wastewater treatment.

2.2 Modelling of wastewater treatment processes

A model is a condensed mathematical representation of what is known about a system. Such a model can be valuable for several purposes, not least to simulate the behaviour of the wastewater treatment plants. The most widely used mathematical model for activated sludge process is the Activated Sludge Model No. 1 (ASM1) (Henze *et al.*, 1987), even though several other models have been proposed (e.g. Henze *et al.*, 1995; 1999; 2000 and Gujer *et al.*, 1999).

The ASM1 model is developed to model organic carbon removal and nitrogen removal. The model includes the following state variables: inert organic material (S_I), readily biodegradable substrate (S_S), particulate inert organic matter (X_I), slowly biodegradable substrate (X_S), active heterotrophic biomass ($X_{B,H}$), active autotrophic biomass ($X_{B,A}$), particulate products from biomass decay (X_P), dissolved oxygen (S_O), nitrate and nitrite nitrogen (S_{NO}), ammonium nitrogen (S_{NH}), soluble biodegradable organic nitrogen (S_{ND}), particulate biodegradable organic nitrogen (X_{ND}) and alkalinity (S_{ALK}). The ASM1 models the main biological processes taking place in wastewater treatment plants including:

- *Aerobic growth of heterotrophs.* The process converts readily biodegradable substrate, dissolved oxygen and ammonium into heterotrophic biomass.
- *Anoxic growth of heterotrophs.* The process converts readily biodegradable substrate, nitrate and ammonium into heterotrophic biomass.
- *Aerobic growth of autotrophs.* The process converts dissolved oxygen and ammonium into autotrophic biomass and nitrate.
- *Decay of heterotrophs.* Heterotrophic biomass is decomposed into slowly degradable substrate and other particulates.
- *Decay of autotrophs.* Autotrophic biomass is decomposed into slowly degradable substrate and other particulates.
- *Ammonification.* Biodegradable organic nitrogen is transformed into ammonium.
- *Hydrolysis of entrapped organic materials.* Slowly biodegradable substrate is converted into readily biodegradable substrate

- *Hydrolysis of entrapped organic nitrogen.* Particulate biodegradable organic nitrogen is transformed to biodegradable organic nitrogen.

Some of the above listed processes use alkalinity others produce alkalinity. Usually alkalinity is not modelled unless there is a specific alkalinity problem at the modelled wastewater treatment plant.

Additionally, the total suspended solids can be estimated from a formula proposed in Henze *et al.* (1995) as a linear combination of the particulate inert organic matter, particulate product from biomass decay, slowly biodegradable substrate, active heterotrophic biomass and active autotrophic biomass. This is used in particular to simulate the sedimentation process, which is not included in the ASM1. Several options for modelling the sedimentation process exist. When using an ideal settler model, no suspended solids are assumed to leave the system with the effluent water stream. Hence, all suspended solids arriving to the settler is removed either via the sludge outtake or is returned to the process via the sludge recycle. This yields a simple mass balance equation. A one dimensional layer model is an alternative that gives insight into the performance of the sedimentation process. In such a layer model, the settler is divided into a number of horizontal layers where exchange of suspended solids between each layer is described by a certain settling velocity function. A description of such a model can be found in e.g. Jeppsson (1996). Additionally, two and three-dimensional models of the settler process exist.

2.3 The benchmark wastewater treatment plant

At the end of the 1990s, a group of researchers decided to develop a simulation platform benchmark, see Spanjers *et al.* (1998) and Pons *et al.* (1999). The platform is a definition of a standard wastewater treatment plant with standard influent conditions; see full description in Copp (2002). The platform is to be used primarily for the objective comparison of control strategies. The transferability of the results from the benchmark system is however an issue of discussion (Olsson, 2002). In this thesis the platform is used widely for demonstrating the effects of various control strategies, see Part III. Hence, a short introduction to the platform is given here.

The plant layout of the system is shown in Figure 2.7. The plant is a traditional pre-denitrification system with five biological reactors (two

anoxic and three aerobic) and a settler. The biological reactors are modelled according to the ASM1. The settler is normally modelled as a ten layer Takacs model (see e.g. Jeppsson, 1996). However, for the purpose of this thesis the settler model is substituted with an ideal settler, as the sedimentation process is not the focus of the work. The average influent flow rate to the plant is $18466 \text{ m}^3/\text{day}$. Three different influent files have been constructed, which imitate: 1) normal conditions, 2) storm weather conditions and 3) rain weather conditions. For the purpose of this thesis, the normal influent conditions are used. This file provides data for a 14-days period of dry weather, i.e. with no major disturbances. The influent flow rate and the influent ammonium concentration to the plant are shown in Figure 2.8. Special performance indices have been developed for assessing the behaviour of the controllers and processes but these are not used in the thesis.

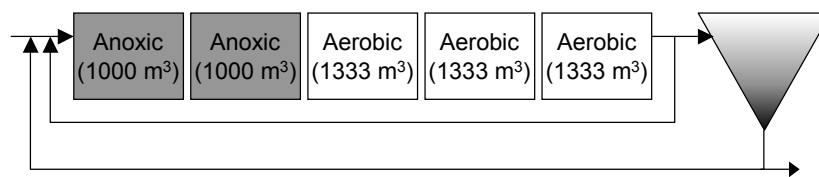

Figure 2.7 Lay-out of the benchmark simulation platform plant.

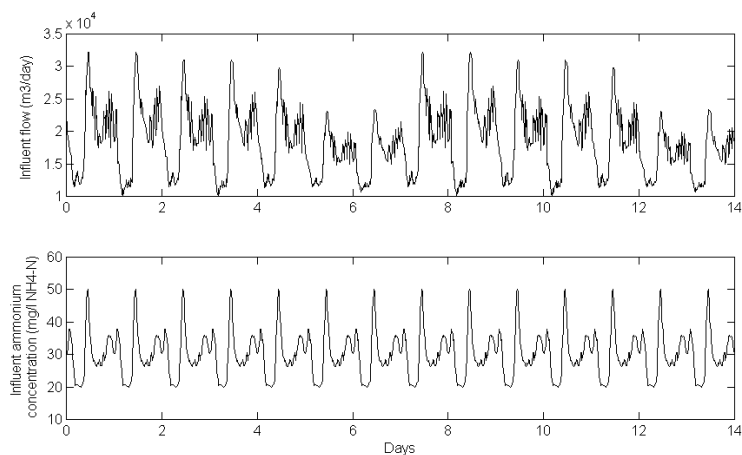

Figure 2.8 Influent characteristics (dry weather).

The main control handles in the plant are aeration in the three biological reactors, internal recirculation, sludge recirculation, sludge outtake rate and dosage of external carbon source. A model of the plant implemented in Matlab/Simulink has been provided by Dr. Ulf Jeppsson, Lund University. Additional steady state calculations based on the plant set-up are carried out in a program called Engineering Equation Solver. For a documentation of this steady-state model, see Appendix C.

More resources

More information on the general topic of wastewater treatment and modelling of wastewater treatment processes can be found in Olsson and Newell (1999), Jeppsson (1996), Henze *et al.* (1992) and Hammer (1986).

Part II Potential for Process Control

Chapter 3 Progress of ICA in wastewater treatment systems

In this chapter, some of the main features of the development in instrumentation, control and automation (ICA) in wastewater treatment systems will be discussed. These include progress in sensor technology, modelling, control and the ultimate implementation in full-scale wastewater treatment plants.

3.1 A change in paradigm

The state of wastewater treatment plant operation can be said to be in a transition or maybe even in the middle of a shift of paradigm. In short, the old paradigm can be described by the perception of wastewater treatment plants as stationary systems, operated without online measurements of process variables and hence without any kind of process control. Some of the traditional design technology has compensated variability in plant load with large reactor volumes. The new paradigm, which this thesis is a part of, stresses the view of wastewater treatment processes as highly dynamic and thus in need of process control. This change in paradigm has been underway for quite a while. The first ICA conference in what is now known as IWA took place in 1973, where the organisers Carmen Guarino (City of Philadelphia), Tony Drake (Greater London Council), Professor John Andrews (Clemson University, USA) and Dr. Ron Briggs (Water Pollution Research Laboratory, UK) played important roles.

The first broad break-through for process control of wastewater treatment plants occurred by the end of the 1970s when dissolved oxygen sensors reached a level of robustness and precision that made them applicable for use in full-scale wastewater treatment plants. The implementation of dissolved oxygen control meant an introduction of

process control in the plants. The plants went from no control of the airflow rate to airflow rate control based on current demand for dissolved oxygen in the reactors. For this change to happen it was necessary to change the perception of the wastewater treatment processes from stationary to dynamic.

There are many challenges for control of wastewater treatment plants and in the following, some of the characteristics that led to the high level of interest from the control-engineering field will be described.

The wide variety of disturbances and variations in the characteristics of the influent is the main challenge for control of wastewater treatment plants. These variations and disturbances have magnitudes that surpass most other process industries. The nature of these variations has been described by e.g. Harremoës *et al.* (1993) and Olsson and Newell (1999). Further examples and classifications of disturbances are given in Section 6.2. They include variations in several time scales together with event disturbances due to e.g. rain and toxicity. While almost all WWTPs are subject to rain disturbances, a survey (Jönsson, 2001) documents that approximately 60% of 109 wastewater treatment plants in Sweden are affected by low levels of inhibition (i.e. the maximum inhibition of nitrification exceeds 5%). Only 4% of the investigated plants are affected by higher levels of inhibition (i.e. the maximum inhibition of nitrification exceeds 20%). In Jönsson (2001) a Danish investigation is quoted that shows that in one fourth of the investigated plants high content of inhibitory substances was measured in the influent (i.e. the maximum inhibition of nitrification exceeds 20 %).

On top of these variations, the aspect of dealing with a primarily biological system adds further to the challenge of controlling the system. Especially the introduction of nutrient removal has increased the complexity of the treatment processes compared to earlier systems that was only build and operated to deal with loads of organic matter and suspended solids.

The possible benefits of improved process control are primarily related to:

- 1) Higher efficiency with regard to the consumption of resources, especially energy and chemicals;
- 2) Ensuring a consistent effluent quality, according to effluent permits;
- 3) Extending the capacity of otherwise overloaded wastewater treatment plants;

- 4) Less expensive retrofitting of old plants and less expensive construction of new wastewater treatment plants due to lower volume requirement.

The last decade of technological progresses within sensor technology and process understanding has increased the opportunities for applying online process control of the variables directly related to quality rather than inferential parameters such as the concentration of dissolved oxygen. The following Sections outline the major historical milestones that led to the current state-of-art.

3.2 Historical introduction

The urban water system, as we know it today is a result of events during the past 200–300 years. The global outbreak of cholera in the nineteenth century triggered the development of modern wastewater treatment systems. The systems first appeared in the form of sewers to lead the wastewater out of urban areas, later in the form of increasingly advanced treatment of the wastewater before discharge into the receiving waters. The activated sludge process was developed in the beginning of the twentieth century. The aim of this process was to remove organic substances using oxygen in the recipients. This was done by aerating the wastewater mixed with microorganisms in reactors – thus allowing the unwanted substances to degrade before they reached the natural recipient such as lakes, rivers, streams and oceans.

Today's focus on nutrients began in the early 1970s and accelerated during the 1980s, when environmental issues attracted increasing attention worldwide. It was established that nutrient pollution of natural recipients has adverse effects on the aquatic ecosystems in lakes, fjords and oceans. Excessive levels of nutrients upset the natural balance of the ecosystems, resulting in high death rates among fish and other aquatic creatures. From the demand for removal of nutrients, a number of plant configurations were developed that exploited the nitrification and denitrification processes. Among the most widespread are the pre-denitrification, the sequencing batch reactor, the post-denitrification and the BioDenitro systems. The introduction of nitrification and denitrification processes, later supplemented by enhanced biological phosphorous removal processes, complicated the treatment systems. The increase in complexity caused a

need for better control of the processes ensuring efficient and consistent operation.

Two of the most important barriers for the development of online control systems for wastewater treatment plants were the lack of sensors and the lack of models of the biological processes. The historical development and importance of these two areas are treated in more detail in the following sections.

3.3 Development within sensor technology

New sensor technology determines the type of control structures that can be applied. The example of the control of the aeration system illustrates the importance of new sensor technology.

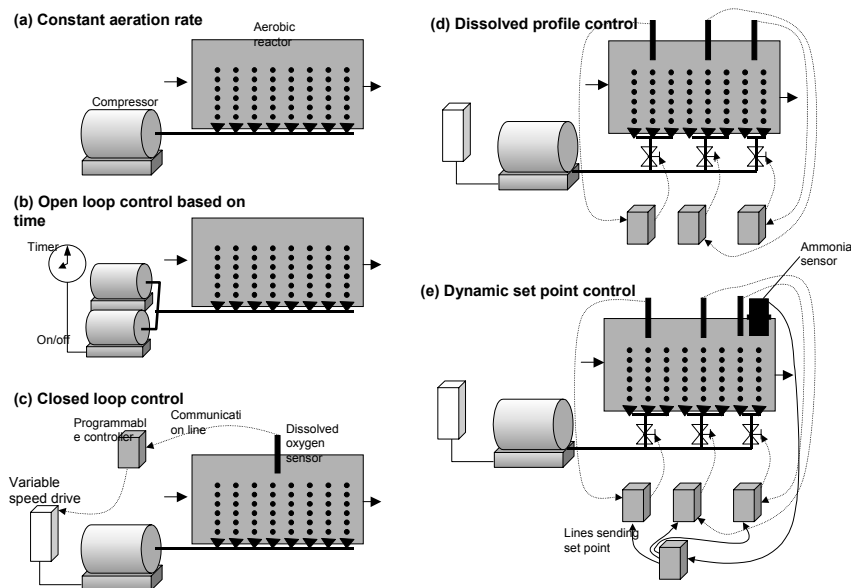

Figure 3.1 Development in control structures for aeration

The control structure for aeration has changed over the last hundred years as more knowledge and better sensors and actuators have become

available. The most basic aeration strategy is to supply a constant level of aeration to the aerobic sections of the plant (Figure 3.1a). This was the preferred approach before the use of dissolved oxygen sensors became common practice. The size of the aerators determines the aeration rate and thus the performance. In this strategy, no consideration is given to the dynamics of the influent load and no measurements are required.

The next step was to use an open loop time-based control of the aeration flow (Figure 3.1b), i.e. applying a high aeration rate during the day and a low rate during the night. This form of open loop control is still not based on actual measurements but rather on experience and the clock.

Control based on DO sensors

The introduction of dissolved oxygen sensors in the 1970s marked the introduction of online process control at most plants, suddenly the magnitude of dynamics that occur in a wastewater treatment process was realised. Wastewater treatment plants were transformed in the mind of operators from stationary to dynamic units with the requirement for automation systems. The realisation that automatic control yielded better results than manual control, see e.g. Wells and Williams (1978) as quoted in Olsson (1979), further stimulated the use of various forms of SCADA systems, programmable logic controllers, telemetry, etc.

The dissolved oxygen sensor is based on a rather simple principle; take for example the most common type, which is based on the Clark principle. In the Clark principle is that a reaction chamber is isolated from the fluid by a membrane, which keeps the reaction chamber separate from the surrounding water but allows oxygen molecules to pass through.

The reaction chamber consists of a silver anode and a gold cathode in an electrolyte solution – a solution of potassium chloride. A polarisation voltage is applied over the anode and cathode, causing the oxygen molecules entering the chamber to react with the cathode first. This reaction supplies electrons to the cathode. The product of this reaction then reacts with the electrolyte thereby releasing chloride ions. These ions are drawn to the anode, where they react with the surface of the anode, thus stimulating electron assimilation. The transfer of electrons from the anode to the cathode creates a current. This current is directly proportional to the oxygen concentration. This means that to produce a DO sensor a cathode and an anode in a special solution separated from the medium by a membrane is all that is needed.

The relative simplicity of the Clark principle for the measurement of dissolved oxygen made it possible at a relatively early stage to develop rugged, easy-to-use, reliable sensors. These characteristics have promoted the wide acceptance of DO sensors across Europe. However, in USA the acceptance seem to be considerably lower, which is ascribed to an early introduction of the sensors before the sensors reached current reliability. This has caused distrust to the instruments and has been a great barrier towards process control in the USA (Watts and Garber, 1993).

When the dissolved oxygen sensor became available and affordable, the level of aeration could be controlled based on the information supplied online from this source (Figure 3.1c). When the first feedback DO controllers were introduced, they put a number of commonly held views to the test. The first of these was that the aeration requirement would be identical in parallel lines, which meant that it would be sufficient to position a dissolved oxygen sensor in just one of the lines, as this sensor could then be used to control all the lines. It soon became apparent that this assumption was wrong. A number of problems were encountered, attributable to several causes. To start with, it is difficult to maintain identical wastewater flow distribution to parallel lines, so the loads on the different lines generally vary. The microorganisms in the various lines may also develop differently, which means that the capacities vary between the lines. Furthermore, the pressure drop in the airflow pipes produce different pressures in different parts of the pipes, and as a result, the airflow in the different pipelines were not the same – even when the valves are open to the same degree. It was apparent that it was necessary to position a controller loop in each parallel line.

The next discovery was the fact that one sensor in each line was generally insufficient because of the length of the tanks. Substrate concentration will decrease progressively from the inlet towards the outlet of the aerobic tank due to biological degradation. The need for aeration therefore decreases with tank length. This realisation led to the introduction of dissolved oxygen profile control (Figure 3.1d). Here, the aerobic reactor is divided into a number of zones that are controlled individually to obtain a proper profile of the concentration of dissolved oxygen.

Control based on nutrient sensors

Though the advent of sensors for dissolved oxygen was important, the control of aeration based on dissolved oxygen is an indirect way of

controlling nitrification and oxidation of organic material and it is not well suited for control of denitrification. The measurements of nitrate and ammonium concentrations provide information more directly related to the performance of the BNR (biological nutrient removal) processes (Figure 3.1e), as these are related directly to the parameters that are being removed. However, the measurements of these parameters are considerably more complicated than the measurement of dissolved oxygen described above. The standard method for measuring ammonium, nitrate as well as phosphate in the laboratory is based on colorimetric methods.

A colorimetric method involves a reaction that causes the solution of the substance to produce a colour, the stronger the colour, the higher the concentration. At low concentrations, it is hardly possible to discern the colouring with the bare eye. Photometers are used to detect the exact strength of the colour by measuring the absorption of a light beam at a specific wavelength. The stronger the colour, the more light is absorbed. Such a method is far more complex than DO measurements as it includes the mixing of chemicals, time for reaction and finally an optical method for determining the strength of the colouring.

That it took approximately 20 years from the introduction of DO sensors to the introduction of nutrient sensors is therefore no surprise. The first widely applicable analysing systems for nutrients appeared in the 1990's. The challenge was first to automate the analysis and later to make it work in the rather rough environment of wastewater treatment plants. In the following, some technical details regarding the measurement of nutrients will be treated. This is motivated by the fact that these technical developments to a certain extent are the initiator of this Ph.D. project. Furthermore, the sensor technicalities are of great importance to how the sensor systems can be used in process control and whether or not the sensors are suited for full-scale plants.

The first type of online analysers to appear was quite similar to the equipment that is found in laboratories. They were more or less traditional analysers where the sample preparation had been automated. The automatic analysers are best suited for effluent wastewater with a low content of particulates. In fact, the particulates in the process tanks of activated sludge systems were the Achilles' heel in most designs. The particles made all the small tubes and valves clog up, effectively stopping sampling and analysis. Ultrafiltration was therefore used for sample preparation, which means that the samples were driven through a micro-porous material. Due to the high content of particulates, the filter had to be cleaned quite frequently. In

Devisscher *et al.* (2002) the average interval between cleaning is estimated to one day, each cleaning procedure taking approximately 45 minutes. The general system is shown in Figure 3.2 as it looks when adapted for the activated sludge reactors. This can be compared with Figure 3.3, which shows the concept of an InSitu[®] sensor also described in Lynggaard-Jensen *et al.*, (1996).

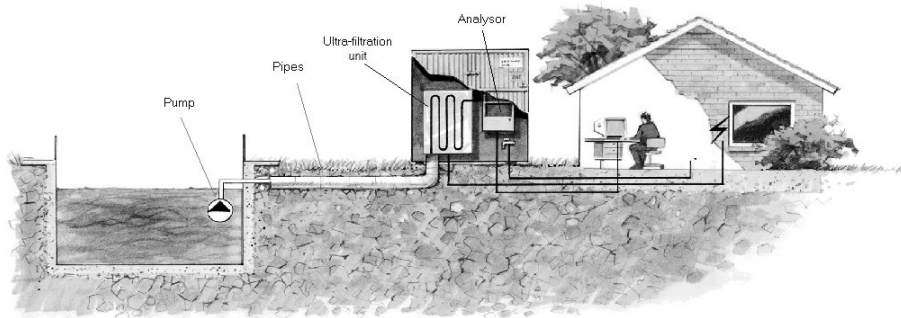

Figure 3.2 Traditional nutrient analysers.

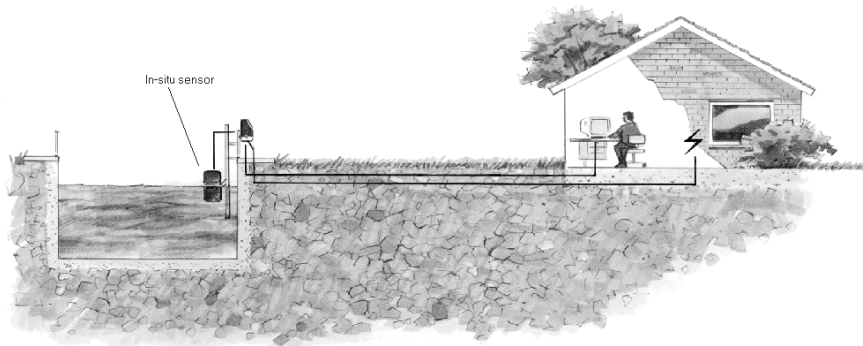

Figure 3.3 InSitu[®] sensor for nutrient analysis.

The development of an in situ system was initiated in order to produce a different type of solution with the characteristics of a “real” sensor such as a DO sensor. InSitu[®] sensors are all based on the colorimetric method; the analysis has been compacted so that it can be performed in a self-contained unit. The principle of the sensor is illustrated in Figure 3.4. The carrier medium (water) that is led in channels on a manifold passes an ion filter.

The nitrate, ammonium and phosphate molecules are transported across the filter by diffusion where larger ions and particles are prevented from entering. After the filter, chemicals are added to make the carrier change colour. This takes a short time and requires a specific temperature, which is controlled internally by the sensor system. The coloured carrier is then analysed by the photometer, which measures the intensity of the colour. A small processor converts this information into a concentration, which is the output from the sensor (4-20 mA). Finally, the used carrier is led into a waste bag that is dealt with by the supplier.

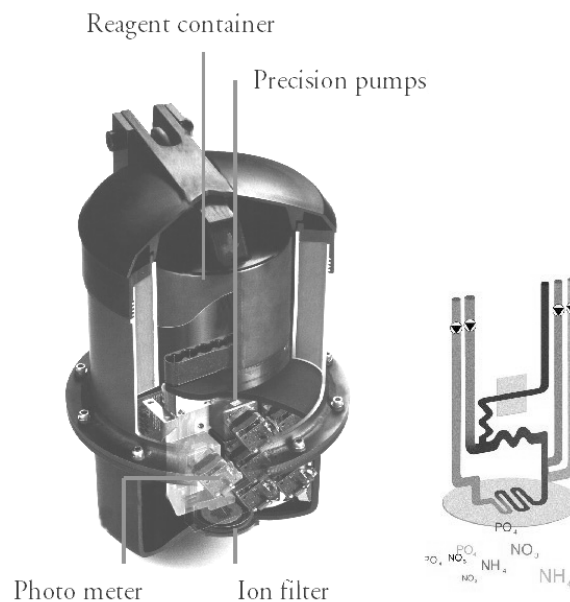

Figure 3.4 Principle of InSitu[®] sensor from Danfoss Analytical.

Photometers have to be calibrated regularly in a laboratory; the same is the case in the sensor. In the InSitu[®] sensors, calibration is carried out automatically at set intervals (typically every three days). Calibration involves substituting the carrier fluid with a known standard concentration. Analysing this liquid makes it possible to establish a renewed correlation between photometer output and concentration. This correlation seldom changes much. Nevertheless, operating an automatic, periodic calibration procedure ensures that the calibration curve is correct at all times. This is

vital for the accuracy of the concentration output that the sensor communicates.

Most importantly, the Danfoss InSitu[®] sensor has a low maintenance requirement. Chemicals and the ion filter are changed once a month by the operator at the plant. The whole manoeuvre takes less than 15 minutes. This low level of maintenance makes it easy to adapt the sensor into operation of full-scale wastewater treatment plants, without the need of specially trained operators.

Several suggestions for control strategies based on nutrient sensors have been put forward in the literature. Overviews of these are given in Schmitz *et al.* (2000) and Weijers (2000). An example regarding sequencing batch reactors is given in Haker (1999). For the control of pre-denitrification systems, see e.g. Balslev *et al.* (1996) and Nielsen and Önnérth (1995). Examples of control of the BioDenitro system are given in e.g. Nielsen and Önnérth (1996) and Sørensen (1996). Examples of precipitation control are given in Devisscher *et al.* (2002) and Ingildsen *et al.*, (2001a). More examples and an analysis of various controllers are given in this thesis.

The market for nutrient sensors for wastewater treatment plants is in a transition from a young to a more mature market. This can be observed by the number of manufacturers being reduced. The latest example is the joining of Staiger Mohilo, Dr. Lange and Contronic into the new global player Danaher.

Control based on indirect parameters

A number of “competing” sensor systems for control of nutrient removal processes exist. Control concepts for sequencing batch reactors and the BioDenitro concept have been suggested based on the measurement of redox potential (ORP) and pH, see e.g. Zipper *et al.* (1998), Paul *et al.* (1998), Caulet *et al.* (1998), Wareham *et al.* (1993), Yu *et al.* (1998) and Charpentier *et al.* (1998). The ORP is primarily used to determine the end of the anoxic phase, by determining the so-called nitrate knee while pH sensors can be used to identify the so-called ammonium valley and nitrate apex. Various methods have been developed either using absolute values or bending points of pH or ORP to control the processes. DO sensors have also been used to identify the end of the nitrification process, which in systems with constant aeration can be identified by an increase in DO (Cecil, 1999). Alternatively, in systems where DO is controlled towards a setpoint the end of nitrification can be identified by a decrease in aeration rate.

The methods above suffer from several drawbacks; firstly, they are inferential, as they do not relate directly to the nitrification or denitrification processes (i.e. nitrate or ammonium concentrations). Instead, they detect when no nitrate or no ammonium is present. Therefore, such a control strategy based on these measurements will cause the processes to stop only when they come to their end or alternatively when maximum time limits are surpassed. This is not necessarily the best strategy. An important advantage with a control system based on pH and redox measurements is that the sensors are inexpensive compared to e.g. nutrient sensors. Moreover, the sensors are easy to maintain. Maintenance is primarily a question of keeping the sensor heads clean.

Oxygen uptake rate measurements (OUR) have also been suggested for the control of wastewater treatment plants. For an overview on this topic, see the scientific and technical report prepared by Spanjers *et al.* (1998) for the International Water Association (IWA). The measurement of OUR has received much attention in the research society but are used to a limited extent only in practice. One of the primary difficulties with the measurement is the reliability and interpretation of the OUR profiles. The signals are discrete and delayed in time, as a whole OUR cycle has to take place in the respirometer, before the result can be interpreted and enter a controller as a control signal. Moreover, the signal cannot tell anything about the nitrate concentration. A method for the measurement of denitrification rates have been suggested based on a method similar to OUR, the measurement is carried out in a Biological Activity Meter (BAM). The method is described by Isaacs *et al.* (1998).

Development of sensor technology for the wastewater treatment field is an active field, which can be seen by the large number of papers published on this subject in the last specialist conference (ICA, 2001). Current research includes methods based on bio-sensing (Gernaey *et al.*; 2001, Nielsen *et al.*, 2002), spectral analysis, mass spectrometry, fluorescence (Vasel *et al.*, 2002), ultrasound, image-processing (Cenens *et al.*, 2002) and fluorescence in situ hybridisation (Bond *et al.*, 1999). Upcoming measurement technology includes the measurement of nitrite (Nielsen *et al.*, 2002), microorganisms (November *et al.*, 2001; Nistor *et al.*, 2002), sludge properties such as flocs and filaments (Cenens *et al.*, 2002), as well as odours and oil contamination (Sanuki *et al.*, 2002; Ueyama *et al.*, 2002).

3.4 Development of a model

The presentation of the activated sludge model no 1 (ASM1) in 1987 (Henze *et al.*, 1987) was an important milestone in the field of wastewater treatment. The model was developed by a task group formed by the International Association on Water Quality (IAWQ) in 1983, now the International Water Association (IWA). The goal of the group was to review earlier suggestions for models and reach a consensus about a new model that would describe the main processes regarding oxidation of organic matter, nitrification and denitrification and their interactions in activated sludge systems. The model can be seen as a condensed mathematical representation of what is known about the system. Still there are some controversies about the exact structure of the model and new versions are suggested recurrently, however, in general the first model, ASM1, is still widely accepted as a reasonable approximation of the processes taking place.

The introduction of the ASM1 has had a large impact on the research within the field of wastewater treatment, especially regarding the fields of plant design and control. Numerous suggestions for control have been put forward based on model simulations. The model is a valuable tool for understanding the processes and their interactions and not least for testing new operational strategies before they are implemented in practice. However, the model also introduced new challenges due to its complexity; the model contains thirteen different components, eight processes and nineteen process parameters. Several of the components and the process parameters are difficult to measure. Thus even though the model provides a common platform for discussing the processes and general features regarding their control, the use for practical simulation of specific wastewater treatment plants is limited. The strength of the model rather lies in providing a common platform for discussions of general characteristics of various plant designs and the impact of various types of controllers.

It is quite difficult to compare the numerous controllers that have been suggested based on the ASM1. The most important obstacle for comparison is that the controllers have been suggested using different types of plant setups and different types of evaluation criteria (Copp, 2002). Hence, Spanjers *et al.* (1998) suggested the development of a standard simulation platform that could be used by developers of controllers for evaluation. The COST actions 682 and 624 took up the challenge and proposed a common benchmark simulation platform (see short description in Section 2.3). COST

Action 624 is an EU research program dedicated to the optimisation of the performance and cost-effectiveness of wastewater management systems by increasing the knowledge of microbial systems and by implementation of integrated plant-wide control based on a description of the entire wastewater system, thereby providing new concepts for dealing with wastewater in a future sustainable society. The program follows up on the COST Action 682 (1992-1998), which was focused on the biological wastewater treatment processes and the optimisation of their design and operation based on process dynamical models (COST 624 homepage).

The benchmark simulation platform proposed in the two EU programmes defines a plant layout, a simulation model, influent loads, test procedures and evaluation criteria. According to the COST homepage the benchmark platform have been used as basis for more than fifty papers to date, some of the latest were published at the ICA-IWA specialist conference in 2001 (see e.g. Vanrolleghem and Gillot, 2002; Vrecko *et al.*, 2002; Carlsson and Rehnström, 2002; Pons and Corriou, 2002; Cheon *et al.*, 2002). The advantage of such a platform is the comparability of control strategies and the provision of a broadly known and accepted platform. However, such a platform also has weaknesses. It describes only one situation, with criteria of interest for only a few countries. In other countries the structure of the effluent permits are altogether different and hence the results from the benchmark platform are not directly transferable to these countries. The difference is for instance related to the application of mean effluent or peak concentrations in the permits and the use of green taxes.

With the introduction of ASM1 came also the introduction of different types of advanced controllers for the activated sludge process. The controllers are based on various approaches. The most frequently suggested control laws have been summarised by Weijers ((2000), pp147-153). Weijers divided the control laws into: 1. Classical control (PID and on/off control), 2. Rule-based control (e.g. logic, expert system and fuzzy control), 3. Model-based control (LQG, model-predictive control (MPC), receding horizon optimal control (RHOC) as well as robust, adaptive and non-linear model-based control) and 4. Supervisory and plant-wide control. Only a few comparisons of advanced control compared to simple control have been carried out. Two important examples are the works by Isaacs and Thornberg (1998) and Lukasse (1999)

In the paper by Isaacs and Thornberg (1998) rule-based control based on heuristics is compared to a stricter model-based controller. Both controllers are implemented in a simulation of a BioDenitro plant. The result is,

however, that the two control strategies perform almost equally well. The advantage of model-based control is that it is based on an optimisation. On the other hand, the rule-based controller has the advantage that no prediction is necessary. The comparison is done based on simulations. In the Ph.D. thesis by Lukasse (1999) four different controllers are compared, three of them are simple and the fourth is an adaptive receding horizon optimal controller (ARHOC). The conclusion of the comparison is *“The difference in the best achievable effluent quality of the four controllers is insufficient to conclude that one of them is indisputably the best. ... The superiority of ARHOC comes in terms of its low sensitivity to suboptimal tuning and load changes and in terms of the little retuning that is required.”* In the simulation, a control goal criterion, which is based on three times the ammonium concentration plus one time the nitrate concentration, is used. I.e. the effect on other parameters was not included – positively or negatively.

3.5 Full-scale implementations

The importance of the development of the ASM1 and the benchmark platform should not be under-estimated. However, it has also caused a serious drawback, best articulated in Olsson-Newell’s assessment of the 7th IAWQ workshop on Instrumentation, Control and Automation (Olsson and Newell, (1998): *“It is apparent that advanced algorithms for control are often suggested and tested by simulation but seldom implemented in plant operation. Here is a challenge for the academic community to really make the effort to bring advanced control all the way to implementation and to prove that it is worthwhile”*. A similar conclusion was drawn from Weijers overview of control law selection, which showed that: *“...advanced control techniques are hardly applied on full scale.”* (Weijers (2000), p. 152). The 8th workshop (ICA 2001) did not substantially change this statement; here a separate session on applied control included only five of the overall seventy papers and posters on control and automation. The approximate distribution between published papers reporting work done in simulations, pilot plants and full scale plants are probably in the order 75% simulation based, 20% pilot plant based and only 5% full-scale implementations (qualified guess). There are many reasons for this but the primary problem is that it is more complex, time consuming and troublesome to carry out experiments in full-scale plants.

It is, however, no secret that most people working in practice with operation of wastewater treatment plants sighs deeply when presented to yet another model simulation showing this or that to be feasible. This is not because the models do not (at least to some extent) describe the processes correctly. The problem is rather that reality poses other types of problems than encountered in models.

One issue is precision of instruments, which in models mostly are assumed perfect. In full-scale wastewater treatment plants, most sensors are only measuring correctly within a margin of plus/minus 10% with a certain response time and often a certain down time or time “out of correct calibration”. This uncertainty of sensors is a basic premise at wastewater treatment plants (as it is in many other process industries) and a large effort is required to ensure full reliability of the total sensor system. On top of that, there are different types of malfunctions of actuators. Summing up all these uncertainties there are several error sources in the determination of the current state and in the effect that can be obtained by available actuators. This result is far from the precision that can be achieved in model simulations. Additionally, many parameters that are easily observable in models are impossible or at least very difficult to observe in reality, such as biomass dynamics, the incoming disturbances etc..

Another important issue is related to the flexibility of the plant design, which is mostly lagging considerably behind the flexibility of model simulations. Actuators are limited, controlled on/off or in steps, not automatically controllable but depending on manual opening and closing of valves, the software is obsolete and difficult to modify, sensors are lacking for various parameters, etc. Such limitations mean that the needs with respect to control are usually not in terms of advanced control algorithms, but for easy-to-implement controllers.

One way of describing the state-of-art is to describe the absolutely most advanced level that has been reached within the field, implying a strong focus on research results. Another way is to look at the technological and practical stage reached on an average or at the “best” (in terms of application of ICA) e.g. 10% of full-scale applications. These two approaches to describe the state-of-art will most certainly yield quite different results. The first angle will involve quite complex and advanced algorithms and models, while a look on the average or the top 10% of full-scale applications will reveal a comparatively basic approach to the control problems at hand. A quite large *technological gap* exists between theoretical and practical levels of advancement within the field. The existence of such a

technological gap is not unusual as a scientific research community in general is expected to be in front of the practice. The question is, however, if the size of the gap is so large that the two ends do not meet.

The STAR concept (Nielsen and Önnérth, 1996, Önnérth *et al.*, 1996) is an important example of an attempt to make the “ends meet”. The STAR concept is a system that is put on top of existing SCADA systems at full-scale wastewater treatment plants. STAR was mainly developed for the control of BioDenitro systems. The system has however also found application in other types of plants. STAR is a supervisory controller that determines setpoints for the underlying SCADA systems based on information retrieved from e.g. nutrient sensors. This seems to be a well-working practical bridge between theoretical results and practical applications.

Table 3.1 Cost-benefit of STAR implementations at seven WWTPs.

WWTP	Size (PE)	Savings (capital and operational costs) Mil. Euro	Cost for STAR and online sensors	Benefit-cost ratio
Ålborg Vest	330.000	6.3	0.6	10.5
Harboøre	75.000	3.6	0.5	7.2
Alborg Øst	100.000	3.8	0.4	9.5
Sydkysten	23.000	1.2	0.3	4
Frederikshavn	85.000	2.5	0.5	5
Borås	130.000	3.0	0.4	7.5
Bjergmarken	68.000	1.8	0.3	6

Though full-scale experiments are in many cases more convincing to professionals working in practice with wastewater treatment plants papers on applied control also have some inherent weaknesses. The primary problem is that reported control is often solutions to specific problems at specific plants. This type of full-scale reports in many cases has a limited scope due to its low level of generalisation. However, the numbers of savings on operational and capital costs that these experiments yield are interesting for other wastewater treatment plants to estimate their possible gain. Dr. Marinus Nielsen, Krüger A/S provided an overview of STAR control at full-scale wastewater treatment plants in Denmark and Sweden. A

cost-benefit overview based on seven implementations is given in Table 3.1. The results were presented at a Danish seminar on application of sensor technology in the environmental plants on May 17, 2001, arranged by the Society of Danish Engineers. The implementations gave an average payback ratio of 7.1, ranging from 4 to 10.5. The ratios are based on information from the respective plants and are to a large part due to savings in investments due to extensions.

3.6 Outlook

The above description of the historical development in the field of process control of wastewater treatment plants has shown that the main technological barriers that earlier dominated the field, i.e. the lack of sensors and models have largely been overcome. The main technological challenge today is to make it work in reality, i.e. in full-scale wastewater treatment plants. Documentation of full-scale experience process control is important in order to investigate the feasibility and to provide proof of principle. Today, only a few different ways of controlling the DO concentration exist depending on the type of aerator (i.e. diffused air or surface aerators). For each of these two types consensus about their control have been reached - more or less. The same is not the case for control based on nutrient sensors.

On the other hand, the challenge of full-scale implementation of process control may not be a purely technical one, or as Allan Manning (EMA Inc., St. Paul, USA) put it on the ICA 2001 conference in Malmö "technology is the easy part" (freely quoted). A large challenge lies in the human factor, a factor that has hardly been considered in the IWA-ICA research community. This is not only a challenge regarding the education and training of operators but also an issue of providing the incentives to make it work and to incorporate process control in the organisation and work procedures. Product development that brings the user in the centre may prove to be of major importance for creating a pull-effect for the application of process control.

Some of the trends that will influence the field of wastewater treatment in the future are:

- 1) A more integrated view on the water cycle;
- 2) Increased privatisation of wastewater treatment plants;
- 3) Increased focus on the sludge problem due to difficulties with end disposal.

Integrated view on the water cycle

Traditionally, the water cycle has been divided into a number of individual entities, with no or little information exchange: the potable water abstraction and cleaning, the water distribution network, the wastewater collection network and the wastewater treatment facilities. Often the systems are looked at separately – having separate organisations - which cause the one system to give problem for the downstream system. In fact, one should regard the upstream and downstream systems together in order to operate the whole system well. The adjacent systems of a wastewater treatment plant are primarily the sewer system and the recipient. In the future, an increased integration of the different entities as well as a wider cooperation between the entities and their customers is expected. Even observations of nature itself may be included, e.g. rain radars and quality indices from recipients. There are several advantages of a closer cooperation between the different entities in the water cycle. Two examples are given below.

Example 1: Water and industry

One example of the improvement that can be gained by integrated water management is the closer cooperation between industry and the water system. Industry needs water from the drinking water plants at a certain quality for its processes and disposes water of a lower quality to the wastewater treatment plants. The performance of the wastewater treatment plant is often closely correlated with how and when the wastewater from industry is sent to the plant. A brewery is a good example. A brewery uses water of different quality: clean water for the direct use in the product and a lower quality product for heating and cooling purposes. The disposed water is usually quite rich in biochemical oxygen demand (BOD) and may therefore be of great value for the wastewater treatment plant during certain periods of the day (during low BOD load it is valuable for the denitrification process) and a problem during other periods of the day (during high BOD load). A coordination between the drinking water plant, the wastewater treatment plant and the brewery can lead to improved use of the water, which can make it possible for all parts to plan their production better.

Example 2: Wastewater treatment plant and the sewers

Another example is to create cooperation between wastewater treatment plants and the sewers. Today the operation of the sewer system and the

wastewater treatment plant is often done by two different organisations. The organisations have two different goals for their operation. The sewer organisation wants to prevent flooding of basements and consequently sends the wastewater to the plant as fast as possible; whereas wastewater treatment plants operate better the smoother the inlet is to the plant. Varying load is one of the largest disturbances in wastewater treatment. Therefore, the plant would like to delay some of the wastewater flow during certain periods of the day as well as during rain. Coordination between the two may lead to an increased overall performance.

Increased privatisation of wastewater treatment plants

Privatisation of water processing plants has been a fact in many countries for years and is a growing phenomenon. However, initially water facilities were a public matter and in many countries, it still is. Large global companies are specialising in taking over the operation of wastewater treatment plants. Economic optimisation is expected to be more in focus at such plants than in public plants. The privatisation may push politicians to impose stricter and more economically based legislation on the plants in order to gain an acceptable quality.

Privatisation may also be of importance for the competence level with which the plants are run. It may become feasible to have competence centres in the various companies dedicated to optimising control and operation of wastewater treatment plants. This may help diffuse knowledge of process control into more full-scale plants.

The sludge problem

The sludge problem has increased over the last 5-10 years. Sludge is judged unfit for use as fertiliser and soil improvement at farmland; hence, new methods for disposal need to be considered. These are in many cases expensive methods, such as disposal at landfills or incineration. Hence, research within the areas of sludge treatment, nutrient recovery, sludge recycling and disposal will increase in the years to come. Methods including mechanical hydrolysis of sludge (e.g. by means of ultrasound) seem promising; see e.g. Niesing (2000).

3.7 Small case stories

The following three case stories show some of the diversity of benefits that applied process control can yield at full-scale wastewater treatment plants. The stories have been collected and published by Danfoss Analytical and can be found in their full length at the homepage of Danfoss Analytical (www.danfoss.com/analytical/).

DO profile control

Lindau wastewater treatment plant is located in southern Germany near lake Constance. The plant is a 60.000 PE plant that has been rebuilt in 1987 after the so-called NH₄-PO system (patented by Dr. Günter Lorenz), which consists of two pre-denitrification systems in series. In Section 5.1 a more thorough description of the plant is given. In 1996, a DO sensor was installed in each of six parallel lines. The lines consist of five zones in series where aeration (by means of bottom aerators) can be controlled independently. A number of profile measurements based on a portable DO meter showed a great variation in the DO profile throughout the lines, see Figure 3.5.

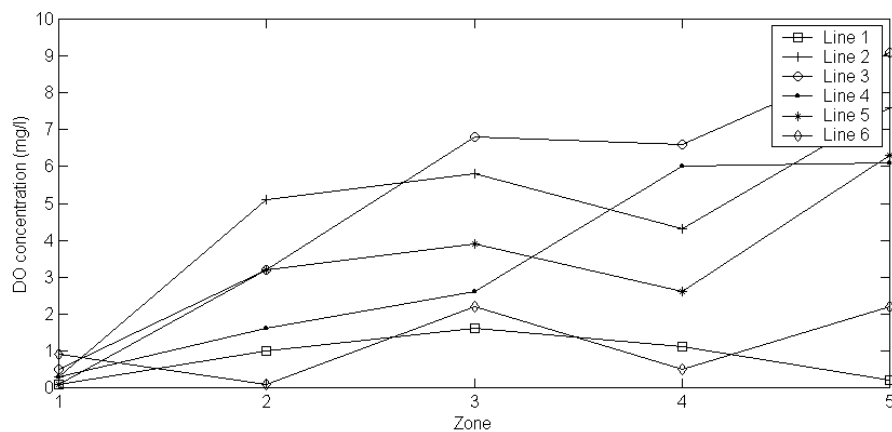

Figure 3.5 Snapshot of DO profile in the six parallel lines at Lindau, manual measurements.

It can be seen that half of the measurements in zones 2 to 5 revealed values greater than 2.5 mg/l (zone 1 is anoxic) indicating excessive aeration. Therefore, a DO profile control scheme was applied to each of the lines, meaning that each individual zone was controlled according to a DO sensor that was placed in the zone. This reduced the energy consumption for aeration from 72.000 kWh per month to 60.000 kWh per month. The payback period of the sensors were calculated to be approximately 18 months.

Extending capacity by nutrient sensors

The town of Himmermark in southern Denmark was earlier served by a main wastewater treatment plant called Himmermark that treated up to 15.000 PE. Load beyond this capacity was sent to a secondary treatment plant 10 km away. During the spring of 1998 the capacities of the two plants were exceeded and it was discussed whether a new plant should be built or the Himmermark plant should be extended. It was decided instead to try to increase the capacity of the Himmermark plant by applying automatic process control. A number of improvements were done at the plant including the installation of an ammonium sensor. The sensor was used to change the phases of the BioDenitro plant according to the need for nitrification. By looking at the online measurements of ammonium concentration it could be observed that during long periods the effluent ammonium concentration from the aerated reactor was zero or close to zero, meaning a loss of aeration. This was avoided by the new control system.

Other improvements included improving the surface aerators to enable a deeper penetration of the water and the installation of a new PLC based SCADA system. On top of that, all the water that had earlier been treated at the secondary plant was now led to Himmermark wastewater treatment plant. By application of these improvements, the capacity of the plant was increased by 33% to 20.000 PE. The cost of the improvements amounted to 1.6 MEuro, which meant a huge saving compared to the alternative solution of building an additional wastewater treatment plant, for which the cost was estimated to 4.3 MEuro.

Improving effluent quality, energy consumption and sludge production by using nutrient sensors

Avedøre wastewater treatment plant is one of the largest plants in Denmark and treats 350.000 PE from the city of Copenhagen and its surroundings. The plant has had ammonium sensors installed during the last couple of years for the control of the BioDenitro plant design. In the final control scheme, periods of zero concentration of ammonium are avoided by controlling the phase lengths. The original data can only be seen as a coloured bitmap, which is difficult to reproduce. Instead, a constructed illustration of the operation is depicted in Figure 3.6.

The control scheme has led to a number of benefits:

- A 10% improvement in nitrogen removal or a reduction of effluent total nitrogen of 1 mg/l, leading to a reduction in green taxes of approximately 70.000 Euro per year. An even more advanced control scheme is currently being considered, which would lead to additional 5% savings.
- Substantial energy savings due to phase control (exact numbers are not quantified).
- Better knowledge about the plant and its operation.

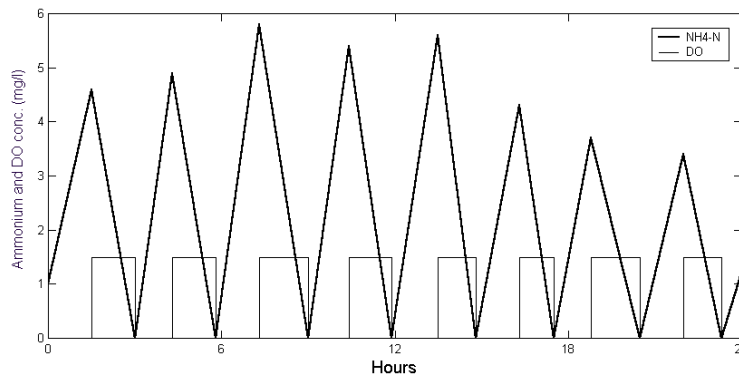

Figure 3.6 Illustration of control at Avedoere wastewater treatment plant reconstructed from a bitmap of one day of data.

3.8 Conclusions

Generally, there is a low level of usage of “advanced control” at wastewater treatment plants. This may be due to a number of reasons such as a poor understanding of the benefits of advanced control and lack of knowledge of how to implement such control. Until recently, large barriers have been low reliability of nutrient sensors and a too high demand for maintenance. This state is changing and as will be shown in Chapter 4, the use of process control sensor systems are gaining in numbers at wastewater treatment plants. As stated by Olsson (2002): “*On-line sensors no longer represent the main limitation for on-line control.*” However, at most wastewater treatment plants the information provided are not exploited fully by applying online control and detection.

It is necessary to work on several fronts to promote process control: creating incentives or making them more clear, making systems that fit to people, creating knowledge of how to control and optimise wastewater treatment plants to reach the potential benefits. These considerations are the basis for the rest of the thesis with a strong focus on the technological perspective.

Chapter 4 International Survey

An international survey has been carried out during 2000 and 2001 together with Paul Lant from Advanced Management Centre at University of Queensland. The survey has quantified the operational practice of full-scale wastewater treatment plants. Some simple key performance indicators are derived that relate the level of removal of ammonium, total nitrogen and phosphorous to the consumed resources, i.e. volume, energy, organic matter and precipitation chemicals. Several indicators are suggested for each substance. The level of utilisation of instrumentation, control and automation (ICA) has also been measured. The performance indicators and the level of ICA utilisation have been compared to investigate if there is a correspondence between the two.

4.1 Background

Efficient operation requires an ongoing commitment to plant optimisation. This is especially due to some of the unique features of wastewater treatment processes, as described in Olsson and Newell (1999). One important feature is the low control of what the plant receives, which makes it important to respond to the quality and quantity of the raw material. Other important reasons are that the disturbances in the influent flow are enormous, temperature varies over the year and event disturbances such as rainstorms induce sudden upsets in the operation.

For a long time, the availability of sensors for the wastewater industry was limited to mostly physical variables and only few sensors for process control were available, such as dissolved oxygen (DO) sensors. Today, sensors and online analysers for measuring the concentrations of nutrients, organic matter, suspended solids and sludge blanket level are available. Such sensors are now becoming widely applied in full-scale wastewater treatment plants, at least in some countries; see Jeppsson *et al.* (2002). The

new sensors can be used in a variety of applications: influent control, DO control, intermittent aeration, internal recirculation, surplus sludge removal, external carbon source dosage, return sludge control (Schmitz *et al.*, 2000), phase control in sequencing batch reactors (Haker, 1999) and precipitation control (Devisscher *et al.*, 2001).

In 1998, Lant and Steffens (1998) published their results based on an Australian benchmarking study, where Australian wastewater treatment plants were benchmarked against “world best” practice in the process industry as a whole. Their main results are presented in Table 4.1. Based on the relative poor assessment of the average wastewater treatment plant they concluded *“There is clearly significant potential for wastewater treatment process control in the areas of advanced process control and the use of on-line analysers. This result is not surprising. Whilst there are lots of automatic control loops implemented to control ancillary equipment on wastewater treatment plants, there are few to control product or effluent quality.”* The paper also raises questions regarding the few parameters where the plants showed good performance, which indicates that these parameters may be the wrong measures and perhaps even indicate the opposite of good performance. For example, issue No. 9 indicates that there is a good control quality at the plants. The explanation for this may be that critical process parameters are not controlled or in other words, what is not measured is not seen. Another example is issue No. 10 which relates to the occurrences of operator intervention. Is the low amount of intervention due to: 1. the automatic system works well, 2. the operators are not trained to intervene in process control or 3. there are relatively few control loops, which result in few problems?

As in many benchmark studies, the result answers some questions as well as raises some new ones. Based on the Australian study it was decided to conduct a new somewhat more extensive study aimed at benchmarking wastewater treatment plants against each other (instead of against the process industry as a whole). This is interesting due to the special traits of the wastewater treatment industry. The first results of this study were published in Ingildsen *et al.* (2001b), since then the study has been extended to include more plants. The results from all the plants are presented here. This study is distinguished from the Australian study by focusing solely on wastewater treatment plants and doing so on an international scale (rather than national). It also provides a measure of the actual performance of the plants and more detailed information regarding the utilisation of instrumentation, control and automation (ICA) at the plants.

Table 4.1 Results from an Australian benchmarking investigation (Lant and Steffens, 1998) based on Process Control Self Assessment Proforma (Brisk and Blackall, 1995).

Process control benchmark	Score					
	0	1	2	3	4	5
1. Percent standalone control loops (percent of plant control loops not in a DCS or control computer)	>95	80	60	40	20	<10
2. Control loops per operator (total number of control loops on the plant divided by the number of operators on a shift)	<10	30	50	70	100	<100
3. Control loops per engineer	>750	500	400	300	200	<150
4. Intermediate complexity control (percent of control loops such as ration, cascade or simple feedforward)	0	5	10	20	30	<50
5. Advanced control (Percent of control loops with techniques such as dead time comp., gain scheduling, self tuning PID, inferential, model based control, expert systems)	0	2	5	10	15	<25
6. Online analysers (number of online analysers divided by number of sample points for lab analysis)	0	0.25	0.5	1	5	>10
7. On-line analysers in control (percent of on-line analysers used in closed loop control)	0	10	25	50	75	100
8. Percent control loops in manual	>50	20	10	5	2	<1
9. Poor control quality (percent of control loops exhibiting undesirable characteristics, e.g. overshoot, long settling time oscillations)	100	70	50	20	5	0
10 Operator intervention (percent of operator time spent resolving control-related problems)	>90	70	50	20	10	<2
<div style="display: flex; align-items: center; gap: 10px;"> <div style="border: 1px solid black; width: 20px; height: 10px; background-color: #e0e0e0; margin-right: 5px;"></div> World class </div> <div style="display: flex; align-items: center; gap: 10px;"> <div style="border: 1px solid black; width: 20px; height: 10px; background-color: #a0a0a0; margin-right: 5px;"></div> Average Score </div>						

The goal of the study is two-fold:

1. To obtain an indication of current state-of-art at wastewater treatment plants with regard to the applied types and numbers of sensors and to which extent these sensors are used for process control purposes.
2. To develop a benchmark method, specifically aimed at evaluating wastewater treatment plant operations. The chosen method for benchmarking is based on the use of a few key performance indicators. Hence, the study includes identifying a small number of key performance indicators (KPI) expressing the performance of wastewater treatment plant operation and ICA utilisation. These key performance indicators should be comprehensive enough to indicate true differences. At the same time, they should be based on information so simple that most plants are able to provide the required data. The method should be applicable internationally.

The first goal is important from a process control researcher's point of view. Over the last two decades, researchers within the control field of wastewater treatment have proposed a long list of interesting concepts for improving wastewater treatment plant operation by the use of new ICA technology. However, there seems to be a discrepancy between the state-of-art in research and in practice (as described in Chapter 3). One reason for this may be lack of understanding (by researchers) of the current state-of-art in practice at full-scale WWTPs. Such understanding is of great importance in order to solve the right problems, rather than "solving the problems right".

The second goal is important from a plant management view. There is generally an increasing pressure for better performance in the wastewater industry due to stricter regulation and increased privatisation. This causes a need for methods to compare wastewater treatment plant operation performance. Plant managers and operators need to be able to compare performance and gain knowledge about best practices. Additionally, it is of interest to investigate whether there is a correspondence between high performance, i.e. high score in the key performance indicators, and a high level of ICA utilisation.

In the following, the method of investigation is first presented. Then statistics from the survey is discussed regarding design, operational

expenditures and the level of ICA utilisation. This introduces the available data and some of the variations that have been found. Then the focus changes to the development of a method for benchmarking.

4.2 Method of investigation

A questionnaire including key elements regarding plant design, operation and utilisation of ICA as well as the respondents opinion was prepared and translated into English, German, Danish and Swedish, see Appendix B. The questionnaire was developed based on principles outlined in Salant and Dillman (1994). These principles and considerations are summarised in Box 1.

Several compromises needed to be made in the study. One compromise regarded the extensiveness of the questionnaire. On one hand, there was a need for a large amount of detailed information on design and the consumption of resources, as well as a need of comparability. Hence, in the ideal questionnaire the questions should be formulated unambiguously, which would have led to lengthy explanations on how the various data should be gathered and calculated. On the other hand, such a questionnaire would be too laborious or even impossible for the respondent to answer. Hence, the respondent would either give up and not participate at all or alternatively skip many questions. It was decided not to include many explanations but let the respondent reply in the way that is normally done at the plant. This means that the comparison may not be 100% fair. On the other hand, as will be seen in the results, the differences between the plants are so significant that this problem may be minor. Even with the free formulation chosen, several plants have skipped numerous questions and several respondents have commented on the questionnaire as being too laborious.

Distribution of the questionnaire was a difficult task. First of all a series of questionnaires was mailed to wastewater treatment plants in Sweden (30 plants contacted, 11 responded), Denmark (14 plants contacted, 6 responded), Germany (33 plants contacted, 0 responded) and Australia (9 contacted, 9 responded). The questionnaire was saved as a MS-Word document (as a form) on a floppy disc, which the respondents should fill in on the PC and return in a pre-paid reply envelope or by email. Researchers in UK, Italy and France were contacted and asked to help distribute the questionnaire as well. The study was also announced at the first IWA Conference on ICA in Malmö, June 3-7, 2001 and at the second IWA world

water congress in Berlin, October 15-19, 2001 (at a benchmarking session). The study was also announced in an email newsletter published by "European Water Management News" (www.ewaonline.de). Finally, a homepage was built from where the questionnaires could be downloaded. In spite of this extensive campaign, the number of respondents was rather meagre. Anyway, the initial goal of at least 30 respondents was met as 36 replies were received.

Box 1 Principles and considerations when devising the questionnaire (inspired by Salant and Dillman (1994)).

- Questions should be unambiguous, not vague, neutral, easy to comprehend, properly explained
- Consider "need to know" versus "nice to know"
- Not too many questions
- Will the results of all questions be relevant?
- Ensure confidentiality
- Can validity be questioned?
- Is importance of preciseness stressed?
- What to do when you cant answer a question or in doubt?
- Are we open to not thought of ideas?
- Location for comments
- Is the sequence of the questions meaningful?
- Is practice properly questioned?
- Cover letter: what is it about and why should people participate?
- Use of easy cues for the person who browses through the questionnaire
- Not too cluttered, coherent layout, no confusion
- Abbreviation and jargon avoided
- Is context clear?
- Open or close ended questions
- Avoid results that are complex and difficult to communicate
- Measuring units
- Does it cover the areas of interest?

The method of how to get in contact with the respondents naturally poses some questions about the generality of the investigation. The directly contacted plants were not chosen at random, but consisted mainly of well-

known (to us or colleagues) plants. This is true for all contacts except the German ones with whom no previous contacts existed. It might be suggested that a majority of the respondents come from plants that have an expressed interest in the utilisation of ICA and hence are some of the leading ones within the field. The problem is worst regarding the level of ICA utilisation, while the general performance is probably not as influenced. On the other hand, the “German experience” with no respondents at all shows that the chosen method of getting in contact was necessary in order to receive answers at all. Hence, the material is not statistically adequate to draw general conclusions about the whole of the wastewater treatment industry. The investigation should rather be seen as a first attempt to find out the variability in performance and an indication of current state-of-art.

Table 4.2 Country of participants.

Countries	Participants
Sweden	11
Australia	9
Denmark	6
The Netherlands	3
Spain	2
South Africa	1
New Zealand	1
Japan	1
Italy	1
Canada	1

Monetary units have been avoided in the questionnaire, so all data have been provided in units such as kWh per year and kg per day. Cost is obviously important at the individual plant when prioritising where to improve plant operation. However, cost comparison is not quite as objective as resource comparison, due to exchange rates and different prices on energy and chemicals. Tax on effluent water quality is another issue that may change the focus of the plant; in the investigation, only the Danish and the Dutch wastewater treatment plants paid such taxes.

In the investigation, 36 wastewater treatment plants from 10 different countries participated (Table 4.2). The participants include plants with and

without biological nutrient removal and plants of different sizes. The plants have been in operation from 2 to 74 years.

Statistical methods applied

The collected data are investigated by means of simple statistical methods. For investigation of correlation between parameters, the data are plotted to see if there are visual patterns indicating correlation. Dependency can usually be detected by an x-y plot. To support the visual impression and to quantify the level of correlation the correlation coefficient is calculated. The correlation coefficient indicates how well pairs of data can be fitted to a straight line. Perfect linearity yields correlation coefficients of +/-1. Points that are randomly scattered result in a correlation coefficient of zero (no linear trend).

Box 2 Description of a *t*-test.

It is assumed that:
 X_1, \dots, X_n , $X_i \in N(m_1, s)$ and Y_1, \dots, Y_m , $Y_i \in N(m_2, s)$
 where s is unknown. The aim is to test if $m_1 \leq m_2$.
 The test value is:

$$Z = \frac{\bar{X} - \bar{Y}}{S \sqrt{\frac{1}{n} + \frac{1}{m}}}$$
 where $S^2 = \frac{(n-1)S_Y^2 + (m-1)S_X^2}{n+m-2}$,
 where $S_X^2 = \frac{1}{n-1} \sum_{i=1}^n (X_i - \bar{X})^2$ and $S_Y^2 = \frac{1}{m-1} \sum_{i=1}^m (Y_i - \bar{Y})^2$
 The hypothesis is accepted if $Z < t(n+m-2)_{1-\alpha}$

A statistical method based on normal distributions are used to test groups of data against each other, to determine if the mean value is higher in one group. The method is used, for example, to test if the key performance indicators are better for wastewater treatment plants with specific sensor equipment than in groups without. The groups are tested against each other by means of a *t*-test. The key performance indicators are assumed normally distributed and the variance in the two groups is assumed the same. The

tests are performed at an α of 5%, where α is the probability of rejecting a hypothesis even though it is true. The tests are carried out by calculating the specific test value, called Z. This is calculated as described in Box 2 (for more details see e.g. Montgomery (2000)).

4.3 The design aspect

In this section the wastewater treatment plants in the investigation are introduced. Here basic data are presented regarding size distribution (Figure 4.1), type of processes (Table 4.3), the components they are designed to remove (Table 4.4), current load situation, temperatures and number of parallel lines. In the investigation, all plants are anonymous. In order to keep track of the plants they have all been assigned a number from 1 to 36 based on their average influent flow rate. Number 1 has the largest average influent flow rate and the plant with the smallest average influent flow rate is assigned number 36. The numbering can be seen in Figure 4.1. Here it can also be seen that the influent flow rate is only to some extent correlated to the size of the wastewater treatment plant expressed as the volume of the biological reactors (correlation coefficient of 0.58).

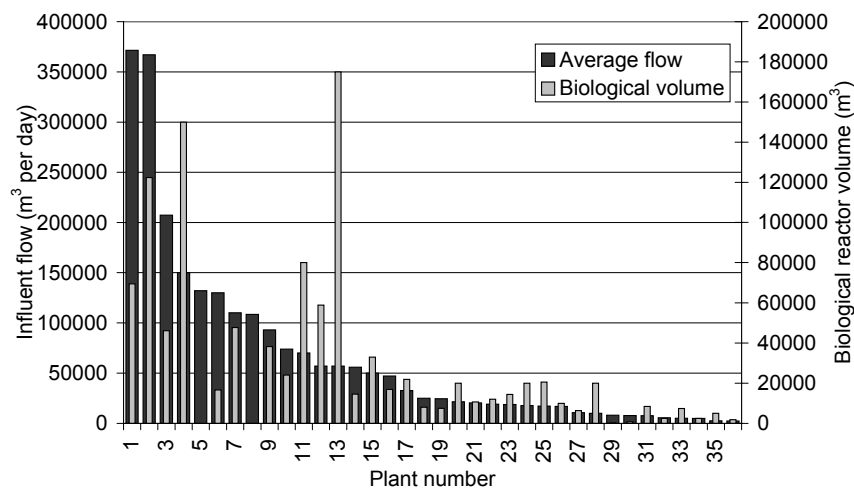

Figure 4.1 Size of plants.

As can be seen from Table 4.3, most plants have a design that is different from the five standard outlines suggested in the questionnaire. They include special outlines as well as combinations of several of the suggested designs. The plants without biological nutrient removal naturally do not have any of the suggested designs. The survey shows that the pre-denitrification plant design is the most common, while the others are scarcer. Such an account depends to some extent on geography. In Denmark, for example the BioDenitro concept (for a description of this concept see e.g. Bundgaard *et al.*, 1989) is probably one of the most frequent designs, while other countries may have developed other traditions. The design of the plants may have an impact on the performance of the plant. For example, the post-denitrification systems are generally assumed to have a larger consumption of COD per removed kg of nitrogen, because influent COD is only to a small extent used as a carbon source for denitrification, hence this type of plant design is often dependent on an external carbon source.

Table 4.3 Types of plants.

Type	Number
Pre-denitrification	11
SBR	2
Simultaneous nitrification and denitrification	3
Post-denitrification	2
Alternating	3
Other	15

From Table 4.4, it can be seen that the WWTPs are designed for different types of treatment. The three plants that are not designed for COD removal are two plants for phosphorous removal and a pure sedimentation/sludge digestion plant. It is ensured that the same types of plants are compared.

The load to the WWTPs varies from 0.33 to 7.9 times the hydraulic design load. On an average, loads are 1.1 times the design loads. Most plants are close to their original design load. Only two plants receive more than two times the hydraulic load they are designed for and another two plants receives less than half their design load. 64% of the plants receive less than their design load.

Table 4.4 Substances the plants are designed to remove.

Type of removal	Number
COD removal	33
NH ₄ removal (not tot-N)	2
Tot-N removal	29
Phosphorous removal	28
Only chemical P removal	11
Only biological P removal	7
Both biol. and chem. P removal	10

The water temperature varies considerable from plant to plant. Not surprisingly, the highest temperatures are found in Australia, with an average of 9°C higher water temperature than in Sweden and Denmark. The average summer temperature for all the plants is 20°C, the maximum is 28 °C and minimum is 12°C. In the winter, the average is 13°C, maximum is 22°C and minimum is 7°C. This is expected to have some impact on performance as higher removal rates are generally obtained at higher temperatures.

On an average, the plants are divided into 4.1 lines, the maximum number of lines is 15 lines and minimum is one line. One line on an average takes 25400 m³/day, maximum is 367000 m³/day per line and minimum is 1220 m³/day per line.

4.4 Operational expenditures

The operation of the plant is associated with various expenditures, these includes energy consumption, usage of external carbon source, sludge production (disposal costs), usage of precipitation chemicals and the amount of employees at the plants. In the following sections, the various resources are discussed and related to the average flow (where applicable). Additionally, the issue of green taxes are discussed.

Energy

Energy consumption is one of the most important costs in the operations budget of many wastewater treatment plants. Figure 4.2 shows that the energy consumption correlates poorly to the influent flow rate; the correlation coefficient is only 0.75.

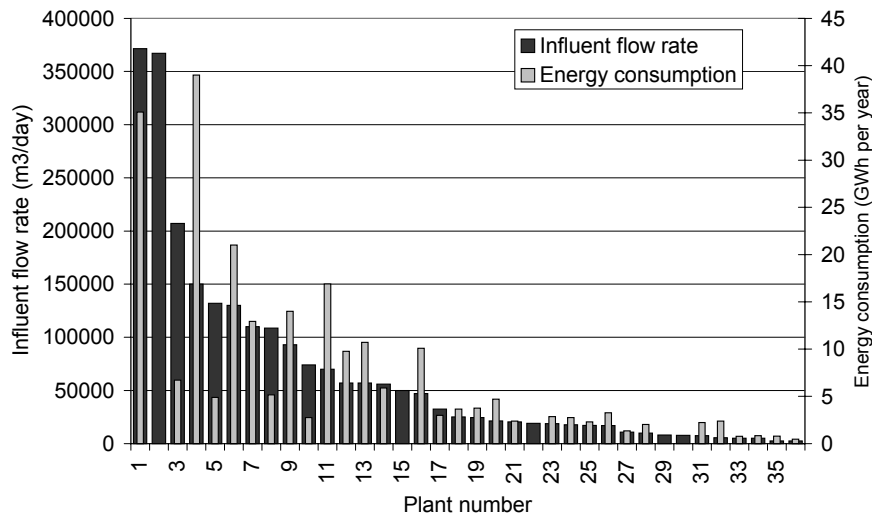

Figure 4.2 Total energy consumption.

Only 36% of the wastewater treatment plants were able to split the recording of the energy consumption into the areas of pre-treatment, biological treatment, sludge treatment and other. All of these wastewater treatment plants except plant No. 6 and No. 14 were designed for the removal of both COD and total nitrogen. (Plant No. 6 was designed for COD and ammonium removal, while plant No. 14 were only designed for COD removal). As can be seen in Figure 4.3 the majority of the energy is used in the biological part ranging from 7 to 90% with an average of 56%. Pre-treatment operations in general do not consume a lot of energy. For a few plants (No. 4 and No. 10), the energy consumption for sludge treatment is large but at most plants it is around 10%. No explanation regarding the high energy consumption at the two WWTPs were found. The aeration consumes between 24 and 90% of the energy used for the biological part, on an average 59% (based on 11 plants). Eleven of 26 plants have energy production (the remainder have not answered this question). The energy production ranged from 1.4% to 200% of the energy consumption. Two wastewater treatment plants produce more energy than they consume. The average energy production (for plants with energy production) covers 57% of the energy consumption.

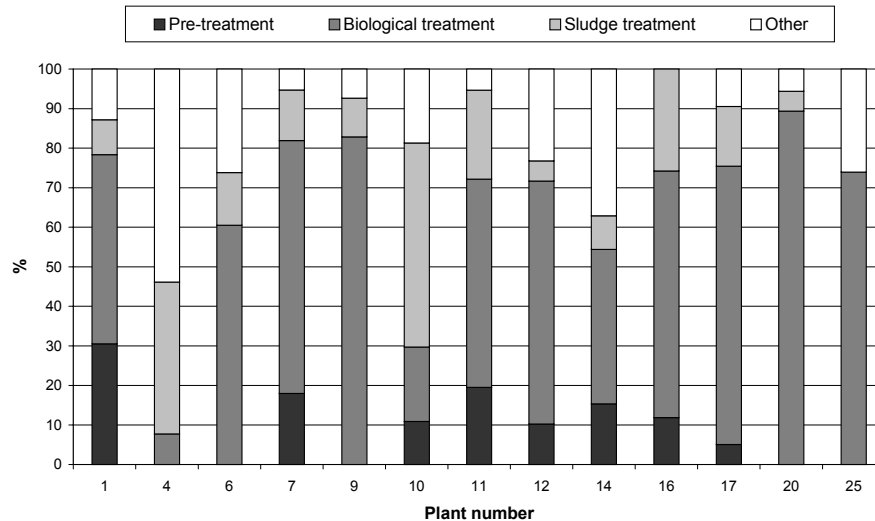

Figure 4.3 Distribution of energy between processes.

COD consumption

Only five of the 36 wastewater treatment plants (14%) use an external carbon source. The dosage of external carbon varies considerably between the five plants from 0.25 g COD/m³ influent wastewater to 210 g COD/m³ influent wastewater. The influent C/N-ratio indicates the amount of available organic matter for the denitrification of nitrogen. Generally, at a low influent C/N ratio the plant may not be able to sufficiently reduce the amount of nitrogen (Henze *et al.*, 1992). The influent C/N ratios in the plants using an external carbon source do not explain why exactly these plants use external carbon source. The lowest influent C/N ratio observed among the plants using external carbon source is 7.6 mg COD/mg N, which is only the seventh lowest influent C/N ratio (of 30 plants). The plant that uses most external carbon has a C/N-ratio of 11.8 mg COD/mg N. The median C/N-ratio in the full population is 11.3 mg COD/mg N, the lowest is 3.4 mg COD/mg N and the highest is 471 mg COD/mg N. In Table 4.5, an overview of the five plants that use external carbon dosage is presented. It is surprising that two plants with post-denitrification do not use an external carbon dosage. One explanation may be that these two plants have rather high C/N-ratios (respectively 11.4 and 20.2 mg COD/mg N). Table 4.5 does

not provide a clear answer to the question why exactly these wastewater treatment plants use an external carbon source. The reason may be inexpensive access to carbon source.

Table 4.5 Plants with external carbon dosage.

External COD (g/m ³)	C/N-ratio (mg COD/mg N)	Plant design
210	9.9	Simultaneous nit-/denitrification
9.6	11.8	Post-denitrification
8.0	12.7	30% SBR and 70% predenitrification
5.3	9.8	AB-process
0.25	7.6	BioDenipho

Sludge production

For some wastewater treatment plants the sludge production correlates poorly with the influent flow rate, see Figure 4.4 (correlation coefficient is 0.84). The original sludge amount (incl. water) has also been recorded. The water content before dewatering varies from 69.3% to 99.98% (second highest water content is 97.2%). The average water content is 81.4%.

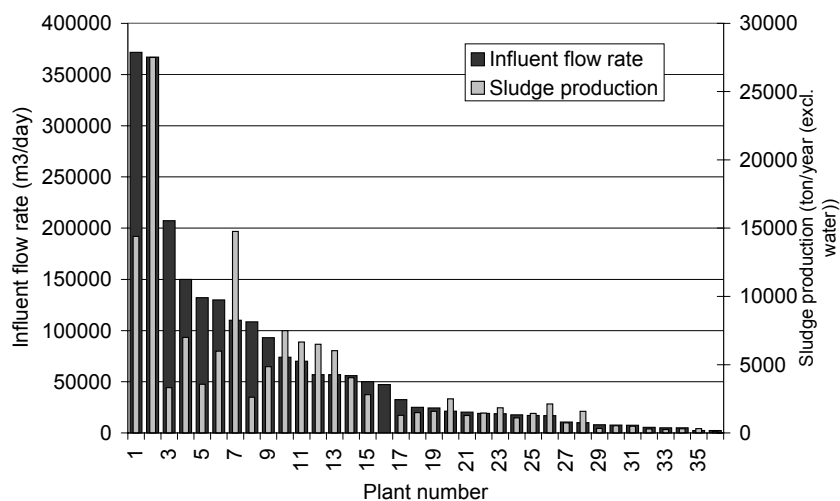

Figure 4.4 Sludge production.

Consumption of precipitation chemicals

The consumption of precipitation chemicals varies considerably from plant to plant as can be seen in Table 4.6. There does not seem to be any correlation with regard to either type of precipitant, operation mode of precipitation (pre-, simultaneous- or post-precipitation), effluent total phosphorous concentration and, surprisingly, neither of the presence or absence of biological phosphorous removal. In the benchmarking section, the consumption will be related to the amount of removed phosphorous.

Table 4.6 Dosage of precipitation chemicals.

Dosage (mole per litre of wastewater)	Type of precipitation	Effluent Tot-P (mg P/l)	Bio-P included	Precipitant
181	Sim	0.1	Yes	Fe
109	Sim	0.2	No	Fe
105	Post	0.3	Yes	Fe
68	Post	0.3	No	Fe
46	Pre	1.00	Yes	Fe
18.2	Post	0.12	No	Fe
9.4	Pre+Post	NA	Yes	Fe
8.7	Post	0.3	Yes	Al
8.7	Sim+Post	0.08	No	Fe
4.7	Sim	0.4	No	Fe
4.5	Sim	NA	No	Fe
4.3	Sim+Post	0.80	No	Fe+Al
2.6	Sim	0.33	No	Fe
2.5	Post	NA	No	Al
2.0	Pre+Sim	0.70	No	Fe
2.0	Pre+Post	0.20	Yes	Fe
0.69	Sim	1.5	Yes	Fe
0.57	Sim	NA	Yes	Al
0.28	Sim+Post	0.40	Yes	Fe
0.022	Sim	1.00	No	Fe

Employees

The plants are manned as described in Table 4.7. The most common is that the plants are manned five days a week during daytime. The part of the time that the plants are manned seems to be governed to some extent by tradition in the various countries. In Denmark, all plants are manned five days a week during the day, in Sweden, most plants are manned five days a week during the day as well though some have a couple of hours additionally during the weekend (classified as “other”). In Australia on the other hand, all plants are manned seven days a week.

Table 4.7 Manning of plants.

Part of time the plant is manned	Percentage of plants
Five days a week during the day	42%
Seven days a week during the day	19%
Day and night seven days a week	19%
Unmanned	6%
Other	14%

The number of employees (including sub-contractors) per plant varies from 1.8 to 74 full-time employees with an average of 17.4 employees (median is 11.5). There is some correspondence between size of plant and numbers of employees. The highest number of employees is found in plants No. 7, No. 1 and No. 4, i.e. plants with relatively high influent flow rate. However, there are also some large plants with relatively few employees, e.g. the second largest plant has only 26 employees and the third largest plant only has 10 employees, which is less than the second smallest plant, that have 14 employees. See also Figure 4.5.

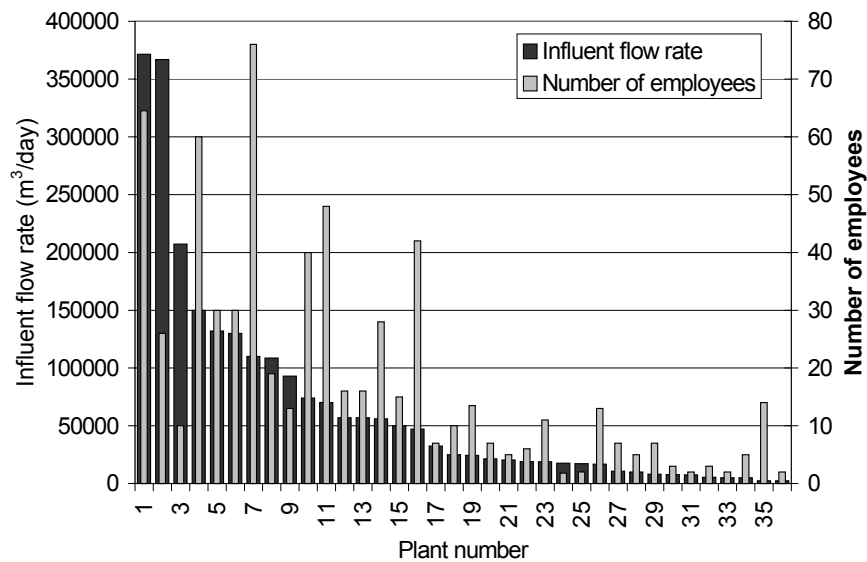

Figure 4.5 Number of employees (including part-time employees, which counts for 0.5).

Green taxes

Only the Danish and two of the Dutch plants pay green taxes. From three Danish green accounts, it can be seen that the green taxes amounts to a considerable part of the operational cost, on an average 13% (Avedøre (1999): 14%, Silkeborg (2000): 12% and Søholt (1999): 13%).

4.5 Level of ICA usage

Each wastewater treatment plant has given a sensor inventory stating type and number of sensing points and how many of the points that are used for online control. A summary of the data is given in Table 4.8. It can be seen that most of the present sensors measure physical variables. Most of these sensors are used for online control. Of the process control variables, the DO sensor is the most popular and the sensor type that has been implemented in online control to the widest extent. Sensors for control of sedimentation processes are also quite popular including suspended solids sensors and sludge blanket level sensors.

Table 4.8 Summary of sensor inventory.

Parameter	Average	Median	Max	% of plants with this sensor	% used in online control
<i>Physical variables</i>					
Flow rate sensors	51	16.5	1000	100	80
Level sensors	60	10	1000	92	82
Airflow rate sensors	33	1.5	1000	58	98
Air pressure sensors	32	2	1000	75	96
<i>Process control variables (biological processes)</i>					
DO sensors	9.8	8	64	92	98
Ammonium sensors	1.25	0.5	5	50	31
Nitrate sensors	0.86	0	5	36	19
Phosphate sensors	0.5	0	5	28	44
COD sensors	0.083	0	3	3	0
BOD sensors	0.083	0	3	3	0
OUR sensors	0	0	0	0	0
Redox sensors	0.89	0	7	28	34
<i>Process control variables (sedimentation processes)</i>					
Suspended solids sensors	3.4	1.5	20	61	45
Sludge blanket level sensors	2	0	12	44	55
<i>Other variables</i>					
pH sensors	2.3	1	23	64	28
Conductivity sensors	0.64	0	12	28	57
Methane sensors	0.83	0	8	28	27

A rather wide application of nutrient (ammonium, nitrate and phosphorous) sensors, especially ammonium sensors, is also observed. Especially the phosphorous sensors seem to be used for online process control. Surprisingly few plants use any type of sensors for the measurement of organic matter (COD and BOD) and none use oxygen uptake rate (OUR) sensors.

The observations regarding DO sensors and nutrient sensors seem to support the conjecture introduced in Chapter 3 that DO sensors represent proven technology, while nutrient sensors are the new emerging sensor system at WWTPs.

Based on the 24 plants that have provided data on the number of controllers applied at the plant, the following shows. On an average, the plants have applied a total number of 83 controllers; 61% of these are on/off controllers; 37% are PID controllers; 1.8% are advanced controllers (i.e. more advanced than PID or on/off) and 0.34% are controllers of unknown type. All plants have implemented at least one PID controller, 75% have some on/off controllers implemented and 25% have at least one advanced controller implemented. Looking at the type of aeration control as an indicator of the level of advancement of ICA usage (Figure 4.6), it can be seen that only one plant use a constant aeration rate and one plant have manual control of aeration. None use a time-based control strategy, 8 plants use a single DO sensor to control the aeration, while 19 plants use DO profile control, making it the most common type of control. Five plants use ammonium sensors to control aeration (one is using the STAR system, (see description p. 40)). The last two plants do not have aeration.

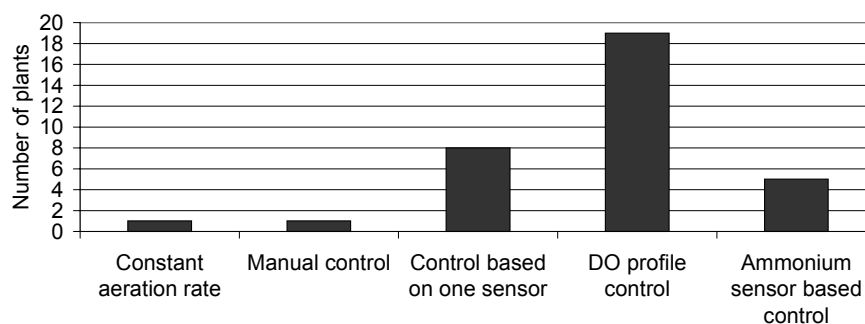

Figure 4.6 Choice of aeration strategy.

The plants have been asked to name their most important control handles (maximum limit of 7 handles). The most important control handles are listed in Table 4.9, where it can be seen that aeration, sludge outtake, sludge recirculation and dosage of chemicals are the most popular. Of the given control handles, 12% are operated on/off, 15% are operated in a step-wise fashion and 73% are operated continuously within a specific range. The plants have indicated whether the operational range is suitable for the processes at hand or not, 14% were not suitable; of these 27% had too broad ranges, 36% too narrow ranges and 33% had ranges that were either too high or low.

Table 4.9 Most important control handles.

Control handles	Mentioned By number of plants
Aeration	31
Sludge outtake	27
Sludge recirculation	24
Dosage of chemicals	14
Internal recirculation	9
Phase length	8
Inlet pumps	6
Digester operation	4
Aeration volume	3
Chlorination	3
Odour control	3
External carbon	1
Step feed	1
Other	27

The wastewater treatment plants were asked: "How do you judge your current use of instrumentation, control and automation?" Answers can be seen in Table 4.10. Only two plants say that no more could be gained, while the majority (66%) say that more or a lot more could be gained.

Table 4.10 Answers to judgement of ICA utilisation.

Answer	%
A lot more could be gained	11
More could be gained	55
Maybe more could be gained	28
No more could be gained	6

Table 4.11 Types of improvements with new ICA implementations.

Type of improvement	Number
Energy savings	6
N removal	3
Effluent quality	2
Modernisation of control system	2
More stable operation	2
Reduction in use of chemicals	2
Sludge dewatering	2
Better cleaning	1
Better monitoring	1
Biogas production	1
Easier operation	1
Smoother inlet	1
Nitrification improved	1
P-removal improved	1
Reduced bulking	1
Reduced taxes	1
Revelation of hydraulic problems	1
Savings in labour costs	1
Difficult to quantify	3

27 plants of 36 have applied new control principles within the last five years. Various benefits were achieved by the new control equipment in the various wastewater treatment plants. A list of improvements is given in Table 4.11, where all types of improvements are listed together with the number of WWTPs that reported this type of improvement. Some plants

reported more than one type of improvement. The striking feature about this overview is that even though reduction in energy consumption is the dominant type of improvement the list of possible benefits is rather long and several of the benefits are only stated by a single wastewater treatment plant. This indicates that there are many different types of benefits associated with applying new control equipment; it also shows that only a few of these are directly related to economic savings.

4.6 Principles of benchmarking

Benchmarking is a well-established business practice that has yielded large improvements in different areas ranging from manufacturing to human resource management and from customer satisfaction to product design. Many industries have been through the process of optimisation of operation performance. An example is the power industry, where benchmarking has sparked a debate on performance in energy production, contributing to an increased privatisation of the industry in many countries.

The wastewater industry is also being increasingly privatised, which increases the focus on performance assessment and best practices in operation. Performance assessment has developed globally during the last ten years, which is documented in an international report of state-of-art in performance assessment presented at the 2nd IWA world water congress in Berlin, October 12-15, 2001 (Merkel, 2001). The report describes the international state-of-art within performance assessment for WWTPs based on 16 national reports from: Australia, Czech Republic, Denmark, Finland, France, Germany, Japan, The Netherlands, Norway, Portugal, Poland, Romania, South Africa, Sweden, UK and USA. The report states that performance assessment have increased in importance. Privatisation, commercialisation and deregulation have had a significant effect since the 1980s. The actors promoting performance assessment are legislators, regulators, associations and utilities. Nguyen (2001) also points out that the technological advances in instrumentation and data processing have made better analysis possible. Most performance assessment projects focus on the sectors of economy and finance, technology, organisation, quality of product, quality of service and environment (Merkel, 2001).

The aim of benchmarking is to identify and learn from best practices. A good example of a benchmarking project with this exact aim is provided in Schulz (2001). The study was carried out by a collection of German groups of wastewater treatment plants in total around 100 plants. In the initial study

the operation costs, the investment costs and the overall costs of the entire plant were analysed to identify extreme values. Based on the analysis of WWTPs with extreme values the primary reason for deviations were found to stem primarily from the mechanical and the biological treatment. Ten measures to improve the efficiency was determined for each plant. It was also established that in smaller plants the costs for acquiring the data for benchmarking could not be justified by the potential savings. Hence, a simpler scheme was developed for plants below 10 000 PE.

IWA recently published "Performance indicators for water supply systems" (Alegre *et al.*, 2000). A similar work is underway for the wastewater industry, called "Performance indicators for wastewater services" which is expected to be ready in 2003 together with a "Manual of Best Practice".

Benchmarking is a sensitive subject due to its character of "judgment", which introduce the risk that the results may be misused by e.g. politicians (Balmér, 1999). The interpretation of the results from a benchmark study at a specific wastewater treatment plant should be done carefully and with regard to the performance limits and special conditions at the specific wastewater treatment plants. Examples of issues that are of importance for the interpretation of the results of such a study are:

- The history of expansions of the wastewater treatment plant;
- Special issues regarding the wastewater composition, e.g. special substances (for example toxic ones) and content of particulate versus dissolved organic matter;
- Variations of the influent flow and composition, which are generally higher for smaller wastewater treatment plants than for larger ones. Special conditions may also exist due to industries with periodic outlets;
- The design of the wastewater treatment plant in terms of pre-treatment, biological treatment and post-treatment, e.g. wastewater treatment plants with lagoons for effluent polishing will typically achieve lower effluent phosphorous contents than wastewater treatment plants without these features;
- Local priorities may influence parameters. The priority between investments and operational costs is one example. Some may feel that a high investment cost can be justified by a low operational cost or vice versa. It may be highly prioritised that the green areas of the

plant are well kept; hence, a person is employed to cut the grass. The presence of green taxes may provide an incentive to use more energy or chemicals to reduce the green taxes;

- Other site-specific circumstances may be present.

This could be interpreted so that there are always possible “excuses” available to “explain away” a poor assessment (which is probably also the case). However, such a “strategy” of finding “good excuses”, indicates that the assessment is not received in the right spirit. A benchmark assessment should rather be used to pinpoint possible weak points in the wastewater treatment plant. This may trigger a more detailed analysis in order to improve the performance. For some wastewater treatment plants, it may be of greater value to monitor a site-specific set of key performance indicator over a number of years to observe improvements. The benefit of comparing performance with other wastewater treatment plants is to give a benchmark as to how high a performance is practically possible or even to push the limits further. The type of benchmarking suggested here does not yield absolute upper performance limits. A parameter like the Carnot efficiency, which describes the maximum efficiency at which a heat-machine can work (Both *et al.*, 1990), would be useful if applied to wastewater treatment plants. However, such upper limits are difficult to obtain even theoretically due to the nature of the wastewater treatment process. For certain operations some theoretical key numbers can be found, such as stoichiometric relations between phosphorous content and chemical dosage, or oxygen need compared to organic or nitrogen content.

In the work presented here simple key performance indicators, are suggested. The indicators are related to various factors, e.g. volume -, energy – and chemicals exploitation. The key performance indicators can be used to evaluate performance of individual process parts. To assess the performance of a whole wastewater treatment plant a combination of several key performance indicators can be used. The idea in this work is to give a score for each key performance indicator from one to three, three being the highest performance. The scores from all the key performance indicators are then averaged to give an overall performance indicator.

4.7 Simple key performance indicators

The focus of the work on key performance indicators is mainly related to nitrogen and phosphorous removal.

Ammonium removal

Dissolved oxygen is used for the removal of ammonium through the process of nitrification. Hence, it makes good sense to relate the removal of ammonium to the energy consumption. The best way of doing this is to relate the removal only to the energy consumption for aeration. However, only 13 of the 36 wastewater treatment plants were able to state the energy consumption for aeration. Therefore, a comparison to total energy consumption is also carried out, though such a performance indicator is less decisive due to the variable amount of energy that is consumed for aeration from plant to plant. In WWTPs that are designed for biological nutrient removal the main part of the aeration energy, is used for ammonium reduction (to nitrate), as a large part of the biodegradable organic matter is removed in the denitrification process. However, in WWTPs where denitrification is not included the reduction of organic matter is done by aerobic oxidation. Hence, in such wastewater treatment plants, both ammonium and organic matter oxidation should be related to the energy consumption for aeration. However, in the dataset, there are only two with ammonium removal (and not nitrogen removal), therefore the parameter is not derived.

In the key performance indicator, all incoming nitrogen is assumed to appear as ammonium. This is not entirely true as a considerable amount of the nitrogen is in the form of organically bound nitrogen. According to Henze *et al.* (1992), this fraction amounts to approximately 40%. However, most of this fraction undergoes ammonification, resulting in the formation of ammonium, which is eventually followed by nitrification. Hence, this is a reasonable assumption.

Another important resource for the nitrification process is the volume available for biological transformations. Hence, the ammonium removal is also related to the volume of the biological reactors. An overview of the resulting key performance indicators is shown in Table 4.12.

In Table 4.12 minimum, maximum, average, median and a measure of variability are given for the key performance indicators. It is interesting to see the large difference between minimum and maximum values. Average

and median values are provided to give a feeling for the normal value. Median values are better for the indication of “normal” in the case of the presence of extreme values (whether they are correct or due to an erroneous input in the questionnaire).

Table 4.12 Proposals for key performance indicators for ammonium removal.

	KPI _{NH4} 1 g NH ₄ per kWh (total energy)	KPI _{NH4} 2 g NH ₄ per kWh (aeration energy)	KPI _{NH4} 3 g NH ₄ per m ³ (biological volume)
Number of plants	19	6	19
Minimum	22.8	96.2	15.3
Maximum	148.5	262.7	160.4
Average	79.0	173.3	57.6
Median	71.1	174.8	45.2
Max/Min	6.5	2.7	11.5

The correlation between KPI_{NH4}1 and KPI_{NH4}2 is relatively low (only 0.55 (only based on 6 points)), which indicates that total energy consumption cannot easily be used as a substitute for the energy consumption for aeration. The correlations between the two energy related parameters and KPI_{NH4}3 are all less than +/- 0.1, which indicates that a good (or poor) performance in one of the parameters KPI_{NH4}1 or KPI_{NH4}2 does not necessarily yield a good (or poor) in KPI_{NH4}3.

The KPI_{NH4}s have been investigated for bias due to temperature and effluent ammonium concentration.

Bias is investigated by plotting the key performance indicators against the temperature and the effluent ammonium concentration, respectively. Only wastewater treatment plants with total nitrogen removal are included. If no correlation is observed the plots are not shown, only the correlation coefficient is given. With regard to KPI_{NH4}1, there are too few data to investigate bias. In Figure 4.7, the bias of KPI_{NH4}2 against the effluent ammonium concentration is shown. If the data point at 5 mg/l NH₄-N is disregarded it is possible to see a trend towards more removal of ammonium per kWh the higher the effluent concentration is, which is as expected.

There seem to be no bias on KPI_{NH4}1 with regard to temperature (correlation coefficient is 0.24). For KPI_{NH4}3 there seems to be no bias with

regard to effluent ammonium concentration (correlation coefficient is -0.097). A weak correlation with temperature can be observed (correlation coefficient is 0.41), see Figure 4.8.

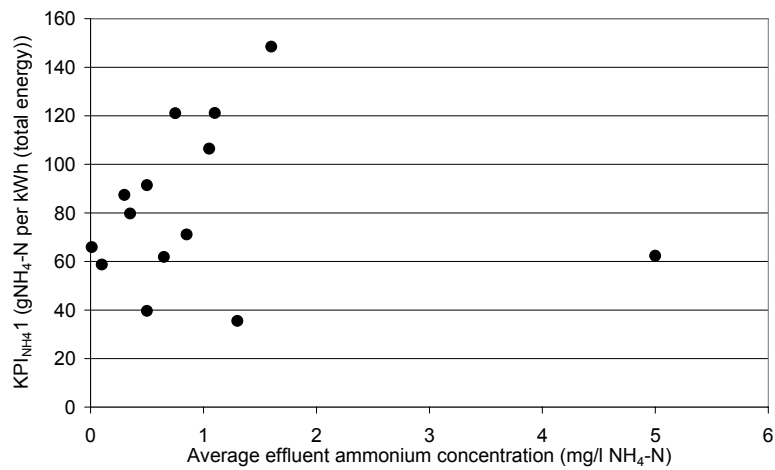

Figure 4.7 Bias detection on KPI_{NH4_2} against average effluent ammonium concentration.

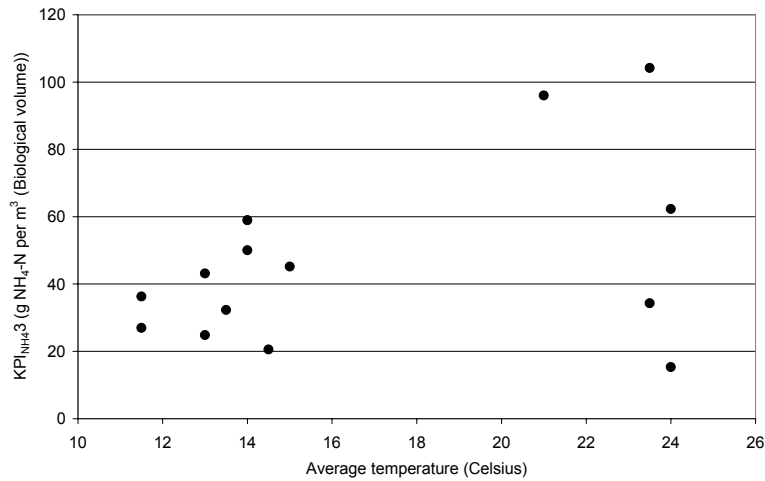

Figure 4.8 Bias detection on KPI_{NH4_3} against average temperature.

This is also as expected, as the nitrification rate per gram of microorganisms is generally increasing with the temperature, hence less volume is required at higher temperatures. However, for both of the detected bias's it must be stressed that the correlation coefficients are rather insignificant

Nitrogen removal

Total nitrogen removal is largely limited by the available organic matter and the biological volume. Hence, three types of parameters are suggested: percentage of influent nitrogen removed, removed total nitrogen per volume of biological reactor volume and, finally, three different parameters that relate nitrogen removal to the available amount of organic matter (sum of amount in influent and amount dosed as external carbon source). For the removal of nitrogen, it is easier to reach low total nitrogen content with a high C/N ratio than with a low one. The amount of removed total nitrogen per available amount of organic matter indicates the level of exploitation of available organic matter. An alternative parameter is the actually reached effluent total nitrogen divided by the influent C/N ratio.

A pre-denitrification system where the internal recirculation is not sufficient to ensure nitrate in all of the anoxic volume is an example of poor performance. The key performance indicators should reveal this; such an operation will lead to lower than possible utilisation of the available organic material for the removal of nitrate. A low level of utilisation of the organic carbon may also have the disadvantage that the organic matter is not degraded anoxically but aerobically leading to additional consumption of aeration energy. However, it is also an option to remove large parts of the organic material in the primary settler (maybe even enhanced by pre-precipitation). Hence, it is not an unequivocal parameter for measuring the utilisation of carbon source by denitrification (which by the way is a problem with a lot of these simple key performance indicators). The parameter is of greatest value to wastewater treatment plants that use external carbon source in spite of the fact that wastewater treatment plants with lower C/N ratio are able to meet their total nitrogen effluent criterion without the use of external carbon. However, other explanations may exist for poor performance, e.g. the distribution of COD between easily degradable organic matter and particulate matter is of great importance. The parameters are summarised in Table 4.13.

Table 4.13 Proposals for key performance indicators for total nitrogen removal.

	KPI _{TN1}	KPI _{TN2}	KPI _{TN3}	KPI _{TN4}	KPI _{TN5}	KPI _{TN6}
	Removal of tot-N (%)	Removed g Tot-N per m ³ (Biol. volume)	Tot-N per g COD in influent	g removed Tot-N per g COD in influent and dosed	Effluent Tot-N divided by influent C/N ratio	Effluent Tot-N divided by total C/N ratio (incl. dosage)
Number of plants	19	18	16	15	16	15
Minimum	16.8	11.7	0.030	0.030	0.17	0.22
Maximum	96.5	100.3	0.23	0.23	2.31	2.31
Average	76.4	45.4	0.093	0.094	0.73	0.76
Median	80.9	40.4	0.077	0.073	0.61	0.62
Max/min	5.8	8.6	7.7	7.7	13.6	10.5

The correlations between any of the parameters from KPI_{TN3} to KPI_{TN6} are high (all above 0.78), while the correlations between KPI_{TN1} and KPI_{TN2} against all parameters are low (all below +/- 0.34). This seems to indicate that KPI_{TN3} to KPI_{TN6} express more or less the same indicator. Hence, only one of the parameters should be used. The most logic choice for a key performance indicator expressing the COD utilisation is the KPI_{TN4}.

The correlations with effluent total nitrogen, temperature and C/N ratio have also been investigated. For KPI_{TN1} the correlation to the C/N ratio (correlation coefficient of -0.16) and the temperature (correlation coefficient of 0.14) are negligible. There is a correlation with effluent total nitrogen, which seems reasonable as the parameter expresses the removal percentage.

KPI_{TN2} has a weak correlation with temperature (correlation coefficient is 0.42 for plants designed for total nitrogen removal). From the plots of KPI_{TN2} against temperature (not shown), it can be seen that the wastewater treatment plants are divided into two groups. One group consists of plants with average temperatures around 12°C; the KPI_{TN2} in this group lies rather close together (18-60 g TotN removed /m³). The other group shows average temperatures around 23°C, the parameter KPI_{TN2} in this group seems more spread with values between 10 and 100 g TotN removed /m³. The

correlation between temperature and KPI_{TN2} is, however, low (correlation coefficient of 0.30). There is no correlation between KPI_{TN2} and effluent total nitrogen concentration (correlation coefficient of 0.075) nor towards the C/N ratio (correlation coefficient of -0.34).

KPI_{TN4} has a strong correlation to the C/N ratio, which seems reasonable, as the C/N ratio is included in the expression for this parameter. The correlations to temperature (correlation coefficient of 0.42) and effluent total nitrogen concentration (correlation coefficient of -0.48) are weak.

Phosphorous removal

For the removal of phosphorous only two parameters are suggested. The most interesting parameter measures the efficiency of chemical precipitation by means of the mole relationship between removed phosphorous and dosed precipitation chemicals. The other key performance indicator states the level of removal of total phosphorous, see Table 4.14.

The correlation between the two parameters is low (correlation coefficient of 0.17). The key performance indicators might depend on whether the plant is designed for biological phosphorous removal or not. A t-test was performed where the key performance indicators were divided into two groups, one with biological phosphorous removal and the other without. Even though a difference in averages was observed, this was not significant on a $\alpha = 5\%$ level (the critical α was 32%, i.e. not close to significant)

Table 4.14 Proposals for key performance indicators for total phosphorous removal.

	KPI_{TP1} Mole metal per mole TP removed	KPI_{TP2} Removal of TP%
Number of plants	16	16
Minimum	0.13	82.1
Maximum	8.23	98.8
Average	1.52	94.0
Median	1.13	95.6
Max/min	63.3	1.2

Sludge production

Sludge production is primarily related to the influent COD load, hence a key performance indicator that relates sludge production to influent COD load is devised, see Table 4.15. The max/min-ratio indicates large differences in this key performance indicator. However, if the two largest values are disregarded the max/min ratio is reduced to 3.7 indicating a considerably lower variability in the data and the remaining key performance parameters are then below 1.0 kg dry sludge per kg influent COD. No special conditions apply to the two wastewater treatment plants with KPI_{Sludge} above 1.0. They are both relatively small plants. However, there is no general trend that small plants have a high KPI_{Sludge} (correlation coefficient towards average current influent flow is -0.1). Both plants are designed for removal of total nitrogen, COD and chemical and biological phosphorous removal.

Table 4.15 Key performance indicator for sludge production.

	KPI_{Sludge} Kg dry sludge per kg influent COD
Number of plants	31
Minimum	0.24
Maximum	2.56
Average	0.55
Median	0.40
Max/min	10.8

4.8 ICA utilisation and performance

The correspondence between the ICA utilisation and the performance. Tests for various key performance indicators have been carried out, where the plants are divided into groups according to their usage of key sensors.

Phosphate sensors

It is reasonable to assume that wastewater treatment plants with online phosphate measurements have a better performance of chemical

phosphorous precipitation than those without. To test this the 16 wastewater treatment plants that have provided data for the KPITP2 are divided into two groups, one that has access to phosphate sensors (group A) and one that does not (group B). It is then tested whether the average key performance indicator is better in group A than in group B. The key performance indicator for the two groups is given in Table 4.16.

The test result is given in Table 4.17; this shows that the average performance in group A is better than in group B. The difference is, however, not significant on a $\alpha = 5\%$ level. The hypothesis is close to significant as an $\alpha = 6.4\%$ would result in acceptance of the hypothesis.

Table 4.16 The KPI_{TP1} for group A (with phosphate sensors) and group B (without phosphate sensors).

Group A	Group B
0.72	0.58
1.08	0.30
0.13	2.7
0.80	8.23
0.26	1.31
1.18	1.20
1.58	1.34
0.52	2.42

Table 4.17 Test regarding KPITP1 and availability of a phosphate sensor.

t-Test: Two-sample assuming equal variances		
	Group A	Group B
Mean	0.78	2.26
Variance	0.24	6.48
Observations	8	8
Pooled variance	3.36	
Hypothesized mean difference	0	
df	14	
Z	-1.61	
P(T<=t) one-tail	0.064	
t critical one-tail	1.76	

Ammonium and nitrate sensors

For the parameter KPI_{TN2} there is a significant difference in performance between wastewater treatment plants with and without nitrate and/or ammonium sensors, see Table 4.19. Surprisingly, the wastewater treatment plants without any of these sensors perform best (significance level α of 2.7%). Hence, another explanation for the difference is sought and it appears that the countries with cold wastewater are the ones with nutrient sensors. That means that a division of the group into wastewater treatment plants with higher and lower average temperatures than 20°C, gives the same group division, see Table 4.18. In a few cases, the temperature data has not been given but the home country of the wastewater treatment plant is presented. This is sufficient to show whether the wastewater treatment plant belong to the high respective low temperature group. Hence, it cannot be said whether the difference is due to the presence of sensors or due to the higher water temperature. However, the temperature explanation makes most sense. This confoundation means that it makes little sense to test any of the parameters related to biological removal (i.e. KPI_{TN} and KPI_{NH_4}) against presence or absence of specific sensors, as there will always be a doubt whether a significant difference is due to the sensor or the temperature effect.

Table 4.18 Group A (with nutrient sensors) and group B (without sensors).

Group A	Group B	Group A (temperature)	Group B (temperature)
90.0	11.7	16.5	24
14.8	34.1	12.5	23.5
18.6	60.5	14.5	24
20.6	65.7	Denmark	Australia
20.9	83.9	13	21
25.6	85.9	11.5	Australia
30.8	100.3	13.5	23.5
32.9		11.5	
40.3		13	
40.6		15	
44.8		15	

It has also been tested if WWTPs with a combination of biological and chemical phosphorous removal use less precipitation chemicals per removed amount of phosphate (i.e. KPI_{TP1}) than wastewater treatment plants with only chemical phosphorous removal. Surprisingly, the average KPI_{TP1} is higher in the group with a combination of biological and chemical removal but the difference is not significant at an $\alpha = 5\%$ level (not close to significant either). Several explanations for this exist: biological phosphorous removal may not be exploited sufficiently, dosage may not be corrected according to the actual biological removal or wastewater treatment plants that are not designed for biological phosphorous removal may have the process unintentionally.

Table 4.19 Test regarding KPITN2 (and temperature).

t-Test: Two-sample assuming equal variances		
	Group A	Group B
Mean	40.12	63.14
Variance	440.6	972.9
Observations	15	7
Pooled Variance	600	
Hypothesized mean difference	0	
df	20	
t Stat	-2.05	
P(T<=t) one-tail	0.027	
t critical one-tail	1.72	

4.9 Conclusions

The most striking feature of the above analysis is the great variation in almost all indicators, regarding both performance measurement and ICA utilisation. This huge difference can neither be explained solely by size of plant nor by special conditions of the plants. Rather it indicates real differences in performance at different plants, meaning that improvements are possible at many plants.

ICA is not the single dominant factor for plant performance. Other issues such as the design of the plant, the ambient temperature, the energy efficiency of the various control handles are obviously also of high importance. While most of these features are not easy to change, there are

opportunities for most plants to tighten up the operation by optimisation based on increased application of ICA. This is recognised by most of the participants where only 8% state that no more could be gained by more application of ICA. 12% claim that a lot more could be gained, 52% state that more could be gained, while the rest, 28%, claim that maybe more could be gained.

The advantage of simple key performance indicators is that the parameters are easy to calculate and the data for these are widely available. Surprisingly, statistical investigation has shown that the indicators are only to a small extent related to basic physical parameters such as temperature and effluent concentrations. This is not the same as to say that the indicators are not affected by these parameters; rather the variabilities in the datasets are so large that with the present relatively small amount of plants these correlations are not easily visible. There are several disadvantages with the use of simple key performance indicators. Firstly, it is difficult to come up with one single indicator for each subject treated. In most cases, several key performance indicators are suggested and it is difficult to evaluate which is better. For example, is it better to have a good removal per m³ of biological volume or per kWh of aeration energy? Secondly, it is difficult to define one single overall assessment of a wastewater treatment plant. A method using ratings based on percentiles are suggested, but it does not provide an objective overall measure.

It is difficult to devise performance indicators that are comprehensive enough to be objective and at the same time are based on readily available plant operation data. Firstly, optimality is not uniformly defined across or even within countries. Secondly, large amounts of data are needed to reach an objective parameter and this is not available at all plants, as observed in the survey. Thirdly, even if the criteria were well known and the data were available, a clear understanding of how to combine the various factors into a few ones does not exist. Nitrogen removal is an apparent example. How should energy consumption, volume, availability of organic matter and temperature be weighted into one criterion?

Finding optimal performance by modelling may provide the answer to the question on how to combine plant operation information into effective parameters. A lot of work is being carried out in the benchmark modelling initiative (see the COST 624 homepage). Here a well-defined wastewater treatment plant is used to make objective comparisons of various control strategies to find the best solutions for control. However, this work is not yet at a stage where it is easy to find optimal solutions. Stationary state

analysis of the plants by means of operational space maps seems to be one promising approach (Ingildsen *et al.*, 2002a). The modelling work can contribute to establishing a good understanding of best practices, which to a great part is about using optimal control structures. This involves answering questions of which sensors to use, how to combine them with the available control handles and with which kind of controllers.

Chapter 5 The Implementation Process

The process of actually implementing new control concepts in wastewater treatment plants has received little attention in the ICA-IWA research community. In this chapter, a simple framework for this process is suggested. It is postulated that the implementation process is or should be divided into four steps: an initial analysis, a monitoring phase, an experimental phase and finally an automatic control phase, see Figure 5.1. This work focuses on the implementation of sensors for the control of the nutrient removal processes. However, the same process may be applicable for the implementation of other types of equipment.

In the following, this approach will be referred to as the “Practical Implementation Process”. The four phases in the process will be described in detail in the following Sections by means of examples and experiences from two implementation processes in full-scale WWTPs. One implementation process took place at the Lindau wastewater treatment plant in Southern Germany. In Lindau only the two first steps: the initial analysis and the monitoring phase were carried out. The remaining steps are yet to be completed by the staff at the Lindau wastewater treatment plant. The other implementation process took place at the Swedish wastewater treatment plant of Källby in Lund. The experiments at this site are also the focus of Part IV of this thesis. At the Källby, the focus of the implementation was put on the last three steps in the implementation process.

The initial situations at the two wastewater treatment plants were quite different in regard to usage of nutrient sensors. The Källby wastewater treatment plant had already nutrient analysers installed in the effluent from the secondary sedimentation unit and was therefore quite experienced with using this type of information to adjust the DO setpoints and the number of aerated zones as well as the precipitation dosage. At the Lindau wastewater

treatment plant, on the other hand the personnel did not have experience with equipment for on-line measurement of nutrient concentrations. Therefore, their situation resembles the situation that many wastewater treatment plants are faced with today when considering their first investment in nutrient sensors.

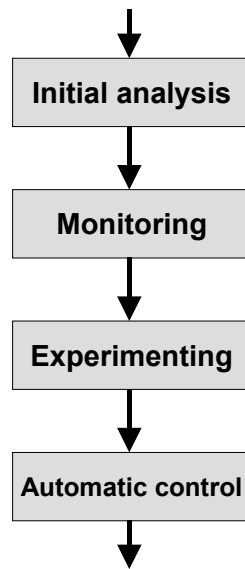

Figure 5.1 The “Practical Implementation Process” includes four phases in the implementation process.

5.1 Introducing the Lindau wastewater treatment plant

Because the Lindau WWTP is used to demonstrate the two first phases of the implementation process a short introduction to the plant is necessary. Several characteristics of this plant are interesting from a control and optimisation perspective. The plant has a rather special design called a NH₄-PO system (patented by Dr. Günter Lorenz), which is characterised by considerable control flexibility.

The plant layout is depicted in Figure 5.2. The primary treatment consisting of a trash rack, a sand- and fat catch and a primary sedimentation unit are followed by the biological treatment. The biological treatment is divided into two steps. In the first step, the water is divided into two parallel

streams, a high loaded activated sludge system and a low loaded activated sludge system. The high loaded step treats both wastewater and the thickened sludge from the primary sedimentation. This step is 80% aerated and no denitrification is expected to take place here. The low loaded system is a traditional pre-denitrification system for nitrogen removal. The only special feature of the system is that no surplus sludge is taken out; instead, the surplus sludge is allowed to go over the weirs of the secondary sedimentation unit into the second step.

In the second step of the biological treatment, the two water streams from the first step are combined and treated in a traditional pre-denitrification system. The sludge taken out from this system is recycled to the inlet of the plant making nitrification and oxidation of organic matter possible already in the sand- and fat catch. This means that all surplus sludge is removed from the high-loaded activated sludge system in the first step only. From the secondary step, effluent wastewater is recycled to equalise the hydraulic load on the whole system. Simultaneous precipitation of phosphate is carried out in the secondary step. This is followed by a filter, which is installed to meet the strict demands for phosphorous removal.

The plant design has the following special features:

1. Modified two-step biological system;
2. Hydraulic equalisation;
3. Pre-activation of sand- and fat catch with microorganisms from the second step;
4. Primary sludge degradation in the high loaded activated sludge system;
5. Anaerobic sludge storage tanks applied in each of the pre-denitrification system. The storage tanks are located in the sludge recirculation streams (not depicted in Figure 5.2).

The effluent criteria for the plant are summarised in Table 5.1. The total nitrogen criterion has been chosen to reduce the payable amount of green taxes. In principle, this criterion could have been 18 mg/l N. The influent wastewater characteristics are summarised in Table 5.2. According to a major investigation by Wilderer and Genes (1998), the nitrogen removal at the Lindau WWTP takes place as shown in Figure 5.3.

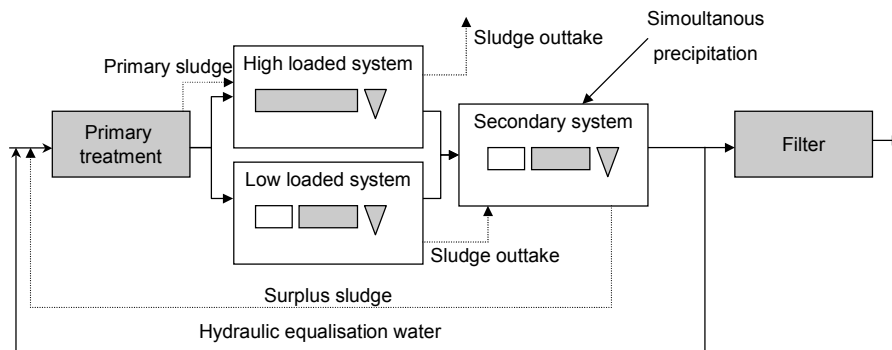

Figure 5.2 Layout of the Lindau wastewater treatment plant.

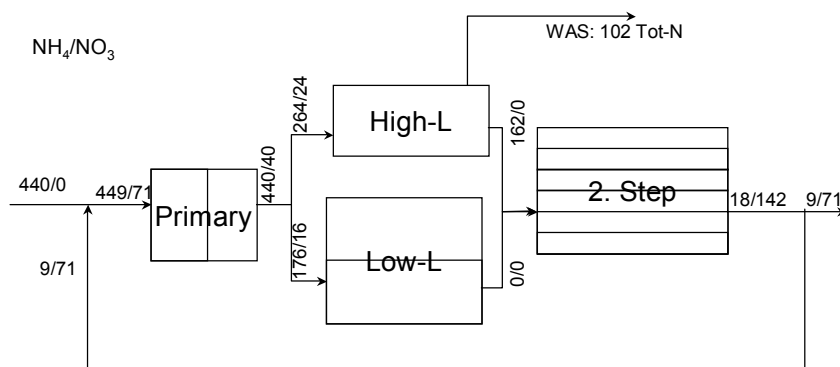

Figure 5.3 Nitrogen removal in the Lindau wastewater treatment plant according to Wilderer and Genes (1998). The first number denotes ammonium load, the second denotes nitrate load. The numbers are in kgN/day.

Table 5.1 Effluent criteria for the Lindau wastewater treatment plant.

	Criterion
Total Phosphorous	0.3 mg/l P
Total Nitrogen	11 mg/l N
Ammonium	10 mg/l NH ₄ -N

Table 5.2 Influent wastewater characteristics.

Parameter	Normal value
Flow	15000-18000 m ³ / day
COD	6300 kg/day
Tot-N	440 kg/day
NH ₄ -N	295 kg/day
Tot-P	5.1 kg/day
COD/BOD-relation	1.2

5.2 Initial analysis phase

In Ingildsen and Olsson (2001) a framework for a five-step plant analysis was suggested:

1. Focus of analysis;
2. Establish a knowledge pool;
3. Interpretation of the knowledge pool;
4. Recommendations for improvements;
5. Implementation and evaluation of improvements.

Compared to the “Practical Implementation Process” step one through four in the five-step plant analysis corresponds to the initial analysis phase while step five corresponds to the remaining phases.

This five-step approach was tested at the Lindau wastewater treatment plants. However, it soon became apparent that such an approach was too rigid and did not give a fair description of the actual process. The observed process was much more chaotic and to a wider extent governed by the people involved in the process, their interest, knowledge, background, experience, etc. For example, the establishment and interpretation of a knowledge pool is rather a process of exchanging opinions and experience between the actors in the task group. Of course, this does not mean that the process should just run without a strategy. Most of the issues discussed in Ingildsen and Olsson (2001) did at one time or another appear in the discussion and the planning of the project. However, it makes more sense to divide the initial analysis phase into two steps.

The first step is about idea generation and achieving a common understanding of the wastewater treatment plant, i.e. its problems, opportunities and priorities. In the following, this will be labelled the “idea

generation step”. The second step is about choosing a set of ideas that is going to be put to the test in the subsequent steps of the “Practical Implementation Process”. This is in the following named the “idea selection step”. The two steps are described below using the Lindau wastewater treatment plant as a case story.

Idea generation step

Typically, a task group is formed to work on the new control implementation. At Lindau wastewater treatment plant, the task group included the daily manager and operator at the plant, the plant designer, a sensor sales person and the author of this thesis.

In the ideal case, there is a clear understanding of the focus of the analysis as well as the priorities of the project. However, often the focus and priorities are something that is discussed (or even negotiated) because the members in the task group have different opinions. Often this discussion may lead to new knowledge and insights for all parties. Examples of foci are: the biological removal of nitrogen, phosphorous and organic matter, or trimming the aeration system on its own. Alternatively, it might prove beneficial to concentrate on the control and tuning of all mechanical parts, including pumps, stirring aggregates, compressors, variable speed drives, valves, etc. A third option would be to analyse the hydraulic pattern: for example if there are parallel processes, does the flow split equally between them?

At the Lindau wastewater treatment plant, the focus of the project was the improvement of the process control of nitrogen and phosphorous removal by means of online nutrient sensors. During the initial phase the focus and the priorities became more specific and was finally narrowed down to:

1. Saving precipitation chemicals, hence also reduce the amount of produced sludge, while ensuring an effluent total phosphorous concentration of 0.3 mg P/l as stated in the permit;
2. Saving energy while ensuring effluent total nitrogen concentration of 11 mg/l N as stated in the permit.

Two types of objectives can be defined: either operational cost reduction (opportunity approach) or improvement of effluent water quality (problem approach). In many cases, both cost reduction and improvement in effluent

water quality can be obtained, but one objective has usually the higher priority.

Cost distribution tables can serve to highlight areas in which work should be focussed to produce the greatest effect when the opportunity approach is used. The aeration process and the sludge treatment are often the most important consumers of energy, so savings made in these areas are most likely to have a significant impact on the cost of operating the plant as a whole. Cost reduction was the chosen objective at Lindau, as the plant did not experience problems with complying with effluent criteria. Moreover, the cost of green taxes (based on outlet of nitrogen, phosphorous and organic matter) constitutes a relatively small fraction of the variable operation costs at the plant. The cost distribution for the various parts of the operation is stated in Table 5.3.

Table 5.3 Cost distribution at the Lindau wastewater treatment plant.

Variable costs:	
Energy	20%
Sludge disposal	15%
Chemicals	6%
Green taxes	3%
Overhead costs:	
Salaries	40%
Maintenance	11%
Other	5%

Two different approaches can be used to identify the potential for improvements in operations. One option is a top-down approach, which starts with the definition of what the plant should be able to achieve and then working downwards through the control hierarchy by determining the performance criteria for each process. The next step is to define what these criteria will mean for each component and the control of it. This may result in new control methods or need of sensors. The other approach is a bottom-up strategy, where the starting point is the plant as it is. A bottom-up analysis is focused on what can be achieved with the existing equipment or newly purchased equipment. Optimisation analysis is generally not carried out as a “one-shot analysis” but rather as a continuous discussion between

operators, managers, engineers and programmers. Discussions of this kind typically feature elements of both the bottom-up and top-down approach.

The discussions may often have a character of brainstorming, discussions about the plant performance and “archaeological” investigations into old plant drawings and operational data on variables like energy and effluent concentrations over the last several years.

Plant tests can be a valuable source of data and information. However, running an effective plant test is a difficult task – many things may go wrong. When taking measurements, the sampling process itself is often the weak link because it is difficult to take truly representative samples. Furthermore, chemical analyses have to be carried out very fast after the samples have been collected, for some parameters within a few minutes. Unwanted variations may come into play: a valve may be leaking, a rainstorm could change the conditions for the whole experiment from “normal” operation to “wet weather” operation, an automatic sampler may have been incorrectly programmed, etc. This is not to say that such tests are worthless or impossible, but they must be planned carefully and even then, it is difficult to consider all potential problems.

In many cases, the “information pool” contains unreliable and incomplete data sets. The fact that all analyses will have to be based on such data is a basic premise for plant analysis in wastewater treatment plants (as in many other process industries). Therefore, the data should be approached systematically as well as creatively, to identify all plausible explanations. Models may assist in the interpretation of data, as a model can take several factors and time scales into account at once. The interpretation of data can often be quite difficult because the effects observed may be due to a number of reasons that overlie one another and take place in different time scales. Models may help to distinguish between these different reasons. Although it is difficult to use models effectively, modelling is often the best tool available if experience and intuition prove insufficient. Experience is naturally an asset in analysing plant data. However, according to Hovat (1995), who has worked with similar analyses in the chemical industry: *“Proper interpretation of plant performance is corrupted by fluctuations, sampling random errors and gross errors: the greatest hindrance, however, is overcoming plant and analysis mythologies.”*

Control of the low loaded activated sludge system

- The internal nitrate recirculation can be controlled by means of a nitrate sensor at the end of the last anoxic reactor to ensure full utilisation of the denitrification volume in order to ensure high total nitrogen removal at all times.
- The aeration can be controlled by means of ammonium sensors. The actuation can be either the DO setpoint or the amount of zones aerated. The control can be done by:
 1. Applying an ammonium sensor at the end of the aerobic reactors and control the aeration by means of feedback control;
 2. Applying an ammonium sensor at the head end of the aerobic reactors and control the aeration by means of feedforward control;
 3. Combining feedforward and feedback control.

Control of the secondary activated sludge system

- The six parallel lines can be controlled by a similar strategy as for the low loaded activated sludge system.
- Another option is to stop the flow through one or more lines during low load (i.e. night time). In the lines without aeration, anaerobic digestion and possibly biological phosphorous release may take place. At the same time, aeration energy will be saved.

Division of flow between high and low loaded activated sludge systems

- The division of the flow between the two systems could be controlled as to achieve close to full removal of ammonium in the low loaded system and leading the rest to the high loaded system. This could be controlled by means of a feedforward or feedback controller.

Control of filter water

- The flow of ammonium rich water from the filter can be controlled so that it is led to the low loaded system when nitrification capacity is available. An ammonium sensor can be used for feedback or feedforward control.

Biological phosphorous removal

- Biological phosphorous release takes place at various locations in the plant. This could be monitored and possibly controlled by means of online phosphate sensors. Several sensor locations for such a control system is probably necessary and as little experience with such control exist, it will be necessary to test various sensor locations and maybe supplement this information by further plant analysis.

Dosage of phosphate precipitation chemicals

- The dosage of precipitation chemicals can be controlled using a phosphate sensor. This can be done by:
 1. Feedback control based on a sensor in the effluent from the flocculation chamber
 2. Feedforward based on a sensor located in the influent to the flocculation chamber, which measures the incoming load

Box 3 Catalogue of ideas for the Lindau WWTP.

The result of the idea generation phase should be a catalogue of control ideas. Formulating these ideas may often expose a lack of understanding of parts of the plant. Different explanations may come up for a certain phenomenon or no explanations at all may come up. An example from the Lindau wastewater treatment plant is the question of where the biological phosphorous release takes place in the plant. There are at least two options: in the part of the highly loaded system that is not aerated and hence is anaerobic, or in the anaerobic sludge storage tanks located in the return activated sludge line in the pre-denitrification systems. As will be shown later the timely variation in reactors may also mean that reactors for denitrification may be part-time anaerobic, see p. 99.

Hence, a proposal for the control of biological phosphorous removal in the system would also have to include an analysis of how the biological phosphorous removal actually takes place.

The main ideas suggested at the Lindau wastewater treatment plant were collected in a small catalogue describing six proposals, see Box 3.

Idea selection step

The second stage of the initial analysis is the actual selection of which ideas from the idea generation phase to work with. While the idea generation step was characterised by a spirit of “everything is allowed”, the second step is more practical and down-to-earth. Here, the barriers and limitations of the plant are discussed and economy is an important part of the discussion. To implement the full catalogue of ideas (Box 3) at Lindau WWTP would involve a large number of sensors, which would be far too costly. During the idea selection step, cost-benefit deliberations may be helpful.

It is difficult, if not impossible, to make promises about how much a wastewater treatment plant stands to gain by improving process control, e.g. by introducing nutrient sensors. The benefits will vary from plant to plant depending on 1) the available control handles and their functional characteristics, 2) the general design of the plant, 3) the variation in load(s) to which the plant is subjected, 4) the current operational strategy, 5) the problems specific to the plant, 6) the expertise available at the plant (i.e. the skills of its operators, programmers, engineers, laboratory personnel, electricians, etc.), and 7) the amount of time, energy and resources devoted to the optimisation work. A wide range of benefits are possible depending on the project focus: improvement in the quality of the effluent, reductions

in the consumption of energy (aeration and pumping) and chemicals (precipitation chemicals and external sources of organic carbon), increased capacity, improved disturbance rejection and risk minimisation. Not all benefits can be assigned an exact monetary value. In some cases, the benefit of the implementation of new sensor systems may be the highlighting of areas of poor performance. However, it is not possible to know just how poor the start-conditions are before analysers are in operation. A valuable approach may be to examine the improvements in performance achieved by other plants. When recommending improvements it may also be helpful to consider the Pareto principle, which states that 80% of the improvement in performance can be achieved with 20% of the effort.

At the Lindau wastewater treatment plant, one limitation was a maximum number of three nutrient sensors, which was chosen due to economic reasons. Therefore, the task was to choose the three ideas that were expected to yield the highest benefit in terms of reduction in energy and consumption of chemicals. As the energy issue is primarily related to aeration it was decided to focus on the nitrification processes. In the Lindau plant, nitrification takes place at two locations, the low loaded and the secondary activated sludge systems. It was decided to apply two ammonium sensors to monitor the effluent ammonium from these two systems, to determine if a potential savings existed, and if so, to try to control the aeration to ensure a close to constant effluent concentration of ammonium based on feedback control. If feedback showed to be too slow, the sensors would be moved to provide feedforward control instead. Secondly, it was decided to attempt to control the dosage of phosphorous precipitation chemicals by means of a phosphate sensor in the effluent from the precipitation system. Again, it was planned to observe the phosphate concentration during a certain period to determine if any benefits could be obtained.

After the decisions are taken, the practicalities follow. One important issue is to find the actual locations of the sensors. There may be different types of limitations as to where the sensors can actually be located. These are determined by the size of the sensor, the mounting of the sensor, some process parts may be covered and hence difficult to access (access is necessary for mounting and servicing the instrument). It should also be considered if the location will yield representative measurements. For example, if several streams are mixed, it is important to measure in the correct stream or, alternatively, where the streams are sufficiently mixed. Such issues are difficult to resolve theoretically and in most cases must be

decided based on judgement from the task group. Three-dimensional hydraulic models may be used to solve the problem theoretically, however, a “trial and error” approach will probably prove to be faster and less expensive. At the Lindau wastewater treatment plant, it was not possible to mount the phosphate sensor at the end of the flocculation (i.e. the secondary biological system), instead the sensor had to be mounted in the effluent from the sedimentation unit. This naturally causes some delay in the signal due to the retention time in the settler.

Additionally, plant wide issues should be considered, i.e. can the controller that is to be implemented cause problems in other parts of the plant? For example, problems might involve the introduction of hydraulic shock loads or early utilisation of organic matter, which is needed downstream. This was not found to be the case at Lindau WWTP with any of the suggested controllers.

5.3 Monitoring phase

Instead of proceeding directly to the automatic control phase from the initial analysis phase, it will often show valuable to include a monitoring phase to gain an understanding of the current operation. Monitoring may often lead to new knowledge about the processes and hence spur new questions. During the monitoring phase, it is a great advantage if the sensor can be moved around to find the most suitable locations. At the Källby wastewater treatment plant, a special metal rig was designed where the sensors were mounted. The rig could fit over the concrete basin walls in almost all zones, which made it easy to move the sensors around to test various locations.

It is often necessary to carry out some mathematical analysis of the new data to gain a better understanding. On some occasions, simple models may be helpful in order to explain the given patterns. Data may need to be supplemented by various types of laboratory tests, to confirm or reject a hypothesis on a possible explanation for the behaviour of the signals. The explanations may be complex and involve the measurement of several parameters, such as DO concentration, sludge concentration and flow rates.

Various features can be observed when using for example nutrient sensors. Three examples of this are given below. The examples illustrate what type of features that can be observed and include a description of some of the tools that can be helpful in the analysis of the data. Often

brainstorming sessions by the task group may be necessary to come up with plausible explanations.

Example 1: Ammonium effluent monitoring

The first data series from Lindau was quite revealing in terms of demonstrating the level of excessive aeration taking place in the two pre-denitrification systems. The data can be seen in Figure 5.4 and Figure 5.5. A large part of the time both sensors show values close to zero mg/l $\text{NH}_4\text{-N}$, indicating excess aeration.

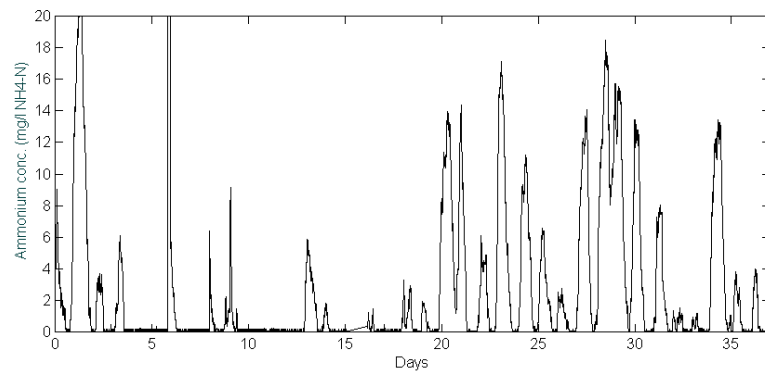

Figure 5.4 The first data series with the ammonium sensor located at the outlet of the last reactor in the low loaded activated sludge system.

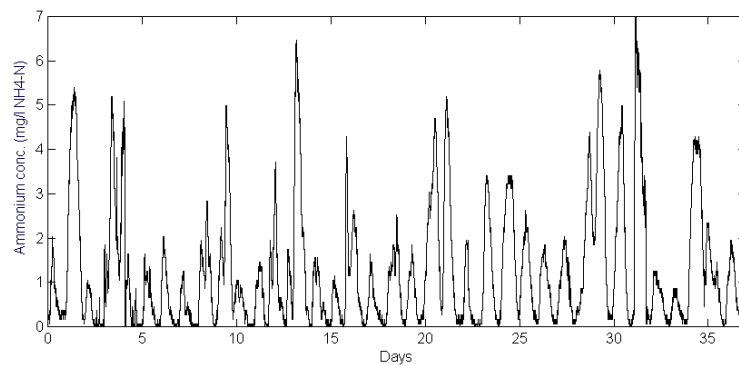

Figure 5.5 The first data series with the ammonium sensor located at the outlet of the last reactor in the secondary activated sludge system.

Plotting the distribution of the data, see Figure 5.6, shows that 65% of the time the concentration of ammonium is below 0.1 mg/l in the low loaded system. This means that during the majority of the time the aeration is on even though no ammonium is present. A more reasonable setpoint at this location would be in the range of e.g. 2-3 mg/l $\text{NH}_4\text{-N}$. At some instances, the ammonium concentration is very high, close to 20 mg/l. A more thorough investigation of the reasons for this behaviour should be carried out. Some possible reasons are spikes in the influent, malfunction of aeration and filter water being recycled. The actual reason was not identified.

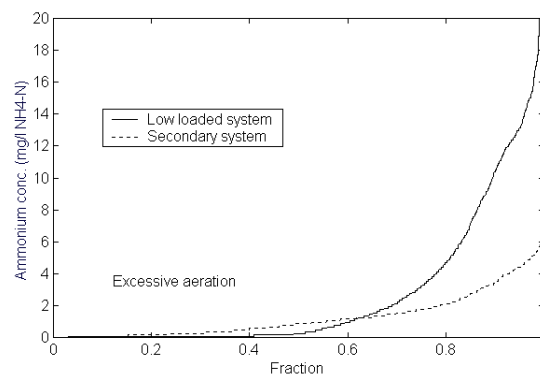

Figure 5.6 Distribution of data from the low loaded and the secondary system.

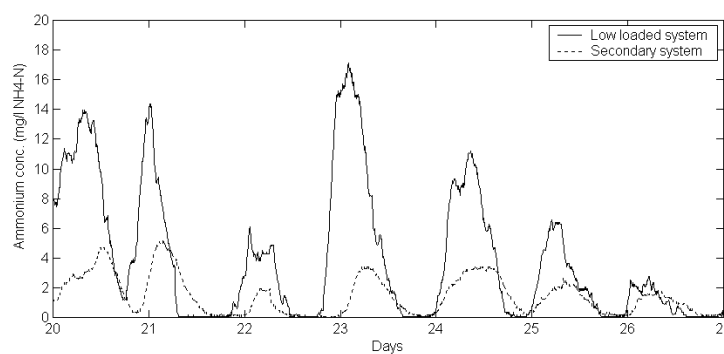

Figure 5.7 Example of how the sensor from the low loaded system can be used for feedforward control of the second system.

A distribution plot of the ammonium concentrations from the secondary system (Figure 5.6) show that 92% of the time the ammonium concentration is below 4 mg/l $\text{NH}_4\text{-N}$, 79% of the time below 2 mg/l $\text{NH}_4\text{-N}$ and 15% of the time the concentration is below 0.1 mg/l $\text{NH}_4\text{-N}$. This indicates that also the secondary system has excessive aeration a large part of the time.

The ammonium measurement from the outlet of the low loaded system can be used for feedforward control of the secondary system, see Figure 5.7.

Example 2: Monitoring ammonium, nitrate and phosphate together

Monitoring the variation of the nutrient concentrations over the day gives insight into the magnitude of variations in the reactor as well as the temporal variation in the location of the processes. The example in Figure 5.8 is taken from a monitoring period at the Källby WWTP. The plant is a pre-denitrification system; consisting of ten consecutive zones, see a more detailed description of the Källby WWTP in Chapter 9. Figure 5.8 gives an example from a period where a nitrate, an ammonium and a phosphate sensor were located in the second last anoxic zone.

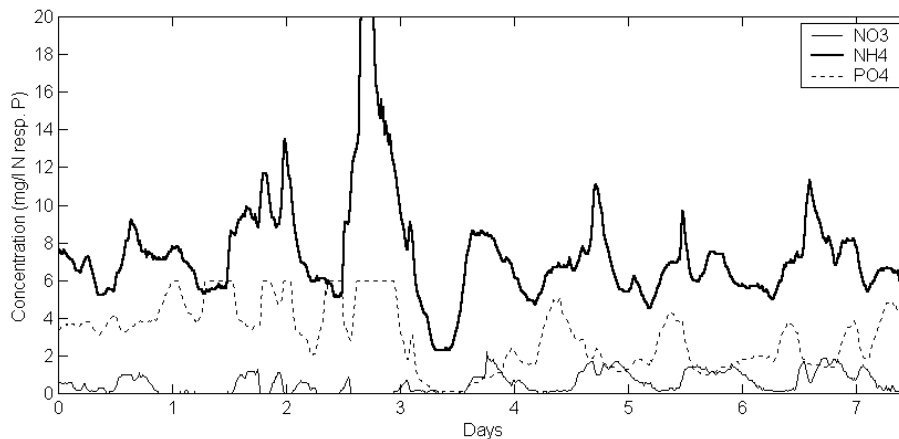

Figure 5.8 Observation of the nutrients concentrations over time.

Some key observations are:

NH₄: the variation of the ammonium concentration into the aerobic zones is considerable and quite fast with varying daily patterns.

NO₃: part of the time the nitrate is zero or close to zero, showing that the anoxic zones are not used to their full capacity at all times.

PO₄: biological phosphorous increases rapidly when no nitrate is present, i.e. when the zone becomes anaerobic. The hypothesis is that this shows that even at this late stage volatile fatty acids (VFA) are available for biological phosphorous release. It should be noted that the phosphorous release starts immediately when the nitrate has disappeared. This is an example where additional laboratory tests may be helpful in order to confirm or reject the somewhat surprising hypothesis.

Example 3: Observation and modelling of nitrification

In some cases, it may be helpful to use simple mathematical models to analyse the resulting data from an observation period. In this example, the ammonium into the aerobic reactors (sensor A) and out of the sedimentation unit (sensor B) was monitored. The pattern that is detected by sensor A can to some extent be recognised in the measurements from sensor B. However, the delay is due to the transport time through the aerobic zones and the sedimentation unit and, therefore, varies depending on the influent, the internal recirculation and the sludge recirculation flow rates. It is therefore difficult to see with the bare eye whether the two measurements are in correspondence, i.e. the aerobic reactors are functioning satisfactorily. The simple model used for this purpose is given in Equation (5.1).

C_6 is the ammonium concentration in zone 6, etc., C_A is the ammonium concentration measured by sensor A and C_B is the ammonium concentration measured by sensor B. Q is the influent flow rate, Q_{int} is the internal recirculation flow rate and Q_{RAS} is the sludge recirculation flow rate. The nitrification rate is denoted r_{nit} and expressed in the unit $g/m^3/day$, while K is a half saturation constant, which is set to 1 mg/l NH₄-N. Based on this simple model it is possible to either estimate r_{nit} based on the two sensor signals or, alternatively, if r_{nit} is assumed constant the effluent ammonium concentration (sensor B) can be predicted. In Figure 5.9, the two sensor signals and the prediction of sensor B are plotted. This shows a fairly good correspondence between the prediction and the sensor B measurements despite the simplicity of the model.

$$\begin{aligned}
\frac{dC_6}{dt} &= \frac{Q + Q_{int} + Q_{RAS}}{V_6} * (C_A - C_6) - r_{nit} * \frac{C_6}{C_6 + K} \\
\frac{dC_7}{dt} &= \frac{Q + Q_{int} + Q_{RAS}}{V_7} * (C_6 - C_7) - r_{nit} * \frac{C_7}{C_7 + K} \\
\frac{dC_8}{dt} &= \frac{Q + Q_{int} + Q_{RAS}}{V_8} * (C_7 - C_8) - r_{nit} * \frac{C_8}{C_8 + K} \\
\frac{dC_9}{dt} &= \frac{Q + Q_{int} + Q_{RAS}}{V_9} * (C_8 - C_9) - r_{nit} * \frac{C_9}{C_9 + K} \\
\frac{dC_{10}}{dt} &= \frac{Q + Q_{int} + Q_{RAS}}{V_{10}} * (C_9 - C_{10}) \\
\frac{dC_B}{dt} &= \frac{Q + Q_{int} + Q_{RAS}}{V_S} * (C_{10} - C_B)
\end{aligned} \tag{5.1}$$

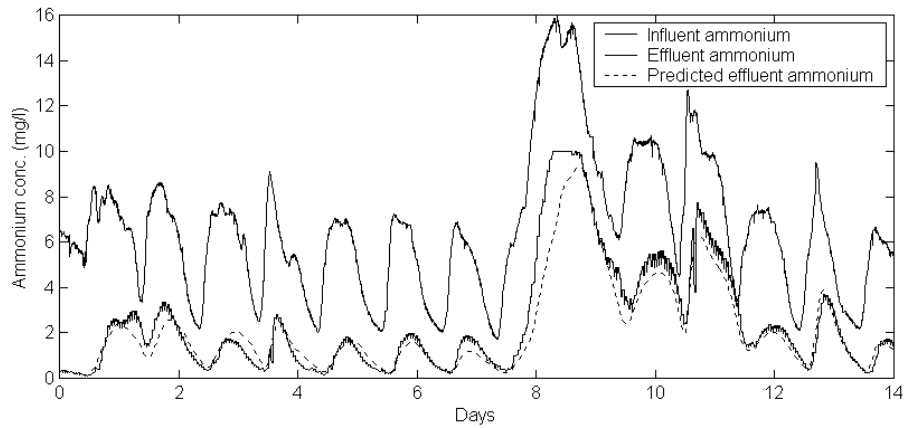

Figure 5.9 Prediction of effluent ammonium concentration (sensor signal B) based on influent ammonium concentration (sensor signal A).

In Figure 5.10, the estimation error is plotted together with the average DO concentration in the aerated zones. A significant part of the variation in the error can be explained by the changing DO concentration. Especially recognisable is the event where the aeration system stopped for twelve hours. However, also minor variations of the DO concentration seem to

affect the error, i.e. the nitrification rate. Other variables, such as the amount of suspended solids and the temperature, also have an impact on the error. These variables could also have been included in the model as they are both measured, which would further improve the behaviour of the model. This type of detection system can also be used to detect toxic events.

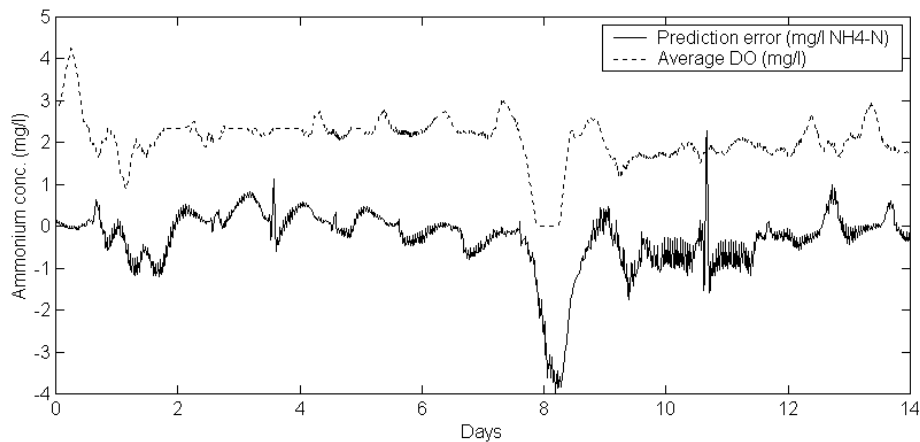

Figure 5.10 Estimation error and average DO concentration.

5.4 Experimenting phase

The experimenting phase is primarily concerned about testing control ideas before implementing them into automated control solutions. This is typically done by doing manual adjustments, e.g. changing setpoints, flow rates, etc. The purpose of this step is to investigate if the assumptions about how the processes will react to various adjustments hold true. The aim is also to get an impression of the controllability of the processes, i.e. how large a change in a given process variables is obtained given a certain change in a given control handle position (i.e. the gain) and how delayed is this reaction (i.e. the time constant). This phase may also help detecting possible interactions between the processes. Yet another reason for this phase is to identify situations where a control different from the (soon to be) normal one is required, for example during special events such as rainstorms, industrial loads or toxicity.

Benefits from online sensors can in fact be obtained at two levels. Firstly, The operation can be improved by static optimisation, where e.g., a constant DO setpoint is changed from 2.5 to 2 mg/l or the internal recirculation is increased. This manual setpoint change may often lead to considerable improvement in operation. Secondly, the operation can be improved by dynamic optimisation, where setpoints are changed automatically and dynamically to improve performance.

The experimental phase can also be used to test controllers before actually implementing them. This can be done by letting the controller suggest the actions, but not actually carrying them out. By looking at the suggested actions, the operator can determine if the controller behaves in a sensible way. The following, two examples of the experimental phase are given from the Källby wastewater treatment plant.

Example 4: Internal recirculation

Figure 5.8 showed that the anoxic zone at the Källby wastewater treatment plant was not fully utilised at all times. Therefore, it was hypothesised that a larger internal recirculation flow rate would lead to an increased removal of total inorganic nitrogen (i.e. nitrate plus ammonium). Hence, in order to improve the utilisation of the anoxic zones the internal recirculation flow rate was increased to its maximum value in one of two parallel identical biological lines. This led to a significant and immediate improvement in the effluent concentration of total inorganic nitrogen in the experimental line of almost 2 mg/l, as shown in Figure 5.11, where the two parallel lines are compared.

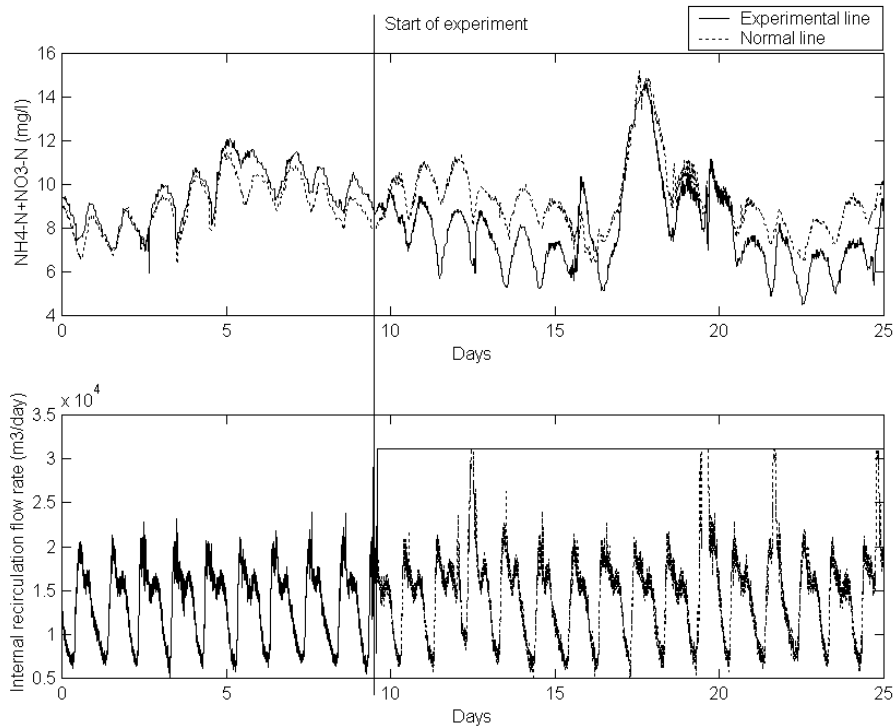

Figure 5.11 Experimenting with the internal recirculation flow rate.

Example 5: Selection of the number of aerated zones

At the Källby wastewater treatment plant, the number of aerated zones can be varied between three and six. Typically, the number of aerated zones is increased during the winter, when the nitrification rate slows down due to the decrease in temperature. The number of zones is increased again in the spring when temperature rises. In Figure 5.12, an example is shown, where an experiment with the number of aerated zones is carried out. Before 21/1, zones 5 to 9 are aerated. However, as the effluent ammonium concentrations are low and stable the operator shuts down zone 5 at 21/1. However, this causes the effluent ammonium concentration to increase more than expected and therefore zone 5 is turned back on on January 24.

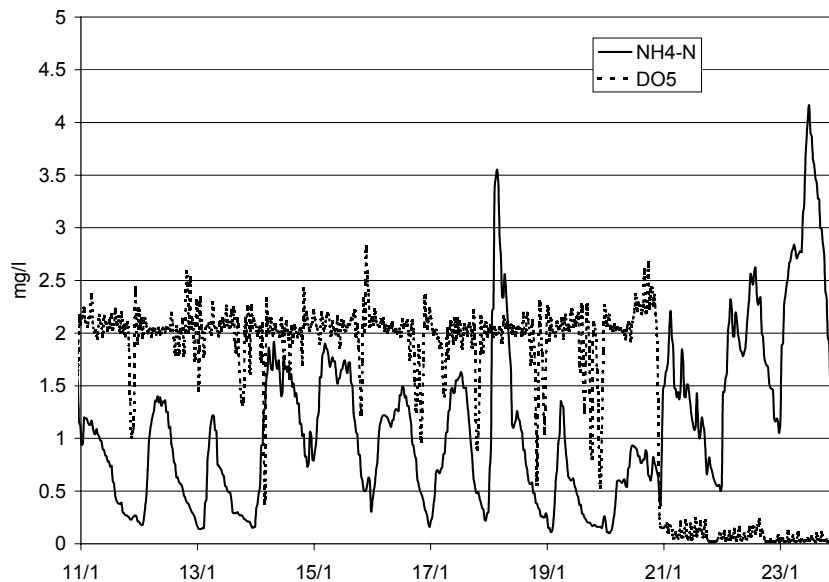

Figure 5.12 Experiments with the number of aerated zones.

5.5 Automatic control phase

The actual implementation of automatic control is the last phase of the implementation process. Several examples of this phase will be given in Part IV in the thesis. In spite of the experimental phase, some experiments still need to be carried out in the beginning of the automatic control phase. This especially involves the tuning of the controllers. Controllers based on nutrient sensors typically have rather long time constants and it may take several days to tune them. It is often wishful to test several controller options. This creates a need for the sensors to be movable and for the programming work to be easy to implement and test.

It is often rather complex to try out new methods of control due to the programming environment. There is a lack of easy-to-use “playground-software” where automatic control procedures can be tested without all the (eventually) necessary safety issues.

Programming can no longer be entrusted completely to external specialists. It is absolutely essential to command this skill in-house – not necessarily in the form of a professional programmer, but simply in the

form of one or more persons who are willing to learn how to deal with the parts of the programming that have to do with process control. The internal programming resource person(s) should focus on how to implement control in the system, i.e. how to access the required sensor data, how to manipulate them in a program and how to send new commands to the actuators. Close co-operation with a professional programmer will often prove invaluable during such projects.

Full-scale issues

Full-scale implementation of automatic control is more complex in nature than modelling and even pilot scale plants. Below, a list of the most important issues as experienced during full-scale experiments at the Källby wastewater treatment plant is provided. The problems are of general nature and apply to many plants.

- (1) **Actuators** may limit the ability for control, i.e. by having a too low maximum or too high minimum capacity. This is a fundamental barrier for more widespread acceptance of new control strategies. Many existing wastewater treatment plants are simply not designed for real-time control. The ability to adjust the control handles in a continuous way, for example, by using variable speed drives, is also of paramount importance to get a smooth and effective control. Often valves are poorly designed for control. One problem may be their non-linear behaviour. Another problem is that their operating range for control is only a fraction of the range of the valve. This makes the control difficult and inaccurate.
- (2) **Low-level controllers** should be well functioning before implementing high-level control. This is of fundamental importance in process control. For example, a proper functioning dissolved oxygen control is a prerequisite for supervisory control of nitrification. Again, the flexibility of the actuators is often overlooked. For example, the compressors have to be able to deliver quite variable airflow rates in order to ensure energy savings. In addition, the airflow valves to the aerators have to be properly controlled. At the Källby wastewater treatment plant, the dissolved oxygen control manages to keep the DO standard deviation below 0.2 mg/l.

- (3) The design of controllers requires a clear **control performance goal** that fits the compliance criteria. For example if compliance is defined as weekly averaged concentrations, it is not necessary to remove normal diurnal variation in the effluent.
- (4) **Quality assurance** of all measurements and actuators is a pre-requisite for correct interpretation of the process behaviour. Many possible errors can occur in the transition from process to sensor to controller and to actuator. Examples are sensor fouling, defective wiring and pumps, etc.
- (5) Be certain that the **measurement is representative** for the process in focus. One example of a wrong location of sensors stems from the Källby wastewater treatment plant, see Figure 5.13. Here the nitrate sensor was located five metres from the inlet to the first aerobic zone. The response of the nitrate signal was not quite as expected. After some time it was realised that the nitrate concentration was strongly correlated with the dissolved oxygen concentration in the first aerobic zone. A portable DO meter was used to check if the effect could be due to dissolved oxygen entering the previous zone opposite the direction of the wastewater stream causing nitrification in the anoxic zone. DO could be detected in an area of approximately 30 m² before the inlet of the aerobic zone in concentrations up to 1.5 mg/l. Therefore, the nitrate sensor was moved further 10 metres upstream, away from the aerobic zone.

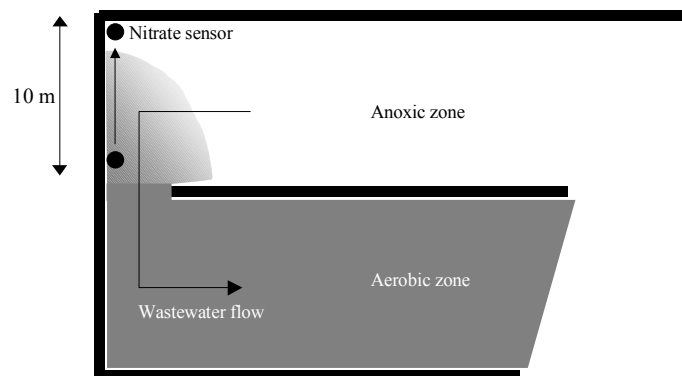

Figure 5.13 Nitrate sensor location should be several metres away from aerobic zone.

- (6) Beware that the behaviour of the processes changes in **several time scales**. The sludge properties that change slowly are particularly important to monitor. One of the important properties is the settling characteristic. The sludge volume index (SVI) and the diluted sludge volume index (DSVI) are good parameters to monitor for this purpose (Jenkins *et al.*, 1993). Changes in the SVI are often related to floc forming properties; in case of troubles with this parameter, microscopic analysis is required to identify the problematic filaments in order to apply the proper remediation. Another important issue about the sludge is its content of nitrifiers, which is primarily affected by the amount of nitrified ammonium, see Ingildsen *et al.*, (2001b). The more ammonium that is nitrified the higher the concentration of nitrifiers; this is naturally also strongly linked to the aerobic sludge age and the temperature.

Evaluation of controllers

After having had the new controllers implemented for a certain period the controllers need to be evaluated. Evaluation of the benefit of control is a rather tricky part of implementing control. There exist at least three different ways to make such evaluations: by means of parallel lines, by means of modelling and by means of consecutive periods.

Generally, the best option is to compare parallel and identical lines as suggested in the example of testing the influence of the internal recirculation flow rate on p. 104. Such comparisons require that the lines are truly parallel all through the part that is being investigated. For example, if the effect on the sludge is investigated, it makes little sense if the sedimentation unit is used for both of the two lines, which are being compared. It is also important that the lines are truly identical. This is usually not a problem regarding the construction of the lines, but rather to make sure that the lines receive the same influent flow rate (also during high flow rate situations) and composition. Such experiments also require that the measurement equipment of the evaluated parameters have a similar calibration. For example if airflow rate to the two lines are investigated, it is important that the airflow rates in both lines measure correctly. The same is the case for effluent concentrations.

Another method of evaluation is by means of simulation. A recent example of this approach is presented in Krause *et al.* (2002). The whole wastewater treatment plant is simulated where both the original control

strategy and the new control strategy are simulated by using actual data from the plant. The two strategies can then be compared regarding almost any chosen parameter. This method is rather difficult to apply especially due to the difficulties in calibrating the model to get a reasonable correspondence between model and reality. It is often so that different sets of parameters can yield the same outputs in the key variables (Jeppsson, 1996). To make a “perfect” calibration a large amount of tests need to be carried out and many parameters need to be measured with a high time resolution. This may often be too costly and complicated. Hence, a simplified model is often used or standard parameters are assumed and hence the result is not quite as exact. The model simulations can give an indication of the approximate range of the savings. The models can be used for prediction as well as evaluation.

An often-used method is to compare two consecutive periods, one where the control concept is applied and one where it is not. That means that after having the automatic control on for some time the performance is compared to the performance of an earlier period. In many cases, this may be the only choice for evaluation. However, it is important to be aware of the great uncertainties this involves. The uncertainties are due to different conditions during the two periods. These include factors such as: water temperature, hydraulic pattern (e.g. number and magnitude of rain storms), influent composition, sludge age and sludge composition as well as other special conditions arising during the two periods. Even when comparing two consecutive years of data the data are influenced by many different circumstances that make the comparison uncertain.

5.6 Conclusions

A process consisting of four phases are suggested for the implementation of new control concepts in full-scale wastewater treatment plants. The process involves 1) an initial analysis phase, 2) a monitoring phase, 3) an experimental phase and 4) an automatic control phase. The general issues to be aware of in the different steps together with practical experiences are reported as inspiration and guideline to similar projects. The process is believed to be effective in the sense that various aspects of the control are considered before the actual implementation takes place, thus ensuring a high probability of success in the actual implementation. The pace of the process also makes it possible for a whole team to stay “in the loop” and to be involved throughout the process.

Part III Control System Design Aspects

Chapter 6 Control Goal Translation

*"Would you tell me, please, which way I ought to go from here?"
"That depends a good deal on where you want to get to," said the Cat.
"I don't much care where—" said Alice.
"Then it doesn't matter which way you go," said the Cat.
Alice in Wonderland, Lewis Carroll*

In order to apply the appropriate type and amount of control it is of paramount importance to understand the nature of the goal of the operations. Or if paraphrasing Lewis Carrol's words: "If the goal of the operation is not well understood, it doesn't matter which type of control you apply". The goal of wastewater treatment plant operation is not crisp clear per se, but rather multidimensional and open to interpretations. In this chapter, it is sought to "translate" the legislative requirements as well as economical aspects into specific control goals that can be used as basis for the identification of a suitable control structure and suitable controllers.

6.1 Goal formulation

Fundamentally the concept of control is about adjusting dynamic systems either in order to: 1) identify a best route from A to B or 2) maintain a system at a specific point in spite of disturbances (Olsson and Piani, 1992). The goal of wastewater treatment is mainly of the latter type. Therefore, the understanding of the type of disturbances that the system is subjected to holds a central position in operational goal formulation. Goals for WWTP operation can be defined in different ways. The most important aspects of goal formulation in wastewater treatment are: to in spite of 1) disturbances clean the water to 2) comply to legislative criteria with some considerations to 3) cost.

As discussed by Weijers (2000), a simple goal as “Maximise treatment efficiency against minimal cost” is not sufficiently explicit. It even seems to be a self-contradiction as a higher quality (treatment efficiency) generally comes with an increased cost. Thus, it is rather a matter of determining the trade-off between quality and cost. Two control strategies can (at least in principle) be compared objectively by comparing cost at equivalent quality or quality at equivalent cost. Difficulties appear, when comparing intermediate solutions where neither cost nor quality is kept constant. In order to solve this dilemma it has often been suggested to define a specific mathematical multi-criterion encompassing parts of or all of the operation at wastewater treatment plants (see e.g. Weijers, 2000 and Vanrolleghem *et al.*, 1998).

Such a multi-criterion is typically formulated as a linear or quadratic sum of variables pertaining to cost and quality possibly under one or more constraints. The primary advantage of the formulation of such a criterion is that it enables a search for combinations of control inputs that will yield “optimal” performance. Explicit solutions exist for some goal formulations such as the Linear Quadratic Gaussian Control method (Åström and Wittenmark, 1997). Most types of goal formulations, however, require an iterative search method.

The point of view in this thesis is that even though such an explicit mathematical multi-criterion is in theory appealing, it is not feasible from a practical point of view in wastewater treatment plant operation. The huge work that is demanded to define optimality and then optimise a wastewater treatment plant towards such a goal is not warranted by the possible economical benefit of doing so. Additionally, the uncertainty in measurements makes it difficult to verify small improvements.

Therefore, rather than using a complex (but perhaps precise) mathematical multi-criterion, simple pragmatic solutions are sought. The solutions should enable the plant operator to ensure compliance to effluent criteria at low or minimum cost.

However, the special characteristics of wastewater treatment make it difficult to guarantee compliance in all situations. The largest disturbances are the influent wastewater characteristics, which are generally not controllable. The situation is similar to that of sewer systems. In this field, the traditional design methods are based on hydrographs, and return periods of strong rain events are used, see e.g. Andersen *et al.* (1984). Such standard risk methods do not exist (at least to the authors knowledge) for design and

control of wastewater treatment plants.² Instead, it is suggested that it should be possible to hedge against the risk of not complying.

Hedging means: “reduce one's risk of loss on (a bet or speculation) by compensating transactions on the other side.” (The Concise Oxford Dictionary, 1993).

Several examples of hedging are applied in operation and design of wastewater treatment plants today. One example is the over-dimensioning of reactor volumes in order to hedge against large disturbances and future developments in the catchment area. In operations, many wastewater treatment plants apply a constant DO setpoint that is too high most of the time in order to hedge against incidents of high influent nitrogen loads. The DO setpoint is set higher than necessary in order to reduce the risk of not being in compliance during the next compliance inspection.

The level of hedging is chosen at each individual wastewater treatment plant depending on the variability of the influent characteristics and the cost of hedging. Hedging can also be reduced by improving control. For this to be attractive the cost of control (i.e. sensors, maintenance, implementation, etc.) should be less than the reduction in the cost of hedging.

6.2 Disturbances

Wastewater treatment plants are subjected to a multitude of external disturbances that are generally not controllable. In order to discuss these disturbances in a systematic way, it makes sense to divide the disturbances into three main types:

1. Seasonal variations in load and flow, water temperature, nitrification rate, etc;
2. Diurnal variations in concentrations of pollutants and flow;
3. Event disturbances, such as rain events, toxic events and peak loads.

On top of external disturbances come internal disturbances that are generated at the plant or in conjunction with the operation of the sewer systems. Examples of internal disturbances are: breakdown of essential equipment, (e.g. aeration equipment), the recycling of high loads of nitrogen

² An initial experiment systematically dealing with uncertainty due to disturbances is, however, reported in Bixio *et al.* (2001) where a probabilistic Monte Carlo engine is coupled to a wastewater treatment plant model.

from the sludge filter press and sudden high rates of pumping like large pumping stations in the sewer system or backwash of filters that can send hydraulic shocks through the whole system and thus impair operation.

Due to this variety of disturbances, the choice of a stationary control strategy (i.e. constant DO setpoint, sludge age, etc.) is a question of risk minimisation. The control strategy is often chosen to be more conservative than necessary to reduce risk of violation of permits during e.g. high load situations.

The safety margin applied with stationary control strategies can be reduced with automatic process control. This reduction in safety margin is the main reason for the savings that can be achieved with automatic process control. Secondary savings can be reached by fine-tuning of the sludge age, volume distribution, etc. An important example of this is aeration. If aeration is not controlled but kept at a constant level, the aeration rate should be large enough to ensure a reasonable DO setpoint during the highest load of the day. However, as oxygen demand varies over the day the application of DO control gives a saving during the period of the day where the load is low. The primary savings pertain to reduction of the safety margin. Secondary savings can be reached by ensuring an even DO profile over the volume, choosing the best sludge age, aerating the best number of zones, etc.

Safety margins are applied to withstand disturbances. Controllers for wastewater treatment plant operation can be divided into three classes depending on the type of disturbance they are designed to reject:

Class I

Class I controllers reject seasonal variations. Most plants perform this control work manually by adjusting sludge age, amount of aerated volumes, DO setpoint, etc. at a low frequency ranging from a couple of times a year to a couple of times a month depending on sophistication. The changes are based on 1) operator knowledge such as: “when temperature drops sludge age should be increased” and 2) effluent samples that e.g. show a need for an increase or decrease in dosage of chemicals or DO setpoint. The basis for this control can typically come from 24-hour samples taken once a week. Such information is generally not sufficiently frequent to detect fast variations. The noise (in the form of variance) on the signal means that only when a couple of samples have shown the same tendency the operation will be changed (especially when the removal degree is more than sufficient).

This mode of optimisation causes a large time-delay in the system. Online input to a class I controller will improve performance compared to the above. To be able to reject seasonal disturbances the online information need not to be more frequent than once an hour and a delay in the signal of several hours or so is generally not a problem. This means that analysers located in the effluent from the secondary settler are sufficient for the purpose, in spite of the delay caused by the settlers.

Class II

Class II controllers reject seasonal as well as diurnal variations. In many cases, it is not possible to fully reject diurnal variations as the incoming disturbances show a larger range of variation than the actuators can handle. However, disturbance reduction is normally possible. For example, by varying the DO setpoint it is possible to reduce the variation in effluent ammonium concentration. Class II controllers require measurement signals that are not significantly delayed compared to the rate of change taking place in the reactors.

Class III

Class III controllers handle event disturbances. Event disturbances are so large that normal controller actions, such as DO setpoint controllers do not suffice to handle the disturbances satisfactorily. Instead, an abrupt change in operational set-up (such as using new actuators) is required. Several options for such changes in operation exist. Some examples of controllers for this purpose are: Aeration Tank Settling (ATS) where the aeration reactor is used for sedimentation (Nielsen *et al.*, 1996). In Yuan *et al.* (1998; 2000), it is suggested to store a spare nitrification capacity by temporary storage of excess sludge. Dauphin *et al.* (1998) describes a way to control rain basins. Class III controllers are characterised by the need for early detection and the controller action typically consist of major changes in operation. In Rosen *et al.* (2001), a framework for detection and reaction to such extreme events is proposed. Class III controllers rely on fast measurements and may require feedforward action. For this purpose, upstream measurement is valuable. An overview of the three classes is shown in Table 6.1.

The primary aim of the discussion here concerns controllers of class I and II. Class II controllers will also, to the extent that normal operation conditions allow, reduce the effect of event disturbances.

Several controller options exist in each class ranging from simple PID and on/off controllers to advanced controllers such as model based controllers, fuzzy controllers, detection methods based on chemometric methods, grey box models, etc. A more advanced type of controller may be chosen if simple controllers do not suffice or if it provides important benefits such as larger energy savings, increased robustness or easier tuning. However, the application of advanced non-standard solutions requires more work and higher educational level at the plant. Again, cost of the additional effort needs to show a reasonable payback period.

Table 6.1 Classification of controllers.

	Class I	Class II	Class III
Rejected disturbance	Seasonal	Diurnal and seasonal	Event disturbances
Controller reaction time	Slow reaction (days/weeks)	Medium reaction (hours/minutes)	Fast reaction (before the disturbance reaches the plant)
Required measurement	Online effluent or frequent 24-hour samples (slow sampling sufficient)	Online measurement in process (fast sampling necessary)	Online upstream from the plant (options include industrial outlets and rain gauges)

6.3 Effluent quality criteria

The class of controller that is needed in wastewater treatment plant operation largely depends on the effluent water quality criteria applied to the plant. In the following, different types of effluent criteria will be discussed. The basis for this discussion is the difference in legislation within the European Union. A good overview of the legislation in the EU is easily available from a comprehensive study of the different types of standards in the EU countries carried out by the European Water Pollution Control Association (EWPC) Task Group within Effluent Standards (Jacobsen and

Warn, 1999). It is assumed that legislation within the wastewater area in countries outside the EU show similar characteristics as one or more of the member countries.

In the EU the effluent quality criteria are becoming increasingly homogenised in terms of same effluent criteria for total nitrogen, total phosphorous, BOD, suspended solids, etc. However, national differences between how these limits are applied create large differences in how the actual implementation of the limits is done.

One conclusion from the EWPC study was that: *"The elements in a compliance assessment include sampling, analyses, assessment methods and further conditions specified in the permit. All these elements have an influence on the resulting judgement of a given effluent. Different methods for all these elements are practised within the European countries, therefore direct comparisons of the effluent standards expressed in mg/l will be misleading."*

Three major differences between the ways the criteria are enforced in the different member countries have important impacts on how the criteria translate into control goals.

These main differences are:

1) *Time frame of sampling method*

Three different sampling methods exist: 1) grab samples (or 2-hour samples), 2) 24-hour time (-T) or flow proportional (-F) samples and 3) seven day flow proportional samples.

2) *Whether data for extreme events are excluded*

Several countries apply data exclusion in case of extreme events such as heavy rain and other unusual situations.

3) *Compliance assessment method*

Six different methods of compliance assessment exist:

I: Each sample shall comply;

II: A certain percentage of the samples shall comply;

III: Variable number of the samples shall comply;

IV: The arithmetic average shall comply;

V: The arithmetic average modified by a weighted standard deviation shall comply;

VI: The average percentage of reduction of overall load entering the wastewater treatment plants in a sensitive area shall comply.

The conditions in each of 16 countries are summarised in Table 6.2.

Table 6.2 Conditions for compliance evaluation (Jacobsen and Warn, 1999).

Country	Sample method	Data exclusion	Compliance assessment method	Samplings per year
EU-direct.	24h-T or 24h-F or 7d-F	√	IV	4-12
Austria	Grab or 24h-F		IV	12-260
Switzerland	Grab or 24h-F	√	?	52-162
Germany	Grab		I(+100%), II(80%)	4-12
Denmark	24h-F		V	12-24
Spain	24h-T or 24h-F or 7d-F	√	IV	4-12
Estonia	24h-F or 24h-T	√	I	4-52
France	24h-F	√	IV	12-52
Finland	24h-F		I(+33-100%), IV	12
Italy	Grab		I	12-52
Norway	24h-F		I(+100%), IV	12-60
Netherlands	24h-F or 24h-T		IV or VI	4-12
Portugal	24h-T or 24h-F or 7d-F	√	IV	4-12
Russia	24h-T		IV	?
Sweden	24h-F (N) or 24h-T (P)		IV	12-52
Slovakia	24h-T	√	I	12-52
UK	Grab		IV	4-52

From a control perspective, the time frame of compliance and whether data exclusion is acceptable are of major importance. These two issues determine the class of controller that needs to be applied according to Table 6.1.

For example, using the effluent ammonium concentration criterion as an example of the translation of effluent criteria into control objectives, it is well known that variation in effluent pollution concentration in most municipal wastewater treatment plants follows a diurnal as well as an annual pattern determined by the influent variation in nitrogen load. Therefore, when determining how to control the various control handles it makes sense dividing the effluent criteria into three different types:

- 1) Short time frame of sampling (considerably shorter than one day, e.g. grab samples);
- 2) Medium time frame of sampling (around one day e.g. 24-hour samples combined with compliance assessment I).

- 3) Long time frame of sampling (considerably larger than one day, e.g. compliance assessment method IV or V).

Examples exist of all three types, 1) in Germany two hour samples define compliance, 2) in Estonia compliance is tested in 24-hour samples and 3) long time frames are used in, for example, Sweden where compliance for some parameters are defined as annual averages.

The two extremes: annual averages and peak concentrations witness quite different ways of perceiving the effect of effluent wastewater on the recipient. As stated in Jacobsen and Warn (1999) “*For local conditions evidently pollution problems with a short response time such as oxygen depletion, hygienic and aesthetic pollution, should be regulated by criteria for extreme values, whereas problems with a long response time such as eutrophication and bio-accumulation, should be regulated by criteria for average values, for example on an annual basis.*” Jacobsen and Warn (1999) also suggest a common criterion based on, for example, 95% percentiles for short response time effects and 50% percentiles for long response time effects.

If the criterion is defined as a maximum value over a short time period, (i.e. as in German, Austrian, Swiss, Italian and British legislation where grab samples are used) energy savings can be achieved by variance reduction. A lower variance means that the average concentration can be closer to the maximum limit, which leads to a reduction in hedging, see schematic in Figure 6.1. In the case of nitrogen, this leads to a lower consumption of energy for aeration and external carbon (if applied). This corresponds to a class II or even a class III controller depending on whether data exclusion is allowed.

Special considerations have to be paid in wastewater treatment plants that receive high peak loads, for example, from industry and where maximum value criteria apply. In some cases, the handling of extreme events determines if one controller is better than another. This is, for example, the case in Krause *et al.* (2002), where four extreme events in a data set of 17 days defines which of several aeration control strategies is the better. This may imply the need for a class III controller.

If the criterion is defined over long time frames, such as a monthly or an annual basis, the need for variance reduction over the day is less important. Instead, a controller should adjust the system to varying conditions, so that the effluent concentration on an average over the required time frame keeps

below the required value. Wastewater treatment plants with medium time frames have a need that lies between the two extreme situations.

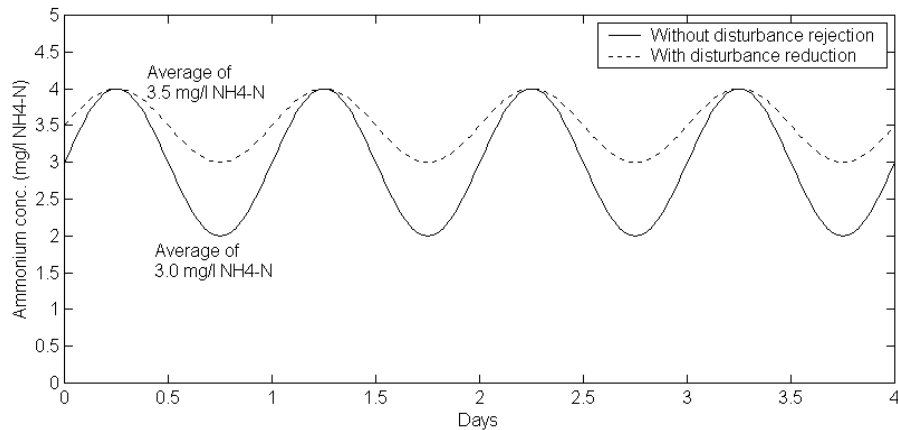

Figure 6.1 When criteria is defined as maximum limits reduced variance means savings.

Cost considerations

It is important to consider the relative cost of the control handles in the biological part before choosing which handle to focus on. In a report (Müller, 1999) prepared for the Ministerium für Umwelt, Raumordnung und Landwirtschaft des Landes Nordrhein-Westphalen (Ministry of Environment in Nordrhein-Westphalen), average energy costs of different parts of a wastewater treatment plant is reported. A model plant of 100.000 personal equivalents is proposed that resembles an average plant. The energy consumption in the biological part is divided as shown in Table 6.3. The table shows that it is far more beneficial to find savings by lowering the energy consumption for aeration than for anything else. Reducing internal recirculation flow rate will hardly lead to significant savings. Therefore, the attention naturally focuses on the control of aeration, which is also the subject on which most controller proposals are given, according to Nielsen (2001). The distribution between types of reported control in the literature is as shown in Table 6.4.

In general, it is cheaper to have a larger part of the total-N in the form of ammonium, as the reduction of ammonium to nitrate is costly in terms of

energy for aeration. However, a strategy with high effluent ammonium content reduces the robustness of the system because such a strategy results in a smaller amount of nitrifiers as will be discussed in Section 6.4 (see also Ingildsen *et al.* (2002a)). An explicit criterion for effluent ammonium reduces the flexibility to decide how large a part of the total N in the effluent should be in the form of ammonium and nitrate, respectively.

Table 6.3 Relative energy consumption of various handles in a model pre-denitrification plant of 100.000 PE (Müller *et al.*, 1999, p. 55).

	Total energy consumption	Consumption per m ³ of wastewater	Percentage of total biological treatment
Aeration	3.760 kWh/d	135.5 Wh/m ³	83%
Mixing	480 kWh/d	19.6 Wh/m ³	10%
Internal rec.	140 kWh/d	5.7 Wh/m ³	3%
Sludge return	170 kWh/d	6.9 Wh/m ³	4%
Total biological treatment	4.550 kWh/d	186 Wh/m ³	100%

Table 6.4 Controllers reported in literature (Nielsen, 2001).

What is controlled	Reports in literature
Aeration	51%
Flow	14%
Recirculation	11%
Excess sludge	11%
Return sludge	8%
Carbon source	3%
Chemical precipitation	3%

Green taxes, as applied in Denmark, Belgium and some of the Bundesländer in Germany, change the optimality definition by giving an incentive to decrease effluent concentrations below the legal effluent limits. With this type of criteria, the definition of optimality to a higher extent resembles standard control engineering definitions of optimality criteria as a multi-criteria cost function. However, as the taxes applied on the effluent quality are constant over a long time interval (years) this probably does not

have to be considered dynamically, rather, it is possible to determine an “internal” effluent concentration aim that is considered to be the most economically viable weighing cost of operation against cost of taxes. This internal aim does not have to be as strictly complied with as the official legal criteria. However, it can be compared to a legal aim that is defined based on a long time frame, e.g. several months.

6.4 Balancing effluent quality, economy and robustness

Robustness of the nitrogen removal process primarily depends on the available amount of nitrifiers. This amount cannot be changed rapidly; therefore, the operational strategy should be chosen to ensure a proper amount of nitrifiers in the system in order to be prepared for disturbances.

An operational space map is an efficient tool to compare a large number of operational strategies to find an optimal choice of setpoints based on a certain criterion. Typically, such a multi-criterion includes a weighted sum of cost of operation and effluent quality (total nitrogen concentration). Due to the relative high cost of aeration, a search for the “optimal” solution result in a relatively high fraction of the effluent total nitrogen in the form of ammonium. However, such a strategy may introduce a risk into operation because a low degree of ammonium removal leads to a low amount of nitrifiers. This in turn leads to a reduced ability to reject event disturbances, such as large variations in the ammonium load, drop in temperature, the presence of toxic/inhibitory compounds in the influent, etc.

A control structure applied to the benchmark plant (described in Section 2.3) has been studied. The structure involves two control handles that are effective on the medium time scale: namely the internal recirculation flow rate and the aeration. The aeration is controlled in such a fashion that a constant dissolved oxygen (DO) concentration is maintained in all three aerobic reactors. The internal recirculation flow rate is controlled to keep the nitrate concentration in the last anoxic reactor at a constant but nonzero level, as suggested by Londong (1992). This strategy has been devised to ensure full utilisation of the denitrification volumes, which is seen to be the most important aspect of internal recirculation control (Yuan *et al.*, 2001). Both controller loops are implemented with PI algorithms. In order to limit the recirculation of dissolved oxygen to the anoxic reactors, the DO setpoint in the last aerobic reactor is kept at 1.0 mg/l in all simulations. This is done in order to minimise the effect of varying influence of recirculated dissolved oxygen to the anoxic part in the simulations. The sludge wastage flow rate is

kept constant in all simulations at 385 m³/day and the sludge recirculation flow rate is kept constant equal to the average dry weather influent flow rate.

Eighty-four combinations of DO and nitrate setpoints, ranging from 0.5 to 3.5 mg/l DO and 0.5 to 4 mg/l NO₃-N, respectively, were tested by means of simulating the benchmark model with the two control loops in place. Each simulation was carried out for 84 days by repeatedly using the two weeks dry weather influent data defined in the benchmark system. The simulation data over the last 14 days were used to evaluate the effluent quality and the corresponding operational cost. The effluent quality was evaluated in terms of total nitrogen discharged. The cost was evaluated based on the average K_{La} over the 14 days and the average internal recirculation flow rate.

The use of stationary simulations (with time-varying data) rather than steady state ones has been chosen to enable evaluation of the ability of the controllers to deal with normal daily disturbances. The later discussion of disturbances is therefore not about the normal daily disturbances in terms of variable load but rather about event disturbances, such as large variation in the influent flow rate and composition, the presence of toxic/inhibitory compounds in the influent or variation in temperature.

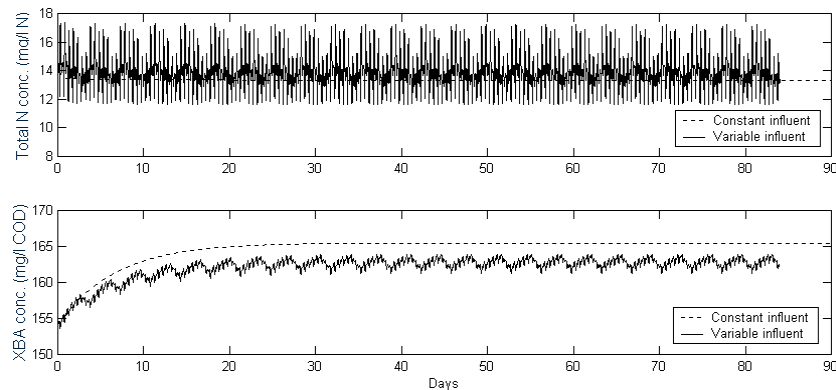

Figure 6.2. Difference between steady state simulation (constant influent) and stationary simulation (variable influent).

Figure 6.2 illustrates the difference between stationary and steady state solutions. The system operated in the same manner causes slightly higher

effluent total nitrogen in the stationary than in the steady state situation. It can also be seen that 84 days of simulation is sufficient to remove the effect of the initial guess of the various variables in the system as the amount of nitrifiers stabilises after approximately 30 days.

Finally, the performance of the wastewater treatment plant during event disturbances was studied for a few different DO setpoints with the aim to study the impact of DO setpoint on the ability of the system to reject significant disturbances. The studied disturbances consist of a three-day period with low influent temperature as well as a 50% ammonium load disturbance.

The eighty-four stationary simulation studies enabled the construction of operational space diagrams, which show how the choice of DO and nitrate setpoints influences the effluent quality and the operational cost (Figure 6.3 to Figure 6.8).

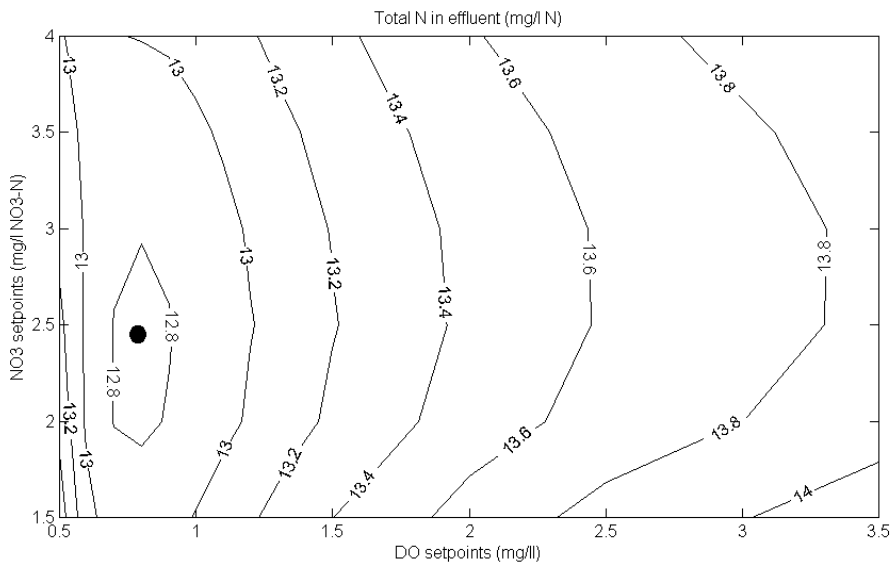

Figure 6.3. Operational space diagram for the two controllers. The dot indicates the simulation with the lowest concentration of total nitrogen in the effluent.

The operational space diagram in Figure 6.3 illustrates how the effluent total nitrogen varies as a function of the choice of DO and nitrate setpoints. A clear optimum can be found at a DO setpoint of 0.8 mg/l DO and a nitrate

setpoint of 2.5 mg/l $\text{NO}_3\text{-N}$. The application of low DO setpoints results in non-negligible discharge of ammonium nitrogen (see Figure 6.4). However, the low DO setpoint enabled simultaneous nitrification and denitrification in the aerobic reactors, leading to lower total nitrogen concentration in the effluent.

The diagram in Figure 6.3 indicates a relatively weak interaction between the control of aeration and that of internal recirculation. In practice, this means that the optimal operating point can be found by testing different DO and nitrate setpoints quite independently. Figure 6.3 also gives an indication of the sensitivity of not applying the optimal setpoints. The sensitivity is small regarding the choice of the nitrate setpoint in the explored area, but high when choosing a lower DO setpoint and medium when choosing a higher DO setpoint.

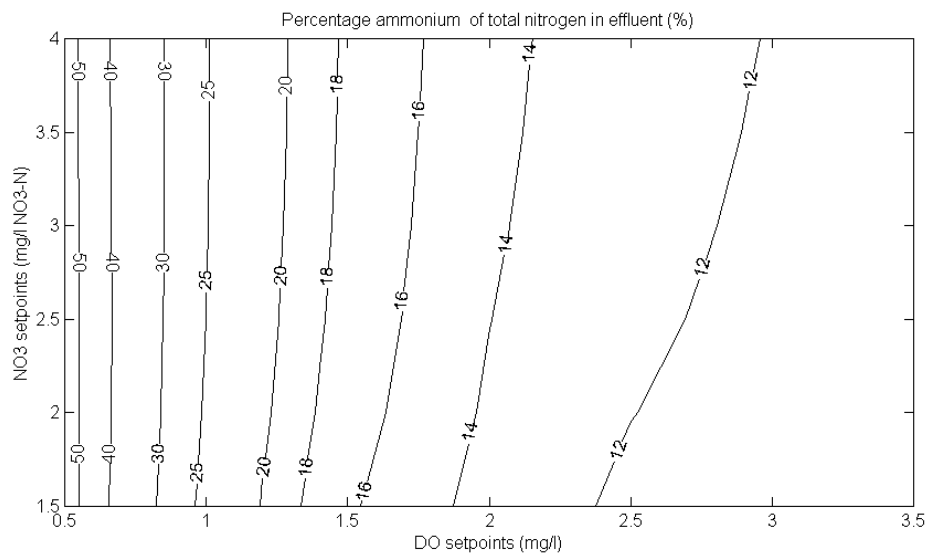

Figure 6.4. Percentage of effluent total N in the form of $\text{NH}_4\text{-N}$ as a function of the two setpoints.

Figure 6.5 shows that the cost of aeration depends solely on the choice of DO setpoint, the higher DO setpoint the higher cost of aeration. Cost of recirculation is relatively low compared to the cost of aeration, as the lifting height for the internal nitrate recirculation is low. It is, however, interesting

to see that the amount of pumping depends on both the nitrate and the DO setpoint. Obviously, the higher the nitrate setpoint the more pumping is needed. However, the choice of DO setpoint influences the amount of pumping even more. The reason is that the higher the DO setpoint the more nitrate will be produced in the aerobic part of the system. Thus, a high nitrate concentration at the end of the aerobic part follows with a high DO setpoint, which results in a lower need for pumping to maintain a certain nitrate setpoint at the end of the anoxic reactors.

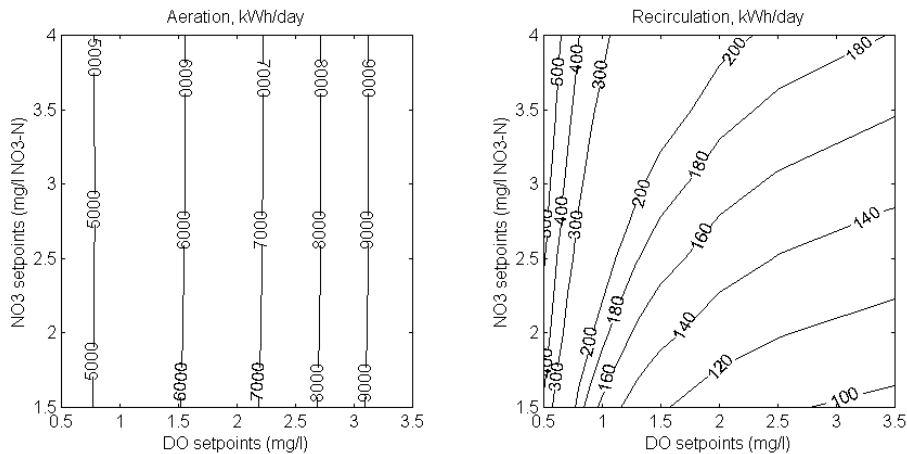

Figure 6.5. Aeration energy and recirculation energy as a function of the two setpoints.

Figure 6.6 depicts the effects of various trade-offs between cost and quality. This has been investigated by applying various weighting constants on respectively the average effluent total nitrogen concentration and the energy consumption (due to aeration and recirculation) i.e., a multi-criterion including cost and quality. The higher the weight of quality the more important is the quality regarded in comparison to the operation costs. Clearly, the more the weight is put upon quality the more the shape of the contour plot resembles the effluent total nitrogen operational space (Figure 6.3) and the more weight that is put upon cost the more it resembles the cost of aeration (Figure 6.5, left). The more weight that is put on operational cost the lower is the optimal DO setpoint, because lower DO enables savings in aeration cost.

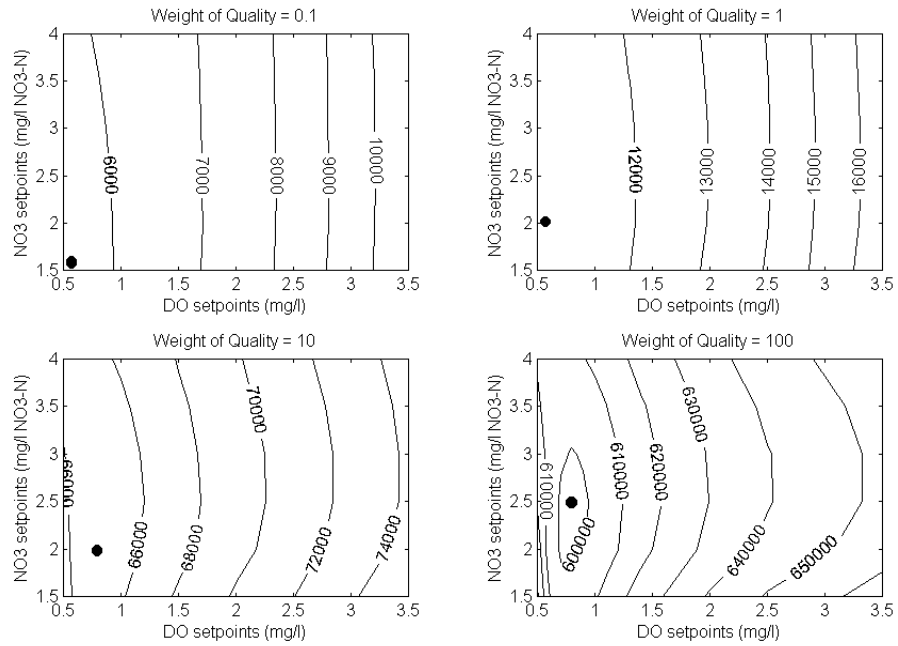

Figure 6.6. Effect of including cost and effluent quality into the criterion describing optimality. The dot indicates the simulation with the best value.

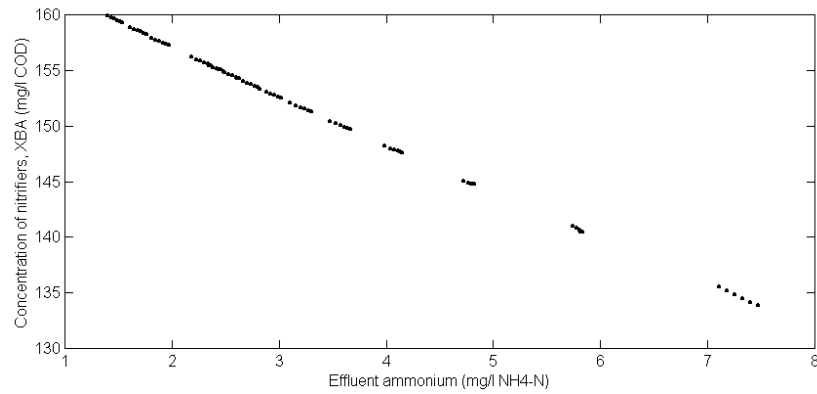

Figure 6.7. Concentration of nitrifiers is a linear function of the effluent ammonium concentration.

At a certain sludge age, it is possible to affect the amount of nitrifiers by the DO setpoint. In the above case, the amount of nitrifiers in the system is 15% less when the system is operated at a DO setpoint of 0.5 mg/l than when operated at 3.5 mg/l. This is because a significant amount of ammonium nitrogen is discharged without being oxidised when the system works at a low DO. This causes a limited production of nitrifiers; in fact the amount of nitrifiers depends almost linearly on the amount of removed ammonium, see Figure 6.7. The amount of nitrifiers as a function of the choice of setpoints can be seen in Figure 6.8.

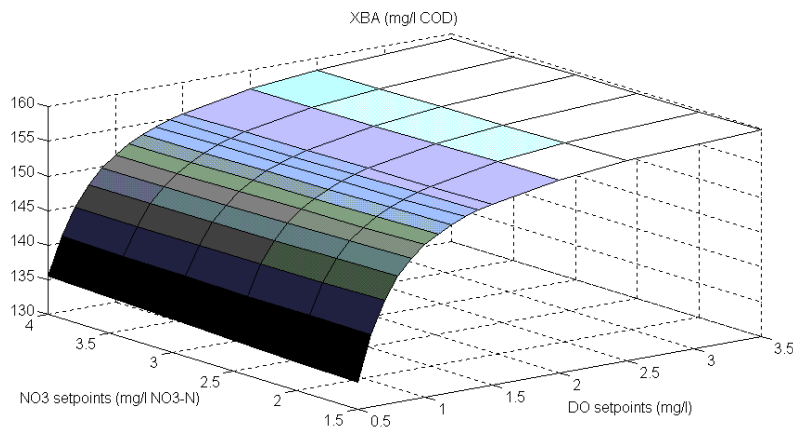

Figure 6.8. Amount of nitrifiers (XBA) as a function of the chosen setpoints.

Disturbance rejection has been investigated by applying a number of disturbances to the benchmarking plant. The responses of the system, when operating at three different DO setpoints (0.5, 1.0 and 2.0 mg/l, respectively), to a sudden drop in mixed liquor temperature, are simulated and shown in Figure 6.9. In the simulations, the temperature was lowered from 15 to 10 °C during three days (71 to 73), which was simulated as a drop in the maximum specific growth rates of heterotrophs and autotrophs from 4 and 0.5 day⁻¹ to 3 and 0.3 day⁻¹, respectively. The best rejection of the disturbance is obtained when the system works at a DO setpoint of 2 mg/l, whilst the worst rejection ability is observed in the case with a DO setpoint of 0.5 mg/l. The average effluent tot-N during days 71 to 73 can be

used as an indicator of the ability to reject disturbances, the concentrations are: 17.3, 18.1 and 21.3 mg/l for the strategies involving DO setpoints of 2, 1 and 0.5 mg/l. As explained above and verified by simulation data, this is caused by the fact that, in the case of a high DO setpoint, the system contains more nitrifiers than in the case with lower DO setpoint. The biomass grows exponentially when the substrate concentration is not the limiting factor, which is the case during the nitrification upset. Thus, the small difference in the initial amount of nitrifiers causes a large difference in the performance of the system. This increased ability to take care of disturbances is the key message of the hedging point strategy.

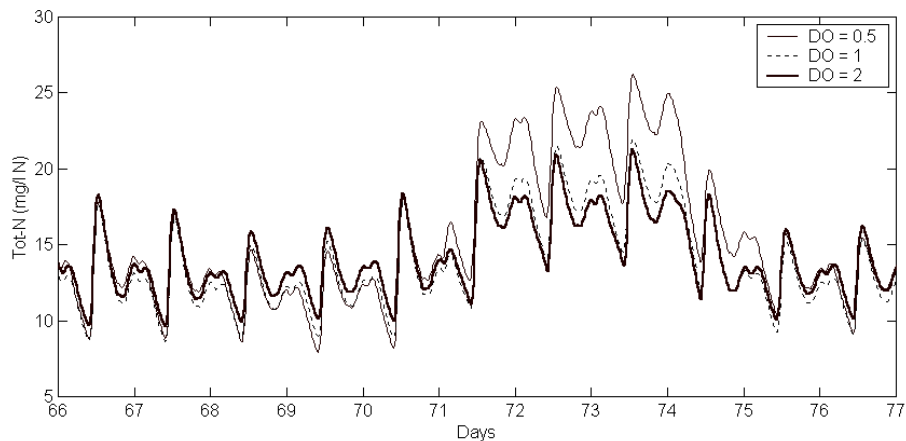

Figure 6.9. Disturbance rejection diminished for lower DO setpoint.

If the event could have been predicted and thus reacted upon, e.g. by increasing the DO setpoint to 2 mg/l from day 71 and forth, the disturbance rejection by the strategies with lower DO setpoints would be improved. However, the strategy with the highest stationary DO setpoint is still the best during the disturbance. The average effluent total nitrogen concentrations and ammonium concentrations (in parenthesis) from day 71 to 73 are in this case: 17.3 (12.4) mg/l N, 17.6 (13.0) mg/l N and 18.8 (15.0) mg/l N for the strategies with DO setpoints of 2, 1 and 0.5 mg/l. Clearly in spite of the application of the same setpoints during the disturbance in each of the three cases the strategy with the highest initial amount of nitrifiers

(i.e. the highest stationary choice of DO setpoint) demonstrated the best disturbance rejection.

A load disturbance where the influent ammonium concentration is increased from day 71 to day 73 by 50% has also been tested (not shown). The effluent ammonium during the disturbance period increased by respectively 220%, 260% and 280% for DO setpoints of respectively 2 mg/l, 1 mg/l and 0.5 mg/l. Again a reduced disturbance rejection ability is indicated at lower DO setpoints. Effluent total nitrogen was almost the same in the three cases, showing that the nitrification process is almost the only affected process.

The cost versus quality analyses simulation studies advocate a low DO setpoint, which favours nitrate removal over ammonium removal. This should be used with care. The amount of nitrifiers present in the system is primarily determined by the amount of ammonium oxidized, while the amount of heterotrophs is almost independent of the amount of nitrate removed. Compromising ammonium removal for nitrate removal through applying a low DO may be detrimental to the total nitrogen removal during nitrification upset and may therefore result in violation of the effluent requirement due to reduced disturbance rejection ability.

Choosing the operating point of a BNR plant based on an optimality criterion limited to effluent quality and operating cost during stationary conditions is not sufficient to ensure a consistent performance of the system. The occurrence of disturbance events is an inherent characteristic of wastewater systems, which leads to temporary deterioration of the effluent water quality. The severity of these deteriorations is determined by how well the system is prepared to counteract the disturbances. It is possible to hedge the system against disturbances by ensuring a safety margin of nitrifiers in the system. Given a certain sludge age, hedging can be introduced by choosing a DO setpoint that is higher than that of the stationary optimal operating point. In practice, the hedging can be carried out systematically by defining an “internal” ammonium effluent concentration. That means, when defining an optimality criterion, balance between cost and quality as well as disturbance rejection ability should be established.

6.5 Conclusions

Having a clear understanding of the goal that is to be achieved during daily operation is of paramount importance when developing and

implementing a control structure. In this chapter, issues regarding the formulation of goals in WWTPs are discussed. It has been established that the formulation of the effluent criteria are important for the choice of controllers and control structure. Especially, the time frame of the criteria is important, i.e., whether compliance should be obtained for grab samples or for annual averages. Disturbances to the plant can be divided into three classes: seasonal variations, diurnal variations and event disturbances. The class of disturbance that the controller should be designed to reject is determined by the time frame applied in the effluent criteria. When discussing biological nitrogen removal an important choice is the distribution of the total nitrogen between ammonium and nitrate. This choice is typically not determined in the effluent criteria and is therefore an internal decision on the plant. Generally, it is cheaper to have the majority of the nitrogen on the form of ammonium rather than nitrate, as this reduces the energy consumption for the aeration, which is one of the major operational costs. However, it has been shown that a high effluent ammonium concentration reduces the plants ability to reject disturbances. Therefore, it is necessary to balance cost, quality and robustness, when deciding on the goal of operation. By applying a lower effluent ammonium concentration the system is hedged against disturbances, this is, however, at the cost of additional energy for aeration.

Chapter 7 Control Structure Selection

The basis for controlling any technical system is the selection of a suitable control structure. By identification of control structure is meant the determination of the overall philosophy of the control system rather than dedication to development and testing of individual control loops. According to Larsson and Skogestad (2000), control structure design involves five main tasks:

1. Selection of controlled variables;
2. Selection of manipulated variables (control handles);
3. Selection of measurements;
4. Selection of control configuration (a structure interconnecting measurements/setpoints and manipulated variables);
5. Selection of controller type (control law specification, e.g. PID, decoupler, etc.).

The first task is to some extent a matter of goal formulation as described in Chapter 6. The second task of selecting the control handles is rather limited in a standard pre-denitrification system, where only few control handles are available. Selection of measurements (task 3) has become significantly easier after nutrient sensors that can be located anywhere in the process have become available. However, looking at the full ASM1 model it is obvious that several parameters are still not measurable online.

The primary focus of this chapter is task four: selection of control configuration, while the choice of controller type (task 5) is discussed in Chapter 8. Two important aspects regarding control structure selection are treated in this chapter. Firstly, the couplings in the system are investigated to find out if the control problem can be decomposed into smaller sub-problems. Secondly, the aspect of control authority is analysed, i.e. to which

extent the control handles are able to influence the processes to reject disturbances.

7.1 Control structure selection

According to Larsson and Skogestad (2000), two different approaches can be taken to control structure selection: the process oriented approach or the mathematically oriented approach. The pure mathematically oriented approach involves finding a truly optimal centralised controller. This approach is rarely carried out in practice, especially when the complexity of the control problem is beyond the simple. Instead, decentral single loop controllers are often used. Larsson and Skogestad (2000) have several explanations for this choice. They especially emphasize two important reasons: 1) to reduce the cost involved in defining the control problem and setting up a detailed dynamic model, required in a centralised system with no predetermined links; and 2) because decomposed control systems are less sensitive to model uncertainty, since they usually do not use an explicit model.

In wastewater treatment processes the issue of model uncertainty include several aspects beyond the mismatch between the ASM1 and reality: 1) uncertainty regarding precision of measurements; 2) difficulties in determining the model parameters, of which several are time-variable and depending on the water temperature; 3) the inability to measure several of the states (such as e.g. biomass composition); and 4) difficulties in modelling physical issues such as non-ideal mixing. The result of these uncertainties is that the basis for a centralised controller is rather insecure. Another reason for not applying the purely mathematically oriented approach to a wastewater treatment system is that the objective of the operation may change during event disturbances, for example, during rain it is more important to keep the sludge in the system than to minimise the effluent concentration of nitrogen.

The process oriented approach, on the other hand, is more pragmatic and involves the development of heuristic rules based on experience and process understanding. When applying this approach, it is acknowledged that the design of an all-embracing system for the whole plant is too large and complex a task. Instead, the problem is decomposed into smaller sub-problems. According to Larsson and Skogestad (2000) there are four common ways of decomposing the control problem, these are based on 1)

units; 2) process structure; 3) control objectives (material balance, energy balance, quality, etc.); and 4) time scale.

In this chapter, the process-oriented approach is taken by developing some guidelines (what Larsson and Skogestad (2000) refers to as “heuristic rules”) for the selection of control configuration.

7.2 Couplings in the system

A typical pre-denitrification plant has five major control handles available for the BNR process: the airflow rate (and the airflow distribution), the internal recirculation, the sludge outtake, the external carbon dosage and the sludge recirculation. The purpose of control is to manipulate these five control handles in order to reach satisfactory performance. The primary outputs from the plant are effluent ammonium, nitrate, organic matter and suspended solids. This means that in principle the system has multiple inputs and multiple outputs, which indicates that a MIMO (multiple input – multiple output) solution seems to be preferable. A MIMO solution implies that the control handles are coordinated according to the couplings in the system. This means that one output variable cannot be controlled by one input variable only but it depends on the manipulation of more control handles.

A solution involving a number of SISO (single input – single output) controllers also called a SISO solution is an alternative to the MIMO solutions. In SISO solutions the control of each individual control handles is not coordinated with any other. SISO solutions are often based on feedback loops and hence not based on detailed models of the system. MIMO solutions, on the other hand, require the additional knowledge of the internal structural couplings in the plant. MIMO solutions are justifiable if the couplings in the system are significant, as such solutions may improve the performance considerably; see e.g. Wittenmark *et al.* (2000, pp. 223-226).

It has often been claimed that pre-denitrification systems are multivariable and in need of a multivariable control structure, i.e. MIMO solutions. Below are three examples of this:

Lindberg (1997, p. 148) writes: “*The activated sludge process is a quite complex process where many states and non-linear relations are involved. The process is multivariable, i.e. it has several inputs and outputs. This means among other things that one input affects several outputs. For example, a change in the airflow rate affects both the ammonium and nitrate concentrations.*” He compares a system of three SISO controllers to

a MIMO system and concludes that: *“These controllers (MIMO, red) works even better than the SISO controller. The outputs were kept very close to the desired setpoints. It was also easier to tune these controller faster than the SISO controller, since the multivariable controllers are based on a multivariable model where all cross-couplings are known.”*

Steffens and Lant (1999) write: *“The control problem is by definition a multivariable problem: that is, there are multiple control objectives and multiple manipulated variables. Moreover, the relationships between the inputs and outputs are complex (non-linear and time varying).”* In their conclusion, based on tests of various model-based controllers, they write: *“Control of predenitrifying activated sludge processes is a multivariable control problem, which is best addressed by multivariable control algorithms.”* It should be emphasized that the multiple control objectives as well as the non-linearity and time-varying nature of the process will also influence the design of SISO controllers.

Weijers (2000, p. 160) writes: *“In the view of the characteristics of the process, which is non-linear, time variant (as a result of changing parameters), multivariable and relatively slow one might expect that application of more advanced control might give advantage over classical control. At the moment thorough comparative studies have not been undertaken to address this question.”*

The hypothesis in this thesis is that in a predenitrification system (with constant volume distribution between aerobic and anoxic reactors) the control problem can be decomposed according to processes. The control problem can be decomposed into the control of the nitrification process in the aerobic reactor(s) and the denitrification process in the anoxic reactor(s). The nitrification process is primarily influenced by the DO concentration in the medium time scale (hours and days) and the sludge outtake in the longer time scale (weeks and months); while the denitrification process is primarily influenced by the internal recirculation flow rate and the external carbon dosage, where both are working in the medium time scale.

The primary aim of this analysis is to look at the biological reactions. Therefore, aspects concerning the sludge recirculation and the interaction between the settler and the biological reactors will not be discussed. Generally, it can be said that the primary goal of the sludge recirculation is to keep the sludge within the system as described by Olsson and Newell (1999, p. 477). There are obviously more to the control of sludge retention, however, the subject will not be treated further here.

A qualitative analysis

The underlying assumptions for decomposing the problem according to the process conditions for nitrification and denitrification is that the couplings between the two processes are weak and easier to deal with outside the primary controllers rather than by a centralised controller. The main couplings between the aerobic and anoxic reactors are:

- 1) Transfer of dissolved oxygen from the end of the aerobic volume to the beginning of the anoxic volume via the internal recirculation, leading to reduced denitrification capacity;
- 2) Carbon source is often the limiting factor for the level of achieved denitrification. The part that is not used for denitrification in the anoxic part of the plant “leaks” to the aerobic part, where it is degraded aerobically. This leak causes loss of denitrification capacity (loss of organic matter) and slightly increased air consumption in the aerobic volumes (for aerobic degradation of the organic matter);
- 3) Simultaneous nitrification and denitrification (SND) in the aerobic reactor during low DO setpoints leads to increased denitrification capacity;
- 4) The nitrification process supplies the denitrification process with nitrate. If the nitrification process is significantly reduced or stopped, this will impair or stop the denitrification process as well.

If other couplings exist between the two types of reactors, they are smaller in effect than the above listed couplings.

The effect of the first coupling is hardly reduced by applying multivariable control but is rather reduced by ensuring a low DO concentration in the reactor from where the internal recirculation is returned to the anoxic reactor(s). The second coupling appears when the internal recirculation flow rate is too high or low, thus a control strategy that prevents this from happening should be applied. This can be done in a rather simple way as will be shown later. The third coupling gives the positive effect that a low DO setpoint both reduces energy and increases SND, i.e. an increased total nitrogen removal. The conflict in this case consists in whether SND should have a higher priority than nitrification in the aerobic volumes. However, in most cases the need for ammonium removal will be given higher priority, thus SND will take place when ammonium removal

allows. The fourth coupling appears if the nitrifiers are lost or the aeration is shut off. This is outside of the “normal” operation area.

Relative Gain Array analysis

A more quantitative analysis of the couplings can be carried out using a method called the Relative Gain Array (RGA) analysis, which is a well-known and accepted method for investigation of couplings in MIMO systems (Shinskey, 1979, Maciejowski, 1989, Skogestad and Postlethwaite, 1996 and Wittenmark *et al.*, 2000).

According to Shinskey (1979, p. 197): “Relative gain is a measure of the influence a selected manipulated variable has over a particular controlled variable relative to that of other manipulated variables acting on the process.” This is exactly what is sought for in this investigation.

The RGA analysis is based on the RGA matrix, which in principle consists of two components. Firstly, the open loop gains between control inputs and controlled outputs are found. This is done by keeping all control inputs except one constant. The effect of this input on each of the outputs is investigated to find the stationary values of: $\frac{\Delta y_i}{\Delta u_j}$, where y_i are the outputs

from the process and u_j are the inputs. This yields a matrix of the open loop gains. Secondly, the “closed loop” gains are found. This is done by keeping all outputs except one constant. This output is changed by changing the necessary control inputs. Thereby, the closed loop gains are found. The RGA matrix (A) is then the open loop gains divided by (or normalised by) the closed loop gains.

Consider the example of finding the RGA in the case, where the internal recirculation flow rate and the DO setpoint are the control inputs and the effluent total inorganic nitrogen concentration (i.e. the sum of the nitrate and the ammonium concentrations) and the ammonium concentrations are the outputs. Firstly, the internal recirculation flow rate is changed slightly and the effect on the two effluent concentrations is recorded, secondly the DO setpoint is changed and the effect on the two effluent concentrations are recorded. Hereby it is possible to find the open loop gains. Secondly, the closed loop gains are found. This is done by changing the internal recirculation flow rate and the DO setpoint to firstly obtain a change in the total inorganic nitrogen concentration but no change in the effluent ammonium concentration. Secondly, the internal recirculation flow rate and

the DO setpoints are changed to obtain a change in the effluent ammonium concentration, while the effluent total inorganic nitrogen concentration is kept constant. This gives the closed loop gains. The open loop gains are normalised by dividing them by the closed loop gains. Thereby, a relative gain array (RGA) is obtained. One of the main advantages of the RGA analysis is that it is independent of the choice of controller.

The best pairing of control inputs and controlled outputs is found where the elements in the RGA are closest to one. Due to the normalisation, the sum of the row and the columns yields one. This means that for a two-by-two system one parameter (λ) is sufficient to characterise the whole matrix, see Equation (7.1). The farther away the parameter λ is from one or zero, the more significant is the interaction, see Table 7.1. There is no exact upper or lower limit for how much λ should deviate from 0 or 1 before MIMO solutions is to prefer over SISO solutions.

$$\Lambda = \begin{bmatrix} \lambda & 1 - \lambda \\ 1 - \lambda & \lambda \end{bmatrix} \quad (7.1)$$

The aim of this analysis is to investigate the couplings between the control handles that influence the processes in the medium time scale. Control handles pertaining to the fast and the slow time scale are considered separately. The control of the aeration to obtain a certain DO setpoint is taking place in the fast time scale, while the control of the sludge wastage flow rate takes place in the slow time scale (Jeppsson, 1996). The control of these two control handles should not be considered together with the medium term control handles, which are:

- The supervisory control of the DO setpoint;
- The internal recirculation flow rate;
- The external carbon dosage.

The considered controlled outputs are the effluent total inorganic nitrogen concentration (i.e. nitrate plus ammonium concentration) and the effluent ammonium concentration. The effluent concentration of organic matter is generally not a problem in the control of pre-denitrification systems as most organic matter is degraded in the denitrification volumes, thus compliance to BOD or COD criteria rarely constitute a problem unless pertaining to poor sedimentation, i.e. loss of particulate organic matter.

Table 7.1 Level of interaction using RGA.

Λ	Effect
$-\infty - -1$	Difficult interaction
$-0.15 - 0.15$	Weak interaction
0	No interaction
1	No interaction
$0.85 - 1.15$	Weak interaction
$2 - \infty$	Difficult interaction

The relative gain array method is limited to quadratic systems, i.e. the same number of inputs and outputs. Therefore, in order to investigate a two-by-three system (two controlled variables and three manipulated variables) two analyses are carried out. One, where the external carbon dosage is kept constant and the coupling between the internal recirculation flow rate and the DO setpoint is investigated and another, where internal recirculation flow rate is kept constant and the coupling between the carbon dosage and the DO setpoint is investigated. In this way, two quadratic structures are obtained.

Finding the relative gain array

Determining the RGA matrix Λ involves the following steps:

- 1) Define the dynamical model of the system in terms of differential equations;
- 2) Find the steady state solution;
- 3) Linearise the dynamical system;
- 4) Find the transfer function matrix G of the system;
- 5) Find the relative gain matrix (Λ) based on G .

Firstly, the differential equations for the system are defined. The analysis is based on ASM1 (Henze *et al.*, 1987), however, for this purpose, it is not necessary to include the full ASM1 model. Instead, a reduced form is used. In this investigation, only issues pertaining to the medium time frame is being investigated. This means that slowly changing variables are assumed constant. Therefore, the amounts of autotrophic and heterotrophic organisms are kept constant, which means that the processes describing the decay of microorganisms (P_4 and P_5) are excluded (see Appendix B for nomenclature).

Additionally, in order to simplify the system the processes P_6 , P_7 and P_8 are excluded. The processes are hydrolysis (of organic matter and of entrapped organic nitrogen) and ammonification. The exclusion is justifiable because the processes have a constant rate regardless of which reactor they appear in (except for the case where neither dissolved oxygen nor nitrate is present, where hydrolysis stops). In Yuan *et al.* (2002) the following argumentation is used: “As the particulate bCOD (S_S , red) has to be hydrolysed before being degraded, the degradation of this part of bCOD goes slowly. Therefore, it is reasonable to assume that the particulate bCOD is equally available for anoxic and aerobic reactors, because of this slow degradation process of the particulate bCOD.” In the context of control structure selection, the significance of this statement is that it is not possible to manipulate the process of hydrolysis by available control handles. Therefore, the process will not substantially change the basic effects of the two control handles internal recirculation flow rate and DO concentration with regard to total nitrogen and ammonium in the effluent.

$$\begin{aligned}
\frac{dS_{\text{NH}}(1)}{dt} &= \frac{Q}{V_1} S_{\text{NH},\text{in}} - \frac{Q + Q_{\text{int}}}{V_1} S_{\text{NH}}(1) + \frac{Q_{\text{int}}}{V_1} S_{\text{NH}}(2) - i_{\text{XB}} P_2 \\
\frac{dS_{\text{NH}}(2)}{dt} &= \frac{Q + Q_{\text{int}}}{V_2} S_{\text{NH}}(1) - \frac{Q + Q_{\text{int}}}{V_2} S_{\text{NH}}(2) - i_{\text{XB}} P_1 - \left(i_{\text{XB}} + \frac{1}{Y_A}\right) P_3 \\
\frac{dS_{\text{NO}}(1)}{dt} &= -\frac{Q + Q_{\text{int}}}{V_1} S_{\text{NO}}(1) + \frac{Q_{\text{int}}}{V_1} S_{\text{NO}}(2) - \frac{1 - Y_H}{2.86 Y_H} P_2 \\
\frac{dS_{\text{NO}}(2)}{dt} &= \frac{Q + Q_{\text{int}}}{V_2} S_{\text{NO}}(1) - \frac{Q + Q_{\text{int}}}{V_2} S_{\text{NO}}(2) + \frac{1}{Y_A} P_3 \\
\frac{dS_S(1)}{dt} &= \frac{Q}{V_1} S_{S,\text{in}} - \frac{Q + Q_{\text{int}}}{V_1} S_S(1) + \frac{Q_{\text{int}}}{V_1} S_S(2) - \frac{1}{Y_H} P_2 \\
\frac{dS_S(2)}{dt} &= \frac{Q + Q_{\text{int}}}{V_2} S_S(1) - \frac{Q + Q_{\text{int}}}{V_2} S_S(2) - \frac{1}{Y_H} P_1
\end{aligned} \tag{7.2}$$

The reduction in the number of processes also leads to a reduction in states (called components in the ASM1 model). The remaining variables are the concentrations of ammonium, nitrate, readily biodegradable organic matter and dissolved oxygen. In the investigation, it is assumed that the dissolved oxygen concentration in the aerobic reactor is a manipulated

variable and that it can be controlled to obtain any constant value below saturation (i.e. short time scale dynamics is disregarded).

The considered system is a two-tank system with one anoxic and one aerobic reactor. The total anoxic and aerobic volumes are the same as in the benchmark plant and influent characteristics are similar to those of the benchmark system (Copp, 2002). First, a simplified model is considered where aerobic processes are assumed only to take place in the aerobic reactor and anoxic processes are assumed only to take place in the anoxic reactor. In this simplified model, the dissolved oxygen concentration in the anoxic reactor is assumed zero mg/l. The system dynamics is described by the simplified model in Equation (7.2):

The nomenclature is according to the ASM1 model; see also nomenclature, Appendix A. The influent flow rate is denoted by Q and the internal recirculation flow rate is denoted by Q_{int} .

The next task is to find stationary values for the system, i.e. setting the derivatives to zero. For this task, the Engineering Equation Solver program EES (see Appendix C) is used, which given the influent concentrations, the influent flow rate, the internal recirculation flow rate and the various process parameters calculates the steady state states of the equation system. The model is transformed to a standard state-space model with x (state variables), y (outputs) and u (inputs) as defined in Equation (7.3).

$$x = \begin{bmatrix} S_{NH}(1) \\ S_{NH}(2) \\ S_{NO}(1) \\ S_{NO}(2) \\ S_S(1) \\ S_S(2) \end{bmatrix} \quad u = \begin{bmatrix} Q_{int} \\ S_O(2) \end{bmatrix} \quad (7.3)$$

$$\frac{dx}{dt} = Ax + Bu$$

$$y = Cx + Du$$

$$C = \begin{bmatrix} 0 & 1 & 0 & 0 & 0 & 0 \\ 0 & 1 & 0 & 1 & 0 & 0 \end{bmatrix} \text{ and } D = 0$$

Thirdly, the system is linearised. This is justifiable as a linear model is a good approximation in a sufficiently small neighbourhood around a certain steady state solution. The standard method for linearisation involves performing a Taylor series expansion of the non-linear function around the steady state solution, disregarding all terms involving derivatives of larger than first degree. Hence, all partial derivatives to both x and u components are found and set up as described in Equation (7.4).

$$a_{ij} = \left. \frac{\partial f_i}{\partial x_j} \right|_0 \quad \text{and} \quad b_{ij} = \left. \frac{\partial f_i}{\partial u_j} \right|_0$$

$$A' = \begin{bmatrix} a_{11} & a_{12} & \cdots & a_{1n} \\ a_{21} & a_{22} & \cdots & a_{2n} \\ \vdots & \vdots & \ddots & \vdots \\ a_{n1} & a_{n2} & \cdots & a_{nn} \end{bmatrix} \quad \text{and} \quad B' = \begin{bmatrix} b_{11} & b_{12} & \cdots & b_{1m} \\ b_{21} & b_{22} & \cdots & b_{2m} \\ \vdots & \vdots & \ddots & \vdots \\ b_{n1} & b_{n2} & \cdots & b_{nm} \end{bmatrix} \quad (7.4)$$

For the system in Equation (7.4), the A matrix is derived in Equation (7.5) and the B matrix is derived in Equation (7.7).

$$A = \begin{bmatrix}
-\frac{Q+Q_i}{V_1} & \frac{Q_i}{V_1} & -i_{XB} \frac{\partial P_2}{\partial S_{NO}(1)} \\
\frac{Q+Q_i}{V_2} & -\frac{Q+Q_i}{V_2} - (i_{XB} + \frac{1}{Y_A}) \frac{\partial P_3}{\partial S_{NH}(2)} & 0 \\
0 & 0 & -\frac{Q+Q_i}{V_1} - \frac{1-Y_H}{2.86Y_H} \frac{\partial P_2}{\partial S_{NO}(1)} \\
0 & +\frac{1}{Y_A} \frac{\partial P_3}{\partial S_{NH}(2)} & \frac{Q+Q_i}{V_2} \\
0 & 0 & -\frac{1}{Y_H} \frac{\partial P_2}{\partial S_{NO}(1)} \\
0 & 0 & 0 \\
0 & -i_{XB} \frac{\partial P_2}{\partial S_S(1)} & 0 \\
0 & 0 & -i_{XB} \frac{\partial P_1}{\partial S_S(2)} \\
\frac{Q_i}{V_1} & -\frac{1-Y_H}{2.86Y_H} \frac{\partial P_2}{\partial S_S(1)} & 0 \\
-\frac{Q+Q_i}{V_2} & 0 & 0 \\
0 & -\frac{Q+Q_i}{V_1} - \frac{1}{Y_H} \frac{\partial P_2}{\partial S_S(1)} & \frac{Q_i}{V_1} \\
0 & \frac{Q+Q_i}{V_2} & -\frac{Q+Q_i}{V_2} - \frac{1}{Y_H} \frac{\partial P_1}{\partial S_S(2)}
\end{bmatrix} \quad (7.5)$$

$$\begin{aligned}
\frac{\partial P_1}{\partial S_S} &= \mu_H \frac{K_S}{(S_S + K_S)^2} \frac{S_O}{S_O + K_{O,H}} X_{BH} \\
\frac{\partial P_2}{\partial S_S} &= \mu_H \frac{K_S}{(S_S + K_S)^2} \frac{K_{O,H}}{S_O + K_{O,H}} \frac{S_{NO}}{S_{NO} + K_{NO}} \eta_g X_{BH} \\
\frac{\partial P_2}{\partial S_{NO}} &= \mu_H \frac{S_S}{S_S + K_S} \frac{K_{O,H}}{S_O + K_{O,H}} \frac{K_{NO}}{(S_{NO} + K_{NO})^2} \eta_g X_{BH} \\
\frac{\partial P_3}{\partial S_{NH}} &= \mu_A \frac{S_O}{S_O + K_{O,H}} \frac{K_{NH}}{(S_{NH} + K_{NH})^2} X_{BS}
\end{aligned} \quad (7.6)$$

$$B = \begin{bmatrix} \frac{(S_{NH}(2) - S_{NH}(1))}{V_1} & 0 \\ \frac{(S_{NH}(1) - S_{NH}(2))}{V_2} & -i_{XB} * \frac{\partial P_1}{\partial S_O(2)} - (i_{XB} + Y_A) * \frac{\partial P_3}{\partial S_O(2)} \\ \frac{(S_{NO}(2) - S_{NO}(1))}{V_1} & 0 \\ \frac{(S_{NO}(1) - S_{NO}(2))}{V_2} & Y_A * \frac{\partial P_3}{\partial S_O(2)} \\ \frac{(S_{SS}(2) - S_{SS}(1))}{V_1} & 0 \\ \frac{(S_{SS}(1) - S_{SS}(2))}{V_2} & -\frac{1}{Y_H} * \frac{\partial P_1}{\partial S_O(2)} \end{bmatrix} \quad (7.7)$$

Where

$$\begin{aligned} \frac{\partial P_1}{\partial S_O(2)} &= \mu_H \frac{S_{S2}}{S_S(2) + K_S} \frac{K_{OH}}{(S_O(2) + K_{OH})^2} X_{BH} \\ \frac{\partial P_2}{\partial S_O(2)} &= \mu_H \frac{S_{NH}(2)}{S_{NH}(2) + K_{NH}} \frac{K_{OH}}{(S_O(2) + K_{OH})^2} X_{BA} \end{aligned} \quad (7.8)$$

Finding the transfer functions for the system involving the matrices A , B , C and D is carried out by the Matlab function called `tf`. Finally, the relative gain array (RGA) is found by taking $K = G(0)$, i.e. the stationary value. K is transformed to the RGA matrix by this calculation:

$$\Lambda = K \times K^{-T}$$

Where \times denotes the Schur product, i.e. the element-by-element multiplication.

Using a DO setpoint of 2 mg/l and an internal recirculation flow rate two times the influent the RGA yields:

$$\Lambda = \begin{bmatrix} -0.0000014 & 1.0000014 \\ 1.0000014 & -0.0000014 \end{bmatrix}$$

This gives a λ of -1.4×10^{-6} , which indicates that the interaction between the two control handles is weak (see Table 7.1). The couplings are as predicted, i.e. the internal recirculation flow rate primarily influences total nitrogen and the DO setpoint primarily influences the amount of ammonium. Testing various values of the defining parameters ($S_{S,in}$, $S_{NH,in}$, DO setpoint and internal recirculation flow rate) does not change the relative gain array matrix significantly.

Extending the simplified model

The low level of interaction found above was a result of a simplified system with the following assumptions:

1. Aerobic and anoxic processes only take place in their respective dedicated reactors
2. No dissolved oxygen is transferred from the aerobic to the anoxic reactor

These two assumptions were regarded to be two of the four effects causing interaction. Consequently, the next step is to remove these two assumptions by allowing aerobic and anoxic processes in both anoxic and aerobic reactors. Therefore, the DO concentration in the anoxic reactor is added as an additional state. The model is expanded in Equation (7.9). The RGA is calculated using the same procedure as for the simplified model.

$$\begin{aligned}
\frac{dS_{\text{NH}}(1)}{dt} &= \frac{Q}{V_1} S_{\text{NH},\text{in}} - \frac{Q+Q_{\text{int}}}{V_1} S_{\text{NH}}(1) + \frac{Q_{\text{int}}}{V_1} S_{\text{NH}}(2) - i_{\text{XB}} P_2 - i_{\text{XB}} P_1 - (i_{\text{XB}} + \frac{1}{Y_A}) P_3 \\
\frac{dS_{\text{NH}}(2)}{dt} &= \frac{Q+Q_{\text{int}}}{V_2} S_{\text{NH}}(1) - \frac{Q+Q_{\text{int}}}{V_2} S_{\text{NH}}(2) - i_{\text{XB}} P_2 - i_{\text{XB}} P_1 - (i_{\text{XB}} + \frac{1}{Y_A}) P_3 \\
\frac{dS_{\text{NO}}(1)}{dt} &= -\frac{Q+Q_{\text{int}}}{V_1} S_{\text{NO}}(1) + \frac{Q_{\text{int}}}{V_1} S_{\text{NO}}(2) - \frac{1-Y_H}{2.86Y_H} P_2 + \frac{1}{Y_A} P_3 \\
\frac{dS_{\text{NO}}(2)}{dt} &= \frac{Q+Q_{\text{int}}}{V_2} S_{\text{NO}}(1) - \frac{Q+Q_{\text{int}}}{V_2} S_{\text{NO}}(2) - \frac{1-Y_H}{2.86Y_H} P_2 + \frac{1}{Y_A} P_3 \\
\frac{dS_S(1)}{dt} &= \frac{Q}{V_1} S_{\text{S},\text{in}} - \frac{Q+Q_{\text{int}}}{V_1} S_S(1) + \frac{Q_{\text{int}}}{V_1} S_S(2) - \frac{1}{Y_H} P_2 - \frac{1}{Y_H} P_1 \\
\frac{dS_S(2)}{dt} &= \frac{Q+Q_{\text{int}}}{V_2} S_S(1) - \frac{Q+Q_{\text{int}}}{V_2} S_S(2) - \frac{1}{Y_H} P_2 - \frac{1}{Y_H} P_1 \\
\frac{dS_O(1)}{dt} &= -\frac{Q+Q_{\text{int}}}{V_1} S_O(1) + \frac{Q_{\text{int}}}{V_1} S_O(2) - \frac{1-Y_H}{Y_H} P_1 - (\frac{4.57}{Y_A} + 1) P_3
\end{aligned} \tag{7.9}$$

Coupling between the internal recirculation flow rate and the DO setpoint

The solution for a DO setpoint of 2 mg/l and an internal recirculation flow rate of two times the influent is $\lambda = 1.07$. This again indicates weak interaction (though increased compared to the simpler model). The analysis has been carried out for a variety of internal recirculation flow rates and DO setpoints, see Figure 7.1 (The influent concentration of easily degradable organic matter is set at 60 mg/l COD and the influent ammonium concentration is set at 30 mg/l $\text{NH}_4\text{-N}$). Most importantly, the interaction coefficient λ is always showing a low value. The value is increasing for high DO setpoints and high internal recirculation flow rates indicating an increased coupling due to dissolved oxygen in the internal recirculation stream. The special behaviour around an internal recirculation flow rate of 0.9 times the influent flow rate corresponds to the setting of the internal recirculation flow rate so that it results in the lowest total nitrogen concentration (see Figure 7.2). This means that the coupling increases slightly close to the internal recirculation flow rate resulting in the minimum effluent total inorganic nitrogen, however, the coupling are always weak.

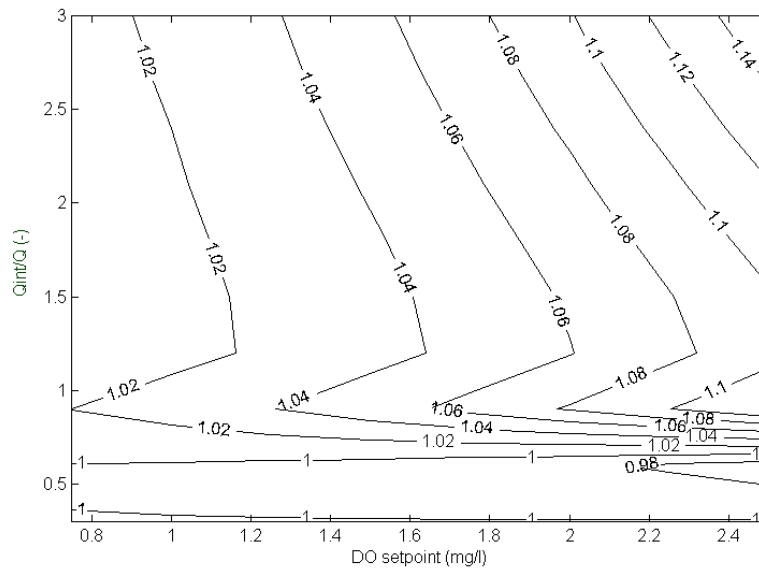

Figure 7.1 λ as a function of choice of the two control variables: DO setpoint and internal recirculation flow rate. The controlled parameters are the effluent total inorganic nitrogen and ammonium concentration.

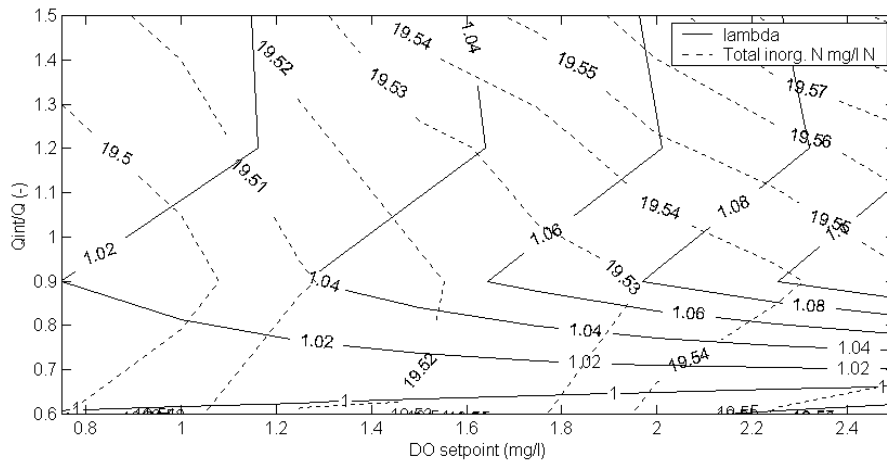

Figure 7.2 The line of special behaviour of λ corresponds to maximum removal of effluent total inorganic nitrogen (zoom of Figure 7.1).

Coupling between the external carbon dosage and the DO setpoint

An analysis of the interaction between the DO setpoint and the dosage of external carbon is also carried out. The external carbon source is modelled as the concentration of influent easily degradable organic matter, S_S . The interaction between the two control handles is small in the investigated operational space, where the internal recirculation flow rate is set at two times the influent flow rate, see Figure 7.3.

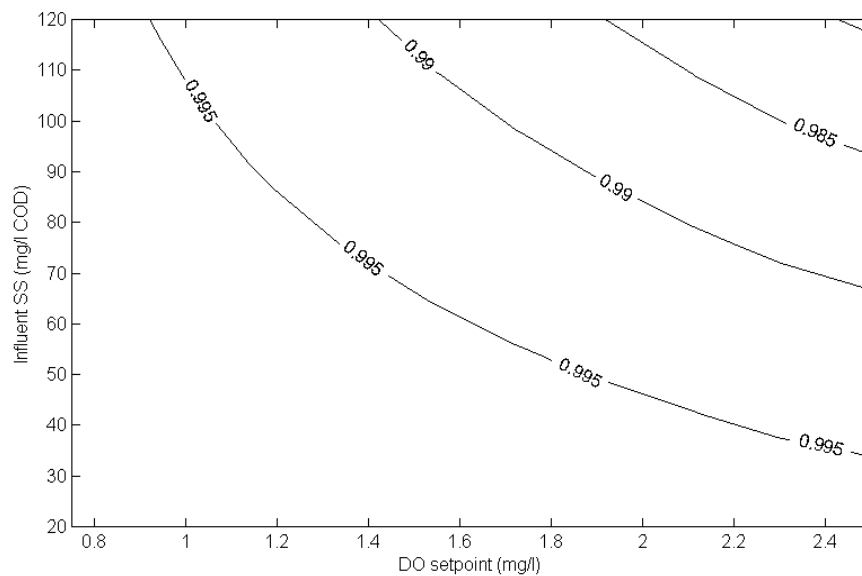

Figure 7.3 λ as a function of choice of the two control variables: DO setpoint and external carbon dosage. The controlled parameters are the effluent total inorganic nitrogen and ammonium concentration.

Summary of analysis

The relative gain analysis above indicates that the interactions between the recirculation flow rate and the DO setpoint and between external carbon dosage and the DO setpoint are weak. Total nitrogen is primarily controlled by the internal recirculation flow rate and the external carbon dosage, while

effluent ammonium is primarily controlled by the DO concentration in the aerobic reactor. Neither the addition of more reactors nor the inclusion of ammonification or hydrolysis is expected to significantly change this conclusion. Therefore, it seems reasonable to choose a SISO solution rather than a MIMO solution. It should be noted that the RGA method only relies on steady-state values. Similar methods that include dynamics have been suggested, but are not included in this work.

7.3 Control authority

It has often been claimed that the control authority of pre-denitrification systems is low. The term control authority is used in several meanings. Here, the term “control authority” is used to imply the ability of the available control handles to influence the system to be controlled in order to reject disturbances. The investigation of control authority in the pre-denitrification system is about investigating the control handles for the removal of nitrogen. As stated in the coupling analysis above, the nitrification process is primarily influenced by the DO setpoint and the sludge outtake flow rate, while the denitrification process is primarily influenced by the internal recirculation flow rate and the external carbon dosage. In the following, the ability to influence nitrification and denitrification is investigated separately.

Controlling nitrification

The benchmark wastewater treatment system is simplified for this first analysis, so that the nitrification part of the plant is represented by one aerobic reactor only with a volume of 4000 m³, while the rest of the plant is as specified in the benchmark model.

A steady-state correspondence between required effluent ammonium, the DO concentration in the aerobic reactor and the necessary sludge age (SA) exists. This can be calculated for steady state conditions using the ASM1 model, see Equation (7.10).

The correspondence for the parameters in the benchmark model is shown in Figure 7.4. This clearly shows that the lower the DO concentration the higher the necessary sludge age in order to obtain a certain effluent ammonium concentration. In the benchmark model, there is an effluent ammonium requirement of 4 mg/l NH₄-N, which means that the necessary

sludge ages are respectively, 5.4, 5.8, 7.1 or 10.3 days if the corresponding steady state DO setpoints are 3.0, 2.0, 1.0 or 0.5 mg/l.

$$\begin{aligned} \frac{dX_{BA}}{dt} &= \text{growth} - \text{sludge outtake} - \text{decay} \\ &= \left(\mu_A \frac{S_{NH}}{S_{NH} + K_{NH}} \frac{S_O}{S_O + K_{OA}} \frac{V_{aerob}}{V_{Total}} - \frac{1}{SRT} - b_A \right) * X_{BA} = 0 \end{aligned} \quad (7.10)$$

$$\Downarrow$$

$$SA = \frac{1}{\mu_A \frac{S_{NH}}{S_{NH} + K_{NH}} \frac{S_O}{S_O + K_{OA}} \frac{V_{aerob}}{V_{Total}} - b_A}$$

V_{aerob} is the aerobic volume, V_{total} is the total biological volume. The remaining symbols are explained in Appendix A.

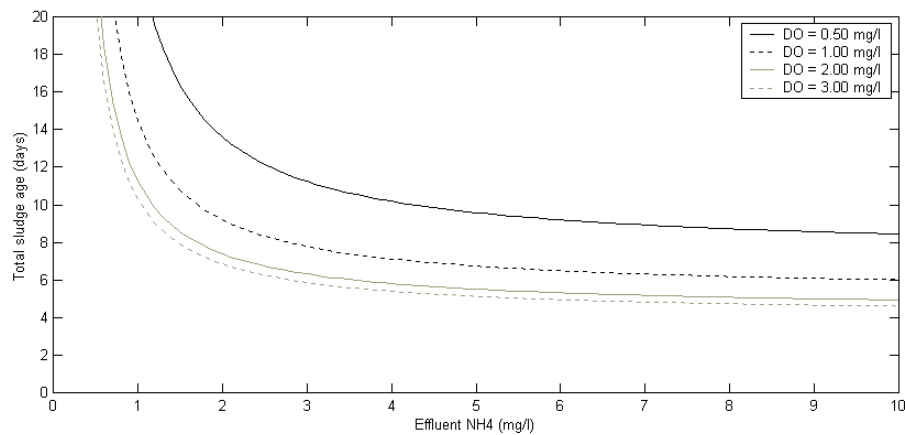

Figure 7.4 Correspondence between sludge age and effluent ammonium for various DO concentrations.

The DO setpoint and the sludge outtake flow rate work in two quite different time frames, but these frames strongly influence each other. Therefore, it is important to pay attention to both control handles at once. To counteract daily variations in load a strong control handle in the medium

time scale is required. The DO setpoint works in this time-scale while the sludge age is a long time scale parameter, which is not suitable to use to counteract medium scale disturbances.

The control authority of the DO setpoint can be expressed as how much a change in setpoint changes the nitrification rate. This authority can be represented as the derivative of the nitrification rate with respect to the DO concentration. This is illustrated in Figure 7.5, which shows that the nitrification rate has a higher sensitivity to the DO concentration at lower DO concentrations. As can be seen from Figure 7.5, increasing the DO concentration above 2.0 mg/l only yield a small increase in the actual nitrification rate. This means that the longer the sludge age the lower is the average DO setpoint and hence the higher is the control authority of the DO setpoint.

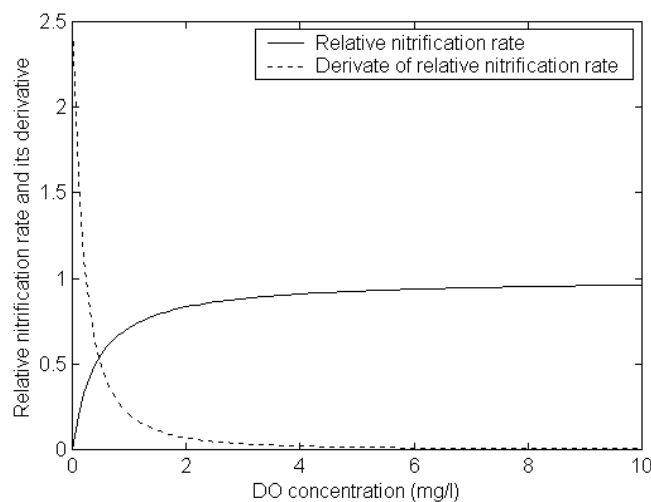

Figure 7.5 The strength of the DO setpoint as a means for control.

To confirm this a number of simulation experiments have been carried out. In the experiments, the ammonium concentration in the aerobic reactor was controlled towards an ammonium setpoint of 4 mg/l $\text{NH}_4\text{-N}$ for various activated sludge wastage rates. The applied controller was a cascaded PI controller, where the master ammonium controller sends a DO setpoint to the slave DO controller. The ammonium controller was limited to send DO

setpoints between 0 and 2.5 mg/l. The results of the simulations are shown in Figure 7.6.

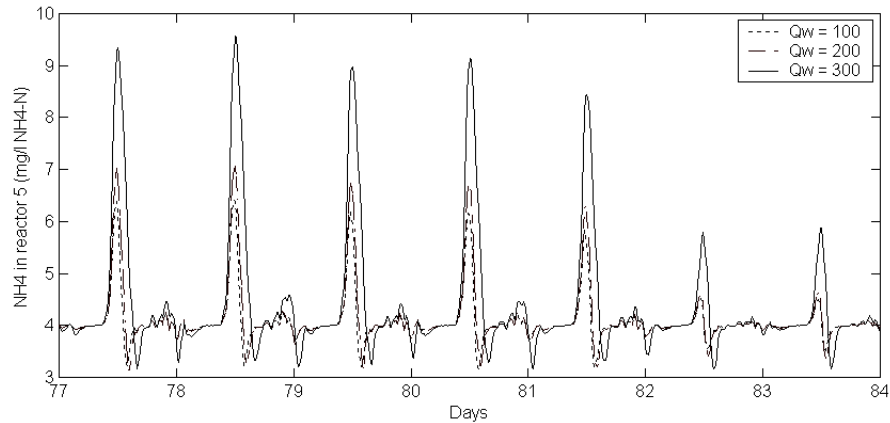

Figure 7.6 A cascaded controller controls the ammonium concentration towards a setpoint of 4.0 mg/l $\text{NH}_4\text{-N}$.

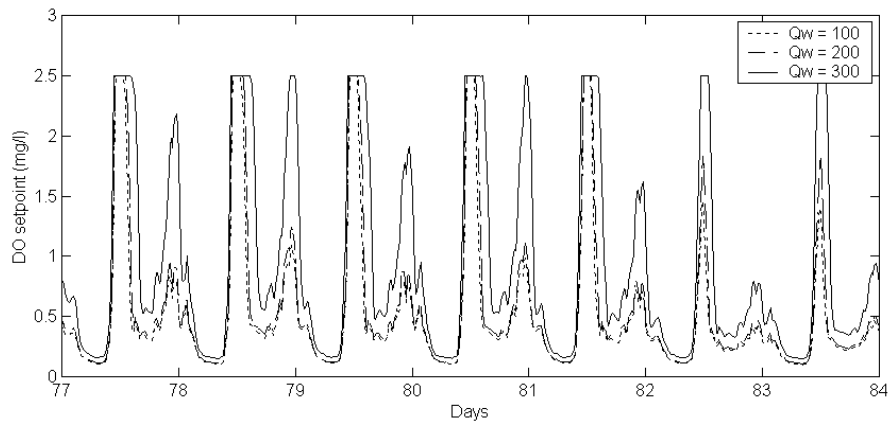

Figure 7.7 DO concentrations during the three simulations in stationary state.

As expected, the simulation shows that the lower sludge wastage rate (i.e. the higher sludge age) that is applied, the better the system is able to counteract ammonium load disturbances. The three strategies resulted in

maximum effluent ammonium concentrations of 9.5, 7.0, 6.6 mg/l $\text{NH}_4\text{-N}$, respectively. The DO concentrations for the three simulations are shown in Figure 7.7. At higher sludge wastage rates the maximum DO concentration limit is reached for a larger part of the time. The average DO concentrations in the simulations were 0.53 mg/l, 0.59 mg/l and 0.95 mg/l, respectively.

In the benchmark plant, as is often the case in normally dimensioned plants, it is not possible to fully reject the ammonium disturbances by means of controlling the DO setpoint. By full disturbance rejection ability, is meant that the effluent ammonium concentration will not deviate from its setpoint due to actuator limitation. Therefore, if a certain effluent ammonium concentration criterion is to be met on average over a certain time frame, the applied ammonium setpoint should be somewhat lower than the actual criterion. This is discussed further in Section 8.1.

Controlling denitrification

Internal recirculation flow rate and external organic carbon dosage are the two major control handles influencing the denitrification process. The control handles work both in the medium time scale.

Internal recirculation flow rate has often been blamed of having a low control authority. This has been investigated by means of steady-state operational maps; see Figure 7.8 to Figure 7.11. The maps have been created by keeping the sludge age constant and adjusting the sludge outtake correspondingly. The DO setpoints are the same throughout all three reactors and has been varied using the following concentrations: 1.00, 1.50, 2.00, 2.50 and 3.00 mg/l. Ten evenly distributed values of the internal recirculation flow rate has been used. EES is used to calculate the operational space maps; see Appendix C for a description of EES.

The effluent total nitrogen as a function of internal recirculation flow rate and DO setpoint has been investigated. The maximum nitrogen removal for each DO setpoint is achieved where the nitrate value at the end of the anoxic reactor has a certain value. See for example Figure 7.8, here maximum total nitrogen removal is reached where the nitrate concentration is 2.5 mg/l $\text{NO}_3\text{-N}$. Looking at all of the operational maps it can be seen that the nitrate setpoint resulting in maximum nitrogen removal varies only slightly. The amount of organic matter (S_s) in the influent has a larger influence on the best choice of nitrate setpoint than the sludge age. Choosing a nitrate setpoint between 1 and 3 mg/l $\text{NO}_3\text{-N}$ leads to a close to maximum nitrogen removal in a wide range of operational conditions.

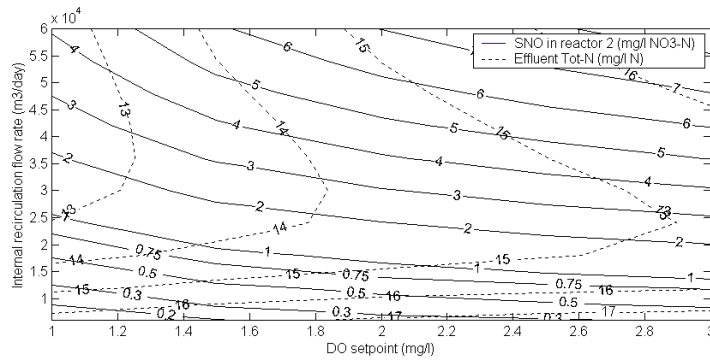

Figure 7.8 Operational map with a sludge age of 8 days.

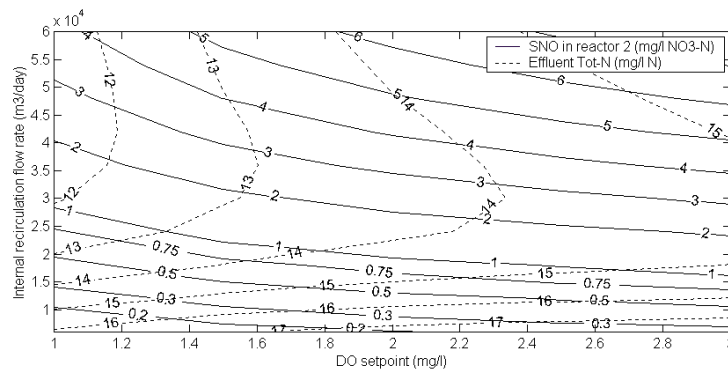

Figure 7.9 Operational map with a sludge age of 12 days.

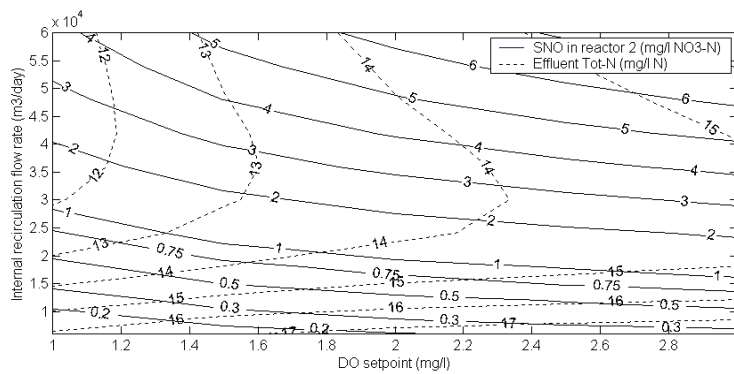

Figure 7.10 Operational map with a sludge age of 20 days.

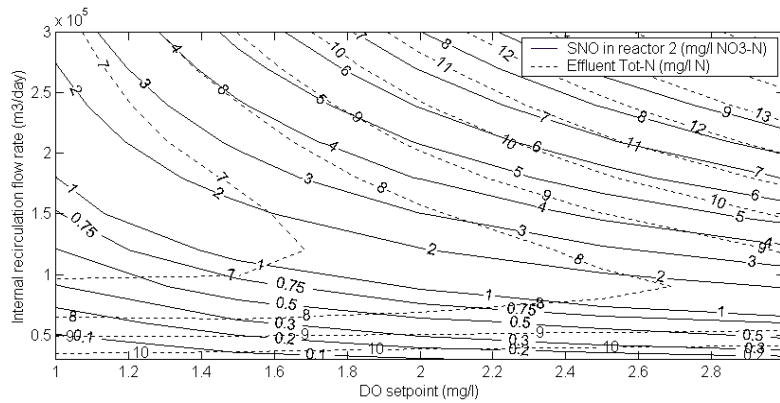

Figure 7.11 Operational map with a sludge age of 8 days and the double concentration of readily degradable organic matter (S_5).

Due to the low cost of internal recirculation, there is no reason to reduce the internal recirculation flow rate below the level where the lowest effluent total nitrogen is achieved even if the effluent total nitrogen concentration are below the effluent criterion. Thus, the control authority of this control handle can be said to be low when it has been optimised. If total nitrogen at this strategy is below the effluent criterion for total nitrogen, no more analysis is needed. If the effluent total nitrogen concentration is too high, other means need to be considered, e.g. the dosage of external organic matter.

The control authority of the external carbon dosage is high, though the closer the effluent nitrate concentration comes to zero $\text{mg/l NO}_3\text{-N}$ the larger is the internal recirculation and at the same time the higher dosage is needed to reduce the effluent nitrate concentration further. This can be seen in Figure 7.12, where the simulations are continued to the extreme. In this steady-state simulation the DO setpoints are controlled to obtain an effluent ammonium concentration of $4 \text{ mg/l NH}_4\text{-N}$, the internal recirculation is controlled to obtain a nitrate concentration in the end of the anoxic zone of $0.1 \text{ mg/l NO}_3\text{-N}$ and the sludge age is kept constant at 8 days.

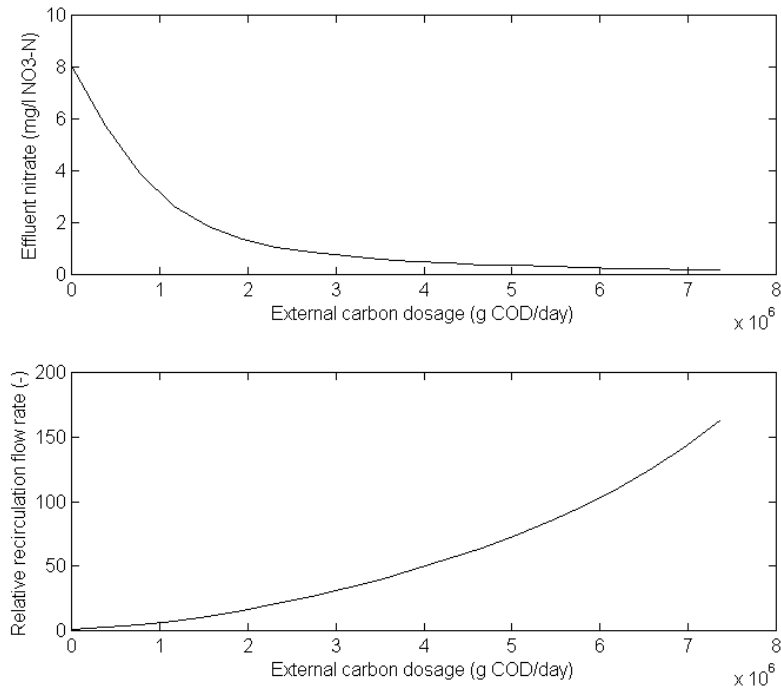

Figure 7.12 Control authority of external carbon dosage. (Relative recirculation flow rate (subplot 2) is related to the influent flow rate).

7.4 Conclusions

The control of nitrification and denitrification is close to independent, which indicates that a single-input single-output (SISO) control system will perform adequately well compared to a MIMO control system. The limitations of control authority of the control handles limit the controllability of the system. For nitrification, the DO setpoint can be used to reject disturbances in the medium time frame, while sludge outtake is not well suited for this due to its slow action. The two control handles have a strong impact on each other. The control authority of the DO setpoint depends largely on the amount of nitrifiers in the system, i.e. the sludge age. Higher sludge age means higher disturbance rejection ability.

For denitrification, the optimal control of internal recirculation flow rate should always be applied in order to minimise the effluent total nitrogen. This is done by applying a nitrate setpoint in the range of 1-3 mg/l $\text{NO}_3\text{-N}$ at the end of the anoxic reactor volume. After the application of this control method, no more can be gained by the internal recirculation, meaning that it has no more control authority. If more total nitrogen needs to be removed, e.g. external carbon source needs to be applied. This rather strong control handle can ensure a required effluent total nitrogen concentration given a reasonable anoxic volume.

Based on these observations the following control strategy is suggested:

- 1) ammonium should - if available actuators allow - be reduced to a certain effluent ammonium setpoint. This setpoint may be determined by the effluent permit or in order to ensure a suitable concentration of autotrophic microorganisms and thus to ensuring a sufficient disturbance rejection ability, as described in Section 6.4.
- 2) As much nitrate as possible should be removed in the anoxic reactors by use of the internal recirculation only. If this control leads to an effluent total nitrogen concentration below the effluent criterion, then there are no reasons to reduce pumping in order to save money, as the cost of pumping is low or negligible compared to other costs.
- 3) If total nitrogen is too high after the internal recirculation control is optimised an external carbon source need to be dosed to exactly reach the required total nitrogen. Generally, the nitrate setpoint in the last anoxic reactor needs to be lowered at increased carbon dosage.

The above conclusions regarding the analysis of interactions are based on a simplified model (compared to the full ASM1) and do not include slow and fast reactions as well as the interaction between settler and the biological reactors nor the control of the sludge recirculation flow rate.

In case of green taxes, an effluent total nitrogen concentration below the criterion may be feasible. This issue has not been investigated in detail, however, it seems reasonable to assume that in case of green taxes a static optimum exists that corresponds to controlling the plant towards other setpoints than the legislative, but still rather constant setpoints. Thus, the same control strategy as described above may be applicable.

Chapter 8 Selection of Controllers

Having established that nitrification and denitrification can be divided into two separate control problems, the next step is to find a suitable set of controllers for the two parts. It has been established that for nitrification, the major control handles are the DO setpoint and the sludge outtake flow rate, and for denitrification the major control handles are the internal recirculation flow rate and the external carbon dosage. In this chapter, controllers for each of these four major control handles in pre-denitrification systems are suggested. Especially, issues regarding the selection of measurements and measurement location as well as the selection of controller type are discussed. These two issues are important steps in the design of control structures. Generally, the philosophy of the suggestions is that online sensor information is advantageous and that the location of the sensors providing the signals for control should be located as close to the processes as possible. Thereby it is possible to use comparably simple controllers using well-known methodology, primarily dependant on the use of PID controllers.

Several controller options exist for each control handle ranging from simple PID and on/off controllers to advanced controllers such as model based -, feedforward -, gain-scheduling -, non-linear -, fuzzy controllers and controllers with dead-time compensation, etc. In this work, it is argued that when choosing the controller type a sensible selection criterion is to choose the simplest one that satisfies the requirements. Simple controller types such as on/off and PID also have the advantage that they represent well-known methodology at wastewater treatment plants and thus are more probable to gain wide acceptance. A more advanced type of controller can be chosen if it provides important benefits such as better control, larger energy savings, increased robustness or easier tuning. Other important criteria are that the controller should if possible be based on existing and reliable sensor

technology, involve as few sensors as possible and only if necessary rely on models.

8.1 DO setpoint control

Aeration control has received much attention in literature and in practice. An important reason for this is naturally that the cost of aeration is one of the major operation costs in a wastewater treatment plant see Figure 4.3 and Table 6.3.

Most wastewater treatment plants have means to control the DO setpoint, by on/off, PI or cascaded PI controllers. Such controllers are not new and will therefore not be discussed further here. However, because many wastewater treatment plants experience trouble with such controllers some practical hints on how to control the DO concentration will be given in Section 10.1. In this section, it will be assumed that DO can be controlled at any setpoint trajectory with a short response time. Therefore, the dynamics of this controller are not discussed further. A PI controller takes care of DO control in the dynamic simulations that are referred to in the following.

Time frame of effluent criterion

The first issue to discuss is which class of controller (according to the classification system in Section 6.2) that should be applied in the case of the supervisory DO setpoint controller in the following referred to as the ammonium controller. The required class of an ammonium controller depends on the formulation of the effluent criterion.

1. If an effluent ammonium criterion is defined, the ammonium controller should be able to comply with this in the required time frame. The requirements for the controller are considerably stricter if short time frames apply (e.g. if grab samples are used) than if long time frames apply (e.g. if weekly averages are used).
2. If no ammonium criterion is defined, the ammonium controller should be able to keep an effluent ammonium setpoint on an average within a time frame of a couple of days. The chosen ammonium criterion is internal, which means it is defined based on

operational issues only. The two main issues to consider are robustness (see Section 6.4) and energy consumption.³

Disturbance rejection for ammonium removal is defined in the sense that influent load variations are met by a varying nitrification capacity in order to create a close to constant effluent ammonium concentration. According to model simulations, this property does not yield significant energy savings when a criterion is formulated based on a long time frame. In fact, simulations show that higher disturbance rejection leads to higher energy cost per removed load of ammonium, which will be shown later, this is however contradicted in the full-scale experiments documented in Section 10.5.

Options for the ammonium sensor position

The number and locations of sensors are important issues when determining the type of ammonium controller. In Figure 8.1, the most obvious locations for ammonium sensors are depicted. These options can be divided into a group with the purpose of giving feedforward information (positions 1 to 3) and another group providing feedback information (positions 4 and 5). A controller based solely on sensors in feedforward positions has the weakness that a good model of the nitrification process is needed and that this model cannot be updated by looking at the response from feedback sensors. Therefore, in general a feedback controller is needed, either giving feedback from the outlet of the aerobic reactor or from the effluent of the secondary settler. Feedback controllers can be combined with feedforward information from sensors at positions 1, 2 or 3.

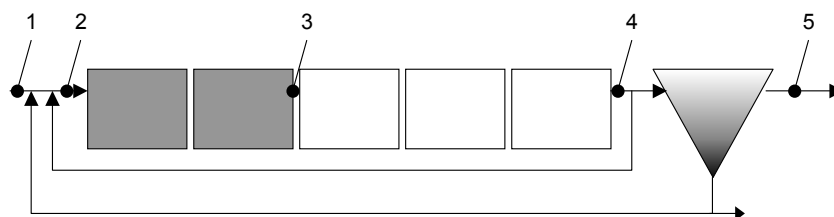

Figure 8.1 Options for locations of ammonium sensors.

³ In some cases special attention is paid to the receiving waters of the effluent by controlling the ammonium content to a rather low value in order to minimise the risk of toxic incidents during high pH episodes. Such considerations should pertain to the external effluent ammonium criterion.

Taking a closer look at the ammonium sensor location options for feedback control, the advantage of using feedback from the effluent of the secondary settler is that all reactions taking place in the settler are also included in the feedback information. However, as nitrification is assumed to take place to a limited extent in the secondary settler, due to lack of dissolved oxygen, this argument may not be so important. A more important feature of this sensor position is that the sedimentation unit causes a severe time delay of the signal to the reactions actually taking place in the nitrification reactor. The delay is often in the range of several hours up to half a day (in the benchmark simulation platform the delay is 3.6 hours on an average). This severely reduces the opportunities for using this measurement to react to daily variation taking place in the nitrification reactors. However, slow variations can be reacted upon by a controller based on a sensor located at this position.

A sensor position at the end of the aerobic reactor makes it possible to react to daily variations and to some event disturbances. A controller based on this sensor position can be further enhanced by supplementing it with a feedforward controller, based on one of the three positions proposed in Figure 8.1. Controllers based on each of the two feedback positions and a feedforward position is tested later. However, an analysis on how to control the DO profile is carried out first.

Optimisation of the DO profile

In the case of the benchmark simulation platform and many other wastewater treatment plants, several reactors or zones in a series are applied to improve the performance and the flexibility of the aeration system. The question is how to treat these reactors in series? Should the same setpoint be applied in all, or is there a certain DO profile that shows advantages over others? A steady state analysis of this problem has been carried out in EES, see description in Appendix C. Here the benchmark platform is implemented with an ideal settler. The internal recirculation flow rate is controlled to keep a nitrate setpoint in the second reactor at 2 mg/l $\text{NO}_3\text{-N}$ and a sludge age of 8 days is maintained in all simulations, while the sludge recirculation is set equal to the influent flow rate. The experiment includes testing a number of DO profiles, which is done in the following way. The dissolved oxygen in each of the three reactors is varied so that the resulting effluent ammonium is always the same, namely 4 mg/l $\text{NH}_4\text{-N}$. This is done by varying the DO setpoints in reactors three and four in a specific range

and then adjust the DO setpoint in reactor five from simulation to simulation to ensure the effluent ammonium criterion. Energy consumption and the effluent total nitrogen concentration are investigated. Energy consumption can be expressed at least in two different ways, either as the sum of the required K_{La} or as the transformation of K_{La} into energy. The later is based on the formula given in the benchmark simulation platform. The advantage of the sum of K_{La} is that it is not aeration system specific, as the energy consumption formula, which is given for Degremont DP230 porous disks. Hence, both parameters will be investigated in the following.

From an energy point of view, steady state simulations show that a minimum aeration need is achieved if the same DO setpoint is applied in all reactors. This is shown in Figure 8.2 for the sum of K_{La} . The plot for aeration energy have the same shape and optimum (hence it is not shown), however, the gradient is somewhat steeper, meaning that more energy is used the further the profile is away from the “optimum” than when looking at the sum of K_{La} .

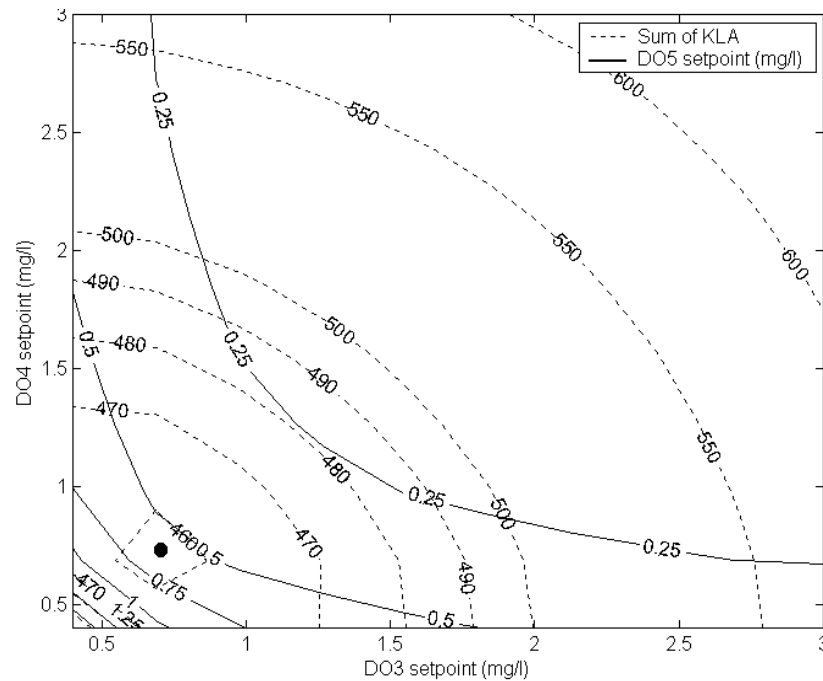

Figure 8.2 Sum of K_{La} as a function of various DO profiles (effluent ammonium concentration is kept at 4 mg/l $\text{NH}_4\text{-N}$).

Minimisation of effluent total nitrogen is an alternative criterion to test. Qualitatively, two issues seem important. Firstly, it seems that low DO in the beginning of the aerobic reactors (i.e. in reactor 3) may lead to increased removal of total nitrogen as simultaneous nitrification and denitrification can take place here if the DO setpoint is close to or below $K_{O,A}$ value. Secondly, it may be beneficial to lower the DO concentration in the last nitrification reactor (reactor 5) in order to reduce the internal recirculation flow rate of DO to the anoxic reactors. As can be seen from Figure 8.3 it seems that the issue of minimising the recirculating DO is the most important effect. At the lowest DO setpoint in reactor 5, the best effluent total nitrogen concentration is achieved.

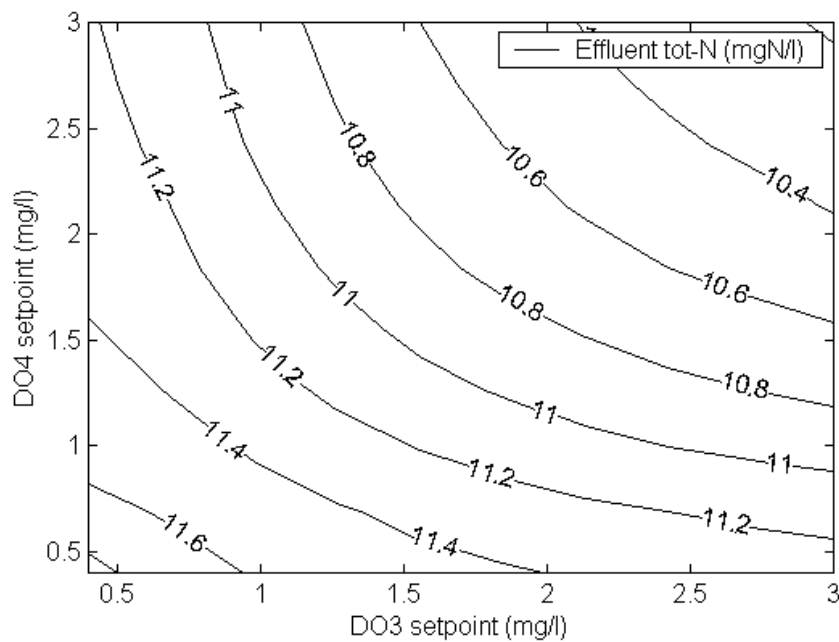

Figure 8.3 Effluent total nitrogen as a function of the DO profile (effluent ammonium concentration is kept at 4 mg/l $\text{NH}_4\text{-N}$).

The findings suggest that if the aim is to minimise energy consumption the DO profile should be “flat”, i.e. that the DO setpoints should be kept at the same level in all three reactors. If total nitrogen removal is the primary

objective a low DO in reactor five should have a high priority. Examples of the result of various DO profiles are given in Table 8.1.

Table 8.1 Examples of various DO profiles and their influence on total effluent nitrogen and the energy consumption.

DO3 (mg/l)	DO4 (mg/l)	DO5 (mg/l)	Tot-N (mg/l N)	K_{La}
0.7	0.7	0.6	11.6	456
1.6	1.3	0.2	10.4	494
1.0	1.0	0.3	11.3	466
1.8	1.8	0.13	10.8	527
3	3	0.067	10.2	661

Test of feedback controllers

As suggested in Figure 8.1, there are several options for the control of the DO setpoint based on ammonium sensors, depending on the location of sensors. Here different control structures primarily based on feedback controllers will be tested.

Firstly, the importance of sensor location in feedback control is investigated by applying a simple PI controllers to an ammonium sensor located at the outlet of the last aerobic reactor (reactor 5) and in the effluent from the secondary settler, respectively. In the following, the controller based on an ammonium sensor located in the effluent will be called the *effluent controller*, while the controller based on the sensor in the last aerobic reactor will be called the *in situ controller*. Both controllers are controlled towards an ammonium setpoint of 4 mg/l $\text{NH}_4\text{-N}$. The result of the two simulations can be seen in Figure 8.4 and Figure 8.5, where the scale of the y-axis is the same for the sake of comparison.

In both simulations, a sludge outtake rate of 100 m^3/day is used. This corresponds to a relatively long sludge age of 28 days. The reason for this high choice of sludge age is to give the system some control authority as described in Section 7.3. The controllers are limited by a maximum DO concentration of 4 mg/l and a minimum DO concentration of 0 mg/l. The importance of the choice of maximum limits is investigated later. The maximum limit of the K_{La} value that is implemented in the benchmark plant has been removed. The aerobic reactors are simulated as one reactor with the volume of 4000 m^3 . In the PI controllers, a gain (K) of 1 and an integration time (T_i) of two days are used. This choice of high T_i puts the

main control ability on the proportional part. The simulations were run until a stationary response was reached for a whole week. The figures show the last week of the simulations.

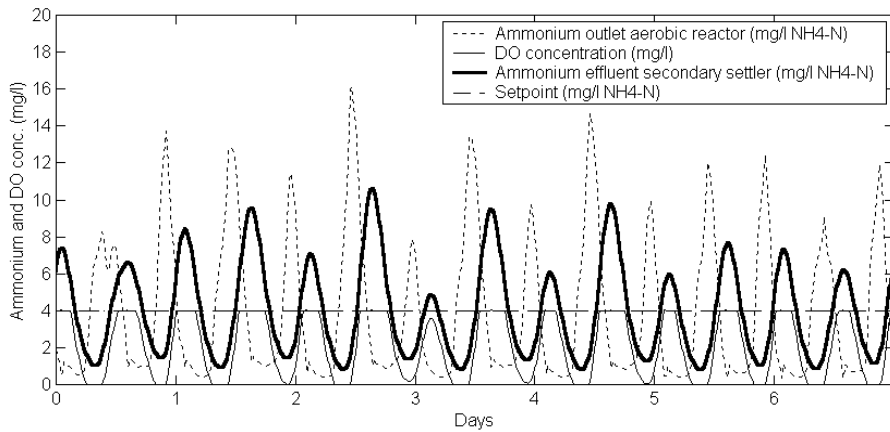

Figure 8.4 Performance of *effluent controller* (a PI controller is used).

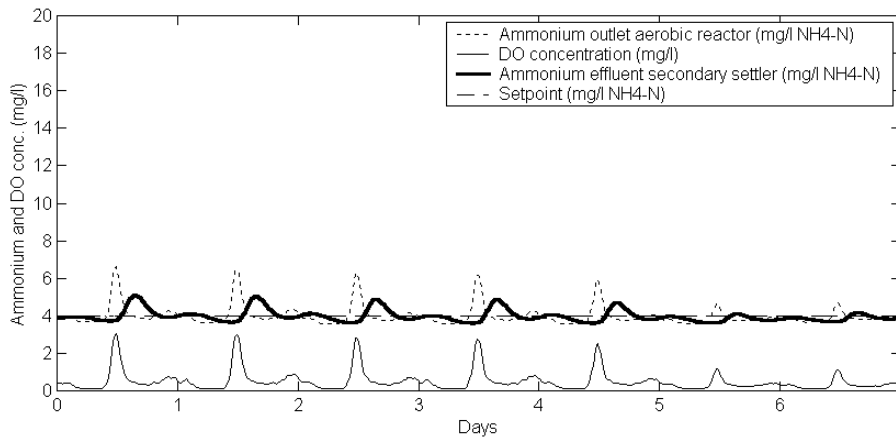

Figure 8.5 Performance of the *in situ controller* (a PI controller is used).

The PI controller increases the DO setpoint during high ammonium concentration. In the case of the *effluent controller*, this means that due to the long delay caused by the settler the DO is increased during periods when

the ammonium concentration in the reactors is actually rather low and vice versa. This gives a rather poor disturbance rejection. In the case of the *in situ controller*, the disturbance rejection is considerably better. Here it can be seen that the DO setpoint is increased at the right times. Obviously, the two controllers demonstrate quite different performances; the maximum effluent ammonium concentration in the case where the *effluent controller* is used is 10.6 mg/l NH₄-N, while the maximum value in the *in situ controller* is 5.1 mg/l NH₄-N. By decreasing the integration time constant to 15 minutes in the *in situ controller*, the performance of the controller can be improved to a maximum effluent ammonium concentration of 4.7 mg/l NH₄-N.

The importance of the long sludge age has been investigated by doubling the sludge outtake (200 m³/day), which leads to a sludge age of 16.9 days. Using the *in situ controller* this increases the maximum ammonium concentration over a week to 5.6 mg/l NH₄-N. The maximum effluent ammonium concentration naturally depends on the maximum allowable DO setpoint. An investigation of the effect of various maximum DO setpoints was also performed and the results can be seen in Table 8.2.

Table 8.2 Effect of the choice of maximum DO setpoint in the *in situ controller*.

Qw, sludge age	Max DO (mg/l)	Max effl. NH ₄ (mg/l NH ₄ -N)	Mean effl. NH ₄ (mg/l NH ₄ -N)	Sum of K _L a (day ⁻¹)
100 m ³ /day	2	5.30	4.00	170
Sludge age: 21.8 d.	4	4.88	4.00	184
	6	4.79	4.00	210
250 m ³ /day	2	7.06	4.41	166
Sludge age: 10.5 d.	4	6.32	4.23	187
	6	6.04	4.2	241
385 m ³ /day	2	8.98	5.00	169
Sludge age: 7.1 d.	4	7.94	4.59	206
	6	7.54	4.46	293

As can be seen from the table only the control strategy applied to a long sludge age (21.8 days) leads to average effluent concentrations of 4 mg/l NH₄-N. At lower sludge ages the controller is not sufficient to ensure this average setpoint, neither its maximum value. In these cases, a supervisory controller based on a moving average filter should adjust the ammonium

setpoint to obtain the desired effluent concentration. An example of the performance of such a corrected controller can be seen in Figure 8.6, where a sludge outtake of 385 m³/day (sludge age of 7.1 days) is used together with a maximum DO limit of 6 mg/l. The resulting average effluent ammonium concentration is here 4 mg/l NH₄-N.

Looking more into detail at the case with a sludge age of 21.8 days, it can be seen that when a higher maximum DO setpoint is allowed the disturbance rejection ability is improved slightly, but this is at the cost of a significant increase in the consumption of aeration energy. An alternative to increasing the sludge age is to increase the aerobic volume (with consideration to the anoxic volume).

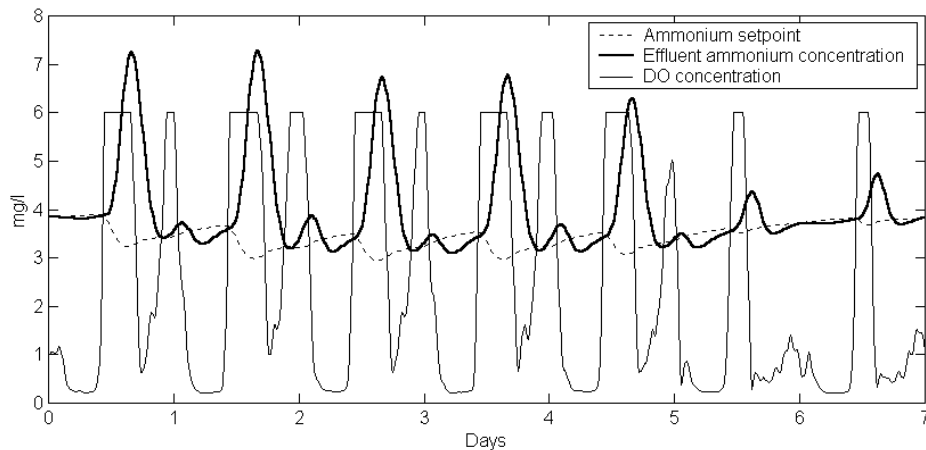

Figure 8.6 *In situ* PI controller with a correcting term to ensure correct average effluent ammonium concentration.

The problem with the *effluent controller* is not easy to solve as the information is so seriously delayed. However, this does obviously not mean that the information from this sensor location is worthless. Instead of a PI controller a slow integral controller, also called a floating controller can be used. A floating controller ensures that the setpoint is reached on an average over a period of several days. It can be compared to the work done by operators where the DO setpoint is adjusted to account for slow variations based on effluent measurements of ammonium either from a monitoring sensor system or from grab samples. Such a controller does not react

directly on the error but only on the integrated error. Therefore, it has no direct effect on sudden disturbances. Instead, it slowly adjusts the DO to reach a certain average effluent ammonium concentration. The simulation of such a strategy can be seen in Figure 8.7. Here a long period of simulation is chosen to show how the *effluent floating controller* slowly finds the right (close to) constant DO setpoint. In fact, it can be seen that the disturbance rejection ability of this controller is better than the *effluent PI controller* as the maximum ammonium concentration in the effluent from the secondary settler is 7.9 mg/l NH₄-N (compared to 10.6 mg/l NH₄-N in the case of the PI controller). This indicates that the *effluent controller* based on PI increases the disturbances rather than reduces them.

The energy consumption (in terms of average $K_{L,a}$) of the *effluent floating controller* is 159, while for the *in situ PI controller* the average $K_{L,a}$ is 166 (i.e. 4.4% more $K_{L,a}$ is used by the *in situ controller*).

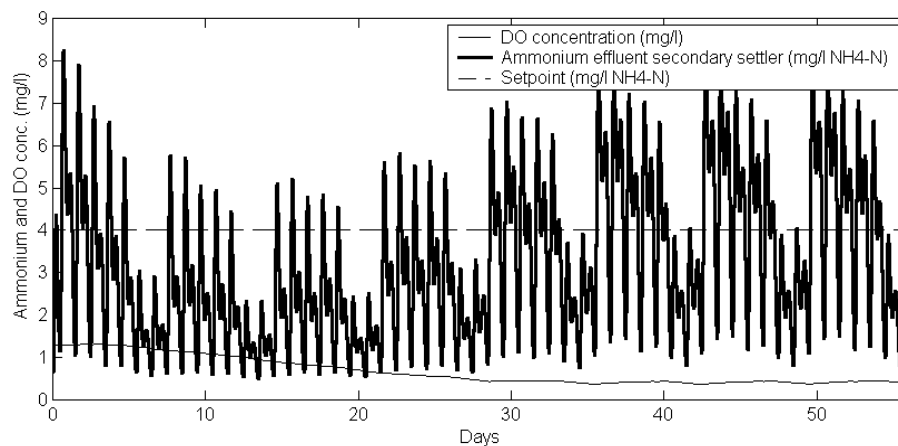

Figure 8.7 Performance of the *effluent floating controller*.

Test of feedforward controllers

On the other hand, when disturbance reduction is the key objective of the ammonium controller an even better result may be obtainable by the introduction of a feedforward term. The next step is therefore to combine the *in situ PI controller* with a feedforward term based on the load of ammonium into the aerobic reactor measured by a sensor located in position

3 (see Figure 8.1), i.e. in the influent to the aerobic reactor. In this case, the simplest possible feedforward input is chosen namely a linear one; this controller is called the *in situ FFFB controller* (FFFB stands for a combination of FeedForward and FeedBack). The result of this concept can be seen in Figure 8.8.

The maximum ammonium concentration in the effluent from the settler in this simulation is 4.2 mg/l NH₄-N, i.e. almost full disturbance rejection. The K_{La} value for this control scheme is 178. The performance of the various controllers are summarised in Table 8.3. The table shows that an increased disturbance rejection can be achieved at the cost of higher energy consumption. That this needs to lead to an increased energy cost is contradicted in the full-scale experiments documented in Section 10.5.

Table 8.3 Performance of various controllers.

Controller type	Max NH ₄ -N (mg/l NH ₄ -N)	K_{La}
<i>In situ FFFB controller</i>	4.2	178
<i>In situ FFFB controller</i>	4.7	166
<i>Effluent floating controller</i>	7.9	159

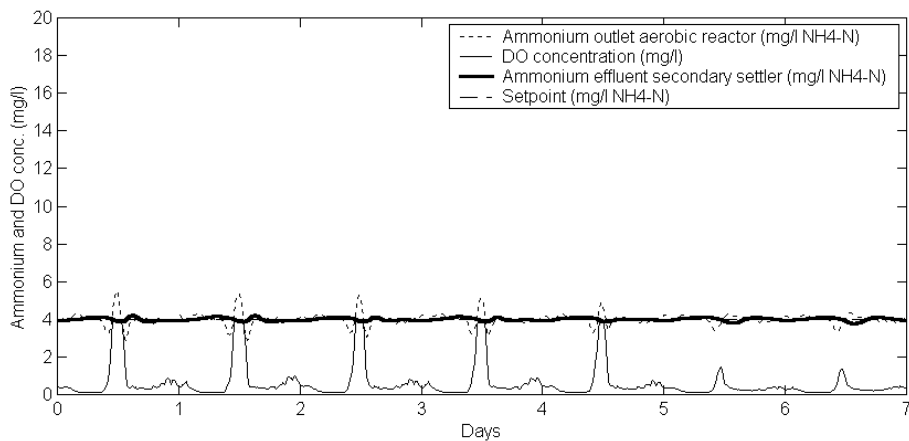

Figure 8.8 Performance of the FFFB in situ controller.

If a wastewater treatment plant can only afford one ammonium sensor in the line, the control structure designer also has a choice of implementing a pure *feedforward controller*. A pure *feedforward controller* has the disadvantage that a model of the nitrification rate as a function of the dissolved oxygen concentration needs to be estimated in order to achieve a constant effluent ammonium concentration. This is rather difficult, especially if no effluent sensors are available to correct for the estimated output error of the model. However, a simple linear load dependant *feedforward controller* on its own, like the one described in the *in situ FFFB controller* may also achieve reasonable results. Some manual tuning of the feedforward gain and offset needs to be done. This can be accomplished quite precisely in a simulation where the effluent data is available. However, it is much more difficult in full scale plants where only grab samples or daily averages are available.

An example of the performance of such a scheme is shown in Figure 8.9. Here the same offset and gain is used as in the *in situ FFFB controller*. The simulation example has an average effluent ammonium of 4.1 mg/l $\text{NH}_4\text{-N}$ and the maximum value is 6.5 mg/l $\text{NH}_4\text{-N}$ (average $K_{L,a} = 182$). This means that the performance regarding disturbance rejection lies in between the *in situ controller* and the *effluent floating controller* (although with a higher energy consumption). Better models than a simple linear one can obviously be found that may improve the performance, see for example suggestions in Ingildsen *et al.* (2002b).

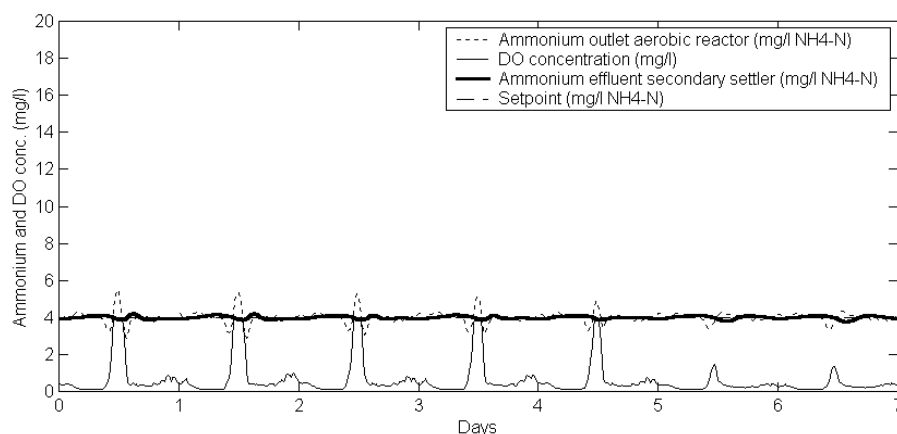

Figure 8.9 Pure feedforward controller.

Based on the above simulation cases it seems reasonable to conclude that by using an *in situ controller* a good controller performance can be obtained. The controller can be further improved by complementing it with a feedforward term to form a *in situ FFFB controller*.

Further tests of the *in situ controller*

The *in situ PI controller* is further tested where three aerobic reactors are placed in series instead of one large, i.e. more plug-flow like system. The DO setpoint is controlled at the same concentration in all three reactors. In this case, the maximum effluent ammonium concentration becomes 4.7 mg/l NH₄-N, which is the same performance as with one reactor.

Time delay in the sensor reduces the efficiency of the controller. In Table 8.4, an overview of the effect of various time delays in the sensor is summarised based on the benchmark simulation platform with the *in situ PI controller*. When the time delay was raised to 30 minutes, the controller had to be made slower by tuning. The controller efficiency can be evaluated by looking at the maximum ammonium effluent from the secondary settler. It can be seen that the performance is reduced when the response time of the sensor is increased. This underlines the importance of a short response time of the sensor.

Table 8.4 Overview of the importance of sensor response time.

Response time	K	T_i	Max NH ₄ -N effl.
0 min	1	15	4.7
10 min	1	15 min	5.1
20 min	1	15 min	5.3
30 min	0.3	6 hours	6.4

8.2 Internal recirculation flow rate control

In Section 7.3, it was established that the control authority of the internal recirculation flow rate was rather limited. In fact, steady state operational maps showed that when the concentration of nitrate at the end of the last anoxic reactor is in the range 1-3 mg/l NO₃-N no more could be gained by this control handle in terms of reduction of total nitrogen. It was

also shown that from an economical point of view it made little sense to reduce cost of pumping to discount the total nitrogen removal. This means that a controller that can maintain such a nitrate setpoint is sought. It is not critical that the setpoint is kept precisely at a certain setpoint; i.e. a deviation bandwidth of e.g. 1 mg/l $\text{NO}_3\text{-N}$ is acceptable.

The control of internal recirculation flow rate by means of a nitrate sensor at the outlet of the last anoxic reactor was proposed already in 1992 by Londong (1992). In Yuan *et al.* (2002) an elementary mass balance analysis on the biodegradable organic matter was carried out. The analysis concludes that in order to maximise nitrogen removal the most important aspect is to ensure that the anoxic fraction is kept anoxic, which implies a nitrate setpoint of approximately 2 mg/l $\text{NO}_3\text{-N}$ in the last anoxic reactor.

A PI controller has been simulated to control the nitrate concentration at the end of the anoxic reactor at 2 mg/l $\text{NO}_3\text{-N}$ in the benchmark simulation platform. The following settings were used for the remaining control handles (an ideal settler is used):

- The sludge return flow rate is constant at 18446 m³/day (equals average influent concentration);
- DO setpoint in reactors 3 to 5 is controlled by an in situ controller towards an ammonium setpoint of 4 mg/l $\text{NH}_4\text{-N}$ (no correction term);
- WAS is 385 m³/day.

The resulting nitrate concentration in the last anoxic reactor is shown together with the internal recirculation flow rate in Figure 8.10. This shows that a PI controller is sufficient for the control of the internal recirculation. At two incidents (day 0.5 and day 6.5), the nitrate concentration deviates some from the setpoint. At these setpoints, the actuator is at its max, i.e. the controller saturates. However, these deviations do not imply a serious deterioration of the controller.

If the nitrate sensor signal is delayed, the controller performance deteriorates. In fact, the controller needs to be made slower by re-tuning even for small response times. The performance when the nitrate sensor signal is delayed by 10 minutes is shown in Figure 8.11. In this case, a gain of 12500 and an integration time constant of 25 minutes are used. This is a significantly slower controller compared to the parameters used for the case with no delay (Figure 8.10). Here a gain of 100000 and an integration time

constant of 15 minutes were used. The poorer performance results in a slightly higher average effluent total inorganic nitrogen concentration (i.e. nitrate plus ammonium concentration) of 12.96 mg/l N compared to 12.73 mg/l N, without a delay in the sensor response.

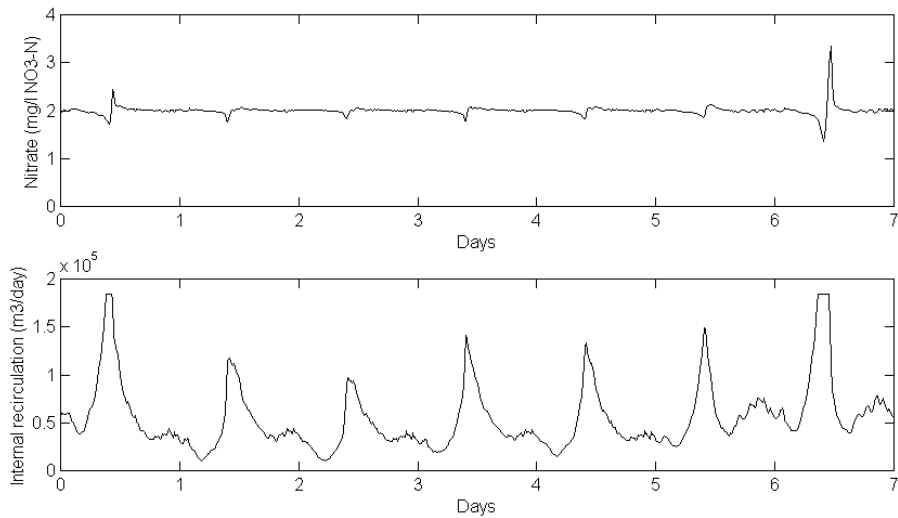

Figure 8.10 PI control of internal recirculation flow rate to obtain a nitrate setpoint of 2 mg/l in the end of the anoxic reactors.

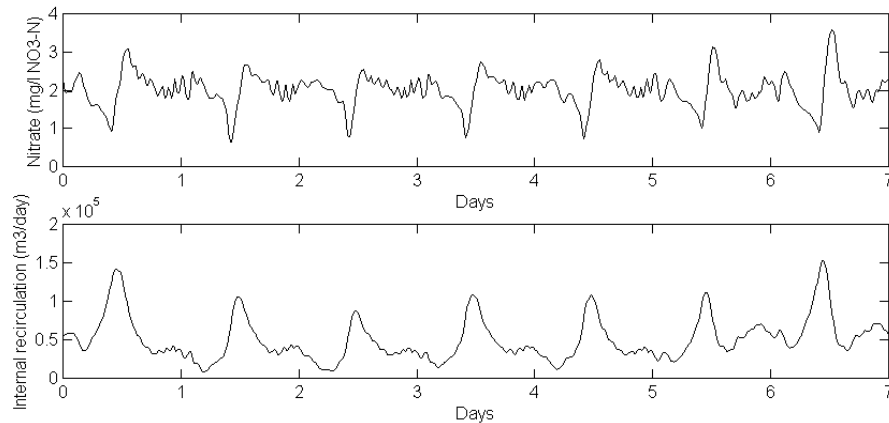

Figure 8.11 PI controller for internal recirculation flow rate using a nitrate sensor with 10 minutes response time.

One of the most widely applied internal recirculation flow rate control strategy is to apply an internal recirculation flow rate proportional to the influent flow rate (the other is applying a constant internal recirculation flow rate). The performance of this flow proportional control strategy (ratio control) and the nitrate setpoint strategy has been compared by means of stationary simulations (i.e. dynamic simulations of normal influent variation until stationarity is reached).

The stationary state result of the two strategies is shown in Figure 8.12 for various choices of ratios and nitrate setpoints. The results have all been “normalised” by dividing the average internal recirculation flow rate by the average influent flow rate to make the two strategies easily comparable.

Figure 8.12 shows that the constant nitrate setpoint strategy yields the best total nitrogen removal for all average recirculation flow rates. The difference in optimal effluent total nitrogen is, however, less than 0.5 mg/l total nitrogen at the optimal point. In it self the savings due to reduced pumping energy and/or the slightly improved nitrogen removal does not give sufficient benefit to argue in favour for applying this slightly more advanced strategy, which also requires a nitrate sensor. However, other advantages exist.

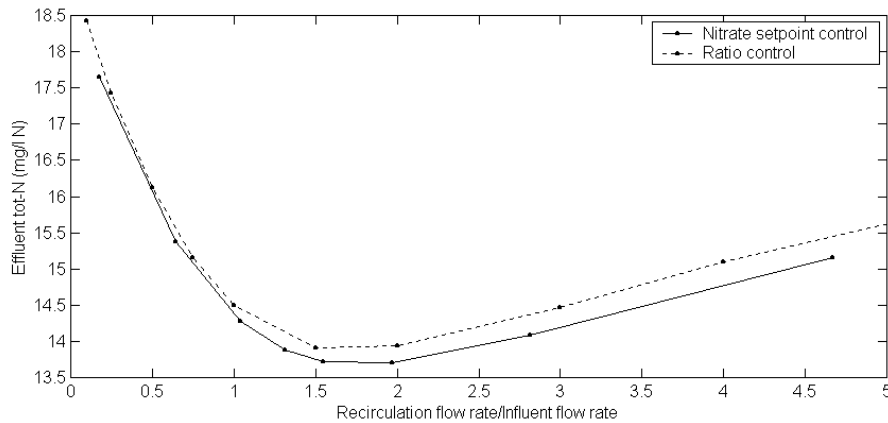

Figure 8.12 Comparison of ratio and setpoint control strategies.

One important advantage with the nitrate setpoint control strategy is that it is always known that the control handle is controlled close to optimality, while it in practice is more difficult to establish what is the optimal ratio in the flow proportional strategy. In the benchmark simulation platform (at the given conditions: sludge age, ammonium removal, volume distribution, etc.), the optimal factor is around 1.8, but in other plants and under different conditions the factor will be different. This difficulty in determining the optimal point is not the case with the nitrate setpoint strategy, because the optimal setpoint is approximately the same for a lot of different condition as established in Section 7.3. In Figure 8.13, the results of the nitrate setpoint simulations from Figure 8.12 are plotted as a function of the chosen nitrate setpoint. The figure shows that effluent total nitrogen is rather insensitive to the actual choice of nitrate setpoint, i.e. if the setpoint is chosen 1 mg/l too high or too low the control performance will not deteriorate significantly. It can also be seen that the deterioration is less severe when choosing the nitrate setpoint slightly too high than too low. The ratio controller, on the other hand, is more sensitive to wrong setting of the ratio.

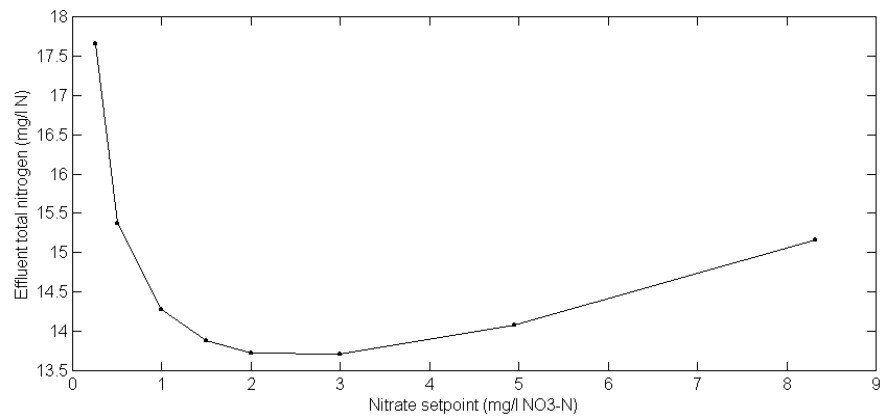

Figure 8.13 Effect of various nitrate setpoints.

Another clear advantage of the nitrate setpoint control strategy is its performance when denitrification rate, nitrate load or organic matter load changes. Nitrate load, for example, will change if the amount of nitrified ammonium changes, e.g. by change of control strategy by increasing or decreasing of the DO setpoints. In these cases, the nitrate setpoint control strategy adjusts the control to the situation, while the ratio controller only works close to optimality when the conditions are constant. An example of this adaptation can be seen in Figure 8.14. Here the same data is simulated for the two strategies ratio control, where the internal recirculation is controlled proportionally to the influent flow rate and nitrate setpoint control at the end of the last anoxic reactor. After 7 days, the influent concentration of easily degradable organic matter (S_S) is increased by 50%. In the simulations the optimum setpoints and rates are used according to Figure 8.12, therefore during the initial conditions the performance of the two strategies is almost identical.

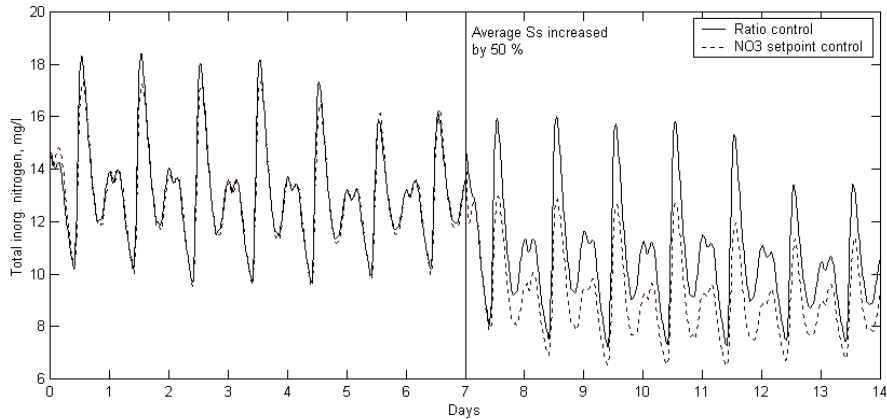

Figure 8.14 Comparison of the two strategies ratio control and nitrate setpoint control during change of organic matter in the influent.

However, the nitrate setpoint strategy performs significantly better when the amount of organic matter in the influent is increased. This is because the nitrate setpoint strategy increases internal recirculation to ensure full utilisation of the anoxic reactors independently of the changed conditions, while the flow ratio controller does not adapt to the changed conditions. In the first week the average total inorganic nitrogen effluent of the two strategies are 12.35 (flow ratio control) and 12.23 (setpoint control), while during the second week the effluents are: 10.07 mg/l (flow ratio control) and 8.56 mg/l (setpoint control). That means that an improvement of 18.5% was observed in the ratio-controlled case while the setpoint controlled case yielded an improvement of 30% attributable to the increase of easily biodegradable organic matter. Additionally, the amount of consumed K_{La} is smaller in the setpoint-controlled case because less dissolved oxygen is used for degradation of organic matter in the aerobic reactors. In the setpoint controlled case the K_{La} use increased by 1.22%, while in the ratio case it increased by 2.95%.

The principle of a nitrate setpoint control strategy is applicable regardless of effluent quality criteria, because the cost of internal recirculation flow rate is usually so small that it does not make any sense optimising the relationship between cost and quality. The strategy maximises total nitrogen removal (with a given volume and sludge age) as it

ensures full utilisation of the anoxic reactor volume. If this strategy does not meet the effluent total nitrogen criterion, there are several options for improvements, including increasing the anoxic volume (with consideration to the needs for the aerobic volumes), increasing sludge age or adding an external carbon source.

8.3 External carbon dosage control

As shown in Section 8.2, it is possible to control the internal nitrate recirculation flow rate to obtain a close to maximum removal of nitrate regardless of the choice of DO setpoints, sludge age or influent organic matter. However, if the system after the implementation of this scheme still does not meet effluent total nitrogen criteria one option is to apply an external carbon source. The dosage of external carbon should be controlled in order to just reach the effluent criteria for total nitrogen, as external carbon source is generally expensive. The control of the external carbon source has to be coordinated with the control of the internal recirculation. Both control handles affect the anoxic zone in the medium time scale.

Here it is suggested that the internal recirculation flow rate controller as suggested in Section 8.2 is supplemented with a controller that has total inorganic nitrogen (i.e. the sum of ammonium and nitrate) in the outlet of the aerobic reactors as input and the external carbon dosage as output. The structure is depicted in Figure 8.15.

Controller A ensures full utilisation of the anoxic volume and hence of the incoming organic matter regardless if it stems from an external carbon source or the influent. The second controller B controls the inorganic nitrogen content towards a given setpoint depending on effluent criteria. Controller C corrects this effluent total inorganic nitrogen setpoint depending on the type of effluent criterion. Additionally, some kind of safety limits should be applied to the dosage of external carbon. For example in the case of strong inhibition due to toxicity, the controller would increase the dosage beyond the reasonable.

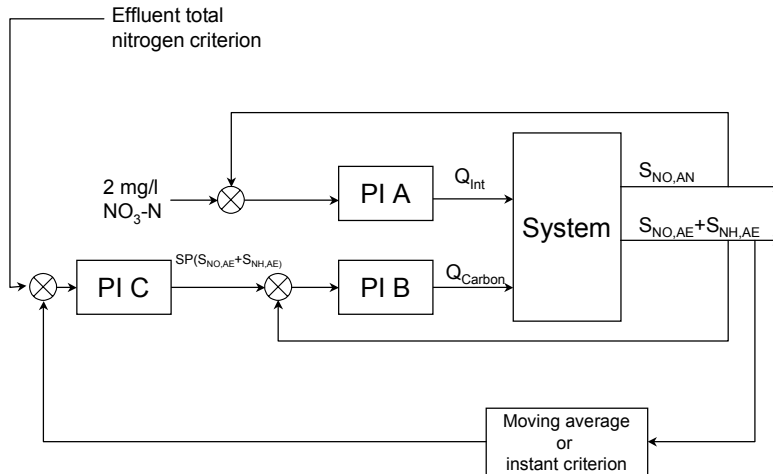

Figure 8.15 Control structure for the carbon dosage and the internal recirculation.

In wastewater treatment plants where the effluent criterion is based on instant values of total nitrogen the setpoint to the controller PI C does not do any correction, instead the maximum allowable value (instant criterion) is used directly as input to controller B. Possible overshoot in the controller will be smoothed out by the filtering effect of the secondary settler.

In wastewater treatment plants where the effluent total nitrogen criterion is based on an average value of total nitrogen over several days, the setpoint-correcting controller PI C corrects the setpoint by using a moving average filter of the inorganic nitrogen content from the outlet of the aerobic reactor as input.

Simulations have been carried out for both of the two situations. The performance of a controller where an average effluent total nitrogen concentration of 6 mg/l N is aimed at is shown in Figure 8.16. The correcting controller (PI C) corrects the setpoint by means of a moving average filter with a time constant of 7 days. The resulting effluent inorganic nitrogen can be seen together with the carbon dosage flow rates (SS concentration in the carbon dosage is assumed to be 3 000 000 mg/l COD). The in situ controller for the DO setpoints is applied (setpoint of 4 mg/l $\text{NH}_4\text{-N}$), RAS equals the average influent flow rate and the sludge outtake is set constant at 385 m³/day. The carbon dosage controller fulfils its aim by keeping the average effluent total nitrogen at 6 mg/l N.

The resulting instant setpoint into the controller B varies slightly around 7 mg/l N during the 21 days of simulations. Thus, a controller with an instant effluent criterion of 7 mg/l N has a similar performance (hence it is not shown).

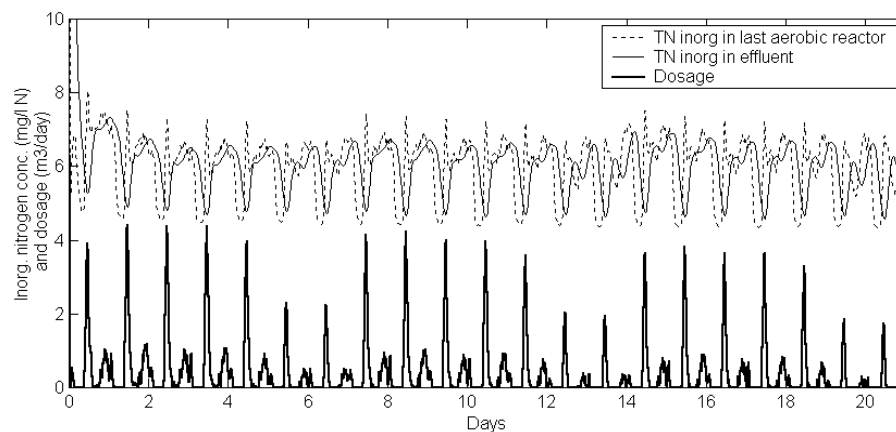

Figure 8.16 Carbon dosage controller performance (moving average effluent criterion of 6 mg/l $\text{NH}_4\text{-N}$).

8.4 Sludge age control

The sludge outtake rate is often expressed in terms of the sludge retention time (SRT) or sludge age. The control of the SRT towards a certain value is not particularly difficult. It is controlled by the sludge wastage flow rate, which is generally a variable that should be changed slowly and in many cases are manipulated manually. The control handles should be operated slowly and usually adjustments in the outtake flow rate are just made a number of times a year. This control could be automated by means of suspended solids sensors in one of the biological reactors and one in the sludge outtake stream (or the sludge return stream, assuming it has the same suspended solids concentration as the outtake stream). A slow (PI) controller with time constants in the range of several days or even weeks can be applied, where the input to the controller is a calculation of the sludge age and the output is the sludge outtake rate. Special attention should be given to compensate for situations with sludge escape. For this purpose a suspended solids sensor in the settler effluent is helpful.

A question that is more difficult to answer is which SRT to choose for the plant. Several factors influence this choice:

In favour of a long SRT are:

- Ensures that nitrifiers are not washed out;
- Gives higher control authority of the DO setpoint manipulation, i.e. a higher ability to reject disturbances, see Section 6.4;
- Decreases sludge production due to higher conversion of suspended solids into degradable substances.

In favour of a short SRT are:

- Ensures that the capacity of the settlers is sufficient, also to handle hydraulic shock loads. This implies less sludge escape or bypassing of the biological part of the plant;
- Reduces risk of filamentous bacteria, i.e. sludge bulking (Jenkins *et al.*, 1993);
- Additionally, it supports the growth of phosphorous accumulating organisms, i.e. the opportunity to remove phosphorous biologically, see e.g. Scheer and Seyfried (1996) or Rodrigo *et al.* (1996).

The cost of aeration has an optimum at a certain sludge age, because two factors are of importance to the cost of aeration. Firstly, the lower a DO setpoint that can be applied the less expensive, this factor points at a high sludge age. However, a high sludge age results in large endogenous respiration and hence a larger consumption of oxygen.

The choice of SRT is limited by two factors; upwards the SRT should not be any longer than the settlers can retain the solids. Downwards the SRT should not go lower than as to avoid wash out of nitrifiers. These limitations may vary over time as a function of temperature, sludge settleability, etc. In the span between the two limits, the choice is a matter of balancing risks, economy and control authority, see Figure 8.17.

A steady state analysis based on the benchmark simulation platform has been carried out in EES; see Appendix C. Here, the DO setpoints in the three aerobic reactors have been controlled at the same level. The selected level is chosen to result in the effluent ammonium concentration becoming exactly 4 mg/l NH₄-N. Internal recirculation flow rate is controlled to yield

a nitrate setpoint at the end of the last anoxic reactor of 2 mg/l $\text{NO}_3\text{-N}$. Various sludge ages have been tested ranging from six to twenty days and the effect on the sum of used K_{La} , the sludge production, the effluent total nitrogen and the concentration of nitrifiers in the system have been investigated. The last parameter -concentration of nitrifiers - to some extent indicates the control authority of aeration and hence the disturbance rejection ability regarding ammonium of the system as discussed in Section 6.4.

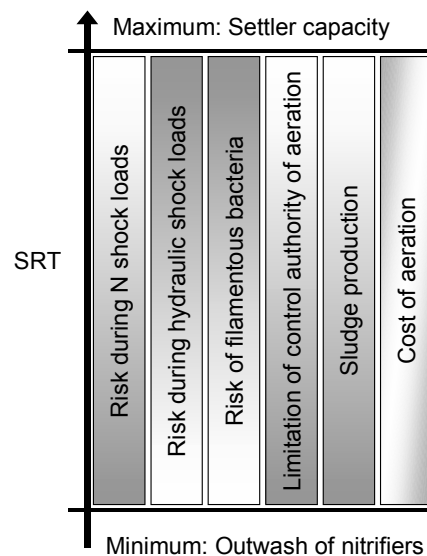

Figure 8.17 Considerations when choosing an appropriate sludge age. Dark colour indicates high risk, light colour indicates lower risk.

The result is shown in Figure 8.18. The figure shows that depending on the factor that is considered most important various choices of the SRT can be made. Seen from a pure energy point of view a sludge age of 7-8 days seems reasonable, while sludge production, total nitrogen and disturbance rejection aspects all point towards considerably higher values of SRT, which in real-life will be limited by the capacity of the settler (the simulator uses an ideal settler which has infinite capacity). If, for example, an effluent total nitrogen criterion of 8 mg/l N is given, a sludge age larger than 13 days should be chosen in order to avoid dosage of external carbon source.

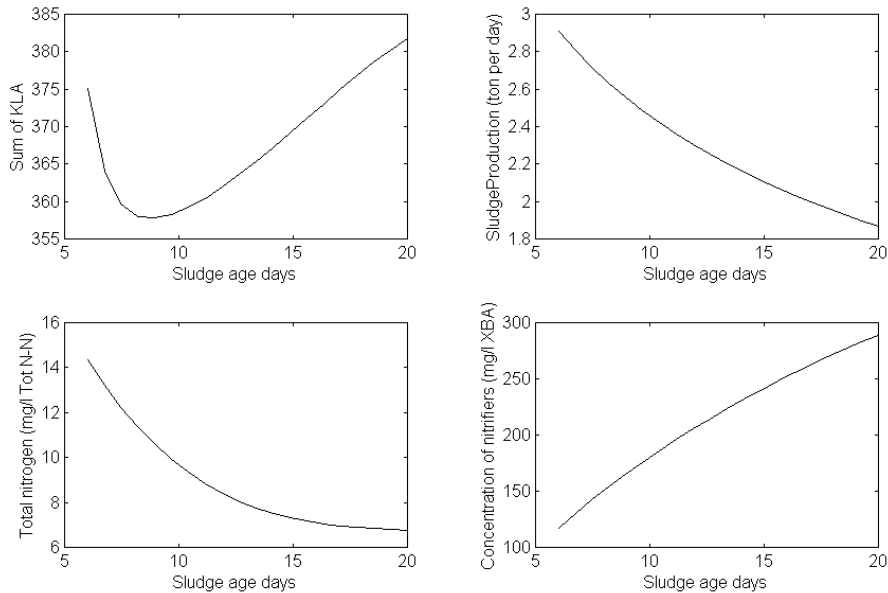

Figure 8.18 Steady state simulations of the sludge age.

8.5 Conclusions

Based on the tests of the controllers in this chapter it is possible to make some simple recommendations for the type of controller that needs to be applied in activated sludge BNR plants to comply with total nitrogen and ammonium effluent criteria.

The ammonium criterion

Three types of ammonium controllers are recommended. According to simulations, the larger the disturbance rejection the controller provides the higher is the energy consumption, so this offset needs to be considered. The controller with the strongest disturbance rejection ability is the FFFB in situ controller, which uses an ammonium load proportional feedforward signal from the inlet to the aerobic reactor(s) combined with a PI feedback signal from an ammonium sensor located at the end of the aerobic reactor(s). A slightly poorer disturbance rejection is obtained by using the in situ

controller, which consists only of the PI feedback signal from an ammonium sensor located at the end of the aerobic reactor(s). By using this type of controller only one ammonium sensor is necessary. The lowest disturbance rejection is obtained by the slow integral controller. This floating-point controller slowly adjusts the DO setpoint so that the average over a couple of days comply with a certain set point. Sensor location in the end of the aerobic reactor(s) or the effluent of the secondary settler can be chosen freely for the integral controller. This type of controller features the lowest energy consumption of the three controllers.

The shorter time frame the effluent ammonium criterion is based on the better disturbance rejection ability is needed. For example when grab samples are applied, the FFB in situ controller or at least the in situ controller should be used. While, if average samples over weeks or months are used in the effluent permit, the in situ controller or the slow integral controller may suffice. If no effluent ammonium concentration criterion is defined in the permit an internal operations related criterion should be used. In this case, the criterion should be complied with over a longer time frame, i.e. days or weeks.

By the application of controllers for the effluent concentration of ammonium considerable amounts of energy can be saved compared to a strategy of a constant DO setpoint. The reason for the saving is that when control is applied the safety margin that needs to be applied when using a constant DO setpoint can be reduced considerably. The savings depends on the normally applied safety margin. In WWTPs without an explicit ammonium criterion in the effluent permit, it might even not have been decided, which effluent ammonium concentration that suffice. A discussion of this and following testing of various options may lead to considerable energy savings.

The total nitrogen criterion

The application of controllers of total nitrogen depends largely on the current performance. If the effluent total nitrogen criterion is easily reached by simple control, such as constant internal recirculation flow rate or influent flow proportional internal recirculation flow rate, the value from an energy saving point of view (and hence from an economic point of view) of applying additional controllers is questionable. From an environmental point of view, on the other hand, a maximum removal of total nitrogen is

wishful, especially as the maximisation of the total nitrogen removal is reached without significant additional energy consumption.

If the effluent total nitrogen concentration, on the other hand, is close to the criterion defined in the permit, an internal recirculation flow rate controller based on an online nitrate sensor at the end of the anoxic reactor(s) should be applied to ensure maximum removal. This control loop is simple and no better alternatives have been identified in this work. If the implementation of this control loops is not sufficient to comply with the effluent total nitrogen criterion and it is necessary to apply an external carbon source, online control is crucial from an economic point of view, as external carbon source is usually expensive and hence the dosage should be minimised. A control structure for the combined control of internal recirculation flow rate and external carbon source dosage has been proposed. In the strategy, the internal recirculation is controlled as described above. This is combined with a feedback loop with the total inorganic nitrogen (i.e. nitrate plus ammonium) as input and the carbon dosage as output.

Optimising sludge age

When optimising the plant it is also possible to manipulate the SRT, which influence: aeration energy, disturbance rejection ability, minimum effluent total nitrogen obtainable and sludge production. The sludge age cannot be changed rapidly and is limited upwards by the settler capacity and downwards by the risk of nitrifier washout. Figure 8.18 show how the sludge age (SRT) influence various factors.

In summary, the stricter (short time scale) the effluent criteria are the more sensors are needed, with a maximum of two ammonium and two nitrate sensors. On top of the control structure, the sludge age can be optimised according to present priorities.

Another aspect, that is not dealt with here, is the optimal distribution between aerobic and anoxic volume and if possible the dynamic control of this distribution. Aspects of biological phosphorous removal has not been discussed either.

Part IV Full-Scale Experiments

Chapter 9 Experimental Set-Up

In this part of the thesis, a number of full-scale experiments with automatic process control are presented. The experiments were all carried out at the Källby wastewater treatment plant. This chapter contains a description of the plant, the experimental lines, the applied sensors, analyses, actuators and automation system. The actual experiments are presented in Chapter 10 (control of biological nitrogen removal) and Chapter 11 (control of chemical phosphorous removal).

9.1 The lay-out of the Källby WWTP

The Källby wastewater treatment plant is a primarily municipal plant serving 90 000 persons in the city of Lund, Sweden. The plant was originally built in 1933-1939 for mechanical and biological treatment with hand cleaned sedimentation basins, oxidation ditches and open sludge digestion dams. The oxidation ditches were the first in Sweden; today they are used as post-treatment lagoons. In 1959-61 sand catch, pre-sedimentation, fixed film reactors and post-sedimentation reactors were added. In 1972-74, the plant capacity was extended and two fixed film lines were added as well as reactors for chemical precipitation, sludge digestion and mechanical sludge treatment. In 1995-1997, the plant was retrofitted to include nitrogen removal. This was done by converting the fixed film lines to activated sludge pre-denitrification systems as well as building two new activated sludge lines also based on the pre-denitrification principle. The load into the plant is described in Table 9.1. A further description of the variation in the variables is given later in this section. The effluent criteria are given in Table 9.3. The full process layout is shown in Figure 9.1. Dimensions of the plant can be seen in Table 9.3.

Table 9.1 Influent load to the Källby WWTP.

Municipal wastewater	24000 m ³ /day
Industrial wastewater	1000 m ³ /day
Other water (e.g. rain)	0-20000 m ³ /day
Total dry weather flow	25000-45000 m ³ /day
Max flow rain	5000 m ³ /hour
Organic material	4900 kg BOD ₇ /day
Phosphorous	280 kg P/day
Nitrogen	1550 kg N/day
Sludge to digester	100-130 m ³ /day
	5.4-7.3 ton TS/day
Sludge after digestion	80-110 m ³ /day
	4.0-5.1 ton TS/day
Dewatered sludge	7000 m ³ /year
	1800 ton TS/year

Table 9.2 Effluent criteria.

BOD ₇	10 mg COD/l	Monthly average
Total P	0.3 mg P/l	Monthly average
Total N	12 mg/l N	Yearly average

Table 9.3 Dimensions of the plant components (numbers in parentheses represent the number of lines).

Grids	3*2500 m ³ /hour
Aerated sand catch (2)	310 m ³
Pre-sedimentation (10)	1600 m ³ (3100 m ²)
Biological line B1+B2	9400 m ³
Sedimentation B1+B2 (6)	1920 m ² (3840 m ³)
Biological line B3+B4	12500 m ³
Sedimentation B3+B4 (6)	1500 m ² (5200 m ³)
Flocculation (2)	1040 m ³
Chemical sedimentation (12)	2160 m ² (4320 m ³)
Sludge digestion chamber	3000 m ³

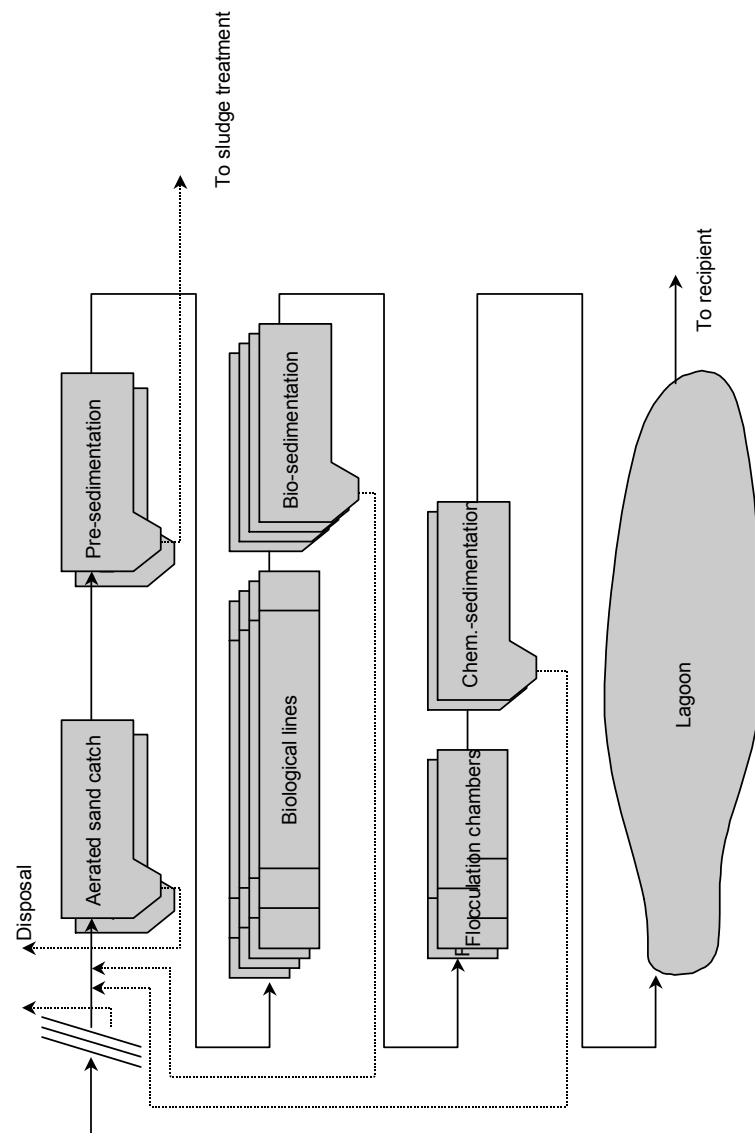

Figure 9.1 General plant layout regarding the water treatment, the Källby WWTP.

Pre-treatment of the raw wastewater consists of rough filtering followed by an aerated sand catch, which again is followed by a pre-sedimentation.

The biological treatment involves nitrogen removal and takes place in a pre-denitrification system with an option to include an anaerobic reactor for biological phosphorous release by redirecting the wastewater and the sludge in the system. This option was not used during the time of the experiments. The biological treatment is divided into four parallel lines (B1, B2, B3 and B4) including parallel secondary sedimentation. The lines are identical two by two. The layout of the biological lines used in the experiments is discussed in detail later.

After the biological treatment, the water streams are divided into two parallel identical chemical precipitation lines (K1 and K2) including parallel sedimentation. After sedimentation, the effluent is led to three large lagoons from where it flows into a nearby stream.

Sludge from the grids and the aerated sand catch are deposited directly. Sludge digestion of the remaining sludge is carried out on-site. Sludge for digestion is taken out only from the primary sedimentation. The sludge outtake from the biological and chemical sedimentation units are recycled to the aerated sand catch and hence taken out in the primary sedimentation as well. The sludge flow from the chemical sedimentation can also be re-directed to any of the biological reactors. This option is used during sludge escape events from the biological lines. In this way, the sludge is prevented from escaping the biological step by, in principle, extending the biological sedimentation volume with the chemical sedimentation volume, which usually has considerable over-capacity.

The sludge treatment starts with thickening of the sludge followed by anaerobic digestion. The digested sludge is further thickened by centrifuging before disposal. The gas produced in the digester is used to produce electrical power and heat.

9.2 The biological lines

The biological lines B3 and B4 are used for the experiments regarding nitrogen removal described in Chapter 10. The biological lines B1 and B2 are not used in the experiments and hence not discussed further. In the following, the lines will be referred to as the experimental line (B3) and the reference line (B4). The lines have the same construction with 10

consecutive zones (volumes of these zones are as stated in Table 9.4). The line layout is shown in Figure 9.2.

Table 9.4 Volumes of the zones in the biological lines (m³).

V1	V2	V3	V4	V5	V6	V7	V8	V9	V10
604	648	645	649	669	636	715	723	715	285

The aerated part of the biological line is controlled according to the DO profile principle see Section 3.3. The zones 4 to 9 can be aerated. Zones 4 and 5 and zones 6 and 7 are controlled together (two and two) based on one DO sensor, while zones 8 and 9 are controlled individually. Zones 5 and 7 can also be operated individually if the “partner zone” is unaerated. Mixers are installed in zone 1 through 6 as well as in zone 10. Zone 10 is considerably smaller than the others and is used for deoxygenation to reduce the amount of recycled oxygen via the internal recirculation.

Aeration is supplied by ceramic membranes at the bottom of the reactors. Three compressors supply air to the same air pipeline. The amount and rate of the compressors are controlled by a pressure setpoint. Hence, a pressure sensor is located in the pipeline. Control valves control the airflow rate to each of the controlled zones. The aeration is controlled by a feedback control system using cascaded control loops; see detailed description in Section 10.1.

The sludge sedimentation takes place in three parallel sedimentation units for each biological line. The sludge recirculation is controlled by three on/off pumps per sedimentation basin. This yields four different rates of pumping: 0, 10370, 20740 and 31110 m³/day. The sludge pump removes sludge ranging from 0 to 20 m³/hour. Finally, there is an internal recirculation pump that pumps water from zone 10 to zone 2. This flow rate can be varied continuously between 0 and 31100 m³/day (up to 3.7 times the average influent flow rate).

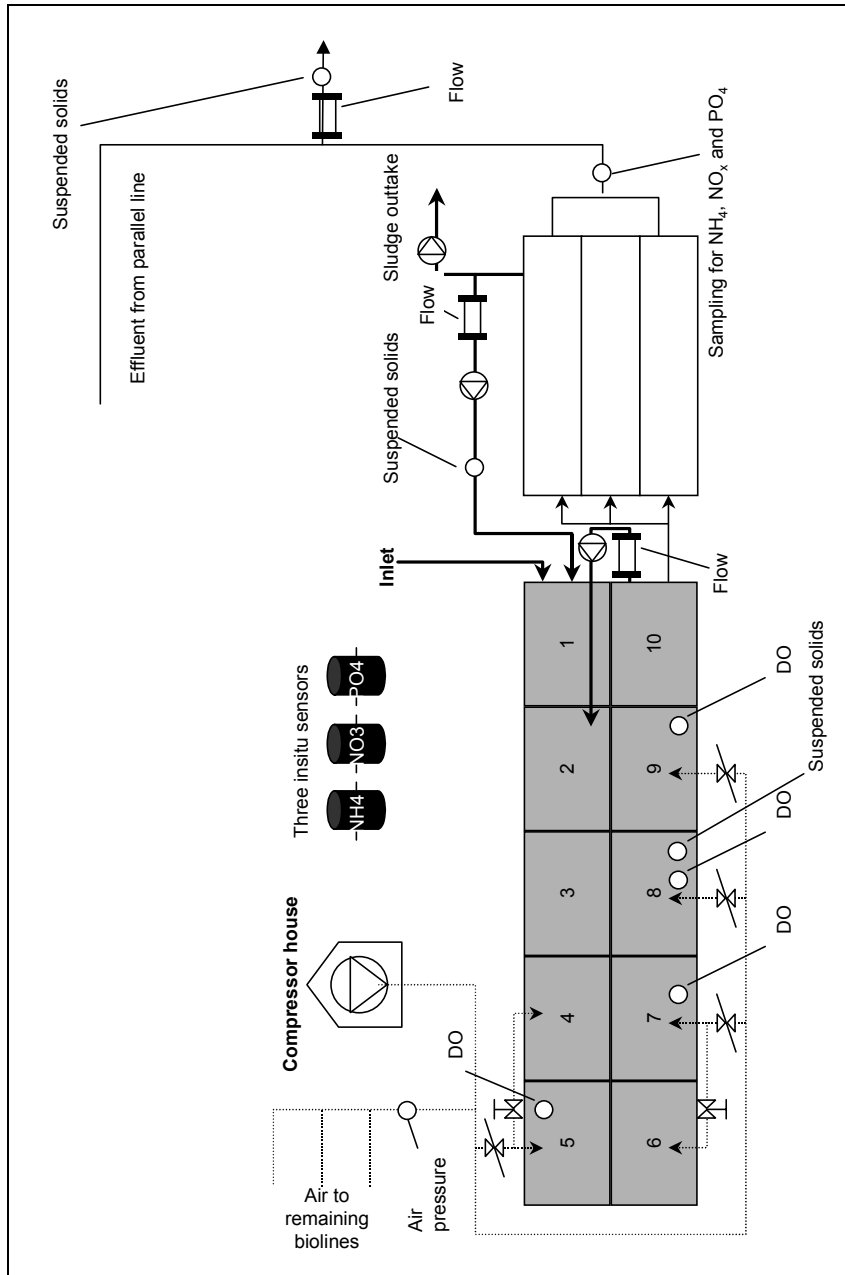

Figure 9.2 Layout of the biological lines.

The lines are equipped with:

- DO sensors in zones 5, 7, 8 and 9;
- Suspended solids sensors in zone 8 and in the sludge return;
- A sampling point for automatic analysers for ammonium, nitrate and phosphate concentrations in the outlet from the secondary settler;
- Flow meters on the two recycle pipes;
- A shared effluent flow meter measuring the sum of the flows from the outlets of the two lines B3 and B4.

In the experimental line, additionally three Danfoss InSitu[®] sensors are available: an ammonium, a nitrate and a phosphate sensor.

Investigation of whether the lines are identical

When performing experiments with parallel and identical lines with the purpose of comparing the two lines, it is of major importance that the loads to the experimental and the reference lines are the same. This is difficult to ensure at the Källby wastewater treatment plant due to the flow division and the lack of individual flow sensors for each of the lines. The flow division construction can be seen in Figure 9.3.

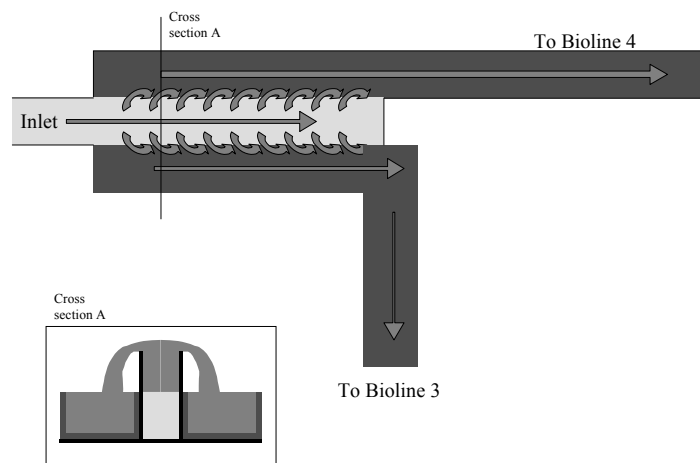

Figure 9.3 Flow splitting between the two biological lines.

The flow is divided over two straight weirs (length 2 metres). If the weirs are not adjusted to the exact same height a higher flow rate will cross the weir at the lowest position, causing an uneven flow distribution between the two lines. Hence, the weir heights were re-measured and adjusted in both ends. The final difference in height between the two is less than 1 mm. Additionally, long time series have been analysed where the two lines are controlled in the same way, i.e. the same sludge outtake, recirculation rates and DO profile. During these experiments the air consumption, the sludge accumulation and the effluent ammonium and nitrate concentrations in the two lines were close to identical over several weeks. The inaccuracy in ensuring a zero-difference between the two lines is estimated to be less than 3% (it is not possible to say which have the highest load). Hence, in the following the lines are assumed identical.

9.3 Variation into the plant

All wastewater treatment plants are subjected to a wide range of disturbances and variations. The number and range of the disturbances are important for the demands for disturbance rejection ability of the plant. It has earlier been suggested to classify external disturbances as diurnal variations, yearly variations and discrete event disturbances. The disturbances typically propagate through the system causing key process parameters to vary. In the following, examples of disturbances at the Källby wastewater treatment plant are shown.

Diurnal variations

Variations in the medium time scale (daily variations) are often recognisable from week to week. The most important variation in the medium time scale is the variation of the influent flow rate; see Figure 9.4, where a two-week time-series of flow rate measurements without event disturbances are plotted. Additionally, the influent concentrations of nitrogen and phosphorous vary during the day. The variation in concentrations has been measured during a normal 24-hour period in a measuring campaign in 1999. The result is shown in Figure 9.5. This shows that the variation in concentrations is moderate compared to the variations in flow. However, the combined effect of flow and concentrations yields quite a varying pattern in the biological reactors, see example in Section 5.3 on p. 97. The variation also causes variation in controlled variables, such as

the airflow rate. The total airflow rate to maintain a DO setpoint of 2.5 mg/l over a week can be seen in Figure 9.7.

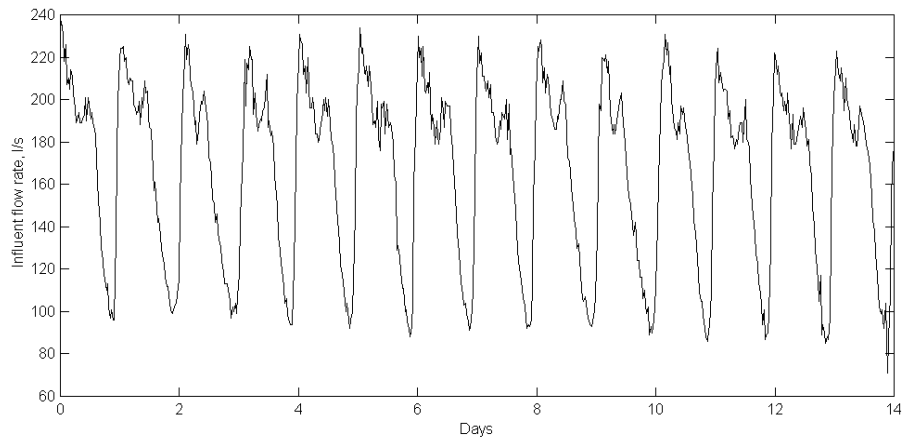

Figure 9.4 Flow rate pattern

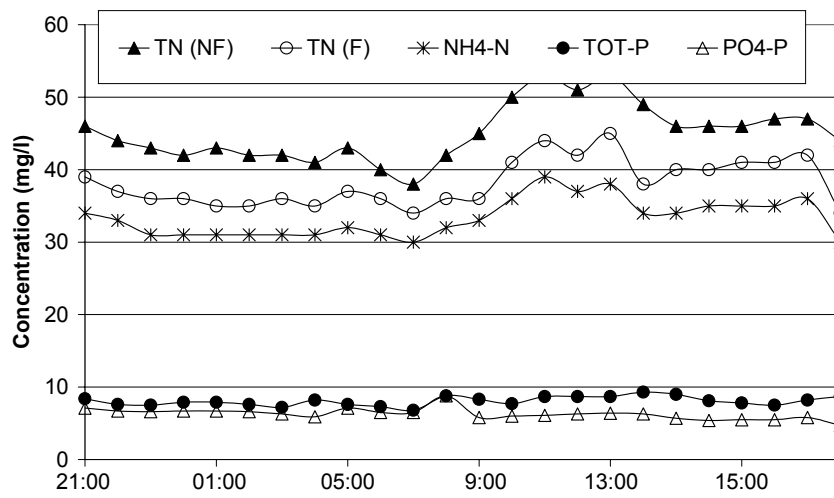

Figure 9.5 Variation in influent concentrations over 24 hours (September 28, 1999). (F) means filtered, (NF) means not filtered.

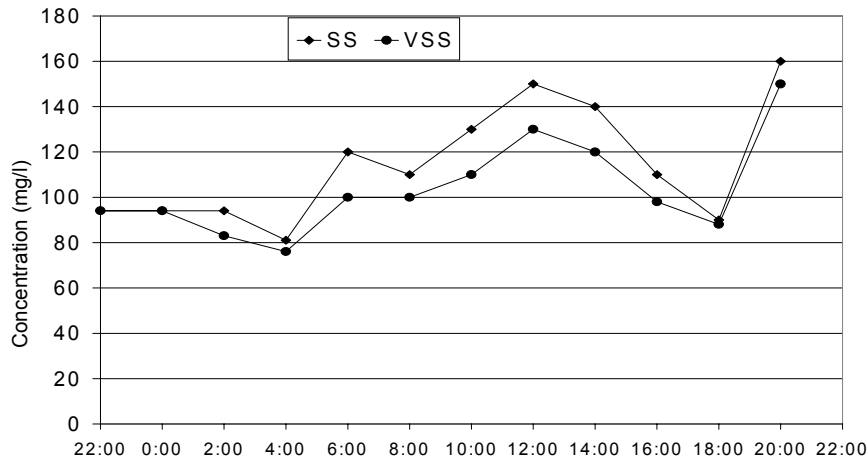

Figure 9.6 Variation in influent concentrations over 24 hours (September 28, 1999).

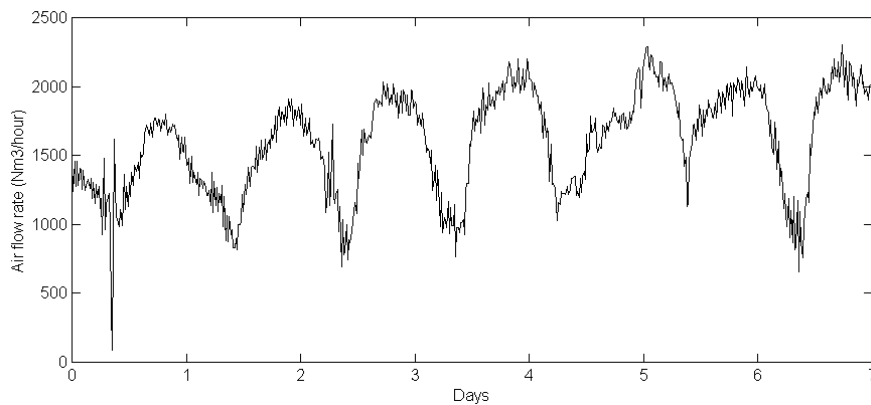

Figure 9.7 Variation in airflow rate to a biological line over a week.

The influent flow rate and the control strategy of the sludge recirculation also induce a daily pattern in the suspended solids concentration in the reactors. In principle, part of the sludge is shifted back and forth between the settlers and the biological reactors. This causes a daily variation in the suspended solids concentration at both places. The daily variation is in the range of ± 200 mg/l suspended solids or approximately $\pm 5\%$ of the total concentration.

Yearly variations

The wastewater treatment plant also experiences slow variations, with yearly cycles. Especially, the water temperature shows such annual variations. The temperature influences important parameters in the plant, especially with regard to the microbiological community. The sludge age and the number of aerated zones need to be adjusted according to the water temperature. At the Källby wastewater treatment plant, the water temperature typically varies between 7 °C and 20 °C over a year. The influent flow rate may also exhibit yearly variations. Being located in a university city the Källby wastewater treatment plant also experiences variations depending on the presence or absence of students. The load is reduced remarkably during the summer, when the students leave for summer vacation. The effect of rainy seasons is naturally also visible in the time series. At the start of the fall semester, the plant operates with a combination of two challenges, a significant increase in load and a falling temperature.

Discrete event disturbances

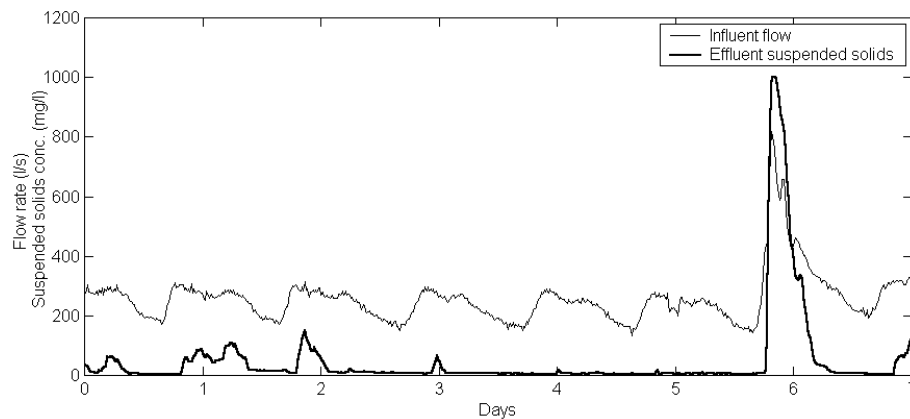

Figure 9.8 Sludge escape due to rain event on day 5 and 6.

Event disturbances happen more or less at random and can therefore not be predicted as is the case with the variations in the slow and medium time scale (at least to some extent). The best-known types of events are due to

rain or toxicity. These may seriously disturb the operation of a plant. At the Källby wastewater treatment plant, there are no records of major toxic events. However, rain events frequently disturb the sludge sedimentation; see an example of this in Figure 9.8. It can be seen that the settler is close to its maximum capacity as even daily flow variations cause escape of sludge (though in limited amount). However, when a large rain event occurs during days 5 and 6 a major sludge escape takes place. Another type of event disturbance is due to internal failures, i.e. due to sensor or actuator malfunctions.

9.4 Sensors

Sensor precision is of great importance when using the sensors for control. When performing parallel experiments for comparison the importance increases further. Therefore, a quality verification system has been introduced at Källby where the sensors are checked weekly. It is important to make the verification in a time-efficient manner due to the large number of sensors and the frequent checks necessary. Therefore, the methods are developed with regard to both precision and time-efficiency. In the following, the different types of sensors and their specific traits are described together with a description of how signal quality is verified for each of the sensors.

In situ nutrient sensors

The Danfoss InSitu[®] nutrient sensors for the measurements of ammonium, nitrate and phosphate have been described earlier (Section 3.3). At Källby, one of each type of sensor has been available throughout the experimental period. The sensors were installed on special rigs, which made it possible to move the sensors. The specific sensor location is described for each experiment. For moving the sensors, a crane was used; the operation required the work of two men for approximately an hour.

The checking of nutrient sensors located in the mixed liquor sludge is a rather delicate matter that requires great attention to sampling and analysis. Firstly, it has to be realised that the sludge keeps on transforming substances in the sampling glass. Therefore, the whole procedure from sampling to analysis has to take place as fast as possible. After extensive experiments, the following procedure has proved to be effective: A sample of approximately 200 ml of MLSS is taken out as close as possible to the

sensor measuring head. This is done by a sampling device that can be opened and closed under the overlying sludge covering (if such is present). The time of sampling is noted. The sample is filtered using a normal paper filter on site, to remove the majority of the sludge. Then the sample is taken as fast as possible to a micro filter where suction is applied to filter the sample. After this filtering, the sample is analysed by Dr. Lange cuvette tests. The whole procedure usually takes less than 20 minutes, including 10 minutes of reaction time in the cuvette tests. The corresponding sensor value is found “a response time” later than the sampling time. By using this procedure, it is possible to get a good precision.

Even for sensors in the chemical precipitation chamber the micro filtering is necessary. The difference between using normal filter paper and micro filtration is typically small, however, as the measurements are often in the range 0.4-0.6 mg/l even small deviations give large relative errors.

Effluent analysers

The four lines are sampled one at the time for 15 minutes, i.e. a new sample is available every hour for each of the lines. The flow of the sample is shown in Figure 9.9.

The flow into the sample box is large compared to the box size (i.e. short retention time). Hence, the water in the sample box is exchanged rapidly. From the sample box, most water is discharged immediately. The actual sample is taken from the sample box and led to a filtering unit. The filtering unit consists of a moving filter paper controlled by the pressure difference over the filter. The ammonium analyser receives the sample directly from the sample box without any filtering. There is a lag time in the system due to transportation time and response time of the sensors, but at the end of the 15 minutes sampling period the value is assumed representative. At the end of the sampling time interval the concentration value is saved as a zero-order hold system; see Figure 9.10. It is possible to see the individual as well as the combined sampling curves in the SCADA system.

Biological lines

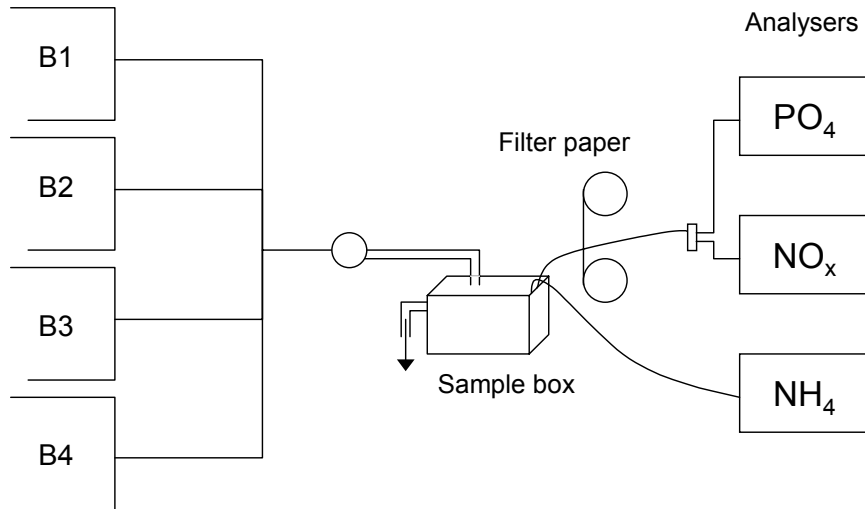

Figure 9.9 Sampling system for effluent analysers.

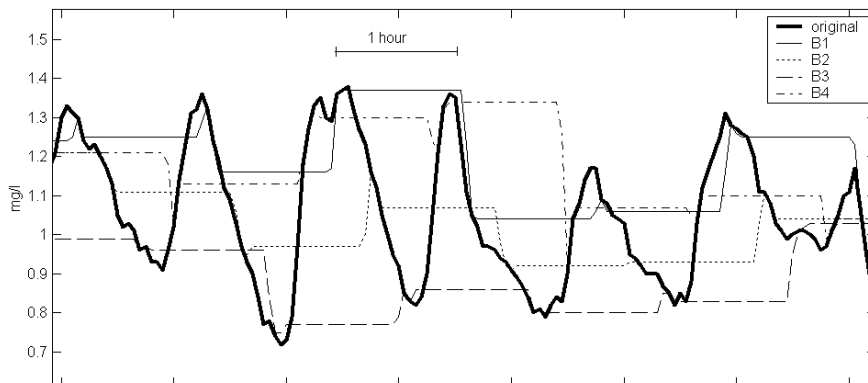

Figure 9.10 Sampling of the four biological lines (B1-B4).

The nutrient analysers are:

NO_x: WTW 201 Nitrate Analyser, which works with UV, i.e. no chemicals are added. Compensation for background colour is used.

PO₄: WTW P201 Phosphate analyser, which works with a colorimetric method based on Phosphor acid-Molybdat-Vanadat-Complex.

NH₄: Contronic Ammonium Monitor B462, which uses an electrode to measure the amount of ammonium in the liquid at a pH>11, where 98.3% is on the NH₃ (ammonia) form.

The verification of the effluent analysers is not quite as sensitive to the method of filtering as that of sensors in the mixed liquor, because the amount of active microorganisms present is small. Therefore, a fast analysis preceded by filtering by standard paper filters is sufficiently correct. The difficulty in verifying the traditional sensor type is rather where and when to check the sensor. At Källby WWTP, the following procedure has shown effective: A sample is taken from the effluent, filtered and analysed. The value is checked against either the sensor output closest to the sampling time or as an average of the preceding and the following sensor sample. This method works because the variation in concentration from hour to hour in the effluent is generally slow.

DO sensors

Danfoss Evita DO sensors are used in the biological lines. A sensor is located in each zone where the aeration can be aerated individually. The DO sensors consist of a Clark cell, described in Section 3.3. The sensors are reliable and stable. The required maintenance is washing and calibration once every two weeks.

Suspended solids sensors

The suspended solids sensors are all of the type CERLIC 9540. The sensors work by measuring the reflection and absorption of infrared light in the NIR range. To ensure a satisfactory operation of the sensors they have to be cleaned biweekly. The sensors have been checked weekly for an extended period, showing stable values without drift and therefore calibration is rarely requested.

Airflow sensors

The airflow sensors are of the type “Kontram type AF 88”. The measurement compares the temperature at two locations in the airflow stream between which the air stream is heated. The temperature difference is proportional to the flow velocity. The airflow meters are used for the cascaded control loops of the DO setpoint. Additionally, the sensors are used for measuring the amount of energy (indirectly) used by different control strategies, when comparing parallel experiments. After initial experiments at the plant, it became apparent that several of the airflow sensors were not calibrated correctly. Therefore, a calibration procedure was devised. The procedure revealed great differences in terms of calibration of the sensors.

The airflow sensors’ calibrations were carried out twice. The first time on April 27, 2001 and the second time on May 5, 2001, this time more thoroughly. The two experiments yielded approximately the same results. Therefore, only the second experiment is documented here.

The basic idea of the calibration procedure is to run one compressor at minimum speed and only let air through one valve at a time. It is assumed that the airflow at this speed is constant regardless of which valve is opened. Therefore, it is possible to correct the airflow sensors by multiplying each measured airflow rate by a specific factor. This factor does not mean that the measurement becomes exact. Rather it adjusts all the sensors to be comparable. As a fully closed valve yields zero Nm^3/hour for all sensors, it is assumed that no offset exists.

The influence of the pressure on the airflow was investigated. This was done by slowly closing a valve to increase the pressure and at the same time measure the airflow at different pressure levels (four different levels were measured), see Figure 9.11. In the actual calibration procedure, the pressure was changed from 0.543 to 0.583 bars, which means that the airflow changed 4% from maximum to minimum. As this is considered significant, the airflow is corrected according to the regression line in Figure 9.11.

Additionally, it is not safe to open only one valve (for all valves) at a time, as minimum compressor speed yields too high an airflow for the smallest of the valves. Therefore, in some cases more than one valve are open simultaneously. The results of the aeration experiment are shown in Table 9.5. The valve name is the biological line number followed by the number of the zones that the valve supplies with air.

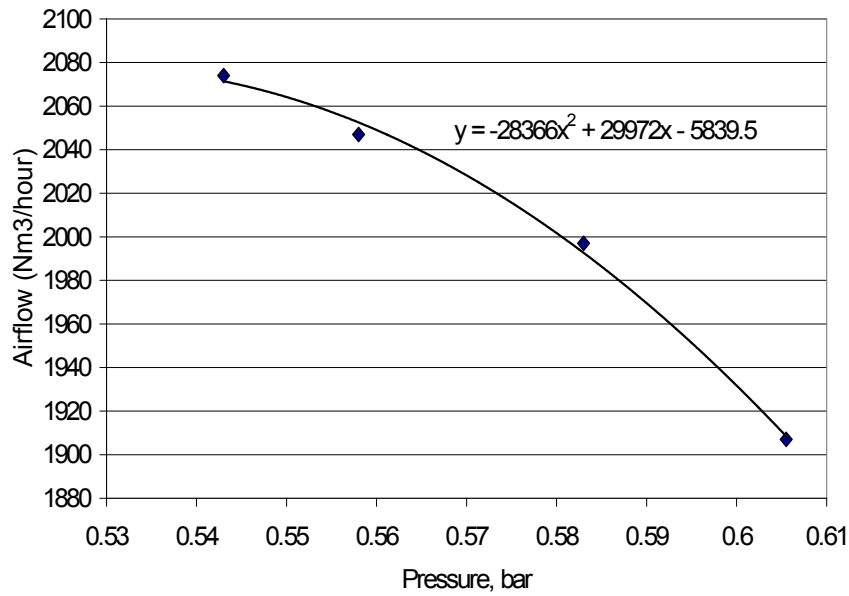

Figure 9.11 The influence of pressure on airflow (compressor is operated at minimum speed).

Table 9.5 Measurements in aeration experiment.

Valve name 1	Valve name 2	Flow 1	Flow 2	Sum of flow	Pressure	Corrected sum of flow
3_67		1996		1996	0.547	2065
4_67		2074		2074	0.543	2074
3_8	3_67	453	1195	1648	0.578	2009
3_9	3_67	889	1236	2125	0.583	1997
3_67	4_8	1146	1071	2217	0.572	2022
3_67	4_9	1350	1001	2351	0.576	2014
4_67	3_8	1185	481	1666	0.5675	2030
4_67	3_9	1302	831	2133	0.58	2004
4_67	4_8	1077	1238	2315	0.554	2053
4_67	4_9	1267	1185	2452	0.5755	2015
3_67	4_67	1088	1096	2184	0.555	2052
4_8	3_8	930	667	1597	0.5595	2044

The least square method is applied to find the correction factors that fit the data best. The final correction factors are given in Table 9.6. The correction factors for airflow sensors 3_45 and 4_45 were found at a later stage.

Table 9.6 Final correction factors.

Valve name	Factor
3_45	0.77
3_67	1.00
3_8	1.87
3_9	0.88
4_45	0.77
4_67	0.97
4_8	0.83
4_9	0.67

9.5 Laboratory analyses

In the following the applied laboratory analysis are discussed.

Nutrient concentrations

The effluent sensors and the InSitu[®] sensors have been verified frequently in the laboratory to ensure quality of the experiments. Nitrate, ammonium and phosphorous concentrations have been analysed by the Dr. Lange cuvette test. The principles of these are described below:

Nitrate:

In a solution containing sulphur- and phosphorous nitrate-ions react with 2,6 dimethylphenole forming 4-nitro-2,6-dimethylphenol, which is measured by a photometer. The measurement range is 0.23-13.5 mg/l NO₃-N.

Ammonium:

Ammonium-ions react at pH of 12.6 with hypochlorite ions and salicylations, using nitroprussidsodium as a catalyst forming indophenoleblue, which is measured by a photometer. The measurement range is 0.015-2.0 mg/l NH₄-N.

Phosphate:

Phosphate-ions react in acid solution with molybdate- and antimonions and are transformed to an antimonylphosphorousmolybdate complex, which is reduced by ascorbic acid to phosphorousmolybdenblue and measured by a photometer. The measurement range is 0.05-1.5 mg/l PO₄-P.

Suspended solids

Suspended solids are measured according to Swedish standard SS-EN 872-1.

Sludge volume index

The sludge volume index (SVI) is an indicator of the ability of the sludge to settle. The analysis is carried out by taking a 1-litre sample of the sludge from the aerated reactors and allowing it to settle for 30 minutes. The volume that the settled sludge occupies after the 30 minutes (the sludge volume (SV)) is then related to the concentration of suspended solids. Hence, the SVI expresses the volume that one gram of sludge occupies after 30 minutes of sedimentation, i.e. a small SVI means good settleability characteristics. If the settled sludge volume is high (more than 300 ml/l), a diluted sludge volume index can be determined. The SVI and DSVI do not yield the same values, so in the experiments both SVI and DSVI (based on a 1:2 solution of the sludge) were determined. An empirical formula relating the two indices yields reasonable results. The formula predicts that if the sludge volume is larger than 300 ml, then the DSVI (or the “real” SVI) can be found by using $SV_{\text{real}} = 200 + SV/300$. The origin of this formula is unknown, but it yields reasonably good correspondence, hence explaining the difference between the two indices. The sampling of the sludge is important to get reliable and comparable results. It is imperative that bulking sludge on the surface is not included. Suspended solids are measured in the laboratory and not taken from the suspended solids sensors in order to ensure precision. At the same time, the laboratory analysis is used as a verification of the suspended solids sensors.

Nitrification rate

Measurement of nitrification rate is traditionally used for determination of the inhibition of sludge due to toxic substances in the water. At the

Källby wastewater treatment plant, there is no history of inhibitory substances. The industrial contribution to the plant is low, approximately 4%. Instead, the nitrification rate is used as an estimate of the amount of nitrifiers in the sludge, which is an important parameter when experimenting with a reduction in the aeration energy consumption by reducing the nitrification. A difference in nitrification rate between the two parallel lines will indicate a difference in the concentration of nitrifiers (assuming no or equal inhibition in the two lines).

Nitrification rate is measured in the laboratory after a procedure based on ISO 9509:1989(E). The experiment is performed by parting a sludge sample into two. Ammonium is added to the two sludge samples and the samples are aerated. In one sample, the nitrification is inhibited by adding ATU (a toxic substance). After four hours of aeration, the difference in nitrate between the two samples is measured. This difference divided by the amount of suspended solids (or volatile suspended solids) and time yields the nitrification rate.

Microscopic investigations

The sludge is investigated in a microscope to detect changes in the population, the amount and type of filamentous bacteria and the floc form. The investigation is done at 100x and 400x magnification with a phase-contrast microscope⁴ (1000x magnification with oil immersion is also used occasionally). The microscope is of the brand Zeiss Axiolab. The sludge sample is taken from the biological reactors and wet mounted on a glass slide, i.e. a drop of activated sludge is placed on a clean glass slide. A clean cover glass is placed on the drop, whereby the drop is spread out on an area of approximately 2 cm² between the two pieces of glass. The slide is then placed in the microscope and investigated according to a protocol developed at Källby WWTP.

The protocol for sludge investigation is developed based on Jenkins *et al.* (1993), Eikelboom and Buijsen (1983) and Westlund *et al.* (1996). These books were also frequently consulted for interpretation of the microscopic samples. The protocol includes investigation of floc size, form and filament effect (none, bridging or opening). The amount of total filament and filaments sticking out of the flocs as well as the floc compactness are observed. Various types of zoogeal colonies, bacteria and protozoa,

⁴ A phase microscope increases the contrast in the picture compared to a traditional light microscope.

rotatories and nematodes are observed and the dominant and secondary filaments are identified.

The identification of filaments can be done by various staining techniques, which involves a fixed smear on a slide. A fixed smear is prepared by spreading out a drop of sludge on a glass slide and letting it dry in the air. Subsequently the staining is carried out. Neisser and Gram staining were used. However, after several years of experience with the sludge at Källby it has been observed that four different filaments are “always” the dominant ones. These four can be differed without staining by a trained eye. Hence, staining is only carried out in case of doubt. The most common filaments at Källby are: type 0041, type 0092, *Microthrix Parvicella* and *Nostocoida Limicola* (the last type is not as common as the others). Other types of filaments may appear, however, usually in very small amounts. The four dominating filaments are common in Sweden and the sludge is characterised as typical Swedish municipal sludge.

9.6 Quality verification of sensors

A quality verification procedure has been introduced to ensure consistent measurements by the sensor equipment. The controlled sensors include: the InSitu[®] sensor, the effluent nutrient sensors, the DO sensors and the suspended solids sensors. The DO sensors are checked every time they are cleaned by locating the sensors next to each other and check if they produce the same value (two by two). Additionally, the absolute value is checked once a month by a portable DO meter.

For the nutrient and suspended solids sensors, time series of verification values have been stored and gross errors have been reacted upon within one or a few days. A typical time series can be seen in Figure 9.12. Such a time dependant chart can be used to investigate if the sensor is subject to sudden errors. Plotting the data on an x-y plot shows if there is a systematic bias in the measurements, e.g. due to interference from other substances. For the effluent ammonium data, a bias exists as can be seen in Figure 9.13. The R^2 value is rather high indicating that this is a bias that exists at all times. The reason for the bias has not been investigated. In the experiments, the effluent ammonium data are corrected for the bias.

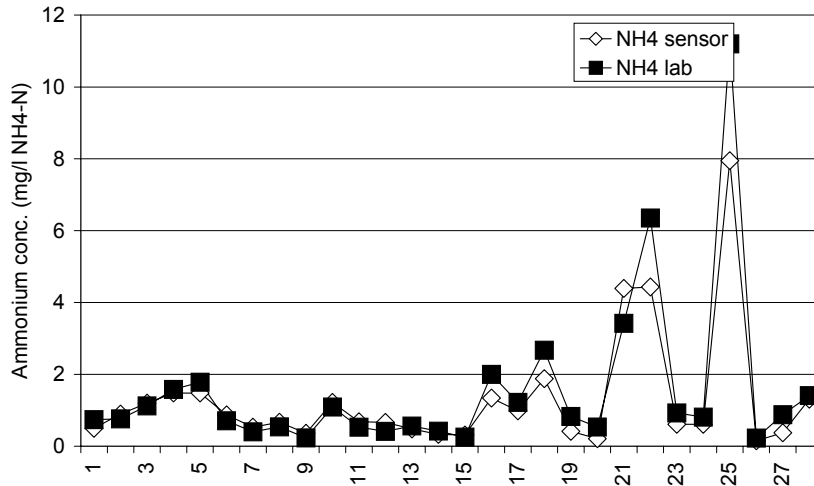

Figure 9.12 Time series of quality system for effluent ammonium sensor.

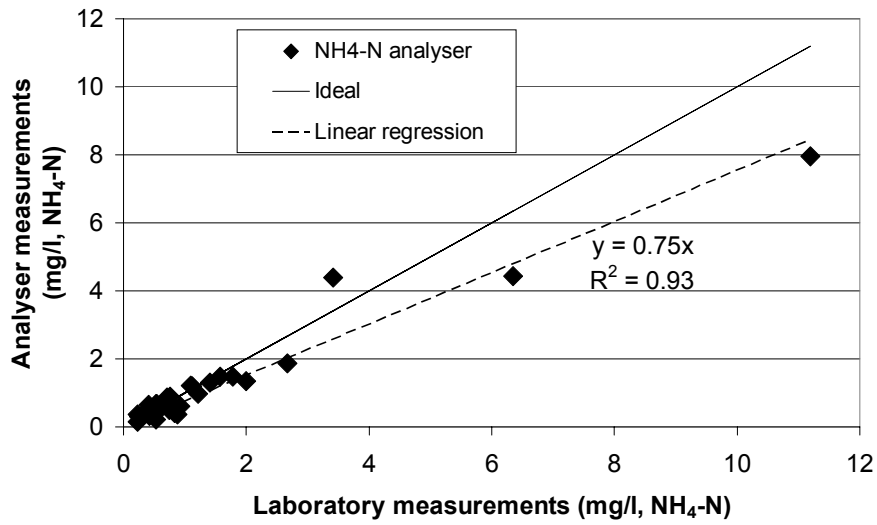

Figure 9.13 Comparison of laboratory and analyser measurements in quality verification for the effluent ammonium analyser.

The UV sensor for measuring NO_x in the effluent is suspected to be quite sensitive towards interference from other substances in the

wastewater; especially certain types of organic matter and nitrite are known to interfere. The interfering substances in wastewater are not present in distilled water, which is used for the calibration standards. Hence, the analyser is suspected to be biased. An initial investigation was carried out on October 2nd, 2001, right after a successful calibration of the instrument. Both standard solutions and filtered wastewater samples were analysed in the laboratory and by injecting the samples directly into the nitrate analyser. As can be seen in Table 9.7, the standards showed a good correspondence, while the wastewater samples showed a significantly poorer correspondence.

Table 9.7 Check of wastewater and standard solutions

	Lab.	Analyser
Wastewater sample 1	5.9	7.3
Wastewater sample 2	6.0	7.1
Standard solution (5 mg/l NO ₃ -N)	4.9	4.8
Standard solution (10 mg/l NO ₃ -N)	10	9.7

A more thorough analysis of the interference problem was carried out on October 10, 2001. Two large samples of wastewater were taken and filtered. One sample was taken from the end of the denitrification basin with a nitrate concentration close to zero mg/l (S1) and the other was taken from the effluent from the biological sedimentation units (S2). Based on these and a standard solution of 100 mg/l NO₃-N, six samples were prepared as shown in Table 9.8. The nitrate concentration of the samples were analysed in the laboratory. Nitrite concentration was also determined in the laboratory by standard methods, but showed to be negligible. NO_x was then measured in the analyser by injecting the samples directly into the analyser; see results in Table 9.8.

The correspondence between the nitrate concentration and the NO_x concentration measured by UV was linear; see Figure 9.13. However, a discrepancy between the two measurements was detected with regard to both offset and slope.

The quality verification time-series data may indicate that the amount and composition of interfering substances in the wastewater is varying over time; see Figure 9.15. The large spread of data may indicate that the real regression line is actually changing depending on the present interferents.

This fit gives a quite different regression line than in Figure 9.14. In the experiments, the effluent nitrate data are corrected according to Figure 9.14.

Table 9.8 Interferents experiment.

#	Mix of	Lab. (mg/l NO ₃ -N)	Lab. (mg/l NO ₂ -N)	UV analyser (mg/l NO _x -N)	Difference (%)
1	100 ml S1	0.174	0.023	1.25	620
2	50 ml S1 +50 ml S2	1.47	0.020	2.45	67
3	100 ml S2	2.61	0.018	3.5	34
4	500 ml S1 +25 ml STD	5.17	n.a.	5.95	15
5	500 ml S1 +50 ml STD	9.21	n.a.	9.75	5.9
6	500 ml S1 +75 ml STD	14.22	n.a.	14.2	0.14

A better R^2 value is reached for the effluent phosphate measurements, however, these measurements also show considerable bias; see Figure 9.16. In the experiments, the effluent phosphate data are corrected for the bias.

The Danfoss InSitu[®] ammonium sensor shows a good correspondence between laboratory and sensor measurements, indicated by an almost perfect regression line and a high R^2 value of 0.93, see Figure 9.17. No correction of bias is carried out in the experiments.

The Danfoss InSitu[®] phosphate sensor also show a high R^2 value of 0.91, see Figure 9.18. However, the sensor is generally measuring a value that is around 11% lower than the laboratory value. The reason for this has been found to be due to the analysis technique in the quality verification procedure (i.e. not due to the sensor). In the beginning, the samples were only filtered using a normal paper filter, which means that small amounts of phosphate bound to particulates stayed in the sample. After changing the procedures to filtering the samples using micro filtration, the correspondence improved. Of five correctly filtered measurements only one was different from the sensor measurement (Sensor: 0.1 mg/l PO₄-P and laboratory analysis 0.2 mg/l PO₄-P). No correction of bias is carried out in the experiments.

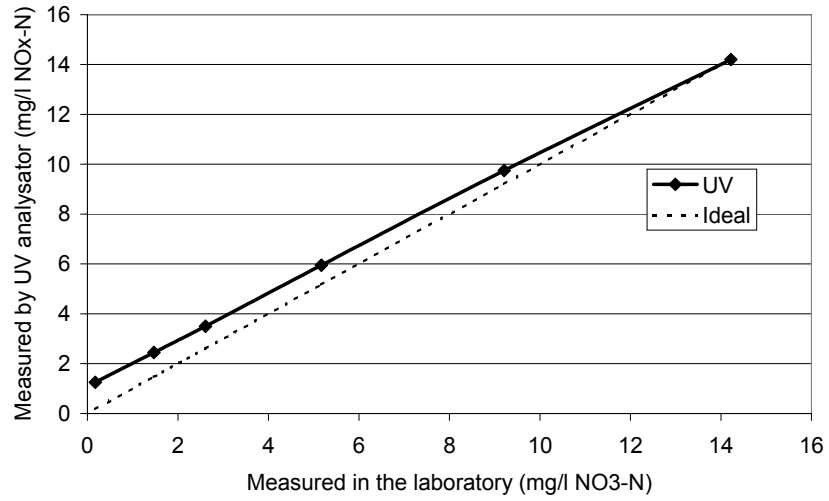

Figure 9.14 Correspondence between nitrate and NO_x measured by the UV analyser.

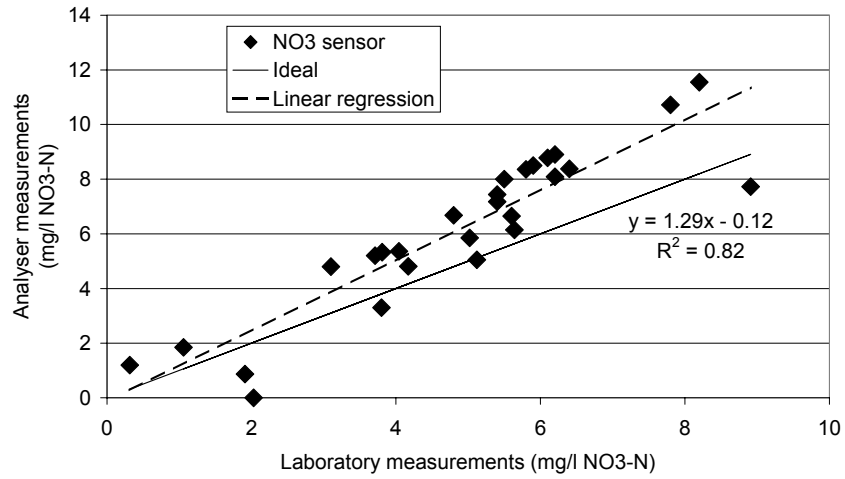

Figure 9.15 Comparison of laboratory and analyser measurements in quality verification for the nitrate effluent analyser.

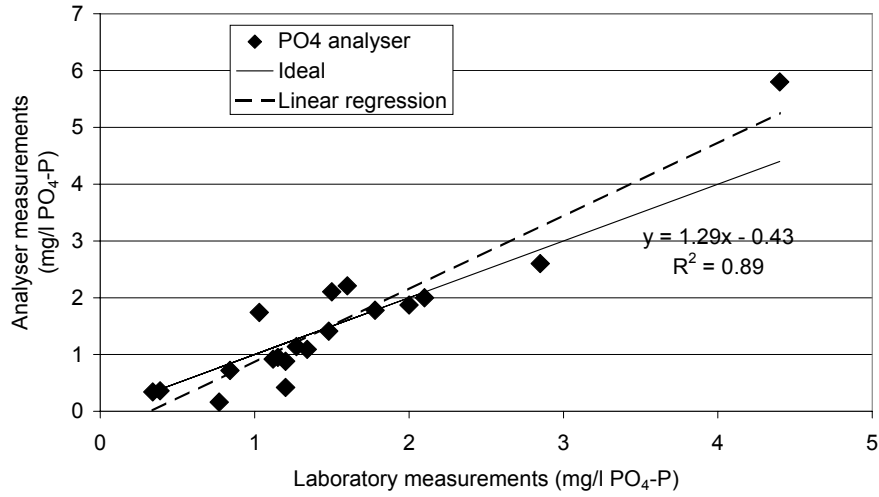

Figure 9.16 Comparison of laboratory and analyser measurements in quality verification for the phosphate effluent analyser.

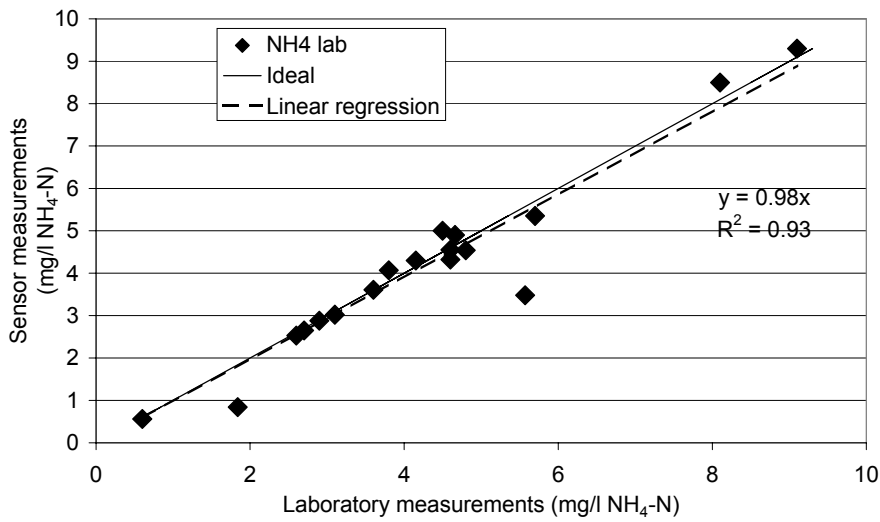

Figure 9.17 Comparison of laboratory and analyser measurements in quality verification for the Danfoss Evita ammonium sensor.

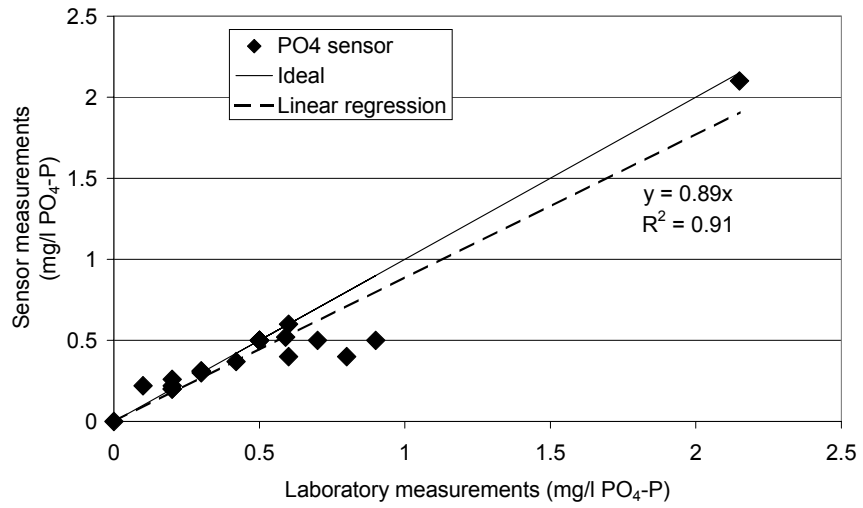

Figure 9.18 Comparison of laboratory and analyser measurements in quality verification for the Danfoss Evita phosphate sensor.

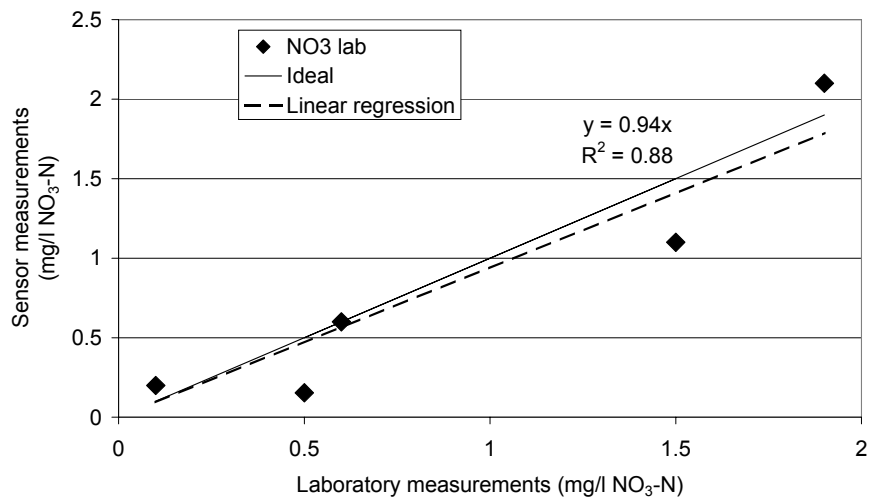

Figure 9.19 Comparison of laboratory and analyser measurements in quality verification for Danfoss Evita nitrate sensor.

The measurements of the InSitu[®] nitrate sensor are not suited for comparison as most of the sensor measurements show 0 mg/l, which yielded laboratory analysis results ranging from 0.00 to 0.25 mg/l. However, the difference may be due to the dissolved oxygen entering the sample during the process of sampling and, hence, the difference may not be real. The remaining data are shown in Figure 9.19, and although they are few, they show a reasonable (though not perfect) correspondence. No correction of bias is carried out in the experiments, as absolute values from this sensor are not used in the documentation of the experiments.

The precision of the suspended solids sensors is generally high, especially for the ones measuring in the mixed liquor. Removing outliers that were due to lack of cleaning the R² for the remaining sensor checks of the sensors in the mixed liquor is 0.91 and the regression line is close to ideal (sensor value = 1.03 * laboratory value). Only 5.7% of the measurements were outside the range of ±10% of the laboratory values. The performance of the measurements in the sludge return stream is poorer, with an R² value of 0.84 and a regression of: sensor value = 1.05 * laboratory value. In these measurements, 30% were outside the range of ± 10% of the laboratory value. At this sampling point, it is more difficult to get representative samples due a higher noise level in the sensor, which is possibly due to the high flow rate past the sensor head. The high noise level may account for part of the difference between the laboratory and sensor values. The sensor types in the mixed liquor and the return sludge stream are the same, so an alternative explanation may be that the sensors are not quite as precise at higher concentrations of suspended solids. No correction of bias is carried out in the experiments.

9.7 Energy consumption of actuators

An experiment was carried out to determine how to translate airflow rate into energy consumption for the compressors. It was found that the airflow rate could be translated into power by the formula (10.1).

$$\text{Power} = 0.0115 \text{ kW}/(\text{h}/\text{Nm}^3) * \text{Airflow} + n * 28 \text{ kW} \quad (10.1)$$

where n is the number of compressors in operation. This means that simply having a compressor running without yielding any air requires 28 kW. Each compressor produces a maximum airflow rate of 3700 Nm³/h. When this amount is exceeded, an additional compressor is turned on. To

generalise savings in airflow in one line into savings for the whole plant, the following approximation is used. On an average 31% of the influent flow rate go into each of the lines B3 and B4; the rest (38%) goes into the lines B1 and B2. Hence, the total airflow (to all of the lines), given a certain control strategy in one of the lines (B3 or B4) are applied in the entire plant, is found by multiplying the airflow consumption in this line by a factor of 3.26. Thereafter, the airflow rate is converted to power.

The power consumption for aeration lies in the range between 50 and 220 kW, with an average of around 112 kW. That means that for one of the lines B3 or B4, the power consumption is approximately 35 kW. The total power consumption for pumping is around 10 kW; see Table 9.9. The power consumption for stirring is approximately 2.5 kW per line, as the mixers are only running 10% of the time. The relative division of the power consumption can be seen in Figure 9.20.

Table 9.9 Power consumption for the pumps in the biological line.

Pump	Range (kW)	Average (kW)
Internal recirculation	0-5	2.5
Sludge recirculation	3-9	7
Surplus sludge	0-5.5	0.5
Total	3-19.5	10

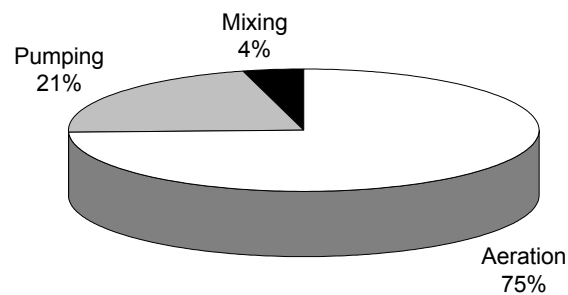

Figure 9.20 Energy consumption in one biological line in the Källby WWTP.

9.8 Automation system

Traditionally, programming of new control methods are done in the SCADA system or in PLCs. However, this requires an external expert every time a change is going to be made. As various algorithms and strategies were going to be tested, which would lead to frequent changes, this solution was not sufficiently flexible. Instead, a simple interface was developed in MATLAB, which could be modified easily from a standard PC. Several experiments were carried out and in the beginning many problems with fall-out of MATLAB were experienced, the SCADA system, the communication link between the two (DDE) and the PC itself. However, the final interface, which is described here, was reasonably stable with a mtbf (mean time between failures) of more than a month. The failure frequency meant that safe modes had to be applied and that the system had to be monitored on a frequent basis, however, as a research platform it worked out satisfactorily.

The basic layout of the system is shown in Figure 9.21. An interface starts and stops the program and determines which of the controllers are going to be active. The program is called the “controller shell” and it starts by reading all necessary parameters from a file. The parameters include minimum and maximum values, setpoints, integration times, gains, file locations etc. The controller shell subsequently goes into a loop, until it is stopped via the user interface. The loop sweeps through the whole program, waits 20 seconds and makes a new sweep. The program consists of a number of *if-then* statements, which keep track of when the different controllers are going to be executed. The program code for each controller is implemented in individual programs. A command called *eval()* is used; it works like this *eval('try','catch')*. Which means that the program tries to run the controller program ('try'), however, if this fails a 'catch' program is run instead. The 'catch' program is typically a safe mode program. For the DO setpoint controller, for example, the safe program sets all DO setpoints at 2.5 mg/l, which is a conservative setting avoiding problems in the processes.

A number of associated programs have been developed for the controller shell, the most important ones are summarised in Table 9.10. The programs ensure that transfer of data works in a safe way and that data are requested several times if it fails the first time. The PI and I controllers are used repeatedly and are made as ancillary programs in order to avoid reprogramming them repeatedly. The rest of the controllers are tailor made

to fit the SCADA system format. The MATLAB code for the programs is collected in a work report (Ingildsen, 2002).

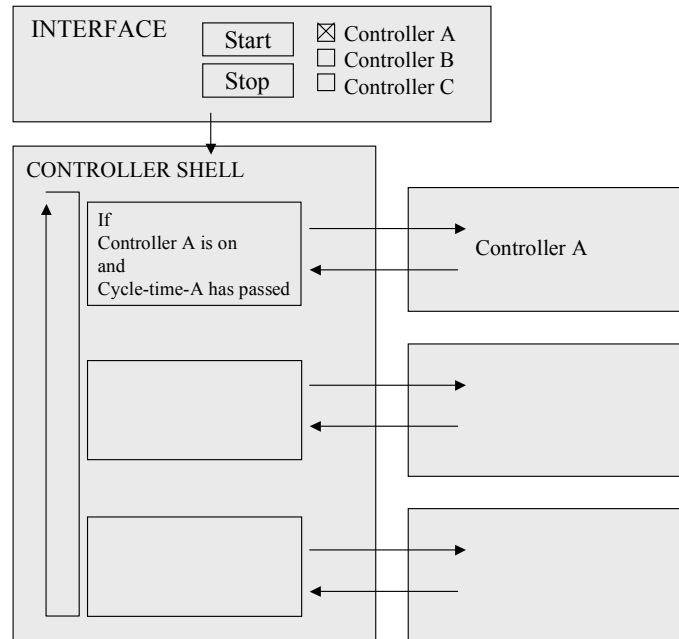

Figure 9.21 Programming platform in MATLAB.

Table 9.10 Ancillary programs developed for the controllershell.

Program name	Content of program
<i>PIC</i>	Proportional- integral controller.
<i>IC</i>	Integral controller.
<i>Plotcontrollers</i>	Plots setpoints, actual values and control inputs.
<i>POKE_DATA</i>	Pokes data to the SCADA system via DDE. Includes several safety features. A variant that sends digital data also exists called <i>POKE_DATA_DIG</i> .
<i>REQCURRENT</i>	Requests the current value of a certain point of the SCADA system via DDE. Includes several safety features. A variant that sends digital data also exists called <i>REQCURRENT_DIG</i> .
<i>REQHISTDATA</i>	Requests historical data from the SCADA via DDE.

9.9 Conclusions

This chapter introduced the wastewater treatment plant of Källby and the use of instrumentation and automation during the experiments. The chapter gives a description of the most important issues laying behind the experiments, which are described in the following two chapters. An extensive effort is demanded to keep all the equipment working and sufficiently precise for performing control comparison experiments. As Olsson (2002) puts it: “*Some of the implementation aspects may be more perspiration than inspiration.*”

Chapter 10 Control of Nitrogen Removal

Though this chapter is on nitrogen removal, the main focus is on the control of nitrification by means of controlling the DO setpoint, which eventually means the control of aeration. Aeration is one of the most powerful actuators in the nitrogen removal system. In the survey described in Chapter 4 aeration was assessed as the single most important actuator. All plants with nitrogen removal judged this as one of the seven most important control handles. Aeration is also one of the control handles that bear large potential economical savings in terms of reduced energy consumption. In Ferrer (1998), it is estimated that aeration consumes approximately 50% of the consumption of electrical power. In the survey documented in Chapter 4, aeration consumes between 24 and 90% of the energy used for the biological treatment, with an average of 59%.

Four different controllers and control structures for the control of the DO setpoint are tested at the Källby wastewater treatment plant. These are:

- A. A feedforward controller based on an ammonium sensor located in the head end of the aerobic zone. Several models are suggested for the feedforward term, and a hydraulic model is tested;
- B. A slow floating feedback controller from an ammonium analyser located in the effluent from the secondary settler;
- C. The controller B is combined with a feedforward control term based on an ammonium sensor located in the head end of the aerobic zone. The feedforward term is proportional to the incoming ammonium load;
- D. A PI feedback controller based on an in situ ammonium sensor located in the outlet from the last zone.

An overview of the tested controllers is given in Figure 10.1.

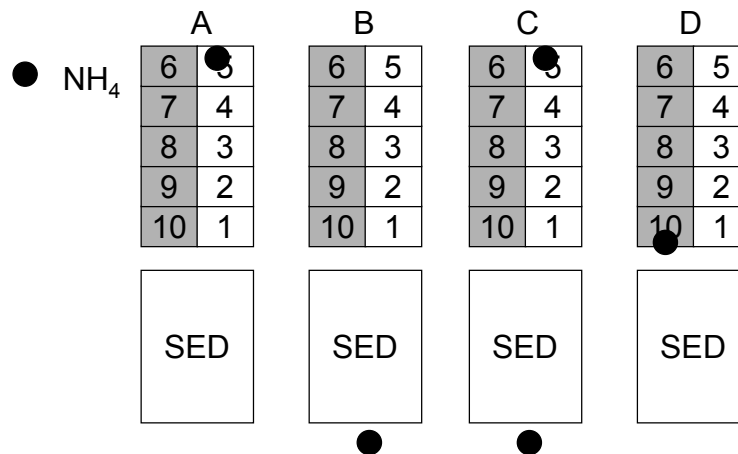

Figure 10.1 Overview of the tested controllers. (The dots symbolise the sensor positions).

In the beginning of the project, the basic hypothesis was that a feedforward term would be the most important term for controlling the aeration. This assumption was based on the belief that fast reaction to load variations was the most important issue when controlling the system. However, the use of feedforward terms is sensitive to the behaviour of the applied model. The full-scale tests show that a feedback controller based on an ammonium sensor located in the last zone provide a signal that is fast enough to control the DO setpoint according to load variations.

A controller using only feedback has the advantage over feedforward controllers that no explicit model of the process is needed. As Skogestad and Postlewaith (1996) write about the use of feedback control: “*The fundamental reasons for using feedback control are therefore the presence of 1) signal uncertainty - unknown disturbance, 2) model uncertainty and 3) unstable plant.*” In the context of wastewater treatment plants, it may be added that it is also to ensure simplicity of the controller. A simple PI controller is easier to implement than an advanced model-based controller is, which needs configuration, i.e. determination of a suitable model, at each individual plant. A “perfect” model would also need to rely on a large number of sensors to account for changes in the key concentrations and the performance of nitrifiers, depending on temperature and toxicity. Another difficulty is the determination of a proper model for the correspondence

between actual nitrification rate and the DO concentration. Monod kinetics has been suggested for this as an approximation of the correspondence. The determination of a suitable hydraulic model may also cause problems due to non-ideal flow behaviour such as channelling, stagnation and short-circuiting (see e.g. Newell *et al.* (1997)).

An analysis of different types of controllers for the control of effluent ammonium based on simulations using the ASM1 model was given in Chapter 8. The analysis compared different types of controllers. The simulations showed a good performance of the controller of type D, i.e. the *in situ controller*. The same result is found in the full-scale tests. In the following, the four controllers are evaluated in the same order as they were carried out, i.e. as mentioned in the list above.

A basic requirement for being able to carry out these experiments is that the DO control works satisfactorily, which means that DO concentrations follow the DO setpoint trajectory rapidly and precisely. Making the DO control system work satisfactorily is quite a challenge in many wastewater treatment plants. At the Källby wastewater treatment plant, the control of dissolved oxygen initially also worked unsatisfactorily. A method for tuning the controllers is described in detail in Section 10.1. The description can be used as a guide at wastewater treatment plants with a similar design of the aeration system as the one at Källby WWTP's, i.e. a system with diffused air from bottom aerators, where the air pipes serve several biological zones as well as several biological lines.

An attempt was made to control the internal recirculation according to the principle suggested in Chapter 8. This was a simple PI feedback controller based on a nitrate sensor in the end of the last anoxic reactor. However, due to limitation in the maximum capacity of the internal recirculation pump, the control did not work as intended. The effect of the control is nevertheless documented where applied (Sections 10.3 and 10.4).

10.1 DO control

In spite of the fact that DO control have been implemented at numerous wastewater treatment plants for quite some years, there are still plants with difficulties in making this particular control loop work satisfactorily. Källby had experienced problems with the control of the DO for several years. The poor performance resulted in the DO concentration exhibiting large variations around the setpoint and the compressors frequently starting and stopping. An example of a three-day period is shown in Figure 10.2. The

DO concentration oscillates considerably and in a period from day 0.75 to 1.1 there is not a sufficient flow of air to maintain the setpoint at 2.5 mg/l DO.

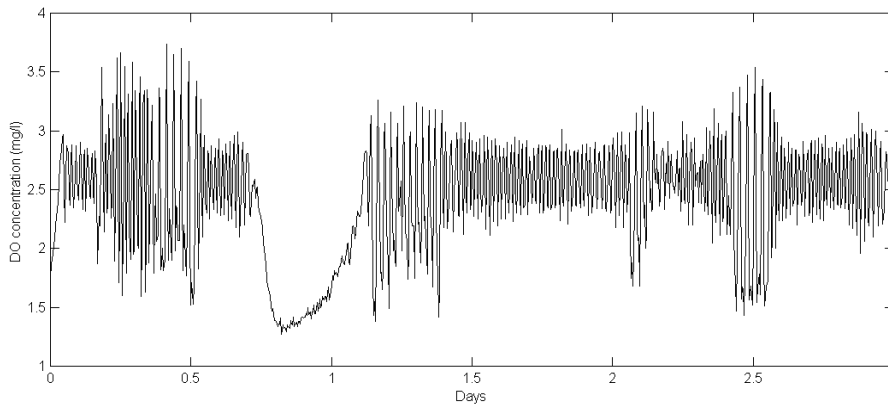

Figure 10.2 Example from a period with poor DO control.

Several theories regarding the cause of the problem were proposed and tested. The design of the aeration system was changed so that all four parallel biological lines were run by a set of three compressors instead of as earlier by two sets of three compressors. To make this change a new air pipe was installed to connect the air distribution system in the biological lines 1 and 2 with the compressors in biological line 3 and 4, thereby turning off the compressors belonging to the biological lines 1 and 2 for good. This, however, did not lead to the expected improvements. Finally, a tuning project was initiated where all controllers were tuned. This is described in the following.

The aeration system consists of the following controllers:

A pressure controller

The controller increases/decreases the speed of the compressors in order to keep a constant pressure setpoint in the aeration pipe. This controller is a simple PID controller.

Sixteen cascaded DO controllers

Each of the four biological lines has four zones where the DO is controlled individually by a cascaded control loop. The cascaded control loop consists of a master and a slave controller. The master controller uses the online measurement of DO as input and sends a setpoint for the airflow rate as output. The slave controller receives the airflow rate setpoint and controls the valve position based on the actual measurement of airflow, see Figure 10.3. Both the master and the slave controllers are PI controllers.

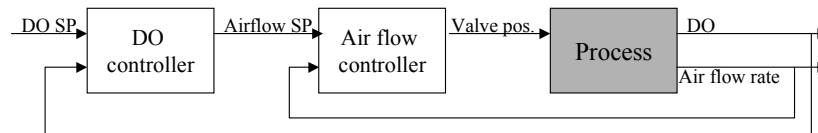

Figure 10.3 Cascaded controller for DO control.

A cascaded loop is used rather than a single loop due to the non-linearity of the air valves, which makes it difficult to make a single loop PI controller perform well. The slave controller can be said to “linearise” the valve to make the DO controller perform better (Olsson and Newell, 1999, p. 445). For each cascaded control loop there are two PI controllers to be tuned.

The tuning process

The tuning of such an interconnected system where 33 PI controllers work on the same process has to be approached systematically. An effective procedure involves setting all the cascaded DO controllers in manual, where all valve positions are set at a reasonable position, e.g. close to the normal average position. This ensures that the system is tuned for a “normal situation”. The tuning of the pressure controller is performed first as the DO controllers depend on a fairly constant air pressure in order to work satisfactorily. If the air pressure varies significantly during the tuning of the DO loops, it will affect the experiment. Several methods for tuning PI control loops are suggested in the literature, see e.g. Olsson and Newell (1999), Wittenmark *et al.* (2000), Hägglund (1990) and Heilmann (1998).

A well-proven method is the open loop step response test, which is a method to find the approximate gain and integral time constant. Using a gain-value (K) between $1/\text{process gain}$ and $0.8/\text{process gain}$ has shown good results at Källby. The integral time constant is determined based on the time it takes from the input is changed until a new stable output is reached. Various methods based on theoretical findings exist to determine the precise integral time constant based on the step response. However, these are difficult to use in practical tuning of the aeration system. Instead, a simple rule of thumb is that the integral time constant (T_i) should lie between 70-100% of the time from the input change to the first of a series of stable values. After turning the controller into automatic again, it is possible to experiment with various parameters in the nearby range of those found above, to determine the best. However, it is often difficult to verify which is better.

At the Källby WWTP, the open loop step response method was used for the pressure controller. Quite surprisingly, the estimates of particularly the integration time constant (30 seconds) were significantly different from the default value (15 minutes). The rationale behind the original value was that the compressors needed to operate close to their maximum allowable pressure most of the time. This means that even a small overshoot would cause the compressors to stop, wait for a couple of minutes and restart. The large integration time constant was believed to ensure a slow and smooth operation of the compressor during start-up. However, the disadvantage of this was that when pressure increased above the setpoint, the controller was slow to correct this, leading in many cases to the pressure rising above the critical pressure limit.

After tuning the air pressure controllers, each individual cascaded DO control loop were tuned. During which, the rest of the controllers were set in manual mode to avoid the controllers to influence each other during the open loop experiments. The tuning of a cascaded system is done by first setting both the master and the slave controller in manual mode and make the open loop step response experiment on the valve position controller. Here, a small integration time constant (T_i) was found (between 15 and 30 seconds). When good performance of the valve position controllers is achieved, the slave loop is set in automatic mode and different airflow rates are tested to get step response curves for the master controller. The integration time constant of the master controller was in the range of 4-10 minutes.

Result of the tuning

The positive effect of the tuning project is documented in Figure 10.4. The incident in day 1 when the DO concentration increases above 6 mg/l is due to calibration of the sensors. The DO setpoint in zones 6, 7 and 8 is 2.5 mg/l and the setpoint in zone 9 is 2 mg/l. During the following month, the controller parameters were further adjusted and finally, it was possible to obtain a control, where the DO concentration had a standard deviation of less than 0.2 mg/l.

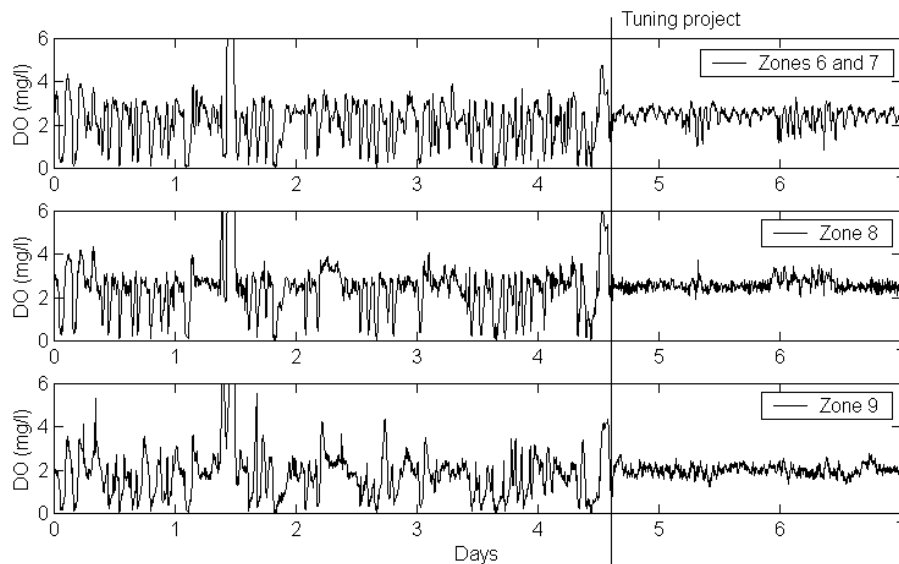

Figure 10.4 The effect of the tuning project on the DO control.

A supervisory pressure controller

Obviously, this significantly improved the DO control. However, soon a new problem became apparent. The problem was due to the connection of all four lines to the same set of compressors. During periods when the biological load on the plant was high - and thus the need for airflow rate was high, the valves in one of the lines soon saturated at 100% unable to supply sufficient airflow to the various zones. This meant that at certain periods the DO concentration was considerably below the setpoint in one

line. This was a problem for the processes as well as for the control experiments. The experiments depended on the identical conditions in the two biological lines used for comparison, which was not met if one line was not sufficiently supplied with air. Therefore, a supervisory pressure setpoint controller was developed.

The idea of the supervisory pressure setpoint controller was to control the pressure setpoint in such a way that the most open valve was almost completely open, e.g. 95% open. At the same time, this would lead to a minimisation of the pressure loss in the system. A PI controller was implemented, which would work as a master controller of the pressure controller. However, the set-up showed not to be effective, due to the rapid fluctuations in the valve positions. Instead, a more heuristic controller was used.

A “soft sensor” was developed, which every 15 minutes takes the average valve position over the last 21 minutes for all valves. The maximum of these averages are used as the input to the controller. If this input is larger than 95%, the pressure setpoint is increased by 0.0025 bars. If the input is less than 60%, the air pressure setpoint is reduced by 0.0025 bars. Maximum and minimum limits of the air pressure setpoint are applied to protect the compressors. The controller is depicted in Figure 10.5; it was implemented in the controller shell described in Section 9.8. The controller worked satisfactorily after some tuning of the parameters.

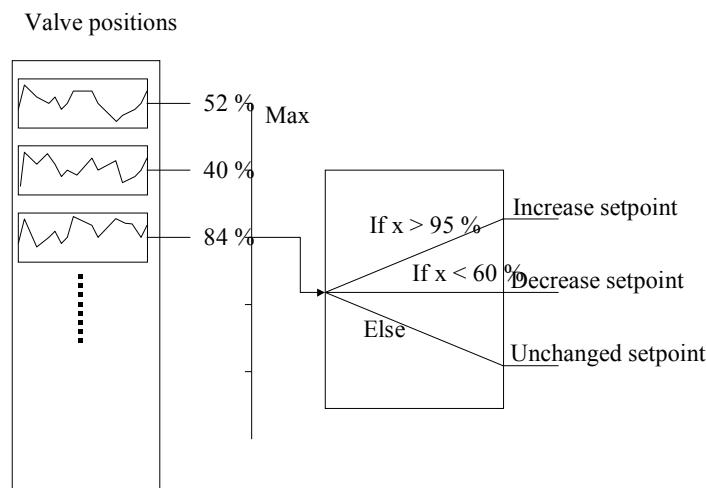

Figure 10.5 The principle of the supervisory pressure setpoint controller.

10.2 Feedforward control based on a hydraulic model

The first ammonium controller to be tested at the Källby WWTP was a feedforward controller based on an ammonium sensor located in the head end of the aerobic zone. The controller is also published in Ingildsen *et al.* (2002b). Being the first controller to be tested the test procedure was not quite as well developed as in the remaining experiments and as described in Chapter 9. The sensor quality system was not implemented, the “Controller shell” was not developed, the problem with insufficient aeration in the experimental line was not solved until the end of the experimental period and sludge characteristics were not monitored on a weekly basis.

Description of controller

When applying feedforward control, a model is required to determine the setpoints. Various reduced models for ammonium can be considered for use in such a feedforward controller. The most advanced model making sense in terms of the accessible on-line information at WWTPs is a controller relating the dependency between ammonium removal rate and the ammonium, dissolved oxygen and suspended solids concentrations. A possible model is shown in Equation (11.1) (for one reactor). In this model, it is assumed that the most important reaction affecting the ammonium concentration in the aerobic process unit can be modelled as nitrification, i.e. all other processes influencing ammonium are compounded in this equation:

$$\frac{dS_{NH}}{dt} = \frac{Q + Q_{int} + Q_{RAS}}{V} (S_{NH,in} - S_{NH}) - r_{max} \frac{S_O}{S_O + K_{OA}} \frac{S_{NH}}{K_{NH} + S_{NH}} * X_{Susp} \quad (11.1)$$

where Q is the influent flow rate, Q_{int} is the internal recirculation flow rate, Q_{RAS} the return activated sludge flow rate, S_{NH} the ammonium concentration, S_O the DO concentration, X_{Susp} the concentration of suspended solids, K_{NH} and K_{OA} the half saturation constants and r_{max} the maximum removal rate.

However, in the striving for controller simplicity a much simpler model is suggested and tested. Instead of modelling the ammonium removal, ammonium is modelled as a tracer (no reactions). This choice has the advantage that no parameters have to be estimated, but the model is still

able to predict how a load variation propagates through the aerobic reactors. Imagine a pulse of e.g. salt going through the aerobic reactors; the pulse maximum will first appear in the first reactor, and then somewhat later and more diluted in the second reactor, etc. Control based on such a simple hydraulic model will ensure that the dissolved oxygen concentration is increased at the right time in each of the reactors. The time lag varies; it depends on the volumes of the aerobic reactors and the flow pattern. The resulting estimated concentrations multiplied by the flow through the reactors give a measure for the estimated ammonium load. Note that the load of organic matter is not included as most organic substrate is assumed removed in the anoxic reactors.

Gain-functions describing the correspondence between the estimated ammonium load and the required dissolved oxygen (DO) concentration, has to be defined for each reactor. The gain-functions can be simple linear functions or functions that are more complex. An example of a set of gain-functions based on the Monod kinetics is shown in Figure 10.6 (minimum and maximum limits for the setpoints are applied). The gain-functions can be adjusted either by the operator or by an automatic procedure.

An automatic procedure based on the measurements of the effluent ammonium concentrations is suggested later, but is not tested in the controller.

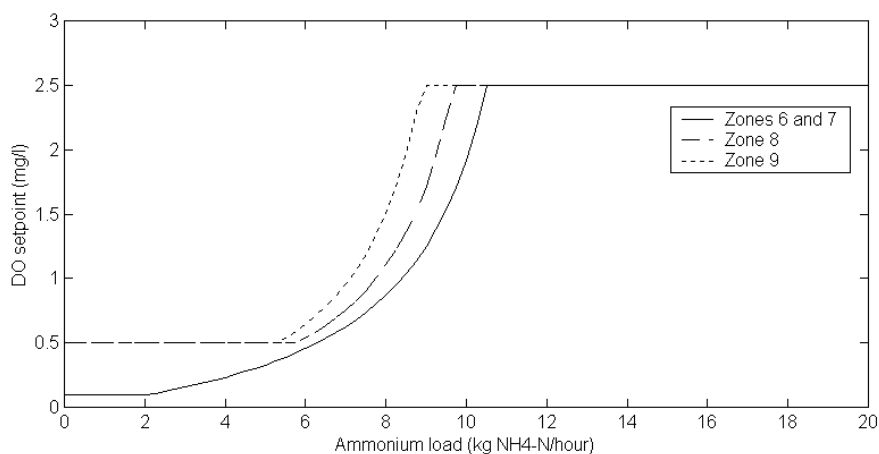

Figure 10.6. Example of gain-functions based on Monod kinetics (DO67 means DO in reactors 6 and 7, etc.).

Once an hour, model simulations (in Matlab) are carried out based on the continuous ammonium measurements from the sensor at the head of the aerated reactors and the flow sensors. Historic and current data are acquired from the SCADA system via a DDE (Dynamic Data Exchange) link. An example of a simulation is shown in Figure 10.7. The simulations are based on ordinary differential equations with one equation for each reactor. Each equation describes the hydraulics of the ammonium through the reactors as if it was a tracer. The initial guess of the concentration in each reactor is 6 mg/l $\text{NH}_4\text{-N}$; by simulating a period of ten hours back in time, the effect of this initial guess is removed. The simulations are used to calculate the estimated ammonium load on each of the reactors. Based on these loads, DO setpoints are determined according to the gain-functions (see Figure 10.6). An apparent example of peak propagation through the reactors can be seen in Figure 10.7, the peak appears in reactor five at 4.8 hours and it takes approximately two hours for it to travel to reactor 9.

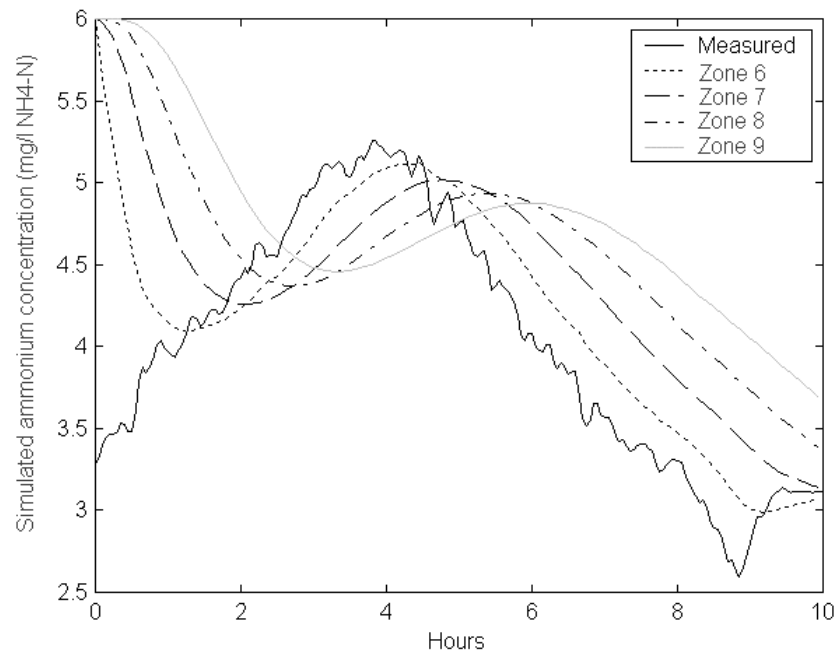

Figure 10.7. Example of a simulation.

Results

The controller was implemented at the Källby WWTP for a period of 35 days, from February 15 to March 20, 2001. The DO setpoints in reactors 6 and 7 during the online period are shown in Figure 10.8. The controller malfunctioned four times, marked by black lines above the upper graph. The problem was found to be due to synchronisation errors between the PC (on which the controller was implemented) and the SCADA system. A safe mode (DO setpoint of 2 and 2.5 mg/l, respectively) was applied during the periods of malfunctions.

During the experiment, various gain-functions were tested. The aim was to reach the same effluent ammonium concentration in the experimental line as in the reference biological line, while at the same time saving energy for aeration in terms of total airflow rates to the respective biological lines. One of the experimental gain-functions had the aim of enhancing simultaneous nitrification and denitrification (SND) in zones 6 and 7 during low load. This was implemented by using gain-functions for zones 6 and 7, which yielded lower DO setpoints during low load than for the remaining zones. However, it was not possible to prove a positive effect in effluent nitrate concentration of this strategy.

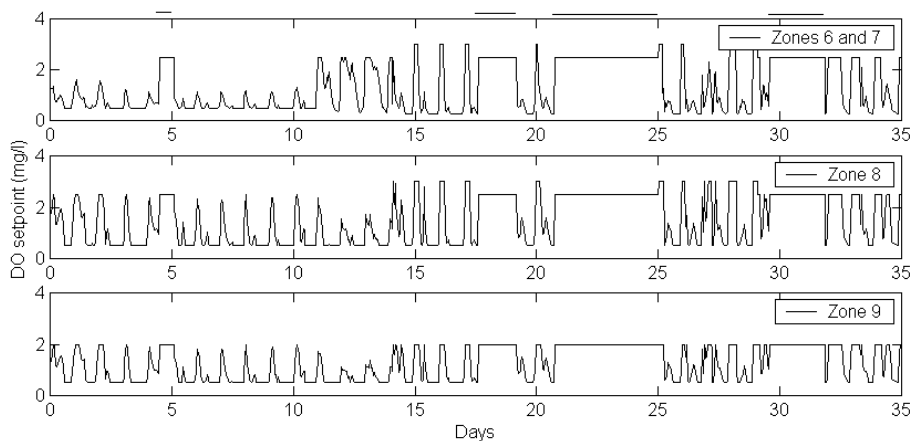

Figure 10.8. DO setpoints in the various zones during the experiment.

Average effluent ammonium concentrations were similar in the two lines over the whole period (see Figure 10.9): 0.46 mg/l $\text{NH}_4\text{-N}$ in the

experimental line and 0.40 mg/l $\text{NH}_4\text{-N}$ in the reference line. Ammonium removing efficiencies in the lines were 91% in the experimental line and 92% in the reference line (calculations based on inlet load of ammonium to the aerated zones in the experimental line). The sum of nitrate and ammonium in the effluent from the experimental line was on an average 6.1 mg/l N and 6.0 mg/l N from the reference line. The variation in effluent ammonium seem to be quite similar in the two lines, i.e. no significant improvement in disturbance rejection due to the controller.

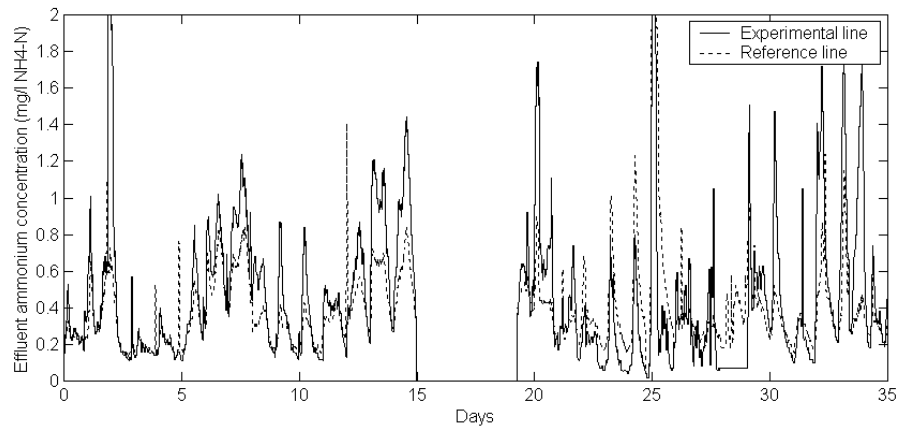

Figure 10.9. Effluent ammonium concentration during the experiment.

During the whole period the airflow rate to the experimental line was 10.0% less than to the reference line, which corresponds to an energy saving of 8.2%. The opportunity for energy reduction is probably even higher, due to three reasons.

1. The actuator limitation reduced the efficiency of the controller. A minimum airflow is pre-set for each of the zones. This limitation exists in order to ensure a proper operation of the overly large compressors during periods with low oxygen consumption. This caused excess DO concentration during periods with low load. Additionally, the aeration system is designed in a way that periodically makes the supply of air insufficient in the experimental line. This has been partly remedied by increasing the air pressure during high load (during the last week of the period);

2. During the documented period, a full optimisation of the gain-functions has not been achieved. Periods with various gain-functions were tested leading to various savings and ammonium removal efficiencies;
3. An aeration membrane in the experimental line broke shortly before the start of the experimental period, leading to excessive loss of air from the experimental line during the whole period. It is not possible to estimate this loss.

During the whole period, the internal recirculation flow rate was controlled proportionally to the influent flow rate, by a factor 2.25. The most important issue regarding control of internal recirculation flow rate is, however, that the denitrification volume is fully utilised; this is the case during the experimental period as the nitrate concentration at the end of the anoxic process unit is never zero, see Figure 10.10. Two periods of nitrate sensor malfunction were experienced, when the sensor shows 20 mg NO₃-N/l. These are not correct values but due to a power failure (day four) and depletion of sensor chemicals (day seven).

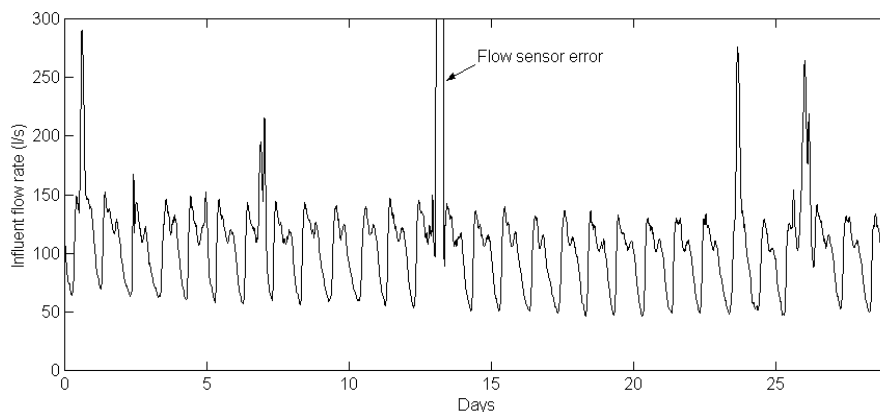

Figure 10.10. Nitrate concentration at the end of the anoxic process unit.

It has been claimed that a consistently low DO concentration may lead to excessive growth of filamentous bacteria (see e.g. Olsson and Newell (1999), p. 373). Microscopic investigations of the sludge in the two biological lines have been performed three times during the experiment;

these do not indicate such problems during the experiment. There was little difference between the two biological lines with a slight tendency towards more filamentous bacteria in the reference line. The content of filamentous bacteria was relatively high probably due to a high sludge age in both lines (24 days). Problems with bulking and foaming were observed in both biological lines. Diluted sludge volume index (DSVI) was measured at the end of the period showing values of 93 ml/g in the experimental line and 95 ml/g in the reference line. This does not indicate any difference in settleability of the sludge between the two lines. The DSVIs are in a normal range (Jenkins *et al.*, 1993) in spite of problems of bulking and foaming.

Automatic procedure for estimation of the gain-function

Prediction of the effluent ammonium concentration during constant DO setpoints based on a model of the nitrification rate depending only on ammonium concentration has shown to be rather efficient at the Källby WWTP (Ingildsen *et al.*, 2000). This model has been further enhanced by including a Monod term that describes the dependency on dissolved oxygen concentration (see Equation (11.2)), and by automatically estimating the parameters r_{\max} , K_{OA} and K_{NH} with the Nelder-Mead simplex algorithm (Nelder and Mead, 1965). The optimisation is based on a minimisation of the difference between measured and simulated effluent ammonium concentrations.

$$r_{nit} = r_{nit,\max} \frac{S_o}{S_o + K_{OA}} \frac{S_{NH}}{S_{NH} + K_{NH}} \quad (11.2)$$

The optimisation strategy was tested on the first 27 days of the experimental period. An optimisation was carried out every day (at time 1.5, 2.5, etc) based on measured data 0.5 day back in time. From the optimisation algorithm's point of view, it is essential to include dynamic data and the main dynamics in the effluent ammonium data are visible during the first 12 hours of every day (for the other 12 hours the effluent data is more or less constant at low values). The optimised parameter set is then used to simulate the following 24 hours (e.g. from day 1.5 until day 2.5) after which a new optimisation is carried out. During days 15 to 20, the effluent analyser malfunctioned, so no optimisation was carried out during

this time interval (the simulation simply used the parameter set that was determined at time 14.5).

The results of the estimation can be seen in Figure 10.11. Clearly, the simplified model can explain a large part of the variation in the effluent ammonium concentration. The difference may be explained by the fact that several processes influencing ammonium are not included in the model; these include ammonification and heterotrophic growth. Additionally, the hydraulics of each zone are idealised, i.e. completely mixed reactors are assumed. Based on these limitations the performance of the model is rather good.

The variation in the estimated parameters can be seen in Figure 10.12, maximum removal rate (r_{\max}) can be seen in the upper plot, while the estimates of K_{NH} and K_{OA} can be seen in the lower plot. The parameters show relatively small variation, which indicate that the model is reasonably stable over the experimental period. The estimated parameters can be used to update the gain-functions based on the Monod kinetics, as shown in Figure 10.6. This set of parameters was implemented in the gain-functions during the last seven days of the experiment.

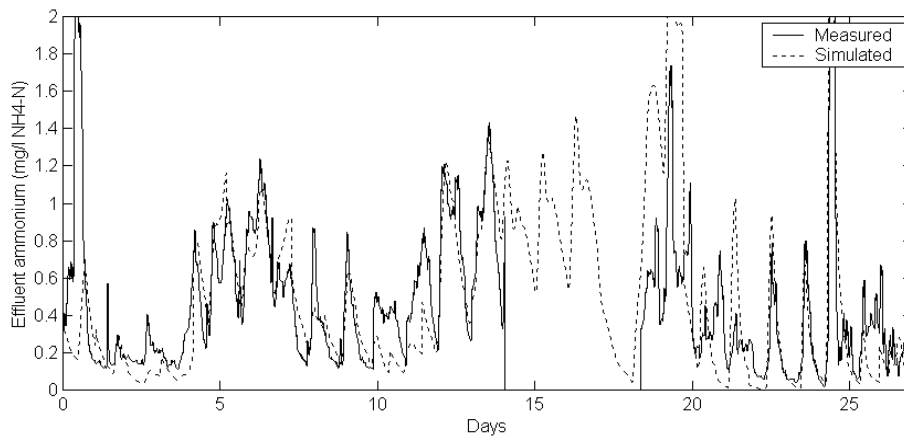

Figure 10.11. Performance of the model with parameter optimisation based on the Nelder-Mead simplex algorithm.

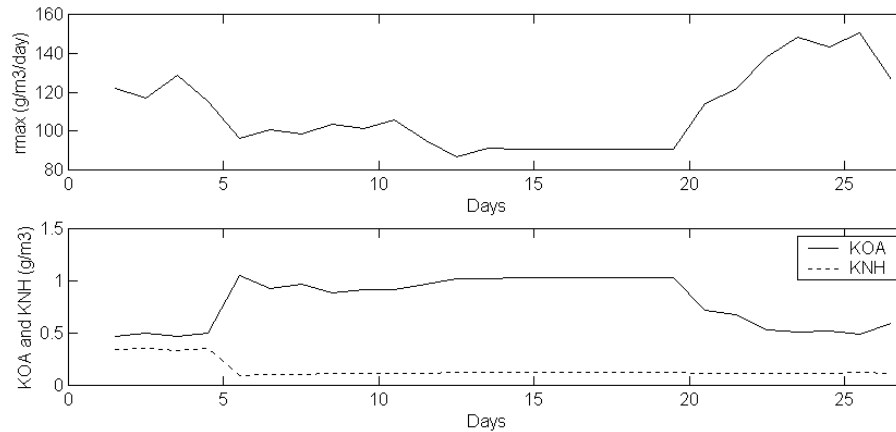

Figure 10.12. Estimate of r_{\max} , K_{OA} and K_{NH} based on the Neelder-Mead algorithm.

Summary of evaluation

A feedforward controller for the control of dissolved oxygen based on ammonium load has been proposed and implemented at a full-scale plant during 35 days. Based on this experimental period, it can be concluded that the suggested controller yields a decrease in the dissolved oxygen concentration during large parts of the day, leading to savings in airflow rate of 10.0% and an energy saving of 8.2%, while maintaining almost the same effluent quality as in the reference line. The variation in effluent ammonium concentration does not seem to be significantly reduced by the controller.

A method for estimating the gain-functions in the feedforward controller has been suggested based on a model describing the effluent ammonium concentration. The model shows reasonable correspondence with the measurements.

There was no evidence of additional growth of filamentous organisms or deterioration in the sludge properties during the experiment.

10.3 Slow floating controller

In Chapter 8, it was shown (by simulation) that an ammonium analyser located in the effluent from the secondary settler could be used as a feedback signal to the ammonium controller to ensure a certain average effluent ammonium concentration from the biological stage of a BNR plant.

The proposed feedback controller is a floating controller, which is the same as a controller with integral action only. The reason for choosing a floating controller rather than e.g. a PI or PID controller is that the delay of the signal due to the hydraulic retention time in the settler is so large that a proportional feedback term will be out of phase with the processes taking place in the aerated part of the biological zones.

The controller time constants in the floating controller should be relatively long, i.e. in the range of several days; faster controller actions will lead to an unwanted amplification of the disturbances. Hence, the purpose of the controller is to slowly correct the DO setpoint so that the average effluent ammonium concentration over several days remains at a certain average level. The controller is not designed to remove incoming variations or disturbances.

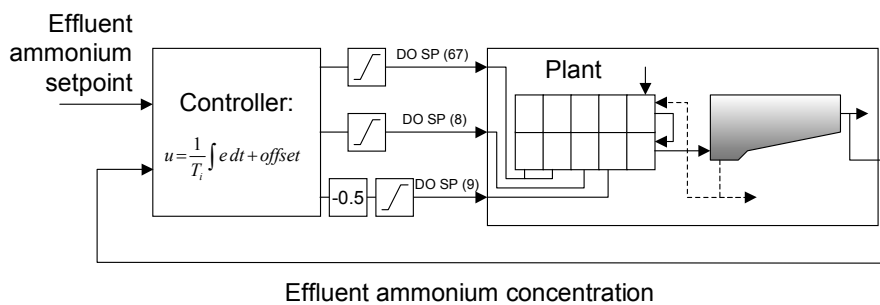

Figure 10.13 Slow floating controller.

The effluent ammonium analyser, which measures the ammonium concentration in the outlet of the secondary clarifier every hour, was used as input to the controller. The DO setpoints in the aerated zones were used as the output. Minimum (1 mg/l DO) and maximum (2.5 mg/l DO) limits on the DO setpoints were applied to avoid extreme DO values in case of failure of the analyser or the controller. The DO setpoint in the last aerobic zone (zone 9) was set to 0.5 mg/l less than in the other aerated zones in order to reduce recycling of DO to the anoxic zones. During the experiment, zones 6, 7, 8 and 9 were aerated. The controller is depicted in Figure 10.13.

The controller was implemented in the experimental line and results compared to the reference line, which was controlled with a constant DO setpoint. The experiment was carried out from October 4 to November 2, 2001. The controller was implemented in the “Controller shell” (Chapter 9).

Additionally, a controller for the internal recirculation flow rate was used. The aim of this controller was to ensure a nitrate setpoint at the end of the anoxic zone at 2.5 mg/l NO₃-N. However, during the full experiment the internal recirculation flow rate could not be increased sufficiently to reach this setpoint. Instead, the controller saturated and hence the internal recirculation was set to its maximum at all times. This makes a detailed evaluation of this controller uninteresting, as control is not actually applied. However, setting the internal recirculation to its maximum caused an improvement in the experimental line compared to the reference line in terms of lower effluent inorganic nitrogen (i.e. nitrate plus ammonium). This improvement is also documented in the following.

During the experimental period, the reference line was controlled with a constant DO setpoint of 2.5 mg/l in zones 6 to 8 and 2 mg/l in zone 9. The internal recirculation flow rate was controlled at 2.25 times the influent flow rate. The sludge outtake rate and the sludge recirculation flow rate were controlled in the same way in both lines.

Controller performance

The controller performance can be seen in Figure 10.14. The controller reacts properly to the input, i.e. it ensures an average effluent ammonium concentration close to the setpoint of 1.6 mg/l NH₄-N. The average concentration over the full period is 1.64 mg/l NH₄-N. In the beginning of the period, the integration time constant was set to 2 days. However, the change in the DO setpoints seemed to be too rapid. Hence, the integration time constant was increased to 4 days on day five and to 7 days on day seven. From then on, the integration time was kept constant. The poor performance can especially be seen during days 3 and 4. The high effluent ammonium concentration (day 4) appears on a Sunday, which is generally a day of low load. The problem seems to be that the DO setpoints have been lowered too much due to the low load on Saturday. This means that the peak load on Sunday is not due to a peak influent ammonium load (which is confirmed by looking at the effluent from the reference line, see Figure 10.10) but due to the controller characteristics, hence, the increase of the integration time constant.

The high ammonium effluent events on day 7, day 24 and day 26 are all due to rain events, see plot of influent flow rate in Figure 10.16. The reason for the high ammonium concentrations on day 19 is unknown. It is not due to failure in the aeration system, low concentration of suspended solids or

high influent flow rate. A small peak can also be seen in the ammonium concentration of the reference line, see Figure 10.15. The event may be explained by an inhibition of the nitrifiers, e.g. due to inhibiting substances in the influent.

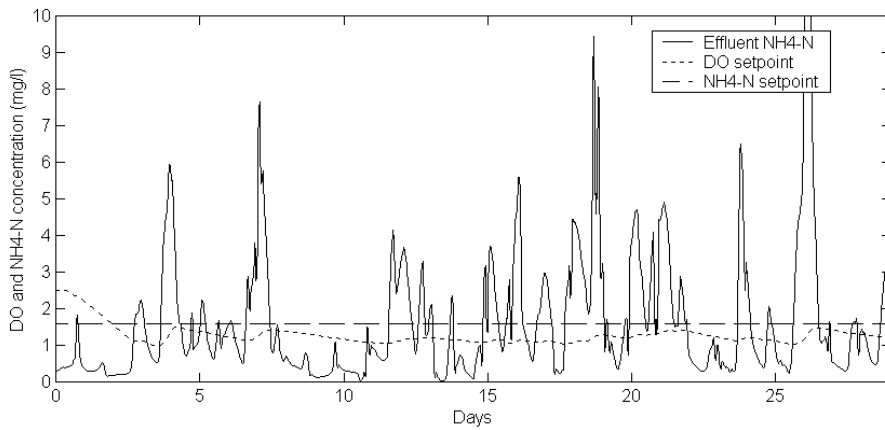

Figure 10.14 Performance of Slow floating controller based on the ammonium analyser in the effluent from the settlers.

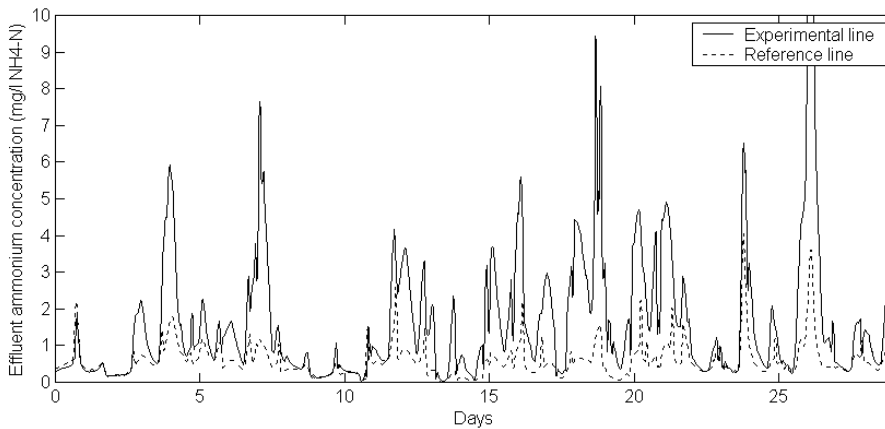

Figure 10.15 Comparison of effluent ammonium from the two biological lines.

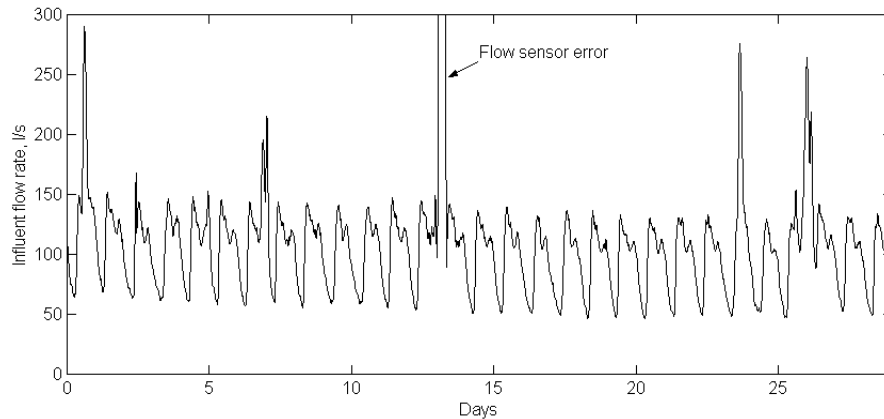

Figure 10.16 Influent flow rate to experimental line.

Comparison of the result in the two biological lines

The effluent ammonium concentration is higher in the experimental line than in the reference line. This is due to the lower average DO setpoint that is applied in the experimental line. The difference causes a saving in airflow rate of 17.0% in the experimental line compared to the reference line, see Table 10.1. If the strategy were applied to all of the lines the energy savings for aeration would yield 13.3%. The influent concentration of total nitrogen has been measured in five 24 hour flow-proportional samples during the experimental period, which showed concentrations of: 27, 39, 42, 42 and 30 mg/l, i.e. an average of 36 mg/l total nitrogen. This is used to calculate the removal level of ammonium. Taking the last parameter in Table 10.1, amount of air used to remove a certain amount of ammonium; the experimental line shows a performance that is 17.7% better than in the reference line.

The increase of the internal recirculation flow rate in the experimental line led to a reduction of the total inorganic nitrogen content in the effluent. This can be seen in Figure 10.17. On an average the total inorganic nitrogen in the experimental line is 5.78 mg/l total nitrogen, while in the reference line the concentration is 6.47 mg/l total nitrogen (both calculated as flow proportional means), i.e. effluent inorganic nitrogen is 10.7% lower in the experimental line than in the reference line. The average internal recirculation in the experimental line is 323 l/s, while it is 231 l/s in the

reference line, i.e. an increase in the experimental line of 40% compared to the reference line. This leads to an increase in power consumption of 75% or an absolute additional power consumption of 0.8 kW.

Table 10.1 Results in the two lines.

Parameter	Experimental line	Reference line
Average flow-prop. effluent NH ₄ -N (mg/l)	1.70	0.62
90% percentile of NH ₄ -N (mg/l)	4.01	1.09
Removal of NH ₄ (%)	95	98
Average airflow rate (Nm ³ /min)	20.54	24.76
Average power consumption for aeration if the strategy was applied to all lines (kW)	107.1	92.9
Removed ammonium per amount of air (g/Nm ³)	10.96	9.30

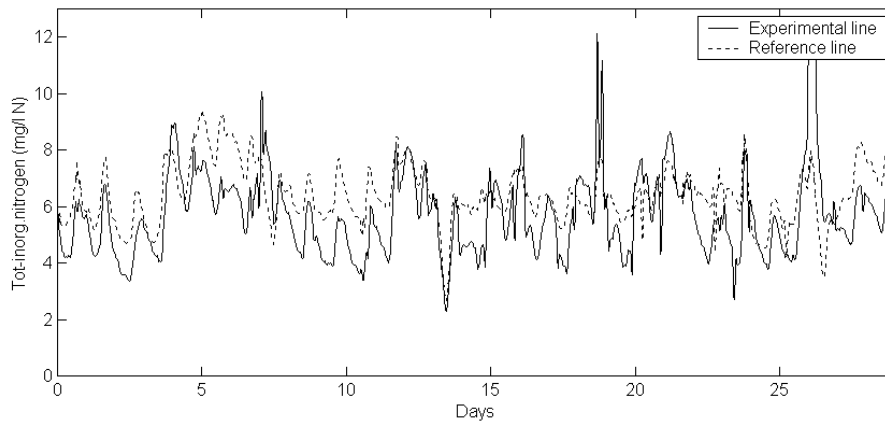

Figure 10.17 Comparison of the effluent total inorganic nitrogen concentration.

Sludge

The effect of the control strategy on the sludge properties has been investigated. The sludge age during the experiment was on an average 16

days, which means that the experimental period covers almost two sludge ages. During this time, it is assumed possible to see tendencies to deteriorations/improvements in the sludge properties.

During the period, the sludge outtake rates in the two lines are approximately the same. However, the sludge mass in the experimental line increases compared to the reference line. At the start of the experiment, the sludge concentration in the reference line was 3% higher than in the experimental line, while at the end of the experiment the sludge concentration was 3% lower than in the experimental line. This means that the sludge concentration had increased by 300 mg/l in the experimental line compared to the reference line. This corresponds to an extra net production of $300 \text{ g/m}^3 \cdot 6000 \text{ m}^3 / 29 \text{ days} = 62 \text{ kg/day}$ in the experimental line compared to the reference line. The estimated total net production⁵ of sludge in the lines is estimated at around 900 kg/day. This means that the additional sludge production is around 7%.

The additional sludge production cannot be theoretically explained by the changed process conditions. Generally, most of the sludge is assumed to consist of heterotrophic microorganisms (X_{BH}) and inert organic material (X_i). These two fractions normally make up more than 90% of the sludge. The strategy is expected to have an effect on the autotrophic microorganisms; the production of autotrophs (X_{BA}) should decrease slightly as less ammonium is nitrified. However, this effect would indicate a slight decrease in net sludge production, so this predicts the opposite of what is observed. The effect is assumed marginal anyway as the nitrifiers constitute such a small part of the sludge. The increase in denitrification may cause an increase in anoxic heterotrophic growth (X_{BH}). However, this effect is also marginal. The available amount of organic matter (S_s) is generally the limiting factor for heterotrophic growth rather than the denitrification of nitrate; this because most of the organic matter that is not used in denitrification is usually oxidised in the aerobic zones and hence leading to the same growth. The amount of inert material (X_i) is not affected by the change in control strategy. The hydrolysis of particulate organic matter (X_s) is only marginally affected by the control strategy. The anaerobic volume is reduced in the experimental line due to the increased internal recirculation. This would lead to an increase in hydrolysis; hence, this also predicts the opposite of the observed effect. In conclusion, the control strategy is

⁵ The change in suspended solids concentrations is described as influent minus effluent amount of suspended solids plus a net production of sludge due to the biological processes.

predicted to cause a slight decrease in sludge production and not as observed an increase.

Therefore, other explanations of the increased net sludge production have been sought. Two hypotheses have been identified.

Hypothesis 1: No major escape of suspended solids has taken place during the experiment. However, an almost constant effluent suspended solids of 5 mg/l from the two lines takes place continuously (effluent suspended solids concentrations were not measured in each line). This yields a sludge loss of 92 kg per day ($0.005 \text{ kg/m}^3 * 18500 \text{ m}^3/\text{day}$). This means that difference in sludge loss between the two lines may be an explanation of the difference. However, looking at the overflow weirs in the two lines there does not seem to be any obvious difference.

Hypothesis 2: Both lines have bulking problems. A lot of the sludge can be lost because of this; if the reference line has more severe bulking than the experimental line, this may explain the difference. By visual inspection of the sedimentation tanks of the two lines it seems to be true that the reference line has more bulking sludge. Thus, this seems to be a more plausible explanation. This argument is somewhat strengthened by the knowledge that at least during part of the period the sludge in the reference line had a higher concentration of *Microtrix Parvicella*, see Appendix D, known to cause bulking sludge. Part of the bulking sludge is removed via scrapers in the sedimentation unit (the amount is not measured).

It is not possible to determine the exact reason for the measured increase in net sludge production in the experimental line. However, it seems to be related to better sludge characteristics in the experimental line than in the reference line, i.e. fewer pin point flocs (hypothesis 1) and/or less bulking sludge (hypothesis 2). The change may be due to the control strategy or it may be a “random” change. The effect may also be due to measurement errors in the suspended solids sensors, however, good correspondence between laboratory measurements and sensor measurements of the suspended solids in the mixed liquor speaks against this hypothesis.

The ability of the sludge to settle has been investigated by means of the sludge volume index (SVI) and the diluted sludge volume index (DSVI). The applied dilution was 1:2. The measurements over the experimental period can be seen in Figure 10.18. Though variations can be seen over the period there does not seem to be any significant difference between the sludge settleability of the two lines.

The microbiological investigation did not show significant differences between the two lines. During the period, photos were taken of the

microscopic investigations in the two lines. A summary of the finding is found in Appendix D.

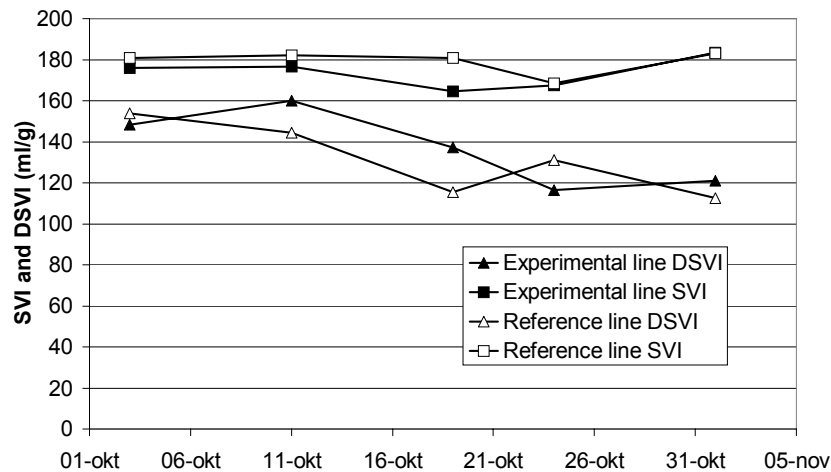

Figure 10.18 Effect on sludge settleability.

As described in Ingildsen *et al.* (2002a) the concentration of nitrifiers are expected to drop if the removal of ammonium is reduced. To test this the maximum nitrification rate (per amount of suspended solids or volatile suspended solids) was determined in the laboratory. This rate depends on the concentration of nitrifiers and the maximum nitrification rate (per concentration of nitrifiers). If it is assumed that the maximum nitrification rate per concentration of nitrifiers is the same in the sludge in the two biological lines, the maximum nitrification rate per amount of suspended solids (or volatile suspended solids) can be used as indicators for the concentration of nitrifiers. Therefore, it is expected that the maximum nitrification rate (per amount of suspended solids or volatile suspended solids) will drop more in the experimental line than in the reference line.

This is somewhat supported by the experimental data presented in Figure 10.19 even though the tendency is weak (note an additional data point beyond the experiment is added to check whether the last data set was just an outlier). In the beginning of the data set, the maximum nitrification rate of the reference line actually dropped more than the maximum nitrification rate in the experimental line. As this control experiment was

followed up with another experiment where effluent ammonium in the experimental line were higher than in the reference line, the effect on maximum nitrification rate can be observed as if it was one long experiment, extending the time series and hence, covering more “sludge ages”. This is documented in Figure 10.27.

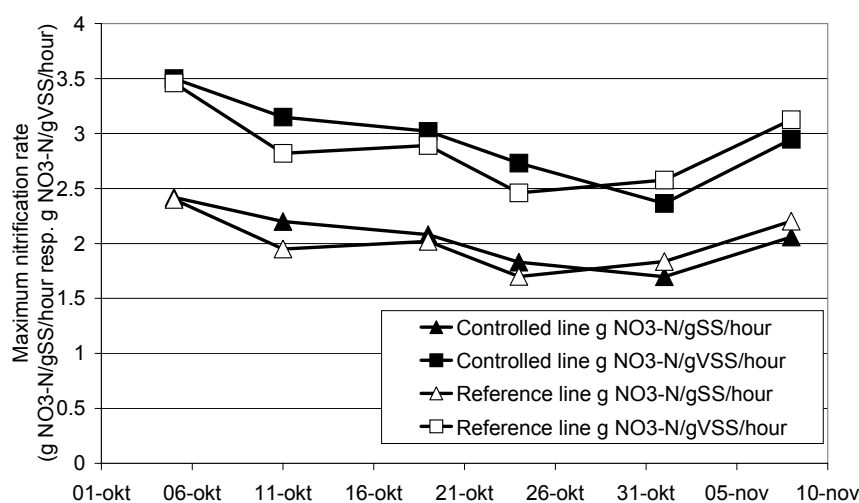

Figure 10.19 Comparison of the maximum nitrification rate.

Summary of evaluation

The effluent ammonium controller performed well in the sense of keeping effluent ammonium at a certain value on an average over a long time. This means that the ammonium controller is effective at wastewater treatment plants where maximum monthly or annual averages of effluent ammonium concentrations are specified. However, the control work could also have been carried out by an operator, adjusting the DO setpoints a couple of times per week or per month to match effluent measurements from the online analysers.

The incidents of high effluent ammonium in the experimental line are due to poor controller performance as they could have been avoided by increasing the nitrification capacity by e.g. increasing the DO setpoint. This

indicates that a more dynamic (i.e. with shorter time constant) controller will perform better.

The annual cost of aeration at the Källby wastewater treatment plant is approximately 0.5 million SEK, therefore a savings in energy of approximately 13% would yield annual savings of 65.000 SEK. It is a control goal formulation issue to determine if such a saving can be justified by the slightly higher effluent ammonium concentration.

The controller for the internal recirculation flow rate did not work properly due to the maximum limitation of the internal recirculation pump. However, the effluent total inorganic nitrogen of the plant was decreased by applying larger internal recirculation pumps. In the experiment, the effluent inorganic nitrogen concentration was decreased by 10.7%, which was achieved by a small increase in power consumption (0.8 kW).

The ability of the sludge to settle and the maximum nitrification rate of the sludge (and hence the disturbance rejection ability) are not significantly affected by the control scheme. A slight increase in observed net sludge production is assumed to be due to a higher sludge escape in the reference line than in the experimental line either via the effluent or via the surface scrapers in the sedimentation unit or to the sludge covering.

10.4 Combined feedback and feedforward control

The application of a slow floating feedback controller showed satisfactory results in terms of saved energy, however the performance with regard to the variation in effluent ammonium was poor due to the constant low DO setpoints during high load situations. Therefore, an improvement of this controller is sought through a simple feedforward term based on ammonium load measurements in the head end of the aerobic zone. The idea of the controller is to apply a simple feedforward term to vary the DO setpoint based on the incoming load to the aerobic zone. The controller is depicted in Figure 10.20.

The feedforward term uses a constant factor, called the FFFactor, which is multiplied by the incoming load to the aerobic zone. The FFFactor was set to 0.3 (mg DO*hour/l/kg NH₄-N). The incoming load was calculated as the sum of the flows (i.e. influent flow, internal recirculation and sludge recirculation), multiplied by the ammonium concentration in the head of the aerobic zone. The controller output was implemented as in (10.2).

$$u = \text{FFFactor} * \text{NH}_4\text{-N load} + \text{integral controller part} + \text{offset} \quad (10.2)$$

Additionally, the internal recirculation flow rate controller was applied as in the slow DO controller experiment. The control of the reference line was also kept the same (Section 10.3), except the DO setpoints were reduced to 2.0 mg/l in zones 6 to 8 and 1.8 mg/l in zone 9. The experiment took place from November 6 to November 29, 2001.

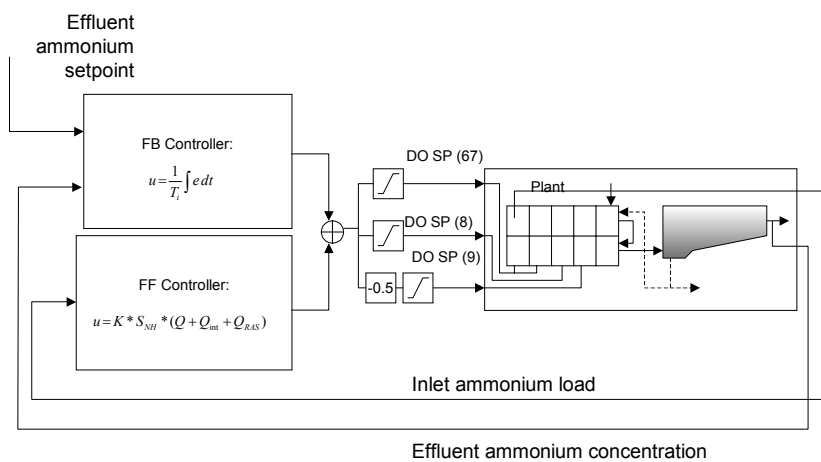

Figure 10.20 Combined feedforward and feedback controller.

Controller performance

The performance of the controller is shown in Figure 10.21. As can be seen from the DO setpoint, the controller is saturated a great part of the time reaching either maximum or minimum values of the DO setpoint. This means that the controller can be interpreted almost as an on/off controller, where the *on* level is the maximum DO setpoint and the *off* level is the minimum DO setpoint. The integral action slowly changes the ammonium concentration at which the controller turns *on* or *off*, to ensure an average effluent ammonium concentration close to the ammonium setpoint. The minimum DO setpoint has been changed during the experiment. In the beginning (days 1-4) the minimum DO setpoint was set at 1 mg/l, later (days 4-18) the minimum DO setpoint was set to 0.5 mg/l and finally at the end of the experiment (days 18-24) the minimum DO setpoint was set to 0.25 mg/l.

The peak effluent ammonium concentrations that were seen in the slow floating controller (Section 10.3) are largely avoided. The controller is however slow at reaching the desired ammonium setpoint. At around day 9 the controller is close to the desired ammonium setpoint. However, due to what is interpreted as a sensor calibration error in the InSitu[®] sensor during days 12-15 (interval between recalibration is three days) the feedforward term yields too high DO setpoints. This is corrected at day 15 (new calibration), after which the ammonium setpoint is found again. The next change in controller performance appears at day 18 and is due to a lowering of the minimum DO setpoint to 0.25 mg/l. This change has a significant effect and it takes a couple of days before the controller adjusts to this. Therefore, the best performance of the controller can be seen during the periods: days 9-12, days 15-18 and days 21-24.

The plan was to continue the control experiment for one or two more weeks. However, a malfunction of the InSitu[®] sensor meant that it had to be sent to the manufacturer for repair. When the sensor came back it was relocated, see Section 10.5.

For the periods of good performance, the effluent ammonium stayed approximately inside the range 0.5-3.5 mg/l NH₄-N. The strategy shows a considerably better performance than the slow floating controller did (Section 10.3).

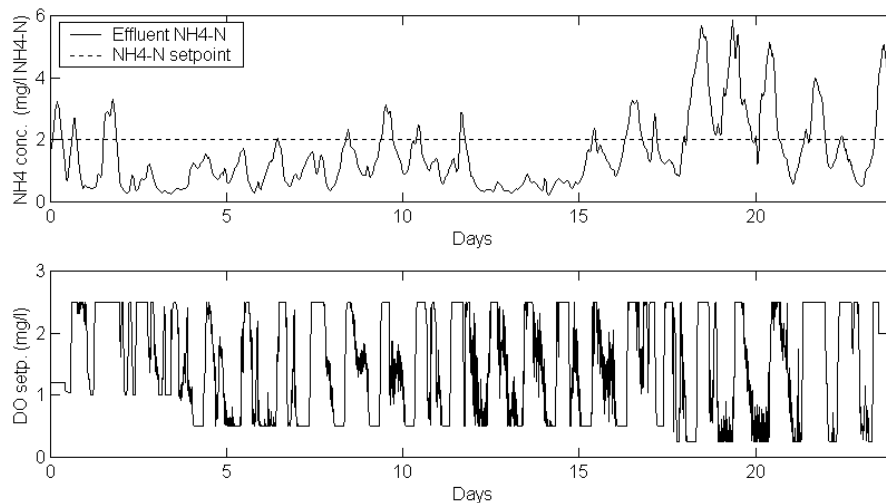

Figure 10.21 Performance of the controller combining feedforward and feedback.

Comparison of the result in the two biological lines

It can be seen, when comparing the effluent ammonium concentration of the two lines, that at three occasions the experimental line shows a significantly better disturbance rejection than the reference line, see day 2, 8 and 18. This is due to the maximum DO setpoint, which is higher than the average DO setpoint applied in the reference line. These incidents of high effluent ammonium concentrations are all due to high influent flow rate (see Figure 10.23). During the event of day 22, the disturbance rejection ability is the same in the two lines.

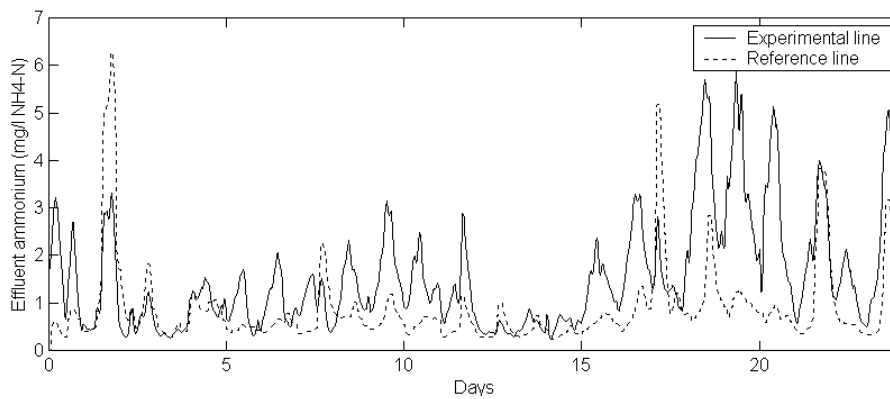

Figure 10.22 Comparison of the effluent ammonium of the two lines.

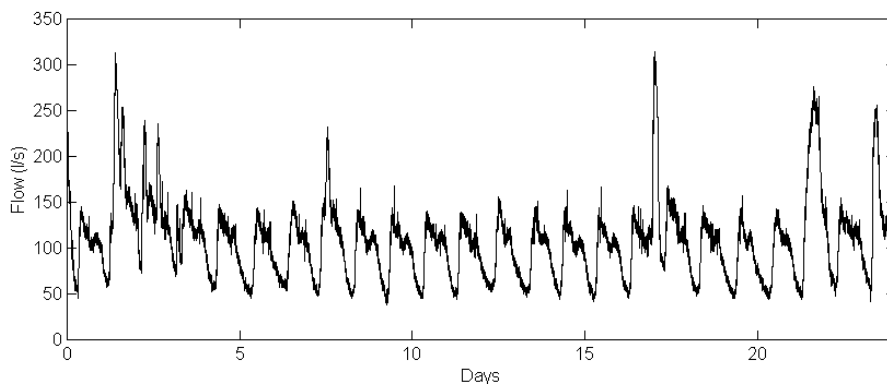

Figure 10.23 Influent flow rate to the lines.

The results are summarised in Table 10.2. The flow-averaged effluent ammonium concentration in the experimental line over the full period is 1.61 mg/l NH₄-N and 1.05 mg/l NH₄-N in the reference line. The influent concentration of total nitrogen has been measured in four 24-hour flow-proportional samples during the period. These showed the following concentrations: 28, 43, 41 and 38 mg/l. On an average, this gives 37.5 mg/l. This means that the average removal degree in the experimental line was 96% and 97% in the reference line. The savings in airflow rate for the whole period were 11.7% and in energy consumption, the savings were 10.4%. The removal of ammonium per amount of air is 11.5% better in the experimental line than in the reference line.

Table 10.2 Results in the two lines.

Parameter	Experimental line	Reference line
Average flow-prop. effluent NH ₄ -N (mg/l)	1.61	1.05
90% percentile of NH ₄ -N (mg/l)	3.25	1.51
Removal of NH ₄ (%)	96	97
Average airflow rate (Nm ³ /min)	19.56	22.16
Average power consumption for aeration if the strategy was applied to all lines (kW)	86.7	96.7
Removed ammonium per amount of air (g/Nm ³)	11.36	10.19

As can be seen in Figure 10.24, the savings are in particular achieved during the low DO setpoints, while the slightly higher DO concentrations during maximum DO setpoint result in a temporarily increased cost compared to the reference line.

The increase of the internal recirculation flow rate in the experimental line led to an improvement of the total inorganic nitrogen in the effluent. This can be seen in Figure 10.25. On an average, the total inorganic nitrogen in the experimental line is 5.67 mg/l total inorganic nitrogen and in the reference line the concentration is 6.68 mg/l total inorganic nitrogen (both calculated as flow proportional means), yielding 15.1% lower effluent total inorganic nitrogen in the experimental line than in the reference line. The

average internal recirculation in the experimental line is 321 l/s, while it is 211 l/s in the reference line, i.e. an increase in the experimental line of 42% compared to the reference line. This leads to a small increase in power consumption for pumping of 0.92 kW.

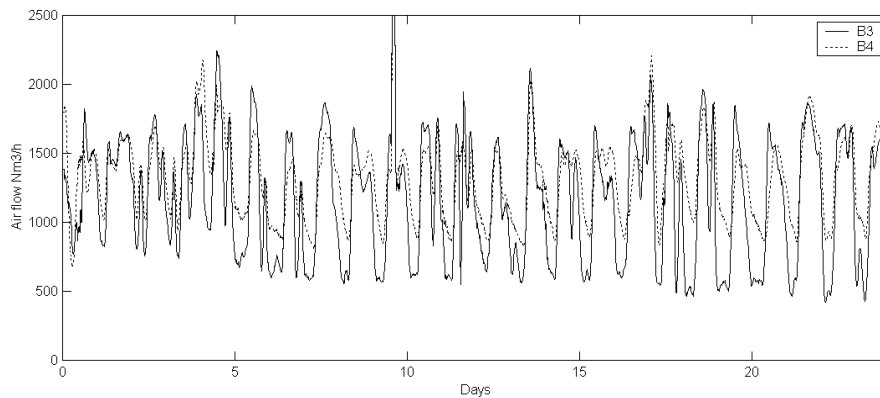

Figure 10.24 Comparison of total airflow to the two lines.

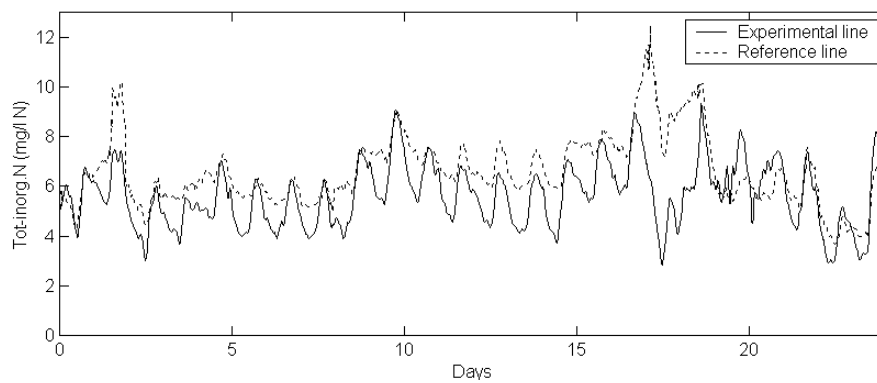

Figure 10.25 Comparison of the effluent inorganic nitrogen concentration from the two lines.

Sludge

The sludge outtake in the experimental line was increased slightly as the initial suspended solids concentration in the line was higher than in the

reference line. Over the whole period, the sludge outtake in the experimental line was 7% higher than in the reference line. This caused the suspended solids concentrations in the experimental line to stay constantly 3% higher than in the reference line, indicating that the level of accumulation in the two lines were the same. That means that the net sludge production is slightly higher in the experimental line, corresponding to approximately 157 kg/day (on an average). This is even more than during the previous experiment (2.5 times as much). The same hypotheses about the reasons for the difference can be proposed. However, the hypothesis of sensor calibration error is more likely in this case, as the calculation is primarily based on data from the suspended solids sensor located in the sludge recirculation pipeline. This sensor is less precise than the suspended solids sensor in the bioreactor, as described in Section 9.6.

The sludge settleabilities and maximum nitrification rates are compared for the period involving both the period of this control experiment and the slow floating controller. This gives a period corresponding to almost two months or approximately four sludge ages.

The SVI results are plotted in Figure 10.26, which shows that the two control experiments have had no effect on the sludge settleability indices SVI and DSVI as the indices in the two biological lines follow one another. It is interesting to see that the two indices to a certain extent develop into different directions, i.e. an improvement in DSVI appears simultaneously with a deterioration in the SVI. Again, the DSVI is judged the most reliable as the SVI led to high sludge volumes (close to 870-950 ml/1000 ml), while the sludge volumes were within the normal range for the DSVI (200-400ml/1000ml).

The change in maximum nitrification rate can be seen in Figure 10.27. The plot is difficult to interpret. The general trend supports the theory that the maximum nitrification rate is decreasing in the experimental line compared to the reference line due to lower ammonium removal. However, the last data point indicates that the maximum nitrification rate is the same in the two biological lines at the end of the period (as it was in the beginning). The best interpretation of the graph is that it supports the hypothesis, however, the relative decrease in nitrifier concentration is small. This also seems reasonable, as the difference between the effluent ammonium concentrations in the two lines during the two experiments was small. A larger difference in effluent ammonium concentration is needed to prove the hypothesis of reduction in nitrifier concentration by this method. This means that the difference in effluent ammonium concentration in the

two experiments is not large enough to significantly affect the disturbance rejection ability of the system.

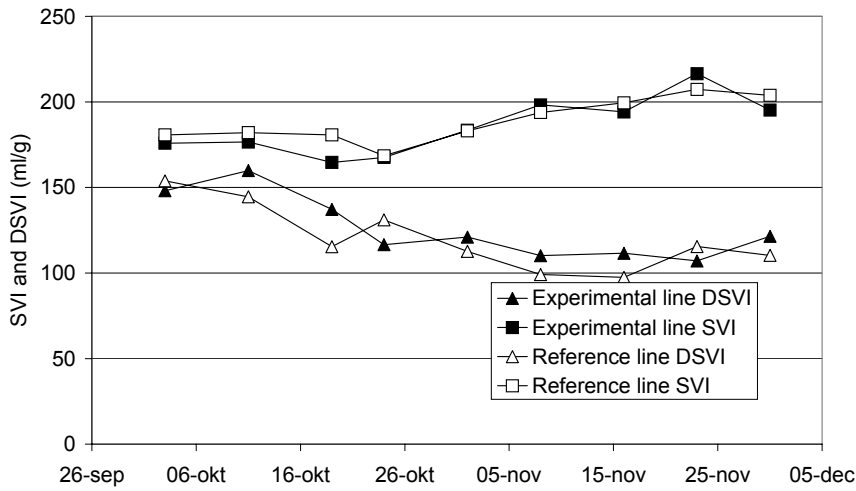

Figure 10.26 Changes in the SVI and DSVI in the two lines.

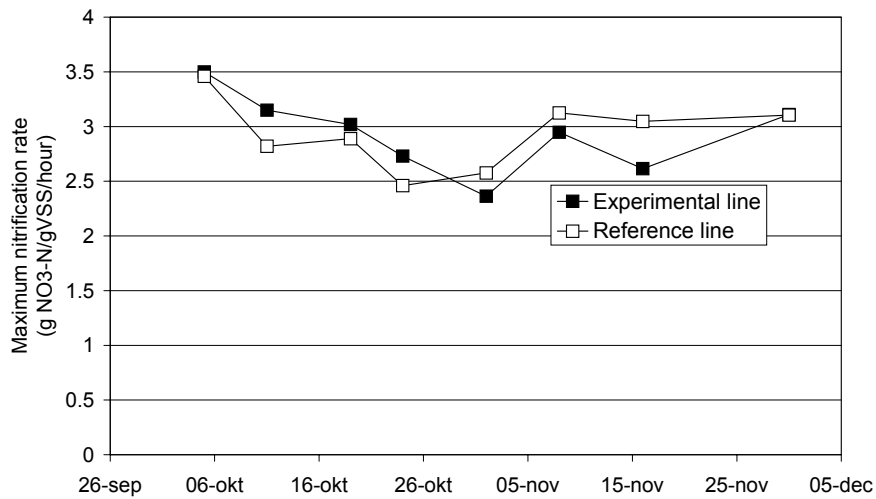

Figure 10.27 Changes in the maximum maximum nitrification rate in the two lines.

Summary of evaluation

This controller performs (as predicted) better in terms of rejecting disturbances in nitrogen load than the floating feedback controller based on effluent ammonium measurements. Due to the smaller difference between the flow-proportional effluent ammonium concentrations in the two lines, the energy savings are smaller in this experiment (10.4%). The sludge properties do not seem to be affected significantly by the control experiment. The controller shows the best performance so far in terms of removed ammonium per amount of air, i.e. $11.36 \text{ g NH}_4\text{-N/Nm}^3$, even though the effluent ammonium concentration is slightly lower than in the experiment feedback controller based on effluent ammonium. However, the controller is slow at finding the correct setpoint. This is partly due to the changing of minimum DO setpoint.

10.5 In situ controller

Simulations in Section 8.1 have shown that a feedback PI controller based on an ammonium sensor located at the outlet of the last aerobic zone is an efficient way to control the DO setpoints in the aerobic zones to obtain a high level of disturbance rejection. To test this in full-scale, the InSitu[®] ammonium sensor was moved to the outlet of zone 10. First, however, the normal variations during a constant DO setpoint strategy were observed for eleven days, see Figure 10.28. The result is quite different from the ammonium concentration in the effluent from the secondary settler. The variations in ammonium concentration from zone 10 resembles the daily profile that was observed at the Lindau wastewater treatment plant, see Section 5.3, p. 97. If concentrations less than $0.1 \text{ mg/l NH}_4\text{-N}$ are defined as total ammonium removal (this is a reasonable value considering the noise on the measurement signal) it means that ammonium is fully removed 30% of the time. This indicates that aeration can be reduced at least during 30% of the time. For comparison, no measurement points in the effluent from the settler below 0.1 mg/l were found. Consequently, total ammonium removal cannot be observed by using an automatic ammonium analyser in the settler effluent, due to the mixing effect of the settlers.

A simulation of the settler as a completely mixed reactor with no biological reactions taking place, gives a reasonable (though far from perfect) fit to the measurements, see Figure 10.29. It seems as if the model is performing better in the end of the simulated period than in the beginning,

there is no obvious explanation for this. A possible explanation is that either of the ammonium sensors might be out of perfect calibration during the first part of the period. The settler can be seen, to have a smoothing effect equal to or better than a simulated completely mixed reactor. This knowledge proved useful, as the ammonium analyser in the effluent from the settler was not working during most of the time of the experiment with this controller. By this type of simulation, it was possible to reconstruct the signal.

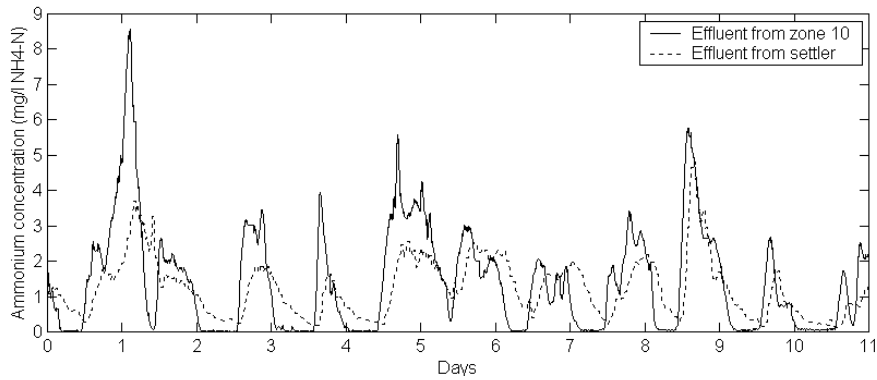

Figure 10.28 Comparison of measurements from the two ammonium measurement locations during a constant DO setpoint control strategy.

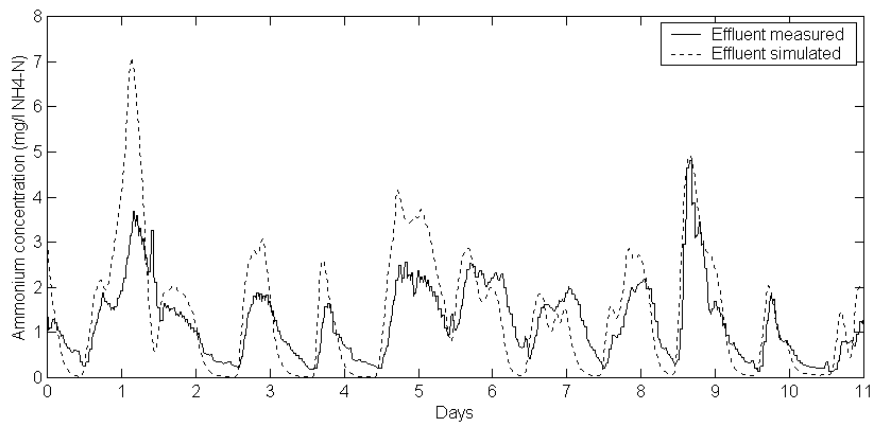

Figure 10.29 Simulation of ammonium concentration in the effluent from the settler.

Description of controller

The controller is depicted in Figure 10.30. The ammonium InSitu[®] sensor was located at the outlet from the 10th zone and a simple PI controller was used with the ammonium concentration as input and the DO setpoints in zones 5 to 9 as outputs. A control experiment was started on January 21, 2002 and ended on March 5, 2002. The experiment has been divided into two periods. During the first period an ammonium setpoint of 1.5 mg/l NH₄-N was selected (from January 21 to February 6) and during the second period an ammonium setpoint of 3 mg/l NH₄-N was chosen (from February 6 to March 5). During the whole period, the influent flow sensor was not working, however, a reasonable estimate could be created using other flow sensors.

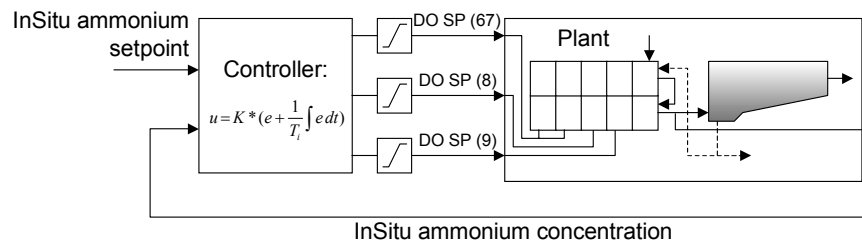

Figure 10.30 The in situ controller.

The period was extremely rainy (see Figure 10.31). During the 41 days 127 mm of rain fell. This resulted in sludge escape during a large part of the period, giving rise to at least two problems. Firstly, the effluent nutrient sensors are sensitive to suspended solids in the effluent and therefore they were turned off for protection for a large part of the time. Secondly, due to the large sludge escape the sludge return from the chemical lines was led back to the biological lines, which means that the sludge from the two lines were mixed. Therefore, it is difficult to evaluate the effect of the control strategy on the sludge properties. On the other hand, the advantage is that the performance during rain events has been tested thoroughly.

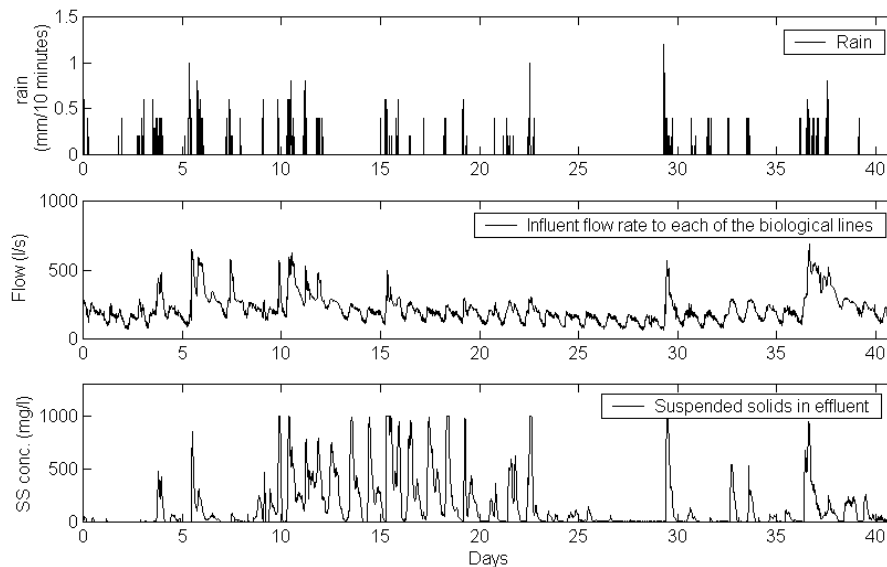

Figure 10.31 Data from the experimental period, showing extraordinary rainy conditions leading to frequent incidents of sludge escape.

Controller performance during the first period

The controller performance during the first period (with an ammonium setpoint of 1.5 mg/l $\text{NH}_4\text{-N}$) can be seen in Figure 10.32. During the majority of the time, the nitrification capacity was too small to maintain the desired ammonium setpoint, causing the DO setpoint to be at its maximum allowed value a large part of the time. During the first three days, zones 6 to 9 were aerated. To increase the nitrification capacity, zone five was also aerated from day three and onwards. During the first week the maximum allowed DO setpoint was 4 mg/l. It was reduced during the last part of the period to 3 mg/l, as it was suspected that the high DO setpoint mainly caused increased power consumption without any increase in disturbance rejection. This is supported by the experiments as the ammonium peaks do not seem to be significantly larger (i.e. worse performance) during the period with the lower maximum DO setpoint.

Only during shorter periods in days 5, 13, 14 and 15, the nitrification capacity is sufficiently high for the controller to perform as intended. The

realised performance during day five is shown in detail in Figure 10.33. Here it can be seen that there are some oscillations in the controller output, which is probably due to too high gain or too low integration time. It is surprising that the small oscillations of ± 0.5 mg/l DO cause such large oscillations in the ammonium concentration. It can also be seen that the DO setpoint trajectory is not followed sufficiently fast when the DO setpoint suddenly increases. This indicates that the control of the supervisory air pressure controller is too slow (the airflow valves are fully open, not shown).

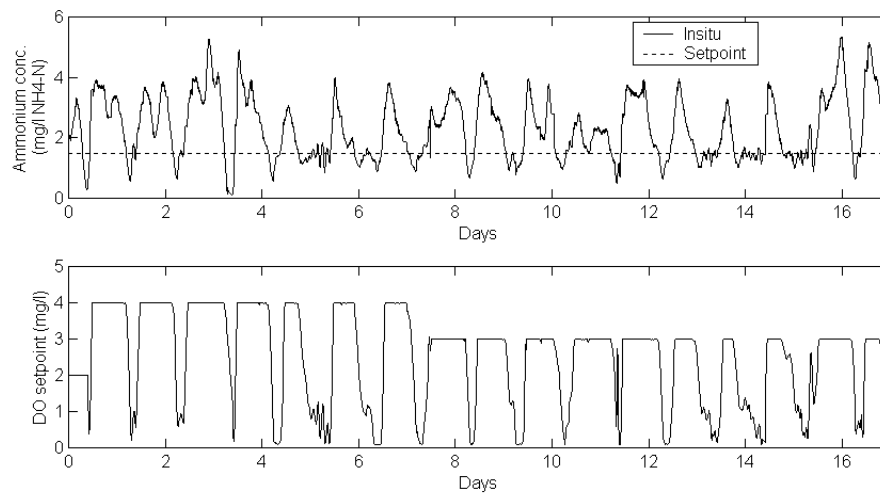

Figure 10.32 Performance during first period of in situ controller implementation.

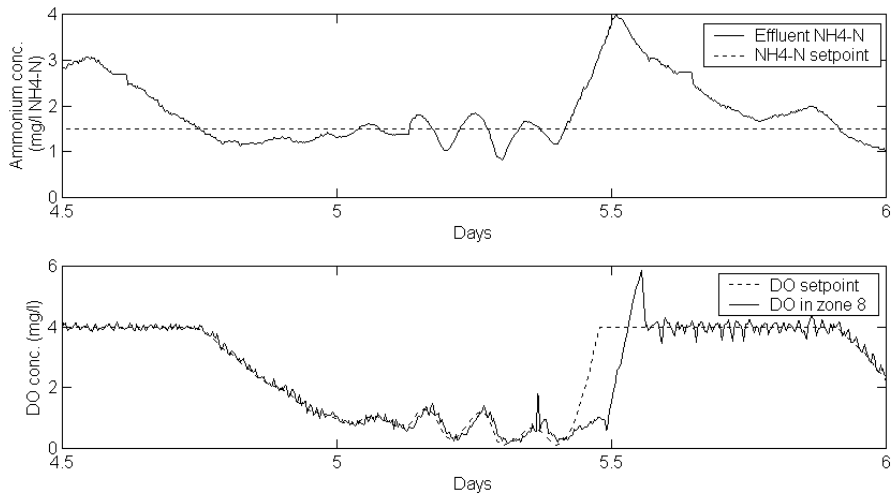

Figure 10.33 Detailed picture of the control during day 5.

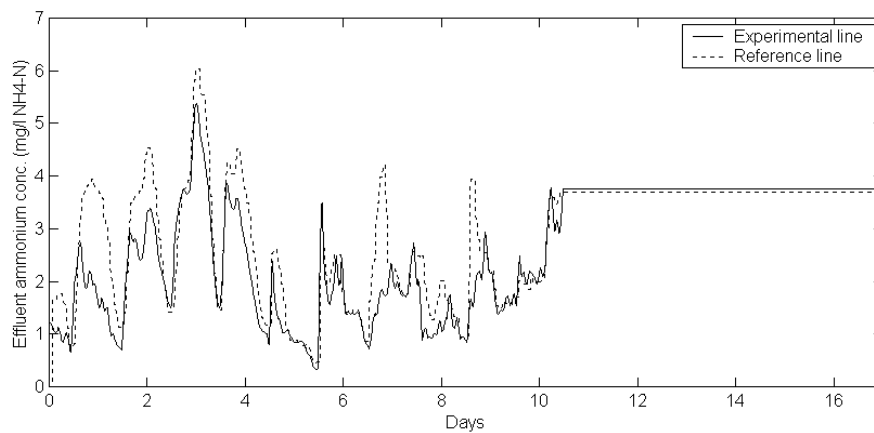

Figure 10.34 Comparison of the effluent ammonium concentration in the two lines.

Looking at the whole period, it can be seen that the controller works more or less as a minimum ammonium controller, ensuring that total removal of ammonium (i.e. no ammonium in the effluent) is avoided. The controller has no control authority during the part of the time when the ammonium load is too high (DO setpoint at its maximum). From the

comparison of the effluent ammonium concentration from the two lines in Figure 10.34 it can be seen that during the time where the effluent analysers worked the effluent from the experimental line was actually lower than in the reference line. The average ammonium concentration in the experimental line during the period was 1.94 mg/l NH₄-N; while it was 2.37 mg/l NH₄-N in the reference line, see Table 10.3. The experimental line has higher removal efficiency during the peak loads. During the same period, the airflow to the experimental line was 12.5% lower than in the reference line. An airflow comparison over the full period is shown in Figure 10.35. This contradicts the simulation results in Section 8.1, that showed that it is not possible to gain energy savings without compromising the effluent ammonium concentration.

Table 10.3 Result in the two lines (first period).

Parameter	Experimental line	Reference line
	1.94	2.37
Average flow-prop. effluent NH ₄ -N (mg/l)	(Period where effluent analysers worked)	(Period where effluent analysers worked)
	2.38	
	(Full period)	
90% percentile of NH ₄ -N (mg/l) (simulated effluent)	3.52 (1.48 times average)	3.96 (1.67 times average)
Average airflow rate (Nm ³ /min)	22.4	25.9
Average power consumption for aeration if the strategy was applied to all lines (kW)	97.1	109.7

Over the whole period, the experimental line used 13.6% less airflow corresponding to 11.5% less energy, than the reference line. By comparing the periods when maximum DO is 4 and 3 mg/l, it can be seen that the experimental line uses less airflow (compared to the reference line) when maximum DO setpoint is 3 mg/l. During the period when the maximum DO setpoint is 4 mg/l, the airflow savings in the experimental line are 12.5%,

during the period when the maximum DO setpoint is 3 mg/l; the power savings are 14.4%, i.e. a distinguishable difference. However, it cannot be verified that the effluent ammonium concentration remained at the same or lower level in the two lines throughout the whole period with a maximum DO setpoint of 3 mg/l.

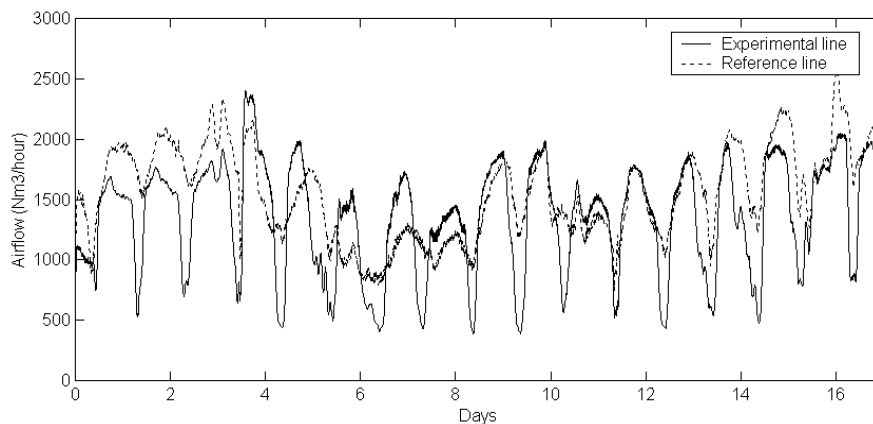

Figure 10.35 Comparison of the airflow to the two lines.

Due to the large number of rain events during the period, it is not possible to obtain a reasonable estimate of the influent load based on the weekly mean values. Therefore, it is not possible to calculate some of the previously discussed parameters for this experiment.

Controller performance during the second period

The controller performance during the second period (with an ammonium setpoint of 3 mg/l $\text{NH}_4\text{-N}$) can be seen in Figure 10.36. The controller performance during this period is better as the capacity of nitrification is sufficient to maintain the applied setpoint for the majority of the time. In fact, at certain periods of the day, the minimum DO setpoint of 0.25 mg/l yields too high a nitrification capacity. Even though the controller is characterised by a too high gain part of the time, it is capable of maintaining the effluent ammonium concentration close at the requested setpoint a significant amount of the time. From day 29, the gain is reduced from 1.00 to 0.75 and the applied integration time during the experiment is

40 minutes. The reduction in the gain results in a reduction in oscillations from day 29.

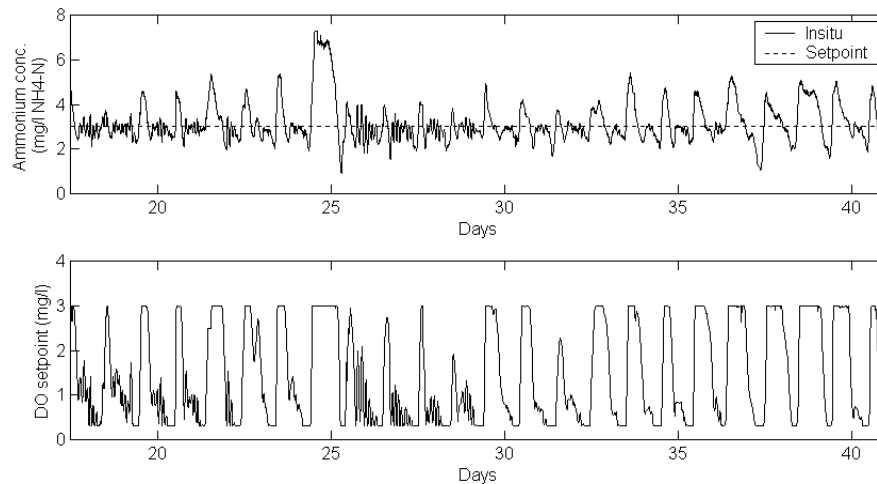

Figure 10.36 Performance of the in situ controller during the second period.

From day 25.5 to day 29, the capacity is sufficient at almost all times and a long period when the controller worked as planned can be observed. This is depicted in detail in Figure 10.37. During the period the standard deviation on the ammonium concentration is 0.50 mg/l $\text{NH}_4\text{-N}$. Additionally, the settler has a smoothing effect on the curve, which reduces the variation further. A simulation of the settler (not shown) as a completely mixed reactor yields an effluent ammonium curve with a standard deviation of 0.27 mg/l $\text{NH}_4\text{-N}$ (i.e. 9% of the average value) or a 90% percentile of 3.2 mg/l $\text{NH}_4\text{-N}$.

The described reduction of the gain further decreases variation during periods where the capacity is sufficient (see Figure 10.38). The two periods are not directly comparable as the controller is in saturation a larger part of the last period. However, looking at the periods in between saturation it can be seen that variation has been reduced.

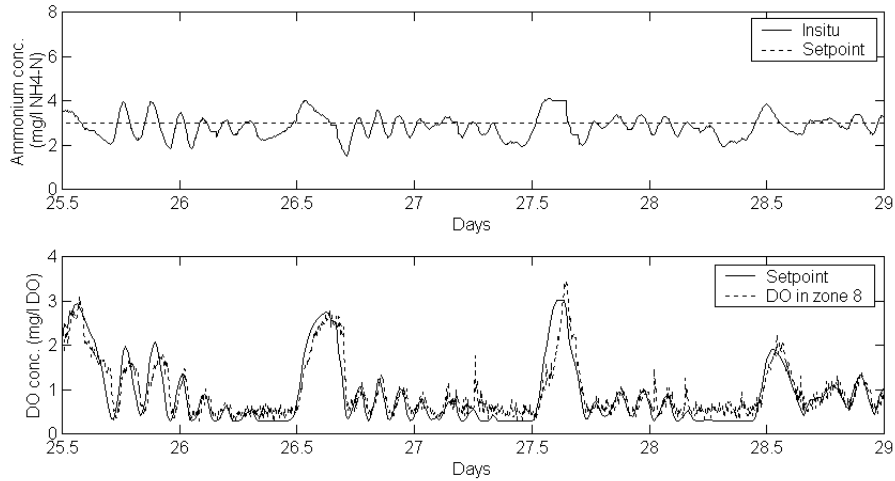

Figure 10.37 Controller performance during period with sufficient nitrification capacity.

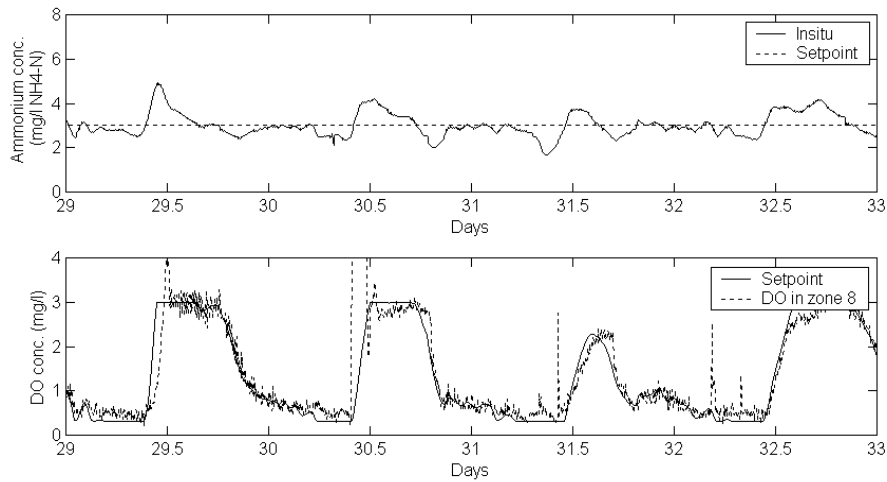

Figure 10.38 Performance after the controller gain has been reduced to 0.75 (compare to Figure 10.37).

Table 10.4 Overview of results in the two lines (second period).

Parameter	Experimental line	Reference line
Average flow-prop. effluent NH ₄ -N (mg/l)	3.28	Not measured
90% percentile of NH ₄ -N (mg/l)	4.27	Not measured
Average airflow rate (Nm ³ /min)	21.6	29.8
Average power consumption for aeration if the strategy was applied to all lines (kW)	91.6	120.2

The results of the second period from the two lines are given in Table 10.4. The performance in terms of disturbance rejection is the best found so far, where the 90% percentile is only 30% above the average concentration. The average effluent ammonium concentration is 8.5% higher than the setpoint. This could have been corrected by applying a slow master controller for the ammonium setpoint, which would correct it so that the average over time would have been the proposed 3 mg/l as described in Section 8.1. The savings in energy are considerable compared to the reference line, airflow rate savings are 27.7% and energy savings are 23.8%. Unfortunately, it is not possible to compare these savings with the achieved effluent ammonium concentration in the reference line due to malfunction of the effluent analysers during the experimental period.

Test of a non-linear controller

There seems to be a tendency to non-linearity in the controller performance, see Figure 10.39 for a good example of this. The PI controller performs well in the beginning, i.e. when the DO setpoint is around 0.75 mg/l. However, when the DO setpoint decreases it seems as if the gain of the controller is too high. The nitrification process appears more sensitive to changes in DO concentration at low DO concentrations than at high DO concentrations. This is further supported by the earlier observation that it makes little difference for the effluent ammonium concentration if the maximum DO setpoint is set to 4 or to 3 mg/l, indicating a low sensitivity at high DO setpoints.

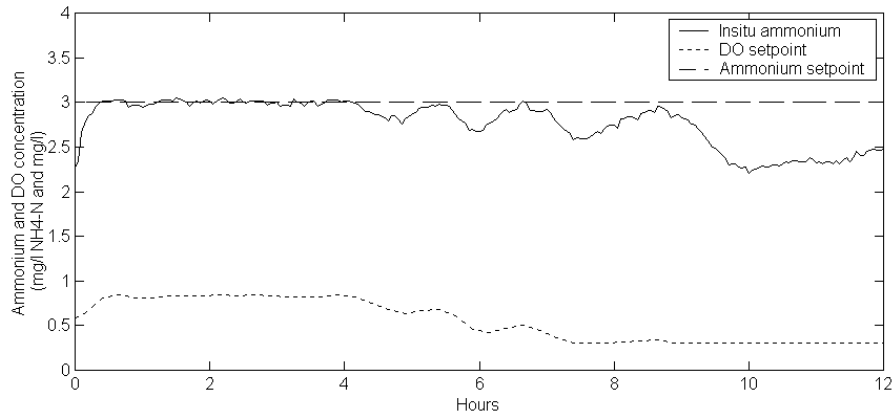

Figure 10.39 Example of non-linear behaviour?

The effect can be explained by the ammonium removal rate being dependent on the DO concentration in a non-linear fashion, often described by a Monod term (e.g. in ASM1), see Figure 10.40. Therefore, a non-linear controller was implemented and tested. Instead of controlling the DO concentration as the output (u) from the PI controller, the relative nitrification rate is controlled. The relative nitrification rate ($r_{nit,rel}$) is transformed into DO setpoints according to Equation (11.3).

$$r_{nit,rel} = \frac{S_O}{K + S_O} = u$$

i.e. (11.3)

$$S_O = \frac{uK}{1 - u}$$

The resulting performance is shown in Figure 10.41, which indicate that a non-linear controller applying Monod kinetics performs slightly better than a linear PI controller (as no oscillation appear during low DO setpoints). From hour 2 to 16, where the controller is not in saturation, the standard deviation is only 0.13 mg/l NH₄-N (or 4% of the average concentration). A similar approach to compensate for the non-linearity in DO control has been tried by Lindberg (1997).

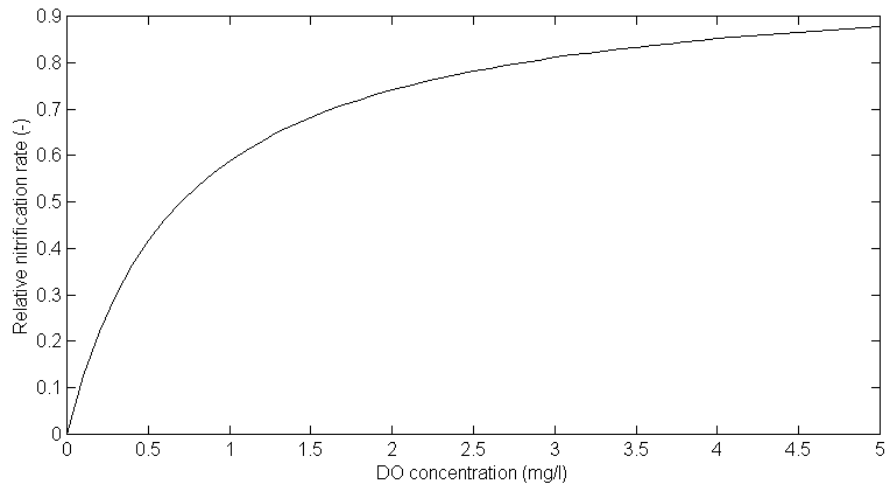

Figure 10.40 Monod kinetic is often used to describe the nitrification rate's dependency of the DO concentration (half saturation constant of 0.7 mg/l).

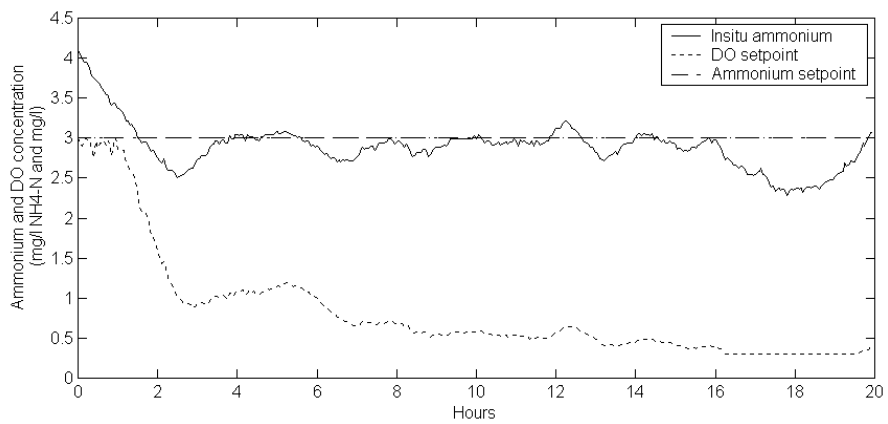

Figure 10.41 Control experiment with non-linear controller.

Evaluation of sludge

During the experimental period, there was severe sludge escape. The escaped sludge is caught in the chemical sedimentation and returned to the biological lines. The sludge escape during the full period was 3.7 ton per

day from the two lines or approximately 7.7% of the sludge content of the biological reactors per day. This means that the lines are no longer parallel with regard to the sludge and investigations of sludge properties in the two lines for comparison make little sense as they both contain a mixture of the sludges from the two lines. Nevertheless, sludge volume index analysis, maximum nitrification rate analysis and microscopic investigations were carried out but showed no significant differences (not shown). These results do not certify that the control strategy did not affect the sludge characteristics, but here it is indeterminable.

Summary of evaluation

The in situ controller demonstrated the best performance of the four proposed controllers in terms of adjusting the DO setpoints to obtain a certain effluent ammonium setpoint. It seems that the dynamics of the system is no more complex than that a PI controller can reject the incoming disturbances given the required nitrification capacity. The controller maintains the setpoint at all times except during controller saturation. The maximum and minimum limits could have been circumvented by adding or removing an aerated zone. However, this cannot be done automatically at the Källby WWTP. In order to develop a controller for this purpose, a smooth transition in the controller when turning on or off an additional zone needs to be developed. In plants where the average concentration over a long time frame is the important issue the number of zones should be chosen so that both maximum and minimum saturations are reached an equal amount of the time (or no saturation at all if possible), i.e. on an average the nitrification capacity should be sufficient.

Improved performance of the controller could be achieved if the DO setpoint controller was faster. As can be seen in Figure 10.33, the DO concentration sometimes has difficulties following a rapid change of the setpoint. This could be corrected by increasing the response time of the supervisory pressure controller. It might also be possible to achieve a slight improvement by adding a derivative term to the in situ controller (i.e. using a PID controller). This has not been verified.

The experiment during the first period (ammonium setpoint of 1.5 mg/l $\text{NH}_4\text{-N}$) demonstrated that, by removing the periods when the effluent ammonium concentration from the last aerobic zone is close to zero, the energy consumption can be significantly reduced (compared to a constant DO profile) without deteriorations in effluent ammonium concentration. A

further reduction in air consumption can be achieved if the ammonium setpoint is increased (second period). Unfortunately, it is difficult to quantify this additional saving during this period because the effluent ammonium analysers malfunctioned during the whole period.

A non-linear controller, taking the non-linear dependency of nitrification rate to DO concentration into consideration, was also tested. The non-linear controller gave a slightly better performance. However, for practical implementations the small oscillations in the linear PI controller are not considered to be of major importance.

10.6 Conclusions

Four different controller concepts for effluent ammonium concentration control have been tested in full-scale. The best controller performance is achieved by the PI controller based on an in situ ammonium sensor located at the end of the aerobic reactor. This result was to some extent expected from the simulation study documented in Section 8.1. It shows that the process is not faster, nor more complex, than it is controllable by simple feedback control provided the feedback sensor is located at the end of the aerobic reactor(s). Thereby, the need for model-based control is not apparent and a simple controller and control structure can be applied. This result is valid for the Källby wastewater treatment plant but is also assumed valid for numerous similar plants, as the range and rate of change of disturbances are considered normal compared to other plants of similar size. Small plants may experience faster variations due to their more limited catchment area and plants with large industrial loads may experience faster variations. At such plants, the control method may be less applicable. In this case, the controller may be supplemented by a feedforward term as suggested in Section 10.2 or 10.4. The performance of the controller system is limited by minimum and maximum limits for the aeration. These limits may be circumvented by additionally controlling the number of aerated zones.

The online control of aeration resulted in considerable savings of energy consumption. The experiment documented in Section 10.5 (the first part of the experiment) showed that it is possible to reach better effluent ammonium concentration as with a constant DO profile and at the same time save 10-15% of the airflow, simply by avoiding periods when ammonium concentration is close to 0 mg/l $\text{NH}_4\text{-N}$. Further savings can be achieved by increasing the ammonium setpoint. In the second experiment,

further energy savings were achieved by increasing the ammonium setpoint from 1.5 mg/l $\text{NH}_4\text{-N}$ to 3 mg/l $\text{NH}_4\text{-N}$, which did not seem to cause problems with regard to disturbance rejection or sludge characteristics.

The internal recirculation flow rate controller did not perform satisfactorily at any time during the experiments as the maximum pumping flow rate was too low to ensure the desired nitrate setpoint. Therefore, it was not possible to verify if the simulated results, which indicated that a simple PI controller is sufficient for this control. However, the increase in internal recirculation due to the application of the controller led to considerable reductions in the effluent total inorganic nitrogen concentration at a low energy cost.

Chapter 11 Control of Phosphate Precipitation

The control of precipitation of phosphate has received relatively little attention in scientific publications. This is probably due to the relatively low cost of precipitation chemicals. However, as the price for sludge disposal increases the cost associated with phosphorous precipitation increases. In this chapter, four different control strategies are suggested and three are tested in full-scale at the Källby WWTP. The best performance is achieved by a simple feedback controller based on a phosphate sensor located at the end of the flocculation chamber.

11.1 Chemical precipitation at the Källby WWTP

As described in Chapter 9, phosphorous is removed by post-precipitation at the Källby wastewater treatment plant. This is carried out in two identical and parallel chemical lines. The lines consist of a dosage system, where the precipitation chemicals are dosed into the water stream that flows into a flocculation chamber, where soft mixing favours the development of flocs. This is followed by parallel sedimentation basins, where the chemical sludge is removed. The average retention time in the flocculation chamber is one hour and the average retention time in the sedimentation basins is 4.3 hours. Biological processes and sedimentation processes in the lagoons also remove part of the phosphorous (especially during summer), so the effluent phosphorous concentration from the settler has to be adjusted to the current phosphorous removal capacity of the lagoons. The preceding biological lines also include partial biological

phosphorous removal, thus the dosage of precipitation chemicals has to be adjusted to the current influent phosphorous load to the chemical part.

At the Källby WWTP, Fe^{+++} is used for precipitation. A 13.7% (weight) solution is used, with a density of 1.42 kg/l. The cost is 8.76 SEK (0.97 Euro) per kg Fe^{+++} . The consumption of chemicals is 90 tonnes Fe^{+++} per year, corresponding to a cost of 790 000 SEK (8 7778 Euro) per year. In Barbe *et al.* (1999), it is stated that 2.62 g SS is formed per g Fe added, this means that at the Källby the suspended solids production due to chemical precipitation is 240 tonnes of suspended solids. Sludge at the Källby is dried to a sludge content of 20-25%. Consequently, the sludge production from chemical sedimentation is approximately 960-1200 ton per year. The cost of deposition of the sludge is 250 SEK/ton (28 Euro/ton), i.e. a cost of 240000-300000 SEK (26667 – 33333 Euro) per year. The total cost of chemical precipitation is thus 1.03-1.09 million SEK (0.11-0.12 million Euro) per year.

11.2 Controller options for precipitation

Phosphorous precipitation can be controlled in several different ways, see Figure 11.1.

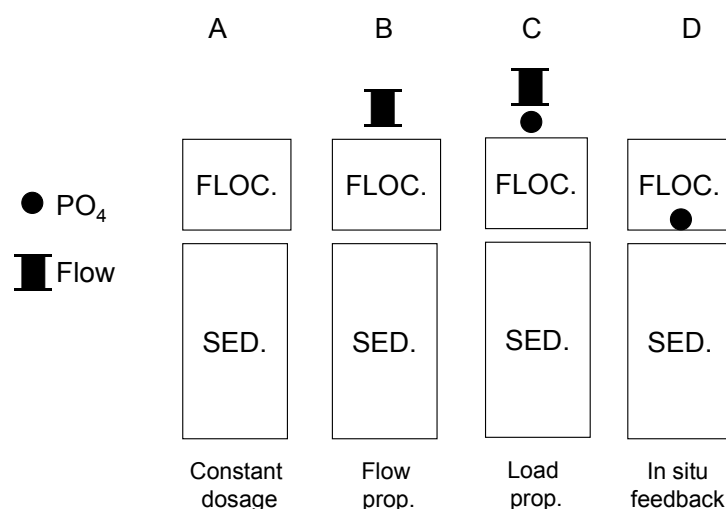

Figure 11.1 Overview of types of precipitation control. (The dots symbolise phosphate sensor position, “squares” symbolise the flow sensor position).

Description of the controller types in Figure 11.1:

A. Constant dosage

This corresponds to a no control situation. The dosage rate should be set high enough to ensure sufficient phosphorous reduction at all times. Therefore, at certain times the dosage will be too high.

B. Flow proportional dosage

An improvement to the constant dosage control scheme is to dose proportionally to the influent flow rate. This considerably reduces the dosage. The basic assumption for this type of control is that the influent phosphate concentration is fairly constant. This is, however, mostly not the case, as can be seen in Figure 11.2.

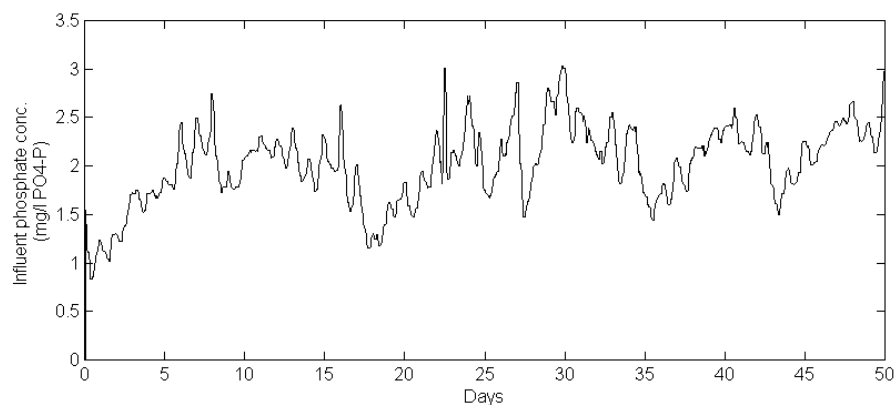

Figure 11.2 Example of variation in PO₄-P concentration into the chemical step.

C. Load proportional dosage

When measuring the influent phosphate concentration to the chemical lines, the load (calculated as the influent flow rate multiplied by the influent phosphate concentration) can be used to control the dosage. It is assumed that the ratio between the influent phosphate and the need of chemicals has a constant relationship.

D. Feedback control

The above assumption of a constant relationship between influent phosphate load and dosage may not be entirely correct, as factors such as pH and mixing efficiency may influence the process. An alternative is therefore to apply a feedback loop, which controls the

dosage towards a certain phosphate setpoint in the effluent. The feedback signal can come either from the end of the flocculation reactor or from the end of the sedimentation tanks. Locating the sensor at the effluent of the flocculation chamber is preferable as it introduces a smaller time lag compared to a signal from the effluent from the sedimentation basins.

At the Källby WWTP, three different control structures for phosphate precipitation have been tested. These are the above options B to D. The results of the experiments are documented in the following.

11.3 Flow proportional feedforward control

A flow proportional controller was tested during a period from April 23 to May 27, 2001.

Performance of controller

The influent flow rate and the dosage can be seen in Figure 11.3.

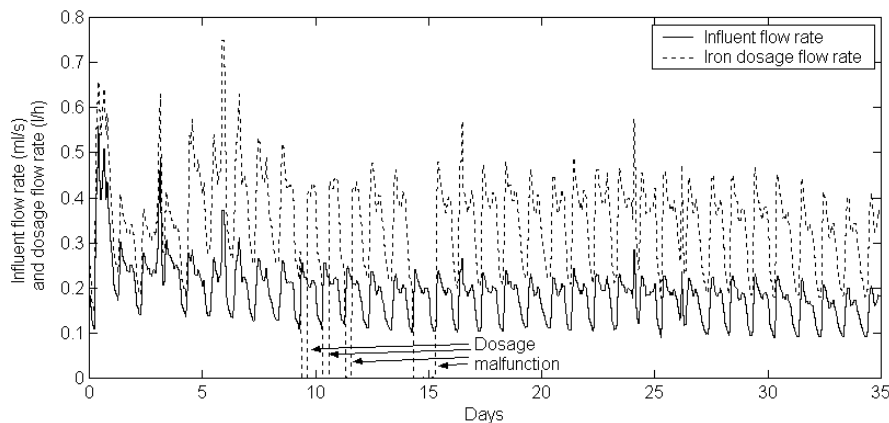

Figure 11.3 Influent flow rate and dosage of precipitation.

The performance in terms of effluent phosphate can be seen in Figure 11.4. Four periods of malfunction can be seen in the effluent phosphate concentration (days 9, 10, 11 and 15). Especially the last incident (day 15) is

easy detectable in Figure 11.4, where the effluent phosphate concentration increases drastically.

The influent phosphate concentration into the chemical step is measured as the effluent phosphate from the biological lines (see Figure 11.5). The curve is not divided into the four different lines. Some problems with the analyser were experienced during the period, as can be seen. However, it can be seen that the influent phosphate concentration is increasing during the second half of the period, which seems to be the explanation for the increase in effluent phosphate concentration during the same period (Figure 11.4).

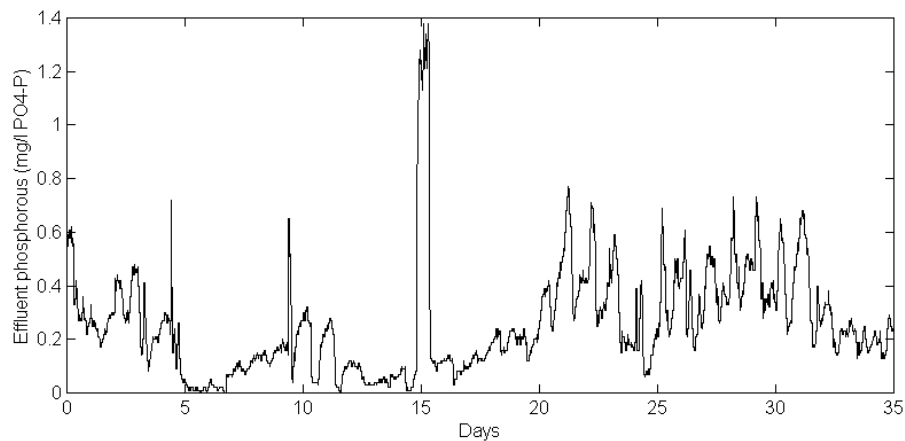

Figure 11.4 Effluent phosphate concentration from flocculation chamber based on a flow proportional controller.

The effluent phosphate concentrations from the sedimentation chamber and from the lagoons have been simulated and are shown in Figure 11.6 and Figure 11.7. The effluent from the settler and the lagoons are based on a simulation, where no transformations are assumed in either the settler or the lagoons. The smoothing effect of the settler is small compared to the effect of the lagoons (due to the long retention time). Even the incident due to dosage pump malfunction on day 15 is hardly a significant disturbance when examining the effluent phosphate concentration from the lagoon.

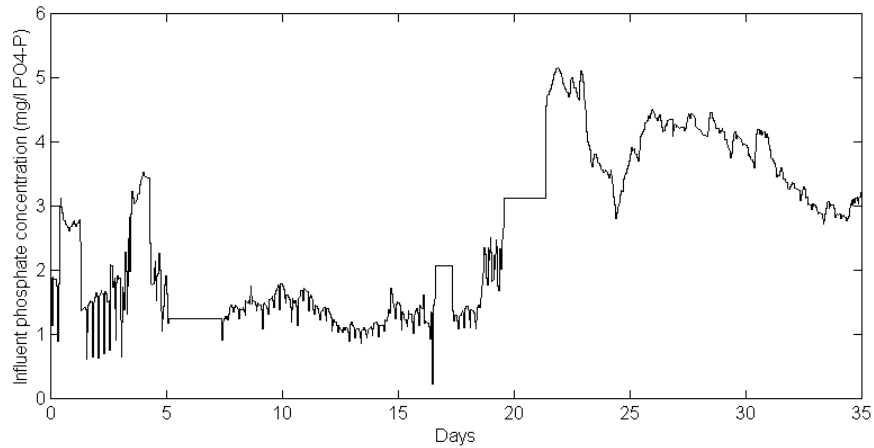

Figure 11.5 Influent phosphate concentration into the chemical step. (There was problems with the sensor during part of the period).

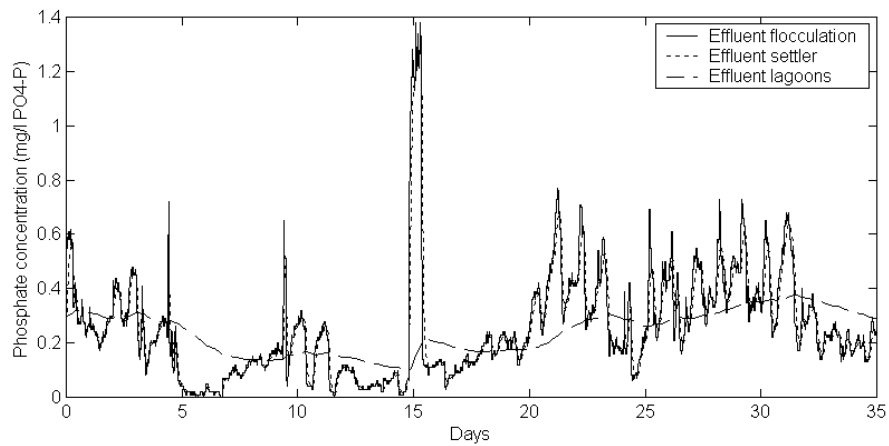

Figure 11.6 Simulation of the effluent concentrations of phosphate from settler and lagoons.

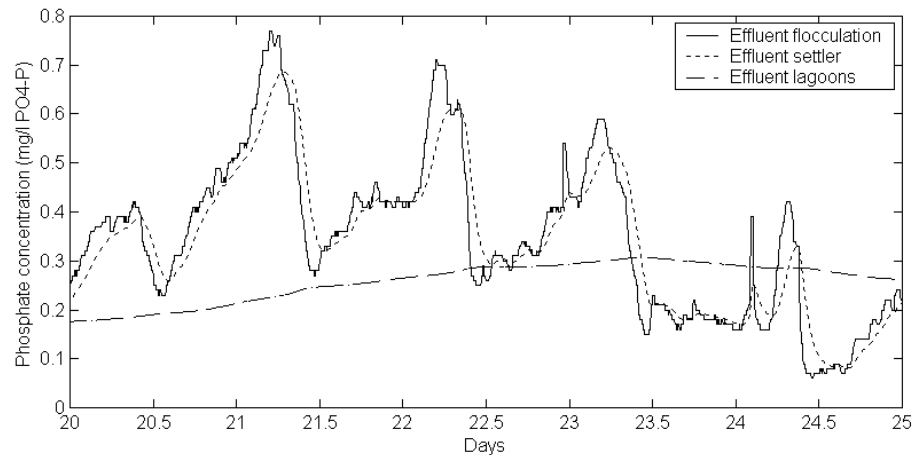

Figure 11.7 Detailed look of simulation in Figure 11.6.

11.4 Load proportional feedforward control

The flow proportional feedforward controller did not consider the varying influent phosphate concentration. This is particularly important as the influent phosphate concentration shows a slow variation from week to week. The variation in the influent phosphate into the chemical step can be due to a number of reasons. At the Källby WWTP, the changing efficiency of the biological phosphorous removal in the biological line is a significant disturbance. Another source of disturbance is the variation in the influent phosphate concentration.

A phosphate load based feedforward controller is expected to be able to remedy the effluent variation due to varying phosphate concentrations. An experiment with this type of controller was carried out during the period from June 26 to July 11, 2001. The feedforward controller is based on the effluent analysers from the biological lines. The experimental line (K1) receives wastewater from the biological lines B1 and B3. The load is calculated based on phosphate measurements and flow measurements in the two lines. A maximum limit of 1.82 l/h for the precipitation dosage is applied; this limit is in effect during the measurement error during the days 6 and 7.

The resulting effluent phosphate concentration from the flocculation chamber has been recorded during the period (see Figure 11.8). This is

plotted together with the dosage flow rate. The effluent phosphate concentration shows a quite high variation. The reasons for the peaks during the days 1, 3 and 4 are unknown; they may be due to a sudden phosphate release in the biological lines.

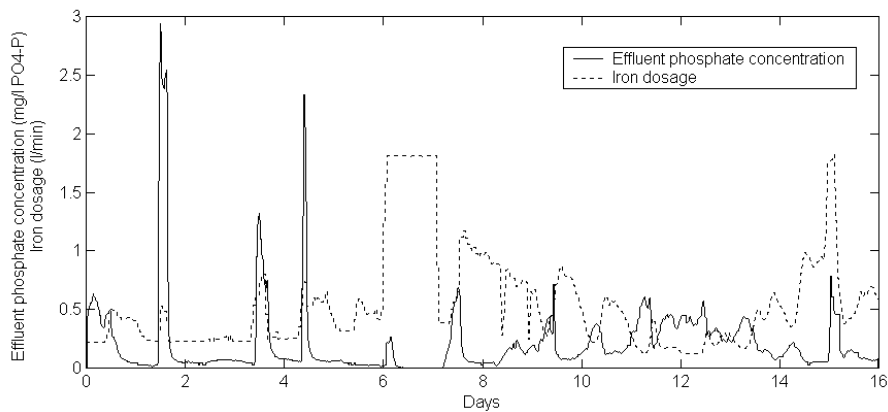

Figure 11.8 Flocculation chamber effluent phosphate concentration and the iron dosage (influent phosphate load based control).

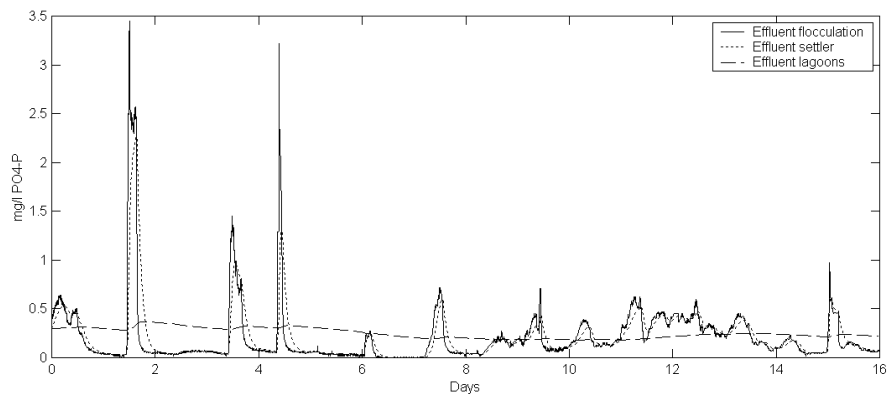

Figure 11.9 Simulation of effluent from settler and lagoons.

A simulation of the effluent from the settler and the lagoons is shown in Figure 11.9. In the period, there were only two incidents of rain (days 6 and 15) and as the experiments were carried out in the summer the retention time in the lagoons was almost five days on an average. This naturally has a

quite smoothing effect on the effluent phosphate concentration, even during the peak events. Therefore, the effluent phosphate concentration from the lagoons shows only small variation

11.5 Feedback control

The retention time in the flocculation chamber is short, on an average around one hour. This is considerably smaller than the time constant of the variation in influent load of phosphate to the chemical step. Hence, it should be possible to control the phosphate precipitation by means of feedback control based on an in situ phosphate sensor located in the effluent of the flocculation chamber. This has been tested during the period from October 3 to November 28, 2001 (see Figure 11.10 and Figure 11.11).

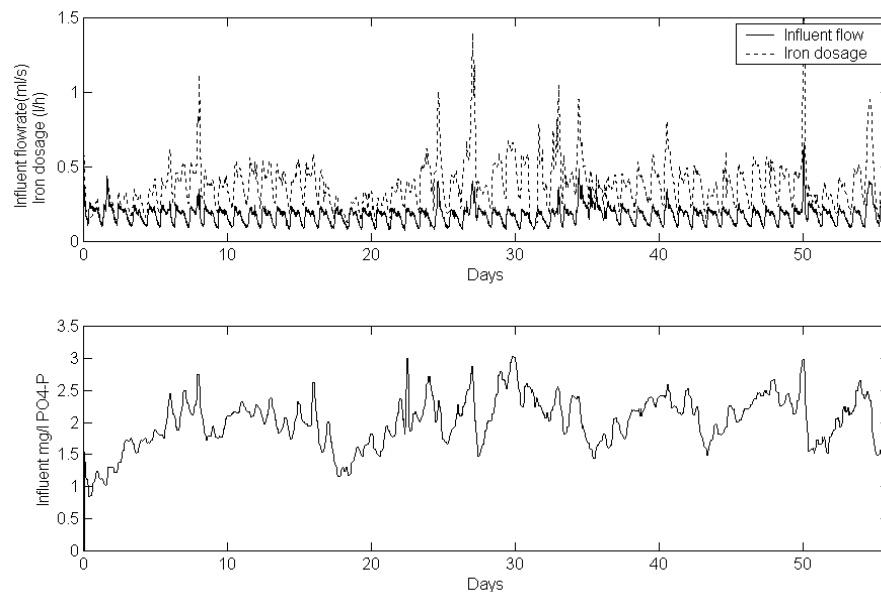

Figure 11.10 Feedback control based on effluent phosphate concentration from the flocculation chamber.

The performance in terms of effluent phosphate concentration can be seen in Figure 11.11 and a shorter period can be seen in detail in Figure 11.12. Note that the setpoint is changed from 0.5 mg/l $\text{PO}_4\text{-P}$ to 0.4 mg/l

PO₄-P on day 23 and back to 0.5 mg/l PO₄-P on day 33. The peak concentration on day 31 is due to a malfunction of the dosage pump. The standard deviation of the phosphate concentration from the flocculation chamber in Figure 11.12 is 0.031 mg/l PO₄-P. A simulation shows that the standard deviation on the effluent phosphate concentration from the settler is further reduced to 0.018 mg/l PO₄-P.

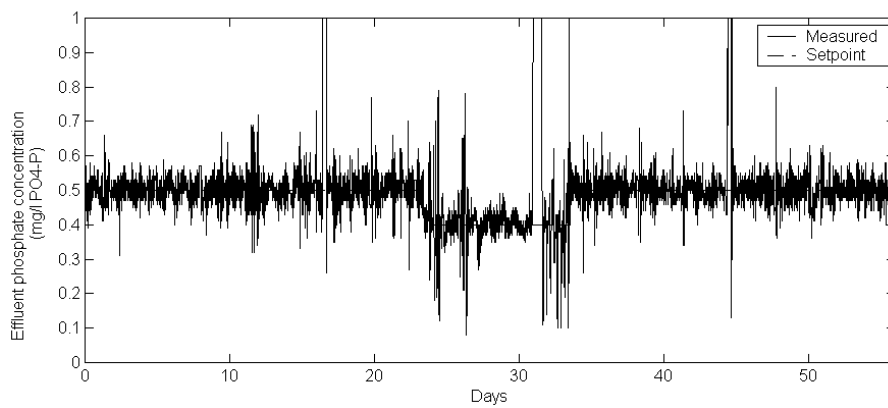

Figure 11.11 Effluent phosphate concentration from flocculation chamber, control by feedback controller.

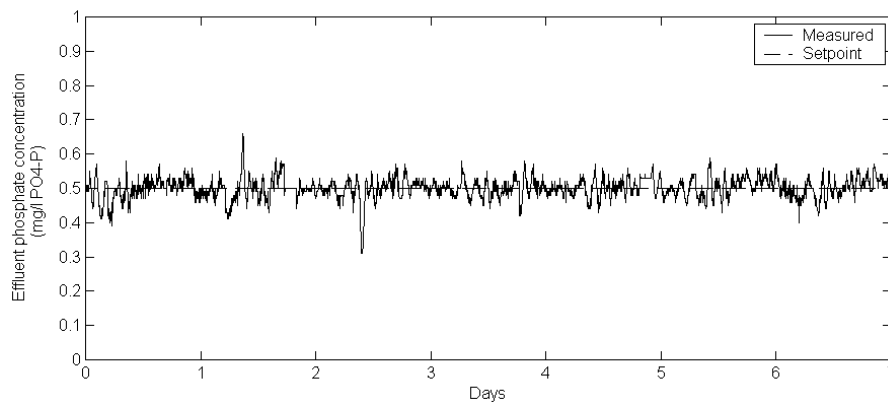

Figure 11.12 Effluent phosphate from the flocculation chamber (detail), control by feedback controller.

During some periods of the experiment, there are more oscillations than normal. These oscillations are mostly caused by periods of rinsing or calibration of the sensor. The sensor is calibrated once every three days (lasting 2 hours) and rinsed every 12 hours, (lasting 32 minutes). During periods of calibration and rinsing the sensor provides a constant output equal to the last measured value. When the sensor starts measuring again the concentration may deviate from the setpoint. This occasionally causes oscillations, see example in Figure 11.13. Some of the oscillations are also caused by experiments with the gain and integration time constants. The best values have been found to be a gain of 7 litre chemicals/minute/(mg PO₄-P/l) and an integration time constant of 30 minutes.

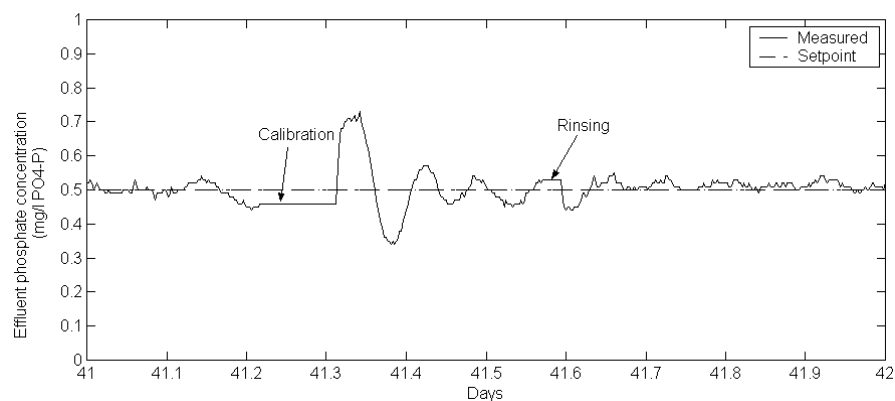

Figure 11.13 Oscillations in effluent phosphate concentration due to calibration and rinsing of sensor.

The proposed controller is based on the effluent phosphate concentration while most effluent permits are defined in terms of effluent total phosphate concentration. However, at the Källby WWTP, it was discovered that the total phosphorous and the orthophosphate concentrations are linearly correlated, with a regression value of 0.96. The regression was based on 28 24-h samples (see Figure 11.14). This means that it is possible to control the process towards a certain phosphate setpoint and be reasonably certain that the total phosphorous concentration will be in compliance as well. A linear correspondence between the two types of concentrations was also described by Ammundsen *et al.* (1992).

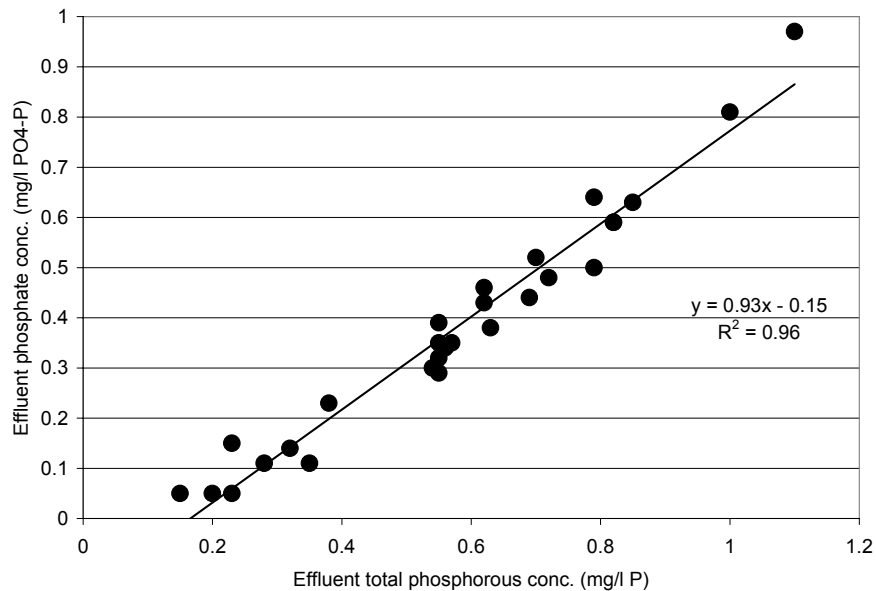

Figure 11.14 Effluent phosphate concentration as a function of total phosphate concentration (based on daily average samples).

The feedback controller works well in terms of precision. This can be used to quantify the savings when comparing various strategies. It has earlier been discussed that the options for precipitation dosage control are:

1. Constant dosage;
2. Flow proportional dosage;
3. Load proportional dosage;
4. Feedback control.

The first period, when a setpoint of 0.5 mg/l PO₄-P was applied (days 1 to 23), is used for comparison of the resource consumption of the different strategies. The choices of the controller constants, on which Table 11.1 is based, are based on 100% compliance. That means that, at any time a given controller should provide at least the same dosage flow rate as the feedback controller provided (see Figure 11.15). If compliance in 90% of the time is accepted, it means that 10 % of the time the dosage may be less than in the feedback controller. This 90% compliance quantification is included to avoid extreme situations.

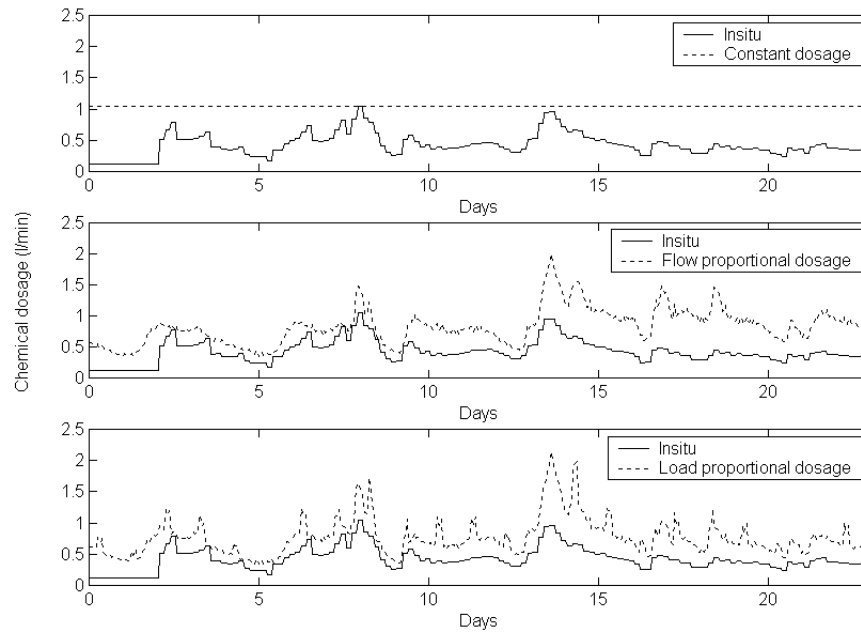

Figure 11.15 Comparison of strategies (100 % compliance).

Table 11.1 and Table 11.2 summarises the comparison of the four strategies for 100% and 90% compliance. As expected, the in situ controller is the best controller (in terms of small need for precipitation chemicals), the load proportional control comes in second, then the flow proportional and the poorest performance is achieved with a constant dosage rate, i.e. no control. This is seen in both cases (.e. for 100% and 90% compliance).

Table 11.1 Comparison of control strategies (100% compliance).

Strategy	Average dosage (l/min)	Relative consumption (to the in situ controller)
Insitu	0.42	
Constant dosage	1.04	264%
Flow proportional dosage	0.83	209%
Load proportional dosage	0.80	201%

Table 11.2 Comparison of control strategies (90% compliance).

Strategy	Average dosage (l/min)	Relative consumption (to the in situ controller)
In situ	0.42	
Constant dosage	0.66	167%
Flow proportional dosage	0.62	156%
Load proportional dosage	0.54	136%

During the experiment with the feedback controller, the parallel and identical line K2 was controlled based on a load proportional dosage. The gain of the controller was adjusted by the operator based on information from weekly effluent flow averaged phosphate and total phosphorous concentrations measured in the laboratory. The average dosage applied in the experimental line (K1) was 0.40 l/min over the whole period and in the reference line the average dosage applied was 0.52 l/min, i.e. 30% more chemicals were used in the reference line. This fits well with the predictions in Table 11.2 (which was 36%). This means that 90% compliance is a good measure for the savings that can be obtained with the respective types of control.

The weekly laboratory samples are used to evaluate the average effluent concentrations of total phosphorous and phosphate in the two lines during the experiment, see averages in Table 11.3. A calculation of the effluent total phosphorous in K1 based on the setpoints of 0.5 and 0.4 mg/l PO₄-P means that the predicted effluent total phosphorous concentration should yield 0.68 mg/l total phosphorous (i.e. the average of 10 days times effluent total P of 0.6 mg/l P and 45 days of effluent total P of 0.7 mg/l P ((10*0.6+45*0.7)/55)). This is exactly the effluent total phosphorous concentration measured in the experimental line. The distribution between total phosphorus and phosphate is not exactly as expected (i.e. 0.48 mg/l PO₄-P). This may be due to processes taking place in the sampling box during the week it takes to collect the sample. The effluent from the reference line is lower as more precipitation chemicals are added. This is most likely an effect of the operators applying a “safe strategy” to ensure compliance at all times, not risking any samples above the required level.

Table 11.3 Effluent phosphorous concentration based on weekly samples during the experimental period of the feedback controller.

	mg/l total P	mg/l PO ₄ -P
Experimental line	0.68	0.40
Reference line	0.51	0.26

11.6 Conclusions

The feedback controller shows the best performance with an almost perfect match of the setpoint. The controller is easy to implement, as a PI controller is sufficient. This result lies well in line with the conclusion from the control of aeration. Again, it appears that the variations are not faster than that it is possible to use feedback provided that the sensors are located as close as possible to the processes. In this case, the sensor is located at the end of the flocculation chamber. The performance of a controller based on a sensor at the end of the sedimentation reactor has not been tested. Such a controller is expected to show somewhat poorer results as the time delay is increased by a factor five. Applying an in situ feedback controller is especially beneficial if the phosphate criterion is based on a short time period (e.g. grab samples). An additional (slower) feedback loop can be applied to find the right phosphate setpoint based on a sensor located at the end of the lagoons, this has not been tested.

Part V Discussion and Conclusions

Chapter 12 Discussion

The state of art in wastewater treatment plant operation is in a state of transition towards better control of the unit processes in the plants. This is especially promoted by the access to easy-to-use in situ nutrient sensors that provide important online informations well-suited for automatic process control. The change is similar to the change experienced two decades ago when DO sensors became widely available. Today the control of the DO concentration is standard at many plants, similarly the control of nitrification, denitrification and phosphorous removal will become standard at most WWTPs in the near future. The aim of this thesis has been to provide knowledge of how to apply these new sensors to obtain useful benefits. The task has been accomplished by a combination of full-scale experiments, model simulations and a large international survey investigating the current state-of-art in WWTP operation.

A number of aspects of control of wastewater treatment processes have been discussed in the preceding chapters. In this chapter, an overall discussion of the subject based on the achieved results is presented.

12.1 How to control full-scale plants using nutrient sensors

This thesis shows that it is possible to control the removal processes of nitrogen and phosphorous by using nutrient sensors. The most important conclusion is probably that large improvements can be achieved by a reasonably simple SISO control structure based on simple PI controllers.

It has been shown in full-scale experiments that a simple PI controller of the DO setpoint may significantly reduce the disturbances in incoming nitrogen load to yield an effluent ammonium concentration as defined by the controller. The controller cannot reject all disturbances due to upper and lower limitations in the aeration capacity. However, during periods of

sufficient aeration capacity a close to constant effluent ammonium setpoint can be maintained. This type of dynamic control of the DO setpoint leads to significant aeration energy savings, even when the effluent ammonium concentration is lower in the controlled line than in the reference line. One improvement of this control loop may be the control of the number of aerated zones. This would mean that the internal recirculation rate would have to be controlled depending on the number of anoxic zones, i.e. a MIMO solution would probably be necessary. The suggested in situ feedback solution may also be improved by a feedforward term, which gives an estimate of the incoming disturbances. Several types of feedforward calculations have been suggested, however, it might even be sufficient to base such a term on influent flow rate; this has not been verified. Additionally, simple controllers for the control of internal recirculation flow rate and carbon dosage have been suggested, which are also based on a control structure consisting of simple cascaded PI controllers. These have been tested on the benchmark simulation platform and shown good performance.

The dosage of precipitation chemicals can also be controlled by a simple PI controller. Full-scale tests have shown that it is possible to reach an almost perfect disturbance rejection. This leads to significant reduction in the dosage of chemicals and, hence, also in the produced amount of chemical sludge.

The single most important reason for why it is possible to apply such simple control structures is the access to sensors that can be placed directly in the process, i.e. in the mixed sludge liquor and in the flocculation chamber of the chemical precipitation. These locations significantly reduce the dead time compared to a sensor location in the effluent of the secondary settler. So, if a pre-denitrification plant has to choose one location for a nutrient sensor, a feedback location as close as possible to the process being controlled is expected to be the most effective. The application of mathematical models in the controllers, such as model predictive control, does therefore not seem so important.

The type of controller that is required depends on the type of disturbance rejection that is needed at the specific plant. This is largely determined by the definitions of the effluent permits. Especially, the aspect concerning the type of samples that has to comply to a given effluent concentration criterion is of importance. Permits defined by grab samples obviously pose higher demands on disturbance rejection than monthly or even annual average concentrations. This also implies that the shorter the sampling time frame, the larger the expected benefit due to online control.

On the other hand, it has been found that the control of the internal recirculation flow rate should be performed so that maximum removal of nitrogen is reached at all times, due to the limited amounts of energy needed for pumping. This means that in pre-denitrification systems, where external carbon source is not used, the control authority is limited and it is easy to control the system close to this limit. Again, the control of the distribution between aerated and non-aerated zones may influence this.

An implementation process for nutrient sensors in wastewater treatment plants has been suggested together with a number of interesting cases stories illustrating some of the insights that can be reached during such a process. This process consists of four steps:

1. *The initial analysis phase.* Possible potential is identified and ideas for controllers are developed;
2. *The monitoring phase.* The sensors are installed at suitable locations to follow the daily variations resulting from the existing operation. Improvements are identified;
3. *The experimenting phase.* Testing the effect of manually changing the operation;
4. *The automatic control phase.* The actual implementation and documentation of the automatic process control.

12.2 What are the benefits?

It is difficult to give precise estimates of the benefits a wastewater treatment plant stands to gain by implementing process control based on nutrient sensors. The difficulty is due to the different strengths and weaknesses of the plants as well as the different opportunities and threats plants are confronted with. The benefits can be divided into economic and quality-related benefits and more “soft” benefits. In the following, a small SWOT⁶ analysis will be carried out, outlining some of the issues that determine the achievable benefits of improved control, i.e. the *strengths* and *weaknesses* of plants. Secondly, the *opportunities* and *threats* are discussed, including an overview of possible economic and soft benefits.

⁶ SWOT stands for Strengths, Weaknesses, Opportunities and Threats.

Strengths and weaknesses of WWTPs

Looking first at the strengths and weaknesses of specific plants, especially two areas are of importance: technical issues and issues pertaining to the staff at the plant.

The technical issues are related to plant and automation system design. For both, *flexibility* is the key word that determines the opportunities of a plant. An inflexible plant has small chances of achieving improvements by process control. Flexibility includes issues such as:

- It should be possible to operation the actuators automatically;
- The operational range of actuators should be broad and in a range where the actuators can actually influence the processes;
- Continuous operation of actuators is to prefer over less flexible types of operation, such as on/off operation;
- It should be easy to implement new controllers and control structures in the control system.

Another important technical aspect is the initial state of the plant. There are large differences in the performance of plants that have not yet implemented automatic control. These differences depends on the skills of the operator to maintain a close to optimal steady-state operation and/or the risk the plant manager is willing to take. The further away a plant is from its steady-state optimum the more (relatively) is to be gained by applying automatic control. The importance of the initial state can also be observed in an investigation of the potential benefits of DO control at seven Danish wastewater treatment plants carried out in 1979 by DHI Water and Environment (Andersson, 1979). The results in terms of energy savings are summarised in Table 12.1, which shows that the savings constitute between 3% and 66% of the energy used for aeration. Obviously, it is more favourable to obtain 66% savings than 3%. In spite of these large differences, the international survey reported in this thesis shows that most wastewater plants actually do use automatic DO control.

As discussed earlier, it seems reasonable to draw a parallel between the introduction of DO control in the 1970s and 1980s with the present introduction of nutrient sensor based control. In the above investigation, the difference in obtained improvement may be due to the chosen constant aeration rate applied before the DO control experiment. In the case of

control of effluent ammonium, the savings may be a function of the applied DO setpoints and number of aerated zones used before implementing the new control strategy based on ammonium sensors.

Table 12.1 Savings due to the implementation of DO control at seven Danish WWTPs (Andersson, 1979).

	With aeration control		Without aeration control		Savings	
	Power for aeration kWh/day	Total power kWh/day	Power for aeration kWh/day	Total power kWh/day	Power saving for aeration %	Total power saving %
Aså	176	231	523	578	66	60
Br. Dam	390	459	402	471	3	2.5
Fakse	2627	3628	3570	457	26	21
Jyllinge	335	519	893	1077	62	52
Slagelse	2905	4719	3690	5504	21	14
Tårnby	1800	2799	2300	3299	22	15
Viborg	3300	3976	4536	5212	27	24

Another important issue regarding the potential benefits of control is the “human aspect”. The present dedication, skills, knowledge, competences, creativity, etc., are aspects of major importance for the success of implementing new control equipment. The mere purchase of nutrient sensors does not lead to improvements. The sensors can be used at different level of advancement. Today, many sensors are “only” used for monitoring at WWTPs. Based on the provided information, operators occasionally adjust various process parameters. This is only the first step in harvesting the potential of nutrient sensors. More stands to be gained by automating the optimisation procedure and implementing dynamic process control. An investigation at a full-scale plant in Denmark has shown that manual control based on nutrient sensors provided a yearly saving of 10% of the operating costs, while advanced control (STAR) led to the double savings (Önnerth and Nielsen, 1994).

Opportunities and threats

The economic opportunities of process control include:

- Energy savings due to reduced need of aeration;
- Savings in precipitation chemicals consumption;
- Reduction in sludge production and, hence, in the cost for sludge disposal;
- Reduction of green taxes;
- Increase of capacity and, hence, elimination of the need to extend overloaded plants by more reactor volumes.

The economic savings depend on prices on energy, chemicals, sludge disposal and green taxes, as well as the need of plant extensions. These prices may vary considerably from country to country; the current energy prices in a number of selected countries can be seen in Table 12.2. The economic benefit of a 20% savings on aeration energy is obviously quite different in Japan compared to South Africa. Though it has not been possible to provide a comprehensive list of prices for the cost of sludge disposal, it is known that the prices for this also varies considerably from country to country; even within countries the price may vary. Additionally the presence or absence of green taxes makes a tremendous difference in the incentives for improved control.

The size of the plant (i.e. the size of the budget) is also of great importance for the potential savings. In larger plants, it is generally easier to achieve sufficient savings ensure a proper pay-back period for the investments in nutrients sensors and additional control equipment. The largest economic benefit is probably achieved by plants that would otherwise have to be extended.

Besides the pure economic benefits, there are a number of “soft” benefits, which are not so easy to measure in economical terms. These benefits include:

- *Certainty of compliance at all time.* Unexpected situations do not cause random fluctuation of the effluent quality;
- *Revealing the unknown potential.* By monitoring the information from online nutrient sensors, new features of the plants can be discovered. Several examples of this have been given in the thesis. The information may, for example, reveal additional capacity;
- *Understanding of event disturbances.* Events of high loads, toxicity, actuator malfunctions, etc., may not be realised in plants without online measuring equipment. This gives a false sense of security and

means that disturbances may have adverse but unnoticed effects in the recipient;

- *Compliance to future demands.* The quality demands on plant operation are increasing. Nutrient sensors as well as other types of sensor equipment will be a necessity to comply with future demands.

Table 12.2 Electricity prices for industry (International Energy Agency, 2002).

	USD/kWh		USD/kWh
Japan	0.16	Mexico	0.05
Italy	0.09	Spain	0.05
Turkey	0.09	United Kingdom	0.05
Switzerland	0.08	Belgium	0.04
Austria	0.07	Czech Republic	0.04
India	0.07	Finland	0.04
Chinese Taipei	0.06	Poland	0.04
Korea	0.06	Slovak Republic	0.04
Netherlands	0.06	United States	0.04
Portugal	0.06	Canada	0.03
Denmark	0.05	Sweden	0.03
Germany	0.05	New Zealand	0.02
Hungary	0.05	South Africa	0.02
Ireland	0.05		

What is most important - the economic benefits or the “soft” benefits? Another way of posing the question is to ask for a cost-benefit analysis of flow sensors, sludge concentration sensors, PLCs, mixers, etc. The reason for the installation of a large amount of the standard equipment in WWTPs is simply that the plant could not be operated without it. Plants have been forced to operate without online access to the key parameters ammonium, nitrate and phosphate, due to the lack of available sensors. Today, the sensors are available, which leads to discussions of the cost-benefit of such sensors. In the future, however, the sensors will probably be considered just as indispensable as the rest of the standard equipment at WWTPs.

The sensors may also be useful to combat some of the threats WWTPs face. Examples of threats are: increased compliance checking, new and stricter effluent permits, increased demands for energy-efficient operation, competition with (and between) private water companies, increasing cost of sludge disposal, increasing energy costs, need of plant extensions, increasing (or introduction of) green taxes. There may be many other threats; to some of these threats increased process control may be the solution.

12.3 Future development of sensors

Sensor technology for wastewater treatment plant operation (as well as in general) is developing rapidly these years. The sensors are becoming more robust, smaller, easier to maintain, less sensitive to the harsh environment they operate in and not least importantly, they are becoming cheaper. These improvements are primarily due to increased understanding of the currently applied technologies as well as new sensing technologies. Developments within areas such as multivariate calibration of sensors also have the potential of allowing better interpretation of the provided signals (see e.g. Øjelund, 2001). New types of sensors are also being developed, which give access to new types of online information, such as information on microbiological properties.

Having access to online key process variables makes a major difference. By online information it is possible to dynamically adjust the processes to improve operational performance, which is not possible to the same extent by manually taken grab samples or 24-hour samples. Additionally, it is of major importance that the work effort for maintenance of the sensors should be small, so that operators can focus on using the signals for process control, rather than spending their time changing ultrafiltration units, pumps and pipes.

Today, the two major barriers for the wide dissemination of nutrient sensors are the price and the reputation of poor reliability of the sensors. Nutrient sensors are typically a factor 8-12 more expensive than DO sensors. This means that the purchase of nutrient sensors by wastewater treatment plants often represents a significant investment, which needs to be considered carefully. This is unfortunate, as the situation should rather be that wastewater treatment plants had many sensors installed to monitor and control the processes. It also means that smaller plants cannot easily justify the investment based on cost-benefit considerations alone, the economic

incentives are simply too weak. For example, a Swedish plant of 100.000 PE needs an energy saving on aeration of approximately 15% to justify the investment of one sensor (pay-back period less than three years). In Denmark, where the energy price is considerably higher, an 8% saving is sufficient. In Denmark, there is an additional incentive due to green taxes, which further justifies the investment. For example, at a Danish WWTP of 100.000 PE the investment in one sensor can be justified by a reduction of the average effluent total nitrogen of only 0.4 mg/l N or a reduction of the average effluent total phosphorous concentration of only 0.07 mg/l P.

Both the price and the reliability of the sensors have improved considerably during the last years and are expected to improve evenmore.

12.4 Topics for further research

Further research is needed in the field of realising full-scale control in wastewater treatment systems. In this thesis, it is argued that simple feedback controllers are often sufficient to reach a considerably improved performance in the control of the processes based on nutrient sensors. An important requirement is that the sensors can be located insitu, i.e. in the process reactors. In this work, the control of the distribution between aerobic and anoxic reactor volumes has not been studied. This may be an interesting subject for further research. The control of enhanced biological phosphorous removal processes represent another interesting field, where considerable improvements may be achievable. The focus of this thesis has been the control during normal operating conditions; feedforward aspects are believed to be of higher importance when focusing on event disturbances.

The area of full-scale implementation in general needs more attention by the research society. It is important to gain a better understanding of the limitations and opportunities of full-scale plants and processes. One aim is to influence the design tradition towards including a higher level of flexibility in new wastewater treatment plants, so that operation is taken into consideration already from the initial design. Another important aim is naturally to improve operation of currently existing plants as well as providing case stories that promote the successful application of process control in full-scale WWTPs.

It is problematic that plants, due to over-dimensioned design, have no or few incentives to improve operation, because the effluent concentrations are below the ones demanded by the effluent permits. The plants can do

better than that. There is a need for better definitions of operational goals. Using percentiles of effluent concentrations as a basis for effluent criteria (Jacobsen and Warn, 1999) may be more sensible than currently applied criteria. More research is needed in the field of defining operational goals that promote the desired type of behaviour. This probably also includes finding a suitable structure for the application of green taxes, which strengthens the incentive to improve operations. The goals may also become more integrated with current needs of the receiving water recipient.

In order to improve plant operation further, there is a need for better integration of sensors into plant operation. At many plants, sensors are merely used for monitoring and occasionally adjusting process parameters. Automatic process control promises considerable further improvements. A prerequisite for these improvements is precise and reliable sensors. Therefore, it is important that the maintenance and quality verification of the control and sensor systems become integrated parts of the working procedures at the plants. This involves frequent quality verification, knowledge of how the controllers work, as well as easy opportunity to modify and improve the control system. Often, it seems as if the control systems are rather rigid and difficult to change by the operators. This is unfortunate as it discourages initiatives to improve the current control system. There is a need for control systems that empower the operator.

Benchmarking methods have improved rapidly during the last years. Benchmarking enables objective comparisons of operational performance between wastewater treatment plants, which is important to encourage further improvements. Such external benchmarking procedures combined with monitoring of internal performance indicators are expected to be an integral part of future plant operation. Research into improved methods of benchmarking is also needed.

Chapter 13 Conclusions

The Danish word for *science* is *videnskab*, which means *the creation of knowledge*. The purpose of this chapter is to summarise the knowledge that has been created during the project.

The most important conclusion of this thesis is that it is possible to significantly improve operational performance in full-scale plants by means of relatively simple control structures and controllers based on in situ nutrient sensors.

In the thesis, the control structures and the controllers are described and tested in models and simulations as well as in a full-scale wastewater treatment plant. The control structures are based on in situ nutrient sensors, which mean sensors located at the right place. The right place for process control is in the processes. Therefore, it is of major importance that the sensors can work in the harsh environments present in the mixed sludge liquor and in the flocculation chamber of chemical precipitation. This is the case for the Danfoss Insitu[®] sensors, which represent the starting point of this Ph.D. project.

The implementation of the control structures in a full-scale wastewater treatment plant has demonstrated significant savings in energy consumption and precipitation chemicals consumption, reduction in sludge production and improvement of the effluent water quality. The improvement in effluent water quality is both in terms of less variation and effluent concentrations exactly at the level that is determined in advance.

The experiments have shown that it is possible to achieve lower effluent ammonium concentration with less energy consumption for aeration by dynamic control of the DO setpoint. This dynamic control can be performed based on a feedback signal from an ammonium sensor located in the last aerobic reactor. The reduction in dead time due to the in situ location of the sensor means that the controller does not need to rely on mathematical models of the processes, but are controllable based on simple feedback.

Simple control methods for the control of internal recirculation flow rate and the dosage of external carbon sources has also been suggested and simulations on the benchmark platform seem promising. The methods have however not been tested in full-scale experiments.

In addition, automatic process control of dosage of phosphate precipitation chemicals based on feedback has provided significant savings. The feedback strategy was superior to control strategies of constant dosage rate, flow proportional dosage rate and load proportional dosage rate.

An implementation procedure involving an initial analysis phase, a monitoring phase, an experimenting phase and an automatic process control phase has been suggested. Examples from this procedure taken from two full-scale WWTPs have shown several interesting features that can be observed when using nutrient sensors.

An international survey aiming to investigate if there is a clear correspondence between high utilisation of ICA at a given WWTP and high operational performance has been carried out. It was not possible to show a clear correspondence. Wastewater treatment plants with online phosphate sensors, however, showed almost significantly ($\alpha = 6.4\%$) better performance in terms of the amount of dosed precipitation chemicals. Similar results were not obtainable for the use of sensors regarding nitrogen removal (ammonium and nitrate sensors). One explanation for this may be that the presence or absence of such sensors coincided with the WWTPs being located in warm or cold climates.

The future for process control at WWTPs looks exciting with new sensors being introduced and current sensors being improved as well as their costs being reduced. There is a large potential in improving WWTP operation, leading to economic, environmental and other benefits.



Appendices

Appendix A Nomenclature and Abbreviations

ASM	Activated Sludge Model
b_A	Autotrophic decay rate (ASM1)
b_H	Heterotrophic decay rate (ASM1)
BNR	Biological Nutrient Removal
BOD	Biological Oxygen Demand
COD	Chemical Oxygen Demand
COST	EU Project on optimal management of wastewater systems (action 624)
DDE	Dynamic Data Exchange
DO	Dissolved Oxygen
DSVI	Diluted Sludge Volume Index
EWPC	European Water Pollution Control Association
f_P	Fraction of biomass yielding particulate products (ASM1)
IAWQ	International Association on Water Quality
ICA	Instrumentation, Control and Automation
IWA	International Water Association
i_{XB}	Mass N/mass COD in biomass (ASM1)
i_{XP}	Mass N/mass COD in products from biomass (ASM1)
K	Gain
k_a	Ammonification rate (ASM1)
k_h	Max. specific hydrolysis rate (ASM1)
K_{NH}	Ammonium half saturation constant for autotrophs (ASM1)

K_{NO}	Nitrate half saturation constant for heterotrophs (ASM1)
$K_{O,A}$	Oxygen half saturation constant for autotrophs (ASM1)
$K_{O,H}$	Oxygen half saturation constant for heterotrophs (ASM1)
K_S	Half saturation constant for heterotrophs (ASM1)
K_X	Half saturation constant for hydrolysis of slowly biodegr. substrate (ASM1)
MIMO	Multiple Input – Multiple Output
Mtbf	Mean time between failures
N	Nitrogen
NH ₄	Ammonium
ORP	Oxygen Reduction Potential
OUR	Oxygen Uptake Rate
P	Phosphorous
PO ₄	Phosphate (ortho-phosphate)
P_1	Aerobic growth of heterotrophs (ASM1)
P_2	Anoxic growth of heterotrophs (ASM1)
P_3	Aerobic growth of autotrophs (ASM1)
P_4	Decay of heterotrophs (ASM1)
P_5	Decay of autotrophs (ASM1)
P_6	Ammonification of soluble organic nitrogen (ASM1)
P_7	Hydrolysis of entrapped organics (ASM1)
P_8	Hydrolysis of entrapped organic nitrogen (ASM1)
Q	Influent flow rate
Q_{int}	Internal recirculation flow rate
Q_{RAS}	Return sludge flow rate
Q_w	Wastage flow rate
R&D	Research and development
RAS	Return Activated Sludge
RGA	Relative Gain Array
$r_{nit,rel}$	Relative nitrification rate
r_{max}	Maximum transformation rate

S_{ALK}	Alkalinity (ASM1)
SCADA	Supervisory Control And Data Acquisition
S_I	Inert organic material (ASM1)
SISO	Single Input – Single Output
S_{ND}	Biodegradable organic nitrogen (ASM1)
SND	Simultaneous nitrification and denitrification
S_{NH}	Ammonium concentration (ASM1)
S_{NO}	Nitrate and nitrite concentration (ASM1)
S_O	Dissolved oxygen concentration (ASM1)
S_S	Readily biodegradable substrate (ASM1)
SS	Suspended solids
SVI	Sludge Volume Index
SWOT	Strengths, Weaknesses, Opportunities and Threats
T_i	Integration time constant
UV	Ultra Violet
VFA	Volatile Fatty Acids
VSS	Volatile suspended solids
WAS	Waste activated sludge
WWTP	Wastewater treatment plant
$X_{B,A}$	Active autotrophic biomass (ASM1)
$X_{B,H}$	Active heterotrophic biomass (ASM1)
X_I	Particulate inert organic matter (ASM1)
X_{ND}	Particulate biodegradable organic nitrogen (ASM1)
X_P	Particulate products arising from biomass decay (ASM1)
X_S	Slowly biodegradable substrate (ASM1)
X_{susp}	Concentration of suspended solids
Y_A	Autotrophic yield (ASM1)
Y_H	Heterotrophic yield (ASM1)
η_g	Correction factor for anoxic growth of heterotrophs (ASM1)
η_h	Correction factor for anoxic hydrolysis (ASM1)
μ_A	Autotrophic max. specific growth rate (ASM1)

μ_H Heterotrophic max. specific growth rate (ASM1)

Appendix B Questionnaire

This appendix contains the cover letter and the questionnaire used in the international survey documented in Chapter 4.

Cover letter

Dear colleague

"Is there a clear connection between high use of Instrumentation, Control and Automation (ICA) equipment and high performance of wastewater treatment plants?"

We have decided to answer this question by devising a questionnaire that makes it possible to benchmark wastewater treatment plants against each other based on level of use of ICA, cost of operation and effluent water quality. The aim of the study is to develop a tool for international benchmarking of plant operation and to investigate the role of ICA in wastewater treatment plants.

You can participate

If you are working at or in cooperation with a wastewater treatment plant, we would like you to participate in this international survey. All you have to do is answer the questionnaire in this envelope and mail or email it to us (see address below). When the study is finished, we will send you the results, so that you can see how your plant is benchmarked against other plants. As a thank you for the help we will also send you a new book on applied control called "Get more out of your wastewater treatment plant" by Pernille Ingildsen and Professor Gustaf Olsson.

The results of the study will be published in the scientific and technical report that is going to be written based on the IWA-ICA conference in Malmö, 2001. The results will also be published in the Ph.D. thesis of Pernille Ingildsen and might additionally be published as a paper in a water

magazine, e.g. Water, Science and Technology. However, the anonymity of your plant is guaranteed.

You are more than welcome to distribute the questionnaire to colleagues at other wastewater treatment plants. The more answers we get the better the benchmark tool. Last chance to participate in the benchmark is August 1 2001.

The study

The study is carried out in cooperation between Institute of Industrial Electrical Engineering and Automation (IEA, Lund University, Sweden), Advanced Wastewater Management Centre (AWMC, Queensland University, Australia) and Danfoss Analytical (Denmark). If you have any questions about the study please contact Pernille Ingildsen at the conference or by email.

Kindly regards

Pernille Ingildsen (IEA and Danfoss Analytical)

and

Paul Lant (AWMC)

Email address:

pernille.ingildsen@iea.lth.se or ingildsen@danfoss.dk

Mail address:

Pernille Ingildsen

Henrik Ibsensvej 9, 3. tv

DK-1813 Frederiksberg C

Denmark

Information about you

YOUR NAME		POSITION	
EMAIL		PHONE (WORK)	

Plant information

NAME OF PLANT	
ADDRESS	

CITY AND POSTAL CODE		COUNTRY	
-------------------------	--	---------	--

Design and operation

To make an even comparison of the design and operation costs please give up data based on a full year in the following questions. Choose 1999 or 2000 .

1) What is your plant design called, e.g. recirculation plant, sequencing batch reactor, ...

PREDENITRIFICATION OR RECIRCULATION PLANT

SEQUENCING BATCH REACTOR

SIMOULTANEOUS NIT-/DENITRIFICATION

POST DENITRIFICATION

ALTERNATE NIT-/DENITRIFICATION

OTHER, PLEASE SPECIFY:

2) How large a flow is your wastewater treatment plant designed to treat?

AVERAGE DESIGN FLOW M^3/DAY

MAXIMUM DESIGN FLOW $M^3/2-HOURS$

3) How large is the current flow?

CURRENT AVERAGE FLOW M^3/DAY

4) How large a portion of the current flow is industrial wastewater?

INDUSTRIAL WASTEWATER %

5) How large is the volume of the biological reactors (including aerobic, anoxic and anaerobic volume) and the secondary sedimentation unit (the settler related to biological removal)?

BIOLOGICAL REACTORS M³

SEDIMENTATION M³

HOW MANY PARALLEL LINES ARE THE BIOLOGICAL TREATMENT DIVIDED INTO? (NUMBER OF LINES)

6) Which substances are the plant designed to remove?

Tick the ones that apply

- COD (CHEMICAL OXYGEN DEMAND, I.E. ORGANIC MATTER)
- AMMONIUM (BUT NOT NITRATE)
- TOTAL NITROGEN (BOTH AMMONIUM AND NITRATE)
- PHOSPHOROUS (CHEMICAL REMOVAL)
- PHOSPHOROUS (BIOLOGICAL REMOVAL)

7) How long has the plant been in operation?

YEARS IN OPERATION YEARS

8) Are there any special features about your wastewater treatment plant, please describe?

DIFFICULT INLET SITUATION

UNUSUAL PROCESS TECHNOLOGY

SPECIAL EFFLUENT QUALITY REQUIREMENTS

OTHER

9) Influent, effluent and effluent criteria for the plant?

Inlet loads:

TOT-N (kg/day)

TOT-P (kg/day)

COD (kg/day)

Effluent (if no special requirement exists "-" in the field)

	EFFLUENT SUMMER	CRITERIA SUMMER	EFFLUENT WINTER	CRITERIA WINTER
TOT-N (MG/L)				
NH ₄ -N (MG/L)				
TOT-P (MG/L)				
COD (MG/L)				
SS (MG/L)				

10) What is the average temperature of the wastewater?

SUMMER °C OR FAHRENHEIT

WINTER °C OR FAHRENHEIT

11) What is the yearly energy consumption (all gross values)?

TOTAL CONSUMPTION KWH/YEAR

FOR PRE-TREATMENT KWH/YEAR

(EVERYTHING BEFORE THE BIOLOGICAL PART)

FOR THE BIOLOGICAL PART KWH/YEAR

AERATION CONSTITUTES	% OF THE BIOLOGICAL PART
FOR SLUDGE TREATMENT	KWH/YEAR
OTHER PURPOSES	KWH/YEAR
HOW MUCH ENERGY IS PRODUCED?	KWH/YEAR

12) How much precipitation chemical is used per year?

Chemicals for precipitation of phosphate have an active substance that binds with the phosphate molecules. This substance can for example be iron, aluminium or polymers. The amount of active substance is usually written on the product specification from the supplier.

If no precipitation chemicals are used, enter zero in the yearly consumption field

TYPE OF ACTIVE SUBSTANCE

YEARLY CONSUMPTION KG ACTIVE SUBSTANCE/ YEAR

TYPE OF PRECIPITATION:

PRE- SIMULTANEOUS - POST-PRECIPITATION

13) If an external carbon source for support of denitrification and/or biological phosphorous removal is used, how much is used?

If no external carbon source is used, enter zero in the yearly consumption field

YEARLY CONSUMPTION KG COD PER YEAR

14) How much sludge is produced in the plant?

TOTAL WEIGHT (TON/YEAR INCL. WATER)

DRY WEIGHT (TON/YEAR EXCL. WATER)

15) Over the last year how large a part of the year was the effluent requirements violated?

VIOLATION HAPPENED (% TIME OF LAST YEAR)

16) How often was the treatment bypassed last year?

WHERE THE BIOLOGICAL STEP WAS BYPASSED

(NUMBER OF EVENTS OVER A YEAR)

WHERE ALL TREATMENT WAS BYPASSED

(NUMBER OF EVENTS OVER A YEAR)

17) How much was paid in taxes or fines last year?

TAX ON NITROGEN

TAX ON PHOSPHOROUS

TAX ON COD OR BOD

FINES

OTHER PLEASE DESCRIBE

18) How large a part of the time is the plant manned?

Tick the one that applies

FIVE DAYS A WEEK DURING THE DAY

SEVEN DAYS A WEEK DURING THE DAY

DAY AND NIGHT SEVEN DAYS A WEEK

UNMANNED PLANT

OTHER AMOUNT (hours per week)

19) How many people work at the plant (including subcontractors)?

NUMBER OF PERSONS FULL TIME

NUMBER OF PERSONS PART TIME

Use of Instrumentation, Control and Automation (ICA)

20) What type and number of sensors or automatic analysers are installed in the plant?

	NUMBER OF MEASURING POINTS	HOW MANY OF THEM ARE USED FOR ONLINE CONTROL?
FLOW		
WATER LEVEL OR PRESSURE		
AIRFLOW		
AIR PRESSURE		
DISSOLVED OXYGEN (DO)		
AMMONIUM		
NITRATE		
PHOSPHATE		
SUSPENDED SOLIDS		
REDOX POTENTIAL		
SLUDGE BLANKET		
UV		
COD		
BOD		
RESPIROMETER		
PH		

CONDUCTIVITY		
METHANE		

Additional sensors not on the above list can be added here:

	NUMBER OF SENSORS	HOW MANY OF THEM ARE USED FOR ONLINE CONTROL?

21) How many closed control loops are applied in the plant?

TOTAL AMOUNT

- PID CONTROLLERS
- ON/OFF CONTROLLERS
- ADVANCED CONTROL LOOPS

ADVANCED MEANS MORE ADVANCED THAN PID, SUCH AS ADAPTIVE CONTROL, DEAD TIME COMPENSATION, MODEL BASED CONTROL, ...

22) How is aeration controlled?

- CONSTANT AERATION OVER THE DAY
- AERATION BASED ON PRE-DETERMINED TIMES
- AERATION BASED ON A SINGLE DO SENSOR
- DO PROFILE CONTROL

I.E. CONTROL BASED ON A ZONATION OF THE AEROBIC REACTOR (SEVERAL DO SENSORS USED)

CONTROL BASED ON AMMONIUM SENSOR

OTHER, PLEASE DESCRIBE

23) What type of aeration system is applied in the plant?

COMPRESSED AIR VENTILATION (membranes of ceramic or plastic)?

SURFACE AERATORS – ROTORS

SURFACE AERATORS – TURBINES

OTHER:

24) List the most important control handles on the plant

Control handles are variables that you can change to alter the plant performance for example, aeration, return sludge, sludge outtake, internal recirculation, aerobic/anoxic phase length, etc.

NAME OF CONTROL HANDLE (E.G. AERATION)	TYPE OF OPERATION	IS THE CONTROL HANDLE RANGE SATISFACTORY?
	<input type="checkbox"/> ON/OFF OPERATION <input type="checkbox"/> STEPWISE OPERATION <input type="checkbox"/> CONTINUOUS OPERATION	<input type="checkbox"/> RANGE TOO BROAD <input type="checkbox"/> RANGE TOO NARROW <input type="checkbox"/> RANGE TOO HIGH OR LOW <input type="checkbox"/> SUITABLE RANGE
	<input type="checkbox"/> ON/OFF OPERATION <input type="checkbox"/> STEPWISE OPERATION <input type="checkbox"/> CONTINUOUS OPERATION	<input type="checkbox"/> RANGE TOO BROAD <input type="checkbox"/> RANGE TOO NARROW <input type="checkbox"/> RANGE TOO HIGH OR LOW <input type="checkbox"/> SUITABLE RANGE
	<input type="checkbox"/> ON/OFF OPERATION <input type="checkbox"/> STEPWISE OPERATION <input type="checkbox"/> CONTINUOUS OPERATION	<input type="checkbox"/> RANGE TOO BROAD <input type="checkbox"/> RANGE TOO NARROW <input type="checkbox"/> RANGE TOO HIGH OR LOW <input type="checkbox"/> SUITABLE RANGE
	<input type="checkbox"/> ON/OFF OPERATION <input type="checkbox"/> STEPWISE OPERATION	<input type="checkbox"/> RANGE TOO BROAD <input type="checkbox"/> RANGE TOO NARROW <input type="checkbox"/> RANGE TOO HIGH OR

	<input type="checkbox"/> CONTINUOUS OPERATION	LOW <input type="checkbox"/> SUITABLE RANGE
	<input type="checkbox"/> ON/OFF OPERATION <input type="checkbox"/> STEPWISE OPERATION <input type="checkbox"/> CONTINUOUS OPERATION	<input type="checkbox"/> RANGE TOO BROAD <input type="checkbox"/> RANGE TOO NARROW <input type="checkbox"/> RANGE TOO HIGH OR LOW <input type="checkbox"/> SUITABLE RANGE
	<input type="checkbox"/> ON/OFF OPERATION <input type="checkbox"/> STEPWISE OPERATION <input type="checkbox"/> CONTINUOUS OPERATION	<input type="checkbox"/> RANGE TOO BROAD <input type="checkbox"/> RANGE TOO NARROW <input type="checkbox"/> RANGE TOO HIGH OR LOW <input type="checkbox"/> SUITABLE RANGE
	<input type="checkbox"/> ON/OFF OPERATION <input type="checkbox"/> STEPWISE OPERATION <input type="checkbox"/> CONTINUOUS OPERATION	<input type="checkbox"/> RANGE TOO BROAD <input type="checkbox"/> RANGE TOO NARROW <input type="checkbox"/> RANGE TOO HIGH OR LOW <input type="checkbox"/> SUITABLE RANGE
	<input type="checkbox"/> ON/OFF OPERATION <input type="checkbox"/> STEPWISE OPERATION <input type="checkbox"/> CONTINUOUS OPERATION	<input type="checkbox"/> RANGE TOO BROAD <input type="checkbox"/> RANGE TOO NARROW <input type="checkbox"/> RANGE TOO HIGH OR LOW <input type="checkbox"/> SUITABLE RANGE

Your opinion

25) Where do you see the greatest opportunity to improve your wastewater treatment plant's performance regarding Instrumentation, Control and Automation?

26) How do you judge the current use of instrumentation and control system of your plant?

- A LOT MORE COULD BE GAINED
- MORE COULD BE GAINED
- MAYBE MORE COULD BE GAINED
- NO MORE COULD BE GAINED

27) What do you see as the most important bottleneck in your wastewater treatment plant?

28) What do you see as the largest future threat to your wastewater treatment plant?

29) How do you feel about this statement? "Instrumentation, control and automation will gain in importance at wastewater treatment plants in the coming years?"

STRONGLY AGREE

MILDLY AGREE

NEITHER AGREE NOR DISAGREE

MILDLY DISAGREE

STRONGLY DISAGREE

30) Have you applied any new control the last 5 years?

If so, in a few words what improvements was the outcome (e.g. 5% energy savings)

Comments on this questionnaire or any of its questions:

Please return the filled out questionnaire either by mail (disk) or email:

Mail address:

Pernille Ingildsen

Henrik Ibsensvej 9, 3. tv

DK-1813 Frederiksberg C

Denmark

Appendix C Stationary Analysis using EES

EES is the abbreviation for Engineering Equation Solver. The basic function provided by EES is the solution of a set of algebraic equations. The benchmark plant equations have been implemented in the program, with all differentials set at zero. The used set of equations can be seen below. The equations correspond to the open loop assessment defined by the benchmark group. In the implementation, the settler has been modified, so instead an ideal settler has been used. EES is used to test ideas about best strategies for the operational use of the available control handles: aeration, internal recirculation, sludge outtake and external carbon dosage. In order to verify that the program yields correct values the open loop assessment has been run on the EES platform. The steady state values of EES are compared to the values provided by the benchmark group in Table C.13.1. This comparison shows a fine correspondence for all parameters. The difference between the two sets of data is probably due to the different settler model implementation.

Table C.13.1 Comparison of open loop assessment for the benchmark platform and EES (result in parenthesis from EES).

			1	2	3	4	5	Unit
$S_{I,stab}$	30	$S_{I,i}$	30 (30)	30 (30)	30 (30)	30 (30)	30 (30)	$\frac{g}{m^3}$ COD
$S_{S,stab}$	69.5	$S_{S,i}$	2.81 (2.70)	1.46 (1.41)	1.15 (1.12)	0.995 (0.97)	0.889 (0.87)	$\frac{g}{m^3}$ COD
$X_{I,stab}$	51.2	$X_{I,i}$	1149. (1252)	1149. (1252)	1149. (1252)	1149. (1252)	1149. (1252)	$\frac{g}{m^3}$ COD
$X_{S,stab}$	202.32	$X_{S,i}$	82.1 (83.51)	76.4 (77.8)	64.9 (66.24)	55.7 (57.04)	49.3 (50.64)	$\frac{g}{m^3}$ COD
$X_{B,H,stab}$	28.17	$X_{B,H,i}$	2552 (2675)	2553 (2676)	2557 (2680)	2559 (2682)	2559 (2682)	$\frac{g}{m^3}$ COD
$X_{B,A,stab}$	0	$X_{B,A,i}$	148 (161.2)	148 (161.1)	149 (161.8)	150 (162.4)	150 (162.6)	$\frac{g}{m^3}$ COD
$X_{P,stab}$	0	$X_{P,i}$	449 (513.1)	450 (513.8)	450 (514.7)	451 (515.7)	452 (515.6)	$\frac{g}{m^3}$ COD
$S_{O,stab}$	0	$S_{O,i}$	0.00430 (0.0041)	0.0000631 (0.000058)	1.72 (1.55)	2.43 (2.3)	0.491 (0.49)	$\frac{g}{m^3}$ COD
$S_{NO,stab}$	0	$S_{NO,i}$	5.37 (5.39)	3.66 (3.65)	6.54 (6.65)	9.30 (9.47)	10.4 (10.51)	$\frac{g}{m^3}$ N
$S_{NH,stab}$	31.56	$S_{NH,i}$	7.92 (7.57)	8.34 (8.00)	5.55 (5.07)	2.97 (2.43)	1.73 (1.276)	$\frac{g}{m^3}$ N
$S_{ND,stab}$	6.95	$S_{ND,i}$	1.22 (1.19)	0.882 (0.859)	0.829 (0.810)	0.767 (0.753)	0.688 (0.677)	$\frac{g}{m^3}$ N
$X_{ND,stab}$	10.59	$X_{ND,i}$	5.28 (5.40)	5.03 (5.15)	4.39 (4.51)	3.88 (3.99)	3.53 (3.64)	$\frac{g}{m^3}$ N
$S_{ALK,stab}$	7	$S_{ALK,i}$	4.93 (-)	5.08 (-)	4.67 (-)	4.29 (-)	4.13 (-)	$\frac{mol}{m^3}$
X_{stab}		X_i	3285 (3553)	3282 (3551)	3278 (3546)	3274 (3542)	3270 (3537)	$\frac{g}{m^3}$ SS
$Q_{0,stab}$	18446							

Implementation of benchmark model

```

Program code
{% Control Inputs}
KLA1 = 0
KLA2 = 0
KLA3 = 240
KLA4 = 240
KLA5 = 84
NIS =55338
BIS = Q
SSdosage = 0
Qw = 385
SludgeAge =
(V1*Susp1+V2*Susp2+V3*Susp3+V4*Susp4+V5*Susp5) /Qw/Su
spS

{Outputs}
TN = SNHS+SNOS+SNDS
AIR = KLA3+KLA4+KLA5

{% Process Constants}
mu_H = 4.0
K_S = 10.0
K_OH = 0.2
K_NO = 0.5
b_H = 0.3
mu_A = 0.5
K_NH = 1.0
K_OA = 0.4
b_A = 0.05
ny_g = 0.8
k_a = 0.05
k_h = 3.0
K_X = 0.1
ny_h = 0.8
Y_H = 0.67
Y_A = 0.24
f_P = 0.08
i_XB = 0.08
i_XP = 0.06
SO_sat = 8.0

{% Design parameters}
V1 = 1000
V2 = 1000
V3 = 1333
V4 = 1333
V5 = 1333
VS = 6000

```

```

{% Influent concentrations}
SIin = 30
SSin = 69.5+SSdosage;
XIin = 51.20
XSin = 202.32
XBHin = 28.17
XBain = 0
XPin = 0
SOin = 0
SNOin = 0
SNHin = 31.56
SNDin = 6.95
XNDin = 10.59
Q = 18446

{% reactor 1}
proc11 = mu_H*(SS1/(K_S+SS1))*(SO1/(K_OH+SO1))*XBH1
proc12 = mu_H*(SS1/(K_S+SS1))*(K_OH/(K_OH+SO1))*(SNO1/(K_NO+SNO1))*ny_g*XBH1
proc13 = mu_A*(SNH1/(K_NH+SNH1))*(SO1/(K_OA+SO1))*XBA1
proc14 = b_H*XBH1
proc15 = b_A*XBA1
proc16 = k_a*SND1*XBH1
proc17 = k_h*((XS1/XBH1)/(K_X+(XS1/XBH1)))*((SO1/(K_OH+SO1))+ny_h*(K_OH/(K_OH+SO1))*(SNO1/(K_NO+SNO1)))*XBH1
proc18 = proc17*XND1/XS1

reac11 = 0
reac12 = (-proc11-proc12)/Y_H+proc17
reac13 = 0
reac14 = (1-f_P)*(proc14+proc15)-proc17
reac15 = proc11+proc12-proc14
reac16 = proc13-proc15
reac17 = f_P*(proc14+proc15)
reac18 = -((1-Y_H)/Y_H)*proc11-((4.57-Y_A)/Y_A)*proc13
reac19 = -((1-Y_H)/(2.86*Y_H))*proc12+proc13/Y_A
reac110 = -i_XB*(proc11+proc12)-(i_XB+(1/Y_A))*proc13+proc16
reac111 = -proc16+proc18
reac112 = (i_XB-f_P*i_XP)*(proc14+proc15)-proc18

0 = 1/V1*(Q*SIin+NIS*SI5+BIS*SIS-(Q+NIS+BIS)*SI1)+reac11
0 = 1/V1*(Q*SSin+NIS*SS5+BIS*SSS-(Q+NIS+BIS)*SS1)+reac12

```

```

0          =          1/V1*(Q*XIin+NIS*XI5+BIS*XIS-
(Q+NIS+BIS)*XI1)+reac13
0          =          1/V1*(Q*XSin+NIS*XS5+BIS*XSS-
(Q+NIS+BIS)*XS1)+reac14
0          =          1/V1*(Q*XBHin+NIS*XBH5+BIS*XBHS-
(Q+NIS+BIS)*XBH1)+reac15
0          =          1/V1*(Q*XBAin+NIS*XBA5+BIS*XBAS-
(Q+NIS+BIS)*XBA1)+reac16
0          =          1/V1*(Q*XPin+NIS*XP5+BIS*XPS-
(Q+NIS+BIS)*XP1)+reac17
0          =          1/V1*(Q*SOin+NIS*SO5+BIS*SOS-
(Q+NIS+BIS)*SO1)+reac18+KLA1*(SO_sat-SO1)
0          =          1/V1*(Q*SNOin+NIS*SNO5+BIS*SNOS-
(Q+NIS+BIS)*SNO1)+reac19
0          =          1/V1*(Q*SNHin+NIS*SNH5+BIS*SNHS-
(Q+NIS+BIS)*SNH1)+reac110
0          =          1/V1*(Q*SNDin+NIS*SND5+BIS*SNDS-
(Q+NIS+BIS)*SND1)+reac111
0          =          1/V1*(Q*XNDin+NIS*XND5+BIS*XNDS-
(Q+NIS+BIS)*XND1)+reac112

{% reactor 2}
proc21 = mu_H*(SS2/(K_S+SS2))*(SO2/(K_OH+SO2))*XBH2
proc22 = mu_H*(SS2/(K_S+SS2))*(K_OH/(K_OH+SO2))*
(SNO2/(K_NO+SNO2))*ny_g*XBH2
proc23 =
mu_A*(SNH2/(K_NH+SNH2))*(SO2/(K_OA+SO2))*XBA2
proc24 = b_H*XBH2
proc25 = b_A*XBA2
proc26 = k_a*SND2*XBH2
proc27 =
k_h*((XS2/XBH2)/(K_X+(XS2/XBH2)))*((SO2/(K_OH+SO2))+
ny_h*(K_OH/(K_OH+SO2))*(SNO2/(K_NO+SNO2)))*XBH2
proc28 = proc27*XND2/XS2

reac21 = 0
reac22 = (-proc21-proc22)/Y_H+proc27
reac23 = 0
reac24 = (1-f_P)*(proc24+proc25)-proc27
reac25 = proc21+proc22-proc24
reac26 = proc23-proc25
reac27 = f_P*(proc24+proc25)
reac28 = -((1-Y_H)/Y_H)*proc21-((4.57-
Y_A)/Y_A)*proc23
reac29 = -((1-Y_H)/(2.86*Y_H))*proc22+proc23/Y_A
reac210 = -i_XB*(proc21+proc22)-
(i_XB+(1/Y_A))*proc23+proc26
reac211 = -proc26+proc28
reac212 = (i_XB-f_P*i_XP)*(proc24+proc25)-proc28

```

```

0 = 1/V2*((Q+NIS+BIS)*(SI1-SI2))+reac21
0 = 1/V2*((Q+NIS+BIS)*(SS1-SS2))+reac22
0 = 1/V2*((Q+NIS+BIS)*(XI1-XI2))+reac23
0 = 1/V2*((Q+NIS+BIS)*(XS1-XS2))+reac24
0 = 1/V2*((Q+NIS+BIS)*(XBH1-XBH2))+reac25
0 = 1/V2*((Q+NIS+BIS)*(XBA1-XBA2))+reac26
0 = 1/V2*((Q+NIS+BIS)*(XP1-XP2))+reac27
0 = 1/V2*((Q+NIS+BIS)*(SO1-SO2))+reac28+KLA2*(SO_sat-SO2)
0 = 1/V2*((Q+NIS+BIS)*(SNO1-SNO2))+reac29
0 = 1/V2*((Q+NIS+BIS)*(SNH1-SNH2))+reac210
0 = 1/V2*((Q+NIS+BIS)*(SND1-SND2))+reac211
0 = 1/V2*((Q+NIS+BIS)*(XND1-XND2))+reac212

{% reactor 3}
proc31 = mu_H*(SS3/(K_S+SS3))*(SO3/(K_OH+SO3))*XBH3
proc32 = mu_H*(SS3/(K_S+SS3))*(K_OH/(K_OH+SO3))*
(SNO3/(K_NO+SNO3))*ny_g*XBH3
proc33 = mu_A*(SNH3/(K_NH+SNH3))*(SO3/(K_OA+SO3))*XBA3
proc34 = b_H*XBH3
proc35 = b_A*XBA3
proc36 = k_a*SND3*XBH3
proc37 = k_h*(XS3/XBH3)/(K_X+(XS3/XBH3))*((SO3/(K_OH+SO3))+
ny_h*(K_OH/(K_OH+S_O3))*(SNO3/(K_NO+SNO3)))*XBH3
proc38 = proc37*XND3/XS3

reac31 = 0
reac32 = (-proc31-proc32)/Y_H+proc37
reac33 = 0
reac34 = (1-f_P)*(proc34+proc35)-proc37
reac35 = proc31+proc32-proc34
reac36 = proc33-proc35
reac37 = f_P*(proc34+proc35)
reac38 = -((1-Y_H)/Y_H)*proc31-((4.57-Y_A)/Y_A)*proc33
reac39 = -((1-Y_H)/(2.86*Y_H))*proc32+proc33/Y_A
reac310 = -i_XB*(proc31+proc32)-(i_XB+(1/Y_A))*proc33+proc36
reac311 = -proc36+proc38
reac312 = (i_XB-f_P*i_XP)*(proc34+proc35)-proc38

0 = 1/V3*((Q+NIS+BIS)*(SI2-SI3))+reac31
0 = 1/V3*((Q+NIS+BIS)*(SS2-SS3))+reac32
0 = 1/V3*((Q+NIS+BIS)*(XI2-XI3))+reac33
0 = 1/V3*((Q+NIS+BIS)*(XS2-XS3))+reac34
0 = 1/V3*((Q+NIS+BIS)*(XBH2-XBH3))+reac35
0 = 1/V3*((Q+NIS+BIS)*(XBA2-XBA3))+reac36
0 = 1/V3*((Q+NIS+BIS)*(XP2-XP3))+reac37

```

```

0 = 1/V3*((Q+NIS+BIS)*(SO2-SO3))+reac38+KLA3*(SO_sat-SO3)
0 = 1/V3*((Q+NIS+BIS)*(SNO2-SNO3))+reac39
0 = 1/V3*((Q+NIS+BIS)*(SNH2-SNH3))+reac310
0 = 1/V3*((Q+NIS+BIS)*(SND2-SND3))+reac311
0 = 1/V3*((Q+NIS+BIS)*(XND2-XND3))+reac312

{% reactor 4}
proc41 = mu_H*(SS4/(K_S+SS4))*(SO4/(K_OH+SO4))*XBH4
proc42 = mu_H*(SS4/(K_S+SS4))*(K_OH/(K_OH+SO4))*(SNO4/(K_NO+SNO4))*ny_g*XBH4
proc43 = mu_A*(SNH4/(K_NH+SNH4))*(SO4/(K_OA+SO4))*XBA4
proc44 = b_H*XBH4
proc45 = b_A*XBA4
proc46 = k_a*SND4*XBH4
proc47 = k_h*(XS4/XBH4)/(K_X+(XS4/XBH4))*(SO4/(K_OH+SO4))+ny_h*(K_OH/(K_OH+SO4))*(SNO4/(K_NO+SNO4))*XBH4
proc48 = proc47*XND4/XS4

reac41 = 0
reac42 = (-proc41-proc42)/Y_H+proc47
reac43 = 0
reac44 = (1-f_P)*(proc44+proc45)-proc47
reac45 = proc41+proc42-proc44
reac46 = proc43-proc45
reac47 = f_P*(proc44+proc45)
reac48 = -((1-Y_H)/Y_H)*proc41-(4.57-Y_A)/Y_A*proc43
reac49 = -((1-Y_H)/(2.86*Y_H))*proc42+proc43/Y_A
reac410 = -i_XB*(proc41+proc42)-(i_XB+(1/Y_A))*proc43+proc46
reac411 = -proc46+proc48
reac412 = (i_XB-f_P*i_XP)*(proc44+proc45)-proc48

0 = 1/V4*((Q+NIS+BIS)*(SI3-SI4))+reac41
0 = 1/V4*((Q+NIS+BIS)*(SS3-SS4))+reac42
0 = 1/V4*((Q+NIS+BIS)*(XI3-XI4))+reac43
0 = 1/V4*((Q+NIS+BIS)*(XS3-XS4))+reac44
0 = 1/V4*((Q+NIS+BIS)*(XBH3-XBH4))+reac45
0 = 1/V4*((Q+NIS+BIS)*(XBA3-XBA4))+reac46
0 = 1/V4*((Q+NIS+BIS)*(XP3-XP4))+reac47
0 = 1/V4*((Q+NIS+BIS)*(SO3-SO4))+reac48+KLA4*(SO_sat-SO4)
0 = 1/V4*((Q+NIS+BIS)*(SNO3-SNO4))+reac49
0 = 1/V4*((Q+NIS+BIS)*(SNH3-SNH4))+reac410
0 = 1/V4*((Q+NIS+BIS)*(SND3-SND4))+reac411
0 = 1/V4*((Q+NIS+BIS)*(XND3-XND4))+reac412

```

```

{% reactor 5}
proc51 = mu_H*(SS5/(K_S+SS5))*(SO5/(K_OH+SO5))*XBH5
proc52 = mu_H*(SS5/(K_S+SS5))*(K_OH/(K_OH+SO5))*
(SNO5/(K_NO+SNO5))*ny_g*XBH5
proc53 = mu_A*(SNH5/(K_NH+SNH5))*(SO5/(K_OA+SO5))*XBA5
proc54 = b_H*XBH5
proc55 = b_A*XBA5
proc56 = k_a*SND5*XBH5
proc57 = k_h*((XS5/XBH5)/(K_X+(XS5/XBH5)))*((SO5/(K_OH+SO5))+
ny_h*(K_OH/(K_OH+S05))*(SNO5/(K_NO+SNO5)))*XBH5
proc58 = proc57*XND5/XS5

reac51 = 0
reac52 = (-proc51-proc52)/Y_H+proc57
reac53 = 0
reac54 = (1-f_P)*(proc54+proc55)-proc57
reac55 = proc51+proc52-proc54
reac56 = proc53-proc55
reac57 = f_P*(proc54+proc55)
reac58 = -((1-Y_H)/Y_H)*proc51-((4.57-
Y_A)/Y_A)*proc53
reac59 = -((1-Y_H)/(2.86*Y_H))*proc52+proc53/Y_A
reac510 = -i_XB*(proc51+proc52)-
(i_XB+(1/Y_A))*proc53+proc56
reac511 = -proc56+proc58
reac512 = (i_XB-f_P*i_XP)*(proc54+proc55)-proc58

0 = 1/V5*((Q+NIS+BIS)*(SI4-SI5))+reac51
0 = 1/V5*((Q+NIS+BIS)*(SS4-SS5))+reac52
0 = 1/V5*((Q+NIS+BIS)*(XI4-XI5))+reac53
0 = 1/V5*((Q+NIS+BIS)*(XS4-XS5))+reac54
0 = 1/V5*((Q+NIS+BIS)*(XBH4-XBH5))+reac55
0 = 1/V5*((Q+NIS+BIS)*(XBA4-XBA5))+reac56
0 = 1/V5*((Q+NIS+BIS)*(XP4-XP5))+reac57
0 = 1/V5*((Q+NIS+BIS)*(SO4-
SO5))+reac58+KLA5*(SO_sat-SO5)
0 = 1/V5*((Q+NIS+BIS)*(SNO4-SNO5))+reac59
0 = 1/V5*((Q+NIS+BIS)*(SNH4-SNH5))+reac510
0 = 1/V5*((Q+NIS+BIS)*(SND4-SND5))+reac511
0 = 1/V5*((Q+NIS+BIS)*(XND4-XND5))+reac512

{% Sedimentation unit}
gam = (Q+BIS)/(BIS+Qw)
0 = 1/Vs*(Q+BIS)*(SI5-SIS)
0 = 1/Vs*(Q+BIS)*(SS5-SSS)
0 = 1/Vs*(Q+BIS)*(SO5-SOS)
0 = 1/Vs*(Q+BIS)*(SNO5-SNOS)

```

```
0 = 1/Vs*(Q+BIS) * (SNH5-SNHS)
0 = 1/Vs*(Q+BIS) * (SND5-SNDS)
XIS = gam*XI5
XSS = gam*XS5
XBHS = gam*XBH5
XBAS = gam*XBA5
XPS = gam*XP5
XNDS = gam*XND5

{SUSP}
Susp1 = 0.75*(XS1+XI1+XP1)+0.9*(XBA1+XBH1)
Susp2 = 0.75*(XS2+XI2+XP2)+0.9*(XBA2+XBH2)
Susp3 = 0.75*(XS3+XI3+XP3)+0.9*(XBA3+XBH3)
Susp4 = 0.75*(XS4+XI4+XP4)+0.9*(XBA4+XBH4)
Susp5 = 0.75*(XS5+XI5+XP5)+0.9*(XBA5+XBH5)
SuspS = 0.75*(XSS+XIS+XPS)+0.9*(XBAS+XBHS)
```

Appendix D Microbiological Investigations

Introduction

It has often been claimed that low DO concentrations in biological reactors for wastewater treatment would lead to deterioration of the properties of the sludge. The deterioration has been claimed to be due to the formation of filamentous microorganisms that impair the ability of the sludge to settle. This appendix documents the effect on the experiments documented in Section 10.3.

Results

The microbiological investigations was carried out by taking two samples of each sludge and look at this in detail in the microscope at 100 times magnification and 400 times magnification. At 100 times magnification, the floc structure can be observed, while at 400 times magnification smaller organisms such as bacteria can be observed. Additionally, Neisser and Gram colouring were applied to one frame per week per biological line. In Table D.13.2 is a summary showing photos at 100 times magnification.

Table D.13.2 Photos from the two lines.

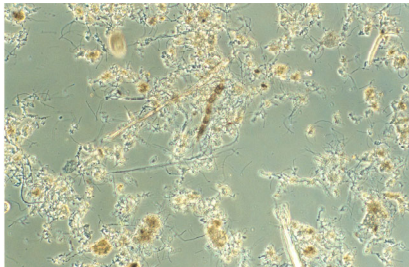
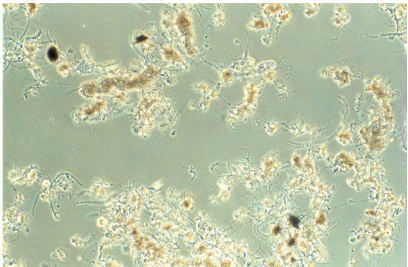
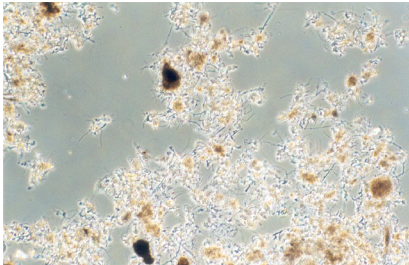
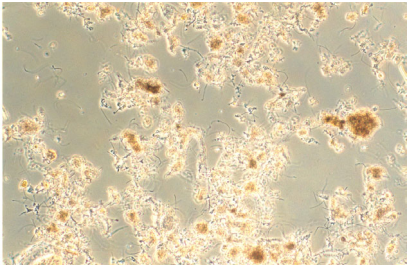
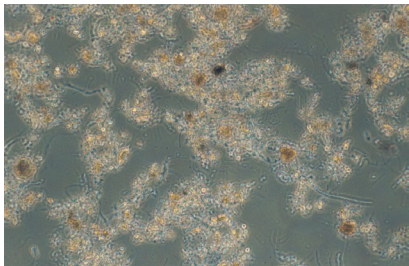
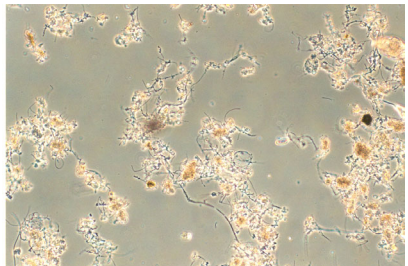
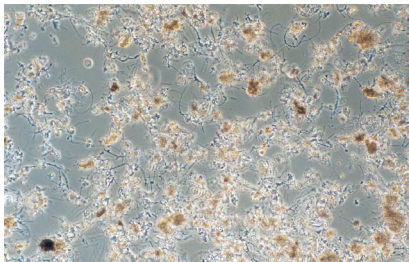
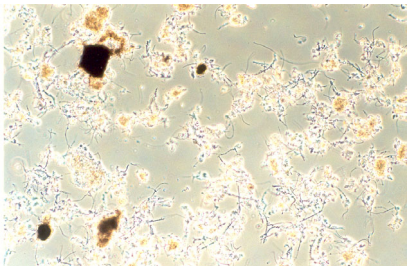
Experimental line	Reference line
October 4 th 	
October 11 	
October 19 th 	
October 24 th 	

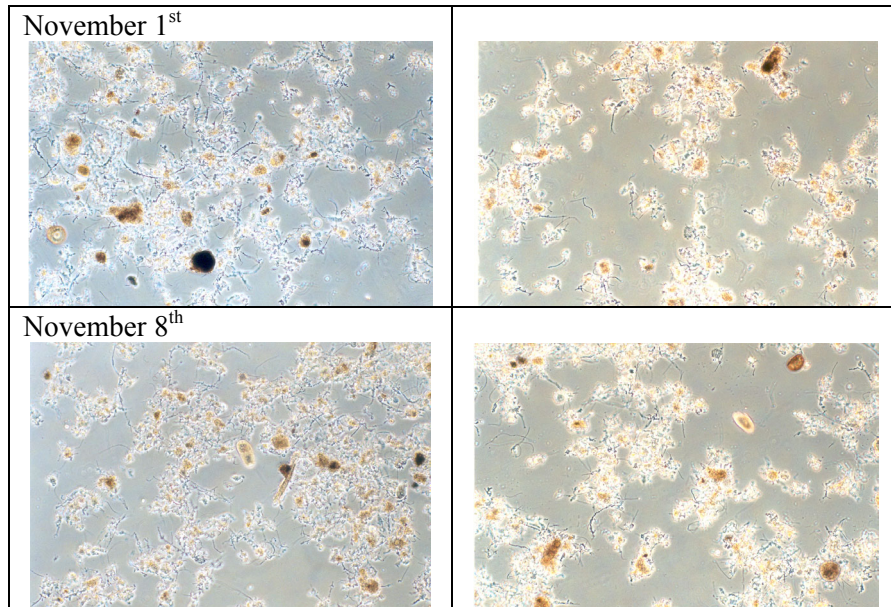

The difference between the two lines is described in protocols and a summary of the protocols is given in Table D.13.3.

Table D.13.3 Summary of microscopic protocols.

October 4	The two lines are almost the same; the flocs are perhaps slightly more compact in B4 than in B3.
October 11 th	The two lines are almost the same. A change from last time is that there seems to be more protozoa and rotatories as well as more zoogloale colonies.
October 19	The two lines differ slightly. B4 has smaller flocs and less floc networks. B4 has more spiralformed bacteria (400x) and fewer point formed bacteria (400x). In addition, fewer filaments are observed in B4 than in B3. The filaments in B3 are primarily in the water phase.
October 24	B4 is as last time, while B3 has larger, more compact floc systems, more spiralformed bacteria, other bacteria, and more filaments.
November 1	Hardly any difference between the two lines is observable. The flocs in B3 are still slightly larger and consist of more networks. Generally, the amount of spiral formed bacteria has increased.
November 8	The difference between the two lines is small. B3 has slightly larger floc networks and fewer spiralformed bacteria and protozoa than B4.

Table D.13.4 Identification of filaments.

	Experimental line	Reference line
October 4	Dominant filaments: M. Parvicella and 0092 Secondary filaments: N. Limicola and 0041	Dominant filaments: M. Parvicella and 0092 Secondary filaments: N. Limicola and 0041
October 24	Dominant filaments: 0092 Secondary filaments: M. Parvicella, N. Limicola, 0041	Dominant filaments: M. Parvicella and 0092 Secondary filaments: N. Limicola and 0041
November 1	Dominant filaments: 0092 Secondary filaments: M. Parvicella, N. Limicola and 0041	Dominant filaments: 0092 Secondary filaments: M. Parvicella, N. Limicola and 0041

Looking at filaments Table D.13.4, there are differences between the two sludges. In the beginning of the experiment, the *M. Parvicella* and 0092 are the two dominant filaments. At the end of the experiment 0092 are more dominant than *M. Parvicella*, this change seem to happen earlier in the experimental line than in the reference line.

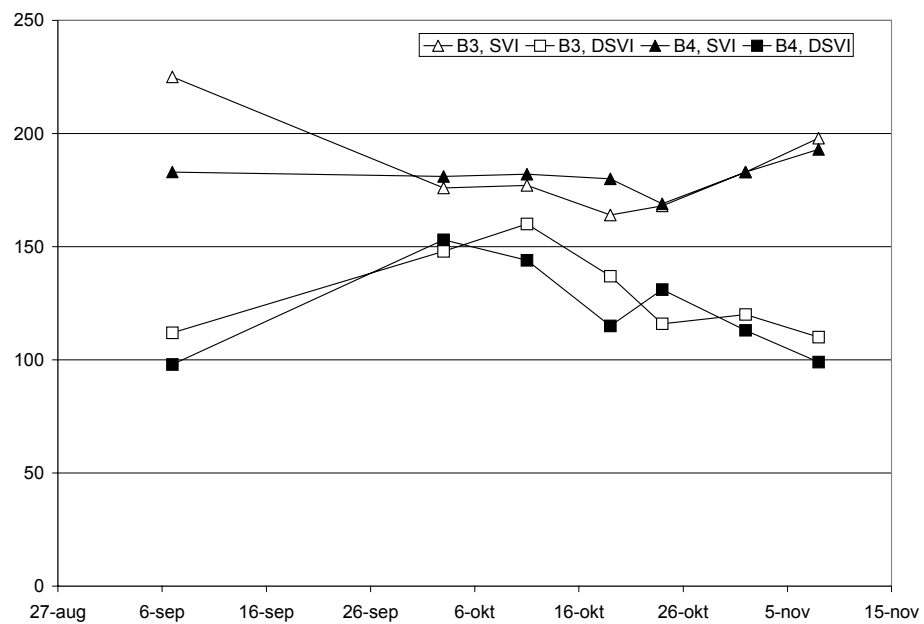

Figure D.13.1 Changes in SVI and DSVI.

In Figure D.13.1, the changes in sludge volume index (SVI) and diluted sludge volume index (DSVI) are shown. The first measurement point stems from before the start of the control experiment. The differences between the two lines seem to be minor.

Conclusion

During the experiment, some differences between the two lines were observed. However, the changes were minor and seemed not to have a deteriorating influence on sludge settling characteristics in the controlled line

References

- Alegre, H. (2000). *Performance indicators for water supply services*. IWA publishing, London, UK, ISBN 1900222272.
- Ammundsen B., Önnérth T.B., Nielsen, M.K. (1992). Biological phosphorous removal in traditional wastewater treatment plants (In Danish). *Stads- og Havneingeniøren*, No. 8, pp. 79-82.
- Andersen, E.B., Linde-Jensen, J.J., Jensen, H.T., Winther, L. and Mikkelsen, I. (1984). *Afløbsteknik*. (In Danish). Polyteknisk forlag, Lyngby, Denmark, ISBN 87-502-0618-4.
- Andersson, L.G. (1979). *Energy savings at wastewater treatment plants*. Final report contract No. 314-77-EE-DK, Water Quality Institute (DHI Water and Environment), Hørsholm, DK.
- Andrews, J.F. and Briggs, R. (1973). Instrumentation, Control and Automation for Wastewater Treatment Systems (J.F. Andrews and R. Briggs, Editors) *Progress in Water Technology*, Vol. 6, no 5-6, IAWPR (The International Association on Water Pollution Research), London.
- Åström, K. J. and Wittenmark, B. (1997). *Computer controlled systems: theory and design*. Prentice Hall Inc., Upper Sadle River, NJ 07458, ISBN 0-13-314899-8.
- Avedøre (1999). *Årsberetning 1999*. (In Danish). Spildevandscenter Avedøre, Denmark.
- Balmér, P. (1999). Resursförbrukning och driftkostnader vid kväverening i Nordiska reningsverk (in Swedish). *Proc. from Nordic conference on nitrogen removal and biological phosphorus removal in Oslo*, February 2-4, 1999.

- Balslev, P., Lynggaard-Jensen, A. and Nickelsen, C. (1996). Nutrient sensor based real-time on-line process control of a wastewater treatment plant using recirculation. *Wat. Sci. Tech.* Vol. 33, No. 1, pp. 183-192.
- Barbe, J., Desjobert, C. and Neveu, G. (1999). *Phosphate removal from urban wastewater. Extract of study on phosphate removal by Office International de l'Eau, CEFIC and Kemira.* www.Kemira.com.
- Baumann, P. and Krauth, G. (1993). Styring med næringssaltmaalere på renseanlæg. (In Danish, translated from Korrespondenz Abwasser 8/92). *Vand og Miljø* Vol. 10, No. 2, pp. 44-48.
- Bechmann, H. (1999). *Modelling of wastewater systems.* Ph.D. thesis, IMM, DTU, Denmark (IMM-PHD-199-69), ISBN 87-88306-01-1.
- Bixio, D., Parmentier, G., Rousseau, D. Verdonck, F., Meirlaen, J., Vanrolleghem, P.A. and Thoeye, C. (2001). A quantitative risk analysis tool for design/simulation of wastewater treatment plants. *Proc. from 2nd IWA world congress*, Berlin, October 15-19, 2001.
- Bond, P.L., Keller, J., Blackall, L.L. (1999). Bio-P and non-bio-P bacteria identification by a Novel microbial approach. *Wat. Sci. Tech.* Vol. 39, No. 6, pp. 13-20.
- Both, E and Christiansen, G. (1990). *Termodynamik.* (In Danish). Den Private Ingeniørfond, Lyngby, ISBN 87-7381-031-2.
- Brisk, M. and Blackall, N. (1995). Benchmarking for best practice. *Process and Chemical Engineering*, November, pp. 44-49.
- Bundgaard, E., Andersen, K. and Petersen, G. (1989). BioDenitro and BioDenitro systems-experiences and advanced model development: the Danish systems for biological N and P Removal. *Wat. Sci. Tech.* Vol. 21, pp. 1727-1730.
- Carlsson, B. and Rehnström, A. (2002). Control of an activated sludge process with nutrient removal – a benchmark study. *Wat. Sci. Tech.* Vol. 45, No. 4/5, pp.135-142.
- Calet, P., Lefevre, F., Bujon, B., Reau, P., Philippe, J.P. and Audic, J. (1998). Automated aeration management in wastewater treatment:

- interest of the application to serial basins configuration. *Wat. Sci. Tech.* Vol. 37, No. 12, pp. 35-42.
- Cecil, D. (1999). Redox potential and the control of nitrogen removal. *Proc. from Nordic conference on nitrogen removal and biological phosphorus removal in Oslo*, February 2-4, 1999.
- Cenens, C., Jenné, R. and Van Impe, J.F. (2002). Evaluation of different shape parameters to distinguish between flocs and filaments in activated sludge images. *Wat. Sci. Tech.* Vol. 45, No. 4/5, pp. 85-92.
- Charpentier, J., Martin, G. Wacheux, H. and Gilles, P. (1998). ORP regulation and activated sludge: 15 years of experience. *Wat. Sci. Tech.* Vol. 38, No. 3, pp. 197-208.
- Cheon, S., Kim, S., Woo, H., Copp., J. B., and Kim, C. (2002). Evaluation of a respirometry-based loading rate control strategy for the activated sludge process using the IWA simulation benchmark. *Wat. Sci. Tech.* Vol. 45, No. 4/5, pp. 143-150.
- Clausen, G. and Önnnerth, T.B. (2000). Bjerghmarken udvider kapaciteten ved styring. (In Danish). *Stads- og Havneingeniøren* No. 2, pp. 11-15.
- Copp., J. (2002). *The COST simulation benchmark – description and simulator manual*. COST (European Cooperation in the field of Scientific and Technical Research), Brussels, Belgium.
- COST 624 homepage <http://www.ensic.u-nancy.fr/COSTWWTP/>.
- Dauphin, S., Joannis, C., Deguin, A., Bridoux, G., Ruban, G. and Aumond, M. (1998). Influent flow control to increase the pollution load treated during rainy periods. *Wat. Sci. Tech.* Vol. 37, No. 12, pp. 131-139.
- Devisscher, M., Bogaert, H., Bixio, D., Van de Velde, J. and Thoeye, C. (2002). Feasibility of automatic chemicals dosage control - a full-scale evaluation. *Wat. Sci. Tech.* Vol. 45, No. 4/5, pp. 445-452.
- DHI-MIT homepage, <http://www.mit.dhi.dk/>.

- Eikelboom, D.H. and Buijsen, H.J.J. (1983). *Microscopic sludge investigation manual*. TNO, Research institute for environmental hygiene.
- Ferrer, J. (1998). Energy saving in the aeration process by fuzzy logic control. *Wat. Sci. Tech.* Vol. 38, No. 3, pp 209-217.
- Gernaey, K, Yuan, Z. and Vanrolleghem, P.A. (2001). Titrimetric biosensing of biological wastewater treatment plants. *Proc. from the 1st IWA conference on Instrumentation, Control and Automation*, Malmö, June 3-7, 2001, pp. 107-114.
- Gujer, W., Henze, M., Mino, T. and van Loosdrecht, M.C.M. (1999). Activated sludge model, No. 3., *Wat. Sci. Tech.* Vol. 39, No. 1, pp. 183-193.
- Hägglund, T. (1990). *Praktisk processreglering*. (In Swedish). Studentlitteratur, Lund, Sweden, ISBN 91-44-3101-2.
- Haker, R. (1999). Experiences with online measuring instruments for SBR-operation in Kalmar. *Vatten* No. 55, pp. 33-39.
- Hammer, M. (1986). *Water and wastewater technology*. Prentice-Hall.
- Harremoes, P., Capodaglio, A.G., Hellström, B.G., Henze, M., Jensen, K.N., Lynggaard-Jensen, A., Otterpohl, R. and Soeberg, H. (1993). Wastewater treatment plants under transient loading – performance, modelling and control. *Wat. Sci. Tech.* Vol. 27, No.12 pp. 71-115.
- Heilmann, T. (1998). *Praktisk regulering og instrumentering*. (In Danish). Heilmanns, Holte, DK, ISBN 87-90603-02-8.
- Henze, M. Harremoes, P., la Cour Jansen, J. and Arvin, E. (1992). *Spildevandsrensning – biologisk og kemisk* (In Danish). Polyteknisk forlag, Lyngby ISBN 87-502-0738-5. Also published in English with the title *Wastewater treatment, Biological and chemical processes* by Springer Verlag, Germany, 1995.
- Henze, M., Grady Jr.C.P.L., Gujer, W., Marais, G.v.R. and Matsuo, T. (1987). *Activated sludge model No. 1*. IAWPRC scientific and technical reports, London, UK, IAWPRC (IAWQ).

- Henze, M., Gujer, W., Mino, T. and von Loosdrecht, M.C.M. (2000). *Activated sludge model ASM1, ASM2, ASM2d, ASM3. Scientific and technical report No. 9.* IWA publishing, London, UK.
- Henze, M., Gujer, W., Mino, T., Matsuo, T., Wentzel, M.C. and Marais, G. (1995). *Activated sludge model No. 2. Scientific and technical report No. 2.* IAWQ, London, UK.
- Henze, M., Gujer, W., Mino, T., Matsuo, T., Wentzel, M.C., Marais, G. and von Loosdrecht, M.C.M. (1999). Activated sludge model No. 2d, *Wat. Sci. Tech.* Vol. 39, No. 1, pp. 165-182.
- Holmberg, U. (1986). Adaptive dissolved oxygen control and on-line estimation of oxygen transfer and respiration rates. *AIChE Annual Meeting.*
- Hovat, S.C. (1995). Inherent bias in plant performance. *AIChE 1995 Summer national meeting*, August 2, 1995. (www.engr.ukans.edu/~ktl/plant/pp.abost.pdf).
- Husmann, M., Orth, H., Schlegel, S. and Teichgraber, B. (1998). Application of Process Control for Improved Nitrogen Removal. *Wat. Sci. Tech.* Vol. 38, No. 3, pp. 263-269.
- ICA (2002). *Proc. from the 1st IWA conference on Instrumentation, Control and Automation*, Malmö, Sweden, June 3-7., Vol. 1-2. Published in *Wat. Sci. Tech.* Vol. 45, No. 4/5.
- IndAqua (1998-1999). *IndAqua the water industry user group – The user requirements.* Esprit Programme P26240.
- Ingildsen, P. (2002). *Documentation of control system implemented at the Källby WWTP.* Technical report, IEA, LTH, Lund University. CODEN:LUTEDX/(TEIE-7183)/1-30/(2002).
- Ingildsen, P. and Olsson, G. (2001a). Exploiting online in situ ammonium, nitrate and phosphate sensors in full-scale wastewater treatment plant operation. *Proc. from second IWA world congress*, Berlin, October 15-19, 2001.

- Ingildsen, P., Jeppsson, U. and Olsson, G. (2002b). Dissolved oxygen controller based on on-line measurements of ammonium combining feedforward and feedback. *Wat. Sci. Tech.* Vol. 45, No. 4/5, pp. 453-460.
- Ingildsen, P., Lant, P. and Olsson, G. (2001b) Benchmarking plant operation and instrumentation, control and automation in the wastewater industry. *Proc. from 2nd IWA world congress*, Berlin, October 15-19, 2001.
- Ingildsen, P., Olsson, G. and Jeppsson, U. (2000). Using nutrient sensors for estimation and control of a full scale activated sludge process. *Proc from WaterTech Enviro 2000*, Sydney, 9-13 April, 2000.
- Ingildsen, P., Olsson, G. and Yuan, Z. (2002a). A hedging point strategy – balancing effluent quality, economy and robustness in the control of wastewater treatment plants. *Wat. Sci. Tech.* Vol. 45, No. 4/5, pp. 317-324.
- Isaacs, S. and Thornberg, D. (1998). A comparison between model and rule based control of a periodic activated sludge process. *Wat. Sci. Tech.* Vol. 37, No. 12, pp. 343-351.
- Isaacs, S., and Thornberg, D. (1998). Rule Based Control of a Periodic Activated Sludge Process. *Wat. Sci. Tech.* Vol. 38, No. 3, pp. 281-289.
- Isaacs, S., Mah, T. and Maneshin, S.K. (1998). Automatic monitoring of denitrification rates and capacities in activated sludge processes using fluorescence or redox potential. *Wat. Sci. Tech.* Vol. 37, No. 12, pp. 121-129.
- Isaacs, S., Nielsen M. and Hansen N. (1999). STAR solution to variable Loads. *Water Quality International*, January/February 1999.
- Jacobsen, B.N. and Warn, T. (1999). Overview and comparison of effluent standards for urban waste water treatment plants in European countries. *European Water Management*, Vol. 2, No. 6, pp. 25-39.
- Jenkins, D., Richard, M.G. and Daigger, G.T. (1993). *Manual on the causes and control of activated sludge bulking and foaming*. 2nd edition. Lewis Publishers, Chelsea, Michigan, ISBN 0-87371-873-9.

- Jeppsson, U. (1996). *Modelling Aspects of wastewater treatment processes*. Ph.D. thesis, Dept. of Industrial Electrical Engineering and Automation, Lund University, Sweden.
- Jeppsson, U., Alex, J., Pons, M.N., Spanjers, H. and Vanrolleghem, P.A. (2002). Status and future trends of ICA in wastewater treatment – a European perspective. *Wat. Sci. Tech.* Vol. 45, No. 4/5, pp. 485-494.
- Joergensen O., Önnérth T.B. og Andreassen I. (1995). Besparelser ved styring med STAR. (In Danish). *Stads- og havneingeniøren* No. 1, pp. 43 – 45.
- Jönsson, K. (2001). *Inhibition of nitrification in municipal wastewater – sources, effects, evaluation and remedies*. Ph.D. thesis, Dept. of Water and Environmental Engineering, Lund University, Sweden, ISBN 91-7874-127-0.
- Kayser, R. (1990). Process control and expert systems for advanced wastewater treatment plants. *Proc. 5th IAWPRC Workshop on Instrumentation, Control and Automation of water and wastewater treatment and transport systems*, Yokohama and Kyoto, Japan, pp. 203-210.
- Krause, K., Böcker, K. and Londong, J. (2002). Simulation of a nitrification control concept considering influent ammonium load. *Wat. Sci. Tech.* Vol. 45, No. 4/5, pp. 413-420.
- Lant, P. and Steffens, M (1998). Benchmarking for process control: “Should I invest in improved process control?” *Wat. Sci. Tech.* Vol. 37, No. 12, pp. 49-54.
- Larsson, T. and Skogestad, S. (2000). Plantwide control – A review and a new design procedure. *Modelling, identification and control*, Vol. 21, No. 4, pp. 209-240.
- Lindberg, C.-F, and Carlsson, B. (1996). Non-linear and setpoint control of the dissolved oxygen dynamics in an activated sludge process. *Wat. Sci. Tech.* Vol. 33, No. 1, pp. 135-142.

- Lindberg, C.-F. (1997). Control and estimation strategies applied to the activated sludge process. Ph.D. thesis, Uppsala University, Sweden, ISBN 91-506-1202-6.
- Londong, J. (1992). Strategies for optimised nitrate reduction with primary denitrification. *Wat. Sci. Tech.* Vol. 26, No. 5-6, pp. 1087-1096.
- Lukasse, L. (1999). *Control and identification in activated sludge processes*. Ph.D. thesis, Dutch Institute of Systems and Control (DISC), Wageningen Agricultural University, The Netherlands.
- Lynggaard-Jensen, A and Nielsen, M.K. (1993). Superior tuning and reporting (STAR). – a new concept for online process control of wastewater treatment plants. *Proc. from 6th IAWPRC conference on instrumentation and control*.
- Lynggaard-Jensen, A. (1994). Sensors for water quality and their potential. *Advances in water quality monitoring. Technical reports in hydrology and water resources* Vol. 42, pp. 162-181. World Meteorological Organisation (WMO).
- Lynggaard-Jensen, A. (1995). Status for on-line sensors and automated operation of wastewater treatment plants. *Proc. Nordic seminar nitrogen removal from municipal wastewater*.
- Lynggaard-Jensen, A. and Harremoës, P. (Eds) (1996). IAWQ workshop on sensors in waste water technology. *Wat. Sci. Tech.* Vol. 33, No. 1.
- Lynggaard-Jensen, A., Eisum, N.H., Rasmussen, I., Svankjaer Jacobsen, H. and Stenstroem, T. (1996). Description and test of a new generation of nutrient sensors. *Wat. Sci. Tech.* Vol. 33, No. 1, pp. 25-35.
- Maciejowski, J.M. (1989). *Multivariable feedback design*. Addison-Wesley Publishing Company, UK, ISBN 0-201-18243-2.
- Merkel, W. (2001). Performance assessment in the water industry. *Proc. from 2nd IWA world congress*, Berlin, October 15-19, 2001.
- Montgomery, D. C. (2000). *Design and analysis of experiments* (5th Ed.). Wiley, ISBN 0-471-31649-0.

- Müller, A., Kobbel, B., Künti, T., Pinnekamp, J., Seibert-Erling, G. and Böcker, K. (1999). *Energie in Kläranlagen – Handbuch*. (In German). Ministerium für Umwelt, Raumordnung und Landwirtschaft des Landes, Nordrhein-Westfalen.
- Nelder, J.A. and Mead, R. (1965). A simplex method for function minimization. *Computer J.* No. 7, pp. 308-313.
- Newell, B., Bailey, J., Islam, A., Hopkins, L. and Lant, P. (1997). Characterising bioreactor mixing with residence time distribution (RTD) tests. *Wat. Sci. Tech.* Vol. 37, No. 12, pp. 43-47.
- Nguyen, B. (2001). Performance assessment – national French report. *Proc. from 2nd IWA world congress*, Berlin, October 15-19, 2001.
- Nielsen, M.K. (2001). *Control of wastewater systems in practice*. Draft for Scientific and Technical Report on Instrumentation, Control and Automation as published on the homepage: www.smac.dk.
- Nielsen, M.K. and Lynggaard-Jensen, A. (1993). Superior Tuning And Reporting (STAR). - A new concept for on-line process control of wastewater treatment plants. *IAWQ ICA workshop 1993*, Hamilton, Canada.
- Nielsen, M.K. and Önnérth, T.B. (1995). Improvement of a recirculating plant by introducing STAR control. *Wat. Sci. Tech.* Vol. 31, No. 2, pp. 171-180.
- Nielsen, M.K. and Önnérth, T.B. (1996). Strategies for handling of on-line information for optimising nutrient removal. *Wat. Sci. Tech.* Vol. 33, No. 1, pp. 211-222.
- Nielsen, M.K., Carstensen, J. and Harremöes, P. (1996). Combined control of sewer and treatment plant during rainstorm. *Wat. Sci. Tech.* Vol. 34, No. 3-4, pp. 181-187.
- Nielsen, M.K., Revsbech, N.P., Larsen, L.H. and Lynggaard-Jensen, A. (2002). On-line determination of nitrite in wastewater treatment by use of a biosensor. *Wat. Sci. Tech.* Vol. 45, No. 4/5, pp.69-76.

- Niesing, B. (2000). Weniger Klärschlamm - mehr Biogas, *Fraunhofer-Magazin* No. 3, pp. 34-35.
- Nistor, C. Osvik, A., Davidsson, R., Rose, A., Vollenberger, U., Pfeiffer, D., Emnéus, J. and Fiksdal, L. (2002). Detection of Escherichia Coli in water by culture-based amperometric and lumniometric methods. *Wat. Sci. Tech.* Vol. 45, No. 4/5, pp.191-200.
- November, E.J., Cenens, C. and Van Impe, J.F. (2001). Accuracy of online viable biomass measurement based on capacitance readings of activated sludge during batch and fed-batch process operation. *Proc. from the 1st IWA conference on Instrumentation, Control and Automation*, Malmö, June 3-7, 2001, pp. 155-162.
- Øjelund, H. (2001). *Multivariate calibration of chemical sensors*. Ph.D. thesis, IMM, DTU, DK.
- Olsson, G (1977). State-of-art in sewage in sewage treatment plant control. *AIChE Symposium Series*, 72, pp. 52-76.
- Olsson, G and Piani, G. (1992). *Computer systems for automation and control*. Prentice Hall International Ltd., UK, ISBN 0-13-45781-4.
- Olsson, G. (1979). Process reglering i reningsverk – en översikt. (In Swedish). *Driftövervakning och mätteknik vid VA-anläggningar*, Svenska vatten- och avloppsverksföreningen, VAV M26, april 1979.
- Olsson, G. (1985). Control strategies for the activated sludge process. *Comprehensive Biotechnology* (Moo-Young, M. (Ed)), Pergamon Press. Chapter 65, pp. 1107-1119.
- Olsson, G. (1993). Advancing ICA technology by eliminating the constraints. *Wat. Sci. Tech.* Vol. 28, No. 11-12, pp. 1-7.
- Olsson, G. (2002) Lessons learnt at ICA2001. *Wat. Sci. Tech.* Vol. 45, No. 4/5, pp. 1-8.
- Olsson, G. and Andrews, J. F. (1978). The dissolved oxygen profile – a valuable tool for control of the activated sludge process. *Wat. Res.* Vol. 12, pp. 985-1004.

- Olsson, G. and Newell, B. (1999). *Wastewater treatment systems – modelling, diagnosis and control*. IWA Publishing, London, ISBN 1-900222-15-9.
- Olsson, G., Aspegren, H. and Nielsen, M.K. (1998). Operation and control of wastewater treatment – a Scandinavian perspective over 20 years. *Wat. Sci. Tech.* Vol. 37, No. 12, pp. 1-14.
- Olsson, G., Rundqwist, L., Eriksson, L and Hall, L. (1985). Self-tuning control of the dissolved oxygen concentration of activated sludge systems. *Advances in Water Pollution*, Drake, R. A. R. (Ed), Pergamon, Houston, Texas, USA, pp. 721-728
- Önnerth, T.B. and Nielsen, M.K. (1994). Control of biological nutrient removal plants in practice. Paper from *Advanced course in biotechnology, May 30, 1994*.
- Önnerth, T.B., Nielsen, M.K. and Stamer, C. (1996). Advanced computer control based on real and software sensors. *Wat. Sci. Tech.* Vol. 33, No. 1, pp. 237-245.
- Paul, E., Plisson-Saune, S., Mauret, M. and Cantet, J. (1998). Process state evaluation of alternating oxic-anoxic activated sludge using ORP, pH and DO. *Wat. Sci. Tech.* Vol. 38, No. 3, pp. 299-306.
- Pons, M. N. and Corriou, J. P. (2002). Implementation of storage tanks on the COST 624 benchmark. *Wat. Sci. Tech.* Vol. 45, No. 4/5, pp.159-166.
- Pons, M. -N., Spanjers, H. and Jeppsson, U. (1999). Towards a benchmark for evaluating control strategies in wastewater treatment plants by simulation. *Computers and Chemical Engineering Supplement 23S*, S403-S406, 1999.
- Rodrigo, M.A., Seco, A., Peña-roja, M. and Ferrer, J. (1996). Influence of sludge age on enhanced phosphorous removal in biological systems. *Wat. Sci. Tech.* Vol. 34, No. 1-2, pp. 41-48.
- Rosen, C. (2001). *A chemometric approach to process monitoring and control – with applications to wastewater treatment operation*. Ph.D. thesis, Dept. of Industrial Electrical Engineering and Automation, Lund University, Sweden.

- Salant, P. and Dillman, D.A. (1994). How to conduct your own survey. John Wiley and Sons, Inc. New York, ISBN 0-471-01273-4
- Samuelsson, P. (2001). *Modelling and control of activated sludge processes with nitrogen removal*. Dissertation for the degree of Licentiate of philosophy in Automatic Control. Uppsala University, Sweden.
- Sanuki, Y., Hiraoka, M., Ohto, T. Kanai, H. and Tada, H. (2002). Sensor system using polarization analysis method to monitor oil-on-water in water purification plants and rivers. *Wat. Sci. Tech.* Vol. 45, No. 4/5, pp.167-174.
- Scheer, H. and Seyfried, C.F. (1996). Enhanced biological removal: modelling and design in theory and practice. *Wat. Sci. Tech.* Vol. 34, No. 1-2, pp. 57-66.
- Schmitz, H., Husmann, M. and Orth, H. (2000). MSR-Konzepte zur verbesserung der Stickstoffelimination in Belebungsanlagen – Ein Überblick. (In German) *Wasser-Abwasser*, Vol. 141, No. 15, pp. S16-S23.
- Schulz, A. (2001). Benchmarking in wastewater management on the basis of technical and economic indexing systems. *Proc. from 2nd IWA world congress*, Berlin, October 15-19, 2001.
- Shinskey, F.G. (1979) *Process control systems*. 2nd edition. McGraw-Hill, New York, USA.
- Silkeborg (2000). Grøn information i Silkeborg Kommune, (In Danish). Denmark.
- Skogestad, S. and Postlewaith, I. (1996). *Multivariable feedback control*. John Wiley and Sons, Chichester, UK, ISBN 0-471-94277-4
- Søholt (1999). Grønt regnskab 1996-1999 Søholt renseanlæg. (In Danish). Denmark.
- Sørensen, J. (1996). Optimization of a nutrient removing wastewater treatment plant using on-line monitors. *Wat. Sci. Tech.* Vol. 33, No. 1, pp. 265-273.

- Sorensen, J., Thornberg, D. and Nielsen, M. (1994). Optimisation of a Nitrogen-Removing Biological Wastewater Treatment Plant Using On-Line Measurements. *Water Environ. Res.* Vol. 66, No. 3, pp. 236-242.
- Spanjers, H., Vanrolleghem, P.A., Nguyen, K., Vanhooren, H. and Patry, G.G. (1996). Towards a simulation-benchmark for evaluating respirometry-based control strategies. *Wat. Sci. Tech.* Vol. 37, No. 12, pp. 219-226.
- Spanjers, H., Vanrolleghem, P.A., Olsson, G. and Dold, P.L. (1998). *Respirometry in control of the activated sludge process: Principles. Scientific and Technical Report No. 7.* IAWQ, UK, ISBN 1-90222-04-3.
- Steffens, M.A. and Lant, P. (1999). Multivariable control of nutrient-removing activated sludge systems. *Wat. Res.* Vol. 33, No. 12, pp. 2864-2878.
- The Concise Oxford Dictionary* (1993). Oxford University Press, Walton street, Oxford OX2 6DP.
- Thornberg D.E., Nielsen, M.K., Eriksson, J. (1998). Upgrading of Borås wastewater treatment plant based on intelligent process and operation control. *Wat. Sci. Tech.* Vol. 37, No. 9, pp. 57-63.
- Thornberg, D., Nielsen, M. and Andersen, K. (1993). Nutrient removal: on-line measurements and control strategies. *Wat. Sci. Tech.* Vol. 28, No. 11/12, pp. 549-560.
- Thornberg, D.E. (1988). Nitrogen removal by computer control of a simple activated sludge plant. *Wat. Supply* No. 6, pp. 361-369.
- Thornberg, D.E., Nielsen, M.K., Lynggaard-Jensen, A. (1992). A new approach to control of wastewater treatment plants. The STAR concept. *IWSA Yearbook*.
- Ueyama, S., Hijikata, K. and Hirotsuji, J. (2002). Water monitoring system for oil contamination using polymer coated quartz crystal microbalance chemical sensor. *Wat. Sci. Tech.* Vol. 45, No. 4/5, pp.175-180.

- Vanrolleghem, P.A. and Gillot, S. (2002). Robustness and economic measures as control benchmark performance criteria. *Wat. Sci. Tech.* Vol. 45, No. 4/5, pp. 117-126.
- Vanrolleghem, P.A., Jeppsson, U., Carstensen, J., Carlsson, B. and Olsson, G. (1998). Integration of wastewater treatment plant design and operation. – a systematic approach using cost functions. *Wat. Sci. Tech.* Vol. 34, No. 3-4, pp. 159-171.
- Vasel, J.-L., Praet, E. (2002). On the use of fluorescence measurements to characterize wastewater. *Wat. Sci. Tech.* Vol. 45, No. 4/5, pp.109-116.
- Vrecko, D., Hvala, N. and Kocijan, J. (2002). Wastewater treatment benchmark: What can be achieve with simple control? *Wat. Sci. Tech.* Vol. 45, No. 4/5, pp.127-134.
- Wareham, D., Hall, K. and Mavinic, D. (1993). Real time control of wastewater treatment systems using ORP. *Wat. Sci. Tech.*, Vol. 28, No. 11-12, pp. 272-282.
- Watts, J.B. and Garber, W.F. (1993). Instrument and system maintenance: a design and operational necessity. *Wat. Sci. Tech.* Vol. 28, No. 11-12, pp. 447-456.
- Weijers, S. (2000). *Modelling, Identification and Control of Activated Sludge Plants for Nitrogen Removal*. Ph.D. thesis, Technical University of Eindhoven, The Netherlands, ISBN 90-386-0997-3.
- Wells, C.H. and Williams, C.L. (1978). *Dissolved oxygen control in an activated sludge plant*. Internal report, Sparling division of Envirotech, Santa Clara, California. (Quoted in Olsson, G. (1979)).
- Westlund, Å.D., Hagland, E. and Rothman, M. (1996). *Mikroskopering av aktivt slam – manual*. (In Swedish). SYVAB, Stockholm Vatten.
- Wilderer, P.A. and Genes, K.M. (1998). *Nährstoffelimination auf Kläranlagen durch mehrstufige prozessführung und nutzung von Überschussschlamm in fremden Reaktionsräumen*. (In German). Endreport on a project about the Lindau wastewater treatment plant. Lehrstuhl für Wassergüte- und Abfallwirtschaft, Technische Universität München, Germany.

- Wittenmark, B., Aaström, K.J. and Joergensen, S.B. (2000). *Process control*. Department of Automatic control, Lund University, Sweden.
- Yu, R., Liaw, S., Chang, C. and Cheng, W. (1998). Applying real time control to enhance the performance of nitrogen removal in the continuous-flow SBR system. *Wat. Sci. Tech.* Vol. 38, No. 3, pp. 271-280.
- Yuan, Z., Bogaert, H., Leten, J. and Verstrate, W. (2000). Reducing the size of nitrogen removal activated sludge plants by shortening the retention time of inert solids via sludge storage. *Wat. Res.* Vol. 34, No. 2, pp. 539-549.
- Yuan, Z., Bogaert, H., Vansteenkiste, G. and Verstraete, W. (1998). Sludge storage for countering nitrogen shock loads and toxicity incidents. *Wat. Sci. Tech.* Vol. 37, No. 12, pp. 173-180.
- Yuan, Z., Keller, J. and Lant, P. (2001). *Optimization and control of nitrogen removal activated sludge plants: a review of recent developments*. Draft for scientific and technical report on instrumentation, control and automation as published on the homepage: www.smac.dk.
- Yuan, Z., Oehmen, A. and Ingildsen, P. (2002). Control of nitrate recirculation flow in pre-denitrification systems. *Wat. Sci. Tech.* Vol. 45, No. 4/5, pp.29-36.
- Zipper, T., Fleischmann, N. and Haberl, R. (1998). Development of a new system for control and optimisation of small wastewater treatment plants using oxidation-reduction potential (ORP). *Wat. Sci. Tech.* Vol. 38, No. 3, pp. 307-314.