



# LUND UNIVERSITY

## Arterial Thrombosis in Factor V Leiden or Activated Protein C Resistance. Clinical and Experimental Studies.

Sampram, Ellis

2012

[Link to publication](#)

*Citation for published version (APA):*

Sampram, E. (2012). *Arterial Thrombosis in Factor V Leiden or Activated Protein C Resistance. Clinical and Experimental Studies*. [Doctoral Thesis (compilation), Clinical Coagulation, Malmö]. Clinical Coagulation Research Unit, Clinical Science, Malmö.

*Total number of authors:*

1

### General rights

Unless other specific re-use rights are stated the following general rights apply:

Copyright and moral rights for the publications made accessible in the public portal are retained by the authors and/or other copyright owners and it is a condition of accessing publications that users recognise and abide by the legal requirements associated with these rights.

- Users may download and print one copy of any publication from the public portal for the purpose of private study or research.
- You may not further distribute the material or use it for any profit-making activity or commercial gain
- You may freely distribute the URL identifying the publication in the public portal

Read more about Creative commons licenses: <https://creativecommons.org/licenses/>

### Take down policy

If you believe that this document breaches copyright please contact us providing details, and we will remove access to the work immediately and investigate your claim.

LUND UNIVERSITY

PO Box 117  
221 00 Lund  
+46 46-222 00 00

# **Arterial Thrombosis in Factor V Leiden or Activated Protein C Resistance: Clinical and Experimental Studies**

Ellis Senanu Kojo Sampram  
Doctoral Thesis 2012



**LUND**  
UNIVERSITY

Lund University, Faculty of Medicine.  
Departments of Coagulation Disorders and Haemostasis and Vascular Diseases  
Skåne University Hospital, Malmö, Sweden. 2012

Present address:  
Ellis S. K. Sampram, MD  
Senior Fellow, Vascular Surgery  
Department of Vascular Surgery  
Detroit Medical Center/Wayne State Medical School  
Detroit, MI 48201. USA.  
esampram@gmail.com



Copyright © Ellis S. K. Sampram

Faculty of Medicine, Departments of Coagulation Disorders and Vascular  
Diseases Skåne University Hospital Malmö. Lund University

ISBN 1652-8220  
ISSN 978-91-87189-42-5  
Lund University, Faculty of Medicine Doctoral Dissertation Series  
2012:79

Printed in Sweden by Media-Print, Lund University  
Lund 2012

“You may encounter many defeats, but you must not be defeated. In fact, it may be necessary to encounter the defeats, so you can know who you are, what you can rise from, how you can still come out of it.”

– Maya Angelou

To Lene, Daniella and Patrick





## Table of Contents

<b>Abbreviations</b> .....	6
<b>List of Papers</b> .....	7
<b>Introduction</b> .....	9
<b>Epidemiology</b> .....	16
<b>Factor V Leiden and venous thromboembolism</b> .....	17
<b>Deep Vein Thrombosis and Pulmonary Embolism</b> .....	19
<b>Thromboprophylaxis</b> .....	21
<b>Interactions with concomitant inherited defects of hemostasis</b> .....	22
<b>Factor V mutation in Women</b> .....	23
<b>Arterial Thrombosis</b> .....	24
<b>Factor V Leiden and Arteriosclerosis</b> .....	24
<b>Factor V Leiden and Coronary disease</b> .....	25
<b>Factor V Leiden and Stroke</b> .....	26
<b>Factor V Leiden and Peripheral artery disease</b> .....	27
<b>Experimental studies</b> .....	28
<b>Diagnostic work-up of patients with inherited thrombosis</b> .....	29
How do patients benefit from Factor v mutation testing .....	30
<b>Aim of Studies</b> .....	31
<b>Materials and Methods</b> .....	32
Paper I .....	32
Paper II.....	32
Paper III .....	32
Paper IV .....	33
<b>Ethics</b> .....	35
<b>Statistics</b> .....	36
<b>Results</b> .....	37
Paper I .....	37
Paper II.....	38
Paper III .....	38
Paper IV .....	39
<b>Limitations</b> .....	40
<b>Discussion</b> .....	41
Venous thromboembolism .....	41
Atherosclerosis and Factor V Leiden.....	42
Arterial Thrombosis and Factor V Leiden.....	42
<b>Conclusion</b> .....	47
<b>Future Considerations</b> .....	48
<b>Populärvetenskaplig sammanfattning på svenska (Comprehensive summary in Swedish)</b> .....	49
<b>Acknowledgements</b> .....	51
<b>References</b> .....	52
<b>Appendix (Paper I-V)</b> .....	59
Paper I	
Paper II	
Paper III	
Paper IV	

## Abbreviations

AAA	Abdominal aortic aneurysm
APC	Activated protein C
APCr	Activated protein C ratio
aPTT	Activated Partial Thromboplastin Time
ApoE	Apolipoprotein E
Arg	Arginine
AT	Antithrombin
CLI	Critical limb ischemia
DVT	Deep vein thrombosis
FV	Factor V
FVa	Activated Factor V
FVac	Anticoagulant Factor V
FVL	Factor V Leiden
FVIIIa	Activated Factor VIII
Fv+/+	Wild type
FvQ/+	Heterozygote
FvQ/Q	Homozygote
Gln	Glutamine
IHD	Ischemic heart disease
PAD	Peripheral artery disease
PE	Pulmonary embolism
TTO	Time to occlusion
VTE	Venous thromboembolism

## **LIST OF PUBLICATIONS**

This thesis is based on the following papers, which will be referred to in the text by their Roman numerals

- I. Activated protein C resistance in patients with peripheral vascular disease. Sampram ESK, Lindblad B, Dahlbäck B. *J Vasc Surg* 1998;28:624-9.
  
- II. The Impact of Factor V mutation on the risk for occlusion in patients undergoing peripheral vascular reconstructions. Sampram ES, Lindblad B. *Eur J Vasc Endovasc Surg*. 2001;22:134-8
  
- III. Arterial Thrombosis in mice with Factor V Leiden mutation. Sampram ES, Saad Y, Ouriel K. *Vascular*. 2008;16:31-4.
  
- IV. APC resistance due to Factor V Leiden is not related to inflammatory mediators, survival or rate of amputation up to ten years in patients with critical limb ischemia. Sampram ESK, Gottsäter A, Lindblad B, Svensson PJ. Submitted



## Introduction

Protein C is one of the key regulatory proteins for the coagulation Factors Va and VIIIa, whereby when activated, activated protein C (APC) limits the degree of thrombus formation. The major anticoagulatory function of the coagulation cascade is achieved by antithrombin (Figure 1 Dahlbäck 1999).

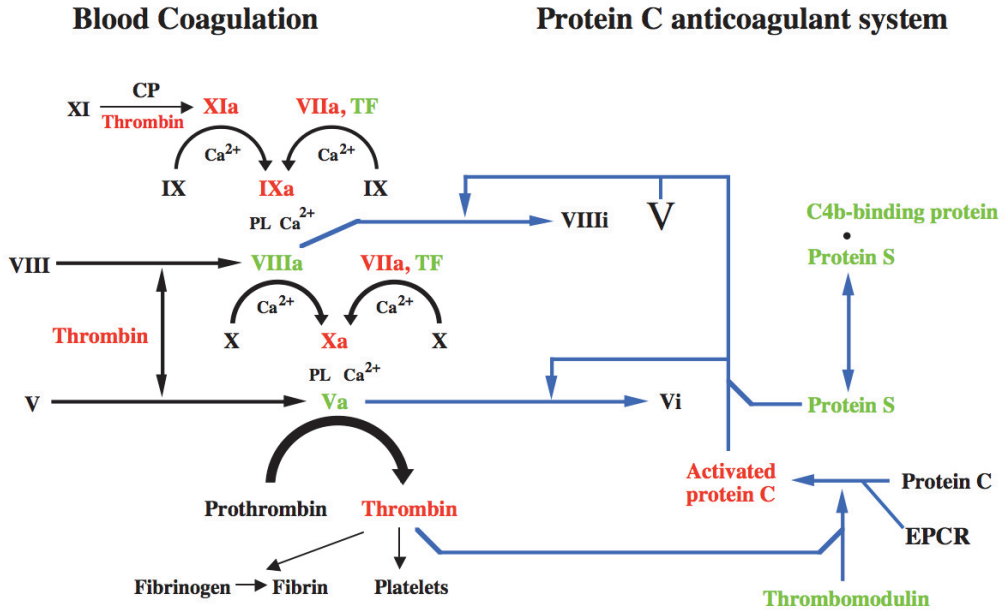

*Figure 1. Schematic representation of blood coagulation and the protein C anticoagulant system. The figure also highlights the dual role of thrombin as both a procoagulant and anticoagulant factor. Illustrated by Marie Dauenheimer. With permission from Blood.*

Other important inhibitors of the coagulation cascade are protein S, thrombomodulin and the tissue factor pathway inhibitor. Protein C is activated on the endothelial surface by complex formation of thrombin, thrombomodulin, and protein C. This activated protein C has an anticoagulative effect by cleaving and inactivating Factor Va and VIIIa, thereby inhibiting the coagulation cascade. These phospholipid cell membrane reactions are potentiated by Factor V and protein S (Figure 2).

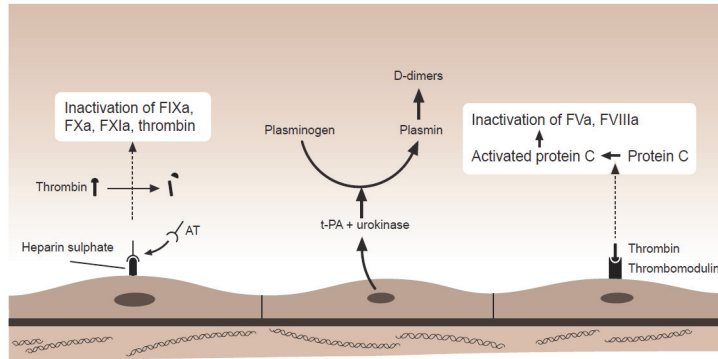

**Figure 2. Mechanisms of anticoagulation.** Schematic drawing of different parts of the anticoagulative effects that on the vessels surface are important for regulation of the coagulation and thrombus formation. AT = antithrombin. With permission from Casper Asmussen and Studentlitteratur.

In 1993, Dahlbäck and coinvestigators (Dahlbäck, Carlsson et al. 1993) described activated protein C (APC)-resistance. Plasma samples from families with severe recurrent venous thromboembolism showed reduced anticoagulant response using an activated partial thromboplastin time (aPTT) assay after the addition of APC (Dahlbäck et al. 1993). Extensive work involving 45 Swedish families with recurrent venous thromboembolism showed that 34 out of the 45 investigated families (76%) had abnormal aPTT-assay reactions to activated protein C (Svensson & Dahlbäck, 1994). This pioneer study showed the hereditary nature of this abnormality and also that APC-resistance occurred in a much higher frequency than any other coagulation factor previously known to contribute to the development of deep venous thrombosis or pulmonary embolism. After the various mechanisms for the poor anticoagulant mechanism of APC were excluded, Factor V was found to act as a cofactor, together with protein S, for the less than expected prolongation of aPTT found after adding APC. Thus nonactivated Factor V and protein S act as a cofactor for APC for the inactivation of FVa and FVIIIa (Figure 3). (Dahlbäck 1999).

## Activation and propagation of coagulation

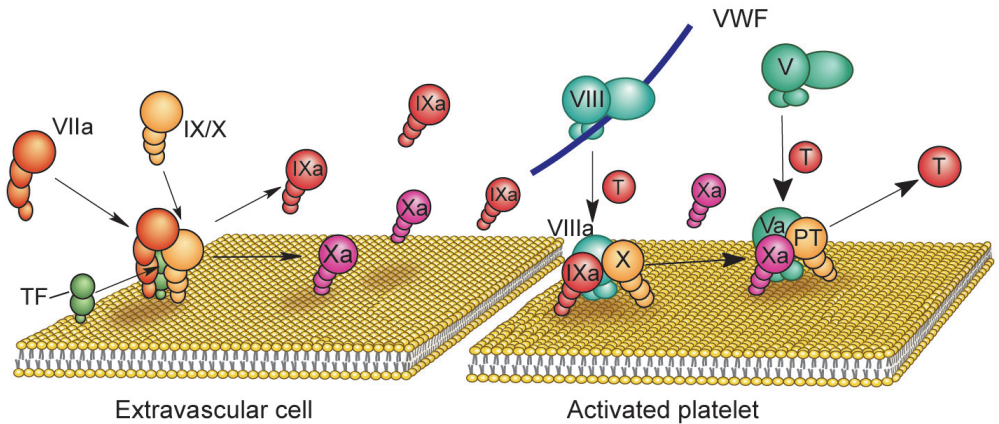
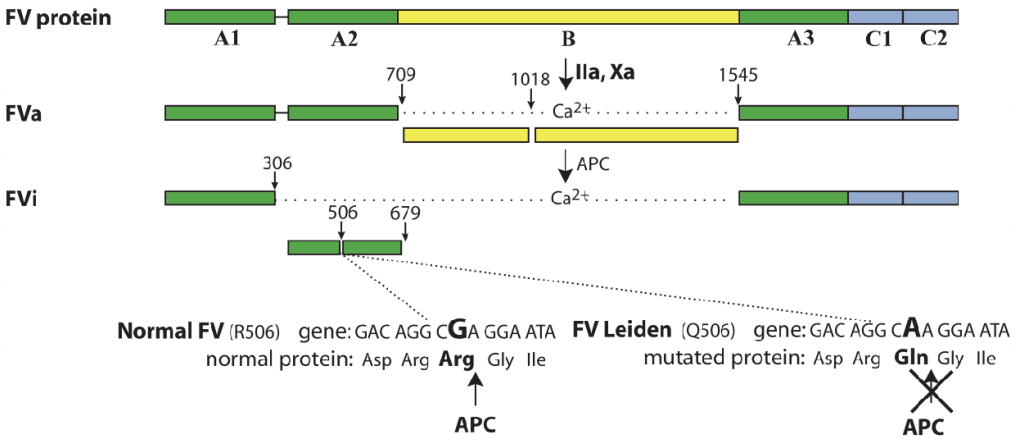

**Figure 3. The initiation and propagation of blood coagulation.** The reactions of blood coagulation take place on the surface of cell membranes where enzymes and cofactors form complexes that efficiently convert their respective proenzyme substrates to active enzymes. The reaction sequence is initiated by the exposure of tissue factor (TF) to blood with subsequent binding of FVII/FVIIa and activation of FIX and FX. The following assembly of tenase (FIXa/FVIIIa) and prothrombinase (FXa/FVa) complexes on the surface of negatively charged phospholipid membranes (provided mainly by platelets) results in amplification, propagation, and generation of high concentration of thrombin (T). The initial thrombin that is formed feedback-activates FVIII (circulating with von Willebrand factor (VWF) and FV. Illustration by Marie Dauenheimer. With permission from Blood.

It was soon found that APC-resistance was due to a single point arginine-for-glutamine mutation in the gene coding for coagulation Factor V, Figure 4. This phenomenon leads to the replacement of arginine by glutamine at position 506 and responsible for the abnormal function of APC in most cases. The first report on this mutation came from a research group in Leiden, Netherlands (Bertina et al. 1994). This mutation came to be known as Factor V Leiden (FVL). It was confirmed from other groups (Zöller & Dahlbäck, 1994). This point mutation site is one of the three cleavage sites on Factor V for the proteolytic degradation by the natural anticoagulant activated protein



C.



**Figure 4. Activation and degradation of normal FV and FV Leiden.** FV circulates as a single-chain high-molecular-weight protein. Thrombin (or FXa) cleaves a number of peptide bonds, which results in the liberation of the B domain and generation of FVa. Three peptide bonds in FVa are cleaved by APC (Arg306, Arg506, and Arg679) resulting in inhibition FVa activity. The FV Leiden mutation eliminates one of the APC cleavage sites, which impairs the degradation of FVa. Illustration by Marie Dauheimer. With permission from Blood.

This mutation renders the activated form of Factor V relatively resistant to degradation by activated protein C. This, in turn, leads to the laboratory abnormality of resistance to activated protein C (Figure 4). Most cases of APC resistance are due to FVL mutation. Extensive research since 1993 has now confirmed Factor V Leiden to be the most commonly known hereditary abnormality of the clotting system to date, with a prevalence of heterozygous carriers of 3% to 15% and homozygous carriers of about 1% (Zöller, Svensson et al. 1994). Due to this mutation (Arg506Gln or R506Q) at the cleavage site for activated protein C (APC), Factor Va is inactivated at a reduced rate (Figure 4). This defect leads to a reduced anticoagulant effect of APC, with a less-than-expected prolongation of aPTT. Further characterisation of the FV anticoagulant effect has shown multiple properties of the anticoagulant function of FV (Thorelli, Kaufman et al. 1998; Cramer and Gale 2012):

## Inactivation of FVa by APC

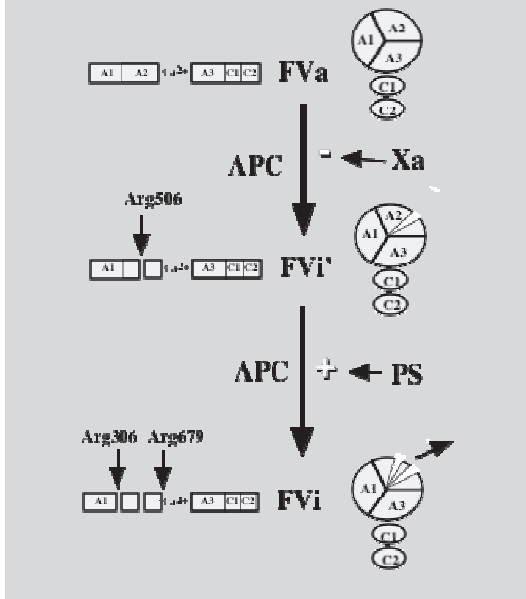

**Figure 5. Inactivation of FVa by APC.** FVa is composed of the heavy (A1+A2) and light (A3+C1+C2) chains that are linked together by calcium-dependent noncovalent bonds. APC inhibits the activity of FVa by cleaving three bonds at Arg306, Arg506, and Arg679 in the A2 domain. The Arg506 is the most kinetically preferred of the three bonds but results in only partial inactivation (FVi' denotes the inactivation intermediate resulting from the Arg506 cleavage of FVa). When FVa is part of the prothrombinase complex, the Arg506 cleavage site is protected by FXa. Full inactivation is the result of proteolysis at Arg306, a site that is not protected by FXa. Protein S potentiates the cleavage at Arg306 but not that at the Arg506 site. After full degradation by APC, the A2 fragments dissociate from the rest of the FVimolecule. With permission from Elsevier.

Factor V is normally prothrombotic, binding to Factor X to form the prothrombin complex, which in turn activates Factor II to cross-link fibrin complexes. As part of normal feedback inhibition, Factor Va is deactivated by APC by cleavage at amino acid 506, thus limiting the extent of clot formation (Figure 5). This substitution at position 506 leads to increased thrombin generation through a dual mechanism: (1) decreased APC-mediated inactivation of the procoagulant form of Factor V (Factor Va), and (2) decreased APC-mediated conversion of Factor V to an anticoagulant form, that functions as a cofactor for the inactivation of Factor VIIIa. Thus, Factor V Leiden can be considered to be both a gain-of-function mutation (leading to increased Factor Va prothrombotic activity) and a loss-of-function mutation (leading to decreased Factor Va anticoagulant activity) (Dahlbäck 1999; Cramer and Gale 2012).

At vascular injury sites, thrombin generation gives rise to activated platelets deposition, activation of coagulation Factors V, VIII, XI, and the conversion of fibrinogen to fibrin, and subsequent formation of fibrin network (Davie 1995), (figure 6).

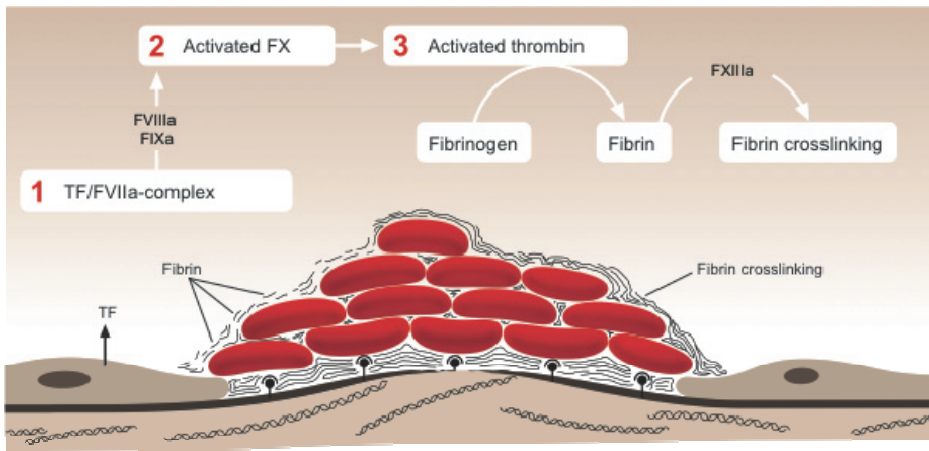
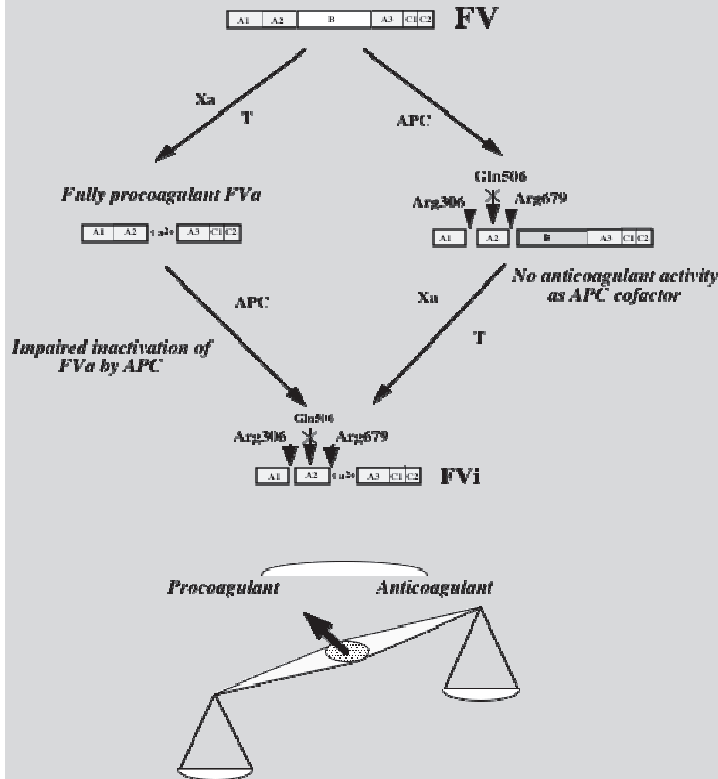

Figure 6. Plasma coagulation during secondary hemostasis. With permission from Casper Asmussen.

On the other hand, thrombin generated on intact endothelial cells initiate anticoagulant protein C system, a modulation achieved by the binding of thrombin to the endothelial cell surface protein thrombomodulin (TM). This complex induces a shift in substrate specificity of thrombin from procoagulant to an anticoagulant direction (Esmon 1995). FV circulates as a profactor, expressing no procoagulant properties or limited procoagulant properties (Dahlbäck 1999). Thrombin or FXa cleaves FV, which results in the generation of procoagulant FVa (Kane and Davie 1988; Monkovic and Tracy 1990; Thorelli, Kaufman et al. 1998). The anticoagulant properties of FV are expressed after limited proteolysis of FV by APC, which converts FV to an anticoagulant molecule (Dahlbäck 1999) functioning as a cofactor to APC in the degradation of FVIIIa (Shen and Dahlbäck 1994; Thorelli, Kaufman et al. 1998). As such, circulating FV can be recruited by either procoagulant or anticoagulant pathways. Under normal physiologic conditions, the balance is shifted in favor of anticoagulant, a circulating APC may cleave FV, thus recruiting it to the anticoagulant pathway (Dahlbäck 1999). As planned by nature, a prerequisite for health is a carefully controlled balance between the procoagulant and anticoagulant systems. Since proteolytic activity of APC is specific for positively charged amino acids, the Arg to Gln replacement results in loss of the APC cleavage site at position 506 in both FV and FVa (Heeb, Kojima et al. 1995; Kalafatis, Bertina et al. 1995; Nicolaes, Tans et al. 1995; Aparicio and Dahlbäck 1996). Hence, the loss of APC cleavage site at position 506 impairs both the APC-mediated degradation of FVa and the conversion of FV to an anticoagulant APC cofactor. This means that the synergistic APC cofactor activity between FV and protein S that is required for the efficient inhibition of FVIIIa cannot be expressed in the presence of mutant FV (Varadi, Rosing et al. 1996; Thorelli, Kaufman et al. 1998). The dual effects of the FV Leiden mutation result in a hypercoagulable clottsystem that confers a life-long risk of thrombosis (Dahlbäck 1999) (Figure 7).

**FV Leiden causes APC resistance by dual mechanisms**



**Figure 7. FV Leiden mutation causes hypercoagulable state through dual mechanisms.** The Arg506 to Gln mutation in FV results in the loss of APC cleavage site at this position in both FV and FVa. There are two biologic consequences of this mutation that both change the balance between procoagulant and anticoagulant forces in a procoagulant direction, one being impaired degradation of FVa and the other being loss of APC cofactor function of FV. The mutation does not affect the procoagulant function of FVa. The APC-mediated inactivation of FVa is impaired because the cleavage site at position 506 is lost. This cleavage site is highly sensitive to APC in normal FVa, but it is protected by FXa in the prothrombinase complex. As a consequence, the Arg506Gln mutation preferentially impairs the degradation of free FVa – that is, FV not bound to FXa in the prothrombinase complex – whereas the degradation of FVa in the prothrombinase complex is less affected by the mutation. Mutant FV cannot be converted to an anticoagulant APC cofactor (important for FVIIIa inactivation), because this requires Arg506 cleavage by APC. With permission from Elsevier.

## Epidemiology

After the first description of APC resistance by Dahlbäck et al 1993, APC resistance was quickly demonstrated to be mainly caused by a single point mutation (Arg506Gln, R506Q or 1691G→A) in the coding region of the Factor V gene (Figure 4). This mutation, Factor V Leiden, is now known to be the most prevalent risk factor for venous thromboembolism (VTE) in people of European descent, mostly Caucasians, occurring in 3% to 15% of the general population in Europe and North America (Segers et al. 2007). Importantly, the same haplotype is seen in all FVL alleles. One has calculated that the mutation occurred only once and that the estimated age of the mutation is about 30 000 years which could be compared to the out-of-Africa migration that occurred about 100 000 years ago (Zivelin, Griffin et al. 1997). This would explain why the mutation is mostly found in Caucasians, and almost non-existent in sub-Saharan Africa. Numerous studies have attempted to determine the prevalence of FVL in the population, some of these are shown in **Table 1**. Estimates vary between 1% and 15% of the population, with greater prevalence in Caucasians. The greatest FVL prevalence appears to occur in people of Greek, Swedish, or Lebanese descent.

*Table 1: Prevalence of FVL-mutation in the general population*

Author	Number studied	Country	Frequency of FVL
Svensson et al	288	Sweden	11.1%
Zöller et al	251	Sweden	14.7%
Irani-Hakime et al	174	Lebanon	14.4%
Schroder et al	1628	Germany	7.1%
Ridker et al	4047	USA	3.7%
		Hispanic-Americans	2.2%
		African-Americans	0.5%
		Asian-Americans	1.3%
Mazoyer et al	6154	France	3.8%
Ioannou et al	240	Greece	3.3%
Akar et al	4276	Turkey	7.9

These observations ushered in a new era in the clinical evaluation of thromboembolism. For the first time, it became possible to diagnose a genetic defect (with a defined biochemical mechanism) in a substantial fraction of patients with VTE. Before the discovery of Factor V Leiden, hereditary risk factors could be identified in <5% of patients presenting with VTE, even when a strong family history of thrombosis was obtained. In the current era, with widespread availability of genetic testing for Factor V Leiden and another common hereditary risk factor, prothrombin G20210A, it is now possible to identify a genetic thrombophilic factor in 10% to 20% of unselected patients with VTE and up to 50% of patients with familial thromboembolism (Koster, Rosendaal et al. 1993; Ridker, Hennekens et al. 1995; Price and Ridker 1997; Svensson, Zöller et al. 1997).

In a large population study, the prevalence of Factor V Leiden mutation was determined in a cohort of 4047 U.S. men and women (Ridker, Miletich et al. 1997). This cross-sectional study revealed the overall carrier frequency for the mutation as 3.7% (95% CI, 3.1% to 4.3%) and the allele frequency was 1.9% (CI, 1.6% to 2.2%). The observed distribution of genotypes was consistent with that predicted by the Hardy-Weinberg equilibrium. Factor V Leiden mutation was found to be most prevalent in white persons (5.3% [CI, 4.4% to 6.2%]) and was significantly less prevalent in other ethnic groups (2.2% in Hispanic Americans, 1.2% in African Americans, 0.5% in Asian Americans, and 1.3% in Native Americans) ( $P <$

0.001). The highest incidence in a population has been reported from Sweden, specifically in the area where this thesis was carried out, where FVL frequency of 11% was reported (Holm, Zöller et al. 1996). Other studies also show that the mutation is not distributed equally among ethnic groups (Fujimura, Kambayash et al. 1995; Rees, Cox et al. 1995; Mannucci, Duca et al. 1996). Low prevalence in the western Mediterranean countries and notably uncommon in Asian and African populations, a fact that may explain the decreased risk for venous thromboembolism in these groups (Burkitt 1972). These findings could have a confounder effect on population studies from areas of racial admixture. Prevalence data in homogenous populations, such as Sweden, would be near to the reality.

*Table 2 Prevalence of FVL in Malmö City, Sweden*

<b>Author</b>	<b>No of healthy controls</b>	<b>No of Factor V Leiden</b>	<b>%</b>
<b>Holm et al. 1996</b>	<b>101</b>	<b>11</b>	<b>11</b>
<b>Svensson et al 1997</b>	<b>288</b>	<b>32</b>	<b>11</b>
<b>Lindqvist et al 1998</b>	<b>2480</b>	<b>270</b>	<b>10.9</b>

### **Factor V Leiden and venous thromboembolism**

Since 1993, clinical studies have shown that Factor V Leiden mutation is associated with increased risks for primary (Isma et al. 2009) and recurrent VTE (Ridker, Miletich et al. 1995; Prandoni, Lensing et al. 1996; Simioni, Prandoni et al. 1997). The impact of Factor V Leiden mutation and the risk for venous thromboembolism was confirmed in a large prospective study (Ridker, Hennekens et al. 1995). In this study of a cohort of 14 916 men who had no history of cardiovascular disease or cancer, 121 cases of venous thromboembolism occurred during a mean follow-up period of 8.6 years. The prevalence of the mutation was 11.6% among men with venous thromboembolism compared with 6.0% among those who remained healthy during follow-up (relative risk, 2.7 [CI, 1.3 to 5.6]; P = 0.008). The importance of resistance to activated protein C as a risk factor for venous thromboembolism in the general population was also shown in the Leiden Thrombophilia Study (Koster, Rosendaal et al. 1993), where APC resistance was detected in 21% of patients with deep venous thrombosis compared with 5% of age- and sex-matched controls; this yielded an almost seven-fold (matched odds ratio, 6.6 [CI, 3.6 to 12.0]) increase in risk for deep venous thrombosis in persons with resistance to activated protein C. Further analysis showed that only 80% of these individuals with APC resistance were heterozygous or homozygous for Factor V Leiden mutation. Other studies support the high correlation between resistance to activated protein C

and Factor V Leiden mutation. In the Malmö Thrombosis Study of 1140 patients with VTE the FVL-mutation was found in 288 (31%) patients, of which 261 were heterozygous, and 27 homozygous (Isma, Svensson et al. 2009). The lifetime relative risk of a venous or arterial thrombotic event, compared with the general population, was only increased 2.2-fold for FVL patients. Meanwhile, the same risk for patients with protein C deficiency was increased 7.3-fold, for antithrombin deficiency patients 8.1-fold, and for those with protein S deficiency, the increased risk was 8.5-fold (Martinelli, Mannucci et al. 1998). Also, the age at first thromboembolic event has been reported to be slightly less in patients heterozygous for Factor V Leiden mutation than in persons without the mutation (Koster, Rosendaal et al. 1993; Bertina, Koeleman et al. 1994; Rosendaal, Koster et al. 1995). In studies not confounded by the presence of acquired risk factors like trauma, use of oral contraceptives, pregnancy, risks associated with Factor V Leiden mutation increase with age (Price and Ridker 1997). The incidence of thromboembolism among heterozygous male carriers of factor V Leiden mutation was shown to increase with age at a rate significantly greater than that in unaffected men (P for trend across age groups = 0.008) (Price and Ridker 1997; Ridker, Glynn et al. 1997). Factor V Leiden mutation has been shown to be the most common identifiable risk factor in referral population of patients (prevalence, 11% to 37%) (Koster, Rosendaal et al. 1993; Svensson and Dahlbäck 1994; Voorberg, Roelse et al. 1994; Ridker, Hennekens et al. 1995; Rosendaal, Koster et al. 1995), Table 3. Affected persons in the families with hereditary VTE in our hospital were also shown to have reduced thrombosis-free survival (Zöller, Svensson et al. 1994).

Author	No of VTE- patients	FVL
Svensson et al 1994	104	40%
Ehrenforthet al 1999	1200	27.2%
Isma et al 2010	1140	31%
Eroglu et al 2012	1202	22.8%

*Table 3 Frequency of FVL in VTE-patients*

A relative rare form of venous thrombosis is mesenteric vein thrombosis. It has been reported to be frequent among APC-resistance individuals and case reports have pointed out this risk (Bergensfeldt, Svensson et al. 1999). In a recent analysis of 51 patients from our hospital with mesenteric vein thrombosis 13 out of 29 tested had FVL (45%) (Acosta and Bjorck 2003).

## Deep vein thrombosis and pulmonary embolism

Venous thrombosis and pulmonary embolism pose a serious health problem. In USA half a million people are hospitalized each year and 500-1000 deaths occur due to venous thromboembolism (VTE), which is also a leading cause of maternal death. The incidence of symptomatic venous thrombosis cases is approximately 1 in 1000 people per year.

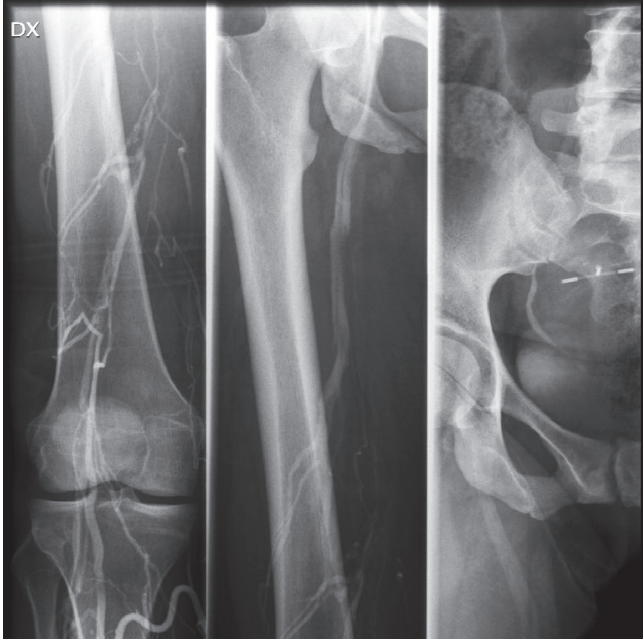

*Figure 8. Young woman with FVL and presenting with recurrent ilio-femoral venous thrombosis diagnosed with phlebography.*

The actual incidence of venous thrombosis is 0.1-0.3% per year (Desmarais, de Moerloose et al. 1996; Manten, Westendorp et al. 1996), out of which symptomatic pulmonary embolism is present in about a third of patients with venous thrombosis (Martinelli, Cattaneo et al. 1997). Venous thrombosis is a multifactorial condition (Figure 8) caused by a combination of genetic, acquired or environmental influences. Natural anticoagulant systems (the protein C system, antithrombin and tissue factor pathway inhibitor) are in place to keep coagulation in check. Excess clotting occurs when there is a disturbance in one of the coagulation inhibitor mechanisms or in natural lysis of clots.

Known genetic causes explain about 50% of venous thrombosis cases. Most inherited thrombosis disorders involve a defect in one of the natural anticoagulant mechanisms.

<b>Genetic Disorder</b>	<b>Prevalence among patients with venous thrombosis</b>
Factor V mutation (APC resistance)	20-40%
Protein S deficiency	5-6%
Protein C deficiency	2-5%
Antithrombin deficiency	2-4%
Plasminogen deficiency	1-2%
Heparin cofactor II deficiency	<1%
Unknown genetic defects?	~40%



The most common genetic causes (APC resistance and deficiencies of protein C, protein S and antithrombin) all have dominant inheritance with incomplete penetrance. Clinical presentation of thrombosis in affected individuals is similar for all the disorders and the thrombosis is often recurrent. In those affected, the first thrombotic event usually occurs in adulthood except for homozygous protein C deficiency which can cause severe thrombosis in the newborn. Studies have shown that up to a third of families affected with inherited thrombosis have two genetic defects, one of which is the Factor V mutation. The Factor V mutation has been discovered in numerous families with deficiencies in protein C, protein S or antithrombin. This combination of two genetic risk factors (or homozygosity for one) increases penetrance dramatically, resulting in very high risk of thrombosis. Acquired or environmental conditions can precipitate a thrombotic event. These include:

- Pregnancy
- Oral contraceptive use
- Estrogen therapy
- Obesity
- Malignancy
- Diabetes mellitus
- Venous stasis from immobility
- Trauma
- Post-operative state
- Lupus anticoagulant

Furthermore, carriers of the FVL mutation also run increased risk for recurrence of VTE after their first episode. According to a systematic review (Ho, Hankey et al. 2006), the FVL mutation was present in 21.4% among 3104 patients with first-ever VTE, and the odds ratio for recurrence of VTE in this group was 1.41(95% CI, 1.14-1.75; p=08). One year later Marchiori et al (Marchiori, Mosena et al. 2007) published a systematic review and meta-analysis of 10 different studies, involving 3203 patients with their first provoked or unprovoked VTE episode. The relative risk for recurrence of VTE in patients with heterozygous FVL mutation compared to VTE patients without the mutation was 1.39 (95% CI, 1.15-1.67). Traditionally, deep vein thrombosis (DVT) and pulmonary embolism (PE) have been considered as two entities of the same disease. Recently, however, different studies have shown that the prevalence of some risk factors differs in patients with DVT compared with those of PE. Desmarais et al (Desmarais, de Moerloose et al. 1996) described in 1996 that the factor FVL mutation seems to be a stronger risk factor for DVT than for PE. This differential effect known as “Factor V Leiden paradox” has been shown by several reports (Martinelli, Cattaneo et al. 1997; Turkstra, Karemaker et al. 1999; Emmerich, Rosendaal et al. 2001; Meyer, Emmerich et al. 2001; van Stralen, Doggen et al. 2008; Makelburg, Veeger et al. 2010). The pathophysiological mechanism for this Factor V Leiden paradox is still not clear. Makelburg et al in their report reported an annual incidence for DVT in non-carriers of FVL as 0.19% (95%CI, 0.19-0.23) and 0.41% (95%CI, 0.28-0.58) in carriers of the mutation, first ever reported. For PE, these incidences were 0.07% for both non-carriers and carriers of FVL mutation. Other studies have also reported low prevalence of FVL among patients with fatal pulmonary embolism (Hooper and De Staercke 2002), and the higher incidence of DVT than PE in patients with Factor V Leiden (Martinelli, Battaglioli et al. 2007).

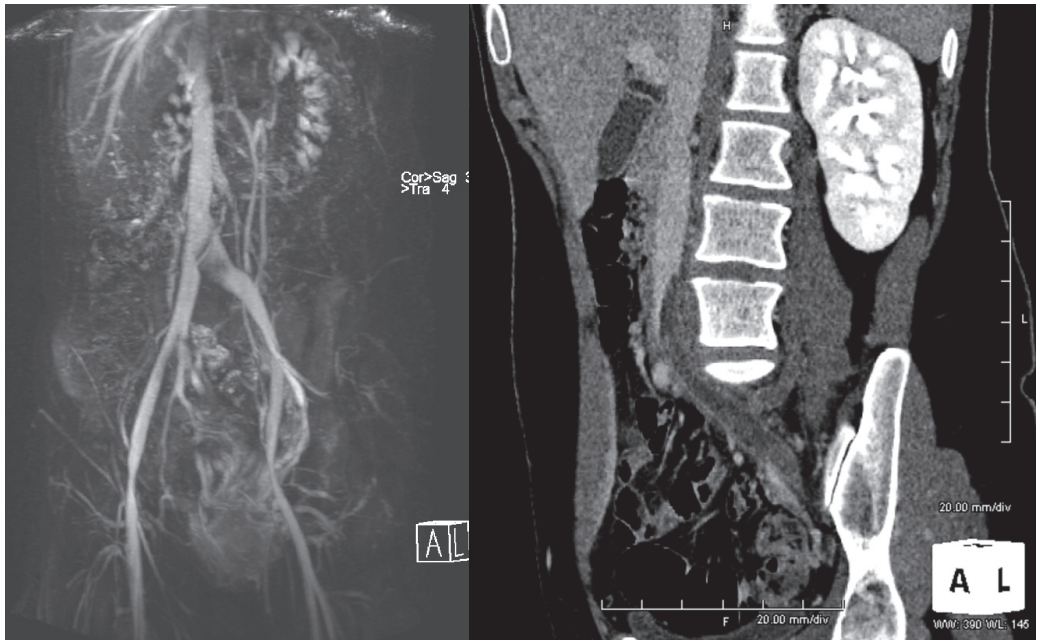

*Figure 9. MR or CT-phlebography can give valuable information regarding vena cava and iliac veins.*

## **Thromboprophylaxis**

Patients with FVL are generally not afforded special precautions when undergoing surgery. Support for this practice was established in a 1998 study of 825 subjects (Ryan, Crowther et al. 1998) with and without FVL who underwent total hip or knee replacement. Although the absolute incidence of venous thromboembolism, as diagnosed by venogram (Figure 9), was higher in FVL patients (31%) than controls (26%), the authors found no statistically significant association between FVL and venous thrombosis. However, in another study, APC-resistance was analyzed in 645 patients undergoing hip arthroplasty. In this study, however, only clinical symptomatic postoperative thromboembolic events were recorded. 14 % of the patients had APC-resistance (Lindahl et al 1999). Of these, 10% had clinical symptomatic venous thromboembolism compared to 2% in patients without APC-resistance. In a study of 1600 orthopaedic patients from 12 European countries (Wahlander, Larson et al. 2002), who were electively scheduled for hip or knee surgery, a tendency was found towards increased risk of VTE with Factor V Leiden after surgery. Little research has been published on the efficacy of coagulation precautions for FVL patients, but the clear association of FVL and graft occlusion suggests that it is a worthy area of investigation. Overall, with present knowledge and in spite of the fact that the number of studies are insufficient, patients with APC-resistance or Factor V Leiden that are immobilized, undergoing operation, a low threshold for the use of thromboprophylaxis seems prudent.

Thromboprophylaxis are, in general, offered to pregnant women that have had an episode of venous thromboembolism and it should also be considered if a pregnant woman is known to have Factor V Leiden mutation (see below).

## **Interaction with Concomitant Inherited Defects of Hemostasis**

Despite a lack of definitive prevalence data, FVL is thought to be the most commonly inherited hypercoagulable disorder. The next most prevalent disorder, protein C deficiency, is less than half as common as FVL, occurring in an estimated one in 200 people. Other thrombophilic disorders include antithrombin III deficiency, which occurs in an estimated one in 300 people, and protein S deficiency, which occurs in 0.13% of the population.

It was previously believed that the FVL disorder, deficiencies in protein S or protein C, and antithrombin deficiency were unique disorders with independent genetic etiologies. Recent studies have begun to demonstrate an inter-relationship among these conditions. For example, a study of families with protein S deficiency found that 39% of subjects also carried the FVL mutation (Zöller, Berntsdotter et al. 1995). In another study, 18 of 128 families (15%) with antithrombin deficiency were also FVL carriers (van Boven, Reitsma et al. 1996). All inherited thrombophilic disorders have not yet been linked to a single genetic locus. From a clinical standpoint, however, patients diagnosed with one thrombophilic defect clearly have greater risk for carrying a second.

It appears that, for patients who carry more than one thrombophilic defect, the risk of thromboembolism is increased synergistically. In an analysis of eight case-control studies examining the effect of FVL and prothrombin G20210A defect, the odds ratio for patients heterozygous for FVL and prothrombin mutation was 4.9 and 3.8, respectively (Emmerich, Rosendaal et al. 2001). However, the odds ratio for patients with both disorders was 20.0, far larger than even the sum of each individual risk.

Patients homozygous for Factor V Leiden mutation seem to be at even higher risk of VTE. In the Leiden Thrombophilia Study, the risk for VTE among patients homozygous for Factor V Leiden mutation was increased 80-fold (CI, 22-fold to 289-fold). Furthermore, homozygous patients presented with initial thromboembolism at a younger age (median age, 31 years) than did those who were heterozygous (median age, 44 years) or unaffected (median age, 46 years) by the mutation.

Factor V Leiden mutation enhances the risk for thrombosis in patients with other thrombophilic states, such as protein C and protein S deficiencies or hyperhomocystinemia . In a study(Gandrille, Greengard et al. 1995) of 113 patients with symptomatic protein C deficiency, the prevalence of the Factor V Leiden mutation was 14% . In a study(Zöller, Berntsdotter et al. 1995) of seven families with both protein S deficiency and Factor V Leiden mutation, 72% of members with both defects had a thrombotic event compared with 19% of those with only protein S deficiency and 19% of those with only Factor V Leiden mutation . Factor V Leiden mutation enhances the risk for thrombosis in patients with other thrombophilic states, such as protein C and protein S deficiencies or hyperhomocystinemia(Koeleman, Reitsma et al. 1994; Gandrille, Greengard et al. 1995; Koeleman, van Rump et al. 1995; Zöller, Berntsdotter et al. 1995; Ridker, Hennekens et al. 1997).Factor V Leiden mutation also seems to enhance the thrombotic risk associated with both inherited and acquired forms of hyperhomocystinemia.

## Factor V mutation in women

The risk for venous thromboembolism increased with oral contraceptive use (Ross, Pike et al. 1986). In a case-control study by the World Health Organization of 1143 women with venous thromboembolism, it showed that the relative risk among persons using oral contraceptives compared with persons who did not use oral contraceptives was 4.15 (CI, 3.09 to 5.57) in Europe and 3.25 (CI, 2.59 to 4.08) in developing countries (1995). The risk for thromboembolic events was increased fourfold with oral contraceptive use alone (relative risk, 3.8 [CI, 2.4 to 6.0]) and increased eightfold with Factor V Leiden mutation alone (relative risk, 7.9 [CI, 3.2 to 19.4]) (Vandenbroucke, Koster et al. 1994). However, the risk for thromboembolic events was increased more than 30-fold in women with Factor V Leiden mutation who also used oral contraceptives (relative risk, 34.7 [CI, 7.8 to 154]) (Vandenbroucke, Koster et al. 1994).

While, traditionally, the use of estrogen as hormone replacement therapy in postmenopausal women has not been considered a major risk factor for venous thromboembolism (1974; Petitti, Wingerd et al. 1979; Devor, Barrett-Connor et al. 1992), recent reports have found increased risk for thromboembolism in users of oral estrogen replacement compared with nonusers (Daly, Vessey et al. 1996; Grodstein, Stampfer et al. 1996; Jick, Derby et al. 1996). No studies have examined the potential interaction between Factor V Leiden mutation and hormone replacement therapy. However, compared with women using oral contraceptives, those receiving replacement therapy tend to be older and thus have a higher absolute risk for idiopathic thromboembolism. Thus, the absolute increase in risk associated with Factor V Leiden mutation may be greater among persons using hormone replacement therapy than among those using oral contraceptives (Price and Ridker 1997).

During pregnancy and the puerperium women are predisposed to venous thromboembolism, which is a major cause of maternal death (Sachs, Brown et al. 1987; Sipes and Weiner 1990). The cause of the increased risk is not completely clear, but may be related to pregnancy-induced changes in hemostasis. Associations between venous thromboembolism during pregnancy and Factor V Leiden mutation have been reported (Hellgren, Svensson et al. 1995; Bokarewa, Bremme et al. 1996; Hirsch, Mikkola et al. 1996). These reports revealed in small case series that 40% to 59% of women with pregnancy-related venous thromboembolism had resistance to activated protein C or Factor V Leiden mutation. In another study (Rai, Regan et al. 1996) of 50 patients with second-trimester pregnancy loss, the prevalence of resistance to activated protein C was 20%, significantly higher than the prevalence in women who only had a history of first-trimester miscarriage (5.7%;  $P < 0.02$ ) and the prevalence in controls. Finally, studies have shown that resistance to activated protein C can be acquired during pregnancy (Cumming, Tait et al. 1995; Hirsch, Mikkola et al. 1996). Benefits of Factor V Leiden on survival in postpartum has been reported (Lindqvist, Svensson et al. 1998). This study found a reduction in the risk of intrapartum bleeding in carriers of the FV:Q506 allele. This suggested an evolutionary selection mechanism in favor of FVL, resulting in a reduced hemorrhage and mortality in the intrapartum.

## ARTERIAL THROMBOSIS

In 1994 the first clinical case with both arterial and venous thrombotic complications from our hospital was presented (Lindblad, Svensson et al. 1994). It involved a young male (32 years of age) with popliteal artery occlusion, suspected to be due to popliteal entrapment. His claudication progressed and the occluded popliteal segment was reconstructed with an autologous vein bypass. In spite of good run-off it occluded twice in the early postoperative period and after thrombectomy that reoccluded a second venous bypass was performed successfully. He was on heparin intra- and postoperatively, was mobilized and sent home. The day after discharge, he died *mors subita* of massive pulmonary embolism from lower extremity DVT. He had a strong familial history of thrombosis and both parents and one brother had APC-resistance. This led to our teams interest to further investigate in our hospital the role of APC-resistance in patients with arteriosclerosis, arterial thrombosis and functioning of arterial repair. It is still controversial, however, whether Factor V Leiden influences the risk of arterial thrombotic disease.

It's intriguing, however, why there's still uncertainty about the impact of APC resistance in arterial thrombosis while the impact of APC resistance on venous thrombosis is well established by the avalanche of studies reported the last twenty years. Early on during this period, studies on venous thrombosis suggested less impact on arterial thrombosis. This has thwarted the interest in research in arterial thrombosis in this field. In recent years, however, there have been numerous case reports showing the positive impact of APC resistance on arterial thrombosis.

### Factor V Leiden and arteriosclerosis:

Virchow's triad postulated the causes of venous thrombosis to be due to stasis, vascular wall injury and hypercoagulable state. Even though Virchow originally suggested his triad regarding venous thrombosis, it has been applied to both venous and arterial thrombosis since then. In patients with APC resistance, the low flow state in the venous system fulfills two factors for development of thrombosis in Virchow's triad: low flow and hypercoagulable state. The same cannot be said about the arterial system with its high flow state. Does Factor V Leiden need endothelial injury, a nidus, for its impact?

Whether Factor V Leiden influences the risk of development of arteriosclerosis is still debatable, and few studies have investigated the association (Kiechl, Muigg et al. 1999; Willeit, Kiechl et al. 2000; Volzke, Wolff et al. 2005). The association of FVL with the development of arteriosclerosis is not uniformly shown. For example, the Bruneck Study (Kiechl, Muigg et al. 1999; Willeit, Kiechl et al. 2000) data showed that the presence of the FVL 1691A allele was an independent risk factor for prevalent carotid atherosclerosis as well as for the progression of atherosclerotic carotid plaques and for incident carotid stenosis with lumen narrowing greater than 40%. Animal studies in FVL mice may be more revealing (Eitzman, Westrick et al. 2005; Shen, Lu et al. 2009), and experimentally enhanced arterial thrombosis and atherosclerosis development is seen associated with FVL. A recent population study (Weischer, Juul et al. 2010) showed that prothrombin G20210A heterozygosity alone and in combination with Factor V Leiden R506Q heterozygosity predicts 1.5 and 6.0 fold risk of ischemic heart disease compared to non-carriers. Several reports, including a controlled study among patients with coronary stenosis, are suggestive of an association with coronary heart disease, however, several other studies have shown conflicting relationships. The reason for the lack of consistency among studies is unclear but may reflect differences in the prevalence of other risk factors that act synergistically with Factor V Leiden. When the

presence of another factor is important for manifesting the elevated risk, this interaction may go unobserved in clinical studies of selected groups of individuals among whom this other factor is absent or uncommon. The conflicting results nevertheless makes it unlikely that Factor V Leiden is a major risk factor for development of arteriosclerosis or arterial thrombotic disease as it is of venous thromboembolism. Still, even if it had only a moderate effect on the risk of myocardial infarction (MI), or if it imparted a large risk to a subgroup of the population, Factor V Leiden would be important because of its high allele frequency and the large burden of arterial disease in many populations.

In various clinical studies(Ouriel, Green et al. 1996; Sampram, Lindblad et al. 1998; Vig, Chitolie et al. 2004) on thrombophilia and arterial disease there seemed to be a higher prevalence of Factor V Leiden in patients with arterial disease compared with control groups, leading to hypothesis that Factor V Leiden might be a risk factor for the development of arterial thrombosis (Figure 10), supported by experimental data(Bohm and Al-Khaffaf 2003). Some case-control studies have suggested that Factor V Leiden may be a risk factor for stroke or myocardial infarction in certain subgroups (Boeckholdt and Kramer 2007).

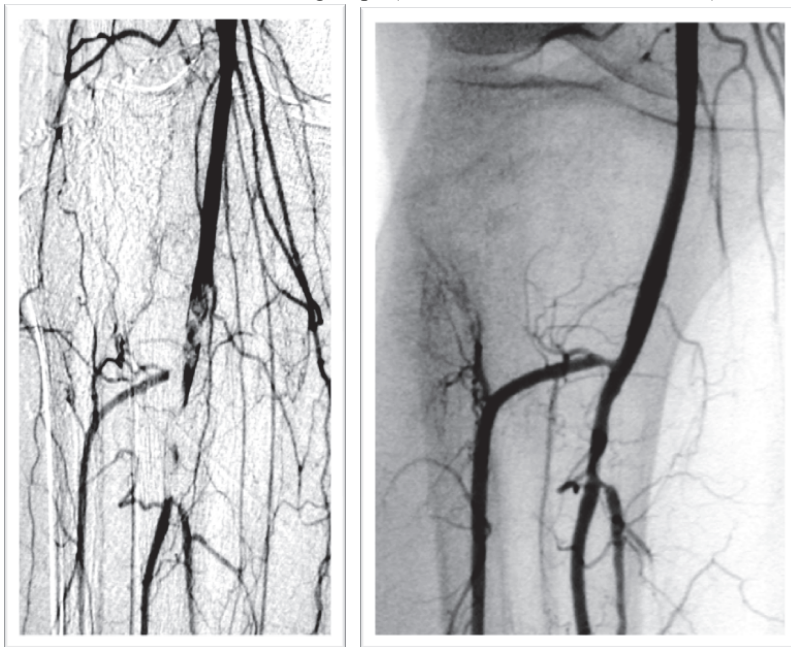

*Figure 10. A patient with FVL and acute ischemia with occlusion of the popliteal artery that was endovascularly treated with catheter aspiration technique.*

### **Factor V Leiden and coronary disease:**

In early studies from our hospital, male patients with myocardial infarction had FVL in 22% compared to 10% frequency in healthy controls(Holm, Zöller et al. 1996). Several studies have investigated the relationship between the FVL mutation and risk of myocardial infarction. A meta-analysis of six studies from 2001 showed weak or absent significance for coronary arteriosclerotic disease development in FVL-individuals(Boeckholdt, Bijsterveld et al. 2001). However, in this analysis, when studies investigating patients with myocardial infarction before age 55 were included, a significance of Factor V Leiden was shown. In the Physicians' Health Study, FVL carriership was not associated with an increased risk of

myocardial infarction(Ridker, Hennekens et al. 1995). This finding was confirmed in several other large studies, including the Cardiovascular Health Study(Cushman, Rosendaal et al. 1998) and the Copenhagen Heart Study(Juul, Tybjaerg-Hansen et al. 2002). Thus no certain relationship has been established for coronary arteriosclerosis and FVL.

On the other hand, studies investigating the relative small group of patients with myocardial infarction but without evidence of atherosclerosis have suggested that FVL may in such cases indeed be a risk factor(Mansourati, Da Costa et al. 2000). A recent population study(Weischer, Juul et al. 2010) from the same geographic area as Copenhagen Heart Study showed that Factor V Leiden R506Q heterozygosity in combination with Prothrombin G20210A heterozygosity predicts a 6.0 fold risk of ischemic heart disease compared to non-carriers in the general population. This is in agreement with a recent meta-analysis (Ye, Liu et al. 2006) which suggested that Factor V alone predicted increased risk of IHD. The rationale for these observations is that in the absence of coronary artery disease, for forming an arterial thrombi, other risk factors must be present to trigger these relative rare cases of myocardial infarction. For instance, the presence of FVL was significantly higher among people who developed myocardial infarction without evidence of coronary artery disease than among those with coronary artery disease or healthy controls(Mansourati, Da Costa et al. 2000). Another study, (Rosendaal, Siscovick et al. 1997) suggested that FVL may be associated with an increased risk of myocardial infarction among young women, who are at very low risk of having significant coronary artery disease. This study observed that an interaction exists between FVL and smoking. Whereas the presence of one risk factor led to a moderately elevated risk, smoking carriers of FVL mutation had a 32-fold increased risk of myocardial infarction. However, larger studies and meta-analysis among patients who developed myocardial infarction at a young age did not confirm this observation. A large Italian Study identified 1210 young survivors of myocardial infarction at age younger than 45 years(2003) and found no evidence for an association between FVL and myocardial infarction at young age. Another meta-analysis estimated that FVL carriers had an odds ratio of 1.3 (95%CI, 0.9 to 1.9) of developing myocardial infarction before the age of 55 years(Juul, Tybjaerg-Hansen et al. 2002).

## **Factor V Leiden and Stroke**

Studies have extensively looked at the association between carriership of the FVL mutation and the risk of developing stroke. Large studies investigating the relationship with unselected ischemic stroke observed no significant association(Ridker, Hennekens et al. 1995; Cushman, Rosendaal et al. 1998; Hankey, Eikelboom et al. 2001). Thus arteriosclerotic induced stroke is the most common and not related to FVL. However, similar to findings for myocardial infarction, several studies on FVL and stroke risk have focused on patient populations deemed to have a low atherosclerotic burden. Considering the racial variations in the prevalence of Factor V Leiden, whether study populations are homogenous or admixed could play a confounding factor on results. In these populations, the results have been inconsistent. Furthermore, with a limited sample size, if a disease-causing allele is more frequent in one population compared with the other, it will be easier to detect an association in that population. Casas and coworkers(Casas, Hingorani et al. 2004), in their large meta-analysis on 19 studies involving a total of 3028 cases and 7131 controls, concluded that there's a genetic component to common stroke but failed to find a single gene with a major effect. They suggested a synergistic effect of several gene variants, each exerting a modest effect, contributing to stroke. Weischer et al found similar results. In another study among women who suffered an ischemic stroke before the age of 45 years, FVL was not a risk factor(Longstreth, Rosendaal et al. 1998). However, a recent meta analysis (Hamedani, Cole

et al. 2010) of 18 case-control studies of ischemic stroke in adults 50 years of age and younger found an association between Factor V Leiden and ischemic stroke in young adults, particularly in patient populations in which there is an increased clinical suspicion of prothrombotic state. Furthermore, another study among young women observed an interaction between smoking and the FVL mutation, a finding that is consistent with findings in the field of myocardial infarction (Lalouschek, Schillinger et al. 2005). In this study, women with only one of these risk factors had only a moderately elevated risk. On the other hand, smoking carriers that also had the FVL mutation had an odds ratio for stroke of 8.8 (95%CI, 2.0 to 38.0) compared with nonsmoking noncarriers. A recent study from Finland (Haapaniemi, Helenius et al. 2009) involving 860 adult patients with first-ever ischemic stroke revealed a strong association with Factor V Leiden.

In another highly selected group of patients with a very low burden of atherosclerosis, namely children some studies suggest that FVL may indeed be a risk factor for stroke (Kenet, Sadetzki et al. 2000). The relative risk associated with FVL carriership was estimated to be 5-fold (OR= 4.8, 95%CI, 1.4 to 16.5). In line with this, recent studies from Portugal, Lebanon and Turkey have revealed a strong association between Factor V Leiden and arterial ischemic stroke in pediatric patients (Barreirinho, Ferro et al. 2003; Duran, Biner et al. 2005; Muwakkit, Majdalani et al. 2011). Whereas these studies show associations, others did not (Kontula, Ylikorkala et al. 1995; Landi, Cella et al. 1996; Madonna, de Stefano et al. 2002; Aznar, Mira et al. 2004).

The strong association of Factor V Leiden with venous but not arterial thrombosis is paradoxical because excessive thrombin generation might be expected to contribute importantly to thrombosis in both veins and arteries. As reiterated above, this paradox may be related to the multifactorial nature of arterial disease, with many gene-gene and gene-environment interactions that may confound genetic association studies and nature of hemodynamics in veins and arteries. This synergistic effects are revealed in some of the above studies.

## **Factor V Leiden and Peripheral Arterial Disease:**

Most earlier reports didn't find any or only weak association between FVL and PAD (Reiner, Siscovick et al. 2001). The last 15 years has seen an avalanche of case reports of FVL patients with severe arterial thrombotic events (de Moerloose and Boehlen 2007). Since earlier studies concluded that there was no association between thrombophilia and PAD there have been limited number of studies evaluating such an association. But recently, further studies involving peripheral vascular patients have found very high prevalence of FVL and APC resistance in this patient population (Lassila 2012). In a recent meta-analysis (Vig, Chitolie et al. 2004) on available data on the prevalence of thrombophilia defects in patients with peripheral vascular disease and subsequent failure of vascular interventions suggested that the risk of occlusion following arterial revascularization in patients with an identified thrombophilia defect appears to be almost three times that of patients with no evidence of a thrombophilia defect. In 1996 Ouriel et al found that activated protein C resistance was more prevalent in patients with PAD, and an even higher incidence was found in those patients presenting with graft occlusion following infrainguinal bypass. However, in this study only APC ratio was measured rather than FVL and the study comprised a limited number of individuals. The following year, Donaldson et al studied the role of APC-resistance in vascular surgical patients using APC-ratio and Factor V Leiden testing in 262 patients undergoing arterial reconstruction. This study found a higher prevalence of APC-resistance but not Factor V Leiden in patients preoperatively when compared to the general population. Importantly, a subgroup of patients with early graft failure showed a higher prevalence of APC-resistance.





**Figure 11.** An acute ischemic foot in a FVL-patient. Note the pale mottled skin. This patient required immediate revascularization.

A population study (Cushman, Rosendaal et al. 1998) did not find increased risk of future arterial thrombosis in adults with FVL (Figure 11). Another population study (Kiechl, Muigg et al. 1999) suggested an independent and gradual association between low response to APC and both advanced atherosclerosis (stenosis) and arterial disease, suggesting FVL being only one aspect of this relationship. Recently, Sartori et al (Sartori, Conti et al. 2011) found that the presence of multiple thrombophilic alterations in patients who underwent PTA for PAD was associated with increased risk of arterial thrombotic events, whereas each single thrombophilic alteration was not.

## Experimental Studies

In experimental studies the differences between populations can be eliminated and cofounders minimized. Experimental studies by Eitzman et al shed new light on the influence of Factor V Leiden in arterial disease (Cui, Eitzman et al. 2000; Eitzman, Westrick et al. 2005). Eitzman and colleagues used a murine model, the Factor V Leiden mouse, to examine the effects of excessive thrombin generation on arterial thrombosis and the development of atherosclerosis. The Factor V Leiden mouse carries the murine equivalent of human Factor V Leiden, introduced by engineering a point mutation into the murine Factor V gene. Homozygous Factor V Leiden mice have the expected APC resistance phenotype and they spontaneously deposit fibrin in their tissues, a finding suggestive of chronic low-grade thrombin generation. Previous work with this murine model has provided some instructive lessons vis-à-vis the importance of genetic modifiers of thrombosis and fibrinolysis. The first lesson was that the severity of the thrombotic phenotype of the Factor V Leiden mouse is highly dependent on genetic background, which implies the existence of modifier genes (Westrick and Ginsburg 2009). A second lesson was provided by the demonstration that

the Factor V Leiden mouse can be used to unmask the antithrombotic phenotype of candidate genes, such as protein Z and tissue factor pathway inhibitor. These observations were being exploited by Ginsburg and colleagues, who were using the Factor V Leiden/heterozygous tissue factor pathway inhibitor mouse as a platform for a mutagenesis screen to identify novel genetic modifiers of thrombosis. Another recent lesson was that the Factor V Leiden mouse has impaired fibrinolytic activity, possibly because of increased activation of the thrombin-activatable fibrinolysis inhibitor. Eitzman et al report that the Factor V Leiden mouse is abnormally susceptible to experimental thrombosis induced by photochemical injury of the carotid artery. This finding is consistent with reports of accelerated thrombosis in mice with other genetic abnormalities of coagulation that lead to increased thrombin generation, such as deficiency of thrombomodulin or heparin cofactor II. Taken together, these observations demonstrated definitively that unregulated thrombin generation can contribute to arterial thrombosis, at least in mice. Eitzman et al also used a bone marrow transplantation approach (Eitzman, Westrick et al. 2005) to determine that it is the plasma pool, rather than the platelet pool, of Factor V Leiden that makes the greater contribution to accelerated arterial thrombosis.

An even more interesting result was obtained when Eitzman et al crossbred Factor V Leiden mice with apolipoprotein E (apoE)-deficient mice (Eitzman, Westrick et al. 2005). ApoE-deficient mice have markedly elevated levels of plasma total cholesterol, and they develop complex atherosclerotic lesions spontaneously. At 1 year of age, apoE-deficient mice that were homozygous for Factor V Leiden exhibited almost 3 times more aortic atherosclerosis than did apoE-deficient mice with wild-type Factor V genes. ApoE-deficient mice that were heterozygous for Factor V Leiden had an intermediate extent of atherosclerosis, which suggests that even low-grade thrombin generation may influence the development of arterial disease in mice. Importantly, all of the mice were crossbred to C57BL/6 mice for several generations to minimize the influence of genetic background.

The Factor V Leiden mouse has proven to be a useful model of thrombotic disease, and it continues to teach us lessons about the vascular consequences of unregulated thrombin generation. The findings by Eitzman et al strongly support a role for thrombin as a driver of arterial thrombosis and atherosclerosis in mice. What can we learn from this study about the influence of Factor V Leiden on arterial disease in humans? The relevance of these findings to humans who are heterozygous for Factor V Leiden is uncertain and requires more study. For humans who are homozygous for Factor V Leiden, however, these findings from the Factor V Leiden mouse may have implications for the prevention and treatment of arterial disease. Because excessive thrombin generation appears to be particularly pathogenic during the later stages of atherosclerosis (when thrombotic complications often occur), it may be hypothesized that such patients could benefit from therapeutic intervention to inhibit thrombin or its generation, restore sensitivity to APC, or enhance fibrinolysis. This hypothesis could be tested initially in the Factor V Leiden mouse and later translated to the clinical setting. As we learn more about the genetic and environmental modifiers of arterial thrombosis, similar approaches could be taken with other risk factors.

## **Diagnostic work-up of patients with inherited thrombosis**

After a few purely acquired causes of thrombosis have been ruled out (eg. vasculitis, lupus anticoagulant), the diagnostic workup of all thrombotic patients should include, in excess of imaging, the Factor V mutation test along with an "inherited hypercoagulability" panel (Lassila 2012). The original APC resistance assay (Dahlbäck, Carlsson et al. 1993) relies on the ability of APC to prolong the aPTT through inactivation of FVa and FVIIIa. Activated protein C ratio (APCr) is the ratio of the clotting times determined in the presence and absence of APC. An APCr below a predefined cut-off value indicates failure of APC to

prolong the clotting time of plasma and consequent APC resistance. Although the aPPT-based assay is sensitive to FVL mutation, it is not specific for this mutation, as several other genetic and acquired conditions may result in a poor APC-response. The Factor V mutation test is accurate regardless of the clinical condition or medication of the patient (Cooper, Goodeve et al. 2012). APC resistance test may provide insight into different mechanisms of APC resistance. Diagnosis of an inherited thrombotic disorder can be made in approximately 50% of all venous thrombosis cases. Any significant association of FVL and arterial thrombosis has not been shown but young patients may have such association.

**How do patients benefit from Factor V mutation testing?**

If the mutation is identified, it may:

- Establish an etiology for an individual's prone to thrombosis
- Identify individuals and families at increased risk for future thrombosis
- Contribute towards prevention of thrombosis by influencing patient management, for example, avoidance of oral contraceptives for individuals with the factor mutation and aggressive anticoagulant therapy after major surgery or trauma.

## **AIM OF STUDIES**

The general aim of the present thesis was to study the impact of Factor V Leiden (a hypercoagulable state) on arterial thrombosis in peripheral vascular patients.

Specific aims were:

- To prospectively assess the prevalence of Factor V Leiden in peripheral vascular patients requiring treatment (**Study I**)
- To prospectively evaluate the impact of Factor V Leiden on the rate of arterial occlusions after peripheral vascular revascularizations. (**Study II**)
- To experimentally study the Factor V Leiden – associated arterial thrombosis in an experimental model of homozygous, heterozygous, and wild-type mice in development of arterial thrombosis. (**Study III**).
- To evaluate the impact of Factor V Leiden on mortality and amputation in patients with Critical Limb Ischemia. (**Study IV**)

## Materials And Methods

The following is a short summary of materials and methods for each paper. Detailed descriptions can be found in each paper (Appendix).

### **Paper I: APC resistance and PVD patients.**

679 patients electively admitted to the vascular ward unit of our tertiary care academic medical center from January 1995 to October 1996 were prospectively analyzed using an APC resistance screening test, as described elsewhere in this thesis, to determine the frequency of abnormal APC ratio ( $\leq 2.6$ ). The Factor V R506Q gene mutation (Leiden) was analyzed in patients with an APC ratio less than 3.0.

#### **Comments:**

This is a prospective study. At the start of our study, there were very limited studies on arterial thrombosis and FVL. Our database was initiated as an effort to prospectively study FVL and arterial thrombosis in our patients. This first study was an attempt to assess the prevalence of APC resistance and FVL in our peripheral vascular patients. Our control group is the already published venous thrombosis study control group from this hospital (Svensson, Zöller et al 1997). To ascertain that these individuals did not have vascular diseases is of course not possible, but at the time of the data collection, none of the control group had a history of vascular disease. Patients were grouped into index peripheral vascular procedures; carotid artery, abdominal aortic aneurysms, aortoiliac occlusive disease, femoropopliteal occlusive disease, venous disease and others. All data was also recorded in the SwedVasc peripheral vascular registry. At the time of this study, patients on warfarin were excluded from the analysis since the APC-ratio analysis kits available could not measure APC-ratio in this group of patients. For a 5% difference in prevalence and 80% power, the material size was determined to be equal to 500 patients; and for a 10% difference, the material size needed to be approximately equal to 100 patients.

The study was not set up to assess other hypercoagulable states in these patients.

### **Paper II: Impact of FV mutation on occlusion of peripheral vascular reconstructions.**

775 patients admitted electively to the vascular unit of Malmö University hospital, Sweden were prospectively analyzed for frequency of FVL and patency of peripheral vascular reconstructions. Postoperative complications and associated risk factors were also analyzed. The patients were grouped into anatomic sites in line with the EuroVasc Report 1997. Operations at different anatomical sites in the same patient were counted separately and analyzed for one month and 12 months patency.

#### **Comments:**

This is a prospective study. The patients were grouped into anatomic sites in line with the EuroVasc Report 1997. Operations at different anatomical sites in the same patient were counted separately and analyzed for one month and 12 months patency. This study was not set up to evaluate the different index procedures in each group separately. To analyze patency can be complex, especially in patients undergoing several procedures over a period of time. We used the criteria used by SwedVasc and primary patency included also the relative small group of assisted primary patency we noted. During the study only carotid reconstructions were of such magnitude that would have allowed a single type of reconstruction to be evaluated. Under other procedures, the procedures were of such mixed anatomic sites to warrant any such analysis.

### **Paper III: Experimental study.**

This is an experimental arterial thrombosis research study. Heterozygous FVL mice were crossbred to C57BL/6J mice over several generations in the animal laboratory at Cleveland Clinic Lerner Research Institute, Cleveland, Ohio, USA. 74 mice of wild-type, heterozygous

and homozygous for Factor V Leiden mutation, were analyzed for arterial thrombosis development after standardized vascular injury. Genotypes of the mice were unknown to the operator prior to experiment. Arterial injury was created in a segment of the common carotid artery with ferric chloride. Time to occlusion (TTO) of the vessel, after reestablishing blood flow, was recorded.

**Comments:**

This study is an experimental model to study FVL-associated arterial thrombosis in wild-type, heterozygous and homozygous FVL mice. This was an effort to minimize the variability that clouds clinical studies of an association between FVL and arterial thrombosis. This model was chosen to lessen the influence of other confounding hypercoagulable states and differences in the flow situation and with an endpoint of arterial thrombosis. During the breeding process, it was observed that there were many stillbirths, although this was not discussed in the paper. It would be interesting to analyze these stillbirths for their genotypes and possible cause of death.

Many experimental techniques have been used for arterial injury and subsequent arterial thrombosis development. All of them have limitations. One such obviously is the lack of arteriosclerosis in the investigated segment. Furthermore, the exposure and procedure may differ slightly between each experimental animal. In this study, importantly, the operator was blinded.

## STUDY III

### Experimental Set-up

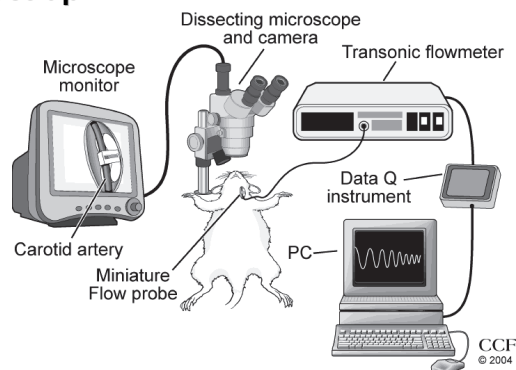

**Paper IV: Critical limb ischemia and FVL and mortality.** During a 12 months period, 259 consecutive patients from the three southmost health care districts in Skåne, Sweden were referred to our vascular diseases department with a confirmed CLI diagnosis. Out of the 259 patients, in total 256 (99%) were screened for APC-resistance with either FV specific APC-ratio (n=247) or specific genetic analysis of the Factor V Leiden mutation (n=204). Blood sampling and analysis of inflammatory mediators were made. One-, 3-, 5-, and 10-year mortality after admission and amputation rate after one year were assessed from hospital files, together with treatment data from the first year after admission.

***Comments:***

This is a prospective study with a long follow-up. Our intention was not only to analyze mortality overall, but also evaluate the reasons for death and frequency of other new major arteriosclerotic events. The declining autopsy rate currently has made analysis of reasons for death uncertain. Initially we also documented major new arterial events but since so many other health facilities were involved without a uniform way for diagnosis, even such records became unreliable.

## **ETHICS**

The clinical studies were approved by the Lund University Ethical Committé and informed consent was obtained as required. The experimental study was reviewed and approved by the Review Board for Animal Research at Cleveland Clinic, Cleveland, Ohio, USA. The care and breeding of animals were according to legislation for animal research.



## STATISTICS

### **Paper I**

The statistical significance of variables between patients with peripheral vascular disease and the Malmö control group was determined with  $\chi$  analysis. Significance was assumed when a  $P$ -value of less than 0.05 was achieved.

### **Paper II**

A comparison within the group was done with a Yates corrected Chi-square test. Significance was assumed when a  $p$ -value of less than 0.05 was achieved. Odds ratio (OR) and 95% confidence interval (CI) were calculated.

### **Paper III**

Differences in the actual versus expected genotype frequencies were assessed with the Chi-square test. The statistical significance of differences in TTO between the various groups was assessed with the Student  $t$ -test to compare two groups and with one-way analysis of variance (followed by pairwise post hoc comparison) when multiple groups were compared. A two-tailed  $p$ -value of less than 0.05 was considered significant.

### **Paper IV**

The comparisons between the groups were performed with the Mann-Whitney  $U$ -test for continuous variables and the  $\chi$  test was used for nominal variables. Results were presented as mean $\pm$ standard deviation.  $P$ -values  $< 0.05$  (2-tailed) were considered as significant. StatView 5.0 (SAS Institute, Cary, NC) was used for statistical calculation.

# RESULTS

## Paper I: The prevalence of Factor V Leiden in peripheral vascular patients.

154 patients (22.7%) of 679 consecutive patients were found to have Factor V mutation or APC-ratio  $\leq 2.6$ , compared with 34 of the 278 (12.2%) Malmö control subjects. Out of this, Factor V Leiden mutation was seen in 102 patients (15.2%), and abnormal APC ratio found in 132 patients (19.8%)(Figure I:1 and 2). Of those that underwent vascular interventions, graft occlusion occurred in 41/679 patients, and 13 (32%) of these had Factor V Leiden gene mutation.

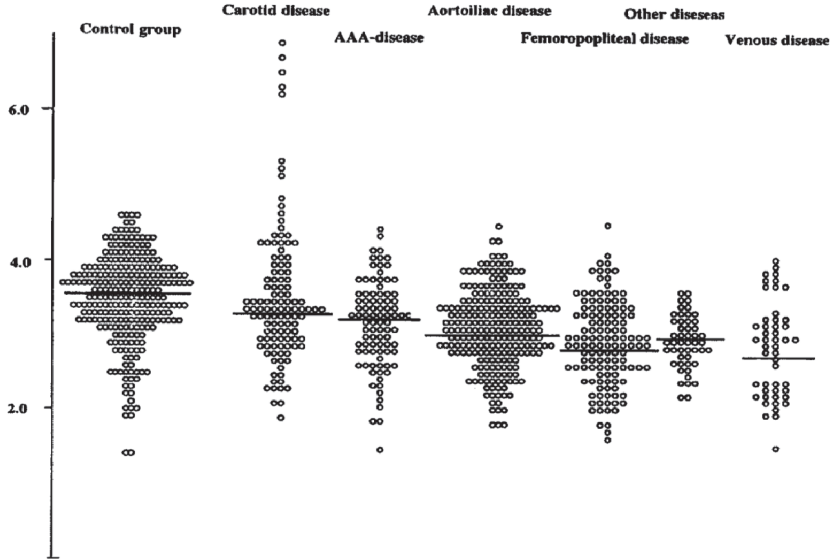
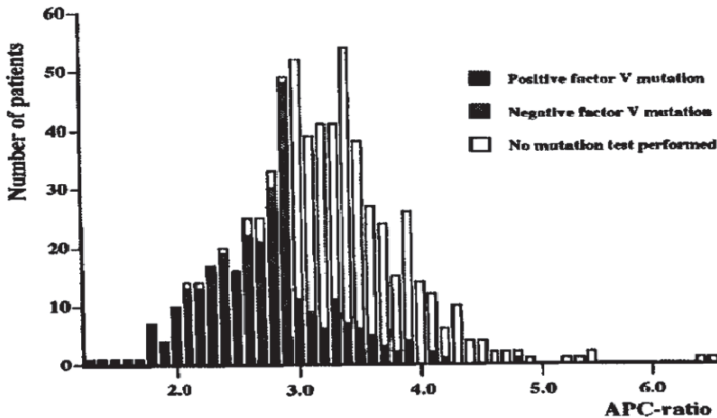

Fig 1. The individual APC ratios and their distribution in the different groups. The line indicates the median value.



**Fig 2.** The distribution of APC ratios and their relation to factor V gene mutation.

### Paper II:: Impact of FVL-mutation on occlusion of peripheral vascular reconstructions.

In this prospective study, 93 (12%) of the 775 patients were heterozygous for FVL. Among the infrainguinal patients frequency of FVL was 16% compared with 10% in the controls (OR 1.60, CI 0.91-2.81). In the 775 reconstructions, postoperative occlusions were more frequent at one month (14% vs 7%;  $p=0.02$ ) in patients with FVL compared with patients without mutation. Infrainguinal reconstructions comparing carriers vs non-carriers showed non-significant but strong tendency toward more occlusions (37% vs 22%  $p=0.15$  and 46% vs 27%  $p=0.09$ ) at one and twelve months respectively.

**Table 4.** Comparison of the occlusion rates of patients with normal Factor V and Factor V-Leiden after peripheral vascular procedures in the different groups.

Type of reconstructions	No. and percentage of occlusions in individuals with Factor V-Leiden at 1 month	No. and percentage of occlusions in individuals with Factor V-Leiden at 1 year	No. and percentage of occlusions in individuals with normal Factor V at 1 month	No. and percentage of occlusions in individuals with normal Factor V at 1 year
Carotis	0/15	1/12 (8%)	1/162 (1%)	2/127 (2%)
AAA	0/17	0/14	2/109 (2%)	2/84 (2%)
Renal artery	0/4	0/3	0/52	1/32 (3%)
Aortoiliac	2/25 (8%)	3/18 (17%)	8/195 (4%)	22/164 (13%)
Infrainguinal	10/27 (37%)	12/26 (46%)	32/145 (22%)	35/129 (27%)
Venous	1/5 (20%)	1/4 (25%)*	3/19 (16%)	4/14 (29%)
Total	13/93 (14%)*	17/77 (22%)*	46/682 (7%)	66/550 (12%)

\*:  $p=0.02$ .

### Paper III: Experimental study.

Genotype analysis of the seventy-four offsprings revealed wild-type 34%, heterozygote 60% and homozygotes 7% for FVL. The TTO differed significantly among the three genotypes ( $p=0.02$ ) (Table III:4). TTO was greatest in the wild-type mice ( $p < 0.001$  vs heterozygous,  $< 0.001$  vs homozygous) and least in the homozygotes ( $p = 0.001$  vs heterozygotes).

There was occlusion of the carotid artery within sixty minutes of injury in 72 of the 74 mice studied. Two wild-type mice remained patent after 60 minutes.

**Paper IV: Critical limb ischemi and FVL and mortality.**

Of the 256 CLI patients, 35 (14 %) were heterozygotes and 2 (1 %) homozygotes for the Factor V gene mutation, whereas 219 (86 %) patients were non-APC resistant. No significant differences were found between APC resistant and non-APC resistant patients regarding inflammatory mediators. Furthermore, there were no significant differences between groups regarding 1-, 3-, 5- or 10-year survival or 1-year amputation rate. Non-APC resistant patients more often had infrainguinal atherosclerosis (172[79 %] vs 22[59 %];  $p=0.017$ ).

## Limitations

The clinical studies are prospectively observational studies. Initially, all the parameters that later became of interest when analyzing results may not have been included. One such limitation can be found in study **IV**, where the reason for death was initially recorded but data was omitted during analysis due to uncertainty of the data. This uncertainty is partly due to the successive decrease in autopsy frequency, which nowadays is very limited.

Another factor to bear in mind when reading this thesis is that this project has been stretched over a long period of time, and includes materials collected many years ago, and since then new pharmacological treatments, environmental factors, change in disease severity of those included may have occurred.

In experimental studies (**III**), the differences between species regarding for example coagulation functions should be taken into consideration and results cautiously interpreted. In our experimental study (**III**), results were obvious and corroborate the fact that Factor V Leiden potentiates arterial thrombosis development. However, in the clinical situation, the importance of having Factor V Leiden is less clear, and there seems to be so many other factors that may have greater impact on arterial disease and thrombosis than FVL per se. Selection bias in the clinical studies (**I, II, IV**) may arise from the fact that not all claudicants may have treatment-requiring vascular disease. It is also possibly that, if all out-patients had also been included in the registry, we could have arrived at different frequencies for APC-resistance. Thus, our found frequencies cannot be generalized to arterial or venous vascular disease cohorts but will only reflect the frequencies of APC-resistance in hospitalized patients, with the criteria for treatment that was used 10-15 years ago. Nevertheless, only small changes in the guidelines for treatment has occurred during that time and current. We have had fairly strict criteria for not recommending to those with infrainguinal arteriosclerotic disease and claudication treatment in excess of optimizing pharmacological therapy.

Likewise, even if we tried to document all patients with critical limb ischemia (**study IV**) and even if our vascular unit is the only referring institution, some patients could have been referred directly to plastic surgery reconstruction for ulcer treatment or to orthopedic department, who happens to be responsible for amputations and care in our health system and would not be included. Moreover, some patients with critical limb ischemia will not seek health care or have other more serious comorbidities, making treatment of limb ischemia a low priority and even questionable and therefore will not be referred.

The control population used in **study I and II** is limited. They did not have symptoms of arteriosclerotic disease at blood sampling, but since arteriosclerosis is a disease everyone will develop it is not possible to obtain a true healthy non-diseased control group. However, several control groups from the city of Malmö show a prevalence of about 10% for APC-resistance. Unpublished data from Malmö Blood Donors comprising over 5.000 individuals are showing the same frequency.

Another limitation with this work is that the laboratory tests for diagnosing APC-resistance has changed. Initially, the APC-ratio was measured with the original method (**Study I**). This means that patients on oral anticoagulants (about 10% of vascular patients) could not be tested. This group only became candidates for testing after DNA-testing for the FVL-gene became possible. However, in **Study I and II**, the study design included DNA-testing on those having low APC-ratios and oral anticoagulant treated patients were not included. Additionally, the APC-ratio test was improved by using Factor Va depleted plasma (**Study II and IV**). In **study IV**, warfarin patients were included with FVL-gene mutation test..

## Discussion

Since the description of a novel defect in the hemostatic pathway in 1993 by Dahlbäck and coinvestigators in Malmö, Sweden, there has been an avalanche of clinical studies to delineate this new phenomenon. This defect was described as a hypercoagulable state, in a hereditary fashion in families with a high incidence of deep venous thrombosis, due to resistance to activated protein C (APC) resistance (Svensson and Dahlbäck 1994). This defect was subsequently found by investigators in Leiden, Netherlands and confirmed by others (Bertina, Koeleman et al. 1994) to be due to a single adenine-for-guanine point mutation in the gene coding for coagulation Factor V. This leads to the replacement of arginine by glutamine at position 506. This mutation became known as Factor V Leiden. Factor V Leiden is now known to be the most common genetic risk factor for coagulation disorders known, albeit, with less penetrance and with substantial geographic variations.

Activated protein C (APC) is the body's own defense against blood coagulation (Dahlbäck 1999). Activated Factor V (FVa) is a procoagulant cofactor which cleaves prothrombin to form thrombin. Through a feedback mechanism thrombin activates protein C to APC which in turn degrades FVa at several positions, one of them being position 506. Due to the mutation at position 506, FVa is only degraded to a limited degree to stop the coagulation reaction. Interestingly, APC has been found to work with a dual mechanism as anticoagulant. APC degrades intact FV to anticoagulant FV (FV<sub>ac</sub>), which in turn functions as a synergistic cofactor to APC and protein S in degradation of FVIIIa. Not only does the degradation of FVIIIa result in anticoagulation, but the amount of FV being converted to procoagulant FVa is also reduced, due to the conversion of intact FV to FV<sub>ac</sub>. Health is a balance between procoagulant and anticoagulant activities. Due to the mutation at 506 position, APC is able to degrade neither FV nor FVa fully resulting in a life-long hypercoagulable state.

### Venous thromboembolism

Venous thromboembolism is a multifactorial disease affecting about 1 in 1000 individuals annually. This is a major health problem world wide. Clinical studies over the last twenty years have established APC resistance due to Factor V mutation as the most prevalent inherited cause of venous thrombosis. In this thesis we have not extensively delved into the association between APC-resistance and venous thrombosis. In **Study I**, a group of 50 patients had treatment for venous disease. This comprises elective patients undergoing venous treatment for varicose veins and venous insufficiency with secondary skin manifestations, and/or chronic venous occlusions treated with endovascular recanalization. The frequency of pathological APC-ratio in this group was high (38%), suggesting that many in this group had earlier venous thrombosis. This, furthermore, adds support to other reports on APC-resistance and its relation to venous thrombosis. Zöller et al (Zöller, Svensson et al. 1994) found 90 % Factor V gene mutation in selected families in Sweden with APC resistance and also high risk of recurrent VTE. In another selected series (Griffin, Evatt et al. 1993) of unexplained juvenile or recurrent thrombosis, the prevalence of resistance to activated protein C was 52% to 64%. In a population-based case-control study (Koster, Rosendaal et al. 1993) of 301 patients below 70 years of age with a first episode of deep venous thrombosis, 21% were found to have resistance to APC compared to 5% of age- and sex-matched controls; yielding an almost seven-fold (matched OR, 6.6) increase in risk for DVT in persons with APC resistance. Furthermore, Bertina and coworkers (Bertina, Koeleman et al. 1994), and confirmed by others (Sun, Evatt et al. 1994; Voorberg, Roelse et al. 1994; Zöller and Dahlbäck 1994; Zöller, Svensson et al. 1994) showed that 80% of APC resistant persons were heterozygous or homozygous for Factor V Leiden mutation. In a large prospective study (Ridker, Hennekens et al. 1995) of apparently healthy 14 916 men, this association was again confirmed, with a prevalence of the mutation 11.6% among men with venous

thromboembolism compared with 6.0% among those who remained healthy, corresponding figures for APC-resistance were 50% versus 7%(Svensson and Dahlbäck 1994).

### Arteriosclerosis and Factor V Leiden

The development of arteriosclerosis is multifactorial with also important environmental factors. For example, while physical activity may delay the progression of arteriosclerosis, smoking may substantially progress it. Although we documented in **study I and II** an overrepresentation of FVL-patients among our arteriosclerotic populations compared to a control population, there were also some differences in frequencies between the carotid group, aortoiliac and femoro-popliteal groups, with somewhat higher prevalence of FVL and APC-resistance in lower extremity arterial occlusive disease. On the other hand, Kiechl et al have reported higher incidence of FVL in carotid patients and even found progression of arteriosclerotic plaque to be more rapid in FVL-individuals. In experimental studies, enhanced arteriosclerosis has been reported (Eitzman, Westrick et al. 2005; Shen, He et al. 2009). However, in most other studies, association between arteriosclerosis and FVL has not been found. The complexity of development of arteriosclerosis makes the association to FVL to be minor, if at all existent. However, after development of arteriosclerosis, FVL may be a factor in developing more frequent and extensive arterial thrombi, arteriosclerotic lesion being a nidus. The higher frequency of APC-resistance in lower extremity arteriosclerotic occlusive disease requiring treatment as seen in **study I and II** may be due to the fact that APC-resistant individuals have longer stenotic lesions with more severe symptoms and requiring treatment.

In patients with venous thromboembolism about 80% of APC-resistance is FVL-positive. In arteriosclerotic cohorts (**study I, II and IV**) we found that two-thirds of pathologic APC-ratios were FVL gene mutation. Thus, more common in arteriosclerotic patients is yet unknown other mechanism causing a hypercoagulable state measured as abnormal APC-ratio. In **study IV**, no relation between high levels of fibrinogen, abnormal APC-ratio and normal FVLtest was noted.



Figure 12: German Physician Rudolf Virchow (1817-1902)

### Arterial thrombosis and Factor V Leiden

Unlike in venous thromboembolism, the impact of APC resistance in arterial thrombosis is yet to be elucidated. Current clinical studies are plagued with generally confusing and contradictory results (Bockholdt and Kramer 2007). In selective clinical and animal studies the association has been confirmed (**study III**), while population and case-control studies have been conflicting (**study I, II, IV**).

Our interest in arterial thrombosis and APC resistance came as a result of the death of a thirty-two year-old APC-resistant patient who died of massive arterial and venous thrombosis in our vascular surgery department, as described in the introduction. It is intriguing that FVL could have such a high impact on venous thromboembolism, but not on arterial thromboembolism. Obviously, hemodynamics in venous and arterial systems are different. Moreover, thromboembolism is also a typical

multifactorial disease. Virchow (Figure 12) postulated in his triad, in as far back as 1856, three broad categories of factors contributing to venous thrombosis and pulmonary embolism, including hypercoagulability, hemodynamic changes (stasis, turbulence) and endothelial injury/dysfunction. Although Virchow's concept originally relates to venous thrombus, it holds true today for both arterial and venous thromboembolism. With our current knowledge of thrombosis, Virchow's triad can simply be called multifactorial, including genetics, age, immobilization, surgery, trauma, pregnancy, oral contraceptives, hormone replacement, and inflammatory conditions. While arterial system is a high flow system, the venous system is a low flow system which makes it prone to thrombosis. However, arterial thrombosis occurs mostly in smaller (Lassila 2012) or stenotic vessels where there's reduced arterial blood flow. The smaller vessels are located mostly in peripheral arteries and in organs like the brain, heart, retina etc. Importantly, the concentration of thrombomodulin, which is of vital importance for protein C activation, varies from 0.15 nM in large vasculature to 500 nM in the microvasculature (Esmon 1989), the latter being the vessels where the majority of blood coagulation/haemostasis takes place, thereby locating protein C activation to the sites of where active coagulation occurs (Cramer and Gale 2012).

Casas and coworkers (Casas, Hingorani et al. 2004) in their large meta-analysis of 19 studies and Weischer et al (Weischer, Juul et al. 2010) in their population study of 9231 of ischemic stroke patients concluded that FVL is not associated with ischemic stroke and additionally they state that there's a genetic component to common stroke but failed to find a single gene with a major effect and suggested a synergistic effect of several gene variants, each exerting a modest effect, contributing to stroke. Likewise, in study **I**, **II** and **IV**, we didn't find a higher rate of previous stroke in APC-resistant individuals.

However, a recent meta analysis (Hamedani, Cole et al. 2010) of 18 case-control studies of ischemic stroke in adults  $\leq 50$  years of age, association between young individuals suffering from stroke and FVL was found. Similarly, recent studies from Israel, Portugal, Lebanon and Turkey have revealed a strong association between Factor V Leiden and arterial ischemic stroke in pediatric patients (Kenet, Sadetzki et al. 2000; Barreirinho, Ferro et al. 2003; Duran, Biner et al. 2005; Muwakkit, Majdalani et al. 2011).

Numerous studies have investigated the relationship between the FVL mutation and risk of myocardial infarction with again conflicting results. Boekholdt et al, in a meta-analysis from 2001 (Boekholdt, Bijsterveld et al. 2001), including six studies that were reviewed, showed weak or absent significance, but when studies investigating patients with myocardial infarction before age 55 were included, a significance of Factor V Leiden was shown. In large studies including Physicians' Health Study, Cardiovascular Health Study and Copenhagen Heart Study, FVL carriership was not found to be associated with an increased risk of myocardial infarction. This is in agreement with the frequencies of previous myocardial infarction seen in our study **I**, **II**, and **IV** which were the same in APC-resistant and non-APC-resistant patients. Also younger individuals with myocardial infarction do not have a clear association with FVL, and in a meta-analysis it was estimated that FVL carriers had an odds ratio of 1.3 (95%CI, 0.9 to 1.9) of developing myocardial infarction before the age of 55 years (Juul, Tybjaerg-Hansen et al. 2002). Importantly, several studies have suggested that FVL may indeed be a major risk factor in rare cases when myocardial infarction occurs in people without evidence of atherosclerosis (Boekholdt and Kramer 2007). An interaction between smoking and the FVL mutation in young women with stroke has been reported, a finding that is consistent with findings in the field of myocardial infarction (Lalouschek, Schillinger et al. 2005).

During last 15 years, numerous case reports of FVL patients with severe arterial thrombotic events have been published. There are relatively few large studies involving FVL and PAD. Initial studies in this selected group of patients (Ouriel, Green et al. 1996; Donaldson, Belkin



et al. 1997) found that activated protein C resistance was more prevalent in patients with PAD, and an even higher incidence in those patients presenting with graft occlusion following infrainguinal bypass. Recently, studies involving peripheral vascular patients have found very high prevalence of FVL and APC resistance in this patient population. This is in accordance with results from our studies (Study I, II and IV) where we showed a high prevalence of APC resistance and Factor V Leiden in patients with limb ischemia. The increased risk of occlusion of graft reconstructions reported above (Doanldsson et al, Ouriel et al) is further documented in our analysis of a reasonable large cohort of vascular reconstructions (study II), where about a two-fold increased risk for occlusion was noted for APC-resistant patients. In a meta-analysis (Vig, Chitolie et al. 2004) on available data on the prevalence of thrombophilia defects in patients with peripheral vascular disease and failure of vascular interventions, it was suggested that the risk of occlusion following arterial revascularization in patients with an identified thrombophilia defect appears to be almost three times that of patients with no evidence of a thrombophilia defect. However, conflicting data from clinical reports exist. Cushman and coinvestigators (Cushman, Rosendaal et al. 1998) did not find increased risk of future arterial thrombosis in adults with FVL. Sartori and coworkers (Sartori, Conti et al. 2011) recently found that the presence of multiple thrombophilic alterations in patients who underwent PTA for PAD was associated with increased risk of arterial thrombotic events, whereas each single thrombophilic alteration was not. Animal studies (Eitzman, Westrick et al. 2005) have also revealed synergistic contribution of vascular injury to penetrance of FVL in development of arterial thrombosis. This association was further verified in our experimental study (Study III), which showed increased arterial thrombosis in the presence of Factor V Leiden in injured arterial segment compared to normal factor V.

Kiechl and coinvestigators (Kiechl, Muigg et al. 1999) suggested an independent and gradual association between low response to APC and both advanced atherosclerosis (stenosis) and arterial disease, suggesting FVL being only one aspect of this relationship. High plasma homocysteine (Taylor, Moneta et al. 1999; de Jong 2001) levels are associated with fatal and non-fatal cardiovascular events and are a modest predictor of both coronary artery disease, stroke, and symptomatic peripheral vascular disease. In addition, hyperhomocysteinemia increases the mortality risk of patients with peripheral vascular disease (de Jong 2001; Taute, Taute et al. 2004). Hyperhomocysteinemia and FVL disorder are also both associated with thromboembolism, with a synergistic increase in hypercoagulability when present in the same patient. A prospective study (Ridker, Hennekens et al. 1997) of 800 men followed for 10 years demonstrated a relative risk of venous thromboembolism (VTE) of 3.6 for FVL patients, 3.4 for patients with hyperhomocysteinemia, and 21.8 for those carrying both traits. The risk for arterial thrombosis was not studied. In study IV, we could not document any difference in levels of homocysteine between FVL patients and non-carriers, neither did we find decreased mortality in those having FVL and increased levels of homocysteine. However, this study was not designed for such analysis and number of patients did not allow for such an evaluation statistically. The mechanism of the relationship between hyperhomocysteinemia and thrombosis is not yet elucidated, although apparent. Hypotheses include smooth muscle cell proliferation, oxidative stress, nitric oxide suppression, and increased leukocyte recruitment. Among the many pathways homocysteine appears to affect, one of the most prominent is stimulation of the prothrombotic capacity of Factor V. Thus, people with FVL have diminished ability to regulate Factor Va and thus may be particularly vulnerable to high serum homocysteine levels synergically. In addition, the role of homocysteine-induced endothelial damage in localized areas of peripheral arterial disease, may serve as the nidus for arterial thrombi.

The Factor V gene is expressed co-dominantly. From 90% to 95% of people with the FVL mutation are heterozygotes; the remainder are homozygotes and constitute most of the recognized clinical cases. Data from the Leiden Thrombophilia Study demonstrated that FVL patients have an overall 6.6-fold increased risk of thrombosis compared with the general population, with homozygotes having significantly increased risk compared to heterozygotes. None of these studies looked at arterial thrombosis, however, since FVL seems to be a much less potent factor such an analysis would have required much larger cohorts to be worthwhile. FVL is thought to be the most commonly inherited hypercoagulable disorder. The next most prevalent disorder, protein C deficiency, is less than half as common as FVL, occurring in an estimated one in 200 people. Other thrombophilic disorders include antithrombin III deficiency, which occurs in an estimated one in 300 people, and protein S deficiency, which occurs in 0.13% of the population. Despite greater prevalence, however, the risk of thrombosis as a result of FVL is much smaller than the risk associated with other inherited thrombophilias. In an Italian study (Martinelli, Mannucci et al. 1998), the lifetime relative risk of a venous or arterial thrombotic event, compared with the general population, was only increased 2.2-fold for FVL patients. The same risk for patients with protein C deficiency was increased 7.3-fold, for antithrombin deficiency patients 8.1-fold, and for those with protein S deficiency, the increased risk was 8.5-fold. Recent studies have begun to demonstrate an inter-relationship among these conditions. For example, a study of families with protein S deficiency found that 39% of subjects also carried the FVL mutation (Zöller, Berntsdotter et al. 1995). In another study, 18 of 128 families (15%) with antithrombin deficiency were also FVL carriers (van Boven, Reitsma et al. 1996). From a clinical standpoint, however, patients diagnosed with one thrombophilic defect clearly have greater risk for carrying a second.

The Prothrombin G20210A variant is found to be the second most common hereditary thrombophilic defect found in patients with VTE (Ranguelov, Rosenthal et al. 2002). Heterozygotes for G20210A increase the levels of prothrombin in plasma approximately 25%, a change presumably responsible for the propensity to develop VTE (Poort, Rosendaal et al. 1996; Franco and Reitsma 2001). Weisher et al found an increased risk of ischemic heart disease in individuals with Prothrombin G20210A alone or in combination with FVL. This is in support of earlier reports of increased risk of ischemic heart disease in Prothrombin G20210A heterozygotes alone versus non-carriers. The mechanism of interaction between Prothrombin G20210A and FVL in increased thromboembolism may be found in increased thrombin generation in G20210A and increased conversion of FV to FVa.

The lifetime risk for venous thromboembolism among unselected persons is lower than the population prevalence of the Factor V Leiden mutation. Thus, screening programs for primary prevention are likely to be inefficient. In fact, if persons found to carry the mutation are subsequently advised to use long-term anticoagulant therapy, screening intended for primary prevention could result in a net clinical hazard because the lifetime risks of anticoagulation are substantial.

In contrast, screening for Factor V Leiden mutation may prove effective among patients who have had a first episode of venous thromboembolism since they have a substantial risk for recurrence. In accordance with primary prevention discussion, it is unlikely that screening before surgery is warranted, particularly because adequate thromboprophylaxis in the postoperative period reduces risks in most patients regardless of Factor V Leiden status. Acquired risk factors, such as surgery, trauma, immobilization, pregnancy, and oral contraceptives can trigger thrombosis in patients who are heterozygous for protein C, protein S, or antithrombin III deficiency, as well as in patients with Factor V Leiden. Our studies (Study I-III) have shown the synergistic effect of vascular injuries on FVL in development of arterial thrombosis. This synergistic effect has also been revealed in patients homozygous for homocystinuria who have factor V Leiden (Di Minno, Tufano et al.

2012). High concentrations of homocysteine can induce the activation of factor V in endothelial cells and inhibit the activation of protein C, compromising a major mechanism by which blood coagulation is controlled. The increased tendency to thrombosis in patients with the combination of homocystinuria and Factor V Leiden could result from an additive adverse effect of these two defects on a common protective mechanism in the coagulation cascade.

These observations suggest that additional contributing factors may be needed for thrombosis to occur. These observations also imply that a search for other hereditary thrombotic disorders should be conducted in patients who are found to carry mutant genes predisposing them to thrombosis. Patients with more than one mutation should be evaluated carefully before they undergo surgical, medical, or obstetrical procedures that carry an increased thrombotic risk, since they may require regimens of appropriate prophylactic anticoagulant therapy.

## **CONCLUSIONS**

Resistance to activated protein C or Factor V Leiden mutation is more prevalent in patients with peripheral vascular diseases than the general population.

FVL increases about two-fold the risk for occlusions of vascular reconstructions.

Experimentally, FVL enhances arterial thrombosis development after vessel wall injury.

No difference in long-term (10 years) mortality or one-year amputation rate is seen between FVL-positive and FVL-normal patients with critical limb ischemia.

## **FUTURE CONSIDERATIONS**

Obviously, there's need for further knowledge about APC-resistance and Factor V Leiden in patients with arteriosclerosis, acute and chronic arterial ischemia and patency of arterial reconstructions. From current knowledge, APC-resistance and Factor V Leiden may have an impact also on arterial disease, but further trials are needed for further delineation of these risks. For example, that arterial reconstructions have a two-fold risk of occlusion in FVL patients is only shown in a few studies, while studies involving recent new procedures, as well as multicenter studies are lacking.

Currently, about 20-40% of APC resistant individuals do not have FVL. This group seems to be larger in patient cohorts having arteriosclerosis. This suggests that there may be other causes of APC-resistance besides FVL. Further studies to elucidate the mechanism of, so called, "functional" APC resistance in causing hypercoagulability is needed. High levels of fibrinogen is one such factor that has been discussed, however, data are not entirely supportive.

Future studies on thrombophilia and arterial thrombosis should be geared towards selected populations according to race and geographic areas, vascular disease patients including venous thrombosis patients, as well as referral patients.

Clinical trials designed to evaluate the benefit-to-risk ratio of factor V Leiden mutation screening in patients with risk of venous thromboembolism and subsequent long-term anticoagulation are needed. Thus, until clinical trials showing efficacy of long-term therapy are undertaken, screening for the factor V Leiden mutation is likely to remain clinically important for persons with a family or personal history of thrombophilia. In this group, knowledge of factor V Leiden mutation status may be particularly useful if the affected person or family member is found to be homozygous.

# POPULÄRVETENSKAPLIG SAMMANFATTNING PÅ SVENSKA

## (Comprehensive summary in Swedish)

Vi människor har förmågan att levra blodet i anslutning till skadade kärlområden. Detta gör att vi inte förblöder vid traumatiska kärlskador. Blodlevringsförmågan är komplex och beroende på samspel mellan skadad kärlvägg och blodet. Självklart kan kärlväggen skadas även av annat än trauma och blodet kan levra sig och ge blodproppsbildning. I åldrandets sjukdomspanorama är många sjukdomar förorsakade av sådan oönskad blodproppsbildning både i artärer – de blodkärl som leder det syresatta, näringsrika blodet ut från hjärtat, liksom i vener -de kärl som för blodet tillbaka till hjärtat.

Balansen mellan att ha god levringsförmåga vid kärlskada men undvika proppbildning på skadade kärl är mycket delikat. På artärsidan ger åderförkalkning skador på kärlväggen med risk för hjärtinfarkt, slaganfall och nedsatt blodcirkulation till olika organ och till benen. På vensidan ses blodproppsbildning efter operation, och vid vissa svåra sjukdomstillstånd. Det förekommer också blodproppar utan säker orsak. Olika förändringar i blodets levrings- och proppbildande förmåga har delvis kartlagts. Vid vårt sjukhus fann man en sådan förändring – så kallad APC-resistans för cirka 20 år sedan. Denna faktor är den vanligaste orsaken till blodproppsbildning inom venösa kärl som vi känner till. Den ses ofta i familjer och den genetiska defekten benämner man Faktor V Leiden som nästan var tioende svensk har. Denna defekt påverkar egentligen inte blodlevringsförmågan utan mer kroppens förmåga att inte bygga större blodlever eller blodpropp än vad som är nödvändigt inom kärlskadat område. Vår förmåga att stoppa bildandet av blodpropp så att denna inte även bildas där blodkärlet är friskt är nedsatt. Riskökningen är marginell i vardagssituationen men vid sjukdom eller trauma kan den vara av betydelse.

Man har under dessa tjugo år lärt sig ganska mycket om denna APC-resistans vid venös blodproppsbildning. Man har också undersökt om artärbloodproppsbildning är lika starkt kopplat till denna defekt. Eftersom frekvensen av APC-resistans varierar i olika folkgrupper har resultaten av andra studier inte varit samstämmiga. Denna avhandling visar en del av de undersökningar som har bedrivits för att kartlägga betydelsen av APC-resistans vid arteriell kärlsjukdom.

I det första delarbetet undersöktes patienter som hade behandlingskrävande kärlsjukdom. Av de 679 undersökta hade 23% APC-resistans och den genetiska defekten Faktor V Leiden sågs hos 15%. Resultaten visade även att kärlocclusion (igenproppning av behandlat kärlområde) efter kärlkirurgisk behandlingsåtgärd sågs oftare hos APC-resistenta.

I det andra delarbetet studeras 775 kärlbehandlingar och efter ett år hade 14% av de APC-resistenta jämfört med 7% hos de som ej var APC-resistenta proppat igen det behandlade området.

Dessa studier talar för något ökad risk för de som har APC-resistans eller Faktor V Leiden att utveckla behandlingskrävande artärsjukdom och att få sin kärlåtgärd igenproppad. Denna riskökning var dock mycket lägre än den som ses vid venös blodproppsbildning. I delarbete tre studeras om risken för artär-bloodproppsbildning var ökad. I en experimentell modell på möss med eller utan den genetiska defekten för Faktor V Leiden studerades artärens

blodproppsbildning. En från kärlet utsida åsamkad kärlskada på halspulsådern proppades igen väsentligt snabbare på möss med den genetiska defekten.

I det sista arbetet avsågs att studera betydelsen av Faktor V Leiden hos patienter med mycket starkt nedsatt blodcirkulation till benen så att till och med risk för amputation förelåg. Kunde man i denna mycket svårt sjuka grupp se om dödlighet eller risk för amputation påverkades? Av de 256 undersökta patienterna hade 15% Faktor V Leiden mutationen. Hos dessa 15% påverkades ej vare sig nödvändigheten av amputation vid ett års uppföljning eller dödlighet upp till tio år efter behandling.

Sammanfattningsvis har denna avhandling påvisat en något ökad förekomst av APC-resistans eller Faktor V Leiden-mutationen hos patienter med behandlingskrävande kärlsjukdom, det förelåg även en dubblad risk för att kärlbehandlingen proppar igen inom ett år efter åtgärd. Till yttermera visso bekräftas att den genetiska defekten, i en experimentell studie på möss, påskyndar blodproppsbildning i skadad artär. Emellertid, dessa riskökningar med APC-resistans eller Faktor V Leiden avspeglas ej i resultaten hos starkt kärlsjuka patienter, där risken för amputation eller överlevnad inte var förändrad. Även om risken finns där ger Faktor V Leiden mutationen nog endast en liten riskökning och många andra riskfaktorer dominerar.

## **Acknowledgements**

I wish to express my heartfelt gratitude to all who one way or the other helped in accomplishment of this thesis:

**Bengt Lindblad, MD, PhD.** Bengt and I have known each other over the last 16 years, when I first approached him about doing research. He didn't hesitate and the rest is many years of his unflinching support and guidance. Bengt has become a friend, a mentor and a teacher to me. Retirement this year did not dissuade him from his commitment and support. Thanks for your invaluable friendship and guidance over the years.

**Kenneth Ouriel, MD.** Former Chairman, Division of Surgery, Cleveland Clinic, Ohio and former Vice President, New York Presbyterian Hospital, NY, for accepting me to the Cleveland Clinic for my PostDoc, and for his mentorship and friendship.

**Peter Svensson, MD, PhD,** for graciously accepting to become my supervisor when Bengt went into retirement this year.

**Björn Dahlbäck, MD, PhD,** for his constructive criticisms for my first paper many years ago, and now allowing me to use his diagrams in this thesis.

**My family:** my lovely wife, Lene, and our two wonderful children, Daniella and Patrick, for their love, patience, support and sacrifices. You are my light.

**My mother,** Amelia, for instilling in me early the importance of education, and her sacrifices, despite not having been to school herself. All I am and hope to be, I owe you my angel mum. May you Rest In Peace.

Last but not the least, my brothers and sisters, my extended family and friends, for being there for me over the years with love, patience and sacrifices.



## References

- (1974). "Surgically confirmed gallbladder disease, venous thromboembolism, and breast tumors in relation to postmenopausal estrogen therapy. A report from the Boston Collaborative Drug Surveillance Program, Boston University Medical Center." N Engl J Med**290**(1): 15-19.
- (1995). "Venous thromboembolic disease and combined oral contraceptives: results of international multicentre case-control study. World Health Organization Collaborative Study of Cardiovascular Disease and Steroid Hormone Contraception." Lancet**346**(8990): 1575-1582.
- (2003). "No evidence of association between prothrombotic gene polymorphisms and the development of acute myocardial infarction at a young age." Circulation**107**(8): 1117-1122.
- Acosta, S. and M. Björck (2003). "Acute thrombo-embolic occlusion of the superior mesenteric artery: a prospective study in a well defined population." Eur J Vasc Endovasc Surg**26**(2): 179-183.
- Aparicio, C. and B. Dahlbäck (1996). "Molecular mechanisms of activated protein C resistance. Properties of factor V isolated from an individual with homozygosity for the Arg506 to Gln mutation in the factor V gene." Biochem J**313** ( Pt 2): 467-472.
- Aznar, J., Y. Mira, et al. (2004). "Factor V Leiden and prothrombin G20210A mutations in young adults with cryptogenic ischemic stroke." Thromb Haemost**91**(5): 1031-1034.
- Barreirinho, S., A. Ferro, et al. (2003). "Inherited and acquired risk factors and their combined effects in pediatric stroke." Pediatr Neurol**28**(2): 134-138.
- Bergensfeldt, M., P. J. Svensson, et al. (1999). "Mesenteric vein thrombosis due to factor V Leiden gene mutation." Br J Surg**86**(8): 1059-1062.
- Bertina, R. M., B. P. Koeleman, et al. (1994). "Mutation in blood coagulation factor V associated with resistance to activated protein C." Nature**369**(6475): 64-67.
- Boekholdt, S. M., N. R. Bijsterveld, et al. (2001). "Genetic variation in coagulation and fibrinolytic proteins and their relation with acute myocardial infarction: a systematic review." Circulation**104**(25): 3063-3068.
- Boekholdt, S. M. and M. H. Kramer (2007). "Arterial thrombosis and the role of thrombophilia." Semin Thromb Hemost**33**(6): 588-596.
- Bohm, G. and H. Al-Khaffaf (2003). "Thrombophilia and arterial disease. An up-to-date review of the literature for the vascular surgeon." Int Angiol**22**(2): 116-124.
- Bokarewa, M. I., K. Bremme, et al. (1996). "Arg506-Gln mutation in factor V and risk of thrombosis during pregnancy." Br J Haematol**92**(2): 473-478.
- Burkitt, D. P. (1972). "Varicose veins, deep vein thrombosis, and haemorrhoids: epidemiology and suggested aetiology." Br Med J**2**(5813): 556-561.
- Casas, J. P., A. D. Hingorani, et al. (2004). "Meta-analysis of genetic studies in ischemic stroke: thirty-two genes involving approximately 18,000 cases and 58,000 controls." Arch Neurol**61**(11): 1652-1661.
- Cooper, P. C., A. C. Goodeve, et al. (2012). "Quality in molecular biology testing for inherited thrombophilia disorders." Semin Thromb Hemost**38**(6): 600-612.
- Cramer, T. J. and A. J. Gale (2012). "The anticoagulant function of coagulation factor V." Thromb Haemost**107**(1): 15-21.
- Cui, J., D. T. Eitzman, et al. (2000). "Spontaneous thrombosis in mice carrying the factor V Leiden mutation." Blood**96**(13): 4222-4226.
- Cumming, A. M., R. C. Tait, et al. (1995). "Development of resistance to activated protein C during pregnancy." Br J Haematol**90**(3): 725-727.

- Cushman, M., F. R. Rosendaal, et al. (1998). "Factor V Leiden is not a risk factor for arterial vascular disease in the elderly: results from the Cardiovascular Health Study." Thromb Haemost**79**(5): 912-915.
- Dahlbäck, B. (1999). "Procoagulant and anticoagulant properties of coagulation factor V: factor V Leiden (APC resistance) causes hypercoagulability by dual mechanisms." J Lab Clin Med**133**(5): 415-422.
- Dahlbäck, B., M. Carlsson, et al. (1993). "Familial thrombophilia due to a previously unrecognized mechanism characterized by poor anticoagulant response to activated protein C: prediction of a cofactor to activated protein C." Proc Natl Acad Sci U S A**90**(3): 1004-1008.
- Daly, E., M. P. Vessey, et al. (1996). "Risk of venous thromboembolism in users of hormone replacement therapy." Lancet**348**(9033): 977-980.
- Davie, E. W. (1995). "Biochemical and molecular aspects of the coagulation cascade." Thromb Haemost**74**(1): 1-6.
- de Jong, S. (2001). "Hyperhomocysteinaemia in patients with peripheral arterial occlusive disease." Clin Chem Lab Med**39**(8): 714-716.
- de Moerloose, P. and F. Boehlen (2007). "Inherited thrombophilia in arterial disease: a selective review." Semin Hematol**44**(2): 106-113.
- Desmarais, S., P. de Moerloose, et al. (1996). "Resistance to activated protein C in an unselected population of patients with pulmonary embolism." Lancet**347**(9012): 1374-1375.
- Devor, M., E. Barrett-Connor, et al. (1992). "Estrogen replacement therapy and the risk of venous thrombosis." Am J Med**92**(3): 275-282.
- Di Minno, M. N., A. Tufano, et al. (2012). "Identifying high-risk individuals for cardiovascular disease: similarities between venous and arterial thrombosis in perspective. A 2011 update." Intern Emerg Med**7**(1): 9-13.
- Donaldson, M. C., M. Belkin, et al. (1997). "Impact of activated protein C resistance on general vascular surgical patients." J Vasc Surg**25**(6): 1054-1060.
- Duran, R., B. Biner, et al. (2005). "Factor V Leiden mutation and other thrombophilia markers in childhood ischemic stroke." Clin Appl Thromb Hemost**11**(1): 83-88.
- Eitzman, D. T., R. J. Westrick, et al. (2005). "Homozygosity for factor V Leiden leads to enhanced thrombosis and atherosclerosis in mice." Circulation**111**(14): 1822-1825.
- Emmerich, J., F. R. Rosendaal, et al. (2001). "Combined effect of factor V Leiden and prothrombin 20210A on the risk of venous thromboembolism--pooled analysis of 8 case-control studies including 2310 cases and 3204 controls. Study Group for Pooled-Analysis in Venous Thromboembolism." Thromb Haemost**86**(3): 809-816.
- Esmon, C. T. (1989). "The roles of protein C and thrombomodulin in the regulation of blood coagulation." J Biol Chem**264**(9): 4743-4746.
- Esmon, C. T. (1995). "Thrombomodulin as a model of molecular mechanisms that modulate protease specificity and function at the vessel surface." FASEB J**9**(10): 946-955.
- Franco, R. F. and P. H. Reitsma (2001). "Genetic risk factors of venous thrombosis." Hum Genet**109**(4): 369-384.
- Fujimura, H., J. Kambayash, et al. (1995). "Coagulation factor V Leiden mutation may have a racial background." Thromb Haemost**74**(5): 1381-1382.
- Gandrille, S., J. S. Greengard, et al. (1995). "Incidence of activated protein C resistance caused by the ARG 506 GLN mutation in factor V in 113 unrelated symptomatic protein C-deficient patients. The French Network on the behalf of INSERM." Blood**86**(1): 219-224.
- Griffin, J. H., B. Evatt, et al. (1993). "Anticoagulant protein C pathway defective in majority of thrombophilic patients." Blood**82**(7): 1989-1993.

- Grodstein, F., M. J. Stampfer, et al. (1996). "Prospective study of exogenous hormones and risk of pulmonary embolism in women." Lancet**348**(9033): 983-987.
- Haapaniemi, E., J. Helenius, et al. (2009). "Ischaemic stroke patients with heterozygous factor V Leiden present with multiple brain infarctions and widespread atherothrombotic disease." Thromb Haemost**101**(1): 145-150.
- Hamedani, A. G., J. W. Cole, et al. (2010). "Meta-analysis of factor V Leiden and ischemic stroke in young adults: the importance of case ascertainment." Stroke**41**(8): 1599-1603.
- Hankey, G. J., J. W. Eikelboom, et al. (2001). "Inherited thrombophilia in ischemic stroke and its pathogenic subtypes." Stroke**32**(8): 1793-1799.
- Heeb, M. J., Y. Kojima, et al. (1995). "Activated protein C resistance: molecular mechanisms based on studies using purified Gln506-factor V." Blood**85**(12): 3405-3411.
- Hellgren, M., P. J. Svensson, et al. (1995). "Resistance to activated protein C as a basis for venous thromboembolism associated with pregnancy and oral contraceptives." Am J Obstet Gynecol**173**(1): 210-213.
- Hirsch, D. R., K. M. Mikkola, et al. (1996). "Pulmonary embolism and deep venous thrombosis during pregnancy or oral contraceptive use: prevalence of factor V Leiden." Am Heart J**131**(6): 1145-1148.
- Ho, W. K., G. J. Hankey, et al. (2006). "Risk of recurrent venous thromboembolism in patients with common thrombophilia: a systematic review." Arch Intern Med**166**(7): 729-736.
- Holm, J., B. Zöller, et al. (1996). "Prevalence of factor V gene mutation amongst myocardial infarction patients and healthy controls is higher in Sweden than in other countries." J Intern Med**239**(3): 221-226.
- Hooper, W. C. and C. De Staercke (2002). "The relationship between FV Leiden and pulmonary embolism." Respir Res**3**: 8.
- Isma, N., P. J. Svensson, et al. (2009). "Prospective analysis of risk factors and distribution of venous thromboembolism in the population-based Malmo Thrombophilia Study (MATS)." Thromb Res**124**(6): 663-666.
- Jick, H., L. E. Derby, et al. (1996). "Risk of hospital admission for idiopathic venous thromboembolism among users of postmenopausal oestrogens." Lancet**348**(9033): 981-983.
- Juul, K., A. Tybjaerg-Hansen, et al. (2002). "Factor V Leiden: The Copenhagen City Heart Study and 2 meta-analyses." Blood**100**(1): 3-10.
- Kalafatis, M., R. M. Bertina, et al. (1995). "Characterization of the molecular defect in factor VR506Q." J Biol Chem**270**(8): 4053-4057.
- Kane, W. H. and E. W. Davie (1988). "Blood coagulation factors V and VIII: structural and functional similarities and their relationship to hemorrhagic and thrombotic disorders." Blood**71**(3): 539-555.
- Kenet, G., S. Sadetzki, et al. (2000). "Factor V Leiden and antiphospholipid antibodies are significant risk factors for ischemic stroke in children." Stroke**31**(6): 1283-1288.
- Kiechl, S., A. Muigg, et al. (1999). "Poor response to activated protein C as a prominent risk predictor of advanced atherosclerosis and arterial disease." Circulation**99**(5): 614-619.
- Koeleman, B. P., P. H. Reitsma, et al. (1994). "Activated protein C resistance as an additional risk factor for thrombosis in protein C-deficient families." Blood**84**(4): 1031-1035.
- Koeleman, B. P., D. van Rump, et al. (1995). "Factor V Leiden: an additional risk factor for thrombosis in protein S deficient families?" Thromb Haemost**74**(2): 580-583.
- Kontula, K., A. Ylikorkala, et al. (1995). "Arg506Gln factor V mutation (factor V Leiden) in patients with ischaemic cerebrovascular disease and survivors of myocardial infarction." Thromb Haemost**73**(4): 558-560.

- Koster, T., F. R. Rosendaal, et al. (1993). "Venous thrombosis due to poor anticoagulant response to activated protein C: Leiden Thrombophilia Study." *Lancet***342**(8886-8887): 1503-1506.
- Lalouschek, W., M. Schillinger, et al. (2005). "Matched case-control study on factor V Leiden and the prothrombin G20210A mutation in patients with ischemic stroke/transient ischemic attack up to the age of 60 years." *Stroke***36**(7): 1405-1409.
- Landi, G., E. Cella, et al. (1996). "Arg506Gln factor V mutation and cerebral ischemia in the young." *Stroke***27**(9): 1697-1698.
- Lassila, R. (2012). "Role and management of coagulation disorders in peripheral arterial disease." *Scand J Surg***101**(2): 94-99.
- Lindblad, B., P. J. Svensson, et al. (1994). "Arterial and venous thromboembolism with fatal outcome and resistance to activated protein C." *Lancet***343**(8902): 917.
- Lindqvist, P. G., P. J. Svensson, et al. (1998). "Factor V Q506 mutation (activated protein C resistance) associated with reduced intrapartum blood loss--a possible evolutionary selection mechanism." *Thromb Haemost***79**(1): 69-73.
- Longstreth, W. T., Jr., F. R. Rosendaal, et al. (1998). "Risk of stroke in young women and two prothrombotic mutations: factor V Leiden and prothrombin gene variant (G20210A)." *Stroke***29**(3): 577-580.
- Madonna, P., V. de Stefano, et al. (2002). "Hyperhomocysteinemia and other inherited prothrombotic conditions in young adults with a history of ischemic stroke." *Stroke***33**(1): 51-56.
- Makelburg, A. B., N. J. Veeger, et al. (2010). "Different risk of deep vein thrombosis and pulmonary embolism in carriers with factor V Leiden compared with non-carriers, but not in other thrombophilic defects. Results from a large retrospective family cohort study." *Haematologica***95**(6): 1030-1033.
- Mannucci, P. M., F. Duca, et al. (1996). "Frequency of factor V Arg506 Gln in Italians." *Thromb Haemost***75**(4): 694.
- Mansourati, J., A. Da Costa, et al. (2000). "Prevalence of factor V Leiden in patients with myocardial infarction and normal coronary angiography." *Thromb Haemost***83**(6): 822-825.
- Manten, B., R. G. Westendorp, et al. (1996). "Risk factor profiles in patients with different clinical manifestations of venous thromboembolism: a focus on the factor V Leiden mutation." *Thromb Haemost***76**(4): 510-513.
- Marchiori, A., L. Mosena, et al. (2007). "The risk of recurrent venous thromboembolism among heterozygous carriers of factor V Leiden or prothrombin G20210A mutation. A systematic review of prospective studies." *Haematologica***92**(8): 1107-1114.
- Martinelli, I., T. Battaglioli, et al. (2007). "Type and location of venous thromboembolism in patients with factor V Leiden or prothrombin G20210A and in those with no thrombophilia." *J Thromb Haemost***5**(1): 98-101.
- Martinelli, I., M. Cattaneo, et al. (1997). "Low prevalence of factor V:Q506 in 41 patients with isolated pulmonary embolism." *Thromb Haemost***77**(3): 440-443.
- Martinelli, I., P. M. Mannucci, et al. (1998). "Different risks of thrombosis in four coagulation defects associated with inherited thrombophilia: a study of 150 families." *Blood***92**(7): 2353-2358.
- Meyer, G., J. Emmerich, et al. (2001). "Factors V Leiden and II 20210A in patients with symptomatic pulmonary embolism and deep vein thrombosis." *Am J Med***110**(1): 12-15.
- Monkovic, D. D. and P. B. Tracy (1990). "Activation of human factor V by factor Xa and thrombin." *Biochemistry***29**(5): 1118-1128.

- Muwakkat, S. A., M. Majdalani, et al. (2011). "Inherited thrombophilia in childhood arterial stroke: data from Lebanon." *Pediatr Neurol***45**(3): 155-158.
- Nicolaes, G. A., G. Tans, et al. (1995). "Peptide bond cleavages and loss of functional activity during inactivation of factor Va and factor VaR506Q by activated protein C." *J Biol Chem***270**(36): 21158-21166.
- Ouriel, K., R. M. Green, et al. (1996). "Activated protein C resistance: prevalence and implications in peripheral vascular disease." *J Vasc Surg***23**(1): 46-51, Discussion 51-42.
- Petitti, D. B., J. Wingerd, et al. (1979). "Risk of vascular disease in women. Smoking, oral contraceptives, noncontraceptive estrogens, and other factors." *JAMA***242**(11): 1150-1154.
- Poort, S. R., F. R. Rosendaal, et al. (1996). "A common genetic variation in the 3'-untranslated region of the prothrombin gene is associated with elevated plasma prothrombin levels and an increase in venous thrombosis." *Blood***88**(10): 3698-3703.
- Prandoni, P., A. W. Lensing, et al. (1996). "The long-term clinical course of acute deep venous thrombosis." *Ann Intern Med***125**(1): 1-7.
- Price, D. T. and P. M. Ridker (1997). "Factor V Leiden mutation and the risks for thromboembolic disease: a clinical perspective." *Ann Intern Med***127**(10): 895-903.
- Rai, R., L. Regan, et al. (1996). "Second-trimester pregnancy loss is associated with activated C resistance." *Br J Haematol***92**(2): 489-490.
- Ranguelov, R. D., N. Rosenthal, et al. (2002). "Detection of factor V Leiden and prothrombin gene mutations in patients who died with thrombotic events." *Arch Pathol Lab Med***126**(10): 1193-1196.
- Rees, D. C., M. Cox, et al. (1995). "World distribution of factor V Leiden." *Lancet***346**(8983): 1133-1134.
- Reiner, A. P., D. S. Siscovick, et al. (2001). "Hemostatic risk factors and arterial thrombotic disease." *Thromb Haemost***85**(4): 584-595.
- Ridker, P. M., R. J. Glynn, et al. (1997). "Age-specific incidence rates of venous thromboembolism among heterozygous carriers of factor V Leiden mutation." *Ann Intern Med***126**(7): 528-531.
- Ridker, P. M., C. H. Hennekens, et al. (1995). "Mutation in the gene coding for coagulation factor V and the risk of myocardial infarction, stroke, and venous thrombosis in apparently healthy men." *N Engl J Med***332**(14): 912-917.
- Ridker, P. M., C. H. Hennekens, et al. (1997). "Interrelation of hyperhomocyst(e)inemia, factor V Leiden, and risk of future venous thromboembolism." *Circulation***95**(7): 1777-1782.
- Ridker, P. M., J. P. Miletich, et al. (1997). "Ethnic distribution of factor V Leiden in 4047 men and women. Implications for venous thromboembolism screening." *JAMA***277**(16): 1305-1307.
- Ridker, P. M., J. P. Miletich, et al. (1995). "Factor V Leiden and risks of recurrent idiopathic venous thromboembolism." *Circulation***92**(10): 2800-2802.
- Rosendaal, F. R., T. Koster, et al. (1995). "High risk of thrombosis in patients homozygous for factor V Leiden (activated protein C resistance)." *Blood***85**(6): 1504-1508.
- Rosendaal, F. R., D. S. Siscovick, et al. (1997). "Factor V Leiden (resistance to activated protein C) increases the risk of myocardial infarction in young women." *Blood***89**(8): 2817-2821.
- Ross, R. K., M. C. Pike, et al. (1986). "Risk factors for uterine fibroids: reduced risk associated with oral contraceptives." *Br Med J (Clin Res Ed)***293**(6543): 359-362.

- Ryan, D. H., M. A. Crowther, et al. (1998). "Relation of factor V Leiden genotype to risk for acute deep venous thrombosis after joint replacement surgery." Ann Intern Med**128**(4): 270-276.
- Sachs, B. P., D. A. Brown, et al. (1987). "Maternal mortality in Massachusetts. Trends and prevention." N Engl J Med**316**(11): 667-672.
- Sampram, E. S., B. Lindblad, et al. (1998). "Activated protein C resistance in patients with peripheral vascular disease." J Vasc Surg**28**(4): 624-629.
- Sartori, M., E. Conti, et al. (2011). "Thrombotic risk factors and cardiovascular events after endovascular intervention for peripheral arterial disease." Eur J Vasc Endovasc Surg**42**(6): 817-823.
- Shen, L. and B. Dahlbäck (1994). "Factor V and protein S as synergistic cofactors to activated protein C in degradation of factor VIIIa." J Biol Chem**269**(29): 18735-18738.
- Shen, Y. C., Z. C. He, et al. (2009). "[Effect of alpha-galactosidase A deficiency on FV leiden fibrin deposition and thrombosis in mice]." Zhonghua Xue Ye Xue Za Zhi**30**(3): 162-165.
- Shen, Y. C., D. F. Lu, et al. (2009). "[Factor V Leiden mutation leads to enhanced atherosclerosis in apolipoprotein E deficient mice]." Zhonghua Xin Xue Guan Bing Za Zhi**37**(1): 59-62.
- Simioni, P., P. Prandoni, et al. (1997). "The risk of recurrent venous thromboembolism in patients with an Arg506-->Gln mutation in the gene for factor V (factor V Leiden)." N Engl J Med**336**(6): 399-403.
- Sipes, S. L. and C. P. Weiner (1990). "Venous thromboembolic disease in pregnancy." Semin Perinatol**14**(2): 103-118.
- Sun, X., B. Evatt, et al. (1994). "Blood coagulation factor Va abnormality associated with resistance to activated protein C in venous thrombophilia." Blood**83**(11): 3120-3125.
- Svensson, P. J. and B. Dahlbäck (1994). "Resistance to activated protein C as a basis for venous thrombosis." N Engl J Med**330**(8): 517-522.
- Svensson, P. J., B. Zöller, et al. (1997). "The factor VR506Q mutation causing APC resistance is highly prevalent amongst unselected outpatients with clinically suspected deep venous thrombosis." J Intern Med**241**(5): 379-385.
- Taute, B. M., R. Taute, et al. (2004). "Hyperhomocysteinemia: marker of systemic atherosclerosis in peripheral arterial disease." Int Angiol**23**(1): 35-40.
- Taylor, L. M., Jr., G. L. Moneta, et al. (1999). "Prospective blinded study of the relationship between plasma homocysteine and progression of symptomatic peripheral arterial disease." J Vasc Surg**29**(1): 8-19; discussion 19-21.
- Thorelli, E., R. J. Kaufman, et al. (1998). "The C-terminal region of the factor V B-domain is crucial for the anticoagulant activity of factor V." J Biol Chem**273**(26): 16140-16145.
- Turkstra, F., R. Karemaker, et al. (1999). "Is the prevalence of the factor V Leiden mutation in patients with pulmonary embolism and deep vein thrombosis really different?" Thromb Haemost**81**(3): 345-348.
- van Boven, H. H., P. H. Reitsma, et al. (1996). "Factor V Leiden (FV R506Q) in families with inherited antithrombin deficiency." Thromb Haemost**75**(3): 417-421.
- van Stralen, K. J., C. J. Doggen, et al. (2008). "Mechanisms of the factor V Leiden paradox." Arterioscler Thromb Vasc Biol**28**(10): 1872-1877.
- Vandenbroucke, J. P., T. Koster, et al. (1994). "Increased risk of venous thrombosis in oral-contraceptive users who are carriers of factor V Leiden mutation." Lancet**344**(8935): 1453-1457.
- Varadi, K., J. Rosing, et al. (1996). "Factor V enhances the cofactor function of protein S in the APC-mediated inactivation of factor VIII: influence of the factor VR506Q mutation." Thromb Haemost**76**(2): 208-214.

- Vig, S., A. Chitolie, et al. (2004). "Prevalence and risk of thrombophilia defects in vascular patients." *Eur J Vasc Endovasc Surg***28**(2): 124-131.
- Volzke, H., B. Wolff, et al. (2005). "Interaction between factor V Leiden and serum LDL cholesterol increases the risk of atherosclerosis." *Atherosclerosis***180**(2): 341-347.
- Voorberg, J., J. Roelse, et al. (1994). "Association of idiopathic venous thromboembolism with single point-mutation at Arg506 of factor V." *Lancet***343**(8912): 1535-1536.
- Wahlander, K., G. Larson, et al. (2002). "Factor V Leiden (G1691A) and prothrombin gene G20210A mutations as potential risk factors for venous thromboembolism after total hip or total knee replacement surgery." *Thromb Haemost***87**(4): 580-585.
- Weischer, M., K. Juul, et al. (2010). "Prothrombin and risk of venous thromboembolism, ischemic heart disease and ischemic cerebrovascular disease in the general population." *Atherosclerosis***208**(2): 480-483.
- Westrick, R. J. and D. Ginsburg (2009). "Modifier genes for disorders of thrombosis and hemostasis." *J Thromb Haemost***7 Suppl 1**: 132-135.
- Willeit, J., S. Kiechl, et al. (2000). "Distinct risk profiles of early and advanced atherosclerosis: prospective results from the Bruneck Study." *Arterioscler Thromb Vasc Biol***20**(2): 529-537.
- Ye, Z., E. H. Liu, et al. (2006). "Seven haemostatic gene polymorphisms in coronary disease: meta-analysis of 66,155 cases and 91,307 controls." *Lancet***367**(9511): 651-658.
- Zivelin, A., J. H. Griffin, et al. (1997). "A single genetic origin for a common Caucasian risk factor for venous thrombosis." *Blood***89**(2): 397-402.
- Zöller, B., A. Berntsdotter, et al. (1995). "Resistance to activated protein C as an additional genetic risk factor in hereditary deficiency of protein S." *Blood***85**(12): 3518-3523.
- Zöller, B. and B. Dahlbäck (1994). "Linkage between inherited resistance to activated protein C and factor V gene mutation in venous thrombosis." *Lancet***343**(8912): 1536-1538.
- Zöller, B., P. J. Svensson, et al. (1994). "Identification of the same factor V gene mutation in 47 out of 50 thrombosis-prone families with inherited resistance to activated protein C." *J Clin Invest***94**(6): 2521-2524.

## **APPENDIX (PAPER I-V)**









# Activated protein C resistance in patients with peripheral vascular disease

Ellis Senanu K. Sampram, MD, Bengt Lindblad, MD, PhD, and Björn Dahlbäck, MD, PhD, Malmö, Sweden

**Purpose:** The frequency of activated protein C (APC) resistance, caused by factor V R506Q gene mutation and abnormal APC ratio, in patients with peripheral vascular diseases was analyzed.

**Methods:** All patients electively admitted to the vascular ward unit of our tertiary care academic medical center from January 1995 through October 1996 (n = 679) were prospectively analyzed using an APC-resistance screening test to determine the frequency of abnormal APC ratio ( $\leq 2.6$ ). Baseline activated partial thromboplastin time (APTT) and its prolongation after the addition of a standard amount of APC were determined. The factor V R506Q gene mutation (Leiden) was analyzed in patients with an APC ratio less than 3.0. Statistical comparisons were made to an age-matched control population (n = 278).

**Results:** The factor V Leiden gene mutation or abnormal APC ratio was detected in 154 of the patients (22.7%), compared with 34 of 278 the control subjects (12.2%;  $t = 13.65$ ;  $P < .001$ ). The factor V Leiden gene mutation was found in 102 patients (15.2%), compared with 29 control subjects (10.4%;  $t = 4.64$ ;  $P < .05$ ); an abnormal APC ratio was found in 132 patients (19.8%), compared with 26 (9.8%) of controls ( $t = 14.56$ ;  $P < .001$ ). The frequency of the factor V Leiden gene mutation was significantly increased in patients with femoro-popliteal occlusive disease (n = 126), to 21.6% ( $t = 16.94$ ;  $P < .001$ ), and venous disease (n = 50), to 36.0% ( $t = 20.93$ ;  $P < .001$ ). Overall, 63% of the patients with abnormal APC ratios tested positive for the factor V Leiden gene mutation. A significantly increased frequency of APC resistance was demonstrated in patients undergoing aorto-iliac (n = 37) or femoro-crural graft reconstructions (n = 72); it was found in 41% and 35%, respectively ( $P < .001$ ). In addition, a significantly increased frequency of APC resistance was found in patients who suffered from occlusion after reconstruction; 13 of 41 (32%) had the factor V Leiden gene mutation ( $P < .001$ ), and 19 of 39 (49%) had an abnormal APC ratio ( $P < .001$ ).

**Conclusion:** The factor V Leiden gene mutation and abnormal APC ratios are significantly increased in patients with lower extremity peripheral vascular disease and failed reconstructions. An abnormal APC ratio was seen without factor V Leiden gene mutation in 37% of patients with peripheral vascular diseases, suggesting additional causes of an abnormal APC ratio, exclusive of gene mutation. (J Vasc Surg 1998;28:624-9.)

Antithrombin and protein C are important anti-coagulant proteins.<sup>1</sup> After the activation of protein C on the endothelial surface by the complex formation of thrombin, thrombomodulin, and protein C, protein C inhibits the coagulation cascade via prote-

olytic degradation of coagulation factors Va and VIIIa. These phospholipid cell membrane reactions are potentiated by protein S.<sup>2</sup> Recently, we demonstrated such potentiation with APC resistance or abnormalities in factor V.<sup>3</sup> APC resistance is caused by a defect in factor V caused by a single point mutation of Arg506 to Gln (factor V Leiden).<sup>4-6</sup> This mutation is found in 40% to 50% of patients with venous thromboembolism.<sup>7-11</sup> For screening of APC resistance, an APC-ratio test has been used. Abnormal APC ratio is in a venous cohort due to factor V Leiden gene mutation in 75% to 95% of patients.<sup>12-14</sup> Thus, the factor V Leiden gene mutation causing APC resistance was found with a 10-fold increased prevalence in such patients, compared

From the Department of Vascular and Renal Diseases, and the Department of Clinical Chemistry (Dr Dahlbäck), Malmö University Hospital, Lund University.

Reprint requests: Ellis S. K. Sampram, MD, Department of Vascular and Renal Diseases, Malmö University Hospital, S-205 02 Malmö, Sweden.

Copyright © 1998 by The Society for Vascular Surgery and International Society for Cardiovascular Surgery, North American Chapter.

0741-5214/98/\$5.00 + 0 24/1/93022

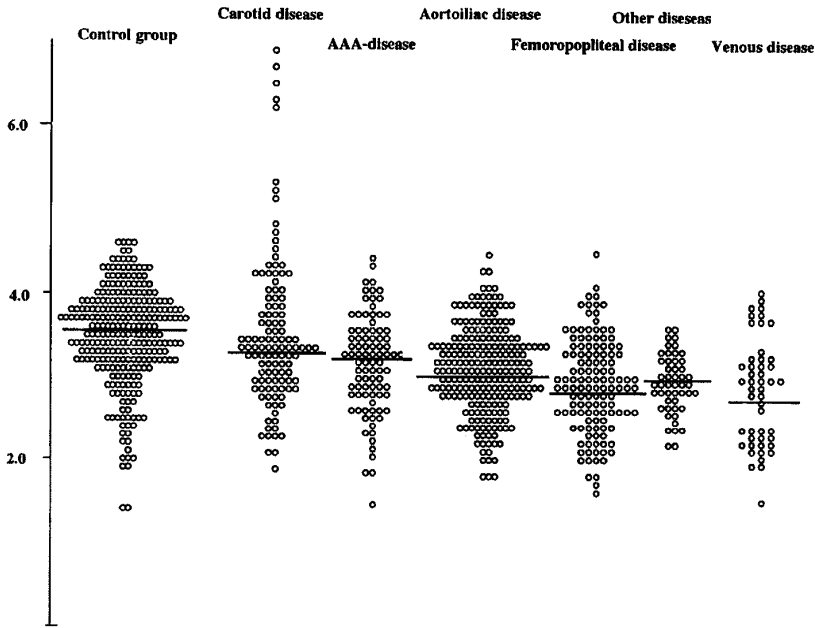

Fig 1. The individual APC ratios and their distribution in the different groups. The line indicates the median value.

with other inherited anticoagulant protein deficiencies; however, this does not account for all cases of an abnormal APC ratio.<sup>10</sup> The true prevalence of APC resistance in the general population remains to be determined. In healthy control subjects, a 3% to 11% incidence is reported.<sup>8-11</sup> Important geographical and racial differences have been found. In the Malmö, Sweden, general population, a frequency from 7% to 11% of APC resistance has been confirmed.<sup>10,15,16</sup>

APC resistance or the defect in factor V Leiden is characterized by an abnormal anticoagulant response to activated protein C.<sup>2</sup> APC resistance can be screened for with an assay that determines the anticoagulant response to APC in an activated partial thromboplastin time (APTT) reaction. Although this assay has been standardized, high levels of fibrinogen, factor VIII, and antiphospholipid syndromes may cause abnormal results.<sup>13,17</sup> In addition, the assay cannot be performed on patients receiving oral anticoagulants or heparin. Although modifications of the test may be more specific, demonstration of the factor V Leiden gene mutation remains the most specific test.<sup>6,12,13</sup>

On the basis of our observation that APC resistance was frequent in patients with early femoro-

crural graft occlusion,<sup>18,19</sup> the frequency of APC resistance and abnormal APC ratios without the factor V Leiden gene mutation was studied in patients with peripheral vascular disease.

## PATIENTS AND METHODS

Between January 1995 and October 1996, 679 patients underwent APC-resistance analysis. All patients had blood sampling 2 to 3 days before elective admittance to the vascular surgery ward unit. This prospective and consecutive analysis of elective patients included determination of activated partial thromboplastin time (APTT; automated, Organon Teknika) and simultaneous analysis of the anticoagulant effect after the addition of a standardized amount of APC, 20 nmol/L human APC in 10 mmol/L Tris HCl/0.05 mol/L NaCl/30 mmol/L CaCl<sub>2</sub>, 0.1% bovine serum albumin at pH 7.5 (Chromogenix AB, Mölndal, Sweden)<sup>2</sup>. The APC ratio was the ratio of clotting time with and without the addition of APC. An abnormal APC ratio was set at 2.6 or less.<sup>10</sup> In patients with an APC ratio of 3.0 or less, determination of the factor V Leiden gene was made with PCR-amplifying technique with 2 primers for confirmation of the mutation, as previously described.<sup>12</sup>

**Table I.** Number of patients with APC resistance and abnormal APC-test for different categories of arteriosclerosis

	Number of patients	Positive factor V gene mutation, but APC test not possible	Positive factor V gene mutation and normal APC test	Positive factor V gene mutation and abnormal APC test	Normal factor V gene mutation, but abnormal APC test	Factor V gene mutation not done, but normal APC test
Control group	278		8	21	5	
Carotid disease	116		1	10	1	1
Abdominal aortic aneurysm	93	3	2	7	5	
Aorto-iliac occlusive disease	233	5	2	23	15	4
Femoro-popliteal occlusive disease	126	2	3	22	18	1
Venous disease	50		2	16	3	
Other	61	1	1	2	4	
Total vascular patients	679	11	11	80	46	6

Calculation of the sample size was on the basis of the frequency of APC resistance in age-matched and sex-matched control subjects from the city of Malmö, where 29 of 278 of the control subjects displayed the factor V Leiden gene mutation and 26 had abnormal APC ratios ( $\leq 2.6$ ). The median age of control subjects was 57 years.<sup>16</sup> For a difference in frequency of 5%, the material size needed to be approximately equal to 500 patients; for a 10% difference, the material size needed to be approximately equal to 100 patients.

Based on the most significant arteriosclerotic lesion, patients were divided into groups: those with carotid disease (stenosis normally  $>70\%$ ), those with abdominal aortic aneurysm (diameter  $>5$  cm), those with aorto-iliac occlusive disease ( $<200$  m walking distance), those with femoro-popliteal occlusive disease (critical ischemia), or those with venous disease. The group classified as other peripheral vascular diseases included patients with fibromuscular dysplasia, thromboangiitis obliterans, and upper extremity ischemia.

The statistical significance of variables between patients with peripheral vascular disease and the Malmö control group was determined with  $\chi^2$  analysis. Significance was assumed when a  $P$  value of less than .05 was achieved.

## RESULTS

Of the 679 consecutive patients, factor V Leiden gene mutation or an APC ratio of 2.6 or less was found in 154 patients (22.7%), compared with 34 of the 278 (12.2%) Malmö control subjects ( $t = 13.65$ ;  $P < .001$ ). The factor V Leiden gene mutation was seen in 102 patients (15.2%;  $t=4.64$ ;  $P < .05$ ), and an abnormal APC ratio was found in 132 patients

(19.8%;  $t = 14.56$ ;  $P < .001$ ). Subgroup analysis is illustrated in Tables I and II and Fig 1. An increased frequency ( $P < .01$  for APC and  $P < .001$  for abnormal APC ratio) was noted in patients with arteriosclerotic lesion in the femoro-popliteal segment and in patients with venous diseases ( $P < .001$ ), as compared with the control group.

As shown in Table I, APC-ratio testing was not possible in 11 patients because of current oral anticoagulation therapy; however, factor V Leiden gene mutation was possible. Factor V Leiden gene mutation was demonstrated in 11 patients with an APC ratio of 2.6 or less. In 6 patients with abnormal APC ratios and in 10 patients with ratios between 2.7 and 3.0, the factor V Leiden gene mutation test was not performed (Fig 2).

The age distribution of the 679 patients is illustrated in Fig 3. The median age was 70 years, which is similar to the median age of 72 years for the groups of patients with carotid, aorto-iliac, and femoro-popliteal occlusive disease. Patients with abdominal aortic aneurysmal disease and venous disease were slightly younger, with median ages of 65 years and 53 years, respectively.

The frequency of factor V Leiden gene mutation and abnormal APC ratio based on patient age are shown in Table III. There was a trend for APC resistance to decrease with age ( $t = 1.99$ , NS). However, the frequency of abnormal APC ratios did remain unchanged. Therefore, the number of patients with abnormal APC ratios and normal factor V Leiden gene mutation tests increased with age, from a frequency of 0.7% for those 61 years or younger to 5.5% in patients older than 61 years.

Patients undergoing aorto-iliac graft reconstructions ( $n = 37$ ) and femoro-crural reconstructions ( $n$

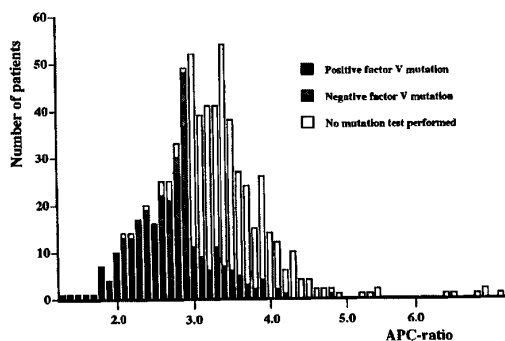

Fig 2. The distribution of APC ratios and their relation to factor V gene mutation.

= 72) had a high frequency of factor V Leiden gene mutation and abnormal APC ratios (41% and 43%, 35% and 46%, respectively), compared with the control population ( $t = 22.64-38.76$ ,  $P < .001$ ). Overall, of those that underwent operations, graft occlusion occurred in 41 patients. Of these patients with occluded grafts, 13 of 41 (32%;  $t = 12.94$ ;  $P < .001$ ) had factor V Leiden gene mutation, and 19 of 39 (49%) had abnormal APC ratios ( $t = 36.90$ ;  $P < .001$ ).

## DISCUSSION

The impact of APC resistance on the development of peripheral arterial thrombosis remains to be defined. This study was undertaken to determine the frequency of the factor V Leiden gene mutation (APC resistance) and the frequency of abnormal APC ratio in patients with peripheral vascular disease.

The incidence of APC resistance, validated with factor V Leiden gene analysis in patients with myocardial infarction, has been reported to be a frequency between 2.5% to 18%, compared with a frequency in control subjects of 0.7% to 11%.<sup>15,20,21</sup> Given this wide variability, further studies, with subgroup-analysis, will be required to determine whether an increase in the frequency of APC resistance exists in these patients.

In patients who had strokes, one study, which did not validate results with factor V Leiden gene analysis, showed a 20% incidence of APC resistance<sup>11</sup>; however, other studies validated with factor V Leiden gene mutation analysis have found a frequency approximately equal to 5% both in patients who have had strokes and in control populations.<sup>22-24</sup> This is in accordance with our results.

APC resistance in patients with peripheral vascu-

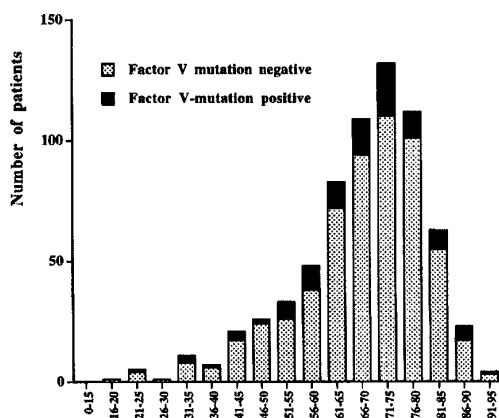

Fig 3. Age distribution for 679 elective patients with peripheral arteriosclerosis and venous disease at a vascular surgical ward unit. The findings of factor V gene mutation is also shown.

lar disease is only reported in 2 studies.<sup>25-26</sup> One of these studies, not validated with factor V Leiden gene mutation analysis, included 173 patients with peripheral vascular disease and reported a 5% incidence rate of abnormal APC ratio in patients who have had strokes, 11.5% in patients with aneurysmal disease, and 13.7% in patients with lower extremity arteriosclerosis. With a normalized sensitivity ratio (NSR), abnormal APC ratio was documented in 10.6% to 22.0% of patients with peripheral vascular disease.<sup>26</sup> Interestingly, Ouriel et al found that 5 of 10 infrainguinal reconstructions in patients with abnormal APC ratios occluded within the first year. In a retrospective analysis of 23 occluded infrainguinal reconstructions at our institution, 64% of occlusions within 1 month occurred in patients with abnormal APC ratios.<sup>19</sup> Therefore, the identification and treatment of patients with abnormal APC ratios before arterial reconstruction could optimize these results. Further studies are needed.

In the present study, a high incidence of the factor V Leiden gene mutation and abnormal APC ratios was found in patients with aorto-iliac and femoro-popliteal occlusive disease and venous disease. This confirms results from earlier studies.<sup>25,26</sup> In this study, the frequency of factor V Leiden gene mutation or abnormal APC ratio in patients with carotid disease and abdominal aortic aneurysmal disease was not significantly different than in control subjects. These findings regarding patients with carotid disease strongly support earlier studies.<sup>22-24</sup>

**Table II.** Frequencies and percentages of APC resistance (test positive for factor V gene mutation) and abnormal APC-ratio test ( $\leq 2.6$ ) for different categories of arteriosclerosis

	<i>Factor V gene mutation test positive number and percent</i>		<i>Abnormal APC ratio number and percent</i>	
Control group	29/278	(10.4%)	26/278	(9.4%)
Carotid disease	11/115	(9.6%)	12/116	(10.3%)
Abdominal aortic aneurysm	12/93	(12.9%)	12/90	(13.3%)
Aorto-iliac occlusive disease	30/229	(13.1%)	42/228	(18.4%)*
Femoro-popliteal occlusive disease	27/125	(21.6%)†	41/124	(33.1%)‡
Venous disease	18/50	(36.0%)‡	19/50	(38.0%)‡
Others	4/61	(6.6%)	6/60	(10.0%)
Total vascular patients	102/673	(15.2%)	132/668	(19.8%)*

Significance compared with the Malmö control population: \* $P < .05$ , † $P < .01$ , ‡ $P < .001$ .

**Table III.** Age variation of APC resistance and abnormal APC ratio (percentage in brackets)

<i>Age</i>	<i>Number of patients</i>	<i>Factor V gene mutation positive</i>	<i>Abnormal APC ratio</i>
$\leq 60$	153	28 (18.3%)	29 (19.0%)
61–75	324	48 (14.8%)	66 (20.4%)
$\geq 76$	202	26 (12.9%)	37 (18.8%)

For patients with abdominal aortic aneurysmal diseases, the frequency of factor V Leiden gene mutation and/or abnormal APC ratio was equal to control populations, contrary to the findings of Ouriel et al, who noted an increased frequency.<sup>25</sup>

Younger patients displayed a higher frequency of the factor V Leiden gene mutation. The frequency of a mutation must be the same in different age groups. However, one reason for our reported difference could be that arteriosclerotic patients with the factor V Leiden gene mutation may have earlier occlusions and, therefore, earlier symptoms of their peripheral vascular disease. In the same way, patients with lower extremity arteriosclerosis and the factor V Leiden gene mutation may occlude longer segments, giving more severe symptoms that more frequently require vascular reconstruction.

In the present study, the factor V Leiden gene mutation assay was performed on 98% of the patients at risk of having APC resistance (ie, APC ratio  $< 3.0$ ). Surprisingly, only 67% of patients with abnormal APC ratios had verification of factor V Leiden gene mutation. In contrast, studies of venous thrombosis patients have demonstrated a factor V Leiden gene mutation in 75% to 95% of patients with abnormal APC ratios.<sup>10,15</sup> This discrepancy may be caused by differences in patient population. Peripheral vascular surgery patients are known to

have a higher frequency of coagulation; high fibrinogen, high factor II, V, VIII, IX, X, or anticoagulation; antiphospholipid syndrome—defects known to interfere with the APC-resistance screening test.<sup>13,16</sup> In the present study, no markers for other hypercoagulable states were analyzed.

Eleven patients who had an APC ratio greater than 2.6 had the factor V Leiden gene mutation and only 67% of those with an APC ratio below 2.6 had the mutation, illustrating the APC-resistance screening test's weakness in being specific for the factor V mutation. A variety of screening techniques have been used. Recently, our laboratory has used factor V depleted plasma for the APC-resistance screening test. This has been found to be more accurate and specific for confirmation of the factor V Leiden gene mutation.<sup>16</sup> It is not known which test should be used in vascular surgery patients. Maybe the old, less specific APC-ratio test has a higher predictive value for graft occlusions than a more specific APC-resistance test or the determination of the factor V Leiden gene mutation.

In summary, a high frequency of the factor V Leiden gene mutation and abnormal APC ratios was found in patients with lower extremity peripheral occlusive vascular disease. This finding was seen in almost half of early vascular reconstructions that thrombosed. The importance of APC resistance and abnormal APC ratio needs to be studied further.

## REFERENCES

- Dahlbäck B. The protein C anticoagulant system: Inherited defects as basis for venous thrombosis. *Thromb Res* 1995;77:1-43.
- Dahlbäck B, Carlsson M, Svensson PJ. Familial thrombophilia due to a previously unrecognized mechanism characterized by poor anticoagulant response to activated protein C: Prediction of a cofactor to activated protein C. *Proc Natl Acad Sci USA* 1993;90:1004-8.



3. Dahlbäck B, Hildebrand B. Inherited resistance to activated protein C is corrected by anticoagulant cofactor activity found to be a property of factor V. *Proc Natl Acad Sci USA* 1994;81:1396-400.
4. Greengard JS, Sun X, Xu X, Fernandez JA, Griffin JH, Evatt B. Activated protein C resistance caused by Arg506Gln mutation in factor Va. *Lancet* 1994;343:1535-6.
5. Bertina RM, Kooleman BPC, Koster T, Rosendaal FR, Dirven RJ, de Ronde H, et al. Mutation in blood coagulation factor V associated with resistance to activated protein C. *Nature* 1994;369:64-7.
6. Zöller B, Dahlbäck B. Linkage between inherited resistance to activated protein C and factor V mutation in venous thrombosis. *Lancet* 1994;343:1536-8.
7. Griffin JH, Evatt B, Wideman C, Fernandez JA. Anticoagulant protein C pathway defective in a majority of thrombophilic patients. *Blood* 1993;82:1989-93.
8. Koster T, Rosendaal FR, De Ronde F, Briet E, Vandenbroucke JP, Bertina RM. Venous thrombosis due to poor response to activated protein C: Leiden thrombophilia study. *Lancet* 1993;342:1503-6.
9. Faioni EM, Franchi F, Asti D, Sacchi E, Bernardi F, Mannucci PM. Resistance to activated protein C in nine thrombophilic families: interference in a protein S functional assay. *Thromb Haemost* 1993;70:1067-91.
10. Svensson PJ, Dahlbäck B. Resistance to activated protein C as a basis for venous thrombosis. *N Engl J Med* 1994;330:517-21.
11. Halbmayr WM, Haushofer A, Schön R, Fischer M. The prevalence of poor anticoagulant response to activated protein C (APC resistance) among patients suffering from stroke or venous thrombosis and among healthy subjects. *Blood Coagul Fibrinol* 1994;5:51.
12. Zöller B, Svensson PJ, He X, Dahlbäck B. Identification of the same factor V gene mutation in 47 out of 50 thrombosis-prone families with inherited resistance to activated protein C. *J Clin Invest* 1994;94:2521-4.
13. de-Ronde H, Bertina RM. Laboratory diagnosis of APC-resistance: a critical evaluation of the test and development of diagnostic criteria. *Thromb Haemost* 1994;72:880-6.
14. Dahlbäck B. Factor V gene mutation causing inherited resistance to activated protein C as a base for venous thromboembolism. *J Intern Med* 1995;237:221-7.
15. Holm J, Zöller B, Svensson PJ, Berntorp E, Erhardt L, Dahlbäck B. Myocardial infarction in two young women associated with homozygous resistance to activated protein C. *Lancet* 1994;343:917.
16. Svensson PJ, Zöller B, Mattiasson I, Dahlbäck B. The factor V R506Q mutation causing APC-resistance is highly prevalent amongst unselected outpatients with clinically suspected deep venous thrombosis. *J Int Med* 1997;241:379-85.
17. Zöller B. Familial Thrombophilia. Resistance to activated protein C and protein S deficiency [thesis]. Malmö (Sweden): Lund University; 1996.
18. Lindblad B, Svensson PJ, Dahlbäck B. Arterial and venous thromboembolism with fatal outcome in a young man with inherited resistance to activated protein C. *Lancet* 1994; 343:917.
19. Lindblad B. A new important factor for early femorocrural graft occlusions—abnormal activated protein C-resistance-test. In press 1996.
20. Kontula K, Ylikorkala A, Miettinen H, Vuorio A, Kauppinenmakelin RK, Hamalainen L, et al. Arg506Gln factor V mutation (factor V Leiden) in patients with ischaemic cerebrovascular disease and survivors of myocardial infarction. *Thromb Haemost* 1995;73:558-60.
21. Emmerich J, Poirier O, Evans A, Marques-Vidal P, Arveiler D, Luc D, et al. Myocardial infarction, Arg506 to Gln factor V mutation, and activated protein C resistance. *Lancet* 1995;345:321.
22. Catto A, Carter A, Ireland H, Bayston TA, Philippou H, Barrett J, et al. Factor V Leiden gene mutation and thrombin generation in relation to the development of acute stroke. *Arteriosclerosis Thromb Vasc Biol* 1995;15:783-5.
23. Syrjälä M, Tatlisumak T, Lindsberg P, Palotie A, Kaste M. FV Arg-506-Gln mutation in ischemic stroke [abstract]. *Thromb Haemost* 1995;73:1124.
24. Ridker PM, Hennekens CH, Lindpaintner K, Stampfer MJ, Eisenberg PR, Miletich JP. Mutation in the gene coding for coagulation factor V and the risk of myocardial infarction, stroke, and venous thrombosis in apparently healthy men. *N Engl J Med* 1995;332:912-7.
25. Ouriel K, Green RM, DeWeese JA, et al. Activated protein C resistance: prevalence and implications in peripheral vascular disease. *J Vasc Surg* 1996;23:46-52.
26. Donaldson MC, Belkin M, Whittemore AD, Mannick JA, Longtine JA, Dorfman DM. Impact of activated protein C resistance on general vascular surgical patients. *J Vasc Surg* 1997;25:1054-60.

Submitted Feb 18, 1998; accepted Jun 26, 1998.





## The Impact of Factor V Mutation on the Risk for Occlusion in Patients Undergoing Peripheral Vascular Reconstructions

E. S. K. Sampram\* and B. Lindblad

Department of Vascular Diseases Malmö-Lund, Lund University, Malmö University Hospital, Malmö, Sweden.

**Objective:** to determine the impact of Factor V-Leiden on the patency of peripheral vascular reconstructions.

**Design:** prospective, open and consecutive study.

**Methods:** a total of 775 patients, who were electively admitted between 1995 and 1997 to the vascular ward unit, were prospectively analysed for frequency of Factor V-Leiden mutation and patency of reconstruction (one month and one year). The patients were grouped into carotid, abdominal aortic aneurysm (AAA), renal artery, aortoiliac, infrainguinal, and venous categories according to procedures and anatomical sites. Post-reconstruction complications and associated risk factors were also analysed.

**Result:** in infrainguinal patients Factor V-Leiden was seen in 16% of the patients compared with 10% in the controls. (Odds ratio 1.60, CI 0.91–2.81). Hypertension, pulmonary disease and smoking were more frequent in individuals without Factor V-Leiden. Analysing all 775 reconstructions, occlusions were more frequent at one month (14% vs 12%) ( $p = 0.02$ ) in patients with Factor V-Leiden compared with patients without the mutation. Though this trend was also noted few patients having infrainguinal reconstructions, the difference was not significant (37% vs 22% ( $p = 0.15$ ) and 46% vs 27% ( $p = 0.09$ ) after 1 and 12 months, respectively).

**Conclusion:** factor V mutation (Factor V-Leiden) was more frequent in patients having occluded vascular reconstructions. Further evaluation is needed.

**Key Words:** Factor V-Leiden; Occlusion; Peripheral vascular reconstruction.

### Introduction

The vitamin K-dependent plasma protein, Protein C, when activated (Activated Protein C or APC) on endothelial cells by thrombin–thrombomodulin complex, inhibits clotting selectively by degrading coagulation factors Va and VIIIa.<sup>1–6</sup> Protein S, also a K vitamin-dependent plasma protein, functions as a cofactor to APC.

Inherited APC resistance is now known to be due to (Arg506 to Gln) in the Factor V (Factor V-Leiden).<sup>4–6</sup> As a result of this mutation one of three APC cleavage sites is lost, which renders it unavailable as a cofactor to APC<sup>3–6</sup> resulting in the hypercoagulable state. Factor V-Leiden is found in 20–60% of analysed patients with venous thromboembolism<sup>7–11</sup> and in a venous thrombosis cohort.<sup>12,13</sup> In Malmö the frequency of Factor V-Leiden is 7–11 in the general population,<sup>7,12</sup> but there are marked geographical variations.<sup>14</sup> Unlike

venous thrombosis, the role of Factor V-Leiden mutation as a risk factor for arterial thrombosis is unclear.

The role of Factor V-Leiden in coronary bypass grafting occlusion has not been established.<sup>15</sup> Two studies of peripheral vascular reconstruction<sup>16,17</sup> suggested a lower patency in patients with low APC ratio. The aim of this prospective study was to determine the impact of Factor V-Leiden on the short-term post-operative thrombotic events (occlusions) in peripheral vascular reconstructions.

### Material and Method

A total of 775 patients undergoing elective vascular reconstructions between January 1995 and 1997 were prospectively and consecutively included. Clinical data were entered into the control, Swedish Vascular Registry database, SwedVasc.<sup>18</sup> DNA analyses to confirm Factor V-Leiden was identical using a PCR amplifying technique.<sup>19</sup>

In all 921 different reconstructions were carried out as follows: carotid, abdominal aortic aneurysm (AAA),

\*Please address all correspondence to: E. S. K. Sampram, Department of Vascular Diseases Malmö-Lund, Malmö University Hospital, S-205 02 Malmö, Sweden.

renal artery, aortoiliacal, infrainguinal, and venous including open and endovascular procedures. This grouping is in line with the Eurovasc Report 1997.<sup>20</sup> Operations at different anatomical sites were counted as separate operations. After a follow-up period of 12 months any procedure at the same anatomical sites was regarded as a new reconstruction and followed for another 12 months. A patient was recorded as occluded only once, if occlusion occurred in one or more reconstructions at the same anatomical site. This study does not intend to analyse the different index procedures in each category separately.

Follow-up was carried out between February 1995 and December 1998. Patients were called for follow-up one month and one year after reconstructions. During these follow-up periods the patients underwent clinical status evaluation, noninvasive examination, and angiography if indicated. Function/patency was recorded as patent-improved, patent-unchanged, patent but deteriorating, patent-dead, death as a result of other causes, occluded-improved, occluded-unchanged occluded-deteriorating, occluded-dead. For secondary patency, patients were recorded as secondary patency-improved, unimproved, unchanged or dead. To determine patency/occlusion a combination of clinical, haemodynamic and angiographic factors were employed as indicated. All carotid patients underwent routinely neurologic and duplex examination within two months after the procedures. All patients undergoing vascular reconstruction were started on low molecular weight heparin before operation and until discharge. After discharge most patients continued with antiplatelet therapy (low dose ASA normally 75–160 mg daily).

Associated risk factors and post-reconstructive complications were also analysed and compared among the groups. Mortality was controlled by the Swedish National Death Registry.

#### Statistical analysis

A comparison within the groups was done with a Yates corrected Chi-square test. Significance was assumed when a *p*-value of less than 0.05 was achieved. Odds ratio (OR) and 95% confidence interval (CI) were calculated.

#### Results

Twelve percent (93/775) of patients were heterozygotes for Factor V-Leiden (Table 1). Thirty-six died

before one month and 102 by one-year follow-up. Table 1 shows the rate of mortality and frequency of Factor V-Leiden among the different groups. Table 2 compares the frequencies of associated risk factors. Hypertension (OR 0.62; CI 0.39–0.97), pulmonary disease (OR 0.43; CI 0.21–0.88) and smoking (OR 0.60; CI 0.36–0.99) were more frequent in patients without Factor V-Leiden mutation. Post-reconstruction complications (Table 3) showed higher frequency of deep or graft infection and occlusion/thrombosis in the Factor V-Leiden mutation group. At one month there were few recorded occlusions for carotid, AAA, or renal artery patients with or without Factor V-Leiden. A non-significant tendency for early occlusion in aortoiliac individuals and patients who had infra-inguinal procedures with Factor V-Leiden was seen (Table 4). In the total series occlusion at one month and 1 year occurred significantly more often in patients with Factor V-Leiden: 14% vs 7% and 22% vs 12%, respectively (Table 4). At one year 148 patients did not undergo follow-up examinations for patency leaving us with 627 original patients of whom 12% (77/627) had Factor V-Leiden.

#### Discussion

The importance of APC resistance for venous thrombosis is established,<sup>21–23</sup> but for arterial thrombosis the findings are less certain. Several studies on APC resistance and myocardial infarction have not confirmed APC resistance as a risk factor.<sup>14,24</sup> Graft occlusion after coronary artery bypass surgery has not been found to be higher in APC-resistant patients than in those who are not.<sup>15</sup> Results from studies on stroke and APC resistance with or without Factor V-Leiden gene analyses are still conflicting.<sup>11,24–25</sup> One study, evaluating the prevalence of APC resistance in patients with peripheral vascular disease and correlating the disorder to outcome after vascular surgery, suggests APC resistance as relatively common in patients with peripheral vascular disease.<sup>16</sup> This study also suggests APC resistance as a risk factor for failure of infra-inguinal bypass. In another study, Donaldson *et al.*<sup>17</sup> suggested, although weakly, like Ouriel *et al.*,<sup>16</sup> a higher risk of occlusion in infrainguinal reconstructions, but found that Factor V-Leiden mutation was not more prevalent in peripheral vascular surgical patients than in a control population. In contrast to their findings we have found, in this analysis and an earlier study,<sup>26</sup> an increased incidence of the Factor V-Leiden mutation in patients with infrainguinal, peripheral vascular disease. Fisher *et al.*<sup>27</sup> have recently in their studies also

**Table 1. Percentage of Factor V-Leiden and rate of mortality among the different groups, 1 month and 1 year after peripheral vascular procedures. (AAA=abdominal aortic aneurysm. Odds ratio with 95% confidence intervals).**

Age and sex-matched control group	Normal Factor V		Factor V-Leiden		Mortality 1 year	Mortality 1 month	Percentage of individuals with Factor V-Leiden	Odds Ratio (CI)
	No. of patients	Mortality 1 month	No. of patients	Mortality 1 month				
Carotid	249	N/A	29	N/A	N/A	N/A	10%	1.0
AAA	162	6/162 (4%)	15	0/15	0/15	0/15	9%	0.80 0.41-1.53
Renal artery	109	7/109 (6%)	17	3/17 (18%)	3/17 (18%)	3/17 (18%)	14%	1.34 0.71-2.54
Aortoiliacal	52	1/52 (2%)	4	0/4	0/4	0/4	7%	0.66 0.22-1.96
Infringuinal	195	6/195 (3%)	25	24/195 (12%)	6/25 (24%)	6/25 (24%)	11%	1.10 0.62-1.04
Venous	145	9/145 (6%)	27	28/145 (19%)	6/27 (22%)	6/27 (22%)	16%	1.60 0.91-2.81
Total	19	1/19 (5%)	5	2/19 (11%)	0/5	0/5	21%	2.26 0.78-6.51
	682	30/682 (4%)	93	87/682 (13%)	6/93 (7%)	15/93 (16%)	12%	1.17 0.75-1.82

indicated a greater prevalence of APC resistance in patients undergoing peripheral arterial bypass grafting and a trend for APC resistance to be associated with graft failure.

The lower rate of hypertension, pulmonary disease and smoking in patients with Factor V-Leiden mutation must be interpreted cautiously. No other reports to our knowledge support such an associated pattern.

This prospective study was started to determine if there existed any differences in the rate of occlusion/patency after peripheral vascular procedures in patients with Factor V-Leiden mutation. This study limits itself to divisions in peripheral vascular reconstructions to achieve its objectives without delving into the index procedures separately. We are aware of the fact that post-reconstruction occlusion is a complex process involving the type of reconstruction, the run-off situation, smoking habits, graft material etc. Likewise, other abnormalities of the anticoagulant system besides the Factor V-Leiden, such as hereditary deficiencies of protein C, S, antithrombin III, and the prothrombin G2010A mutation, could influence the postreconstructive occlusion rate. Twelve percent of our patients had Factor V mutation. In a control population age matched and from the same area inherited APC resistance is seen in 7-11%.<sup>26</sup> There is a trend of a higher prevalence of inherited APC resistance in peripheral vascular surgery patients as a whole with the exception of those with carotid and renal artery diseases. A higher prevalence of Factor V-Leiden was found in infrainguinal patients, 16%, and in venous patients, 21%. This is in agreement with our previous findings.<sup>26</sup> In this study, we noted a higher occlusion rate in the subgroup of infrainguinal procedures with Factor V mutations within the first month ( $p=0.09$ ) and one year ( $p=0.05$ ) after reconstruction. This finding is supported by other groups.<sup>16,17</sup> The increased risk of occlusion noted in this study in the aortoiliac and venous groups is in line with other earlier studies,<sup>8,10,12,23</sup> but due to our small number of occluded reconstructions, this needs to be cautiously evaluated.

Presently, besides poor run-in and run-off, early graft occlusion (within 30 days) is most often considered to be the result of technical problems. Graft occlusion after one month but within one year after reconstruction has been judged to be a result of graft stenosis or intimal hyperplasia. APC resistance is now found in patients with venous thrombosis to be at least 10 times more common than any other inherited deficiencies of anticoagulant proteins.<sup>7</sup> In patients with inherited APC-resistance due to Factor V gene mutation, a two-fold risk for early occlusion in lower extremity reconstructions was seen in this study. This

**Table 2. Preoperative risk factors compared between patients with Factor V-Leiden and normal Factor V, respectively. (Odds ratio with 95% confidence intervals).**

Associated risk factors	Normal Factor V (n = 682)	Factor V-Leiden (n = 93)	Odds ratio (CI)
CVI	180 (26%)	21 (23%)	0.81 0.49–1.36
Diabetes	101 (15%)	14 (15%)	1.02 0.56–1.87
Hyperlipidemia	71 (10%)	11 (12%)	1.15 0.59–2.27
Hypertension	321 (47%)	33 (36%)	0.62 0.39–0.97
Cardiac	269 (39%)	31 (33%)	0.77 0.49–1.21
Earlier vascular surgery due to atherosclerosis	221 (32%)	25 (27%)	0.77 0.47–1.25
Pulmonary	136 (20%)	9 (10%)	0.43 0.21–0.88
Renal	90 (13%)	10 (11%)	0.79 0.40–1.58
Smoking	233 (34%)	22 (24%)	0.60 0.36–0.99
No risk factors	42 (6%)	6 (7%)	1.05 0.43–2.54

**Table 3. Post-operative complications after procedures within 1 month. (Odds ratio with 95% confidence intervals).**

Post-reconstruction complications	Normal Factor V (n = 682)	Factor V-Leiden (n = 93)	Odds ratio (CI)
Bleeding/haematoma	52 (8%)	7 (8%)	0.99 0.43–2.24
Infection (superficial)	31 (5%)	5 (5%)	1.19 0.45–3.15
Infection (deep/graft)	3 (0%)	4 (4%)	10.17 2.24–46.19
Occlusion/thrombosis	41 (6%)	12 (13%)	2.32 1.17–4.59
Cardiac	43 (6%)	9 (10%)	1.59 0.75–3.38
Pulmonary	16 (2%)	1 (1%)	0.45 0.06–3.41
Cerebrovascular insult	14 (2%)	0	—
Amputation	12 (2%)	2 (2%)	1.23 0.27–5.57

**Table 4. Comparison of the occlusion rates of patients with normal Factor V and Factor V-Leiden after peripheral vascular procedures in the different groups.**

Type of reconstructions	No. and percentage of occlusions in individuals with Factor V-Leiden at 1 month	No. and percentage of occlusions in individuals with Factor V-Leiden at 1 year	No. and percentage of occlusions in individuals with normal Factor V at 1 month	No. and percentage of occlusions in individuals with normal Factor V at 1 year
Carotis	0/15	1/12 (8%)	1/162 (1%)	2/127 (2%)
AAA	0/17	0/14	2/109 (2%)	2/84 (2%)
Renal artery	0/4	0/3	0/52	1/32 (3%)
Aortoiliac	2/25 (8%)	3/18 (17%)	8/195 (4%)	22/164 (13%)
Infrainguinal	10/27 (37%)	12/26 (46%)	32/145 (22%)	35/129 (27%)
Venous	1/5 (20%)	1/4 (25%)	3/19 (16%)	4/14 (29%)
Total	13/93 (14%)*	17/77 (22%)*	46/682 (7%)	66/550 (12%)

\*:  $p=0.02$ .

implicates the relative importance of inherited APC resistance due to Factor V-Leiden in the development of arterial thrombosis. Possibly, a small imperfection of a vascular procedure could add to the Factor V mutation and subsequent development of an occlusion.

In conclusion, we have in this study found a significantly higher frequency of early occlusion of vascular procedures in patients with inherited APC resistance due to Factor V mutation. Infrainguinal reconstructions in patients with Factor V mutation showed a two-folded risk of occlusion within the first month and after one year though these findings were not significant. There is a need for more studies and confirmations of our findings before recommendations can be given for a preoperative screening of patients undergoing vascular operations. There is likewise a need for a more detailed evaluation of the different procedures in the infrainguinal group, in order to define the specific reconstructions with an increased risk for early occlusion in inherited APC-resistant patients.

#### Acknowledgements

This investigation was partly supported by grants from Förenade Liv Mutual Group Life Insurance Company, Stockholm, Sweden, Lund University Hospital and Region Skåne.

#### References

- 1 DAHLBÄCK B, CARLSSON M, SVENSSON PJ. Familial thrombophilia due to a previously unrecognized mechanism characterized by poor anticoagulant response to activated protein C: Prediction of a cofactor to activated protein C. *Proc Natl Acad Sci USA* 1993; **90**: 1004-1008.
- 2 DAHLBÄCK B, HILDEBRAND B. Inherited resistance to activated protein C is corrected by anticoagulant cofactor activity found to be a property of factor V. *Proc Natl Acad Sci USA* 1994; **91**: 1396-1400.
- 3 BERTINA RM, KOELEMAN PC, KOSTER T *et al*. Mutation in blood coagulation factor V associated with resistance to activated protein C. *Nature* 1994; **369**: 64-67.
- 4 VOORBERG J, ROELSE J, KOOPMAN R *et al*. Association of idiopathic venous thromboembolism with single point-mutation at Arg506 of factor V. *Lancet* 1994; **343**: 1535-1536.
- 5 ZÖLLER B, DAHLBÄCK B. Linkage between inherited resistance to activated protein C and factor V gene mutation in venous thrombosis. *Lancet* 1994; **343**: 1536-1538.
- 6 TUDDENHAM EGD. Thrombophilia: The new factor is old factor V. *Lancet* 1994; **343**: 1515-1516.
- 7 SVENSSON PJ, DAHLBÄCK B. Resistance to activated protein C as a basis for venous thrombosis. *N Engl J Med* 1994; **330**: 517-521.

- 8 KOSTER T, ROSENDAAL FR, DE RONDE H *et al*. Venous thrombosis due to poor anticoagulant response to protein C: Leiden Thrombophilia Study. *Lancet* 1993; **342**: 1503-1506.
- 9 GRIFFIN JH, EVATT B, WIDEMAN C, FERNANDEZ JA. Anticoagulant protein C pathway defective in majority of thrombophilic patients. *Blood* 1993; **82**: 1989-1993.
- 10 ROSENDAAL FR, KOSTER T, VANDENBROUCKE JP, REITSMA PH. High risk in patients homozygous for factor V-Leiden (Activated Protein C resistance). *Blood* 1995; **85**: 1504-1508.
- 11 HALBMAYER WM, HAUSHOFER A, SCHÖN R, FISCHER M. The prevalence of poor anticoagulant response to activated protein C (APC-resistance) among patients suffering from stroke or venous thrombosis and among healthy subjects. *Blood Coagul Fibrinolysis* 1994; **5**: 51.
- 12 SVENSSON PJ, ZÖLLER B, MATTIASSON I, DAHLBÄCK B. The factor V R506 Q mutation causing APC-resistance is highly prevalent amongst unselected outpatients with clinically suspected deep venous thrombosis. *J Intern Med* 1997; **241**: 379-385.
- 13 RIDKER PM, HENNEKENS CH, LINDPAINTNER K *et al*. Mutation in the gene coding for coagulation factor V and the risk of myocardial infarction, stroke, and venous thrombosis in apparently healthy men. *N Engl J Med* 1995; **332**: 912-917.
- 14 EMMERICH J, POIRIER O, EVANS A *et al*. Myocardial infarction, Arg 506 to Gln factor V mutation, and activated protein C resistance. *Lancet* 1995; **345**: 321.
- 15 ERITSLAND J, GJÖNNES G, SANDSET PM, SELJEFLØT I, ARNESEN H. Activated protein C resistance and graft occlusion after coronary artery bypass surgery. *Thromb Res* 1995; **79**: 223-226.
- 16 OURIEL K, GREEN RM, DEWEESE JA, CIMINO C. Activated protein C resistance: Prevalence and implications in peripheral vascular disease. *J Vasc Surg* 1996; **23**: 46-52.
- 17 DONALDSON MC, BELKIN M, WHITTEMORE AD *et al*. Impact of activated protein C resistance on general vascular surgical patients. *J Vasc Surg* 1997; **25**: 1054-1060.
- 18 SWEDVASC. Vascular Surgical audit during a five year period. Changing patterns of vascular surgery 1987-1991. *Eur J Vasc Endovasc Surg* 1994; **8**: 472-477.
- 19 ZÖLLER B, SVENSSON PJ, HE X, DAHLBÄCK B. Identification of the same factor gene mutation in 47 out of 50 thrombosis-prone families with inherited resistance to activated protein C. *J Clin Invest* 1994; **94**: 2521-2524.
- 20 PAASKE WP, EUROVASC REPORT 1997. Vascular and Endovascular Surgical Activity in Denmark, Finland, Norway, Sweden and Northern Ireland. *Eur J Vasc Endovasc Surg* 1999; **17**: 537-538.
- 21 ZÖLLER B, GARCIA DE FRUTOS P, HILLARP A, DAHLBÄCK B. Thrombophilia as a multigenic disease. *Haematologica* 1999; **84**: 59-70.
- 22 DAHLBÄCK B. Factor V gene mutation causing inherited resistance to activated protein C as a base for venous thromboembolism. *J Intern Med* 1995; **237**: 221-227.
- 23 VANDENBOUCKE JP, KOSTER T, BRIET E *et al*. Increased risk of venous thrombosis in oral-contraceptive users who are carriers of factor V-Leiden mutation. *Lancet* 1994; **344**: 1453-1457.
- 24 KONTULA K, YLIIKORALA A, MIETTINEN H *et al*. Arg506Gln factor V mutation (factor V-Leiden) in patients with ischemic cerebrovascular disease and survivors of myocardial infarction. *Thromb Haemost* 1995; **73**: 558-560.
- 25 CATTO A, CARTER A, IRELAND H *et al*. Factor V-Leiden Gene mutation and thrombin generation in relation to the development of acute stroke. *Arterioscler Thromb Vasc Biol* 1995; **15**: 783-785.
- 26 SAMPRAM ESK, LINDBLAD B, DAHLBÄCK B. Activated protein C resistance in patients with peripheral vascular disease. *J Vasc Surg* 1998; **28**: 624-629.
- 27 FISHER CM, TEW K, APPLEBERG M. Prevalence and outcome of activated protein C resistance in patients after peripheral arterial bypass grafts. *Cardiovasc Surg* 1999 Aug; **7**(5): 519-525.

Accepted 5 May 2001









ORIGINAL ARTICLE

## Arterial Thrombosis in Mice with Factor V Leiden Mutation

Ellis S. Sampram<sup>\*†‡</sup>, Yasser Saad<sup>\*</sup>, and Kenneth Ouriel<sup>\*</sup>

The factor V Leiden (FVL) mutation has been demonstrated to be associated with the development of venous thrombosis in humans. Whether such a propensity also exists in the arterial circulation remains controversial. In an effort to minimize the variability that clouds the clinical study of arterial thrombosis, we studied FVL-associated arterial thrombosis in an experimental model of homozygous, heterozygous, and wild-type mice. Heterozygous FVL mice were crossbred to C57BL/6J mice over several generations. The genotypes of the resulting three genotype groups (wild type, heterozygous FVL, and homozygous FVL) were blinded to the investigators. Arterial injury was produced with the injection of ferric chloride into an isolated segment of carotid artery. Arterial thrombosis was assessed with an ultrasonic flow probe and the time to occlusion (TTO) was recorded. The carotid artery occluded within 60 minutes of injury in 72 of the animals studied (97.3%). The carotid artery remained patent at 60 minutes in the remaining two animals, both of whom were subsequently found to be genotypically wild type. There was a statistically significant relationship between TTO and genotype ( $p = .002$ ). TTO was greatest in the wild-type mice ( $p < .001$  vs heterozygous,  $< .001$  vs homozygous) and least in the homozygotes ( $p < .001$  vs heterozygotes). Increased thrombogenicity is present in mice with the FVL mutation and is more prolonged in homozygotes than heterozygotes. These findings provide some corroboration to the clinical studies that suggest an increased risk of arterial events in patients with the FVL mutation.

**Key words:** factor V Leiden, factor V mutation, hemophilia, hypercoagulable state, mice, vascular injury

Protein C is one of the key regulatory proteins in the coagulation cascade. Activated protein C (APC) is an antithrombotic protein that cleaves and inactivates factor Va and VIIIa, thereby inhibiting the coagulation cascade. Resistance to APC has been described in some patient groups with deep venous thrombosis (DVT),<sup>1,2</sup> documented to be due to a point mutation in the gene encoding factor V (Arg<sup>506</sup>→Gln),<sup>1-8</sup> also called the factor V Leiden (FVL) mutation. As a result of this point mutation, APC is unable to cleave factor Va and inhibit the coagulation cascade, resulting in a lifelong procoagulatory condition with an increased risk of thrombosis in humans. The FVL mutation has been shown to be the most occurring risk factor, known to date, for hypercoagulability.

Studies have documented APC resistance owing to FVL in 20 to 60% of patients with DVT.<sup>3</sup> By contrast, the

impact of the FVL mutation on arterial thrombogenicity remains ill-defined. We hypothesized that APC resistance on the basis of FVL mutation may predispose to thrombosis following vascular injury. Recently, mice have been generated carrying heterozygous (FvQ/+) and homozygous (FvQ/Q) factor V mutations.<sup>9</sup> We chose to use this animal model of FVL to determine whether this genotypic variant predisposes to the development of arterial occlusion following vascular injury.

### Materials and Methods

#### Animals

All experimental procedures were approved by The Cleveland Clinic Foundation Animal Committee on Use and Care of Laboratory Animals. Knockout mice carrying the FVL mutation, as previously described, were used.<sup>9,10</sup> Two pairs of heterozygous FVL mice were obtained (Dr. David Ginsburg, University of Michigan, Ann Arbor, MI) and were crossbred to C57BL/6J mice for more than eight generations. The offspring comprising the three genotype groups (wild type, heterozygous FVL, and homozygous

\*Department of Vascular Surgery, The Cleveland Clinic, Cleveland, OH;

†Department of Peripheral Vascular Diseases, Malmö University Hospital, Malmö Sweden, Lund University, Lund, Sweden;

‡Department of Surgery, North Shore University Hospital and Long Island Jewish Medical Center, Long Island, Manhasset, NY.

Correspondence to: Ellis Sampram, MD, 227 Washington Avenue, Garden City, NY 11530; e-mail: esampram@gmail.com.

FVL) were blinded to the investigators (Table 1). On reaching adulthood (32–52 weeks of age, weight 25–30 g), the animals were anesthetized (intraperitoneal pentobarbital, 120 mg/kg) and placed on a warm blanket maintained at 37°C (Figure 1) using an experimental set-up previously described.<sup>11–16</sup> The common carotid artery was exposed through a midline cervical incision and was isolated using a dissecting microscope with digital imaging capabilities. An ultrasonic flow probe (Model 0.5VB, Transonic Systems, Ithaca, NY) was positioned around the common carotid artery and the vessel was bathed in 0.9% sodium chloride solution to allow continuous flow monitoring using data acquisition software (WinDaq, DataQ Instruments, Akron, OH).

#### Endothelial Injury

The sodium chloride solution was removed from the wound and filter paper (0.5 × 1.0 mm) saturated with 10% ferric chloride (FeCl<sub>3</sub>) was applied to the adventitial surface of the carotid artery at a point immediately proximal to the flow probe. The filter paper was removed after 3 minutes and saline was replaced in the wound. Carotid blood flow was continuously monitored and the

time to occlusion (TTO) was defined as the duration between removal of the FeCl<sub>3</sub> filter paper and the cessation of flow. The experiment was terminated after 60 minutes in animals that did not develop occlusion. The pathophysiology of FeCl<sub>3</sub> vascular injury has been described.<sup>16</sup>

#### Genotype

At the end of each experiment, the toes and the tail of each mouse were amputated, frozen, and stored for future genotyping. Genotyping was performed on the frozen tail tissue with polymerase chain reaction as previously described.<sup>11</sup>

#### Statistical Analyses

Differences in the actual versus expected genotype frequencies were assessed with the chi-square test. The statistical significance of differences in TTO between the various groups was assessed with the Student *t*-test to compare two groups and with one-way analysis of variance (followed by pairwise post hoc comparison) when multiple groups were compared. A two-tailed *p* value of less than .05 was considered significant.

Table 1. Frequency of the Three Genotypes in the 74 Animals Bred to Adulthood

Genotypic Group	Genotype	Number of Animals
Wild type	Fv+/+	25
Heterozygous	FvQ/+	44
Homozygous	FvQ/Q	5

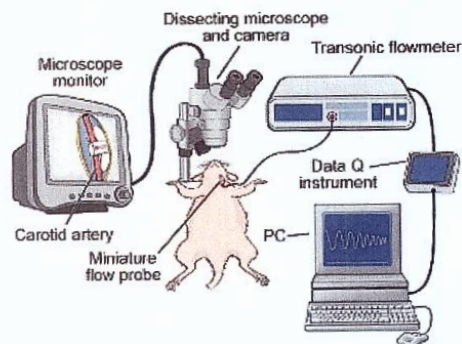

Figure 1. The experimental study set-up. Reprinted with the permission of The Cleveland Clinic Center for Medical Art & Photography® 2008. All rights reserved.

#### Results

Seventy-four offspring were successfully bred to adulthood and underwent genotypic analysis. By genotypic analysis, 33.8% were wild type, 59.5% were heterozygous, and 6.8% were homozygous for the FVL mutation (see Table 1). These frequencies were significantly different from the expected ratio of 25% wild type, 50% heterozygotes, and 25% homozygotes ( $p = .001$ ), suggesting a link between early mortality and the homozygous genotype.

Overall, 72 of 74 animals occluded the carotid vessel within 60 minutes of FeCl<sub>3</sub>. The two animals that did not develop occlusions were subsequently demonstrated to be genotypically wild type. The TTO differed among the three genotypes ( $p = .002$ ; Table 2). TTO was greatest in the wild-type mice ( $p < .001$  vs heterozygous,  $< .001$  vs

Table 2. Time to Occlusion in the Three Genotype Groups

Genotype	n	TTO (s) SD	95% CI
Wild type	23	290 ± 146	230–350
Heterozygous FVL	44	132 ± 50	116–147
Homozygous FVL	5	21 ± 21	0–48

CI = confidence interval; FVL = factor V Leiden; TTO = time to occlusion.



homozygous) and least in the homozygotes ( $p < .001$  vs heterozygotes).

## Discussion

Dahlback and colleagues first described APC resistance in 1993.<sup>1</sup> Knowledge of this abnormality, related to a mutation that is associated with abnormal factor V, has grown tremendously since then. FVL is now described as the most occurring genetic risk factor for vascular thrombosis.<sup>2-4,7,8</sup> Patients heterozygous for FVL exhibit a fivefold increase in the rate of thrombosis.<sup>17</sup> In homozygotes, the risk is dramatically increased to as much as 80 times that of the general population.<sup>17</sup> But in contrast to a solid association between FVL and venous thrombosis, the data relating FVL and arterial events remain controversial. Nevertheless, some clinical studies suggest an increased risk of thrombosis after arterial revascularization,<sup>18-25</sup> implicating vessel wall injury during the revascularization procedure as the triggering event. Not unexpectedly, the relationship between FVL and failure of arterial reconstructive procedures appears especially high in homozygotes. These findings are not universal, however, and several studies have failed to detect a solid relationship between FVL and arterial occlusion.<sup>26-28</sup>

Paradoxically, clinical studies have preceded basic investigation on FVL and arterial occlusion. Noting the paucity of well-controlled experimental data, we sought to investigate the relationship between FVL and arterial thrombosis in a knockout animal model. Systematic back-crossbreeding produced 22 wild types, 44 heterozygotes, and 5 homozygotes. These frequencies differed substantially from the expected mendelian inheritance frequencies of 25%, 50%, and 25%, respectively. During the breeding process, there were many perinatal deaths. The genotype of these animals was not tested since the blinding dictated by the experimental protocol did not allow knowledge of animal genotypes during the experiment. Nevertheless, it is quite likely that many of the deaths occurred in homozygotes, a contention consistent with the known association between human FVL and spontaneous abortion.<sup>29-32</sup> Our frequencies would suggest an 80% perinatal mortality rate in homozygotes, and previous studies demonstrated widespread multiorgan thrombosis in FVL mice that died during the perinatal period.<sup>10</sup>

Our study documented more rapid vascular thrombosis in the setting of FVL and arterial injury. This finding was more prominent in homozygous mice compared with heterozygotes. A recent study by Eitzman and colleagues,

using rose Bengal, found similar results to our study.<sup>33</sup> Although clinical data have been conflicting, with some studies demonstrating an increase in the risk of arterial events and others not, the well-controlled laboratory setting minimized variability and confirmed the relationship between FVL and arterial thrombosis. Noting the importance of APC and the role of factor V in intrinsic anticoagulation, an increased risk in FVL mice was not unexpected.

This finding has clinical relevance; the presence of FVL would be anticipated to be a risk factor for such arterial events as in situ thrombosis over an atherosclerotic plaque or occlusion of a vascular reconstructive procedure. It raises the question of whether patients with FVL develop arterial complications in the presence of more mild disease. For instance, are FVL patients more susceptible to cerebral embolization in the setting of a lower-profile carotid bifurcation plaque? Are patients with lesser degrees of restenosis at the site of a coronary or peripheral arterial stent more likely to develop occlusion? These and other clinical questions can be answered only by thoughtful, well-designed clinical studies; our experimental findings serve only to stimulate the performance of clinical analyses. Until such data are available, clinicians should maintain a high index of suspicion for FVL in patients with failed arterial reconstructions. As well, one should have a lowered threshold for the use of periprocedural antithrombotic therapy in patients with known FVL.

## References

1. Dahlback B, Carlsson M, Svensson PJ. Familial thrombophilia due to a previously unrecognized mechanism characterized by poor anticoagulant response to activated protein C: prediction of a cofactor to activated protein C. *Proc Natl Acad Sci U S A* 1993;90:1004-8.
2. Dahlback B. Inherited thrombophilia: resistance of activated protein C as a pathogenic factor of venous thromboembolism. *Blood* 1995;85:507-14.
3. Koster T, Rosendaal FR, de Ronde H, et al. Venous thrombosis due to poor anticoagulant response to activated protein C: Leiden thrombophilia study. *Lancet* 1993;342:1503-6.
4. Svensson PJ, Dahlback B. Resistance to activated protein C as a basis for venous thrombosis. *N Engl J Med* 1994;330:517-22.
5. Bertina RM, Koeleman BPC, Koster T, et al. Mutation in blood coagulation factor V associated with resistance to activated protein C. *Nature* 1994;369:64-7.
6. Greengard JS, Sun X, Xu X, et al. Activated protein C resistance caused by Arg<sup>506</sup>Gln mutation in factor Va. *Lancet* 1994;343:1361-2.
7. Zoller B, Svensson PJ, He X, Dahlback B. Identification of the same factor V gene mutation in 47 out of 50 thrombosis-prone families

- with inherited resistance to activated protein C. *J Clin Invest* 1994; 94:2521-4.
8. Vooberg J, Roelse J, Koopman R, et al. Association of idiopathic venous thromboembolism with single point-mutation at Arg<sup>506</sup> of factor V. *Lancet* 1994;343:1535-6.
  9. Yang TL, Cui J, Rehmtulla A, et al. The structure and function of murine factor V and its inactivation by protein C. *Blood*. 1998;91: 4593-9.
  10. Cui J, Eitzman DT, Westrick RJ, et al. Spontaneous thrombosis in mice carrying the factor V Leiden mutation. *Blood* 2000;96:4222-6.
  11. Farrehi PM, Ozaki CK, Carmeliet P, et al. Regulation of arterial thrombolysis by plasminogen activator inhibitor-1 in mice. *Circulation* 1998;97:1002-8.
  12. Kurz KD, Main BW, Sandusky GE. Rat model of arterial thrombosis induced by ferric chloride. *Thromb Res* 1990;60:269-80.
  13. Zhu Y, Farrehi PM, Fay WP. Plasminogen activator inhibitor type 1 enhances neointima formation after oxidative vascular injury in atherosclerosis-prone mice. *Circulation* 2001;103:3105.
  14. Zhu Y, Carmeliet P, Fay WP. Plasminogen activator inhibitor-1 is a major determinant of arterial thrombolysis resistance. *Circulation* 1999;99:3050-5.
  15. Dorffler-Melly J, Schwarte LA, Ince C, Levi M. Mouse models of focal arterial and venous thrombosis. *Basic Res Cardiol* 2000;95: 503-9.
  16. Konstantinides S, Schafer K, Thinnis T, Loskutoff DJ. Plasminogen activator inhibitor-1 and its cofactor vitronectin stabilize arterial thrombi after vascular injury in mice. *Circulation* 2001;103:576-83.
  17. Franchini M, Veneri D. Inherited thrombophilia: an update. *Clin Lab* 2005;51:357-65.
  18. Burns PJ, Mosquera DA, Bradbury AW. Prevalence and significance of thrombophilia in peripheral arterial disease. *Eur J Vasc Endovasc Surg* 2001;22:98-106.
  19. Sampram ES, Lindblad B. The impact of factor V mutation on the risk for occlusion in patients undergoing peripheral vascular reconstructions. *Eur J Vasc Endovasc Surg* 2001;22:134-8.
  20. Fisher CM, Tew K, Appleberg M. Prevalence and outcome of activated protein C resistance in patients after peripheral arterial bypass grafts. *Cardiovasc Surg* 1999;7:519-25.
  21. Ray SA, Rowley MR, Bevan DH, et al. Hypercoagulable abnormalities and postoperative of arterial reconstruction. *Eur J Endovasc Surg* 1997;13:363-70.
  22. Ouriel K, Green RM, De Weese JA, Cimino C. Activated protein C resistance: prevalence and implications in peripheral vascular disease. *J Vasc Surg* 1996;23:46-52.
  23. Vig S, Chitolie A, Sleight S, et al. Prevalence and risk of thrombophilia defects in vascular patients. *Eur J Vasc Endovasc Surg* 2004;28:124-31.
  24. Aleksic M, Jahn P, Heckenkamp J, et al. Comparison of the prevalence of APC-resistance in vascular patients and in a normal population cohort in western Germany. *Eur J Vasc Endovasc Surg* 2005;30:160-3.
  25. Girolami A, Simioni P, Scarano L, Girolami B. Advances in basic, laboratory and clinical aspects of thromboembolic diseases. Venous and arterial thrombophilia. *Haematologica* 1997;82:96-100.
  26. Ardissino D, Mannucci PM, Merlini PA, et al. Prothrombotic genetic risk factors in young survivors of myocardial infarction. *Blood* 1999;94:46-51.
  27. Rosendaal FR, Siscovick DS, Schwartz SM, et al. Factor V Leiden (resistance to activated protein C) increases the risk of myocardial infarction in young women. *Blood* 1997;89:2817-21.
  28. Juul K, Tybjaerg-Hansen A, Steffensen R, et al. Factor V Leiden: the Copenhagen City Heart Study and 2 meta-analyses. *Blood* 2002; 100:3-10.
  29. Rey E, Kahn SR, David M, Shrier I. Thrombophilic disorders and fetal loss: a meta-analysis. *Lancet* 2003;361:901-8.
  30. Kupfermine MJ, Elder A, Steinman N, et al. Increased frequency of genetic thrombophilia in women with complications of pregnancy. *N Engl J Med* 1999;340:9-13.
  31. Dizon-Townson DS, Meline L, Nelson LM, et al. Fetal carriers of the factor V Leiden mutation are prone to miscarriage and placental infarction. *Am J Obstet Gynecol* 1997;177:402-5.
  32. Younis JS, Ohel G, Brenner B, Ben-Ami M. Familial thrombophilia—the scientific rationale for thrombophylaxis in recurrent pregnancy loss. *Hum Reprod* 1997;12:1389-90.
  33. Eitzman DT, Westrick RJ, Shen Y, et al. Homozygosity for factor V Leiden leads to enhanced thrombosis and atherosclerosis in mice. *Circulation* 2005;111:1822-5.

