



LUND UNIVERSITY

Molecular Mechanisms in Amyloid Disorders. Novel Treatment Options in Hereditary Cystatin C Amyloid Angiopathy.

Östner, Gustav

2013

[Link to publication](#)

Citation for published version (APA):

Östner, G. (2013). *Molecular Mechanisms in Amyloid Disorders. Novel Treatment Options in Hereditary Cystatin C Amyloid Angiopathy*. [Doctoral Thesis (compilation), Division of Clinical Chemistry and Pharmacology]. Division of Clinical Chemistry and Pharmacology, Faculty of Medicine, Lund University.

Total number of authors:

1

General rights

Unless other specific re-use rights are stated the following general rights apply:

Copyright and moral rights for the publications made accessible in the public portal are retained by the authors and/or other copyright owners and it is a condition of accessing publications that users recognise and abide by the legal requirements associated with these rights.

- Users may download and print one copy of any publication from the public portal for the purpose of private study or research.
- You may not further distribute the material or use it for any profit-making activity or commercial gain
- You may freely distribute the URL identifying the publication in the public portal

Read more about Creative commons licenses: <https://creativecommons.org/licenses/>

Take down policy

If you believe that this document breaches copyright please contact us providing details, and we will remove access to the work immediately and investigate your claim.

LUND UNIVERSITY

PO Box 117
221 00 Lund
+46 46-222 00 00

Molecular Mechanisms in Amyloid Disorders

Novel Treatment Options in Hereditary Cystatin C Amyloid Angiopathy

GUSTAV RANHEIMER ÖSTNER

Clinical Chemistry
Department of Laboratory Medicine
Lund University, Sweden



LUND
UNIVERSITY

DOCTORAL DISSERTATION

by due permission of the Faculty of Medicine, Lund University, Sweden,
to be defended at Wallenberg Neurocenter, *Segerfalksalen*, Sölvegatan 17, Lund,
Saturday 14th of September 2013 at 9.15 a.m.

Faculty opponent

Professor Elvar Theodorsson
Clinical Chemistry
Department of Clinical and Experimental Medicine
Linköping University, Sweden

Organization LUND UNIVERSITY, Faculty of Medicine Dep. of Laboratory Medicine, Clinical Chemistry Author: Gustav Ranheimer Östner	Document name: Doctoral Dissertation Date of issue: September 14 th 2013 Sponsoring organization
Title and subtitle: Molecular Mechanisms in Amyloid Disorders. Novel Treatment Options in Hereditary Cystatin C Amyloid Angiopathy.	
Abstract <p>The pathophysiological process in Alzheimer's disease and other amyloid disorders usually involves the transformation of a soluble monomeric protein via potentially toxic oligomers into amyloid fibrils. The structure and properties of the intermediary oligomers have been difficult to study due to their instability and dynamic equilibrium with smaller and larger species. This has hampered the development of a deeper understanding of the molecular pathophysiology of the disorders and strategies for their treatment. In hereditary cystatin C amyloid angiopathy (HCCAA), a cystatin C variant is deposited in arterial walls and causes brain hemorrhage in young adults. Although carriers of the cystatin C variant may be easily identified by genetic testing, no treatments are available.</p> <p>In the present investigation, redox experiments involving a recombinant double-cysteine mutant of cystatin C were used to generate stable oligomers (dimers, trimers, tetramers, decamers and high-molecular-weight oligomers) and these were characterised concerning size, shape and function. The results showed the oligomers to be highly ordered, domain-swapped assemblies of cystatin C and that the oligomers could not build larger oligomers, or fibrils, without domain swapping. The stabilised oligomers were used to induce antibody formation in rabbits. Oligomer-specific antibodies were obtained and these could be used to selectively remove cystatin C dimers from biological fluids containing both dimers and monomers.</p> <p>A miniaturised high-throughput system was developed and used to test 12 monoclonal antibodies and 1040 drugs in a clinical drug library for their capacity to reduce cystatin C dimer formation <i>in vitro</i>. Several candidates for treatment of HCCAA could be identified.</p> <p>In a different set of patients, scheduled for elective surgery, the plasma levels of cystatin C, creatinine and four inflammatory markers were studied in order to investigate the influence of inflammation on cystatin C, to evaluate its usefulness as a marker of glomerular filtration rate (GFR, 'kidney function'). The cystatin C level did not change significantly during the observation period (seven days) and did not correlate with the level of any of the four inflammatory markers, and thus, the inflammatory status of a patient does not influence the role of cystatin C as a marker of GFR.</p>	
Key words cystatin C, amyloid, amyloidosis, oligomers, domain swapping	
Classification system and/or index terms (if any)	
Supplementary bibliographical information	Language: English
ISSN and key title: 1652-8220	ISBN: 978-91-87449-50-5
Recipient's notes	Number of pages: 98 Price Security classification

Signature _____ Date _____

Lund University, Faculty of Medicine Doctoral Dissertation Series 2013:78

Molecular Mechanisms in Amyloid Disorders

Novel Treatment Options in Hereditary Cystatin C Amyloid Angiopathy

GUSTAV RANHEIMER ÖSTNER



LUND
UNIVERSITY

2013

Cover: Cystatin C amyloid oligomers (*green*), formed by propagated domain swapping of ten monomeric subunits (*i.e.* decamers); antibody (*blue*), specific for oligomer epitopes; map, illustrating the scientific collaboration between Lund and Reykjavik.

© Gustav Ranheimer Östner

Clinical Chemistry
Department of Laboratory Medicine
Lund University Hospital, Sweden

Lund University
Faculty of Medicine Doctoral Dissertation Series 2013:78
ISBN 978-91-87449-50-5
ISSN 1652-8220

Printed in Sweden by Media-Tryck, Lund University
Lund 2013



**CLIMATE
COMPENSATED
PAPER**



REPA[®]
A part of FTI (the Packaging and
Newspaper Collection Service)

To my beloved family



The author on a field trip to Silfrá; a lagoon created by crystal clear water from a melting jökull. Tingvallavatn, Iceland, 2009.



The author with his family in August 2013. The youngest member arrived in the middle of the preparation of this thesis. From left: Gustav, Sofia, Axel, Vilgot, Hulda, Baby Östner.

Dissertation Committee

- Project Advisor:** Anders Grubb, MD, Professor
Clinical Chemistry, Department of Laboratory
Medicine, Lund University, Sweden
- Assistant Advisor:** Magnus Abrahamson, Associate Professor
Head and Chair, Department of Laboratory
Medicine, Lund University, Sweden
- Faculty Opponent:** Elvar Theodorsson, MD, Professor
Clinical Chemistry, Department of Clinical and
Experimental Medicine, Linköping University,
Sweden
- Examining Committee:** Catharina Svanborg, MD, Professor
Microbiology, Immunology and Glycobiology,
Department of Laboratory Medicine, Lund
University, Sweden
- Katrin Mani, MD, Associate Professor
Glycobiology, Department of Experimental
Medical Science, Lund University, Sweden
- Daniel Otzen, Professor
iNANO and Department of Molecular Biology
and Genetics, Aarhus University, Denmark

Abstract

The pathophysiological process in Alzheimer's disease and other amyloid disorders usually involves the transformation of a soluble monomeric protein via potentially toxic oligomers into amyloid fibrils. The structure and properties of the intermediary oligomers have been difficult to study due to their instability and dynamic equilibrium with smaller and larger species. This has hampered the development of a deeper understanding of the molecular pathophysiology of the disorders and strategies for their treatment. In hereditary cystatin C amyloid angiopathy (HCCAA), a cystatin C variant is deposited in arterial walls and causes brain hemorrhage in young adults. Although carriers of the cystatin C variant may be easily identified by genetic testing, no treatments are available.

In the present investigation, redox experiments involving a recombinant double-cysteine mutant of cystatin C were used to generate stable oligomers (dimers, trimers, tetramers, decamers and high-molecular-weight oligomers) and these were characterised concerning size, shape and function. The results showed the oligomers to be highly ordered, domain-swapped assemblies of cystatin C and that the oligomers could not build larger oligomers, or fibrils, without domain swapping. The stabilised oligomers were used to induce antibody formation in rabbits. Oligomer-specific antibodies were obtained and these could be used to selectively remove cystatin C dimers from biological fluids containing both dimers and monomers.

A miniaturised high-throughput system was developed and used to test 12 monoclonal antibodies and 1040 drugs in a clinical drug library for their capacity to reduce cystatin C dimer formation *in vitro*. Several candidates for treatment of HCCAA could be identified.

In a different set of patients, scheduled for elective surgery, the plasma levels of cystatin C, creatinine and four inflammatory markers were studied in order to investigate the influence of inflammation on cystatin C, to evaluate its usefulness as a marker of glomerular filtration rate (GFR, 'kidney function'). The cystatin C level did not change significantly during the observation period (seven days) and did not correlate with the level of any of the four inflammatory markers, and thus, the inflammatory status of a patient does not influence the role of cystatin C as a marker of GFR.

Sammanfattning på svenska (Summary in Swedish)

Ett felaktigt protein som klumpar ihop sig i hjärnans blodkärl är orsaken till hjärnblödning och för tidig död hos unga islänningar. Sjukdomen är ärftlig och uppkommer på grund av en enda felaktig byggsten, orsakad av en mutation, i proteinet cystatin C. Det muterade proteinet bildar mikroskopiska proteinkedjor, fibriller, som klumpar ihop sig i bland annat hjärnans blodkärl. Detta leder så småningom till att blodkärlet spricker och det uppstår en hjärnblödning.

Med genteknik har den felaktiga genen hos islänningarna tidigare kopierats. En syntetisk version av genen har förts in i bakterier, som kan tillverka det muterade proteinet i laboratorief flaskor. Genom att i flera steg rena fram det isländska proteinet från bakterierna, är det möjligt att studera hur proteinet beter sig i lösningar som liknar kroppens egna. Dessa undersökningar har visat att proteinet bildar par genom att två proteinmolekyler hakar i varandra, så kallat domänutbyte. Samma domänutbytesmekanism, där flera molekyler hakar i varandra, ligger bakom bildandet av de långa proteinkedjorna, fibrillerna. Detta innebär att en substans som blockerar domänutbytet, skulle kunna användas i ett läkemedel för att förhindra fibrillbildning hos patienterna.

I ett av projekten som beskrivs i föreliggande avhandling, var målet att hitta substanser som verkar stabiliserande och förhindrar domänutbyte hos det muterade proteinet. Ett experimentellt system, där proteinet efter upprening försiktigt värmdes upp för att få proteinet att byta domäner och bilda par, provades noggrant ut. Proteiner är normalt sett känsliga för värme och det var en stor utmaning att hitta precis rätt förhållande för att driva på domänutbyte, utan att förstöra proteinet. Det finns ett obegränsat antal kemiska substanser som skulle kunna fungera, och det skulle ta oändligt lång tid att testa substanser en i taget. Därför var ett viktigt delmål att utforma ett testsystem där ett stort antal substanser kan testas samtidigt. Men det var mödosamt och tidskrävande att rena fram de mängder av proteinet som behövdes, och därför utvecklades ett snabbtest i miniatyrformat. För att testa om en substans, i det nya systemet, kunde blockera parbildning hos det muterade proteinet, krävdes endast två mikrogram cystatin C i en tiomikroliters portion. Detta gjorde det möjligt att gå igenom 1040 kända läkemedel för att se om de har någon

stabiliserande effekt. Ett antal olika antikroppar testades också, och sammantaget hittades ett flertal kandidater som verkade stabiliserande. Dessa utvärderas nu ytterligare i andra experimentella system, för att de bästa substanserna skall kunna väljas ut.

Ett flertal andra obotliga sjukdomar, till exempel Alzheimers sjukdom och Creutzfeldt-Jakobs sjukdom; det vill säga den mänskliga formen av *galna ko-sjukan*, orsakas av att proteiner, andra än cystatin C, bildar fibrillklumpar. Vid dessa sjukdomar, samt även vid isländsk hjärnblödning, har man i elektronmikroskop sett speciella ringformer, som uppträder före fibrillerna bildas. Dessa ringformer har visats vara mycket giftigare för celler än fibriller. Mellanformerna har dock varit svåra att undersöka, beroende på att de är flyktiga och inte låter sig isoleras. Med bristande kunskaper om de molekylära mekanismer som orsakar denna grupp av sjukdomar har inga verksamma läkemedel kunnat utvecklas. Eftersom domänutbytesmekanismen har konstaterats också vid Creutzfeldt-Jakobs sjukdom, finns skäl att misstänka att samma eller snarlika mekanismer ligger bakom flera sjukdomar i denna grupp.

I en av studierna användes en designad genvariant av cystatin C som, i precis rätt kemisk miljö, kunde förmås att bilda stabila mellanformer. Det miniatyriserade testsystemet var här mycket användbart, eftersom ett stort antal kemiska förhållanden behövde prövas ut, innan de stabila mellanformerna kunde erhållas. Efter en framgångsrik upprepningsprocedur kunde mellanformerna undersökas gällande storlek, form och funktion. Alla mellanformer, vilka bestod av två, tre, fyra och tio länkade molekyler samt en ännu större form, visade sig ha bildats genom domänutbyte. Ingen av dem kunde bygga större former, eller fibriller, utan domänutbyte, och mellanformen som bestod av tio molekyler hade en tydlig ringform när den undersöktes i elektronmikroskop. De stabiliserade mellanformerna användes för att bilda antikroppar i kaniner. De antikroppar som erhöles var specifika för mellanformer och kunde, efter en särskild upprepningsprocedur, användas för att selektivt ta bort mellanformer av cystatin C i ett blodbaserat testsystem.

I ett tredje projekt studerades en egenskap hos cystatin C som är av betydelse för alla kategorier patienter, d.v.s. om halten av cystatin C i blod kan påvisa njursjukdom. I en grupp patienter, som skulle genomgå kirurgi, undersöktes om inflammation hos patienter påverkar halten av cystatin C i blodet, eller om halten till största delen beror på hur väl njurarna fungerar. Detta gjordes som ett led i att utvärdera om halten av cystatin C är ett användbart mått på njurfunktionen. Halten av cystatin C förändrades inte nämnvärt under observationsperioden och samvarierade inte med halten av någon av de fyra inflammationsmarkörerna som uppmättes. Alltså påverkar inte det inflammatoriska tillståndet hos en patient hur väl cystatin C fungerar som markör för njurfunktion.

Útdráttur á íslensku (Summary in Icelandic)

Gallað prótein sem fellur út í æðum heilans orsakar heilablæðingar og ótímabær dauðsföll hjá ungum Íslendingum. Sjúkdómurinn er ættgengur og er afleiðing aðeins eins rangs hlekks, punktstökkbreytingar, í próteininu cystatin C. Stökkbreytta próteinið myndar smásæjar próteinkeðjur sem líkjast reipi, trefjur, sem falla meðal annars út í æðum heilans. Þetta leiðir smám saman til þess að æð rofnar og heilablæðing á sér stað.

Gallaða genið hjá Íslendingunum hefur áður verið afritað með hjálp erfðataekni. Tilbúin gerð af geninu hefur verið flutt í bakteríur sem geta framleitt stökkbreytta próteinið í tilraunaglösom. Með því að einangra íslenska próteinið frá bakteríunum í mörgum þrepum er mögulegt að rannsaka hvernig próteinið hegðar sér í lausn sem líkist líkamsvessa. Þessar athuganir hafa sýnt að próteinið myndar pör með því að tvær próteinsameindir krækjast saman, svokölluð léna-skipti. Sama lénaskiptaferli, þar sem sameindir krækjast saman, á sér stað við myndun löngu próteinkeðjanna, trefjanna. Þetta þýðir að efni sem hindrar léna-skiptinguna væri hægt að nota í lyf sem kæmi í veg fyrir trefjumyndun hjá sjúklingum.

Í einu þeirra verkefna sem er lýst í fyrirbyggjandi ritgerð var markmiðið að finna efni sem gerir stökkbreytta próteinið stöðugra og hindrar léna-skiptingu hjá því. Tilraunakerfi, þar sem einangrað próteinið var hitað varlega til að fá það til að skipta um lén og mynda pör, var prófað nákvæmlega. Prótein eru venjulega næm fyrir hita svo það var ögrandi viðfangsefni að finna nákvæmlega réttar aðstæður til að koma af stað léna-skiptingu án þess að skemma próteinið. Til eru óteljandi efni sem gætu virkað og það myndi taka óendanlegan tíma að prófa efnin eitt í einu. Þess vegna var eitt mikilvægt undirmerkið að þróa prófunarkerfi sem gerir kleift að prófa mörg efni samtímis. Þar sem það var mikil þolinmæðisvinna og tímafrekt að einangra það magn af próteininu sem þörf var á, var þróað smáskala hraðpróf. Til að prófa hvort efni, í nýja kerfinu, gæti hindrað paramyndunina hjá stökkbreytta próteininu, var aðeins þ örf á tveimur míkrógrömmum cystatin C í tíu míkrólítra skammt. Með þessu móti var hægt að fara yfir 1040 þ ekkt lyf til að kanna hvort þ au hafi einhver hamlandi áhrif. Nokkur mismunandi mótefni voru líka prófuð, og samtals fundust mörg möguleg efni sem virkuðu hamlandi. Þ au eru nú prófuð enn frekar í öðrum tilraunakerfum til að hægt verði að velja bestu efnin.

Ástæða margra annarra ólæknandi sjúkdóma, til dæmis Alzheimer og Creutzfeldt-Jakob sjúkdómsins (*p.e.* kúariða) er að prótein, önnur en cystatin C, mynda trefjur. Í þessum sjúkdómum, auk íslenskra heilablæðinga, hafa greinst í rafeindasmásjá sérstök hringlaga form sem myndast áður en trefjurnar myndast. Komið hefur í ljós að þessi hringform eru miklu eittraðri fyrir frumur en trefjur. Erfitt hefur reynst að einangra og rannsaka milliformin vegna þess að þau eru hvarfgjörn og í jöfnu magni við minni og stærri form. Vegna þekkingarskorts á þeirri efnavirkni sem veldur þessari tegund sjúkdóma hafa engin virk lyf verið þróuð. Þar sem léna-skiptingaferillinn hefur einnig verið staðfestur í Creutzfeldt-Jakobs sjúkdómnum er ástæða til að ætla að sami eða sambærilegur ferill eigi sér stað í fleiri tengdum sjúkdómum.

Í einu verkefni var notað sérhannað genaafbrigði af cystatin C sem væri, í nákvæmlega réttu efnafræðilegu umhverfi, hægt að nota til að mynda stöðug milliform. Smáskala prófunarkerfið kom hér að góðum notum því prófa þurfti margar efnafræðilegar samsetningar áður en tókst að fá stöðug milliform. Eftir að ferillinn hafði verið endurtekinn með góðum árangri var hægt að athuga stærð, lögun og virkni milliformanna. Öll milliformin, sem samanstóðu af tveimur, þremur, fjórum og tíu hlekkjuðum sameindum auk enn stærri forma, höfðu myndast með léna-skiptum. Ekkert þeirra gat myndað stærri form eða trefjur án léna-skipta, og milliform sem samanstóðu af tíu próteinum höfðu greinilega myndað hringform þegar þau voru skoðuð í rafeindasmásjá. Stöðugu milliformin voru notuð til að mynda mótefni í kanínum. Mótefnin sem fengust voru sértæk fyrir milliformin og hægt var, eftir nákvæma einangrun þeirra, að nota þau til að fjarlægja milliform af cystatin C í blóð- grundvölluðu tilraunakerfi.

Í öðrum hópi sjúklinga, sem átti að undirgangast skurðaðgerð, var athugað hvort bólga hefði áhrif á magn cystatin C í blóði, eða hvort magnið ráðist aðallega af starfsemi nýrnanna. Þessi rannsókn var liður í að meta hvort magn cystatin C er nothæft til að mæla nýrnastarfsemina. Cystatin C magnið breyttist ekki markvert á meðan á rannsókninni stóð og tengdist ekki magni þeirra fjögurra bólgulífefna sem skoðuð voru. Þannig hefur bólguástand hjá sjúklingi ekki áhrif á hversu vel cystatin C virkar sem mælikvarði á nýrnastarfsemi.

List of Publications

This thesis is based on the following papers, referred to in the text by their Roman numerals. The papers are appended at the end of the thesis.

- I. Grubb, A., Björk, J., Nyman, U., Pollak, J., Bengzon, J., Östner, G., and Lindström, V.
CYSTATIN C, A MARKER FOR SUCCESSFUL AGING AND GLOMERULAR FILTRATION RATE, IS NOT INFLUENCED BY INFLAMMATION.
Scandinavian Journal of Clinical and Laboratory Investigation (2011) 71, 145-149

- II. Östner, G., Lindström, V., Postnikov, A. B., Solovyeva, T. I., Emilsson, S. I., and Grubb, A.
HIGH THROUGHPUT TESTING OF DRUG LIBRARY SUBSTANCES AND MONOCLONAL ANTIBODIES FOR CAPACITY TO REDUCE FORMATION OF CYSTATIN C DIMERS TO IDENTIFY CANDIDATES FOR TREATMENT OF HEREDITARY CYSTATIN C AMYLOID ANGIOPATHY.
Scandinavian Journal of Clinical and Laboratory Investigation (2011) 71, 676-682

- III. Östner, G., Lindström, V., Hjort Christensen, P., Kozak, M., Abrahamson, M., and Grubb, A.
STABILIZATION, CHARACTERIZATION AND SELECTIVE REMOVAL OF CYSTATIN C AMYLOID OLIGOMERS.
Journal of Biological Chemistry (2013) 288, 16438-16450

Contents

Abstract	vi
Sammanfattning på svenska (Summary in Swedish)	vii
Útdráttur á íslensku (Summary in Icelandic)	ix
List of Publications	xi
Abbreviations	xiv
Introduction	1
Protein Misfolding, Oligomers and Amyloid.....	2
<i>Amyloid formation and amyloidosis</i>	2
<i>Oligomers as potentially toxic intermediates</i>	7
<i>Protein misfolding in a cellular context</i>	9
<i>Modes of protein homeostasis deterioration</i>	12
Hereditary Cystatin C Amyloid Angiopathy.....	16
Cystatins and Cysteine Proteases.....	21
Alzheimer’s Disease and the Amyloid Cascade Hypothesis	23
Cystatin C in Alzheimer’s disease	27
Domain Swapping and Amyloid Formation	29
Cystatin C as a Marker of Glomerular Filtration Rate (‘Kidney Function’).....	32
Aims of the Study	35
Material and Methods	37
Patient Study Group and Biomarker Quantifications.....	37
Recombinant Protein Production and Purification	37
Clinical Drug Compound Library.....	38
Biochemical Assays	38
<i>High-throughput screening</i>	38
<i>Immunochemical methods</i>	39
<i>Separation methods</i>	39
<i>Oligomer production, stabilisation and purification</i>	39
<i>Enzyme activity assays</i>	40
Imaging Techniques.....	40
Antibody Production.....	40
Results and Discussion	41
Plasma Cystatin C is Not Influenced by Inflammation (Paper I).....	41
High-throughput Testing for HCCAA Drug Candidates (Paper II)	44
<i>Assay development</i>	45

<i>Screening of a drug library</i>	46
<i>Testing a panel of monoclonal antibodies</i>	49
Stabilisation and Selective Removal of Amyloid Oligomers (Paper III)	51
<i>Production and characterisation of stabilised oligomers</i>	51
<i>Biological activity of stabilised oligomers</i>	58
<i>Stabilised oligomers display general oligomer-epitopes</i>	60
<i>Propagated domain swapping is required in the formation of oligomers and fibrils</i>	61
<i>Production and purification of oligomer-specific antibodies</i>	64
<i>Reactivity of oligomer-specific antibodies in gel diffusion and on immunoblotting</i>	65
<i>Selectivity of oligomer-specific antibodies in free solution</i>	66
<i>Oligomer-specific antibodies selectively bind dimers in blood plasma</i>	66
Conclusions	73
Future Perspectives	75
Acknowledgements	77
References	81
Appendices	98

Abbreviations

AD	Alzheimer's disease
AFM	atomic force microscopy
APP	amyloid precursor protein
A β	amyloid- β peptide
CAA	cerebral amyloid angiopathy
CRP	C-reactive protein
CSF	cerebrospinal fluid
DMSO	dimethyl sulfoxide
DTT	dithiothreitol
ECM	extracellular matrix
EM	electron microscopy
ER	endoplasmic reticulum
ERAD	endoplasmic reticulum-associated degradation
GdnHCl	guanidine hydrochloride
GFR	glomerular filtration rate
HCCAA	hereditary cystatin C amyloid angiopathy
HMW	high-molecular-weight
HPLC	high-pressure liquid chromatography
IAPP	islet amyloid polypeptide
IL-1	interleukin 1
L68Q	glutamine has replaced leucine at position 68
MALDI-TOF-MS	matrix-assisted laser desorption/ionisation time-of-flight mass spectrometry
NFT	neurofibrillary tangles
pAb	polyclonal antibodies
PBS	phosphate-buffered saline
PD	Parkinson's disease
PDB	Protein Data Base
SAA	serum amyloid A
SDS-PAGE	sodium dodecylsulphate polyacrylamide gel electrophoresis
SEC	size-exclusion chromatography

TCEP	tris(2-carboxyethyl)phosphine
TNF- α	tumour necrosis factor α
TTR	transthyretin
UPR	unfolded protein response
wt	wildtype

Introduction

Misfolded proteins cause some of the most prevalent human diseases of our time. The growing number of patients affected by disorders caused by protein misfolding provides a major challenge for future healthcare. Today, Alzheimer's disease (AD) is one of the most prevalent chronic diseases in the aging population and Parkinson's disease (PD) is the second most prevalent neurodegenerative disease [1,2]. Neuropathologically, both conditions are characterised by insoluble protein deposits in the brain—in PD by intraneuronal α -synuclein inclusions called *Lewy bodies* and in AD by extracellular *amyloid- β plaques* and intracellular *tangles*. Protein misfolding is implicated in other pathologies like amyotrophic lateral sclerosis (ALS), Huntington's disease, the spongiform encephalopathies (prion diseases), age-related diabetes mellitus, cystatin C amyloidosis with brain hemorrhage (the main focus of this thesis) and a number of other conditions characterised by tissue amyloid deposition.

To date, at least 25 different amyloid-forming proteins involved in human disease have been identified [3]. Some of the resulting conditions show classical Mendelian inheritance, usually with an autosomal dominant pattern, but the most common are age-related and occur spontaneously in previously healthy individuals. Thus, amyloid disorders constitute a threat to anyone who is aging and not just to members of predisposed families. At the same time, studies of the rather uncommon inherited forms of amyloid disorders provide critical information about the genetic background, the basic mechanisms, and the pathophysiological consequences of protein misfolding and tissue amyloid deposition.

This investigation has been focused on the molecular mechanisms underlying amyloid formation and novel strategies to prevent amyloid disorders. In the laboratory, these disorders can be studied in cellular or pure protein systems. An advantage of using pure protein systems is the opportunity to define the behaviour of specific proteins to better understand the results obtained from studies of cells, tissues and intact patients. As will be highlighted throughout this text; by studying how purified proteins behave, and misbehave, in near physiological buffers, conclusions can be made on how complex molecular mechanisms proceed *in vivo*.

Protein Misfolding, Oligomers and Amyloid

Amyloid formation and amyloidosis

The molecular pathophysiological process in the amyloid disorders usually involves the transformation of a soluble functional monomeric protein into potentially toxic aggregates and insoluble *amyloid fibrils* (Fig. 1) [4]. At least 25 different proteins have been identified to form amyloid in humans (Table I), and the heterogeneous group of diseases associated with amyloid deposits is referred to as amyloidosis [3].



Figure 1. Principle mechanism of amyloid fibril formation.

Proteins are normally soluble as monomers, but some proteins self-aggregate into dimers, trimers *etc* resulting in long insoluble microscopic fibers (*fibrils*).

Each type of amyloidosis is characterised by deposition of one particular fibril protein [5], and the deposits may be either distributed throughout the body (systemic) or localised to one particular organ or tissue. Naturally, most systemic amyloidoses result from deposition of plasma proteins, or fragments thereof, abundant in blood, while amyloid tissue compartmentalisation may arise as a result of the physiological expression and distribution of a specific precursor protein. In general, clinical symptoms may arise from organ dysfunction as a consequence of the amyloid deposition and tissue disruption, or as a result of protein aggregate toxicity [6]. The latter seems to be especially true in neurodegenerative diseases where the extent of amyloid deposition is poorly correlated with disease severity [7].

In clinical medicine, systemic amyloidosis may result in various symptoms but the kidney is the most frequently affected organ [8]. Accordingly, amyloidosis is an important differential diagnosis when patients present with proteinuria. The challenge is, however, to detect amyloid early since early treatment of amyloidosis is associated with much better outcomes and survival.

Table I. Amyloid protein precursors in humans.* Adopted from [3].

Amyloid precursor	Systemic/ Localised	Syndrome/tissue involvement
ABriPP	S	Familial dementia, British
ADanPP	L	Familial dementia, Danish
Apolipoprotein AI	S, L	Familial, aorta, meniscus
Apolipoprotein AII	S	Familial
Apolipoprotein AIV	S	Sporadic, senile
Amyloid Precursor Protein, APP/A β	L	Alzheimer's disease, senile
Atrial natriuretic factor	L	Cardiac atria
β_2 -microglobulin	S, L?	Hemodialysis-associated, joints
Cystatin C	S	Familial
Fibrinogen α -chain	S	Familial
Gelsolin	S	Familial, Finnish
Immunoglobulin, heavy chain	S, L	Primary, myeloma-associated
Immunoglobulin, light chain	S, L	Primary, myeloma-associated
Insulin	L	Iatrogenic
Islet amyloid polypeptide	L	Islets of Langerhans, diabetes mellitus II insulinom
Kerato-epithelin	L	Familial, cornea
Lactadherin	L	Senile aortic, arterial media
Lactoferrin	L	Cornea
Leukocyte chemotactic factor 2	S	Mainly kidney
Lysozyme	S	Familial
Odontogenic ameloblast-associated protein	L	Odontogenic tumours
Prion protein	L	Spongiform encephalopathies
(Pro)calcitonin	L	C-cell thyroid tumours
Prolactin	L	Ageing pituitary, Prolactinom
Semenogelin I	L	Vesicula seminalis
Serum amyloid A	S	Secondary, reactive
Transthyretin	S, L?	Familial, senile systemic, tenosynovium

* α -synuclein, huntingtin and some other precursors form inclusions without amyloid properties [3].

While localised amyloidosis is mainly treated conservatively, management of systemic amyloidosis involves radical approaches. Correct typing of the amyloid precursor is essential, because the central concept of current amyloidosis treatment is elimination of the supply of amyloidogenic protein. Thus, if an immunoglobulin light chain amyloidosis is detected, the treatment targets the underlying neoplastic process (the malignant B-cell clone) using aggressive chemotherapy.

Since most plasma proteins are produced and secreted by the liver, a subset of patients with systemic amyloidosis will benefit from liver transplantation. However, more attractive pharmacological treatments, targeting systemic fibrillogenesis, are being tested in clinical trials [8].

The term *amyloid* is somewhat misleading and derives from the first description of the tissue deposits by Rudolph Virchow in 1854 [9]. First to use the term, however, was Matthias Schleiden, a German botanist who coined the word in 1838 [10]. Virchow applied a staining method commonly used by botanists to demonstrate starch and consequently, the deposits in human tissues were termed amyloid from the Latin word for starch—*amylum*. However, a few years later it was shown that the main constituents of the amyloid deposits were proteins [11].

Despite the heterogeneity of the different precursor proteins, amyloid fibrils show remarkable structural homogeneity when viewed by electron microscopy or atomic force microscopy (AFM)—typically extracellular deposits of unbranched twisted fibrils about 10 nm wide and of undetermined length (Figs. 2 and 3) [4,12,13].

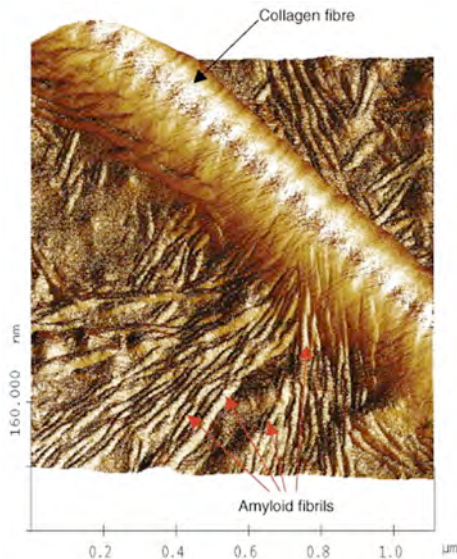

Figure 2. Tissue amyloid fibril deposition.

Surface plots of a tapping mode atomic force microscopy image of β_2 -microglobulin *ex vivo* amyloid material obtained from the femoral head of a patient affected by dialysis-related amyloidosis. The red arrows point out to the amyloid fibrils surrounding a collagen fibre (black arrow). Adapted from [13].

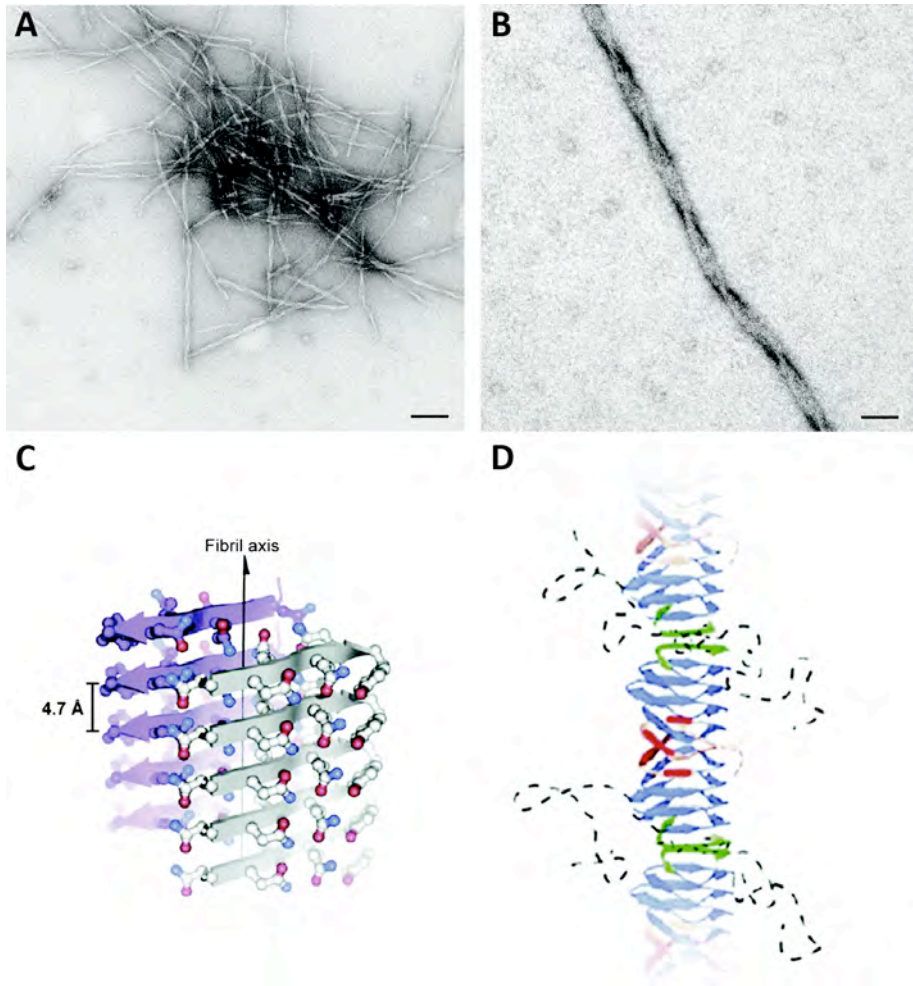

Figure 3. Structures of amyloid fibrils.

(A) and (B), electron micrographs of long twisted amyloid fibrils formed *in vitro* from cystatin C. Scale bars: 80 nm in (A), 20 nm in (B). (C) and (D), models of the core of amyloid fibrils, showing stacked β -sheets where the interacting protein chains are hydrogen-bonded, 4.7 Å apart, and the resulting β -sheets twist slightly in the direction of the fibril long axis. (C) and (D) have been modified from [4].

Today, a number of different amyloid-binding dyes exist, with the most well known being Congo red, adopted from the textile industry and introduced as a histological stain in 1922 [14]. This stain is still the gold standard for detection of amyloid deposits. In clinical pathology, Congo red is usually complemented by immunohistochemistry (usually immunofluorescence) for amyloid typing [8]. The fact that Congo red-stained amyloid emit apple-green birefringence when slides are observed under polarised light [14] suggests that the deposits contain a highly ordered structure. Indeed, X-ray diffraction and other techniques have shown that the core of the amyloid fibrils are composed of stacked β -sheets, arranged perpendicular to the fibril axis (Fig. 3) [4,15,16]. The interacting protein chains are hydrogen-bonded; 4.7 Å apart, and the resulting β -sheets are 6-11 Å apart and twist slightly in the direction of the fibril long axis. Complete fibrils are composed of 2-6 protofilaments, each 2.5-3.5 nm in diameter.

This basic structural arrangement is found regardless of the precursor protein. The fact that different proteins and peptides without any sequence homology adopt the same uniform structure is puzzling but likely relates to the fact that this ultrastructure is very stable, as evident from the resilient nature of *in vitro*-formed amyloid fibrils.

For amyloid fibrils to form, amyloidogenic protein monomers must be destabilised by *intrinsic* or *extrinsic* factors, *i.e.* mutations or changes in the protein milieu. Experimental studies have revealed destabilising conditions that promote unfolding and aggregation of normally soluble monomeric proteins, namely high temperature or pressure, low pH, and certain solvents [17]. High protein concentration increases the rate of protein interactions and is often necessary to study protein self-assembly *in vitro*. At extreme conditions, any protein is prone to aggregation, in the same way the protein ovalbumin turns into tasty clumps of egg white when a chicken egg is fried in a pan at high temperature. However, the temperature denaturation is instantaneous and random, whereas self-aggregation of amyloidogenic proteins likely occurs via distinct pathways where monomers assemble into dimers, trimers *etc* before the appearance of mature amyloid fibrils.

Studies of *in vitro* fibril formation suggest a nucleation-dependent mechanism of fibrillisation [18]. The typical features of this type of kinetic are a *lag phase*, an *elongation phase* and a *plateau phase* (Fig. 4). During the lag phase, monomers undergo partial unfolding and begin self-assembly as *oligomers*, which, during the elongation phase, act as nuclei for fibrillisation. As the pool of monomers is depleted, the plateau phase commences. The lag phase

may be reduced by adding *seeds*; in the form of preformed fibrils, fibrillar fragments, or oligomers which promote nucleation and further fibrillisation (Fig. 4) [19].

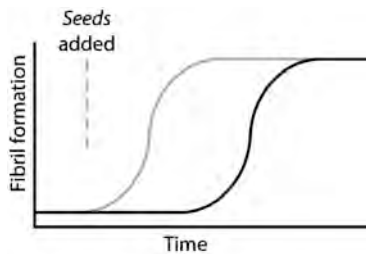

Figure 4. Kinetics of amyloid fibril formation.

The initiation of fibrillisation *in vitro* occurs after a long lag phase (*black line*), which may be reduced by adding preformed oligomers or fibrils: a phenomenon known as *seeding* (*grey line*).

Apart from establishing the kinetics of fibril formation, *in vitro* studies have pointed to the importance of intermediate species, termed *oligomers*, not only as nuclei for fibril growth, but also as central players in the pathophysiology.

Oligomers as potentially toxic intermediates

The soluble intermediary oligomers have received much attention in the last decade. Already in 1998 there was evidence for a prefibrillar toxic species [20]. But oligomers are transient and proved to be very difficult to study and characterise. In following studies, cellular experiments showed that isolated amyloid fibrils were rather inert when added to cell cultures, with a modest effect on the cells, while the oligomers displayed strong dose-dependent cytotoxicity [21,22]. Furthermore, oligomers formed *in vitro* from different proteins and peptides were reported to display similar size and shape (annular, about 10-15 nm diameter) when visualised by EM, indicating common mechanisms of toxicity [23,24]. Consistent with a common structure, conformation-specific antibodies raised against oligomers of one protein could recognise aggregates obtained from other amyloidogenic proteins [25].

Although the concept of oligomer toxicity is increasingly accepted, the mechanism of toxicity is still under debate, and the role of oligomers in the *in vivo* situation is far from established. Several mechanisms of toxicity have been proposed, involving direct receptor-interactions and synaptic dysfunction, or intracellular effects possibly as a result of cellular uptake [26].

Intriguingly, it has been shown that annular oligomers may insert into cellular membranes, creating pores and disrupting ion homeostasis [24,27]. Annular oligomers may form from an array of amyloidogenic precursors, including amyloid- β ($A\beta$), α -synuclein, ABriPP, ADanPP, serum amyloid A (SAA) and islet amyloid polypeptide (IAPP) (Fig. 5) [23].

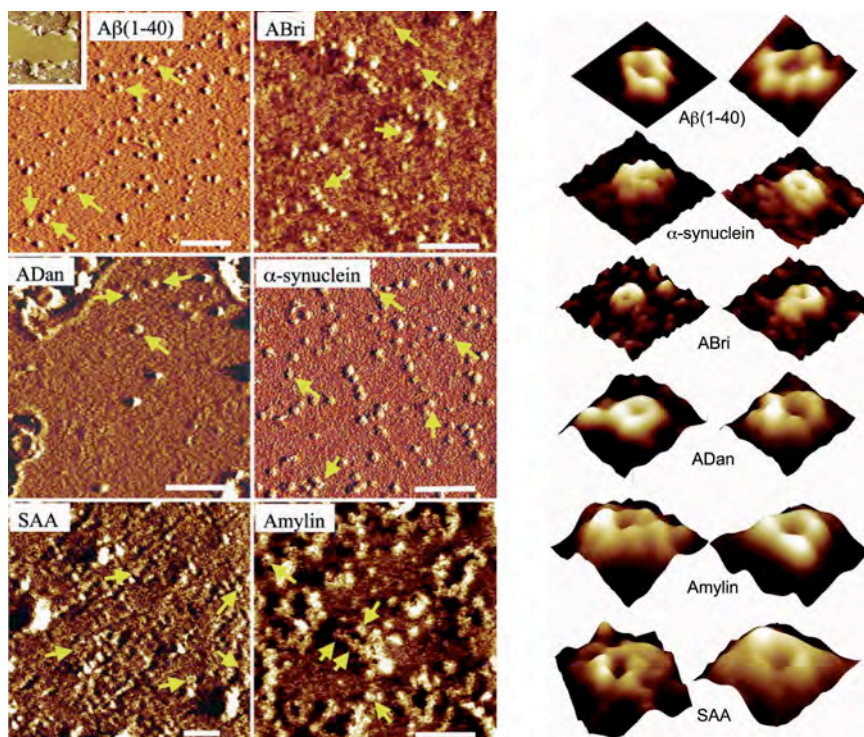

Figure 5. Atomic force microscopy images of amyloid peptides reconstituted in membrane bilayers.

A range of amyloid precursors form channel-like oligomers with a central pore in lipid membranes (*left panel*). Individual structures are displayed at high resolution (*right panel*) with two examples shown for each molecule. Image sizes are 25 nm for $A\beta$, 25 nm for α -synuclein, 35 nm for ABri, 20 nm for ADan, 25 nm for IAPP (also called *amylin*) and 20 nm for SAA. Scale bars: 100 nm. Modified from [23].

A range of oligomeric species and oligomer formation pathways have been reported in the literature [28]. But studies have been far from congruent and it has not been possible to clearly define the pathogenic species [26]. The critical number of monomeric subunits and their ultrastructure within oligomers is largely unknown. The pathways of oligomer formation and the conversion of oligomers into fibrils is still an unsolved puzzle. Oligomers have been difficult to study due to their instability and dynamic equilibrium with smaller and larger species, and this has hampered the development of a deeper understanding of the molecular pathophysiology of the amyloid disorders and strategies for their treatment.

As a consequence of the discovery of oligomers and the increasing evidence of intracellular amyloid, the definition of amyloid is no longer restricted to extracellular deposits [3]. The term *proteopathy* has been introduced and extends to include not only the classical Congo red-positive amyloidoses, as clinical conditions previously not regarded as amyloidosis display evidence of proteotoxicity as an inherent pathologic mechanism [29]. For example, it is becoming increasingly appreciated that the loss of β -cells within islets of the pancreas in diabetes mellitus type II patients, is related to toxic effects of accumulating IAPP [30,31].

Protein misfolding in a cellular context

The folding of a protein into its proper three-dimensional shape is one of the most fundamental processes in biology. Proteins function as enzymes, cellular scaffolds, receptors, signalling molecules, specific antibodies, storage containers, carriers, molecular engines, membrane channels, and so on, all of which relies on the unique three-dimensional structure of a protein. All proteins are produced within cells, with a specific stretch of DNA (the gene), as a blueprint. The messenger RNA (mRNA) is transcribed from the gene in the nucleus and carries the genetic information to a ribosome in the cell cytosol or, if the protein is to be excreted, to a ribosome in the membrane of the endoplasmic reticulum (ER) (Fig. 6).

Nature has evolved a number of systems to maintain protein homeostasis, or proteostasis, to ensure the proper folding of proteins, including different *molecular chaperones* and detectors of misfolded and aggregated proteins; all efficiently coupled to degradative systems. Chaperones, like calnexin, calreticulin and the heat-shock proteins (Hsp), are necessary *folding catalysts* and protect hydrophobic patches during folding, before the proteins adopt their fully functional *native* conformation. The ability of cells to sense

misfolded proteins relies in part on the detection of hydrophobic patches aberrantly exposed on protein surfaces.

Although the final three-dimensional structure of a protein is defined by the sequence of its amino acids—as Anfinsen pointed out already in the 1950s [32]—cytosolic and ER-resident chaperones aid in the proper folding of newly translated proteins. If the mature protein inside the ER for some reason does not fold properly into its native conformation, the protein may be tagged with ubiquitin and degraded by the proteasome after translocation to the cytosol, so called *ER-associated degradation* (ERAD). If an excess of unfolded proteins reside within the ER (called *ER stress*) and the folding capacity of the ER is exceeded, sequestering of key chaperones (like binding immunoglobulin protein, BiP) initiates an *unfolded protein response* (Fig. 6) [33]. This includes transcriptional upregulation of additional chaperones and proteasome components. If the ER stress continues and cannot be abated, the cell undergoes programmed cell-death (apoptosis).

Protein aggregates residing in the cytosol may be degraded by autophagy where lysosomes engulf and degrade aggregates in the same way the regular turnover of cellular organelles is maintained. This degradative pathway may also target soluble aggregates and proteins, and is essential for the survival of neurons [34].

Extracellular protein homeostasis is probably less well-regulated, and little is known about the specific mechanisms involved [35]. However, recent studies have identified extracellular chaperones with the ability to inhibit aggregation of unfolded proteins [36].

There is an abundance of complex extracellular matrix (ECM) components outside the cells, but the intracellular environment is relatively more crowded, with a total protein concentration of over 300 g/l, compared to 20 g/l in interstitial fluids [35]. Still, amyloid depositions are in almost all cases observed extracellularly upon post-mortem examinations, and this has led to speculations about possible amyloid-inducing components of the ECM. A number of such *amyloid enforcers* have been described, including heparan sulphate proteoglycans, glucosaminoglycans and other negatively charged polyelectrolytes [37]. ECM components are often found within amyloid deposits, as are some other recurring molecules, *e.g.* serum amyloid protein component (SAP) and apolipoprotein E (ApoE).

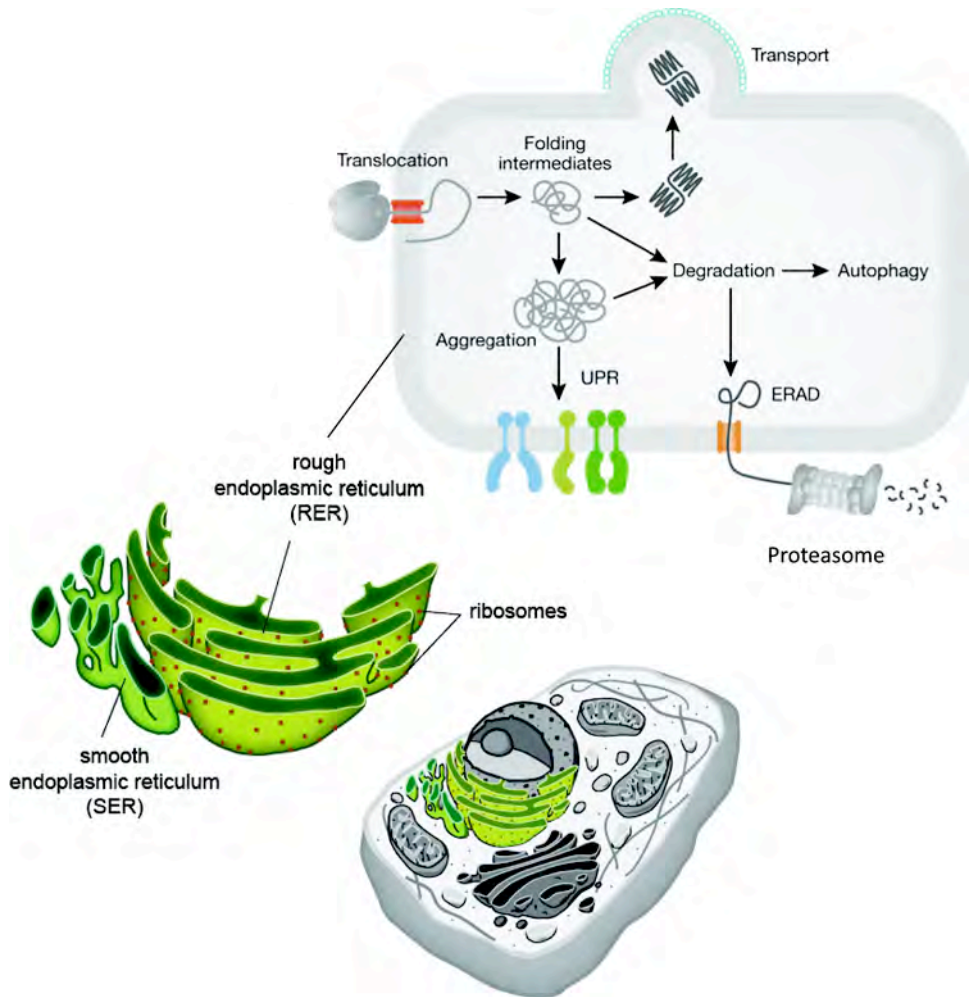

Figure 6. Protein quality control.

A schematic representation of a cell (*below*), where nascent peptide chains (folding intermediates) inside the ER (*above*) reach their native conformation with the help of ER-resident chaperones (not illustrated). ERAD is initiated on the recognition of non-native proteins by quality control receptors. These terminally misfolded proteins are then translocated to the cytosol, where an E3 ubiquitin ligase marks the substrate for proteasomal degradation. ER, endoplasmic reticulum; ERAD, endoplasmic-reticulum-associated degradation; UPR, unfolded protein response. Modified from [38].

Modes of protein homeostasis deterioration

The chaperones, degradation signals and associated pathways together constitute the *proteostasis network*, with critical functions to maintain viable and healthy cells. Neurodegeneration is believed to result from deterioration of several molecular and cellular pathways within the proteostasis network, thus explaining the appearance of neuronal protein inclusions and extracellular amyloid common to various neurodegenerative diseases [39]. The amyloid plaques in AD, the Lewy bodies in PD, and the aggregates in Huntington's disease, often contain ubiquitin and proteasomal components [40]. Another argument for the proteostasis deterioration model is found in familial PD, where mutations in two genetic loci (*PARK2*, *PARK4*) are associated with defects in the protein degradation system: *PARK2* encodes an E3 ligase of the ubiquitination system, and *PARK4* encodes a ubiquitin ligase/hydrolase [41].

Mutations affecting any protein involved in the proteostasis network, would potentially contribute to faulty protein turnover and the formation of protein aggregates. Mutations affecting proteins *not* directly involved in the proteostasis network, will also contribute to faulty proteostasis if the mutation is a missense mutation and affects protein stability. The explanation for this is that as the (mutated) RNA is translated by ribosomes and the number of misfolded protein copies increase, the chaperones and associated enzymes are essentially hijacked, leaving the cell with a reduced capacity to handle the basal (normally low) levels of misfolded proteins [40].

The efficiency of the cellular machinery to repair DNA damage is reduced when the cell has reached a certain number of cell divisions and thus, *de novo* mutations are no longer corrected. Naturally, as cells age and accumulate mutations, all of these central cellular functions may be affected. As the capability of the cellular machinery to handle misfolded proteins decline, an increased load of aggregates, ER stress, and the UPR will eventually result in cell death.

Thus, any mutation, spontaneous or inherited, affecting DNA repair enzymes, chaperones, UPR signalling, ubiquitination, the proteasome or affiliated signalling systems, will lower the threshold for any given cell to cope with an increased load of misfolded proteins. There might be certain mutations, affecting the functions of central components of the proteostasis pathways, which leave cells with an increased susceptibility to faulty proteostasis.

Such a model of *progression through acquired mutations* is well established in cancer development. A number of critical genes have been found mutated in cancer and they offer profound insights into the basic mechanisms of tumour development. In clinical practice, these genes are routinely assessed to characterise tumours and provide information on the prognosis of a certain tumour, as well as knowledge of which treatment strategy to choose [42].

Originally derived from a single cell, tumours develop through the accumulation of a number of mutations necessary for the tumour to grow and metastasise. Tumour cells need to acquire mutations in several genes, perhaps ten or more, to bypass the normal limitations on cell proliferation. These mutations affect proteins involved in key cellular processes which leave the cancer cells with certain characteristics: 1) they have the ability to divide without the need for growth signals, 2) they have the ability to divide indefinitely, 3) they are genetically unstable, thereby easily acquiring additional mutations, 4) they avoid apoptosis, 5) they have an ability to invade adjacent tissues and survive in a remote environment [43].

Some of the genes are *oncogenes* with a *gain-of-function* effect, driving cancer growth. One example is mitogen-activated protein kinase (MAPK), which acts as a promoter of cell proliferation. Consequently, a mutation in only one of the alleles of an oncogene may result in constitutive activation and tumour progression.

Other genes are *tumour suppressors*, with a *loss-of-function* effect. An important example is p53, which is mutated early in a number of different tumours. It exerts control over cell cycle progression, can induce DNA repair and initiate apoptosis. Malignant tumours arise when both alleles of tumour suppressors are mutated, and the resulting protein is completely lost.

This mode of disease progression is not directly applicable to neurodegenerative disease because fully differentiated neurons are post-mitotic, and thus there is no clonal expansion that explains accumulation of mutations through genetic instability. Instead, *proteotoxic progression* likely relies on additional mechanisms.

Post-mortem neuropathological examinations of AD brains show cortical lesions in both hemispheres, often with the hippocampal regions affected early in the disease, and with amyloid plaques at multiple sites where a large number of pyramidal neurons are affected. Hence, each affected region of the brain seems to develop pathology somewhat independently. The reason for this could be that the pathology to a large extent relies on extrinsic factors, such as toxic protein aggregates, oxidative stress or microglia activation, all of which have been proposed as important features of AD pathology [44]. Thus, the components of the proteostasis network may be post-translationally modified by reactive oxygen species (ROS) during inflammation or other types of cellular stress. Also, the amyloid plaques may be the common downstream result of cellular injury of different origins. Besides, routine neuropathological methods (using amyloid dyes) might not detect all features of the pathology.

A sequential deterioration of several components of the neuronal proteostasis network is likely a factor in neurodegeneration. There is ample evidence for *secretory pathway stress* in the pathogenesis of amyotrophic lateral sclerosis (ALS), a common motoneuron degenerative disease [45]. Moreover, the increasing inability of aging neurons to adapt to defective proteostasis may explain the age-related onset, the slow progression, the (presumably) long presymptomatic phase, and the characteristic multifocal amyloid deposits associated with, for example, AD.

As is the case in cancer development, proteostasis deterioration may involve the loss of certain genes/proteins, critical to maintain healthy cells. It is reported that the loss of the ability to undergo apoptosis—often as a result of mutant p53—is a critical early event in many tumours and this feature might also be important in deteriorating neurons. In consequence, stressed neurons that avoid apoptosis might, for example, harbour diffusible protein aggregates, harmful to adjacent cells.

In essence, the intricate interactions and the complex regulation of the neuronal proteostasis network have only begun to be deciphered and provide exciting possibilities for future therapeutic interventions.

Conversely, the basic concepts of protein misfolding can be applied in cancer research. Current efforts aim to prevent loss of tumour suppressors by protein stabilisation. As reported [46], a pharmacological approach has successfully been applied to rescue the loss of misfolded (mutant) p53 in breast cancer and glioblastoma cells, and similar examples involving this strategy will follow.

Classical genetic diseases may also be regarded as protein misfolding diseases, when mutations affect protein stability. In cystic fibrosis and phenylketonuria, intense efforts are on-going to find correctors that will rescue the loss of the misfolded chloride channel in the case of cystic fibrosis [47] and in phenylketonuria the misfolded enzyme phenylalanine hydroxylase. In the latter example the natural cofactor tetrahydrobiopterin was modified to accommodate stabilisation of the fold of the enzyme and is now in clinical use (sapropterin, Kuvan[™]), providing an elegant example of a pharmacological chaperone [48].

However, an important difference between the recessive inborn disorders and their *loss-of-function* nature, and the amyloid disorders, is the toxic—*gain-of-function*—dominant character of the misfolding protein in amyloidosis. Importantly, proteotoxic diseases occur as spontaneous, progressive neurodegenerative disorders in the broad population (*i.e.* AD and PD). Thus, there is a strong need for efficient risk stratification in the general public, and, to be able to prevent disease progression, early diagnosis is essential. However, one of the most promising strategies in the therapeutic prevention of amyloid disorders, namely, direct targeting by stabilising the misfolding protein, has so far failed to reach the clinic [49]. One important exception involves transthyretin (TTR) amyloidosis, where the quaternary structure of TTR (a homotetramer) may be stabilised by natural or synthesised ligands, thus preventing misfolding and aggregation. The European Medicines Agency recently approved such a stabiliser (tafamidis) for the treatment of TTR familial amyloid polyneuropathy [50].

Hereditary Cystatin C Amyloid Angiopathy

In 1935, a general practitioner named Árni Árnason described a number of families in the rural northwest of Iceland where young adults died from hemorrhagic stroke [51]. Almost 40 years later, the pathologic origin was revealed as fibrillar amyloid deposits within the walls of cerebral arteries of affected individuals when examined post-mortem [52]. A decade later, sequencing of a protein extracted from the amyloid deposits of the brain vessels showed that the amyloid protein was cystatin C [53]—an endogenous cysteine protease inhibitor—at the time known as γ -trace, the single polypeptide chain of which recently had been sequenced [54].

Complete sequencing of amyloid extracts demonstrated a protein variant, with one amino acid difference compared to normal cystatin C, as the main component of the amyloid [55]. In the cystatin C variant, a glutamine residue at position 68 replaced a leucine residue (L68Q cystatin C) as a result of a single nucleotide polymorphism (CTG→CAG) in exon 2 of the *CST3* gene, situated on chromosome 20 [56,57].

Immunohistochemical studies verified the extensive deposition of cystatin C within the media of small and middle-sized cerebral arteries (Fig. 7). Microscopic examinations also demonstrated perivascular fibrosis and degenerated smooth muscle cells interspersed with congophilic hyaline material within the vessel wall, and also showed amyloid-positive staining in peripheral tissues like the spleen, lymph nodes, salivary glands, testes and skin [58,59].

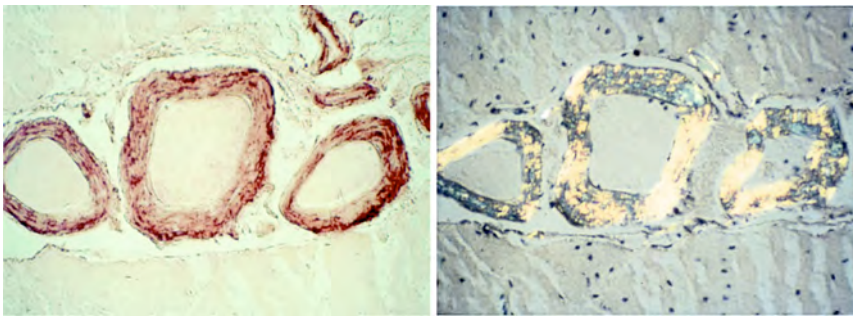

Figure 7. Hereditary Cystatin C Amyloid Angiopathy (HCCAA).

Cross-sections of cerebral arteries of an Icelandic HCCAA patient. Strong immunoreactivity is observed after staining with anti-cystatin C antibodies (*left*). A yellow-green birefringence is evident when Congo red-stained slides are viewed in polarised light (*right*). Courtesy of Anders Grubb, Lund University Hospital, Lund, Sweden.

Cloning and sequencing of cDNA encoding cystatin C identified the loss of an *AluI* restriction site and allowed development of a rapid polymerase-chain-reaction-based diagnostic procedure [56,60,61], replacing the previous diagnostic test of quantifying cystatin C in cerebrospinal fluid (CSF) and detection of the abnormally low CSF levels in L68Q cystatin C carriers [62].

Family studies have revealed a typical autosomal dominant pattern of inheritance (Fig. 8) with high penetrance of the phenotype, namely fatal intracerebral hemorrhage. Genetic linkage data and thorough genealogical studies have concluded that all known copies of the L68Q mutation derive from a common ancestor born roughly 18 generations ago, around 1550 [63].

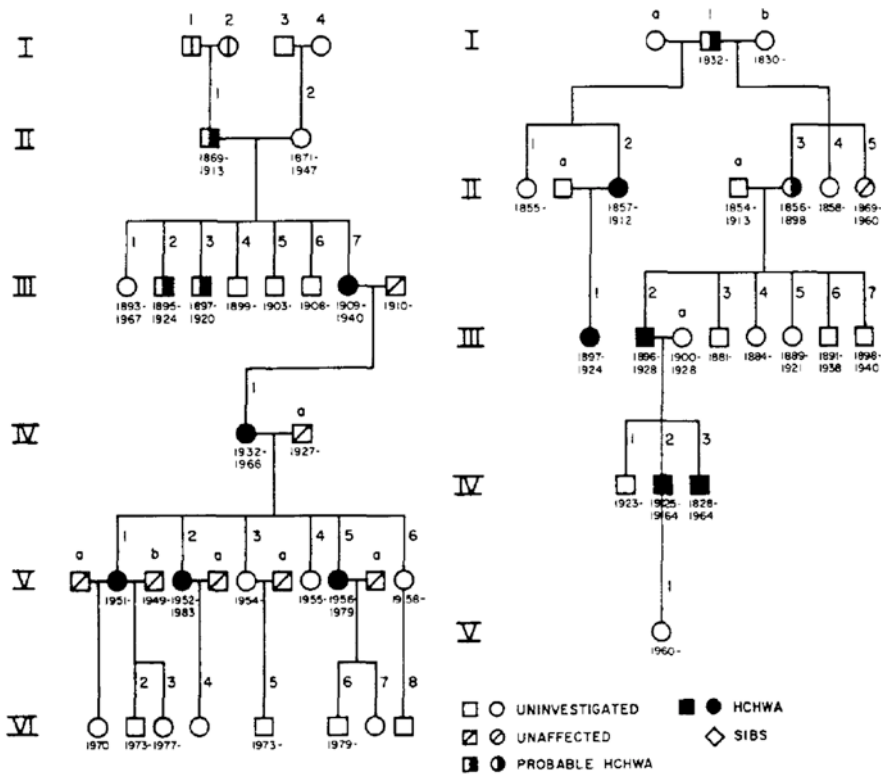

Figure 8. Hereditary cystatin C amyloid angiopathy pedigrees.

Transmission in two families of the allele causing HCCAA (also called hereditary cerebral hemorrhage with amyloidosis, HCHWA). Women are depicted as circles, men as squares. The year of birth and life span are shown beneath the symbols. As expected for a dominant disease, about half of the sib-groups are carriers on average. Adopted from [64].

HCCAA is not uncommon in the small population of Iceland (~320 000), and the disease accounts for about 17% of all strokes in persons under 35 years of age [65]. If patients survive the initial attack, cerebral bleedings are recurrent and associated with dementia and paralysis [66].

Cloning techniques have also allowed the efficient production of recombinantly expressed human cystatin C in *Escherichia coli* [67] and subsequent characterisation of the biochemical properties of the L68Q variant in comparison to the wildtype (wt) protein [68]. The variant protein displays decreased temperature stability and a very low expression yield compared to the wt protein, despite careful optimisation of the expression conditions.

Intriguingly, the anodal mobility shift observed from agarose gel electrophoresis when monomeric cystatin C was incubated at elevated temperatures, represented a conversion of the monomeric protein into dimers, as evident from gel filtrations [68]. At physiological temperature (37°C) L68Q cystatin C was shown to convert into a dimeric form rapidly, in contrast to the wt protein, which did not convert into dimers at all in non-denaturing buffers at this temperature.

The high-yield expression system and successful purifications of the wt protein allowed crystallisation experiments, and when the three-dimensional structure was finally solved by X-ray diffraction [69] it was evident that the crystals contained a dimeric species (Fig. 9C). The 2.5 Å resolution structure displayed a perfectly symmetrical *domain swapped* dimer, where the N-terminal and α -helix domain of one monomer was extended and located in another monomer, in exchange for an identical domain [69]. In addition, the three-dimensional fold revealed the location of the Leu68→Gln substitution in the core of the molecule, where the longer, hydrophilic glutamine side-chain is placed in a hydrophobic environment; exerting a repulsive force on the α -helix, thus providing an elegant explanation for the described increased dynamic property of L68Q cystatin C [70] and the high tendency to dimerise [68,71]. In HCCAA patients' blood, dimers were detected by gel filtration of plasma samples and subsequent immunodetection [72].

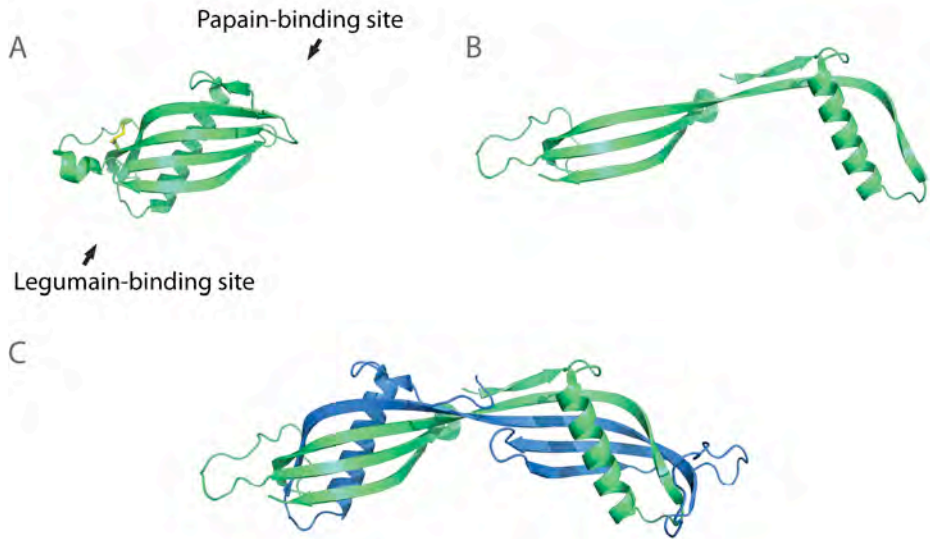

Figure 9. The structure of human cystatin C.

The three-dimensional fold of monomeric cystatin C is displayed in a ribbon representation (A) together with partially unfolded ('open') (B) and dimeric wildtype cystatin C (C), illustrating the mechanism of three-dimensional domain swapping. Upon dimerisation, the papain-binding site is abolished; while the legumain-binding site is preserved. The L68Q variant shows rapid conversion to dimers under native conditions [68]. The figure was prepared in PyMOL [73] using coordinates available in the Research Collaboratory for Structural Bioinformatics Protein Databank (<http://www.rcsb.org/pdb>) under Protein Data Base (PDB) entries 3GAX [74] and 1TIJ [75].

As evident from electron microscopy and thioflavin T staining, L68Q cystatin C forms doughnut-shaped oligomers and amyloid fibrils upon incubation *in vitro* under non-denaturing conditions, whereas wt cystatin C requires slightly denaturing conditions to produce oligomers and fibrils *in vitro* [76,77].

The hypothesis of a *propagated domain swapping* mechanism (discussed below) in the formation of oligomers and fibrils was tested *in vitro* by genetical engineering of double-cysteine mutants of wt and L68Q cystatin C, by introducing two cysteine residues at strategic sites to prevent, by the disulfide bridge formed, domain swapping under denaturing conditions. Indeed, the stabilised mutants formed neither dimers, nor amyloid fibrils [76,77]. By selective reduction of the disulfide bridge in the mutants under slightly denaturing conditions *in vitro* and subsequent oxidation, low amounts of high-molecular-weight (HMW) oligomers could be produced and investigated [77].

The role of cystatin C dimers and oligomers in the *in vivo* situation is not clear, neither if these species form intracellularly or after cystatin C has been secreted. Cell experiments have indicated that both wt and L68Q cystatin C dimers may form intracellularly in overexpressing cells, and the variant protein was either retained in the ER, or exported as a (papain-inactive) dimer [78].

Solubilised cystatin C amyloid from a HCCAA patient was shown to be cytotoxic to cultured human cerebrovascular smooth muscle cells, and similar *ex vivo* aggregates were taken up by macrophage-type cells and induced a pro-inflammatory response [79,80]. However, the molecular nature of these aggregates has not been defined.

Cystatins and Cysteine Proteases

Cystatin C is a low-molecular mass protein, which functions as a natural inhibitor of cysteine proteases [81]. In humans, it forms a very tight but reversible complex with the cysteine cathepsins, which are lysosomal proteases involved in normal protein turnover, degradation of ECM and antigen-presentation [82]. Cystatin C belongs to the type 2 cystatins, which are translated with a signal peptide and secreted, in contrast to type 1 cystatins (also known as the *stefins*), which are cytosolic. Type 3 cystatins (the *kininogens*) are intravascular [82].

Cystatin C is a non-glycosylated monomeric protein and, as the most abundant of the cystatins in extracellular fluids, is believed to play an important role in regulating aberrant protease activity outside the cells (although recent data also suggest intracellular activity, see below). It is widely distributed in human tissues and body fluids, with the highest concentration in seminal vesicles (~50 mg/l) and CSF (~5.8 mg/l) [83].

The basic structure of secreted cystatin C is displayed in Fig. 9. The sequence of its single 120-residue long polypeptide chain, its secondary and tertiary structures, and the location of its papain and legumain inhibitory sites, have previously been described [69,84].

The cysteine cathepsins and their endogenous inhibitors (the cystatins) are involved in pathologic processes in which an imbalance between proteases and inhibitors has been proposed as a prominent pathophysiologic mechanism, for example in AD [85,86] (discussed below), cancer and atherosclerosis [87,88]. In metastasising cancer, upregulation of proteases and downregulation of protease inhibitors enable tumours to grow, move through the stroma, invade basal lamina, and reach the blood stream [88,89]. Also, human cancer cells internalise cystatin C via a yet unknown endocytic mechanism, thereby promoting proteolysis of the ECM [82,90,91].

In both coronary arterial disease and abdominal aortic aneurysm, plasma levels of cystatin C have been reported to detect or prognosticate disease [92-95]. However, the evidence is conflicting [96], presumably because of the strong relation of plasma cystatin C to kidney function. Since the plasma level of cystatin C is (inversely) correlated to glomerular filtration rate (GFR, discussed below) it is obvious that plasma cystatin C may not fairly represent local changes at sites of pathologic processes. Therefore, caution is needed when interpreting the plasma level of cystatin C as an indicator of any pathologic processes outside of the kidneys.

Alzheimer's Disease and the Amyloid Cascade Hypothesis

While the familial forms of amyloidosis (see Table I) inarguably results from accumulation of each associated precursor protein, the pathophysiology of sporadic amyloid disorders is more often debated. An important example is AD, which accounts for about 70% of all dementias and affects about 120,000 individuals in Sweden. Worldwide, more than 35 million individuals suffer from AD and the number is increasing due to an aging population and higher diagnosis rates [44]. AD is expected to affect more than 100 million individuals by 2050 [97].

AD is clearly age-related and is characterised by progressive cognitive decline, memory loss and behavioural changes, resulting in social disability and difficulties in executing activities of daily life. The disease is chronic, long lasting, and currently incurable, with an ensuing profound impact on both formal health care services and informal care provided by family members. AD represents an increasing public health concern and the societal costs are huge, with an estimated total cost of dementia in western Europe (2010) of 210 billion US dollars, of which ~40% represents cost of informal care [98].

The core pathological hallmarks of AD are parenchymal amyloid plaques and neurofibrillary tangles (NFT), originally identified by the German physician Alois Alzheimer more than a decade ago [99]. These features are evident upon post-mortem examinations, as are cerebral amyloid angiopathy (CAA) and brain atrophy. The neuronal degeneration and synaptic loss, occurring particularly in the hippocampus, amygdala and temporal cortex, is thought to result from the accumulation and toxic effects of the 4.5 kDa peptide *amyloid- β* ($A\beta$), which forms the bulk of the amyloid plaques (NFT are formed by hyperphosphorylated *tau*) [44].

$A\beta$ aggregation, resulting from an imbalance between production, degradation and clearance mechanisms, is well established in AD, but important questions remain regarding the role of $A\beta$ and the apparently complex pathophysiologic mechanisms [100]. $A\beta$ is a product of stepwise proteolytic cleavage of a larger transmembrane precursor (amyloid precursor protein, APP) and was first identified in cerebrovascular amyloid extracts from AD patients [101]. APP cleavage by the secretase complex in neuronal membranes results in $A\beta$ monomers of differing lengths (predominantly $A\beta_{40}$ and $A\beta_{42}$). APP is highly expressed in the central nervous system but its normal physiologic functions have so far been difficult to define [102].

Despite 30 years of research, the role of A β peptides in AD pathology remains elusive. There is strong evidence for overproduction and reduced clearance of A β in AD brains, especially of the A β ₄₂ peptide, and *in vitro* studies demonstrate that A β ₄₂ is the more aggregation-prone peptide [103]. A β peptides can be measured in CSF, and the levels or ratio of A β ₄₂, A β ₄₀, total-tau and p-tau are useful indicators of progression to manifest AD, even 5-10 years prior the onset of dementia [104]. Apparently, the lower the relative concentration of A β ₄₂, the higher the risk of AD development. This finding might be explained by the idea that the more A β ₄₂ accumulating in the brain, the less reaches the CSF.

The *amyloid cascade hypothesis* was first described nearly 20 years ago by John Hardy and Gerry Higgins in *Science* (although the original paper was later retracted when Higgins was accused of scientific misconduct, because the results concerning the presented AD mouse model, could not be repeated. The hypothesis, however, has been widely recognised). The hypothesis postulates that the accumulation of fibrillar A β in the brain is the major event behind the pathology in sporadic AD [105]. All other attributes of the disease, including hyperphosphorylated tau and NFT, microglia activation, synaptic dysfunction, neuronal loss, dementia, and brain atrophy, are secondary to the formation of amyloid plaques.

The hypothesis is greatly supported by the fact that all known mutations causing early-onset familial AD (about 5% of all AD cases) locates to the A β -sequence, its precursor APP, or to the secretases (presenilins) that are involved in APP cleavage. These mutations appear to facilitate enhanced production and/or aggregation of A β ₄₂ in the brain. While most AD-associated mutations in APP flank the A β region, mutations associated with severe CAA all occur within the region coding for A β [106]. The *APP* gene resides on chromosome 21, of which a triplicate is found in Down's syndrome, thus explaining the universal occurrence of AD in Down's syndrome individuals [107-109]. Moreover, recent whole-genome sequence data identified a mutation in *APP* that confers protection against AD and age-related cognitive decline, again supporting that APP/A β is central to AD pathology [110].

The most consistently associated risk gene for late-onset AD is *APOE*, encoding apolipoprotein E. A 3-fold increased risk for developing AD has been reported in individuals harbouring one copy of the *APOE* ϵ 4 allele, and a 8-fold increased risk in homozygotes [111].

In recent years, the amyloid hypothesis has been questioned, in part because many studies fail to find a strong correlation between the extent of A β amyloid plaques, and the severity of clinical symptoms [112]. This has been reported in both human subjects and in animal models. Transgenic mice that overexpress A β have evidence of neural degeneration prior to the formation of amyloid plaques [113], and amyloid deposits are found in humans who died without any symptoms of dementia [114]. Importantly, two decades of intensive research, focusing on reducing or removing amyloid deposits, have failed to produce any meaningful therapeutic interventions [115]. Some researchers therefore question whether amyloid is the most relevant target.

There is a large body of evidence from *in vitro* and *in vivo* studies to suggest that key features of the AD phenotype can be induced solely by soluble A β oligomers [100]. Oligomers in general do not stain with traditional amyloid dyes, which might explain why they went undetected for so many years. Interest in the A β oligomer originated from Dennis Selkoe's group in 1995, when small A β oligomers were isolated from cultures of Chinese hamster ovary cells expressing a mutant form of APP [116]. The same group recently isolated A β oligomers directly from AD brains and showed that soluble A β oligomers potently induced synaptic dysfunction in rodent hippocampus. Moreover, insoluble amyloid plaque cores from AD cortex did not impair synapse function unless they were first solubilised to release A β dimers, suggesting that plaque cores are largely inactive but sequester dimers that are synaptotoxic. Thus, amyloid plaques may serve as a local reservoir of small diffusible toxic oligomers. A number of soluble forms of A β have been reported, including dimers, trimers, hexamers, nonamers, dodecamers and also larger annular species [100,117].

In the last couple of years, several large clinical trials have evaluated anti-amyloid therapies with mostly disappointing results [118]. Several antibody-based therapies have shown benefits in animal models of AD but once evaluated in human trials, they have either demonstrated low efficacy or severe side effects. Recently, the low-molecular-weight γ -secretase inhibitor semagacestat was reported to provide no measurable effect, providing yet another disappointing example of an amyloid-modulator without clinical efficacy. These are discouraging facts, considering the tremendous amount of work and financial expenses put into each of these drug development projects.

In general, the cost to bring a novel drug from initial promising results on the lab bench, to patient bedside, is about 1.8 billion US dollars [119]. The process of drug discovery, drug development and optimisation, toxicity and animal testing, formulation, regulatory approval and clinical evaluation, usually

takes about 15 years [120]. In consequence, the Food and Drug Administration in the US approves only 20-30 new drugs every year. However, both time and cost may be substantially reduced by re-purposing of already approved drugs [120]—a strategy employed in the second study described under *Results and Discussion* (Paper II).

Since no disease-modifying treatments have been developed, the only pharmacological treatments for AD patients available are cholinesterase inhibitors (rivastigmine) and N-methyl-D-aspartate (NMDA) receptor antagonists (memantine). These drugs may offer some patients symptomatic relief, in the form of modest improvement of cognitive function, but no protection against disease progression [121].

One reason for the poor outcome of clinical trials might be that the failed drugs have not gone through optimal preclinical evaluation. A number of different AD animal models exist, *e.g.* mice transgenic for various mutations in human APP, presenilins, tau, and recently several crossbreeds of those animals. Each of these strains may appropriately model some aspects of the pathology but there is not yet any model which reproduce the full spectrum of AD in a manner similar to human disease [114].

Another reason for the lack of clinical efficacy of compounds with proven *in vitro* effects, could be that most trials have included patients with advanced disease and that it probably is difficult to reverse amyloid pathology once established. A better approach could be to identify and treat individuals with presymptomatic disease or mild symptoms (denoted *mild cognitive impairment*, MCI). However, although neuropsychiatric testing, lumbar puncture with CSF-marker analysis, and brain imaging, might identify those at risk [122], the clinical outcome is often difficult to measure, and there are ethical considerations in treating presymptomatic individuals. In addition, to reach and evaluate any measurable effects, such studies would require a large number of participants and many years of follow-up. Thus, these types of studies are risky and extremely costly, but the investment will of course, in the case a blockbuster drug against AD is found, be worthwhile.

There is now broad consensus that, to prevent disease progression, AD should be treated during its earliest stages. An international task force of investigators from academia, industry, non-profit foundations, and regulatory agencies have made this and many other recommendations that should improve the likelihood of success in future trials [123]. Moreover, in the pipeline are novel oligomer- and protofibril-targeting therapies [124,125] hopefully efficacious enough to slow or prevent AD progression.

Cystatin C in Alzheimer's disease

In vitro and *in vivo* studies indicate a role of cystatin C in the development of AD. Cystatin C is suggested to protect against AD, possibly by direct binding to A β and inhibition of A β aggregation [126-130]. Another proposed mechanism involves induction of autophagy by cystatin C, offering neuroprotection by enhanced clearance of autophagy substrates by lysosomes [131]. Cystatin C was identified as the key inhibitor of cathepsin B-induced A β degradation in an animal model of AD and hence, lowering of cystatin C levels could be beneficial [85]. In human AD brains, cystatin C immunoreactivity was predominantly found in regional areas of neuronal degeneration, although a clear co-localisation with A β was not found [132]. Experiments involving cultured hippocampal neurons suggested direct protection of cystatin C from A β -induced toxicity [133]. Cystatin C was demonstrated to induce proliferation of neural stem cells [134,135]. Low serum levels of cystatin C were reported to precede clinically manifest AD in elderly men [136], and cystatin C levels in CSF were shown to be positively correlated with CSF A β ₄₂ [137] (however, associations based on serum levels of cystatin C are often confounded by kidney function, discussed below).

Thus, it is not clear if the role of cystatin C in AD involves its 'normal' biological function (protease inhibition), is related to neuronal protection by other mechanisms, or is associated with the amyloidogenic property of cystatin C.

A common haplotype, encoding an A25T substitution in precursor cystatin C (*i.e.* cystatin C with its signal peptide of 26 amino acid residues), has been reported to associate with late-onset AD [138,139] but this finding was not observed in other studies [140-142]. The same protein variant is implicated in age-related macula degeneration (AMD type 11) where retinal vessels display proteinaceous deposits (termed *Drusen*) [143,144]. Intriguingly, although characteristic amyloid fibrils have so far not been detected in Drusen, the extracellular deposits stain with oligomer-specific antibodies [145].

Interestingly, in human CSF, A25T cystatin C was recently identified by mass spectrometry to be O-glycosylated with a core HexHexNAc at the resulting threonine [146]. The authors describe an enrichment procedure for glycoproteins in CSF and subsequent proteomic profiling—a method that allows identification of glycan attachment sites but not quantitative estimations. This is the first report of glycosylated cystatin C in humans. The

cellular processing and the pathologic consequences of glycosylation of A25T cystatin C, has not yet been investigated.

Stroke is the third most common cause of death and the leading cause of neurological disability. Globally, an estimated 16 million individuals suffered from a first-ever stroke in the year 2005, with an estimated prevalence of 62 million stroke survivors [147]. In Sweden, about 213 first-ever strokes annually per 100,000 individuals occur [148]. Ischemic stroke is more common but hemorrhagic stroke produces high death rates (~50%) and is feared also because the sequelae are more severe compared to ischemic stroke.

An important and common cause of intracerebral hemorrhage is sporadic cerebral amyloid angiopathy, characterised by the progressive deposition of A β (predominantly A β ₄₀ [149]) in the walls of small to medium-sized arteries, arterioles and capillaries in the cerebral cortex [150]. Mild CAA is a common pathological finding in the elderly but severe CAA results in spontaneous cerebral hemorrhages and dementia [151]. CAA is generally underdiagnosed, in part because development of CAA is not correlated with the presence of common cerebrovascular risk factors including hypertension, diabetes mellitus or hyperlipidemia [150].

Population-based autopsy studies indicate a CAA prevalence of 20-40% in non-demented and 50-60% in demented elderly populations. In AD, CAA is commonly found at autopsy in more than 90% of cases [150].

While the Icelandic mutation (L68Q cystatin C) is rare and probably not a common cause of cerebral hemorrhage in non-Icelandic populations (only one such patient has been described [152]), the contribution of wt cystatin C to vascular pathology in the aging population is not well understood. Low levels of cystatin C have been detected in CSF of CAA patients, also without concurrent point mutations in the cystatin C gene. This condition has been referred to as *sporadic* cystatin C amyloid angiopathy (SCCAA) since normal wt cystatin C is co-deposited with A β in cerebral vessels [153].

Several other studies have verified a co-localisation of cystatin C and A β within the cerebrovasculature in AD patients and in cases with sporadic CAA [154-157], but the prevalence and clinical significance of SCCAA is unknown.

Domain Swapping and Amyloid Formation

Since the amyloid cascade hypothesis was presented in 1992, the basic molecular mechanisms of amyloid formation have been the subject of intense studies. The intriguing fact that cells and tissues contain thousands of different proteins, yet amyloid tissue depositions include only a single amyloidogenic protein as the main component [5], suggests distinct pathways in the assembly of amyloid. Christian Anfinsen, awarded the Nobel prize in chemistry in 1972 for his work on ribonuclease, postulated that for each amino acid sequence, only one protein conformation of lowest free energy exists [32]. However, the amyloidogenic proteins display several stable forms; *i.e.* the native monomer, most likely some of the oligomeric forms, and the fibrillar structures. This contradiction might be explained if the oligomers and fibrils contain subunits of native-like conformations.

A number of proteins are described in the literature to self-assemble by the mechanism of *domain swapping*, where dimers and oligomers form without general unfolding of the interacting monomers [158].

Domain swapping was first described in 1994, when it was evident from crystal structures of diphtheria toxin that the protein could dimerise by extension of a protein domain in exchange for an identical domain of another monomer [159]. In order to swap domains, the native monomers first must be destabilised by intrinsic and/or extrinsic factors, resulting in partial unfolding. When two partially unfolded monomers interact, a domain-swapped dimer is formed.

Domain-swapped proteins retain secondary structures, and thus, are native-like in the domain-swapped conformations. Several amyloid-forming proteins have been shown by X-ray crystallography to undergo domain swapping and dimer formation. Examples include cystatin C, the prion protein (Fig. 10), β_2 -microglobulin, neuroserpin, T7 endonuclease I, and ribonuclease A [69,160-164]. Moreover, experimental data suggest that amyloidogenic proteins may form long protein chains by *propagated domain swapping* where one monomer extends a swapping domain to another monomer which, in turn, extends a domain to yet another monomer, and so on (Fig. 11) [77,165,166]. In this way, propagated domain swapping could result in the formation of small oligomers, large oligomers and complete fibrils.

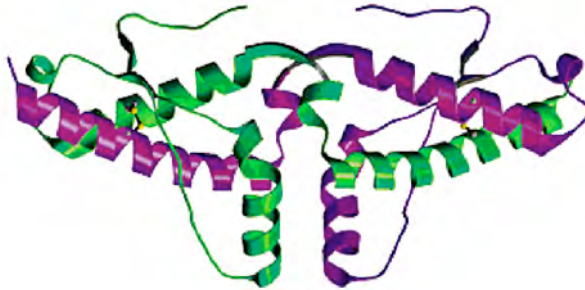

Figure 10. The human prion protein dimer, formed by domain swapping.

Crystal structure of dimeric human prion protein (PDB: 114M) [163]. Prion diseases are a group of neurodegenerative diseases that include scrapie in sheep, bovine spongiform encephalopathy (BSE) in cattle (*mad cow disease*), Creutzfeldt-Jakob's disease, fatal familial insomnia and kuru in humans.

Although domain-swapped dimers and small oligomers retain secondary structures, some derangement would likely occur in larger assemblies because amyloid fibrils display high β -sheet contents, and the stability of fibrillar structures probably relies on β -sheet stacking [16]. Increasing contents of β -sheet structure have been demonstrated by circular dichroism spectroscopic measurements of oligomer and fibril samples of several amyloid proteins, including cystatin C [77]. In domain-swapped dimeric cystatin C, two strands that cross from one domain to the other in the linker region form an antiparallel β -sheet and are involved in as many as 34 main chain hydrogen bonds [69]. A similar two-stranded antiparallel β -sheet is formed at the dimer interface in domain-swapped prion protein (Fig. 10) as well as in dimeric β_2 -microglobulin [160].

According to the model of propagated domain swapping, the growing oligomer ends with an extended monomer, ready to accept another monomer. This results in a growing oligomer with 'open ends', usually depicted in the literature as a linear polymer (as exemplified in Fig. 11) [160-162,164,167,168].

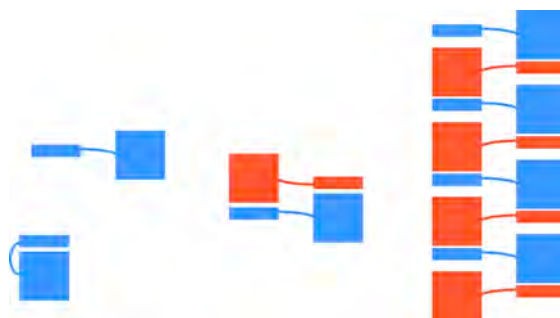

Figure 11. Propagated domain swapping.

Simplified schematic model for dimer formation and 'open-ended' propagated domain swapping in the formation of larger oligomers.

However, if the final monomeric subunit in the growing oligomer swaps its domain back to the first monomer, a cyclic closed-ended oligomer forms. Theoretically, domain-swapped oligomers of all sizes can be cyclic, as long as there is no steric hindrance for *the final swap*. Nevertheless, as larger oligomers form, the final swap is probably less likely to occur because of the increasing distance between the two 'open ends'. Moreover, whenever a swap produces an oligomer of high free energy, another swap is likely to occur. As a result, only some—thermodynamically favoured—oligomers will form in any given system.

The model of linear oligomers, with terminal 'open' monomers, might be in line with the experimentally observed seeding phenomena where, once the open-ended oligomers form, the exponential growth phase begins. Still, linear oligomers are not generally observed when oligomers are studied by EM and AFM. Instead, oligomeric samples commonly display circular objects, consistent with a cyclic arrangement of monomeric subunits. However, detailed information on the molecular organisation of such annular oligomers is still lacking.

Cystatin C as a Marker of Glomerular Filtration Rate (‘Kidney Function’)

Knowledge of glomerular filtration rate is essential to detect and follow impairment of renal function, for the use of potentially nephrotoxic radiographic contrast media and to allow correct dosage of medicines cleared by the kidneys [81]. GFR in humans cannot be measured directly and invasive techniques based on measuring the plasma or renal clearance rate of injected substances (*e.g.* inulin, iohexol), exclusively excreted via glomerular filtration, are therefore required for the correct measurement of GFR. But these measurements cannot be generally applied, because they are labour-intensive, time-consuming, expensive, and not free of risks for the patient. The plasma or serum concentrations of endogenous substances, particularly creatinine, have therefore been used as markers for GFR for almost a century. However, it has become evident that the creatinine concentration is far from ideal as a GFR marker because it is significantly influenced by factors other than GFR [169]. The shortcomings of creatinine have prompted a search for a more reliable endogenous marker of kidney function.

Because of its small size (13.3 kDa), cystatin C is freely filtered through the glomeruli of the kidneys and then almost completely reabsorbed by the proximal tubuli cells. As a consequence of glomerular injury, cystatin C is not filtered through the glomeruli and the plasma level of cystatin C increases [81,170]. Since 1994, following the development of a rapid, automated cystatin C assay [171], plasma cystatin C has been routinely measured in the clinical laboratory of Lund University Hospital in Sweden. In comparison to creatinine, cystatin C has several advantages as a marker of GFR. First, there is only a minor effect of muscle mass, race or gender on plasma cystatin C, obviating the need for anthropometric estimates [169]. Second, cystatin C is not affected by dietary intake of meat [172,173]. Third, cystatin C is a more sensitive marker for GFR decline in the GFR range above 60 ml/min/1.73 m² [174].

Chronic kidney disease affects more than 10% of the population and is associated with increased mortality, especially from cardiovascular causes. Increased levels of cystatin C have been shown to be associated with less successful aging than normal levels of cystatin C, and cystatin C has been described to have a better diagnostic performance than creatinine to predict successful aging [175-180].

A number of large epidemiological studies have revealed a statistically significant correlation between the plasma level of cystatin C and degree of inflammation, as measured by C-reactive protein (CRP) and other markers of inflammation [179,181-184]. On the basis of these observations it has been proposed, that an ability of cystatin C to detect inflammation is the reason for the better diagnostic performance compared to creatinine, in predicting cardiovascular events and death [184]. In contrast, other investigators have explained the advantage of cystatin C as a prognostic marker for cardiovascular events, by it being a better marker for GFR than creatinine [175].

Thus, there is a need to clarify the relationship between cystatin C and inflammation.

Aims of the Study

Amyloid tissue deposits have been recognised for 150 years, but the etiology and the mechanisms underlying protein misfolding and amyloid disorders have been largely unknown. The increasing number of affected patients have spurred much interest in amyloid research and, during the last two decades, tremendous efforts have been invested in delineating the pathologic basis of these disorders. Yet today, there are hardly any treatments available.

An overall goal of contemporary amyloid research is *a better understanding of the early mechanisms of protein misfolding, to enable the development of effective treatments*. The present studies were undertaken in an effort to contribute to such an understanding by investigations of hereditary cystatin C amyloid angiopathy. The specific objectives were:

- To investigate the relationship between the levels of plasma cystatin C and inflammation (Paper I).
- To develop experimental systems to allow high-throughput testing of potential drug candidates for hereditary cystatin C amyloid angiopathy (Paper II).
- To define the mechanisms of cystatin C misfolding and aggregation *in vitro* (Paper II and III).
- To identify the different molecular forms of cystatin C and establish methods for selective targeting of these aggregates (Paper III).

Material and Methods

Detailed descriptions of the materials and methods used in this investigation can be found in the appended papers and only short descriptions will therefore be given in this section.

Patient Study Group and Biomarker Quantifications

In order to study the effects of inflammation on biomarker levels, patients scheduled for elective surgery were enrolled according to the criteria detailed in Paper I.

Recombinant Protein Production and Purification

All recombinant protein variants of human cystatin C were expressed in *E. coli* and have previously been characterised regarding sequence, size, charge and biological activity [60,67,68,76,83,84,185]. The three-dimensional structures of human wt cystatin C and the stab1 cystatin C variant (stabilised by two cysteines (L47C/G69C) introduced at strategic positions by site-directed mutagenesis, forming a disulfide link between the adjacent β 2- and β 3-strands, which (in wt cystatin C) separate during domain swapping and dimer formation) have previously been determined at the atomic level using X-ray crystallography [69,74]. Much of the results presented in this thesis, *e.g.* regarding different molecular forms of cystatin C, rely on data obtained in previous projects [68,69,71,76,77].

The purification procedures for the recombinant proteins were optimised and modified as detailed in Papers II and III. The homogeneity of protein batches was confirmed by size-exclusion chromatography (SEC), sodium dodecylsulphate polyacrylamide gel electrophoresis (SDS-PAGE), agarose gel electrophoresis and, in some cases, mass spectrometry.

Clinical Drug Compound Library

The US Drug Collection is a substance library with 1040 drug compounds already approved for use in humans. All compounds are either clinically used drugs or have reached clinical testing stages, and 95% of the drugs are currently off patent. The compound library was purchased from a commercial source and was stored as 10 mM stock solutions in dimethyl sulfoxide (DMSO) at -80°C (see Paper II for details).

Biochemical Assays

High-throughput screening

A novel high-throughput screening assay is described in detail in Paper II. In brief, aliquots of a cystatin C stock solution were added to solutions of guanidine hydrochloride (GdnHCl) in phosphate-buffered saline (PBS), and portions of 10 μ l of the mixtures were distributed into the wells of 384-well microtiter plates (Fig. 12). DMSO, the vehicle of the US Drug Collection, or the active compounds, were added to each well, the plates were sealed with sealing tapes and incubated in a heat cabinet. Samples were analysed in a high-pressure liquid chromatography/size-exclusion chromatography (HPLC-SEC) system, or by agarose gel electrophoresis.



Figure 12. 384-well microtiter plate.

One of the microtiter plates used for high-throughput testing of substances for capacity to reduce formation of cystatin C dimers (Paper II). Assay volume was 10.4 μ l (25 μ l total well volume) and plates were carefully sealed with sealing tape to avoid sample evaporation. The same assay format was used to find the optimal conditions for the induction of oligomer formation from reduced monomeric stable cystatin C (Paper III).

Immunochemical methods

Particle-based immunoturbidimetry (Papers I and III), double radial immunodiffusion, also called Ouchterlony analysis (Paper III), immunoblotting (Paper III) and immunosorption (Paper III).

Separation methods

Gel filtration alias SEC (Papers II and III), ion-exchange chromatography (Papers II and III), affinity chromatography (Paper III), agarose gel electrophoresis (Papers II and III), SDS-PAGE (Paper III).

Oligomer production, stabilisation and purification

Novel protocols for the production and purification of stable cystatin C oligomers are described in detail in Paper III.

In short, lyophilised stab1 cystatin C was reconstituted in 0.5 ml PBS in 1.5 ml tubes, the concentration was measured in 1.5 μ l droplets using a NanoDrop 2000 spectrophotometer, and concentrations adjusted before the addition of GdnHCl from a 8 M stock solution, giving final concentrations of GdnHCl of 1 M. To this mixture was added freshly dissolved dithiothreitol (DTT) in PBS at 0.9 mg/ml (6.25 mM) giving final concentrations of DTT and cystatin C of 225 μ M (corresponding to a cystatin C concentration of 3 mg/ml), and the tubes were kept at room temperature for 2 h. After centrifugation at 10,000 g for 10 min, 0.5 ml samples were injected in an ÄKTA fast protein liquid chromatography (FPLC) system running a Superdex 75 GL 10/300 column in 150 mM ammonium bicarbonate, pH 7.8, with a flow rate of 0.5 ml/min and the eluate monitored by its absorption at 280 nm. Fractions of 0.5 ml were collected and the tubes stored open to ambient air at 4°C over night to allow re-formation of disulfide bonds by spontaneous oxidation. Fractions were analysed by non-reducing silver-stained SDS-PAGE, pooled and concentrated to 1–3 mg/ml in ultrafiltration devices. The protein concentration was measured, samples aliquoted and either lyophilised or stored at 4°C or -20°C.

Enzyme activity assays

Protease inhibition assays are described in Paper III.

Imaging Techniques

Electron microscopy (Paper III) and atomic force microscopy (Paper III).

Antibody Production

Production of polyclonal and monoclonal antibodies is described in Papers II and III.

Results and Discussion

Plasma Cystatin C is Not Influenced by Inflammation (Paper I)

This study was undertaken to verify or refute a causal relationship between the levels of cystatin C or creatinine and the degree of inflammation.

Plasma samples from 35 patients were analysed the day before elective surgery and subsequently during seven consecutive days. Twenty patients had CRP-levels below 1 mg/l before surgery and low levels of the additional inflammatory markers SAA, haptoglobin and orosomucoid, thus indicating absence of systemic inflammation. Surgery caused marked inflammation with high peak values of CRP and SAA on the second day after the operation. The cystatin C level did not change significantly during the observation period and did not correlate significantly with the level of any of the inflammatory markers (Fig. 13).

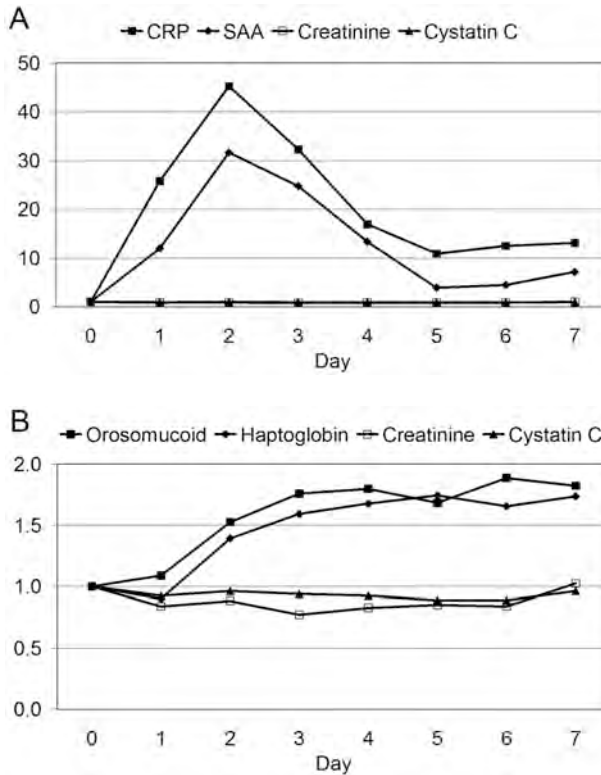

Figure 13. Biomarker levels after surgery.

Changes in plasma levels of (A) CRP, SAA, creatinine and cystatin C and of (B) orosomucoid, haptoglobin, creatinine and cystatin C during seven consecutive days after elective surgery. Day zero denotes the day before surgery. The ordinates represent the median level of each analyte in multiples of the preoperative level.

A number of large cohort studies have demonstrated a significant statistical correlation between the plasma levels of CRP, and cystatin C. However, correlations in cohort studies may suggest, but do not demonstrate, causal relationships between the levels of the studied biomarkers. CRP and SAA were selected because their plasma levels are known to increase rapidly and extensively after initiation of an inflammatory process and swiftly decrease after disappearance of the cause of the inflammation. Haptoglobin and orosomucoid were selected because inflammation produces a more sustained increase of their plasma levels than those of CRP and SAA.

The present study indicates that the advantage of cystatin C compared to creatinine as a marker of successful aging is *not* due to that an increased level of cystatin C signals the presence of inflammation in addition to a decrease in

GFR, as previously suggested [179,181-184]. The advantage might, of course, solely be related to the fact that cystatin C is a better marker for a decrease in GFR than creatinine, but additional causes for its superiority as a marker for successful aging might be suggested. For example, cystatin C might identify the alteration in the composition of the glomerular filtrate with a reduced filtration of large molecules, *e.g.* cystatin C (13 343 Da), but an unaltered filtration of small molecules, *e.g.* water (18 Da) and creatinine (113 Da), which often occurs before a decrease in GFR can be demonstrated [186-189]. The capacity of cystatin C to early identify an abnormal filtration quality might also explain the observation that an elevated cystatin C level indicates higher incidence of cardiovascular events and death even in the presence of a normal GFR [178,190].

Interestingly, several of the established inflammatory markers reported to indicate higher incidence of cardiovascular events and death also fall into the category 'large molecules' of the renal filtrate. The two pro-inflammatory cytokines tumour necrosis factor α (TNF- α) (17 kDa) and interleukin 1 (IL-1) (18 kDa) are freely filtered through the glomerular membrane, and the elimination of these molecules from blood normally relies on kidney excretion. Thus, one can speculate that their ability to predict cardiovascular events and death might, at least in part, be explained by their capacity to early identify an abnormal filtration quality, even in the presence of a normal GFR. According to this hypothesis, even minor glomerular injuries (in the creatinine blind GFR range) cause increased plasma levels of these potent cytokines through decreased elimination, resulting in inflammation with negative effects on the cardiovascular system [191].

Cytokines are also reported to negatively affect the kidney. Increasing evidence has implicated TNF- α as a major participant in the pathogenesis of kidney injury, promoting inflammation, apoptosis, and accumulation of ECM, reducing glomerular blood flow and damaging the glomerular permeability barrier [192]. Thus, the causes and consequences of cardiovascular disease and kidney disease might be bidirectional.

In conjunction, there is support for aggressive anti-inflammatory therapy in end-stage renal disease [193], and trials are underway to test the potential of targeting IL-6 to decrease cardiovascular injury. In this regard, targeting IL-1 was recently shown to decrease systemic inflammation in hemodialysis patients [194].

The observations reported in two recent studies of plasma cystatin C in hypertensive patients and in patients on hemodialysis agree with the result of the present study that there is no correlation between cystatin C and CRP in important patient groups [195,196].

High-throughput Testing for HCCAA Drug Candidates (Paper II)

This is the first report of systematic testing of substances reducing the aggregation of cystatin C. Although carriers of the allele for L68Q cystatin C may easily be identified by a polymerase-chain-reaction-based diagnostic procedure, no treatment to avoid amyloid deposition and early death by brain hemorrhage is available. In order to identify substances potentially useful for treatment of patients with hereditary cystatin C amyloid angiopathy, a high-throughput system for testing the ability of drugs or monoclonal antibodies to reduce the *in vitro* formation of cystatin C dimers, was developed.

Because screening of thousands of compounds requires huge batches of purified target protein, a large effort was put into production and extensive purification of recombinant human cystatin C. The *E. coli* production system used has proven efficiency in the expression and purification of soluble monomeric wt cystatin C. However, in the same expression system, the L68Q variant is obtained only at very low yields. Therefore, a different system was used to obtain recombinant L68Q cystatin C by refolding the protein from *E. coli* inclusion bodies. This protocol provides higher quantities of expressed protein but, because of the high tendency of the L68Q variant to form dimers and larger aggregates even at room temperature, the yield of purified monomeric L68Q cystatin C from the final SEC step is generally low. Thus, to ensure large homogenous protein batches and assay reproducibility, wt cystatin C was used throughout assay optimisation and screening runs.

Under slightly denaturing conditions, wt cystatin C shows similar unfolding properties as L68Q cystatin C under physiological conditions [68]. The atomic-level structure of L68Q cystatin C has not yet been determined by crystallography, but studies using nuclear magnetic resonance indicate that the fold of the wt protein is virtually identical to that of the variant protein [70].

Assay development

The conditions previously described to induce dimer formation of wt cystatin C [76] was used as a starting point for the development of an assay to detect substances preventing cystatin C dimerisation. Various combinations of incubation temperature, time period, guanidinium chloride concentration and concentration of cystatin C monomers were tested in low-volume formats to induce dimer formation of recombinant cystatin C. A number of test tubes and microtiter plates with different well volumes were tested, and the extent of dimerisation was analysed by HPLC-SEC and agarose gel electrophoresis.

The conditions used to dimerise cystatin C were optimised and selected so that about 60% of the protein dimerised after incubation for 24 hours and analytical SEC was used to measure the degree of dimerisation (Figs. 14 and 15).

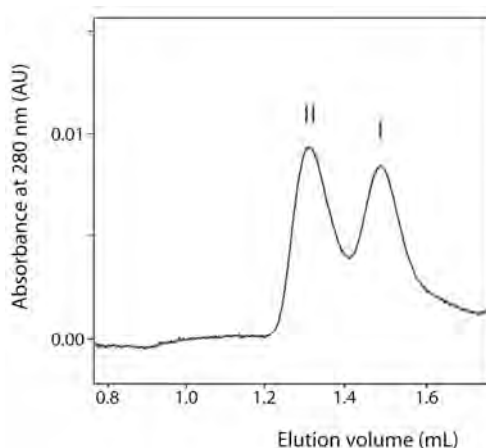

Figure 14. Size-exclusion chromatography of monomeric and dimeric cystatin C.

A solution of monomeric cystatin C, 0.2 mg/ml in PBS buffer with 0.96 M guanidinium chloride and 3.8% DMSO (v/v), was heated to 40°C for 24 h and applied to the column. A Waters HPLC system was used to run the analytical Superdex 75 column in 150 mM ammonium bicarbonate, pH 7.4, with a flow rate of 0.1 ml/min. The effluent was monitored for light absorption at 280 nm. The peaks containing monomeric and dimeric cystatin C are labelled I and II, respectively.

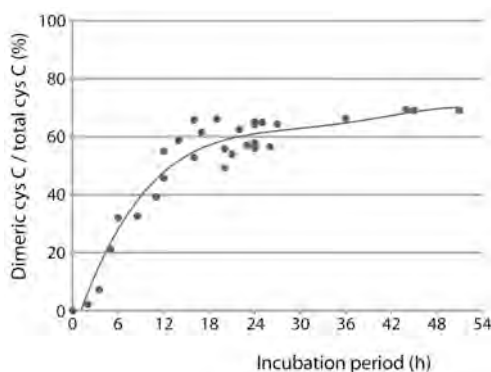

Figure 15. Cystatin C dimer formation.

Solutions of monomeric cystatin C, 0.2 mg/ml in PBS buffer with 0.96 M guanidinium chloride and 3.8% DMSO (v/v), were heated to 40°C for different periods and their content of dimeric cystatin C analysed by SEC. Each dot shows the results for one sample.

However, SEC is not suitable for high-throughput analysis and was therefore replaced by an agarose gel electrophoresis system followed by densitometric scanning for assessment of dimerisation (Fig. 16). This system allows determination of the dimer fraction in 40 samples in about 2 hours, when one agarose gel slab is run. Several gel slabs may be run simultaneously, thus increasing the analytical capacity accordingly. The amount of cystatin C required in the new dimerisation system was reduced compared to that of the previous system [9] by use of a lower cystatin C concentration (0.2 *vs* 0.5 mg/ml) and a smaller incubation volume of 10.4 μ l. To test the capacity of a substance to reduce dimerisation of cystatin C, using the new system, thus requires only about 2 μ g of isolated cystatin C. The major benefit of using HPLC-SEC was the rapid throughput time when analysing single samples. However, agarose gel electrophoresis allowed simultaneous testing of 40 samples and was the method of choice in the final screening runs.

Screening of a drug library

A high-throughput system based upon a miniaturised assay and agarose gel electrophoresis was developed and used to test 1040 drugs in a clinical drug library for their capacity to reduce cystatin C dimer formation *in vitro*. Seventeen substances reducing dimer formation by more than 30% were identified (Table II).

The most potent compound identified, dobutamine hydrochloride, reduced dimer formation by 74%. Six compounds showed more than 50% inhibition of dimer formation, namely dobutamine hydrochloride, bithionate sodium, norepinephrine, carboplatin, hydroquinone and meclocycline sulfosalicylate. Among the 17 drugs reducing dimer formation by more than 30% were two catecholamines (dobutamine hydrochloride, norepinephrine), two proton pump-inhibitors (lansoprazole, pantoprazole), two platinum-based compounds (carboplatin, cisplatin) and four tetracycline analogues (meclocycline sulfosalicylate, oxytetracycline, methacycline hydrochloride, doxycycline hydrochloride). It is encouraging that all of these drugs already have been approved for use in humans and some may be administered at high doses for long periods without adverse side effects.

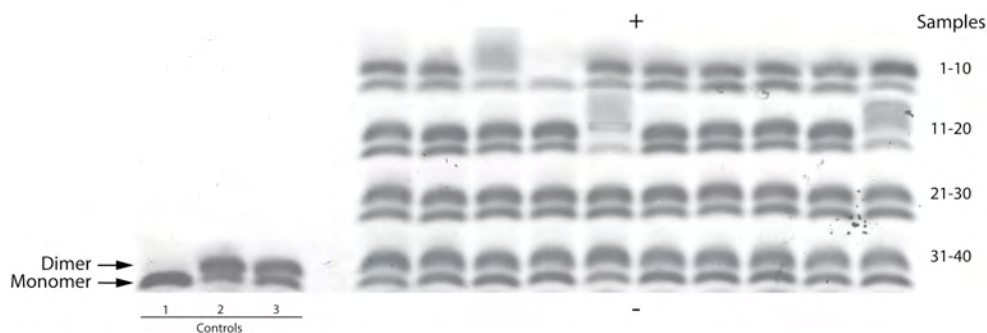

Figure 16. Agarose gel electropherogram showing the capacity of 40 drugs in a drug library to reduce dimerisation of cystatin C.

Solutions of monomeric cystatin C, 0.2 mg/ml in PBS buffer with 0.96 M guanidinium chloride, were incubated at 40°C for 24 h in the absence (controls) and presence of 385 μ M of 40 drugs in the 'US Drug Collection' and analysed by horizontal agarose gel electrophoresis. The controls are monomeric cystatin C before heat induction of dimerisation (1), the cystatin C solution after heat induction without (2) and with 3.8% (v/v) DMSO (3). The four application lanes display the capacity of the 40 drugs to reduce dimerisation of cystatin C. The drugs were added in DMSO to the solution of monomeric cystatin C and the final DMSO concentration was 3.8% (v/v). Sample number 4 contains dobutamine and shows a significant reduction of cystatin C dimerisation. Samples 3, 15 and 20 produce patterns which do not allow estimation of dimer/monomer concentrations. The anode (+) and cathode (-) are indicated.

Table II. Reduction of cystatin C dimer formation by drugs in a clinical drug library.

Ranking list of the 30 most potent substances of the 1040 present in the drug compound library 'US Drug Collection'. All substances were tested at a concentration of 385 μ M in an assay volume of 10.4 μ l, as described in Paper II. The inhibition percentages represent the mean of two runs.

	Drug name	Molecular mass (Da)	Drug action	Inhibition of dimer formation (%)*
1	Dobutamine hydrochloride	338	Cardiotonic	74
2	Bithionate sodium	400	Anthelmintic, antiseptic	73
3	Norepinephrine	169	Adrenergic agonist	53
4	Carboplatin	371	Antineoplastic	52
5	Hydroquinone	110	Antioxidant	52
6	Meclocline sulfosalicylate	695	Antibacterial	51
7	Cetylpyridinium chloride	340	Antiinfective (topical)	49
8	Oxytetracycline	497	Antibacterial	48
9	Lansoprazole	369	Antiulcerative	48
10	Methacycline hydrochloride	479	Antibacterial	48
11	Colistimethate sodium	1736	Antibacterial	48
12	Suramin	1429	Antiprotozoal, antiviral	44
13	Cephalothin sodium	418	Antibacterial	43
14	Cisplatin	300	Antineoplastic	37
15	Doxycycline hydrochloride	481	Antibacterial	36
16	Tannic acid	1701	Astringent	36
17	Pantoprazole	383	Antiulcerative	35
18	Minocycline hydrochloride	494	Antibacterial	30
19	Dibucaine hydrochloride	380	Anesthetic (local)	30
20	Ethylnorepinephrine	234	Bronchodilator	30
21	Pyrrvinium pamoate	770	Anthelmintic	30
22	Methyldopa	211	Antihypertensive	29
23	Enoxaparin sodium	1859	Antithrombotic	27
24	Gramicidin	1141	Antibacterial	25
25	Gallic acid	170	Antineoplastic,	25
26	Trifluridine	296	Antiviral	25
27	Sulfisoxazole acetyl	309	Antibacterial	23
28	Cetrimonium bromide	364	Antiinfectant	22
29	Rolitetracycline	528	Antibacterial	21
30	Isoproterenol hydrochloride	248	Bronchodilator	21

*In each assay run, control dimer formation was evaluated in the presence of drug vehicle (DMSO) only.

There is a rationale for developing an assay with dimer formation as the assay read-out. First, dimers are quite stable and allow detection using two reliable separation techniques (agarose gel electrophoresis and HPLC-SEC). Second, substances reducing formation of dimers of amyloid-producing proteins, also have the potential to reduce formation of larger oligomers and fibrils (*i.e.* potentially toxic species).

The idea was not to try to identify small molecules which prevents the interaction of two protein monomers, because protein-protein interactions generally relies on binding affinities and contact areas larger than low-molecular-weight compounds in general can dislodge. Rather, the idea was to identify small molecules that stabilise the monomer and prevent the unfolding mechanism (domain swapping). Thus, use of the dimer/monomer ratio as the assay read-out enabled an indirect measurement of domain swapping and the identification of compounds which block domain swapping. However, this assay also identifies substances which interact with the dimer specifically (forming a complex), or those which dissociate dimers into monomers (if such compounds exist). In all cases, the assay read-out is attractive, but the assay does not provide the specific mechanism involved.

Interestingly, previous *in vitro* and *in vivo* studies suggest that tetracycline and structural analogues may substantially reduce abnormal protein accumulation in various other forms of amyloidoses with different monomeric protein precursors involved in the formation of amyloid. Recent examples include reduction of *in vitro* fibril formation by β_2 -microglobulin (dialysis-related amyloidosis) [197], TTR (familial amyloid polyneuropathy) [198], prion protein (Creutzfeldt-Jakob's disease) [199], IAPP (diabetes mellitus type II) [200], α -synuclein (Lewy body dementia and PD) [201] and A β (AD) [202]. In addition, tetracycline administration has been shown to delay diabetes onset and suppress disease progression in a transgenic IAPP mouse model of diabetes mellitus type II [203].

Testing a panel of monoclonal antibodies

A similar system for testing the capacity of monoclonal antibodies against cystatin C to reduce the *in vitro* formation of cystatin C dimers was also developed and used to test a panel of 12 monoclonal antibodies. Seven antibodies reducing dimer formation by more than 30% were identified and the two most potent, Cyst28 and HCC3, reduced dimerisation by 75 and 60%, respectively (Fig. 17).

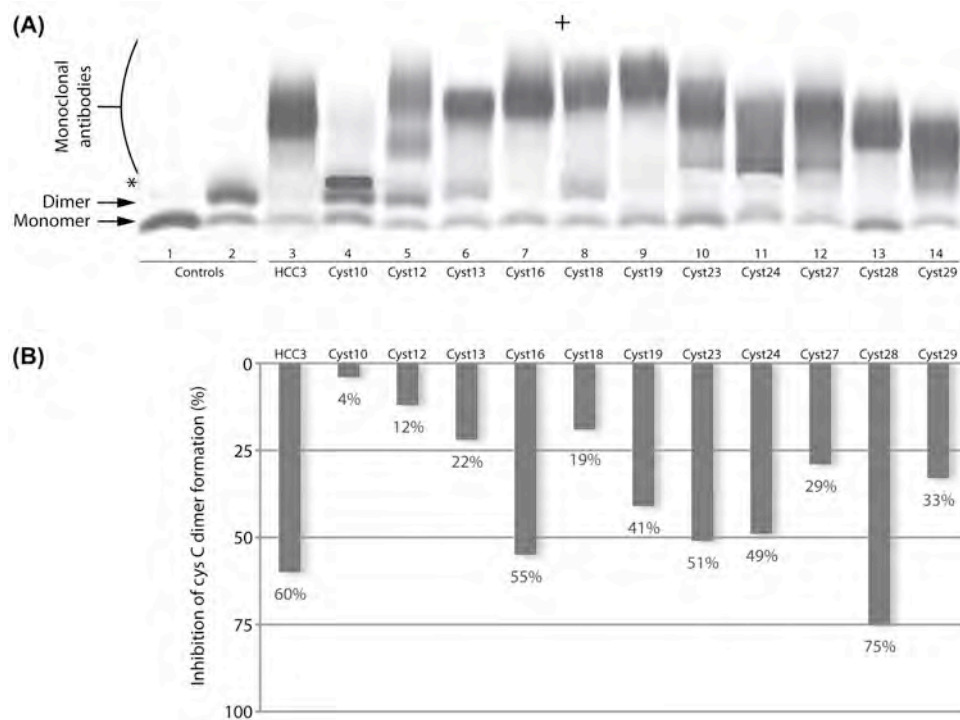

Figure 17. The capacity of 12 monoclonal antibodies to reduce dimerisation of cystatin C.

(A) Solutions of monomeric cystatin C, 0.4 mg/ml in PBS buffer with 1.0 M guanidinium chloride, were heated to 40°C for 24 h in the absence (lane 2) and presence of 12 different monoclonal antibodies against cystatin C and analysed by agarose gel electrophoresis. Lane 1 shows the solution of monomeric cystatin C before heat induction of dimerisation. Lanes 3 – 14 show the effects on dimerisation by 12 different monoclonal antibodies, denoted HCC3 and Cyst10 – 29. The antibodies show differing mobilities related to their isoelectric points. Antibody Cyst10 precipitated during incubation and the given percentage for its inhibition of dimer formation is therefore unreliable. Point of sample application (*) and anode (+) are indicated. (B) Graph showing the percentage reduction of dimer formation produced by the different monoclonal antibodies, as determined by densitometric scanning of the electropherograms in (A).

The decision to test a panel of murine monoclonal antibodies was based upon the successful present use of many monoclonal antibodies for treatment of several human diseases [204]. The complete mRNA sequences coding for the light and heavy chains of one of the two most potent antibodies (HCC3) have recently been determined (unpublished results), facilitating the development of a humanised similar monoclonal antibody with less antigenicity in human subjects.

Stabilisation and Selective Removal of Amyloid Oligomers (Paper III)

Production and characterisation of stabilised oligomers

The miniaturised *in vitro* screening assay described in Paper II was employed in order to find the optimal conditions for the induction of oligomer formation from monomeric stab1 cystatin C (Fig. 18). This variant of cystatin C has two cysteines (L47C/G69C) introduced at strategic positions by site-directed mutagenesis, forming a disulfide link between the adjacent β 2- and β 3-strands, which (in wt cystatin C) separate during domain swapping and dimer formation [69]. In the oxidised state the disulfide bond suppress this conformational flexibility of the monomer and prevents domain swapping [76].

The initial objective was to find near physiological conditions to induce domain swapping and dimer formation of monomeric stab1 cystatin C, by testing mildly denaturing parameters (heating, GdnHCl) combined with reducing agents (DTT, TCEP) during different incubation time periods. It was possible to test a large number of conditions in parallel, using the low-volume (10 μ l) assay format. In the optimal setting, the reducing agent should be perfectly titrated to leave the two intrinsic disulfide bonds (Cys⁷³-Cys⁸³, Cys⁹⁷-Cys¹¹⁷) intact, and only reduce the additional (solvent-exposed) disulfide bridge to enable domain swapping of the monomeric protein.

Indeed, after screening a number of different conditions, it was evident that when neutral buffers (pH 7.4) were used with mild denaturation (0.5 or 1.0 M GdnHCl) and the addition of exactly 1:1 molar equivalents of DTT, dimer formation without precipitation was evident from agarose gel electrophoresis.

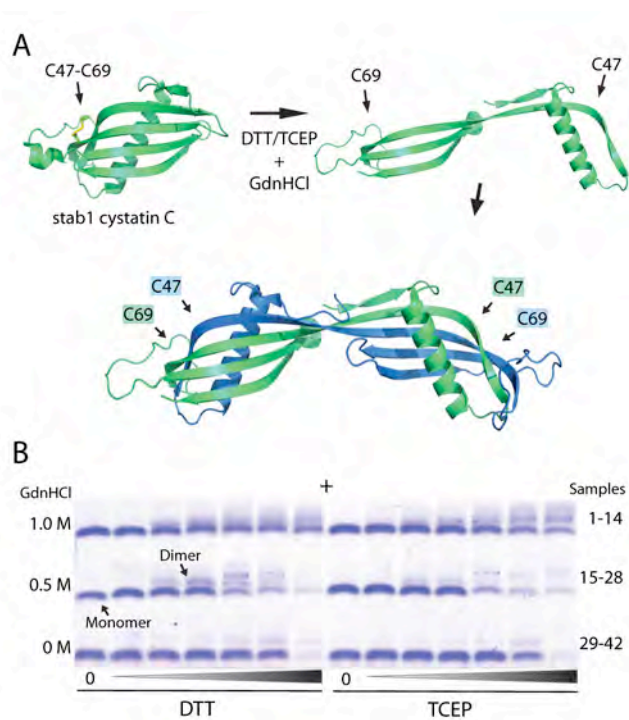

Figure 18. Induced dimer formation of disulfide-stabilised cystatin C.

(A) The crystal structure of monomeric L47C/G69C (denoted *stab1*) cystatin C is displayed in a ribbon representation together with partially unfolded and dimeric wt cystatin C, illustrating the mechanism of three-dimensional domain swapping whereby the first hairpin loop extends and tertiary structure elements are exchanged. The disease-associated L68Q variant shows rapid conversion to dimers under native conditions [68]. Under non-reducing conditions *stab1* cystatin C is stabilised by the added intramolecular disulfide bond and cannot undergo domain swapping and dimer formation. In a reduction reaction the disulfide is broken, allowing domain swapping and dimerisation in mildly denaturing buffers. The figure was prepared in PyMOL [73] using coordinates from PDB entries 3GAX [74] and 1TIJ [75]. (B) Agarose gel electrophoresis of *stab1* cystatin C samples, after incubation for 24 h at 40°C in PBS, pH 7.4, in the absence (samples 1, 8, 15, 22, 29, 36) or presence of the reducing agents DTT or TCEP (samples 2-7, 16-21, 30-35 and 9-14, 23-28, 37-42, respectively) and low levels of GdnHCl. The optimum yield of conversion to dimers was obtained in 0.5 and 1.0 M GdnHCl by adding exactly 1:1 molar equivalents of DTT (samples 4 and 18). Higher concentrations of reducing agents resulted in protein precipitation. The anode is marked by a *plus* sign.

Next, analytical HPLC-SEC was utilised to establish the optimal protocol for the induction of not only dimers, but also trimers and higher-order oligomers. This was accomplished by increasing the protein concentration, still retaining the 1:1 molar equivalents of DTT, while decreasing the temperature and also the incubation time (to minimise protein loss by precipitation). By incubating mixtures of GdnHCl and DTT-treated stab1 cystatin C at 3 mg/ml in 0.5 ml volumes at room temperature, a number of cystatin C oligomers were obtained and purified using preparative SEC (Fig. 19).

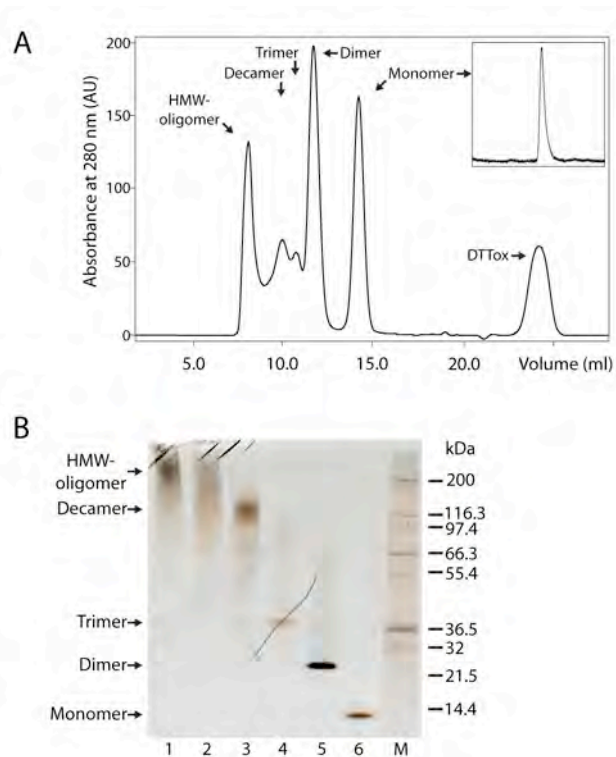

Figure 19. Formation and purification of stabilised cystatin C oligomers.

(A) When purified monomeric disulfide-stabilised (stab1) cystatin C (*inset*) was incubated at a high concentration (3 mg/ml) in PBS, pH 7.4, and 1 M GdnHCl at room temperature for 2 h with the addition of an equimolar amount of the reducing agent DTT, SEC, using a column of Superdex 75 GL 10/300, demonstrated the formation of several oligomeric species. A population of HMW-oligomers (>100 kDa) was eluted in the void volume and a peak representing oxidised DTT was observed (*DTTox*). (B) SDS-PAGE displaying the stability and purity of cystatin C-containing fractions (lane 1-6) isolated by SEC. *M*, Mark12 Protein Ladder. Samples were boiled in 2% SDS without reducing agents prior to electrophoresis, and proteins were demonstrated by silver staining.

The yield of some oligomers was low, but, after concentration by ultrafiltration and re-chromatography, high enough to permit their characterisation. Fractionation of the incubation mixtures by SEC in ammonium bicarbonate buffers enabled not only isolation of oligomers, but also removal of salts and oxidised DTT. All of the oligomers were SDS-stable, but DTT-sensitive, in SDS-PAGE, indicating that intermolecular disulfide bridges stabilised them, thus supporting a model of propagated domain swapping in the formation of oligomers [76,77]. Concentrated samples of the stabilised oligomers could be stored at -20°C or 4°C for more than one year, or pass through lyophilisation and reconstitution cycles in aqueous buffers with pH values ranging from 4 to 9, without alteration in size, according to non-reducing SDS-PAGE.

In order to determine the molecular mass and number of monomeric subunits in each of the isolated oligomeric species, we used SDS-PAGE, mass spectrometry, native HPLC-SEC, transmission electron microscopy and atomic force microscopy, producing the results summarised in Table III. SDS-PAGE showed bands corresponding to purified and stabilised monomers, dimers, trimers, decamers and HMW-oligomers (Fig. 19B). Tetramers were obtained in some preparative runs and were observed in some decamer fractions (Fig. 23C). The HMW-oligomers migrated in SDS-PAGE as a diffuse band with a molecular mass of >200 kDa, similar to the annular oligomers formed from wt and L68Q cystatin C, as previously described [77].

Mass spectrometry analysis using MALDI-TOF revealed monomers, dimers, trimers and tetramers, but failed to identify the mass of the larger oligomers. All fractions except the HMW-oligomers eluted as distinct and uniform chromatographic peaks in SEC analyses. Using a calibrated column of Superdex 200, the mass distribution of the fractions corresponded to monomers, dimers, trimers and tetramers. The HMW-oligomeric fraction eluted in the void volume of the column. In both preparative and analytical SEC, the decamer fraction displayed a delayed elution profile in a retention volume corresponding to 4.8 monomeric subunits.

Table III. Molecular mass of stabilised cystatin C oligomers.

The experimental masses were obtained from isolated disulfide-stabilised cystatin C oligomers by three different methods and are related to the theoretical mass of monomeric stab1 cystatin C (13.377 kDa). Mass data are given in units of kDa and the calculated number of monomeric subunits displayed within parentheses.

	SDS-PAGE	MALDI-TOF MS	HPLC-SEC	Theoretical mass
Monomer	11.9 (0.9)	13.379 (1.0)	10.2 (0.8)	13.377 (1.0)
Dimer	21.0 (1.6)	26.761 (2.0)	26.0 (1.9)	26.754 (2.0)
Trimer	34.3 (2.6)	40.096 (3.0)	40.6 (3.0)	40.131 (3.0)
Tetramer	49.7 (3.7)	53.455 (4.0)	50.6 (3.8)	53.308 (4.0)
Decamer	127 (9.5)	N.A.	63.8 (4.8)	133.770 (10.0)
HMW-oligomer	>200 (>15)	N.A.	N.A.	N.A.

The HMW-oligomer and decamer fractions were examined by electron microscopy, and circular objects with most diameters in the 12–16 nm range were visible in the HMW-oligomer fraction (Fig. 20A). The decamer sample contained slightly smaller circular objects, with a diameter of 9–13 nm (Fig. 20B). A significant number of both the HMW-oligomeric and decameric objects displayed central cavities. The isolated HMW-oligomers and decamers were further characterised by AFM and, as shown in Fig. 20C and D, the cross-sectional analysis showed a height of 1.2–1.4 nm for both objects. Crystallographic data for chicken cystatin and stab1 cystatin C indicate that this corresponds to monomolecular layers in both objects [74,205]. The resolution of the AFM tip used in the measurements, did not allow visualisation of the central cavities displayed by electron microscopy.

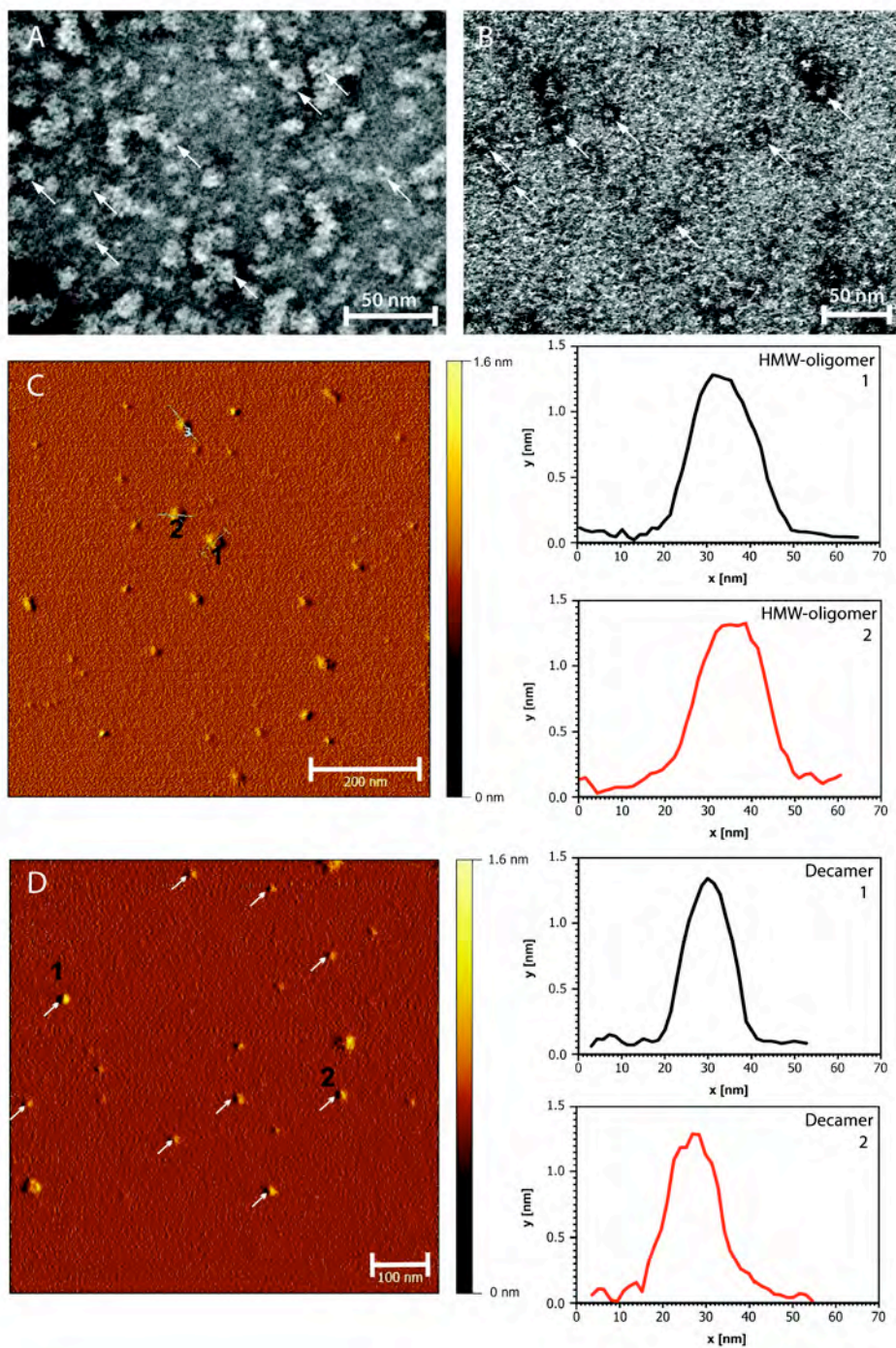
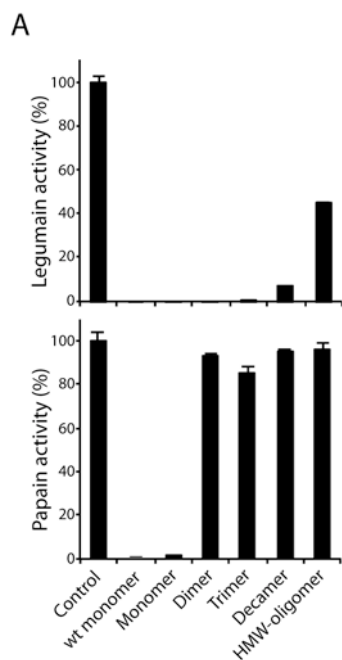

Figure 20. Micrographs of stabilised cystatin C oligomers.

Negative-stain electron microscopy images of disulfide-stabilised HMW-oligomers (**A**) and decamers (**B**), isolated by SEC. In both samples circular structures were visualised (*arrows*), with some objects resembling the pore-like morphology of oligomers formed from several other precursor proteins [23,24,27]. Atomic force microscopy images (*left*) paired with duplicate diagrams (*right*) representing the cross-sectional analyses of HMW-oligomers (**C**) and decamers (**D**). The profiles of two HMW-oligomers and two decamers are given. The height of both oligomeric species is 1.2–1.4 nm, corresponding to a monomolecular layer of cystatin C subunits.

Biological activity of stabilised oligomers

To investigate the conformational changes induced during cystatin C oligomerisation, we tested the inhibitory capacity of the stabilised oligomers towards the two cysteine proteases papain and legumain, both of which are inhibited by monomeric cystatin C [84]. The stabilised dimer was as potent an inhibitor of legumain (102%) as the stabilised monomer (100%) or wt monomeric cystatin C (101%) (Fig. 21A). The retained inhibitory capacity towards legumain was also shown for the stabilised trimer (99%) and was only partially lost in the decamer and HMW-oligomer fractions (93% and 55%, respectively). In contrast, the dimer and the other oligomers showed complete loss of inhibitory capacity towards papain (Fig. 21A). Figure 21B shows structural models explaining the loss of the papain inhibitory activity, while the legumain inhibitory activity is preserved.



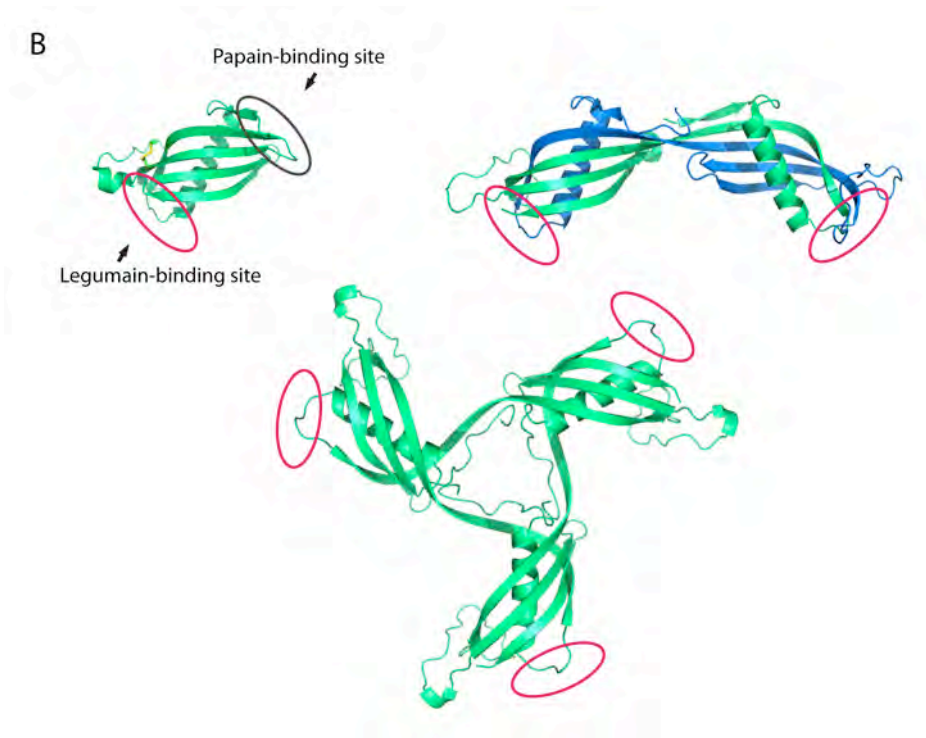

Figure 21. Oligomers are domain-swapped and retain a native-like fold.

(A) Inhibitory capacity of isolated cystatin C oligomers tested against the two proteases, legumain and papain, both of which are inhibited by monomeric cystatin C. The *control* samples represent the full protease activity without inhibitors. Native, non-stabilised, monomeric cystatin C is denoted *wt monomer*. *Monomer*, *Dimer* etc. refer to disulfide-stabilised molecules. *Error bars*, standard deviation. (B) Crystal structure of monomeric stab1 cystatin C (PDB entry 3GAX) displaying the two protease binding sites residing on opposite sides of the molecule, where the N-terminal and two hairpin loops (L1 and L2) constitute the papain-binding domain and the legumain-binding domain resides in proximity to Asn-39 [84]. The crystal structure of dimeric cystatin C (PDB entry 1TIJ) shows disruption of the papain-binding loop L1 that acts as a hinge to the swapping domain, whereas the fold of the legumain-binding domain is retained and accessible. The three-dimensional model of trimeric cystatin C was constructed in PyMOL by repositioning of the domain swapping structural elements (residues 1-57) in the monomer (PDB entry 1TIJ). The oligomer model is in agreement with previous experimental data obtained for dimeric *wt* cystatin C and the presented inhibitory profiles for stabilised oligomeric cystatin C.

Stabilised oligomers display general oligomer-epitopes

Amyloid oligomers might display unique epitopes common to all oligomers, but not present in monomers, and oligomers formed from a number of different amyloidogenic proteins can be detected with use of the A11 antibody [25]. As shown in Fig. 22, all isolated cystatin C oligomers, but not monomers, were recognised by A11, although the reaction was weak. This indicates that these oligomers share epitopes unique to oligomers.

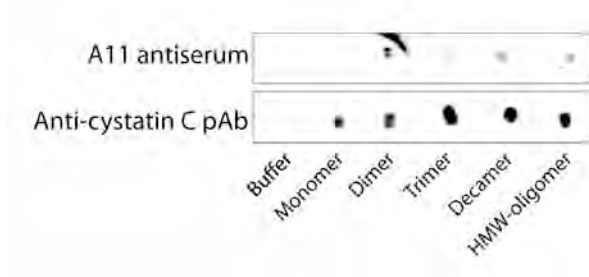

Figure 22. Immunoblotting reveals common oligomeric epitopes in stabilised cystatin C oligomers.

Stabilised cystatin C oligomers and monomers, purified by SEC and concentrated by ultrafiltration, were dot-blotted onto nitrocellulose membranes and probed with A11 antibodies. A11 was originally raised against A β -oligomers and reacts with oligomers of several other amyloidogenic proteins, but not with the protein monomers [25]. In the control blot, samples were probed with commercially available polyclonal anti-cystatin C antibodies (*pAb*).

Propagated domain swapping is required in the formation of oligomers and fibrils

To elucidate if smaller oligomers are merely building blocks in the formation of larger oligomers and fibrils, or if further oligomerisation requires propagated domain swapping, we assessed the propensity for small stabilised oligomers to form HMW-oligomers. As reported previously [77] and shown for wt cystatin C in Fig. 23A, during the lag phase of fibril formation, already after 1 h of incubation at 48°C in mildly denaturing buffers (pH 4.0), both wt and L68Q cystatin C form ring-shaped oligomers detectable by SDS-PAGE or electron microscopy. Prolonged incubation results in fibril formation, as shown for wt cystatin C after 3 weeks of incubation (Fig. 23B).

When isolated stabilised cystatin C monomers, dimers, trimers and decamers were incubated under these conditions, no formation of HMW-oligomers (Fig. 23C) or fibrils could be found. In contrast, unstabilised monomeric wt cystatin C formed both HMW-oligomers and fibrils (Fig. 23A–C). This supports the notion that domain swapping—propagated in an open-ended fashion—is a prerequisite for formation of, not only fibrils[76], but also of HMW-oligomers. A schematic model for the oligomerisation process is given in Fig. 23D.

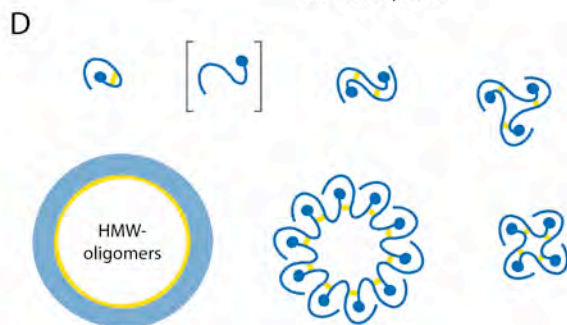
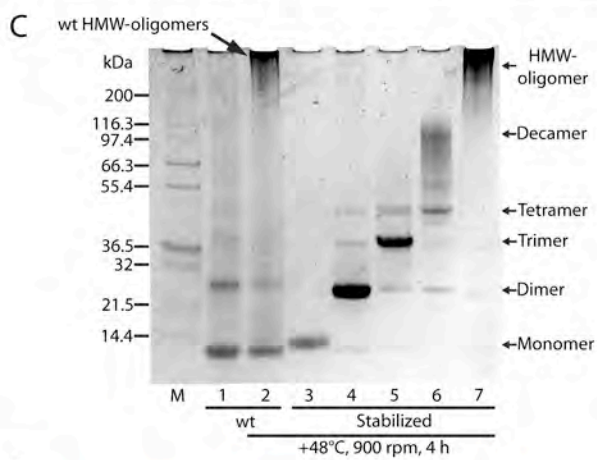
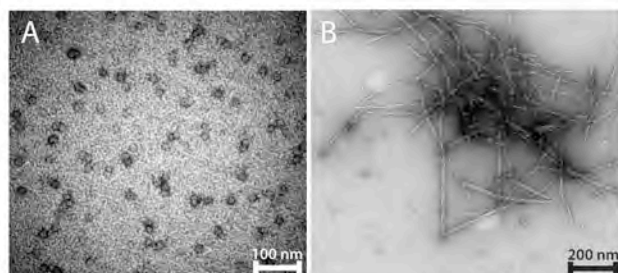

Figure 23. Ring-closed stabilised oligomers are unable to propagate a domain swap.

(A) Electron micrograph of non-stabilised oligomers, produced by incubation at 48°C for 4 h of wt cystatin C in 50 mM sodium acetate, pH 4.0, 100 mM NaCl. (B) Micrograph recorded after prolonged incubation of the sample in A, showing the formation of long twisted fibrils with approximate widths of 10 nm. (C) SDS-PAGE run at 4°C with non-reduced samples in 0.1% SDS to detect formation of HMW-oligomers. HMW-oligomers form after 4 h incubation at 48°C of monomeric wt cystatin C (lane 2) as detailed above, compared to the control sample stored at 4°C (lane 1). Neither the disulfide-stabilised monomer (lane 3) nor the stabilised oligomers (lane 4-7) form any larger species after the incubation, suggesting that propagated domain swapping is required in the formation of larger oligomers. *M*, Mark12 Protein Ladder. (D) Model of the *in vitro* generation and molecular organisation of cystatin C oligomers, where intermolecular disulfide bonds are re-formed in the isolated oligomeric species. The results in C show that the stabilised oligomers cannot oligomerise further, suggesting that no free thiols exist; *i.e.*, all oligomers are formed by propagated domain swapping and closed head-to-tail.

Production and purification of oligomer-specific antibodies

The successful purification and the evident stability of the isolated oligomers prompted us to immunise rabbits in an effort to raise antisera specific for oligomeric cystatin C. We chose the stabilised and isolated dimers and HMW-oligomers, respectively, as immunogens for immunisation trials in two sets of rabbits. The specific antigen-antibody reactions of the antisera obtained were characterised by diffusion-in-gel techniques.

In order to obtain oligomer-specific antibodies without reactivity towards monomeric cystatin C, we purified the antibodies from dimer and HMW-oligomer immunised animals according to the scheme in Fig. 24. First, absorption of monomer-binding antibodies was accomplished by affinity chromatography of immunoglobulin fractions using Sepharose-coupled monomeric cystatin C. The flow-through fractions were collected and the oligomer-reactivity verified (Fig. 25), before isolation of oligomer-specific antibodies using stabilised HMW-oligomers coupled to a Sepharose column. The fractions obtained by acidic elution from this column contained oligomer-specific antibodies from either dimer or HMW-oligomer-immunised rabbits.

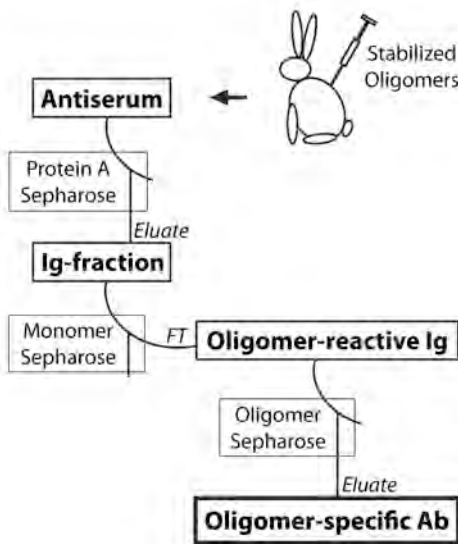

Figure 24. Production and purification of oligomer-specific antibodies.

Schematic summary of the key steps in the isolation of oligomer-specific antibodies. Immunisations were performed using stabilised cystatin C dimers (0.1 mg/injection) or HMW-oligomers (0.05 mg/injection). The absorption of monomer-binding antibodies from the immunoglobulin fractions obtained was critical to avoid cross-reactivity in specificity assays (Fig. 25). *FT*, flow-through; *Ig*, immunoglobulin; *Ab*, antibodies.

Reactivity of oligomer-specific antibodies in gel diffusion and on immunoblotting

The specific antibodies from oligomer immunised rabbits precipitated stabilised dimers, but not monomers, in double radial immunodiffusion (Fig. 25A). They also precipitated stabilised HMW-oligomers (data not shown). No difference could be observed between antibodies obtained by immunising with stabilised dimers and those obtained by immunising with stabilised HMW-oligomers. The cerebral hemorrhage-causing L68Q variant of cystatin C spontaneously forms dimers [68] and the specific antibodies also precipitated these, but not monomeric L68Q cystatin C (Fig. 25A). The antibodies reacted strongly with HMW-oligomers, decamers and trimers, and weakly with dimers, but not at all with monomers, in immunoblotting experiments (Fig. 25B).

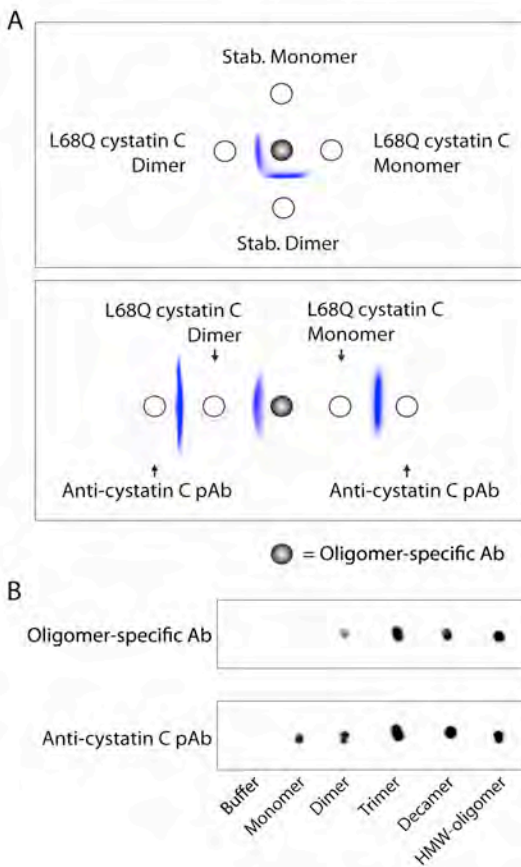

Figure 25. Reactivity of oligomer-specific antibodies.

(A) The specificity of antibodies, purified as described in Fig. 24 from the antisera obtained after immunisation with stabilised cystatin C oligomers, was tested by double radial immunodiffusion. L68Q cystatin C dimers, associated with HCCAA [72], showed antigenic identity with stabilised dimers, while monomers were non-reactive. Polyclonal antibodies raised against monomeric cystatin C (*anti-cystatin C pAb*) were used for comparison. (B) Immunoblots displaying the antigenic recognition of the oligomer-specific antibodies. Polyclonal antibodies raised against monomeric cystatin C (*anti-cystatin C pAb*) were used for comparison.

Selectivity of oligomer-specific antibodies in free solution

To assess the reactivity of the oligomer-specific antibodies in free solutions of dimeric and monomeric cystatin C, the following system was used. Mixtures of antibodies, stabilised monomers and stabilised dimers were prepared and electrophoresed in agarose gels under native conditions. The results showed that dimers were the preferred antigen, although a minor monomer-reactivity could be detected. As shown in Fig. 26, the antibodies could deplete a solution of dimeric cystatin C. Addition of the antibodies to a solution of both monomeric and dimeric cystatin C resulted in a shift of the dimer/monomer ratio from 60/40 in the control sample to 15/85, indicating the potential of these antibodies for selective removal of dimers and, probably, oligomers in general.

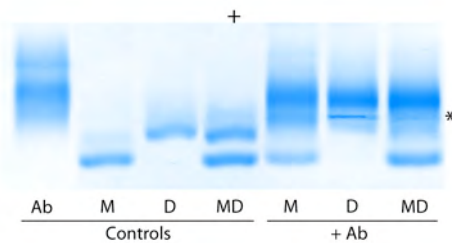

Figure 26. Selectivity of oligomer-specific antibodies as shown by agarose gel electrophoresis.

The oligomer-specific antibodies were added to isolated monomers, dimers or a mixture of monomers and dimers to assess their antigenic specificity. *Ab*, oligomer-specific antibodies; *M*, stabilised monomer; *D*, stabilised dimer; *MD*, mixture of stabilised monomers and dimers. An *asterisk* marks the point of sample application and the anode is marked by a *plus* sign.

Oligomer-specific antibodies selectively bind dimers in blood plasma

To test if the oligomer-specific antibodies would selectively target oligomers also in complex biological systems, we developed a sensitive system for the detection of monomers and dimers in blood plasma using SEC followed by immunodetection (SEC-ELISA). The oligomer-specific antibodies were, in increasing concentrations, added to equal aliquots of plasma containing 0.9 mg/l of monomeric and 1.7 mg/l of dimeric cystatin C and, after 2 h incubation at room temperature and centrifugation at 10,000 *g* for 10 min, the

mixtures were run in the SEC-ELISA system. A significant and dose-dependent decrease in cystatin C immunoreactivity in the fractions corresponding to dimers was observed, while monomeric cystatin C was less affected (Fig. 27A). Using antibody concentrations of 8 and 16 mg/l, respectively, corresponding to 50 and 100 nM, the dimeric cystatin C fraction was reduced by approximately 65 and 95%, respectively (Fig. 27B). A concomitant increase in cystatin C immunoreactivity was also observed in the void volume of the column (SEC exclusion >100 kDa).

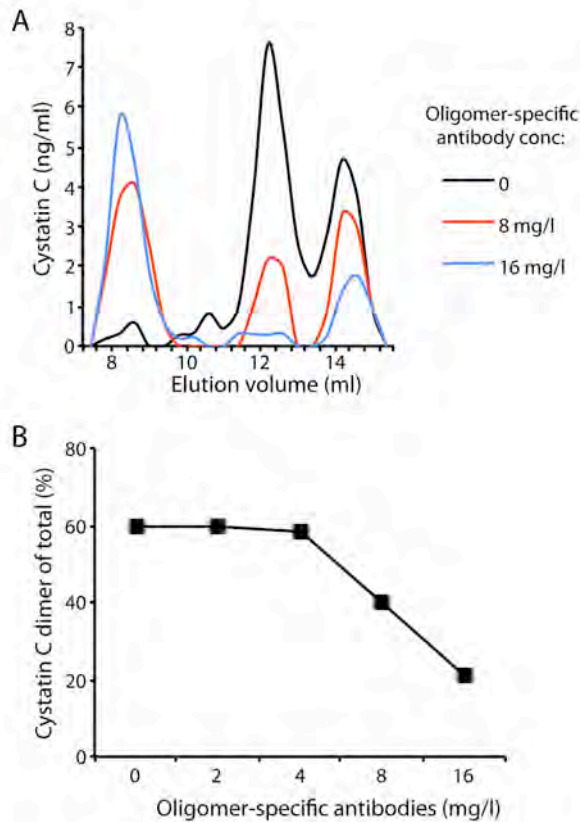

Figure 27. Selective depletion of dimeric cystatin C in blood plasma.

Immunochemical quantification of cystatin C in the fractions of SEC of plasma samples on a column of Superdex 75 GL 10/300 (A and B). In the control sample (*black line*) stabilised dimeric cystatin C was added to normal human plasma, resulting in a concentration of 1.7 mg/l (endogenous monomeric cystatin C = 0.9 mg/l). The oligomer-specific antibodies were added to the plasma sample 2 h before fractionation (*red and blue line*). (B) Plot displaying the percentage dimeric cystatin C of total cystatin C (monomeric + dimeric) after the addition of increasing amounts of oligomer-specific antibodies.

The results concerning oligomer size, using SDS-PAGE, MALDI-TOF MS, and HPLC-SEC, agreed for the dimers, trimers, and tetramers (Table III). But for the oligomers, which, as evaluated by SDS-PAGE, represented decamers, the HPLC-SEC results suggested a considerably smaller (pentameric) structure. However, EM and AFM of these oligomers showed circular objects, the size of which was more compatible with a decameric than a pentameric structure (Fig. 20). In addition to dimers, trimers, tetramers, and decamers, a more heterogeneous fraction of HMW-oligomers were also produced. Interestingly, EM and AFM showed that both the decamers and the HMW-oligomers were round objects, although the size of the HMW-oligomers was larger and more variable than that of the decamers (Fig. 20). Furthermore, AFM indicated that the heights of both the decamers and the HMW-oligomers corresponded to a monomolecular layer of the subunits.

It is not known whether the specific set of oligomers (dimers, trimers, tetramers and decamers) produced in our study are relevant to the set of oligomers present *in vivo* in different amyloid disorders. It has been observed that the set is influenced by the incubation conditions. For example, the incubation conditions used for crystallisation of monomeric cystatin C resulted in a population of nearly 100% cystatin C dimers [69].

The present study indicates that the higher the concentration of monomeric cystatin C is, the higher the amounts of larger oligomers formed. But the reason why virtually no pentamers, hexamers, heptamers, octamers and nonamers are observed is not known; neither if it would be possible to generate these oligomers by manipulation of the incubation conditions. X-ray diffraction analysis of crystals of stabilised decamers, tetramers and trimers, together with the known three-dimensional structure of dimeric cystatin C [69], might reveal if they share stabilising structures, which are energetically unfavored in pentamers, hexamers, heptamers, octamers and nonamers.

The homogeneity and stability of the oligomers might allow studies of their detailed structures using X-ray diffraction. This would be of particular interest for the decamers, as their gross structure, as defined by EM and AFM, is similar to those of oligomers described for other amyloidogenic proteins [23,27]. It is also noteworthy that a similar gross structure has been described for cytotoxic amyloid oligomers [24].

A further indication that the decamer of cystatin C is similar in structure to oligomers of other amyloidogenic proteins is that the A11 antibodies, raised against A β -oligomers and reacting with oligomers of several other amyloidogenic proteins [25], also react with the cystatin C decamers, but not with monomeric cystatin C (Fig. 22).

The stoichiometry of the reduction procedure used in the present study indicated that only the introduced disulfide bridge, preventing domain swapping in stable cystatin C, was reduced in the process, leaving the two other intramolecular disulfide bridges of native cystatin C intact (Fig. 18). Furthermore, an interesting property of the stable oligomers was that their inhibitory capacity for papain was completely lost, whereas their capacity to inhibit legumain was virtually unaltered, since each subunit of the oligomers inhibited approximately one legumain molecule. These properties are compatible with the known structures of monomeric cystatin C and its dimer. As displayed in Fig. 21B, the two inhibitory sites (for papain or legumain) of monomeric cystatin C are well separated. Previous structure-function studies of dimeric cystatin C [69,84] have shown that the papain-inhibitory site of monomeric cystatin C is completely disrupted during domain swapping and thus not present in dimeric cystatin C. In contrast, the legumain-inhibitory site is not influenced by the swapping of domains and thus intact in the cystatin C dimer [84]. The results for the oligomers in the present study are therefore compatible with the hypothesis that a propagated domain swapping mechanism is operating in the formation of the oligomers, similar to the single domain swapping occurring in the formation of dimers (Fig. 21B).

These results strongly suggest that the isolated oligomers are not random aggregates, but instead highly ordered, domain-swapped assemblies of monomeric cystatin C with the two disulfide bridges of native cystatin C intact in the subunits of the oligomers. The stability of the oligomers is most likely induced by novel intermolecular Cys⁴⁷-Cys⁶⁹ bonds, stabilising the swapped domains.

Although domain swapping has been demonstrated for a diverse set of amyloidogenic proteins, including β_2 -microglobulin, ribonuclease A, T7 endonuclease I, antithrombin and the prion protein [69,161,162,164,206,207], it is not clear if domain swapping is a general mechanism of amyloid aggregation, or if other mechanisms also exist.

One crucial part in understanding the pathophysiology of the amyloid disorders is to identify building blocks of HMW-oligomers and fibrils [28]. The availability of stable small to medium sized oligomers might allow such studies. In the present investigation, mildly denaturing conditions, inducing the formation of HMW-oligomers from monomeric wt cystatin C, were used in an effort to produce such HMW-oligomers from stabilised monomeric, dimeric, trimeric and decameric cystatin C. Surprisingly, no HMW-oligomers were produced from any of the smaller oligomers, which, as analysed by SDS-PAGE, seemed to be unaffected by these incubation conditions (Fig. 23C). Therefore, at least for cystatin C, domain swapping seems to be required for all steps in the production of HMW-oligomers. This means that a substance, preventing (propagated) domain swapping, potentially would suppress the formation of larger oligomers from smaller ones and from monomeric cystatin C. It has previously been shown that formation of amyloid fibrils from monomeric wt cystatin C requires domain swapping [76].

Although the stabilised oligomers do not seem to be building blocks in the formation of amyloid fibrils, it will be of interest to investigate if any of them can catalyse the formation of amyloid fibrils from natural, non-stabilised, monomeric wt and L68Q cystatin C, as described for seeding of the incubation mixtures with sonicated preformed fibrils of wt and L68Q cystatin C [77].

The evident stability of the cystatin C oligomers also indicates that free cysteine thiols are absent, suggesting that all oligomers are closed by domain swapping head-to-tail (Fig. 23D). Such a mechanism, together with the monomolecular layer organisation of subunits observed in AFM, might explain the toroidal (doughnut-shaped) morphology of the structures observed in EM and AFM. Similar morphologies have been described for the pore-like oligomeric assemblies described by others [23,24,27] and a similar mechanism of domain swapping head-to-tail might therefore be operating also in the formation of these assemblies. Importantly, pore-like oligomers might be the oligomeric structures responsible for cellular toxicity, by permeabilising membranes and disrupting ion homeostasis [24].

The blood of patients with HCCAA contains dimers of L68Q cystatin C and perhaps larger oligomers [72]. The availability of stabilised cystatin C oligomers raised the possibility of producing antisera specific for oligomeric cystatin C. Such antisera might be used as tools to reduce the amounts of cytotoxic oligomers and to reduce the formation of HMW-oligomers and amyloid fibrils in HCCAA patients. They may also be used for diagnostic purposes, as the presence of cystatin C oligomers has been demonstrated only in HCCAA patients and not in healthy individuals [72]. Indeed, immunisation of rabbits with stabilised dimeric cystatin C, or stabilised cystatin C HMW-

oligomers, and absorption of the antisera using columns of immobilised monomeric cystatin C, resulted in antisera with selectivity for oligomeric cystatin C, including cystatin C dimers. Best results were obtained when the specific antibodies were isolated by use of columns with immobilised stabilised HMW-oligomers. The specific antibodies could selectively precipitate, not only stabilised cystatin C dimers and oligomers, but also L68Q cystatin C dimers, present in HCCAA patients (Fig. 25). They could, in addition, be used to reduce the dimer-monomer cystatin C ratio, not only in pure solutions containing only these two molecular species, but also in complex biological fluids as blood plasma (Figs. 26 and 27).

Interestingly, the immune response of all rabbits immunised with dimeric or HMW-oligomeric cystatin C were of an oligoclonal nature, as shown by the appearance of a few charge-homogeneous bands in the immunoglobulin zone of the agarose gel electropherograms of all antisera, exemplified in Fig. 26. This raises the possibility of producing rabbit monoclonal antibodies specific for oligomeric cystatin C, thus making generally available large pools of reagents with well defined properties for future research and treatment attempts. A further property of these antibodies, which might be interesting to study, is whether they, like the A11 antibodies, will react with amyloid oligomers of other proteins than cystatin C.

Conclusions

- The inflammatory status of a patient does not influence the plasma level of cystatin C.
- A simple high-throughput system for testing the capacity of drugs and monoclonal antibodies to reduce the *in vitro* formation of cystatin C dimers was constructed and several candidates for treatment of HCCAA could be identified.
- Cystatin C amyloid oligomers are cyclic and form by the mechanism of propagated domain swapping.
- Amyloid oligomers can be selectively targeted and removed from biological fluids.
- Oligomer stabilisation is a powerful strategy to study and target amyloid oligomers.

Future Perspectives

One of the worst situations in clinical medicine is when a person is newly diagnosed with a disease for which there exists no treatment. In a perfect world, treatments would be developed prior to diagnostic tests, not the other way around. This gruesome situation is motivation enough for any medical student to join a lab and start doing research.

Despite intensive research over the past three decades, there is a lack of treatments for amyloid disorders. AD, with more than 35 million affected, is the most common of them, while HCCAA is confined to a number of families in Iceland. Several pathophysiologic features are shared within this group of disorders. Most notable is the amyloid deposits, which show common structural characteristics but may not be the actual cause of the disease.

In the last decade, research focus has shifted towards more proximal species, *oligomers*, which appear earlier in the formation of amyloid. There are extensive *in vitro* and *in vivo* evidence for their existence, and their toxicity is quite well established. So is it only the oligomers and not the amyloid that cause disease? Amyloid deposits have been suggested to function as local reservoirs for the more bioactive oligomers [208]. In this respect, amyloid may indeed be important but are not the primary targets of intervention.

In rare cases of amyloidosis, the amyloid plaque-load may reach several kilograms and is clearly enough to ascribe the accompanying clinical symptoms. In many instances, however, plaques are tiny and correlate poorly with the clinical picture. In any case, interference with proximal mechanisms likely holds the key to successful therapeutic interventions.

Removal of the misfolding precursor is a logical approach and an established treatment in some amyloidoses. However, organ removal and transplantation is not the way forward, especially not in AD. Stabilisation of the precursor protein seems appropriate and successful examples exist. High-throughput screening may identify candidates directly while structure-based design may be used to select a set of compounds for *in vitro* validation. However, structure-based *de novo* design requires reliable structural data, which do not exist for all amyloid precursors. For those where structural information is available, one difficulty is that amyloid proteins often are of low molecular

mass with a compact structure (*e.g.* cystatin C) and that it is challenging to model candidate molecules on a structure which has no larger caves or grooves.

Targeting toxic oligomers is another attractive strategy. Again, *de novo* design is only possible if reliable structural data exist. In the meantime, antibody-based therapy—immensely successful in the treatment of inflammatory diseases and cancer—is an important way forward. However, because antibodies are large and may not reach the site of oligomer formation, the complementarity determining regions of potent antibodies may have to be defined, and peptides or other small molecules designed based upon the active binding site, in order for drug candidates to reach the target.

Amyloid is most often found as extracellular deposits. But protein misfolding does not always begin extracellularly and oligomers may form within the cellular secretory system and cytosol. Dysfunction of quality control mechanisms likely contributes to protein aggregation and oligomer formation. Thus, there might be targets worth pursuing within the proteostasis network. Along the same lines are studies on intraneuronal A β —a topic of great interest [209]. Studies of apparently healthy primary cells from HCCAA patients show the L68Q variant to be efficiently degraded by the ubiquitin-proteasome system (results to be published). Hence, proficient quality control mechanisms might explain the observation that L68Q cystatin C carriers do not develop symptomatic disease until they are in their twenties or thirties. That is, some cellular stress or derangement of protein quality control is required for oligomers and fibrils to form.

Whether oligomers form inside or outside cells, they will probably expose hydrophobic amino acids. To escape the aqueous environment, they bind cell membranes and they aggregate further. Thus, clusters of fibrils with a hydrophobic interior are protective and also represent thermodynamically stable structures. Hydrophobic patches alone, however, cannot explain the specificity with which an amyloid precursor self-assembles in the crowded *in vivo* environment. That is, amyloid assembly pathways likely rely on forces other than mere hydrophobic interactions. Propagated domain swapping is one assembly mechanism that might explain the inclusion of only one specific protein in the large bulk of amyloid deposits.

Domain swapping as a mechanism in amyloidosis merits further investigation. The detailed structures of the resulting oligomers should be defined by X-ray crystallography or small-angle X-ray scattering. This will reveal epitopes possible to target with antibodies, peptides or small molecules. The toxicity of stabilised oligomers should also be investigated in cell cultures and cytotoxicity mechanisms defined.

Acknowledgements

I'm privileged to have met with so many brilliant colleagues and new friends throughout the years of working in these projects. Many individuals have contributed. In particular, I'd like to acknowledge:

Anders Grubb, for all great scientific discussions we had over the years; for believing in me; for always taking the time to listen; and especially, for your endless generosity and inspiring friendly ways.

Veronica Lindström, for the hard work you put into these projects; for the superb protein batches we obtained; for always sharing your expertise in the lab; and for being a great colleague and friend.

Magnus Abrahamson, for many interesting discussions and journal clubs; for always keeping your door open; and for sharing your expertise on research in general and cystatins in particular. I always enjoy learning the true story behind a reference!

Hanna Wallin, for kind help in the lab, for valuable scientific input; and for your positive, unbiased nature. We are finally at the finishing line!

Anne-Cathrine Carlberg Löfström, for your resolute struggles to obtain L68Q cystatin C; and for your warm and kind spirit.

Kerstin Samuelsson, for great efforts in expressing recombinant proteins.

Ulf Ekström and *Carl-Gustaf Magnusson*, for valuable and inspiring discussions.

All my colleagues at Clinical Chemistry in Lund, for helping me out; for cheering me up when experiments fail; and for all our pleasant coffee breaks!

Ástríður Pálsdóttir, for welcoming me into your lab; and for many exciting discussions.

Birkir T. Bragason, for great discussions; for sharing your expertise in cell biology and cell culturing; and for the many hours of tireless work we spent under the hood.

All the staff at Keldur, Experimental Pathology, Reykjavik, for helping me out with my projects; and for all the cakes, discussions and sweets at coffee breaks!

Joanna Pollak, Aneta Szymanska, Maria Smuzynska and Rafal Rostankowski, for contributing to the projects; and for our long happy days in the lab.

Eric Carlemalm, for guiding me into the world of electron microscopy.

Maciej Kozak, for the wonderful AFM analyses.

Bo Holmqvist and *Peter Ekström*, for many exciting hours at the confocal microscope.

Jenny Apelqvist and *Freddi Andersson*, for valuable discussions; and for continuing the important work on cystatins.

All FLÄK-members, for the discussions, the laughs and beers at Brösarps Gästgiveri.

Malin Eliasson, for taking such good care of my children this summer.

My brother-in-law *Össur I. Emilsson*, for hands-on contributions to the projects and the Icelandic abstract.

My father-in-law *Emil B. Karlsson*, for your never-ending hospitality in Reykjavik; and for your last minute efforts to translate the abstract!

My stepfather, *Nicolae Östner*, for teaching me the value of planning; 1-5-10 years ahead!

My *mother*, for your love and endurance, and for always claiming I would become a doctor; you never thought I'd become one twice!

My *father*, for your love and support; for your open, vibrant mind; and for always believing in me.

My *brother*, for bringing me up as a close friend; for all the hard work we put into solving crossword-puzzles over coffee while not attending school; this is the result!

My wonderful little *sister*, already grown and a proud mother; for keeping your lovely spirit!

Vilgot, Axel, Sofia och min fina lilla *bebis*, det är Ni som ger mig kraft och glädje varje dag. Det är Ni som har hjälpt mig skriva den här boken. Jag är den lyckligaste pappan i världen :) Jag älskar er !

Hulda, for being a brilliant wife; the happy days and laughter we share, the hardships we endure, it is all I wish for and more. Thank you for endless support ;)

All other *friends* and *relatives*, for your support, your understanding and encouragement.

During the course of the research underlying this thesis, the author was enrolled in a multidisciplinary doctoral programme endorsed by the Swedish National Research School in Pharmaceutical Sciences (FLÄK).

This work was supported in part by the Swedish Science Research Council (Project No. 5196) and by grants from the A. Österlund, and G. and J. Kock Foundations, and the Royal Physiographic Society in Lund, Sweden.

Acknowledgements

References

1. Mayeux, R., and Stern, Y. (2012) Epidemiology of Alzheimer disease. *Cold Spring Harb Perspect Med* **2**, a006239
2. Schapira, A. H. (2009) Neurobiology and treatment of Parkinson's disease. *Trends Pharm Sci* **30**, 41-47
3. Sipe, J. D., Benson, M. D., Buxbaum, J. N., Ikeda, S., Merlini, G., Saraiva, M. J., and Westermark, P. (2010) Amyloid fibril protein nomenclature: 2010 recommendations from the nomenclature committee of the International Society of Amyloidosis. *Amyloid* **17**, 101-104
4. Chiti, F., and Dobson, C. M. (2006) Protein misfolding, functional amyloid, and human disease. *Annu Rev Biochem* **75**, 333-366
5. Westermark, P., Benson, M. D., Buxbaum, J. N., Cohen, A. S., Frangione, B., Ikeda, S., Masters, C. L., Merlini, G., Saraiva, M. J., and Sipe, J. D. (2007) A primer of amyloid nomenclature. *Amyloid* **14**, 179-183
6. Sideras, K., and Gertz, M. A. (2009) Amyloidosis. *Adv Clin Chem* **47**, 1-44
7. Eisenberg, D., and Jucker, M. (2012) The amyloid state of proteins in human diseases. *Cell* **148**, 1188-1203
8. Picken, M. M. (2010) Amyloidosis-where are we now and where are we heading? *Arch Path Lab Med* **134**, 545-551
9. Virchow, R. (1854) Zur Cellulose-Frage. *Virchows Arch Path Anat* **6**, 416-426
10. Kyle, R. A. (2001) Amyloidosis: a convoluted story. *Br J Haematol* **114**, 529-538
11. Friedreich, N., and Kekulé, A. (1859) Zur Amyloidfrage. *Virchows Arch Path Anat* **16**, 50-65
12. Cohen, A. S., and Calkins, E. (1959) Electron microscopic observations on a fibrous component in amyloid of diverse origins. *Nature* **183**, 1202-1203
13. Bellotti, V., and Chiti, F. (2008) Amyloidogenesis in its biological environment: challenging a fundamental issue in protein misfolding diseases. *Curr Op Struct Biol* **18**, 771-779
14. Bennhold, H. (1922) Eine spezifische Amyloidfärbung mit Kongorot. *Munch Med Wochenschr* **69**, 1537-1538
15. Astbury, W. T., Dickinson, S., and Bailey, K. (1935) The X-ray interpretation of denaturation and the structure of the seed globulins. *Biochem J* **29**, 2351-2360

16. Makin, O. S., and Serpell, L. C. (2005) Structures for amyloid fibrils. *FEBS J* **272**, 5950-5961
17. Stine, W. B., Jr., Dahlgren, K. N., Krafft, G. A., and LaDu, M. J. (2003) In vitro characterization of conditions for amyloid-beta peptide oligomerization and fibrillogenesis. *J Biol Chem* **278**, 11612-11622
18. Jarrett, J. T., and Lansbury, P. T., Jr. (1992) Amyloid fibril formation requires a chemically discriminating nucleation event: studies of an amyloidogenic sequence from the bacterial protein OsmB. *Biochemistry (Mosc)* **31**, 12345-12352
19. Jarrett, J. T., and Lansbury, P. T., Jr. (1993) Seeding "one-dimensional crystallization" of amyloid: a pathogenic mechanism in Alzheimer's disease and scrapie? *Cell* **73**, 1055-1058
20. Lambert, M. P., Barlow, A. K., Chromy, B. A., Edwards, C., Freed, R., Liosatos, M., Morgan, T. E., Rozovsky, I., Trommer, B., Viola, K. L., Wals, P., Zhang, C., Finch, C. E., Krafft, G. A., and Klein, W. L. (1998) Diffusible, nonfibrillar ligands derived from Abeta1-42 are potent central nervous system neurotoxins. *Proc Natl Acad Sci U S A* **95**, 6448-6453
21. Walsh, D. M., Klyubin, I., Fadeeva, J. V., Cullen, W. K., Anwyl, R., Wolfe, M. S., Rowan, M. J., and Selkoe, D. J. (2002) Naturally secreted oligomers of amyloid beta protein potently inhibit hippocampal long-term potentiation in vivo. *Nature* **416**, 535-539
22. Bucciantini, M., Giannoni, E., Chiti, F., Baroni, F., Formigli, L., Zurdo, J., Taddei, N., Ramponi, G., Dobson, C. M., and Stefani, M. (2002) Inherent toxicity of aggregates implies a common mechanism for protein misfolding diseases. *Nature* **416**, 507-511
23. Quist, A., Doudevski, I., Lin, H., Azimova, R., Ng, D., Frangione, B., Kagan, B., Ghiso, J., and Lal, R. (2005) Amyloid ion channels: a common structural link for protein-misfolding disease. *Proc Natl Acad Sci U S A* **102**, 10427-10432
24. Kagan, B. L. (2012) Membrane pores in the pathogenesis of neurodegenerative disease. *Prog Mol Biol Transl Sci* **107**, 295-325
25. Kaye, R., Head, E., Thompson, J. L., McIntire, T. M., Milton, S. C., Cotman, C. W., and Glabe, C. G. (2003) Common structure of soluble amyloid oligomers implies common mechanism of pathogenesis. *Science* **300**, 486-489
26. Kaye, R., and Lasagna-Reeves, C. A. (2013) Molecular mechanisms of amyloid oligomers toxicity. *J Alzheimers Dis* **33 Suppl 1**, S67-78
27. Lin, H., Bhatia, R., and Lal, R. (2001) Amyloid beta protein forms ion channels: implications for Alzheimer's disease pathophysiology. *FASEB J* **15**, 2433-2444

28. Bemporad, F., and Chiti, F. (2012) Protein misfolded oligomers: experimental approaches, mechanism of formation, and structure-toxicity relationships. *Chem Biol* **19**, 315-327
29. Powers, E. T., Morimoto, R. I., Dillin, A., Kelly, J. W., and Balch, W. E. (2009) Biological and chemical approaches to diseases of proteostasis deficiency. *Annu Rev Biochem* **78**, 959-991
30. Meier, J. J., Kaye, R., Lin, C. Y., Gurlo, T., Haataja, L., Jayasinghe, S., Langen, R., Glabe, C. G., and Butler, P. C. (2006) Inhibition of human IAPP fibril formation does not prevent beta-cell death: evidence for distinct actions of oligomers and fibrils of human IAPP. *Am J Physiol Endocrinol Metab* **291**, E1317-1324
31. Gurlo, T., Ryazantsev, S., Huang, C. J., Yeh, M. W., Reber, H. A., Hines, O. J., O'Brien, T. D., Glabe, C. G., and Butler, P. C. (2010) Evidence for proteotoxicity in beta cells in type 2 diabetes: toxic islet amyloid polypeptide oligomers form intracellularly in the secretory pathway. *Am J Pathol* **176**, 861-869
32. Anfinsen, C. B. (1973) Principles that govern the folding of protein chains. *Science* **181**, 223-230
33. Ellgaard, L., and Helenius, A. (2003) Quality control in the endoplasmic reticulum. *Nat Rev Mol Cell Biol* **4**, 181-191
34. Nixon, R. A., and Yang, D. S. (2011) Autophagy failure in Alzheimer's disease--locating the primary defect. *Neurobiol Dis* **43**, 38-45
35. Yerbury, J. J., Stewart, E. M., Wyatt, A. R., and Wilson, M. R. (2005) Quality control of protein folding in extracellular space. *EMBO Rep* **6**, 1131-1136
36. Wyatt, A. R., Yerbury, J. J., Poon, S., and Wilson, M. R. (2009) Therapeutic targets in extracellular protein deposition diseases. *Curr Med Chem* **16**, 2855-2866
37. Alexandrescu, A. T. (2005) Amyloid accomplices and enforcers. *Protein Sci* **14**, 1-12
38. Cyr, D. M., and Hebert, D. N. (2009) Protein quality control--linking the unfolded protein response to disease. Conference on 'From Unfolded Proteins in the Endoplasmic Reticulum to Disease'. *EMBO Rep* **10**, 1206-1210
39. Balch, W. E., Morimoto, R. I., Dillin, A., and Kelly, J. W. (2008) Adapting proteostasis for disease intervention. *Science* **319**, 916-919
40. Meredith, S. C. (2005) Protein denaturation and aggregation: Cellular responses to denatured and aggregated proteins. *Annals of NY Acad Sci* **1066**, 181-221
41. Zhang, Y., Gao, J., Chung, K. K., Huang, H., Dawson, V. L., and Dawson, T. M. (2000) Parkin functions as an E2-dependent ubiquitin-protein ligase

- and promotes the degradation of the synaptic vesicle-associated protein, CDCrel-1. *Proc Natl Acad Sci U S A* **97**, 13354-13359
42. Rakha, E. A. (2013) Pitfalls in outcome prediction of breast cancer. *J Clin Path* **66**, 458-464
43. Pare, R., Yang, T., Shin, J. S., and Lee, C. S. (2013) The significance of the senescence pathway in breast cancer progression. *J Clin Path* **66**, 491-495
44. Querfurth, H. W., and LaFerla, F. M. (2010) Alzheimer's disease. *N Engl J Med* **362**, 329-344
45. Nassif, M., Matus, S., Castillo, K., and Hetz, C. (2010) Amyotrophic lateral sclerosis pathogenesis: a journey through the secretory pathway. *Antioxid Redox Signal* **13**, 1955-1989
46. Puca, R., Nardinocchi, L., Porru, M., Simon, A. J., Rechavi, G., Leonetti, C., Givol, D., and D'Orazi, G. (2011) Restoring p53 active conformation by zinc increases the response of mutant p53 tumor cells to anticancer drugs. *Cell Cycle* **10**, 1679-1689
47. Balch, W. E., Roth, D. M., and Hutt, D. M. (2011) Emergent properties of proteostasis in managing cystic fibrosis. *Cold Spring Harb Perspect Biol* **3**, a004499
48. Muntau, A. C., and Gersting, S. W. (2010) Phenylketonuria as a model for protein misfolding diseases and for the development of next generation orphan drugs for patients with inborn errors of metabolism. *J Inherit Metab Dis* **33**, 649-658
49. Rochet, J. C. (2007) Novel therapeutic strategies for the treatment of protein-misfolding diseases. *Expert Rev Mol Med* **9**, 1-34
50. Johnson, S. M., Connelly, S., Fearn, C., Powers, E. T., and Kelly, J. W. (2012) The transthyretin amyloidoses: from delineating the molecular mechanism of aggregation linked to pathology to a regulatory-agency-approved drug. *J Mol Biol* **421**, 185-203
51. Arnason, A. (1935) Apoplexie und Ihre Vererbung. *Acta Psychiatrica et Neurologica* **Suppl VII**
52. Gudmundsson, G., Hallgrimsson, J., Jonasson, T. A., and Bjarnason, O. (1972) Hereditary cerebral haemorrhage with amyloidosis. *Brain* **95**, 387-404
53. Cohen, D. H., Feiner, H., Jensson, O., and Frangione, B. (1983) Amyloid fibril in hereditary cerebral hemorrhage with amyloidosis (HCHWA) is related to the gastroentero-pancreatic neuroendocrine protein, gamma trace. *J Exp Med* **158**, 623-628
54. Grubb, A., and Löfberg, H. (1982) Human gamma-trace, a basic microprotein: amino acid sequence and presence in the adenohypophysis. *Proc Natl Acad Sci U S A* **79**, 3024-3027
55. Ghiso, J., Jensson, O., and Frangione, B. (1986) Amyloid fibrils in hereditary cerebral hemorrhage with amyloidosis of Icelandic type is a

- variant of gamma-trace basic protein (cystatin C). *Proc Natl Acad Sci U S A* **83**, 2974-2978
56. Palsdottir, A., Abrahamson, M., Thorsteinsson, L., Arnason, A., Olafsson, I., Grubb, A., and Jensson, O. (1988) Mutation in cystatin C gene causes hereditary brain haemorrhage. *Lancet* **2**, 603-604
57. Abrahamson, M., Islam, M. Q., Szpirer, J., Szpirer, C., and Levan, G. (1989) The human cystatin C gene (CST3), mutated in hereditary cystatin C amyloid angiopathy, is located on chromosome 20. *Hum Genet* **82**, 223-226
58. Löfberg, H., Grubb, A. O., Nilsson, E. K., Jensson, O., Gudmundsson, G., Blöndal, H., Arnason, A., and Thorsteinsson, L. (1987) Immunohistochemical characterization of the amyloid deposits and quantitation of pertinent cerebrospinal fluid proteins in hereditary cerebral hemorrhage with amyloidosis. *Stroke* **18**, 431-440
59. Benedikz, E., Blöndal, H., and Gudmundsson, G. (1990) Skin deposits in hereditary cystatin C amyloidosis. *Virchows Arch Path Anat* **417**, 325-331
60. Abrahamson, M., Grubb, A., Olafsson, I., and Lundwall, Å. (1987) Molecular cloning and sequence analysis of cDNA coding for the precursor of the human cysteine proteinase inhibitor cystatin C. *FEBS Lett* **216**, 229-233
61. Abrahamson, M., Jonsdottir, S., Olafsson, I., Jensson, O., and Grubb, A. (1992) Hereditary cystatin C amyloid angiopathy: identification of the disease-causing mutation and specific diagnosis by polymerase chain reaction based analysis. *Hum Genet* **89**, 377-380
62. Grubb, A., Jensson, O., Gudmundsson, G., Arnason, A., Löfberg, H., and Malm, J. (1984) Abnormal metabolism of gamma-trace alkaline microprotein: The basic defect in hereditary cerebral hemorrhage with amyloidosis. *N Engl J Med* **311**, 1547-1549
63. Palsdottir, A., Helgason, A., Palsson, S., Bjornsson, H. T., Bragason, B. T., Gretarsdottir, S., Thorsteinsdottir, U., Olafsson, E., and Stefansson, K. (2008) A drastic reduction in the life span of cystatin C L68Q carriers due to life-style changes during the last two centuries. *PLoS Genet* **4**, e1000099
64. Jensson, O., Gudmundsson, G., Arnason, A., Blöndal, H., Petursdottir, I., Thorsteinsson, L., Grubb, A., Löfberg, H., Cohen, D., and Frangione, B. (1987) Hereditary cystatin C (gamma-trace) amyloid angiopathy of the CNS causing cerebral hemorrhage. *Acta Neurol Scand* **76**, 102-114
65. Gudmundsson, G., Olafsson, E., Blöndal, H., Arnason, A., and Heuser, W. (1998) Hereditary cerebral hemorrhage in Iceland. Incidence for the 35 year period 1960-1994. *Icelandic Med J Suppl* **37**, 76
66. Olafsson, I., and Grubb, A. (2000) Hereditary cystatin C amyloid angiopathy. *Amyloid* **7**, 70-79

-
67. Abrahamson, M., Dalboge, H., Olafsson, I., Carlsen, S., and Grubb, A. (1988) Efficient production of native, biologically active human cystatin C by *Escherichia coli*. *FEBS Lett* **236**, 14-18
68. Abrahamson, M., and Grubb, A. (1994) Increased body temperature accelerates aggregation of the Leu-68-->Gln mutant cystatin C, the amyloid-forming protein in hereditary cystatin C amyloid angiopathy. *Proc Natl Acad Sci U S A* **91**, 1416-1420
69. Janowski, R., Kozak, M., Jankowska, E., Grzonka, Z., Grubb, A., Abrahamson, M., and Jaskolski, M. (2001) Human cystatin C, an amyloidogenic protein, dimerizes through three-dimensional domain swapping. *Nat Struct Biol* **8**, 316-320
70. Gerhartz, B., Ekiel, I., and Abrahamson, M. (1998) Two stable unfolding intermediates of the disease-causing L68Q variant of human cystatin C. *Biochemistry (Mosc)* **37**, 17309-17317
71. Ekiel, I., and Abrahamson, M. (1996) Folding-related dimerization of human cystatin C. *J Biol Chem* **271**, 1314-1321
72. Bjarnadottir, M., Nilsson, C., Lindström, V., Westman, A., Davidsson, P., Thormodsson, F., Blöndal, H., Gudmundsson, G., and Grubb, A. (2001) The cerebral hemorrhage-producing cystatin C variant (L68Q) in extracellular fluids. *Amyloid* **8**, 1-10
73. Schrodinger, L.L.C. (2010) The PyMOL Molecular Graphics System, Version 1.3r1.
74. Kolodziejczyk, R., Michalska, K., Hernandez-Santoyo, A., Wahlbom, M., Grubb, A., and Jaskolski, M. (2010) Crystal structure of human cystatin C stabilized against amyloid formation. *FEBS J* **277**, 1726-1737
75. Janowski, R., Kozak, M., Abrahamson, M., Grubb, A., and Jaskolski, M. (2005) 3D domain-swapped human cystatin C with amyloidlike intermolecular beta-sheets. *Proteins* **61**, 570-578
76. Nilsson, M., Wang, X., Rodziewicz-Motowidlo, S., Janowski, R., Lindström, V., Önnarfjord, P., Westermark, G., Grzonka, Z., Jaskolski, M., and Grubb, A. (2004) Prevention of domain swapping inhibits dimerization and amyloid fibril formation of cystatin C: use of engineered disulfide bridges, antibodies, and carboxymethylpapain to stabilize the monomeric form of cystatin C. *J Biol Chem* **279**, 24236-24245
77. Wahlbom, M., Wang, X., Lindström, V., Carlemalm, E., Jaskolski, M., and Grubb, A. (2007) Fibrillogenic oligomers of human cystatin C are formed by propagated domain swapping. *J Biol Chem* **282**, 18318-18326
78. Levy, E., Jaskolski, M., and Grubb, A. (2006) The role of cystatin C in cerebral amyloid angiopathy and stroke: cell biology and animal models. *Brain Pathol* **16**, 60-70
79. Jonsdottir, G., Ingólfssdottir, I. E., Thormodsson, F. R., and Petersen, P. H. (2013) Endogenous aggregates of amyloidogenic cystatin C variant are

- removed by THP-1 cells in vitro and induce differentiation and a proinflammatory response. *Neurobiol Aging* **34**, 1389-1396
80. Vilhjalmsdottir, D. T., Blöndal, H., and Thormodsson, F. R. (2007) Solubilized cystatin C amyloid is cytotoxic to cultured human cerebrovascular smooth muscle cells. *Exp Mol Path* **83**, 357-360
81. Grubb, A. O. (2000) Cystatin C--properties and use as diagnostic marker. *Adv Clin Chem* **35**, 63-99
82. Wallin, H., Bjarnadottir, M., Vogel, L. K., Wasselius, J., Ekström, U., and Abrahamson, M. (2010) Cystatins--Extra- and intracellular cysteine protease inhibitors: High-level secretion and uptake of cystatin C in human neuroblastoma cells. *Biochimie* **92**, 1625-1634
83. Abrahamson, M., Barrett, A. J., Salvesen, G., and Grubb, A. (1986) Isolation of six cysteine proteinase inhibitors from human urine. Their physicochemical and enzyme kinetic properties and concentrations in biological fluids. *J Biol Chem* **261**, 11282-11289
84. Alvarez-Fernandez, M., Barrett, A. J., Gerhartz, B., Dando, P. M., Ni, J., and Abrahamson, M. (1999) Inhibition of mammalian legumain by some cystatins is due to a novel second reactive site. *J Biol Chem* **274**, 19195-19203
85. Sun, B., Zhou, Y., Halabisky, B., Lo, I., Cho, S. H., Mueller-Stainer, S., Devidze, N., Wang, X., Grubb, A., and Gan, L. (2008) Cystatin C-cathepsin B axis regulates amyloid beta levels and associated neuronal deficits in an animal model of Alzheimer's disease. *Neuron* **60**, 247-257
86. Bernstein, H. G., Kirschke, H., Wiederanders, B., Pollak, K. H., Zipress, A., and Rinne, A. (1996) The possible place of cathepsins and cystatins in the puzzle of Alzheimer disease: a review. *Mol Chem Neuropathol* **27**, 225-247
87. Cheng, X. W., Huang, Z., Kuzuya, M., Okumura, K., and Murohara, T. (2011) Cysteine protease cathepsins in atherosclerosis-based vascular disease and its complications. *Hypertension* **58**, 978-986
88. Gocheva, V., and Joyce, J. A. (2007) Cysteine cathepsins and the cutting edge of cancer invasion. *Cell Cycle* **6**, 60-64
89. Keppler, D. (2006) Towards novel anti-cancer strategies based on cystatin function. *Cancer Lett* **235**, 159-176
90. Ekström, U., Wallin, H., Lorenzo, J., Holmqvist, B., Abrahamson, M., and Aviles, F. X. (2008) Internalization of cystatin C in human cell lines. *FEBS J* **275**, 4571-4582
91. Wallin, H., Abrahamson, M., and Ekström, U. (2013) Cystatin C properties crucial for uptake and inhibition of intracellular target enzymes. *J Biol Chem* **288**, 17019-17029
92. Eriksson, P., Deguchi, H., Samnegard, A., Lundman, P., Boquist, S., Tornvall, P., Ericsson, C. G., Bergstrand, L., Hansson, L. O., Ye, S., and

-
- Hamsten, A. (2004) Human evidence that the cystatin C gene is implicated in focal progression of coronary artery disease. *Arterioscler Thromb Vasc Biol* **24**, 551-557
93. Ferraro, S., Marano, G., Biganzoli, E. M., Boracchi, P., and Bongo, A. S. (2011) Prognostic value of cystatin C in acute coronary syndromes: enhancer of atherosclerosis and promising therapeutic target. *Clin Chem Lab Med* **49**, 1397-1404
94. Bengtsson, E., Nilsson, J., and Jovinge, S. (2008) Cystatin C and cathepsins in cardiovascular disease. *Front Biosci* **13**, 5780-5786
95. Lindholt, J. S., Erlandsen, E. J., and Henneberg, E. W. (2001) Cystatin C deficiency is associated with the progression of small abdominal aortic aneurysms. *Br J Surg* **88**, 1472-1475
96. Salgado, J. V., Souza, F. L., and Salgado, B. J. (2013) How to understand the association between cystatin C levels and cardiovascular disease: Imbalance, counterbalance, or consequence? *J Cardiol* In press
97. Brookmeyer, R., Johnson, E., Ziegler-Graham, K., and Arrighi, H. M. (2007) Forecasting the global burden of Alzheimer's disease. *Alzheimers Dement* **3**, 186-191
98. Wimo, A., Jonsson, L., Bond, J., Prince, M., and Winblad, B. (2013) The worldwide economic impact of dementia 2010. *Alzheimers Dement* **9**, 1-11 e13
99. Alzheimer, A. (1907) Uber eine eigenartige Erkrankung der Hirnrinde. *Allg Z Psychiat* **64**, 146-148
100. Gilbert, B. J. (2013) The role of amyloid beta in the pathogenesis of Alzheimer's disease. *J Clin Path* **66**, 362-366
101. Glenner, G. G., and Wong, C. W. (1984) Alzheimer's disease: initial report of the purification and characterization of a novel cerebrovascular amyloid protein. *Biochem Biophys Res Commun* **120**, 885-890
102. Ho, T., Vessey, K. A., Cappai, R., Dinet, V., Mascarelli, F., Ciccotosto, G. D., and Fletcher, E. L. (2012) Amyloid precursor protein is required for normal function of the rod and cone pathways in the mouse retina. *PLoS One* **7**, e29892
103. Iwatsubo, T., Odaka, A., Suzuki, N., Mizusawa, H., Nukina, N., and Ihara, Y. (1994) Visualization of A beta 42(43) and A beta 40 in senile plaques with end-specific A beta monoclonals: evidence that an initially deposited species is A beta 42(43). *Neuron* **13**, 45-53
104. Buchhave, P., Minthon, L., Zetterberg, H., Wallin, A. K., Blennow, K., and Hansson, O. (2012) Cerebrospinal fluid levels of beta-amyloid 1-42, but not of tau, are fully changed already 5 to 10 years before the onset of Alzheimer dementia. *Arch Gen Psychiat* **69**, 98-106
105. Hardy, J. (2009) The amyloid hypothesis for Alzheimer's disease: a critical reappraisal. *J Neurochem* **110**, 1129-1134

106. Grabowski, T. J., Cho, H. S., Vonsattel, J. P., Rebeck, G. W., and Greenberg, S. M. (2001) Novel amyloid precursor protein mutation in an Iowa family with dementia and severe cerebral amyloid angiopathy. *Ann Neurol* **49**, 697-705
107. Busciglio, J., Pelsman, A., Wong, C., Pigino, G., Yuan, M., Mori, H., and Yankner, B. A. (2002) Altered metabolism of the amyloid beta precursor protein is associated with mitochondrial dysfunction in Down's syndrome. *Neuron* **33**, 677-688
108. Olson, M. I., and Shaw, C. M. (1969) Presenile dementia and Alzheimer's disease in mongolism. *Brain* **92**, 147-156
109. Glenner, G. G., and Wong, C. W. (1984) Alzheimer's disease and Down's syndrome: sharing of a unique cerebrovascular amyloid fibril protein. *Biochem Biophys Res Commun* **122**, 1131-1135
110. Jonsson, T., Atwal, J. K., Steinberg, S., Snaedal, J., Jonsson, P. V., Bjornsson, S., Stefansson, H., Sulem, P., Gudbjartsson, D., Maloney, J., Hoyte, K., Gustafson, A., Liu, Y., Lu, Y., Bhangale, T., Graham, R. R., Huttenlocher, J., Bjornsdottir, G., Andreassen, O. A., Jonsson, E. G., Palotie, A., Behrens, T. W., Magnusson, O. T., Kong, A., Thorsteinsdottir, U., Watts, R. J., and Stefansson, K. (2012) A mutation in APP protects against Alzheimer's disease and age-related cognitive decline. *Nature* **488**, 96-99
111. Serretti, A., Olgiati, P., and De Ronchi, D. (2007) Genetics of Alzheimer's disease. A rapidly evolving field. *J Alzheimers Dis* **12**, 73-92
112. Lue, L. F., Kuo, Y. M., Roher, A. E., Brachova, L., Shen, Y., Sue, L., Beach, T., Kurth, J. H., Rydel, R. E., and Rogers, J. (1999) Soluble amyloid beta peptide concentration as a predictor of synaptic change in Alzheimer's disease. *Am J Pathol* **155**, 853-862
113. Marx, J. (2001) Neuroscience. New leads on the 'how' of Alzheimer's. *Science* **293**, 2192-2194
114. Selkoe, D. J. (2011) Resolving controversies on the path to Alzheimer's therapeutics. *Nat Med* **17**, 1060-1065
115. Citron, M. (2010) Alzheimer's disease: strategies for disease modification. *Nat Rev Drug Discov* **9**, 387-398
116. Podlisny, M. B., Ostaszewski, B. L., Squazzo, S. L., Koo, E. H., Rydell, R. E., Teplow, D. B., and Selkoe, D. J. (1995) Aggregation of secreted amyloid beta-protein into sodium dodecyl sulfate-stable oligomers in cell culture. *J Biol Chem* **270**, 9564-9570
117. Larson, M. E., and Lesne, S. E. (2011) Soluble Abeta oligomer production and toxicity. *J Neurochem* **120 Suppl 1**, S125-139
118. Marchesi, V. T. (2012) Alzheimer's disease 2012: the great amyloid gamble. *Am J Pathol* **180**, 1762-1767

-
119. Paul, S. M., Mytelka, D. S., Dunwiddie, C. T., Persinger, C. C., Munos, B. H., Lindborg, S. R., and Schacht, A. L. (2010) How to improve R&D productivity: the pharmaceutical industry's grand challenge. *Nat Rev Drug Discov* **9**, 203-214
120. Aronson, J. K. (2007) Old drugs--new uses. *Br J Clin Pharmacol* **64**, 563-565
121. Ballard, C., Gauthier, S., Corbett, A., Brayne, C., Aarsland, D., and Jones, E. (2011) Alzheimer's disease. *Lancet* **377**, 1019-1031
122. Riverol, M., and Lopez, O. L. (2011) Biomarkers in Alzheimer's disease. *Front Neurol* **2**, 46
123. Vellas, B., Carrillo, M. C., Sampaio, C., Brashear, H. R., Siemers, E., Hampel, H., Schneider, L. S., Weiner, M., Doody, R., Khachaturian, Z., Cedarbaum, J., Grundman, M., Broich, K., Giacobini, E., Dubois, B., Sperling, R., Wilcock, G. K., Fox, N., Scheltens, P., Touchon, J., Hendrix, S., Andrieu, S., and Aisen, P. (2013) Designing drug trials for Alzheimer's disease: What we have learned from the release of the phase III antibody trials: A report from the EU/US/CTAD Task Force. *Alzheimers Dement* **9**, 438-444
124. Lord, A., Gumucio, A., Englund, H., Sehlin, D., Sundquist, V. S., Soderberg, L., Moller, C., Gellerfors, P., Lannfelt, L., Pettersson, F. E., and Nilsson, L. N. (2009) An amyloid-beta protofibril-selective antibody prevents amyloid formation in a mouse model of Alzheimer's disease. *Neurobiol Dis* **36**, 425-434
125. Hillen, H., Barghorn, S., Striebinger, A., Labkovsky, B., Muller, R., Nimmrich, V., Nolte, M. W., Perez-Cruz, C., van der Auwera, I., van Leuven, F., van Gaalen, M., Beshpalov, A. Y., Schoemaker, H., Sullivan, J. P., and Ebert, U. (2010) Generation and therapeutic efficacy of highly oligomer-specific beta-amyloid antibodies. *J Neurosci* **30**, 10369-10379
126. Selenica, M. L., Wang, X., Ostergaard-Pedersen, L., Westlind-Danielsson, A., and Grubb, A. (2007) Cystatin C reduces the in vitro formation of soluble Abeta1-42 oligomers and protofibrils. *Scand J Clin Lab Invest* **67**, 179-190
127. Sastre, M., Calero, M., Pawlik, M., Mathews, P. M., Kumar, A., Danilov, V., Schmidt, S. D., Nixon, R. A., Frangione, B., and Levy, E. (2004) Binding of cystatin C to Alzheimer's amyloid beta inhibits in vitro amyloid fibril formation. *Neurobiol Aging* **25**, 1033-1043
128. Mi, W., Jung, S. S., Yu, H., Schmidt, S. D., Nixon, R. A., Mathews, P. M., Tagliavini, F., and Levy, E. (2009) Complexes of amyloid-beta and cystatin C in the human central nervous system. *J Alzheimers Dis* **18**, 273-280
129. Mi, W., Pawlik, M., Sastre, M., Jung, S. S., Radvinsky, D. S., Klein, A. M., Sommer, J., Schmidt, S. D., Nixon, R. A., Mathews, P. M., and Levy, E.

- (2007) Cystatin C inhibits amyloid-beta deposition in Alzheimer's disease mouse models. *Nat Genet* **39**, 1440-1442
130. Kaeser, S. A., Herzig, M. C., Coomaraswamy, J., Kilger, E., Selenica, M. L., Winkler, D. T., Staufenbiel, M., Levy, E., Grubb, A., and Jucker, M. (2007) Cystatin C modulates cerebral beta-amyloidosis. *Nat Genet* **39**, 1437-1439
131. Tizon, B., Sahoo, S., Yu, H., Gauthier, S., Kumar, A. R., Mohan, P., Figliola, M., Pawlik, M., Grubb, A., Uchiyama, Y., Bandyopadhyay, U., Cuervo, A. M., Nixon, R. A., and Levy, E. (2010) Induction of autophagy by cystatin C: a mechanism that protects murine primary cortical neurons and neuronal cell lines. *PLoS One* **5**, e9819
132. Deng, A., Irizarry, M. C., Nitsch, R. M., Growdon, J. H., and Rebeck, G. W. (2001) Elevation of cystatin C in susceptible neurons in Alzheimer's disease. *Am J Pathol* **159**, 1061-1068
133. Tizon, B., Ribe, E. M., Mi, W. Q., Troy, C. M., and Levy, E. (2010) Cystatin C Protects Neuronal Cells from Amyloid-beta-induced Toxicity. *J Alzheimers Dis* **19**, 885-894
134. Hu, Y., Hung, A. C., Cui, H., Dawkins, E., Bolos, M., Foa, L., Young, K. M., and Small, D. H. (2013) Role of Cystatin C in Amyloid Precursor Protein-induced Proliferation of Neural Stem/Progenitor Cells. *J Biol Chem* **288**, 18853-18862
135. Kato, T., Heike, T., Okawa, K., Haruyama, M., Shiraishi, K., Yoshimoto, M., Nagato, M., Shibata, M., Kumada, T., Yamanaka, Y., Hattori, H., and Nakahata, T. (2006) A neurosphere-derived factor, cystatin C, supports differentiation of ES cells into neural stem cells. *Proc Natl Acad Sci U S A* **103**, 6019-6024
136. Sundelöf, J., Ärnlov, J., Ingelsson, E., Sundström, J., Basu, S., Zethelius, B., Larsson, A., Irizarry, M. C., Giedraitis, V., Ronnema, E., Degerman-Gunnarsson, M., Hyman, B. T., Basun, H., Kilander, L., and Lannfelt, L. (2008) Serum cystatin C and the risk of Alzheimer disease in elderly men. *Neurology* **71**, 1072-1079
137. Sundelöf, J., Sundström, J., Hansson, O., Eriksdotter-Jonhagen, M., Giedraitis, V., Larsson, A., Degerman-Gunnarsson, M., Ingelsson, M., Minthon, L., Blennow, K., Kilander, L., Basun, H., and Lannfelt, L. (2010) Cystatin C levels are positively correlated with both Abeta42 and tau levels in cerebrospinal fluid in persons with Alzheimer's disease, mild cognitive impairment, and healthy controls. *J Alzheimers Dis* **21**, 471-478
138. Finckh, U., von der Kammer, H., Velden, J., Michel, T., Andresen, B., Deng, A., Zhang, J., Muller-Thomsen, T., Zuchowski, K., Menzer, G., Mann, U., Papassotiropoulos, A., Heun, R., Zurdel, J., Holst, F., Benussi, L., Stoppe, G., Reiss, J., Miserez, A. R., Staehelin, H. B., Rebeck, G. W., Hyman, B. T., Binetti, G., Hock, C., Growdon, J. H., and Nitsch, R. M.

- (2000) Genetic association of a cystatin C gene polymorphism with late-onset Alzheimer disease. *Arch Neurol* **57**, 1579-1583
139. Chuo, L. J., Sheu, W. H., Pai, M. C., and Kuo, Y. M. (2007) Genotype and plasma concentration of cystatin C in patients with late-onset Alzheimer disease. *Dement Geriatr Cogn Disord* **23**, 251-257
140. Maruyama, H., Izumi, Y., Oda, M., Torii, T., Morino, H., Toji, H., Sasaki, K., Terasawa, H., Nakamura, S., and Kawakami, H. (2001) Lack of an association between cystatin C gene polymorphisms in Japanese patients with Alzheimer's disease. *Neurology* **57**, 337-339
141. Monastero, R., Camarda, C., Cefalu, A. B., Caldarella, R., Camarda, L. K., Noto, D., Averna, M. R., and Camarda, R. (2005) No association between the cystatin C gene polymorphism and Alzheimer's disease: a case-control study in an Italian population. *J Alzheimers Dis* **7**, 291-295
142. Nacmias, B., Bagnoli, S., Tedde, A., Cellini, E., Guarnieri, B. M., Bartoli, A., Serio, A., Piacentini, S., and Sorbi, S. (2006) Cystatin C and apoe polymorphisms in Italian Alzheimer's disease. *Neurosci Lett* **392**, 110-113
143. Zurdel, J., Finckh, U., Menzer, G., Nitsch, R. M., and Richard, G. (2002) CST3 genotype associated with exudative age related macular degeneration. *Br J Ophthalmol* **86**, 214-219
144. Paraoan, L., Ratnayaka, A., Spiller, D. G., Hiscott, P., White, M. R., and Grierson, I. (2004) Unexpected intracellular localization of the AMD-associated cystatin C variant. *Traffic* **5**, 884-895
145. Luitl, V., Isas, J. M., Kaye, R., Glabe, C. G., Langen, R., and Chen, J. (2006) Drusen deposits associated with aging and age-related macular degeneration contain nonfibrillar amyloid oligomers. *J Clin Invest* **116**, 378-385
146. Nilsson, J., Ruetschi, U., Halim, A., Hesse, C., Carlsohn, E., Brinkmalm, G., and Larson, G. (2009) Enrichment of glycopeptides for glycan structure and attachment site identification. *Nat Methods* **6**, 809-811
147. Strong, K., Mathers, C., and Bonita, R. (2007) Preventing stroke: saving lives around the world. *Lancet Neurol* **6**, 182-187
148. Ghatnekar, O., Persson, U., Glader, E. L., and Terent, A. (2004) Cost of stroke in Sweden: an incidence estimate. *Int J Techn Asses Health Care* **20**, 375-380
149. Yamada, M., and Naiki, H. (2012) Cerebral amyloid angiopathy. *Prog Mol Biol Transl Sci* **107**, 41-78
150. Charidimou, A., Gang, Q., and Werring, D. J. (2012) Sporadic cerebral amyloid angiopathy revisited: recent insights into pathophysiology and clinical spectrum. *J Neurol Neurosurg Psychiatr* **83**, 124-137
151. Yamada, M. (2000) Cerebral amyloid angiopathy: an overview. *Neuropathology* **20**, 8-22

-
152. Graffagnino, C., Herbstreith, M. H., Schmechel, D. E., Levy, E., Roses, A. D., and Alberts, M. J. (1995) Cystatin C mutation in an elderly man with sporadic amyloid angiopathy and intracerebral hemorrhage. *Stroke* **26**, 2190-2193
 153. Shimode, K., Kobayashi, S., Imaoka, K., Umegae, N., and Nagai, A. (1996) Leukoencephalopathy-related cerebral amyloid angiopathy with cystatin C deposition. *Stroke* **27**, 1417-1419
 154. Vinters, H. V., Nishimura, G. S., Secor, D. L., and Pardridge, W. M. (1990) Immunoreactive A4 and gamma-trace peptide colocalization in amyloidotic arteriolar lesions in brains of patients with Alzheimer's disease. *Am J Pathol* **137**, 233-240
 155. Maruyama, K., Ikeda, S., Ishihara, T., Allsop, D., and Yanagisawa, N. (1990) Immunohistochemical characterization of cerebrovascular amyloid in 46 autopsied cases using antibodies to beta protein and cystatin C. *Stroke* **21**, 397-403
 156. Levy, E., Sastre, M., Kumar, A., Gallo, G., Piccardo, P., Ghetti, B., and Tagliavini, F. (2001) Codeposition of cystatin C with amyloid-beta protein in the brain of Alzheimer disease patients. *J Neuropathol Exp Neurol* **60**, 94-104
 157. Itoh, Y., Yamada, M., Hayakawa, M., Otomo, E., and Miyatake, T. (1993) Cerebral amyloid angiopathy: a significant cause of cerebellar as well as lobar cerebral hemorrhage in the elderly. *J Neurol Sci* **116**, 135-141
 158. Liu, Y., and Eisenberg, D. (2002) 3D domain swapping: as domains continue to swap. *Protein Sci* **11**, 1285-1299
 159. Bennett, M. J., Choe, S., and Eisenberg, D. (1994) Domain swapping: entangling alliances between proteins. *Proc Natl Acad Sci U S A* **91**, 3127-3131
 160. Liu, C., Sawaya, M. R., and Eisenberg, D. (2011) beta(2)-microglobulin forms three-dimensional domain-swapped amyloid fibrils with disulfide linkages. *Nat Struct Mol Biol* **18**, 49-55
 161. Yamasaki, M., Li, W., Johnson, D. J., and Huntington, J. A. (2008) Crystal structure of a stable dimer reveals the molecular basis of serpin polymerization. *Nature* **455**, 1255-1258
 162. Guo, Z., and Eisenberg, D. (2006) Runaway domain swapping in amyloid-like fibrils of T7 endonuclease I. *Proc Natl Acad Sci U S A* **103**, 8042-8047
 163. Knaus, K. J., Morillas, M., Swietnicki, W., Malone, M., Surewicz, W. K., and Yee, V. C. (2001) Crystal structure of the human prion protein reveals a mechanism for oligomerization. *Nat Struct Biol* **8**, 770-774
 164. Sambashivan, S., Liu, Y., Sawaya, M. R., Gingery, M., and Eisenberg, D. (2005) Amyloid-like fibrils of ribonuclease A with three-dimensional domain-swapped and native-like structure. *Nature* **437**, 266-269

-
165. Zerovnik, E., Stoka, V., Mirtic, A., Guncar, G., Grdadolnik, J., Staniforth, R. A., Turk, D., and Turk, V. (2011) Mechanisms of amyloid fibril formation--focus on domain-swapping. *FEBS J* **278**, 2263-2282
166. Bennett, M. J., Sawaya, M. R., and Eisenberg, D. (2006) Deposition diseases and 3D domain swapping. *Structure* **14**, 811-824
167. Jaskolski, M. (2001) 3D domain swapping, protein oligomerization, and amyloid formation. *Acta Biochim Pol* **48**, 807-827
168. Staniforth, R. A., Giannini, S., Higgins, L. D., Conroy, M. J., Hounslow, A. M., Jerala, R., Craven, C. J., and Waltho, J. P. (2001) Three-dimensional domain swapping in the folded and molten-globule states of cystatins, an amyloid-forming structural superfamily. *EMBO J* **20**, 4774-4781
169. Grubb, A., Nyman, U., Björk, J., Lindström, V., Rippe, B., Sterner, G., and Christensson, A. (2005) Simple cystatin C-based prediction equations for glomerular filtration rate compared with the modification of diet in renal disease prediction equation for adults and the Schwartz and the Counahan-Barratt prediction equations for children. *Clin Chem* **51**, 1420-1431
170. Löfberg, H., and Grubb, A. O. (1979) Quantitation of gamma-trace in human biological fluids: indications for production in the central nervous system. *Scand J Clin Lab Invest* **39**, 619-626
171. Kyhse-Andersen, J., Schmidt, C., Nordin, G., Andersson, B., Nilsson-Ehle, P., Lindström, V., and Grubb, A. (1994) Serum cystatin C, determined by a rapid, automated particle-enhanced turbidimetric method, is a better marker than serum creatinine for glomerular filtration rate. *Clin Chem* **40**, 1921-1926
172. Preiss, D. J., Godber, I. M., Lamb, E. J., Dalton, R. N., and Gunn, I. R. (2007) The influence of a cooked-meat meal on estimated glomerular filtration rate. *Ann Clin Biochem* **44**, 35-42
173. Tangri, N., Stevens, L. A., Schmid, C. H., Zhang, Y. L., Beck, G. J., Greene, T., Coresh, J., and Levey, A. S. (2011) Changes in dietary protein intake has no effect on serum cystatin C levels independent of the glomerular filtration rate. *Kidney Int* **79**, 471-477
174. Roos, J. F., Doust, J., Tett, S. E., and Kirkpatrick, C. M. (2007) Diagnostic accuracy of cystatin C compared to serum creatinine for the estimation of renal dysfunction in adults and children--a meta-analysis. *Clin Biochem* **40**, 383-391
175. Shlipak, M. G., Sarnak, M. J., Katz, R., Fried, L. F., Seliger, S. L., Newman, A. B., Siscovick, D. S., and Stehman-Breen, C. (2005) Cystatin C and the risk of death and cardiovascular events among elderly persons. *N Engl J Med* **352**, 2049-2060
176. Stevens, L. A., and Levey, A. S. (2005) Chronic kidney disease in the elderly--how to assess risk. *N Engl J Med* **352**, 2122-2124

-
177. Zethelius, B., Berglund, L., Sundström, J., Ingelsson, E., Basu, S., Larsson, A., Venge, P., and Årnlöv, J. (2008) Use of multiple biomarkers to improve the prediction of death from cardiovascular causes. *N Engl J Med* **358**, 2107-2116
 178. Sarnak, M. J., Katz, R., Fried, L. F., Siscovick, D., Kestenbaum, B., Seliger, S., Rifkin, D., Tracy, R., Newman, A. B., and Shlipak, M. G. (2008) Cystatin C and aging success. *Arch Int Med* **168**, 147-153
 179. Taglieri, N., Koenig, W., and Kaski, J. C. (2009) Cystatin C and cardiovascular risk. *Clin Chem* **55**, 1932-1943
 180. Jernberg, T., Lindahl, B., James, S., Larsson, A., Hansson, L. O., and Wallentin, L. (2004) Cystatin C - A novel predictor of outcome in suspected or confirmed non-ST-elevation acute coronary syndrome. *Circulation* **110**, 2342-2348
 181. Koenig, W., Twardella, D., Brenner, H., and Rothenbacher, D. (2005) Plasma concentrations of cystatin C in patients with coronary heart disease and risk for secondary cardiovascular events: more than simply a marker of glomerular filtration rate. *Clin Chem* **51**, 321-327
 182. Singh, D., Whooley, M. A., Ix, J. H., Ali, S., and Shlipak, M. G. (2007) Association of cystatin C and estimated GFR with inflammatory biomarkers: the Heart and Soul Study. *Nephrol Dial Transplant* **22**, 1087-1092
 183. Keller, C. R., Odden, M. C., Fried, L. F., Newman, A. B., Angleman, S., Green, C. A., Cummings, S. R., Harris, T. B., and Shlipak, M. G. (2007) Kidney function and markers of inflammation in elderly persons without chronic kidney disease: the health, aging, and body composition study. *Kidney Int* **71**, 239-244
 184. Knight, E. L., Verhave, J. C., Spiegelman, D., Hillege, H. L., de Zeeuw, D., Curhan, G. C., and de Jong, P. E. (2004) Factors influencing serum cystatin C levels other than renal function and the impact on renal function measurement. *Kidney Int* **65**, 1416-1421
 185. Abrahamson, M., Ritonja, A., Brown, M. A., Grubb, A., Machleidt, W., and Barrett, A. J. (1987) Identification of the probable inhibitory reactive sites of the cysteine proteinase inhibitors human cystatin C and chicken cystatin. *J Biol Chem* **262**, 9688-9694
 186. Grubb, A. (2010) Non-invasive estimation of glomerular filtration rate (GFR). The Lund model: Simultaneous use of cystatin C- and creatinine-based GFR-prediction equations, clinical data and an internal quality check. *Scand J Clin Lab Invest* **70**, 65-70
 187. Grubb, A., Lindström, V., Kristensen, K., Christensson, A., Wide-Swensson, D., Strevens, H., Schmidt, C., and Blirup-Jensen, S. (2007) Filtration quality: a new measure of renal disease. *Clin Chem Lab Med* **45**, 73-74

188. Strevens, H., Wide-Swensson, D., Torffvit, O., and Grubb, A. (2002) Serum cystatin C for assessment of glomerular filtration rate in pregnant and non-pregnant women. Indications of altered filtration process in pregnancy. *Scand J Clin Lab Invest* **62**, 141-147
189. Roberts, M., Lindheimer, M. D., and Davison, J. M. (1996) Altered glomerular permselectivity to neutral dextrans and heteroporous membrane modeling in human pregnancy. *Am J Physiol* **270**, F338-343
190. Rifkin, D. E., Katz, R., Chonchol, M., Fried, L. F., Cao, J., de Boer, I. H., Siscovick, D. S., Shlipak, M. G., and Sarnak, M. J. (2010) Albuminuria, impaired kidney function and cardiovascular outcomes or mortality in the elderly. *Nephrol Dial Transplant* **25**, 1560-1567
191. Schindler, R. (2004) Causes and therapy of microinflammation in renal failure. *Nephrol Dial Transplant* **19 Suppl 5**, V34-40
192. Sanchez-Nino, M. D., Benito-Martin, A., Goncalves, S., Sanz, A. B., Ucero, A. C., Izquierdo, M. C., Ramos, A. M., Berzal, S., Selgas, R., Ruiz-Ortega, M., Egido, J., and Ortiz, A. (2010) TNF superfamily: a growing saga of kidney injury modulators. *Mediat Inflamm* **2010**, ID182958
193. Kaysen, G. A., and Kumar, V. (2003) Inflammation in ESRD: causes and potential consequences. *J Renal Nutr* **13**, 158-160
194. Elewa, U., Sanchez-Nino, M. D., Martin-Cleary, C., Fernandez-Fernandez, B., Egido, J., and Ortiz, A. (2012) Cardiovascular risk biomarkers in CKD: the inflammation link and the road less traveled. *Int Urol Nephrol* **44**, 1731-1744
195. Okura, T., Jotoku, M., Irita, J., Enomoto, D., Nagao, T., Desilva, V. R., Yamane, S., Pei, Z., Kojima, S., Hamano, Y., Mashiba, S., Kurata, M., Miyoshi, K., and Higaki, J. (2010) Association between cystatin C and inflammation in patients with essential hypertension. *Clin Exp Nephrol* **14**, 584-588
196. Al-Malki, N., Heidenheim, P. A., Filler, G., Yasin, A., and Lindsay, R. M. (2009) Cystatin C levels in functionally anephric patients undergoing dialysis: the effect of different methods and intensities. *Clin J Am Soc Nephrol* **4**, 1606-1610
197. Giorgetti, S., Raimondi, S., Pagano, K., Relini, A., Bucciantini, M., Corazza, A., Fogolari, F., Codutti, L., Salmona, M., Mangione, P., Colombo, L., De Luigi, A., Porcari, R., Gliozzi, A., Stefani, M., Esposito, G., Bellotti, V., and Stoppini, M. (2011) Effect of tetracyclines on the dynamics of formation and destructure of beta2-microglobulin amyloid fibrils. *J Biol Chem* **286**, 2121-2131
198. Cardoso, I., Merlini, G., and Saraiva, M. J. (2003) 4'-iodo-4'-deoxydoxorubicin and tetracyclines disrupt transthyretin amyloid fibrils in vitro producing noncytotoxic species: screening for TTR fibril disrupters. *FASEB J* **17**, 803-809

-
199. Tagliavini, F., Forloni, G., Colombo, L., Rossi, G., Girola, L., Canciani, B., Angeretti, N., Giampaolo, L., Peressini, E., Awan, T., De Gioia, L., Ragg, E., Bugiani, O., and Salmona, M. (2000) Tetracycline affects abnormal properties of synthetic PrP peptides and PrP(Sc) in vitro. *J Mol Biol* **300**, 1309-1322
200. Aitken, J. F., Loomes, K. M., Konarkowska, B., and Cooper, G. J. (2003) Suppression by polycyclic compounds of the conversion of human amylin into insoluble amyloid. *Biochem J* **374**, 779-784
201. Ono, K., and Yamada, M. (2006) Antioxidant compounds have potent anti fibrillogenic and fibril destabilizing effects for synuclein fibrils in vitro. *Journal of neurochemistry* **97**, 105-115
202. Forloni, G., Colombo, L., Girola, L., Tagliavini, F., and Salmona, M. (2001) Anti-amyloidogenic activity of tetracyclines: studies in vitro. *FEBS Lett* **487**, 404-407
203. Aitken, J. F., Loomes, K. M., Scott, D. W., Reddy, S., Phillips, A. R., Prijic, G., Fernando, C., Zhang, S., Broadhurst, R., L'Huillier, P., and Cooper, G. J. (2010) Tetracycline treatment retards the onset and slows the progression of diabetes in human amylin/islet amyloid polypeptide transgenic mice. *Diabetes* **59**, 161-171
204. Beck, A., Wurch, T., Bailly, C., and Corvaia, N. (2010) Strategies and challenges for the next generation of therapeutic antibodies. *Nat Rev Immunol* **10**, 345-352
205. Bode, W., Engh, R., Musil, D., Thiele, U., Huber, R., Karshikov, A., Brzin, J., Kos, J., and Turk, V. (1988) The 2.0 Å X-ray crystal structure of chicken egg white cystatin and its possible mode of interaction with cysteine proteinases. *EMBO J* **7**, 2593-2599
206. Li, J., Hoop, C. L., Kodali, R., Sivanandam, V. N., and van der Wel, P. C. (2011) Amyloid-like fibrils from a domain-swapping protein feature a parallel, in-register conformation without native-like interactions. *J Biol Chem* **286**, 28988-28995
207. Knaus, K. J., Morillas, M., Swietnicki, W., Malone, M., Surewicz, W. K., and Yee, V. C. (2001) Crystal structure of the human prion protein reveals a mechanism for oligomerization. *Nat Struct Biol* **8**, 770-774
208. Shankar, G. M., Li, S., Mehta, T. H., Garcia-Munoz, A., Shepardson, N. E., Smith, I., Brett, F. M., Farrell, M. A., Rowan, M. J., Lemere, C. A., Regan, C. M., Walsh, D. M., Sabatini, B. L., and Selkoe, D. J. (2008) Amyloid-beta protein dimers isolated directly from Alzheimer's brains impair synaptic plasticity and memory. *Nat Med* **14**, 837-842
209. Gouras, G. K., Willen, K., and Tampellini, D. (2012) Critical role of intraneuronal Abeta in Alzheimer's disease: technical challenges in studying intracellular Abeta. *Life Sci* **91**, 1153-1158

Appendices