



LUND UNIVERSITY

Teacher roles during amusement park visits – insights from observations, interviews and questionnaires

Pendrill, Ann-Marie; Kozma, Cecilia; Theve, Andreas

Published in:
ICPE - EPEC 2013 Proceedings

2014

[Link to publication](#)

Citation for published version (APA):
Pendriill, A.-M., Kozma, C., & Theve, A. (2014). Teacher roles during amusement park visits – insights from observations, interviews and questionnaires. In L. Dvořák, & V. Koudelková (Eds.), *ICPE - EPEC 2013 Proceedings* (Vol. 2013, pp. 591-599). MATFYZPRESS. http://www.icpe2013.org/uploads/ICPE-EPEC_2013_ConferenceProceedings.pdf

Total number of authors:
3

General rights

Unless other specific re-use rights are stated the following general rights apply:
Copyright and moral rights for the publications made accessible in the public portal are retained by the authors and/or other copyright owners and it is a condition of accessing publications that users recognise and abide by the legal requirements associated with these rights.

- Users may download and print one copy of any publication from the public portal for the purpose of private study or research.
- You may not further distribute the material or use it for any profit-making activity or commercial gain
- You may freely distribute the URL identifying the publication in the public portal

Read more about Creative commons licenses: <https://creativecommons.org/licenses/>

Take down policy

If you believe that this document breaches copyright please contact us providing details, and we will remove access to the work immediately and investigate your claim.

LUND UNIVERSITY

PO Box 117
221 00 Lund
+46 46-222 00 00



ICPE-EPEC 2013

The International Conference on Physics Education

Active learning – in a changing world of new technologies

August 5-9, 2013

Prague, Czech Republic

Conference Proceedings



The ICPE-EPEC 2013 conference was organized by:

- The International Commission on Physics Education (ICPE) – Commission C14 of the International Union of Pure and Applied Physics (IUPAP)
 - The European Physical Society Physics Education Division (EPS PED)
 - The Faculty of Mathematics and Physics, Charles University in Prague
-

Committees

ICPE-EPEC 2013 Scientific Advisory Committee

Leoš Dvořák, *Charles University, Czech Republic*
Pratibha Jolly, *University of Delhi, India*
Robert Lambourne, *Open University, UK*
Priscilla Laws, *Dickinson College, USA*
Marisa Michelini, *University of Udine, Italy*
Cesare Mora, *Instituto Politécnico Nacional, Mexico*
Deena Naidoo, *University of the Witwatersrand, South Africa*
Roberto Nardi, *State University of São Paulo, Brazil*
Hideo Nitta, *Tokyo Gakugei University, Japan*
Gorazd Planinšič, *University of Ljubljana, Slovenia*
Elena Sassi, *University of Naples "Federico II", Italy*
Laurence Viennot, *Université Paris 7 - Denis Diderot, France*
Michael Vollmer, *Brandenburg University of Applied Sciences, Germany*

ICPE-EPEC 2013 Program Committee

Leoš Dvořák, *Charles University, Czech Republic*
Robert Lambourne, *Open University, UK*
Hideo Nitta, *Tokyo Gakugei University, Japan*
Gorazd Planinšič, *University of Ljubljana, Slovenia*
Laurence Viennot, *Université Paris 7 - Denis Diderot, France*

The Local Organizing and Program Committee

Leoš Dvořák, Irena Dvořáková, Věra Koudelková, Marie Snětinová and Vojtěch Žák,
*Department of Physics Education, Faculty of Mathematics and Physics,
Charles University, Czech Republic*

ICPE-EPEC 2013 Conference Proceedings

Editors: Leoš Dvořák and Věra Koudelková

Charles University in Prague, MATFYZPRESS publisher, Prague, 2014

ISBN 978-80-7378-266-5

All papers of this book were reviewed by two independent reviewers.

No English-language editing and proofreading was done either by the publisher or by the editors, so the quality of language of papers is under the authors' responsibility.

Introduction

The International Conference on Physics Education, ICPE-EPEC 2013, took place in Prague, Czech Republic, on August 05-09, 2013. The general focus of the conference was *Active learning – in a changing world of new technologies*.

The conference was organized by the International Commission on Physics Education, which is commission C14 of the International Union of Pure and Applied Physics (IUPAP), by the Physics Education Division of the European Physical Society (EPS) and by the Faculty of Mathematics and Physics of Charles University in Prague, namely by its Department of Physics Education. IUPAP and EPS also provided financial support for the conference.

The conference was held at the Hotel Dorint Don Giovanni, where, over the course of five days, more than three hundred participants took the opportunity to inspire each other, as well as exchange new ideas and experiences. The success of the conference was due in part to our competent technical backup, for which we would like to express our thanks to all the hotel staff, and namely to the conference agency Maxin Prague, that bore on its shoulders much of the conference logistics.

Being physicists, we should provide also some numbers characterizing the conference: 311 participants from 55 countries, presented eight keynote lectures, 171 oral talks in sessions, 15 workshops and 120 posters. Together, the scientific programme filled up about 30 hours (counting all the sessions and workshops it was more than 92 hours). Informal discussions, undoubtedly added a lot more to that.

Looking beyond numbers, as they cannot express the atmosphere of the conference, we should state that, in accordance with the conference subtitle, the participants were tremendously active. (This was shown for example in the large attendances at evening workshops, which often lasted till half past nine.) We would like to thank all the people who helped to make the whole ICPE-EPEC 2013 an interesting, inspiring and fruitful event: the members of the scientific, program and organizing committees, the referees, session chairs, local organizers, keynote speakers and in fact, all the participants who presented their ideas and results.

Now let us turn to this Proceedings. Altogether we received 7 keynote papers and 158 papers from oral presentations, workshops and poster presentations.

To collect all the papers, communicate with authors and referees, put the book in its final form and to ensure that it would be finished in a finite time, was a formidable task to which Věra Koudelková, the editor of this Proceedings, devoted many months of her life. Personally, I would like to offer her my heartfelt thanks for all her hard work, as by myself I surely would not have been able to finish the Proceedings before the hundredth anniversary of the conference.

There were two independent reviewers for each paper. We are very indebted to all the experts who were willing to spend their time, energy and experience to do these reviews. Anyone who has ever done one knows that sometimes it is not an easy task. Moreover, in some cases the papers were amended and reviewed a second time. The reason why we did not make just a simple accept / don't accept process was simple: we wanted the Proceedings to reflect as much as possible of what was presented and discussed at the conference. So we preferred to offer the authors the possibility to improve their papers, even though this meant a greater workload to reviewers and editors.

Finally, there are the 85 accepted papers from oral presentations, 6 from workshops and 61 from poster presentations published in this book. Their topics, the age groups which they are concerned with and other characteristics form a rather complex mosaic. Therefore we decided to divide the oral presentation and poster papers into three broad categories: Research papers, Mixed papers (where both research and development elements are present) and papers on Classroom ideas. We are aware of the fact that some papers in the Classroom ideas category present activities that may be rather local and, as such, could not be published for example, in research journals on physics education. However, such activities form part of a broad area that fits under the title Active Learning. These activities can be inspiring for some readers and therefore deserve being published in the Proceedings, as it aims to cover the broad spectrum of contributions presented at ICPE-EPEC 2013 conference.

Selected conference papers will also be published in a special issue of the journal *Scientia in Education*, which like this Proceedings will also be freely available. We hope that both these publications will provide you, the reader, the opportunity to get acquainted in greater detail with the ideas and results of the conference participants and also, perhaps, to recall some of the friendly and inspiring atmosphere of ICPE-EPEC 2013.

Prague, June 2014,

Leoš Dvořák

How to find what you need in this Proceedings

As you can see in the Table of Contents, the Proceedings starts with Keynote papers; they are presented in the same chronological order as they were presented at the conference. Next are the papers on oral presentations, shown in three parts according to their categories, Research papers, Mixed papers and papers on Classroom ideas. (The classification is, in a sense, a working one rather than an absolute). In each category, the papers are ordered alphabetically according to the last name of the first author. After a small group of workshop papers, papers of contributions presented as posters follow, again in three categories and in alphabetical order according to authors' names. All papers are listed in the detailed Table of Contents; you can also use pdf bookmarks to browse them.

There is a list of authors at the end of this Proceedings but, perhaps a bit surprisingly, without any page numbers. This is because we are using the advantage of the electronic form of this book – instead of seeking specific pages, it is much more convenient to use the search tool available in any pdf reader to find all occurrences of the author's name throughout the entire book. It is true that it does also find the author's name, for example, in the references; however, this can easily be distinguished, and of course, you can also use a full text search in many other ways. So good luck in finding all you need! (Note: In case you feel, like the Beatles, that All You Need is Love, you might find it necessary to look beyond this Proceedings. Good luck in this case too.)

The conference was sponsored by **IOP Publishing** and **JABLOTRON**
CREATING ALARMS

The conference was organized using excellent service of the agency **MaxinPRAGUE**
DETAILS CREATE EXCELLENCE

Table of contents – global

Keynote papers	1
Oral presentations	121
Research papers.....	121
Mixed papers (research and development)	267
Classroom ideas papers	663
Workshops	817
Posters.....	867
Research papers.....	867
Mixed papers (research and development)	946
Classroom ideas papers	1089
List of reviewers	1287
List of authors	1288

Table of contents – detailed

Keynote papers

E. Etkina: Using physics to help students develop scientific habits of mind.....	2
R. Leitner: Recent Discoveries in Particle Physics and Physics Teaching	16
L. Mathelitsch: Sport and Physics.....	28
I. Dvořáková: Active learning in the Heureka Project.....	47
P. Jolly: Physware: A collaborative initiative for strengthening physics education and promoting active learning in the developing world.....	63
J. Sliško: Active physics learning	82
K. Ishii: Active Learning and Teacher Training	103

Oral presentations – research papers

A. Cavallo et.al: Examining Factors that Influence Science Career	122
S. Daniel et.al: Contextual categorisation of academics’ conceptions of teaching.....	132
C. Haagen: Theory-Practice Gap	144
W. Chantharanuwong et.al: The Current Situation of Students’ metacognition of the High School Science Classrooms in Thailand	153
M. Kekule et.al: Inquiry Based Science Education and Getting Immediate Students’ Feedback about Their Motivation	160
A. Kosionidis: Modernising the Astronomy Curriculum of Greek P.E.....	167
Mchunu SP et. al.: Conceptual difficulties in mechanics.....	175
A. Pereira: Bridging Conceptual Change and Sociocultural Analysis: Toward a Model of Conceptual Distribution	192
G. Pospiech et.al: Use of mathematical elements in physics – Grade 8	199
G. Rankin: Students' understanding of angular speed.....	206
D. Sands: Evidence for Dual Processing Theory	213
A. Strahl et. al.: Just how deterring are formulas?	221
H. Takahashi et. al: Lessons from old Japanese experiment textbooks	228
S. Vercellati et. al: Electromagnetic phenomena and prospective primary teachers	235
L. Vinitzky-Pinsky et. al: History Sheds Light on the Difference in the Nature of Physics and Mathematics in Guiding Physics Educators to a Better Understanding of Mind Preferences of Students	242
J. Yasuda and M.Taniguchi: Validating the Force Concept Inventory with Sub-Question.	250
G. Zuccarini et. al.: University students’ ideas on physical meaning and role of wavefunction and state vector in quantum physics.....	258

Oral presentation – mixed papers (research and development)

G. J. Aubrecht: Successful school change.....	268
S. Barbieri et.al: The explicative power of the vector potential.....	279
W. J. Barojas, G. C. M. Martinez: A keplerian laboratory of didactics.....	287
O. R. Battaglia et.al: An approach to the concept of statistical distribution.....	300
M. Bondani et. al: The “LuNa” Project.....	309
J. B. Marks: The Predict-Observe-Explain technique as a tool for students’ understanding of electric circuits.....	317
K. C. Cheung: Lessons learned from PISA 2006.....	327
B. S. C. Cortela, R. Nardi: In-Service Education of University Professors.....	335
S. Daniel et.al: The messy transition from wrong to right.....	341
C. Fazio et.al: Quantitative and qualitative analysis.....	354
G. Feldman et.al: Student Engagement in a Collaborative Group-Learning Environment.....	365
X. Feng et.al: PI in Chinese Introductory Physics Course.....	374
E. Gama and M. F. Barroso: Students’ Video Production.....	381
S. R. T. Gatti, R. Nardi: Considerations on the Possibilities of Cooperation Between the University and Schools.....	388
K. Gedigk et.al: Development of interest in particle physics.....	396
M. Stellato et.al: A guided inquiry based sequence on oscillations.....	405
M. Giliberti et.al: Magnetic vector potential in secondary school.....	417
M. Gojkošek et.al: Coding scheme for assessment of explanations.....	424
B. Gregorcic et.al: Effective use of IWB.....	432
C. Haagen: Nature of White Light.....	439
M. Hawner et.al: Cosmic rays in out-of-school settings.....	451
R. Holubová: Innovations in physics’ teacher education.....	459
P. Horváth: Car Braking Distance.....	466
T. Kranjc, N. Razpet: Exergy in school?.....	474
R. Lambourne: Learning objects and their dissemination.....	482
P. Laws et. al.: Using online interactive physics-based video analysis exercises to enhance learning.....	486
Y. Lehavi and B. S. Eylon: Teachers' concept image of energy.....	492
R. E. Lopez et.al: Physics Teachers and the NGSS.....	501
E. Q. B. Macabebe et.al: Effect of collaborative learning in ILD on student conceptual understanding of motion graphs.....	509
J. Mackay et.al: Using Pencasts to find out how students think about physical ideas.....	517

L. Melo et.al: PCK on Electric Fields	525
T. Meszéna: Chaos at High School	533
M. Michelini, et.al.: Exploration of students' ideas on superconductivity	541
M. Michelini et.al: PCK research based module formation of prospective primary teachers on energy	552
T. Milěj et. al.: Climate Change Education	561
V. Montalbano et.al: Active learning in pre-service teacher education	570
U. A. Okoronka, K. D. Taale: Application of CPPQC	579
A-M. Pendrill et.al: Teacher roles in amusement parks	591
A. C. S. Jesus, R. Nardi: The evolution of future teachers' imaginary	600
J. Svobodová et.al: Informal Teaching of Special Theory of Relativity	607
E. Swinbank et.al: Extended project work for school physics students	613
G. P. Thomas et.al: Transforming Undergraduate Physics Laboratories	621
T. B. Tran et.al: Development of a Pre-service Course	629
M. Tyntarev: Developing the course of "Practical Theoretical Physics"	643
H. Urban: Sequential Reasoning in Electricity	647
A.Wadhwa: Using Class-room Communication System in Phys. Lab.	655

Oral presentation – classroom ideas papers

P. Ageorges et.al: Some lessons from a 3-year experiment of Problem-based learning in Physics in a French School of engineering	664
S. Rehan Ali et.al: Impact of Project Based Learning of Physics	671
S. L. Chang et.al: Transforming Engineering Physics Tutorials with Cooperative Learning and Learning Assistants: A First-Hand Experience	678
Z. Drozd, J. Houfková: Competitions of the Young Debrouillards Clubs	685
F. Favale, M. Bondani: Teaching physics with diving practice	690
M. Garcia-Guerrero et.al: Chain Reaction	698
A. Gróf: The drinking bird engine	702
G. R. Hale et.al: Increasing Physics Teacher Production	711
J. Houfková et. al.: Experiments in Science at Preschool/Kindergarten and Primary School	719
A. Kazachkov et.al: In-Service Teachers' Training Creative Physics Workshops at the National Polytechnic Institute in Mexico	725
O. Kéhar, M. Randa: Astronomical Catalogs in Education	731
R. B. Khaparde: It is never too late to introduce procedural	736

A.Lindell et.al: CPL – combining informal science and art education to primary and science teacher education.....	742
R. Müller: What, if anything, is entropy trying to tell us?.....	750
S. Occhipinti: Searching for models and guideline for effective Teaching-Learning using investigation and peer education.....	759
M. Petó: Experiments with CanSat	766
J. I. Pfeffer: Physics on a Shoestring: Experiments with Soap Films.....	775
S. Puttisanwimon et. al: Assessment of Just-in-Time-Teaching (JiTT).....	784
L. Richterek et.al: Computer modelling in Czech Physics Olympiad.....	792
I. S. Ruddock: A novel undergraduate experiment in birefringence.....	800
D. Sebestyen: Physics during Sightseeing in London and Paris.....	806
M. Snetinova et.al: Web Database of Solved Problems.....	812

Workshops papers

L. Dvořák: Semiconductors at Work.....	818
K. Ishii et.al: Simple and Beautiful Experiments VI by LADY CATS	826
R. Kusak: Physics Lab with Modern Technology.....	836
M. E. Oláh, C. Fülöp: Teaching particle physics in a research laboratory.....	844
E. Swinbank et.al: Embedding formative assessment and promoting active learning.....	852
E. van den Berg, P. Kruit: Investigating with Concept Cartoons.....	859

Posters – research papers

M. C. Cifuentes et.al: Physics Teacher's Practical Knowledge.....	868
M. Elsholz, T. Trefzger: Impact of teaching practice.....	876
M. Kekule, B. Zajacova: Students' Epistemological Beliefs.....	882
L. Koníček, et. al.: Pupils' Competition in Physics.....	892
V. Koudelková, L. Dvořák: High schools students' misconceptions.....	898
S. R. Kussuda, R. Nardi: The careers chosen by physics teachers and the teachers' shortage in Brazil.....	906
M. G. Müller et.al: Influence of peer discussion on confidence in ConcepTest responses..	913
M. Sato: Can Dynamic Concept Be Acquired by Drawing a Conceptual Diagram?.....	918
S. Vercellati et.al: Inquiring 5 years old pupils on MST curricula.....	922
C. Wagner, A. Vaterlaus: Agent based Simulation of Group Work Performance.....	929
B. Zajacova: Optics Achievement Test for Research of Learning Styles in Physics.....	938

Posters – mixed papers (research and development)

S. Rehan Ali et.al: A Cell Phone Operated Robot	947
D. M. Coca: The use of smartphones in class to improve physics learning.....	954
P. D. Colombo Jr & C.C. Silva: Teaching solar physics.....	960
C. Haagen: Colour Vision Tube.....	965
V. Kerlínová et. al.: Creation of workbook in physics for pupils of technical fields at secondary school.....	972
Č. Kodejška et.al: An Alternative Approach to Experiments in Physics at School.....	979
F. Leto et.al: Research based discussions on optics with teachers to integrate professional development with everyday school work	987
E. Marín et.al: PCK on Kinetic Molecular Model	995
V. Montalbano et.al: A pilot experience in physics lab for vocational school	1004
V. Montalbano: An inquiry-based laboratory on friction	1010
N. Pizzolato et.al: Open Inquiry learning and the Nature of Science	1018
A. V. Ribeiro et.al: Introduction of nanoscience and nanotechnology in a high school ..	1027
G. Schiltz, A. Vaterlaus: Mobile Lab Classes: STM for secondary school students	1034
V. Schneider et.al: PROFILES and Stages of Concern in Georgia.....	1039
J. Slisko, J. Radovanović: A video-based delayed transfer test.....	1044
M. Snetinova et. al.: Students' Perception of the Problem solving Process in Physics	1052
N. Takahashi et.al: Found Misunderstanding of Convection.....	1058
A. Tasnádi: Climate Models in Physics Lessons	1065
C. Uribe et.al: Effects of studying a refutational.....	1073
M. Volná, R. Kubínek: Interdisciplinary approach in teaching Physics	1082

Posters – classroom ideas papers

F. A. G. de Araújo et.al: Science interval project: we can teach and learn physics during the leisure	1090
G. J. Aubrecht: How geographically uniform is Earth's temperature rise?	1098
P. Böhm: Does Ice Cube Melt Faster in Tap Water or in Salt Water?.....	1108
M. Černý: Processing and visualization of measurement results in physical Laboratory..	1112
J. Česáková, M. Křížová: Let's use our heads to play	1120
V. Covlea et.al: New approach of some learning techniques in Physics	1125
T. Franc: Interesting Facts about Tides.....	1131
C. Fulop: Teaching Newton's law of cooling in „hands-on“ measurement approaches	1137
A. M. Gutierrez, et.al: Introducing Students to Experimental Research Work.....	1145

M. Hasegawa: Optical communication set with LEDs.....	1151
E. Hejnová: Concept Cartoons as a Teaching and Learning Strategy at Primary Schools in the Czech Republic	1158
R.Chalupnikova, I. Korberova: Project Day: Technology of metal manufacturing	1164
J. L. Jiménez et.al: Relevance of thought-provoking experiences for teaching physics	1169
P. Kácovský et.al: The Summer Maths and Physics Camp.....	1175
P. Kácovský et.al: Popularization of Physics by Using an Interactive Shows	1180
L. Kolářová, R. Kubínek: Nanotechnology: Interdisciplinary collaboration.....	1184
Z. Koupilová et.al: Database of selected papers of Physics Teachers' Inventions Fair	1191
M. Kühn et.al: Online Tutorials in Physics and Engineering.....	1195
P. Kuriščák et.al: Programming Simulations as a Way to Understand Physical Laws	1203
J. Kvapil: Experiments and Students' Individual Work	1211
Y. Lehavi et.al: A simple kit for detecting quantitative changes in energy	1219
L. Ličmanová, L. Koníček: Optics – The spatial and spectral properties of light sources.	1225
K. Lipertová: Science toys	1231
T. Medvegy: Investigation of smart fluid properties.....	1246
M. Nováková, M. Kireš: Monitoring the level of the basic elements of students' scientific literacy	1254
J. Reichl: New technologies in teaching of physics	1261
J. Šestáková: Peer Instruction for the age group 12-15	1269
M. Tanemura et.al: Soap Films with Variable Frames of Prisms.....	1273
V. Timková , Z. Ješková: Computer-aided activities for inquiry-based skills development	1279

Keynotes papers

Using physics to help students develop scientific habits of mind

Eugenia Etkina

Rutgers University, NJ USA¹

Abstract

Interactive engagement curricula are successful in helping students develop conceptual understanding of physics principles and solve problems. However, another benefit of actively engaging students in the construction of their physics knowledge is providing them with an opportunity to engage in habitual “thinking like physicists”. Some examples of such thinking are: drawing a sketch before solving any physics problem, subjecting normative statements to experimental testing, evaluating assumptions, or treating each experimental results as an interval. We can help students develop these “habits of mind” if we purposefully and systematically engage them in the processes that mirror the processes in which physicists engage when they construct and apply knowledge. For such engagement to occur, we need to deeply re-conceptualize the role of experiments in physics instruction and their interaction with the theory. However, most importantly, we need to rethink the role of the instructor in the classroom.

I. Introduction

What knowledge and what abilities are needed to succeed in this 21st century workplace? This question has been addressed by individual research studies examining the need for various process abilities and for declarative knowledge of people in that workplace [1, 2, 3, 4]. Duggan and Gott [5] studied the science used by employees in five science-based industries: a chemical plant specializing in cosmetics and pharmaceuticals, a biotechnology firm specializing in medical diagnostic kits, an environmental analysis lab, an engineering company manufacturing pumps for the petrochemical industry, and an arable farm. They found that most of the scientific conceptual understanding used by employees was learned on the job, and not in high school or university courses. They concluded: “A secure knowledge of procedural understanding appeared to be critical.”

Aikenhead [6] summarized his own and other studies as follows: “In science-rich workplaces, procedural knowledge had a greater credence than declarative knowledge (Chin et.al [6]) and employees consistently used concepts of evidence in their work to such an extent that Duggan and Gott [5] concluded: procedural knowledge generally, and concepts of evidence specifically, lie at the heart of ... science-based occupations.”

In addition to individual research studies like these, there have been a plethora of national studies and reports concerning desired outcomes of science education [7, 8, 9, 10]. Recently published Next Generation Science Standards [11] used the term “science practices” and made those as important for student learning as the content of science itself. In this paper I will use the term “scientific abilities” coined and used by the Physics

¹ Although the paper bears my name only, this work is based on the collaborative efforts of many people, such as A. Van Heuvelen, A. Karelina, M. Ruibal-Villasenor, C. Hmelo-Silver, R. Jordan, S. Murthy, D. Brookes, and M. Gentile.

Education Research group at Rutgers University to describe our work and findings in this area.

II. Scientific abilities

We started the scientific abilities project started in 2003 by identifying the most important procedures, processes, and methods that scientists use when constructing knowledge and when solving experimental problems. The list of scientific abilities that our physics education research group developed includes (A) the ability to represent physical processes in multiple ways; (B) the ability to devise and test a qualitative explanation or quantitative relationship; (C) the ability to modify a qualitative explanation or quantitative relationship; (D) the ability to design an experimental investigation to develop a new concept, test a concept or apply a set of concepts to solve a practical problem; (E) the ability to collect and analyze data; (F) the ability to evaluate experimental predictions and outcomes, conceptual claims, problem solutions, and models, and (G) the ability to communicate.

To help students develop these abilities, one needs to engage students in appropriate activities, and to find ways to assess students' performance on these tasks and to provide timely feedback. Activities that incorporate feedback to the students are called formative assessment activities. Specifically, the students need to understand the target concept or ability that they are expected to acquire and the criteria for good work relative to that concept or ability. They need to be able to assess their own efforts in light of the criteria. Finally, they need to share responsibility for taking action in light of the feedback. The feedback should be descriptive and criterion-based as opposed to grades without clear criteria.

In real life, how can one make formative assessment and self-assessment possible?

One way to implement formative assessment and self-assessment is to use self-assessment rubrics. An assessment rubric allows learners to see learning and performance goals, self-assess their work, and modify it to achieve the goals. A rubric contains descriptions of different levels of performance, including the target level. Students can use the rubric to help self-assess and improve their own work. Instructors can use the rubric to evaluate students' work and to provide feedback.

After making the list of scientific abilities that we created rubrics to help students self-assess themselves and improve their work. The process through which we developed and validated the rubric is described in detail in [12]. The most important part of the work was that we found that it is impossible to assess each ability from the list above as one unit. For the purposes of development and assessment we had to break each ability into smaller sub-abilities (total of 39 items). For example, for the ability to collect and analyze data we identified the following sub-abilities: (i) the ability to identify sources of experimental uncertainty, (ii) the ability to evaluate how experimental uncertainties might affect the data, (iii) the ability to minimize experimental uncertainty, (iv) the ability to record and represent data in a meaningful way, and (v) the ability to analyze data appropriately. Figures 1 and 2 below shows examples of several rubrics (all of them are available at <http://paer.rutgers.edu/scientificabilities>).

Figure 1 shows rubrics for several sub-abilities of the ability to represent information in multiple ways and Figure 2 shows rubrics several sub-abilities of the ability to design experimental investigation. Each item in the rubrics corresponds to one of the sub-abilities. The scale of 0-3 in the scoring rubrics (0, missing; 1, inadequate; 2, needs some

improvement; and 3, adequate) was found to be the easiest when writing the rubrics and also later when we needed to achieve inter-rater reliability scoring student work (see examples in the Figures 1 and 2).

<i>Ability to represent information in multiple ways</i>				
Scientific Ability	Missing	Inadequate	Needs some improvement	Adequate
<i>Representations students can make</i>				
Picture	No representation is constructed.	Picture is drawn but it is incomplete with no physical quantities labeled, or important information is missing, or it contains wrong information, or coordinate axes are missing.	Picture has no incorrect information but has either no or very few labels of given quantities. Majority of key items are drawn in the picture.	Picture contains all key items with the majority of labels present. Physical quantities have appropriate subscripts
Force Diagram	No force diagram is constructed.	Force diagram is constructed but contains major errors: missing or extra forces (not matching with the interacting objects), incorrect directions of arrows or incorrect relative length of force arrows.	Force diagram contains no errors in force arrows but lacks a key feature such as labels of forces with two subscripts or forces are not drawn from single point.	The diagram contains all appropriate force and each force is labeled so that one can clearly understand what each force represents. Relative lengths of force arrows are correct.
Motion Diagram	No motion diagram is constructed.	The diagram does not represent the physical process accurately, either spacing of the dots or the directions and length of v arrows or Δv arrows do not match the motion.	The diagram matches the process but is missing one key feature: dots that represent position or velocity arrows, or Δv arrows.	The diagram contains no errors in dots, v arrows or Δv arrows and it clearly matches the motion of the object.
Mathematical	No representation is constructed.	Mathematical representation lacks the algebraic part (the student plugged the numbers right away) has the wrong concepts being applied, signs are incorrect, or progression is unclear. The first part should be applied when it is appropriate.	There are no errors in the reasoning, however they may not have fully completed steps to solve problem or one needs effort to comprehend the progression.	Mathematical representation contains no errors and it is easy to see progression from the first step to the last step. The final answer is reasonable in terms of magnitude, has correct units and is makes sense for the limiting cases.

Figure 1. Sub-abilities of the ability to represent information in multiple ways

Scientific Ability	Missing	Inadequate	Needs ^{some} improvement	Adequate
Is able to identify the phenomenon to be investigated	No mention is made of the phenomenon to be investigated.	An attempt is made to identify a phenomenon to be investigated but is described in a confusing manner, or is not the phenomena of interest	The phenomenon to be investi-gated is described but there are minor omissions or vague details.	The phenomenon to be investigated is clearly stated.
Is able to design a reliable experiment that investigates the phenomenon	The experiment does not investigate the phenomenon.	The experiment involves the phenomenon but due to the nature of the design it is likely the data will not contain any interesting patterns.	The experiment investigates the phenomenon and it is likely the data will contain interesting patterns, but due to the nature of the design some features of the patterns will not be observable.	The experiment investigates the phenomenon and there is a high likelihood the data will contain interesting patterns. All features of the patterns have a high likelihood of being observable.
Is able to decide what is to be measured and identify independent and dependent variables	The chosen measurements will not produce data that can be used to achieve the goals of the experiment.	The chosen measurements will produce data that can be used at best to partially achieve the goals of the experiment.	The chosen measurements will produce data that can be used to achieve the goals of the experiment. However, independent and dependent variables are not clearly distinguished.	The chosen measurements will produce data that can be used to achieve the goals of the experiment. Independent and dependent variables are clearly distinguished.
Is able to use available equipment to make measurements	At least one of the chosen measurements cannot be made with the available equipment.	All chosen measurements can be made, but no details are given about how it is done.	All chosen measurements can be made, but the details of how it is done are vague or incomplete.	All chosen measurements can be made and all details of how it is done are clearly provided.
Is able to describe what is observed without trying to explain, both in words and by means of a picture of the experimental set-up.	No description is mentioned.	A description is mentioned but it is incomplete. No picture is present. Or, most of the observations are mentioned in the context of prior knowledge.	A description exists, but it is mixed up with explanations or other elements of the experiment. A labeled picture is present. Or some observations are mentioned in the context of prior knowledge.	Clearly describes what happens in the experiments both verbally and by means of a labeled picture.

Figure 2. Rubrics for several sub-abilities of the ability to design an experiment to investigate a phenomenon

III. Investigative Science Learning Environment

Obviously, the rubrics alone are not enough to help the students learn to think like scientists. They need to be engaged in the activities that mirror scientific practice. Many inquiry-based curricula have individual activities that engage students in some of the

practices, but there are a few which do it systematically and purposefully. One of those is Investigative Science Learning Environment (ISLE).

ISLE [13] (developed in 1985-2000 first for high school physics and then for college physics) engages students in the processes that mirror scientific practice to help them learn physics. Specifically, students start learning a new concept by observing a few very simple experiments (called observational-experiments). They then use available representations (motion diagrams, graphs, force diagrams, energy bar charts, etc.) to identify patterns, develop multiple explanations for those patterns and finally, test the explanations (with the purpose of ruling them out). The testing involves first designing a new experiment, the outcome of which they can predict using their explanation, second conducting the experiment, and third comparing the predictions to the outcomes of the testing experiment. This purposeful testing of proposed explanations using hypothetico-deductive reasoning is one of the most important features of ISLE, which in turn directly reflects common reasoning in science and, in particular, in experimental physics. Often the unexpected outcome of a testing experiment serves as an observational experiment for a new cycle.

The ISLE framework was developed to help students construct new concepts [13], however it can be successfully utilized when students apply the concepts that they have already constructed to analyze complex phenomena [14]. Recently an introductory physics textbook using ISLE approach with the supporting workbook for the students and an instructor guide for the teachers has been published [15].

IV. Developing Scientific Abilities in an ISLE-based course

Over the last 10 years we conducted multiple studies investigating how introductory students develop scientific abilities in an ISLE-based course in which most of the activities (including instructional labs where the students design their own experiments using scientific abilities rubrics) engage students in the processes that mirror scientific practice. In this section I will present brief summaries of those studies with relevant references so the reader can find the original papers and explore the details. Numerous examples of the activities that students do, including all laboratory investigations can be found at <http://paer.rutgers.edu/scietificabilities>.

IV.1 Study of multiple representations

This study is reported in the paper by Rosengrant, Van Heuvelen and Etkina [16]. The study investigated how students who learned physics through ISLE with an explicit focus on representing phenomena in multiple ways use those representations when they are solving problems on their own (an explicit focus involves several things: teaching students to construct a mathematical representation of the problem using one of the concrete representations; asking them to represent the problem situation without solving for anything and engaging them in Jeopardy-type problem where the solution is provided and the students need to recreate the problem situation and represent it in multiple ways; all of those multiple representation activities are provided in reference 15 and two examples are in Appendix 1 in this paper). Specifically, the study investigated the use of free-body (force) diagrams by students in a large enrollment (700 students) algebra-based general physics course. It was a two-year quantitative and qualitative study of students' use of free-body diagrams while solving physics problems. We found that when students are in a course that consistently emphasizes the use of free-body diagrams in the context of ISLE,

the majority of them (60 - 70% as opposed to 15% in a traditionally taught course) do use diagrams on their own to help solve exam problems even when they receive no credit for drawing the diagrams (to make this conclusion we collected scrap papers on which student did work solving problems on multiple choice exams, we identified those students who drew the diagrams, and then we scored those free-body/force diagrams using the rubrics described above). We also found that students who draw diagrams correctly (scored a 2 and 3 on the free-body/force diagram rubric) are significantly more successful in obtaining the right answer for the problem. Lastly, we interviewed students to uncover their reasons for using free-body diagrams. We found that high achieving students used the diagrams to help solve the problems and as a tool to evaluate their work while low achieving students only use representations as aids in the problem-solving process. (See reference 16 for the details of the study).

IV.2 Study of student acquisition of scientific abilities

We conducted several studies that investigated how students develop experiment-related scientific abilities in real time in ISLE instructional laboratories. The ISLE laboratories are naturally integrated in the learning process. In laboratories students design their own experiments without cookbook instructions but with the support of special guiding questions and self-assessment rubrics described above. An example of a laboratory handout is provided Appendix B.

The most important aspect of the ISLE laboratories is that students have to implement different scientific abilities, such as evaluating uncertainties and assumptions not because the lab handout requires those steps but because without them the students cannot solve the problem. For example, the students need to determine the specific heat of an object made of an unknown material. If they conduct only one experiment, there is no way to say whether the number they obtain makes any sense since there is no “accepted value.” Therefore, the students need to design a second independent experiment and then make a decision on the value of the specific heat based on the assumptions in their mathematical procedure and the experimental uncertainties in their values.

In a typical laboratory, students conduct one or two experiments.

All of the experiments can be grouped into three big categories (according to their role in the ISLE cycle). The first type is observational experiment that takes place when students have to investigate a new phenomenon that they have not yet seen in large room meetings or problem solving sessions. When students design observational experiments, they need to figure out how to collect the data suggested by the laboratory handout and how to analyze the data to find patterns. For example, they need to find a pattern between the current through and potential difference across a resistor. The second type of experiments is testing experiment that students design when they need to test a hypothesis. This hypothesis is usually based on a pattern observed in a previous laboratory experiment or it is a hypothesis that students devised in other parts of the course prior to the laboratory. Sometimes they have to test a hypothesis that “a friend has devised” – these are usually based on known student ideas from the physics education research. For example, students need to test a hypothesis that magnetic poles are electrically charged. The third type is application experiment. This is experimental problem that requires students to design several experiments to determine the value of some physical quantity – such as the coefficient of friction between their shoe and the carpet. The application experiments, as their name suggests, are the experiments where students have to apply one or more concepts that they already know to solve the problem. The laboratory handout scaffolding

questions and the rubrics are different for these three types of experiments. Appendix B shows an example of the laboratory handout for the first two types of experiments.

To study the development of abilities that students develop while designing and carrying out the above experiments abilities we collected and scored the lab reports of 60 students in an algebra-based introductory physics course at Rutgers University (enrollment of about 200 students) during one semester (the course followed ISLE). The details of the studies can be found in the following references [17]. Here I provide the summary of our findings.

The research questions that we answered in the reported studies were: How long does it take for the majority of the students to develop different scientific abilities? Does this time depend on the ability? And are there any specific abilities that are especially difficult?

We investigated several abilities and their development over the course of one semester by scoring the lab reports of 60 students in the course Physics for the Sciences at Rutgers University using the rubrics described above. We found that at the beginning of the semester the majority of the students received the scores of 0 and 1 on the rubrics and as the semester progressed the scores increased. After week #5 students started showing significant improvement on some abilities (ability to design an experiment, ability to identify experimental uncertainties, ability to communicate) and by week 7 - 8 (this means that students had 7 to 8 3-hour laboratories and had to write 7 to 8 lab reports) over 80% were receiving scores of 2 and 3 on the majority of the rubrics (including such ones as the ability to evaluate uncertainty, ability to recognize the difference between the hypothesis and the prediction, ability to identify assumptions, etc.). After week 8 the number of students receiving high scores stopped changing being settled around 80%. The only ability that never reached 80% of scores 2 and 3 and kept steadily improving was the ability to evaluate the effects of assumptions. We think that this finding can be explained by the fact that this particular ability depends on the knowledge of the relevant physics material more than any other abilities. These results have been repeated multiple times over the years and we find them to be very robust. Another robust finding (that persists in different universities) is student attitude towards such laboratories. As they differ drastically from traditional cook book labs to which students are accustomed, at the beginning of the semester they are lost and anxious, and do not know what to do or how to do it. However by about week 8 of the semester one can notice a significant shift in their behaviors. They become more relaxed and they know what is expected of them - they know what to do. The real changes come at the end of the semester when they not only know what to do but also how to do it. These three easily recognizable stages in student attitudes towards such design labs were first documented by X. Zou who implemented ISLE labs at the California State University, Chico but later we also observed them year after year at Rutgers.

IV. 3 Transfer of scientific abilities

After we found that students do indeed develop scientific abilities as scored by the rubrics when working on the physics design experiments we wanted to investigate whether they transfer these abilities to a different content area. The issue of transfer is extremely complicated and I will not delve here into the details of different models of transfer and how we set up the experiment to study one of the types of transfer in our case. All of the details are described in the paper by Etkina et.al, published in 2010 in the Journal of

Learning Sciences [18]. Here, again, I will briefly outline the structure of the study and summarize the findings.

Population: The study was conducted in the first (fall) semester the same course where we conducted the previous study, there were 193 students attending various activities varied through the semester. There were two 55-min lectures, one 80-min recitation, and a 3-hour lab per week. There were two midterm exams and one paper-and-pencil final exam and final lab exam. All students learned through the same ISLE approach in large room meetings and in smaller recitations. The lab sections were split into two groups: design labs (4 sections) and non-design labs (4 sections). Students registered for the sections in March of the previous academic year. In the previous years we found no difference in performance of lab sections on exams, thus we can assume that during the experimental year the student group distribution was random. During the semester, students were not informed about the study. At the end, we disclosed the procedure and students signed a consent form allowing us to use their work for research. We took precautions to ensure that the groups were equal in learning ability using Lawson's test of hypothetico-deductive reasoning in the first lab session [19]. Coletta and Philips [20] found that student's learning gains are strongly correlated with their scores on this test. Our lab sections were statistically the same. To ensure that the treatment was the same too, we used the same three instructors to teach the labs. Two of the instructors taught one design and one non-design section and the third instructor taught two of each. All instructors were members of the PER group, highly skilled in the interactive teaching.

Experimental group: Design labs (4 sections): Students in the experimental group had ISLE design labs described above. They had to design their own experiments and use rubrics for self-assessment.

Control group: Non-design labs (4 lab sections): Students in the control group used the same equipment as in design labs and performed the same number (sometimes even more) experiments. The lab handouts guided them through the experimental procedure but not through the mathematics.

Assessment of student learning of physics and acquisition and transfer of scientific abilities: We assessed student learning by their performance three paper-and-pencil course exams (2 midterms and one final) and on two transfer tasks. Course exams had a multiple-choice portion and an open-ended portion (3 problems per midterm and 5 on the final).

Transfer to Physics: To assess how students transfer scientific abilities to an unfamiliar physics content in the same functional context, we developed a lab task where both groups designed an experiment and wrote a lab report. In contrast to regular labs that students performed during semester, this particular task was identical for the experimental and the control groups. The task involved drag force in fluid dynamics. This physics content was not covered in the course. Students were provided some necessary and some redundant information in the lab handout and had access to textbooks and the Internet.

The students performed this task during the lab (3 hours) on week 13 of the semester. Prior to this, they performed 10 labs.

Transfer to Biology: The second transfer experiment involved a biology task that was given as the final lab exam for the course in week 14. Both the experimental and the control groups had to design an experiment to find the transpiration rate of a certain species of plant and subsequently to write a report detailing their experimental procedures, calculations and conclusions.

During the practical exam students in each lab section worked in the same group of three or four as they did during the semester. As during the semester, students submitted individual reports for grading.

When the exam was graded students from both groups received scores that reflected their performance relative to the standards for two different kinds of labs. After the semester was over, the researchers used the scientific abilities rubrics to code student work.

Findings Acquisition of normative science concepts

With regard to the normative science concepts that were assessed via multiple-choice and free-response exam questions and problems, students in the design and non-design groups performed similarly on both midterms and the final exam: Midterm Exam 1, $F(1, 182) = 0.25$, $p = 0.62$; Midterm Exam 2, $F(1, 180) = 1.31$, $p = 0.25$; final exam, $F(1, 180) = 0.45$, $p = 0.502$ (to make three contrasts, we used the sequential Bonferroni correction, critical value of 0.017;).

Scientific abilities rubrics: Physics Transfer task: Reading of the lab reports revealed the features that made a difference in the performance of two groups. The quantitative analysis of the lab reports supported the general impression on students' performance. There were significant differences in the lab reports of design students and non-design students. Design students demonstrated significantly better scientific abilities than the non-design students specifically on the following rubrics: *Evaluating the effect of assumptions* (fifty seven design students (more than 60%) received score 2 or 3; not a single student in non-design section made an attempt to do this); *Evaluating effect of uncertainties*: (only 11 of non-design students (12%) got score 2 or 3 while more than 50% of design students evaluated the effect of experimental uncertainties in this lab. The difference between the groups is statistically significant (Chi-square = 30, $p < 0.001$)); *Evaluating the result by means of an independent method* (about 64 of design students (72%) got score 2 or 3, while in non-design sections only 38 students (43%) did. The difference between the groups is statistically significant (Chi-square = 16, $p < 0.001$)); *Communication* (more than 60% of design students drew a picture while only 8% of non-design students did. The difference in student scores on the communication is statistically significant (chi-square = 60.6, $p < 0.001$)). In addition we found the differences in students use of force diagrams and overall consistency of representations with the design students significantly outperforming the non-design students.

We found very similar results for the biology task, design group students demonstrated the transfer of acquired scientific abilities significantly better than non-design students. The details of the analysis can be found in reference 18.

V. Discussion

In my talk at the conference and here I attempted to show that inquiry-based instruction with proper scaffolding and formative assessment can be successful in helping students develop scientific habits of mind that are needed for the success in the 21st century. Examples of such habits of mind - scientific abilities - are the skills and procedure that are needed in all areas of future lives of our students and are called for by the documents guiding science education. We can help all students (not necessarily physics majors) develop such abilities and later these students also transfer those abilities to new content areas. Three things are important here:

1. ISLE is not an open inquiry-based curriculum that engages student in random investigations of phenomena with the hope of them finding out things on their own. It is a heavily scaffolded approach that encourages students to construct and test their own understanding through a series of carefully chosen experimental investigations supported with specific questions and self-assessment rubrics, aided by concrete representations.
2. It takes time for the students to develop those abilities (5-8 weeks), so we should not get discouraged when after a month of instruction our students still cannot design their own experiments or evaluate how the assumptions might affect the results of their calculations.
3. We should not be afraid that students will not learn the “right” physics if they design their own experiments and make mistakes. We found that engaging students in experimental design when they sometimes come up with “wrong” solutions and do not practice solving traditional physics problems does not hurt them in terms of the acquisition of normative physics knowledge. However, they benefit significantly in terms of persistence and ability to approach new problems as scientists.

Appendix 1

Examples of Multiple Representations activities:

Representing the problem situation in multiple ways: You are riding to the top floor of your residence hall. As the elevator approaches your floor, it slows to a stop. Construct a motion diagram and a free-body (force) diagram for the elevator [with you inside] as the object of interest as the elevator slows down to a stop.

Jeopardy problem: The mathematical expressions below could represent many physical situations. Invent one situation and describe it with words, with a force diagram, with a sketch, and with a motion diagram. The object moves vertically. We assume that $g = 10 \text{ m/s}^2 = 10 \text{ N/kg}$.

$$- T + (1000 \text{ kg})(10 \text{ N/kg}) = (1000 \text{ kg})(2.0 \text{ m/s}^2)$$

$$- 0 + (- 8.0 \text{ m/s}) = (2.0 \text{ m/s}^2) t$$

$$y = (- 8.0 \text{ m/s}) t + (1/2)(2.0 \text{ m/s}^2) t^2$$

Appendix 2

A laboratory handout with the examples of two different types of experiments:

Lab 3: The Electric Potential and Electric Currents

LEARNING GOALS OF THE LAB

1. Learn how to construct a working apparatus using a schematic picture.
2. Learn to fit functions to data in order to represent graphical patterns with mathematical expressions.

I. OBSERVATIONAL EXPERIMENT: DETERMINE A MATHEMATICAL RELATIONSHIP BETWEEN CURRENT THROUGH AND VOLTAGE ACROSS A RESISTOR

Design an experiment to determine a mathematical relationship between the current through a resistor and the voltage across that resistor. First you will design your experiment using the simulation from experiment II. Clear the simulation; then use it to build a circuit that will allow you to accomplish your goal.

To measure the current through the resistor using an ammeter, you need to let this current pass **through the ammeter**. To measure the voltage (potential difference) across the resistor using a voltmeter, you need to connect the voltmeter so **it measures the electric potential before and after the resistor**:

An ammeter and a voltmeter are available in the simulation by checking the appropriate checkboxes. Once you have built the circuit using the simulation, call your TA over and explain it to them. Also, explain what measurements you are going to make and how you will use them to accomplish your goal. Once you have done this, build your circuit using real equipment.

Available equipment: Voltage source resistor, 2 multimeters, connecting wires.

RUBRIC B: Ability to design and conduct an observational experiment					
Scientific Ability		Missing	Inadequate	Needs some improvement	Adequate
B3	Is able to decide what physical quantities are to be measured and identify independent and dependent variables	The physical quantities are irrelevant.	Only some of the physical quantities are relevant.	The physical quantities are relevant. However, independent and dependent variables are not identified.	The physical quantities are relevant and independent and dependent variables are identified.
B7	Is able to identify a pattern in the data	No attempt is made to search for a pattern	The pattern described is irrelevant or inconsistent with the data	The pattern has minor errors or omissions	The patterns represents the relevant trend in the data

RUBRIC G: Ability to collect and analyze experimental data					
Scientific Ability		Missing	Inadequate	Needs some improvement	Adequate
G2	Is able to evaluate specifically how identified experimental uncertainties may affect the result	No attempt is made to evaluate experimental uncertainties.	An attempt is made to evaluate experimental uncertainties, but most are missing, described vaguely, or incorrect. Or only absolute uncertainties are mentioned. Or the final result does not take the uncertainty into the account.	The final result does take the identified uncertainties into account but is not correctly evaluated.	The experimental uncertainty of the final result is correctly evaluated.
G4	Is able to record and represent data in a meaningful way	Data are either absent or incomprehensible.	Some important data are absent or incomprehensible.	All important data are present, but recorded in a way that requires some effort to comprehend.	All important data are present, organized, and recorded clearly.
G5	Is able to analyze data appropriately	No attempt is made to analyze the data.	An attempt is made to analyze the data, but it is either seriously flawed or inappropriate.	The analysis is appropriate but it contains minor errors or omissions.	The analysis is appropriate, complete, and correct.

Include the following in your writeup:

- a) Devise a procedure for your investigation and briefly describe your experimental design. Include a labeled sketch of your setup.
- b) What important physical quantities change during the experiment? What are the independent and dependent variables in your experiment?
- c) Build the circuit according to your picture. **Then, call your lab instructor over to check the circuit.** After you've done that, you can turn on the voltage source.

- d) Record your data in an appropriate manner. Construct a graph. Think what mathematical functions may fit your data (Excel has features that let you explore how well different functions fit your data).
- e) Find the SIMPLEST mathematical function that does fit your data. Think of uncertainties (error bars). Does the function you chose cross through the regions defined by the error bars?
- f) Formulate a quantitative rule relating the current through a resistor to the voltage (potential difference) across the resistor.

II. TESTING EXPERIMENT: CURRENT-VOLTAGE DEPENDENCE

The goal of this experiment is to test whether the rule relating the current through a resistor and the voltage across resistor is applicable to a light bulb. Remember that the purpose of testing experiment is to reject, not to support the rule under test.

Available equipment: Voltage source (again, keep the voltage below 5V), light bulb, resistors, 2 multimeters, connecting wires.

Write the following in your report:

- a) State what rule you are testing.
- b) Brainstorm the task and make a list of possible experiments whose outcome can be predicted with the help of the rule.
- c) Briefly describe your chosen design. Include a labeled sketch.
- d) **Use the rule being tested to make a prediction** about the outcome of the experiment.
- e) Perform the experiment. Record the outcome.
- f) Is the outcome consistent or inconsistent with the prediction? Explain in detail how you decided this.
- g) Based on the prediction and the outcome of the experiment, what is your judgment about the rule being tested?
- h) Ask your classmates in other lab groups about their results. Are they consistent with yours?

V. WHY DID WE DO THIS LAB?

- a) Discuss how plotting the data in experiment III helped you identify the relationship between the current through the resistor and the voltage across it.
- b) What other question/phenomena could you investigate using the available equipment from this lab?
- c) Give an example of an experiment from your field of study where a pattern in data is used to construct a mathematical relationship.

POSTSCRIPT (OPTIONAL, AND REALLY JUST FOR YOUR AMUSEMENT): THE PLATYPUS



The platypus, a native of Australia, is an odd type of mammal called a monotreme. It has fur, webbed feet, and a bill like a duck. The young are born from eggs and although the mother produces milk for them she has no nursing organs we would recognize: milk seeps through a patch of skin on the mother's underside.

The platypus lives in freshwater streams and eats crustaceans, insects, and small fish. The platypus is a beaver-sized animal and must need to eat a lot of bugs, but its small and

beady eyes don't look very helpful for finding its prey among the rocks and sand at the bottom of a muddy creek.

The secret to this animal's success is actually in its bizarre beak. This contains millions of electroreceptive cells that can detect the incredibly minute electric field that is generated by the neurons of bugs and shrimp!

Professor Uwe Proske of Monash University reports that about two-thirds of the sensory area of a platypus's brain is connected to the beak. The system seems to have evolved completely independently from similar electroreceptive systems in fish such as sharks.

However it operates, and however it evolved, it seems to work remarkably well. The platypus manages to capture half its body weight in food every night.

References

- [1] Chin P., Munby H., Hutchinson N. L., Taylor J., Clark, F.: "Where's the science? Understanding the form and function of workplace science." In E. Scanlon, P. Murphy, J. Thomas, A& E. Whitelegg (Eds.), *Reconsidering science learning* (pp. 118-134), London: Routledge Falmer (2004).
- [2] Coles M.: "What does industry want from science education?" In K. Colhoun, R. Panwar, & S. Shrum (Eds.), *Proceedings of the 8th symposium of IOSTE* (Vol. 1, pp. 292-300). Edmonton: Faculty of Education, University of Alberta (1997).
- [3] Gott R., Duggan S., Johnson P.: "What do practicing applied scientists do and what are the implications for science education?" *Research in Science & Technological Education* **17**, 97-107, 1999.
- [4] Lottero-Perdue E., Brickhouse N. W.: "Learning on the job: The acquisition of scientific competence", *Science Education* **86**, 756-782, 2002.
- [5] Duggan S., Gott R.: "What sort of science education do we really need?" *International Journal of Science Education* **24**, 661-679, 2002.
- [6] Aikenhead G. S.: "Science-Based Occupations and Science Curriculum: Concepts of Evidence," *Science Education* **89**, 242-275, 2005.
- [7] Czujko R.: (1997) *The Physics Bachelors as a Passport to the Workplace: Recent Research Results in The Changing Role of Physics Departments in Modern Universities*, E. F. Redish & J. S. Rigden, Eds. AIP Conf. Proc. No 399, Woodbury, NY.
- [8] See updated standards at <http://www.abet.org/Linked%20Documents-UPDATE/Criteria%20and%20PP/E001%2005-06%20EAC%20Criteria%209-15-05.pdf>
- [9] *Improving Undergraduate Instruction in Science, Technology, Engineering, and Mathematics: Report of a Workshop*, The National Academies Press, 500 Fifth Street, N.W., Washington, DC 20001 (2003). See at <http://darwin.nap.edu/books/0309089298/html>
- [10] *Educating the Engineer of 2020: Adapting Engineering Education to the New Century*, (The National Academies Press, 500 Fifth Street, N.W., Washington, DC 20001 (2005). See at <http://nap.edu/catalog/11338.html>

- [11] Next Generation Science Standards, Achieve, 2013.
- [12] Etkina E., Van Heuvelen A., White-Brahmia S., Brookes D. T., Gentile M., Murthy S., Rosengrant D., Warren A.: (2006) Developing and assessing student scientific abilities. *Physical Review. Special Topics, Physics Education Research*. 2, 020103.
- [13] Etkina E., Van Heuvelen A.: (2007) Investigative Science Learning Environment - A Science Process Approach to Learning Physics, in E. F. Redish and P. Cooney, (Eds.), *Research Based Reform of University Physics*, (AAPT), Online at http://per-central.org/per_reviews/media/volume1/ISLE-2007.pdf
- [14] Etkina E., Planinšič G., Vollmer M.: (2013) A simple optics experiment to engage students in scientific inquiry, *American Journal of Physics* 81 (11), 815 - 822.AJP.
- [15] Etkina E., Gentile M., Van Heuvelen A.: *College Physics*. San Francisco, CA: Pearson, 2013; Etkina, E., Gentile, M., Van Heuvelen, A., *The Physics Active Learning Guide*, San Francisco, CA: Pearson, 2013 (Second edition); Etkina E., Brookes D., Van Heuvelen A.: *Instructor Guide for College Physics*. San Francisco, CA: Pearson, 2013.
- [16] Rosengrant D., Van Heuvelen A., Etkina E.: (2009). Do students use and understand free body diagrams? *Physical Review, Special Topics, Physics Education Research*, 5, 010108.
- [17] Etkina E., Karelina A., Ruibal-Villasenor M.: (2008). How long does it take? A study of student acquisition of scientific abilities. *Physical Review, Special Topics, Physics Education Research*, 4, 020108; 9.
- Etkina E., Karelina A., Murthy S., Ruibal-Villasenor M.: (2009). Using action research to improve learning and formative assessment to conduct research. *Physical Review. Special Topics, Physics Education Research*, 5, 010109; 14.
- Karelina A., Etkina E.: (2007). Acting like a physicist: Student approach study to experimental design. *Physical Review, Special Topics, Physics Education Research*, 3, 020106.
- [18] Etkina E., Karelina A., Ruibal-Villasenor M., Jordan R., Rosengrant D., Hmelo-Silver C.: (2010). Design and reflection help students develop scientific abilities: Learning in introductory physics laboratories, *Journal of the Learning Sciences*, 19, 1, 54-98.
- [19] Lawson A. E.: (1978). The development and validation of a classroom test of formal reasoning. *Journal of Research in Science Teaching*, 15(1), 11-24.
- [20] Coletta V. P., Phillips J. A.: (2005). Interpreting FCI scores: Normalized gain, preinstruction scores, & scientific reasoning ability. *American Journal Physics*, 73(12), 1172-1182.

Recent Discoveries in Particle Physics and Physics Teaching

Rupert Leitner

Faculty of Math and Physics, Charles University, Prague, Czech Republic

Abstract

In 2012 major discoveries in particle physics were announced, the most important being the discovery of a Higgs boson with CERN LHC experiments ATLAS and CMS, as well as a very important measurement of the third yet unknown mixing angle in neutrino oscillations experiments Daya Bay and RENO. Main aspects of these discoveries are briefly explained with an attempt to use the high school level of physics knowledge.

Keywords: elementary particles, accelerators, Higgs boson, neutrino oscillations

Introduction

In 2012 major discoveries in particle physics were announced, the most important being the discovery of a Higgs boson with CERN LHC experiments ATLAS and CMS, as well as a very important measurement of the third yet unknown mixing angle in neutrino oscillations experiments Daya Bay and RENO. Main aspects of these discoveries will be briefly explained with an attempt to use the high school level physics knowledge. The text is illustrated by several exercises which explain some important features. They are an integral part of the text and can be eventually used to explain the theme to high-school students.

Part I. Brief introduction to elementary particles and their interactions

Specific units in particle physics

Let us start with the relativistic relation between the particle total energy E , its rest mass M , and momentum \vec{P} (c is the speed of light):

$$E^2 = (Mc^2)^2 + (\vec{P}c)^2$$

In particle physics the energies are expressed in units of the electron-volts eV and their decimal multiples keV, MeV, GeV, ... ($1.602 \cdot 10^{-19}$ J). Masses of particles are usually expressed as their rest energies, i.e. by the mass M we mean Mc^2 . Formally this means to use units where the value of c equals to 1. Masses of the proton and the neutron are ~ 1 GeV, the mass of the electron is ~ 0.5 MeV.

Ex 1. Estimate the value of the proton mass and evaluate the proton rest energy in eV.

One mole contains the Avogadro constant ($6.022 \cdot 10^{23}$) of protons and the mass of one mole of protons is approximately 1g, i.e. the mass of the proton is $\sim 1\text{g}/6.022 \cdot 10^{23} = 1.66 \cdot 10^{-24}$ g.

Corresponding equivalent energy is $\sim 1.66 \cdot 10^{-27}$ kg $\cdot (3 \cdot 10^8 \text{ m/s})^2 = 1.49 \cdot 10^{-10}$ J.

This value corresponds to $1.49 \cdot 10^{-10}$ J / ($1.602 \cdot 10^{-19}$ J/eV) ~ 933 MeV.

*The exact value of **proton rest energy is 938.27 MeV, neutron is slightly heavier (939.57 MeV)** and it decays to proton by radioactive beta decay.*

The energy units are used for particle momenta as well, i.e. by \vec{P} we mean the product $\vec{P}c$ and the relation between the particle total energy, its rest mass and momentum has a very simple form:

$$E^2 = M^2 + \vec{P}^2$$

Ex 2. Derive approximate relations between energy a momentum of a) non-relativistic and b) ultra-relativistic particle with mass M

We use the relation: $E^2 = M^2 + \vec{P}^2$

a) non-relativistic particle (the rest energy is much larger than the momentum $M \gg |\vec{P}|$)

$$E = M \sqrt{1 + \frac{\vec{P}^2}{M^2}} \sim M + \frac{\vec{P}^2}{2M}$$

where the first term is the rest energy and the second is a classical expression for the kinetic energy. It is instructive to calculate non-relativistic approximation of the particle velocity

$$\beta = \frac{v}{c} = \frac{|\vec{P}|}{E} \cong \frac{|\vec{P}|}{M + \frac{\vec{P}^2}{2M}} \cong \frac{|\vec{P}|}{M} \left(1 - \frac{1}{2} \left(\frac{|\vec{P}|}{M} \right)^2 \right) \cong \frac{|\vec{P}|}{M}$$

Where again we can recognize non-relativistic velocity $|\vec{P}|/M$

b) ultra-relativistic particle ($M \ll |\vec{P}|$) energy:

$$E = |\vec{P}| \sqrt{1 + \frac{M^2}{\vec{P}^2}} \sim |\vec{P}| + \frac{M^2}{2|\vec{P}|}$$

and its velocity:

$$\beta = \frac{v}{c} = \frac{|\vec{P}|}{E} \cong \frac{|\vec{P}|}{|\vec{P}| + \frac{M^2}{2|\vec{P}|}} \cong 1 - \frac{1}{2} \left(\frac{M}{|\vec{P}|} \right)^2$$

We see that with increasing momentum an ultra-relativistic particle is approaching the speed of the light. An increase of the momentum of ultra-relativistic particle will lead to only very small change of the particle velocity. High energy accelerators therefore increase the particle momentum and energies while velocities of particles are almost equal to the speed of light.

Elementary particles

Although protons, neutrons, pions, kaons etc. are usually called elementary particles, they are particles (so called hadrons) composed of quarks. The list of truly elementary particles and the range of their masses (rest energies) are shown on Figure 1.

Free quarks are not observable; they are bounded inside particles named **hadrons**. There are two types of hadrons:

Baryons composed of three valence quarks, e.g. proton (uud) or neutron (udd). Baryons carry baryon number and have a half integer spin. To present knowledge the baryon number is conserved in all interactions or decays of elementary particles;

Mesons composed of the pair of valence quark and anti-quark, e.g. π^+ ($u\bar{d}$) or K^- ($s\bar{u}$). Mesons have an integer spin, zero baryon number and they could "disappear" by decays to leptons ($\pi^+ \rightarrow \mu^+ + \nu_\mu$) or photons ($\pi^0 \rightarrow \gamma + \gamma$).

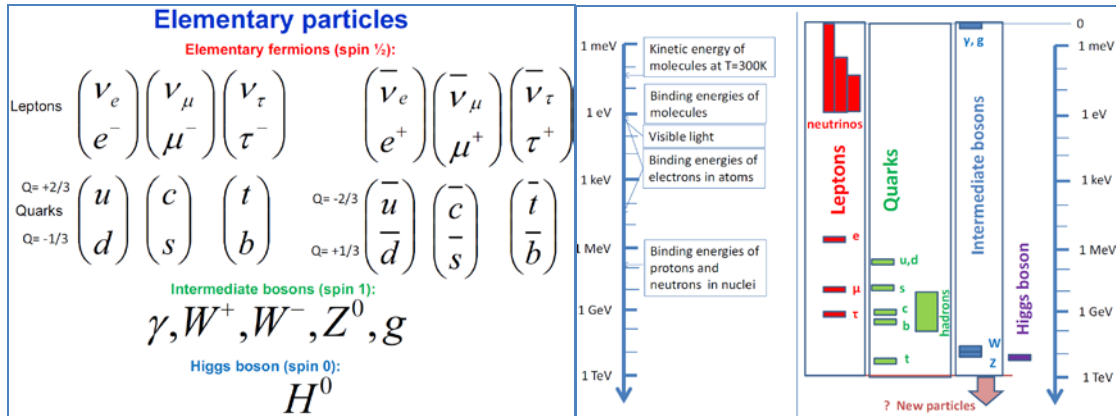

Figure 1. The list of elementary particles (left Figure) and (right Figure) the range of their masses (rest energies)

Particle interactions

Known particle interactions of quarks and leptons are illustrated on Figure 3. Normally we do not consider gravitational interaction that is much weaker than other interactions in the micro world.

The most universal interaction that takes place for all quarks and leptons is the **weak interaction** carried out by intermediate bosons W and Z.

All quarks and charged leptons (not neutrinos) interact also **electromagnetically**.

In addition, quarks interact via the **strong interaction** carried out by gluons.

Interactions of leptons and quarks

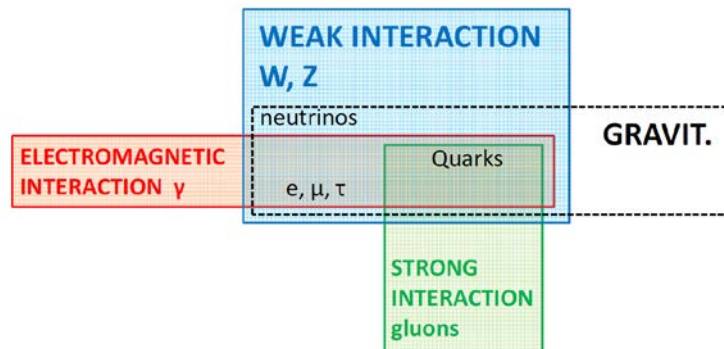

Figure 2. Particle interactions

Very useful tool for the description (and evaluations) of particle interactions are **Feynman diagrams**. On Figure 3 one can see examples of diagrams describing the electromagnetic interactions by an exchange of photons and the beta decay of neutron and muon decay as examples of the weak interaction mediated by the intermediate boson W.

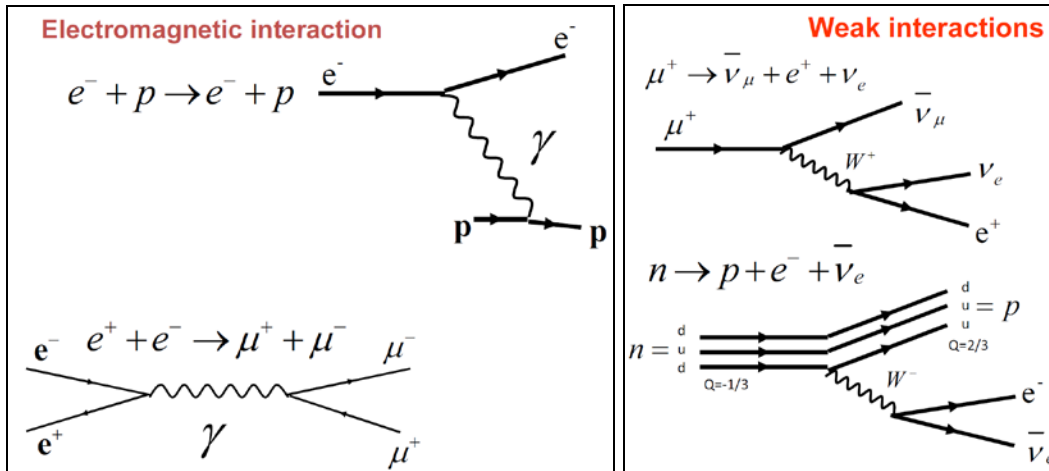

Figure 3.

Left: The elastic scattering of electron on proton ($e^- + p \rightarrow e^- + p$) and the annihilation of electron positron pair into pair of muons ($e^+ + e^- \rightarrow \mu^+ + \mu^-$) as examples of electromagnetic interactions with an exchange of photons.

Right: The muon decay ($\mu^+ \rightarrow \bar{\nu}_\mu + e^+ + \nu_e$) and neutron beta decay ($n \rightarrow p + e^- + \bar{\nu}_e$) as examples of the weak interactions with an exchange of intermediate bosons W.

To describe the strong interactions one shall assign to quarks an additional quantum number called colour. There are three different colours: Red, Green and Blue. The gluons - mediators of the strong force carry a combination of a colour and anti-colour (e.g. $R\bar{B}$, ...). Because one of the combinations ($R\bar{R} + G\bar{G} + B\bar{B}$) does not carry the colour, there are eight different gluons. A complex example of an effective "long" distance interaction of proton and neutron inside the nucleus is illustrated on Figure 4.

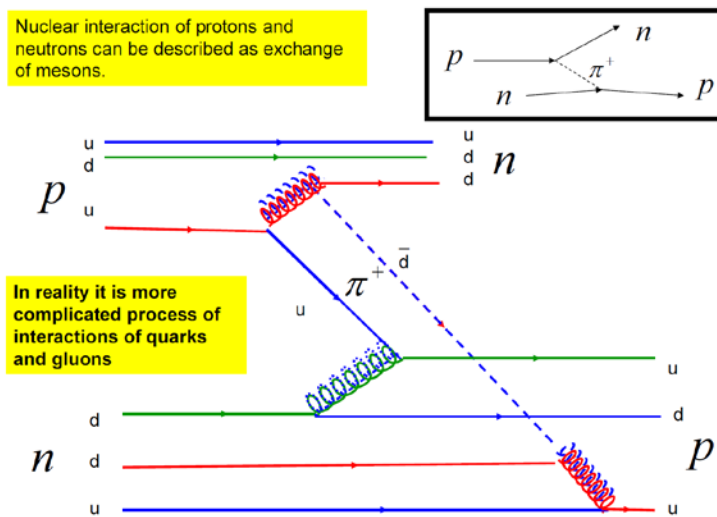

Figure 4. An example of the strong interaction of proton and neutron with the exchange of three gluons: red anti-blue in the top part, green anti-blue and red anti-green in the bottom part of the figure. Effectively the interactions can be described by the exchange of positive pion (the lightest bound state of the u quark and anti-d antiquark).

Part II. The discovery of a Higgs boson

Large Hadron Collider (LHC)

The Large Hadron Collider (LHC) [1] constructed at 27 km long underground tunnel at CERN is the most powerful accelerator and collider of protons and heavy ions worldwide. The LHC orbit consists of eight circle arcs, four interaction sections hosting the LHC experiments and of four straight sections. One straight section hosts the accelerating cavities, two straight sections are used to steer the beams and one is dedicated for beams dump.

Ex 3. Protons at LHC are kept on LHC orbit by the Lorentz force. The force is applied in 1232 magnetic dipoles 15 m long each. Calculate the value of the magnetic field necessary to keep 4 TeV protons on the circular part of the LHC orbit.

First we derive the relation between the proton momentum \vec{P} , magnetic field \vec{B} and radius of the circular orbit R . Let us assume that proton velocity is perpendicular to the magnetic field, the Lorentz force induces the acceleration of protons:

$$e v B = M \gamma \frac{v^2}{R}$$

(M is the rest mass of the particle and γ is its Lorentz factor). The relation can be further edited:

$$e B = \frac{M \gamma v}{R} = \frac{P}{R} \Rightarrow P c = e c B R \Rightarrow P[\text{eV}] \equiv \frac{P c}{e} = c \left[\frac{\text{m}}{\text{s}} \right] B[\text{T}] R[\text{m}]$$

Where we introduced the momentum in energy units (Pc) and expressed it in electron-volts.

Because the value of $c \cong 3 \cdot 10^8 \frac{\text{m}}{\text{s}} = 0.3 \cdot 10^9 \frac{\text{m}}{\text{s}}$ we obtain very simple equation:

$$P[\text{GeV}] = 0.3 B[\text{T}] R[\text{m}]$$

or in TeV and km units:

$$P[\text{TeV}] \equiv 0.3 B[\text{T}] R[\text{km}]$$

The length of the circular part (eight arcs) of the LHC orbit is determined by 1232 dipole magnets 15 m long each, i.e. $1232 \cdot 15 \text{ m} = 18.48 \text{ km}$ that imply the radius $R = 2.94 \text{ km}$.

Using the formula:

$$4[\text{TeV}] \equiv 0.3 B[\text{T}] 2.94[\text{km}]$$

we easily find the value of $B \sim 4.5 \text{ T}$.

Maximal designed magnetic field of $\sim 8 \text{ T}$ of the LHC dipoles will allow colliding $7 \text{ TeV} \square 7 \text{ TeV}$ protons.

Two general purpose experiments ATLAS [2] and CMS [3] were built to measure secondary particles created in proton-proton collisions. One of the main goals of the LHC experiments is to search for the Higgs boson. Because the creation of the Higgs boson is very rare event, the LHC parameters must allow for hundreds of millions of pp interactions per second in order to accumulate enough statistics of the Higgs boson decays. In 2012 the protons has been accelerated to 4 TeV - the highest energy ever reached at accelerators.

Accelerated protons are concentrated in bunches separated by 15 m. Each bunch contains ~ 100 billion of protons and at the collision region in the centers of the ATLAS and CMS detectors bunches are squeezed to perpendicular sizes of the order of 0.03 mm.

Probability of interactions and the cross section

Probability p that the particle interacts with the target is proportional to the density n of target particles and to the length L of the target:

$$p = 1 - e^{-\sigma n L} \xrightarrow{\sigma n L \rightarrow 0} \sigma n L$$

with the coefficient of proportionality σ called the **cross section**. The cross section σ has the dimension of cm^2 , units of the cross section are barns (**1 barn = 10^{-24}cm^2**).

In the experiment we can tune the interaction probability by changing the target parameters; however the value of the cross section σ however is the intrinsic characteristic of a particular particle interaction.

Ex 4. The value of the (total) cross section σ of LHC 4 TeV protons with 4 TeV protons is 0.1 barn. Calculate how many protons interact in one bunch crossing.

Let us assume $N=100$ billion of protons in each bunch of cylindrical shape with the radius r of 0.03 mm and $L=10$ cm. Probability that one proton from the first bunch interacts with N protons of the second bunch is:

$$p = \sigma n L = \sigma \frac{N}{S L} L = \sigma \frac{N}{S} = \sigma \frac{N}{\pi r^2}$$

and the number of interaction per one bunch crossing is simply given by:

$$N_{\text{int}} = N p = \sigma \frac{N^2}{\pi r^2} = 0.1 \cdot 10^{-24} \text{cm}^2 \frac{(10^{11})^2}{3.14 (0.003 \text{cm})^2} \cong 35$$

Because the total number of protons in the bunches decreases due to pp interactions, the total number of interactions per bunch decreases during the run. The mean value of ~ 20 interactions per bunch crossing has been measured in the ATLAS experiment.

The Higgs boson

The weak and electromagnetic interactions have very similar strengths at high energies. At low energies weak interactions are suppressed because, contrary to massless photon, intermediate bosons W and Z have large masses. Main theoretical motivation to introduce the Higgs boson is to explain non-zero masses of intermediate bosons W and Z . In its simplest form, the theory predicts one electrically neutral spin-less Higgs boson. The Higgs boson is predicted to decay almost immediately into lighter particles. These could eventually decay subsequently to stable or long-living particles.

Theory does not predict the value of the Higgs boson mass, it has to be measured experimentally. The comparison of various experimental data with the theory indicates that if the Higgs boson in its simplest form exists, it shall have the mass around 100 GeV.

It is very important that for each possible value of the Higgs boson mass, theory can predict how often the Higgs boson will be created in pp collisions and with what probabilities it will decay to its final states. Predictions can be illustrated for 125 GeV Higgs boson. The **125 GeV Higgs boson** will be created in **1 out of ~ 5 billions (10^9)** 4 TeV x 4 TeV pp interactions and it will decay to various pairs of particles with following probabilities .

- 58%** to pairs of $b \bar{b}$ quarks (the heaviest quarks to which 125 GeV Higgs could decay);
- 21%** to pairs of intermediate bosons $W^+ W^-$;
- 8.6%** to pairs of **gluons**;
- 6.3%** to pairs of the heaviest leptons $\tau^+ \tau^-$;
- 2.9%** to pairs of $c \bar{c}$ quarks;
- 2.6%** to pairs of intermediate bosons $Z^0 Z^0$;
- 0.23%** to pairs of $\gamma \gamma$.

Ex 5. Theory predicts the probability of the Higgs boson decays to leptons pairs (in general to all fermion pairs) being proportional to squares of leptons (fermions) masses. Estimate the probabilities of 125 GeV Higgs boson decays to pair of muons and pair of electrons.

The probability of the 125 GeV Higgs boson decay to a pair of tau leptons is 6.3%. Masses of leptons are 1778 MeV, 106 MeV and 0.5 MeV for tauons, muons and electrons respectively.

Predicted probability for the Higgs boson decay to a pair of muons is therefore:

$6.3\% (106 \text{ MeV} / 1778 \text{ MeV})^2 \sim 0.022 \%$. Probability of the Higgs boson decay to electrons is negligibly small.

How to discover particles with very short life time

Unstable particles like the Higgs boson that decays almost instantaneously can be discovered using the energy and momentum conservations. Let us assume that the unstable particle with the mass M , the total energy E and the momentum \vec{P} decays to n secondary particles with masses m_i , the total energies e_i and momenta \vec{p}_i . Using the energy and momentum conservation:

$$E = e_1 + e_2 + \dots + e_n$$

$$\vec{P} = \vec{p}_1 + \vec{p}_2 + \dots + \vec{p}_n$$

the relation between the particle rest energy (mass) M , the total energy E and the momentum \vec{P} can be used to calculate the mass M by measured energies and momenta of secondary particles:

$$M^2 = E^2 - \vec{P}^2 = (e_1 + e_2 + \dots + e_n)^2 - (\vec{p}_1 + \vec{p}_2 + \dots + \vec{p}_n)^2$$

This variable is frequently called the invariant mass.

In 2012 the experiments ATLAS and CMS have announced the discovery of a new boson with the mass around 125 GeV [4].

The discovery of a Higgs boson in decays to pair of gammas is using exactly the formula derived in Ex.6 below.

Ex 6. Derive the formula for the invariant mass of pair of gamma particles with momenta \vec{p}_1, \vec{p}_2

forming the angle θ_{12}

$$M^2 = E^2 - \vec{P}^2 = (e_1 + e_2)^2 - (\vec{p}_1 + \vec{p}_2)^2 = e_1^2 - \vec{p}_1^2 + e_2^2 - \vec{p}_2^2 + 2(e_1 e_2 - \vec{p}_1 \vec{p}_2)$$

For gamma particles the energies equal to the sizes of momenta ($e_{1,2} = |\vec{p}_{1,2}|$):

$$M^2 = 2|\vec{p}_1||\vec{p}_2|(1 - \cos \theta_{12}) = 4|\vec{p}_1||\vec{p}_2|\sin^2 \theta_{12}$$

$$M = 2\sqrt{|\vec{p}_1||\vec{p}_2|} \sin\left(\frac{\theta_{12}}{2}\right) = 2\sqrt{e_1 e_2} \sin\left(\frac{\theta_{12}}{2}\right)$$

Energies and directions of gammas are measured using ATLAS or CMS detectors. After careful selection of events with two gammas, the signature of an unstable particle is observed as an excess of events in the distribution of invariant masses in the region of the

mass of an unstable particle. On Figure 5 one can see such signals observed with the ATLAS detector [5].

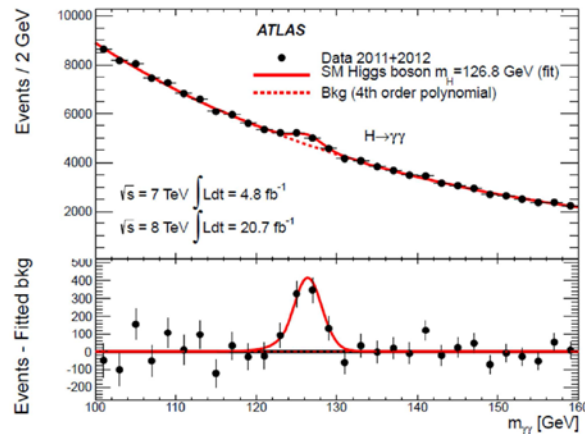

Figure 5. The distribution of invariant masses of two gammas for selected events shows statistically significant excess of events in the region of 125 GeV. The figure is taken from the publication [5].

Similar formula for the invariant mass of four leptons ($e^+e^-e^+e^-$, $e^+e^-\mu^+\mu^-$ and $\mu^+\mu^-\mu^+\mu^-$) is used to evaluate and plot four-lepton invariant mass on Figure 6.

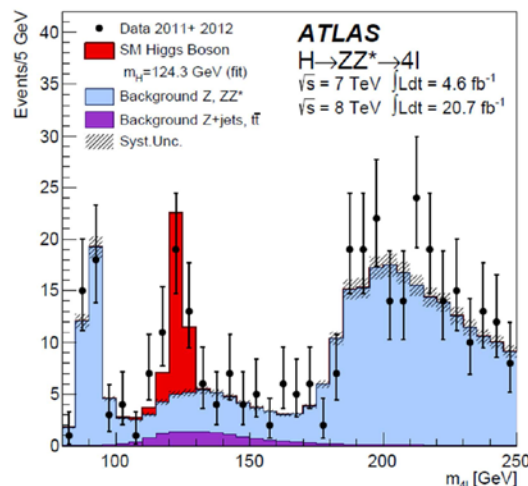

Figure 6. The distribution of the invariant masses of four leptons. Clear signal of the decay of a Higgs particle in red is observed above blue and violet distribution expected without a Higgs boson. The figure is taken from the publication [5].

Summary of Part II

In 2012 the experiments ATLAS and CMS have announced the discovery of a new boson with the mass around 125 GeV.

The mass of the discovered particle (~ 126 GeV) is precisely determined by the position of peaks in the invariant mass distributions.

The new particle is electrically neutral; its charge is equal to the sum of charges of decays products.

Because the particle decays to two gammas (bosons) or four leptons (fermions), it must have an integer spin, i.e. it is the boson. Moreover the decay to two gammas excludes the value 1 of the spin a new boson.

More detailed study of decays agrees with the hypothesis of spin-less particle with positive parity as predicted for a Higgs boson.

Part III. Neutrino oscillations

Neutrinos are the lightest elementary fermions. There are three different neutrino types (flavors): electron, muon and tauon neutrinos. Their tiny masses allow for a very interesting phenomenon of oscillations of neutrino flavors.

Neutrino oscillations are experimentally firmly established phenomena using various neutrino sources:

Accelerator neutrinos. Electron anti-neutrinos with energies up to ~10 MeV produced by beta decays at nuclear power reactors.

Solar neutrinos are electron neutrinos produced in protons fusion at the Sun (energies up to ~ 14 MeV).

Atmospheric and accelerator neutrinos are muon and electron neutrinos and anti-neutrinos with energies of ~ GeV from pions (and muons) decays produced by cosmic rays or accelerators.

A neutrino created in the weak interaction with a specific **flavour** ($f = e, \mu, \tau$) can later be measured to have a different flavour. The probability of measuring a particular flavour for a neutrino varies periodically (oscillates) as it propagates.

Neutrino oscillation can be explained by a mixture between the three flavour ($f = e, \mu, \tau$) and three **mass eigenstates** ($i = 1, 2, 3$) of neutrinos: $\bar{\nu}_f = \sum_{i=1}^3 U_{fi} \bar{\nu}_i$, where U is a unitary 3x3 matrix.

In a simplified case of 2 (mass eigenstates **1** and **2**) x 2 (flavor eigenstates **e** and **f**), the mixing can be described by one mixing angle θ :

$$\begin{aligned}\bar{\nu}_e &= \cos\theta \bar{\nu}_1 + \sin\theta \bar{\nu}_2 \\ \bar{\nu}_f &= -\sin\theta \bar{\nu}_1 + \cos\theta \bar{\nu}_2\end{aligned}$$

Assuming the same values of momenta, different masses m_1, m_2 of mass eigenstates imply different values of total energies E_1, E_2 . During the propagation in time the mass eigenstates acquire quantum mechanical complex phases proportional to the values of their total energies:

$$\bar{\nu}_e(t) = \cos\theta \cdot e^{-\frac{i}{\hbar c} E_1 t} \bar{\nu}_1 + \sin\theta \cdot e^{-\frac{i}{\hbar c} E_2 t} \bar{\nu}_2$$

As a consequence, originally pure electron anti-neutrino state will become a mixture of electron and other flavor(s) anti-neutrino:

$$\bar{\nu}_e(t) = \left(\cos^2\theta \cdot e^{-\frac{i}{\hbar} E_1 t} + \sin^2\theta \cdot e^{-\frac{i}{\hbar} E_2 t} \right) \bar{\nu}_e + \sin\theta \cdot \cos\theta \cdot \left(e^{-\frac{i}{\hbar} E_2 t} - e^{-\frac{i}{\hbar} E_1 t} \right) \bar{\nu}_f$$

The probability to find the anti-neutrino at the time t in its original electron flavor $\bar{\nu}_e$ or in a new flavor $\bar{\nu}_f$ is given by squares of the absolute values of complex coefficients in front of $\bar{\nu}_e$ and $\bar{\nu}_f$ respectively.

The probability $P_{\bar{\nu}_e \rightarrow \bar{\nu}_f}(t)$ can be calculated as follows.

$$\begin{aligned}
 P_{\bar{\nu}_e \rightarrow \bar{\nu}_f}(t) &= \sin \theta \cdot \cos \theta \cdot \left(e^{-\frac{i}{\hbar} E_2 t} - e^{-\frac{i}{\hbar} E_1 t} \right) \sin \theta \cdot \cos \theta \cdot \left(e^{+\frac{i}{\hbar} E_2 t} - e^{+\frac{i}{\hbar} E_1 t} \right) = \\
 &= 4 \sin^2 \theta \cos^2 \theta \frac{1}{2} \left(1 - \frac{e^{+\frac{i}{\hbar} (E_1 - E_2) t} + e^{-\frac{i}{\hbar} (E_1 - E_2) t}}{2} \right) = \sin^2 2\theta \sin^2 \left(\frac{E_1 - E_2}{2\hbar} t \right)
 \end{aligned}$$

Using following approximations (L is the distance between the neutrino source and the detector and $p(\cong E)$ is the neutrino momentum (energy))

$$E_1 - E_2 \cong p + \frac{m_1^2}{2p} - \left(p + \frac{m_2^2}{2p} \right) = \frac{m_1^2 - m_2^2}{2p} \cong \frac{m_1^2 - m_2^2}{2E} \text{ and } t \cong L/c$$

the probability can be written in the form:

$$P_{\bar{\nu}_e \rightarrow \bar{\nu}_f}(L) \cong \sin^2(2\theta) \cdot \sin^2 \left(\frac{m_1^2 - m_2^2}{4\hbar c} \frac{L}{E} \right)$$

Ex 7. Derive the formula for so called survival probability $P_{\bar{\nu}_e \rightarrow \bar{\nu}_e}(L)$.

$$\begin{aligned}
 P_{\bar{\nu}_e \rightarrow \bar{\nu}_e}(t) &= \left(\cos^2(\theta) \cdot e^{-\frac{i}{\hbar} E_1 t} + \sin^2(\theta) \cdot e^{-\frac{i}{\hbar} E_2 t} \right) \left(\cos^2(\theta) \cdot e^{+\frac{i}{\hbar} E_1 t} + \sin^2(\theta) \cdot e^{+\frac{i}{\hbar} E_2 t} \right) \\
 P_{\bar{\nu}_e \rightarrow \bar{\nu}_e}(t) &= \cos^4(\theta) + \sin^4(\theta) + 2 \sin^2(\theta) \cos^2(\theta) \frac{e^{+\frac{i}{\hbar} (E_1 - E_2) t} + e^{-\frac{i}{\hbar} (E_1 - E_2) t}}{2} \\
 &= (\cos^2(\theta) + \sin^2(\theta))^2 - 4 \sin^2(\theta) \cos^2(\theta) \frac{1}{2} \left(1 - \frac{e^{+\frac{i}{\hbar} (E_1 - E_2) t} + e^{-\frac{i}{\hbar} (E_1 - E_2) t}}{2} \right) \\
 P_{\bar{\nu}_e \rightarrow \bar{\nu}_e}(t) &= 1 - \sin^2(2\theta) \sin^2 \left(\frac{E_1 - E_2}{2\hbar} t \right)
 \end{aligned}$$

As expected for 2 neutrino flavours case the following simple relation holds.

$$P_{\bar{\nu}_e \rightarrow \bar{\nu}_e}(t) + P_{\bar{\nu}_e \rightarrow \bar{\nu}_f}(t) = 1$$

Major features of the oscillation formula are as follows.

- There will be **no oscillations** if $\theta = 0$ or $\pi/2$, i.e. when the flavor and the mass eigen-states coincide.
- **No oscillations** will be observed if $m_1 = m_2$, i.e. the observation of **neutrino oscillations imply** (at least one) **non zero neutrino masses**.
- Neutrino oscillations are function of L/E .
- The oscillation amplitude is equal to the value of $\sin^2(2\theta)$.
- The oscillation length is inversely proportional to the value of $m_1^2 - m_2^2$.
- The oscillation formula is not sensitive to the sign of the mass difference $m_1^2 - m_2^2$.

The mixing matrix U for 3x3 neutrino flavor x mass can be described by four parameters: three mixing angles θ_{12} , θ_{13} and θ_{23} and one phase δ .

$$\begin{pmatrix} U_{e1} & U_{e2} & U_{e3} \\ U_{\mu1} & U_{\mu2} & U_{\mu3} \\ U_{\tau1} & U_{\tau2} & U_{\tau3} \end{pmatrix} = \begin{pmatrix} 1 & 0 & 0 \\ 0 & c_{23} & s_{23} \\ 0 & -s_{23} & c_{23} \end{pmatrix} \cdot \begin{pmatrix} c_{13} & 0 & s_{13} e^{i\delta} \\ 0 & 1 & 0 \\ -s_{13} e^{i\delta} & 0 & c_{13} \end{pmatrix} \cdot \begin{pmatrix} c_{12} & s_{12} & 0 \\ -s_{12} & c_{12} & 0 \\ 0 & 0 & 1 \end{pmatrix}$$

where s_{ij} and c_{ij} denote $\sin \theta_{ij}$ and $\cos \theta_{ij}$ respectively. As we will see later, the phase δ would allow for the different behavior of neutrinos and anti-neutrinos and because of that it is called CP violating phase.

The values of two mass square differences and mixing angles θ_{12} , and θ_{23} have been measured in following experiments.

Experiments with atmospheric and accelerator neutrinos measured following neutrino oscillations parameters:

$$|\Delta m_{31}^2| \equiv |m_3^2 - m_1^2| \cong (50 \text{ meV})^2 \quad \theta_{23} \cong 45^\circ$$

and **experiments with reactor and Sun neutrinos**:

$$\Delta m_{21}^2 \equiv m_2^2 - m_1^2 \cong (8.7 \text{ meV})^2 \quad \theta_{12} \cong 34^\circ$$

Because the value of $|\Delta m_{31}^2| \cong 30 \Delta m_{21}^2$, there are two very different neutrino oscillations

lengths (distances to the 1st oscillation minimum $\left(\frac{L}{E}\right)_{1st \text{ min}}$):

$$|\Delta m_{31}^2| \cong |\Delta m_{32}^2| \Rightarrow \left(\frac{L}{E}\right)_{1st \text{ min}} \cong 0.5 \frac{\text{km}}{\text{MeV}} = 500 \frac{\text{km}}{\text{GeV}}$$

$$\Delta m_{21}^2 \Rightarrow \left(\frac{L}{E}\right)_{1st \text{ min}} \cong 15 \frac{\text{km}}{\text{MeV}} = 15000 \frac{\text{km}}{\text{GeV}}$$

Non trivial value of the CP violating phase δ implies the difference between oscillation probabilities for neutrinos and anti-neutrinos, e.g.:

$$P_{\nu_\mu \rightarrow \nu_e} \left(\frac{L}{E}\right) - P_{\bar{\nu}_\mu \rightarrow \bar{\nu}_e} \left(\frac{L}{E}\right) = 2 \sin(\delta) \cos(\theta_{13}) \prod_{i < j=1}^3 \sin(2\theta_{ij}) \sin\left(\frac{\Delta m_{ji}^2 L}{4\hbar c E}\right)$$

The difference is non-zero if all the three mixing angles have non-trivial values ($\theta_{ij} \neq 0, \pi/2$), all the three mass eigenstates have different masses and the value of $\delta \neq 0, \pi$.

The possibility of the measurements of the CP violation in future neutrino oscillations experiments was one of major motivations for precise measurements of the value of the smallest mixing angle θ_{13} .

Summary of Part III

The aim of three reactor neutrino experiments Daya Bay in China, Double Chooz in France and RENO in South Korea was to measure not observed before disappearance of reactor electron anti-neutrinos at distances of 0.5 km/MeV. Such observation would be a discovery of non-zero value of the mixing angle θ_{13} .

Non zero value of θ_{13} has been discovered [6] by the Daya Bay and confirmed by RENO [7] and Double Chooz [8] experiments. At the time of the ICPE-EPEC 2013 conference the most precise value reported by the Daya Bay was [9]:

$$\sin^2(2\theta_{13}) = 0.089 \pm 0.010_{stat} \pm 0.005_{syst}$$

An alternative way to measure the value of θ_{13} is via the observation of the appearance of electron (anti-)neutrinos in muon (anti-)neutrinos at distances 500 km/GeV by T2K (Japan) [10], MINOS (USA) [11] and in near future also by NOvA (USA) experiments.

Because the accelerator appearance experiments measure the combination of $\sin^2(2\theta_{13})$ and the CP violating phase δ the comparison of reactor disappearance and accelerator appearance results would contribute to our knowledge of possible CP violation in neutrino oscillations.

Acknowledgement

Author congratulates the organizers for very interesting conference and he very much thanks for the invitation and for having the unique opportunity to talk to the international audience of physics educators.

References

- [1] Evans L., Bryant P.: LHC Machine, JINST 3 (2008) S08001.
- [2] ATLAS Collaboration, The ATLAS experiment at the CERN Large Hadron Collider, JINST 3 (2008) S08003.
- [3] CMS Collaboration, “The CMS experiment at the CERN LHC”, JINST 3 (2008) S08004.
- [4] ATLAS Collaboration, Observation of a new particle in the search for the Standard Model Higgs boson with the ATLAS detector at the LHC, Phys.Lett. B716 (2012) 1-29. CMS Collaboration, Observation of a new boson at a mass of 125 GeV with the CMS experiment at the LHC, Phys. Lett. B716 (2012) 30–61.
- [5] ATLAS Collaboration, Measurements of Higgs boson production and couplings in diboson final states with the ATLAS detector at the LHC, Phys.Lett. B726 (2013) 88-119. Major ATLAS experiment results and figures are publicly available through the web pages <https://twiki.cern.ch/twiki/bin/view/AtlasPublic>
<https://twiki.cern.ch/twiki/bin/view/AtlasPublic/EventDisplayPublicResults>
- [6] An F. P. et.al: [Daya Bay Collaboration], Phys. Rev. Lett. **108**, 171803 (2012).
- [7] Ahn J. K. et.al: [RENO Collaboration], Phys. Rev. Lett. **108** 191802 (2012). Soo-Bong Kim, Talk at Neutrino 2012, Kyoto, June 4, 2012.
- [8] Abe Y. et.al: [Double Chooz Collaboration], Phys. Rev. Lett. **108**, 131801 (2012).
- [9] An F. P. et.al: [Daya Bay Collaboration], Chinese Physics **C37**, 011001 (2013).
- [10] Abe K.: [T2K Collaboration], Phys. Rev. Lett. **107**, 041801 (2011). New results have been reported at EPS-HEP conference in Stockholm, July 2012.
- [11] Adamson P. et.al: (MINOS), Phys. Rev. Lett. **107**, 181802 (2011).

Sport and Physics

Leopold Mathelitsch

Inst. Physics, Univ. Graz, Austria

Abstract

The combination of sports and physics offers several attractive ingredients for teaching physics, at primary, secondary, as well as university level. These cover topics like interdisciplinary teaching, sports activities as physics experiments, video analysis or modeling. A variety of examples are presented that should act as stimulus, accompanied by a list of references that should support the implementation of sport topics into physics teaching.

Keywords: sport, physics teaching, video analysis, modelling

Introduction

Physics and sports seem to have not much in common, at least in school teaching, where they are very disconnected subjects: disparate with respect to contents, but also to location, kind of activities or interest of students. Despite this distance, one can find good reasons to bring these two subjects of school education closer to each other: different kinds of sports could serve as examples for applying physical laws; sports activities by students can be seen as physics experiments including quantitative exploration; modern technology offers the possibility to visualize and analyze movements. But this proposal should not be seen as one-directional in that sport comes into the physics class, it should be a challenge for a balanced cooperation. Let's take the location as an example: a physics class can take place in the swimming pool or gym, a sport class can experiment in the physics lab. This implies also a strong collaboration of the teachers: a physics teacher needs the support of the sports teacher while students perform activities; on the other hand, the physics teacher can take over the biomechanical part of sports training. A realization of these goals would lead to a true interdisciplinary teaching, written down in many school curricula around the world, but rarely executed in this sense, also around the world.

The aim of this paper is to illustrate and exemplify the above statements in more detail. The next chapter discusses didactic reasons why a connection of sports and physics could be of mutual benefit to both school subjects. Sometimes teachers claim that they do not find proper material, in particular adapted for use in schools. Therefore special focus is laid on an extensive list of references. The main part of this article, however, consists of a collection of examples that should illustrate and support the theoretical claims.

Sports and physics

The link between sports and physics is very important in the professional sport business. In order to improve training techniques and therewith the achievement of athletes, physics enters on several occasions: it plays an important role in the development of new material, it is part of the technological equipment necessary for data taking and analyzing, and it is the basis for biomechanical models trying to understand human performance. Therefore many research institutes have been established, and scientific results are published in corresponding journals.

With regard to school education, the connection of sports and physics is much less obvious. In fact, they represent two subjects that are very often diametric on the scale of attractiveness. Nevertheless, several arguments can be found suggesting to bridge these two sciences even at school level. In the following we will discuss some of them.

Visualization

Observation is a discipline in physics education which is not valued and activated to the extent it deserves. Students should learn to observe carefully and also to describe what they see: on the one hand, it is amazing how varying the descriptions of the same action are given by different students; on the other hand, a detailed description leads very often to the question “why”, and consequently to an attempt for explanation. There could be no better starting point for a topic in physics as when the students ask for an explanation.

Sports actions have one disadvantage in this respect that one cannot observe them easily in reality in a class room. But there exist videos of all kinds of sports actions with the benefit that one can repeat them as often as wanted. And sports actions can be very complex (for example the rotations of a diver off a high board), so that even the task of describing the movement can be demanding to students.

In addition, sports actions can run very fast so that even repetitions do not help in recognizing what is going on. For this reason, slow motion has been used for a long time in analysing such actions. Fortunately, the technological progress made it possible that high-speed cameras are available at such good quality and low price that they became a useful equipment in school labs [1]. An example of such visualization is given in the next chapter treating collisions of billiard balls.

Video analysis

The next step beyond visualization is a quantitative exploration of an action, very often by video analysis. Several programs for such an analysis have been developed with special emphasis on applications in physics education. Some of them are freely available [2,3], some are commercial ones [4,5]. Most of them are very user/student friendly, allowing for tracking certain elements of the action, either by hand or automatically, and enabling easy data taking and processing. Another feature allows for adding information in the video (e.g. velocity or force vectors) leading to a more explanatory presentation [6].

Video analysis is a very important tool in sports research where simultaneous videos of several cameras can lead to a three-dimensional reconstruction of the event. But even with one camera, results can be obtained of high quality, when the action takes place in a plane like the movement of some sports equipment (ball, spear, ...). An attractive feature for school physics is the fact that students can take the video by themselves or play the actor (for example executing a penalty in soccer) and they analyze and calculate their own performance (e.g. motion and speed of the ball).

Experiments

Most of the attraction of sports classes is based on activity: students are not only allowed but encouraged to move, to exercise, to compete. In the physics class, experiments are usually the only possibility for physical activity, and this does not happen too often, in general. Experiments with sports actions could be an interesting and challenging combination of activity and quantitative exploration – both for students and teachers. This can be performed in the class room (a simple determination of the force of the own legs or

the measurement of the coefficient of restitution for different balls), in the physics lab (measurement of the properties of a tennis racket) or out of school (in a billiard saloon).

Experiments in the physics lab are often guided by clear descriptions what the students should do with which apparatus. Sports experiments can be posed as very open tasks, the students could suggest what they want to explore, they should propose and design the experiment. For example, several possibilities exist to measure the coefficient of restitution of a ball; the results of different experiments can be compared and the quality and accuracy of the different methods can be discussed.

Models

Modeling is an important ingredient of scientific research. Physics curricula demand that modeling should also be part of the education of students, even at secondary level [7]. A GIREP conference was dedicated entirely to “Modeling in Physics and Physics Education” [8]. Modeling tools are sometimes even implemented in video analysis software [9].

Working with ideal situations (a mass glides without friction along an inclined plane), the students do not see the value of and necessity for models. Sports actions, in particular when the human body is involved, are very complex. In order to describe and explain them, students see immediately that they have to make approximations, simplifications, and therefore have to work with more or less sophisticated models of the real situation.

Interest

Several studies have shown that physics is not a popular school subject. In a representative study in the province of Styria (Austria) more than one thousand of students aged 10 to 14 were asked which school subjects they like and in which they are interested [10]. The data reveal that the interest is high when the students start with this school type, but that it drops immediately after. The bad message is not only the decrease, but that it happens during the first year of physics teaching.

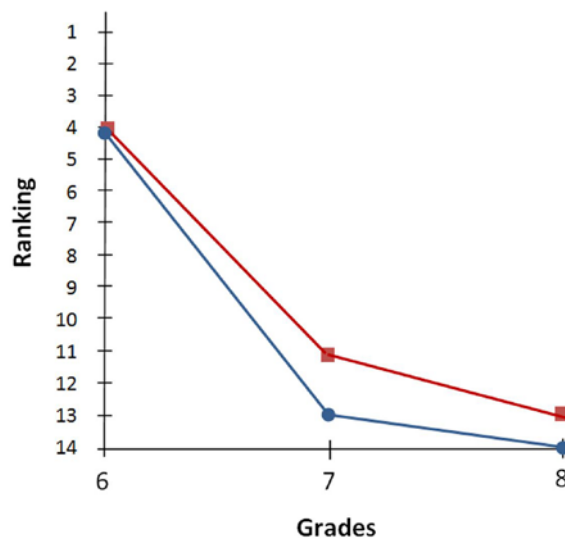

Figure 1. Interest in (blue circles) and popularity of (red squares) the subject physics [10]

Another study by a German group was much more detailed [11]. Figure 2 shows three groups of students, those interested in physics (A), a second group with medium interest (B) and a third one which indicated no interest (C) – this definition is a bit simplified compared to the original article [12]. The students were asked in which components of physics their interest lies, in which field they want to learn more: quantitative physics (brown columns), qualitative physics (green), functioning of technical instruments (red), natural phenomena (yellow), and physics and society (blue). The profile of the three groups is given in the left graphs. And on the very right side the actual offer is shown, as indicated by the students. A discrepancy is obvious and also disturbing. I do not advocate here that the desires of students should be the guidelines for teaching, but, speaking in economic terms, a company is not well advised when it produces against the market (group B and C make about 80 percent of the students).

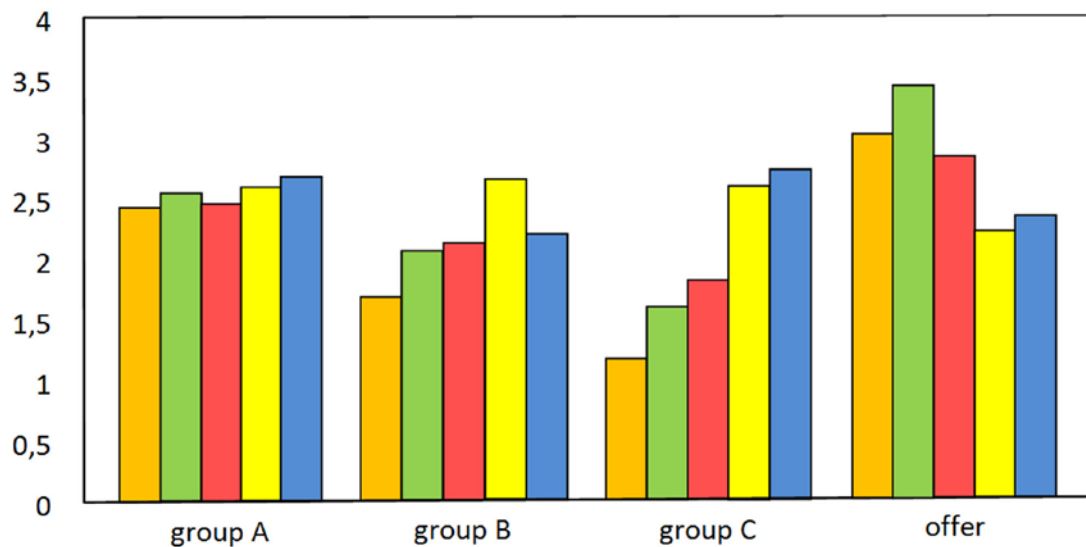

Figure 2. Interest profile of students (description see text) (adapted from [12])

Investigations revealed what particular topic and content are of special interest to students [13]. Not surprisingly, a gender difference shows up: roughly speaking, boys have a tendency to the technological side of physics, whereas girls are interested in those fields that are more related to the human being (biophysics, medicine, society) [14]. Sports falls into both of the above categories, again with some differentiation – boys are more fond of soccer, motor sports, girls more of gymnastics, Nordic walking and related activities. But in general, topics of sport are on the positive side of the interest for the majority of students and could therefore serve the purpose to make physics more attractive to them.

Literature

Literature about the combination of sports and physics can be divided into specific groups. Research papers on the different aspects of biomechanics and related topics fill by far the largest area. I do not even want to try listing the names of journals dedicated to these topics, since they are such a great many. Above all, the articles naturally are so specialized that a transfer to educational purposes is very often difficult to make.

Journals like American Journal of Physics [15] or European Journal of Physics [16] aim at a broader audience, and teachers of physics are an intended target group. The articles therefore give a wider view on a topic. And a noticeable number of articles belong to sports and physics. Therefore a literature research in both journals is a good starting point

in looking for profound information on physical explanations of sports topics. A Resource Letter has been compiled in American Journal of Physics with many references to articles and books ordered along sports topics [17]. The journal Physics World in 2012 dedicated an entire issue to the topic “Physics and Sport” [18].

A gold mine, not only with regard to educational purposes, are books, entitled “Physics and ...” giving a broad but profound view on the sportive and the physical sides of a special kind of sport: “The Physics of Baseball” [19], “The Physics of Basketball” [20], “The Physics and the Art of Dance” [21], “The Physics of Golf” [22], “Physics of Hockey” [23], “Physics of Sailing” [24], “Physics of Skiing. Skiing at the Triple Point” [25], “The Science of Soccer” [26], and similarly “Bicycling Science” [27], “Gliding for Gold” [28], “The Mathematics of Projectiles in Sport” [29], “Golf Balls, Boomerangs and Asteroids” [30]. I apologize for having missed some discipline or book. Equally important are books that give an overview like “The Physics of Sports” [31], “An Introduction to the Physics of Sports” [32], “The Dynamics of Sports: Why That’s the Way the Ball Bounces” [33], or “Gold Medal Physics. The Science of Sports” [34].

Less common are articles that are directed mainly to the implementation into physics education at high school level. “The Physics Teacher” [35] or “Physics Education” [36], for example, act as forum for such publications. “Sports Science” [37] is a booklet dedicated to a young audience. Finally, I would like to point to a special project in the UK called “E-Learning in Physical Science through Sport – ELPSS” within the National Teaching Fellowship Scheme [38]. A collection of so-called reusable learning objects has been developed with a mixture of videos, information and tasks; to my opinion an excellent material on problem-based learning applying sport examples.

Because of the readership of this proceedings, a constraint was set on English literature and no material in other languages was included (not even mine).

Examples

This chapter contains a collection of examples, correlated only by the combination physics and sports exhibiting the many facets of this topic. Most of the examples have been tested in school practice.

Billiard

“Follow shot” is a special action in billiards: the cue ball hits an object ball centrally and then runs after the object ball. In real time one does not recognize what happens in detail. Watching this action in slow motion, however, gives a clearer picture and students can figure out with the naked eye what’s going on (Figure 3). The cue ball is hit on the upper end, therefore it gets speed and rotation in form of top spin (1). Linear momentum is conserved during the collision. Since the two balls have the same mass, the object ball gets the full velocity and the cue ball stops and stays at rest (2). The rotation of the cue ball cannot be transferred to the object ball, because the interaction time is very short and almost no friction works between the balls. Therefore, the rotation stays in the cue ball, it turns on the spot (3). But friction with the fabric causes the cue ball finally to move in the same direction as the object ball (4).

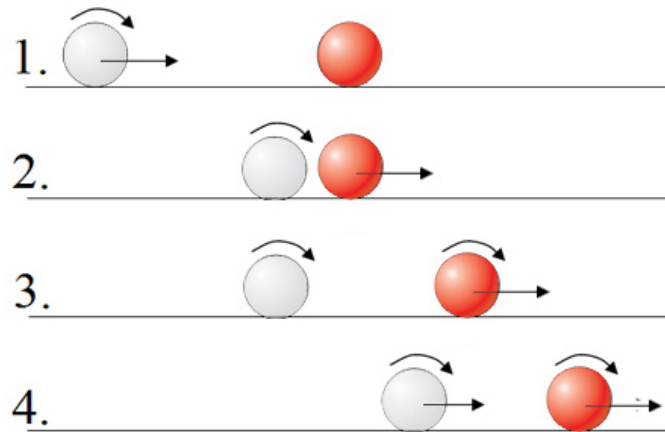

Figure 3. Follow shot (from [39], p. 98)

There exists also the possibility that the cue ball comes back: the player has to hit the ball below the middle and gives it a slice. But this is more difficult, there is the danger to damage the green fabric with the queue and one should not propose this action to students who are playing billiard for the first time.

When the object ball is not hit centrally, the two balls depart always with an angle of 90 degrees between them (Figure 4). Students have problems to believe that this angle is independent of how close to the center or how soft the two balls touch. Basic mathematics should persuade them.

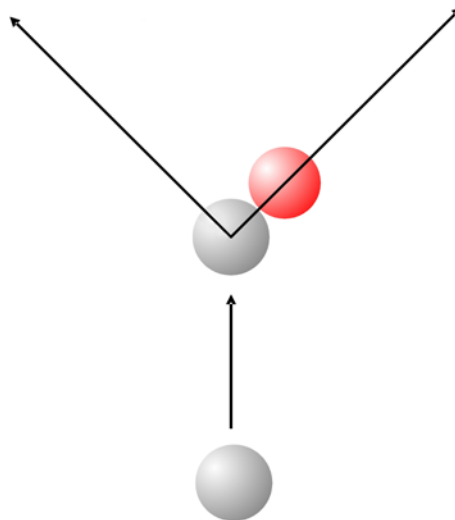

Figure 4. Non-central collision (adapted from [39], p. 99)

Conservation of energy and momentum leads to the following equations

$$\frac{1}{2}m \cdot V^2 = \frac{1}{2}m \cdot v_1^2 + \frac{1}{2}m \cdot v_2^2$$

$$m \cdot \vec{V} = m \cdot \vec{v}_1 + m \cdot \vec{v}_2$$

Division by the mass m and quadrature of the second equations yields

$$V^2 = v_1^2 + v_2^2$$

$$V^2 = v_1^2 + 2\vec{v}_1 \cdot \vec{v}_2 + v_2^2$$

Subtraction of the two lines leads to the final result

$$\vec{v}_1 \cdot \vec{v}_2 = 0 .$$

That means that the angle between the two velocities after the collision has to and will always be 90 degrees.

This is not only a nice example for physics, it would also fit perfectly into the mathematics class after the introduction of the scalar product.

High jump

An important parameter in jumping wide or high is the force of the legs. This force can be measured and calculated by a simple school experiment, at least approximately (Figure 5). The student stands towards a wall, hands upright, and makes a mark with the tips of the fingers. Then he bends the knee, makes again a mark and jumps as high as possible to put another mark. This is easier said than done, in particular the first part. How deep should one bend the knees? If it is not deep enough or too deep, the jump will not be maximal. Therefore the students first have to find out their optimal bending position.

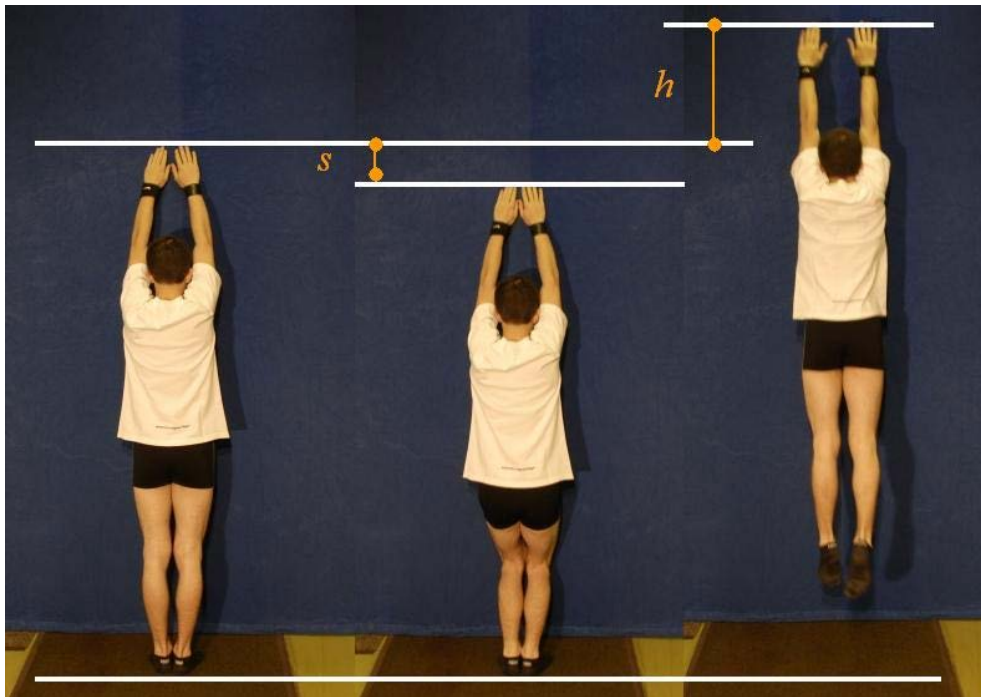

Figure 5. Determining the force of the legs (from [39], p. 57)

The force of the legs F_L is applied along the path s , the distance between the lowest point and the take off, leading to an energy

$$E = F_L \cdot s .$$

This energy is transferred to potential energy by lifting the body from the lowest to the highest position, i.e. along the distance $s + h$

$$E = m \cdot g \cdot (s + h) .$$

Equating these equations yields an expression for the force of the legs F_L .

$$F_L = m \cdot g \cdot \frac{s+h}{s} .$$

The next example will be somewhat unrealistic, namely jumping on the Moon [40]. How high would one jump on the Moon? I will use this question as an example for applying different models.

The first model is based on the assumption that the jump-off velocity is the same on Earth and on Moon. With a given jump-off velocity v , conservation of energy

$$\frac{1}{2} m \cdot v^2 = m \cdot g \cdot h$$

results in a jumping height of

$$h = \frac{v^2}{2g} .$$

Since the gravitational force is only one sixth compared to that on Earth, it gives the result

$$h^{Moon} = 6 \cdot h^{Earth} ,$$

i.e., one jumps six times higher on the Moon as compared to Earth. This calculation and result can be found in many text books.

But one could also imply the assumption that the force of the legs is the same on Earth and on Moon. The accelerating force F is the difference of the force of the legs F_L and the gravitational force F_G

$$F = m \cdot a = F_L - F_G .$$

How strong is the force of the legs? A reasonable assumption is two times the own weight, since one can carry another person on the shoulders. By this, the accelerating forces on Earth and on Moon are

$$F^{Earth} = m \cdot g \quad F^{Moon} = \frac{11}{6} \cdot m \cdot g$$

This leads to the fact that the jump-off velocities are not the same on Moon and on Earth

$$v_{Ab}^{Moon} = \sqrt{\frac{11}{6}} \cdot v_{Ab}^{Earth} ,$$

but differ by approximately 50%. Inserting this in the equation for the jumping height from above gives the result

$$h^{Moon} = 11 \cdot h^{Earth}$$

One jumps eleven times higher on the Moon than on Earth! This is almost twice as much as with the first model. So, which assumption or calculation is correct?

To answer this question we will look at a biomechanical model for jumping [40]. The main ingredient is how a muscle works. Contrary to a common belief a muscle does not function like a spring and would therefore obey a law similar to Hooke's law. Quite differently, the force of a muscle F_M is inversely proportional to its speed v

$$F_M = \frac{c}{v+b} - a$$

where a, b, c are parameters that can vary from person to person. Trying to shift a fixed hindrance exerts more force in the muscle as when the hindrance is moving. Applying this so-called Hill equation, a refined calculation yields the following result [40]

$$h^{Moon} = 10.5 \cdot h^{Earth} .$$

The jumping height on Moon is about 10.5 time as great as on Earth. So, our second model was by far more realistic than the first one.

But men were already on Moon and jumped. Looking at videos, one can recognize only a mingy, a very meager jump. Why didn't John Young go up like hell? First of all, he had some extra weight in his backpack. Secondly, he was afraid of falling. But the main reason was that he was stuck in his space-suit and could barely move.

Bouncing ball

In many ball games, the contact of the ball with some surrounding, racket, floor, wall, basket, concrete layer, is essential. One parameter to characterize such a contact is the so-called coefficient of restitution e . It is defined as the ratio of the velocity after the bounce v_2 relative to the speed before the contact v_1 :

$$e = \frac{v_2}{v_1}$$

Since the velocity, in the ideal case of only gravitational forces, is connected in a straight-forward way with the height, which the ball descends (h_1) and ascends (h_2), the coefficient of restitution can also be expressed in terms of distances

$$e = \sqrt{\frac{h_2}{h_1}} .$$

It is a motivating and for many students also demanding task to determine the coefficient of restitution for several sport balls to a certain accuracy. Since several possibilities can be found to measure the speeds and distances, different groups of students can challenge each other with the quality of their result. A golf ball should not be missing in the assortment of balls, since it is always a surprise for the students how reflective this ball is on a hard surface.

One suggestion by students very often is to use sensors and computers for the determination of the parameters of the movement of the ball. Such an analysis cannot only be used for the measurement of distances and speeds, it can also be extended to a discussion about energies [41]. Figs. 6 – 9 show such a series of investigations.

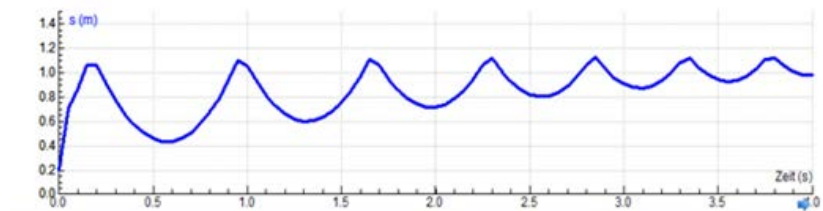

Figure 6. Ball bouncing several times on the floor

The ball is mounted at a certain height and the ball is first located a small distance below the sensor and then falls down to the floor and bounces. The data provide for a diagram

like in Figure 6. This figure is often unfamiliar to the students, since it differs from the usual one in text books, where the floor is taken as center of reference. Therefore they have first to change the frame of reference (Figure 7, red curve).

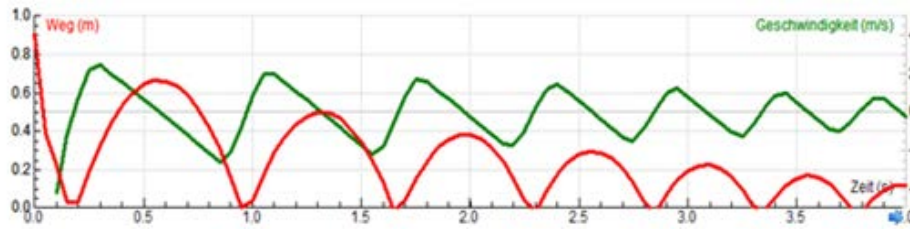

Figure 7. Distance of a bouncing ball relative to the floor (red curve) and corresponding velocity (green curve)

It is a real challenge to the students (sometime up to college) to determine the velocity out of the data on the distance (Figure 7, green curve). And sometimes one has to help with hints like „At which moments is the speed zero?“, „At which is it maximal?“, „What does a negative velocity mean?“.

The next logical step is to calculate the potential and kinetic energies of the ball (Figure 8). Again, the quadrature of the speed is not always a straightforward task for students.

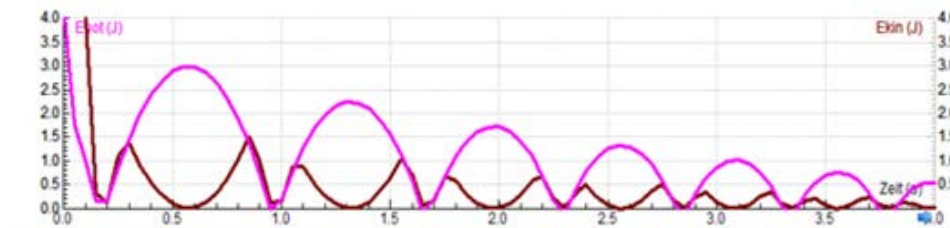

Figure 8. Potential (pink curve) and kinetic energy (brown curve) of the bouncing ball

Addition of both curves gives the total energy of the ball (Figure 9). It is clear that practically no energy is dissipated while the ball is in the air, but that the ball loses almost all of its energy during contact with the floor.



Figure 9. Total energy of the bouncing ball

The figures were produced by a software connected to data analysis (in this case Coach [5]). But I would advise that the students should start and try to make their own figures by hand. Of course it will not be perfect, but it needs an understanding of the kinematic connections that are not always clear to the students.

Tennis

In this part I will concentrate on the interaction of a tennis ball with the racket [42].

First the elasticity of the frame of a racket was measured. The racket was clamped on the handle and different weights were attached on the frame. Fig. 10 shows the deviation of the frame relative to the weight. The relation is nearly a straight line, therefore Hooke's law can be applied and the oscillation time T can be calculated

$$T = 2\pi\sqrt{\frac{m}{k}}$$

The constant k can be taken from the slope of the line in Figure 10 ($k = 10$ kN/m). But which value should one insert for the mass? This is not an easy question since the racket was clamped on one side – we took half of the mass of the racket ($m = 0.16$ kg). This leads to an oscillation time of $T_{frame} = 25$ ms.

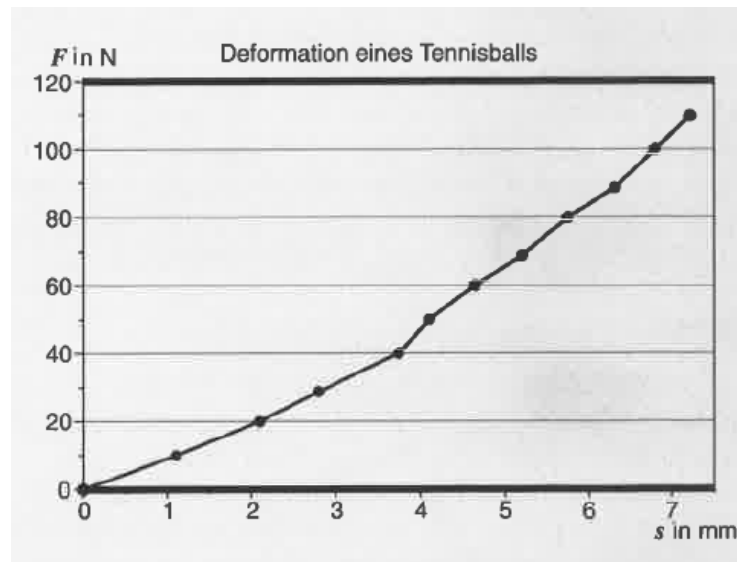

Figure 10. Deviation of the frame of a racket due to different masses attached (from [42])

But we did not feel safe with this measurement, therefore we applied a different method: Strain gauges were glued to the racket and the resulting voltages were measured. The outcome can be seen in Figure 11. The nice oscillation curve confirms that Hooke's law is valid and also the oscillation time of $T_{frame} = 30$ ms is not too far off the result from before.

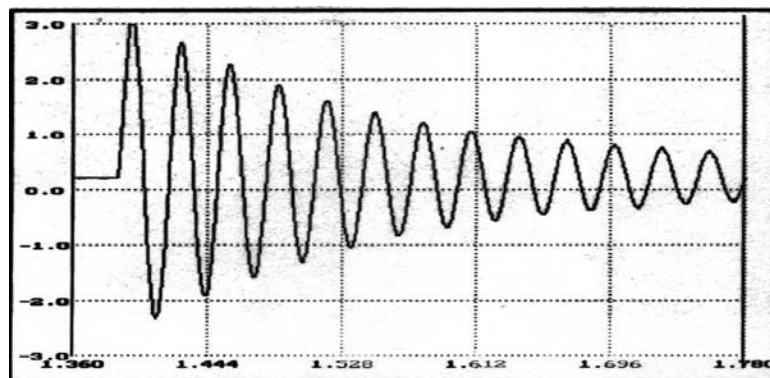

Figure 11. Oscillations of the frame of a racket (from [42])

Next we measured the oscillation of the ball. Again we put weight on it and measured the deflection. The data (Figure 12) do not show such a straight line as before, but in first approximation we take it as straight. In this case the mass of the ball is easy to determine ($m = 0.058$ kg) and with $k = 15$ kN/m an oscillation time of $T_{ball} = 12$ ms results.

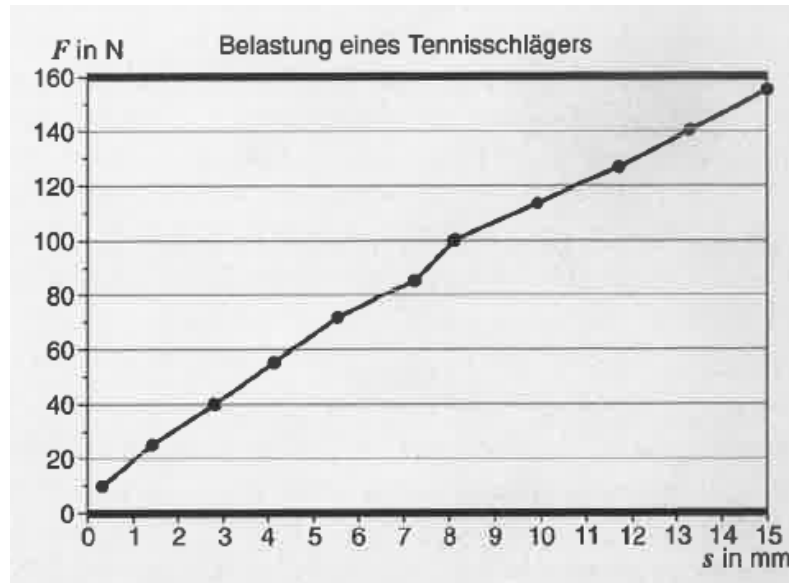

Figure 12. Depression of a ball due to different weights (from [42])

But this does not fit to the first value: The ball hits the racket, it bends back, then forward, but at that time the ball is already off the racket. The energy of the racket is not transferred to the ball, it is wasted energy. But how does the ball get its great speed? There is another oscillating element involved, the strings. This measurement is not easy since the amplitudes are very small, much smaller than the amplitude of the racket itself. We put a clamp on the racket frame and attached a Hall sensor. A small magnet with little weight was glued to the string. The outcome can be seen in Figure 13.

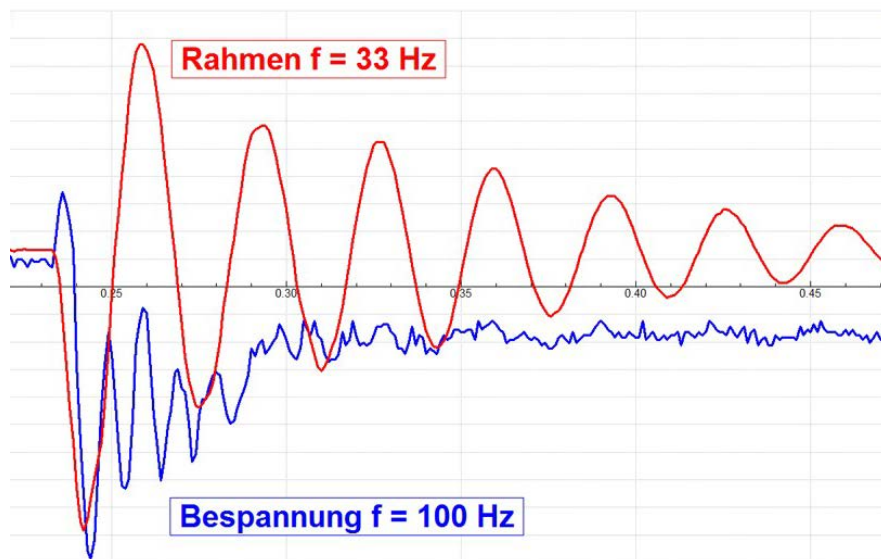

Figure 13. Oscillation of the frame (red curve) and of the strings (blue curve) (adapted from [39], p.88)

The oscillation time of the strings of $T_{string} = 10$ ms fits perfectly to the oscillation time of the ball. So, the ball gets most of its energy from the strings, some from the ball itself. The swing of the frame is wasted energy. Therefore the manufacturer tries to make the racket as stiff as possible. In former times several layers of wood were glued together in a refined manner for this purpose. But these rackets had to be small, larger ones would have been too heavy. With new materials, it was possible to make larger rackets, stiff and light.

Soccer

An English mathematician, Jack Dowie, has found some statistical correlations in scores of football teams [43]. And then he made an astonishing approach: He compared football to radioactive decay. If a large radioactive probe has a certain decay rate, let's say two decays in one minute, then, in the average, two nuclei will decay per minute. But one does not know how many will decay in the next minute, it could be none, one, two, three,.... But physicists know the probability that zero, one, two, three decays will happen very well – it is given by the Poisson distribution

$$P_m(a) = \frac{a^m}{m!} e^{-a} .$$

$P_m(a)$ is the probability that m decays will occur with a being the average decays.

The analogy with soccer goes as follows: A soccer team has a certain strength a , for example measured by the average number of goals per match it has scored in the past months. One does not know the score for the next game m , but taking the model of Dowie, one can calculate the probability of the number of goals according to the Poisson distribution. Given a strength of two goals, then the percentage for zero goal is 13.5%, for one and two goals it is 27%, for three goals 18% and so on. And one can determine probabilities for results of matches. If both teams have the same strength of 2 goals per match, the probability for 0:0 is 1.8%, it is 7.3% for 1:1, 2:1 and so on. With this model Dowie calculated past results of the English Premier Division, with good agreement. We repeated the calculation with the example of the German Bundesliga [44], and the result was similarly good, as can be seen in Figure 14. Students can repeat this calculation with their favorite team and can “predict” the result of the next game. This should also create some feeling of statistical results, which is difficult anyway for young and also older people.

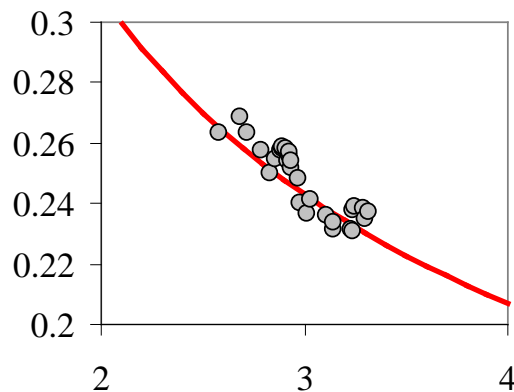

Figure 14. Results of the German Bundesliga (circles) compared to the statistical model (line). (From [44] modified)

Students are not always impressed and convinced by the arguments above. Out of experience, the following points count more: One can bet on the results of soccer games (in many countries called Toto). But this resembles very much a typical gamble of luck (Lotto). And it has to be – otherwise experts of soccer would make a fortune by betting. In soccer, a third-class team can win against a first-class team. This does not happen very often in other kinds of sports, and it was calculated that the portion of chance in football is the highest of all kinds of sports-games [45].

The reason for this strange behavior is simple – it is the low number of goals. Let’s assume that team A is twice as strong as team B (such a big difference is very unlikely in a certain league). In this case, the chance for the next goal is $2/3$ for team A and $1/3$ for team B. Will there be just one goal in the game, which often happens, the chance for team B to win is 33%, which is not small.

Records

Very fascinating for athletes, as well as the observing audience, are records, notably world records [46]. World records will always be broken, even if material, training, ability of athletes would not change [47]. Athletes, as all other living creatures, obey a statistical distribution with respect to different features. Figure 15 shows the example of the strength of a muscle; the sample consists of sports students, therefore the distribution is not symmetric. Therefore one does only have to wait long, and one athlete will come up whose features are more on the edge of the distribution – and he/she will break the record. In addition, material and training improve, and therefore new records are even more likely to occur.

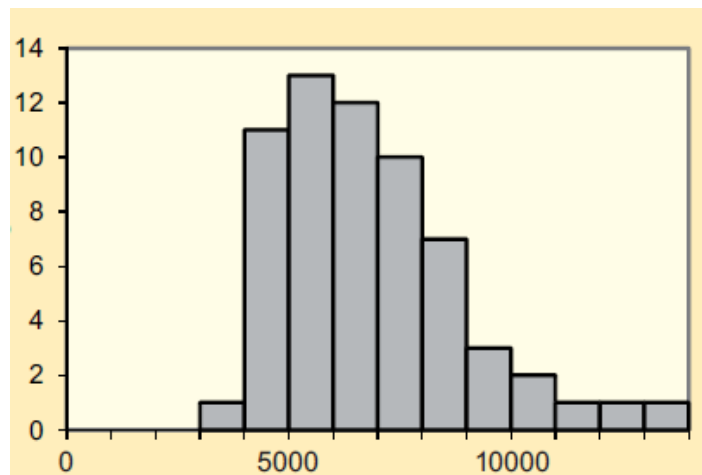

Figure 15. Statistical distribution of the strength of the knee muscle of sports students (from [48])

Many scientists tried to predict how soon a record would be broken, or what will be the ultimate limit a man or woman can achieve. Figure 16 shows the development of the world record in the 100 m dash. The blue squares represent the data till 2008, approximated by an unrealistic linear prediction (green line), and a more realistic prediction based on a logistic function (red curve). This curve levels off and leads to an ultimate record value of 9.5 s, indicated by the thinner dashed line. But world records are rare events and therefore a different kind of statistics (like for earth quakes) has to be used [49]. These models also give an ultimate limit, which is 9.28 s (thick dashed line).

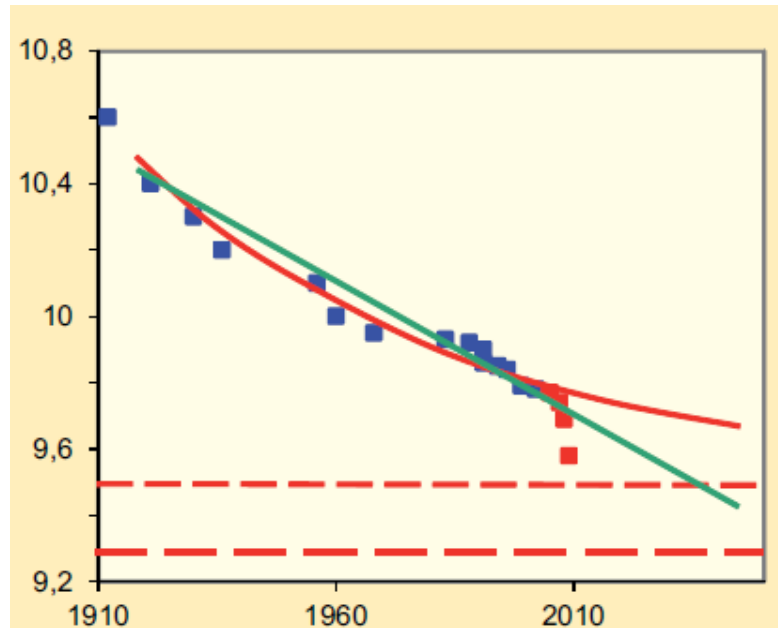

Figure 16. World record of 100 m dash (men) (from [48]). Description in the text.

Adding the last records, mainly by Usain Bolt [50], gives a strange picture, not seen in any prediction. But it was not only Usain Bolt, several other athletes showed similar improvement of their performance. In the meantime some of them were caught taking not-allowed drugs.

Shot put

In shot-put we have the rare occasion that two techniques are applied at the same time. Some athletes use the O'Brien or glide technique (Figure 17), some the spin technique (Figure 18).

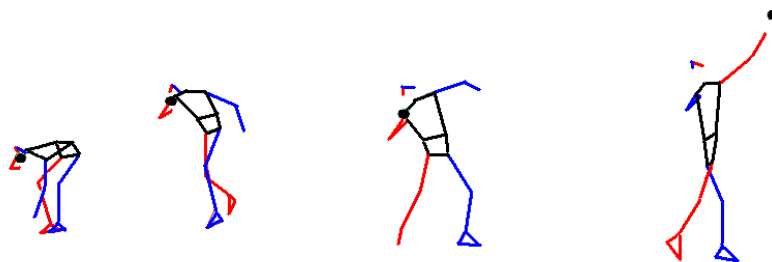

Figure 17. O'Brien or glide technique (from [39], p.74)

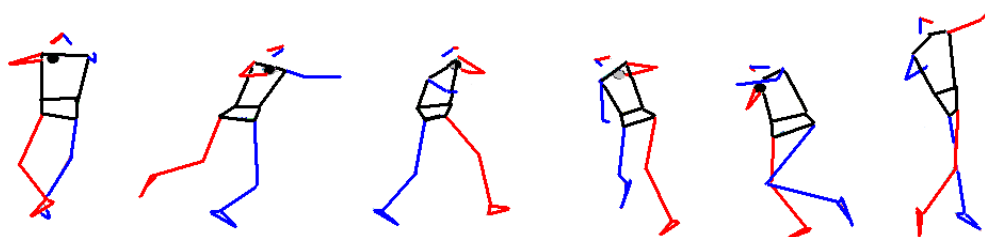

Figure 18. Spin technique (from [39], p.74)

But now a new technique came up, here exemplified by the Viennese athlete V. Watzek: a cartwheel technique (Figure 19). Watzek obeys all rules that are not much: She has to stay within the circle, and the ball has to be on the body before the shot. She said that she had better results after a short time of training. Nevertheless, we will not see this technique, because it became forbidden. Official reason: it is not safe enough. V. Watzek claimed that this technique is safer since the movement goes always along the same line in the forward direction. The real reason is that the establishment struck back. Can you imagine that one of the male or female athletes who are the best in shot put could change to this technique?

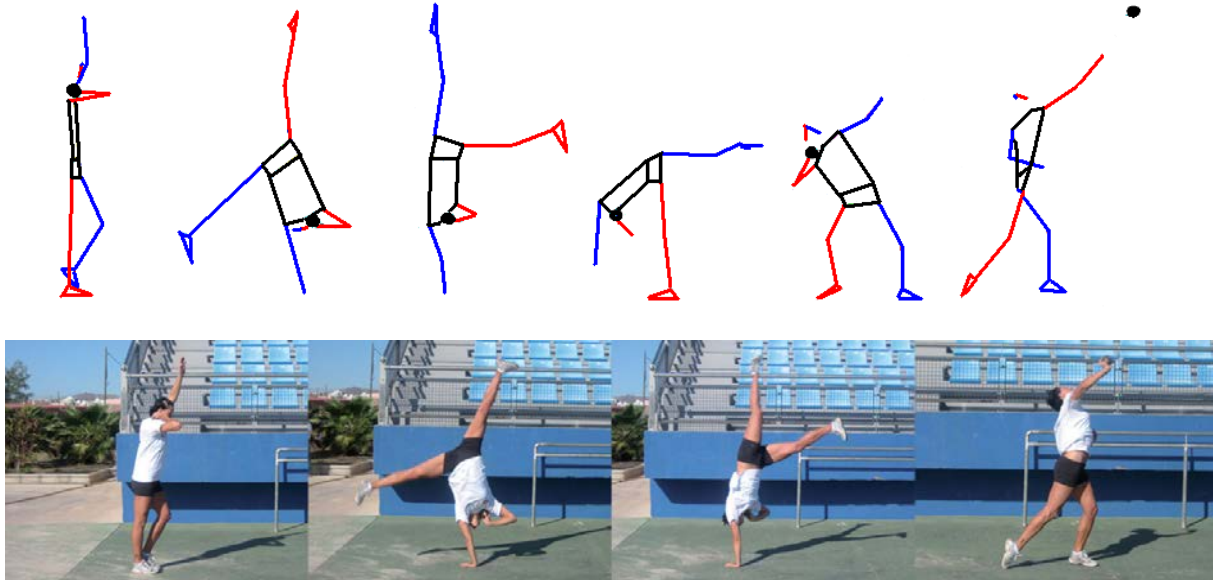

Figure 19. Cartwheel technique (from [39], p. 74, 75)

Conclusions

I hope I could demonstrate with some examples that the combination of sports and physics has a broad range of applications in school physics. With regard to the physics topic it concerns mainly applied mechanics. With regard to pedagogy many aspects can be addressed, experiments, video analysis, project work, interdisciplinary teaching, modeling. An implementation of examples as above has proven to interest also some of those students who were usually not fond of physics. Of course, this topic is not the magic bullet with which physics teaching will escape from the low ranking among the school subjects, but it could help to improve its image from being too abstract and difficult.

Acknowledgement

Most of the examples have been developed in close cooperation with Sigrid Thaller, Theodor Duenbostl and Theresia Oudin. I want to thank also Heimo Latal and Gerhard Rath for support in the preparation of this manuscript.

References

- [1] Heck A., Uylings P.: In a Hurry to Work with High-Speed Video at School. *The Physics Teacher* 48 (2010), p. 176-181.
- [2] Viana: [cit. 1. 2. 1014]. Available from: <http://viana.codeplex.com/>

- [3] Tracker: [cit. 1. 2. 1014]. Available from <http://www.opensourcephysics.org/webdocs/Tools.cfm?t=Tracker>
- [4] Logger Pro: [cit. 1. 2. 1014]. Available from <http://www.vernier.com>
- [5] Coach: [cit. 1. 2. 1014]. Available from <http://cma-science.nl/software/coach6/>
- [6] Measure Dynamics: [cit. 1. 2. 1014]. Available from <http://www.phywe.de/141n110/>
- [7] Guttersrud O.: Mathematical Modelling in Upper Secondary Education. PhD thesis, Univ. Oslo (2008). ISSN 1501-7710.
- [8] van den Berg E., Ellermeijer A. L., Slooten O. (Eds.): Modelling in Physics and Physics Education. AMSTEL Inst. Univ. Amsterdam (2008). ISBN 978-90-5776-177-5.
- [9] van Buuren O., Uylings P., Ellermeijer T.: Towards a learning path for computer modelling. In Raine D., Hurkett Ch., Rogers L. (Eds.): Physics Community and Cooperation. Univ. Leicester (2010). ISBN 978-1- 4461-6219-4
- [10] Lex E., Gunacker E.: Der Physik- und Chemieunterricht aus der Sicht des Schülers. Plus lucis 1/98 (1998), p. 7-12.
- [11] Häußler P., Hoffmann L., Langeheine R., Rost J., Sievers K.: A typology of students' interest in physics and the distribution of gender and age within each type. Int. J. Sci. Educ. 20(2) (1996), p. 223-238.
- [12] Häußler P., Hoffmann L., Langeheine R., Rost J., Sievers K.: Qualitative Unterschiede im Interesse an Physik und Konsequenzen für den Physikunterricht. ZfDN 2(3) (1996), p. 57-69.
- [13] Trumper R.: Factors Affecting Junior High School Students' Interest in Physics. Journal of Science Education and Technology 15(1) (2006), p. 47-58.
- [14] Häußler P., Hoffmann L.: An intervention study to enhance girl's interest, self-concept, and achievements in physics classes. Journal of Research in Science Teaching 39 (2000), p. 870-888.
- [15] American Journal of Physics. [cit. 1. 2. 1014]. Available from <http://ajp.dickinson.edu/>
- [16] European Journal of Physics. [cit. 1. 2. 1014]. Available from <http://iopscience.iop.org/>
- [17] Frohlich C.: Resource Letter PS-2: Physics of Sports. Am J. Phys. 79(6) (2011), p. 565-574.
- [18] Physics World, July 2012. [cit. 1. 2. 1014]. Available from <http://physicsworld.com/>
- [19] Adair R. K.: The Physics of Baseball. New York: Harper Perennial (2002), ISBN 978-0060084363; Cross R.: Physics of Baseball and Softball. New York: Springer (2011), ISBN 978-1-4419-8113-4.
- [20] Fontanella J. J.: The Physics of Basketball. Baltimore: Johns Hopkins Univ. Press (2006), ISBN 978-0801885136.
- [21] Laws K.: Physics and the Art of Dance. New York: Oxford Univ. Press (2002), ISBN 978-0195341010.
- [22] Jorgensen P. T.: The Physics of Golf. New York: Springer (1999), ISBN 978-0387986913.

- [23] Haché A.: Physics of Hockey. Baltimore: Johns Hopkins Univ. Press (2002), ISBN 978-0801870712.
- [24] Kimball J.: The Physics of Sailing. Boca Raton: CRC Press (2010), ISBN 978-1420073768.
- [25] Lind D., Sanders S. P.: The Physics of Skiing: Skiing at the Triple Point. New York: Springer (1996), ISBN 978-1441918345.
- [26] Wesson J.: The Science of Soccer. Oxon: Taylor & Francis (2002), ISBN 978-0750308137.
- [27] Wilson D. G.: Bicycling Science. Cambridge: MIT Univ. Press (2004), ISBN 0-262-73154-1.
- [28] Denny M.: Gliding for Gold. The Physics of Winter Sports. Baltimore: The Johns Hopkins Univ. Press (2011), ISBN 978-1-4214-0215-4.
- [29] de Mestre N.: The Mathematics of Projectiles in Sport. Cambridge: Cambridge Univ. Press (1990), ISBN 0-521-39857-6.
- [30] Kaye B. H.: Golf Balls, Boomerangs and Asteroids. Weinheim: VCH (1996), ISBN 3-527-29323-X.
- [31] Armenti A. (Ed.): The Physics of Sports. New York: American Inst. of Physics (1992), ISBN 9780883189467.
- [32] Spathopoulos V.: An Introduction to the Physics of Sports. CreateSpace Independent Pub. (2013), ISBN 9781483930077.
- [33] Griffing D. F.: The Dynamics of Sports: Why That's the Way the Ball Bounces. Dubuque: Kendall Hunt Pub. Comp. (2000), ISBN 978-0787271299.
- [34] Goff J. E.: Gold Medal Physics: The Science of Sports. Baltimore: Johns Hopkins Univ. Press (2010), ISBN: 978-0-8018-9322-9.
- [35] The Physics Teacher. [cit. 1. 2. 1014]. Available from <http://scitation.aip.org/content/aapt/journal/tpt>
- [36] Physics Education [cit. 1. 2. 1014]. Available from <http://iopscience.iop.org/0031-9120/>
- [37] Wiese J.: Sports Science. New York: John Wiley (2002), ISBN: 0-471-44258-5.
- [38] ELPSS: [cit. 1. 2. 1014]. Available from <http://www.open.ac.uk/opencetl/physics-innovations-centre-excellence-teaching-and-learning/activities-projects/e-learning-physical-science-through-sport-elpss>; Lambourne R: Contribution to this conference.
- [39] Mathelitsch L., Thaller S.: Sport und Physik. Köln: Aulis Verlag (2008), ISBN 978-3-7614-2765-1.
- [40] Thaller S.: Hochsprung auf dem Mond. Physik in unserer Zeit 34(9) (2003), p. 87-89.
- [41] Turner W. A., Ellis G. W.: The Energetics of a Bouncing Ball. The Physics Teacher 37 (1999), p. 496.
- [42] Duenbostl T., Mathelitsch L., Oudin T.: Experimente mit dem Tennisschlaeger. Praxis der Naturwissenschaften-Physik 45(2) (1996), p. 2-9.
- [43] Dowie J.: Football's failing – the deadly draw. New Scientist 91 (1981), p. 515.

- [44] Mathelitsch L., Thaller S.: Fußball mit wissenschaftlichem Maß. *Physik in unserer Zeit* 37(3) (2006), p. 122-125.
- [45] Ben-Naim E., Vazquez F., Redner S.: What is the most competitive sport? *J. of the Korean Phys. Soc.* 50 (2007), p. 124-126; [cit. 1. 2. 1014]. Available from <http://arxiv.org/abs/physics/0512143>
- [46] Gembris D., Taylor, J. G., Suter D.: Trends and random fluctuations in athletics. *Nature* 417 (2002), p. 506.
- [47] Haake S.: Material advantage. *Physics World*, July 2012, p. 26.
- [48] Mathelitsch L., Thaller S.: Olympische Rekorde. *Physik in unserer Zeit* 43(4) (2012), p. 186-189.
- [49] Einmahl J. H. J., Magnus R.: Records in athletics through extreme-value theory. *J. Am. Statist. Ass.* 103 (2008), p. 1382.
- [50] Hernandez Gomez J. J., Marquina V., Gomez R. W.: On the performance of Usain Bolt in the 100 m sprint. *Eur. J. Phys.* 34 (2013), p. 1227-1233.

Active learning in the Heureka Project – teachers in the role of students

Irena Dvořáková

Faculty of Mathematics and Physics, Charles University, Prague, and Junior Secondary School Cerveny vrch, Prague, Czech Republic

Abstract

Our long-term Heureka project is based on the principle of active work in learning and teaching – both at school with students and in teacher training. Teachers in our seminars work the same way as students at schools – solving the same problems, doing the same experiments and sometimes even making the same mistakes. Our seminars provide long-term systematic training – the cycle of seminars for new participants takes ten weekends during the course of two years. That gives all participants the possibility and especially the time to change their approach to teaching physics.

The character of our seminars is rather informal: the seminars are free of charge and teachers join Heureka on a voluntary basis, gaining no formal advantages or benefits at their schools. The seminars take place during weekends, with teachers staying (and sleeping) in classrooms. In the autumn of 2012, we started already the 6th seminar cycle. Over the years, we have built a network of about 150 active teachers who have the possibility to meet at various advanced seminars and at “The Heureka Workshops” annual conference. The conference regularly attracts more than 100 participants and includes international guests.

We are convinced that our experience could be interesting and inspiring for other people working in physics education in different countries.

Keywords: active learning, teachers training, The Heureka Project

1. Introduction

Do you know any teachers training –

- where participants are really active?
- which is organized during weekends and lasts two years?
- which is voluntary and free of charge?
- where participants are accommodated in school, sleeping in their sleeping bags in the classrooms?
- in spite of these non luxury conditions teachers come again and are keen in participating this project?

Do you know such teachers training? If yes, you maybe know (part of) The Heureka Project.

The following text concerns this project, its principles and methods. Several concrete examples of methodological sequences, many tasks and comments from my school work are presented. You can find here a detailed description of three lessons (concerning measurement of time), one labwork (weighing using a piece of a paper) and two tests. This text gives also the results of a research, where the scientific reasoning of students that

attended the Heureka programme was evaluated. The second part of the article describes the teachers training programme that we organize since 2002.

1.1 A few personal words (that you can skip)

Before describing The Heureka Project I would like to say something about my work, because the whole project reflects my long time experience from my school work. I am a lecturer at the Department of Physics Education at the Faculty of Mathematics and Physics, Charles University in Prague. Our department focuses on the preparation of future physics teachers, but organizes also many activities for students from secondary schools and for physics teachers. We also do research in physics education, authors of several textbooks work in our department, etc.

I am also a teacher. I have a part time job at a lower secondary school in Prague. I teach physics to children of ages from 12 to 15 years. For me being a normal teacher is very important. I know how today's children look like, I know the problems in real schools. When speaking with my students at the faculty, I can describe to them some real situations at school, give them examples from my school work. Moreover, my school gives us a good base for the Heureka seminars.

1.2 Formation of The Heureka Project

In the 90s, a group of about 5 people started finding ways to teach physics more actively and interestingly. For me it was very interesting to find, when working on my PhD. thesis many years later, that this empirical approach has many similar characteristics to modern pedagogical approaches, like constructivism and IBSE.

At the beginning we focused only on work with children in my school. Gradually other teachers became interested in our method, wanted to join and teach using this method, so we started to organize weekend seminars for them and the main aim of the project changed to the teacher training.

2. The first main part of The Heureka Project – work with children

The two following examples provide a good illustration of our approach:

2.1 Example of the methodological sequence – Measurement of time

Children in the sixth class (about 13 years old) learn about measurement of the basic physical quantities (length, mass, temperature), and also time. We speak about different ancient clocks and then I tell children a story about Galileo and his investigation of pendulum. I ask children what properties the motion of pendulum could depend on. Children usually come up with many different properties:

- mass of the body
- shape of the body
- length of the string
- deflection at the beginning
- thickness of the string

Together we find that for an appropriate body, a thin string and small angles the motion of the pendulum depends only on its length. This investigation is a task for the next lesson.

For the next lesson I prepare a table for pupils' results. Children work in pairs. Their task is to measure the number of cycles per ten seconds for two different lengths of the pendulum. Each measurement is repeated twice. After measuring children fill in the table (Table 1).



Figure 1, 2. Measuring in the classroom

Table 1. Example of the results of measuring the number of cycles of the pendulum per ten seconds for different lengths (children's results, age about 13, April 2012)

Group	Length (cm)	Number of cycles per 10 s		Average
		1.	2.	
A	10	17	17	17
B	15	9	10	9.5
C	20	9	10	9.5
D	25	11	11	11
E	30	9	9	9
F	35	9	9	9
G	40	8	8	8
H	45	7.5	8	7.75
I	50	7.5	7.5	7.5
J	55	6	6	6
K	60	7	7	7
L	65	6	6	6
M	70	7	7	7
A	75	5.5	6	5.75
B	80	6	6	6
C	90	6	5.5	5.75
D	100	5.5	5.5	5.5
E	110	5	5	5
F	120	5	5	5
G	130	4	4	4
H	140	4.5	4.5	4.5
I	150	4	4	4
J	160	4	4	4
K	170	4	4	4
L	180	4	4	4
M	190	3.5	3.5	3.5

When all groups finish their task, children write the two important columns – length and average number of cycles – in their exercise books. I give them a piece of millimetre graph paper and tell them that they have to draw a dot graph as homework. For most of the children this is the first graph ever they do in the school, so they need some hints. I show children how to start with two axes, discuss with them the scale on both axes, and how to find the point that corresponds to particular coordinates. I also tell them to draw only dots, not a curve. Children draw a graph at home. It is a hard task for them, but usually almost all of them are able to do it. At the beginning of the next lesson I check their work very quickly. Children correct their graph, if it is possible.

On the following figures you can see the expected result of the homework and the common wrong result, when a pupil did not listen to my hints and comments well.

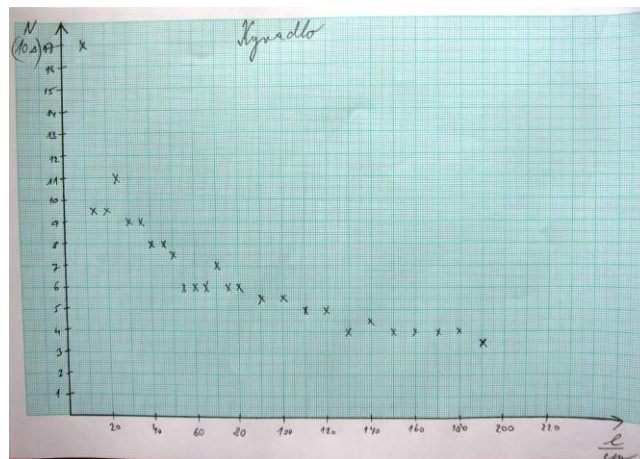

Figure 3. Number of cycles per 10 s versus length – Expected result



Figure 4. Example of a typical incorrect result

After checking the homework I tell children – take a pencil and draw a curve free hand, i.e. the curve, which roughly passes through the dots. Children are first very surprised, but in the end they draw something like this (see Figure 5).

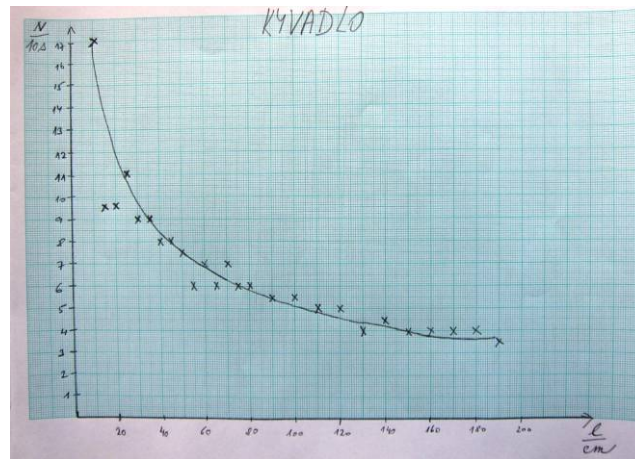

Figure 5. The curve showing how the number of cycles of the pendulum per ten seconds depends on the length (measured data)

Then I show children the precise graph with calculated values and we compare both graphs. I don't tell children "the formula"; I only tell them that the graph is made using a mathematical expression.

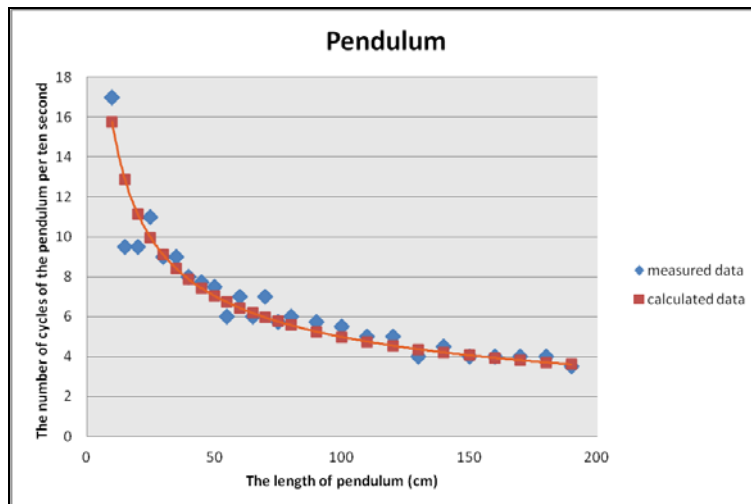

Figure 6. The graph shows both measured and calculated data

We discuss what the graph tells us. Children answer different questions like – You have a pendulum which is 32 cm long, could you find its number of cycles per 10 seconds? How long should a pendulum be which is ticking each second?

At the end of this lesson we speak about the function of a pendulum in mechanical clocks.

2.2 Comments on the methodological sequence Measurement of time

When speaking about this approach, the first question teachers give me usually is “Why do you measure the number of cycles per ten second, instead measuring its period? It would be certainly easier for children and more precise.” The answer is simple. Imagine how a period of pendulum depends on its length. In case we measure a period, the result will be a different curve (see Figure 7). In this case all children would use a ruler and draw a straight line. It would be hard to persuade them that this is not a straight line.

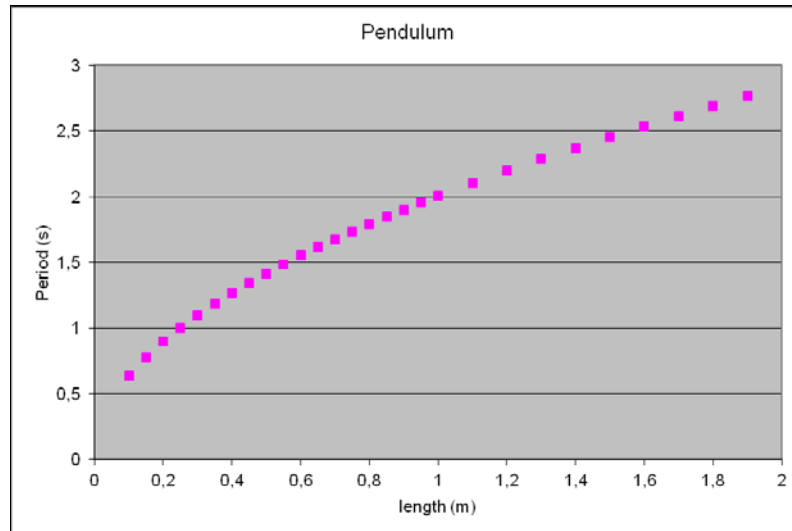

Figure 7. The period/length dependence graph

I must say I consider this sequence to be one of the most important topics in the 6th grade. In the first year of learning physics, children are able to work really like physicists – they formulate the hypothesis, verify it, collect real data, work with them, draw a non-linear graph, discuss this graph, read information from it, compare measured and calculated results, etc. Children will use all these skills (or competencies) during their entire physics studies. Moreover, I use another task concerning pendulum as a lab work in the ninth grade, so children can apply their findings in a different situation several years later. This is the reason I spent three lessons on such a seemingly trivial problem like the principle of a pendulum.

2.3 Example of a written test

My second example is a test:

Written test in the 7th grade – October 2012

1. *A child is on a merry-go-round (carousel). What should the child do and how should the merry-go-round behave to accomplish the following situations:*
 - a) *the child is at rest with respect to the merry-go-round and in motion with respect to the Earth,*
 - b) *the child is in motion with respect to the merry-go-round, at rest with respect to the Earth,*
 - c) *the child is in motion with respect to the merry-go-round and to the Earth too*
 - d) *the child is at rest with respect to the merry-go-round and with respect to the Earth too.*
2. *A motorboat has a speed of 20 metres per second and it takes it 40 min to travel the distance between two ports. How far are the ports? How long does this journey take for a slower boat, which goes at a speed of 10 km per hour?*
3. *The bus went 0.5 hours at a speed of 50 km per hour, then the next 20 km it went at 40 km per hour, then it stood still for half an hour. Then it covered the remaining 100 km at a speed of 50 km per hour. Calculate how many kilometres it covered in total and how long it took (including the rest). Calculate the average speed of this motion. Draw a graph showing the distance-time dependence.*

4. You can see a photo of a guidepost on which distances are given in hours, not in kilometres. Explain in which regions it is used and the reason for it.



5. Design some processes, the speed of which makes sense to measure in:
 a) cm per hour, b) litre per minute, c) kg per year, d) mm per year.

6. Write a story to the graph:

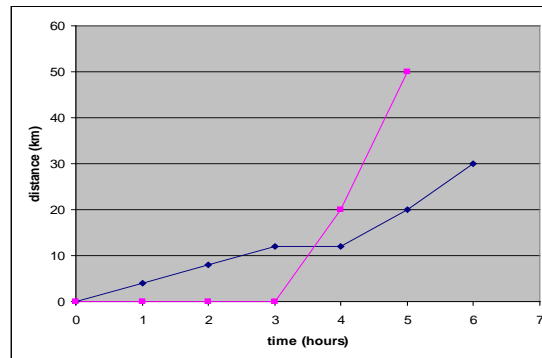

2.4 Comments on the test

As you can see the first three tasks are common tasks you can find in all collections of problems. The tasks number four and five require children to apply their knowledge in a new situation; they did not solve similar tasks before the test.

I would like to emphasize the last task. Children have to think about what bodies probably move (according to their velocity), how their movement looks like, and, moreover, to create a simple story. In my experience this type of tasks is interesting for children for example as a voluntary homework, too. Children like it very much and their stories are very pretty.

Grading this type of exam is not easy for teacher. It is necessary to understand students' ideas, which are sometimes a bit complicated. But my goal is to develop students' thinking, so my tests must require thinking, too.

One important comment: Sometimes teachers who do not teach according to Heureka want to use my tasks. I usually tell them "Be careful. It is not fair to give those tasks to your students in case you use a traditional teaching approach. You cannot require students' thinking in a test, if you do not require their thinking in lessons."

2.5 The basic principles of the Heureka approach

As I said before, the basic principles of The Heureka Project are in agreement with many modern trends in physics education worldwide, in spite of the fact that the authors arrived at these principles independently. The authors had no connection with pedagogical research at that time, because until the early 1990's it was very difficult in the Czech Republic to obtain foreign pedagogical literature.

The most important of these principles include:

- A high rate of student/teacher interaction.
- An inquiry-based approach to teaching.
- Nature is the final authority, not the words of the teacher.

- Mistakes are normal and an important part of the learning process.
- The starting point of teaching and learning is a question and observation.
- The specific physical terms are defined at the end, after observation of experiments and description all important properties.
- We start from things that children know from everyday life.
- Students are not merely passive “objects of education,” but are led to think about problems, formulate hypotheses and use experiments to verify them.

I hope at least some of these basic principles are visible in my previous examples.

2.6 Is there some real impact of the Heureka approach on the thinking abilities of students?

This is a question I was already interested in, but I had no ways how to measure it, until I learned about a Lawson’s test of scientific reasoning several years ago. This test is based on Piaget’s research; it is able to measure concrete- and formal-operation reasoning. It consists of 12 pairs of items. An item is scored correct only if the correct answer is checked **and** also an adequate explanation is given. The maximum number of points is 24. You can find the ideas of the test, its methods and results in articles [1] – [6], it is not the topic of this article. For me it was important that it is possible to use the test for determining the developmental levels of my students. I found that this is a method which allows me to measure students’ abilities.

I decided to test my students at the end of attendance at our school. You can see the results of my students since 2010 to 2013 in Table 2. The next idea was to compare the results of students who learned according to The Heureka Project with students who are not taught according to Heureka. I asked my colleagues who use the Heureka approach and several teachers who do not use this approach to test their students. The age of my students and other students in “the Heureka group” was 15-16 years, the age of students in the control group was 15-18 years. Table 3 shows the total results, Table 4 shows the distribution of students on developmental-reasoning levels described in Piaget’s research. The same results are also shown in graphs (see Figure 8 and Figure 9). Though this does not represent any larger formal pedagogical research yet, I think it may be interesting to see even the partial results.

Table 2. Results of the scientific reasoning test – Lower elementary school, Prague 6 (my classes)

Year	Number of students	Average number of points
2010	23	14.7
2011	21	12.5
2012	20	13.1
2013	29	14.8

Table 3. Complete results of the scientific reasoning test (all groups)

Group	Number of students	Average number of points	Average result (in %)
All my students	93	13.8	57.4%
All classes learned according to the Heureka Project	374	12.7	53.1%
Control group - students who did not learn according to the Heureka	521	8.9	37.1%

Table 4. Distribution of students on developmental-reasoning levels (Piaget)

Level		Heureka group		Control group	
		Number	in percents	Number	in percents
1	Concrete operational level (0-8 points):	87	23.3%	278	53.4%
2	Transitional level (9-16 pts):	196	52.4%	200	38.4%
3	Formal operational level (17-24 pts):	91	24.3%	43	8.3%

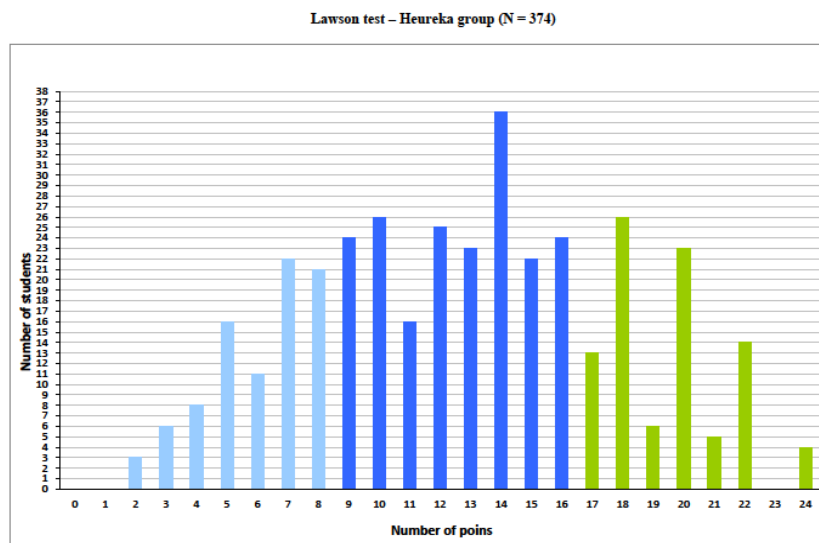

Figure 8. Results of the scientific reasoning test – The Heureka group

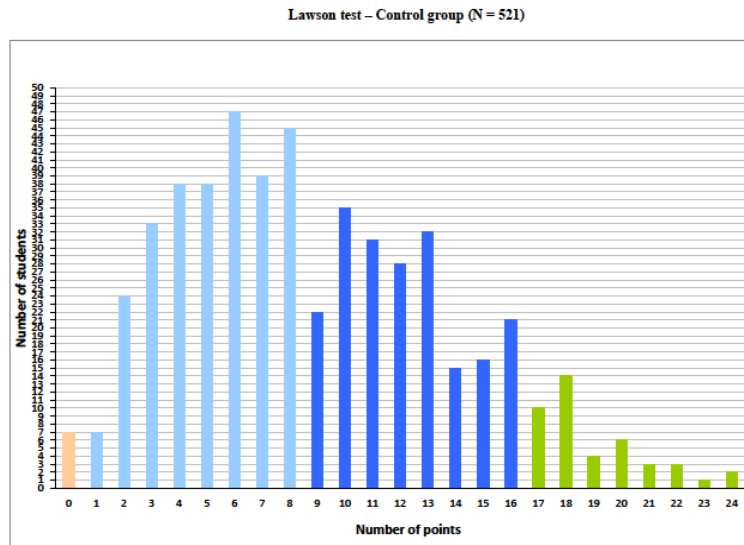

Figure 9. Results of the scientific reasoning test – The control group

The difference between means is highly statistically significant. Further pedagogical research in this area should be done to get general conclusions, but these results seem to clearly indicate that the Heureka approach has a positive impact on the thinking abilities of students.

3. The second main part of The Heureka Project – work with teachers and future teachers

The basic principles mentioned above we use not only in the work with students, but also in the work with teachers. Nowadays we consider teacher training to be the most important part of The Heureka Project.

We organize several types of seminars and prepare an annual conference. All seminars are completely voluntary; participants have no formal advantages or benefits at their schools. The only benefits are the teaching methods, plans of lectures, problems and tasks, etc., which they obtain during seminars. All are published on the internal web pages of the project. Examples of methodological materials were published also in journals and at web pages. All seminars are also free of charge. Our seminars take place in schools, so they are very informal. Participants sleep in their sleeping-bags in classrooms and they have to bring food with them (see Figure 10 and Figure 11). In spite of those conditions, we have more than 150 active participants, some of them even from Slovakia.



Figure 10. “The dining room”



Figure 11. “The sleeping room”

3.1 Seminars for new participants

These seminars are intended for teachers who want to learn Heureka's teaching methods. Seminars are organized during weekends not to interfere with teachers' school work. The whole course consists of 10 weekend seminars during a two year period. Participants work at these seminars very similarly to students at school. They do experiments, solve problems, sometimes write tests, do voluntary homework, etc. (see Figure 12–15). Seminars are focused on:

- new approaches to teaching
- basic physics knowledge and its application
- personal development of participants
- games and other activities suitable for work with children

Besides this they discuss teaching methods they have seen and talk about pedagogical problems in their schools, too.



Figure 12-15: Teachers work at seminars similarly to students

To know more about the participants' opinions, we ask them to write a structured feedback at the end of every seminar. But maybe the best feedback is the fact that teachers continue to come to seminars and spend ten weekends with us. Based on the teachers' own feedback, we can say that the professional competencies of teachers are increasing during the seminars.

Apart from the structured feedback described above, we also ask teachers what they appreciate about these seminars. Twenty three teachers from the fourth course for new participants in 2008/2010 were asked what the attendance of these seminars had brought to them. During the last seminar of the course they completed a small questionnaire with nine open questions. (i.e.: "What changes have you found in your teaching during the last two years?", "What have you learned in these seminars?", etc.). The essential part of their answers is summarized in Table 5.

Table 5. Benefits of the teachers' attendance in the Heureka seminars

Benefits of the attendance in seminars	Number of respondents
Inspiration, getting manuals for teaching	23
Meeting with the same type of people, new friends	19
I learned how to activate more students at school	16
I am more self-confident, I am not afraid to make mistakes	12
Improvement of knowledge of physics	9
It "gives me energy"	7

Teachers called this course "the teachers' kindergarten", because we really start our work from the first lesson in the sixth grade, where children start learning physics, too. It could be unusual to teach physics from scratch teachers who graduated in universities. But in our experience many participants of our seminars are able to calculate difficult tasks but have difficulties with understanding some basic concepts.

We check these basic ideas using several conceptual problems in the test at the beginning of the first seminar. I recommend you to try to solve the four problems and write your solution before you will read the text further. Maybe you will better understand why our participants start to learn physics from scratch.

Test for new participants (part of the test)

1. A car of mass 2500 kg goes up a hill (with a gradient 10%) for two minutes at speed 50 km/h. A figure shows its position after one minute. Draw the net force (i.e. a sum of all forces) acting on the car.

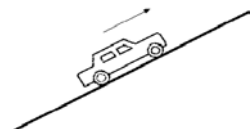

2. A figure shows a convex lens (a magnifying glass), positions of its focal points and a general ray approaching the lens. Draw the ray after it passes through the lens. (Find the precise solution, not any approximation).

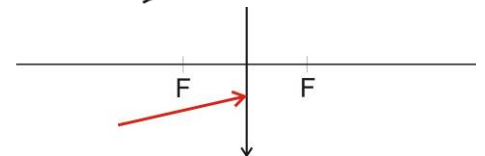

3. In a little pool, there is a small boat with an anchor inside the boat. We mark the level of water on the wall of the pool. How does this level change if we drop the anchor to the bottom of the pool?

Select the right variant and explain your reasoning:

- a) The level of water rises.
- b) The level stays the same.
- c) The level of water falls.

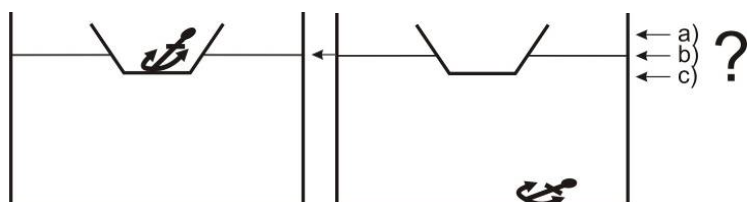

4. The first figure shows a pendulum hanging at rest. In the second figure, there is a moving pendulum shown just at the moment when it goes through the lowest point of its trajectory. Draw the net forces acting on the pendulum in both cases.

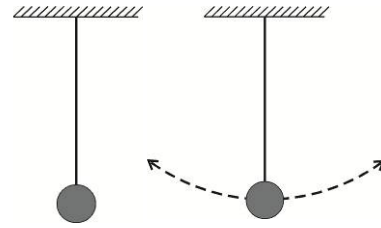

The solution of the test:

1. The car performs rectilinear motion with a constant velocity, so $F = 0$ (the 1st Newton law).
2. Choose a source of the ray, find the image of the source, the general ray goes to this image after passing through the lens (as all other rays passing through the lens).
3. The experiment shows the result. As you can see on photos, the final level of water is lower than the initial.

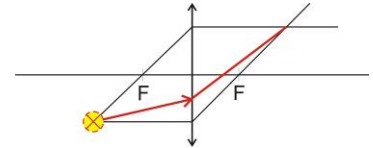

4. First situation – the pendulum is at rest, so the net force $F = 0$ (The 1st Newton law).
Second situation – the pendulum moves along the circle, the net force is centripetal.

We can therefore conclude – seminars for new participants allow teachers to:

- re-learn physics from the beginning
- get their own experience with active learning
- obtain experience with their own misconceptions
- achieve higher tolerance to students’ mistakes during a teaching-learning process
- understand the necessity of a safe atmosphere in the classroom

3.2 Other seminars – for students and for more experienced teachers

There are also seminars for students of our faculty (future teachers of mathematics and physics), who are interested in The Heureka Project. These seminars are organized very similarly to teachers’ seminars for new participants, only not during weekends, but as a standard voluntary seminar (consecutive seminars in 4 terms, two hours per week). Usually more than 80% students from each year attend this seminar.

We also organize seminars for experienced teacher who already finished “the teachers’ kindergarten”. Those seminars have usually one specific topic – e.g. Physics in Biology, History of Physics, Modern technology in the school, etc.

3.3 The Heureka Workshops

“The Heureka Workshops” is an annual conference prepared both for physics teachers and for students – future physics teachers, who attend any of seminars of The Heureka Project, and for guests, too. There were about 130 participants (some of them with their children) in 2013.

To allow teachers to attend the conference without problems in their schools, we organize it during the weekend (usually the first weekend in October).

The characteristic attribute of this conference is its form. The whole conference is organized as a set of workshops (19 workshops were prepared in 2013; two of them were led in English by guests from abroad). There are no invited speakers, no lectures, and no formal meetings. Each workshop takes 90 minutes and repeats typically four times. The workshops are prepared and led by teachers from schools or from a university. The active work of participants is an essential requirement for each workshop. There are no other limitations. The topic could be a set of experiments, building some simple instrument, measurement of some properties of materials, games useful for physics teaching, etc. We built also *Dancing bugs* or *Bridges from newspaper* [7]-[8] in the past. Every year we are surprised how many interesting ideas the teachers have.

As mentioned above, the conference is very informal. It takes place in the high school of a small town Nachod in East Bohemia, where one of the active teachers from The Heureka Project works. Participants sleep in classrooms in their sleeping bags, bring their own food, there is no welcome drink or conference dinner. Maybe this informal character supports the friendly atmosphere of this meeting. Teachers can talk to each other while eating or before sleeping, there are no formal barriers there.

We are pleased that guests from abroad come to Nachod every year in spite of the fact that the conference is conducted in the Czech language and living conditions are far from luxurious. According to our experience, there was never any problem with mutual understanding – either the head of the workshop is able to speak both Czech and English or somebody translates for a foreigner. Some of our guests described their experience and impressions from the conference in reports published in international journals (see Swinbank [9], Planinsic [10], and Milbrandt [11]). We would like to invite readers who are interested to participate in next years’ conferences which will be organized at the beginning of October each year.

4. Bonus – weighing using a piece of paper

Finally I would like to present an excellent idea of Zdenek Polak, the local organizer of the conference The Heureka Workshops.

This is an example of the simplest scales, which are nevertheless able to weight with a considerable precision. This is a very nice application of the lever, that’s why I usually use measuring with these scales as a labwork afterwards we learn about simple machines (a lever, a pulley, etc.). Children measure the mass of all Czech coins; they work individually, not in pairs. They fill in their results to the table on the blackboard (similarly as in the example concerning the pendulum mentioned above) and finally compare them with the official bank values.

You can determine the mass of a coin, a ring, etc. using only:

- a piece of paper
- a pin
- a ruler (for measuring the length)

How to get a weight?

On the package of printing paper it says that the square density of paper is 80g/m^2 . It means, that 1 m^2 of paper (format A0) has a mass of 80 g. One page of paper (format A4) is $1/16\text{ m}^2$, so its mass is 5 g.

How to get scales?

You can fold your piece of paper several times (see Figure 16) to make scales.

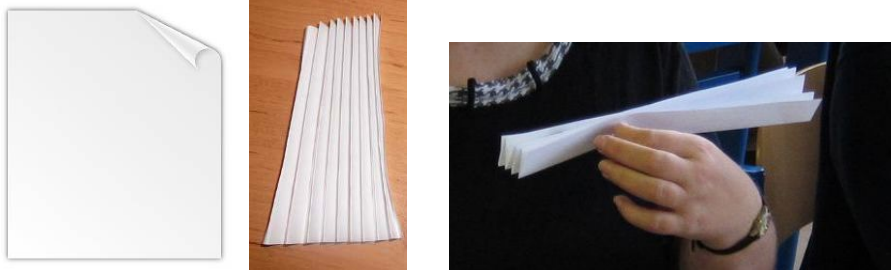

Figure 16. Making scales

How to measure?

Find the centre of mass of the paper (point T). Choose the point for an axis of rotation (A, so A is off-centre), the distance $a = |TA|$ should be about 4-5 cm. Use a pin as an axis of rotation. Now you have a scales, where on one side (in the point T) is a mass of 5 g (mass of the paper), on the other side you will put a measured body. Put a coin (a ring,..) on scales, find its right place for equilibrium (see Figure 17). Measure the distance (b) between the centre of measured body and the axis.

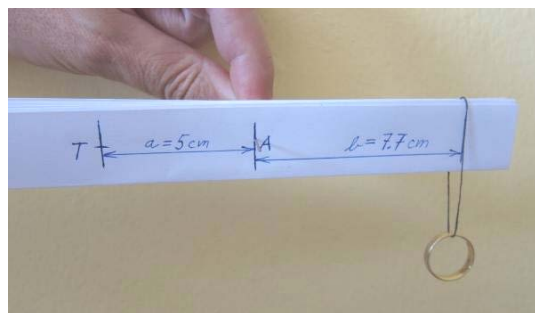

Figure 17. Equilibrium on scales

How to calculate?

Calculate the equation of a lever:

$$F_1 \cdot a = F_2 \cdot b$$

For my ring this worked out as follows:

mass of the paper = 5 g

mass of the ring = x

$a = 5\text{ cm}$

$b = 7.7\text{ cm}$

$$5\text{g} \cdot 5\text{ cm} = x \cdot 7.7\text{ cm}$$

$$x = 25/7.7\text{ g} = 3.2\text{ g}$$

Using precision digital scales I found that the mass of my ring is 3.295 g.

As you can see, this simple instrument is able to weight surprisingly precisely.

5. Conclusion

I described the history and the current state of The Heureka Project. Thanks to the recently acquired support of the Depositum Bonum Foundation, Heureka now has the opportunity to start a new stage of its development. The Foundation is seeking to improve science education in Czech elementary schools. One useful way of promoting this goal is to support physics teachers. With the new school year (2013/2014) the Foundation and Heureka opened fifteen regional centres for physics teachers. The centres are led by teachers who have their own experience with Heureka and who are able to organize monthly meetings for other physics teachers in their regions. The main goal of the meetings is to support the professional development of teachers by giving them an opportunity to share their experience, learn about some new experiments and teaching approaches and borrow modern teaching tools. Built jointly by the Depositum Bonum Foundation and Heureka, the centres are firmly rooted in Heureka's principles which I have outlined above and which have brought tangible improvements into Czech classrooms.

After two decades of existence and growth, The Heureka Project is starting a new stage in its long-term evolution.

References

- [1] Lawson A. E.: The development and validation of a classroom test of formal reasoning. *JOURNAL OF RESEARCH IN SCIENCE TEACHING*, 1978. 15(1), 11-24.
- [2] Lawson A. E., Karplus R., Adi H.: The development of propositional logic and formal operational schemata during adolescence. *JOURNAL OF RESEARCH IN SCIENCE TEACHING*, 1978. 15(6), 465-478.
- [3] Lawson A. E., Bealer J. M.: Cultural diversity and differences in formal reasoning ability. *JOURNAL OF RESEARCH IN SCIENCE TEACHING*, 1984. 21(7), 735-743.
- [4] Lawson A. E.: A review of research on formal reasoning and science teaching. *JOURNAL OF RESEARCH IN SCIENCE TEACHING*, 1985. 22(7), 569-618.
- [5] Renner J. W., Lawson A. E.: Promoting Intellectual Development through Science Teaching. *PHYSICS TEACHER*. 12. May 1973, s. 273-276.
- [6] Dewey I. Dykstra Jr.: Physics Teaching and the Development of Reasoning, sciED, 2011, Volume 2, Issue 2. (online). Available from: <http://www.scied.cz/Default.aspx?ClanekID=345&PorZobr=1&PolozkaID=132>
- [7] Lipertova K.: Dancing bugs, (online). Available from <http://www.youtube.com/watch?v=rf-QP0gfKiE> and <http://www.youtube.com/watch?v=AhTIQegQeSE>
- [8] Piskac V.: Bridges from newspaper, (online). Available from <http://www.youtube.com/watch?v=27cbeFSi7-M> and <http://www.youtube.com/watch?v=rVCSObipAOM>
- [9] Svinbank E.: Reporting from a mattress in Nachod..., *PHYS. EDUC.* 40. 2005, p. 5.
- [10] Planinsic G.: Teachers share experiment know-how, *PHYS. EDUC.* 41. 2006, p. 7-8.
- [11] Milbrandt R.: Innovative Physics Teaching Conferences in the Czech Republic, *THE PHYSICS TEACHER*. Vol. 48 (Sept. 2010), p. 395-396.

Physware: A collaborative initiative for strengthening physics education and promoting active learning in the developing world

Pratibha Jolly

Miranda House, University of Delhi, Delhi 110 007, India

Abstract

Project Physware emanates from globally shared concerns on the lack of high-quality education in physics with detrimental consequences on scientific research and socio-economic progress. A significant milestone in international cooperation, Physware aims to provide a sustainable collaborative model for capacity building of physics educators through a series of Educate the Educator workshops for those in the developing countries. The workshops are carefully designed to promote activity based pedagogic methods proven to be effective through rigorous educational research. They propagate curriculum and resource materials that are easily adapted to the needs of any region. While the emphasis is on using low-cost equipment and appropriate technologies that are locally accessible, participants are also introduced to ways of integrating emerging computer-based technologies for physics teaching, contemporary research, and applications of relevance to the work place. They explore ways of teaching fundamental new physics within the context of contemporary pedagogy that is both, hands-on and minds-on. After the success of a pilot workshop held at Trieste in 2009, the Physware series was launched in 2012 from the University of Delhi. Both workshops brought together a vibrant and eclectic group of participants who contributed actively to creation of innovative resource materials. It is hoped that many participants will emerge as regional leaders. Feedback shows that going beyond the constraints of its workshop format, Physware has the potential to emerge as a professionally networked community of practice.

Keywords: Educate the Educator, Physics Education Research, Active Learning, Low Cost Equipment, Community of Learning and Practice

Introduction

The turn of the century has ushered a greater sensitivity to the common denominator of problems faced by humankind and reinforced the need for finding collaborative solutions. It is widely recognized that in an interconnected world, science and technology will continue to be the key instrument that will decide the pace of further social and economic progress across the globe. The spotlight is now focused on the so-called emerging and developing countries — their potential, changing aspirations and capacity to contribute to global economies. Education and health for all, inclusive growth, greater sensitivity to environmental challenges and issues of sustainability underpin global development agenda and discourse. The national goals of developing countries, in particular, now lay greater stress on access, equity and excellence in education. Recognizing the importance of building a technological backbone employing indigenous research and development programs, the world educational community understands the increasing need to adopt the best pedagogical praxis to meet global benchmarks in the long run [1].

Paradoxically, despite the major strides in science, the quality of the human resources in science and technology continues to be an area of grave concern not just in the developing

countries but across the world. International surveys and assessment of performance tests such as TIMMS (Trends in International Mathematics and Science Study), ROSE (The Relevance of Science Education) and PISA (Programme for Student Assessment) flag serious issue about the state of science education. Growing apprehensions also include the dwindling interest in science amongst young students, the lack of quality in science education in general, the flight of talent from basic sciences and the evident disconnect between formal education and the needs of the workplace and national goals.

Active Learning: *Physware* emanates from and builds on the grave concern that, across the world, the predominant mode of teaching continues to be textbook based lectures. Laboratories are sometimes completely missing or not used appropriately as a part of the learning process in both developed and developing countries. Very few institutions, including those in developed countries, provide innovative learning techniques which are integrated throughout the students' learning of physics and which can help students visualize the physics they are learning and enhance their qualitative and quantitative understanding. Even where laboratory work and/or hands-on activities are an integral part of the curriculum, they often follow a cookbook approach that fails to impart procedural and conceptual knowledge about the activity, which then becomes hands-on without engaging the students minds.

Over the last few decades, systematic research in physics education has helped define a new agenda for teaching-learning environments the world over. Seminal research in physics education and cognitive science has conclusively established that students learn best when they are actively engaged in construction of their own knowledge. Active learning strategies entail engaging students in a carefully guided process of scientific enquiry that helps them to construct their knowledge of physics concepts by direct observation of the physical world.

Research on students' conceptual understanding shows that students bring to the formal classroom spontaneous reasoning based on naive theories about the world. These beliefs and ways of interpreting physical phenomena are significantly different from those they are expected to learn. To engender conceptual change, it is necessary to explicitly confront the students with situations that help them perceive the inconsistency or contradiction between their naive theories and the evidence generated by the phenomena. The resulting disequilibrium can provide the crucial intrinsic motivation for active learning. Guided enquiry methods make use of a learning cycle that includes predictions, small group discussions, observations and comparison of observed results with predictions. The goal is to make students aware of the differences between the beliefs that they bring into the introductory physics classroom, and the actual physical laws that govern the physical world. These learning strategies are known to measurably improve conceptual understanding and simultaneously aid development of good physical reasoning skills. Consequently, the current thrust is to develop active learning environments, instructional material and teaching strategies which are both, hands-on and minds-on [2, 3].

Rubric for Change: Developing and implementing active learning environments is no easy task. There are many reasons that we still have stagnant and traditional curricula. Active learning requires resource material tuned to the local framework. It needs basic equipment that is easy to procure – available off the shelf and affordable; easy to operate – with appropriate level of sophistication; easy to maintain – with available local technical support; robust – of good educational quality. Some of the equipment should be

sufficiently modern – reflecting the state-of-art in education as developing communities also aspire for the best.

There is no clear rubric for change. The overwhelming question for any group attempting educational reform is where to make a beginning. Deep-rooted change affords no shortcuts. It is well recognized that import of curriculum packages, resource materials, experimental kits and equipment, however proficient, cannot fill the lacunae in individual programs. The "not invented here" syndrome can often lead to the collapse of an otherwise excellent idea transported from elsewhere. Thus, it is imperative for each group to continually look into the methodology and content of its programs and develop its own materials and mechanisms taking into account the special constraints in implementation. In education, the wheel has to be continually reinvented. Individual adaptations are necessary and unavoidable – in fact, it is the process of development itself that is of prime importance [4].

Teacher Education: The role of the instructor when active learning materials are introduced into the classroom is of critical importance. This transition requires teachers to accept evidence that most introductory students do not learn effectively from logical explanations by instructors. Teachers must believe in the effectiveness of active learning materials. The ease of this transition is dependent not only on a willingness to give up the role of authority, but also on a number of cultural factors that differ from country to country. This is the ultimate challenge in introducing active learning teaching strategies in different parts of the developing world, and is a vital reason for designing activities that use low-cost equipment.

Large scale curriculum reform rests on creating several opportunities for professional growth for teachers. Onetime participation in a programme, however well conceived, is merely a positive spike that enhances motivation and professional competence for a short duration. The moot question is how transformative this trigger is and how deep rooted the change it brings about. Once back in the environment of their own country, institution and context, will the participants be able to bring innovation into classroom practice and leverage the enhanced pedagogical content knowledge. Diffusion and assimilation of innovation brings its own challenges. Large scale adoption and adaptation of any new idea entails institutional commitment to systemic change, multi-dimensional support and most importantly, a critical mass of those who can affect the change, in letter and in spirit. Then the foremost requirement for transforming educational ecosystems is empowering and educating the educator and changing the understanding they have of the process of teaching-learning [5].

BACKGROUND

Physware, conceptualized as a series of *Educate the Educator* workshops, is an initiative launched to enhance the quality of physics education at the undergraduate level, especially in the developing world. It is a direct outcome of recommendations from the physics education task force of the *World Conference on Physics and Sustainable Development* (WCPSD) from 30 October to 2 November 2005, at Durban, South Africa.

World Conference on Physics and Sustainable Development (WCPSD)

Organized as part of the International Year of Physics (IYP) celebrations, WCPSD was co-sponsored by the Abdus Salam International Centre for Theoretical Physics (ICTP) at Trieste, Italy, the International Union of Pure and Applied Physics (IUPAP), UNESCO and the South African Institute of Physics (SAIP). WCPSD was different as it was visualized

as the starting point of a long term world-wide initiative. The organizers identified that if physics is to impact sustainable development, there is need to understand and suggest action plans for the coming years in four critical areas, namely, Physics Education, Physics and Economic Development, Energy and Environment, and Physics and Health. The aut or Pratibha Jolly as Chair of IUPAP Commission 14 – the International Commission on Physics Education (ICPE) – and Priscilla Laws (Dickinson College, USA) were invited to co-chair the physics education segment. The Secretary of ICPE, Dean Zollman (Kansas State University, USA) joined the efforts as a key member of the Planning Committee that also included Minella Alarcon, Program Officer in charge of Basic Sciences at UNESCO and Associate Member of ICPE.

Physics Education Goals: One of the major concerns of WCPSD was to involve those in developing countries and help strengthen physics education in culturally relevant ways, determined and sustained by local initiatives. The Planning Group identified through its own network potential participants, especially from the developing countries. This stakeholder group joined an electronic forum to exchange views on the specific issues to address themes for invited talks and breakout discussion for action planning. Vibrant discussions led to identification of guidelines for action planning. It was decided to limit focus to the improvement of physics education at the secondary and the university level, especially for future physics teachers in secondary schools. Further, it was decided to set up working groups at the conference to identify the common denominator of problems and suggest how best to promote basic physics teaching that is enhanced by the use of locally developed examples, assignments and projects that are familiar to teachers and their students.

WCPSD Action Plans: The WCPSD concluded with the formulation of specific action plans:

1. To give educators and students in developing countries access to high quality physics education resources by establishing a website and Physics Education Resource Centres in Africa, Asia and Latin America.
2. To develop supplemental instructional materials for secondary physics courses that help students understand how the mastery of physics concepts can enable them to contribute to sustainable development in their own countries.
3. To develop model workshops for teacher-trainers in Asia, Latin America and Africa that exemplify how active learning methods can be adapted to help meet the needs of students in developing countries.
4. To establish a structured multi-disciplinary mobile science community that provides support to mobile science practitioners, enabled by a website at www.mobilescience.info hosted by the Institute of Physics (UK).

The action plans were endorsed by all sponsors. IUPAP, in particular, reported the action plans at the meeting of its Council Chairs and Executive Council held at Institute of Physics, London in February 2006. The WCPSD Planning Group through ICPE was given the mandate of development of model workshops and resource materials for physics teachers and teacher trainers that exemplify how active learning methods can be adapted to meet the needs of students in developing countries and further, mechanisms for electronic sharing of high quality physics education resources by establishing a website. In view of its

ongoing work, Institute of Physics UK, was given charge of implementing the last recommendation on Mobile Science [6].

IUPAP Resolution on Active Learning and Hands-on Education

In furtherance of its commitment to the WCPSD action plans, IUPAP adopted a resolution on importance of active learning, hands on education and laboratory work at the 26th General Assembly held in Tsukuba, Japan, in October 2008 [7]. The resolution urges that National Governments, Physical Societies, Funding agencies, Physicists, and Physics educators in all countries

- support best practice of physics education and physics education research at all levels by encouraging teaching methods, including laboratory work, that actively engage the hands and minds of learners.
- make available funds for establishment of well equipped laboratories and designing appropriate curricula that lay particular emphasis on teaching the skills of the experimenter.
- support indigenous development of low-cost instruments, physics apparatus and equipment, and – when finances allow it – computer-based data-acquisition systems for real-time measurements at the appropriate level of sophistication for a variety of uses in teaching of physics in the classroom and the laboratory.
- support curricula that teach physics with an appropriate diversity of methods, including hands-on approaches, that encourage critical thinking and help students understand how physics is relevant to their local cultures and to a sustainable future for humankind.

To help give effect to the resolution, the IUPAP General Assembly also supported the suggestion of ICPE that

- special sessions be organized on educational aspects of hands-on learning, experimentation, and appropriate assessment, in discipline specific conferences of the IUPAP commissions.
- multinational collaborations and workshops be organized for design and development of resource material for active learning and laboratory work; and further, dissemination through professional training of physics educators.
- electronic resource centres be established for exchange of ideas about local initiatives, teaching materials, prototypes of “hands-on” equipment, in particular those that can be locally adapted for construction by the teachers and their students, to serve a variety of educational needs in diverse cultural contexts.

The adoption of this resolution is a milestone that recognizes the importance of dissemination of best practice in physics education and reiterates the urgent need to give a boost to physics education if research in physics is to thrive.

Promoting Active Learning: An Example of Praxis

A concerted effort has been made to implement the WCPSD Action Plans by all the sponsoring organizations and key players. Workshops to promote Active Learning have been on top of the agenda.

UNESCO Workshops on Active Learning in Optics and Photonics (ALOP): Within the framework of the UNESCO program for basic sciences, an international team of resource persons, led by Minella Alarcon has organized numerous workshops on Active

Learning in Optics and Photonics (ALOP) in various developing countries such as Tunisia (March 2005); Morocco (Cadi Ayyad University, Marrakech, April 2006); India (Miranda House, University of Delhi, November 2006); Tanzania (Dar Es Salaam University, July 2007); Brazil (Universidade de São Paulo, July 2007); Mexico (Leon Guanajuato, November 2007); Argentina (2008); Mozambique (2008), and many more. The outreach till date is more than 600 teachers.

ALOP is a week-long workshop designed for teacher trainers from developing countries focusing on optics and photonics. This is an exciting area of study enabling research on the frontiers with capstone applications in diverse fields using high end technologies. Starting from introduction to light, geometrical optics, optics of the eye, interference, diffraction and spectroscopy, the workshop coherently introduces advanced topics of atmospheric optics and optics in communication. Participants are challenged with intriguing questions on how information is carried by light waves, how light is recorded as an electrical signal, how optical fibres transmit information and what internet communication is all about. The activity based curriculum includes a well-structured training manual. Each module embeds hands-on experiments and activities that can be locally fabricated or set up using easily available inexpensive materials. Each module also integrates concept questions and provides the PER-based Light and Optics Concepts Evaluation (LOCE) tool to measure student learning. The end-of-unit topics motivate teachers and their students to learn basic physics in order to understand new areas of science and technology that are highly valued in the global economy. For better dissemination, the ALOP Manual has been translated in other languages such as Spanish, Portuguese and French to widen outreach, especially in Latin America and Africa.

The ALOP workshop serves as a paradigm for efforts to promote throughout the world the educational goals set by WCPSD [8].

THE PHYSWARE INITIATIVE

As a direct follow-up on the WCPSD and IUPAP mandate, WCPSD co-Chairs Pratibha Jolly, Priscilla Laws joined by Dean Zollman and Elena Sassi proposed the idea of organizing a series of *Educate the Educator* workshops titled *Physware*.

Mission: The core mission of the *Physware* initiative is to impact quality of physics education at the secondary and undergraduate level through collaborative workshops carefully designed to promote active learning methods using prototypes of affordable hands-on equipment that can be locally adapted for construction by teachers and their students throughout the developing world. An important facet is simultaneously providing an exposure to appropriate technologies, computer-based tools and open source softwares for enhancing conceptual understanding, in tune with changing aspirations of developing communities. The goal is to integrate hands-on activities within carefully crafted active learning instructional materials so that these can be used effectively.

The *Physware* initiative aims to go beyond its workshops by also providing a forum to physics educators to share experiences and exchange ideas about dissemination of active learning methods. It is hoped that they will lead similar efforts in their local regions. In the long term, *Physware* envisions creating and strengthening regional and international networks of physics educators who can adopt global best praxis anchored in physics

education research – giving due credence to locally meaningful adaptations situated in local contexts.

Pilot Workshop: Physware 2009

Within this framework, the first *Physware* was held at ICTP, Trieste, from 16 to 27 February 2009 with above listed four as co-directors and Joseph Niemela from ICTP as local co-ordinator and facilitator. Financial support primarily came from ICTP.

Theme: Teaching of Newtonian Mechanics was chosen as the topic for the first workshop.

Participants: In addition to the ICTP publicity network, a concerted attempt was made by the directors to outreach physics education communities by distributing the workshop poster at several physics education events across the world, posting it on pertinent websites and newsletters such as that of ICPE. A record number of more than 200 applications from 48 countries were received, posing a challenge to selection. A rigorous scrutiny enabled selection of 32 participants from 27 countries spread across Africa, Asia, Latin America and Europe. The participants represented a multicultural but eclectic group of extremely talented and innovative physics teachers, teacher-trainers and administrators – some bearing multiple responsibilities. Preference was given to those with demonstrated expertise in developing hands-on activities and potential for assuming leadership role in organization of similar workshops.

Technical Sessions: The two week workshop (with 10 working days) was structured to have four blocks of one hour forty five minutes on each day. Additionally, seven days included a two hour post dinner block to accommodate poster sessions and special discussions. At the outset the participants were given an exposure to seminal physics education research in the context of mechanics. Early discussions compared and contrasted traditional teaching methods with strategies underpinning enquiry-based active learning environments. Participants were introduced to research on students' conceptions of mechanics, research-based concept tests, diagnostic tools and learning cycles that promote active engagement in the context of teaching-learning of kinematics and dynamics. The workshop manual drew on eclectic resources drawn from University of Washington Tutorials, Workshop Physics, Interactive Lecture Demonstrations, Learning with Physics Suite, The AMSTEL resources, Naples PER group material, the Uganda Project and University of Delhi Interactive Lab Tutorials [9-15].

Low-cost Locally Fabricated Set ups: The first week modules embedded activities designed using locally available materials. This mandate led to development of several rough and ready set ups and innovative measurement procedures. For instance, different length pendulums were used as clocks to measure time in arbitrary units. Pendulums were fabricated using walnuts, metal nuts, lengths of vine or thread. These were used variously to investigate oscillatory motion and the affect of changing various physical parameters. A mahogany flower pendulum was used to study damping as petals were gradually peeled off to change its shape, and then put back so that the mass was restored but not the shape. There was much experiential learning with kinesthetic involvement as distance was measured in arbitrary units, innovative clickers were used for equal interval timing to graph motion. The do-it-yourself approach led to fabrication of an interesting range of hand-made carts, dynamic tracks and frictionless surfaces. Battery operated toy fans mounted on carts generated interesting variations in motion. Furniture was juxtaposed to study rolling down makeshift inclined planes. Force was measured with rubber bands and then springs. It was found that acceleration due to gravity could be measured fairly

accurately merely by timing the fall of a coin. Later the ubiquitous cell phone provided a convenient mechanism for accurate measurement of time.



Figure 1. Learning with low cost alternatives

Appropriate Technology-mediated Learning: In the second week, the participants were given a rigorous exposure to appropriate technologies and computer-based measurement. These included use of motion and force sensors, photogates; data and graphical analysis software; and free/open source software. Powerful video data analysis tools were used to analyze video clips of interesting motions such as that of a basketball thrown by a player in action. Participants also created short video clips of objects in motion. A session was devoted to how simulations can be integrated into the learning cycle to enhance conceptual learning. Discussions veered on need to judge if a particular simulation is an appropriate representation of the phenomena or experiment, if it can replace the engagement with the physical world, and how best to judiciously overlay a simulation on a hands-on activity.

The pedagogic strategy of introducing technological refinement only after having worked without it made the participants compare and contrast the two approaches. On one hand – recalling the great excitement of designing and fabricating one's own minimalistic experimental set up – they were able to realize how much conceptual learning can take place without access to sophisticated instruments. On the other hand, they could appreciate the enabling role of technology in enhancing conceptual learning, visualization, and rigorous in-depth investigations.

Expanding Horizons: Two special sessions were organized to introduce the participants to virtual instrumentation project ongoing at the ICTP M-Lab; and construction of communication networks using low-cost wireless technologies. The contemporary value of demonstrations generated a great deal of interest. In another session, the participants evaluated features of low-cost computers, including the much in news “one hundred dollar” computer from MIT.

Projects: The touchstone of *Physware* was collaborative work on projects in small groups. This generated a vibrant atmosphere simulating an effective active learning environment that can be replicated for students. Following the structure of the workshop, the projects in the first week entailed creative use of low-cost materials in active learning of topics of core importance in mechanics. The group presented the work through posters. In the second week, projects judiciously used appropriate computer-based technological tools. As many as fourteen projects were carried out in a span of a day. All the groups made power point presentations. As an illustrative example, one of the projects evaluated effectiveness of different technologies to measure the time of free fall. This entailed real time data acquisition using a motion sensor, video capture and a cell phone as a timing device.

Subsequently this work was refined and published [16]. It is interesting to note that the collaborating team had members from five different countries, namely, Brazil, Columbia, Venezeuela, Argentina, and Cameroon. Without *Physware*, such a group would never have found an opportunity to collaborate and publish jointly.



Figure 2. Comparing three different technologies to measure fall of an object

Outcomes: A measure of the success of the pilot workshop was the immense enthusiasm and diligence with which the participants worked until late at night as sessions stretched to 10 pm on most evenings. Feedback of the participants on formal evaluation forms was extremely positive on all counts.

Figure 3 captures the spontaneity of the Aha Moments! This stands testimony to the uninhibited active engagement and joy of learning as the teacher participants assumed the role of students at the workshop.

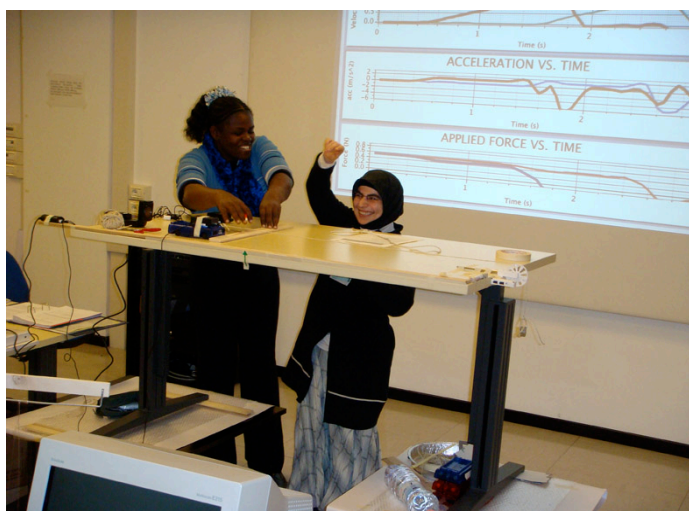

Figure 3. The Aha Moments!

Sharing Concerns: Early in the workshop, the participants were encouraged to participate in evening poster sessions where they could present illustrative extramural and synergetic activities they were engaged in; innovative projects undertaken; interesting informal learning initiatives; or some aspect of physics education in their home institution or country. This served the dual purpose of breaking the ice and identification of areas of

mutual interest and work. The presentations also served to identify the large common denominator of problems faced by all countries.

Evening discussion sessions spanned a wide range of topics. For instance, the issue of under representation of women in physics was discussed. Participants shared informal statistics, country reports, personal experiences and successful initiatives to reverse the trend. The organizers shared the proceedings and resolutions emanating from the three IUPAP sponsored International Conferences on Women in Physics held at Paris 2002, Rio de Janeiro 2005 and Seoul 2008. As a natural extension, issues of multicultural and multiethnic classroom followed.

Towards Advocacy: An important development was that then Director ICTP, K Sreenivasan, remained proactively tuned in and spent several hours interacting with the participants, formally and informally. He listened carefully to the problems of physics education in developing countries and the need for ICTP to initiate programs in the area. The participants functioned well as an advocacy group and urged ICTP to continue support to *Physware* and further, facilitate a web-based system for sharing resources. The group also deliberated separately to provide inputs to an action plan for consolidating *Physware* as a series of global and regional workshops.

Leveraging Social Technologies: The Directors created a Wiki before the workshop for pre-workshop interactions to understand participants' background, needs and to set the agenda. The workshop related information and resource material was made available on the *Physware* website created by ICTP on their portal [17]. However, the highlight of the workshop was the creation of a *Physware* Discussion Group and a Blog during the workshop by one of the participants. She volunteered to be the webmaster and ably led the participants through a special tutorial on how best to use the blog. Others were quick on uptake and throughout the workshop used the sites for exchange of information, resources and discussion on several threads. Social technology became the enabling lifeline for personal bonding, group communication and collaborative professional growth. Participants were quick to realize that the virtual forum would help them overcome geographical divide and personal isolation; it would help them sustain the dialog and the work begun.

Motivating Regional Leaders: As envisioned, the pilot workshop successfully established a primary network of outstanding physics teachers from developing countries with an overview of validated best practices in physics education. These educators expressed enthusiasm about sharing their *Physware* experience and building on it to find solutions to regional and local physics education problems. Since then, some participants have taken a lead role in organizing active learning workshops in their region. For instance, Julio Benegas from Argentina led the Latin American Regional South Cone Workshop on Active Learning in Mechanics at Córdoba in June 2009 [18]. Since then he has taken a lead role in creating a strong collaborative network in the region and organized several other programmes.

INSTITUTIONALIZING PHYSWARE

It was felt that the *Physware* initiative can be sustained and impact physics education only if it is institutionalized. The original sponsors IUPAP – working through its Commission

on Physics Education (ICPE) – and ICTP were seen as the appropriate stakeholders to take the lead role.

Indeed, IUPAP and ICTP share common interests in promoting scientific advancement and high-quality science education in physics and its applications. IUPAP is serving to advance the worldwide development of the physical sciences and to contribute to the application of physics toward solving problems of concern to humanity. The mandate of ICTP includes fostering high-level scientific research in developing countries by providing world-class opportunities for both scientists and students at the post-graduate level. ICTP's role has been pivotal in training and capacity building for strengthening scientific enterprise. It has been continuously developing high-level scientific training programmes with sustained attention on the changing needs of developing countries recognizing that good education is critical to scientific and technological development. Then both organizations have a special focus on the needs of the countries where physics is less developed. A fruitful cooperation between the two institutions in furthering the cause of physics education would serve their common interests better.

In October 2009, the President of IUPAP – acting on behalf of ICPE – and the Director of ICTP signed a Memorandum of Understanding (MoU) for a five year action plan. Under this, it was envisaged that ICPE and ICTP would cooperate in organizing the *Physware Educate the Educator* series of collaborative workshops to promote active teaching-learning in undergraduate physics in the developing world. These would be modelled on the *Physware* pilot workshop organized at ICTP in February 2009. The goal would be to organize five annual workshops with a developing country and ICTP Trieste alternating as venues. ICPE would be a coordination committee. Each year representatives of ICPE and ICTP, jointly with others as desired, would confer to discuss the funding, venue, organization, experts and resource persons and participants. For the workshops to be held at Trieste, ICTP would make an in-kind contribution and leverage the facilities and expertise in fundamental and emerging physics research available at ICTP, including the facilities and expertise of the Multidisciplinary Laboratory and the Science Dissemination Unit. For the workshops to be held outside Trieste, ICTP would provide institutional contacts for hosting workshops in developing countries and use its resources to provide proper publicity for events. These workshops would focus on innovative physics teaching using contexts of specific relevance to the development of the region in which it is held.

It was clear from the outset that a 5-year effort of this nature could not be undertaken within the existing financial structure of only IUPAP or ICTP. Thus it was mandated that ICTP and ICPE would together solicit funds from both public and private sources with the goal of eventually getting governments and regional professional organizations to take major financial responsibility for the workshops in their own territories. In fact, raising grants has been a far bigger challenge than first anticipated. Despite the commitment to a common cause reflected in the MoU, neither IUPAP nor ICTP was able to allocate an annual budget to the proposals submitted.

PHYSWARE 2012

Having played the key role in conceptualizing *Physware* and steering the MoU, the author took up the challenge of raising grants to organize the next workshop in Delhi at her own institution from 26 November to 7 December 2012. The venue was the D S Kothari Centre for Research and Innovation in Science Education (DSKC) established at Miranda House. As committed in the MoU, ICTP sponsored the workshop with partial funding and provided secretarial support from its office in Trieste. The host institution raised funds

locally from several government agencies to cover the significant cost of running a two week residential programme.

Theme: The workshop focused on teaching-learning of Electricity and Magnetism in introductory courses.

Participants: The programme was widely advertised using ICTP's official network and also through local efforts. It drew about 200 applications from 44 countries across the world. The directors scrutinized each application with great care to constitute a multicultural group of 46 physics educators from 12 countries, each with an extremely interesting work profile. This group included 25 international participants. Optimising available funds, preference was given to those from neighbouring countries of South Asia, East Asia and Africa, with largest groups coming from Pakistan, Sri Lanka, Philippines and Nigeria. In addition, there were 21 participants from India – drawn from 10 different federal states – representing the vast geographical, socio-cultural and ethnic diversity of pluralistic India. There was no registration fee. All participants were provided full or partial travel support; complete local hospitality and accommodation on campus for two weeks; and workshop material.

Immersion in an Actual Active Learning Environment: Miranda House, college for women at the University of Delhi is amongst the premiere educational institutions in India. It has two extremely well-equipped large undergraduate physics laboratories. In addition, it has two project-based learning studios fashioned after Workshop Physics programme established by Priscilla Laws at Dickinson College, US. The physical layout and design of work tables encourages collaborative work. The labs have networked computers with high bandwidth access to internet and additionally, access to wi fi available across the campus. The college has been leading efforts in developing innovative lab curriculum that integrates activities ranging from no-cost, low-cost, locally fabricated set ups to sensor-based real time measurements using computers and handheld devices as data acquisition systems. On one hand, the college is able to pull out bits and pieces of odd materials to put together string and sticky tape experiments with great ease. On the other hand, it has available multiple sets of computer-based systems from Vernier, PASCO, COACH and Labview allowing several groups to work simultaneously on a desired activity. Additionally, the college has a large contingent of laboratory support staff who is well trained to source material locally and find innovative solutions for hands-on activities. They are always ready to run down to the local hardware shop or the electronic components bazar to procure items not initially anticipated for use. The international directors were delighted to see how quickly ideas translated into activities. All these facets combined to give the Delhi workshop a hands-on minds-on edge in contrast to the pilot workshop at Trieste where instruments had to be predecided and ported in limited quantities from elsewhere causing major limitations in scope. More importantly, the location was not a simulation but an actual active learning environment in a college primarily devoted to teaching. The story of how the college incrementally reinvented its environment from traditional to innovative proved to be motivational. Participants saw much that could be easily replicated.

Technical Sessions: *Physware* 2012 followed the framework of the earlier pilot workshop. However, there were qualitative differences and advantages that accrued from the choice of venue. These made a huge difference to the academic level of the workshop.

Curriculum: Structured course material was put together as a manual. It unfolded a coherent progression of key concepts over two weeks, as summarized in Table 1.

Table 1. Workshop Course Structure and Concepts Covered

Week 1	Week 2
Electrostatics	Magnetism
Verification of Coulomb's law	Motion of Charges/ Wires in Magnetic Fields
Electric Field Hockey and Rutherford Scattering	Magnetic Field around a Current Carrying Wire
Gauss Law and Faraday's Pail	Motion of Magnets and Coils
Representations of Electric Fields	Electromagnetic Induction
Representations of Electrostatic Potentials	Faraday's Law, Eddy Currents
Basic DC Circuits	Energy Flow in a Simple Circuit
Basic Capacitor Circuits	Electromagnetic Waves
Active Learning in Advanced Courses	Active Learning in Advanced Courses
Projects	Projects

Judicious use was made of materials selected from validated physics research-based curriculums to exemplify active learning of the outlined concepts, foremost amongst them Real Time Physics. Real time measurements and video analysis tools were introduced. An associated reading list drew from seminal work of leading physics education research groups [19-23]. Again, the entire material was uploaded on the ICTP *Physware* website and also on a Google Group created by the Directors for the purpose.

The Jugaad Model of Innovation: The activities leveraged the facilities on hand. A fairly low-cost kit was assembled. In several sessions, a motley collection of wires, magnets and other sundry items were laid on the table and participants asked to demonstrate a principle or concept. They were invariably able to assemble a clever experiment with great dexterity. In India, the art of improvising an ingenious solution with whatever is available is called *Jugaad*. It is widely prevalent in all spheres of life. In translation, the word would translate as *jietinho* in Brazil, *jua kali* in Kenya, *zizhu chuanxin* in China and *ystème D* in France. As an aside, it is pertinent to share six principles of *Jugaad* as identified by authors of a book by that name [24]. These are, to (i) seek opportunity in adversity, (ii) do more with less, (iii) think and act flexibly, (iv) keep it simple, (v) include the margin, and (vi) follow your heart. The last two pertain to the social dimensions of innovation and can help a curriculum developer to extrapolate what would be most appropriate in different settings. In science classes, the *Jugaad* model allows one to put together the so-called string and sticky tape experiments very innovatively. Of course, *Jugaad* can often acquire pejorative connotations – it cannot be the sole way of doing things. As and when needed, appropriate level of sophistication and rigour in design must to be introduced.

An activity to explore equipotential "surfaces" in two dimensions uses a special conducting paper with electrodes painted on it. Equipotentials are then used to construct field lines. This paper could not be procured in Delhi. One of the lab staff fabricated carbonized paper in a jiffy by rubbing ordinary graphite pencil on a small sheet of paper. Electrodes were also created using the same technique. The participants took instant liking to the idea. Playing around, several innovative ways of shading and growing conducting electrodes were tested. A variety of miniaturized conductive configurations were created using the backside of discarded visiting cards (Figure 4). The exercise generated much excitement amongst participants as discussions began from the concept of a resistance before veering to the task on hand. Other examples abound. A common strategy adopted was to place a few items on the table and ask, what can you do with this stuff? For instance, given a

screw, a tiny magnet, a bit of wire, a 1.5 volt battery, it was interesting to trigger imagination and see if a motor could be configured.



Figure 4. Designs for zero cost carbonized paper with electrodes to plot equipotential "surfaces"

Pedagogic Strategies: Participants worked in collaborative groups of 4 to 5 assuming the role of learners with great enthusiasm, negotiating each activity with animated discussions. As stated before, the suggested hands-on activities were designed so that they could easily be replicated in any teaching-learning environment and embedded in any teaching style. The emphasis was on evoking pedagogic strategies which can effectively convert any classroom into an active learning environment. Participants were given exposure to the well-known strategy of using Interactive Lecture Demonstrations (ILD), known to be effective in large classrooms. They were also asked collaboratively to design and present ILDs to communicate a chosen concept. Honouring the immense talent pool, the participants were given freedom to improve suggested set ups, design new activities *ab initio* and suggest new approaches in all sessions while respecting the time schedule. This resulted in many innovative additions to the repertoire.

Enhancing Conceptual Learning: One of the key objects of *Physware 2012* was to introduce the participants to Physics Education Research in the context of the theme of the workshop and the implications for teaching-learning. The directors presented a case study on how the Electric Circuit Conceptual Evaluation (ECCE) was developed based on research. Participants were also introduced to other Physics Education Research-based instructional materials with particular focus on conceptual evaluation on electricity and magnetism. Illustrative examples included those from Real Time Physics and the Brief E&M Assessment (BEMA) tool, which was used extensively throughout the workshop [25]. Select questions from BEMA were embedded in the sessions at appropriate points in almost all sessions, drawing attention to concepts which research shows pose challenge to students learning. All hands-on sessions were followed by in-depth discussions between the entire group and a summative exercise led by the directors.

Expanding Horizons: An invited talk by a young Indian physicist who has been contributing to the ongoing experiments at CERN introduced the participants to particle accelerators and experiments in high energy physics. He spoke on 'Observation of a New Boson at the World's Highest Energy Accelerator' presenting the latest results from CERN on discovery of Higg's Boson. Participants also visited the National Science Centre at Delhi to look at the various interactive models, particularly in the context of the theme of the workshop.

Several sessions were devoted to introducing participants to web based repositories of online resources, open source software, simulations, visualization tools etc. In particular, participants were introduced to the comPADRE and PER User Guide [26]. They also explored extensively the PHET Interactive Simulations from the Colorado Project, the MIT Technology Enhanced Active Learning Studio Project (TEAL), the online course on Visualizing Electromagnetic Fields. They discussed how best to integrate the resources in their own teaching. Dean Zollman introduced the participants to his work on Modern Miracle Medical Machines, and particularly medical imaging. A simple analogous simulation using magnetic compasses introduced the complex concept of magnetic resonance imaging. This was followed by an interesting interactive talk on Alexander Graham Bell and Medical Imaging [27]. The high level of interest and understanding exhibited by the participants led to fine tuning the depth to which each concept was discussed. Departing from the original plan, the directors introduced sessions devoted to pen and paper tutorials for advanced students. For example, in week one, a tutorial from Oregon State University, "Paradigms in Physics: Designing an Electric Field" was introduced. In Week 2, advanced tutorials were on Faraday's Law and on use of Poynting Vector.

Projects and Presentations: The most exciting feature of the workshop was the collaborative work on projects and the opportunity given to each collaborating group to present their work, incorporating the hands-on demonstration with a powerpoint presentation. Participants displayed immense creativity. Each presentation evoked vibrant discussion. Examples include design of a Gravimeter using magnetic induction for accurate measurement of acceleration due to gravity.

Challenges: The directors were kept on their toes and required to continuously think out of the box. They needed a high level of competence to meet the challenging questions posed by a well prepared group of physics educators, who were also deeply committed and deeply engaged to the task on hand. Ultimately, no question was too difficult as answers emerged from within the group through Socratic dialogs. All this became possible because of the collaborative spirit underpinning all activities and the knowledge pool available in the collective. This enhanced the confidence of each participant.

CONCLUSIONS AND FUTURE PLANS

A significant milestone in international cooperation, the *Physware* workshops described herein provide a sustainable model for capacity building of large number of physics educators, especially in the developing countries. *Physware* has successfully established a primary network of outstanding physics teachers who have an overview of validated best practices in physics education. These educators are enthusiastic about sharing their knowledge of active learning using low-cost materials and emerging technologies. Given that training and capacity building of physics educators is seen to be the critical first step if young students are to be motivated to pursue careers in physics or contribute to development as envisioned by their national goals, *Physware* promises to be amongst the most important activities of ICPE in the coming years.

Challenges: Capacity building of educators involves a complex interplay of many factors. Each step in the process of pedagogic innovation, dissemination and diffusion of innovation brings its own unique challenges. The recurring question is how to mainstream innovation. This requires transforming ecosystems. No easy task, this is at best a journey and a work in progress. Very frequently, participation in an innovative programme is a mere spike in the career of the educator. Frequent exposure to best praxis in a variety of

new contexts and sustained support during transformative periods is essential. Long term impact can only be assessed on the basis of how well the individual is (i) able to adopt or adapt the new skills and pedagogic knowledge; (ii) able to apply these to improve her own classroom practice in her own home institution despite constraints of existing educational framework; (iii) disseminate the experience gained to create a critical number of like-minded practitioners who can impact the institutional practices in the long term.

The ultimate success of the *Physware* initiative will depend on growing the circle of influence along three important dimensions, namely,

- (i) the range and depth of content – it is important that subsequent *Physware* workshops should cover more and more topics of physics for comprehensive impact.
- (ii) the quality of content – it is important that each *Physware* workshop should be iteratively refined taking into account the feedback of the participants and further fine tuned to be compatible with local needs and contexts.
- (iii) the scale of educational outreach – it is important that a significantly large number of educators in any region should be exposed to the new pedagogies, receive adequate training, and assume the role of regional leader or agent of change to provide opportunities to more and more educators.

Replicable Workshop Model: The *Physware* workshop model has salient features that make it amenable for wide scale adoption. It:

- (i) uses curriculum and resource material easily adapted to the needs of any region;
- (ii) uses low-cost equipment and locally available technologies;
- (iii) introduces appropriate technology and applications of relevance to the work place, thereby motivating interest;
- (iv) provides ways to integrate topics in contemporary research or applications of these topics thereby introducing participants to teaching fundamental new physics within the context of contemporary pedagogy;
- (v) employs activity based pedagogic methods proven to be effective through educational research;
- (vi) assesses participant needs and attainment of workshop goals through pre-workshop discussions, on-site feedback and post-workshop evaluations;
- (vii) organizes collaborative groups to enhance professional development opportunities for physics educators who teach in developing countries;
- (viii) identifies regional leaders who can in turn organize regional versions of *Physware* workshops thereby reaching out to a critical number of physics educators necessary for affecting change.

Both the *Physware* workshops described herein have been hugely successful in achieving their objectives. They addressed two different themes and make available well-structured curricular material along with an accompanying activity kits. The same model can easily be extended. It is hoped that each subsequent workshop will address a new topic and create several thematic *Physware* Manuals with Activity Kits.

Action Plan: The ICTP-IUPAP MoU five year action plan mandated a structured plan for scale up of the *Physware* initiative and regular organization of the workshops. Figure 5 depicts the vision.

The idea was to develop workshop manual and kits on at least five different topic areas such as Mechanics, Electricity & Magnetism, Waves and Oscillations, Optics, and Thermal

Physics. A different international team of directors that has broad experience with teaching environments, cultural differences and the educational needs of peoples from many nations would be responsible for each theme. Once executed, the material would be continuously upgraded based on feedback. It would also be made available to participants with demonstrated leadership qualities so that they could conduct similar workshops in their own regions. Further, it was suggested that a special session on *Physware* should be organized at each ICPE conference to share, evaluate progress and plan future workshops. All this would have a cascading effect and scale up outreach.

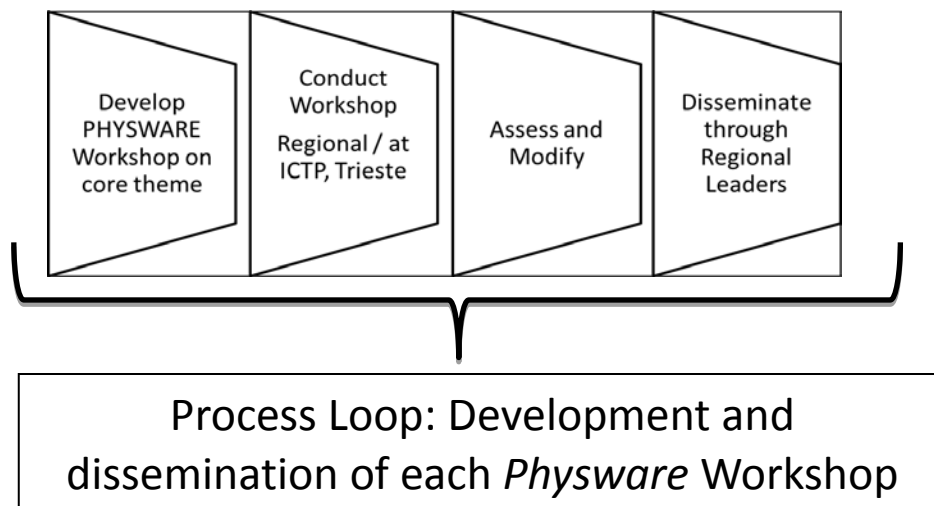

Figure 5. Action Plan for sustained development and outreach through workshops

Multi-institutional Support: Although *Physware* is currently the flagship programme of ICPE, ideas have not translated to action as planned. The single reason for this has been lack of adequate dedicated funds. A long term effort of this nature needs multi-institutional support, public and private sponsorship for organization of at least the first set of workshops with the goal of eventually getting governments and regional professional organizations to take major financial and organizational responsibility for additional capacity building workshops in their own territories. Pending such support, it would be prudent to use developing countries as venue with host institutions taking the responsibility of raising funds locally and ICTP providing partial financial support and logistic support.

Building a *Physware* Community of Practice: Another important clause of ICTP-IUPAP MoU that has so far remained essentially dormant is the commitment to develop a *Physware Resource Website* for physics educators. It was envisaged that this web based repository of high quality physics education resources would serve the needs of those from countries where examples of best practice are not easily available; consolidate the gains of *Physware* workshops; and give sustained support to *Physware* participants for continued sharing of efforts through structured communication. Going beyond, it is crucial to seed formation of a *Physware Community of Learning and Practice* if participants are to overcome isolation in their home institutes or countries and continue collaborations forged at the workshop – while working in their respective countries. The aim would be to undertake sustained computer supported collaborative work to produce concrete outcomes that can be shared globally to impact regional practice of physics education in the long term. No easy task, creating a successful *Physware* community would require a dedicated facilitating team that is knowledgeable about physics education and teacher education. It remains to be seen if the collaborating organizations led by ICPE can deliver this dream.

Acknowledgments

It is a pleasure to thank the *Physware* co-directors Dean Zollman, Priscilla Laws, Elena Sassi, and ICTP coordinator Joe Niemela for an enjoyable and fruitful collaboration. The Delhi workshop would not have been possible without the support of Miranda House staff, particularly Mallika Verma, the local coordinator of *Physware* 2012. It is also a pleasure to acknowledge all the *Physware* workshop participants who are individually responsible for the success of the initiative.

Finally, I dedicate this paper to the memory of Elena Sassi – friend, mentor and co-director who unfortunately is no longer with us. The Delhi *Physware* workshop was probably her last academic engagement, her last adventure. Vivacious, full of energy, she was always surrounded by *Physware* participants wanting to learn more from her. She will be deeply missed.

References

- [1] Science (April, 2013). Grand Challenges in Science Education, Special Issue, Vol. 340, Issue, 6130.
- [2] McDermott L.C. and Redish E.F., (1999). Resource letter PER-1: Physics Education Research, *Am. J. Phys.*, 67, 755-767.
- [3] Laws, P.W. (1997). Millikan Lecture 1996: Promoting active learning based on physics education research in introductory physics courses, *Am. J. Phys.* 65, 14–21.
- [4] Jolly, P. (2002). An Indigenous Process of Pedagogic Innovation: A Case Study on Curriculum Development, *AI & Soc.* 16: 148-162.
- [5] Jolly, P. (2001). A Refresher Course in Physics Education: Training College Teachers to do Classroom Research, P.. In R. Pinto and S. Surinach (Editors), *Physics Teacher Education Beyond 2000*, Elsevier, 249-252.
- [6] Jolly, P. and Laws, P. (April, 2006). World Conference on Physics and Sustainable Development, *ICPE Newsletter*, Vol. 51, 3.
- [7] IUPAP Website: www.iupap.org
- [8] Laws, P.W. (2008). A Lens into the World, *AAPT Interactions*, 21-23.
- [9] Redish, E. F. (2003) *Teaching Physics with the Physics Suite*, John Wiley & Sons, Inc.
- [10] McDermott, L.C., Shaffer, P. and the Physics Education Group, University of Washington, Seattle (1998). *Tutorials in Introductory Physics*, Prentice-Hall Inc.
- [11] Sokoloff, D. R., Thornton R. K. and Laws, P. (1999, 2004). *RealTime Physics: Active Learning Laboratories: The Physics Suite*, Volumes 1 to 4, John Wiley & Sons, Inc.
- [12] Sokoloff, D. R., Thornton R. K. (2004). *Interactive Lecture Demonstrations –Active Learning in Introductory Physics*, John Wiley & Sons, Inc.
- [13] Laws, P. (2004). *Workshop Physics Activity Guide: The Physics Suite*, Volumes 1 to 4, John Wiley & Sons, Inc.

- [14] Laws, P., Teese, R.B., Willis, C.W. and Cooney, P.J. (2009). *Physics with Video Analysis*, Vernier Software & Technology.
- [15] Jolly, P., Bhatia, V.B., Verm, M. (2001). Developing a Research-based Laboratory Curriculum for College Physics (workshop), in R. Pinto and S. Surinach (Editors), *Physics Teacher Education Beyond 2000*, Elsevier, 319-324.
- [16] Rocha, F.S.D., Fajardo, F., Grisolia.M., Benegas, J., Tchitnga, R. (2011). Using “Student Technology” in Introductory Physics: A Comparison of Three High Tech Tools to Study Falling Objects, *The Physics Teacher*, 49, 165- 167.
- [17] Physware workshop, ICTP, Trieste, Italy, 2009.
http://cdsagenda5.ictp.trieste.it/full_display.php?ida=a07137
- [18] Benegas, J., Report of the 2nd Regional South Cone Workshop on Active Learning in Mechanics (AAMe- Córdoba’09) and the 2nd Regional South Cone Conference on Active Learning in Physics (CRAAF-2)
http://journal.lapen.org.mx/sep09/31_LAJPE_288_Julio_Benegas.pdf
- [19] McDermott, L.C. and Shaffer, P.S. (1992). Research as a guide for curriculum development: An example from introductory electricity. Part I: Investigation of student understanding, *Am. J. Phys.* 60 (11), 994-1003.
- [20] Shaffer, P.S. and McDermott, L.C. (1992). Research as a guide for curriculum development: An example from introductory electricity. Part II: Design of Instructional Strategies, *Am. J. Phys.* 60 (11), 1003-1013.
- [21] Knight, R.D. (2004). *Five Easy Lessons – Strategies for Successful Physics Teaching*, Addison Wesley.
- [22] Berg. R.E. (2012). Resource Letter PhD-2: Physics Demonstrations, *Am. J. Phys.* 80, 181.
- [23] Meltzer, D.E. and Thornton, R.K. (2012). Resource Letter ALIP–1: Active-Learning Instruction in Physics, *Am. J. Phys.* 80, 478.
- [24] Radjou, N, Prabhu, J. and Ahuja, S.. (2012) *Jugaad Innovation: A Frugal and Flexible Approach to Innovation for the 21st Century*, Random House India.
- [25] Ding, L., Chabay, R., Sherwood, B., and Beichner, R. (2006). Evaluating an electricity and magnetism assessment tool: Brief Electricity and Magnetism Assessment, *Physical Review Special Topics - Physics Education Research* 2, 010105.
- [26] www.compadre.org
- [27] Kansas State University Physics Education Research Group (2010). *Modern Miracle Medical Machines*, www.phys.ksu.edu.

Active physics learning: Making possible students' cognitive growth, positive emotions and amazing creativity

Josip Sliško

Benemérita Universidad Autónoma de Puebla, Puebla, Mexico

Abstract

It is now well known that carefully designed sequences of active physics learning support students' comprehension of physical concepts and laws. If only this were its effect, active learning should replace lecture-based teaching and passive students' learning at all educational levels. Fortunately, the impacts of active learning experiences in students are much broader. In this paper I present a few examples of tasks that are suited for engaging students in active learning along with research-based and anecdotal evidence about effects of active physics learning on students' cognitive level, emotions and creativity.

Keywords: active physics learning, self-regulated learning, cognitive growth, positive emotions, creative thinking, students' demonstrations of weightlessness

Introduction

Our today's students will live and work in the world of learning organizations and knowledge-based economy that change faster and faster. Life-long learning is their destiny and only possible path towards new employment opportunities and a secure personal and professional future! But the learning is not only a personal need, it is also an economic necessity [1]:

“Any company that aspires to succeed in the tougher business environment of the 1990s must first resolve a basic dilemma: *Success in the marketplace increasingly depends on learning, yet most people don't know how to learn.*”

What's more, those members of the organization that many assume to be the best at learning are, in fact, not very good at it.”

Only “knowledge workers”, whose role is to transform existing and emerging knowledge into new products and services, can satisfy such a necessity. The number and quality of “knowledge workers” affect the present and the future of institutions and companies [2]:

“The most valuable asset of a 21st-century institution (whether business or nonbusiness) will be its *knowledge workers* and their *productivity*.”

Knowledge work requires *continuous learning* on the part of the knowledge worker, but equally continuous teaching on the part of the knowledge worker.”

Becoming a “knowledge worker” is not a trivial task. It requires that one dominate many complex skills which can only be learned through adequate learning experiences [3]:

“Knowledge workers must, effectively, be their own chief executive officers. It's up to you to carve out your place, to know when to change course, and to keep yourself engaged and productive during a work life that may span some 50 years. To do those things well, you'll need to *cultivate a deep understanding of yourself* – not only what your strengths and weaknesses are but also *how you learn, how you work with others...*”

These complex skills, needed by “knowledge workers” and business leaders, are recently called “XXI century skills”. Tim Wagner [4], considers them as “surviving skills” and includes among them:

Critical thinking and problem solving; Collaboration and leadership;

Effective oral and written communication; Finding and analyzing information;

Curiosity and imagination.

Higher-education institutions have a very important social responsibility in education of „knowledge workers“, who should be prepared to face, not only today's known problems, but more future unknown problems which will appear in next decades [5,6].

Keeling and Hersh consider that learning, needed by actual knowledge-based economy,

„...requires that students be fully engaged participants in a powerful intellectual, social, and developmental process. That process requires rigorous self-discipline, effort, and commitment; demanding well-trained teachers; an inspiring, motivating, and diverse curriculum; and an intentionally designed, challenging, formative, and supportive learning environment“[7, p. 20].

Nevertheless, the university teaching, even in the most industrialized countries like the USA, is slow and unprepared to react adequately to these urgent economic needs. Keeling and Hersh made a dramatic diagnosis of that situation:

„The truth is painful but must be heard: we're not developing the full human and intellectual capacity of today's college students because they're not learning enough and because the learning that does occur is haphazard and of poor quality. Too many of our college graduates are not prepared to think critically and creatively, speak and write cogently and clearly, solve problems, comprehend complex issues, accept responsibility and accountability, take the perspective of others, or meet the expectations of employers. Metaphorically speaking, we are losing our minds.“ [7, p. 1].

According to Keeling and Hersch, one of the main causes of this situation is teaching-centered culture of colleges and universities:

„Since teaching is what matters and what is measured, instruction is mostly lecture-driven and learning, to the extent that it occurs, is mostly passive, receptive enterprise. In other words, students should come to class, listen carefully, take good notes, and be grateful.“ [7, p. 20].

Lecture-based physics teaching: a paradigmatic example, some learning outcomes and their cause

The central element of “teaching-centered culture” is lecture-based delivery of the course content. It has its roots in medieval pedagogy, when it was the only possible way of passing knowledge from a teacher to students who lived in a world in which books were very rare and expensive. Times have changed drastically and access to printed and digital books increased dramatically.

Nevertheless, lecture-based teaching, complemented by recitation sessions for solving end-of-chapter problems and cookbook lab activities, is still dominating practice in physics education. Its colorful description was given some times ago [8]:

“Stroll down the corridors of a typical college, and glance in some of the classrooms where freshman courses in physics or other technical areas are being taught. Chances are you will

see something like the following. Instructors in front of their captive — but rarely captivated — audience are extolling, with various degrees of enthusiasm, the virtues of physics and solving the problems of the week. Seated obediently in uniform rows facing their leader are the “students,” vigorously scribbling in attempts to transcribe each utterance and every blackboard marking of the instructor. Eyes glaze as students try to avoid fading off.”

A paradigmatic example of this way of teaching, with the highest degree of instructor’s enthusiasm, might be a set of physics lectures delivered by MIT professor Walter G. H. Lewin in 1999. With YouTube revolution, their video versions became world - wide popular, attracting millions of viewers. Prof. Lewin loves physics, and enjoys sharing his love, both with students in lecture hall and the readers of his recent book [9]. While in lecture-hall, he talks eloquently and with a touch of gentle humor, draws nice sketches and schemes, writes many formulas and performs eye-catching demonstrations and experiments.

What are students doing during the lecture? They have to divide their attention between listening to the words said, copying into their notebooks what is written on the blackboard and watching what is Prof. Lewin trying to demonstrate. Being so, they are not given any opportunity to participate intellectually, by answering and discussing some professor’s rhetoric questions (what will happen if I do that?) or formulating their own questions (why did you say that?).

The above description was derived from Prof. Lewin’s lecture “*Weight, perceived gravity and weightlessness*” [10], which was selected because I recently started to use the topic of weightlessness as a context to explore students creativity (preliminary results will be presented later in the article).

The 50-minute lecture has three main parts, carefully thought out and ordered: (1) concepts’ introduction and application; (2) low-tech and high-tech classroom demonstrations of weightlessness; and (3) video presentation of weightlessness inside a plane in free (engines-off) parabolic motion.

The concept of weight is a very controversial one, having at least three different conceptualizations [11]. Although Prof. Lewin recognizes it, saying explicitly that the weight is a non-intuitive and tricky “thing”, he introduces it straightly (and unorthodoxly) as the upward force a scale exerts on the body being weighted (Figure 1). Such a definition strongly contradicts both students’ previous intuitive ideas about, and learning experiences with the weight concept, but no opportunity is given to them to reconsider their ideas and experiences. Instead, a rapid exposition of a few applications of the weight concept is presented. Some of results, very likely paradoxical to students (bodies of *different masses*, connected by a string over a pulley, in an accelerated motion have the *same weight*), were elaborated and commented as being almost self-evident.

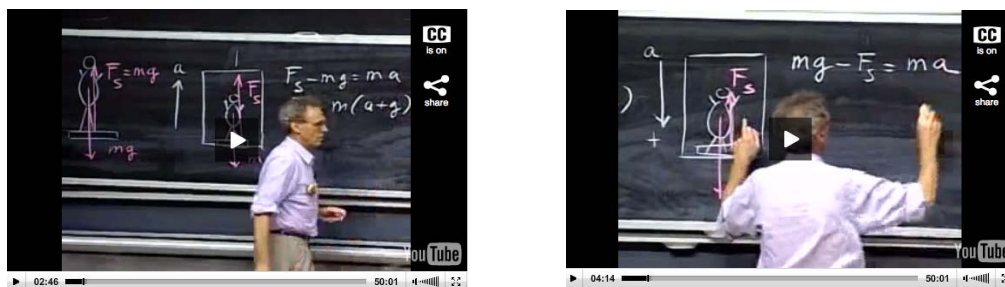

Figure 1. Prof. Lewin is introducing (verbally, visually and symbolically) the concept of the weight as the “force of scale” acting upwards on what is being weighing

Regarding controversial phenomenon of weightlessness, Prof. Lewin presents two types of demonstrations. The first type is low-tech carried out with a one - gallon water container. Initially, Prof. Lewin holds it in his hands, standing on the table (not very common position of a physics professor), and later jumps from the table, separating his hands slightly from the container (Figure 2). Not surprisingly, the container and Prof. Lewin fall in the same way, keeping their spatial configuration equal.



Figure 2. Prof. Lewin is performing a low-tech classroom demonstration of weightlessness of a gallon of water in free fall

The second type of weightlessness demonstration is a high-tech one, showing that two sensitive electronic balances, in free fall, don't register a weight of an attached object. The balances were designed and made at MIT.

It is very important to stress that, before performing both type of demonstrations, Prof. Lewin tells students what they are going to observe.

In the third part, students are shown videos clips about weightlessness experiences of persons on board of a plane moving along a parabolic path with engines off.

The lecture is surely music for the ears of those who already know a lot of physics and are able to understand fine conceptual details and subtle comments. What is unknown, at least to me, is how successful was MIT students' conceptual learning about the phenomenon of weightlessness, checked with right probing questions. Namely, in other educational contexts, students usually have difficulties to gain sound understanding of why and how the bodies behave as weightless [12-15]

Learning results of lecture-based teaching

In fact, poor learning about weightlessness is not an exception but rather a part of general learning outcomes of traditional teaching [16]:

“...No matter how “good” the teacher, typical students in a traditionally taught course are learning by rote, memorizing facts and recipes for problem solving; they are not gaining a true understanding. Equally unfortunate is that in spite of the best efforts of teachers, typical students are also learning that physics is boring and irrelevant to understanding the world around them.”

The diagnosis of unsatisfactory nature of learning results of lecture-based physics teaching can be stated in more specific terms [17,18]:

Conceptual learning is poor or absent.

Functional knowledge is not present.

Students are not able to apply high-order thinking procedures (like going from one to another representation or from abstract definitions and formulas to real word and back).

In addition, even in the domain of physics problem solving, a course part to which a considerable attention is given in traditional lectures, recitation sessions and exams, students mostly “conceptualize” it as a “plug-and-chug” game [19].

Why traditional lecture-based physics teaching does not work well enough?

The basic cause of failure is that this approach to teaching has behind it an erroneous theory of learning, which considers that the essence of learning is reception and memorizing of a clear instructional message. In other words, that approach does not take into account how humans learn [20]. It is almost a trivial fact that humans learn best by doing things, by making and correcting errors.

In order to do things perfectly, humans need to constantly improve their performances. Beside a lot of *step-after-step* practice, they also must think critically and creatively on what they do. It is well understood in sports and music. Nobody will learn to swim listening someone talking about swimming (and about Stokes' force) nor will someone learn to play violin listening someone talking about violin playing (and about Fourier transformations). Successful human learning is, in its very essence, an active process.

What is active physics learning?

Active physics learning (physics learning based on minds-on and hands-on activities) is gaining popularity in physics education, becoming a promising new paradigm which will, sooner or later, replace old paradigm codified in lecture-based teaching and passive learning. It is important to stress that active physics learning paradigm in physics teaching was not inspired and forced by general active learning movement in education [21,22]. Physics education researchers invented it while trying to solve above-mentioned annoying issue of unsatisfactory conceptual students' learning that results from lecture-based teaching.

There are now enough experimental evidences that physics researchers were successful in solving the issue. Namely, activity and inquiry-based learning approach is obviously better than lecture-based teaching regarding conceptual learning [23-25] and problem solving performances [26,27].

What does physics instruction that promotes active learning entail? There are some general answers to this question, such as:

“...Instruction involving students in their own learning more deeply and more intensely than does traditional instruction, particularly during class time” [28],

“...Instructional method that engages students to shift from a passive to an active role in the learning environment” [29].

More informative and practical instructional approach has, as its starting point, the following pedagogical belief:

In order to *learn* physics, students should *do* physics: observe, describe, explain and predict physical phenomena.

In all these thinking processes, students make use of their previous ideas and experiences. When previous ideas do not work, students try new ones, proposed by them or by teacher. New knowledge is the result of *sense making* of new experiences. In order that this sense-making process comes out as a successful one, students should experience, and be conscious of, a “conceptual change” [30,31].

Examples of physics courses that promote active learning

There is a lot of physics-course designs that, in general terms, promote active learning, although might differ in details.

Priscilla Laws (Dickinson College) designed the first lecture-free physics course, called “Workshop physics”, in which students learn physics by doing physics [32-34]. Students in the classroom, with the help of computers, take data about phenomena and make sense of them. Halliday & Resnick textbook is used as a resource material to find out needed information. Its content is not lecture-based delivered to the students in the classroom.

Eric Mazur (Harvard University) designed a method of active learning in which “students teach students” [35]. This is done through peer discussions of subtle points they did not understand by reading assignments (which replace delivery of content). Mazur only “teaches” those parts of the content which students did not comprehend by themselves.

Examples of some other courses that have accepted and implemented fully the paradigm of active physics learning are:

Student-Centered Active Learning Environment for University Physics or SCALE-UP, authored by Robert Beichner at the North Carolina State University [36];

Technology-Enhanced Active Learning or TEAL, designed by John Belcher at MIT [37], and Investigative Science Learning Environment or ISLE, developed by Eugenia Etkina and Alan van Huevelen at the Rutgers [38].

The first two courses were inspired greatly by the ground – breaking “physics studio” approach, designed and installed by Jack M. Wilson at the Rensselaer Polytechnic Institute [39].

Predict – Observe – Explain: an active learning sequence

The most popular sequence of active learning is Predict – Observe – Explain. Explanation and prediction tasks were used long time ago by Piaget as diagnostic tools in his interview-based research on children's causal thinking [40].

Nevertheless, the sequence was introduced into science teaching by White and Gunstone under acronym POE (Predict – Observe – Explain) [41], without mentioning Piaget.

In order that this sequence works, it is necessary that students first have (according to their criterions) a meaningful situation about which they can answer questions. In answering such questions, students activate their intuitive ideas about how material world works or should work.

As can be concluded from its name, the Predict-Observe-Explain sequence consists of three steps.

1. In the first step, through prediction task about how a physical phenomenon or its simple modification will work, student personally activates and formulates his or her alternative ideas about considered physical phenomenon: What do I expect that will happen? Why do I expect that this must or might happen?

In this way, any student has an opportunity to predict personally an outcome of a simple experiment and to conceptually justifies his or her prediction. In this step, especially during elaboration of prediction justification, alternative ideas about functioning of particular segments of physical world are activated and explicitly formulated.

When personal predictions and justifications are formulated, then group discussion of those predictions and justifications comes, with the aim to reach consensus, meaning a group prediction and justification. It is important to tell students that everyone should keep personal prediction and justification, if not completely satisfied with different prediction and justification.

2. The second step is observation and comparison between personal and group prediction and observation. In the case of well thought learning situation, the prediction and observation do not coincide. When this happens, an „epistemological disequilibrium“ has been produced and the students have concluded that their thinking about the studied phenomenon (or some of its modifications) is not adequate.

3. In the third step, students have a challenging task to explain the noted differences and to propose a change in the suppositions and reasoning their prediction was based on. The objective of the change is that the new prediction fits the observation.

My first illustration of Predict-Observe-Explain sequence implementation is students' consideration of the behavior of a jet that flows out of a plastic bottle through a hole made in its wall [42]. Students are able to predict that the jet will stop to flow out if the bottle is in free fall, but the prediction schemes are not related to the weightlessness of water but to the same speed of the bottle and the water or to the («increased») air pressure which keeps water in the bottle.

Nevertheless, even after the students saw that the jet stopped flowing out when the bottle was in free-fall, they do not expect that the jet will stop flow when the bottle is launched up. Their prediction, for the situation when the bottle is moving freely up, is that the jet will not stop flowing out but that the flow will be faster.

After seeing that their prediction does not fit the observation (the jet stops flow out also when the bottle is moving freely up), the students are ready to reconsider critically their situation model and explanatory schemes and to change them.

In my second illustration of the POE, students are asked to predict what will happen with a Pepsi-light can, that floats in water (Figure 3), if oil is poured in the jar.



Figure 3. A Pepsi-light can floats in water

Figure 4. A Pepsi-light can levitates in water and oil

Many students believe that the floating can, having oil pressing down, should go deeper in water. Some even predict that the can will be below the water surface. Observation is quite different: the can rises higher (Figure 4), previously under the surface «Pepsi red-white-blue heart» goes out of water. That consequence of oil pouring is almost a miracle for students. The construction of an adequate qualitative explanation is not an easy task. All students know

to recite Pascal principle but fail to activate it and apply it this context. Hydrostatic oil pressure on the water surface is bigger than on the upper surface of the can and the pressure is transmitted through the water increasing the pressure on the bottom of the can.

Recently an interesting variation of POE learning sequence was suggested [43]. Its acronym PEOR stays for Predict – Explain – Observe – React. The most important part of is naturally R – phase in which students can reinforce, revisit o rethink their initial ideas or test, change or reinforce new ideas.

Fast and slow thinking: a broader view on students thinking in physics learning

As students frequently «fail» in their predictions, it is useful to stress to them the importance of being able to formulate and know own ideas, even if they initially look out as unproductive. In fact, it seems that humans' thought production is carried out by two very different systems. Kahneman, Nobel Prize winner for economics, in his best-selling book “*Thinking, fast and slow*” [44], describes (and gives research-based evidence of) facets of two different modes in which human brains operate when answering questions and solving challenging problems:

System 1 is fast, automatic, frequent, emotional, stereotypic and subconscious.

System 2 is slow, effortful, infrequent, logical, calculating and conscious.

Sparing their mental energy, humans routinely use *System 1* for level of thinking needed by common-type actions (driving a car or buying groceries). Students do the same in their first try to answer «easy» school questions (which body, heavy or light one, will fall faster towards the ground?).

A common person calls *System 2* into action only when *System 1* recognizes that a problem can't be solved in stereotypical approach.

Active physics learning is a great opportunity for students to learn about normality of *System 1* activation and to start to use *System 2* more frequently. That is not an easy task and we should be very patient with students, because even scientists are not always able to resist the «siren's song» of the *System 1*.

Namely, in essence, modern training of future scientists is (or should be!) their systematic preparation in using *System 2* routinely. Nevertheless, to assure a desired accuracy level of scientific production, many quality control mechanisms are in place in scientific journals, being thought out as a collective protective bell against writings in which scientists' thinking, in some “weak moments”, was too fast and carried out by the *System 1*. After years of practice, many scientists are able to use almost exclusively the *System 2* in preparing their research publications.

Surprisingly, some of them, when writing physics textbooks, especially when inventing end-of-chapter problems, give chance and voice to their *System 1* and make errors they would hardly be allowed to have in a published journal article. Alarming enough, some rather trivial errors, measured by professional standards, are repeated in various editions of the same textbooks [45] and some others lived in various physics textbooks for centuries [46].

A very instructive example of fast thinking universality is common answer which many today's students (and some teachers) give to very old «snail problem». Here it comes in its easy, round-number version:

A snail, driven by an unknown reason, decided to climb a 10-meter wall. During the day, it climbs 3 meters, but during the night it falls back 2 meters. After how many days and nights, will it reach the top of the wall?

- (a) 10 days and 10 nights; (b) 10 days and 9 nights;
(c) 8 days and 7 nights; (d) 4 days and 1 night.

Well known wrong answer «10 days and 10 nights» is obtained by an «obvious» reasoning: During one day and one night the snail climbs 1 meter. If it should climb 10 meters, the needed climbing time “must be” 10 times bigger. Slow thinking gives another result. During seven days and seven nights the snail climbs seven meters. At the end of the eighth day, after climbing missing three meters, the snail will reach the top.

What is not so widely known (but surely should be!) is that the fast-thinking students' answer was «professional answer» given by mathematicians to different formulations of this problem during a few centuries, for example, in Italy from early 13th century to late 15th century [47]. Among those mathematicians was also Fibonacci, one of the best in the Middle Ages. In his famous textbook «Liber abaci», published in 1202, he formulated the problem this way:

“On the Lion Who Was in a Pit

A certain lion is in a certain pit, the depth of which is 50 palms, and he ascends daily $1/7$ of a palm, and descends $1/9$. It is sought in how many days will he leave the pit.” [48, p. 273]

Using the same fast-thinking approach as today’s students, Fibonacci finds the difference between $1/7$ and $1/9$, obtaining $2/63$. After that he divides 50 with $2/63$ to get the answer of 1,575 days. Nevertheless, slow-thinking answer is 1,572 days and 1,571 nights.

I will add one more example of fast-thinking phenomenon connected with the snail problem, taken from a recent published book “Games and mathematics. Subtle connections” [49], written by David Wells, former Cambridge student, chess champion and prolific author of many popularization books on mathematics. The book, issued by one of the world best publishing company, has the following review:

“Wells notes that mathematicians use analogy and other play techniques as they construct proof. He draws the reader to a new appreciation of proof - not mere certification of correctness but a deeper exploration of the mathematical world. Games and Mathematics makes an important advance in communicating the nature of mathematics. It contains a profound message for philosophers of mathematics, but all mathematically-inclined readers will find Games and Mathematics as compelling as Wells' excellent "Curious and Interesting" books.”

Dr. Paul Brown, Carmel School, Perth, Western Australia and Author of
“Proof: Interesting Activities in Conjecture and Mathematical Proof”

After such a review, nobody would expect that Wells would offer an incorrect, fast-thinking answer to his formulation of the snail problem (p. 4):

“Another traditional puzzle appeals to me because it sets the solver a trap, albeit a rather obvious one. Here is one version. A snail – or a serpent or a frog! – lies at the bottom of a well, 30 units deep. It climbs 6 units every day but falls back 3 units every night. How long does it take to escape from the well? The obvious answer is that the snail rises 3 units every day-and-night, on balance, so it takes 10 days-and-nights to escape, but this is wrong because it will actually reach the top of the well half-way through the 10th day and after only 9 nights.”

Slow-thinking answer is different. During eight days and eight nights, the snail would climb up to 24 units and during the ninth day, after climbing missing 6 units, would reach the top.

The essence of active learning: self-regulated learning how to learn

As the snail problem shows, fast thinking is very hard to be freed off. Mind, as many of us, first wants to try to carry out mental tasks in the most effortless way. It seems to me that the road toward slow thinking can be better walked if we help students learn how authentic human learning works. In order to make successful experiments with their own learning to improve it, only practice of active learning is not enough. They should also learn about its theory.

Active physics learning, as actually designed and practiced in physics education, might be improved, both at students' and teachers' side, if it is informed about a more complex and much elaborated educational construct, called "*self-regulated learning*" [50-52].

So, a very challenging and far-reaching approach to design of active physics learning would be to inform students much more about the complexity of the learning and thinking process, fast and slow thinking are only a top of an iceberg. That would be done best, if we design opportunities for the students to plan, practice and observe their own learning within the self-regulation paradigm.

Regarding metacognitive aspects of learning, self-regulated learners plan, set goals, organize, self-monitor, and self-evaluate gained results at various points during the learning process. They are also very motivated, showing high self-efficacy, self-attribution and intrinsic task interest. In addition, self-regulated learners know and accept that learning results are better with more efforts and persistence and inside of an adequate learning environment [53]. The success of self-regulated learning depends of students' abilities to activate and use in the best way metacognitive, motivational and behavioral resources and strategies.

According to Zimmerman [54], self-regulated learning process consists of three different phases:

Forethought or planning phase;

Performance phase; and

Self-reflection phase.

In the Planning phase, students activate all necessary knowledge and skills to understand the given problem and make a plan how to solve it.

In the Performance phase, they monitor how they perform, whether some unexpected or unclear details appear, and verify validity of partial and final solution.

Self-reflection phase is the most important part of self-regulated learning. In it, students are supposed to look back and evaluate critically their performance and what was learned and what was not. In the last phase, they try to determine what possible causes of their unsuccessful learning might be. In order to assist students in their self-reflective performance, we should provide students with an adequate and timely feedback at every stage of implemented learning sequence.

In addition, formative and summative assessment should award personal ideas and arguments not only for correctness but also for clearness or originality. Students appreciate when we are interested in what and how they think and when their initial thinking is not punished or subject of laugh. Freedom of thinking, which includes an explicit right to err, is the first precondition of any learning.

Learning from self-recognized and self-corrected personal and group errors seems to be a better way to construct knowledge and skills than direct instruction [55,56].

What are some effects of active physics learning?

In his doctoral research, Dr Mirko Marušić, then a high-school physics teacher in Split (Croatia), explored, under my mentorship, different effects of two designs of active learning experiences: *Read – Present – Question (RPQ)* and *Experiment – Discuss (ED)*. The topics of the RPQ group were actual CERN experiments. The topics of the ED group were simple phenomena for which students hold strong intuitive ideas which differ from scientific ones.

The research was carried out during one semester (16 weeks), within one 45-minute session per week. Interested readers can find more details about students, curriculum and treated themes, in the articles cited below.

In brief, the ED group outperformed the RPQ group in

Classroom Test on Scientific Reasoning [57];

Colorado Learning Attitude about Science Survey [58];

Changing negative attitude towards attractiveness of school physics [59]; and

Changing negative attitude towards physics as profession [60].

Although the analysis is still under way, preliminary results indicate that students initially believed that physics learning helps in developing logical thinking but not creative thinking. After active learning experiences, the students in ED group made much bigger attitudinal change towards the relationship between physics learning and creative thinking. The change in concrete thinkers' attitude is very characteristic. In the RPQ group, concrete thinkers after learning experiences with modern physics topics believe less that physics learning has something to do with development of creative thinking. In ED group the situation is quite opposite. Concrete thinkers made bigger relative attitudinal improvement regarding creativity development.

To measure that attitude and its change, students had to express their justified opinions regarding the statement:

“I feel good while learning physics because it helps me to develop my creative thinking.”

The students could choose one option on a 5-point Likert scale:

(a) I strongly disagree (graded as “-2”); (b) I disagree (“-1”); (c) Neutral (“0”); (d) I agree (“+1”); and (e) I strongly agree (“+2”).

Only in ED group, there were cases of total attitudinal change. Below come three of them:

Student 1

Pre: (-2) *I don't feel well in physics classes because it is boring. This also means there is no creativity, no creative thinking.*

Post: (+2) *I feel good in physics classes that look like a game. It makes it always exciting and encourages us to think creatively with no fear of bad grades.*

Student 2

Pre: (-2) *Studying physics may develop logical but definitely not creative thinking. Everything is predefined. I can fantasize about „what if“ but that is not physics.*

Post: (+2) *Creativity is very much present in physics. It was nice to experience that creative thinking is possible in physics classes as well (debate, analyzing everyday life examples, interesting experiments...).*

Student 3

Pre: (-2) *Creativity in physics that I know does not exist. It may be present in physics in general but I don't find it in physics as a school subject.*

Post: (+2) *Creative thinking processes in physics classes surprise me. We were asked to explain the experiments in from of the class. It was creative and even interesting (funny at times). It is a great feeling!*

How to promote students' creativity in active physics learning?

In the above-commented pilot research, we did not explore students' personal definitions of creativity, believing that a common-sense notion of creativity (generation of novel and useful ideas and products) is shared by majority of them.

In addition, our hypothesis was that active physics learning would help students to discover and feel their own creative potentials.

In the group that performed and discussed experiments with easy-to-find ordinary objects that happened much more than in the group in which students were reading and presenting information about sophisticated physics experiments carried out at the CERN. This is an important initial result which shows that active physics learning can contribute to improve attitude students have towards the relationship between physics learning and development of creative thinking. Students are more likely to connect creativity and physics learning when they do physics, no matter how simply is to carry out and modify physical phenomena studied, than when they read about physicists do cutting-edge physics with extremely sophisticated technology.

Now, more than ever before, it is clear to many that creativity can't be only nice-looking decorative element among other educational objectives. Everybody agree that today's and tomorrow's economic, social, nutritional and medical problems of modern world can only be solved by ever-increasing personal and collective creative thinking. Such a cultural change would be impossible if «teaching and learning creativity» isn't present in classroom on daily basis.

Nevertheless, such a task is far from being simple because there are many hard implementation questions. For teachers, the most important are:

- (a) How to have real and adequate presence of creativity in curriculum?
- (b) How to teach creativity in effective ways?
- (c) How to evaluate progress in creativity thinking of students?

Due to the fact that psychological processes, which creativity thinking and behavior are based on, are extremely difficult to define, explore and evaluate [61,62], these important questions have by now only initial answers [63–65]. In addition, some «practical» suggestion for classroom building of students' creativity are either too numerous [66] or too general [67].

Creativity in problem solving

In my own teaching, at the very beginning, I define creativity operationally as non-routine thinking. To give meaning to this «negative» definition of creativity, students have first to experience what routine thinking is and what its limitations are.

The best way to show it is to present good puzzles to students. Their usefulness comes from the fact that they are easily understandable and usually do not require specific-content knowledge for their solution.

When students approach a puzzle within routine, fast thinking, they either get wrong answer or conclude that it is impossible to answer it. An acceptable answer, of course, can be found only by using non-routine thinking. That is an «Eureka moment» for many students. It comes as an award for initial common-felt frustration when they were in routine-thinking phase.

According to many authors, multiple experiences with transitions between routine and non-routine thinking, when followed by related epistemological discussions and reflections, help students in «improving thinking, learning and creativity» [68], learning about «the art and logic of breakthrough thinking» [69] and making progress in «critical thinking, mathematics, and problem solving» [70].

Connecting creativity and non-routine thinking give me opportunity to help students discover that they are much more creative than they usually think. Namely, many of them connect creativity only with big artistic and scientific creations. In addition, they discover that they can improve such-defined creativity. That is best practiced with the problems that can be solved in routine (algorithmic) ways, but whose solution is much simpler or interesting by using non-routine (creative) approach. Asking for and praising alternative solutions of problems, in my view, give students an opportunity to build disposition for and to practice creative thinking.

When students acquire sufficient content knowledge, then they can explore and improve their creative potential solving «physics puzzles». These are calculation or practical physics problems that, at first sight, look impossible to solve:

Is it possible to determine mean density of Earth using a satellite and a chronometer?

Is it possible to determine relative density of oil using a plastic tube and a ruler?

Is it possible to determine the depth of a lake using only graduated test tube?

As in the case of ordinary puzzles, routine thinking (to determine density one needs to measure mass and volume) is an obstacle for finding the solution. Non-routine or creative thinking is necessary in order to find out surprising fact that there exists a relationship between mean Earth density and the period of a satellite, with no other physical quantity involved. That makes possible to calculate mean density when the value of the period is measure by a chronometer.

Lifting two glasses by one balloon: an example of students' pedagogical creativity

Physics students at my University are exposed mainly to the traditional lecture-based teaching. So, it is not a wonder that, in their first try to prepare and present potential engaging demonstrations for middle-school pupils, the students think that the most important part of them is a “clear and logical” explanation of the physics behind demonstrations. Because of such a belief, in the course “Physics teaching” (an obligatory methodic course for all physics students!), I have to help students' develop “pedagogical creativity”: an ability to use in novel

and appropriate way known physics demonstrations. “Appropriate way” means that presentation of a demonstration should be designed in the form that is likely to motivate and engage pupils in active physics learning.

In the course offered in Spring of 2005, the student Sergio Rivera Hernández designed the best sequence. The account which follows is revised version of the presentation which Sergio and I presented the same year at the International Workshop «New Trends in Physics Teaching» [71].

Sergio started his demonstration by putting on the table a glass (in vertical position) and a desinflated balloon. The he asked: Is it possible to lift the glass using the ballon?

After a while, other students figured out a right answer. The ballon is put in the glass and inflated. When the ballon presses the wall of the glass strongly enough, it is possible to lift the glass by lifting the neck of the ballon. (Figure 5).



Figure 5. Lifting one glass by the ballon
Figure 6. Lifting two glasses by the ballon

After that, a serious challenge came. Sergio put on the table two glasses in vertical position and asked: Is it possible to lift these two glasses using one ballon?

In the first moment, it was a real puzzle for all and nobody had an idea how to lift two glasses. After some time, there were a few unsuccessful tries. A student wanted to use routine solution. She tried to force one glass into other in order in order to lift them together. She pressed so strongly and broke one glass. Finally, we all had to admit that we were totally clueless.

Sergio took two glasses and put them in horizontal position, with their openings near one to other. The he put the ballon between the glasses and inflated it. It was possible to lift two glasses (Figure 6). We all were delighted with the solution which appears to be a simple one when one sees it, but it is extremely hard to find if one follows routine thinking.

After some other students repeated to solution themselves, they had task to discuss the physical mechanism responsible for glass lifting. Students came with to causal models. In the “friction model”, the friction force between the inflated ballon and the glass wall doesn’t allow separation of the glass and the ballon. In the “pressure difference model”, the separation of the glass and the ballon was not possible because of reduced pressure of the air in the glass. That was an *ad hoc* “theory” because students didn’t have any idea how what caused that reduced pressure.

The next task was to design experimental tests of two proposed causal mecanisms. One proposal was the following:

If the lifting is due to friction force, it will not work if the friction is reduced drastically.

To check it, students oiled one glass. The result was that the ballon could lift un-oiled glass but not the oiled one (Figure 7). This experiment confirmed predictive power of “friction model”.

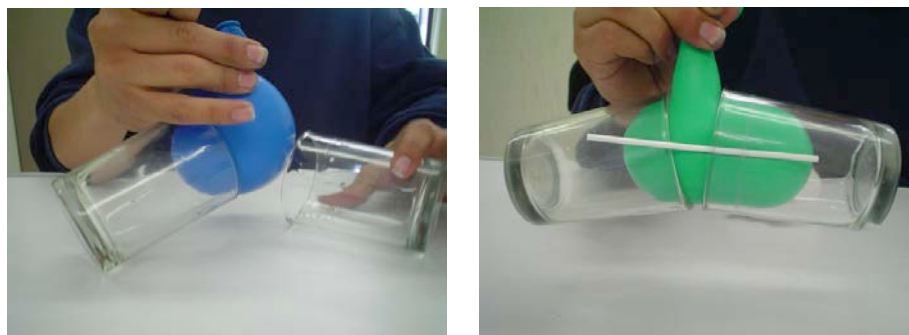

Figure 7. The oiled glass couldn't be lifted
 Figure 8. Equalizing pressure does not make change

Students argued that if the cause of lifting is the reduced pressure in the glass, then if the pressure in the glass is made equal to the atmospheric pressure, the glass wouldn't be lifted. That prediction was checked in the following way. A strong plastic straw was placed between the glass and the balloon, connecting the air in the glass with air outside. That made both pressures equal, without destroying «lifting power» of the balloon (Figure 8). This experiment reduced the credibility of the «pressure difference model».

I consider that both purposeful preparation of engaging demonstrations and discussion and design of experiments, that are necessary to understand better the physics which make demonstrations possible, are adequate and act in complementary fashion to promote students' pedagogical and scientific-thinking creativity.

Weightlessness in classroom: another opportunity for students' creativity

In the course "Physics teaching" students freely choose which demonstration might be engaging for middle-school pupils. They have another opportunity for showing their pedagogical creativity. It happens after they learn about "Bottle in free-fall" demonstration of weightlessness. After getting a clear idea why it happens, as a transfer test, they should design a different free-fall demonstration of weightlessness. I will present a few of students' proposal.

The first is "magnetic demonstration", whose initial idea was proposed by the student Heladio Ayala. Two neodymium magnets (Figure 9) are placed in the plastic tube, one fixed on the top and other movable on the bottom. When the tube is at rest, the upper magnet is unable to lift the lower magnet. In free-fall, the lower magnet is attracted upwards [72].

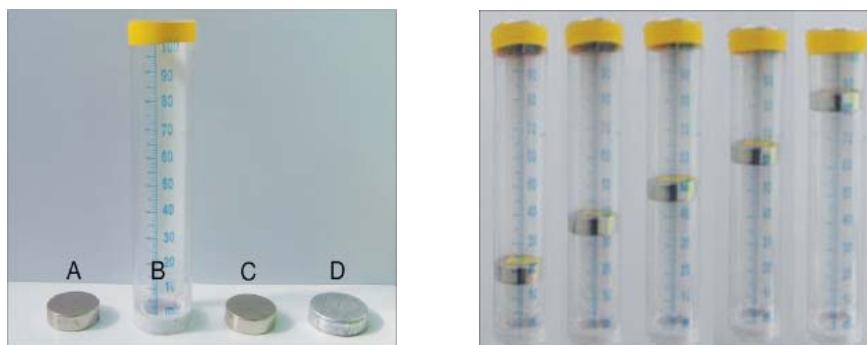

Figure 9. Items needed for magnetic
 Figure 10. The lower magnet is attracted upwards. Demonstration of weightlessness.

The student Eric F. Jiménez Andrade proposed a demonstration with a protractor, a hard cardboard in the form of an L, a spring and a weight. When the protractor is at rest, the weight and the spring keeps the longer arm of the cardboard in horizontal position. In free-fall, the cardboard starts to rotate, because the weight becomes weightless (Figure 11).

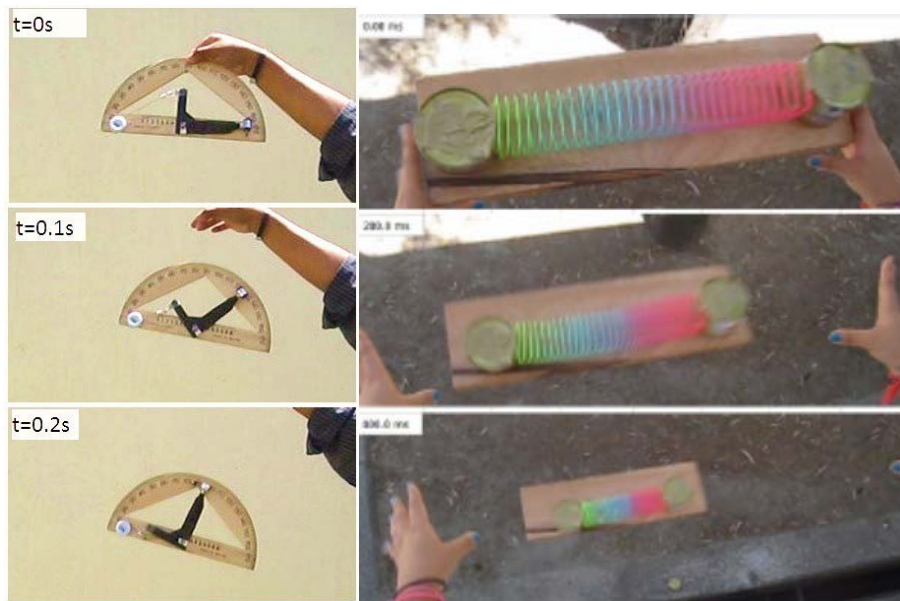

Figure 11. Demonstration with a protractor

Figure 12. Demonstration with a slinky and two cans

The students Adriana Pérez Martínez and Raúl Felipe Maldonado Sánchez proposed a demonstration with a slinky, wood board and two cans. Two cans are attached to the extended slinky and placed on the board.

When in rest, the friction between the cans and the board prevents the slinky from contracting.

In free fall, the cans don't press the board, the friction disappears and the slinky contracts (Figure 12).

Not all proposals were successful. For example, some students thought that a bubble in free-falling bottle should be motionless, because the buoyant force would disappear. They based their design of a weightlessness demonstration on the slow-thinking idea “*no force – no motion*”.

Video recording with high-speed camera and a frame-after-frame analysis, performed by Adrian Corona, show that the bubble continues to move up even after the buoyant force was switched-off in free-fall (Figure 13).



Figure 13. The bubble continues to move upwards even in the free-fall

Conclusions

According to my experience, active physics learning is able to accelerate students' cognitive growth, make positive changes in students' attitude towards physics and to improve their conceptual understanding and creative thinking. I am always glad to learn students' unexpected and amazing ideas. In addition, it makes me happy when students' enjoy learning and when they reveal anonymously that they share the joy or learning with parents, brothers, boyfriends and girlfriends.

To further develop active physics learning, we should work more explicitly on informing students about all complexity of human learning. The paradigm of self-regulated learning has a lot results which might be useful for designing improved active learning sequences.

On the other side, active physics learning should not be preferential pedagogical approach in only one or a few courses. It should be rather a basic element of institutional policy in the domain of learning and teaching. Such an institutional acceptance is neither fast nor easy, due to many «obvious» counter arguments. Seemingly the most solid, cost-effectiveness of lecture-based teaching, was proven to be false [39]. Changes made in Prof. Lewin's video course in its edX version, by which some elements of explicit students' mental activities in video watchings were introduced, are certainly a very good news [73]. Let's hope that in the future we will lecture less and students will learn more.

Acknowledgements

This article is partially based on the results of Josip Sliško's sabbatical research project "Active physics learning on line" supported by CONACyT Mexico in the period August 2012 – July 2013.

The author would like to thank Dr. Marina Milner - Bolotin, from the University of British Columbia, Vancouver, for her insightful comments and suggestions.

References

- [1] Argyris C.: Teaching smart people how to learn, Harvard Business Review 4, No 2 (1991), p. 99 –109.
- [2] Drucker P. F.: Knowledge-worker productivity: The biggest challenge, California Management Review 41, No 2 (1999), p. 79–94.

- [3] Drucker P. F.: Managing Oneself, Harvard Business Review 83, No 1(2005), p. 100 - 109.
- [4] Wagner T.: Rigor redefined. Educational Leadership 66, No 2 (2008), p. 20 – 25.
- [5] Jarvis P. (editor): The Age of Learning: Education and the Knowledge Society. London: Taylor and Francis Group (2001).
- [6] Graham P. A. (editor): Knowledge Economy and Postsecondary Education: Report of a Workshop. Washington, DC: National Academic Press (2002).
- [7] Keeling R. P., Hersh R. H.: We're Losing Our Minds. Rethinking American Higher Education. New York: Palgrave Macmillan (2012).
- [8] Gautreau R., Novemsky L.: Concepts first — A small group approach to physics learning. American Journal of Physics 65, No 5 (1997) p. 418 - 428.
- [9] Lewin W.: *For the Love of Physics: From the End of the Rainbow to the Edge of Time - a Journey Through the Wonders of Physics*. New York: Simon and Schuster (2012).
- [10] Lewin W.: (1999). Lecture 7. <http://ocw.mit.edu/courses/physics/8-01-physics-i-classical-mechanics-fall-1999/video-lectures/lecture-7/>
- [11] Galili I.: Weight versus gravitational force: Historical and educational perspectives. International Journal of Science Education 23, No 10 (2001), p. 1073 - 1093.
- [12] Galili I.: Interpretation of students' understanding of the concept of weightlessness. Research in Science Education 25, No 1(1995), p. 51 - 74.
- [13] Gürel Z., Acar H.: Research into students' views about basic physics principles in a weightless environment. Astronomy Education Review 2, No 1 (2003), 65 - 81.
- [14] Sharma M. D., Millar R. M., Smith A., Sefton I. M.: Students' understandings of gravity in an orbiting space-ship. Research in Science Education 34, No 3 (2004), p. 267 - 289.
- [15] Tural G., Akdeniz A. R., Alev N.: Effect of 5E teaching model on student teachers' understanding of weightlessness. Journal of Science Education and Technology 19, No 5 (2010), p. 470 - 488.
- [16] Wieman C., Perkins K.: Transforming Physics Education, Physics Today 58, No 11 (2005), p. 26 - 41.
- [17] McDermott L. C.: Millikan Lecture 1990: What we teach and what is learned - Closing the gap. American Journal of Physics 59, No 4 (1991), p. 301-315.
- [18] McDermott L. C.: Guest Comment: How we teach and how students learn — A mismatch? American Journal of Physics 61, No 4 (1993), p. 295 - 298.
- [19] Wells M., Hestenes D., Swackhamer G.: A modeling method for high school physics instruction. American Journal of Physics 63, No 7 (1995) p. 606 - 619.
- [20] Bransford J. D., Brown A. L., Cocking R.R. (editors): How People Learn. Brain, Mind, Experience, and School. Expanded Edition. Washington, D.C.: National Academy Press (2001).
- [21] Bonwell C. C., Eison J. A.: Active Learning. Creating Excitement in the Classroom. Washington: The George Washington University (1991).
- [22] Harmin M.: Inspiring Active Learning. A Handbook for Teachers. Alexandria: Association for Supervision and Curriculum Development (1994).

- [23] Hake R. R.: Interactive-engagement versus traditional methods: A six-thousand student survey of mechanics test data for introductory physics courses, *American Journal of Physics* 66, No 1 (1998), p. 64 – 74.
- [24] Deslauriers L., Schelew E., Wieman C.: Improved Learning in a Large-Enrollment Physics Class. *Science* 332, No 6031 (2011), p. 862 - 864.
- [25] Scott T., Gray A., Yates P.: A controlled comparison of teaching methods in first-year university physics. *Journal of the Royal Society of New Zealand* 43, No 2 (2013), p. 88-99.
- [26] Thacker B., Kim E., Trefz K., Lea S. M.: Comparing problem solving performance of physics students in inquiry-based and traditional introductory physics courses. *American Journal of Physics* 62, No 7, (1994), p. 627–633.
- [27] Hoellwarth C., Moelter M. J., Knight R. D.: A direct comparison of conceptual learning and problem solving ability in traditional and studio style classrooms. *American Journal of Physics* 73, No 5, (2005) p. 459 – 463.
- [28] Meltzer D. E., Thornton R. K.: Resource Letter ALIP–1: Active-Learning Instruction in Physics. *American Journal of Physics* 80, No 6 (2012), p. 478-496.
- [29] Prince M.: Does active learning work? A review of the research. *Journal of Engineering Education* 93, No 3 (2004), p. 223 – 231.
- [30] Dykstra D. I., Boyle C. F., Monarch I. A.: Studying conceptual change in learning physics. *Science Education* 76, No 6 (1992), p. 615 - 652.
- [31] Galili I.: Students' conceptual change in geometrical optics. *International Journal of Science Education* 18, No 7 (1996), p. 847 - 868.
- [32] Laws P.: Workshop Physics: Learning introductory physics by doing it. *Change: The Magazine of Higher Learning* 23, No 4 (1991), p. 20 - 27.
- [33] Laws P. W.: *Workshop Physics Activity Guide Modules 1 - 4*, New York, NY: John Wiley and Sons (1996).
- [34] Laws P.W.: Millikan Lecture 1996: Promoting active learning based on physics education research in introductory physics courses. *American Journal of Physics* 65, No 1 (1997), p. 14 – 21.
- [35] Mazur E.: *Peer Instruction: A User's Manual*. Upper Saddle River, NJ: Prentice Hall (1997).
- [36] Beichner R. J.: Student-Centered Activities for Large-Enrollment University Physics (SCALE UP)," presented at the Sigma Xi Forum: "Reshaping Undergraduate Science and Engineering Education: Tools for Better Learning", Minneapolis, MN, 1999 (unpublished).
- [37] Dori Y. J., Belcher J.: How does technology-enabled active learning affect undergraduate students' understanding of electromagnetism concepts? *The Journal of the Learning Sciences* 14, No 2 (2005), p. 243 -279.
- [38] Etkina E., Van Heuvelen A.: Investigative science learning environment – A science process approach to learning physics. In Redish, E. F., Cooney, P.J. (editors): *Research-based reform of university physics*. College Park, MD: American Association of Physics Teachers (2007).

- [39] Wilson J. M.: The CUPLE physics studio. *The Physics Teacher* 32, No 9 (1994), p. 518 – 523.
- [40] Piaget J.: *The child's conception of physical causality*. Oxford, England: Harcourt, Brace (1930).
- [41] White R., Gunstone R.: *Probing Understanding*. London and New York: The Falmer Press (1992).
- [42] Corona A., Sliško J., Planinsic G.: Rising freely bottle also demonstrates weightlessness. *Physics Education* 41, No 3 (2006), p. 8 – 9.
- [43] Bonello C., Scaife J.: PEOR: Engaging students in demonstrations. *Journal of Science and Mathematics Education in Southeast Asia* 32, No 1 (2009), p. 62 - 84.
- [44] Kahneman D.: *Thinking, fast and slow*. New York: Farrar, Straus and Giroux (2011).
- [45] Sliško J.: *Repeated errors in physics textbooks: What do they say about the culture of teaching?* in Raine D., Hurkett C., Rogers L. (editors): *Physics Community and Cooperation*. Vol. 2, Proceedings of the GIREP-EPEC & PHEC 2009 International Conference, Leicester: Lulu / The Center for Interdisciplinary Science, University of Leicester (2011), p. 31 – 46.
- [46] Sliško J.: “Total force” on bodies immersed in air and water: An error living three centuries in physics textbooks. *Review of Science, Mathematics and ICT Education* 4, No 1 (2010) p. 5 – 23.
- [47] Singmaster D.: Sources in recreational mathematics. An annotated bibliography. Eight preliminary edition (2004). Consulted at the web page of the Puzzlemuseum.com: <http://puzzlemuseum.com/singma/singma6/SOURCES/singma-sources-edn8-2004-0319.htm#Toc69534276>
- [48] Sigler L.E.: (2003). *Fibonacci's Liber Abaci. Leonardo Pisano's Book of Calculation*. First soft edition. New York: Springer.
- [49] Wells D.: *Games and mathematics. Subtle connections*. New York: Cambridge University Press (2012).
- [50] Pintrich P. R.: Understanding self-regulated learning. *New directions for teaching and learning*, 1995, No 63 (1995), p. 3 - 12.
- [51] Low R., Jin P.: Self-Regulated Learning In *Encyclopedia of the Sciences of Learning*, New York: Springer (2012), p. 3015 - 3018.
- [52] Zimmerman B. J., Schunk D. H. (editors): *Self-regulated learning and academic achievement: Theoretical perspectives*, New York: Routledge (2013).
- [53] Zimmerman B. J.: Self-regulated learning and academic achievement: An overview, *Educational psychologist* 25, No 1 (1990), p. 3 - 17.
- [54] Zimmerman B. J.: Becoming a self-regulated learner: An overview. *Theory into practice* 41, No 2 (2002), p. 64 - 67.
- [55] Kapur M.: Productive failure in learning the concept of variance. *Instructional Science* 40, No 4 (2012), p. 651 – 672.
- [56] Siler S. A., Klahr D., Price N.: Investigating the mechanisms of learning from a constrained preparation for future learning activity. *Instructional Science* 41, No 1, (2013) p. 191 – 216.

- [57] Marusic M., Slisko J.: Influence of three different methods of teaching physics on the gain in students' development of reasoning, *International Journal of Science Education* 34, No 2, (2012) p. 301 – 326.
- [58] Marusic M., Slisko J.: Effects of two different types of physics learning on the results of CLASS test, *Physical Review Special Topics: Physics Education Research* 8, No 1, (2012), p. 010107/1 – 010107/12.
- [59] Marusic M., Slisko J.: Increasing the attractiveness of school physics: The effects of two different designs of physics learning, *Revista Mexicana de Física E* 58, No 1 (2012) p. 75 - 83.
- [60] Marusic M., Slisko J.: Many high-school students don't want to study physics: active learning experiences can change this negative attitude! *Revista Brasileira de Ensino de Física* 34, No 3 (2012) p. 3401/1 – 3401/11.
- [61] Runco M.A.: Creativity. *Annual Review of Psychology* 55, (2004), p. 657 - 687.
- [62] Hennessey B. A., Amabile T. M.: Creativity. *Annual Review of Psychology* 61, (2010), p. 569 – 598.
- [63] Piirto J.: Creativity for 21st century skills. How to embed creativity into the curriculum. Rotterdam: Sense Publishers (2011).
- [64] Gregerson M. B., Snyder H. T., Kaufman J. C.: *Teaching Creatively and Teaching Creativity*. New York: Springer (2013).
- [65] Barbot B., Besançon M., Lubart T. I.: Assessing Creativity in the Classroom. *The Open Education Journal* 4, Supplement 1: M5 (2011), p. 58 - 66.
- [66] Cheng V. M.: Developing physics learning activities for fostering student creativity in Hong Kong context. *Asia-Pacific Forum on Science Learning and Teaching* 5, No 2 (2004), p. 1 – 33.
- [67] Gregory E., Hardiman M., Yarmolinskaya J., Rinne L., Limb C.: Building creative thinking in the classroom: From research to practice. *International Journal of Educational Research* 62 (2013), p. 43-50.
- [68] Bransford J. D., Stein B. S.: *The Ideal Problem Solver. A Guide for Improving Thinking, Learning and Creativity*. New York: W. H. Freeman & Company (1993).
- [69] Perkins D.: *Archimedes' Bathtub. The Art and Logic of Breakthrough Thinking*. New York: W. W. Norton & Company (2000).
- [70] Michalewicz Z., Michalewicz M.: *Puzzle-based Learning: Introduction to critical thinking, mathematics, and problem solving*, Melbourne: Hybrid Publishers (2008).
- [71] Rivera Hernández S., Slisko J.: Levantar dos vasos mediante un globo: usando un truco de fiestas para enseñar y aprender la naturaleza de la física. *Memorias del Taller Internacional "Nuevas Tendencias en la Enseñanza de la Física"*. Puebla: Facultad de Ciencias Físico-Matemáticas (2005).
- [72] Ayala H., Slisko J., Corona A.: Magnetic demonstration of weightlessness: A spark of student creativity. *The Physics Teacher* 49, No 8 (2011) p. 524 -525.
- [73] Belcher J.: MIT Physics Department's Experience with edX. *MIT Faculty Newsletter* 26, No 1 (2013) p. 1, 12 – 14.

Active Learning and Teacher Training: Lesson Study and Professional Learning Communities

Kyoko Ishii

Faculty of Education, Tamagawa University, Tokyo, Japan

Department of Professional Development of Teachers, Graduate School of Education, University of Fukui, Fukui, Japan

Abstract

Active learning is an innovation of teaching and learning and strongly connected to teacher education reform. A teacher's role in a knowledge-based society is being shifted from

a knowledge teller to a facilitator. It is difficult to shift a teacher's perspective from "how to teach" to "how students learn." However, through a collaborative lesson study, teachers can discuss students' learning in a classroom. The university can function as a facilitator to cultivate a professional learning community.

This paper discusses the practice of active learning in teacher training at the University of Fukui in Japan. The faculty provides active learning for prospective teachers to engage collaboratively in scientific inquiry using physics by inquiry.

Based on the viewpoint that teacher development is a continuous, lifelong process, and the teacher is a reflective practitioner, teacher training should also be an active, lifelong endeavor. Moreover, the system and structure of the lesson study and collaborative reflection promote a professional learning community. Both pre-service and in-service teachers develop pedagogical content knowledge through repeated practice and reflection.

Keywords: lesson study, community of practice, professional learning community, teacher training, intern, physics by inquiry

Introduction

Recently, the academics field has focused on the challenges of active learning; for example, the theme of the International Conference on Physics Education in 2013 was "Active learning – in a changing world of new technologies." The attention on active learning means that the interest of education has turned from "how to teach" to "how students learn." Therefore, active learning is an innovation of teaching and learning and strongly connected to teacher education reform.

Teacher training has concentrated on how to teach and has been conducted without students in places such as a university and a lecture hall. However, it is difficult to learn how students learn in such a situation. Education reform in active learning has not been promoted, and the study has not been collaboratively connected to school practice. Therefore, the importance of collaboration and the professional learning community is discussed (Lieberman & Miller, 2008; Hargreaves, 1994), but is it clear how to cultivate and promote them?

The purpose of this paper is to clarify the strategy of active learning in teacher training. This paper therefore analyzes how the structure of active learning is brought into teacher

education, particularly in Fukui Prefecture and the University of Fukui.³ The paper investigates the active teacher development process regarding the following practical theories:

1. The “teacher as a reflective practitioner” is well known from Schön’s *The Reflective Practitioner* (1984).
2. Effective learning requires “active mental engagement,” which is noted in *Physics by Inquiry* (McDermott & Physics Education Group at the University of Washington, 1996).

The paper is organized as follows. First, it shows the purpose and background of this practice, such as the current situation of education and teacher education in Japan. Particularly, the lesson study as part of the culture of teacher training in Japan is introduced. Section 2 presents the new challenges of education in Fukui Prefecture and the University of Fukui. Section 3 demonstrates the three practices of active learning in teacher training in Fukui Prefecture and the University of Fukui. The first practice is the undergraduate course challenge using physics by inquiry (McDermott & Physics Education Group, 1996) at the University of Fukui (Ishii & Yamada, 2012). The second practice is the lesson study held in a lower secondary school in Fukui Prefecture. The third practice is the student teacher’s lesson study and the curriculum of the graduate school at the University of Fukui (Ishii, 2011, Sasaki, 2011).

According to these three practices, this paper discusses how active learning is related to teacher training through cultivating the professional learning community.

Teacher as a reflective practitioner

For many years, the primary objective of teachers has been to transmit a body of knowledge to their students. Teachers want to know how to teach effectively and want to master techniques for achieving this. Workshops have provided transmitted, non-reflective experiences. However, it is time for this to change: teaching should be transformed into a process of lifelong professional development.

A teacher’s development had previously been discussed as that of a professional practitioner (Schön, 1984). According to Schön, reflective teachers try to listen to their students; they ask themselves, “What do students think in a situation like this?” or “What is causing students’ confusion?” It means teacher training must be changed.

The teacher’s role should change from a knowledge teller to a facilitator supporting students’ collaborative learning, a manager of a community, and a reflective practitioner. The focus must be changed from “how to teach” to “how students learn” because the purpose of education is to make students understand. Teacher training must prepare the opportunities to share teachers’ experiences and steer the discourse toward students’ learning.

³Fukui Prefecture, with a population of 803,200 and an area of 4,189 km², is located 320 km from Tokyo and borders Kyoto Prefecture. It has 330 schools and three education centers, including 30 professional development schools (PDS) with a strong relationship to the University of Fukui, which form the core of the distributed learning community.

Lesson Study

The lesson study is a traditional Japanese way of training teachers through actual “lessons” at the school. Lewis described it as “a process in which teachers jointly plan, observe, analyze, and refine actual classroom lessons” (2012). It was first introduced and covered extensively in the book *The Teaching Gap* (Stigler & Hiebert, 1999). It has a long history in Japan and has become a central issue in educational practice and the professional development of teachers. There are many kinds of lesson studies, such as in-school, in the district, and at the national conference. Usually, a lesson study consists of a research lesson (open class) and debriefing, and it is conducted in a single day (National Association for the Study of Educational Methods, 2011).

Even though the lesson study originated in Japan nearly a century ago, it has spread its wings worldwide and is currently flourishing in several countries as a tool to promote the professional development of teachers. The lesson study is now growing in different ways, responding to a variety of social, cultural, and political contexts, and being applied to a range of disciplines. The World Association of Lesson Studies (WALS) was established in 2006 and has since held annual conferences to share the research and practice of the lesson study. More than 32 countries engage in lesson studies with the Japan International Cooperation Agency (JICA), Asia-Pacific Economic Cooperation (APEC), and United Nations Educational, Scientific and Cultural Organization (UNESCO) (Akita, 2012).

Traditionally, the lesson study was considered a special opportunity for teachers to open their classes and show their lessons to their colleagues and supervisors. Before opening their classes, teachers were under pressure and feared how their lessons and teaching abilities would be rated. They prepared hard to make good lessons to show their colleagues or supervisors. Traditionally, a good teacher meant a technical expert. However, in the new trend, teachers are reflective practitioners, whose aim is to conduct case studies, enabling discussion of students’ learning processes. As a result, in the new lesson studies, participants do not focus on teachers’ activities but rather on children’s learning (Sato, 2011).

Japanese educational system — past and present

The educational system in Japan is centralized. Primary and lower secondary school (junior high school) is compulsory, and 98% of students go to high school for three years after compulsory education. Following high school graduation, 56% of students attend institutions of higher learning, such as university or college. A national curriculum (course of study) determines the contents of learning from primary school to high school for each grade. Textbooks authorized by the Ministry of Education, Culture, Sports, Science and Technology (MEXT) are distributed free to all students during the compulsory education phase.

Based on the course of study, science lessons focus on developing students’ problem-solving skills, scientific thinking, and capacity for in-depth understanding (MEXT, 2008). Actually, many lessons have been teacher centered with an emphasis on transmitting knowledge (Murata & Yamaguchi, 2010).

Education required in a knowledge-based society

The quality of Japanese education is shown in an international survey as Programme for International Student Assessment of Organisation for Economic Co-operation and Development (PISA-OECD) or Trends in International Mathematics and Science Study (TIMSS) (OECD, 2007). Japanese students have good scientific skills and demonstrate

them well. Nonetheless, the survey reveals that they have difficulties applying their knowledge to novel situations and avoid solving unknown questions. Their science lessons have little connection to the real world. The rate of blanks on exams — in which students didn't write anything — is very high. Moreover, there appears to be a poor attitude toward studying. According to the OECD report on Japan, “Students who learn just to memorize and reproduce scientific knowledge and skills may find themselves ill-prepared for tomorrow’s job market” (2007).

What does tomorrow’s job market look like? What kind of innovation will be required in the future? In Japan, the industrial structure has changed in 50 years. The agricultural population is decreasing. The main professions have shifted from production of goods to designing, planning, generating ideas, publishing, marketing, advertising, distribution, and services. The workforce concentration is also changing from manufacturing products to services (Figure 1).

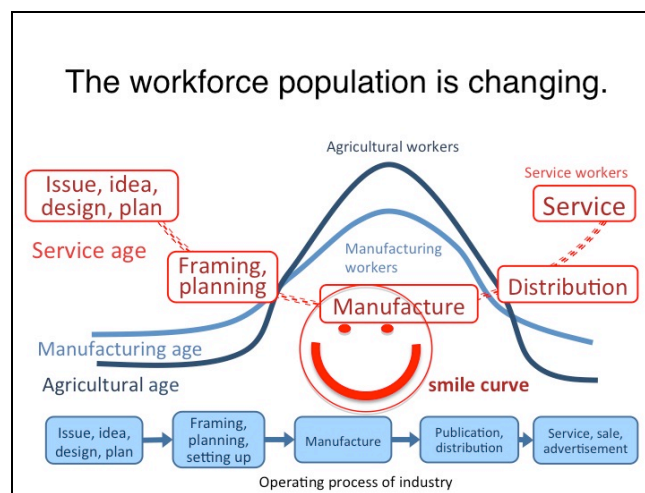

Figure 1. The industrial structure in Japan (smile curve)

In such a society, people require not only stored knowledge, but also the abilities of inquiry, collaboration, application of information, thinking, judgment, and expression, collectively called the smile curve. Therefore, students require active learning rather than listening and memorizing in school.

Japanese teacher education system

Traditionally, a teacher’s life is divided into three stages in Japan. The first stage is getting a teaching certification by going through a university course (4 years), teachers college (4 years), or junior college (almost 2 years) authorized by MEXT and by collecting credits. He/she reads books and discusses policy, history, and problems with education while gaining a certain number of credits. In general, a student needs to obtain a certain number of credits for specific teaching subjects and professional subjects. With some credits and only a four-week teaching practice in school, any student can obtain a teacher’s license. The teacher’s license is valid for all prefectures in Japan, but getting the certificate does not guarantee being hired as a teacher. Teachers are recruited by each prefecture, in other words, by the government. For example, 178,461 students earned a teacher’s license in 2009, but less than 10% or only 17,272 students were employed as teachers (Figure 2, left).

The second stage is employment. Prospective teachers must take an examination to be hired by the local board of education. After they pass the examination and are employed,

they start their teaching career. The third stage is on-the-job training in school, with little relationship with universities, meaning that the responsibility for teachers' development is handled by schools. In the traditional Japanese teacher education system, the pre-service and in-service training phases are separated. The university seems to be separated from the local board and schools (Figure 2, right).

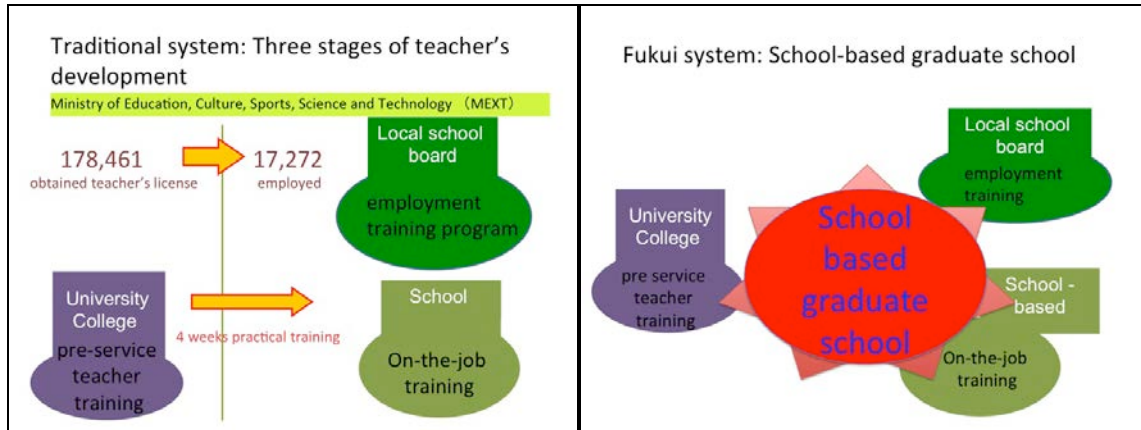

Figure 2. The three stages of the traditional teacher's development (left) and Fukui system (right)

System and curriculum of the Graduate School of Education, University of Fukui

The Graduate School of Education's Department of Professional Development of Teachers at the University of Fukui (DPDT-Fukui) was established in 2008. The system called "school-based, collaborative practice research" represents an innovation in the teacher training system (University of Fukui, 2002). In other words, the graduate school is taking place in schools. Instead of attending a university to learn teaching and learning by reading and hearing, in-service teachers train in school and invite university faculty members to discuss about the actual classroom situation. Pre-service teachers stay in the same school to learn teaching and learning together. In each school, lesson studies, action research, and collaborative learning are held. This arrangement is called a school-based graduate school system with a professional development school (PDS), which constitutes a major challenge in the innovation of teacher training in Japan (Figure 3).



Figure 3. School-based graduate school system (University of Fukui).

The curriculum of this graduate school is based on the viewpoint embodied in the concept of *community of practice* (Wenger et.al, 2002). Both pre-service and in-service graduate students reflect on their own practices from the community of practice perspective. The main curriculum, known as “longitudinal, collaborative action research based in schools,” consists of reflections on practice. Lessons are developed around discussions about teachers’ own practices, listening to one another, reading case studies and theories, and writing about the processes involved in their own teaching practices. They share their practices, observe one another’s practices, and reflect together. The research of the teachers and university faculty is based on practice.

Intern system for pre-service teacher training

Another major challenge involves the intern system for pre-service teacher training, which also takes place mainly in schools. Graduate students spend three days a week in school as interns (student teachers) and attend university two days a week for a year. This system also entails school-based, collaborative practice research; the main curriculum is the same as that of the in-service type, “longitudinal, collaborative action research based in schools.” Each intern has a mentor who is an in-service graduate student in the same school. They open their classes with each other and attend the lesson study together. The professor goes to their school to participate in the lesson study. The new graduate school system tries to connect the three stages of the teacher’s development.

Practice 1: Active learning in undergraduate courses using physics by inquiry

This section discusses the challenges of the undergraduate course using *physics by inquiry* (McDermott & Physics Education Group, 1996). From the viewpoint of teacher development as a lifelong process, learning physics actively to prepare teachers is needed. Developed by the University of Washington, physics by inquiry is designed as a set of laboratory-based modules to help teachers develop a functional understanding.

Undergraduate courses for pre-service teachers should be seen as the starting point of their lifelong teaching careers. However, undergraduate students have a strong belief that studying is just memorizing and reproducing knowledge, based on their prior experiences before entering university. Therefore, they should have an opportunity to engage in scientific inquiry. They cannot teach active learning without themselves experiencing how to learn actively.

We have developed a teacher training program aimed at deepening the scientific understanding of teachers-in-training and have investigated the effects of using physics by inquiry (Ishii & Yamada, 2012).

Comparison between Japanese national curriculum and physics by inquiry

In the national curriculum (course of study), single-bulb circuits are introduced in the third grade; parallel and series circuits in the fourth grade; and voltage, resistance, and Ohm’s law in the second grade in junior high school (eighth grade) (MEXT, 2008). In the third grade, students investigate how to light a bulb in a circuit. They engage in experiments, discuss them, and write down their conclusions. Conclusions such as “When a battery (+), bulb, and battery (-) are connected in a circle, electricity goes through and the bulb lights up” are written in the textbook.

On the other hand, physics by inquiry is designed to develop basic physical concepts and reasoning skills; construct explanatory models with predictive capability; and gain practice in relating scientific concepts, representations, and models to real-world phenomena (McDermot & Physics Education Group, 1996).

The developed program covers direct-current electrical circuits, a topic studied in the third and fourth grades of primary school.

Practice and investigation

The developed program was implemented during the 2012 spring term for 15 weeks from April to July. The participants comprised 100 students at the Faculty of Education and Regional Studies of the University of Fukui (65 women and 35 men, aged 19–25). Most of the participants were in the first year of a four-year teacher education program for primary school. Some had studied physics before, and others had not.

The students' conceptual understanding was analyzed with pre-/post-tests by using DIRECT version 1.2 (Engelhardt & Beichner, 2004). The participants took identical tests before the practice and 1–4 weeks afterward. Although the students learned about electrical circuits, they forgot the meaning of circuit. In other words, they had difficulties in understanding what a circuit is.

The results of the pre-test and interview found that students have typical misconceptions such as “the battery delivers a constant current” and “the current is used up.” This is actually reasonable because we often say “This battery is finished.”

The participants were divided into 25 groups, consisting of four students each. They were fully engaged in the program and learned actively, even though it lasted 180 minutes. They enthusiastically discussed the topic and conducted experiments. From the pre- to post-test analysis, the mean score increased from 38.9% to 46.4%.

The discourse analysis revealed that most groups faced cognitive conflicts during the experiments and discussions about series and parallel circuits.

Discourse analysis

In the lesson about physics by inquiry, the students used their own concepts to hypothesize about and reason through the phenomena. At the experiments, they faced cognitive conflicts as they were unable to explain any further using their concepts. They discussed and did the experiments again and again. Finally, they changed their concepts and explained the phenomena by themselves. This means they constructed the concept socially.

A brief example of four students' discussion in a parallel circuit experiment concerns the question:

“Compare the brightness of each of the bulbs with the brightness of an identical bulb in a single-bulb circuit” (McDermot & Physics Education Group, 1996, p. 395).



Figure 4. The students discussing about the current in a parallel circuit

Figure 5. Shows a typical discussion dialogue illustrating cognitive conflicts between a previous concept and a real phenomenon. Figure 4 shows the discussion and equipment on the table.

Student A: I don't know why. I wonder why the bulbs don't get dimmer when they're connected in parallel.

Student B: But the current at the battery should be the same as a single circuit.

Student C: The two bulbs lit up but the current is the same. Is this OK?

Student A: I think the current should be twice as much, to compare with a single circuit.

Figure 5. Dialogue about the current in a parallel circuit.

Student B presented the strong belief that a battery provides the same current anytime. However, Student A asked the group why it is not consistent with the phenomenon. After the discussion, they started to investigate the brightness of a single circuit again.

Findings from practice in undergraduate courses

Physics by inquiry is engaging and provides the opportunity to learn physics in depth. It is effective for Japanese university students. It provides ideal experiences of reasoning and facing cognitive conflicts. Pre-/post-test results indicated that conceptual difficulties were considerable and widely encountered. The discourse analysis suggested that expressing a concept elicited their own thoughts, exchange of ideas, and reconstruction of the concept. Step-by-step exercises led the students to a conceptual understanding. Moreover, teaching assistants were able to serve as facilitators rather than knowledge tellers. From the discourse analysis, many students formulated a concept of the conservation of electrical current in a circuit.

To encourage active discussion and better understanding, relations within the group and an atmosphere allowing free expression without stress are important. Especially when someone says "I don't know," the discussion becomes active. To promote inquiry, facilitation such as "teaching by asking" is effective.

Practice 2: Lesson study in a school with a local teachers' community

This section provides an example of a lesson study, which occurred on October 17, 2012 in Fukui Prefecture. Nearly 30 teachers gathered from all areas of Fukui Prefecture and other prefectures. The members of the school board, university professors, pre-service graduate

students, and undergraduate students also participated in the lesson study. As usual, the lesson study consisted of a research lesson and debriefing, and it was conducted on the same day.

The research lesson

The topic was “How is light reflected?” The objective was to explore and understand how light is reflected. The target comprised first graders in junior high school (12 and 13 years old). There were 14 boys and 14 girls divided into 7 groups of 2 boys and 2 girls each. This lesson lasted for 70 minutes.

The lesson had four phases.

- Phase 1. Observe the “ball” reflection.
- Phase 2. Conduct a group discussion.
- Phase 3. Share ideas in class.
- Phase 4. Apply the rule to “light” reflection.

Figure 6 shows Phase 1. The teacher assigned the day’s task to the class: “Let’s play billiards. Shoot a ball into a pocket.”



Figure 6. Phase 1: Observe the “ball” reflection

The word “billiards” sounded interesting for the students. Many students became curious about billiards and wanted to play the game. Each group had an experiment table and a whiteboard. They started to examine how a ball is reflected. They observed the ball and tried to find the role of reflection.

Figure 7 illustrates the group discussion in Phase 2.

Each student expressed and discussed his or her thoughts regarding the words, pictures, and diagrams on the whiteboard to discover the role of reflection. The teacher visited each group to listen to the students’ discussion and to ask occasional questions. The participants observed and listened closely to one or two group discussions.

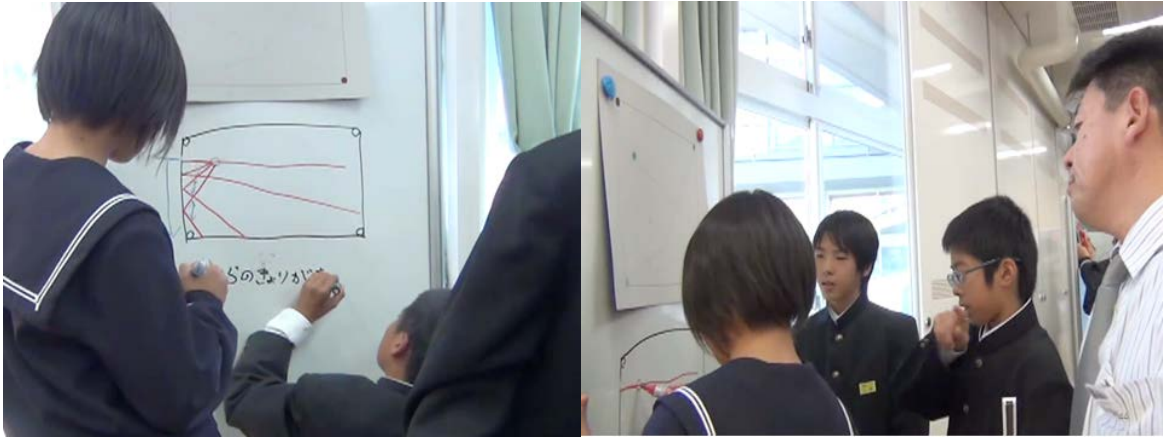

Figure 7. Phase 2: Group discussion and the teacher

The students discussed how to present their findings in front of the whiteboard.

Figure 8 shows the students sharing ideas in the class (Phase 3).



Figure 8. Phase 3: Share ideas in the class

Some of the groups explained their findings to the whole class using their whiteboards. They shared that all of them found the same principle, that a ball reflects the same angle. Finally, the teacher explained the name of the incident angle.

The teacher asked the students to apply the rule of ball reflection to light reflection (Phase 4, see Figure 9). “Let’s play another game. How do we light the doll in the center with a flashlight and eight mirrors?”



Figure 9. Phase 4: Apply the rule to light reflection

Debriefing after lesson (collaborative reflection)

After the lesson was finished, the participants discussed the students' learning process in small groups. They sat at the same tables from which they observed the students and shared their findings (Figure 10).



Figure 10. Debriefing (group discussion)

The participants held discussions based on their observations of the students' performance. An example is shown in Figure 11.

Teacher A: "At first, they didn't realize the rule of reflection. But when this boy succeeded in getting a ball into the pocket, the girl found the path of the ball. After that, they started to discuss actively."

Teacher B: "I saw the girl so precisely. She looked very curious. When they started to talk in front of the whiteboard, she took the pen immediately and started to draw a diagram. But they didn't have the idea of the difference of [the] angle."

Teacher C: "The students didn't express the incident angle on the whiteboard. But they discussed the length of the pathway. I think they noticed that the angle is two times the incident angle. We can consider this to be finding the rule of reflection."

Figure 11. Dialogue excerpt from a group discussion

After the small-group discussions, one teacher represented each group to share what was discussed in their respective groups (Figure 12).

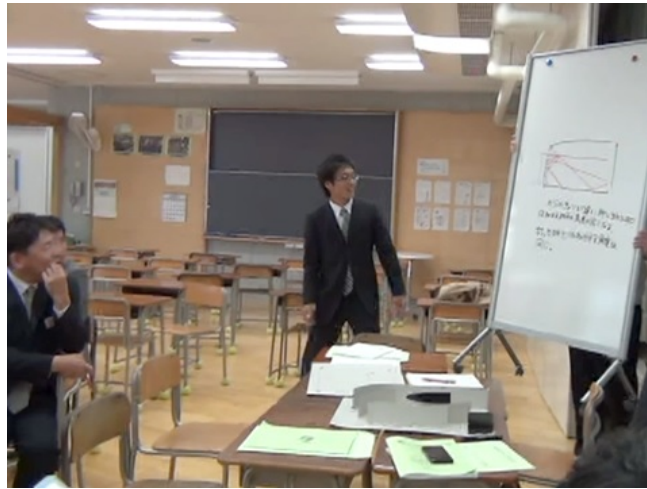

Figure 12. Debriefing (sharing of group discussions)

Findings from the lesson study practice in the local teachers' community

At each table, each participant discussed the performance of the students. The teachers must observe the students' learning and present their findings. Presented with the actual lesson, everybody learns how students learn.

Professional development, which is asked for by in-service teachers, must be supported by practical and collaborative research from organizations that face actual problems and are appropriate for professionals. The cooperation and collaboration of universities, education boards, and schools should form a framework for new teacher education. Through these practices, the university and local professional networks can support the learning community in schools and the distributed community of local teachers.

The new trend in the lesson study focuses on the learning process of students, not the teacher performance. The experience of discussing the learning process of students with colleagues is supported and facilitated by the university. If colleagues construct a learning community, teachers will be stress-free and try to promote students' learning.

Practice 3: Practice and Reflection of an Intern — Yosuke's story

This section presents an example of one intern's lesson study (Sasaki, 2011). Yosuke Sasaki, aged 23, was a graduate student at the University of Fukui. He was an intern at Shimin Junior High School, the same school where practice 2 was held. Yosuke's practice was about sound for the first grade of junior high school, which occurred in September 2010.

Yosuke's Story — Sound

Before the lesson, Yosuke came to the university to discuss and make a lesson plan covering the topic of sound. He decided that the first lesson would be about loudness, and the second lesson would be about high and low frequencies, because these topics seemed easy (Figure 13).

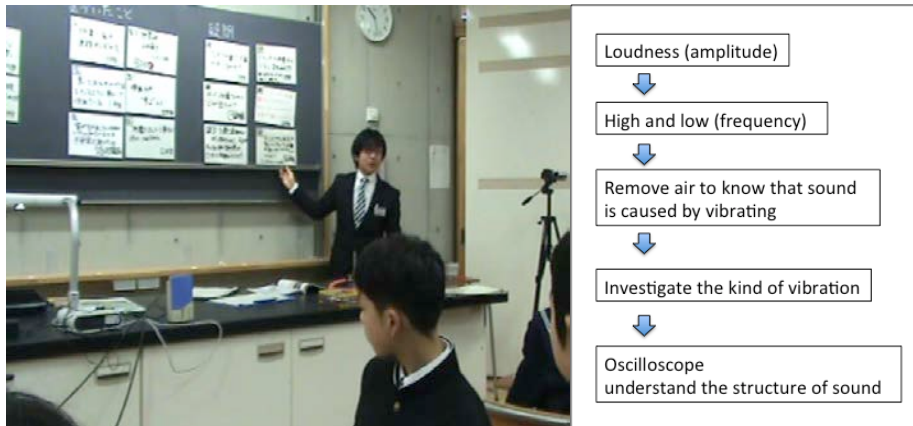

Figure 13. First lesson and first lesson plan of Yosuke (an intern)

At the first lesson, Yosuke taught about loudness and prepared the second lesson as planned. At the second lesson, Yosuke asked the students to make various sounds with a wine glass and mono cord and to think about what the sounds were like. He told them: “Loudness is amplitude, as you learned yesterday. Let’s explore high sound and low sound today.” At that time, he believed that the students understood that loudness is amplitude because he had “taught” it to them in a prior lesson (Figure 14).



Figure 14. Second lesson about high and low frequencies

The students started to make various sounds and investigate them. However, some students made loud, high, small, and low sounds randomly. They just looked like they were playing with instruments. They did whatever they wanted and did not seem motivated (Figure 15).



Figure 15. Yosuke’s confusion about why the students were playing

Yosuke was confused and asked himself: “Why aren’t they examining high and low? Why are they making various messy sounds? Why don’t they follow my assignment?” He went to each group to facilitate their investigation. At this point, he wanted students to conduct the “right” type of investigation.

Many colleagues observed this lesson. Another intern listened to the students talking; a mentor (in-service graduate student) observed what they were trying to do.

After the lesson, Yosuke reflected on his lesson with the professor, other interns, and his mentor (Figure 16).



Figure 16. Debriefing with other interns, mentor, and professor

After the lesson, Yosuke and the observers collaboratively reflected on the lesson. They exchanged their observations about each student’s actions and words, as well as discussed how and what they learned. The mentor told him, “The pupils analyzed sound their own way, although they looked like they were playing.” Another intern said, “The boy I observed seems to be confused about what to do. Does the pupil recognize the difference between frequency and loudness?”

Yosuke realized that the students wanted to investigate by themselves. They were not unmotivated; they merely followed their own interests, not the teacher’s. He realized that he just pushed the inquiry process to the students. He tried to reconsider and redesign the lesson plan.

At the last lesson on sound, Yosuke tried to connect content knowledge with the students’ interest. He arranged the oscilloscope to analyze a pupil’s voice easily. He asked the students, “What does the oscilloscope show?” They then investigated more eagerly and found the wavelengths of high and low sounds (Figure 17).

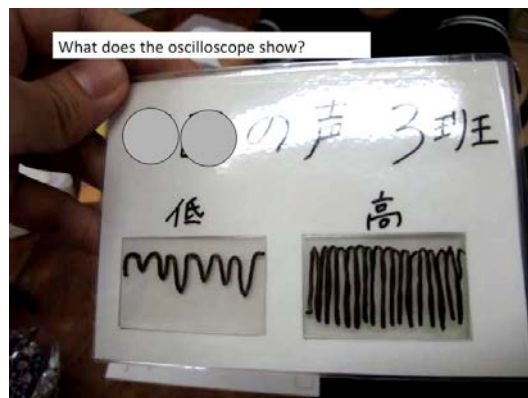

Figure 17. Last lesson: investigation on what the oscilloscope shows

After all the lessons were finished, Yosuke reflected again on his own practice. He realized his insistence on his first lesson plan; however, to facilitate diverse students' learning, he should apply more flexibility in creating the lesson plan. Then he reconstructed the content of the lesson by portraying sound as a dynamic structure (Figure 18).

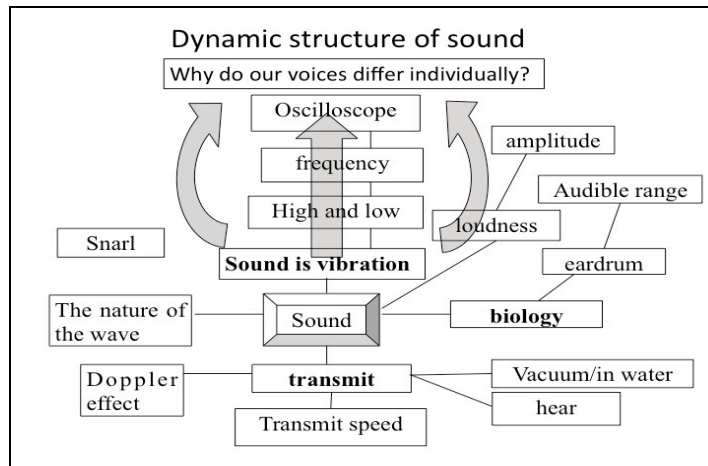

Figure 18. Dynamic structure of sound after Yosuke's reflection

Through this process, he was able to address any student reaction — and the reactions were quite varied. This reconstruction of the lesson content is an important pedagogical phase. Lesson plans do not fit all classes, especially when they involve incorporating active learning into a lesson. It is difficult to teach this fact to novice teachers or students unless they practice it themselves.

Creating such a dynamic structure to design a lesson is considered one of the teacher's skills, called "pedagogical content knowledge (PCK)" (Shulman, 1987). It is said that teachers need a lot of experience and time to acquire PCK.

Structure and learning community to support interns' development

How did Yosuke acquire PCK in such a short time? The structure of the curriculum and the learning community support the interns' development. As shown in Yosuke's year cycle, interns repeat practice and reflect on the lessons many times (Figure 19).

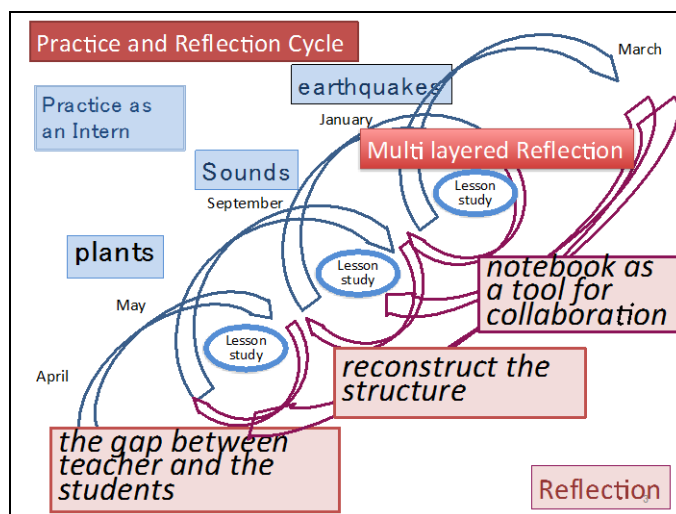

Figure 19. Year cycle of practice and reflection of an intern

The lesson study provides interns with many opportunities for practice and reflection in the course of one year. Yosuke repeated three practice sessions in one year: plants in May, sounds in September, and earthquakes in January. During each practice, many colleagues, professors, and the mentor observed his lesson and reflected on it together. At the first lesson, Yosuke encountered a gap between the teacher and the students. Through his reflection on his second practice on sound, he realized the importance of reconstructing the topic before designing a lesson plan. In his third practice on earthquakes, he used the whiteboard and students' notebooks as tools for communication and facilitation of the students' inquiry.

Yosuke wrote about his practice:

The main and important thing in my learning process is reflection and community. My community is various, as intern colleague, PDS, graduate school, and science seminar, etc. I talked with different people, and think again, write my practice and thought. My thought became clear and tacit knowledge comes up to be shown. (Sasaki, 2011).

The yearlong cycle of an intern is designed to enable him/her to do practice and reflection repeatedly. The curriculum of interns is designed to enable them to observe lessons, teach, perform special activities, etc., in school. Once a week they gather at the university to share their reflections together with professors. They read books and discuss and write their theses with in-service graduate student teachers and university faculty during weekends and the summer and winter holidays. Such repeated reflections with different colleagues have been named "multilayered reflections."

Findings from practice of lesson study in the local teachers' community

The reflection and practice cycle creates opportunities to develop the pre-service students' reflective thinking skills and support their potentials as professionals. The interns' thoughts become integrated and based on multiple perspectives. Student teachers establish their beliefs and theories through integrating experiences and knowledge.

At the lesson study, not only interns but also mentors and professors learn a lot from students learning in the classroom. Therefore, the intern system presents one of the challenges to cultivate a learning community.

Conclusion

This report has discussed active learning in teacher training with three practices at Fukui Prefecture and the University of Fukui. The results show that to cultivate a learning community, each participant should learn actively from the lesson study and communicate dynamically. The students learn actively from the phenomenon with group discussions in the first practice. At the graduate school, all participants—both students and teachers—learn active, collaborative, and reflective strategies in the practice.

The National Science Education Standard notes the standards for professional development:

Although learning science might take in a science laboratory, learning to teach science needs to take place through interactions with practitioners in places where students are learning science, such as in classrooms and schools.

Provide regular, frequent opportunities for individual and collegial examination and reflection on classroom and institutional practice (National Committee on Science Education Standards and Assessment, 1996).

In the lesson study, observing and discussing the students' learning in a collaborative manner constitute active learning for the teachers. To cultivate and promote a professional learning community, it is vital to provide opportunities for collaborative reflection in the classroom, such as through the lesson study and repeated cycle of practice and reflection. The curriculum of the University of Fukui is designed with active, collaborative, and reflective engagement in the professional learning community.

In conclusion, it is clear that collaborative and continuous learning based on "reflective practice" is the essence of teacher training. To enhance awareness of how students learn, collaborative reflection on the lesson by the professional learning community is effective. If colleagues build a learning community, teachers will have their stress levels reduced and will try to promote students' learning. The university can function as a facilitator to cultivate a professional learning community. Both pre-service and in-service teachers develop pedagogical content knowledge through repeated practice and reflection.

Acknowledgments

The author gratefully acknowledges all the teachers and students who were involved in the lesson study and collaborative research. She also thanks Dr. Yoshihide Yamada and Mr. Yosuke Sasaki for participating in this program; without their cooperation, this project would not have been possible.

References

- Akita K.: (2012). Building Learning and Caring Communities through High-Quality Lesson Studies. [online]. [Accessed September 14, 2013]. Available from <http://www.walsnet.org/2012/keynote-speakers.html>
- Engelhardt P., Beichner R.: (2004). Students' understanding of direct current resistive electrical circuits. *American Journal of Physics*, 72(1), 98–115.
[DOI: 10.1119/1.161481.3]
- Hargreaves A.: (1994). *Changing Teachers, Changing Times: Teachers' Work and Culture in the Postmodern Age*. Teachers College Press.
- Ishii K.: (2011). The professional development of a science teacher as a reflective practitioner. *Studies in and on Teacher Education*, 4, 243–254 (in Japanese).
- Ishii K., Yamada Y.: (2012). Teacher training program using active learning based on physics by inquiry. WCPE 2012 Proceedings.
- Lewis C.: (2012). What is Lesson Study? Lesson Study Group at Mills College. [online]. [Accessed September 14, 2013]. Available from <http://www.lessonresearch.net/index.html>
- Lieberman A., Miller L.: (2008). *Teachers in Professional Communities*. Teachers College Press.
- McDermott L.: Physics Education Group at the University of Washington. (1996). *Physics by Inquiry Volumes I and II*. John Wiley & Sons, Inc., New York.

- Ministry of Education, Culture, Sports, Science & Technology in Japan. (2008). Improvement of Academic Abilities (Courses of Study). [online]. [Accessed September 14, 2013]. Available from <http://www.mext.go.jp/english/elsec/1303755.htm>
- Murata Y., Yamaguchi M.: (2010). *A Bilingual Text: Education in Contemporary Japan – System and Culture*. Toshindo.
- National Association for the Study of Educational Methods. (2011). *Lesson Study*. Keisuisha.
- National Committee on Science Education Standards and Assessment. (1996). *National Science Education Standard*.
- Organisation for Economic Co-operation and Development. (2007). Programme for International Student Assessment (PISA) 2006 Science Competencies for Tomorrow's World. [online]. [Accessed September 14, 2013]. Available from http://www.oecdtokyo2.org/pdf/theme_pdf/education/20071204sg_speech.pdf
- Sasaki Y.: (2011). The process of constructing a lesson with collaboration and reflection. (in Japanese).
- Schön D. A.: (1984). *The Reflective Practitioner: How Professionals Think in Action*. Basic Books.
- Shulman L. S.: (1987). Knowledge and teaching: Foundations of new reform. *Harvard Educational Review*, 57, 1–22.
- Stigler J., Hiebert J.: (1999). *The Teaching Gap*: Free Press reprint.
- University of Fukui, Faculty of Education and Regional Studies. (2002). Design of Japanese Teacher Education Reconstruction in 21st Century. Center for Network and Collaboration Supporting Regional Education Reconstruction.
- Wenger E. et.al: (2002). *Communities of Practice: A Guide to Managing Knowledge*. Harvard Business School Press.

Oral presentations

research papers

Examining Factors that Influence High School Physics Students' Choice of Science as a Career

Ann Cavallo, Ramon Lopez, and Gregory Hale

The University of Texas at Arlington

Abstract

This study on high school physics students examined various factors referenced in the literature that may be related to choices in pursuing science careers. These factors include: students' learning approaches (meaningful versus rote), beliefs about Nature of Science (NOS), self-efficacy toward success in science, scientific reasoning, spatial ability, and science enjoyment. These factors were analyzed according to gender and science career choice. The purposes of this study were to: 1) explore possible differences and interactions between these factors among male and female high school physics students, and 2) determine relationships and possible predictive influences of learning approaches, beliefs about NOS, self-efficacy, scientific reasoning, and spatial ability, on science enjoyment and intentions to pursue science careers. Physics students in three different high schools (N = 138) were administered questionnaires to measure the selected factors. Among the findings were significant differences in learning approaches between males and females, with males using more meaningful learning compared to females; students pursuing science careers showed greater self-efficacy toward success in science; and males had higher spatial ability compared to female physics students. Self-efficacy was a significant predictor among females choosing to pursue science careers, whereas meaningful learning was the most significant predictor among male students.

Keywords: science career choice, scientific reasoning, meaningful learning, spatial ability, self-efficacy, nature of science, science enjoyment, gender differences

Introduction and Literature

The science education community has long struggled with declining scientific literacy and waning interest among students to pursue science-related careers. These issues have been so pervasive in the United States that the National Science Teachers Association (NSTA), American Association for the Advancement of Science (AAAS), American Chemical Society (ACS), and National Committee of Science Education Standards and Assessments (NCSESA) each developed initiatives specifically directed toward promoting scientific literacy among all students and encouraging more students to pursue Science, Technology, Engineering, and Mathematics (STEM) careers. Society is now realizing an immense dependency upon scientific and technological knowledge. However, many of today's students show a reluctance or aversion toward science and mathematics, and thus fail to take additional science and mathematics courses in high school or pursue science career paths. Thus, it is well established that dual problems exist with declining scientific literacy and decreasing interest in science careers among students. The current shortage of students pursuing science-related careers has been a prominent concern in the United States because of our nation's quest for leadership in innovation and economic development.

Several factors have been found relevant to examine in the current study based on findings reported and compiled from previous research as potentially related to students' science career choices [1,2,3,4,5,6]. These variables include *meaningful learning approaches, beliefs about Nature of Science (NOS), self-efficacy toward success in science, scientific reasoning ability, and spatial ability*. Meaningful learning is characterized by learners formulating or constructing interrelationships among information, concepts, and processes of science to achieve sound

conceptual understandings. Meaningful learners link new ideas to what is known [7,8]. Unfortunately, many students do not construct interrelationships among information, concepts and processes, and tend to learn science by rote, with facts memorized in isolation with other ideas and concepts [9,10]. Learners' beliefs about nature of science (NOS) have been reported as falling into one of two opposing views, or epistemological beliefs. One view is that science is an authoritative, unchanging, fixed body of knowledge; the opposing view is that science is a tentative, dynamic process [11,12]. Students who hold fixed views of NOS may view science as static body of facts rather than an evidence-based exploratory process. Self-efficacy is the extent to which individuals are confident in their abilities within a specific context or content area [13]. Self-efficacy toward success in science may be related to science achievement and persistence among students [1]. The foundation for scientific reasoning ability is Piaget's intellectual development model [14] in which adolescent through adult learners range in ability from "concrete" to "formal" [15]. Students who are at the concrete stage rely on objects and direct experiences to guide their construction of understanding. Formal reasons do not rely on concrete objects and can learn new concepts in the abstract using logical-mathematical reasoning, mental manipulation, and transformation. Spatial ability is the ability to mentally visualize how objects are arranged in space, the relationships between objects in space, and mental rotation of these objects in space. According to a meta-analysis, spatial ability has a significant, strong influence on learning and achievement in STEM domains [16]. More specifically, spatial ability has been indicated in research to be important factor in learning and achievement in science [17,18,19].

Research has report mixed results on possible differences between male and female students on variables central to this study. Further, it is yet unknown how these variables may be differentially related to science enjoyment and career choices among male and female students in their final years of high school when attitudes toward science have likely been solidified based on past experiences, and career choices are in the process of being made.

Purpose

The purpose of this exploratory study was to investigate differences and predictive influences of the specified factors on high school male and female students' science enjoyment and choices to pursue science careers. The specific purposes of this research are:

1. To explore possible differences between high school physics students' learning approaches, beliefs about NOS, self-efficacy, scientific reasoning ability, spatial ability, and science enjoyment according to gender, intentions to pursue science careers, and the interaction between these variables.
2. To explore possible relationships and predictive influence of learning approaches, beliefs about NOS, self-efficacy, scientific reasoning, and spatial ability on male and female students' science enjoyment and intentions to pursue science careers.

Method

The student participants were 11th and 12th grade students (17 and 18 years old) enrolled in physics (N = 138) in three different public schools in a large urban area in the south-western United States. All three schools are classified by the state's Education Agency as economically disadvantaged (50 percent or more of students are on free and reduced lunch programs). Four teacher-researchers also participated in the study.

The teacher-researchers administered tests and questionnaires in their classrooms assigning code numbers for each student participant to preserve the identity of students in the data analyses. The code numbers were assigned to also help students feel they could respond to questions with assurance of confidentiality in their responses. The teachers were trained to administer the

questionnaires and tests to students in their physics classes adhering to a common protocol and test administration procedure. Tests and questionnaires were administered at the same time during the spring semester of the academic year.

The tests and questionnaires used in this study are briefly described as follows.

Background Questionnaire. This questionnaire obtained information on participant's gender and ethnicity (optional) as well as their age, grade level, number of math and science courses taken, and interest(s) in pursuing science as a career.

The Learning Approach Questionnaire (LAQ). This questionnaire is a Likert-scale instrument that measures the extent to which students learn by memorizing or learning new information on a surface level (rote learning) versus the extent to which students learn by forming connections or interrelationships among concepts learned on a deep-structured level (meaningful learning) [1,2,3].

The Science Knowledge Questionnaire (SKQ). The SKQ is a Likert-scale instrument that measures students' views about the nature of science (NOS). The instrument measures the extent to which students' view science as fixed and authoritatively known, compared to the extent to which students' view science as dynamic and tentatively known (subject to change with new evidence) [2,4,11,12]. This questionnaire also includes questions regarding students' self-efficacy or confidence in their ability to be successful in science [5,13].

Classroom Test of Scientific Reasoning (CTSR). This test measures the scientific reasoning of participants ranging from concrete to formal operational (hypothetical-deductive) [2,15]. For each test item, students respond to a second part by selecting their reasoning for their answers. Both the item and reasoning response must be correct to receive points for the item.

Spatial Ability Test (SAPT). The spatial ability test used in this study was a test published at www.psychometric-success.com. This test determines the extent to which students are able to visualize the orientations of objects in space.

Students' responses to tests and questionnaires were entered onto a spread sheet and analysed using SPSS data analyses software. All appropriate statistical controls and assumptions were utilized in the analysis.

Results

Differences between high school physics students' learning approaches, beliefs about NOS, self-efficacy, scientific reasoning ability, spatial ability, and science enjoyment according to gender, intentions to pursue science careers, and the interaction between these variables.

Descriptive statistics were computed on the factors of this study for all students, and for male and female students. These results are shown in Table 1, and represented graphically in Figures 1 through 6. To determine if observed descriptive data were statistically different and analyze interactions between variables, 2-way analyses of variance (ANOVA) were conducted. The ANOVA procedure determines if the means shown in Table 1 are significantly different for each variable, with significance level set at $p < .05$. Results are reported within the respective figures.

Table 1. Means and SE for All Variables of This Study

Variable	Meaningful Learning		Beliefs in NOS		Self-Efficacy		Scientific Reasoning		Spatial Ability		Science Enjoyment	
	Mean	SE	Mean	SE	Mean	SE	Mean	SE	Mean	SE	Mean	SE
Male	57.96	1.05	43.47	0.99	5.72	0.30	4.39	0.41	35.65	1.06	3.09	0.13
Female	54.69	0.69	43.02	0.65	5.28	0.20	3.42	0.28	32.04	0.71	2.58	0.09
Science Career	58.28	1.11	44.22	1.04	5.92	0.32	4.12	0.43	34.23	1.12	3.31	0.14
No Science Career	54.36	0.59	42.27	0.56	5.08	0.17	3.69	0.24	33.46	0.61	2.36	0.07
Female Yes Science Career	54.68	1.14	44.00	1.07	5.72	0.33	3.35	0.46	32.13	1.19	2.84	1.43
Female No Science Career	54.69	0.77	42.04	0.72	4.84	0.22	3.50	0.31	31.94	0.78	2.31	0.10
Male Yes Science Career	61.89	1.90	44.44	1.79	6.11	0.54	4.89	0.74	36.33	1.89	3.78	0.24
Male No Science Career	54.03	0.90	42.50	0.85	5.33	0.26	3.88	0.38	34.97	0.95	2.40	0.11

Differences in students' meaningful learning approaches according to gender and intentions to pursue science careers. As shown in Table 1 there are observed numerical differences in means in meaningful learning approaches according to gender and science career choice. The 2-way ANOVA results inset in Figure 1 indicated these differences were significant in main effect means, and in the interaction between gender and science career choice. Accordingly, male students use significantly more meaningful learning approaches compared to female students. Students pursuing science careers use significantly more meaningful learning approaches. The source of the significant interaction is that males pursuing science careers use significantly more meaningful learning approaches than males not pursuing science careers and compared to females who are pursuing science careers. Female students tend to use more rote strategies, regardless of whether or not they are pursuing science careers.

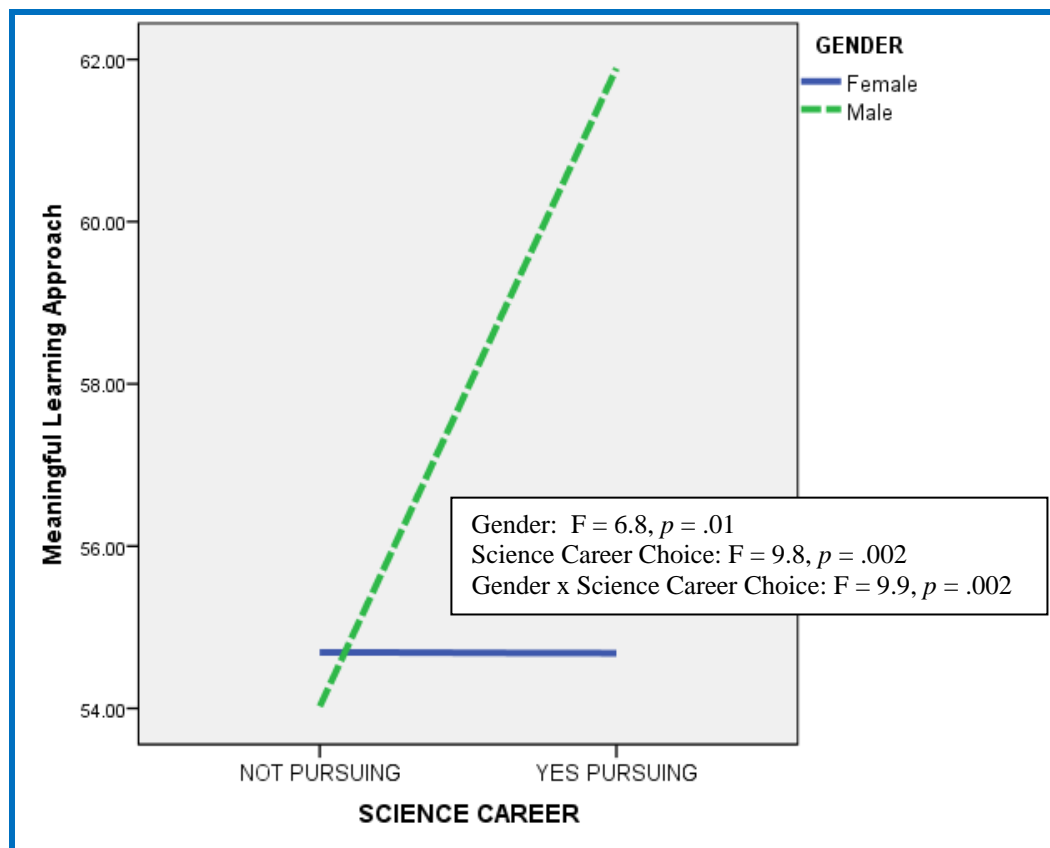

Figure 1. Meaningful Learning and Science Career Choice According to Gender

Differences in students' beliefs about NOS according to gender and intentions to pursue science careers. As shown in Table 1 and represented in Figure 2, the means for both males and females pursuing science careers were descriptively higher in the direction of more tentative views of NOS. However, the 2-way ANOVA results inset in Figure 2 indicated no statistical differences between males and females and between students pursuing/not pursuing science careers according to their beliefs in NOS.

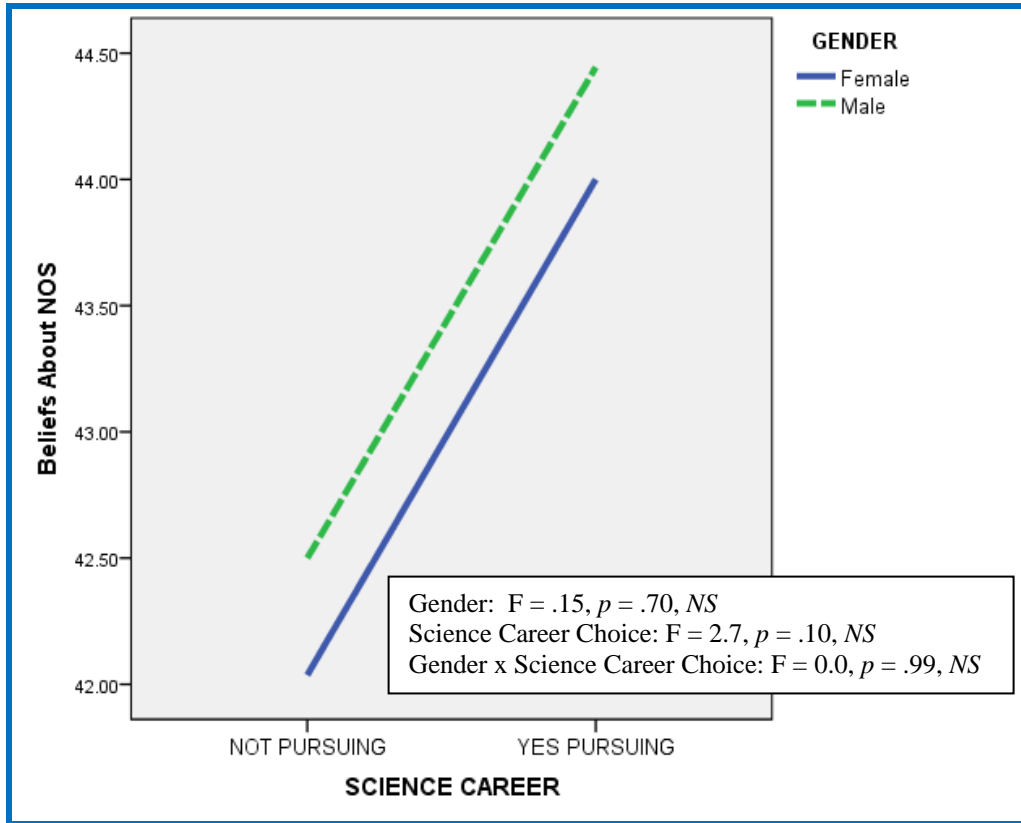

Figure 2. Beliefs about NOS and Science Career Choice According to Gender

Differences in students' self-efficacy according to gender and intentions to pursue science careers. As shown in Table 1 and Figure 3, there were descriptive level differences in self-efficacy means between students pursuing science careers compared to those not pursuing science careers. The 2-way ANOVA results inset in Figure 3 indicated these observed mean differences were significant, with students pursuing science careers having higher self-efficacy in their ability to be successful in science compared to students not pursuing science careers.

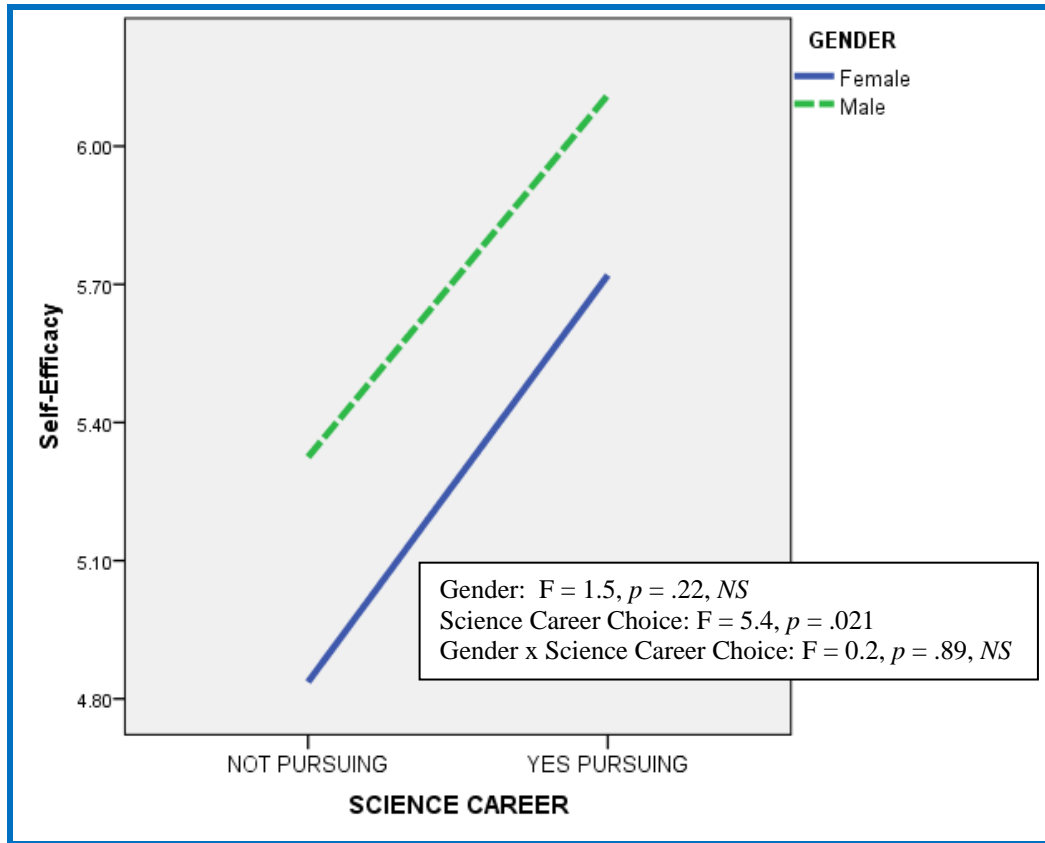

Figure 3. Self-Efficacy and Science Career Choice According to Gender

Differences in students’ scientific reasoning ability according to gender and intentions to pursue science careers. As shown in Table 1 and Figure 4, scientific reasoning ability was descriptively higher for males compared to females. The 2-way ANOVA results inset in Figure 4 indicated the main effect of gender on scientific reasoning was not significantly different, though it approached significance ($p = .056$) and may be worthy of future investigation. There were no differences in scientific reasoning ability between students pursuing/not pursuing science careers.

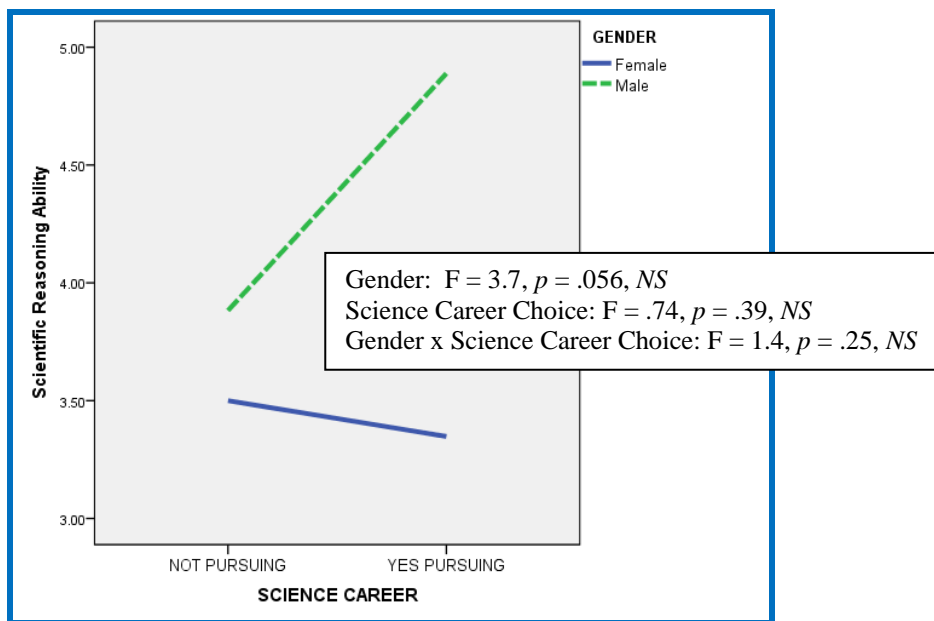

Figure 4. Scientific Reasoning Ability and Science Career Choice According to Gender

Differences in students' spatial ability according to gender and intentions to pursue science careers. As shown in Table 1 and Figure 5 there was a descriptive difference between males and females on spatial ability. This observed descriptive difference was found to be significant, as indicated in the 2-way ANOVA results inset in Figure 5. Males have significantly higher spatial ability than females in this study. There was no statistical difference in spatial ability according to choice to pursue or not pursue as science career, and no interaction between gender and science career choice.

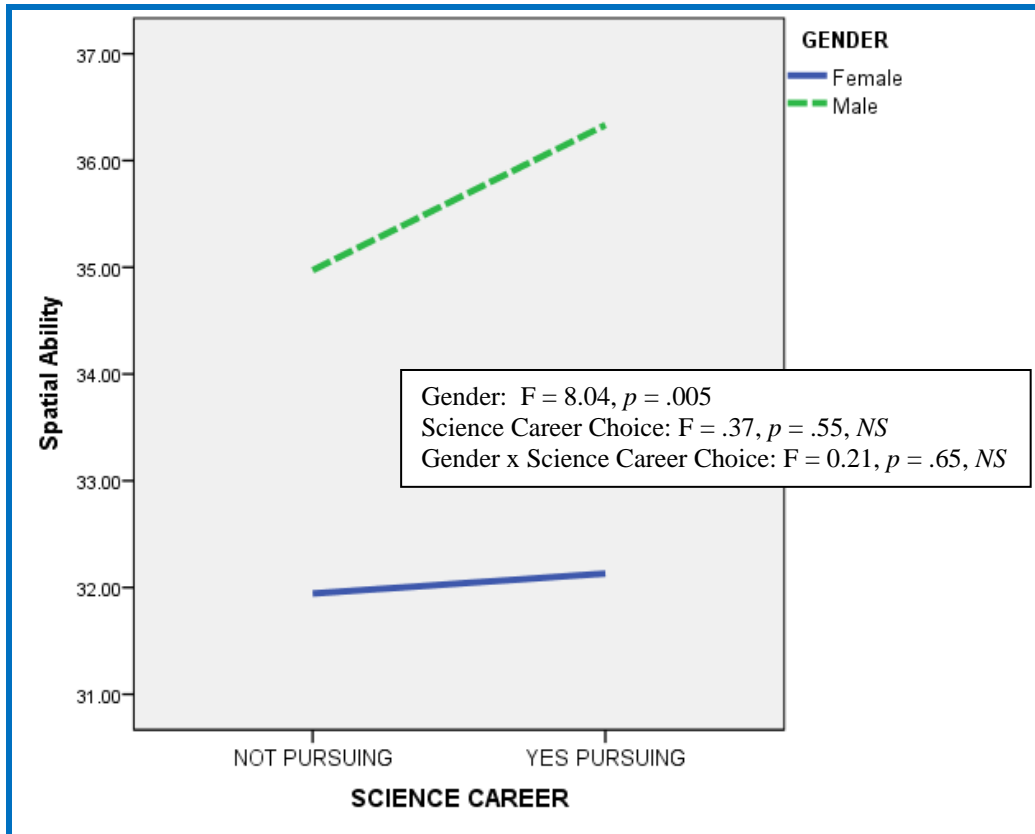

Figure 5. Spatial Ability and Science Career Choice According to Gender

Differences in students' science enjoyment according to gender and intentions to pursue science careers. As shown in Table 1 and Figure 6, there were descriptive differences in means between males and females and students pursuing/not pursuing science careers. According to 2-way ANOVA table inset in Figure 6, there were significant differences between males and females in science enjoyment with males showing greater science enjoyment as the main effect. There were also significant differences, as would be expected, between students pursuing science careers and those not pursuing science careers, with those pursuing careers having higher science enjoyment. A significant interaction was also indicated, with the males pursuing science careers showing significantly greater science enjoyment compared to their female counterparts pursuing science careers.

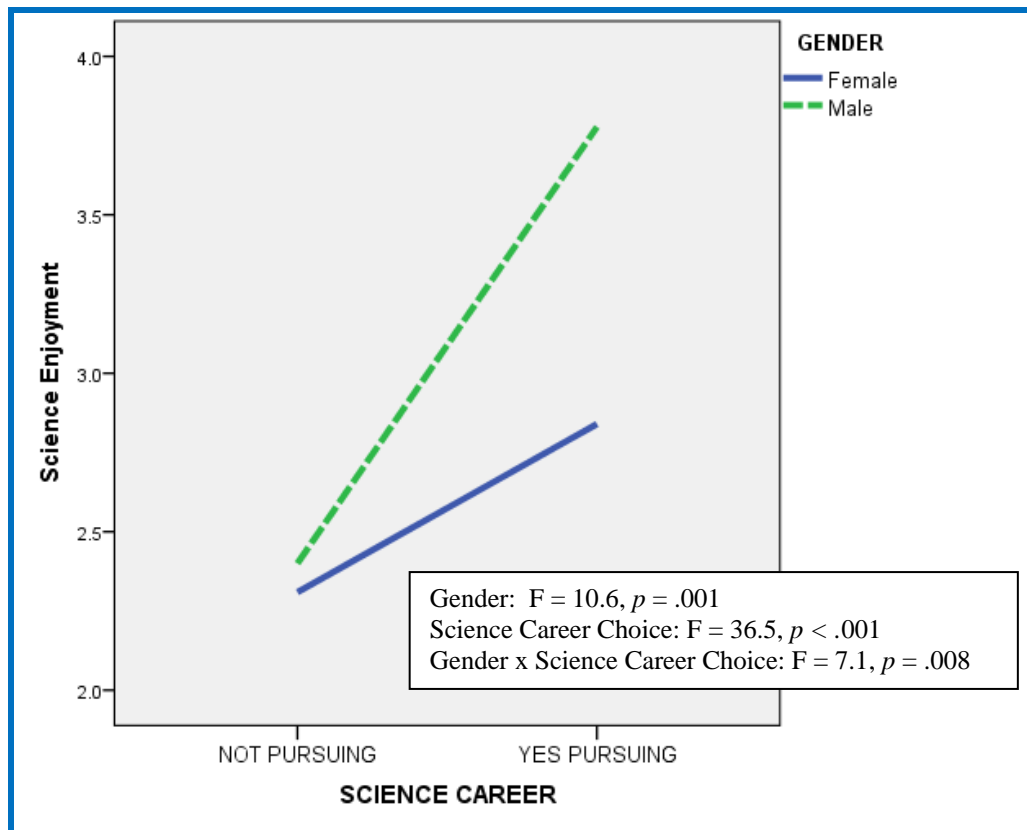

Figure 6. Science Enjoyment and Science Career Choice According to Gender

Relationships and predictive influence of learning approaches, beliefs about NOS, self-efficacy, scientific reasoning, and spatial ability on male and female students' science enjoyment and their intentions to pursue science careers.

Results of Stepwise Multiple Regression analyses revealed that meaningful learning, self-efficacy, and more tentative beliefs in NOS best predicted science enjoyment among males, ($p < .05$) explaining 52% of the variance in science enjoyment scores. Scientific reasoning ability and self-efficacy predicted science enjoyment among females in this study ($p < .05$), explaining 41% of the variance in science enjoyment scores. Meaningful learning best predicted choice of science as a career among the males (R-square = .23, $p < .01$), whereas self-efficacy best predicted science as a career choice among the females (R-square = .08, $p < .05$). Enjoyment of science and scientific reasoning ability significantly predicted science as a career choice for all students (R-square = .28, $p < .05$).

Discussion

The primary findings of this study are summarized as follows:

- Males use more meaningful learning/females more rote memorization; males who learn meaningfully more likely to pursue science careers.
- Students pursuing science careers have greater science self-efficacy.
- Males have higher spatial ability compared to females.
- Males pursuing science careers have greater enjoyment of science compared to females pursuing science careers.
- Self-efficacy a common predictor of science enjoyment:
 - Meaningful learning and beliefs of NOS also predictors among males; reasoning ability was also a predictor among females.
 - Meaningful learning predicts science career choice among males; self-efficacy among females.

- Science enjoyment and scientific reasoning ability predicts science career choices for all students in this study.

The information attained through this research informs teachers and science education researchers of learner characteristics and educational factors that may be important to students' decisions to pursue STEM careers. These findings may help educators better understand and therefore foster the skills and/or learner characteristics that promote their students' science career decisions. With knowledge obtained through this research, educators will be better prepared to impact students in ways that increase interest and reverse the downward trend in the numbers of science professionals currently endured.

References

- [1] Cavallo A. M. L., Laubach T.: (2001). Students' science perceptions and enrollment decisions in differing learning cycle classrooms. *Journal of Research in Science Teaching*, 38, 1029-1062.
- [2] Cavallo A. M. L., Rozman M., Blickenstaff J., Walker N.: (2003). Learning, reasoning, motivation, and epistemological beliefs: Differing approaches in college science courses. *Journal of College Science Teaching*, 33, 18-24.
- [3] Cavallo A. M. L., Potter W. H., Rozman M.: (2004). Gender differences in learning constructs, shifts in learning constructs, and their relationship to course achievement in a structured inquiry, yearlong physics course for life science majors. *School Science and Mathematics*, 104, 288 – 300.
- [4] Cavallo A. M. L., Blickenstaff J., Rozman M., Walker N.: (2007). Learning college science: An investigation of biology and physics students' learning approaches, scientific reasoning, motivational goals, and beliefs about the nature of science. In L. Cooke (Ed.), *Frontiers in Higher Education*. Hauppauge, NY: Nova Science, pp. 207-228.
- [5] Cavallo A. M. L., Gomez P.: (2010). Promoting science understanding and fluency among Hispanic English Language Learners: Strategies, explorations, and new directions. In Sunal W., Sunal, C.S. and Wright, E.L. (Ed.) Special Issue: Teaching Science with Hispanic ELLs in K-16 Classrooms. *Research in Science Education*, Charlotte, NC: Information Age Publishing.
- [6] Steinkamp M. W., Maehr M. L.: (1983). Affect, Ability, and Science Achievement: A Quantitative Synthesis of Correlational Research. *Review of Educational Research*, 53, 369-396.
- [7] Ausubel D. P.: (1963). *The psychology of meaningful verbal learning*. New York: Grune & Stratton.
- [8] Ausubel D. P.: (1968). A subsumption theory of meaningful verbal learning and retention. In R.G. Kuhlén (Ed.), *Studies in educational psychology* (pp. 167-174). Boston: Blaisdell Publishing.
- [9] Novak J. D.: (1988). Learning science and the science of learning. *Studies in Science Education*, 15, 77-101.
- [10] Novak J. D., Gowin D. B.: (1984). *Learning how to learn*. New York: Cambridge University Press.
- [11] Abd-El-Khalick F.: (2006). Over and over again: College students' views of nature of science. In L. B. Flick and N.G. Lederman (eds.), *Scientific Inquiry and Nature of Science: Implications for Teaching, Learning, and Teacher Education* (pp. 389–426). Dordrecht, The Netherlands: Springer.

- [12] Flick L. B., Lederman N. G.: (2006). *Scientific Inquiry and Nature of Science: Implications for Teaching, Learning, and Teacher Education*. Dordrecht, The Netherlands: Springer.
- [13] Bandura A.: (1997). *Self-Efficacy: The Exercise of Control*. New York: Freeman.
- [14] Piaget J.: 1964. Cognitive development in children: Piaget, development and learning. *Journal of Research in Science Teaching*, 2, 176–180.
- [15] Lawson A. E.: (2004). The nature and development of scientific reasoning: A synthetic view. *International Journal of Science and Mathematics Education*, 2(4), 307-338.
- [16] Wai J., Lubinski D., Benbow C. P.: (2009). Spatial Ability for STEM Domains: Aligning Over 50 Years of Cumulative Psychological Knowledge Solidifies Its Importance. *Journal of Educational Psychology*, 101, 817–835.
- [17] Hsi S., Linn M. C., Bell J.: (1997). The Role of Spatial Reasoning in Engineering and the Design of Spatial Instruction. *Journal of Engineering Education*, 4, 151-158.
- [18] Jiang B.: Formal reasoning and spatial ability: A step towards "science for all" (2008). *Theses and Dissertations*. Paper 318. <http://scholarcommons.usf.edu/etd/318>
- [19] Levine S. C., Vasilyeva M., Lourenco S. F., Newcombe N. S., Huttenlocher J.: (2005). Socioeconomic Status Modifies the Sex Difference in Spatial Skill. *Psychological Science*, 16, 841- 845.

Contextual categorisation of academics' conceptions of teaching

Scott Daniel, Alex Mazzolini, Llewellyn Mann

Swinburne University of Technology, Melbourne, Australia

Abstract

Background: *Despite large-class research-based instructional strategies being firmly established in the literature, traditional teacher-centred lecturing remains the norm. This is particularly the case in physics, where Physics Education Research (PER) has blossomed as a discipline in its own right over the last few decades, but research-based strategies are not widely implemented.*

This variation in practice is underpinned by variations in beliefs and understandings about teaching. Studies investigating the spectrum of conceptions of teaching held by teachers and, in particular, academics have almost uniformly identified a single dimension from teacher-centred to student-centred. These studies have used a phenomenographic approach to capture the variety of conceptions of teaching, but have excluded contextual issues like class size.

Research Question: How does class size affect academics' conceptions of teaching?

Method: *This study used an online survey to compare and contrast respondents' experiences of small and large classes, and in particular lectures. The survey was promoted to Australian university academics from a range of disciplines, predominantly science, technology, engineering, and mathematics (STEM). Responses to the sets of small-class questions were analysed independently from the sets of equivalent large-class questions. For each respondent their small-class responses were categorised, where possible, as either being student-centred or teacher-centred, and likewise, independently, for their large-class responses.*

Results: *In total, 107 survey responses were received. Of these, 51 had the sets of both their large- and small-class responses unambiguously categorised. Five of these were student-centred regardless of class size, and 17 of these were teacher-centred regardless of class size. All of the remaining 29 responses were teacher-centred in large classes, but student-centred in small classes. Conversely, none of the responses corresponded to a conception of teaching that was student-centred in large classes and teacher-centred in small classes.*

Implications: *This result demonstrates that the one-dimensional analysis of conceptions of teaching along the spectrum of teacher-centred to student-centred is too simplistic. Conceptions are contextual. At the very least they depend on class size, and perhaps other factors.*

It confirms the hierarchy of understanding from teacher-centred to student-centred reported elsewhere in the literature, with the added feature of an intermediate stage of differing focus depending on class size. One recommendation from this finding is that teaching professional development programs should be focused on developing student-centred conceptions and practices in large classes in particular, as this occurs infrequently but leads to the best student learning outcomes. Moreover, further research on context-specific conceptions of teaching need to be explored.

Keywords: conceptions of teaching, context, professional development, phenomenography

Introduction

Conceptions of teaching

A number of studies have explored the variation in teachers' conceptions of teaching. Kember [1] reviewed 13 such studies and identified a common thread: they all categorised conceptions of teaching along a single dimension anchored at one end with "teacher-centred/content-oriented" conceptions, and at the other with "student-centred/learning-oriented" conceptions (see Table 1 below, adapted directly from Kember [1] p. 262). Although the various studies Kember reviewed differed in how they divided up this continuum into a hierarchy of discrete categories, the opposite poles of teacher-centred/content-oriented and student-centred/learning-oriented were common to all. (In the remainder of this paper the terms "teacher-centred" and "student-centred" will be used as shorthand).

Table 1. Kember's characterisation of the extremes of the continuum of teachers' conceptions of teaching

Aspect	Teacher-centred extreme	Student-centred extreme
Teacher	Presenter	Change agent/developer
Teaching	Transfer of information	Development of person and conceptions
Student	Passive recipient	Lecturer responsible for student development
Content	Defined by curriculum	Constructed by students but conceptions can be changed
Knowledge	Possessed by lecturer	Socially constructed

The studies which Kember reviewed showed a high degree of commonality in identifying this continuum from teacher-centred to student-centred conceptions. This is even the more striking when the diversity of the different studies' participants is considered. In total, almost 500 educators (university academics and adult educators) participated. A wide range of disciplines (e.g. physics, social sciences, English, medicine), countries (e.g. Australia, China, Singapore, USA), and experience levels (from new lecturers to award-winning university teachers) were represented. This finding has also been borne out in subsequent studies [2,3]. Trigwell and Prosser [4] developed a survey instrument (the Approaches to Teaching Inventory, or ATI) using items based on this continuum of conceptions and subsequently refined and validated it with more than 2000 university teachers from a range of disciplines, countries, and experience levels [5-7].

However, in the ATI, and the other studies, the focus was respondents' conceptions of teaching, without regard to how this may vary with respect to contextual factors, such as class size. This then is the focus of this paper: how does class size affect academics' conceptions of teaching? And why is this question important?

Conceptions of teaching underpin teaching and learning practice

Conceptions of teaching matter. They underpin what academics do as teachers, and affect how students learn. Trigwell and Prosser [4] found that academics who hold teacher-

centred conceptions employ teacher-centred strategies, and likewise for those academics with student-centred conceptions. (Although at least one study has contested this [8]).

Furthermore, in a study of almost 4000 students, it was found that students of teachers who describe teacher-centred conceptions adopt shallow approaches to learning, whereas students of teachers who report student-centred conceptions have deeper approaches to their learning [9].

Student-centred teaching practices lead to better student outcomes

Student-centred strategies lead to better student outcomes. This has been shown in a number of studies in a range of contexts. Hake [10] published a seminal study of more than 6000 physics students and found that what he called “interactive-engagement” (student-centred) strategies consistently resulted in greater gains in student conceptual understanding than “traditional” (i.e. teacher-centred) instruction.

Similar results have been found across a range of disciplines [11-13] and countries [14-16]. Student-centred strategies also lead to better student attendance and engagement [17].

Professional development is ineffective if it ignores participants' teaching conceptions

Henderson and Beach [18] reviewed several hundred articles from 1995-2008 reporting on different initiatives to reform undergraduate instruction in science, technology, engineering, and mathematics. They identified a number of factors common to successful, and unsuccessful, reforms. Change strategies that do not acknowledge the beliefs of the participants are ineffective. Conversely, those that align with or are deliberately designed to change teachers' conceptions [19] can be very successful.

Motivation for this study

This study is part of a larger project that aims to understand why traditional, teacher-centred instruction remains the norm [20,21], especially in lectures, when the evidence against its educational effectiveness seems so compelling. In the authors' view, the primary goal of professional development should be to improve learning outcomes for students. In order to do so, it must address academics' conceptions of teaching. Although teaching conceptions are understood in general terms, this study sought to identify whether academics' conceptions of teaching are dependent upon class size in any way. This paper will attempt to answer this question, and then conclude with some conjectures about what this might mean for professional development programs.

Methodology

This project builds on the phenomenographic research literature about conceptions of teaching. Phenomenography assumes that different people conceive of or experience the same phenomenon in a small number of qualitatively distinct ways [22].

It is not assumed that any phenomenographic study will absolutely and unambiguously identify the complete conceptions held by the particular individual participants about the phenomenon in question; rather it is acknowledged that the data collected is just a partial snapshot of their views at the particular time of the study, further filtered through the context of how the data was collected.

In this study, the different contexts of small and large classes were deliberately highlighted to draw out any contrasts in how participants may conceive of teaching in these different settings.

Data was collected using an online survey. Although online surveys are static and coarse compared to the more richly detailed information generated by interviews, more typical of phenomenographic research, it did facilitate recruitment of participants from diverse disciplines and geographic locations. Through the survey, participants for follow-up interviews were recruited. These follow-up interviews will explore participants' conceptions of teaching in more depth, and will be the subject of future publication.

Using an online survey also made it easy to discriminate between respondents' conceptions of teaching small classes versus large classes, because questions about the two contexts could be worded identically. Such transparent even-handedness is difficult to achieve in interviews, where unintended biases in how questions are posed can affect how participants respond. To address the research question of this paper, how respondents answered the set of small class questions was compared and contrasted with how they answered the set of large class questions.

Survey Design

A survey instrument was designed in Survey Monkey™ to explore academics' conceptions of teaching small classes, large classes, and, in particular, lectures. It was promoted to university academics at an Australian university through staff emails and newsletters.

The original survey was constructed by the authors in consultation with a professional form designer. It was then piloted with 6 respondents and reviewed in detail to identify any ambiguous wordings, confusing question sequences, or other issues [23].

The survey consisted of several sections. The first, which will be explored in detail in this paper, was designed to compare and contrast academics' experience of large versus small classes. The second section focused on academics' experiences of lecturing. The third and final section focused on relevant demographic information.

The first section, designed to contrast small and large classes, had 4 parts, each with a different theme:

- Class size & word associations
- The academics' enjoyment
- The academics' confidence
- Student engagement

In the first part respondents were asked to numerically characterise what they meant by a small and large class (i.e. what is the maximum size of a 'small' class, and the minimum size of a 'large' class), and to generate up to five words or phrases that they associated with large and small classes respectively.

The next three parts, focusing on enjoyment, confidence, and engagement, all had a similar design. In the part focused on enjoyment, respondents could use a Likert-scale to identify to what extent they agreed with the statement that they enjoyed teaching large classes, and why, and then likewise for small classes. The following two parts substituted statements about confidence in teaching, and student engagement, but otherwise followed the same layout.

The importance of reducing response bias and minimising respondent burden was paramount [24,25].

For example, two factors affecting how respondents answer multiple-choice or Likert-scale questions are primacy (the first response is favoured) and social acquiescence (respondents want to agree with the perceived views of the researcher) [26,27]. These biases can be offset against one another by ranking the Likert-scale from 'strongly disagree' to 'strongly agree'. The primacy effect favours the response listed first (i.e. 'strongly disagree'), whereas the social acquiescence bias instead typically favours 'strongly agree'.

Although 5-point Likert-scales are frequently used [28], in this study a 7-point scale was chosen. Although this adds somewhat to the respondent burden, and may therefore lead to satisficing (i.e. choosing the minimally adequate, often just neutral, response [29,30]), it was deemed necessary for this study. This was because the scale had not only to differentiate between agree and disagree, but also to discriminate between the intensity of responses to the same statement for small versus large classes. For example, knowing that a particular respondent is confident teaching both large and small classes is not that informative about the differences between these two contexts. By using a 7-point scale (that is, with 3 levels of 'agreement', and 3 levels of 'disagreement'), the contrasting experience between small and large classes could be highlighted.

Context plays a key role in survey design [31]. For this study that meant that it was important to have the pairs of identical questions about large and small classes together in each part, to make it clear that a comparison was intended. Also, each part focused on one particular aspect of the teaching experience (e.g. confidence, enjoyment), and this theme was highlighted at the top of each part to make the focus clear.

Other factors that were important in the survey's design were simplicity of language and the anonymity of respondents. For example, after each Likert-scale response identifying to what extent respondents disagreed or agreed with a statement, they were simply asked "Why is that?" Through an iterative review process between the authors, the professional form designer, and the pilot survey respondents, the questions were revised until they were as simple and clear as possible.

Finally, survey responses were anonymous. This is not only ethically sound but minimises the social desirability bias in which respondents are less likely to report socially undesirable beliefs or behaviours (e.g. lacking confidence, or thinking students are not engaged in their classes).

Data analysis of questions about small and large classes

The survey received 107 responses from a range of disciplines across the university. The sets of responses to only the small class questions were analysed independently of an equivalent analysis of the sets of responses to only the large class questions. These sets of responses (corresponding to one individual respondent) were categorised as being at either extreme of Kember's spectrum: that is, either teacher-centred/content-oriented, or student-centred/learning-oriented. However, some responses, either through their sparseness or the possibility of different interpretations, were categorised as "ambiguous". This term is not used to suggest that the respondents' conceptions were unclear or contradictory, just that the survey instrument was too coarse to discriminate subtleties in their ideas, and only the categorisation of more polarised views could be justified.

In Table 2 some representative responses are shown, and how they were categorised. The set of responses categorised as “ambiguous” came from one respondent, and were categorised as such because they could be interpreted in either a teacher-centred or student-centred way. For example, the teacher could be an animated presenter [dynamic], who’s very active at the front of the class [activities], and the students are watching [engagement]. Alternatively, it could be that there is a lot of interaction between the student and teacher [dynamic], the students are doing a variety of different tasks [activities], and the students are very involved [engagement]. Where it was possible to interpret the set of responses in different ways, they were classified as “ambiguous”.

Table 2. The categorisation of some sample quotes

Teacher-centred	Ambiguous	Student-centred
Performance	Dynamic	Individual questions
Keeping [students'] attention	Lots of marking	Knowing [students'] names
Useful information	Activities	Peer learning
Content-driven	Engagement	Interaction
Getting the message across		Personal
		Depth of learning

Results

The respondents clearly had different views of large and small classes. In Figures 1 and 2 below, word clouds [32] have been generated from the total set of responses to the large class questions, and separately to the small class questions. In these word clouds, words are listed in alphabetical order, with a size proportional to how frequently they occurred in the text.



Figure 1. Common words in the large class responses

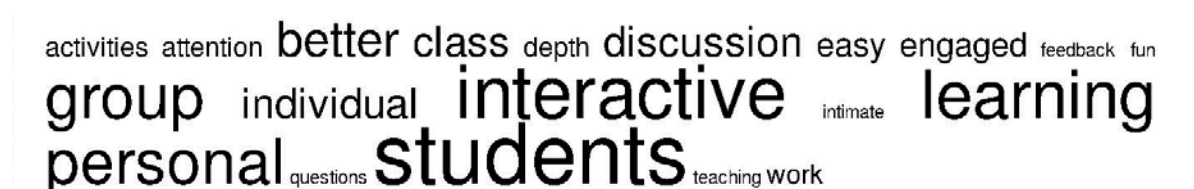

Figure 2. Common words in the small class responses

The connotations of the most common words in the large class responses were quite negative (e.g. “lack”, “difficult”, “noisy”) compared to those for the small classes (e.g. “easy”, “better”, “engaged”). Although this is an interesting difference, it is difficult to draw insightful conclusions because it is only a comparison of word frequency, without regard to what sense, or in what context, these words were used.

Responses to the large class and small class questions were then categorised more meaningfully as either teacher-centred or student-centred (see Table 3 below). Some responses could not be categorised unambiguously because they could be interpreted in multiple ways. These responses have been shaded in Table 3.

Table 3. Categorisation of responses by class size

N = 107		SMALL CLASSES		
		Teacher-centred	Ambiguous	Student-centred
LARGE CLASSES	Teacher-centred	17	34	29
	Ambiguous	0	13	9
	Student-centred	0	0	5

Taking out the “ambiguous” responses to leave only the responses that were categorised unequivocally gives the distribution shown in Table 4 (N=51).

Table 4. Subset of unequivocally categorised responses by class size

N = 51		SMALL CLASSES	
		Teacher-centred	Student-centred
LARGE CLASSES	Teacher-centred	17 (33%)	29 (57%)
	Student-centred	-	5 (10%)

Discussion

These results raise some interesting questions. For example, what is it to be teacher-centred in a large class but student-centred in a small class?

In large classes, teacher-centred instruction could for example simply be the traditional lecture: the sage on the stage [33], whereas student-centred instruction might look more like Peer Instruction [34]: the guide on the side.

Similarly in small classes, teacher-centred instruction could take the form of ‘chalk and talk’ tutorials where the tutor works through a problem on the board, whereas student-centred instruction could include small group problem-solving sessions, for example.

In Table 5 below, the different quadrants have been characterised by these corresponding representative teaching strategies. As a shorthand, these quadrants have been labelled A, B, and C. Note that the bottom-left quadrant has not been labelled, as not one of the 107 survey respondents demonstrated teacher-centred conceptions in small classes, coupled with student-centred conceptions in large classes. Only the converse was observed. On the spectrum between wholly teacher-centred conceptions and wholly student-centred

conceptions there seems to be only one intermediate: teacher-centred conceptions in large classes coupled with student-centred conceptions in small classes.

Table 5. Sample characterisation of different categories of responses

		SMALL CLASSES	
		Teacher-centred	Student-centred
LARGE CLASSES	Teacher-centred	Traditional lectures: the sage on the stage Chalk and talk tutorials: Tutor solves problems on board	Traditional lectures: the sage on the stage Problem-solving in small groups
	Student-centred	Peer instruction in lectures: the guide on the side Chalk and talk tutorials: Tutor solves problems on board	Peer instruction in lectures: the guide on the side Problem-solving in small groups

The weight of evidence summarised earlier in the introduction [10-17] shows that student-centred strategies, in both large and small classes (labelled quadrant C in the table), lead to the best student learning outcomes. In the authors' view, shifting academics' conceptions and practice towards this should be the goal of professional development programs. But how best to affect this transition: for example, should there be programs targeted at the $A \rightarrow B$ transition (i.e. for academics with teacher-centred conceptions of teaching, first developing student-centred conceptions and practice only in small classes), and then other programs separately targeting the transition $B \rightarrow C$ (extending small class student-centred conceptions to a context of larger classes)? And is it even possible for individuals' conceptions of teaching to change, or be changed, in this way?

Academics' conceptions of teaching, just like student conceptions of different phenomena, can change [35]. In fact many successful professional development programs have sought to do just that [18, 19]. However, academics advance through these conceptions at different rates (Martin and Ramsen (1992), cited in [1]), and it certainly seems unlikely that each transition would be equally easy [1]. So perhaps there is some conceptual 'bottleneck', a breakthrough that is difficult to make.

The best candidate from this study is the transition $B \rightarrow C$, the development from teacher-centred to student-centred conceptions in large classes. To draw an analogy from chemistry, this could be the "rate-determining step", where academics progress relatively easily from $A \rightarrow B$, but only a trickle makes the next step $B \rightarrow C$, and so B is the biggest group and C the smallest. Furthermore, the academics with student-centred conceptions (Quadrant C) are probably over-represented in this study because arguably they would value teaching more highly and be more motivated to give up their time to participate in the study in the first place. This self-selection bias means that the proportion of academics holding wholly student-centred conceptions of teaching is probably in fact even smaller, which further reinforces the conjecture that the transition $B \rightarrow C$ is a conceptual bottleneck.

If these transitions between groups happened uniformly, the groups should reflect increases in experience levels. However, this isn't apparent in the demographic data for the three groups, which each have at least 40% of respondents reporting more than 10 years' of academic experience and respondents' "highest qualifications" ranging from undergraduate

to doctoral. It is probably too simplistic to expect conceptual development to run to a timetable, when in fact it is the quality, not quantity, of experiences and critical incidents that drive conceptual change.

So if the transition $B \rightarrow C$, the development from teacher-centred to student-centred conceptions in large classes, is indeed the conceptual bottleneck the relative sizes of the groups suggest it is, it makes sense to focus professional development programs on enabling that change.

Alternatively, it could be argued that supporting step-wise development would be the most effective. That is, if academics with teacher-centred conceptions regardless of class size (Quadrant A in the table above) could be brought together to focus on developing student-centred conceptions and practice in small classes (i.e. the transition $A \rightarrow B$), it would likely be successful as this seems to be a small conceptual shift. Likewise, if academics from Quadrant B (with student-centred views in small classes but teacher-centred views in large classes) could be brought together and supported to develop student-centred conceptions and practice in large classes (i.e. $B \rightarrow C$), for these academics this is a small step. And therefore academics with student-centred views regardless of class size (Quadrant C), whose views align with the evidence about best practice, could perhaps be ignored.

However, the outcome of the phenomenographic research [1-7] that frames this study was not to unambiguously categorise participants' conceptions of teaching, rather the outcome was the set of conceptions themselves. To claim that individual participants' conceptions could be unequivocally identified in some absolute way is spurious. And even if they could be, to group academics by the perceived value of their ideas would certainly be perceived as condescending, if not insulting. So step-wise professional development programs targeted at groups of academics with different conceptions is impractical.

Instead, in the authors' view, professional development programs should be targeted at developing student-centred teaching conceptions and practice in large classes, for all academics. From the survey data, it seems this is a conceptual 'bottleneck' that relatively few academics navigate through. By treating all academics equally, it avoids alienating those academics with teacher-centred conceptions by implying that their ideas are of lesser value. Furthermore, it would support academics with student-centred conceptions (Quadrant C) translate these conceptions into practice. Although conceptions and practice generally align [4], sometimes the practice lags the conception – that is, the conceptions are student-centred but the practice is more teacher-centred [8,36].

This finding is based upon one analysis of the survey data. Further research and analysis is needed to explore these ideas in more detail. To that end, the survey data was also analysed in two other ways. On one hand, complete sets of responses (i.e. complete survey scripts) were categorised using a typical phenomenographic approach [22,37,38] into a spectrum from teacher-centred to student-centred conceptions. On the other hand, individual responses to individual questions were coded for various themes. These two extremes of global and local analysis will be the focus of future publications. In addition, some survey respondents nominated themselves for follow-up interviews, which allowed their ideas about teaching and learning to be explored in more depth.

Conclusion

Analysis of a survey of Australian academics' conceptions of teaching revealed that there seems to be a progression from teacher-centred conceptions, to student-centred conceptions only in a small-class context, to student-centred conceptions regardless of class size. Student-centred conceptions of teaching underpin student-centred practice, which leads to the best student learning outcomes. Professional development programs should be aimed at developing these student-centred conceptions and practice. It has been argued that these programs should be focused on developing student-centred conceptions and practice in large classes in particular, because this is a conceptual bottleneck that few academics navigate through. Further analysis of the survey data and follow-up interviews with some of the respondents will be undertaken to explore these ideas in more depth.

References

1. Kember D.: *A reconceptualisation of the research into university academics' conceptions of teaching*. Learning and Instruction, 1997. **7**(3): p. 255-275.
2. Postareff L., Lindblom-Ylänne S.: *Variation in teachers' descriptions of teaching: Broadening the understanding of teaching in higher education*. Learning and Instruction, 2008. **18**(2): p. 109-120.
3. Samuelowicz K., Bain J.D.: *Revisiting academics' beliefs about teaching and learning*. Higher Education, 2001. **41**(3): p. 299-325.
4. Trigwell K., Prosser M.: *Congruence between intention and strategy in university science teachers' approaches to teaching*. Higher Education, 1996. **32**(1): p. 77-87.
5. Trigwell K., Prosser M.: *Development and Use of the Approaches to Teaching Inventory*. Educational Psychology Review, 2004. **16**(4): p. 409-424.
6. Prosser M., Trigwell K.: *Confirmatory factor analysis of the Approaches to Teaching Inventory*. Br J Educ Psychol, 2006. **76**(Pt 2): p. 405-19.
7. Trigwell K., Prosser M., Ginns P.: *Phenomenographic pedagogy and a revised Approaches to teaching inventory*. Higher Education Research & Development, 2005. **24**(4): p. 349-360.
8. Murray K., Macdonald R.: *The disjunction between lecturers' conceptions of teaching and their claimed educational practice*. Higher Education, 1997. **33**(3): p. 331-349.
9. Trigwell K., Prosser M., Waterhouse F.: *Relations between teachers' approaches to teaching and students' approaches to learning*. Higher Education, 1997. **37**(1): p. 57-70.
10. Hake R.R.: *Interactive-engagement versus traditional methods: A six-thousand-student survey of mechanics test data for introductory physics courses*. American Journal of Physics, 1998. **66**(1): p. 64-74.
11. Prince M.: *Does Active Learning Work? A Review of the Research*. Journal of Engineering Education, 2004. **93**(3): p. 223-231.
12. Masikunas G., Panayiotidis A., Burke L.: *The use of electronic voting systems in lectures within business and marketing: a case study of their impact on student learning*. Research in Learning Technology, 2007. **15**(1): p. 3-20.

13. FitzPatrick K.A., Finn K.E., Campisi J.: *Effect of Personal Response Systems on Student Perception and Academic Performance in Courses in a Health Sciences Curriculum*. Advances in Physiology Education, 2011. **35**(3): p. 280-289.
14. Abdul, B., et.al: *Addressing Student Learning Barriers in Developing Nations with a Novel Hands-on Active Pedagogy and Miniaturized Industrial Process Equipment: The Case of Nigeria*. International Journal of Engineering Education, 2011. **27**(2): p. 458-476.
15. Hussain A., Azeem M., Shakoor A.: *Physics Teaching Methods: Scientific Inquiry Vs Traditional Lecture*. International Journal of Humanities and Social Science, 2011. **1**(19): p. 269-276.
16. Cahyadi V.: *The effect of interactive engagement teaching on student understanding of introductory physics at the faculty of engineering, University of Surabaya, Indonesia*. Higher Education Research & Development, 2004. **23**(4): p. 455-464.
17. Deslauriers L., Schelew E., Wieman C.: *Improved learning in a large-enrollment physics class*. Science, 2011. **332**(6031): p. 862-4.
18. Henderson C., Beach A., Finkelstein N.: *Facilitating change in undergraduate STEM instructional practices: An analytic review of the literature*. Journal of Research in Science Teaching, 2011. **48**: p. 952-984.
19. Ho A., Watkins D., Kelly M.: *The conceptual change approach to improving teaching and learning: An evaluation of a Hong Kong staff development programme*. Higher Education, 2001. **42**(2): p. 143-169.
20. Nunn C.E.: *Discussion in the College Classroom: Triangulating Observational and Survey Results*. Journal of Higher Education, 1996. **67**(3): p. 243-66.
21. Skovsmose O., Valero P., Christensen O.: eds. *University science and mathematics education in transition*. 2009, New York ; London : Springer: New York ; London.
22. Marton F.: *Phenomenography — Describing conceptions of the world around us*. Instructional Science, 1981. **10**(2): p. 177-200.
23. Fowler J., Jackson F.: *How unclear terms affect survey data*. Public Opinion Quarterly, 1992. **56**(2): p. 218-231.
24. Bradburn N.M.: *Respondent burden*. Proceedings of the American Statistical Association (Survey Research Methods Section), 1978: p. 35-40.
25. Choi B.C.K., Pak A.W.P.: *A Catalog of Biases in Questionnaires*. Preventing chronic disease, 2005. **2**(1): p. 1-13.
26. Schuman H., Presser S.: *Questions and Answers in Attitude Surveys: Experiments on Question Form, Wording, and Context*. 1996, United States: Commercial. xiv, 372.
27. King A., Leigh A.: *Are Ballot Order Effects Heterogeneous?* Social Science Quarterly, 2009. **90**(1): p. 71-87.
28. Clason D.L., Dormody T.J.: *Analyzing Data Measured by Individual Likert-Type Items*. Journal of Agricultural Education, 1994. **35**(4): p. 31-35.
29. Krosnick J.A.: *Response Strategies for Coping with the Cognitive Demands of Attitude Measures in Surveys*. Applied Cognitive Psychology, 1991. **5**(3): p. 213-236.

30. Krosnick J.A., et.al: *The impact of 'no opinion' response options on data quality: Non-attitude reduction or an invitation to satisfice?* Public Opinion Quarterly, 2002. **66**(3): p. 371-403.
31. Schwarz N., Sudman S.: eds. *Context effects in social and psychological research*. 1992, Springer-Verlag: New York. xvii, 353 p.
32. Steinbock D.: *Tag Crowd*. 2006 [cited 2013 October 1]; Available from: <http://tagcrowd.com/>.
33. Horton B.W.: *Shifting from the Sage on Stage to the Guide on the Side: The Impact on Student Learning and Course Evaluations*. Journal of Hospitality & Tourism Education, 2001. **13**(5): p. 26-34.
34. Mazur E.: *Peer instruction : a user's manual*. Prentice Hall series in educational innovation. 1997, Upper Saddle River, N.J.: Prentice Hall. xv, 253 p.
35. McKenzie J.A.: *Variation and change in university teachers' ways of experiencing teaching*. 2003, University of Technology, Sydney: Sydney.
36. Henderson C.: *Easier Said Than Done: A Case Study of Instructional Change Under the Best of Circumstances*. in *2003 Physics Education Research Conference*. 2004. Madison, Wisconsin (USA): AIP.
37. Bowden J.A., Walsh E.: eds. *Phenomenography*. 2000, Melbourne: RMIT University Press: Melbourne.
38. Marton F.: *Phenomenography - A Research approach to investigating different understandings of reality*. Journal of Thought, 1986. **21**(3): p. 28-49.

Theory-Practice Gap: The relevance of students' conceptions in geometrical optics for teaching

Claudia Haagen

Austrian Educational Competence Centre, University of Vienna, Vienna, Austria

Abstract

Findings of Physics Education Research during the last few decades were numerous. Looking into daily school practice, we however frequently cannot spot many changes during the past years. This paper analyses to what extent empirical findings from PER are present in the physics classroom. We are focusing on the topic of basic optics for year 8. Research findings are contrasted with authentic learning environments in the form of school textbooks as well as with teachers' priorities concerning key concepts.

Keywords: basic optics, theory-practice gap, vision

Introduction

Physics Education Research (PER) of the last decades has put a major emphasis on research into students' conceptions in different fields of physics [1]. Constructivist approaches have emphasised the importance of considering students' ideas as a starting point for the design of teaching-learning interventions in order to trigger conceptual change ([2]; [3]). Despite these crucial findings of the past decades, it is frequently assumed that these ideas have not yet reached conventional classroom practice. This paper focuses on a fixed content topic of physics, namely geometrical optics. Findings from PER in this field are contrasted with factors relevant for instruction at school: teachers' beliefs about the importance of certain physical key ideas in basic optics (year 8) and school textbooks for year 8 physics classes. The research aim of this study was to find out whether an agreement between these two indicators for school practice and findings from PER can be identified.

Theoretical Background

Conceptual change theory is based on constructivist ideas that learning is not a passive process of information transmission, but rather an active process where students construct knowledge based on their pre-conceptions. Consequently, conceptual change occurs, when existing conceptions are changed through any kind of intervention [4]. Conceptions are defined as "the learner's internal representations constructed from the external representations of entities constructed by other people such as teachers, textbook authors or software designers" [5].

One part of conceptual change research focuses on the identification of students' conceptions, so to say the naïve ideas students have, when they come to physics classes. These conceptions are, however, frequently not in harmony with scientific views and turn out to be extremely resistant to change [6]. There are several lines of thoughts among researchers about the best way to overcome such naïve ideas and turn them into adequate physical ideas. A lot of theoretical discussion has been going on concerning teaching strategies promoting conceptual change. Despite different approaches, all branches of conceptual change theory agree that students' conceptions need to be the starting point for successful interventions. That however means, that teachers need to be

informed about the ideas students possibly have when they enter their physics classrooms.

Conclusions about the relationship of PER and school practice cannot be investigated on a general level due to the unmanageable amount of variables involved. Thus, our research concentrates on one content topic of physics, on one age class of students and uses two indicators for school practice. Within geometrical optics for year 8 students, we focused on the concept of vision, which is known to be central for understanding many subtopics of geometrical optics ([7,8]). This concept is taken to exemplify and compare findings from PER and the situation of physics instruction at schools.

The concept of vision was used for this purpose based on several reasons. This concept proves to be a fundamental key idea of geometrical optics basic to the understanding of several other key concepts like image formation in mirrors or lenses, formation of shadows, colour perception etc. According to Guesne [7], inadequate models of vision are a main reason for learning difficulties students traditionally have, especially in the formation of virtual images. Additionally, a solid concept of vision is regarded as “important when we consider the validity of certain classic experiments in physics teaching” [7]. De Hosson and Kaminski [9] discuss the significance of a good command of basic key ideas for grasping more complex concepts within optics: “recent studies show that certain difficulties that students face in their first years at school remain with them until university in every country”. Consequently, teaching optics needs to produce a scientifically adequate concept of vision [7]. These claims are strongly supported by empirical results of optics curricula which are based on the sender-receiver model. As shown in Herdt’s comparative study of basic instruction in geometrical optics [10], students who were instructed following the curriculum based on the sender-receiver model performed significantly better than students who were conventionally instructed.

After elaborating on the importance of an adequate sender-receiver model and its crucial significance for learning processes in geometrical optics, the most frequently known alternative conceptions on vision are introduced. Guesne [7] has classified the most frequently held conceptions concerning vision into four main categories, which are based on different relations between a light source (LS) and an object (O) seen by an observer’s eyes (OE):

- (1) “light bath idea”: light just needs to be present. There is no relationship established between the three components LS-O-OE.
- (2) “illumination of an object”: light is beamed on the object. A relation is only established between LS and O.
- (3) “active eye”: a kind of active mechanism is attributed to the human’s eye. We have to actively look at an illuminated object in order to see it. A relationship is established between all three components LS-O-OE, without taking the direction of light propagation into account, but rather the “direction of sight”.
- (4) “physicists’ model”: light reflected by an object is received by the human eye. A relationship between all three components LS-O-OE is established based on a correct direction of light propagation.

De Hosson and Kaminski [9] reconstructed the complex process of vision for the age group of 10 to 15 year old children with a model consisting of two different parts; a physical and a psycho-physiological one (cf. Figure 1). The physical part, which resembles Guesne’s “physicists’ model”, explains that we can perceive objects only, when they send off light into our eyes. Within this sender-receiver process [10] we can spot three key concepts of optics: (1) continuous propagation of light (2) selective reflection and absorption and

(3) image formation. These concepts will be subject of the investigations reported in the following sections. The second part of the model, the psycho-physiological one, describes processes going on between the retina and the cortex. This part is thematically rather rooted in the field of biology than in physics.

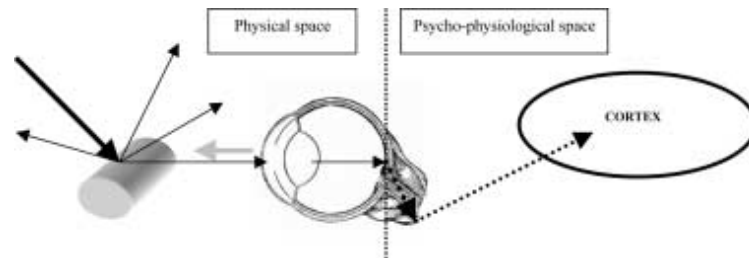

Figure 1. The mechanism of vision divided into a physical and psycho-physiological part ([9], p. 618)

Research Questions

The main research aim of this project was to investigate how findings of PER on students' conceptions are reflected in classroom practice. For the study reported here, we have chosen the domain of geometrical optics, as discussed earlier, focusing on the sender-receiver model which is not only crucial for understanding when we can perceive illuminants and illuminated objects. As indicators for school practice informed by results of PER we investigated both year 8 physics teachers' views on teaching optics and year 8 physics school textbooks.

The detailed research questions were the following:

- How relevant is the concept of vision for teachers when teaching basic optics in year 8?
- How is the concept of vision introduced in physics school textbooks for year 8?
- How is the concept of vision cross-linked with other subdomains of geometrical optics?
- How is the concept of vision integrated in representations in school textbooks?

Design and Methods

The research design consists of two strands which are supposed to be compared and contrasted. On the one hand, we were interested in teachers' views on the importance of certain key concepts for their teaching of optics. We wanted to compare teachers' self-reports with school textbooks, as research results indicate that schoolbooks frequently are the "secret curriculum" teachers follow and in addition the most frequently used resource for lesson preparation [11].

For the teacher survey we constructed a questionnaire including 9 items with a 4 point-likert-scale. Each item focused on a certain key concept of geometrical optics. Teachers were asked to indicate the importance of the mentioned concept for their teaching of optics, covering the choices "has highest priority", "is always mentioned", "is mentioned if there is time left" and "is never mentioned".

The first phase of data collection was conducted online. Here the sample consisted of N=85 teachers of year 8¹ physics classes in all different possible school types at this age

¹ In the Austrian educational system initial teaching of geometrical optics takes place at year 8 according to the curriculum for physics.

level. At this point it is important to mention that the online survey was part of the accompanying research on standardization in science in Austria. As Austrian teachers proved to be very sceptical about the standardization project, many of them refused to fill in the accompanying teacher questionnaire, of which our questionnaire on teaching optics was part. Therefore the response rate was only around 25%. In order to enlarge the sample we decided to use the questionnaire in paper and pencil form during in-service training afternoons. There another N=25 year 8 teachers of all different school types were willing to take part in the survey.

After filling in the questionnaire, these teachers of the paper and pencil group were shown the results of the online survey of the first phase of data collection. We asked them for possible explanations for their colleagues' choices. The idea behind this procedure was to distil reasons why teachers emphasise some key concepts while they neglect others. It is however known that self-reporting is not too reliable, especially not when teachers feel the need to justify their way of teaching. From our experience of the work with in-service teachers we know that teachers are more willing to contribute to discussion when they do not have to talk about their actual teaching but about their colleagues'. Although not talking about their direct teaching experience, the way they reflect a colleague's teaching behaviour is supposed to provide good hints about their own beliefs.

For the textbook analysis, the five best selling Austrian physics school textbooks² for year 8 physics were chosen as well as the alternative student materials [13] we are currently developing in the context of a big project on instruction of basic geometrical optics at lower secondary level. The corpus data consisted of the chapters on geometrical optics in the school textbooks mentioned above and of the alternative student materials [14]. Within the analysis we put a special focus on the concept of light and vision for reasons discussed in the theory part of this paper.

The corpus data was analysed on the levels of content, visual representations and language. In order to cover these different domains, we used two different tools of analysis: "Sachstrukturdiagramme" and a grid for textbook analysis. The content analysis focused on the content structure, analysing the subject matter on a macro level. So called "Sachstrukturdiagramme" ([15,16]) were used for this purpose. An individual "Sachstrukturdiagramm", which is quite similar to a flow chart, was constructed for each unit of analysis, in our case for each textbook. The flow charts represent the key ideas covered, how these key ideas are sequenced and how they are interlinked. Additionally, we analysed to what extent learners' perspectives on these key ideas are taken into account [17]. The textbook analysis grid we used consisted of 8 categories made up of 67 variables focusing on linguistic aspects, forms of visual representation and integration of student conceptions.

Selected results

In this section the results of the teacher survey as well as the results of the school textbook analysis are presented. Results of both types focus on the process of vision and the use of some kind of sender-receiver concept.

² In Austria, school textbooks are provided by the state and parents have to contribute only a small percentage of the costs. Austrian schoolbooks have to be approved by a commission ("schoolbook commission") appointed by government. Usually, there are school textbooks for all classes and research shows [12] that textbooks are very frequently used in Austrian schools.

The Teacher Survey

As already mentioned above, one concept which is basic to many key ideas of geometrical optics is the concept of vision. The results of the teacher survey show that both components of the model of vision are treated differently by the teachers of our sample.

The physical component, which is based on a sender-receiver model, describing the path of light from a light source via an object through the visual system of a receiver as far as to the retina, is a permanent part of optic classes in not even one third of the cases (cf. Figure 2). On the contrary, some psycho-physiological aspects, which describe processes taking place between the retina and the cortex, are treated by over 80% of the teachers as integral part of their optics classes (cf. Figure 2).

When talking to the teachers of the paper and pencil group, we were able to collect some of their beliefs why teachers may tend to attribute more importance to psycho-physiological aspects of vision than to physical ones. On the one hand, a majority of teachers believes that it is anyway obvious for their students that light sent off by an object must enter the eyes to be visible, as it is an everyday phenomenon or as it must for sure be part of elementary science or biology classes. This line of argumentation strongly corresponds with the findings of Guesne [7]. On the other hand, teachers feel frequently the need to account for the fact that we perceive our surroundings upright, while a converging lens like that one in the human eye produces upside-down images. This is usually the point, when the role of the brain is at least mentioned in physics classes of our sample.

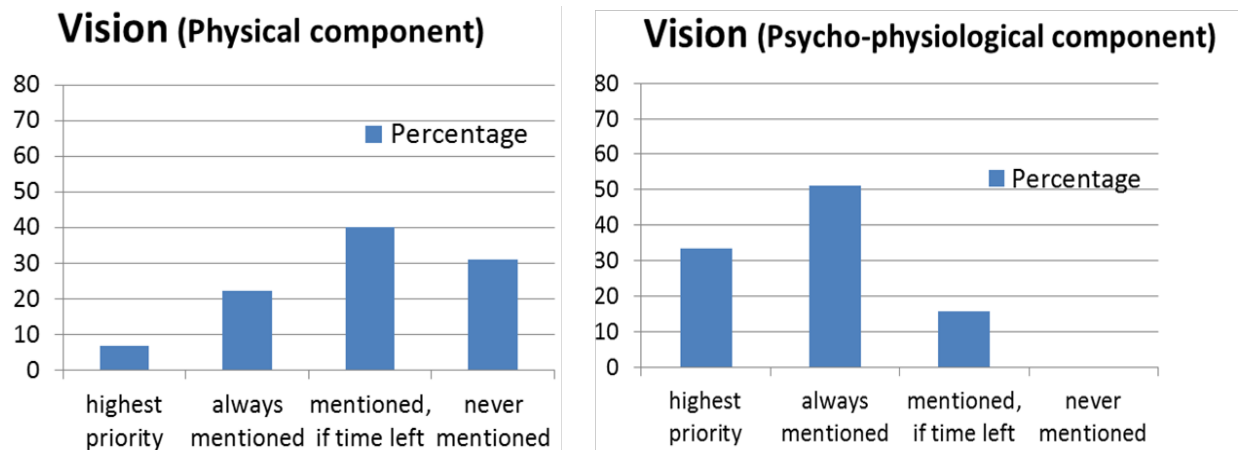

Figure 2. Importance of teaching the key concept of vision

A closer analysis of the basic physical components underlying the process of vision was carried out. Figure 3 shows that the continuous propagation of light is likely not to be mentioned in more than 50% of optics classes. On the other hand, illuminated objects are reconstructed by nearly 90% of the teachers as objects which reflect light (cf. Figure 3). However, as the discussion with the teachers of the paper and pencil group revealed, the law of reflection is here emphasised rather than the selective aspect of reflection.

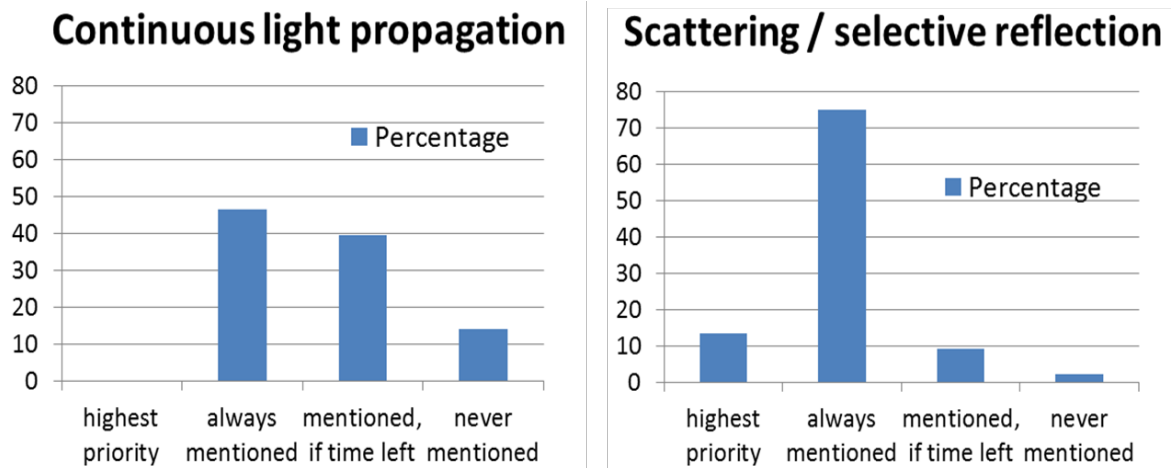

Figure 3. Importance of teaching the key concept of continuous light propagation and reflection

School Textbook analysis

One point of interest within the textbook analysis was the implementation of a sender-receiver model of vision and the way such a model is cross-linked and referred to throughout the optics chapter.

In all materials analysed, the idea of a sender-receiver model is introduced quite at the beginning of the optics chapter. However, big differences could be identified in the quality: In most school textbooks the sender-receiver idea is only briefly mentioned; in none of the school textbooks does the introduction of this important key concept fill more than half a page. Similarly rare are experiments or exercises based on this concept (cf. Figure 4).

Corpus Data	IP	P4	PV	PH	PÜ	UW
Use of sender-receiver model	✓	✓	✓	✓	✓	✓
Covers more than half a book page	x	x	x	x	x	✓
Experiments/exercises to deepen content	x	x	x	x	x	✓

Figure 4. Characteristics of the introduction of vision in school textbooks (IP, P4, PV, PH, PÜ)³ and the alternative student material (UW)

The quantitative analysis of the corpus data revealed that the concept of a sender-receiver model is hardly mentioned in other subsections of the optics chapters (cf. Figure 5). In conventional textbooks the number of textual references does not exceed ten, whereas more than 40 textual references could be identified in the alternative material (UW).

³ The code for each school textbook is an abbreviation of the German title of the book.

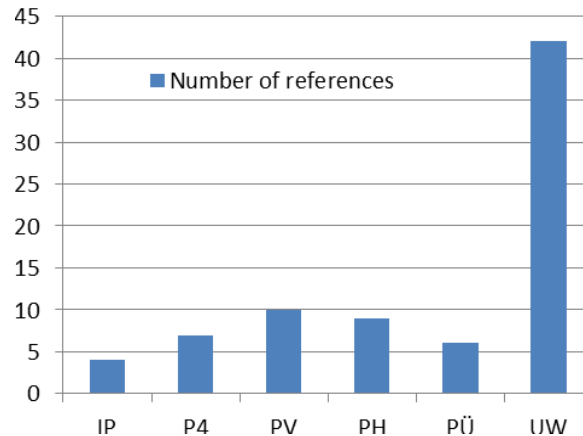

Figure 5. Number of verbal references to the sender-receiver model

Interestingly, such a big contrast between conventional schoolbooks and the alternative material could not be spotted in the category of visual representations. Here the analysis shows a heterogeneous picture within the group of schoolbooks. In the schoolbooks, the sender-receiver model is visually indicated in 1 to 8 cases. The alternative material contains 10 representations indicating a sender-receiver model. At this point it is important to explain when a visual representation is categorized as “indicating a sender-receiver concept”. This category summarizes all visual representations that firstly indicate the presence of an observer, either by symbols as eyes or by full representations of faces or persons. Secondly, the path of light underlying the optical phenomenon represented needs to be linked to the observer.

In visual representations including a sender-receiver concept, we also analysed whether the direction of light propagation is indicated by arrows or the like. In two schoolbooks (P4, PH) the direction of light propagation is not represented at all. Two schoolbooks indicate the direction of light propagation in each representation (IP, PV). However, the schoolbook IP contains in total just one representation based on a sender-receiver concept. In PÜ and in the alternative material UW the direction of light propagation is indicated in about half of the cases.

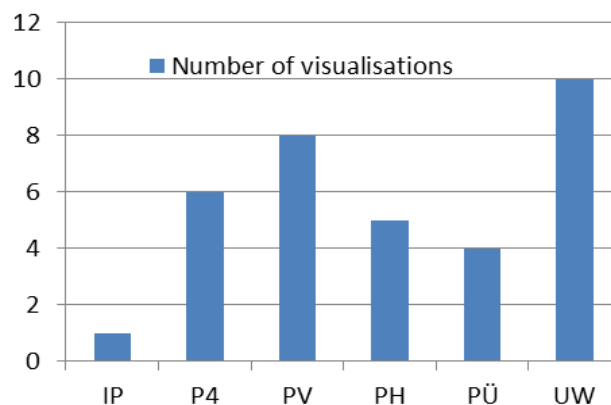

Figure 6. Number of visual representations, where a sender-receiver concept is indicated

Summary & Conclusions

In this study the findings of PER concerning effective teaching environments are contrasted with two indicators for conventional physics instruction in geometrical optics – namely schoolbooks and the importance of certain key concepts from teachers' perspectives. The teacher survey reveals that teachers do not base their teaching of optics so much on a physical model of vision like the sender-receiver model. Results of PER however emphasise its importance for the conceptual understanding of many key ideas in optics. Many teachers of our cohort believe that it is anyway trivial and for sure known by their students that light from an object must enter the eyes in order to produce a visual impression. In contrast, at some stage the majority of teachers mention the influence of the brain for visual perception in their optics classes. The key concepts of continuous light propagation, as well as the aspect of selective reflection are for many teachers not top priority in teaching optics, although PER identifies them as necessary basis for grasping a conceptual understanding of optical phenomena. In summing up, it can be said that the choices teachers make concerning the importance of certain key concepts, are hardly informed by findings of PER.

Similar conclusions can be drawn from the analysis of physics school textbooks. There again a physicists' model of vision, which is according to PER an essential conceptual basis for most topics of optics, is introduced very superficially. In addition, the frequency of verbal crosslinks within the optics chapter shows that this concept is hardly taken up again or deepened by conventional school textbooks. A more heterogeneous situation can be reported concerning visual representations. Some books refer in their representations more to the idea of a sender-receiver model than others. The same holds true for the direction of light propagation, which is only indicated in the representations of some books while other textbooks ignore it or even indicate the direction of sight. This is very counterproductive especially as we know from PER that some students tend to hold the conception of "the active eye" (cf. Guesne's categories of student conceptions on vision). To sum up, most of the school textbooks we analysed do not or only marginally implement findings of PER concerning the concept of vision.

In summarizing, it can be concluded that neither the teaching practice of our sample nor the physics school textbooks analysed indicate a systematic alignment with findings from PER. This clearly portrays the existing gap between school practice and Physics Education Research in this area of geometrical optics we focused our research on. Reasons for this situation are for sure multiple on both sides and the same holds true for strategies that may be able to bridge this gap. First steps could be to make teacher education and in-service trainings more research-based, as well as to make sure that physics education researchers are part of national schoolbook commissions. Finally, the PER community should take even more responsibility to not only conduct research that is relevant for school practice but also to explicitly translate such research results into practice.

References

- [1] Duit R.: Bibliography — STCSE: Students' and teachers' conceptions and science education. Retrieved October 20, 2009; 2009.
- [2] Duit R., Treagust D.: Conceptual change: a powerful framework for improving science teaching and learning. *International Journal of Science Education* 2003; 25(6):671–688.
- [3] Posner G., Strike K., Hewson P., et.al: Accommodation of a scientific conception: Toward a theory of conceptual change. *Science Education* 1982; 66 (2):211–227.

- [4] Chi M., Slotta J., Leeuw N. de: From things to processes: A theory of conceptual change for learning science concepts. *Learning and instruction* 1994; 4(1):27–43.
- [5] Treagust D. F., Duit R.: Conceptual change: A discussion of theoretical, methodological and practical challenges for science education. *Cultural Studies of Science Education* 2008; 3(2):297–328.
- [6] Duit R., Treagust D., Widodo A.: Teaching science for conceptual change: Theory and practice. In Vosniadou S (ed): *International handbook of research on conceptual change*, Routledge, 2008, pp 629–646.
- [7] Guesne E.: Light. In Driver R., Guesne E., Tiberghien A. (eds): *Children's ideas in science*, 1993rd ed. Buckingham, Open University Press, 1985, pp 10–32.
- [8] Langley D., Ronen M., Eylon B. S.: Light propagation and visual patterns: Preinstruction learners' conceptions. *Journal of research in Science Teaching* 1997; 34(4): 399–424.
- [9] Hosson C. de, Kaminski W.: Historical Controversy as an Educational Tool: Evaluating elements of a teaching–learning sequence conducted with the text “Dialogue on the Ways that Vision Operates”. *International Journal of Science Education* 2007; 29(5): 617–642.
- [10] Herdt D.: *Einführung in die elementare Optik. Vergleichende Untersuchung eines neuen Lehrgangs*. Essen: Westarp-Wissenschaftsverlag, 1990.
- [11] Valverde G., Bianchi L., Houang R., et.al: *According to the Book: Using TIMSS to investigate the translation from policy to pedagogy in the world of textbooks*, Dordrecht, The Netherlands: Kluwer Academic Publishers; 2002.
- [12] Rechberger V., Livitzis M., Aldrian J., et.al: *Perceptions of teachers and learners about the mathematics, science and technology curricula in two European countries*. Nikosia, August 2013.
- [13] Haagen-Schützenhöfer C., Rottensteiner J., Fehringer I.: *Unterrichtsmaterialien für den Anfangsoptikunterricht, Version I/2013 (Sekundarstufe I)*. AECCP, Universität Wien, 2013.
- [14] Haagen-Schützenhöfer C., Holzmeier S.: *Wodurch unterscheiden sich Physikschulbücher und forschungsbasiert entwickelte Lernmaterialien zum Themenbereich geometrische Optik?* ÖFEB Symposium, Klagenfurt, 2013.
- [15] Duit R., Häußler P., Kircher E.: *Planung und Analyse von Sachstrukturen für den Physikunterricht*. Unterricht Physik (Bd. 4, S. 35-58). Köln: Aulis-Verlag 1981.
- [16] Müller C., Duit R.: Die unterrichtliche Sachstruktur als Indikator für Lernerfolg–Analyse von Sachstrukturdiagrammen und ihr Bezug zu Leistungsergebnissen im Physikunterricht. *Zeitschrift für Didaktik der Naturwissenschaften* 2004; 10:147–161.
- [17] Duit R., Komorek M., Wilbers J.: Studies on educational reconstruction of chaos theory. *Research in Science Education* 1997; 27(3):339–357.

The Current Situation of Students' metacognition of the High School Science Classrooms in Thailand

Warawun Chantharanuwong¹, Kongsak Thathong², Chokchai Yuenyong³, Khajornsak Buaraphan⁴ and Gregory P. Thomas⁵

¹²³ Science Education, Faculty of Education, Khon Kaen University, Thailand

⁴ Institute for Innovative Learning, Mahidol University, Nakhon Pathom, Thailand

⁵ Secondary Education, Faculty of Education, University of Alberta, Canada

Abstract

This study aimed to explore students' metacognition within their high school science classrooms in Thailand. The Self-Efficacy and Metacognition Learning Inventory-Science (SEMLI-S) was the instrument employed. It measures students' metacognition, self-efficacy and constructivist science learning processes. The SEMLI-S has 30 items and five sub-scales. These five sub-scales, each reflecting a dimension of students' self-perceived metacognitive science learning orientation, are: Constructivist Connectivity (CC), Monitoring, Evaluating, & Planning (MEP), Science-Learning Self-Efficacy (SE), Learning Risk Awareness (AW), and Control of Concentration (CO). Statistical data were collected from 5418 high school students from 40 schools across Thailand. The data were analyzed using One-Way Analysis of Variance (ANOVA) statistical techniques. The analysis of the data suggests that statistically significant variations exist in students' metacognition in relation to their science learning according to their gender ($p < 0.01$) and their regional location within Thailand ($p < 0.05$), and their grade level ($p < 0.05$). No statistically significant variation was found according to participants' age.

The MEP dimension, male students reported statistically significantly higher levels than female students ($p < .05$), students from the North of Thailand reported statistically significantly higher levels than the others regions ($p < .05$), grade 10 students reported statistically significantly higher levels than the other grade levels ($p < .01$). The CC dimension, male students reported statistically significantly higher levels than female students ($p < .001$). No statistically significant variations were found according to and region, grade, and age of students. The SE dimension, male students reported statistically significantly higher levels than female students ($p < .001$), students from the North of Thailand reported statistically significantly higher levels than the others regions ($p < .001$), and grade 10 students reported statistically significantly higher levels than the other grades ($p < .05$). No statistically significant variations were found according to the age of students. In relation to the AW dimension, only the South region students reported statistically significantly higher levels than the other regions ($p < .05$). No statistically significant variations were found according to the gender, grade, and age of students. The CO dimension only the South region students reported statistically significantly higher levels than the other regions ($p < .001$). No statistically significant variations were found according to gender, grade, and age of students. The implications of these variations are discussed.

Keywords: metacognition, science classroom learning, Thailand

Introduction

Metacognition is defined as the ability of individuals to reflect, understand, and control their own thinking, learning, and acting. It is a cognitive process to control their-own thinking activity with planning, monitoring, and evaluating. Also, the development of the learner metacognition is a process of reflection on the thinking processes of analysis, synthesis, and problem solving during teaching and learning activities (Brown, 1987). Metacognition is a construct that is often considered to confer attention on the improvement of students' learning processes and consequently their learning outcomes (Thomas, 2008). Metacognition is extremely important in learning because it is very important to solve problem in many areas. So, the teaching of thinking processes and metacognition is important to people's thinking. Metacognition influences to students understanding and learning. There are talking, writing, language ability, interest, recognition, problem solving, social recognition, monitoring, and several types of self management (Flavell, 1987).

Metacognition refers to students' knowledge, awareness, and control of their learning processes (Baird, 1990; Gunstone, 1991; Thomas & Mcrobbie, 2000). On the metacognitive knowledge is that section of an individual's acquired world knowledge relating to cognitive matters that can be further differentiated into declarative, procedural, and conditional categories (Marzano et al., 1988; Schraw, 1998; Thomas & Mcrobbie, 2000). An individual's declarative metacognitive knowledge includes their conceptions, and also their beliefs of task structures, their cognitive goals, and their own personal abilities. Their procedural metacognitive knowledge includes information about how they perform cognitive tasks. Conditional metacognitive knowledge includes their understanding of both the value and the limitations of their procedural metacognitive knowledge and knowing when, how, and why procedures should be used. Conditional metacognitive knowledge is likely to be associated in an individual's memory with the procedural and declarative metacognitive knowledge to which it relates. Hence, despite metacognitive knowledge being nominally dissectable into three distinct categories, interaction between these categories is evident and necessary. While declarative and procedural metacognitive knowledge are important, their possession alone does not guarantee that students will engage in thoughtful application of that knowledge (Thomas & Mcrobbie, 2000). It is conditional knowledge that dictates if declarative and procedural metacognitive knowledge will be purposefully and appropriately applied (Kuhn, 1996). Further, as well as students needing to possess appropriate metacognitive knowledge, motivational aspects are also crucial determinants in the development of their metacognition (Anderson, 1997; Pintrich, Marx, & Boyle, 1993; Thomas & Mcrobbie, 2000).

Metacognition and Learning:

From the review of selected science education journals by Schraw (2006) we have identified six general areas of instructional strategies for improving science learning. They are (a) inquiry based learning, (b) the role of collaborative support, (c) strategic instruction to improve problem solving and critical thinking, (d) strategies for helping students construct mental models and to experience conceptual change, (e) the use of technology, and (f) the impact of student and teacher beliefs. Each of these six areas has been shown to improve metacognitive awareness and self-regulation (Schraw, 2006). Metacognition is important and should be developed for the learner. When students learn science that to be

improved student higher order thinking and deliberative thinking with metacognition. They have to investigate the solution of questions with formulate problem and the process of solve problem. Students have to search the information for helpful to problem solving. They should be solved the unclear problems. The problem solving is a person individual practice. The persons should be solved problem by their reasons and strategies with the content, attitude, and process skill. The researcher who has been teaching science at this school for 15 years disclosed that her students' average scholastic achievement and thinking abilities needed to be improved. Concern with these needs for the improvement in science learning and thinking skills, she proposed that metacognitive skills strategies should be incorporated in learning science. It is about time to reconsider what and how have the students been taught at schools in those subjects that consequently made no progress on their learning.

Accordingly, the development of students' metacognition is the process of reflective of learning that promotes learning understanding, self- regulation, cognitive processes, problem solving, and the affected of the use in students' life. So, the teaching and learning science should to focus on students' metacognition on the suitable science content.

Metacognition and SEMLI-S

The Self-Efficacy and Metacognition Learning Inventory-Science (SEMLI-S) is the instrument measures students' metacognition, self-efficacy and constructivist science learning processes (Thomas, Anderson, & Nashon, 2008). SEMLI-S is the characteristics of metacognition were reflected has 30 items and five sub-scales. These five sub-scales, each reflecting a dimension of students' self-perceived metacognitive science learning orientation, were named: Constructivist Connectivity (CC), Monitoring, Evaluating, & Planning (MEP), Science-Learning Self-Efficacy (SE), Learning Risk Awareness (AW), and Control of Concentration (CO). Students' completion of the SEMLI-S will provide snapshots of such self-perceptions. It possible uses include collecting pre- and post-data from students in relation to innovations that aim to enhance metacognition and learning processes and for providing feedback for students in relation to their development of metacognitive knowledge and related learning constructivist cognitive processes. The five dimensions and the items that constitute them reflect this analysis and are justifiable in terms of: (a) their salience in relation what is known from the literature to be important for science learning; (b) their usefulness in contributing to understanding students' perceptions of their learning processes; and (c) their confirmatory insights, however minor, in relation to what is already known about the learning context and learning processes of the sample that aided in the development of this instrument.

Methodology

This study, which is to explore the state of the students' metacognition and to reveal the possible relationships the participants' region gender, grade, and age in the first semester of the 2012 academic year of the classrooms of 5,418 grades 10-12 students from 40 schools across Thailand.

a) Participant

From purposive sampling, there were 5,418 students from the south region 734 (13.54%) north region 1208 (22.30%) middle region 12374 (25.36%) northeast region 2102 (38.80%), grades 10: 1621 (29.92%), 11: 2757 (50.88%), and 12: 1040 (19.20%) students. The participants' gender ranged male 1823 (33.65%), and female are 3595 (66.35%). And

the participants' ages ranged are 16: 3284 (60.61%), 17: 1804 (32.80%) and 18: 330 (7.09%) students.

b) Data Collection

The participants were asked to complete the Self-Efficacy and Metacognition Learning Inventory-Science (SEMLI-S) an instrument that measures students' metacognition, self-efficacy and constructivist science learning processes. SEMLI-S has 30 items and five sub-scales. These five sub-scales, each reflecting a dimension of students' self-perceived metacognitive science learning orientation, were named: Constructivist Connectivity (CC), Monitoring, Evaluating, & Planning (MEP), Science-Learning Self-Efficacy (SE), Learning Risk Awareness (AW), and Control of Concentration (CO). Up to this method, the quality of a translation is verified by an independent translator translating into the Thai language and submitted to five experts (three science educator, one metacognition educator, and one English educator). And back translated SEMLI-S were then compared and any disagreement occurred during back-translation was resolved through the meeting.

c) Data Analysis

In data analysis, responses of the SEMLE-S were scored 5 = Almost Always, 4 = Often, 3 = Sometimes, 2 = Seldom, 1 = Almost Never, respectively. The mean higher than 3.0 was interpreted as to be sufficiently oriented to developing and enhancing students' metacognition, while the mean lower than 3.0 was interpreted as not to be sufficiently oriented to developing and enhancing students' metacognition. In addition, the one-way analyses of variance (ANOVA) was employed to reveal reflecting a dimension of students' self-perceived metacognitive science learning orientation to enhance metacognition and the participants' region, grade, gender, and age.

The Results of the Study

1) The students' metacognition of the science classrooms. The table showed that the range of means of the participants' metacognitive orientation of the classrooms was 3.13 to 3.79. The overall mean and standard deviation of attitudinal scores were 3.46 and 0.91, respectively. The results showed that the overall average of Thai students' metacognition is sufficient in every element and every issue.

2) The average value of Thai students' metacognition class by the metacognitive dimension. The table showed that the mean of Thai students' metacognitive dimensions as follow:

Table 1. The average value of Thai students' metacognition class by the metacognitive dimension (n=5418)

Metacognitive Dimensions	Minimum	Maximum	Mean	STD. deviation
V001	30.00	150.00	103.69	17.31
CC	7.00	35.00	24.06	4.58
MEP	9.00	45.00	30.76	5.50
SE	6.00	30.00	19.54	4.22
AW	5.00	25.00	18.53	3.29
CO	3.00	15.00	10.79	2.03

The table showed that the overall means and standard deviation of the participants' metacognition showed that the relationship among of the participants' region, grade, gender, and age. The data were analyzed using One-Way Analysis of Variance (ANOVA) statistical techniques, as Table 3. The analysis of the data suggests that statistically significant variations exist in students' metacognition in relation to their science learning according to their gender ($p < 0.01$) and their regional location within Thailand ($p < 0.05$), and their grade level ($p < 0.05$). No statistically significant variation was found according to participants' age.

Table 2. The mean comparison among of participants' variable on the SEMLE-S as follow: (n = 5418)

Source	SS	Df	MS	F	p
Region	3119.176	3	1039.725	3.474	.015*
Grade	1911.380	2	955.690	3.192	.041*
Age	1255.637	2	627.818	2.096	.123
Gender	-	5416	-	-	.002**
Total	1623286	5417			

($p^* < .05$) ($p^{**} < .01$)

The Table showed that mean of participants' region, grade, and gender were statistically significant variations exist in students' metacognition except age variable. So, the analysis of multiple comparisons within variables were used as follows:

Table 3. The analysis of multiple comparisons among of the participants' region, grade, gender, and age and metacognitive dimensions on the SEMLE-S as follow: (n = 5418)

Metacognitive dimensions	Gender	Region	Grade	Age
MEP	Male > Female ($p < .05$)	North > South > Northeast > Middle ($p < .05$)	10 > 11 > 12 ($p < .01$)	Not differ
CC	Male > Female ($p < .001$)	Not differ	Not differ	Not differ
SE	Male > Female ($p < .001$)	North > South > Middle > Northeast ($p < .001$)	10 > 11 ($p < .05$)	Not differ
AW	Not differ	South > Northeast > Middle > North ($p < .05$)	Not differ	Not differ
CO	Not differ	South > Middle > North > Northeast ($p < .001$)	Not differ	Not differ

The Table showed that the MEP dimension, Male students reported statistically significantly higher levels than female students ($p < .05$), students from the North of Thailand reported statistically significantly higher levels than the others regions ($p < .05$), grade 10 students reported statistically significantly higher levels than the other grade levels ($p < .01$). In relation to the CC dimension, male students reported statistically significantly higher levels than female students ($p < .001$). No statistically significant variations were found according to and region, grade, and age of students. In relation to the SE dimension, male students reported statistically significantly higher levels than female students ($p < .001$), students from the North of Thailand reported statistically significantly higher levels than the others regions ($p < .001$), and grade 10 students reported statistically significantly higher levels than the other grades ($p < .05$). No statistically significant variations were found according to the age of students. In

relation to the AW dimension, only the South region students reported statistically significantly higher levels than the other regions ($p < .05$). No statistically significant variations were found according to the gender, grade, and age of students. In relation to the CO dimension only the South region students reported statistically significantly higher levels than the other regions ($p < .001$). No statistically significant variations were found according to gender, grade, and age of students.

Conclusion of the study

The overall finding indicated that the participants as be sufficiently oriented to developing and enhancing students' metacognition. However, there were that statistically significant variations exist in students' metacognition in relation to their science learning according to their gender, their grade level, and their regional location within Thailand. No statistically significant variation was found according to participants' age. About participants' metacognitive dimensions as the MEP dimension, male gender, north region, and grade10 students reported statistically significantly higher levels than the others. In relation to the CC dimension, male students reported statistically significantly higher levels than female students. No statistically significant variations were found according to and region, grade, and age of students. In relation to the SE dimension, male gender, north region, and grade10 students reported statistically significantly higher levels than the others. No statistically significant variations were found according to the age of students. In relation to the AW dimension, only the South region students reported statistically significantly higher levels than the other regions. No statistically significant variations were found according to the gender, grade, and age of students. In relation to the CO dimension only the South region students reported statistically significantly higher levels than the other regions. No statistically significant variations were found according to gender, grade, and age of students.

Acknowledgements

This work was supported by the Higher Education Research Promotion and National Research University Project of Thailand , Office of the Higher Education Commission, through the Cluster of Research to Enhance the Quality of Basic Education, and the Graduate School of Khon Kaen University, Thailand. Also, sincere thanks for supporting research funding.

References

- [1] Anderson O. R.: (1997). A neurocognitive perspective on current learning theory and science instructional strategies. *Science Education*, 81(1), 67 ± 89.
- [2] Baird J. R.: (1990). Metacognition, purposeful enquiry and conceptual change. In E. Hegarty-Hazel (Ed.), *The student laboratory and the science curriculum* (pp. 183–200). London: Routledge.
- [3] Brown A. L.: (1987). Metacognition, executive control, self-regulation and other Mysterious mechanisms. In F. E. Weinert & R. H. Kluwe (Eds.), *Metacognition, motivation, and understanding* (pp. 65-116). Hillsdale, NJ: Erlbaum.

- [4] Flavell J. H.: (1987). Speculation about the nature and development of metacognition. In F. E. Weinert & R. H. Kluwe (Eds.), *Metacognition, motivation, and understanding* (pp. 1 – 29). Hillsdale, NJ: Erlbaum.
- [5] Chantharanuwong W., Thatong K., Yuenyong C., Thomas G. P.: (2012). Exploring The metacognitive orientation of the science classrooms in a Thai context. *Procedia - Social and Behavioral Sciences*, 46 (2012), p.5116 – 5123.
- [6]. Gunstone R. F.: (1991). Constructivism and metacognition: Theoretical issues and Classroom studies. In R. Duit, F. Goldberg, & H. Niedderer (Eds.), *Research in physics learning: Theoretical issues and empirical studies* (pp. 129 ± 140). Kiel: Institut für die Pädagogik der Naturwissenschaften an der Universität Kiel.
- [7] Kuhn D.: (1996). Is good thinking scientific thinking? In D. R. Olson & N. Torrance (Eds.), *Modes of thought: Explorations in culture and cognition* (pp. 261 ± 282). Cambridge: Cambridge University Press.
- [8] Marzano R., Brandt R. S., Hughes C. S., Jones B. F., Presseisen B. Z., Rankin S. C., Suhor C.: (1988). *Dimensions of thinking: A framework for curriculum and instruction*. Alexandria, VA: Association for Supervision and Curriculum Development.
- [9] Pintrich P. R., Marx R. W., Boyle R. A.: (1993). Beyond cold conceptual change: The Role of motivational beliefs and classroom contextual factors in the process of conceptual change. *Review of Educational Research*, 63(2), 167 ± 199.
- [10] Schraw G.: (1998). Promoting general metacognitive awareness. *Instructional Science*, 26, 113 ± 125.
- [11] Schraw G.: (2006). Knowledge: Structures and processes. In P. A. Alexander & P. H. Winne (Eds.), *Handbook of educational psychology* (2nd ed., pp. 245–264).
- [12] Thomas G. P., McRobbie C. J.: (2000). Using a metaphor for learning to improve students' metacognition in the Chemistry classroom. *Journal of Research in Science Teaching*. 38(2), 222-259.
- [13] Thomas G. P., Anderson D., Nashon S.: (2008). Development of an Instrument Designed to Investigate Elements of Science Students' Metacognition, Self-Efficacy and Learning Processes: The SEMLI-S. *International Journal of Science Education*, 30(13), 1701–1724.

Inquiry Based Science Education and Getting Immediate Students' Feedback about Their Motivation

Martina Kekule¹, Vojtech Zak¹, Zuzana Jeskova², Katarina Kimakova², Maria Ganajova², Marian Kires²

¹ Faculty of Math. and Physics, Charles University, Prague, Czech Republic

² Faculty of Science, Pavol Jozef Safarik University, Kosice, Slovak Republic

Abstract

The paper is based on collecting evidence of the Establish project impact on students. For the purpose two questionnaires based on the existing tools have been used. Questionnaire 1 is a part of Intrinsic Motivation Inventory (IMI) based on the Self-determination theory. It is aimed at assessing students' interests, their perceived choice and usefulness of implemented learning units and should be answered after each learning unit/several IBSE activities. Several items of CLES questionnaire are included there as well. Questionnaire 2 assesses the impact on students' attitudes towards science and technology and on their knowledge about nature of building up science knowledge. Both questionnaires exist in the lower and upper secondary school versions. The paper presents selected data and results which were obtained by addressing the Questionnaire 1, so that the focus is on getting students' feedback about their intrinsic motivation. Our assumption is that active learning is associated with positive intrinsic motivation of students. That is why we find as very important that educators have a possibility to understand the phenomenon more deeply. We aim to present the reliable tool for getting the feedback and to present a way of data processing which does not need advanced statistical methods, so that teachers (as well as science education researchers) can use and analyze data obtained by the tool. Means and standard deviations for items of the subscales Interest/Enjoyment, Perceived choice and Value/Usefulness were computed. To determine the consistency of results, the Standard Pearson correlation coefficient was computed for all items within the subscales. Based on the findings, we can conclude that participants' answers (questionnaire results) were consistent (not responded mechanically).

Keywords: students' feedback, motivation, questionnaire, IBSE

Introduction

The paper is focused on getting students' feedback about their motivation just after their science lessons led by inquiry teaching method. The presented fast feedback tool has been used during the ESTABLISH project [1]. The objective of the project (funding from the European Community's Seventh Programme [FP7/2007-2013] under grant agreement no. 244749) is the wide use and dissemination of inquiry-based teaching method for science education (IBSE) at secondary schools across Europe. Over the course of the project, a number of ESTABLISH teaching and learning materials (units) have been developed and adapted for the use in classrooms in participating countries. The rationale for ESTABLISH lies in creating authentic learning environments for science by bringing together and involving all relevant stakeholders, particularly the scientific and industrial community, policy makers, parents, science education researchers and teachers to drive change in the classroom.

For collecting evidence of the impact of the Establish project on students two questionnaires based on the existing tools have been used. Questionnaire 1 is a part of Intrinsic Motivation Inventory (IMI) [2] based on the Self-determination theory [3] developed by Ryan and Deci. It is aimed at assessing students' interests, their perceived choice and usefulness of implemented learning units and should be answered after each learning unit/several IBSE activities. Several items of CLES questionnaire [4] are included there as well. Questionnaire 2 assesses the impact on students' attitudes towards science and technology and on their knowledge about nature of building up science knowledge. Both questionnaires exist in the lower and upper secondary school versions (12-15/16-19 year-old students).

The paper presents chosen data and results which were obtained by addressing the Questionnaire 1 (when assigning to students from Slovakia), so that the focus is on getting students' feedback about their intrinsic motivation. Our assumption is that active learning is associated with positive intrinsic motivation of students. That is why we find as very important that educators have a possibility to understand the phenomenon more deeply. We aim to present the reliable tool for getting the feedback and to present a way of data processing which does not need advanced statistical methods, so that teachers (as well as science education researchers) can use and analyze data obtained by the tool.

More about the questionnaires

As it is stated in the introductory part, the questionnaire focused on getting immediate feedback includes prevalently parts of Intrinsic Motivation Inventory (IMI). The inventory consists altogether of 45 items which belong to 7 subscales (dimensions). The statistical characteristics of the inventory allow to a researcher to create her/his own questionnaire where she/he includes just items belonging to the dimensions which she/he is interested in. Mainly because of the time limit (we needed a tool for the fast feedback), we chose for our tool just items concerning three dimensions: interest/enjoyment, value/usefulness and perceived choice. "The interest/enjoyment subscale is considered the self-report measure of intrinsic motivation, the other two dimensions are theorized to be positive predictors" [2].

The dimension Interest/Enjoyment measures to what extent students like the performed activity and find it interesting. The dimension Perceived Choice measures to what extent students perceive their choice when performing a given activity. The dimension Value/Usefulness measures how students perceive the value/usefulness of a given activity for themselves. The form of an item is a statement which students assess as a true or not true. For the assessment they use 7 point scale:

1 – 2 – 3 – 4 – 5 – 6 – 7
not at all true – ... – somewhat true – ... – very true

Some items express very similar content what was perceived by some students and as annoying. However, it is necessary when we need to judge if students really assessed the statement or if they only put marks by chance. This consistency in students' responses will be discussed later.

The second part of the questionnaire is based on the CLES questionnaire – the Constructivist Learning Environment Survey. In the section we are focused on ways of students' communication during the activities as an aspect of social interaction that can influence motivation in general as well. The questionnaire origins from the constructivist theory and is widely used for evaluating lessons from this perspective. We used a part of the questionnaire which contains 6 items focusing on students' communication during the

activity (e.g. passivity or activity in the initiation of communication). Students assess how often they communicate using 5 point scale.

Description of the tool

Our questionnaire is intended to be used as a fast feedback after the learning unit and it will be assigned immediately after the unit (at the end of the lesson). It takes about 10 minutes to complete this questionnaire. The questionnaire exists in a version for lower (marked B, about 12 to 15 year-old, ISCED 2), and upper (marked A, about 16 to 19 year-old, ISCED 3) secondary schools.

Questionnaire A – for upper secondary schools

It contains 25 items with the 7 point scale adopted from the IMI and it focuses on assessing the three discussed dimensions (subscales).

Interest/Enjoyment subscale shows the extent to which students like the performed activity and find it interesting. This subscale comprises a total of 8 items, namely 3, 5, 7, 11, 12-R, 15, 17, and 23. The “R” with item no. 12 means that a reverse score is needed. It is an item with the opposite meaning to the other items. It is possible to gain 56 points in total.

Perceived Choice subscale shows how students perceive their choice when performing a given activity. This subscale comprises a total of 8 items, namely 2, 8-R, 9, 14-R, 18-R, 20-R, 22, and 24-R. The “R” means again that a reverse score is needed and it is possible to gain 56 points in total as well.

Value/Usefulness subscale shows how students perceive the value/usefulness of a given activity for themselves. This subscale comprises a total of 9 items, namely 1, 4, 6, 10, 13, 16, 19, 21, and 25. It is possible to gain 63 points in total.

The second part of the questionnaire was taken from the CLES. It contains 6 items and it is possible to gain 30 points in total.

As an example, we present below which items the subscale Interest/Enjoyment consists of:

- While I was doing activities in the learning unit, I was thinking about how much I enjoyed it. (3)
- Activities in the learning unit were fun to do. (5)
- I enjoyed doing activities in the learning unit very much. (7)
- I felt like I was enjoying activities while I was doing them. (11)
- I thought these were very boring activities. (12-R)
- I thought this was a very interesting learning unit. (15)
- I would describe activities in the learning unit as very enjoyable. (17)
- I would describe activities in the learning unit as very fun. (23)

We can see that all eight items express the same (or a very similar) thing: the extent to which students like the performed activity (or the learning unit) and find it interesting, in other words whether the learning unit (activities included in it) was interesting/enjoyable/not boring. The item no. 12-R is reverse (“negative”).

Questionnaire B – for lower secondary schools

This version contains 17 items with the 7 point scale adopted from the IMI and it focuses on assessing the two following dimensions: Interest/Enjoyment and Value/Usefulness.

Interest/Enjoyment subscale shows the extent to which students like the performed activity and find it interesting. This subscale comprises a total of 8 items, namely 2, 4, 6, 8, 9-R, 11, 13, and 16. The “R” with item no. 9 means that a reverse score is needed. It is possible to gain 56 points in total.

Value/Usefulness subscale shows how students perceive the value/usefulness of a given activity for themselves. This subscale comprises a total of 9 items, namely 1, 4, 6, 10, 13, 16, 19, 21, and 25. It is possible to gain 63 points in total.

The second part of the questionnaire was taken from the CLES. It contains 6 items and it is possible to gain 30 points in total.

The above mentioned research tools are available on the web page [5].

An example of data processing

Basic information – means of selected items

As an example of basic data processing, we present a part of the Slovak study which includes approx. 1 500 students. We are focusing on the dimension Interest/Enjoyment (Questionnaire A, upper secondary schools). As mentioned above, it includes 8 items, namely 3, 5, 7, 11, 12-R, 15, 17, and 23. Means (and standard deviations) were computed using software Statistica (see Table 1 and Figure 1), however, e. g. Microsoft Excel can be recommended as well.

Table 1. Means and standard deviations for items of Interest/Enjoyment dimension

Variable	Descriptive Statistics (Date Slovakia_1A.sta)	
	Mean	Std.Dev.
Part1_3	4,75	1,55
Part1_5	4,99	1,57
Part1_7	4,90	1,55
Part1_11	4,82	1,53
Part1_12R	2,79	1,67
Part1_15	4,96	1,46
Part1_17	4,89	1,54
Part1_23	4,80	1,56

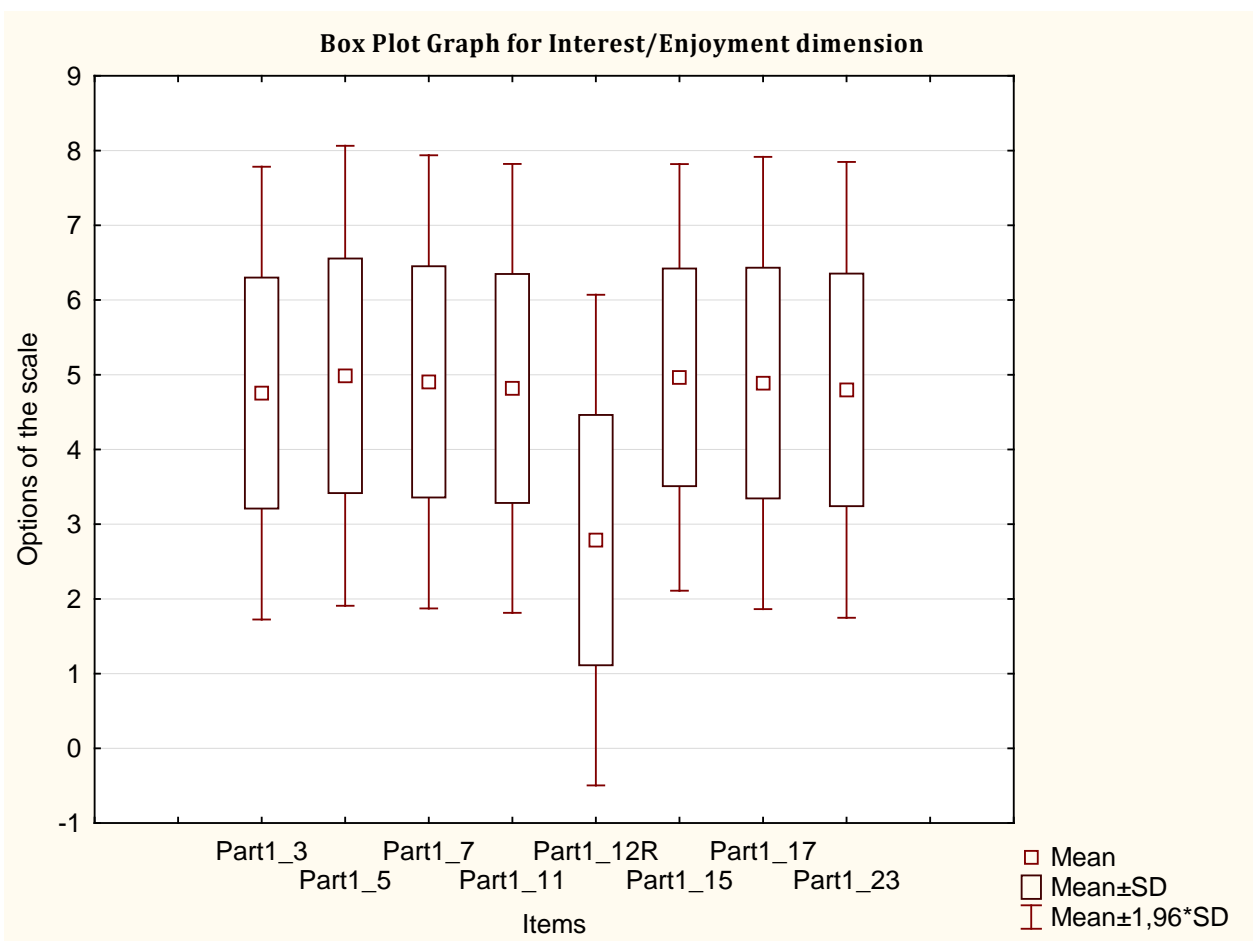

Figure 1. Box Plot Graph for Interest/Enjoyment dimension

The scale has a range from 1 to 7, thus, the average is 4. We can see from the table and the graph that direct items (no. 3, 5, 7, 11, 15, 17, and 23) are assessed positively (nearly 5 on the scale) whereas the only reverse item (no. 12) negatively (approx. 3 on the scale). We can conclude that students assessed the learning unit (activities included in it) as rather interesting/enjoyable. We can also notice that students were consistent in their evaluation because they assessed direct items positively and the reverse item negatively. The opinion expressed by students can be considered as reliable (more details below).

More detailed information – consistency of results

Based on the fact that each of three dimensions (subscales) mentioned above consists of several similar items (and reverse items as well), we can explore whether students really assess the statement or if they only put marks by chance. In other words, we can explore whether students respond the items seriously (consistently) or not. To determine this characteristic – consistency of results – Standard Pearson correlation coefficient was computed (using software Statistica, see Table 2; Microsoft Excel enables users to compute correlation coefficients as well).

Table 2. Standard Pearson correlation coefficient for Interest/Enjoyment dimension

Variable	Correlations (Date Slovakia_1A.sta) Marked correlations are significant at $p < ,05000$ N=1469 (Casewise deletion of missing data)							
	Part1_3	Part1_5	Part1_7	Part1_11	Part1_12R	Part1_15	Part1_17	Part1_23
Part1_3	1,000000	0,763765	0,762522	0,782930	-0,524958	0,716731	0,733328	0,688135
Part1_5	0,763765	1,000000	0,816786	0,807440	-0,558890	0,745488	0,756493	0,756527
Part1_7	0,762522	0,816786	1,000000	0,807380	-0,545114	0,768743	0,778445	0,764461
Part1_11	0,782930	0,807440	0,807380	1,000000	-0,589269	0,762909	0,789213	0,760800
Part1_12R	-0,524958	-0,558890	-0,545114	-0,589269	1,000000	-0,567658	-0,534214	-0,518259
Part1_15	0,716731	0,745488	0,768743	0,762909	-0,567658	1,000000	0,785376	0,760059
Part1_17	0,733328	0,756493	0,778445	0,789213	-0,534214	0,785376	1,000000	0,792286
Part1_23	0,688135	0,756527	0,764461	0,760800	-0,518259	0,760059	0,792286	1,000000

We can see from the table that values of the correlation coefficient are from 0,69 to 0,82 between direct items and from $-0,52$ to $-0,59$ between the reverse and direct items. All correlations are statistically significant at $p < 0,05$. Thus in both cases, we can speak about a high correlation. Based on this findings, we can conclude that students' answers (questionnaire results) are consistent. They express students' opinion repeatedly in the same (or a very similar) way, so we can assume that it is meant seriously.

Conclusions

Our assumption is that active learning is associated with positive intrinsic motivation of students. That is why we have presented the tool for getting students' feedback after learning lessons. The investigated lessons were taught by inquiry based teaching method (IBSE) according to learning units created within the ESTABLISH project. The assessment tools are available in English version on the web page [5] for both teachers and researchers. Their administration takes about 10 minutes, so that it is appropriate in relation to the time of the typical learning unit.

The above presented example of results was obtained by using software Statistica. We recommend this program, especially for research purposes, however, other common statistical programs can be used for gaining results intended for teaching and learning purposes as well, e. g. MS Excel. In other words, the data processing does not need advanced statistical methods, so that teachers (as well as science education researchers) can analyse data obtained using the tool by themselves.

Besides the common basic statistics (mainly means and standard deviations), the way how to determine consistency of results was presented. In case of the high correlation between items related to the same dimension, we can speak about the high consistency of findings. Thus, we can conclude that students' opinions are meant seriously. The presented tool enables teachers and researchers to gather and distinguish reliable data. In this case, the tool can be considered as a reliable tool.

References

- [1] ESTABLISH project, [online]. [cit. 02. 08. 2013]. Available from: <http://www.establish-fp7.eu>
- [2] Intrinsic Motivation Inventory (IMI), [online]. [cit. 02. 08. 2013]. Available from: <http://www.selfdeterminationtheory.org/questionnaires/10-questionnaires/50>

- [3] Ryan R. M., Deci E. L.: (2000). Self-determination theory and the facilitation of intrinsic motivation, social development, and well-being. *American Psychologist*, 55, 68–78, [online]. [cit. 02. 08. 2013]. Available from: <http://www.selfdeterminationtheory.org/questionnaires/10-questionnaires/50>
- [4] Taylor P. C., Fraser B. J., White L. R.: (1994). *CLES: An instrument for monitoring the development of constructivist learning environments*. Paper presented at the annual meeting of the American Educational Research Association, New Orleans.
- [5] Kekule M., Žák V.: *Research tools, tools for the Establish project*, [online]. [cit. 02. 08. 2013]. Available from: <http://kdf.mff.cuni.cz/vyzkum/tools.php>

Identifying critical points in modernising the Astronomy curriculum of Greek Primary Education: a preliminary survey

Aristeidis Kosionidis

Biophysical Environment, Neurosciences and Learning Laboratory, National and Capodistrian University of Athens, Greece

Abstract

We are conducting research on incorporating elements of modern Astrophysics into the late Primary Education curriculum (ages 10-12). As part of this effort, we conducted a preliminary questionnaire survey with 52 postgraduate students at the Primary Education Faculty of the University of Athens to identify areas where special attention will have to be paid when developing teaching materials. The results suggest that our effort to modernize the teaching of Physics must include activities and materials that actively bring teachers in touch with both fundamental and contemporary scientific developments, and also include efforts to deepen their understanding of the function of terminology and scientific language.

Keywords: Primary education, university education, curriculum reform, modern astrophysics, terminology

Introduction

Modern Astrophysics in Astronomy Education Research (AER)

The earliest Astronomy education research (AER) efforts date back to 1922 [1], and are frequently treated as part of larger projects in Physics Education Research. In the recent past, AER has become a more specialised branch, the first Journal exclusively dedicated to it (*Astronomy Education Review*) first being published in 2001.

In the beginning of this century, an overview of AER activities relevant to the US National Science Education Standards [2] and a review of AER literature [3] recorded a scarcity of research relevant to teaching modern Astrophysics and Cosmology. While there have been several notable research efforts in this subject since those reviews were published, both in terms of practical teaching techniques ([4,5]) and in knowledge surveys [6], the majority of this research is focused on teaching college and university students.

Astronomy and Astrophysics in the Greek Education System

In the Greek education system school lasts for 12 years, starting at age 5 (Figure 1).

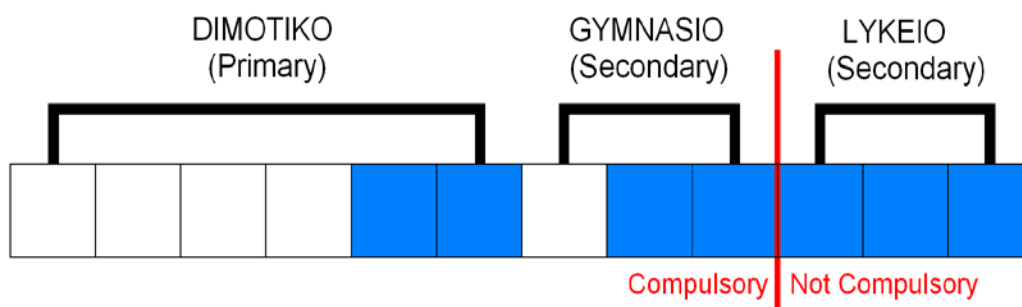

Figure 1. Structure of the Greek education system. Blue colour indicates grades where Physics is taught.

Astronomy and Astrophysics content is mostly incorporated in Physics and Geography. The introduction to Astronomy takes place in 6th grade of primary school. The Geography curriculum incorporates a unit on the Solar System, describing the Earth, Sun, Moon and briefly the planets. The Physics lesson includes a unit on space, describing stars and key moments in human exploration of space, however this unit is rarely taught due to time constraints. Some additional subjects relevant to Astronomy such as the day-and-night cycle, how eclipses occur, and fusion as the Sun's source of energy, appear in the secondary school curriculum.

Only in the later stages of secondary education is modern Astrophysics content encountered, in 2nd *Lykeio* grade, where there is an optional course dedicated to Astronomy, and 3rd *Lykeio* grade, where the Physics lesson for pupils aiming to study science subjects includes a unit on Relativity and modern Astrophysics.

Modern Astronomy and Astrophysics content is almost completely absent in the compulsory part of education. We also note that where such content is present (in the non-compulsory part of secondary education) it is not addressed to all pupils.

Our approach is to investigate introducing modern Astrophysics content in the 5th - 6th grade of Primary Education. Should this prove successful, key concepts of modern Astrophysics will be present at the beginning of a pupil's contact with Physics, at an age that seems to heavily influence the pupil's future relation to science [7]. This will also add to the Physics lesson subjects relevant to contemporary research, helping to present it as an active field pupils can make a connection to. By constructing a framework of basic knowledge early, and conducting the Physics lesson within that framework, we can achieve increased familiarity with these subjects. We will also be able to build upon and expand this framework throughout secondary education, in effect populating the landscape we have described in primary education.

As part of this research effort, we conducted a preliminary questionnaire survey to identify critical areas in developing new teaching materials.

Survey Design

Aims of the survey

Our first goal was to test the effectiveness of the educational system measured relative to the aims stated in the Greek curriculum and in education planning documents by the EU ([8,9]). These aims are:

- Giving pupils fundamental knowledge about the Universe
- Inspiring pupils to stay in touch with significant scientific developments after graduating from school.
- Achieving these goals for all pupils, not just future scientists.

Our second goal was to identify where serving primary education teachers will need the strongest support when asked to teach modern Astrophysics.

Sample Selection

To investigate these two lines of enquiry we needed a group that:

- had graduated from school considerable time before our survey,
- had not pursued careers in Physics and Astronomy,
- included a high percentage of serving teachers.

Our sample was composed of 52 first-year postgraduate students at the Primary Education Faculty of the University of Athens for the years 2008-2009, 2009-2010 and 2011-2012 and is described in Table 1.

Table 1. Sample characteristics

Student Average Age	29	Avg. 11 years since graduating from school
Student Degrees		
Science	20	Mathematics, Biology, Informatics etc. (No student with a Physics Degree)
Humanities	24	Education, Sociology, Music etc.
Business Admin.	8	
Students within Education Establishment		
Primary School Teachers	18	11 permanent/7 temporary
Secondary School Teachers	15	5 permanent/10 temporary

Our sample fulfilled our requirements, and in some respects presented a “best case scenario”:

- Although the students had long graduated from school, they had spent a considerable time since within a learning environment (studying at University).
- Taking a postgraduate course suggests they accept the idea of *improvement through learning*, which would make them more likely to have gained knowledge after school.

The significant number of serving teachers suggests it is a good approximation of both the knowledge level and the reaction when introducing material from modern Astrophysics into schools.

Questionnaire Design

The survey was conducted through a questionnaire of 10 questions. These covered three thematic areas we were interested in investigating.

Theme 1: Students’ familiarity and understanding of scientific terminology (2 questions). We felt this appropriate since we investigate introducing new subjects into the curriculum, which will introduce new terms.

Theme 2: Students’ everyday extra-curricular interaction with Physics subjects, including their self-evaluation (4 questions). How students/teachers perceive their relationship to Physics can be crucial to how they react to being presented with new material. Also, teachers’ ability to accurately evaluate their understanding of the subject is important when they are called to give feedback on testing new teaching materials.

Theme 3: Fundamental knowledge and recent changes in our understanding of the Universe (5 questions). We chose to ask about basic knowledge of the Universe and subjects from modern Astrophysics we intend to experimentally introduce in Physics teaching. One of these questions was combined with the second terminology question (which is why the questions appear to add up to 11).

Time to complete the questionnaires was 25 minutes. The students were informed that their completed questionnaires could be incorporated into published research, and gave their consent.

Survey Results and Discussion

We present the results in the order: Terminology, Physics knowledge, Self-Confidence. A short discussion follows each group of results.

Theme: Terminology knowledge and use

In the first terminology question, we asked the students to define four terms: *Principle*, *Theory*, *Axiom*, and *Definition*. The number of correct answers is shown in Figure 2.

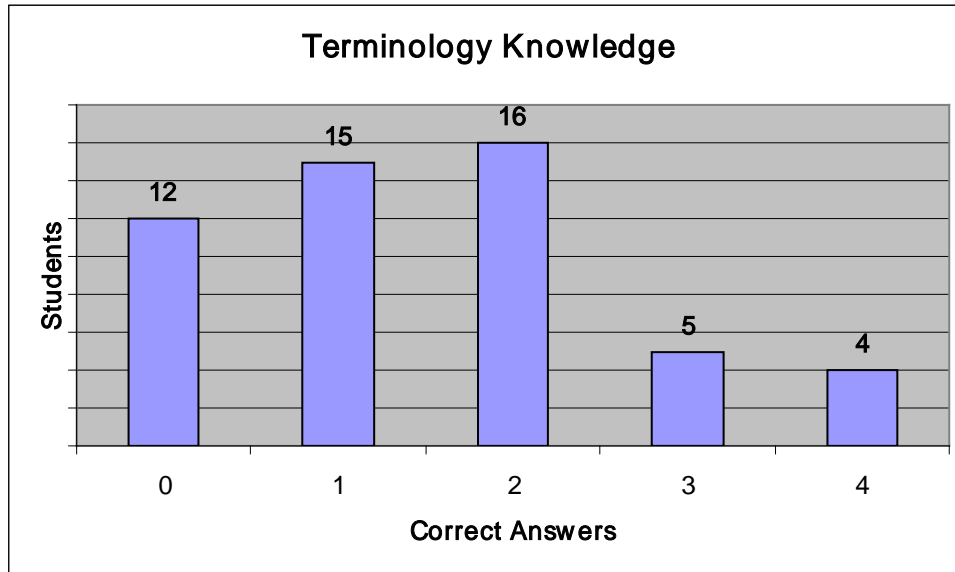

Figure 2. First Terminology Question Results

The average number of correct answers was 1, 5.

In addition to this low score, the students' answers on terminology exhibited significant variety. For example, in the case of the term *Theory*:

- “A general formulation of a subject, that can be provable”
- “A hypothesis about an issue that may not have been proven correct”

The low score and the variation in answers indicate personally-constructed definitions instead of a common understanding of scientific language from a shared and well-defined terminology base.

In addition to testing students' familiarity with the definitions of terms, we wanted to test their ability to use this knowledge. We chose a Physics question that asked the students to explain the *Cosmological Principle* (*Κοσμολογική Αρχή*) to test how many of the students would attempt to explain the Cosmological Principle (CP) by using the definition they had given to the first question. Correctness of the answer was irrelevant in this respect.

We found that of the 31 students who defined principle as an *epistemological* term, slightly more than half (N=18) attempted to explain the CP, and of them only 4 used the term in a manner consistent with their answer to the first question. A clear majority (N=14) treated the word *Αρχή* (*principle*) as it is used in everyday language as a description of time (to signify the *beginning* or *start*).

Theme: Physics Knowledge

The results of the Questions on Astrophysics knowledge are shown in Table 2.

Table 2. Physics knowledge Questions results

Q1: Explain the...	
Cosmological Principle	1 correct answer
Q2: Explain the...	
Critical Density	1 correct answer
Q3: Number of Planets in the Solar System	
8 planets	5
9 planets	17
12 planets	11
Other	11
Don't Know/No Answer	8
Q4: The Universe...	
Has no centre	24
Is Heliocentric	10
Is Geocentric	0
Has an unspecified centre	14
Q5: How many planets have we discovered around other stars?	
Correct answers (correct order of magnitude)	2
No planets have been discovered	3
Other answers	6
Don't Know/No Answer	41

It is clear from the answers to Q1 and Q2 that the students have had very little contact with modern Cosmology and its key concepts.

The first significant finding from Q3 is that only 5 students appear to know of the 2006 declassification of Pluto, which brought the number of Solar System planets to 8. There is a clear majority that gives the pre-2006 number (9 planets). The second finding is the significant number of students who give other numbers for the Solar System planets.

In Q4, nearly half the students state that the Universe has no center, which is consistent with modern Cosmology. We notice a large group (N=10) who accept a heliocentric Universe. This is also somewhat consistent with research finding that in children aged 12-16 the view of a Heliocentric Universe is reinforced compared to earlier ages [10].

In Q5 we note that despite the survey taking place more than fifteen years since the first extrasolar planet discovery in 1992 and at a time when several hundred more had been discovered, the majority of students do not appear to be aware of these developments. Also quite notable is the low but non-zero number of students who claim we have not discovered any planets around other stars.

It is clear from these results that the current structure and methods of the Greek education system are not achieving its stated aims of passing to the pupils lasting knowledge about

fundamental Physics issues in the case of Astronomy. A similar lack of effectiveness in producing citizens who will keep abreast of scientific developments is evidenced by the limited number of students who were aware of Pluto's declassification and the discoveries of hundreds of extrasolar planets.

Theme: Self-confidence regarding Physics

What we refer to here as "Self-confidence" is composed by the students' self-evaluation regarding Physics knowledge and their success or failure in everyday, informal interaction with Physics through information and entertainment media.

When explicitly asked to evaluate their Physics knowledge, only 11 described it as "adequate". Almost half the students (N=25) said they considered their knowledge superior to that of other adults, and an even higher number said it was superior to children (N=34).

We wanted to investigate the relationship between this Self Confidence and actual Physics knowledge as it was measured by our questionnaire. To do so, we assigned numerical values to the students' answers:

- 1 for a correct answer,
- 0 for an incorrect answer,
- 0.5 for a partially correct or accurate answer, where the question permitted one.

With 4 Self-Confidence questions (2 of which were double) and 5 Physics knowledge questions the maximum possible combined score was (6;5). If the students' Self-Confidence was an accurate reflection of their knowledge, we would expect their scores in each to be approximately equal. We plot these results in Figure 3.

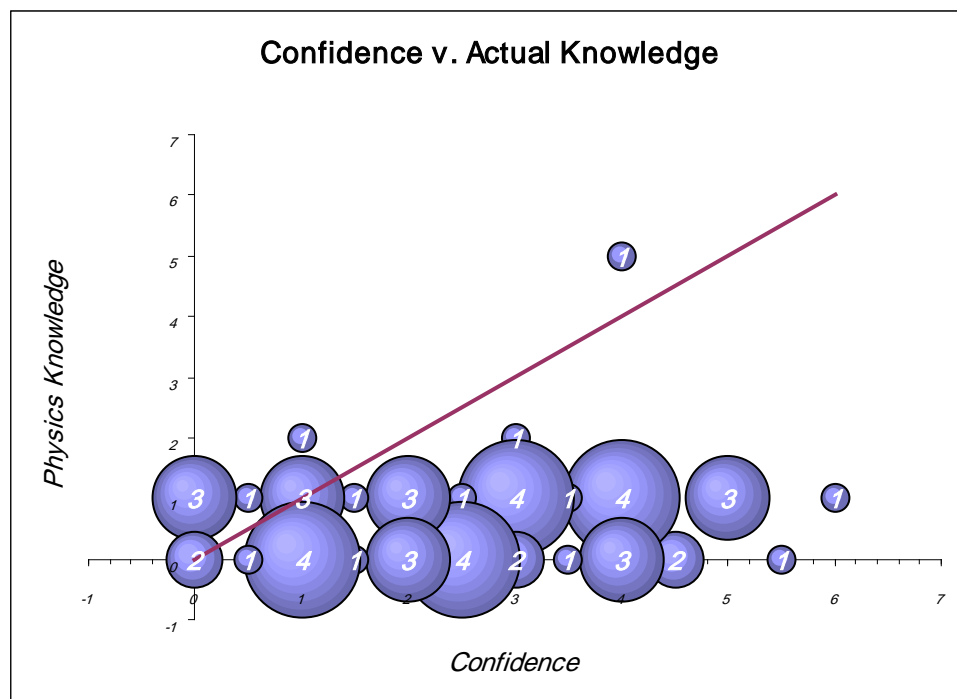

Figure 3. Confidence vs. Actual Knowledge. The line has slope = 1, and corresponds to equal Confidence and Knowledge scores. The size of the spheres corresponds to the number of students at each score.

It is clear that students' Self-Confidence is not an accurate reflection of their knowledge in subjects of Astrophysics. This can be attributed to two factors:

- Students are less able to reflect on their experience with Physics than what would be required for accurate self-evaluation.
- The students consider the subjects we tested them in as “exotic” Physics and do not feel that lack of knowledge there affects their ability to interact with “proper” Physics.

Conclusions

The results of the questionnaire survey point to a failure of the educational system to teach fundamental scientific facts about the Universe. It is also not effective in supplying its graduates with the motivation and tools to keep abreast of the most significant scientific developments.

We also note that our sample's self-evaluation of knowledge of Physics and their ease in dealing with Physics in their daily lives did not reflect their knowledge of Astrophysics.

The survey suggests that students have been required to construct their own framework of definitions and terminology. But when confronted with an unknown scientific term, the majority of the students discarded this framework and turned to everyday language rather than scientific language to understand it.

The survey suggests that our effort to modernize the teaching of Physics by introducing elements from modern Astrophysics will require a robust support network for the teachers involved. The critical points the survey results have identified, and which will need to be a focus of this support, are:

- Basic Astronomy knowledge.
- Developing a common terminology base to improve communication and transferability of results and experiences.
- Understanding the role and use of scientific language vs. everyday language.
- Introducing new Physics terms to accompany the concepts to be taught.
- Additional training in self-evaluation to improve the reliability of feedback from the teachers.

Given the scope of the above, compared to the goals of introducing modern Astrophysics into the classroom, it is suggested that a fruitful approach would be to consider the teacher effectively a co-learner throughout this effort.

References

- [1] Wall C.: A Review of Research Related to Astronomy Education, *School Science and Mathematics*, 73(8), (1973), p. 653-669.
- [2] Adams J. P., Slater T. F.: Astronomy in the National Science Education Standards, *Journal of Geoscience Education*, 48(1), (2000), p. 39-45.
- [3] Bailey J. M., Slater T. F.: A Review of Astronomy education research, *The Astronomy Education Review*, Issue 2, Vol. 2, (2003), p. 20-45.
- [4] Longhini M. D.: The “Box Universe” of 1 m³: An Activity for Introduction to the Study of Astronomy, *Astronomy Education Review*, Volume 8, Issue 1, (2009), [online]. Available from: http://aer.aas.org/resource/1/aerscz/v8/i1/p010202_s1

- [5] Yusofi E., Mohsenzadeh M.: Visualizing Cosmological Concepts Using the Analog of a Hot Liquid, *Astronomy Education Review*, Volume 9, Issue 1, (2010), [online]. Available from: http://aer.aas.org/resource/1/aerscz/v9/i1/p010201_s1
- [6] Bailey J. M., Coble K., Cochran G., Larrieu D., Sanchez R., Cominsky L. R.: A Multi-Institutional Investigation of Students' Preinstructional Ideas About Cosmology, *Astronomy Education Review*, Volume 11, Issue 1, (2012), [online]. Available from: http://aer.aas.org/resource/1/aerscz/v11/i1/p010302_s1
- [7] MEXT, Ministry of Education, Culture, Sports, Science and Technology of Japan, WHITE PAPER ON SCIENCE AND TECHNOLOGY 2004, Science and Technology and Society in the Future: Part 1, The Future of Science and Technology and Society, (2004), [online]. Available from: <http://www.mext.go.jp/english/whitepaper/1302285.htm>
- [8] European Commission, Directorate-General for Education and Culture, Working Group B, "Key Competences": Key Competences for Lifelong Learning: A European Reference Framework, Brussels, (2004), [online]. Available from: <http://ec.europa.eu/education/policies/2010/doc/basicframe.pdf>
- [9] High Level Group on Human Resources for Science and Technology appointed by the European Commission, INCREASING HUMAN RESOURCES FOR SCIENCE AND TECHNOLOGY IN EUROPE, Report to be presented at the EC conference EUROPE NEEDS MORE SCIENTISTS, 2 April 2004, Brussels, (2004), [online]. Available from: http://ec.europa.eu/research/conferences/2004/sciprof/pdf/final_en.pdf
- [10] Spiliotopoulou-Papantoniou V.: Models of the Universe: Children's Experiences and Evidence from the history of Science, *Science & Education*, Volume 16, Numbers 7-8, (2007), p. 801-833.

Conceptual Difficulties Held by High School Students in Mechanics

Mchunu SP¹, Imenda SN²

¹ Umalusi, Pretoria, South Africa

²University of Zululand, South Africa

Abstract

The main purpose of this study was to identify conceptual difficulties held by high school learners concerning mechanics, as one of the prominent topic in south Africa's National Curriculum Statement (NCS). The research sample comprised 140 grade 12 students from four high schools. Convenience sampling was used to select participating schools. A researcher-designed test was used to collect the required data. Although quantitative data were collected, the main thrust of data analysis for the paper was on the qualitative data generated. Five categories of conceptual difficulties evolved from the motivations and explanations given by the participants, namely (a) resolving the components of weight; (b) the concept of work; (c) work-energy theorem applications; (d) kinetic energy concept; and (e) principle of conservation of mechanical energy application. The findings are discussed in line with the purpose of the study.

Keywords: Mechanics, conceptual difficulties, high school learners

Introduction

The South Africa's National Curriculum Statement (NCS) presents 'mechanics' as one of the six knowledge areas to be addressed in the high school physics curriculum, and is allocated 33% of the total marks for Paper One in the National Senior Certificate (NSC). The allocation of 33% of the total marks of Paper One, only to mechanics, shows the importance attached by government and curriculum planners to this aspect of the high school physical science curriculum. However, the study of physics is fraught with numerous conceptual difficulties on the part of many learners. Newtonian mechanics is among the themes of the high school curriculum where conceptual difficulties are widespread (Redish, Saul and Steinberg, 1997).

Context

The results reported here come from a much larger study based on two major considerations: (a) the recognition and awareness of the different learning styles which learners bring to the classroom; and (b) the importance of curriculum implementation to start with a baseline assessment of learners' current state of knowledge and understanding, and end with a clear sense of what has been achieved. The importance of these two points of departure in contextualising this study is briefly sketched below.

Students' Learning Styles

A number of authors (e.g. Felder 1988; Oxford 2003; Pashler, McDaniel, Rohrer & Bjork, 2008) have described the different learning styles that one may find in one's classroom, as well as the recommended teaching strategies that may be appropriate for each one of them.

It is important to stress that the above categories are not mutually exclusive – suggesting that learners are not locked up in one learning style, and that they may learn best in

combinations of the above learning styles. However, these categories express the dominant features that particular learners may exhibit. Thus, although the predominant theme at this conference is on **active learning**, it is important to realise and take note that not all learners best learn through active learning instructional strategies.

Relation to the Main Study

The main study on which this paper is based was undergirded by the model presented in Figure 1, which shows that diagnostic assessment of learners' conceptual difficulties in a particular topic constituted only the first step in a sequence of a number of important steps. This first step forms the main focus of this paper. The study, as a whole, later proceeded to deal with the other aspects of the model – such as designing and identifying the relevant instructional strategies and learning materials - the implementation of which entailed formative assessments and culminated in summative, end-of-learning cycle testing.

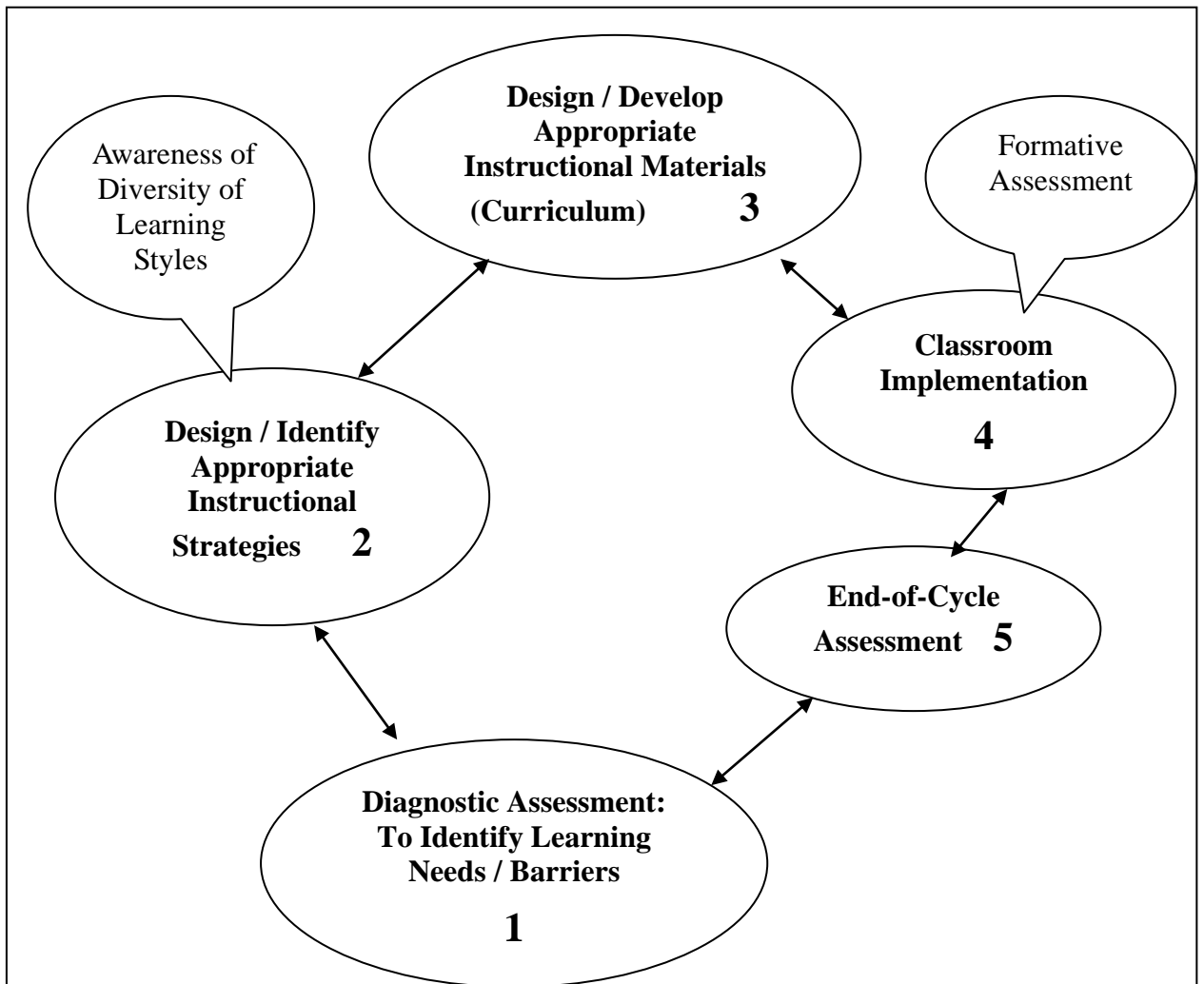

Figure 1. The curriculum development model for the study

Statement of the Research Problem

It is often said that mechanics is an essential prerequisite for most topics in physics. As such, the learner's initial knowledge of mechanics is most critical to his or her subsequent performance in the subject as a whole. Typically, the main purpose of mechanics is to teach learners the fundamental laws and principles of physics, and to give them experience in reasoning out how these laws and principles apply to the world about them. This entails solving problems, both mathematical and conceptual in nature – thereby requiring that learners have a clear understanding of the basic underlying principles involved. However, in the experience of the first author of this paper, there are a number of themes in mechanics which consistently present learning difficulties for learners. These include: work and energy; force, momentum and impulse; weight and acceleration due to gravity; kinematics graphs; projectile motion; and frames of reference. Research has also shown that many students, both at school level and university, experience huge conceptual difficulties with a number of mechanics concepts and principles.

Aim

The aim of this study was to document the conceptual difficulties, in mechanics, experienced by grade 12 high school learners from the Empangeni school district, South Africa. Within the context of the main study, as explained above, the identification of conceptual difficulties held by the grade 12 high school learners was done in order to devise strategies and instructional modes to alleviate the identified learning difficulties.

Research Methods

This was a case study utilising the mixed-methods research paradigm (Johnson & Onwuegbuzie 2004; Guba & Lincoln 2005; Johnson, Onwuegbuzie & Turner 2007; Venkatesh, Brown & Bala 2012-2013). As such, the study collected both quantitative and qualitative data. However, the main objective of the study was achieved mainly through the analysis of the qualitative data, which represented the voices of the learners.

The research sample comprised 140 grade 12 high school learners from four high schools in the Empangeni school district, South Africa. Convenience sampling (LeCompte & Preissle, 1993) was used to select the participating schools. The participating schools were geographically convenient to reach. Thus, the study makes no claim about representativeness of the research sample with respect to the province or, for that matter, the whole country.

Data collection was achieved by the use of a researcher-designed, three-tier multiple choice test - the Test in Basic Mechanics (TBM), to determine students' understanding of, and knowledge about, mechanics. The test consisted of two sections: A and B. Section A dealt with the respondents' biographical information and their preferences regarding instructional and assessment methods, as well as determining their familiarity with, and understanding of, selected concepts in mechanics. Section B consisted of Parts I and II. Part I centred on possible conceptual difficulties in mechanics: subsection A, concerned conceptual difficulties in mechanics with regard to 'work and energy', while subsection B, focused on the conceptual difficulties related to 'work and energy for motion on inclined planes or surfaces'. Part II, sought to reveal learners' alternative conceptions in mechanics: subsection A, sought to reveal possible alternative conceptions about 'projectile motion', whereas subsection B, sought to reveal possible alternative conceptions about 'force and Newton's laws. Altogether, the instrument consisted of twenty five

multiple choice questions. Each question carried five marks: two marks for selecting the intended response, one mark for self-rating and two marks for the motivation. It was from the motivations that the researchers intended to harness possible alternative conceptions.

Each multiple choice question was followed by an open-ended question where the answer had to be motivated. Learners had to rate themselves before motivating each answer. The ratings were categorised as “just a blind guess”, “not very sure”, “fairly sure” and “I’m sure, I’m right”.

Example

Q3.1 Newton’s Third Law states that if an object A exerts a force F on object B, then object B exerts a force – F on object A, equal in magnitude but opposite in direction to F. This means that both forces are exerted at:

- A. *Different times on the same object.*
- B. *Same time on different objects.*
- C. *Different times on different objects.*
- D. *Same time on the same object.* (2)

3.2 How confident are you with your answer? [Please tick in the appropriate box!]

<i>Just a blind guess</i>	<i>Not very sure</i>	<i>Fairly sure</i>	<i>I’m sure I’m right</i>

(1 mark)

3.3 Explain or make comments to support your choice *(2 marks)*

The questions were based on targeted conceptual difficulties and alternative conceptions from the literature review, possible conceptual difficulties and alternative conceptions identified in the preliminary and pilot studies, as well as potential conceptual difficulties and alternative conceptions which had emerged from learners’ responses and problematic notions, from the first author’s experience as a physical science teacher. Therefore, the main focus of the test was not so much on knowledge, *per se*, but the underlying conceptual understanding.

The test was validated for content by two physics professors at the University where the study was conducted, a physical science teacher, and one physical science Subject Advisor from the local Education District. The feedback received from these experts was used to refine the instrument by reformulating and rephrasing many of the options to enhance clarity and remove ambiguity.

Results and Discussion

The first part presents the demographic information of the participants, followed by a table showing their performance on each question. This is then followed by a presentation of the conceptual difficulties that emerged out of this investigation.

Demographics

The research sample consisted of 140 grade 12 high school learners, comprising 56 males (40%) and 84 females (60%); 66% of the research sample were older than 17 years of age;

100% indicated that their home language was Isizulu; the language of instruction was English.

Respondents' Performance on Each Question

Table 1 displays the participating learners' performance on the 15 questions constituting the instrument.

Table 1. Learners' performance across the 15 items (n=140)

Q	A	B	C	D
1	24	66	43*	07
2	33	35*	54	18
3	21	79	17*	23
4	08	21	83	28*
5	21	60*	27	32
6	29	24*	09	78
7	44*	36	28	32
8	61*	31	39	09
9	17	38	17	68*
10	35	45*	20	40
11	36	41	27*	36
12	32	45*	40	23
13	39	30*	47	24
14	66*	24	38	12
15	46	40	32*	22

Note: The * signifies the intended response.

The table shows that the majority of the learners in the research sample experienced difficulties across most of the items. Out of 15 items, 11 of them had less than 50% of the respondents selecting the intended responses.

Most Prevalent Conceptual Difficulties

Overall, five categories of conceptual difficulties evolved from the individual motivations and comments given by the respondents to each of the 15 questions. Each category was assigned a symbol (CD1 to CD5), in no specific order of significance. Some conceptual difficulties appeared in more than one question. Abbreviation CD stands for 'conceptual difficulty'.

Table 2. Most prevalent conceptual difficulties

	CONCEPTUAL DIFFICULTIES	% RESULTS
CD1	Theme: Resolving the Components of the Weight Unable to solve problems that involved resolving ‘the components of force or weight’ – especially those concerning motion on inclined planes/surfaces.	85
CD2	Theme: Work Concept ‘Work’ was simply understood to be the product of force and displacement, that is, $W = F \cdot \Delta x$. The issue of ‘the component of the force’ was disregarded. Thus, they were unable to distinguish between ‘positive work’ and ‘negative work’ as well as ‘no work done’.	52
CD3	Theme: Work-Energy Theorem (Application) Application of the work-energy theorem presented some difficulty to about half the research sample.	48
CD4	Theme: Kinetic Energy In the kinetic energy formula, $K = \frac{1}{2} mv^2$, about half the learners were unable to recognize the relationship between mass and kinetic energy, and between velocity and kinetic energy.	51
CD5	Theme: Principle of Conservation of Mechanical Energy Application of the Principle of Conservation of Mechanical Energy was somewhat difficult to more than half the research sample. In particular, the following concepts appeared to fall outside their understanding: system (isolated or closed), conservation, internal and external forces.	56

With regard to the frequency counts, the magnitude of the learners’ conceptual difficulties were CD1 inability to resolve *components of force or weight* – especially those concerning motion on inclined planes/surfaces (85); followed by CD2 unable to construe the Principle of Conservation of Mechanical Energy (52); CD3 unable to distinguish between *positive, negative* and *no work done* (48); CD4 unable to recognize the relationship between mass and kinetic energy, and between velocity and kinetic energy (51); and CD5 difficulty with the application of the work-energy theorem (56).

The typical responses given by the learners to highlight each of these conceptual difficulties are given below in line with the above five themes.

Theme 1 (CD1): Resolving Components of Weight

Learners’ responses to questions 8 and 9 highlight the conceptual difficulties regarding resolving components of weight. Some of the learners’ voices are given below to illustrate the learning difficulties experienced by learners. [From Table 1, the degree of difficulty is 0.61. In essence, this was one of the easier questions].

Q8. A person skis down a 20 m long snow slope which makes an angle of 25° with the horizontal. The total mass of the skier and skis is 50 kg. There is a constant frictional force of 60 N opposing the skier's motion. The initial speed of the skier as s/he descends from the top of the slope is $2,5 \text{ m}\cdot\text{s}^{-1}$. What is the magnitude of the net force parallel to the slope experienced by the skier?

$$V_i = 2,5 \text{ m}\cdot\text{s}^{-1}$$

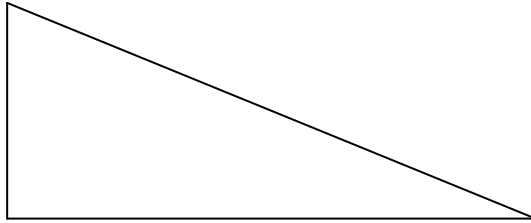

The magnitude of the net force parallel to the slope experienced by the person is

- A. -207,08 N
- B. -147,08 N
- C. **147,08 N**
- D. 207,08 N

(2)

Learners' comments on Question 8:

"I am lost". [Chose option B].

"Since the skier's speed descends, there is a force present and the angle between is 25° . Frictional force will therefore be in the opposite direction ($F_{net} = mg\sin\theta + (-f)$). [Chose option A].

" F_{net} is made by two forces which are frictional force and applied force. Applied force is made up of the mass, the gravitational force and the angle formed". Chose option C – which was the intended response].

" F_{net} is equal to $F\Delta x \cos\theta$, where $F\Delta x$ can be written as $mg\sin\theta$. The skier moves in the direction of the force which gives us 0 which also leads to the answer A. [Chose option A].

"The magnitude of the net force is given by force applied minus frictional force. Force applied can be expressed as distance times the angle given, then that gives us magnitude". [Chose option C].

Learners' comments on Question 9:

Q.9. A box of mass 60 kg starts from rest at height 'h' and slides down a rough slope of length 10 m, which makes an angle of 25° with the horizontal. It undergoes a constant acceleration of magnitude $2 \text{ m}\cdot\text{s}^{-2}$ while sliding.

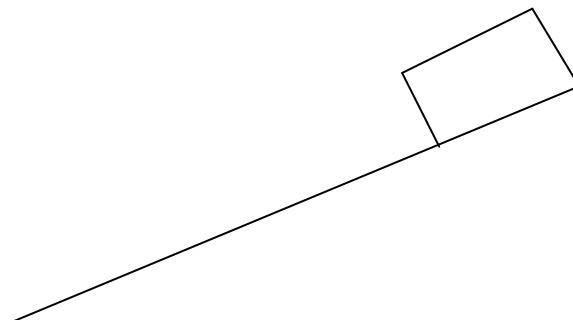

The kinetic energy of the box is

- A. -1 200 J
- B. 2 485 J
- C. -1 285 J
- D. **1 200 J**

(2)

(a) What is the kinetic energy of the box?

“The box is sliding down to the negative side it is illustrated on a Cartesian Plane. So the answer must be negative”. [Chose option A].

“The kinetic energy of the box is made by the force parallel to the surface. The force parallel is made by the mass, the gravitational force and angle $\sin 25^{\circ}$ ”. [Chose option C].

“The kinetic energy should be 2485 J because the work done is 3200 J”. [Chose option B].

(b) What is the work done on the box by the gravitational force?

Options:

- A. -1 200 J
- B. 2 485 J**
- C. -1 285 J
- D. 1 200 J

Students’s Explanations

“Weight is equal to the kinetic energy”. [Chose option D].

“The gravitational force has a heavy force”. [Chose option B, which was the intended response].

The work done on the object is equal to the kinetic energy. The difference is that the gravitational force of the kinetic energy is positive while for the work done it is negative. The work done is negative while the potential energy is positive”. [Chose option B, which was the intended response].

(c) What is the work done on the box by the frictional force?

Options:

- A. -1 200 J
- B. 2 485 J
- C. -1 285 J**
- D. 1 200 J

Students’s Explanations

“I do not know the formula”. (Made no selection).

“Very less friction was done because the slope was not rough and the potential and kinetic energy was applied”. [Chose option A].

(d) What is the magnitude of the frictional force acting on the box?

Options:

- A. -128, 5 N
- B. 128, 5 N**
- C. 1 200 N
- D. -1 200 N

(2)

“The box has friction in order for it to move on the slope until it lands on the ground where potential energy will be zero. [Chose option B, which was the intended response].

Theme 2: Concept of Work

Q1. A 50 kg crate is pulled 40 m along a horizontal floor by a constant force exerted by a person, $F_p = 100\text{ N}$, which acts at a 30° angle as shown in the figure below. The floor is rough and exerts a friction force $F_f = 50\text{ N}$.

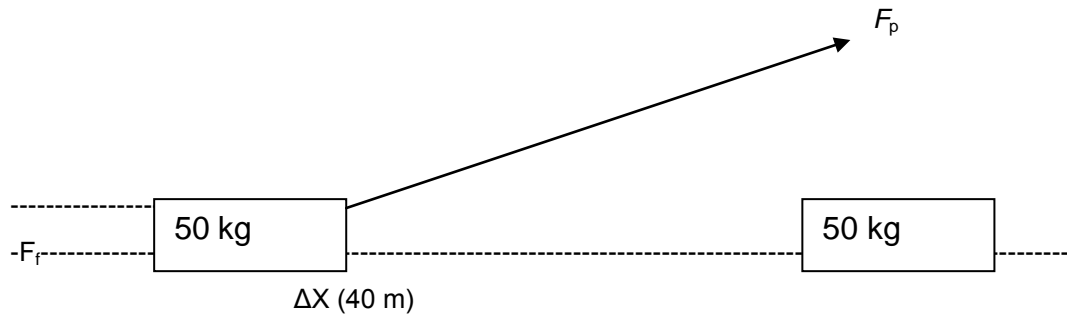

What was the work done by (a) force F_p , and (b) friction force F_f ?

	WORK DONE BY FORCE F_p	WORK DONE BY FRICTION FORCE F_f
A	- 3195 J	2000 J
B	2000 J	3195 J
C	3464 J	- 2000 J
D	- 2000 J	- 3195 J

(2)

(2)

[4]

Learners’ comments on Question 1 with regard to work done by F_p :

“I am not sure whether to put 100 N for the force or use the components of gravity. I am also not sure of the angle to put in the work formula next to the cosine ratio. But according to myself I think we use the force as it is and the angle”. [Chose option A].

“The applied force on the crate is 100 N and the work done is 3195 J, the force applied is greater than the frictional force”. [Chose option B]

“The force applied to a 50 kg block is at an angle of 37 not 180 because they do not form a straight line”. [Chose option A. The intended response was option C].

Learners’ comments on Question 1 regarding work done by friction (F_f):

“Because the frictional force will always be negative since it is opposing the direction of force”. [Chose option A].

“I am not sure of the angle to put next to the cosine ratio if it is 37 or 180. But I think that the angle to put there is 180. Since the force of friction and applied force goes in the opposite direction therefore makes an angle of 180”. [Chose option A].

“The frictional force on a crate is 50 N and the work done is 2000 J. The frictional force is the difference between the net force and the applied force and the frictional force is smaller than the applied force”. [Chose option B].

Theme 3 (CD3): Application of Work-Energy Theorem

With regard to this category of conceptual learning difficulties, learners exhibited difficulty understanding the concept of work done by a **net force** and hence they considered statement III (of question 2) also as correct. Thus, the learners did not understand the work-energy theorem.

Q2. Consider the statement below:

- I. Work is done on an object when a force displaces the object in the direction of the force.*
- II. Mechanical energy of a system is conserved when an external force does no work on the system.*
- III. The work done on an object by a net force is equal to the kinetic energy of the object.*

Which of the above statements is/are CORRECT?

- A. Only I
- B. I and II only**
- C. II and III only
- D. I, II and III

Learners gave the following statements:

“The statements are all true so far as I know”. [Chose option D].

“I think all are true because work is done on an object when a force displaces the object in the direction of the force. Mechanical energy of a system is conserved when an external force does no work on the system. The work done on an object by a net force is equal to the kinetic energy of the object”. [Chose option D].

“Statement (III) supports the work-energy theorem and Statement (II) supports the Principle of Conservation of mechanical energy”. [Chose option C].

“The work-energy theorem states that the net work done by a net force is equal to the kinetic energy, not that the work done on an object by a net force is equal to the kinetic energy”. [Chose B – which was the intended option].

Conceptual difficulties appear to emanate from the fact that when work is done energy is transferred ($W = \frac{1}{2} mv^2$). Doubling the velocity increases work done four times since the velocity is squared. Therefore, the work done cannot be directly proportional to the velocity. The question was about the change in velocity and it related to the work-energy theorem.

With regard to question 3, the learners also exhibited similar conceptual learning difficulties.

Q3. The engine of a car does work, W , to increase the velocity of the car from 0 to v . What is the work done by the engine to increase the velocity from v to $2v$, equal to?

- A. W
- B. $2W$
- C. $3W$**
- D. $4W$

(2)

Learners' comments:

"The work done on an object is equal to the kinetic energy." [Chose option A].

"Power is directly proportional to the velocity and inversely proportional to the work done". [Chose option B].

"As the car engine started to increase the velocity from 0 to v it also increased from v to 2v and from 2v to 3v which shows that the work done is 3 W and the difference is 1." [Chose option C – which was the intended response].

"The work done is twice the original one v". [Chose option B].

Theme 4 (CD4): Kinetic Energy

Q4. An object moving at a constant velocity v has a kinetic energy E. The velocity is changed to 2 v. Which ONE of the following is the correct kinetic energy at this velocity?

- A. $\frac{1}{4} E$
 - B. $\frac{1}{2} E$
 - C. $2 E$
 - D. **$4 E$**
- (2)

Learners' comments:

"Because the velocity is constant when it is changed to 2 v, the kinetic energy is doubled". [Chose option D – which was the intended response].

"It is because the kinetic energy is halved for that velocity that changes from the E that was 2 v to $\frac{1}{2} E$ ". [Chose option B].

"Because the kinetic energy increases by velocity squared if there is any increase in velocity:

$$E = \frac{1}{2} m v^2 = \frac{1}{2} m 2 v^2 = \frac{1}{2} m 4 v^2$$

$$E = 2 E$$

Therefore, the kinetic energy is 2 E". [Chose option C].

"2 E – the work done + kinetic energy leads to the movement of an object to be 2 E kinetic energy". [Chose option C].

"Kinetic energy is inversely proportional to the velocity of an object therefore when the velocity doubles itself, the kinetic energy will be halved therefore it would be $\frac{1}{2} E$ ". [Chose option B].

"As the velocity changes to 2v, so the kinetic energy will be 2E". [Chose option C].

Most learners did not correctly relate the changes in velocity to kinetic energy. The popular response was that if the velocity is changed from v to 2v, kinetic energy also would be changed from E to 2E. They were unable to square the velocity in the *kinetic energy equation and hence the majority option was C (2E) which suggested that doubling the velocity of an object, would also lead to the doubling of the kinetic energy – which is not the case.*

The above two conceptual difficulties appear to come from the kinetic energy concept in that learners could not square the velocity in the kinetic energy formula to solve the problem. As in question 3, by doubling the velocity, the kinetic energy becomes fourfold the previous one.

Theme 5 (CD5): Application of the Principle of Conservation of Mechanical Energy

{Q13. Nthabiseng, a cyclist, is free-wheeling (moving without peddling) along a horizontal surface at a constant speed of $10 \text{ m}\cdot\text{s}^{-1}$. She reaches the bottom of a ramp (position A) that has a height of 1,2 m and a length of 8 m. While free-wheeling up the ramp, she experiences a frictional force of 18 N. The total mass of the cyclist is 55 kg. Which ONE of the following best describes her situation?

- A. Her mechanical energy is conserved.
- B. Her mechanical energy is not conserved.**
- C. Her potential energy is conserved.
- D. Her mechanical energy is constant.}

In this question, learners could not identify key words like ‘she experiences a frictional force of 18N’, and hence the majority of learners applied the Principle of Conservation of Mechanical energy which made them to make wrong choices.

Learners’ comments on Question13:

“The law of conservation of mechanical energy was applied”. [Chose option A].

“I am not quite sure of my answer”. [Chose option A].

“The energy changes when it is not sloppy”. [Chose option D].

Overall, learners did not appear to understand the Principle of Conservation of Mechanical Energy, and failed to consider that mechanical energy is only conserved if there are no external forces or non-conservative forces, like frictional force acting on the system. The Principle is about a closed system and this excludes external forces. The intended response was option B.

Development of Instructional Interventions

Following the identification of conceptual difficulties experienced by the respondents, three sets of instructional interventions were developed with a view to overcoming these difficulties, namely, ‘traditional’, ‘outcome based education’ (OBE) and ‘blended’. The traditional teaching / learning strategy was selected on the basis that reception learning (Ausubel 1962, 1963 & 1977) still remains the dominant teaching and learning strategy in many South African schools and, according to Coetzee (2008), could alleviate students’ learning difficulties and alternative conceptions – if implemented effectively. OBE was selected as one of the intervention instructional strategies for this study on the basis that it forms the main approach recommended for the implementation of South Africa’s National Curriculum Statement (Department of Basic Education 2012). The blended instructional strategy was selected because of its use of multiple approaches, as a way of accommodating the many learning styles that students bring to the classroom (Ellis, Steed & Applebee 2006; Ocaik 2011; Pape 2010; Cronjé 2011). By way of definition, Ellis, et.al (2006: 313) opine that blended learning is a “systematic combinations of e-learning and face to face learning.”

Once these three instructional strategies had been identified, instructional materials for the respective approaches were then developed. In this regard the ‘traditional’ intervention, treated concepts in a teacher-centred learning modality – typical of reception learning, whereby the teacher stands at the front of the classroom and the students passively sit at their desks and listen to the teacher. The lecturing or telling method, and the exclusive use of the prescribed textbook, typified this instructional approach. Accordingly, within class

time, very little or no interaction and communication amongst students, and between the students and the teacher, took place, although the teacher occasionally made use of questions to check students' attention and understanding.

For the OBE group concepts were treated based on the constructivist way of teaching and learning. Learners' questions, comments, responses in tests and during class formed an important part of classroom interactions. Based on the constructivist educational principles, OBE entails an open interaction between the educator and the learners, as well as learner-learner interactions. Thus, the constructivist approach focused on quality over quantity (Mintzes, et al, 1998:327). Gray (1987) also posits that constructivism uses a process approach, focusing on the ideas which are allowed to develop in the learner's own mind through a series of activities. According to the constructivist view, for learners to develop an understanding of the conventional concepts and principles of science, more is required than simply providing practical experiences. More guidance is needed to help learners assimilate their practical experiences into what is possibly a new way of thinking about them (Driver, 1983). A variety of instructional methods were used during this intervention, and these entailed use of interactive student-centred methods. Learners' questions, comments, responses on tests and work at the chalk board were used. Learners' answers were probed to identify the reasons behind these answers. The students were encouraged to actively participate, as much as possible, in the programme through the use of written assignments, giving timely feedback to students, controlled class discussions, negotiating meaning in practical work and small group discussions, hands-on activities, individual problem solving tasks, articulating relevant personal experiences, and wrestling with real world problems rather than memorising answers. Thus, the teacher played the role of a facilitator, ascertaining what the learners already knew, and organize instruction that built on that knowledge. Application of real-life situations was central, and individuality was accommodated as far as possible. The variety of instructional methods compensated for student diversity. Understanding was assessed by means of different continuous assessment assignments – including peer and self-assessment. Furthermore, students were encouraged to use other sources in addition to the prescribed textbook, e.g. reference lists of similar textbooks in the library, lecture material, notes, internet, consultations with other physical science educators and other educators and peers.

In blended learning, concepts and principles are treated in modalities that mix various event-based activities: self-paced learning, live e-learning and face-to-face classrooms. An efficient blended learning programme includes a mixture of these three learning types (Alonso, Lopez, Manrique & Vines, 2005). According to Alonso, *et.al*, (2005), blended learning combines training, coaching, and self-help. In blended learning, teaching and learning involve face-to-face classroom interactions (traditional way of teaching), open interactions between the educator and the learners, interactions among learners themselves, computer-mediated teaching and learning, and co-operative learning. A continuum of teaching strategies was used in the clarification of mechanics concepts and principles.

Thus, in summarizing the interventions, it may be said that the traditional approach to teaching and learning is mainly dominated by lecture or telling method and memorization by learners. The teacher is the disseminator of information. For its part, the OBE approach is dominated by group discussions and the educator is regarded as the facilitator of learning. With regard to the blended approach, all teaching strategies and methods are vitally important since learners tend to have different learner characteristics, with different learning styles. As facilitator, the teacher chooses instructional strategies in the most appropriate and relevant combinations.

Activity Theory as the Theoretical Model for Implementing the Instructional Interventions

The main elements of the Activity Theory (AT) are summarized in Figure 2.

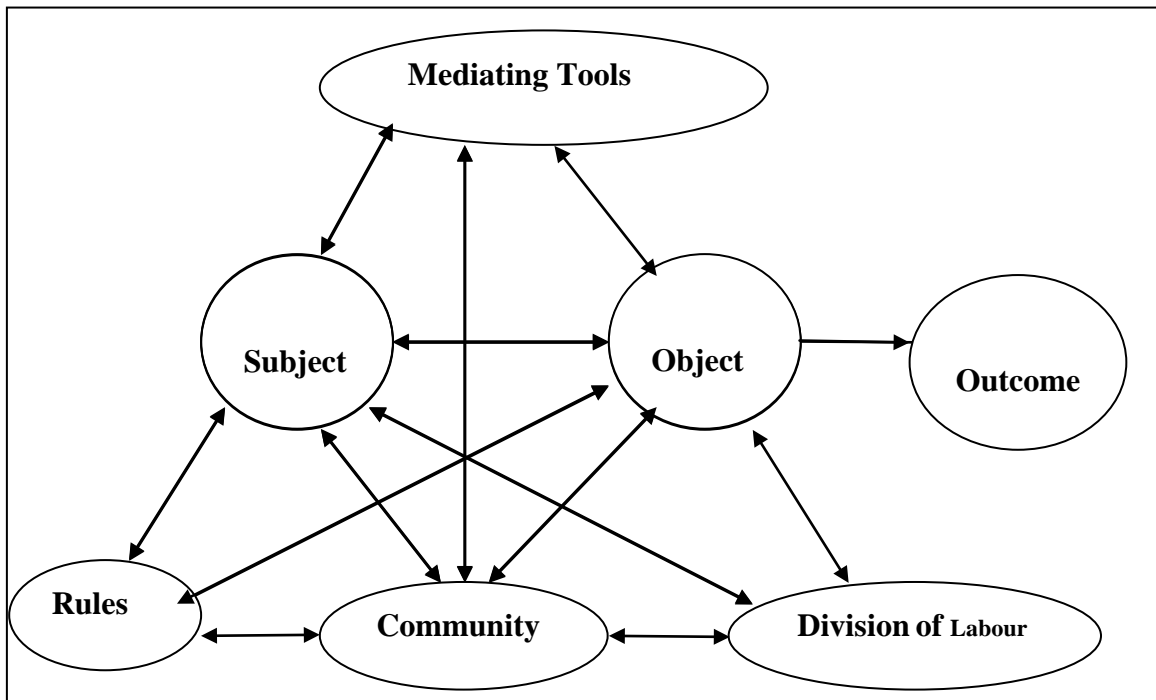

Figure 2. Activity System (based on Engestrom, 1987) for three intervention groups (traditional, OBE and blended)

According to Figure 2, an Activity System consists of mediating tools, subject, object, goal or outcome, division of labour, community and rules. Thus, regarding the traditional intervention, the teacher remained in complete control of the class. He was also a disseminator of information; classroom proceedings were teacher-centred; there was little or no interaction among the learners; and, occasionally, the teacher made use of questions to check learners' attention.

According to this model, the "subject" comprised a group of 35 grade 12 physical science learners. The main object was to identify the conceptual difficulties held by these students in mechanics. The expected outcome was the alleviation of the students' conceptual difficulties in mechanics. The subject and the object were mediated by prescribed textbooks, assignments, worksheets and the TBM (used as both pre- and post-test) as the tools for the traditional intervention. The teacher and the group of thirty five (35) students formed the community as they were sharing the same object with the subject. With regard to the division of labour, the teacher prepared worksheets, TBM, provided input and feedback to learners. Learners were expected to understand the information presented to them, completed worksheets and wrote the TBM. Learners had to follow the rules as outlined in the TBM, worksheets and also to be silent while the test or lessons were in progress.

Regarding the OBE intervention, the teacher served as a facilitator of learning; classroom proceedings were learner-centred, and there were interactions among the learners and between the learners and the teacher – who sometimes made use of questions to check

learners' attention; there was an effort to promote conceptual understanding. This intervention was based on constructivist ways of teaching and learning.

Within the AT system, the 'subject' here also comprised a group of 35 grade 12 physical science students; the main object was the OBE curriculum which was designed to identify the conceptual difficulties in grade 12 physical science mechanics. The expected outcome was the alleviation of the students' conceptual difficulties in mechanics. The subject and the object were mediated by textbooks that served as reference materials, peer-controlled group discussions and assignments, worksheets and TBM (used as both pre- and post-test), over-head projector (OHP) and transparencies, which were tools for the OBE intervention group. The teacher and the group of thirty five (35) learners formed the community as they were sharing the same object with the subject. With regard to the division of labour, the teacher prepared worksheets, TBM, provided input, responsible for facilitation, organised learners into small groups, allowed the learners to interact through discussions, gave feedback to learners. Learners discussed and solved mechanics problems in small groups, completed worksheets, responsible for peer assessment, and wrote the TBM. Learners followed the rules as outlined in the TBM, worksheets and assignments. There were also rules that governed group discussions.

With regard to the blended intervention, the teacher served as a facilitator of learning as for the OBE intervention. He allowed learners to interact with each other and with the facilitator; classroom proceedings were learner-centred, and there was a lot of learner-learner and educator-learner interactions through discussions, as well as question-and-answer interactions. In this approach, the facilitator employed a variety of teaching strategies, including the lecture / telling method, computer- and web-mediated teaching / learning in order to accommodate the different learning styles of the participants – the main focus being on promoting conceptual understanding.

The blended approach was based on constructivist teaching approaches, as well as on the notion of connectivism (as something particularly germane to e-learning). Thus, the blended approach as a strategy that mixes various teaching and learning modes, also involved technology as an important tool for learning.

As for the other interventions, the 'subject' comprised a group of 35 grade 12 physical science learners; the main object was the blended curriculum, which was designed to identify the conceptual difficulties held by the participants in mechanics. The expected outcome was the alleviation of learners' conceptual difficulties in mechanics; the subject and object were mediated by textbooks, serving as reference materials, peer-controlled group assignments, worksheets and the TBM, OHP and transparencies, electronic resources, the Web, laptop computers and data projector. These were the tools for the blended intervention. The teacher and the group of thirty five (35) learners formed the community as they were sharing the same object with the subject. With regard to the division of labour, the teacher prepared instructional materials and the TBM, provided input and feedback, was responsible for facilitation, organised learners into small groups, allowed the learners to interact through discussions; served as facilitator for Web-based learning and other electronic resources. Learners discussed and solved mechanics problems in small groups, completed worksheets, participated in peer assessment, and wrote the TBM; they worked according to the rules as outlined in the TBM, worksheets and assignment. There were also rules that governed group discussions.

Conclusion

The main objectives of this study were to (a) identify and document the conceptual difficulties, in mechanics, experienced by grade 12 high school learners, and (b) devise strategies and instructional modes to alleviate the identified learning difficulties. In this regard, therefore, it may be said that the study achieved its objective. The identification and documentation of the five conceptual difficulties went a long way in directing both the choice of instructional strategies and relevant curricular materials for the learners. This enriched the educational experiences of the learners. Other practitioners could take a leaf from the sequence of activities followed in this study. The learning outcomes of these interventions are reported elsewhere, and fell outside the scope of this paper – save to say that the most effective approach was blended learning; followed by the OBE approach, and then the traditional approach. Thus, the significance of this paper lies in the process outlined above – i.e. the importance of identifying and documenting students' conceptual difficulties as a precursor to the selection / identification of the most relevant and appropriate teaching / learning strategies best suited for alleviating the identified conceptual difficulties.

References

- Alonso F., Lopez G., Manrique D., Vines J.: An instructional model for web-based e-learning education with a blended learning process approach. *British Journal of Educational Technology*, Vol 36 (2) (2005): 217 – 235.
- Ausubel D. P.: The psychology of meaningful verbal learning. Oxford, England: Grune & Stratton, (1963).
- Ausubel D. P.: The facilitation of meaningful verbal learning in the classroom, *Educational Psychologist*, 12(2), (1977).
- Ausubel D. P.: (1962). A Subsumption Theory of Meaningful Verbal Learning and Retention, *The Journal of General Psychology*, 66(2), (1962): 213–224.
- Coetzee A.: Overcoming alternative conceptions concerning interference and diffraction of waves. Thesis Submitted in Fulfilment of the requirements for the degree: Doctor Educationis: Science Education, in the Department of Mathematics, Science and Technology Education. Faculty of Humanities Tshwane University of Technology, 2008.
- Cronjé J. C.: Using Hofstede's cultural dimensions to interpret cross-cultural blended teaching and learning, *Computers & Education*, 56(3), (April 2011): 596–603.
- Department of Basic Education. Revised National Curriculum Statement for Grades R-9 (Schools) Natural Sciences, Pretoria, (2012).
- Driver R.: The pupil as scientist. Milton Keynes: Open University Press, (1983).
- Ellis R. A., Steed A. F., Applebee A. C.: Teacher conceptions of blended learning, blended teaching and associations with approaches to design. *Australasian Journal of Educational Technology*, 22(3), (2006): 312-335.
- Engestrom Y.: Learning by expanding:an Activity-Theoretical Approach to Developmental Research. Helsinki, Finland:Orienta-Konsultit, OY, (1987).
- Felder R. M.: Learning and Teaching Styles In Engineering Education. *Engr. Education*, 78 No 7, (1988), p. 674–681.

Guba E. G., Lincoln Y. S.: Paradigmatic controversies, contradictions, and emerging confluences. In N. K. Denzin & Y. S. Lincoln (Eds.), *The Sage handbook of qualitative research* (3rd ed.). Thousand Oaks, CA: Sage, (2005): 191-215.

Gay L. R.: *Educational research: Competencies for analysis and Application*. Merrill publishing Co. U.S.A, (1987).

Johnson R. B., Onwuegbuzie A. J.: Mixed methods research: A research paradigm whose time has come. *Educational Researcher*, 33 No 7 (2004): 14-26.

Johnson R. B., Onwuegbuzie A. J., Turner L. A.: Toward a Definition of Mixed Methods Research, *Journal of Mixed Methods Research*, 1 No2 (2007): 112-133.

LeCompte M. D., Preissle J.: *Ethnography and qualitative design in educational research* (2nd ed.), San Diego, Academic Press, Inc. (1993).

Mintzes J. J., Wandersee J. H.: The pursuit of a dream: education can be improved. In: Mintzes J. J., Wandersee J. H. and Novak J. D., (eds.). *Teaching for understanding science for understanding: a human constructivist view*, San Diego: Academic Press, (1998).

Ocak M. A.: Why are faculty members not teaching blended courses? Insights from faculty members, *Computers & Education*, 56(3): (2011): 689–699.

Pape L.: Blended Teaching and Learning, *The School Administrator*, 67 (April 2010): 16-21.

Oxford R. L.: Language Learning Styles and Strategies: An Overview, *GALA*, (2003): 1-23.

Pashler H., McDaniel M., Rohrer D., Bjork R.: Learning Styles: Concepts and Evidence, *Psychological Science in the Public Interest*, 9 No3 (2008): 105-119.

Redish E. F., Saul J. M., Steinberg R. N.: On the effectiveness of active-engagement microcomputer-based laboratories. *American Journal of Physics*, 65 (1997), p 45-54.

Venkatesh V., Brown S. A., Bala H.: Bridging the Qualitative–Quantitative Divide: Guidelines for Conducting Mixed Methods Research in Information Systems. *MIS Quarterly* Vol. X No. X (2012-2013): 1-XX.

Bridging Conceptual Change and Sociocultural Analysis: Toward a Model of Conceptual Distribution

Alexsandro Pereira

Universidade Federal do Pampa - Campus Uruguaiana, Brazil

Abstract

Drawing on the ideas of Lev S. Vygotsky, Mikhail M. Bakhtin, and James V. Wertsch, I outline a particular approach to conceptual change, based on the notion of “conceptual distribution.” This proposal is an attempt to reconsider the problem of conceptual change from a sociocultural perspective. According to this model of conceptual distribution, both misconceptions and scientific conceptions are taken to involve an irreducible tension between active agents and the textual resources they employ, especially textual resources in the form of explanations. In the parlance of contemporary cognitive science, conceptions are viewed as being “distributed” in two related, but analytically distinct senses: (1) socially, in small group interaction, as well as; (2) instrumentally in the sense that they involve both people and instruments of knowledge. In the case of social distribution, many researchers have examined the process of meaning making in collaborative learning activities. Instrumental distribution, the focus of what follows, involves agents, acting individually or collectively, and items such as globes, computer simulations, or explanations. This model differs from other theories of conceptual change in suggesting that conceptions in science are best understood as a form of mediated action. From this perspective, conceptual change is viewed as transformations of mediated action, which is associated with the emergency of new forms of mediation, especially scientific explanations. Implications of this model for active learning on physics are outlined.

Keywords: conceptual change, conceptions in science, sociocultural analysis, conceptual distribution, explanation as cultural tools

Introduction

Conceptual change is a major topic of discussion in specialized academic disciplines such as history and philosophy of science, developmental psychology, and science education. In the area of research on learning, educational psychologists have extended conceptual change approach beyond the natural sciences, including mathematics (Vosniadou & Verschaffel, 2004), history (e.g., Limón, 2002), and medicine and health (e.g., Kaufman, Keselman, & Patel, 2008). Over the last decades, conceptual change has become an increasing international movement supported by associations, conferences, specialized books, reviews of the literature, and special issues of scientific journals. The convergence of multiple disciplines in their effort to understand how conceptions change in content and organization has led to the emergency of an interdisciplinary sub-field on its own right. In fact, we have in today’s world a renewed industry of conceptual change.

The best known theory of conceptual change in science education research was developed by Posner, Strike, Hewson and Gertzog (1982). In their approach, there are four conditions to be met in order to someone experience conceptual change. First, there must be dissatisfaction with existing conceptions. Then a new conception must be intelligible, plausible, and fruitful. This “classical approach” to conceptual change, as it has been termed in the literature (e.g., Duit & Treagust, 2003), became the leading paradigm that

guided research on physics education for many years. In fact, learning science became a synonym for conceptual change. In the early 1990s, however, the theory of conceptual change became the focus of strong criticism (e.g., Caravita & Halldén, 1994; Pintrich, Marx, & Boyle, 1993). In short, on the basis of the classical approach the student is like a scientist and conceptual change is a cognitive/rational process of theory replacement. Attempts to solve these problems have led to what Vosniadou (2007) called the “re-framed approach” to conceptual change.

More recently, conceptual change and other related notions such as “conceptual practice” (Kränge, 2007) or “discourse change” (Wickman & Östman, 2002) became a topic of renewed interest in sociocultural studies. In educational psychology, the debate between cognitive and sociocultural perspectives has now been transferred in the area of conceptual change research (see Mason, 2007). One basic issue of this heated debate concerns the problem of reconciling cognitive and sociocultural accounts of human cognition within conceptual change research. In science education tradition, some scholars are reconsidering the problem of conceptual change from a sociocultural perspective (e.g. Furberg & Arnseth, 2009). In what follows, I formulate a “distributed version” of conceptual change by examining how conceptions in science are shaped by the textual resources employed, especially textual resources in the form of explanations.

Methodological preliminaries to the study of conception in science

One influential feature of conceptual change research is the use of analogies with the history and philosophy of science. Carey (1985) envisioned “a much more radical view of restructuring knowledge” (p. 4) in the study of theory change in the history of science. Posner et.al (1982) took contemporary philosophy of science as their “major source of hypothesis” (p. 211). Even the controversies of this field are based on assumptions about the history and philosophy of science. Duschl and Gitomer (1991) drew on the ideas of Larry Laudan to suggest a more gradual and evolutionary view of learning. diSessa (2006) used Stephen Toulmin’s arguments to criticize “coherence” in intuitive knowledge. As Caravita and Halldén (1994) have warned, “in its most uncompromising form this line of reasoning adheres to the recapitulation theory”, according to which “there is a direct parallel between concept formation in the individual learner and concept development throughout the history of science.” (p. 91).

Although most recapitulationist notions are now largely rejected in psychology when they are explicit formulated, their implicit presence is often apparent in the methods used to collect and analyze empirical data (Wertsch, 1991). This seems to be exactly the case for conceptual change research. In *Re-framing the Conceptual Change Approach in Learning and Instruction*, for example, Vosniadou (2007) wrote that “one of the purposes of the present volume is to examine the criticisms of the Kuhnian approach that emerged over the years in the philosophy and history of science, and evaluate their usefulness for theorizing conceptual change in learning and instruction.” (p. 2). As Pozo (1999) argued, there is little reason to assume that what happens in one level of analysis (evolutionary, epistemological, or instructional) should happen in another level. This notion is consistent with Vygotsky’s genetic analysis, according to which each “genetic domain” (phylogenesis, sociocultural history, ontogenesis, and microgenesis) is governed by a unique set of principles (Wertsch, 1991).

This is not to say that history and philosophy of science are not important nor that science education should focus only on the instructional level (i.e. microgenesis). It is to say, however, that recapitulationist assumptions should not be taken for granted. I believe that

developmental forces coming from all genetic domains should be taken into account in order to understand student’s conception in science. On the basis of the above-mentioned, I argue for a change in the analogy. Instead of being grounded in analogies with the history and philosophy of science, I propose an analogy between conceptions in science, on the one hand, and collective memory, on the other – especially a “distributed” account of collective remembering as outlined by James V. Wertsch (2002). I believe that an analogy with collective memory (see table 1) can bring new insights to the problem of conceptual change.

Table 1. An analogy between collective memory and conceptions in science

Wertsch’s account of collective remembering	A sociocultural model of conceptual distribution
<ul style="list-style-type: none"> ▪ It focuses on collective memory ▪ It is about historical events (the past) ▪ It is mediated by national narratives 	<ul style="list-style-type: none"> ▪ It focuses on conceptions in science ▪ It is about natural phenomena (reality) ▪ It is mediated by scientific explanations

Moreover, by being grounded in Wertsch’s (1998) sociocultural analysis, which derives from Vygotsky’s tradition, this proposal incorporates many features of genetic method, avoiding the pitfalls of the recapitulationism that have obscured conceptual change research for many years.

The model of conceptual distribution

Drawing on the ideas of Lev S. Vygotsky, Mikhail M. Bakhtin, and James Wertsch, I outline a particular approach to conceptual change, based on the notion of “conceptual distribution.” This proposal is an attempt to reconsider the problem of conceptual change from a sociocultural perspective. According to this model of conceptual distribution, both scientific conceptions and misconceptions are taken to involve an “irreducible tension” (Wertsch, 1998) between active agents and the cultural tools they employ – a basic issue of conception as mediated action. In the parlance of contemporary cognitive science (e.g. Hutchins, 1995), conceptions are viewed as being “distributed” in two related, but analytically distinct senses: (1) socially, in small group interaction, and; (2) instrumentally in the sense that they involve both people and instruments of knowledge. In the case of social distribution, for example, Mortimer and Scott (2003) have examined the process of meaning making that occurs in science classrooms when teacher and students work together to represent some aspect of physical reality.

“Instrumental distribution,” the focus of what follows, involves agents, acting individually or collectively, on the one hand, and items such as globes, computer simulations, or explanations, on the other. It is a notion that derives from the ideas of Lev Vygotsky about the “instrumental method” in psychology (Vygotsky, 1981). This line of reasoning can be found in the study of Ivarsson, Schoultz and Säljö (2002), in which they examined how children reason about the shape of the earth and gravity with the aid of a map as an “intellectual tool.” According to the authors, when using the map as a resource for reasoning, none of the children suggested that the Earth might be flat, hollow or that people could fall off the planet.

The model of conceptual distribution, by the other hand, focuses on how conceptions in science are fundamentally organized by the “textual resources” it employs, especially textual resources in the form of explanations, both spoken and written. Because the ephemeral nature of the former, they are often “transparent” to the unwary observer and are, therefore, less easily taken as objects of conscious reflection and manipulation. Debates on the nature of explanation have a long history in philosophy and an overview of this topic is quite beyond the scope of this paper. I shall focus on a more limited task of examining explanations in their capacity to serve as cultural tools for members of a group as they represent physical reality.

Grounded in the ideas of Mikhail Bakhtin (1981) about the “multivoiced” nature of human consciousness, this model of conceptual distribution emphasizes that scientific explanations always have a history of being used by others, and as a result bring their own voices to the table. In this approach, “voice” is the “speaking consciousness” (Holquist & Emerson, 1981, p. 434), or general ideological perspective of the members of a collective. According to this model, student’s performances are multivoiced rather than the product of an isolated speaker or cognitive agent and my particular interest is in how more than one voice is reflected in discursive performance. In short, conception in science is distributed between agent and texts, and the task becomes one of listening for the texts and the voices behind them as well as the voices of the particular individuals using these texts in particular settings. This leads to questions about how students can coordinate their voice with those of others that are built into the textual resources they employ.

Representing “reality:” A concrete example from quantum mechanics

In the summer of 2009, “Antonio,” a graduate student of physics education gave a lecture on quantum mechanics for an audience of pre-service physics teachers during a meeting on physics teaching in Brazil. He engaged the audience in a discussion about the Young’s experiment with electrons, and in this connection he asked how was it possible to get an interference pattern at the screen, even when the source emits only a single electron at a time. In response to that question, a participant in the audience said: “According to Paul Dirac, each electron interferes with itself.” Reacting with indignation, Antonio replied: “No, it is not the electron that interferes with itself. It is the *state* of the electron that interferes!” This assertion obviously assigns an ontological status for the concept of quantum state, but it does not make clear what happens to the electron when it goes through the slits. Apparently, this is a question one may not dare to ask.

Looking at Antonio's performance, there is something striking in the way he spoke about this phenomenon. He spoke in a straightforward, confident manner, displaying little doubt or hesitation. It was almost as if he was able to “see” the electron (or the state of the electron) with his own eyes. The idea that a competing interpretation might exist seemed not to have been an option in his mind. As far as Antonio was concerned he was simply describing how the world really *is*. The question to be asked in this case is: How can Antonio be so sure of what he is saying? After all, he was dealing with a “theoretical entity,” which by definition is postulated by theories but cannot be observed (Hacking, 1988). In other words, where did he get this account of physical reality? His conception of quantum interference seemed to be quite different from the participant’s conception.

An obvious answer to this question is that Antonio has learned about quantum interference at the university, with his professors and classmates, through the reading of textbooks and papers. Such learning invariably takes the form of “mastering” (Wertsch, 1998) explanatory text about “what [these entities] can do, what you can do to them and what

they are made of” (Ogborn, Martins, Kress, & McGillicuddy, 2006, p. 7). Thus, instead of being grounded in direct, immediate experience with the natural world, the sort of scientific conception at issue in this case is based on “textual resources” provided by others – i.e., explanations that stand in, or mediate, between the phenomena and our understanding of them. The fact the Antonio relied on textual mediation makes his discursive performance all the more striking. Paraphrasing James Wertsch (2002, p. 5), it was as if he were looking through the explanatory text he was employing and could not see it or appreciate the way it shaped what he was saying.

Despite of any impressions Antonio might have had to the contrary, he was not simply describing *what really happen* with the electron. Moreover, his account of quantum interference was neither a product of an isolated mind or individual speaker nor the result of an independent research. Actually, he was doing what most of us do most of the time when we produce an account of the natural world – especially in those cases involving unobservable entities. Namely, he was employing an item from an “explanatory store” (Kitcher, 1989) which is an essential part of the “cultural tool kit” (Wertsch, 1991) that exists in his sociocultural setting. Thus, the more appropriate answer to the Bakhtinian question, “who is doing the speaking,” in this case is: at least two voices – the speaker and the explanatory text he is employing.

Implications for research in physics education

This model of conceptual distribution implies a redefinition of learning science. From this perspective, learning science is a matter of mastering “scientific explanations” provided by scientists. In this approach, mastering is the same as knowing how to use a relevant cultural tool with facility. This formulation has implications for physics education. First, by being grounded in this “tool metaphor”, it turns out that the mastery of a new explanation does not imply the disappearance of old, daily forms of talk. It means that it is possible for a person to coordinate different points of view and understand when different conceptions are appropriate depending on the context of use (Pozo, Gómez, & Sanz, 1999; Spada, 1994). The task becomes one of enhancing students’ ability to recognize a context and, in terms of this recognition, evoke an appropriate conception (Linder, 1993). A challenge to physics educators is make the students to become aware of the explanatory tools they employ, and to understand why some forms of explanation, as opposed to others, are “privileged” in particular contexts (Wertsch, 1991).

Second, the explanations students provide are not the product of an isolated mind. The general idea is that the “explanatory tools” they employ shape the way they can think and speak about physical reality. Obviously, this tools do not make them think or speak – they are tools; they need to be used by an active agent. This observation highlights that fact that an active agent must be involved, a claim that avoids a kind of instrumental reductionism. The levels of skill of the agents in the use of certain cultural tools only increase with experience. Thus, instead of providing scientific explanations to the students and let them to master these explanations spontaneously, it would be more appropriate to provide them the opportunity to use science concepts and explanations in collaborative learning activities (e.g., debates, problems-solving situations, practical activities). Thus, science classroom should be viewed more as a work office rather than an auditory. From this perspective, conceptual change is viewed as “transformations of mediated action” (Wertsch, 1998), which is associated with the emergence of new forms of explanation.

References

- Bakhtin M. M.: (1981). *The dialogic imagination: Four essays by M. M. Bakhtin*. Austin: University of Texas Press.
- Caravita S., Halldén O.: (1994). Re-framing the problem of conceptual change. *Learning and Instruction*, 4(1), 89-112.
- Carey S.: (1985). *Conceptual change in childhood*. Cambridge: MIT Press.
- diSessa A. A.: (2006). A history of conceptual change research: Threads and fault lines. In: R. K. Sawyer (Ed.), *The Cambridge handbook of the learning sciences* (pp. 265-281). New York: Cambridge University Press.
- Duit R., Treagust D. F.: (2003). Conceptual change: A powerful framework for improving science teaching and learning. *International Journal of Science Education*, 25(6), 671-688.
- Duschl R. A., Gitomer D. H.: (1991). Epistemological perspectives on conceptual change: implications for educational practice. *Journal of Research in Science Teaching*, 28(9), 839-858.
- Furberg A., Arnseth H. C.: (2009). Reconsidering conceptual change from a socio-cultural perspective: analyzing students' meaning making in genetics in collaborative learning activities. *Cultural Studies of Science Education*, 4, 157-191.
- Hacking I.: (1988). *Representing and Intervening: Introductory topics in the philosophy of natural science*. New York: Cambridge University Press.
- Holquist M., Emerson C.: (1981). Glossary. In M. M. Bakhtin, *The dialogic imagination: Four essays by M.M. Bakhtin* (pp. 423-434). Austin: University of Texas Press.
- Hutchins E.: (1995). How a Cockpit Remembers Its Speeds. *Cognitive Science*, 19, 265-288.
- Ivarsson J., Schoultz J., Säljö R.: (2002). Map reading versus mind reading: Revisiting children's understanding of the shape of the earth. In: M. Limon, & L. Mason (Eds.), *Reconsidering conceptual change: Issues in theory and practice* (pp. 77-99). Dordrecht: Kluwer Academic Publishers.
- Kaufman D. R., Keselman A., Patel V. L.: (2008). Changing conceptions in medicine and health. In S. Vosniadou (Ed.), *International handbook of research on conceptual change* (pp. 295-327). New York: Routledge.
- Kitcher P.: (1989). Explanatory unification and the causal structure of the world. In P. Kitcher, & W. C. Salmon (Eds.), *Minnesota studies in the philosophy of science: Vol. XIII. Scientific explanation* (pp. 410-499). Minneapolis: University of Minnesota Press.
- Krange I.: (2007). Students' conceptual practices in science education: Productive disciplinary interactions in a participation trajectory. *Cultural Studies of Science Education*, 2, 171-203.
- Limón M.: (2002). Conceptual Change in History. In M. Limón, & L. Mason (Eds.), *Reconsidering conceptual change: Issues in theory and practice* (pp. 259-289). Dordrecht: Kluwer Academic Publishers.
- Linder C. J.: (1993). A challenge to conceptual change. *Science Education*, 77(3), 293-300.
- Mason L.: (2007). Introduction: Bridging the cognitive and sociocultural approaches in research on conceptual change: Is it feasible? *Educational Psychologist*, 42(1), 1-7.

- Mortimer E. F., Scott P. H.: (2003). *Meaning making in secondary science classroom*. Philadelphia: Open University Press.
- Ogborn J., Kress G., Martins I., McGillicuddy K.: (2006). *Explaining science in the classroom*. Buckingham: Open University Press.
- Pintrich P. R., Marx R. W., Boyle R. A.: (1993). Beyond cold conceptual change: The role of motivational beliefs and classroom contextual factors in the process of conceptual change. *Review of Educational Research*, 63(1), 167-199.
- Posner G. J., Strike K. A., Hewson P. W., Gertzog W. A.: (1982). Accommodation of a scientific conception: Toward a theory of conceptual change. *Science Education*, 66(2), 211-227.
- Pozo G. J.: (1999). Más allá del cambio conceptual: El aprendizaje de la ciencia como cambio representacional. *Enseñanza de las Ciencias*, 17(3), 513-520.
- Pozo G. J., Gómez M., Sanz A.: (1999). When change does not mean replacement: Different representations for different contexts. In W. Schnotz, S. Vosniadou, & M. Carretero (Eds.), *New perspectives on conceptual change* (pp. 161–174). Amsterdam: Pergamon.
- Sinatra G. M., Pintrich P. R.: (2003). *Intentional conceptual change*. New Jersey: Lawrence Erlbaum Associates.
- Spada H.: (1994). Conceptual change or multiple representations? *Learning and Instruction*, 4, 113–116.
- Vosniadou S.: (2007). The conceptual change approach and its re-framing. In S. Vosniadou, A. Baltas, & X. Vamvakoussi (Eds.), *Re-framing the conceptual change approach in learning and instruction* (pp. 1-15). Oxford: Elsevier.
- Vosniadou S., Verschaffel L.: (2004). Editorial: Extending the conceptual change approach to mathematics learning and teaching. *Learning and Instruction*, 14(5), 445-451.
- Vygotsky L. S.: (1981). The instrumental method in psychology. In J. V. Wertsch (Ed.), *The concept of activity in Soviet psychology* (pp. 134-143). Armonk: Sharpe.
- Wertsch J. V.: (1991). *Voices of the mind: A sociocultural approach to mediated action*. Cambridge: Harvard University Press.
- Wertsch J. V.: (1998). *Mind as action*. New York: Oxford University Press.
- Wertsch J. V.: (2002). *Voices of collective remembering*. New York: Cambridge University Press.
- Wickman P.-O., Östman L.: (2002). Learning as discourse change: A sociocultural mechanism. *Science Education*, 86(5), 601-623.

The Use of Mathematical Elements in Physics – View of Grade 8 Pupils

Gesche Pospiech, Erik Oese

TU Dresden, Germany

Abstract

Mathematics is inseparably connected to physics. Therefore an insight into their interplay, especially the structural role of mathematics for physics is central to an understanding of the nature of physics. Mathematics in physics does not only imply the use of formula but also the use of geometrical objects and graphical tools which all play an important role for the description, structuring and explanation of physical processes. The role of formula in physics lessons in school is much debated and considered as complicated. But the attitudes of students in lower secondary school with respect to this interplay are not known. Because the motivation and interest is an important factor for learning a study was conducted in order to reveal the attitude and knowledge of students. It covered the role of formula, diagrams and verbal explanations and their interplay for physics and physics understanding. The instruments were a questionnaire, a short knowledge test and interviews with some of the students. The results of the study as a whole show that the students have a differentiated view on the role and the use of mathematics in physics lessons. In order to find ways to address successfully the difficulties further research on the learning processes and students concepts in the use of mathematical concepts in physics is needed.

Keywords: mathematics, physics education, students' attitudes

Introduction

Understanding physics and learning physical thinking lies in the heart of physics education. This comprises the physical content as well as the methodology of physics. Physics as an empirical science fundamentally relies on experiments, but as well mathematics is inseparably connected to physics. Many physical concepts are strongly interrelated with mathematical structures, as e.g. the concept of velocity or acceleration, (see e.g. Karam & Pietrocola 2010). However, often this structural role of mathematics is obscured in the view of students by rote technical calculations. Therefore formulas are considered by many students as the most significant mathematical element in physics. But also other mathematical elements and representations such as diagrams or geometrical objects are important for the mathematization process. To be able to appreciate the structural role of mathematics and get an insight into the nature of physics as an empirical science which describes its objects with mathematical structures students need an early introduction into these aspects. In this part of physics education only very little is known about the thinking and the knowledge of students which forms the basis for their learning. The presented study intends to contribute to closing this gap.

Theoretical Background

The role of mathematics in physics can be divided into a technical and a structural role (Pietrocola, 2008). The structural role describes how mathematics provide structures (elements, operators, etc.) for recognizing analogies and deep relations in and across physics areas. Whereas in general mainly the technical role, comprising calculating and

computing a result by following a fixed mathematical algorithm, is addressed in physics lessons the structural role is often neglected and rarely exploited by students. On the contrary they tend to use only rudimentary technical problem solving strategies, e.g. the “plug 'n chug”-technique (Tuminaro, 2007).

Using mathematics is done by different representations. It does not only mean the use of formulas but also the use of geometrical objects and graphical tools. All mathematization starts with the use of numbers together with units, (Pospiech, 2006). This basic aspect even starts in primary school where the students use different quantities and compute them. In the next step graphical representations in tables and diagrams are used to structure numerical values of physical quantities and make functional dependencies visible. Also here the mathematics lessons prepare the necessary techniques already from an early age. The decisive step comes when formulas are being introduced. Here different types of formulas can be distinguished: (a) definition of physical quantities (e.g. definition of pressure), (b) description of dependencies (e.g. law of hydrostatic pressure), or (c) development of time dependent quantities. Herewith the difference between the mathematical point of view, e.g. in the definition of “function”, and the use of simple functions such as (direct) proportionalities in physics gets more and more important.

The use of formulas in physics lessons in school is much debated and considered as complicated. Only some studies exist on certain aspects of formulas as seen by students: They concern e.g. preferences with respect to writing of formulas (Strahl et.al 2010), the role of formulas for physics and physicists (Krey 2010, 2012) or their use by teachers (Strahl 2012). Often it is said that formulas would be too difficult or even prevent understanding. A detailed analysis of strategies in problem solving shows very specific problems in the interplay of physics and mathematics for students aged 15 to 16, (Uhdén 2012) which are partly caused by difficulties in the technical aspects of mathematics, but also to a great deal in misunderstandings about the writing and understanding of functions: especially the distinction between dependent and independent variables or constant parameters seems to be difficult. These difficulties belong to the structural role of mathematics in physics.

However, it is not known which attitudes on the role of mathematics in physics the students have right from the beginning of learning physics in secondary school and which interests they show concerning problems with mathematical content. This might be important for developing appropriate teaching learning sequences.

The bridge from the very first beginnings up to the use of mathematical elements in high school from the students' perspective is unknown to a great extent: which difficulties do the students encounter? Which views do they develop on the use of mathematics in physics?

Research Questions

In order to throw a light onto the thinking and the abilities of students with respect to the mathematics-physics interplay an exploratory study was conducted. The focus was on the beginners' lessons where the decisive steps for the development of the students' attitudes are laid:

- What are the attitudes of students with respect to the use of formulas and diagrams as well as to verbal explanations in their physics lessons?
- Are there topics especially suitable for rising the interest of students, also with respect to the use of mathematics?

Design and Methodology of study

The study covered the use of formulas, diagrams and verbal explanations and their interrelations. In the study 192 students in grade 8 (mostly age 14) from 6 schools took part (104 female and 88 male students).

Grade 8 was chosen because in nearly every learning area of physics (hydrostatics, thermal physics and electricity) extensive use of diagrams, formulas and equations is prescribed by the saxonian curriculum. Teachers are obliged to follow the curriculum and treat all these mathematical elements. So in the end of the school year students already have quite extensive experiences with different mathematical elements and have some knowledge on mathematics in physics.

Instruments

In order to address different aspects suitable instruments were chosen. They comprised a questionnaire on the attitudes of the students concerning the use of formulas and diagrams, a short knowledge test on the interpretation of well-known formula (definition of pressure, law of hydrostatic pressure) and interviews with some ($n = 20$) of the students. Questionnaire and knowledge test had been piloted before hand and were in consequence improved.

The questionnaire referred to the students' experience in physics lessons. It addressed the view on the structural role of formulas, on the technical role of mathematics, especially the use of formulas and calculating, the role of diagrams and the general attitude towards physics lessons as well as their interest in quantitative problems. It furthermore asked for the appreciation of verbal explanations compared to use of formulas. It contained 47 items of which 5 items had to be excluded because of reliability issues. The items were answered on a 6 graded Likert scale. In a supplement the students rated problems as interesting, easy or difficult or useful. Furthermore students were asked to indicate their general interest in problems from quite different everyday situations and their wish to know the numerical solution.

The test contained tasks addressing the interrelationship between algebraic, graphical and verbal representations and the handling of formulas and diagrams.

The focus of the interviews was on the individual description of perceived problems in mathematization in physics lessons. Furthermore the students explained diagrams or formulas.

Results

Here we present results on the questionnaire and preliminary results of the interviews.

Questionnaire

The items of the questionnaire can be ordered into 4 factors with good internal reliability shown in Table 1. The first factor addresses the significance and appreciation of formulas (e.g. the item "Formula are helpful"), their role for understanding physics and the valuation compared to verbal explanations. The second factor describes the formal handling of formulas: the self-concept towards transposing formula and being able to calculate with units. The third factor reflects the opinion about diagrams, their meaning, their help for understanding physical relations, and the own ability of handling diagrams. The fourth

factor measures the general liking of physics lessons and of solving physics problems. It is interesting to note, that the mean over all students in the three factors concerning the use of mathematical elements is higher (meaning a more positive attitude) than towards the physics lessons in general. But it is seen that all the mean values are far from the highest value 6.

Table 1. The number of items per factor and the corresponding Cronbach is given. The values of the Likert-scale range between 1 and 6. The higher the value the more positive is the attitude of the students.

	Number of items	Cronbach a	mean	Standard deviation
Factor 1: Formulae	13	0,93	3,74	0,98
Factor 2: Calculating	14	0,88	4,00	0,82
Factor 3: Diagrams	10	0,90	3,87	0,88
Factor 4: Physics lessons	7	0,84	2,91	1,10

General view on the use of mathematical elements

In order to analyse possible patterns in the attitude of students, four groups of students could be identified significantly differing with respect to their views (see Figure 1): there is a “liking”-group with a positive attitude towards physics lessons and a “disliking”-group with a strongly negative attitude, significantly differing in the factor 4: Physics lessons.

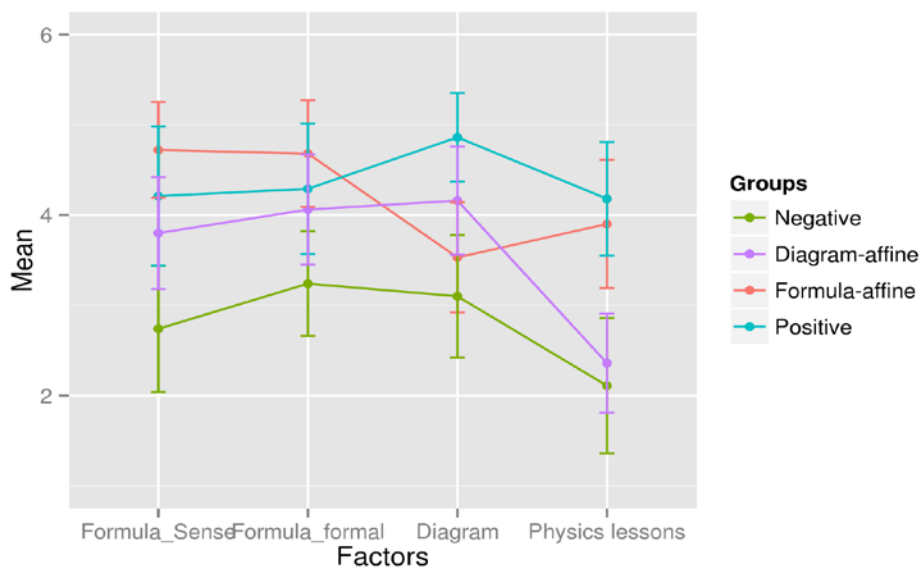

Figure 1. The curves show the mean values of each student group for the four identified factors. The “liking group” is divided in a positive and a formula-affine group, whereas the “disliking group” is separated into a diagram-affine and an overall negative group. All these groups are significantly different.

In the “liking”-group there can be identified one subgroup preferring diagrams (positive, 35 students), and a second subgroup preferring formulas and seemingly not estimating diagrams (formula affine, 40 students). In the “disliking”-group a strongly averse subgroup can be identified (negative, 54 students) and a surprisingly big subgroup liking diagrams at least a bit more than formulas (diagram-affin, 63 students).

The grouping proposed here is to be read only as an indication of how the attitudes of students can be systematized in some way. They can not be seen as clearly separated clusters for all four factors taken together because the views of the groups on each of the factors varies. However, it is interesting to note that students who do not like physics lessons in general may nevertheless like working with diagrams and appreciate them as helpful for visualization and understanding (diagram-affine group). At the same time this is the biggest group of students, about one third of the sample. Also there are students with insight into the usefulness of formulas and high self esteem in handling them, who do not have a similar positive attitude towards diagrams (formula-affine group). A clearly separated group is only the “negative group” with the lowest agreement in all four factors, about 21% of the students. Overall, the appreciation of formulas seems higher than the liking of the physics lessons in general. This finds some explanation in the interviews (see below). The over all gender difference is highly significant, however, the diagram-affine group divides nearly equally between girls and boys, whereas the other groups show a clear gender dichotomy, (see Figure 2).

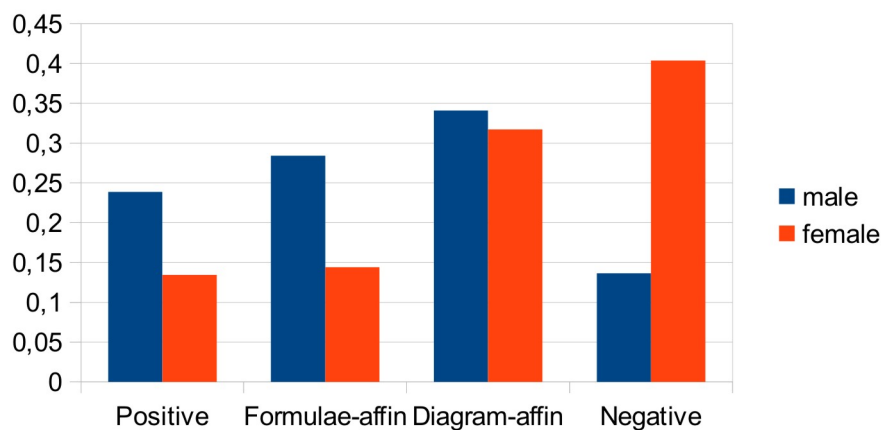

Figure 2. The distribution of students between the groups depends significantly on the gender. 24% of the male, but only 14% of the female students belong to the positive group. However, the proportion of gender in the diagram-group is quite equal.

Also in the knowledge test it can be observed that the groups differ significantly (Chi-Square test, $p = 0.03$) with respect to remembering formula or diagrams or knowledge of units in complex formula. This corresponds to the observation that also the marks the students get in their physics lessons are significantly different between the groups (Chi-Square test, $p = 0.004$).

Interest in problems

For designing attractive problems for students it is important to know, which topics in physical problems would interest them most. The students (N=144) were asked whether they would be interested in heating the house, in knowing the amount of gas for driving

a hot air balloon, pressure needed for pumping the blood into the brain, how big the resistance of a bulb is and whether they would be interested in calculating the result. It is seen from figure 3, in accordance with well known results on interest in physics, that the interest in the biological context is far bigger than in all the other topics.

The interest in the topic itself does not significantly depend on the group, with the single exception of the “bulb resistance” (see Figure 3a), where the positive and the formulae affine groups show significantly higher interest ($p = 0.01$). However, the interest in calculating depends in all four topics highly significant on the group of students (see Figure 3b). It is highest with the problem “heart pressure”. But also – perhaps in view of the discussion on energy consumption and prices – the “house heating” problem rises interest, also in the numerical results.

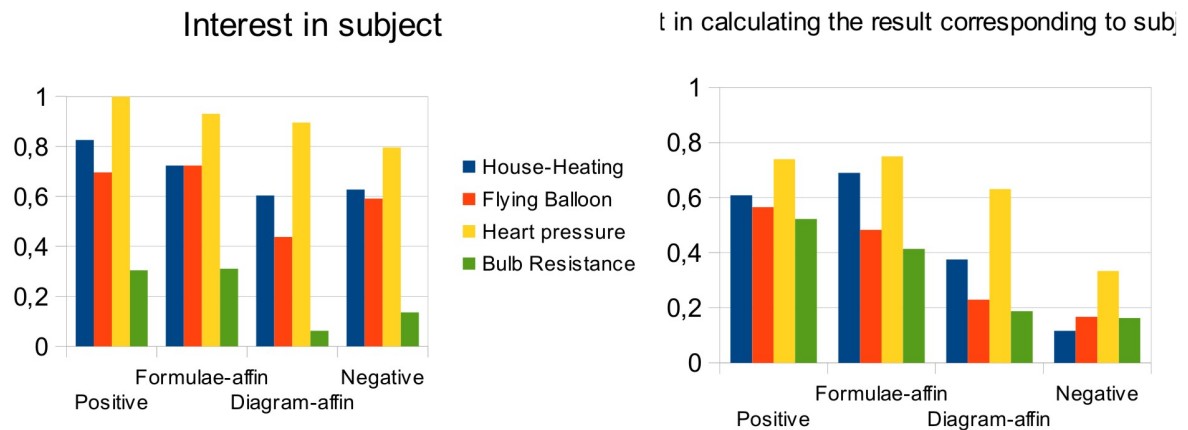

Figure 3. In the diagrams the percentage of students of each group is shown who agree that they are interested in the topic respectively in calculating the result. They answered for each topic separately.

Interviews

The first results from the evaluation of the interviews show a broad range of attitudes.

Students showed several aspects of understanding physics and a differentiated view towards formula in physics with negative as well as positive aspects. Some students uttered that they view formula as help for solving problems and even showed first insight into the structural function of mathematics in the sense that predictions are possible that can not be done by experiments. As an advantage it is seen that a calculation gives unique and concrete results or by inserting numbers an impression about the meaning of formulae is gained. Further advantages of formulae are given by the aspect of communication, because they are shorter and clearer than verbal explanations, they are precisely defined and can easier be remembered than complex definitions. Therefore they can be a help in explanations.

Problems with formulae are seen in the use of the same letters in different meanings, calculating with units or with fractions is difficult. However, the one or other student also expressed to like the handling of formula, e.g. transposing them.

Concerning diagrams the reading and interpretation of given diagrams is considered easy, whereas doing own diagrams are difficult, mostly because of technical reasons: defining

the axes and finding the optimal scale. A clear advantage is their power of visualisation and therefor the help in remembering.

Conclusions

The results of the study as a whole show that the students already in lower secondary school have a differentiated view on the role and the use of mathematics in physics lessons. The overall attitude of the students towards formulas proves to be more positive than often stated. It could be hypothesized that the concrete and purely technical handling of formulas could even be an important intermediate stage towards a development of a deeper understanding. Especially noteworthy is the observation that some students prefer formulas before verbal explanations and that most students appreciate the usefulness of diagrams. It is promising that also students with less overall interest in physics lessons and girls are in this so called “diagram-affine” group. This can be taken as an indication that an appropriate use of diagrams might build a bridge towards more abstract steps of mathematization for students and enhance the view on physics as a whole. Research on this question will be a task for the future. In addition, an appropriate choice of topics might increase the motivation for use of formulas and equations. In this way a natural interest in mathematization might arise.

In order to find ways to address successfully the difficulties further research on the learning processes and students concepts in the use of mathematical concepts in physics is needed.

References

- [1] Karam R., Pietrocola M. (2010): Recognizing the Structural Role of Mathematics in Physical Thought. In: M. F. Tasar & G. Çakmakci (Eds.). Contemporary science education research: International perspectives, S. 65-76. Ankara: Pegem Akademi.
- [2] Krey O. (2012): Die Rolle der Mathematik in der Physik. Berlin:Logos Verlag.
- [3] Krey O., Mikelskis H. F. (2010): The role of mathematics in physics - the students' point of view. In: M. F. Tasar & G. Çakmakci (Eds.). Contemporary science education research: International perspectives, Bd. 4:67-72. Pegem Akademi.
- [4] Pietrocola M. (2008): Mathematics as structural language of physical thought. In: Vicentini, M. & Sassi, E. (Hrsg.), Connecting Research in Physics Education with Teacher Education, Bd. 2. ICPE.
- [5] Pospiech G. (2006): Modellierung und mathematische Kompetenz im Physikunterricht. Frühjahrstagung des Fachverbandes Didaktik der Physik in der DPG, Kassel 2006, auf CD.
- [7] Strahl A., Mohr M., Schleusner U., Müller R. (2010): Wie Schüler Formeln gliedern – eine explorative Befragung. Physik und Didaktik in Schule und Hochschule, 9, 1.
- [8] Strahl A., Thoms L.-J. (2012): Formelnutzung im Physikunterricht – eine Lehrerbefragung. PhyDid B - Didaktik der Physik - Beiträge zur DPG-Frühjahrstagung 2012.
- [9] Tuminaro J., Redish E. F. (2007): Elements of a cognitive model of physics problem solving: epistemic games. Physics Education Research, 3(2).
- [10] Uhden O., Karam R., Pietrocola M., Pospiech G. (2012): Modelling mathematical reasoning in physics education. Science & Educa.

Students' understanding of angular speed

Graham Rankin

Kwantlen Polytechnic University, Canada

Abstract

First and second year university students having had prior instruction in the concept of angular speed were interviewed about this concept in a variety of task settings. The tasks involved the motion of one or more objects moving in a given path as viewed from differing observer positions. Based on interviews during these tasks students were found to hold a variety of conceptualizations and ways of reasoning about angular speed. How these conceptualizations and ways of reasoning arise are described in terms of associations made by students to the words and images experienced during the interviews.

Keywords: angular speed, angular velocity, conceptions, understanding, physics

Introduction

A significant amount of work to date has been done in the field of physics education by researchers primarily interested in students' conceptualizations of physical concepts. These investigations have ranged over such diverse areas as; heat, gravity, statics, electrical circuits, mechanics, sound, vectors, light and quantum mechanics (McDermott & Shaffer, 1992; Lewis, 1994; Langley et al. 1997; Besson, 2004; Apostolides & Valanides, 2008; Yu et al. 2010). Studies as these have provided evidence that many students before, during and after instruction hold physical conceptions at variance with accepted scientific views. This study extends these investigations to students' understanding of the magnitude of angular velocity, the angular speed.

Concepts and context

Concepts rarely stand in isolation (Urhahne, et al. 2011) they are part of a complex web composed of other concepts and ideas embedded in and learned in a social cultural context. And for novice physics students who are still trying to understand new physical concepts some may not exhibit a stable coherent view of seeing the physical world around them. Concepts are not well integrated into a complex web or a network structure of concepts (Kopen T. & Pehkonen, M 2010). For reasons like this, rather than talk about a singular well defined physical concept held by a student, the term conceptualization is used to describe one of several possible ways in which a student may understand or view the physical world.

The Study

Fifteen volunteers, comprising first and second year university students, all of whom had prior instruction about the concept of angular speed were interviewed for this study. There was no attempt to randomize the selection of volunteers and consequently it is not appropriate to do a quantitative analysis on such a sample nor would it be appropriate to generalize to a broader population of students till further studies are done.

The interviews conducted in this study, which are part of a larger study, were designed around several tasks, three of which form the basis of the findings reported herein. Each of

these three tasks required a student to answer questions from different observational positions about the angular speed of an object moving at a constant speed along a given path.

These tasks to be described are, the "oval path" task in which a toy train traveled around an oval track, the "elliptical path" task in which a diagram depicted the motion of an object moving in an ellipse, and the "irregular path" task in which a diagram depicted the motion of an object moving in an irregularly shaped path, as illustrated in the following group of figures.

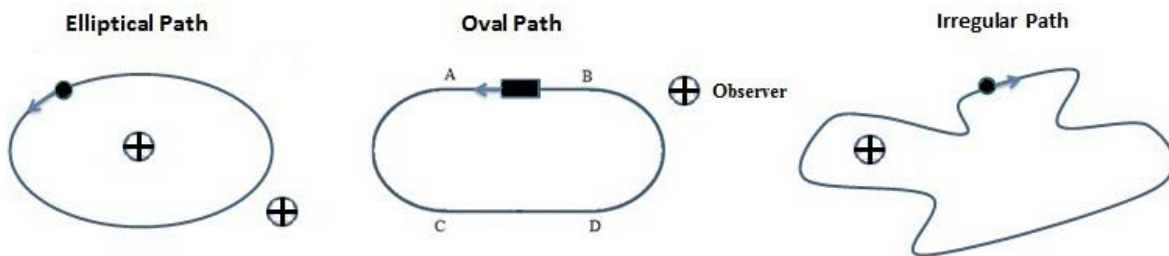

Methodological framework

Categories of description were generated to describe the ways in which students conceptualized the concept of angular speed. The use of categories of description are taken from Marton & Booth's (1997) approach to analyzing qualitative data which was based on Marton's early work on phenomenography.

Categories of description emerge from repeated analysis and reflections of interpretations made from the interview transcripts. Not unlike the hermeneutic cycle, whereby interpretation of a text in the beginning is tentative and then by a series of successive reflections, insights and understandings emerge. The process of forming categories of description however, is never complete, "we can never claim that there are no other ways of seeing a phenomenon than the ones we know of" (Marton, 2006. p 37). And while categories of description serve to characterize the *content* of what students said during the interviews, *categories of reasoning* were constructed to characterize the reasoning processes students were hypothesized to have engaged in during a task.

These categories are reported in two parts. **Part I** describes students' conceptualizations of angular speed and **Part II** describes students' reasoning in responding to questions about angular speed.

PART I

Student's conceptualization of angular speed

Questions asked during the tasks about the angular speed of an object revealed that the position of the observer and the shape of the object's path influenced the way in which students responded to the task questions. The responses were thus classified in terms of the observer *position* and the shape of the object's *path*. While some student responses cohere with a physicist's viewpoint, those that didn't are reported here and are summarized under the headings of position and path, along with quotes which illustrate these aspects.

Position:

1. The angular speed of an object is *independent* of the observer position.
2. The angular speed of an object is measured from a *preferred* observer position.

3. The angular speed of an object does not exist or is zero if the position of the observer is not *enclosed* by the path of the object.

Path:

1. An object moving in a *rectilinear* path does not have an angular speed, irrespective of the observer position.
2. An object moving in an *irregular* path doesn't have an angular speed or it doesn't make sense to talk about the angular speed of such an object, irrespective of the observer position.
3. An object moving in an *irregular* path has an angular speed but you need the centre of the path or the radius of curvature in order to compute the angular speed.

Beyond a description of whether or not an object had an angular speed or whether it made sense to talk about an object having an angular speed it was thought important to try to understand students' reasoning in context about angular speed.

PART II

Students' reasoning about angular speed

Further analysis of student responses during the interviews resulted in the construction of *categories of reasoning* which were characterized as forms of association in the student's memory during the task activity to either the word *angular* or *speed*, to an *equation* for angular speed, or to some aspect of the *context* of the task setting. These forms of associations, each to be described with a few quoted examples, are respectively referred to as: **word**, **symbolic**, and **contextual** associations. It should be noted that during any one interview a student may exhibit several different forms of reasoning in a particular task setting.

Word association

Word association is best illustrated with an example in which a student during an interview when asked to think about the angular speed of an object was reminded of an angular momentum problem in her physics textbook. From the following dialogue it was inferred that the student's interpretation of the word *angular* was guided by a diagram in the textbook.

I know that anything can have angular momentum depending on the reference point, somebody explained (it) to me. I was having some trouble understanding the idea of angular momentum, cause a little diagram in the (text) book, there was an object - I couldn't understand how something that just happened to be moving along had an angular velocity when it wasn't actually rotating or going round in a circle.

This explanation by the student was characterized as being an association of the word *angular* to mean something rotating or going round in a circle.

Another example of word association is taken from the oval path task: [I: Interviewer, D: student]

I: Does the train from your position from where you're looking have an angular speed between points A and B? [student is sitting in line with the straight section of track AB]

D: No.

I: And why?

D: It's not rotating through an angle, it is moving straight.

But, when the student is asked if the train had an angular speed between another section of track which is also straight and is not in direct line of sight with the student as observer, the response does not change,

D: Same as AB moving straight.

Another form of association, *symbolic* association, also played a role in student reasoning.

Symbolic association

Some students, it is thought, upon hearing the words angular speed were cued by the word *speed* to recall the symbol v or ω which in turn acted to cue various formulas having these symbols, hence the description *symbolic* association. The following excerpt of a student dialogue during the elliptical path task illustrates this form of association.

[I: Interviewer, J: student]

J: I was thinking in terms of the formula.

I: The formula being?

J: Velocity equals r times ω . So, ω would be v over r , so if - so if the radius was greater the angular speed would actually be less.

[P: for another student]

I: Is the angular speed (of the ball) a constant (along the elliptical path)?

P: Eh, no it's not.

I: Why?

P: I'll just start getting the, eh - formula here. Its angular speed will say omega because that is a convention, s equal to, proportional to v , or is equal to v over its radius.

In addition to symbolic and word associations, *contextual* association was another construct developed to describe the reasoning used by students during an interview.

Contextual association

In this form of association some feature of the *context* of the task setting serves to evoke an association in the student's mind with some prior experience. To illustrate this, several examples are given in which a physics lecture or a section of a physics textbook is recollected by the student while reasoning about questions posed during the task setting.

A student is asked about how one would measure the angular speed of an object moving at a constant speed in an elliptical path at some point. A diagram of the object's path, with various points along the path being labeled for reference was shown to the student.

[I: Interviewer, K: a student]

I: *If you have to measure the angular speed at point C.*

K: *Need location of foci*

I: *One here and here (pointing to foci of ellipse).*

K: *The instantaneous angular speed?*

I: *Yes. What are some of your thoughts?*

K: *I am trying to think of it in terms of a circle as in sweeping out an area, but the strange thing is the radius varies.*

The student at first forms an *association* with planetary motion then to a circular motion.

Next, another student in the same task setting responds as follows:

[I: Interviewer, M: student]

M: *You made those restrictions (referring to the constant speed of the object moving in an elliptical path) it shoots out what I know about-eh-space, elliptical orbits, speeds and everything. Now you are saying the speed is a constant.*

I: *Because you were thinking of planetary motion?* [an assumption by interviewer]

M: *Right*

Here an *association* of planetary motion is thought to have been made with the motion of an object moving in an elliptical orbit. And, yet another student (P) in this task responds by making an association with simple harmonic motion.

P: *If I know that, if I know it's an ellipse and I know its going to hit its lowest velocity at the two semi - major axes. And, when it does it will appear to kind of slow down and speed up and slow down again. It's like simple harmonic motion again.*

In each of these examples a student makes reference (appropriate or not) to what they perceive as a similar or analogous situation to planetary motion, circular motion or simple harmonic motion. This form of association which is characterized as *contextual association* was also observed in other tasks. In addition, the use of contextual associations to describe a person's reasoning process is consistent with the claim that how a person acts and responds in a situation is inherently contextualized as posit by Brown, Collins and Duguid (1989).

Discussion

Having developed constructs to describe the ways in which students conceptualize and reasoning about the concept of angular speed it is not easy as a consequence to design instructional strategies to address student conceptual difficulties with angular speed. As noted by Reif (2008) in his study of student's interpretation of acceleration:

After using a concept for some time, people may remember commonly occurring special cases of this concept. Indeed, remembering such accumulated (or compiled) special-case

knowledge is efficient. But reliance on such compiled knowledge can also be dangerous because one needs then to remember (and subsequently also to recall) the validity conditions under which such compiled special-case knowledge is actually correct (p. 73-74).

And, Brown (1992) further notes that using examples or analogies designed to help students may fail because the situation is not viewed by the student as analogous or the example does not draw upon valid physical intuitions of the students. However, in this study some students do draw upon analogous situations but have not grasped the underlying concept sufficiently well, especially as it relates to the procedural knowledge needed to utilize the concept correctly in a variety of contexts. In this regard, the role or influence of the physics textbook should not be overlooked.

Erlichson (1994) who reviewed a number of physics textbooks treatment of the relationship between angular momentum and angular velocity concluded that physics textbooks may confuse some students. While other researchers of more elementary science textbooks, as Gibson (1996), have outright claimed to have found falsehoods or "misconceptions" presented in these texts.

At the university level, a physics textbook in addition to presentation of formulas involving angular speed will usually illustrate or use this concept with examples of rotating wheels about a central axis, orbits of planets, and simple harmonic motion as a projection of uniform circular motion. Consequently, it is conjectured that student's conceptualizations of what angular speed is and how to measure it is influenced by these images and formulas in the textbook in a way which may contribute to a students' misunderstanding of this concept.

However, more research is needed to clarify further, and build upon, the findings of this study before designing any instructional strategies. Unfortunately, it may be the case as Henderson et al (2007) claim that such future findings when proven as instructional strategies will only be marginally integrated into instruction.

References

- Apostolides T., Valanides N.: Secondary School Students' Conceptions Relating to Motion under Gravity. *Science Education International*, 2008, 19(4), 405-414.
- Besson U.: Students' Conceptions of Fluids. Research Report. *International Journal of Science Education*. 2004, 26(14), 1683-1714.
- Brown D.: Using examples and analogies to remediate misconceptions in physics factors influencing conceptual change. *J. Res. Sci. Teaching*, 1992, 29(1), 18-34.
- Brown J., Collins A., Duguid P.: Situated Cognition and the Culture of Learning. *Educational Researcher*. 1989 Jan-Feb, 32-42.
- Erlichson H.: Angular Momentum and Angular Velocity. *The Physics Teacher*, 1994, 32 (May), 274-275.
- Gibson D.: Textbook Misconceptions: The Climax Concept of Succession. *American Biology Teacher*, 1996, 58(3), 135-140.
- Henderson C., Dancy M.: Barriers to the Use of Research-Based Instructional Strategies: The Influence of Both Individual and Situational Characteristics. *Physical Review Special Topics - Physics Education Research*, 2007, 3(2), 02012, 1-14.
- Koponen I., Pehkonen M.: Coherent Knowledge Structures of Physics Represented as Concept Network in Teacher Education. *Science & Education*, 2010, 19(3), 259-282.

Langley D., Ronen M., Eylon B.: Light Propagation and Visual Patterns: Pre-instruction Learners' Conceptions. *Journal of Research in Science Teaching*, 1997, 34(4), 399-424.

Marton F., Booth S.: *Learning and Awareness*, Routledge, 1997.

Lewis E.: Heat Energy and Temperature Concepts of Adolescents, Adults, and Experts. Implications for Curricular Improvements. *Journal of Research in Science Teaching*, 1994, 31(6), 657-77.

Marton F.: Sameness and Difference in Transfer, *J. of the Learning Sciences*, 2006, 15(4), 499-535.

McDermott L., Shaffer P.: Research as a Guide for Curriculum Development: An Example from Introductory Electricity. Part I: Investigation of student understanding. *American Journal of Physics* 60(11), 1992, 994-1003.

Reif F.: *Applying Cognitive Science to Education, Thinking and Learning in Scientific and Other Complex Domains*. MIT Press, 2008.

Urhahne D., Kremer K., Mayer J.: *Conceptions of the Nature of Science-Are they General or Context Specific*, *International Journal of Science and Mathematics Education*, 2011, 9(3), 707-730.

Yu K.C., Sahmi K., Denn G.: Studen Ideas about Kepler's Laws and Planetary Orbital Motions. *Astronomy Education Review*, 2010, 9(1), 010108, 1-17.

Evidence for the applicability of Dual Processing theory in physics problem solving

David Sands

Department of Mathematics and Physics, University of Hull, Hull, UK

Abstract

Dual processing theory is a generic name given to a number of different models in cognitive psychology in which it is posited that there are two systems of thought: one fast and intuitive, the other slow and deliberate. In any kind of problem solving, but especially in physics, we want students to think rationally about the problem and engage the second system, but this means that the intuitive system has to be overridden. Whereas there is plenty of evidence in psychology for this kind of thinking, the evidence in the sciences is less obvious. This is probably because intuitive answers are not recognized for what they are, being interpreted instead as misconceptions or a lack of understanding. This paper considers evidence for dual processing theory in physics from the Force Concept Inventory, the well known test of conceptual understanding in mechanics. By gathering supplementary evidence on the reasons for student choices in two questions, 15 and 26, inconsistent or irrational thinking is revealed which is interpreted as direct evidence for system 1 thinking.

Keywords: dual processing theory, force concept inventory, FCI

Introduction

Dual processing theory (DPT) is the name given to that aspect of thinking summarised by Daniel Kahneman in “Thinking Fast and Slow” [1]. It is generally regarded as a universal aspect of human thinking, but so far there has been little application of it to physics. The essential feature of DPT is that there are two ways of thinking, commonly referred to as systems one and two. System one is a fast, intuitive approach to a question, but can often be wrong. System two is the slower, rational system, but it is cognitively expensive: it takes effort and energy to reason through a difficult question properly and as an alternative the brain often invokes simple heuristics (system 1). The phenomenon can be readily observed in psychology, where the right sort of questions can be asked that invoke a system one response. In physics problem solving, however, observing system one responses can be more difficult. The use of intuitive answers has often been interpreted in terms of naïve conceptions, but in fact naïve conceptions are themselves consistent with DPT. According to Stanovich, deeply ingrained ways of thinking can in themselves become heuristics which are adopted in system one responses. Perhaps this explains in part why such alternative conceptions seem very robust: it’s not just that students have developed an alternative framework but that framework is so deeply ingrained in their thinking that it actively inhibits effective reasoning about a problem even when they have the intellectual tools to carry out such reasoning.

This leads to the question as to how DPT can be observed in physics problem solving. Simply presenting students with a physics problem and observing the response will not necessarily enable a distinction between misunderstanding, including naïve misconceptions, and an intuitive response characteristic of system one. Prompting the students for a deeper response only serves to invoke system two and will not in itself confirm whether system one has been invoked in the first instance. The approach taken in

this paper is to analyse the responses to two questions on the Force Concept Inventory (FCI) [2]. The FCI is very well known in physics education and rightly stands as a major achievement in physics education research. It has been used in hundreds of institutions around the globe not only to characterise students' misconceptions in mechanics but also to measure the effectiveness of different approaches to teaching [3]. The FCI is remarkably consistent as a measure of student understanding in mechanics: the author has characterised the starting knowledge of students entering the University of Hull since 2008 and has shown that, question by question, the general behaviour is very similar year on year [4]. However, as the questions are multiple choice, there is no real insight into student thinking behind the answers and for two questions, 15 and 26, the suspicion is that there might be more than simple misconceptions behind the choice of response.

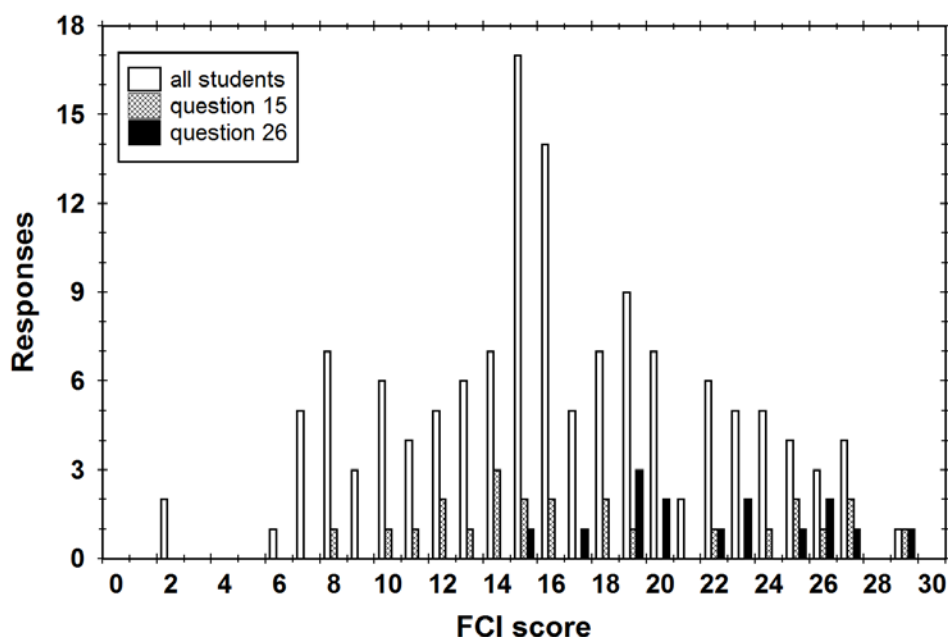

Figure 1. The distribution of scores for those who correctly answered questions 15 and 26 compared with the distribution of scores for all students between 2008 and 2010 inclusive

Question 15 is a test of Newton's 3rd law and asks students to compare the force of a car pushing a truck compared with the force of the truck acting back on the car when the both are accelerating (see Appendix for the details of both questions). A few students get the right answer but most opt for the force of the car on the truck being greater than the force of the truck on the car. As figure 1 shows, however, the question is not selective: students who score lowly on the FCI can answer the question correctly but there are many students who obtain high FCI scores who answer incorrectly. Question 26 tests Newton's second law, but also requires some knowledge of the third law. Figure 1 shows it to be similar in as much as students with a high score on the FCI can get the question wrong, though among the students we have tested there appears to be a higher threshold score for right answer. It is reasonable to conclude that a strong conceptual understanding of Newtonian mechanics is not a pre-requisite for getting either question correct. This paper presents the results of an investigation conducted over the past two years on entry level students aimed at elucidating some of the underlying issues behind the choices on these questions. Common misconceptions are identified, but there are, in addition, some inconsistent choices that appear to be motivated by something other than a clear misconception. A possible interpretation in terms of DPT is discussed.

Methodology

As described above, beginning in 2008 the FCI was completed by all entry level students prior to any instruction. In 2011 and 2012 the author attempted to look deeper into the underlying reasons for the low scores in questions 15 and 26 by setting a supplementary paper-based test immediately after the pre-instruction FCI. In 2011 this asked students to reaffirm their answers to these questions and explain their reasoning. Whilst this approach proved reasonably instructive for question 15 it was less so for question 26: many students simply stated that the resistive force increased until it balanced the pushing force without saying why. Although this indicates that students were not simply failing to apply Newton's 2nd law it gave no insight as to why students failed to recognise that the resistive force remains unchanged. Following an analysis of the responses it became apparent that an independent assessment of students' knowledge of Newton's laws of motion would also be helpful. Therefore, in 2012 the questions were modified and took the form:

1. State, in words that you are most familiar with, Newton's three laws of motion.
2. In the test you have just completed [the FCI] you met the following question [question 15]. Here, I would like you to re-state your answer and explain in words why you think this to be the case.
3. You also met a question similar to the following.

A woman exerts a constant horizontal force on a large box. As a result, the box moves across a horizontal floor at a constant speed " v_o ". If the woman doubles the constant horizontal force that she exerts on the box to push it on the same horizontal floor, the resistance with which the box opposes the push will;

- A. *increase*
- B. *decrease*
- C. *stay the same*

Explain the reasoning behind your answer and explain what you think will happen to the velocity of the box.

A total of 72 students took the pre-instruction FCI and the subsequent paper-based test.

Results

Student responses on Newton's laws of motion are summarised in table I. Many students knew some of the laws, but not all, or mis-identified the laws so that the first law, for example, was stated correctly but identified as the second or the third law. Student responses were therefore categorized as correct if a law was both stated correctly and identified correctly, or partial if the law was stated correctly but mis-identified. The great majority of students had some knowledge of each law, but only about one third of the total, 25 students, could unambiguously state all three together.

This information was gained prior to any instruction at university, but after a long summer break of four months during which time, presumably, little or no physics had been done. The knowledge of the laws of motion indicated in table I would therefore appear to be robust, but the ability to state a law does not necessarily imply understanding nor does an inability to identify the law preclude the ability to apply it. Nearly all our students could be said to have had some knowledge of Newton's third law on entry, but misconceptions around this law are well known and only 14 students were able to answer question 15 correctly. This compares with 34 students who correctly answered question 4, which

also tests the third law by asking about the relative magnitude of the force a truck and a small car exert on each other in a collision between them. In question 15, however, the car is pushing on the truck and both are accelerating. Students who incorrectly answered question 15 almost universally said that the force of the car on the truck is larger than the opposite and in their supplementary answers cited the acceleration as implying a net force.

Table 1. The numbers of students expressing correct or partially correct knowledge of Newton's laws of motion

	First law	Second Law	Third Law
Correct	32	51	45
Partially correct	19	10	20
Total	51	61	65

It is clear that students were applying Newton's second law rather than the third. On the face of it this implies that students didn't understand the third law, but a deeper analysis reveals a more complex behaviour. Of the 65 students who had some knowledge of the third law, 40 expressed it in the classical form: to every action there is an equal and opposite reaction. Nineteen students expressed the law in the form of, "an object A acting on an object B exerts an equal and opposite force to B on A" and 6 students expressed the law in some other form. It might be thought that this second form of the third law (object A on B) is ideally suited to dealing with collisions and the kind of situation contained in question 15, but only 4 of these students answered question 15 correctly (Table II).

Table 2. The numbers of students answering questions 4 and 5 in relation to their statement of the third law

Third law statement	Question 4	Question 15
Action/reaction	18	8
A on B / B on A	11	4
Total	29	12

Two things stand out from this table. First, students who made these two statements do not account for all the people who answered either question correctly: there were others who made no statement of the third law in the supplementary test but who still managed to answer question 15 correctly. Secondly, not all the students who expressed the law in terms of one body acting on another could apply that to a relevant situation, with only four out of nineteen students doing so for question 15. Moreover, of the 12 students in table II who answered question 15 correctly three answered question 4 incorrectly. One stated the law in terms of A on B and the other two stated the law in terms of action and reaction. It is clear, therefore, that whilst it is possible to say that many students who can unambiguously state the third law of motion do not understand it in as much as they are unable to apply it, there is also a great deal of inconsistency in their thinking.

This kind of inconsistency is also apparent in the supplementary information on question 26, which was answered correctly by 16 out of 72 students taking the FCI. However, 31 students correctly identified that the resistive force opposing the motion remains

unchanged, of which 11 chose the correct answer on the FCI. This means that 5 students answered question 26 correctly, but for the wrong reason, whilst 20 students who correctly identified the resistive force as remaining unchanged nonetheless chose an answer to question 26 consistent with an increased, but eventually constant, speed. Of these 20, 16 gave a very clear statement of the second law and of these 16, 14 actually cited the second law as the reason for choosing the wrong answer to question 15. The remaining two of these 16 were able to apply Newton's 3rd law correctly to question 15. Notwithstanding these two, it would appear, then, that there are at least 14 students who understand Newton's second law to the extent that they have both stated it correctly and applied it, albeit incorrectly as it turns out, to an accelerating system to deduce the presence of a net force; who recognise that the resistive force remains unchanged whilst the pushing force has doubled; but who have nonetheless chosen an answer to question 26 consistent with constant speed rather than constant acceleration.

It is difficult to identify any obvious misconception in this pattern of responses. A clear misconception is evident among some of those who believed that an increase in resistance is required by Newton's third law so that there is an equal and opposite reaction to the push on the box. Although this is clearly an incorrect interpretation of the third law that leads ultimately to an incorrect answer, the reasoning that followed from it was, in every case, correct: the speed should increase for a while and eventually become constant. The conclusion was therefore consistent with the students' understanding of the laws of motion, but the students who identified the correct nature of the resistive force but still chose an answer consistent with a constant speed were acting inconsistently. A similar conclusion can be reached in relation to question 15. There are a number of students who have learnt Newton's third law in a form that applies to a body acting on another, but when faced with exactly that situation choose an answer that contradicts that law. A possible explanation of this kind of inconsistency is discussed below.

Discussion

It is unlikely that sufficient information is available to be able to explain these results unambiguously. For example, in a recent set of unpublished interviews with students over their choice of answers to particular questions it emerged that many students do not understand that 3rd law forces do not act on the same body and therefore cannot cancel out. It is possible that this is the cause of the confusion over the role of the second law. It is also possible that students failed to recognise that this is a third law problem, but this seems unlikely given that the forces from the respective vehicles acting on the other are mentioned in the choices. The supplementary information very clearly supports the association of a net force with acceleration, as does the response to question 16, which essentially asks the same question but with the same two vehicles moving at constant speed rather than accelerating. Sixty three students out of 72 answered this correctly, including 18 of the 19 who expressed the law in terms of object A acting on object B. The association between net force and acceleration would appear to be strong enough to override any association with the third law.

Likewise, with question 26 it is possible, perhaps even probable, that the inconsistent answers are guided by the belief that the box must eventually reach a constant speed. Experience would tell us that no matter how hard we push something it goes as fast as we go. If we push harder it just goes faster. A deeper reflection on the problem reveals that it is in fact unphysical. The force originates from the friction between the floor and the person's shoes, so as the person steps the force will vary. It is impossible for a person to provide a constant force in the manner stated in the question. Whether students were

thinking this deeply about the problem is unlikely, as not one person expressed any such thoughts in their supplementary information. What this analysis does reveal, however, is that the thinking required to answer this problem involves a high degree of abstraction: what Stanovich calls cognitive decoupling [5]. In other words, in order to answer this question one has to construct a model of the situation which is decoupled from the perception of reality in order to apply Newton's second law.

Cognitive decoupling is an essential aspect of dual processing theory, on which topic Stanovich has written extensively over the years. In order to avoid confusion, when Stanovich is used in the singular, as above, it refers to Keith E. Stanovich [5]. However, Stanovich has also published jointly with Paula J. Stanovich [6] and this paper will be referred to as S&S. As S&S describe, there are in fact many dual processing theories, but: "Evidence from cognitive neuroscience and cognitive psychology converges on the conclusion that mental functioning can be characterized by two different types of cognition having somewhat different functions and different strengths and weaknesses". These different types are variously referred to as system 1 and system 2 or type 1 and type 2. In earlier work, Stanovich suggested the acronym TASS (The Autonomous Set of Systems) to describe a heterogeneous set of systems that together make up type 1. The distinguishing feature of type 1 is autonomy: such thinking is rapid, automatically triggered by particular cues, independent of higher order cognitive control, can operate in parallel and is cognitively undemanding. Most importantly, "TASS can sometimes execute and provide outputs that are in conflict with the results of a simultaneous computation being carried out by System 2" [5]. In short, type 1 thinking allows for the kind of inconsistent thinking revealed in the answers to questions 15 and 26.

The recognition that type 1 thinking is involved changes the focus of inquiry from the inconsistent thinking itself, which is automatic and in a sense requires no further explanation, to the lack of override, which is the province of system 2. Stanovich and West [7] have presented a four stage scheme for the interaction of systems 1 and 2 and the conditions required for type 2 thinking to override type 1. The four stages are:

1. Does the mindware exist for override? Mindware is the declarative and procedural knowledge needed to be able to answer the question correctly [5]. For question 15, this is Newton's 3rd law. For those students who have clearly stated the law in terms of one object acting on another, the mindware appears to exist as does the potential for override.
2. Is the need for override recognised? Clearly not, as Newton's second law is overwhelmingly cited as the reason for the incorrect choice. As described by Stanovich and West [7], "TASS contains many rules, stimulus discriminations, and decision-making principles that have been practiced to automaticity". Moreover, as S&S point out, "the triggering of this cue-action sequence on just a few occasions is enough to establish it in the autonomous mind". In other words, if students are much more familiar with the operation of the 2nd law than the 3rd, this might be sufficient to trigger a heuristic (type 1) response to the question with no apparent need to question this answer. If the answer is questioned, however, it is still not certain that the heuristic response will be overridden, as the next question must then be considered.
3. Is sustained inhibition or sustained decoupling necessary to carry out the override? If not, a system 2 response (override) can occur. Here the lack of a deeper knowledge about the operation of the law might hamper the override operation. The next question is.

4. Does the person have the decoupling capacity to sustain the override? If so, a system 2 response can occur but if not, the heuristic response is maintained.

Both questions 15 and 26 are similar in that students recognise the relevant law as well as the conditions for it to operate in the situation depicted, but then fail to apply the law. This is what Stanovich and West refer to as an “error of application”. These “can only occur when the relevant mindware has been learned and is available for use in the override process”. Errors of application occur when “people fail to detect the situational cues indicating that the heuristically primed response needs to be overridden and an analytically derived response substituted”, which accurately sums up the failure of students to apply the known relevant law in both questions 15 and 26. However, for question 26 the heuristic response is more likely to originate from a belief in the final answer rather than a rule that has been learned to the point of being automatic. The multiplicity of systems involved in type 1 (TASS) allows for this through *belief* bias and *my-side* bias. Belief bias is self-explanatory. My-side bias is the tendency to view the world from one’s own perspective. Quite possibly, the requirement to overcome a belief bias coupled with the unphysical nature of question 26 requires sustained cognitive decoupling which makes overriding the type 1 response very difficult.

In summary, the kind of inconsistent thinking in both questions 15 and 26 revealed in this paper can be explained with reference to dual processing theory [5]. That is not to say that misconceptions do not exist: they do and some have been identified in this work related to the third law, but these do not explain inconsistent thinking, such as choosing an answer that directly contradicts previously stated knowledge or previous behaviour. The implications for problem solving are clear: not only do we need to teach students about concepts, but we also need to foster rational thinking. Fortunately, dual processing theory as described by S&S is beginning to provide a cognitive framework for rational thinking [6], though the educational implications are not yet clear.

Conclusions

Two questions on the FCI that students find difficult, 15 and 26, have been analysed in detail using information gained from students immediately after taking the FCI but prior to any formal instruction at university. The analysis reveals inconsistent thinking among a number of students. This can be explained by dual processing theory, which essentially posits two different systems of thought which are known to be able to support these kinds of inconsistencies. The analysis suggests that the inculcation of habits of rational thinking is just as important as conceptual knowledge.

References

- [1] Kahneman D.: *Thinking, Fast and Slow*, Penguin (2012), ISBN: 978-0141033570.
- [2] Edward F. Redish: *Teaching Physics with the Physics Suite*, John Wiley & Sons Inc. (2003), ISBN 978-0-471-39378-8.
- [3] Richard Hake: Interactive-engagement vs. traditional methods: A six-thousand-student survey of mechanics test data for introductory physics courses, *American Journal of Physics* **66** (1998) p64-74.
- [4] David Sands: Ausubel’s principle of prior knowledge in first year mechanics. *New Directions*, Issue 7, (2011) 52-57; DOI: 10.11120/ndir.2011.00070052.

- [5] Keith E. Stanovich: Distinguishing the reflective, algorithmic, and autonomous minds: Is it time for a tri-process theory? in Jonathan Evans and Keith Frankish, *In two minds: Dual processes and beyond*, Oxford University Press, Oxford 2009. Published to Oxford Scholarship Online: March 2012, DOI:10.1093/acprof:oso/9780199230167.001.0001.
- [6] Keith E. Stanovich, Paula J. Stanovich: A Framework for Critical Thinking, Rational Thinking, and Intelligence, in D. Preiss and R. J. Sternbergs (Eds), *Innovations in educational psychology: perspectives on learning, teaching and human development*, Springer (NY) 2010 p195-237.
- [7] Keith E. Stanovich, Richard F. West: On the Relative Independence of Thinking Biases and Cognitive Ability, *Journal of Personality and Social Psychology*, **94**, 2008, 672–695; DOI: 10.1037/0022-3514.94.4.672.

Appendix: questions 15 and 26 of the FCI

Question 15. A large truck breaks down out on the road and receives a push back into town by a small compact car (This is illustrated in the FCI with a sketch). While the car, still pushing the truck, is speeding up to get up to cruising speed:

- (A) the amount of force with which the car pushes on the truck is equal to that with which the truck pushes back on the car.
- (B) the amount of force with which the car pushes on the truck is smaller than that with which the truck pushes back on the car.
- (C) the amount of force with which the car pushes on the truck is greater than that with which the truck pushes back on the car.
- (D) the car's engine is running so the car pushes against the truck, but the truck's engine is not running so the truck cannot push back against the car. The truck is pushed forward simply because it is in the way of the car.
- (E) neither the car nor the truck exert any force on the other. The truck is pushed forward simply because it is in the way of the car.

Question 26. If the woman in the previous question [*A woman exerts a constant horizontal force on a large box. As a result, the box moves across a horizontal floor at a constant speed " v_0 "*] doubles the constant horizontal force that she exerts on the box to push it on the same horizontal floor, the box then moves:

- (A) with a constant speed that is double the speed " v_0 " in the previous question.
- (B) with a constant speed that is greater than the speed " v_0 " in the previous question, but not necessarily twice as great.
- (C) for a while with a speed that is constant and greater than the speed " v_0 " in the previous question, then with a speed that increases thereafter.
- (D) for a while with an increasing speed, then with a constant speed thereafter.
- (E) with a continuously increasing speed.

Just how deterring are formulas?

Alexander Strahl, Rainer Müller, Susan Hagendorf & Julian Grobe

TU Braunschweig, Germany

Abstract

Formulas are an effective means for communication in physics. Most teachers would agree, however, that novices tend to be deterred by formulas. Up to now, this common belief has never been substantiated by quantitative research. Here we report on an attempt to identify and quantify the variables that govern the appraisal of physical formulas. In an empirical study, 684 secondary school and university students were asked to indicate for 38 formulas to which extent they perceive the formula as deterring. The result is surprisingly simple. We are able to model the responses with only a single variable: the length of the formula. An explicit model equation (saturating exponential) to fit the data can be given.

Keywords: formula, unit, deterring, length of formula questionnaire study

Introduction

Previous studies on physical formulas concentrated mainly on their role in text comprehension and problem solving. Dee-Lucas and Larkin [1] found that undergraduate physics students judged physical texts containing formulas as more important than their verbal counterparts. The same authors found a slight advantage in text comprehension when the formulas in a physics text were replaced by verbal equivalents. [2] This result was called into question by Müller and Heise [3], who found a significant advantage in text comprehension for secondary school students reading the version with formulas. Remarkably, most of the students interviewed by Müller and Heise expressed a positive attitude towards physical formulas, just as in [4] and [5].

The role of formulas in problem solving has been explored in the context of expert/novice research. There is evidence that experts and novices solve physics problems differently. According to Larkin et.al, [6,7] novices tend to use formulas in the early stages of problem solving, while experts develop a qualitative representation before using equations.

Perhaps the most famous remark on the subject of the present note has been made by Stephen Hawking. In the preface of his popular book “A brief history of time”, [8], he writes: “Someone told me that each equation I included in the book would halve the sales. I therefore resolved not to have any equations at all. In the end, however, I did put in one equation, Einstein's famous equation $E = mc^2$. I hope this will not scare off half of my potential readers”. Presumably, there are two reasons why Hawking did not fear that this particular formula would deter his readers too much: (a) he could assume the readers are familiar with it and (b) it is not too complicated.

Setting of the study

In our empirical study, we asked students to indicate for 38 formulas to which extent they perceived the formula as deterring. The formulas were taken from different fields of physics, with varying length and complexity. Some examples are:

$$s = \frac{a \cdot t^2}{2} \quad (1)$$

$$f = \frac{1}{2\pi\sqrt{L \cdot C}} \quad (2)$$

$$W = \int F \cdot dr \quad (3)$$

$$u_\nu(\nu, T) = \frac{8\pi\nu^2}{c^3} \frac{h\nu}{e^{kT} - 1} \quad (4)$$

$$\Delta K_{kin} = \frac{1}{2}(m_1 \cdot v_1^2 + m_2 \cdot v_2^2) - \frac{1}{2}u^2(m_1 + m_2) \quad (5)$$

We interrogated three different groups of students:

Group 1: A random sample of 288 secondary school students (grade 10 to 12),

Group 2: 258 first-year university students not majoring in physics,

Group 3: 24 physic education students for middle school,

Group 3: 114 first-year physics and electrical engineering majors.

The participants had to complete a questionnaire in which they rated each of the 38 formulas on a scale from 1 (not at all deterring) to 5 (very deterring). For quantitative modeling it is more convenient to use a scale that varies from 0 to 1. The data were thus rescaled by a linear transformation. In total, we obtained 25992 individual ratings from the 684 participants. The group averages of these ratings define a “degree of deterrence” for the 38 formulas.

Thought

At first sight, it seems quite hopeless to predict how the students would assess the formulas. There is an abundance of factors that may affect the rating:

1. the familiarity of the students with the subject area to which the formula belongs,
2. the level of physics expertise of the students,
3. the familiarity with the formula itself or with the variables contained in it,
4. the appearance of unusual symbols (Greek letters, square roots or integral signs),
5. the length of the formula,
6. the structure of the formula (appearance of brackets, fraction bars).

Factors 1 and 3 can be controlled by inspection of the physics curricula of the different groups. The level of expertise can roughly be assessed by the group membership and the last physics grade. On the contrary, it is not entirely obvious how to define the notion “formula length”. We chose the simplest definition we could think of: counting the number of symbols appearing in the formula. Any symbol, be it a letter, a number, a fraction bar, or a plus sign, contributes equally to the length. Functions like sin, cos, or exp and named indices (like the index “kin” in (5)) are counted once. For the formulas (1) – (5) shown above, we obtain a length of 8, 10, 7, 26, and 35, respectively.

Result – formula

Surprisingly the responses of each group could be modelled with a single variable: the formula length defined above. The remaining factors seem to have a much smaller

influence on the degree of deterrence. Figure 1 shows the data of group 2 plotted as a function of formula length. A marked nonlinear relationship is clearly discernible. The graph suggests that the length alone appears to be a good indicator of how deterring a formula is perceived.

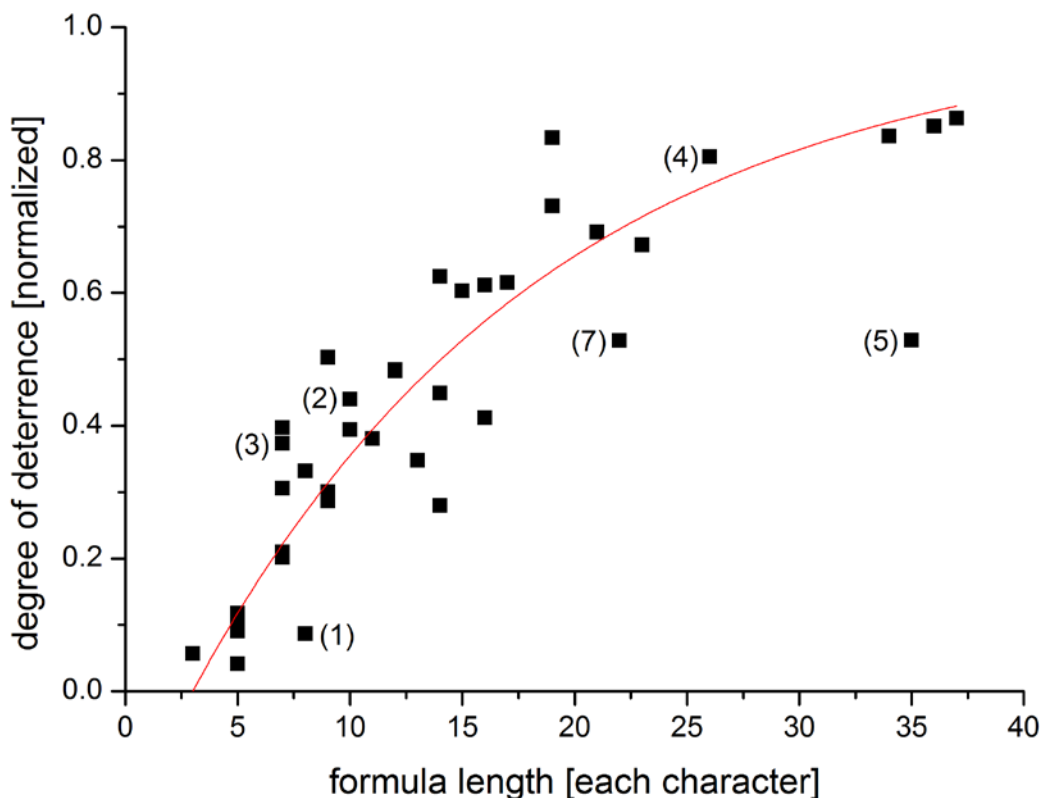

Figure 7. Degree of deterrence vs. formula length for the 38 formulas rated by the students of group 2. The degree of deterrence is defined as the average student rating of the formula within the group, rescaled to the interval (0,1). The solid line is the best fit curve for the model (6). The labels (1) – (5) and (7) mark the formulas shown in the text.

The data can be interpreted as follows: Short formulas are perceived as less deterring than longer ones. The relation is not linear, however. Increasing the formula length by 5 symbols has a stronger effect for a formula of length 5 than for one with length 20. The deterring effect saturates.

Saturation phenomena are known from physics and many other branches of science. Perhaps the simplest example is the charging of a capacitor. Quantitatively, these phenomena are typically described by a saturating exponential of the form $1 - e^{-x}$. An analogous model appeared to be promising for the introduced correlation.

Using a nonlinear least-square method, the data was fitted to the model equation

$$y = 1 - e^{-\frac{x-3}{A}} \quad (6)$$

The fit function intersects the abscissa at $x = 3$, reflecting the fact that this is the smallest conceivable length of a formula (e. g. $a = b$). The parameter A determines the slope of the curve and can be interpreted as a saturation length.

The fitting was done for each group separately. The data point marked with (5) was classified as an outlier and excluded from the analysis. We will return to the interpretation of this point below. Without the outlier, the hypothesis that the fit follows a Gaussian distribution is consistent with the data.

The solid line in Figure 1 shows the curve that best fits the data for group 2. Table 1 lists the corresponding value of A together with common measures for the goodness of the fit. It is remarkable, how well the students responses can be modelled with a single free parameter. The standard error of estimate, for example, is about 0.1. It can be interpreted as the average distance of the data points from the fitting curve.

Table 1. Fit parameters and goodness-of-fit measures for the four groups. Note that, unlike for linear models, it is not possible to interpret R^2 as the percentage of the variance explained by the model.

	<i>formula</i>				<i>unit</i>			
	<i>A</i>	<i>s</i>	R^2	<i>n</i>	<i>B</i>	<i>S</i>	R^2	<i>n</i>
Student (school)	10.75	0.70	0.76	288	10.69	1.82	0.26	143
subsidiary subject (university)	15.95	1.03	0.78	258	14.96	2.97	0.46	304
teaching physics (university)	16.75	0.99	0.86	24				
physics student (university)	30.42	2.26	0.72	114				

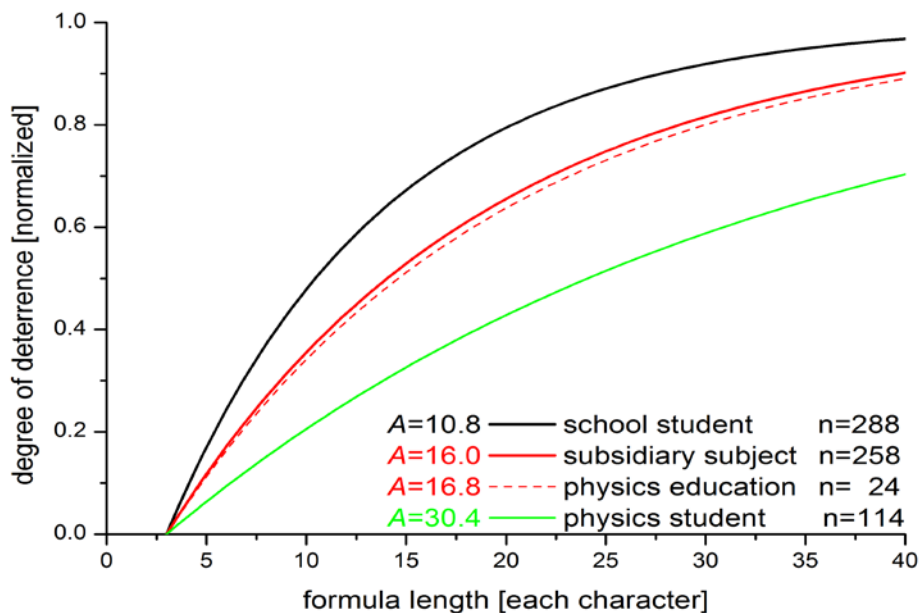

Figure 8. Best fitting curves for the four groups. The characteristic length for each curve can be found in Table 1.

Let us finally comment on the rating of Eq. (5). The perceived degree of deterrence is much lower than expected (data point (5) in Figure 1). We believe to see an instance of

chunking here. In psychology, chunking designates the ability to group several objects into a larger meaningful units [9]. Eq. (5) consists of several similar terms that can be interpreted as kinetic energies. Because of chunking, the formula may be perceived to consist of “less elements”, leading to an apparent reduction of complexity. To a lesser extent, such an effect can also be seen for the formula marked (7)

$$E = \frac{n^2}{8ma^2} (n_x^2 + n_y^2 + n_z^2), \quad (7)$$

where repeating elements may lead to a lower rating. These effects, together with a more detailed analysis of the influence of the other factors mentioned above, are subject to ongoing research.

Result – unit

A follow-up study has been carried out with physical units (like $N \cdot m$ or $V \cdot s / (A \cdot m)$). Here we could find similar correlations between the length of a unit and the degree of deterrence (see Figure 3 and Table 2).

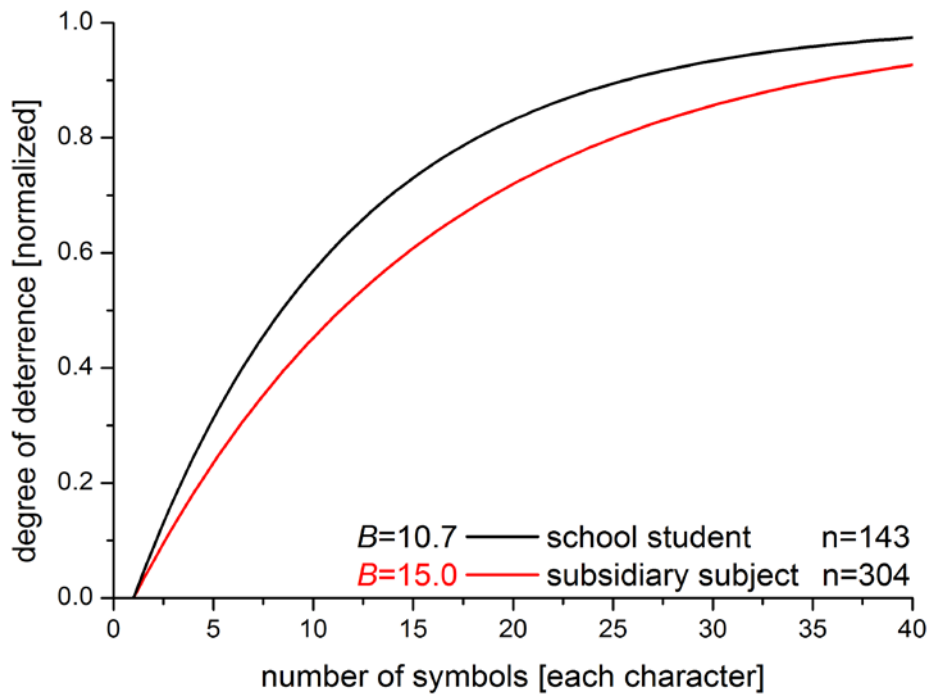

Figure 3. Fitting curve for the deterrence of units

Figure 3 shows the best-fitting curves for a group of school students (n=143) and a group of university students with physics as subsidiary subject (n=304) who assessed the degree of deterrence of 22 units. As in the study on formulas, the length of a unit is determined by the number of its symbols.

The degree of deterrence of units demands a slight modification of the model equation that fitted the data for the length of formulas. The data for units could be fitted to the equation

$$y = 1 - e^{-\frac{x-1}{B}}. \quad (8)$$

The fit parameter B determines the slope of the curves. As shown in Table 1, it differs for school and university students.

In the study on units, we further obtained some interesting results with regard to different representations of fractions. Table 2 shows three different representations of the same fraction. The first of them is preferred by the students.

Table 2. Different degree of deterrence for the same unit (from 0 to 1)

<i>unit</i>	<i>number of symbols</i>	<i>average degree of deterrence</i>
$T = \frac{V \cdot s}{m^2}$	8	0.31
$T = (V \cdot s) / m^2$	10	0.38
$T = V \cdot s \cdot m^{-2}$	9	0.42

Further research carried out along these lines [10] shows that students prefer certain representations of formulas (like a horizontal bar in fractions or writing out the indices within a formula).

The Relevance of our empirical results for the teaching of physics

We finally summarize the results of our empirical studies in order to provide teachers with some guidance for using formulas in their courses:

- In our investigations, students were not so much afraid of formulas. On the contrary, formulas were judged as helpful for understanding physical relationships. [11]
- Formulas are not regarded as too abstract to understand their physical content.
- A high level of significance is attributed to formulas.
- Formulas combine important relationships in compact form.
- Students with a lower level of achievement tend to have more problems with formulas
- Formula transformations and term rearrangements were difficult for all students in our study.
- The length of a formula is the dominant factor in the perceived “deterrence” of the formula.
- There exists “standard forms” for formulas which are regarded as preferable by the students. The same is true for the representation of units.

References

- [1] Dee-Lucas D., Larkin J. H.: Novice rules for assessing importance in scientific texts, *Journal of Memory and Language* 27, (1988), p.288-308.
- [2] Dee-Lucas D., Larkin J. H.: Equations in Scientific Proofs: Effects on Comprehension, *American Educational Research Journal* 28, (1991), p. 661-682.
- [3] Müller R., Heise E.: Formeln in physikalischen Texten: Einstellung und Textverständnis von Schülerinnen und Schülern, *PhyDid* 2/5, (2006), p. 62-70.
- [4] Strahl A., Mohr M., Schleusner U., Müller R.: Beurteilung von Formeln durch Schüler – eine Fragebogen-Untersuchung. published in *Chemie- und Physikdidaktik für die*

Lehramtsausbildung - D. Höttecke (Hg.) GDCP Tagungsband 29 - Lit Verlag Berlin (2009).

- [5] Strahl A., Mohr M., Schleusner U., Kreckler M., Müller R.: Akzeptanz von Formeln – Vergleich zweier Erhebungen. *PhyDid B* (2010).
- [6] Larkin J. H., McDermott J., Simon D. P., Simon H. A.: Models of competence in solving physics problems, *Cognitive Science* 4, 317 (1980).
- [7] Larkin J. H.: The role of problem representations in physics. In Gentner, D. & Stevens, A. L. (Eds.), *Mental models* (pp. 75-98). Hillsdale: Erlbaum (1983).
- [8] Hawking S. A.: *Brief History of Time*, New York: Bantam Dell (1988).
- [9] Chase W. G., Simon H. A.: The mind's eye in chess. In Chase, W. G. (ed.), *Visual information processing*. New York: Academic Press (1973).
- [10] Strahl A., Grobe J., Müller R.: Was schreckt bei Formeln ab? – Untersuchung zur Darstellung von Formeln. *PhyDid B* (2010).
- [11] Strahl A., Mohr M., Schleusner U., Kreckler M., Müller R.: Akzeptanz von Formeln – Vergleich zweier Erhebungen. *PhyDid B* (2010).

Learn from history: Lessons from early modern Japanese physics experiment textbooks

Hiroshi Takahashi¹, Akira Akabane², Jun Shozawa³, Toyomi Tamaki⁴

¹ Faculty of Science and Technology, Gunma University, Maebashi, Japan

² Saitama Medical University, Saitama, Japan

³ Tokyo Future University, Tokyo, Japan

⁴ Mathematical Assist Design Laboratory, Maebashi, Japan

Abstract

The aim of our study is to explore the early history of the education of physics experiments in the Meiji era of Japan (1868 - 1912). In this paper, we examine three Japanese physics experiment textbooks which were published during 1880s. One characteristic feature is that the most of the experiments could be performed using simple handmade apparatuses. We consider what can be learned from the ingenuity of physics education pioneers of the late 19th century.

Keywords: physics experiment, Meiji era, handmade, simple experiment, history of physics education

Introduction

The island nation of Japan had adhered to a closed-door policy to the outside world between 1639 and 1854. During this period, Japan traded only with China and the Dutch through restricted ports. As a result, very little knowledge of modern Western science reached Japan by means of Chinese and Dutch books. From the inception of the Meiji Restoration in 1868, leaders of the nascent Meiji government recognized that science and technology were essential to the development of new industry. Consequently, the full-scale influx of modern Western science was encouraged. The general public also felt that, learning rational thinking of the West would be required for the country's modernization. It is within this context that a publication boom of physics textbooks occurred and present-days historians refer to it as *kyuri-netsu* (literally, enthusiasm for physics) [1]. Itakura [2] reported that *ca.* 40 general science books that primarily cover physics were published in 1872 - 1873. One of the leading educational figures of his time, Yukichi Fukuzawa (1835 - 1901), eagerly disseminated the new idea of rational thinking. His work, *Kunmo Kyuri Zukai* (Illustrated Introductory Physics) [3], first published in 1868, is regarded as the trigger of the publication boom in the early Meiji era.

The Japanese school educational system modelled after the West began when the Education System Order (*Gakusei*) was promulgated in August, 1872. The elementary school curriculum was regulated according to the Elementary School Curriculum (*Shogaku Kyosoku*) established in the following month, and in which five subjects related to science appeared, i.e., Regimen, Natural Philosophy, Natural History, Chemistry, and Physiology (*yojo-kujo*, *kyurigaku-rinko*, *hakubutsu*, *kagaku*, and *seiri*, respectively). The entire curriculum was expected to be completed in eight years. The main scientific subjects, natural history, chemistry, and physiology were taught on the seventh and eighth grades. In practice, however, as Itakura [2] revealed, the majority Japanese elementary schools of the 1870s, there were actually relatively few students in the higher grades where science was

taught. After 1880, the number of students there began to increase and as a result, science education at the elementary level began in earnest. This situation brought about an earnest discussion on how to best perform physics experiments in the classroom. Domestic leaders of science education had recognized the importance of performing experiments and consequently, no less than ten physics experiment textbooks in Japanese were published successively during the four-year span of 1882 - 1886, as Nagata [4] has shown.

In order to explore the early history of physics experiments education in Meiji-era Japan, here, we analyze several representative textbooks among these textbooks. In particular, we will deal with three textbooks. The first is *Rika-Shoshi* (Simple and Easy Experiments of Physics and Chemistry) (1882) [5], a translation of an American textbook but notable for being the first physics experiment textbook written in Japanese. The second is *Kan'i-Shiken-Ho* (Simple Experiments) [6] written by Jun'ichi Udagawa (1848 - 1913). The latter textbook is not a translation, but rather the first original Japanese physics experiment manual. The third textbook is *Kan'i Kikai Rikagaku Shiken-Ho* (Physics and Chemistry Experiments using Simple Apparatuses) [7], written by Makita Goto (1853 - 1930), who is recognized as the most influential figure of Meiji-era physics education. Udagawa is considered a leader of the first generation of educators in physics, and Goto is a leader of the second generation. The outstanding feature of these three textbooks is that the most of experiments can be performed with low-cost, everyday materials.

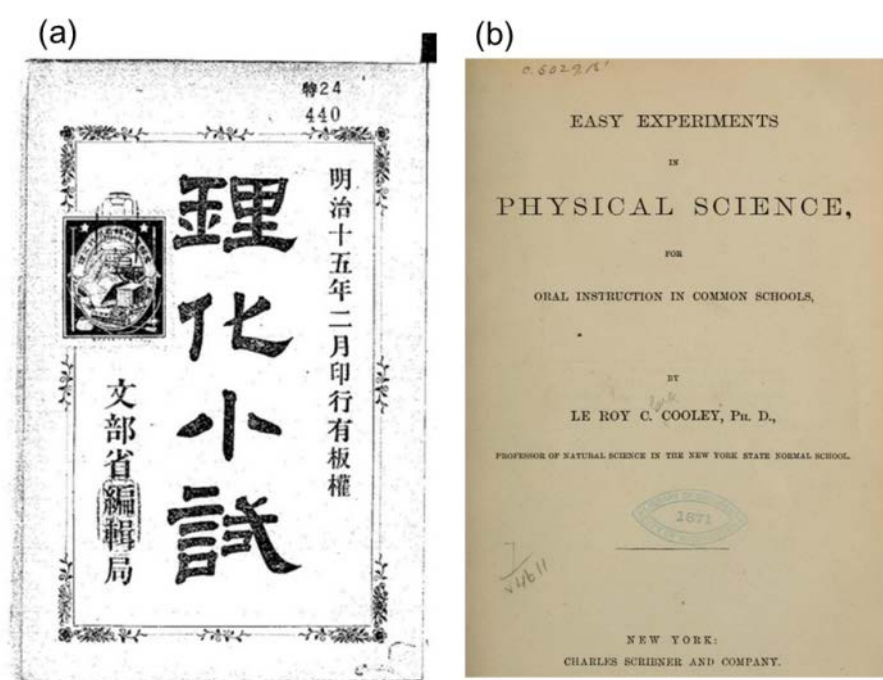

Figure 1. (a) The title page of *Rika-Shoshi* (Monbusho, 1882) [5] (b) The title page of *Easy Experiments in Physical Science* by Le Roy C. Cooley (1870) [8]

First Japanese Physics Experiment Textbook, *Rika-Shoshi*

The first Japanese textbook on physics laboratory teaching is *Rika-Shoshi* (Figure 1 (a)) that was published by *Monbusho* (the Ministry of Education) in 1882. This textbook was translation of *Easy Experiments in Physical Science* (Figure 1 (b)) by Le Roy C. Cooley (1833 - 1916) and published in 1870 by Charles Scribner and Company of New York. The

translator of the textbook, Ten Maomura (1853 - ?), worked at the Tokyo Educational Museum (present-day Tokyo National Museum) when the textbook was published. The original Japanese is the same as the original, which contains 178 experiments, of which 145 are for physics and the remaining 33 for chemistry. As mentioned above, the experiments could be performed by using low-cost apparatus or everyday materials.

Needless to say, during Meiji era, there were vast differences in lifestyle and culture between the East and West. Thus, for Japanese to obtain the same materials was extremely difficult. Consequently, the Japanese version, *Rika-Shoshi*, contains some explanatory notes. For example, the explanatory note in *Rika-Shoshi* recommend using *beniko*, a fine Japanese red powder used in make-up, for coloration as a substitute for of cochineal extract powder. In addition, other explanatory notes called for modifications to the experiments themselves (see [9] for details).

As we have covered the personal history of Jun'ichi Udagawa (1848 - 1913), the editor of *Rika-Shoshi* elsewhere [9], we would like to turn to Le Roy C. Cooley (1833 - 1916), as described in *An Historical Sketch of the State Normal College at Albany* [10]. A graduate of Union College in 1858, Cooley taught mathematics at the Fairfield Academy and Cooperstown Seminar. From 1861, he was appointed professor of Natural Science at the New York State Normal College in Albany. In 1874, he moved to Vassar College, one of oldest colleges for women in the United States. There, he became the first professor of physics, his Ph. D. having been conferred by Union University four years earlier.

One of his most notable review papers was *The Molecular Theory* published in *Popular Science Monthly* (Volume 15, August 1879) [11]. An anonymous reviewer [12] of Cooley's *The New Text-Book of Physics* [13] wrote, "Professor Cooley was among the first to attempt to introduce into elementary instruction in physics the modern doctrine of molecules and molecular action". In fact, *Easy Experiments in Physical Science* was written consistently on the basis of molecular theory. Itakura published a reproduction of *Rika-Shoshi* in 1972. In his postscript of the reproduction, Itakura [14] wrote, "reading *Rika-Shoshi* makes me overjoyed because I found that that early Meiji-era scientific concepts are based on the modern view of matter supported by molecular theory." Itakura have insisted that molecular theory should be taught even at elementary school levels [2]. Indeed, it is probable that *Rika-Shoshi* played an essential role in spreading the concept of molecular theory in Meiji-era Japan.

As expected from the full title of *Easy Experiments in Physical Science, for oral instruction in common schools*, the textbook is not only a teaching manual of physics experiments but also an instructs teachers how to adequately pose questions to students during the experiments. In fact, Cooley wrote "While making an experiment the teacher ought, by skilful questions and appropriate remarks, to keep the attention of the children upon it, so that every part of the apparatus shall be observed and every action definitely seen. Above all things ought to care to be taken that the final inference is seen to be the natural consequence of the facts observed in the experiments".

First Japanese Original Physics Experiment Textbook, *Kan'i-Shiken-Ho*

The editor of *Rika-Shoshi* textbook was Jun'ichi Udagawa, a physics teacher of the Gunma Normal School (now, Gunma University). According to university archives, Udagawa performed some experiments with handmade apparatuses in his physics lectures of 1884. He published the first Japanese original physics experiment textbook, *Kan'i-Shiken-Ho* (Simple Experiments) at the following years. In it, Udagawa explained how experiments in

his previously published textbook, *Butsuri-Shoshi* (Short Course of Physics) could be performed by using mainly everyday materials: “When we have no flask, we should use an ordinal bottle of false bottom”, or, “when no magnetic needle is available, the use of a sewing needle is recommended.” A sewing needle can be easily magnetized by rubbing it with a magnet. When the magnetized sewing needle is rotated freely by suspending it with a thin silk thread, the needle will rotate to the direction of north-south axis.

Physics had become established in the school curriculum at that time. In the preface of *Kan'i-Shiken-Ho*, Udagawa describes his motive for authoring the textbook: “Physics is an indispensable subject in the elementary school curriculum, as evident by the recent *Guidelines for the Course of Study for Elementary Schools* (*Shogaku Kyosoku Koryo*, 1881), thus, I published *Butsuri-Shoshi* (Short Course of Physics).” But Udagawa fully realized the limitations of Japanese schools at that time, saying, “Because physics is based on substance, the laws and principles of physics should be explained through physical experiments. However, local governments are severe financial straits, e.g., and in most mountain villages, it is extremely difficult to obtain satisfactory experimental instruments. Therefore, I wrote this textbook.” Although the Gunma Normal School had proper equipment to perform demonstration experiments at that time [9]. Udagawa preferred to use handmade instruments in his classes. We can interpret such actions that Udagawa thought that when his students became teachers and were placed at a poor rural school, they could make do with common everyday materials.

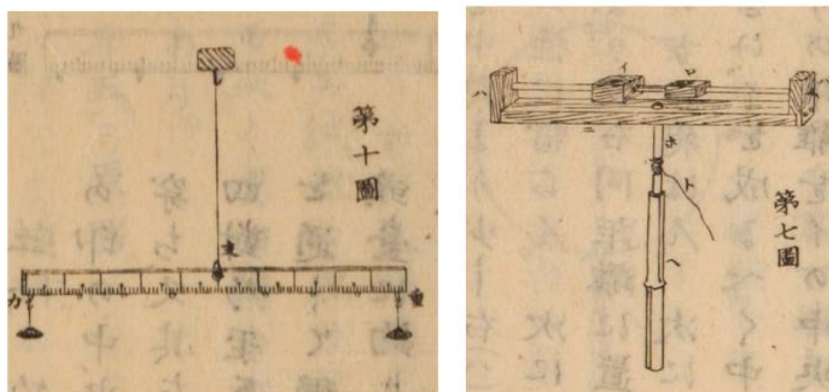

Figure 2. Balance made from a Bamboo Scale

Figure 3. Bamboo apparatus for showing centrifugal force

Makita Goto and His Simple Experiment Textbook

If Jun'ichi Udagawa belonged to the first generation of Japanese physics educators, Makita Goto was a leader in the second generation. Udagawa resigned from the Gunma Normal school in 1885. He then went to work at Imperial Japanese Army General Staff Office, where he taught surveying and photographic techniques for cartography [15]. Udagawa never returned to teach physics at school and he disappeared from the world of physics education after his resignation from the Gunma Normal School. In Udagawa's footsteps, Makita Goto became a leader of physics education. Five years younger than Udagawa, Goto taught physics at the Tokyo Normal School (now Tsukuba University) from 1877 to 1914. During his tenure, he had taught the next generation of Japanese physics teachers.

Goto authored a large number of physics textbooks, usually co-authored with his disciples. Goto's first experiment textbook, *Kan'i Kikai Rikagaku Shiken-Ho Kan-Ichi* (*Simple Physics and Chemistry Experiments Using Homemade Apparatuses, No.1*) was co-

authored by Yonekichi Miyake (1860 - 1929), and published in 1885. The title of “No.1” would seem to indicate a series but no subsequent publication appeared. Although the title indicates that chemistry experiments are included, most of the experiments of the textbook are in physics. It could be that the next book in the series would describe mainly chemistry experiments.

Although not exclusive to *Kan'i Kikai Rikagaku Shiken-Ho Kan-Ichi*, typical of Goto's work is that many of the experimental apparatuses are made from wood or bamboo. Figure 2 shows a balance made from a bamboo scale. To explain centrifugal force, Goto devised an apparatus (shown in Figure 3) that when rotated, two wooden pieces, supported by thin metal wires but are freely movable, move to both ends due to centrifugal force. Many physics textbooks published in Europe and America in the late 19th century, explain the mechanism of lifting-Pump using an illustration as in Figure 4. The lifting-Pump which appears in *Kan'i Kikai Rikagaku Shiken-Ho Kan-Ichi* is made from bamboo tubes (Figure 5).

Most of the architecture in Europe and North America employs inorganic materials such as stones and bricks. In contrast, traditional Japanese architectures such as Buddhist temples, Shinto shrines, are made mainly of wood. It is only natural then, that Japanese physics textbooks would employ traditional building materials such as those found in Goto's work.

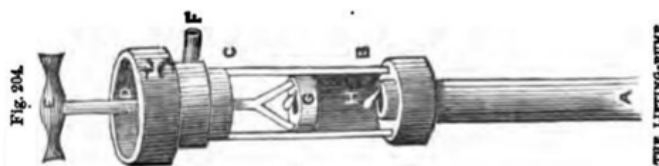

Figure 4. Lifting-pump. This figure is taken from *A Natural Philosophy* by G. P. Quackenbos (1869) [16]



Figure 5. Balance made from a Bamboo

Conclusions

Under the Elementary School Curriculum (*Shogaku Kyosoku*) of 1872, Japanese educational authorities insisted that experiment be performed in science lessons [17]. However, the central government did not usually bear the cost of elementary and secondary schools, rather but the local villages, towns, and prefectures did. Of course, the financial health of local governments varied widely and it certainly was quite difficult for many schools to obtain a full set of ready-made experimental instruments. Given these circumstance, it would be entirely appropriate for the Ministry of Education to publish a translation of *Easy Experiments in Physical Science* as the first physics experiment textbook for elementary schools. The majority of its experiments can be performed using low-cost everyday materials. In spite of the vast differences in culture and lifestyle, because they had a good understanding of handmade physics experiments developed in Europe or North America, early modern Japanese physics educators successfully modified the same experiments with a dash of local ingenuity, especially traditional wood-working.

So, what can be learned from this discussion of early physics experiment textbook in the late 19th century? The same would apply today if one were to use teaching materials

developed by other people in a different context. The most important thing is not to get funding and introduce only the newest and latest teaching materials. It is imperative for educators to consider which improvements or adaptations are required to optimize the materials for their own context. There is no denying that some money is necessary to prepare an experimental apparatus and virtual experiments simulated on a computer can reduce expenses. We would so well to bear in mind Udagawa's preface to *Kan'i-Shiken-Ho*, "physics is based on substance." and that touching and operating real substances are indispensable to understanding the physical world. Handmade and inexpensive experimental apparatuses similar to those developed in the late 19th century could be used in present-day classrooms, if one were to add the appropriate modifications.

Acknowledgment

We would like to acknowledge and thank the staff of the Gunma University Library for their effort in preserving the archives. We would also like to thank Professor Barry Keith (Gunma University) for his English revision of the manuscript. This work was supported by JSPS KAKENHI Grant Numbers 25282043 and 19500779.

References

- [1] The Physical Society of Japan: *Nihon No Butsurigaku-Shi* (Japanese History of Physics) Tokai University Press (1978), ASIN: B000J8KNZU [in Japanese].
- [2] Itakura K.: *Zoho Nihon Rika Kyoiku-Shi* (Japanese History of Science Education, Revised and Enlarged Edition): Kasetu-Sha (2009), ISBN 978-4-7735-0212-1 C3037 [in Japanese].
- [3] Fukuzawa Y.: *Kunmo Kyuri Zukai* (Illustrated Introductory Physics): Keio-Gijuku (1868) [in Japanese] Available from: <http://kindai.ndl.go.jp/info:ndljp/pid/830074>
- [4] Nagata A.: *Nihon Rika Kyouzai-Shi* (The History of Japanese General Science Teaching Materials): Tokyo Horei Publishing (1994) ISBN-10: 4809060888 [in Japanese].
- [5] *Rika-Shoshi* (Simple and Easy Experiments of Physics and Chemistry): Monbusho (1882) [in Japanese]. Available from: <http://kindai.ndl.go.jp/info:ndljp/pid/826131>
- [6] Udagawa J.: *Kan'i-Shiken-Ho* (Simple Experiments) : Bungaku-Sha (1885), [in Japanese] Available from: <http://kindai.ndl.go.jp/info:ndljp/pid/830422>
- [7] Makita G., Miyake Y.: *Kan'i Kikai Rikagaku Shiken-Ho Kan-Ichi* (Simple Physics and Chemistry Experiments Using Homemade Apparatuses, No.1): Fukyu-Sha (1886), [in Japanese].
- [8] Cooley L. C.: *Easy Experiments in Physical Science, for oral instruction in common schools*: C. Scribner and Company (1870), Available from: <http://archive.org/details/easyexperiments00cool>
- [9] Takahashi H., Akabane A., Shozawa J., Tamaki T.: *Rika-Shoshi, the First Physics Experiment Textbook Published in Japanese and Its Editor, Jun'ichi Udagawa*: J. Phys. Soc. Jpn. Suppl. (The Proceedings of The 12th Asia Pacific Physics Conference) (in press).
- [10] New York State University, Albany: *An Historical Sketch of the State Normal College at Albany, N. Y. and a History of Its Graduates for Fifty Years, 1844-1894*:

- Brandow Print Company (1894) Available from:
<http://archive.org/details/historicalskech01newy>
- [11] Cooley L. C.: The Molecular Theory. The Popular Science Monthly 15, August (1879), p. 462-470. Available from:
<http://archive.org/details/popularsciencemo15newy>
- [12] Book Review: The Popular Science Monthly 18, November (1880), p. 135-136.
Available from: <http://archive.org/details/popularsciencemo18newy>
- [13] Cooley L. C.: The New Text-Book of Physics: Charles Scribner's Sons, New York, (1880). Available from: <http://archive.org/details/newtextbookofphy00coolrich>
- [14] Itakura K.: Postscript in the reproduction of *Rika-Shoshi*: Kasetsu-Sha (1972) ISBN: 978-4-7735-0021-9 (4-7735-0021-2) C3340 [in Japanese].
- [15] Okayama-Ken-Meikan (The Directory of Okayama Prefecture): Kenji Sugiyama (1911) ASIN: B008V5U56A [in Japanese].
- [16] Quackenbos G. P.: A Natural Philosophy: D. Appleton and Company, New York, (1869) Available from: <http://archive.org/details/anaturalphiloso06quacgoog>
- [17] Nagata A.: *Shi-Rika-Kyoiku-Nyumon* (New Introduction on General Science Education): Hoshi-No-Wano-Kai (2003) ISBN4-89294-385-1 C3040.

Electromagnetic phenomena and prospective primary teachers

Stefano Vercellati, Marisa Michelini

Research Unit in Physics Education, University of Udine, Italy

Abstract

Even if magnetism and electromagnetism are generally not addressed during the formative courses in Italy, they are part of the curricular programs in primary schools. A formative learning intervention concerning electromagnetism was conducted in the context of the physics course for Prospective Primary Teachers (PPT) held at the University of Udine. In this paper are analysed how PPT address the analysis of the electromagnetic phenomena while they are facing an experimental learning path for pupils, looking to what conceptual nuclei and the learning knots are identified and re-used by them in the design of their own learning path.

Keywords: University education, prospective primary teachers, magnetism and electromagnetism

Introduction

Due to the diffusion of magnetic toys in everyday life, pupils have a larger experiential background on this magnetism than their teachers and they come to school having already well-established spontaneous interpretative models for the magnetic interaction [2,3,6]. In fact, electromagnetism is not a usual taught subject during the formation of Prospective Primary Teachers (PPT) even if magnetic and electric phenomena are part of the curricular topics addressed in the primary school in Italy. This situation creates the paradox of having in class pupils that have more practical experience with magnetic phenomena than their teachers [7]. As emblematic example, in Figure 3, is reported the comparison between pupils' [5,7] and teachers' predictions of the behaviour of two magnets approaching with the same pole when only one of the magnets is constrained.

In particular, previous researches [4,9] highlighted the presence of learning problems in prospective teachers knowledge. It is therefore necessary to produce Design Based Research (DBR) for PPT aimed to find recommendations for the effective implementation of Modules of Formative Intervention (MFI) [4]. The critical improvement of teachers' experience is necessary in order to allow PPT understanding of the roots of the pupils' naïve interpretative models [4].

Rationale and Research Questions

The implementation and the design of a MFI aimed to cover this gap with the pupils developing PPT's competences concerning both contents (CK) and pedagogical aspects (PK) in an interlaced way (PCK) [1,8] was therefore necessary. In this view, the framework offered by an experiential activity related to the development of an inquiry based learning path designed for a particular age group of students, could provide an effective context for an in depth discussion of the learning knots and the core nuclei of the subject [4,9] was designed and implemented to investigate:

RQ1. What are the conceptual referents that PPT use to analyse simple electromagnetic phenomena? (i.e. local vision)

RQ.2 How do the teachers identify learning knots and the conceptual nuclei faced during the proposed learning path?

RQ3. How do the PPT design their own learning path on the light of the conceptual nuclei and the learning knots identified? (i.e. global vision)

Strategies instruments and methods

A significant contribution in the foundation of conceptual nuclei and the identification of the milestones and the stumbling blocks of the subject is proposed by activities based on an experiential model centred on the personal involvement of PPT.

The formative activity proposed was structured in three main phases (Figure 1):

- 1) a MFI in which the content knowledge is offered by means of an experiential model in which PPT face the pupils' learning path;
- 2) the analysis of the subject in which PPT individuate the conceptual nuclei and the learning knots with the aim to compare and to discuss their individual choices in groups;
- 3) the group work phase in which PPT, working in small group, develop a proposal of learning path describing it by means the use of a conceptual map and a list of questions and actions aimed to be adopted in class with pupils.

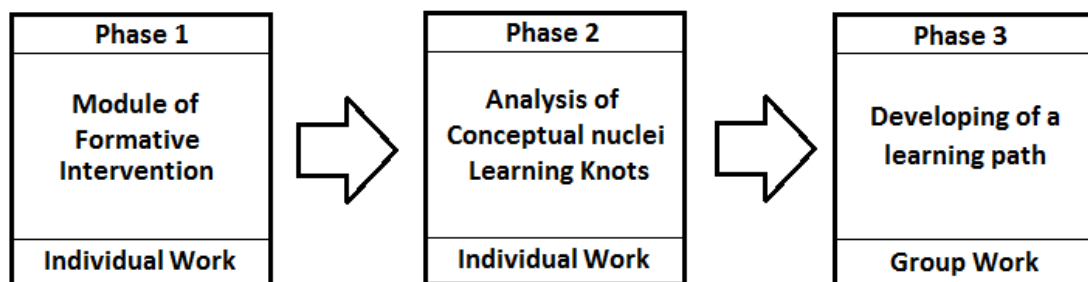

Figure 1. Flow diagram representing the structure of the formative activity

In particular, PPT carried out a well-experimented inquiry based learning path for primary pupils concerning magnetic and electromagnetic phenomena [7]. During the proposed activity, the PPT addresses interactive lecture demonstration, filing personal and group inquiry based worksheets.

The personal worksheet is used during the analysis of the phenomena proposed in the MFI the structured investigation of the conceptual nuclei and learning knots and the individuation of the critical questions. The group worksheet is used during the comparison phase between small groups of PPT to improve, on the basis constructed from the previous analysis, their individual learning path aimed to introduce magnetic and electromagnetic phenomena to pupils.

In Figure 2 are reported the activities and the key questions proposed by the researcher to the teachers during the MFI.

To the PPT formation course participated 120 PPT students, mainly female, in the second year of university (grade 15th, mainly 20 years old).

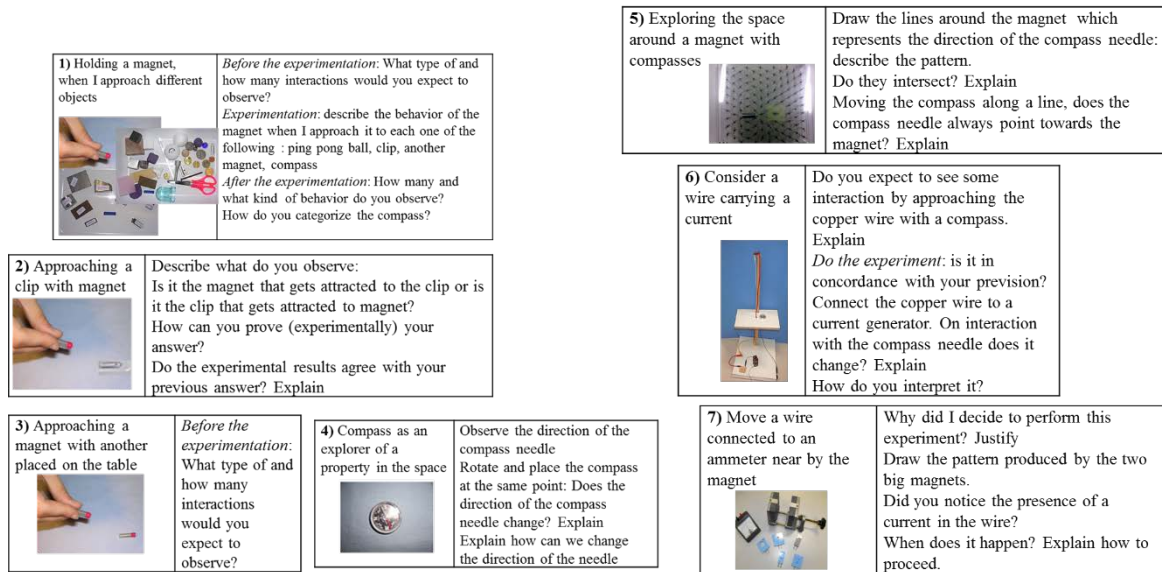

Figure 2. Activities proposed to PPT during the MFI and corresponding key questions

Data and data analysis

PPT worksheets are analysed and, for each item proposed, the PPT answers were categorized in accordance from the categories emerging from the analysis itself.

The analysis of the part related to the MFI gave us a picture of the main PPT alternative conceptions that they use in the interpretation of the phenomena. In particular, concerning situation 1, emerge how PPT focus their attention only on the more noticeable interactions (attraction or repulsion, 73%) and only 24% of them mentioned the possibility to have no (visible) interaction between a magnet and an object. Metals represent also a problem because several of them (64%) do not make a distinction between them, (i.e. “magnets attract metals”).

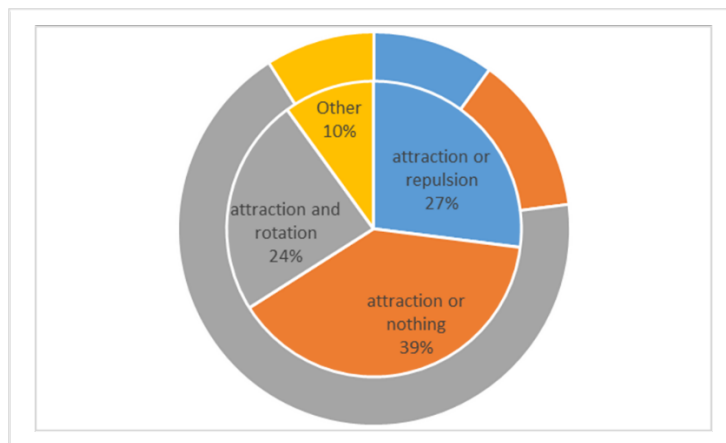

Figure 3. Example of teachers and pupils prediction concerning the behaviour of an unconstrained magnet when it is approached with another magnet in the situation in which two equal poles are faced. The distribution of teachers' answers is shown in the centre, while pupils' answers are represented in the circular crown.

In situation 2, the large majority of the students, identifying the magnet as the “active” object in the interaction, assuring that the magnet attracts the clip (93%) without considering the mutuality of the interaction. The PPT replies to situation 3 is reported in Figure 3; PPT, recalling their previous studies, reported what is written in almost all of the textbooks: “two magnets attract or repel each other” (27%) or referred only to the attraction (39%).

In situation 4, the PPT provide four types of drawings that are reported in Figure 4: 17% of the PPT provide a draw in which the field lines do not follow the orientations of the compass needles, 58% provide a draw in which the lines follow almost always the orientation of the compass needles, 12% provide a draw in which the lines follow always the compass needle and 5% provide a draw in which are represented only the filed lines or the compass needles. It means that, with the exception of some PPT (17% + 5%), the majority of the PPT match the correspondence that there is between the field lines representation and the compass needle orientation.

As regard the Ørsted-like experiment proposed in situation 6, is interesting to notice how, even if the first questions referred to the situation in which there is not electric current flowing, 45% of the PPT describe the situation as if it there is. In fact, they forecasted an explicit rotation of the compass forecasting also in 12% of the cases the perpendicularity of the direction of the compass needle and the wire. It is another context in which, as for situation 2, the PPT referred to their school knowledge in a strong way that, in some cases, overcome also the experimental observation of the approaching to new situations.

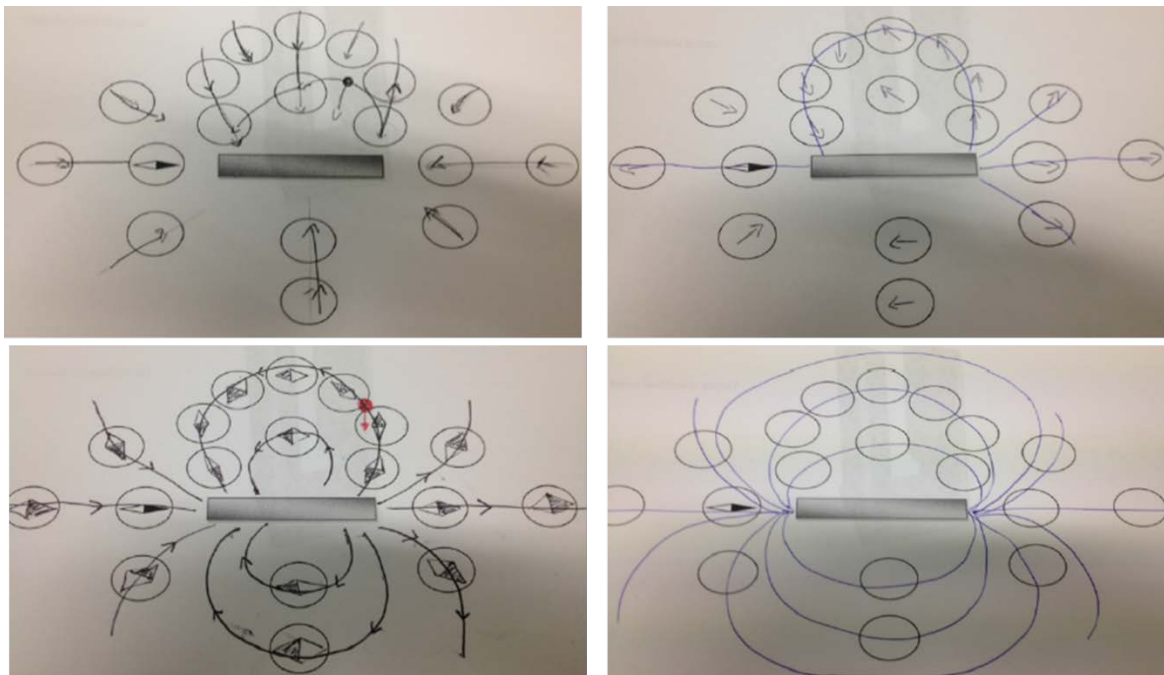

Figure 4. Exemplification draws for each one of the four categories of representation proposed by the PPT

Looking at the data collected during the second phase, the conceptual nuclei individuated by PPT are related only to some of the activities proposed. In particular: no conceptual nuclei are identified for situation 1 and 7; the mutual force involved (situation 2) is mentioned by 5% of the PPT, the polar structure of the magnets (22% - situation 3); the role of the compass as an explorer of the magnetic field (38% - situation 4); the field lines

as orientation lines, the properties of the magnetic field (42%) and the difference between field and force (51%, 42%, 39% – situation 5); the role of the electrical currents (51% - situation 6).

While the individuation of the learning knot is related only to three specific situations: Rotation in magnetic interactions and the presence of the two poles (42%, 21% - situation 3); the difference between force and field, the line of orientation and the definition of field (55%, 51%, 15% - situation 5); the sources of magnetic field (15% - situation 6).

However, the more interesting things happen with the analysis of the phase 3 where the PPT had to re-use the situations proposed constructing their own learning path. If we look at the distribution of the use of the situations propose we have that: 97% of the PPT used situation 1, 35% situation 2, 65% situation 3, 26% situation 4, 19% situation 5 and 0% situations

6 and 7 (Figure 5). Therefore, there is no relation between the use of situations and the identified learning knots or the identified conceptual nuclei. The criterion of selection for the situations included in the learning path is based on another criterion, and in particular, it appears to be strongly associated with the level of self-confidence that PPT have facing of each proposed situation. In the planning of the learning path, they avoid situations that are challenging also for them, proposing situations in which they feel to be familiar.

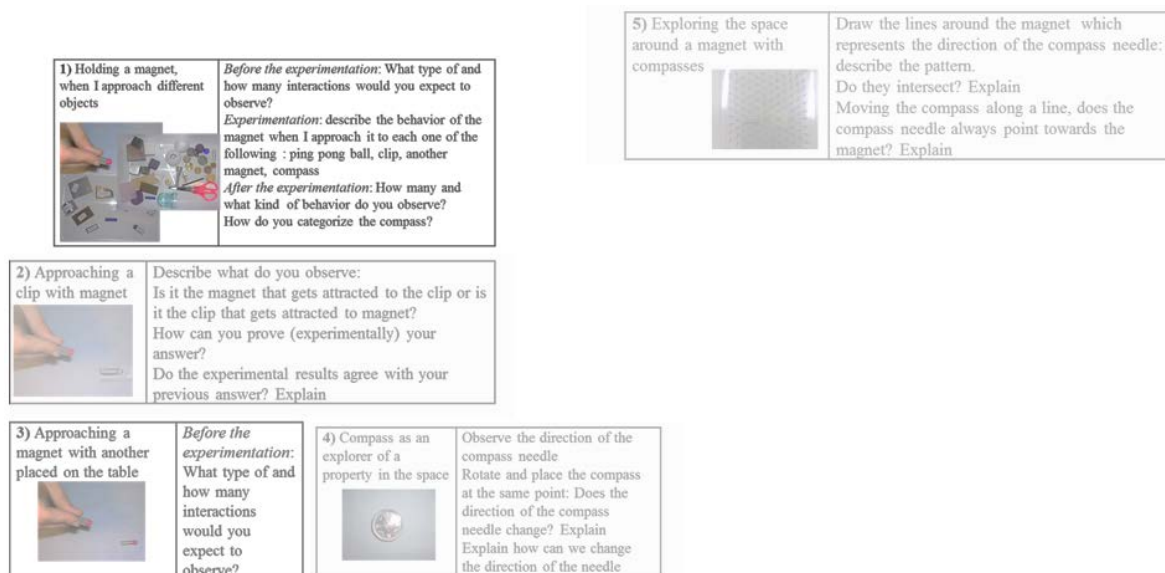

Figure 5. Pictorial representation of the use of the different situation in PPT design work.

The transparency of each activity is related to the use that PPT did of it in their work of designing (how could be noticed, activities 6 and 7 are completely transparent)

All of the groups but three, proposed to address the study of the magnet interaction as the first step of their learning path: 59% propose to identify the way in which the magnets interacts; 31% to explore the interaction of the magnet to categorize objects/material, while 9% use other approaches. For more than half of the groups, the learning path consist in a deep analysis of a that situation (57%), while 13% addressed also the reciprocal nature of the interaction and another 13% proposed to introduce the magnetic field and (9%) the field lines.

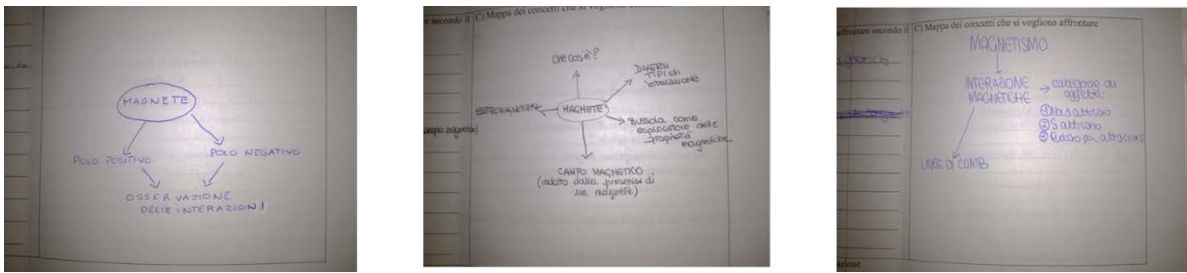

Figure 6. Examples of conceptual maps, designed by the PPT

More than three quarter of the groups began with the selection of the topic, while the remaining quarter began with the drawing of a conceptual map (Figure 6). Only one group mentioned the definition of the learning goals, while others directly design the activities and formulate their key questions. Half of the groups before design the activities and then the questions, while for the other half reversed this process.

Conclusions

Several aspects are shown by the analysis of the worksheets of the three phases. In the first phase, emerges which are the typical approach of the PPT in the addressing the phenomena, and in particular emerge how they strongly referred to their previous school knowledge to give an early interpretation of the phenomena. In particular, PPT reported standard rituals interpretations as the idea that between magnets there is only attraction or repulsion.

In the second phase, the selection of conceptual nuclei and the learning knots, PPT are able to identify the main ones, with particular focus on the aspects that are more surprising for them. In particular, the presence of rotations in the magnetic interactions and the distinction between field and force lines.

In the third phase, during the group and the designing phase, emerges a discontinuity between the work done in the two previous phase. Even if PPT had addressed the phenomena and had identified the conceptual nuclei and the learning knots during the design phase, emerges a reductionist approach. In their learning path, PPT proposed only the first and simpler situations. In this way, they do not include in their learning path several of the important aspect they had identified in the second phase without entering the interpretative plane of the phenomena, but remaining on the descriptive level even if it is addressed in detail. Therefore, emerges the need of a formation phase where PPT had to focus on the interpretative aspects of local conceptual knots overcoming in the planning of pupils activities. It is in fact well known that conceptual familiar referents will be activated on the global plan in a path when are already used on the local level.

References

- [1] Anderson D. K.: (2008) Handbook of Technological Pedagogical Content Knowledge (TPCK) for Educators, Collaborator AACTE Committee on Innovation & Technology, Routledge.
- [2] Challapalli S.R.C.P., Michelini M., Vercellati S.: (20130), Building Formal Thinking with Pupils on Magnetic Phenomena in Conceptual Laboratories, in *Procedia-Social and Behavioral Sciences*, Elsevier, 93, 946-950.

- [3] Gilbert J. K., Boulter C. J., Rutherford M.: Models in explanations, part 1: horses of courses?, *IJSE* 20, 83 - 97 (1998).
- [4] Michelini M. ed.: (2004), *Quality Development in Teacher Education and Training*, Forum, Udine.
- [5] Michelini M., Vercellati S.: (2010), Primary pupils explore the relationship between magnetic field and electricity, in Raine, D., Hurkett, C., Rogers, L., *Physics Ed. Community and Cooperation: Selected Contributions from the GIREP - EPEC & PHEC 2009 International Conference*, Lulu/ The Centre for Interdisciplinary Science, Leicester 2, 62-170.
- [6] Michelini M., Vercellati S.: (2011), Exploring the sources of magnetic field and the interactions between them to interpret electromagnetic induction: a proposal of conceptual laboratory, in proceedings of the GIREP-ICPE-MPTL Conference in Reims.
- [7] Michelini M., Vercellati S.: (2012) Pupils explore magnetic and electromagnetic phenomena in CLOE labs, *Latin American Journal of Physics Education*, Volume 6, Suppl. I.
- [8] Shulman L. S.: (1987), *Knowledge and Teaching: Foundations of the New Reform*. *Harvard Educational Review*, 57 (1), 1-22.
- [9] Vercellati S.: (2010 b) A discussion on disciplinary knots concerning electromagnetism and superconductivity using a Web environment in the context of an EU Project (MOSEM) for research-based in service teacher training, *Selected Paper Book Multimedia in Physics Teaching and Learning-MPTL14, Il Nuovo Cimento C*, Year 2010 Issue 03-May/June, pp189-193.

History Sheds Light on the Difference in the Nature of Physics and Mathematics in Guiding Physics Educators to a Better Understanding of Mind Preferences of Students

Lina Vinitzky-Pinsky¹, Igal Galili²

¹ Achva Academic College, Israel

² Science Teaching Center, The Hebrew University of Jerusalem, Israel

Abstract

Physics and mathematics present two areas of intellectual activity deeply interwoven throughout the long history of science. Despite their close relationship, they preserve different ideological realms. This situation implies complexity of the school curricula of both disciplines. By observing the opinions of physicists and mathematicians in history, one may better understand the role of mathematics in physics and identify specific intellectual requirements of each realm. In a constructive-qualitative research we interviewed twenty individuals. The constructed profile of views on the role of mathematics in physics curriculum revealed a variety of opinions demonstrating their complementarity and certain perplexity. The activity in physics was described by specific values, interests, tolerance to approximate and schematic accounts, experimentation and other features different in sciences and mathematics. Our findings indicate existence of specific intelligence and mind preferences in each field. This contrasts the common view considering physics and mathematics in one category of cognitive abilities and intelligence. Historical examples of different intellectual interests of physicists and mathematicians confirm the delicate balance between the mathematical and physical aspects of knowledge and hence, the need to represent it in physics curricula, teaching materials, assessments, and students selection.

Keywords: comparison of physics and mathematics in education, difference in required intelligence applied in physics and mathematics

Introduction

Mathematics and physics create a symbiosis of two areas of human thought deeply entangled, mutually dependent, and yet different. Their relationship is complex and often implicit in educational practice. History of science is especially informative in this regard showing that mathematicians and physicists while attacking the same topic intuitively were separated in interests and approaches and held different values and goals. This reality of two fields different in nature, but still deeply interwoven and mutually dependent, often creates confusion and obscurity that deserve clarification. We address this complexity with respect to physics education. By observing history of science, considering historical examples, exploring the opinions of physicists and mathematicians on the role of mathematics in physics, we may understand better the ideologies of both realms – mathematics and physics – and identify specific intellectual features of each to be taken into account in education.

Poincaré (1903) and Duhem (1991) elaborated on the veracity of cognitive preferences among scientists and mathematicians. Lacatos (1970) considered the activities in physics and mathematics as a fulfillment of research scientific programs, different in the type of required intellectual activity. However, in education, the awareness of such differences

between the two realms is rarely observed. The situation in education is rather represented by Gardner (1983), who is known for elaborating the idea of multiple intelligences. He did not distinguish between the skills required in mathematics and physics. Both were referred to the same category of logico-mathematical intelligence and assessed in special tests popular in education such as IQ and SAT, for instance.

Furthermore, within the widely spread perspective, common in education, mathematics is considered to be a tool of physics (Krieger, 1987). However, a more profound vision of mathematics-physics relationship can be obtained by applying the idea of Bohr's complementarity introduced by him in quantum physics and expanded to considering knowledge in general (Bohr, 1949/1959). Within this vision, different accounts of reality show complementarity to each other in a special sense. Migdal (1990) explicitly stated this vision regarding the relationship between mathematics and physics. Indeed, it is reasonable to agree regarding these different but related aspects of human activity that the more one focuses on the conceptual account of reality in physics, the less precise the formal account of the same by means of mathematics becomes. Seemingly, one comes at the expense of the other for the different emphasis made and different goal placed in the course of the account.

The current curricular situation, however, may exemplify confusion with regard to the mathematics-physics relationship. It starts from the curricular status of both disciplines. While mathematics is mandatory in many countries, physics usually remains an elective subject, especially in high schools. Instead of educational complementarity of the subjects of leaning for the wide public of learners, physics is learned by a minority of high school students (about 10%, in our country). It is indicative in this regard that to be enrolled in physics class the system requires the student to excel in math. If physics and math present different intelligence, is such precondition appropriate? What level and kind of mathematics do students need to succeed in high school physics? What are the special skills required for learning physics in comparison with mathematics? If mathematics is the language of physics, what else is physics about, beyond its language?

We dealt with these questions in our study of which we address here only certain fragments. In particular, we rendered twenty interviews in the framework of a constructive-qualitative research (Shkedi, 2011). We comprised a representative sample that included teachers of physics, mathematics and physics, science, physics professors experienced in school teaching, and education researchers. We also interviewed the chief supervisor of physics teaching at the Ministry of Education. The chosen teachers were active in rural and urban schools of different socioeconomic status. We applied semi-structured interviews around the questions of our interest and allowed the interviews to progress according to the particular response of the interviewed. Another data resource was provided by rendering a historical review of history of science within the considered perspective. Historical examples provided us with a suggestive background, allowing triangulation in our data analysis and interpretation. This approach increased the reliability of our qualitative research and inferences. Using both resources – interviews and review – we could get a better understanding of the subject of interest and also shed light on the issue of mind preferences of the students relevant in facing the complex situation of physics interwoven with mathematics.

Renowned scholars on the role of mathematics in physics

To facilitate our understanding of the role of mathematics in physics, we briefly reviewed the history of science in this perspective. We started from Pythagorean School which ascribed the central role to numbers and their ratio in the design of cosmos open to understanding. They stated the idea of relationship of numerical characteristics (commensurability) as the most fundamental underpinning of the whole reality observed by people. This mathematical approach reached its highest sophistication in the concept of incommensurability (irrational ratio) – a pure abstract concept regarding numbers. Indeed, no actual measurement could produce an exact irrational number, say, $\sqrt{2}$. The two great Hellenic knowledge frameworks, Platonic and Aristotelian, provided polarized attitudes to the role of mathematics in the theory of nature. The former considered mathematics as a perfect representative of the ideal harmony of true and superior world of ideas and forms, of which the real world is an imperfect representation. As such, mathematics can serve as a reliable guide, if not the only one, of human revealing of the truth about the order of the universe (cosmos)¹. However, as Pythagoreans before him, Plato freely speculated about the meaning of mathematical objects. Thus, the shapes of perfect solids represented, in his view, the basic elements (cube for earth, octahedron for air, icosahedron for water, and tetrahedron for fire). A speculative meaning was ascribed to circular (spherical) shape. It was removed only in the 17th century. The Pythagorean-Platonic approach became paradigmatic representing an extreme *rationalistic* paradigm.

Aristotle suggested an opposite approach to reveal the world design. His physics was entirely qualitative, conceptual, and avoiding any mathematical accounts. It was based on the empirico-logical circle in construction of physics knowledge via applying rules of logic in the course of contemplation of reality. Mathematics was distinguished from sciences by its subject matter and considered eternal, non-changing in time knowledge (Bechler, 1992). For instance, in Aristotle's view, mathematicians perceive in a ball its roundness, the geometrical form, its radius, but ignored matter and its change. Much of his *Physics* Aristotle (1984) devoted to the sophisticated debate with Zeno's paradoxes who by manipulating with the mathematical logic of infinite division of distance excluded the very possibility of real motion – the subject of physics. Aristotle pointed to the subtleties of this paradox. He ingeniously distinguished between motion and a collection of moments, actual from potential infinity. However, lacking mathematical account Aristotle's physics was greatly limited in validity regarding reality and the accuracy regarding any natural phenomenon.

In the following Hellenistic period, scientists rebelled against Aristotelian paradigm including mathematical models into physical accounts of Nature. Euclid, Ptolemy, Archimedes, among others, reached a great progress in the mathematical description of the world. Mathematics provided tools for investigations in mechanics, optics, and astronomy. In a sense, the mathematical account was ahead of the conceptual understanding and practical applications of physics knowledge. The Arabic science (eg. Al-Kindi, Alhazen) continued the Hellenistic trend and further developed mathematics and its application in optics and astronomy (e.g. Al-Khalili, 2010).

In the medieval Europe using mathematics in the research of nature experienced a breakthrough in the fourteenth century in Paris and Oxford. Bradwardine, Heytesbury,

¹ This was the meaning of the logo allegedly decorated the entrance to Plato's academy: Those unversed in geometry will enter here...

and Swineshead in Oxford and Oresme in Paris revived a logico-mathematical approach to philosophical problems significantly improving the conceptual account of phenomena in quantitative terms (instant velocity, acceleration, graphical representation, etc). Galileo fully adopted these results of the medieval scholars and related those to the investigation by means of an experiment with controlled variables. His special vision of the world organization – known as a Book of Nature written in the language of mathematics – designated the new paradigm of Physics – Mathematics relationship. It was this paradigm proclaiming a symbiosis between the two that was further developed in modern physics.

Starting from the scientific revolution of the 17th century Kepler, Descartes, Newton progressed in the mathematical style of problem solving and formulating physical theories. In the following history the progress in mathematics and physics went in parallel and was reciprocally important. Thus, the progress in mechanics was possible only after Newton's invention of mathematical analysis of infinitesimals. The similar breakthrough in optics and electromagnetism took place only in the 19th century due to the development of the mathematical tools such as function of several variables and partial derivatives. That was not without parallel conceptual progress which introduced new conceptions of interference, electrical charges, etc. Light waves and the complex formalism of Fresnel integrals led Maxwell to the theory of electromagnetism that combined qualitative and quantitative accounts of reality.

The case of Maxwell is representative. The model in the basis of his theory incorporated movement and tension of the all-pervading continuous medium. Ontologically it appeared to be entirely false. However, the equations of the theory – Maxwell's Equations – remained valid providing an accurate account for all known at that time electromagnetic phenomena. Does it mean that mathematical formalism surpasses conceptual content of physics? Is mathematical account independent of the model it originally elaborated? Does mathematical account need any material explanation? (Tweney, 2010). The situation in modern physics, where simple mechanical models are lacking, only strengthened this question regarding the nature of physics-mathematics relationship.

History displays physics and mathematics relationship as a symbiosis. The role of mathematics in physics is multiple: it serves as a tool, acts as a language, provides logico-deductive reasoning and a phenomenological model. History shows a strong interdependence of these two areas of intellectual activity different in ideology and epistemology. Thus, for example, while great mathematicians ardently pursued calculation of the PI, it was ignored by physicists. Physicists did not try to prove the existence of motion. They were not aware of the complexity of instant velocity. Physicists took it, as they took motion, as given by intuition and used derivative without worry about the ratio of infinitesimals.

A powerful understanding of the mathematics-physics relationship was reached basing on Bohr's principle of complementarity (Bohr, 1949/1959). In this profound vision, some descriptions of reality are in complementary relationship with one another. Mathematics and physics have such a complementary relationship (Migdal, 1990). This vision recognizes the essential difference between mathematics and physics in the account for the reality. In different context, while seeking different goals, using different tools and appealing to different interests one of the two comes to the fore leaving the other behind.

Opinions of practitioners

As mentioned, we rendered twenty interviews with a representative sample of teachers, professors and researchers related to physics education. We then constructed profile of their views on the role of mathematics in physics education. We were witnesses to a variety of opinions in addressing the subject revealing its perplexity.

One of them, a physics professor experienced in teaching school physics, clearly stated that the difficulties of physics learning were not in understanding of mathematics but in concepts:

Interviewer: Do you believe that the difficulty of students stem from a lack of mathematical knowledge?

Interviewed: No... Actually, fifty-fifty, ... in many cases, students are good in mathematics, but simply do not understand what happens in physics. And it is up to you to explain that to them.

Interviewer: So why are there students who find physics difficult?

Interviewed: That depends on the person. What can I say? There are things that are difficult for them to understand ... to start from the famous error of Aristotle, he thought that strong push was necessary to maintain high speed. We know that in order to move at high speed, we don't need any effort. We need, precisely zero effort, as stated by Newton's first law. These are the difficulties in understanding physics, not connected to mathematics, but rather to general understanding. Problems with understanding of what was stated in Newton's first and second laws impeded the development of physics for 2000 years.

A teacher pointed out another requirement of physics, beyond the qualitative account which appears to be insufficient:

Interviewed: The moment you stop talking qualitatively and start talking quantitatively, it's an absolute requirement.

Furthermore, the interviewed stated that physics differed from mathematics in its values, interests, tolerance to approximate and schematic accounts, need of experiments and observations. Those features were considered unique in science. With regard to the difference in the required abilities, one physics educator said:

Since physics uses approximations, in mathematics (in physics) there are shortcuts. Throughout history, there were physicists who were weak mathematicians, those who did experiments... It is possible to imagine someone who knows to do experiments, possesses engineering ability and is not good in theoretical math. This happens. There are people like this, also in high school where physics is simpler...

Interviewer: What do you mean by that?

Interviewed: There were people who did experiments well but they did not apply mathematics. For example, Edison didn't know well mathematics. In such cases, people who were good with their hands did not do mathematics...

Some of the interviewed also mentioned similarity between mathematics and physics. A physics professor and an educational researcher both stated that science presented a theory. This implied, in their view, looking at reality through a certain framework based on something that one accepts without checking. They believed that this feature is common for all sciences and is similar to mathematics. Theories are somewhat like axioms.

However, unlike mathematics, they stated, there should be a correspondence between theory and reality, which should be tested. They mentioned, however, that many features of specific knowledge are shared by physics and mathematics and they belong to the foundation of scientific thinking. Thinking in both mathematics and physics is based on something known.

In contrast, some others of our sample stated that mathematics differed from physics in its general structure, which incorporates basic concepts, axioms, and definitions, followed by the derived statements regarding the relationship among the concepts. Understanding of the difference between axiom and theorem, specific determination and a claim of existence, various types of proof are required. Mathematics ascribes a special value to a proof. This is different in physics, as one of the interviewees stated:

When a student learns mathematics, he is learning a special discipline.

Mathematicians and physicists may ask questions expressing different interests in their treating the same subject. One of the interviewed illustrated this by an example addressing a root of a number. He said:

It is possible to ask two kinds of question regarding the root from two ($\sqrt{2}$). The first is ontological: Is there a number which is the root of some order of two – a positive number? This presents, in essence, an existential question seeking a real number which presents the root of certain order, and it requires an answer which is an existential proof. The second question is epistemological: How do we know this? How do we get it?

The answer to the second question is different, but it is that answer which might be of interest to a physicist.

Our informants noted which of the mental features they mentioned were mainly required in mathematics, which in physics, or which in both areas. Thus, thinking abstractly, formally, logically, working algorithmically, and analyzing rationally were ascribed to both subjects. Yet, the ability to imagine, think in analogies, intuitively and concretely, consider experiment, transfer between knowledge representations and contexts, provide verbal explanation and heuristic evaluations were mentioned as required especially in physics.

The interviewed added that unlike university level, the mathematical skills required for learning physics at school are significantly diminished in the existing school curriculum. Therefore, students might need more versatile cognitive skills in physics class. A physics teacher from one of the best schools put it as follows:

[School] physics presents students with difficulties beyond those of [school] mathematics. The world of mathematics is a closed one. It is a logical world, and that's it. Physics is not only about logic. Many, many more abilities are required, and in order to be able to do it [physics] you must be concrete and you need to act in the abstract area. You need to be able to translate [the subject] from one [representation] to another. Experimenting in the laboratory is concrete, observation is concrete. The mathematical model is abstract. In order to do meaningful physics, you must be able to go from one to the other. Of course, one may do physics formally, to solve problems out of context, and it will be like math ... in a sense, physics is beyond math. It requires heuristic skills and abilities unlike math which is studied [at schools] as algorithms.

The same teacher also noted another important difference he saw between math and physics in school practice:

Physics uses different representations, and the learner seeks the suitable one. Should this problem be solved by reasoning? or analytically? or by geometry? Should I draw a graph

to show the function? All these questions appear in physics. Geometric, mathematical and algebraic skills are checked at the same time, while in math you look at problem and know in advance, this is a problem in algebra or in induction...

The interviewed agreed that to succeed in physics class it is necessary to be familiar with basic notions of algebra and geometry and manipulate them (for example, isolate variables, solve equations, establish similarity of triangles, apply trigonometric functions, and decompose vectors). However, to succeed in conceptual understanding of physics one needs cognitive and intellectual abilities specific for physics domain.

Conclusion

Given the historical paradigms of mathematics-physics relationship we could better understand the teachers' views on this subject in curricular perspective. It appears that apart from different ontological and epistemological agendas, physics demands a series of psychological features of a particular character. This fact and the profile of interviewed views suggest refinement of the unique logico-mathematical intelligence as currently accepted to be a prerequisite for studying physics. The dependence of physics on mathematics should take into account aspects of a different ideology (values, interests, tolerance to approximate schematic accounts, practical work in experiments, observations, and other features). Lumping physics and mathematics in one category (Vinitzky-Pinsky & Galili, 2013) mislead in recruiting students to physics class, causing missing the potentially appropriate students.

Pertinent history reveals the differences between the nature of physics and mathematics and may guide physics educators toward better understanding of the cognitive preferences shown by the students. In the physics classes there should be comparative understanding of features of mathematics and its values, such as accuracy and rigor of the account, multiple proofs, coherence with axiomatic framework, exact solutions and justifications and features of physics and its values: appreciation of schematic, qualitative, tentative accounts of reality which can be tested experimentally, revealing cause-effect relations in nature and phenomena explanation. The difference in the nature implies the need for a delicate balance between the mathematical and physical aspects of knowledge to be reflected in physics curricula and assessments. It should be displayed in teaching materials and guide the selection of students for physics classes. The complementarity of the two domains is necessary and should be appreciated.

References

- [1] Al-Khalili J.: *Pathfinders. The Golden Age of Arabic Science*. Penguin Books (2010).
- [2] Aristotle: *Physics*. In W. D. Ross (trans) and J. Barnes (eds). *The Complete Works of Aristotle*. Princeton: Princeton University Press (350 B.C.E. /1984).
- [3] Bechler Z.: *Aristotle's philosophy of science*. University airs. Publishing-Ministry of Defense (1992).
- [4] Bohr N.: *Discussion with Einstein on epistemological problems in atomic physics*. In P.A. Schlipp (Ed.), *Albert Einstein: Philosopher-Scientist*. New York: Harper & Row (1949/1959), pp. 201–241.
- [5] Duhem P.: *The Aim and Structure of Physical Theory*. Princeton University Press, Princeton, NJ, (1991), pp. 55-104.

- [6] Gardner H.: *Frames of Mind: The Theory of Multiple Intelligences*. Basic Books, New York, (2011), pp. 135-178.
- [7] Krieger M. H. (1987): *The Physicist's Toolkit*. *American Journal of Physics*, 55, 1033-1038.
- [8] Lakatos I.: *Falsification and Methodology of Scientific Research Programs*. In I. Lakatos & A. Musgrave, *Criticism and Growth of Knowledge*. Cambridge University Press, New York, (1970), p. 91-196.
- [9] Migdal A. B.: *Physics and Philosophy*. *Voprosi Filosofii*, 1, 5-32, Nauka, Moscow (1990) (in Russian).
- [10] Poincaré H.: *Science and Method*. Dover, New York (1903).
- [11] Shkedi A.: *The Meaning behind the words: Methodologies of Qualitative Research: Theory and Practice*. University of Tel Aviv Press, Tel Aviv (2011).
- [12] Tweney R. D. (2010): *Representing the Electromagnetic Field: How Maxwell's Mathematics Empowered Faraday's Field Theory*, *Science & Education*. Available from: <http://www.citeulike.org/article/7081452>
- [13] Vinitzky-Pinsky L., Galili I. (2013): *Refinement of Logico-Mathematical Intelligence in the Context of Physics Education*. Puerto Rico: NARST conference 2013.

Validating the Force Concept Inventory with Sub-Questions

Jun-ichiro Yasuda¹, Masa-aki Taniguchi²

¹ Center for General Education, Gifu University, Gifu, Japan

² Comprehensive Scientific Education Center, Meijo University, Nagoya, Japan

Abstract

We address the validity of the FCI, that is, whether respondents who answer FCI questions correctly have an actual understanding of the concepts of physics tested in the questions. We used sub-questions that test students on concepts believed to be required to answer the actual FCI questions. Our sample size comprises about five hundred respondents; we derive false positive ratios for pre-learners and post-learners, and evaluate the significant difference between them. Our analysis shows a significant difference at the 95% confidence level for Q.6, Q.7, and Q.16, implying that it is possible for post-learners to answer three questions without understanding the concepts of physics tested in the questions; therefore, Q.6, Q.7 and Q.16 are invalid.

Keywords: physics education research, force concept inventory, validation

Introduction

Numerous types of diagnostic tools have been studied to examine how much students have learnt physics. The Force Concept Inventory (FCI) is one of the most important instruments for assessing students' understanding of the Newtonian conceptual framework [1–4]. The FCI is a 30-item, five-choice survey that can be solved without the use of equations. Further, the distractors in the questions are constructed based on the naive conceptions about mechanics.

When conducting a survey using a diagnostic tool such as the FCI, it is first necessary to analyse its validity [5]. Validity refers to whether the instrument measures what it claims to measure. In the case of the FCI, we must investigate whether the FCI accurately assesses students' conceptual learning of Newtonian mechanics.

The FCI has previously been validated from various standpoints. Hestenes and colleagues evaluated the validity of the wording and diagrams in its questions [1,6], while Rebello and Zollman analysed the validity of the distractors in the questions by comparing students' responses to four FCI open-ended questions [7]. Morris and colleagues also evaluated the validity of the distractors by analysing the item response curves [8,9], and Stewart and colleagues validated the contexts of the questions using a ten-question context-modified test [10]. Yasuda and colleagues interviewed students and found that some students were able to provide the correct answer to Q.6, Q.7 and Q.16 even when using the incorrect reasoning [11].

In our approach, we use a decision table to clear the problem (Table 1). In Table 1, the rows mean whether a student answers an FCI question correctly or not, and the columns mean whether the student understands the concept tested in the FCI question or not. False positives refer to correct answers provided by students who do not understand the physics concept being tested in the questions [12]. False negatives, by contrast, refer to incorrect answers provided by students who understand the physics concept tested in the question. The FCI question may be valid if the true positives and true negatives are many enough,

and the FCI question may not be valid if the false positives and false negatives are many enough.

Table 1. Decision Table of an FCI question

	Understanding	NOT Understanding
Correct	True positive	False positive
Incorrect	False negative	True negative

From Table 1, we tackle the following 3 issues:

1. How can we define understanding?

The definition of the word “understanding” is one of the difficult problems of the cognitive science. In our study, we will define understanding operationally by means of decomposed questions of the original FCI question.

2. How can we evaluate the amount of false answers?

There is a well-known statistical variable to quantify the amount of false answers. We will explain and use it later.

3. With the variables, how can we evaluate the validity?

Using the statistical variables, we need a criterion or a standard value to judge whether an FCI question is valid or not. In order to decide the criterion, we form a hypothesis on this issue later.

In simple terms, our research question examines whether students who respond correctly to an FCI question, understands the physics concept that a question is meant to test. We explain our methods in order of the three issues described above.

Method 1: Definition of understanding

Usually, students answer an FCI question and we check whether the answer is correct or not. However, we cannot judge if the student understands the concept tested in the question. Therefore, we decompose an FCI question into a series of cognitively sequenced questions (Figure 1). We refer to these questions as *subquestions*. If a student answers all of the subquestions correctly, we assume that he or she has an understanding of the physics concept tested. The decision table of answers with subquestions is presented in Table 2.

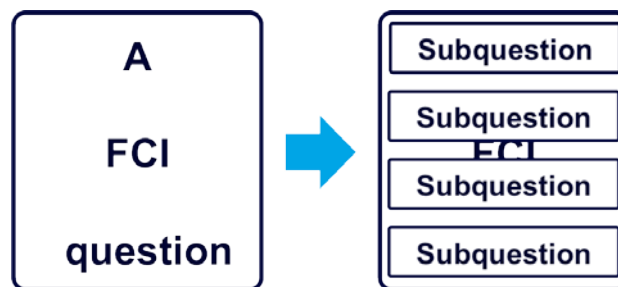

Figure 1. Decomposition of an FCI question

Table 2. Decision Table of an FCI question with subquestions (SQs)

	Answer all SQs correctly	Answer not all SQs correctly
Correct	True positive	False positive
Incorrect	False negative	True negative

Which of the eight choices best represents the direction of the following variables, just after the string breaks? If you think a variable is zero, write 9.

SQ1. Force acting on the ball

SQ2. Acceleration of the ball

SQ3. Velocity of the ball

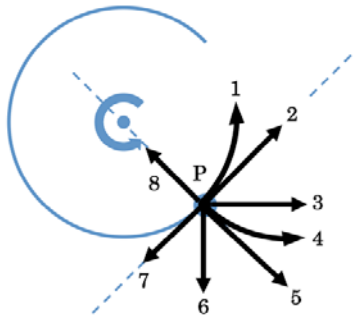

Figure 2. Outline of the subquestions (SQs) of FCI Q.7

As an example, we show the outline of the subquestion of the FCI Q.7 in Figure 2. The original FCI Q.7 probes students to comment on the trajectory of the ball after the string breaks. The subquestions presented in Figure 2 gives more direct information such as force, acceleration and the velocity of the ball after the string breaks [13].

Method 2: Quantification of false positives

We analyze the false positives by evaluating a well-known statistical variable, *false positive ratio*. If event A represents answering an FCI question correctly and event B represents answering all the related subquestions correctly, then the false positive ratio of that question is defined as follows:

$$P(A|NOT B) = \frac{N(A \text{ and } NOT B)}{N(NOT B)}$$

where $N(A \text{ and } NOT B)$ is the number of students who answered an FCI question correctly and answered more than one of the subquestions incorrectly, and $N(NOT B)$ refers to the number of students who answered more than one of the subquestions incorrectly. In this case, the false positive ratio can be interpreted as the identification of the subgroup that does not understand the physics concept and calculating the percentage of correctly answered questions (Figure 3).

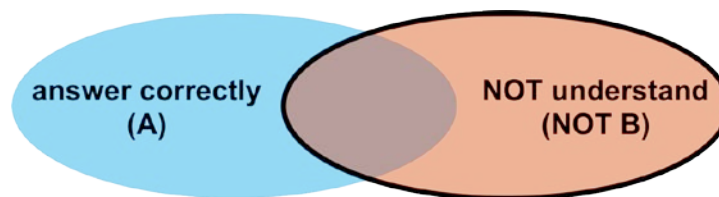

Figure 3. Venn diagram about false positive ratio

Method 3: Criterion of validity

We need a criterion, namely a reference value, to relate the false positive ratio to the validity. The reference value is the “ideal” probability with which a student who does not understand the concept tested answers correctly. If a false positive ratio of an FCI question is much larger than the reference value, the FCI question is judged to be invalid.

The simplest reference value is the probability to answer correctly by random guessing, that is, $1/5 = 0.2$. However, students who misunderstand the concept might tend to choose a wrong answer if the distractors of the question are well constructed, or these might tend to choose a right answer if the distractors of the question are not well constructed. In the former case, the ideal probability is less than 0.2, and in the latter case, the ideal probability is more than 0.2.

Since we need to separate the effect of distractors, we take, as the reference value for each question, the probability with which a student who *has not learnt* (pre-learner) the concept tested but answers correctly: FPR_{pre} [14]. This value is then compared with the probability with which a student who *has learnt* (post-learner) the concept tested and answers correctly: FPR_{post} . If the structure of the question is valid, it follows that only if students cannot understand the physics concept will they answer incorrectly, except in cases of coincidence. Therefore, if we choose the subgroups that do not understand the physics concept tested from both pre-learners and post-learners, the percentage of questions answered correctly for each subgroup should be comparable. However, there is one case in which FPR_{pre} and FPR_{post} are not comparable i.e. when the post-learner responds correctly by using an incorrect physics concept or by remembering the correct answer of a similar question. In this case, the false positive ratio of post-learners could become large. Therefore, if FPR_{post} is significantly larger than FPR_{pre} , we judge that the question is invalid because post-learners can correctly answer the question even if they have no understanding of the physics concept tested.

We can explain this criterion from another standpoint. We begin with forming the following hypothesis: if an FCI question is valid, the FCI question cannot distinguish whether the student has already learnt the concept or not when a student does not understand the concept tested [15]. In this case, the false positive ratio of the pre-learners takes similar value to the false positive ratio of the post-learners. If we take the contraposition of this hypothesis, it follows that an FCI question is invalid if there is a significant difference between the value of the false positive ratio of pre-learners and the false positive ratio of the post-learners. The outline of this logic is shown in Figure 4.

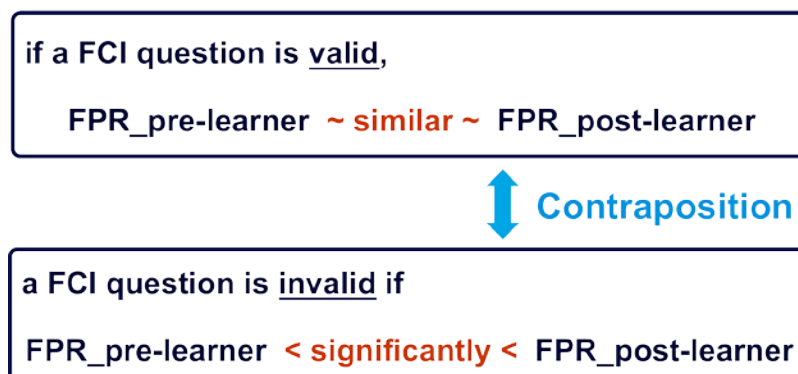

Figure 4. Outline of the logic about our criterion of validity

Table 3. False positive ratios of the pre- and post- learners in this and previous survey

	Q.5	Q.6	Q.7	Q.16
FPR _{pre} (2013)	0.11	0.576	0.35	0.13
FPR _{post} with CL95% error (2013)	0.08±0.06	0.653±0.067	0.61±0.07	0.52±0.05
Significant difference	NO	YES	YES	YES
FPR _{pre} (2012)	0.39	0.26
FPR _{post} with CL95% error (2012)	0.71±0.13	0.50±0.14
Significant difference	YES	YES

Settings

Data collection

We surveyed 524 students at one public university (Gifu U.) and three private universities (Meijo U., Kansai U. and Ritsumeikan U.) from April to June 2013. Respondents comprised students from different departments (e.g.: engineering, agriculture, human studies), and most were students in the university's physics classes (e.g., calculus based mechanics, general physics). The students were given no incentive to participate (in the form of money or grade points).

Surveyed questions

We surveyed the questions that showed false positives from our previous interview study [11]. The questions are Q.6, Q.7, and Q.16. For example, students were able to provide the correct answer to Q.16 even when using the incorrect reasoning that the forces were balanced because the two vehicles were moving at a constant speed. Similar shortcomings have been highlighted by other studies [16,17]. In addition to these questions, for comparison purposes, we surveyed Q.5, which showed no false positives in the interview. The physics concepts tested in each question are as follows; Q.5: circular motion, Q.6: circular motion, Q.7: circular motion, Q.16: Newton's third law [18].

Results

The results of our survey are presented in Table 3 which includes the errors of the false positive ratios of the post-learners (FPR_{post}) at the confidence level 95%. If a false positive ratio of the pre-learners (FPR_{pre}) is out of the error range, we judge that there is a significant difference between the FPR_{post} and the FPR_{pre}. With this criterion, we can see that there is a significant difference on Q.6, Q.7, and Q.16, and there is no significant difference on Q.5. Since Q.5 is the question for comparison, these results are consistent with our previous results. As for Q.6, the FPR_{pre} is just outside of the error bar, because the FPR_{pre} is considerably large. We think this is because the pre-learners can correctly answer Q.6 with knowledge from their daily experience.

We also show in Table 3 the results of our previous survey carried out in 2012 [19]. In this survey, we used similar subquestions as for Q.7 but fewer respondents (N=111). With the Table 3 and its plot, Figure 5, it is clear that these two surveys are consistent and the precision of the data is improved.

Conclusions

We evaluated the validity of the FCI using subquestions and the false positive ratio. The false positive ratios of Q.6, Q.7 and Q.16 indicated that these questions are inadequate at the 95% confidence level. This result implies that it is possible for post-learners to answer these questions without understanding the concepts of physics tested in the questions. This might be because the post-learners can correctly answer questions by using an incorrect physics concept or by remembering the correct answer of a similar question.

On the other hand, the false positive ratio of Q.5 indicated that Q.5 is a valid question and we have found no sign of the false positive on the other 26 questions from the interview study. Therefore, we can expect that 90% of the FCI questions are adequate.

As part of future work, we need to confirm whether those 26 questions are adequate. Moreover, as for the generality, we need to confirm whether our results are true for the students in other countries. We also might need to confirm whether our results are changed if we use different types of subquestions and evaluate the validity of the subquestions. However, we should also think how far one should evaluate the subquestions.

Further future work includes a plan to quantify the validity and estimate the systematic error of the total FCI score. The validation of the FCI has suggested the modification of the inadequate questions, but it might be difficult to compare the data of the modified FCI with the accumulated data. Instead, it will be better to evaluate the systematic error of the FCI from the evaluation of the validity. With this evaluation, we can continue to use the present FCI with reliable limitation.

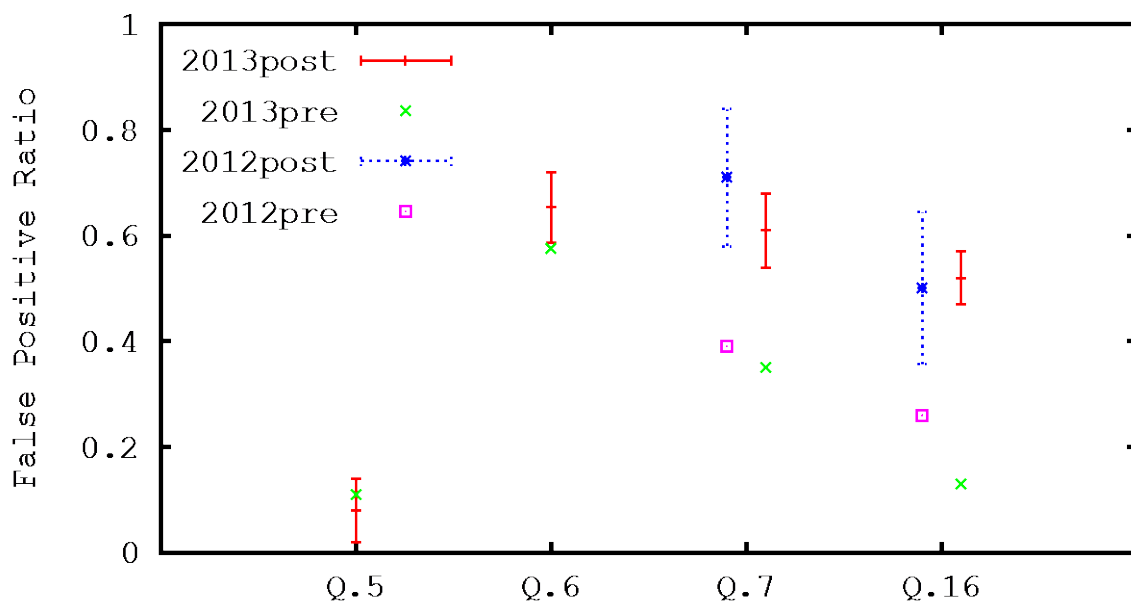

Figure 5. Plot of Table 3. The results of the post-learners are displayed with error bars at 95% confidence level. The number of respondents is 524 for the survey in 2013 and is 111 for the survey in 2012.

References

- [1] Hestenes D., Wells M., Swackhamer G.: Force concept inventory, *Phys. Teach.* 30, 141 (1992).
- [2] Halloun I., Hestenes D.: The initial knowledge state of college physics students, *Am. J. Phys.* 53, 1043 (1985); Common sense concepts about motion, 53, 1056 (1985).
- [3] Huffman D., Heller P.: What does the force concept inventory actually measure? *Phys. Teach.* 33, 138 (1995).
- [4] Heller P., Huffman D.: Interpreting the force concept inventory: A reply to Hestenes and Halloun, *Phys. Teach.* 33, 503 (1995).
- [5] Redish E.: *Teaching Physics with the Physics Suite* (Wiley, Hoboken, NJ, 2003), p. 96.
- [6] Hestenes D., Halloun I.: Interpreting the force concept inventory: A response to March 1995 critique by Huffman and Heller, *Phys. Teach.* 33, 502 (1995).
- [7] Rebello N., Zollman D.: The effect of distracters on student performance on the force concept inventory, *Am. J. Phys.* 72, 116 (2004).
- [8] Morris G.A., Branum-Martin L., Harshman N., Baker S.D., Mazur E., Dutta S., Mzoughi T., McCauley V.: Testing the test: Item response curves and test quality, *Am. J. Phys.* 74, 449 (2006).
- [9] Morris G.A., Harshman N., Branum-Martin L., Mazur E., Mzoughi T., Baker S.D.: An item response curves analysis of the Force Concept Inventory, *Am. J. Phys.* 80, 825 (2012).
- [10] Stewart J., Griffin H., Stewart G.: Context sensitivity in the force concept inventory, *Phys. Rev. ST Phys. Educ. Res.* 3, 010102 (2007).
- [11] Yasuda J., Uematsu H., Nitta H.: Validating a Japanese version of the force concept inventory, *Lat. Am. J. Phys. Educ.* Vol. 6, Suppl. I, (2012).
- [12] The FCI has five multiple-choice answers per question; therefore, if a respondent chooses the correct answer randomly, false positives will appear in 20% of his or her answers. Thus, we should focus on highly frequent false positives.
- [13] You can see the subquestion of Q.16 in [19], and you can get the original FCI questions in the following website of the American Modeling Teachers Association, <http://modelinginstruction.org/researchers/evaluation-instruments/fci-and-mbt/>
- [14] From the questionnaire responses, we determined whether students had studied the concept (for example, Newton's third law or uniform circular motion etc.) tested in FCI questions. If students answered yes to having studied either concept, we called them post-learners and pre-learners otherwise.
- [15] If we compare this hypothesis to the quantum states, this hypothesis is equal to the statement that the state: $| \text{not understanding} | \text{pre-learner} \rangle$ is degenerate with the state: $| \text{not understanding} | \text{post-learner} \rangle$ under the operator: FCI.
- [16] Thornton T.K., Kuhl D., Cummings K., Marx J.: Comparing the force and motion conceptual evaluation and the force concept inventory, *Phys. Rev. ST Phys. Educ. Res.* 5, 010105 (2009).
- [17] Scott T.F., Schumayer D., Gray A.R.: Exploratory factor analysis of a Force Concept Inventory data set, *Phys. Rev. ST Phys. Educ. Res.* 8, 020105 (2012).

- [18] Hestenes D., Jackson J.: Revised Table II for the Force Concept Inventory, <http://modeling.la.asu.edu/R&E/Research.html>
- [19] Yasuda J., Taniguchi M.: Validating two questions in the Force Concept Inventory with subquestions, *Phys. Rev. ST Phys. Educ. Res.* 9, 010113 (2013).

University students' ideas on physical meaning and role of wavefunction and state vector in quantum physics

Giacomo Zuccarini, Marisa Michelini, Alberto Stefanel

Physics Education Research Unit, University of Udine, Italy

Abstract

Difficulties university students find in learning quantum mechanics (QM) are primarily due to the counterintuitive nature of quantum concepts and to the new and highly mathematical structure in which they are shrouded. Within a research on student understanding of QM focused on the connection between concepts and formal entities representing them, a 21 item questionnaire and follow-up interview protocol were designed. In order to test data gathering instruments and get preliminary results, a calibration study was conducted on a small group of university physics students. Data analysis shows that issues on different topics such as measurement, physical meaning of phase relations, stationarity and time evolution elicited on tested students are often related to the way in which incompatibility is described by quantum state formalism and operator structure of observables.

Keywords: university education, quantum mechanics, conceptual understanding

Introduction

Acquiring a solid grasp of quantum mechanics (QM) is essential for physics students' professional development because of its basic scientific content, wide technological applications and the insight it provides into the process of how unexpected results are coped with in scientific research [1]. Nevertheless, the non-intuitive nature of fundamental concepts, whose meaning is strongly related to the formal structure of the theory, hinders the transition from a classical perspective to a quantum one. While taking undergraduate quantum mechanics courses, students often develop survival strategies for performing reasonably well, but they struggle to build a robust knowledge structure [2] as well as to elaborate mental models and visual representations of concepts [3]. A small but growing body of literature on university student understanding has explored their difficulties on a conceptual level [4], and on the connection between formal elements and conceptual ones [2]. The last aspect is especially significant to research on university physics students, as they – unlike secondary school students – have to learn to manipulate formal structures describing quantum ideas. In this respect, research literature shows that student struggle to make sense of the structures used to represent quantum state and observables, for what concerns their representational role (e.g. interpreting wavefunction modulus as particle energy [3]), their use in describing fundamental processes (e.g. applying an operator to the state vector to represent a measurement of the corresponding observable [2,5]), the relation between Hilbert space and lab space (e.g. difficulties in discriminating between entities defined in Hilbert space and those defined in lab space, and respective properties, such as the idea that spin state along one axis doesn't affect spin state along another one «*because they are perpendicular*» [2,6]).

By eliciting important and common issues, research on QM understanding is building a valuable empirical basis to analyse student learning. Anyway some basic topics of undergraduate curriculum still await exploration, even concerning essential aspects such as

state formal representations, i.e. wavefunction (abbr. ψ) and state vector (abbr. $|\psi\rangle$). Examples of barely explored topics are the following: the physical meaning of phase relations in ψ and $|\psi\rangle$, the meaning of continuity constraints and boundary conditions of ψ , role of ψ and $|\psi\rangle$ as descriptions of the state at a single instant. Moreover, recurring use of specific contexts in tests, such as $Re\{\psi\}$ graphs in one-dimensional step potentials, leaves an open question on what elements would emerge by exploring QM ideas from different perspectives. Last, most of existing research is focused on identifying misconceptions in student ideas; there is still a need to explore student reasoning patterns and the roots of elicited conceptions.

In this paper we present the results of the calibration stage of a research designed to investigate student reasoning patterns on formal properties of quantum state representations, their physical meaning, and the connection between them and patterns on basic features of quantum behavior. The investigation relies on case study method, involving 6 physics students belonging to different Italian universities.

Overview of this research

This research is conducted within the framework of the Model of Educational Reconstruction [7], in the perspective of developing a teaching/learning proposal on QM to be focused on the founding concepts of the theory. As a base for a conceptual reconstruction of contents, we performed a review of specific literature on QM at university level and in particular on student's learning problems [8]. Thus, the peculiar way in which physical information is encoded in QM state was identified as crucial aspect and prerequisite to the functional understanding of the theory. In the same stage, open issues of educational research on QM were elicited, especially concerning the origins of student difficulties with the concept of quantum state and its formal representations [8, 9].

In order to elaborate data-gathering instruments suited to provide a picture of student reasoning pathways on the above mentioned aspects, and to structure data analysis, it was necessary to collect student perspectives, their ways of looking, and their points of view. Therefore a case study was designed, including an open questionnaire with four open qualitative essay questions concerning ψ and state vector properties: 1) valid ψ s, 2) the stochastic character of quantum state, 3) the complex nature of its representations, 4) ψ as a description of the state at a point in time. After the written questionnaire, individual follow-up interviews of 20 minutes each were scheduled, focusing on a pre-structured grid and on the discussion of questionnaire results.

On the basis of conceptual reconstruction and case study results [8], a comprehensive grid was elaborated, containing aspects to be included and contexts to be explored. In particular, a cultural section on quantum behavior and domain of applicability of the theory and its formalism was added, in order to explore how reasoning patterns on formal elements of the theory are connected to those regarding features of quantum behavior, and related ways of thinking. The grid is organized in six sections with subsections: quantum behavior and domain of applicability of the theory and its formalism; physical information encoded in formal representations of state – at a point in time; physical information encoded in formal representations of state – time evolution; a time problem: understanding models for the analysis of 1-dimensional quantum scattering; interpreting and sketching ψ and $|\psi|^2$ graphs; formal transposition of patterns of experimental data.

The grid was used to structure a new questionnaire and interview protocol, which were tested by means of a calibration study aimed at finalizing data-gathering instruments and

obtaining preliminary results. Design and outcomes of this study are described in the following sections.

Instruments and methods

The investigation here presented is based on case study method, with questionnaire and individual interviews as data-gathering instruments. The questionnaire consists of 21 items, organized in two sections according to the grid: the first concerns basic quantum behaviour and the domain of applicability of quantum formalism (A), the second concerns ψ and state vector, their formal properties, their use in models describing quantum scattering, their time evolution and the graphical representation of ψ (B). In order to allow a multiple perspective exploration of ideas, items are structured on three levels: cultural, qualitative-conceptual, and formal, the latter in turn divided into vector-algebraic, wavefunction, $Re\{\psi\}$ graphs, $|\psi|^2$ graphs. The interview is scheduled on each item, including first a rogersian section and then a protocol devised to explore student reasoning path more in depth, starting from a stimulus question on student written answer, and following the dynamical evolution of his reasoning by means of reinforcing stimuli.

Our sample included six 3rd year students (2 female and 4 male) from different Italian universities, one from University of Perugia, four from University of Calabria, one from University La Sapienza of Rome. All participants had been high performing students through their undergraduate career (average grade $>26/30$). All of them had followed QM course earlier in the same year, 4/6 had passed the exam (grade $>25/30$). Data gathering was performed in June 2012. The written questionnaire was administered to all students in the Italian language, consistently with the language used in their courses. Two students were interviewed on the whole questionnaire, one only on selected topics.

Written text and interviews were analyzed as a whole data set according to following methods: typical sentences and a-priori categories were built by identification of crucial conceptual contents and literature analysis on difficulties in QM; categories were then revised on the basis of conceptual elements introduced by student answers; emerging element clusters and coherence elements in student reasoning were identified; their answers were organized on the base of the grid described before.

Data and findings

In the present section, a wide selection of questionnaire items are discussed, reporting main results. Items' text is presented in an English version.

Item A1 – Quantum behaviour

What elements characterize/identify the quantum behavior of a system?

Student answers (S1-S6 hereafter) can be divided in two broad categories: those looking at characterizing aspects of quantum formal representations (2/6) and those looking at quantum behaviour properly said (4/6). For the first kind, see S4: «*a system is characterized by a state (ket)*» and S6: «*A quantum state is a vector in an infinite-dimensional Hilbert space*», for the second S3: «*absence of determinism*». Moreover, students cope with item A1 by looking through the properties of formal elements, such as: a) Hamiltonian, considered as key element in describing system features (S1: «*The Hamiltonian of the system determines its features*»); b) Observables as operators

(S6: «*Observables are represented by operators on the state*»); c) Commutativity/non-commutativity (S2: «*commutation relations can reveal indetermination principles between observables*»). Conceptual statements can be found only on the new features of measurement, e.g. «*probabilistic interpretation of measurement*» (S3). Students often focus on quantization of observables as discreteness rather than quantization as correspondence observable-operator. They ascribe discrete spectra to observables in general (S3: «*possible results of any measurement are quantized and discrete*», S2: «*quantized observables*») or to energy in particular, regardless of the physical situation (S4: «*some observables, such as energy, are quantized*»).

Items A2-A3 – Measurement

A2 How does the role of measurement change when passing from Classical Physics to QM?

A3 Predictability and objective nature of measured properties: how do these concepts change in passing from classical mechanics to quantum mechanics?

Students highlight following features of measurement: perturbation of the system (4/6), e.g. «*in QM measurement alters the systems and determines the value of physical quantities*» (S2), and end of deterministic view (3/6), e.g. «*in QM we can't measure two physical quantities at the same time (Heisenberg principle). Collapse of determinism*» (S3). All of them identify the probabilistic nature of quantum predictions. Some students display a formal way of looking, by identifying measurement outcome with the application of an operator to the state vector (2/6), by describing superposition as method to make predictions on measurement results: «*just by looking at system ket $|\alpha\rangle = \sum_i c_i |\alpha_i\rangle$ it is possible to determine on which states the system can be found after measurement $|\alpha_k\rangle$, with probability given by corresponding coefficient c_k , $(p(\alpha_k) = |c_k|^2)$* » (S4), or by stressing the role of commutativity: «*there is uncertainty on measurement of non-commuting observables*» (S5). Others display a conceptual approach, which can be based on indetermination principle, loss of meaning of trajectories, gain of properties at the time of measurement.

Critical aspects are related to ambiguities on the concepts of observable and state, e.g. «*measurement collapses the observable on an eigenstate of the system*» (S1), or to identification of measurement outcome of an observable with the application of an operator to the state vector, transforming it in one of its eigenstates: «*the concept of measurement is linked to an operator on an Hilbert space which, if applied to the state, modifies its properties: the state collapses on an eigenstate of the operator*» (S6). As the set of eigenstates corresponding to measurable values belongs to the operator describing the relevant observable, this idea is probably related to the known issue of applying an Hermitian operator to the state of the system in order to represent the measurement of the corresponding observable [2,5]. Another student associates measurement result with the application of an unspecified operator sending the system in a «*well-defined state*»: «*in QM, measurement can be identified with an operator acting on system ket and sending it in a well-defined state*» (S4).

Item A6 – Incompatibility in measurement

While analyzing concepts involved in preceding questions, some students made the following statements:

1. "If we measure the position of a particle in the ground state of an infinite well potential, its position will change, but not its energy, because a position measurement doesn't alter the energy"
2. "A particle in a stationary state doesn't change its energy after a position measurement because the system remains isolated"
3. "A position measurement on a system in the ground state of a hydrogen atom gives a definite value because its Bohr radius is well defined"

Briefly discuss aspects you agree/disagree with in each student statement.

All three items concern position measurements on an energy eigenstate, and can be found false by recognizing incompatibility between energy and position and its consequences for measurement. Among tested students, only S5 explicitly looks at incompatibility to decide about a statement («I don't agree with the first statement because energy and position are incompatible»), while S2's assessment of the first statement implicitly implies it («False. Measurement can alter energy»). In general, only S2 uses consistent reasoning to answer all sub-questions: «1. False. Measurement can alter energy; 2. False. The act of measuring implies interaction between the system and something else; 3. False. Average [position] value for ground state corresponds to Bohr radius» (actually, the most probable value). Statement 3 is consistently handled by 5/6 students, who recognize that a position measurement on an energy eigenstate can give different results, thus discriminating between quantum model and old quantum physics' one. Statements 1 and 2, on the contrary, are found true by 4/6 students, either handling energy and position as compatible observables: «The first two statements are true: the act of measurement doesn't always alter other properties of the system» (S3), or using an hybrid classical-quantum reasoning: «a stationary state doesn't vary in time. Consequently, energy is conserved» (S4), or without giving any reason (e.g. S5's answer to Statement 2).

As evidenced by S5's case, identifying energy and position as incompatible observables does not imply recognizing incompatibility between a stationary state and a position eigenstate. In the analysis of items on stationarity we'll see that lack of recognition of coincidence between energy eigenstates and stationary states is consistent with results like this.

Student S6 is a different matter. As in items A2-A3, he coherently applies the idea that processes on system are linked to the application of operators on the state: «During position measurement, system energy is not altered, but it can be modified by applying $\hat{a}^{\pm} = \hat{x} \pm i\hat{p}$ to the state vector». S6 connects energy change on a generic system to the application of a creation or annihilation operator, showing that issues with operators in QM are not limited to Hermitian ones.

Items B4-B5 – Physical information encoded in phase relations

B4.1 A beam of silver atoms (spin- $\frac{1}{2}$) identically prepared in the spin state $|\psi\rangle = \alpha|\uparrow_z\rangle + \beta|\downarrow_z\rangle$, propagates in the y direction. The beam is sent through a Stern-Gerlach device with a vertical magnetic field gradient in the z-direction. On the screen we observe two identical spots.

Transpose the experimental outcome in quantum state formalism and describe your reasoning.

B4.2 Afterwards, the device is replaced by a similar one, whose magnetic gradient is in the x direction. The beam is sent through it. Can we expect to see two spots, one markedly brighter than another? Explain your reasoning.

To answer the question, it may be handy to use the following relations:

$$|\uparrow_z\rangle = (|\uparrow_x\rangle + |\downarrow_x\rangle)/\sqrt{2}$$

$$|\downarrow_z\rangle = (|\uparrow_x\rangle - |\downarrow_x\rangle)/\sqrt{2}$$

B5 Given a system's probability distribution in position space, is it possible to deduce its probability distribution in momentum space? Explain your answer.

Among 5 students answering B4.1 in written test, three reconstruct the phenomenology they expect to observe (e.g. identifying the number of spots visible on screen), two express relations on α and β : S2 writes that «*as the spots are identical $\rightarrow |\alpha|^2 = |\beta|^2$* », S3 translates information on equal brightness of the spots in the assumption that « *$\alpha = \beta = 1/\sqrt{2}$* », with further specifications such as «*equal probability of z-component of spin being $|\uparrow_z\rangle$ or $|\downarrow_z\rangle$* » (S3). In interviews, S1 and S6 express the same statement as S3. With the exception of S2, students show not to know how information provided by experimental outcomes is transposed in state formalism.

Item B4.2 explores how student deal with experimental prediction, how they use base change equations (provided in item's text) to perform such prediction, and if they recognize phase's role in this process. Students S3 and S4 start from a state vector whose coefficients contain no phase difference, appropriately using given base change equations (see items in figure) and making predictions consistent with their initial assumption. Students S1, and S6 answer this item by using only base change equations, without any reference to state vector, and conclude that only x spin-up spot will appear because « *$|\uparrow_z\rangle - |\downarrow_z\rangle = 0 = |\downarrow_x\rangle$* ». They interpret transformation equations as providing information on the system under test.

Regarding item 5, all students answer that Fourier transform allows to obtain system's probability distribution in momentum space, starting from probability distribution in position space, as in following example: «*given the fact that we are dealing with conjugate variables, we only need to apply a Fourier transform to the position distribution*» (S2).

When explicitly asked in interview, S3 and S6 claim that coefficients α , β and their square modulus have the same physical meaning, as well as $\psi(x)$ and $|\psi(x)|^2$. Only S1 recognizes that $\psi(x)$ contains more information than $|\psi(x)|^2$, by referring to interference, even if this difference is not connected by the student to the phase function.

In conclusion, the informative content of phases does not emerge neither from the resolution of simple problems in the written questionnaire, nor from the discussion of vector and analytical representation of the state in interviews. Not only the physical meaning of phases was ignored, their presence wasn't included in calculations and comments, thus showing we are facing an unsolved conceptual understanding problem.

Except in one case, $\psi(x)$ and $|\psi(x)|^2$ are interpreted as different ways to convey same physical information.

Items B6, B7, B8, B12, B13 – Stationarity and time evolution

CODE	REPRESENTATION	TOPIC	DESCRIPTION
B6.1- B6.4	Formal-analytical Formal-graphical	A time problem: models for the analysis of 1d quantum scattering.	Temporal relations in plane wave model and wave packet model.
B7,B8	Qualitative Conceptual	Coincidence between energy eigenstates and stationary states.	Students are asked to identify possible relations between given sets of states.
B12, B13	Formal-graphical $ \psi(x) ^2$	Time evolution for stationary and non-stationary states.	Given $ \psi(x) ^2$ graph of a stationary state (B12) and non stationary state (B13), items ask to sketch $ \psi(x) ^2$ graphs at two different instants.

Students link energy eigenstates to stationary states in the ritual situation of infinite potential well (5/6): «*If it's in an energy eigenstate, it should evolve in time in a unitary way and remain constant*» (S5), «*When H doesn't depend on t, energy is conserved. In this case an energy eigenstate is stationary*» (S1). This link is definitely weaker (3/6) if asked on a qualitative-conceptual level (item B7). Inverse implication, even weaker, emerges only in one case (S2: «*the stationary eigenstates are energy eigenstates*»). In fact, students ascribe a stationary nature also to position eigenstates (S5: «*position eigenstates can be stationary, as it happens to energy eigenstates*») and linear combinations of energy eigenstates without discriminating between degenerate and non-degenerate case (S2:«*linear combinations of stationary states are stationary, as they are energy eigenstates*»), while S3 and S4 avoid any answer. Asked in interview if stationary states coincide with energy eigenstates, S6 explicitly says: «*energy eigenstates are stationary, but inverse implication is not valid: also eigenstates of other operators can be stationary*», while S1 shows uncertainties.

The issue of compatibility between sets of eigenstates is resolved when students are able to exploit commutation relations commonly examined in textbooks, such as $[\hat{H}, \hat{p}] = \hat{V}(x)$. This tool is used by most (4/6) in ritual situation of comparison between energy eigenstates and momentum ones (item B8), only by a minority (2/6) in case of comparison between energy eigenstates and position ones (item B7).

The description of time invariance and time evolution produces discrimination between stationary states and non-stationary ones in ritual situation of infinite potential well, while uncertainties emerge in the crucial context of scattering, e.g.: «*incident, reflected, transmitted wave packets are to be considered related to the same instant or all instants because a frequency distribution of electrons gives us a complete spectrum*» (S5).

Also in answers on time evolution, S6 uses the action of operators on a state vector as a conceptual reference, sometimes productively, e.g. identifying incident, reflected and transmitted components of a plane wave as formal elements associated to the same instant («*this ψ describes system state and not its time evolution, for which the action of an*

operator is needed»), sometimes not, as when asked if stationary eigenstates on which a ψ is decomposed can be associated to different instants (*«it depends on the effect of time evolution operator on each of these states»*).

Conclusions

Within the framework of the Model of Educational Reconstruction, we are conducting a research on university student understanding of quantum mechanics, focusing on the connection between physical concepts and formal elements representing them. On the basis of literature analysis, content analysis, and the results of a first case study, the following research instruments were elaborated: a 21 item questionnaire including multi-representation, an interview protocol devised to follow student reasoning patterns in depth. A calibration stage was designed to finalize data-gathering instruments and get preliminary results. The study was conducted on six 3rd year high performing students coming from different Italian universities, after taking QM course and passing the exam (4/6). The written questionnaire was administered to all of them. Two students were interviewed on each item and one on a selection of them. Main findings are the following:

Applying an operator to the state vector as modification of system properties: this idea emerges and is used unproductively for describing quantum state collapse (application to the state of the operator corresponding to the measured observable) and system energy change (application of creation or annihilation operator to a generic state), while it's sometimes used productively in case of time evolution. It is possible that students extend the role of peculiar unitary operators such as time evolution one to operators of different nature (Hermitian ones in particular), or/and mechanically transpose the formal description of an operator as a tool to act on vectors into a process involving physical entities represented by these formal structures.

Information encoded in state formalism: tested students don't recognize the physical role of phases (such as completing information on measurement of observables incompatible with that on whose base the state is expanded). As a consequence, state vector coefficients and their square modulus are interpreted as different ways to convey same physical information, both in discrete and in continuous formalism. This result could help explain known issues such as use of coefficients to express probability without squaring their modulus [2,3,6 p. 224].

Stationarity: students include position eigenstates among stationary states, often as a result of handling energy and position as compatible observables. The only student recognizing coincidence between energy eigenstates and stationary states includes among them linear combinations of energy eigenstates. A need emerges to discuss how incompatibility is encoded in superposition principle.

Entities such as commutation relations and the action of operators on the state are used by students as conceptual references to characterize quantum behavior and manage specific problems, especially in connection with incompatibility and system evolution (measurement and time evolution).

Research instruments will be modified in order to test our hypotheses and explore student understanding of incompatibility and related formal elements, at the base of quantum theory and of deep learning difficulties.

References

- [1] Pospiech G., Michelini M., Santi L., Stefanel A.: Central features of quantum mechanics in physics education. GIREP-EPEC 2010 Conference Proceedings, pp. 85-87.
- [2] Singh C.: Student understanding of quantum mechanics at the beginning of graduate instruction. *American Journal of Physics*, 76(3), 277–287, 2008.
- [3] Robertson E., Kohnle A.: Testing the development of student conceptual understanding of quantum mechanics. GIREP-EPEC&PHEC 2009 Conference Proceedings, pp. 261–273, 2010.
- [4] Mannila K., Koponen I. T., Niskanen J. A.: Building a picture of students' conceptions of wave-and particle-like properties of quantum entities. *European Journal of Physics*, 23(1), 45-53, 2002.
- [5] Gire E., Manogue C., Henderson C., Sabella M., Hsu L.: Resources students use to understand quantum mechanical operators. In PERC 2008 proceedings, AIP, pp. 115–118, 2008.
- [6] Ambrose B. S.: Investigation of student understanding of the wave-like properties of light and matter. Doctoral dissertation, Univ. of Washington. Available from: <http://www.per-central.org/document/ServeFile.cfm?ID=4725&DocID=185&Attachment=1>
- [7] Duit R., Gropengiesser H., Kattmann U.: (2004). Towards science education research that is relevant for improving practice: the model of educational reconstruction. ESERA Summer School 2004.
- [8] Michelini M., Stefanel A., Zuccarini G.: Exploring university student ideas on the relationship between formal aspects and physical meanings in QM. APLIMAT 2013 Conference Proceedings.
- [9] Michelini M., Stefanel A., Zuccarini G.: The complex nature of quantum wavefunction and state vector: analysis of case studies on 3rd year Italian physics students. WCPE 2012 proceedings.

Oral presentations

mixed papers

Three steps to successful change

Gordon J. Aubrecht, II

Ohio State University, Columbus, Ohio, USA

Abstract

With support from the US Department of Education Math and Science Partnership through the Ohio Department of Education, we have discovered a tripartite method that worked at increasing scores on high stakes tests in an at-risk school system. The three parts are a summer content program, grade-level lesson development by teachers working together during the school year, and — most novel — the use of common grade-level formative assessment analysis by teachers. Formative assessments can allow teachers to understand what is and is not working in their classrooms for the purpose of changing how they teach various content. We have helped middle and high school teachers approach formative assessment of open-ended questions. We ask that teachers identify written student ideas for the pretest and see how they might affect the way they present content, then for the posttest, we ask them to identify on the basis of changes in responses and the sorts of responses how they would change their teaching of the content the next time. This study presents a model, as well as its application, for the development of formative assessments in the classroom in a rurally located, city high-needs district in the state of Ohio. Results indicate changes in the way teachers view their pedagogical approaches. Details are discussed.

Keywords: secondary education – lower, upper

Introduction

Within the state of Ohio, home to about 11.5 million people, are many school districts. They are sited in communities ranging from quite wealthy to very poor in terms of their tax base. Typically, schools with a poor tax base have students who come predominantly from homes of parents who have low socioeconomic status (perhaps chronically unemployed, for example) and are often rebellious and flouting any sort of authority, as well as teachers who are less well-prepared in terms of content than is common in the richer districts. School districts having these former characteristics are termed “high-needs” districts. These schools’ scores on high-stakes tests now common throughout the school years in the United States are generally very low.

We call our project the IMPACT project, IMPACT being an acronym for *Inquiry Model for Professional Action and Content-rich Teaching*. We began the program in 2009 in a high-needs middle school in a post-industrial urban area in the midst of rural surroundings (see Figure 1). Some aspects of the program have been described elsewhere. [1] About 80% of students are eligible for free or reduced-cost lunches. The school’s science scores revealed just about 37% of students were being labelled “proficient” or higher in the Ohio Academic Assessment for science given at the end of eighth grade (students are 13-14 years of age) in 2008. The district’s middle school teachers were faced with unwelcome news about the sagging scores and (for the most part) were receptive to our intervention.

The contact with teachers takes place during both the summer and the academic year. According to Garet et.al, [2] “core features of professional development activities that have significant, positive effects on teachers’ self-reported increases in knowledge and skills and

changes in classroom practice: (a) focus on content knowledge; (b) opportunities for active learning; and (c) coherence with other learning activities. It is primarily through these core features that the following structural features significantly affect teacher learning: (a) the form of the activity (e.g., workshop vs. study group); (b) collective participation of teachers from the same school, grade, or subject; and (c) the duration of the activity.” Garet et.al [2] surveyed teachers and found that “[p]rofessional development is likely to be of higher quality if it is both sustained over time and involves a substantial number of hours.” They also conclude that “to improve professional development, it is more important to focus on the duration, collective participation, and the core features.”



Figure 1. The state of Ohio, located in the midwest of the United States. The two yellow arrows point to the original site (northern arrow) and the second site (southern arrow).

Source: Ohio Department of Transportation.

Loucks - Horsley and Matsumoto [3] write that teacher professional development has to address the learner, the knowledge, the assessment, and the community. They write that any teacher professional development must “[p]rovide time, contexts, and support for teachers to think and work at resolving the dissonance through discussion, reading, writing, and other activities that amount, essentially, to the crystallization, externalization, criticism, and revision of their thinking.”

The middle school teachers needed help for several reasons: lack of background in physics, geology, and biology that they were supposed to be teaching because colleges of education are not generally good at preparing students to teach and supplying content support; and inability to answer (or fear of answering) student questions as a result. Our project addresses these deficiencies.

The school district (independent of our project) had purchased a set of kits known as FOSS (Full Option Science System) [4] at the end of the 2007-2008 school year. FOSS was developed at the Lawrence Hall of Science, Berkeley, California by a team of science educators. Their product kits, teacher information and directions, and student workbooks are marketed by Delta Education. The Delta website [5] says that, with the materials, “[s]tudents develop a deep, durable understanding of science concepts and principles through authentic investigations, analysis, and reflection.” Delta claims that the materials bridge “research and practice by providing tools and strategies to engage students and teachers in enduring experiences that lead to deeper understanding of the natural and designed world.” In the Appendix, we reproduce an explanation of the FOSS approach. FOSS encourages students to do some experimentation and to think about the results and the contexts. The kits are a very mild version of guided inquiry, still very much more teacher-centered than most constructivist curricula.

A colleague in this project, Bill Schmitt of the Science Center of Inquiry who has had many years of experience helping teachers in schools, told me that he has seen many cases in which such kits sit unopened and unused on teachers’ shelves. This has been my experience as well. We were determined, once we found out that the FOSS kits were to be used, that the kits would be used as intended to assist students in developing models based on their investigations. The work on content the first summer did prepare teachers to use the kits productively. [6].

Method

The IMPACT program approach involves three steps: Content knowledge support (already referred to above); Lesson development / pedagogical approach support; and Use of common formative assessments (CFAs) with students. The project has met the Ohio Department of Education goal of 120 hours or more of professional development per year. There have been many projects over the years to address content issues for teachers. Some of these have even practiced inquiry as they delivered the content, as we have in this project from the start. There have been some programs that help teachers develop lessons, though most of these have been concerned with one-class lessons rather than the multi-week lessons we are working with teachers to develop. U.S. Federal and various state education officials ask for formative assessments to be used, but these result as implemented mainly in summative assessments and are not suitable for use by teachers willing to change their practices. As far as we know, the melding of these three elements together in a single project, which has emerged as we have worked on this project over time, is unique.

Content and pedagogical knowledge

We began with the content support by demonstrating the sort of pedagogy we hoped teachers would adopt, that is, the content included the guided inquiry pedagogy from the beginning. We unpacked the FOSS kits for teachers the first summer, had them act as students, then had them teach the material to the teachers at the other grade levels. In subsequent years, the summer component has consisted of inquiry activities from the Physics by Inquiry (PbI) materials developed at the University of Washington [7] and extended trips to sites such as Stone Laboratory, a facility of Ohio State University located on Gibraltar Island near Put-in-Bay, South Bass Island in Lake Erie, where both earth science and life science were studied.

Teachers in the program enjoyed their Stone Laboratory experiences so much that they organized a field trip for selected students from their classes the past two years. Students who took part the first year the teachers did the field trip produced a video about their experiences. [8].

While the author has extensive content experience in physical and earth science topics, he is not certifiably expert in life science topics, but he is working to fill gaps in his background in order to assist teachers; his associate Bill Schmitt from the Science Center of Inquiry was once a middle school teacher and has had extensive experience teaching and working with life science topics (and earth and physical science topics as well) as a teacher and museum exhibit developer.

During the second year of the program, students who had experienced the first year of science teaching at the middle school in eighth grade went to the high school; they and their parents complained about the perceived poor quality of the science teaching in the high school, and at the end of the year the school administration ordered the high school teachers to participate. The high school teachers originally disliked being ordered to participate, but eventually they became willingly involved in changing the way they teach and cooperate with the middle school teachers.

Lesson development

In our original work with middle school teachers, we decided that some FOSS lessons needed modification for the particular students. Teachers cooperated in designing alternatives together and taught the same lesson they had designed. We found that this built camaraderie as well as forcing the teachers to examine the content more deeply.

When we added high school teachers, we had in mind that if we could determine something that they were dissatisfied with or wanted to do together, we could build morale for the high school teachers, too, by having them design the lessons.

Several opportunities presented themselves. Biology teachers were unsatisfied by their lessons on DNA and wanted to make changes. We encouraged them to work together and supported them where possible with supplies and equipment, some from the school district, some provided by the Science Center of Inquiry. Teachers of physical science (a ninth-grade subject) found from examining common formative assessments (described below) that, despite their best efforts, ideas about atoms and the periodic table were not making much impact on students.

In both cases, teachers cooperated in design and use of their respective lessons. Since the beginning of the project, middle and high school teachers have created approximately 20 lessons under the direction of project leaders on topics such as how to define life, fossils, atoms, and accelerated motion. The lessons did serve several purposes, but for us, it was building professionalism among the teachers. We regard cooperative lesson-building as an important component of the program as a result.

Common formative assessments

Many school administrators pay lip service to formative assessments, but do not distinguish them from summative assessments. When we had the idea, the administration had said they would do formative assessment, but implemented summative assessment. This difference hindered teachers' development; the author uses formative assessment in his college classes, and was aware of the difference.

This is how we define the term common formative assessment (CFA):

- Common → all students at a given grade level receive same questions.
- Formative → builds teacher awareness of student thinking through comparison of pre – post results for the purpose of informing teaching.
- Assessment → content questions to gain understanding of student ideas and how they change from pre – to post-application.

We did not leave the form and content of the assessments totally up to teachers' choice. We did not dictate the organization of the reports. We wrote:

“We would like you to analyze each question separately.”

“We ask you **not to give scores** to students, but consider what they are saying and how they are justifying or reasoning about what they are saying.”

“The purpose of the analysis is to find out what you have learned in your reflections about how your students think about the subject you are teaching, from your students, prior to teaching it (for the pretest) and after you have finished teaching it, along with what this means to your teaching to the current class (e.g., ‘I plan to reteach X because it was clear there was no progress from the pretest, and the way I plan to do so is ...’); or classes of the future (e.g., ‘Given this year's experience, next year I plan to do Y because ...’).”

“In all cases we (Gordon and Bill) are interested in hearing the voices of your students in the analyses. For example, we would like to see selected quotes that demonstrate student thinking, whether accurate or inaccurate, insightful or misled. The greatest value to be gained from these analyses is about how your students are thinking / reasoning rather than just giving a score to the students. This is what can help you as a teacher to think about how what you've learned from the students will be used in future classes.”

Students of participating teachers complete 4 pairs of CFAs per school year, which address topics appropriate to grade level and addressing Ohio Academic Content Standards. Students are asked to support their answers with reasoning. (Some students are absent for one or the other).

Over time, Marion teachers moved from using entirely grant-staff-created CFAs to creating a greater amount of their own CFA questions. As indicated above, the student answers were scored / assessed by teachers themselves according to individual teacher-created criteria. The reasoning is that formative assessment is meant to address a teacher's practices in the classroom, so the teachers themselves should be responsible for defining what they expect from their own students.

While students do show statistically significant gains at all grade levels on all tests, the true use of CFAs is to inform teaching practices. Examples: Teachers discovered on the pre-assessment that most students did not think there were any wild animals in their neighborhoods and had to modify their instruction for the quarter. Teachers found out that their best efforts to teach atoms were unsuccessful, as already mentioned, so they developed a new atom curriculum together. Teachers discovered that dissolving was mysterious to students ... and that salt was “unrecoverable” from solution despite an experiment students did during the quarter!

Results

Common formative assessments

Here is an authentic teacher voice describing the teacher's interaction with the CFAs. "I was not a fan of this [CFAs] and knew in my heart that it was a waste of time and nothing but another source of stress for the students and myself. But I tried it out and paid attention to what was put on the paper when I graded my student's work. I was amazed at what was being written. Not correct answers and information spit back to me but actual thoughts — good, bad, or indifferent — and ways of thinking about concepts I hadn't taken into consideration. It was interesting to see what misconceptions my students had and what misconceptions did or didn't change over the course of a nine-week period. I am always a better teacher when I know where my students are developmentally but it really helps to know what they are thinking that keeps them there or helps them to move on."

Many other teachers were equally sceptical. A similar sentiment was voiced by a different teacher. "For me, the CFA's were a process which I sincerely did not understand in the beginning yet tolerated them for the money. They are time consuming, difficult to read, and if you are not part of the development process, which I chose not to be, it does not have as much meaning. Being fair, I think the whole thing was a difficult learning experience due to the interference by the administration who really does not understand what is trying to be achieved by a common formative assessment."

Classroom changes

Other teachers focused on the project's changes in their classrooms. A teacher wrote: "I think the performance record of the students is proof for itself when it comes to the impact the grant has had on our school district. The inquiry-based instruction has really brought about the developmental process that was missing from our district for the first couple [of] years I was here. I have noticed the difference in my classroom considering I have at-risk students who come from very low socioeconomic standards. It has allowed them to not be limited to their home life or economic situation, but instead to flourish academically and prove that they can do science — that they do have self-worth. To me, the impact of the grant has implications far beyond just a classroom. We are trying to change the face of a community in dire straits and we are trying to do this through academic success."

Another teacher noted, "I will not say that I whole-heartedly embrace all inquiry teaching but it has caused me to approach teaching a little more opened minded. I now see more value of having students use inquiry as a method of learning. One way in which I have a changed my teaching is to ask myself; 'Can I avoid just telling or explaining something?' and instead have the students see it, touch it or experience it."

Self-reported teacher change

We asked the teachers to fill out an assessment of their teaching at the beginning and end of the year. Based on these assessments, we find:

- Teachers show gains on PBI assessments (part of the content support) in addition to significant gains on Lawson's scientific reasoning diagnostic. A paired t-test showed significant gains after treatment during the 2011-12 school year ($t = 2.798$, $df = 9$, $p = 0.021$) indicating an increase in scientific reasoning ability.

- Teachers show an increase in their belief that they can teach science concepts more effectively after participating in IMPACT.
- From the beginning to the end of the year, there is a reduction in the use of state test scores as an instructional influence. This is important to note due to the focus the program has placed upon using formative assessments rather than summative ones to drive how and what is being taught in the classroom.
- By the end of the school year, teachers report students spending nearly 50% of their time in class working in pairs or small groups. The change from pre- to post-test shows a considerable increase in small group work from the beginning of the school year.
- Students spend more time in class reflecting on their own work from the beginning to the end of the year.

Student change in performance on high-stakes tests

Ohio students take high-stakes state tests at fifth, eighth, and tenth grades. As we have noted, the eighth-grade test is the Ohio Academic Assessment (OAA); the tenth-grade test is called the Ohio Graduation Test (OGT). In addition, the school district received “Race to the Top” federal money, which required sixth-grade and seventh-grade students to take national Terra Nova tests.

On the Terra Nova tests, sixth-grade students ranked in the average range (51.2%); seventh-grade students also ranked in the average range (52.0%). While it may not seem that “average” is very good, recall that these students generally score well below national averages due to their economic situation.

Table 1. OAA science test

School year	Percent proficient or greater	Statewide proficient
2007-2008	37%	—
2008-2009 (1 st yr)	41.9%	62.8%
2009-2010	45%	64.8%
2010-2011	37.9%	67.4%
2011-2012	48%	—
2012-2013	52%	—

Table 2. OGT science test

School year	Percent proficient or greater	Statewide proficient
2007-2008	—	—
2008-2009	52.4%	76%
2009-2010	54.9%	73%
2010-2011 (1 st yr)	63%	74.7%
2011-2012	61.1%	77%
2012-2013	62.5%	77.9%

Tables 1 and 2 indicate the results for the OAA and OGT. It may be seen that the OAA trend is up (the students who were sixth-graders when the project began were characterized by their veteran teachers as exceptionally lacking in ability compared to their usual classes, in accord with the reports of these students' elementary school teachers). Also, the science result for the OGT went up considerably when the first cohort took it, and that gain has remained steadily higher than before, while statewide proficiency has not changed appreciably.

In addition, Figure 2 shows that the step gain on the OGT was evinced not just in science, but across almost all areas tested. While in several areas the percentage scores retreated a bit from 2011-12 levels, they remain significantly higher (except for writing) than those in the years prior to the time the classes with students who had experienced some exposure to our middle school teachers after the project began. In science, the pre-post average difference is $7.9 \pm 2.8\%$, and it is nearly as great in mathematics and social studies.

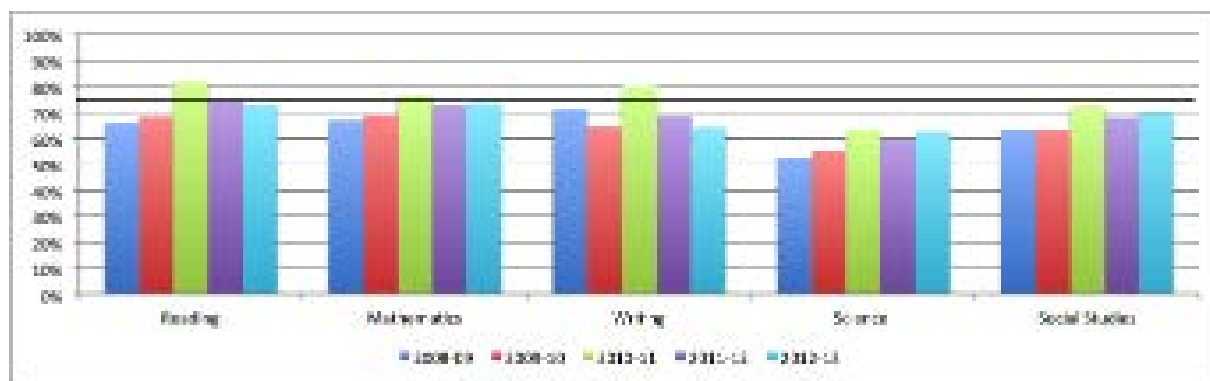

Figure 2. Marion City Schools tenth-grade OGT scores in the five assessment areas over a five-year period (first cohort from middle school took the OGT in 2010-11). The solid line represents Ohio's 75% proficiency expectation.

The OAA and OGT test questions are not generally released, but they consist mainly of four-part multiple choice questions (1 point each), with several short-answer questions (2 points each) and one essay question (4 points). A practice OGT is available from the Ohio Department of Education. [9].

Future direction

IMPACT has worked with Marion City Schools since 2008, and demonstrated successful changes in test scores, but also in intangibles such as teacher professionalism and student involvement in hands-on experiences and in reasoning. Of course, not every teacher has completely changed from what he or she was doing prior to our intervention, but all have made varied degrees of change in the direction of actually listening to their students' ideas and questions as well as of more active student involvement in their classes. One problem we have encountered is that some teachers have tired of the effort of working with us, and so some seem to be taking the easier path, returning to "teaching by telling" rather than involving students in active learning. Nevertheless, the gains seen in this high-needs district are sufficiently impressive to our granting agency make them decide to try to see whether this method can work elsewhere.

Thus, at the suggestion of our granting agency, we have begun working with teachers from South-Western City Schools starting with two one-week inquiry content workshops in the summer of 2013 (both are located near Columbus, Ohio, as was shown in Figure 1).

We hope to be able to show that the three-part method we have developed and tested in Marion will work in a different high-needs school district. The economic situation is better in the South-Western City Schools middle schools, where only about 60% of children are eligible for free or reduced-cost lunches (compared to 80% in Marion). This may help make it easier for South-Western City Schools teachers to reach children in their classes with inquiry methods. We expect to be able to assess these results within three years.

Acknowledgements

This work supported in part by grants from the Ohio Department of Education C1457-OSCI-09-49 (2008-2009), C1667-MSP-10-410 (2009-2010), EDU01-0000006141 (2010-2011), EDU01-0000007902 (2011-2012), GRT00029161 (2012-2013), and ODE-MSP-10673 (2013-2014). The opinions expressed are not necessarily those of the Ohio Department of Education.

The author is grateful for the support, advice, and essential help provided by Bill Schmitt of the Science Center of Inquiry, whose good sense and vast experience with schools and conditions within schools contributed immensely to the successes of this program from its inception. Jennifer Esswein of the Tennessee Department of Education, the internal project evaluator, has also contributed valuable materials, advice, analysis, and assistance over the past two years, some of which is presented here.

References

- [1] Aubrecht G., Schmitt B.: IMPACT 2: *Inquiry Model for Professional Action and Content-rich Teaching* - A partnership to help reform middle school teaching and learning, *AURCO J.* 16 (2010), p. 1-17. Aubrecht G., Schmitt B., Crosley A., Fogle R., Miller A., Tanner T.: Long-term observations of celestial objects in middle school astronomy," *AURCO J.* 17 (2011), p. 1-14. Aubrecht G.: Changing the way teaching occurs in an American middle school, *Lat. Am. J. Phys. Educ.* 6, Supp. 1 (2012), p. 23-26. Aubrecht G., Esswein J., Schmitt B.: Using common formative assessments with middle and high school students to inform pedagogical approaches for teaching scientific content, Proceedings of the World Conference on Physics Education 2012, p.

- 593-600 (Ankara, Turkey: Pegem Akademi, 2014). Aubrecht G.: A successful school intervention program, submitted to the 2013 InterAmerican Conference Proceedings.
- [2] Garet M. S., Porter A. C., Desimone L., Birman B. F., Yoon K. S.: What makes professional development effective? Results from a national sample of teachers, *Am. Ed. Res. J.* 38 (2001), p. 915-945.
- [3] Loucks-Horsley S., Matsumoto C.: Research on professional development for teachers of mathematics and science: The state of the scene. *School Science & Mathematics* 99 (1999), p. 258-271.
- [4] FOSS website: "FOSS is a research-based science program for grades K–8 developed at [Lawrence Hall of Science] with support from the National Science Foundation and published by Delta Education." <http://lhsfoss.org/>, accessed 13 September 2013.
- [5] Delta Education FOSS website, <http://www.delta-education.com/science/foss3/fossall.shtml>, accessed 3 February 2014.
- [6] Aubrecht G., Schmitt B.: Systemic Reform of Science Education at Grant Middle School in Marion, Ohio, FOSS Newsletter, Spring 2009, No. 33, p. 4-9.
- [7] McDermott L.: Physics by Inquiry, Vol. I: Properties of Matter. New York: J. Wiley & Sons, 1996, ISBN 0-471-14440-1. McDermott L.: Physics by Inquiry, Vol. II: Electric Circuits. New York: J. Wiley & Sons, 1996, ISBN 0-471-14441-X.
- [8] Student video available at <http://www.youtube.com/watch?v=HGkvxxff5bU>.
- [9] OGT Practice Test [http://education.ohio.gov/getattachment/Topics/Testing/Testing-Materials/Ohio-Graduation-Tests-\(OGT\)-Full-Length-Practice-T/Science-OGT-Full-Length/Science-Practice_Test.pdf.aspx](http://education.ohio.gov/getattachment/Topics/Testing/Testing-Materials/Ohio-Graduation-Tests-(OGT)-Full-Length-Practice-T/Science-OGT-Full-Length/Science-Practice_Test.pdf.aspx)

Appendix:

Delta Education explains FOSS on its web page <http://www.delta-education.com/science/foss/whatisfoss.shtml> as follows:

The FOSS program is correlated to human cognitive development. The activities are matched to the way students think at different times in their lives. The research that guides the FOSS developers indicates that humans proceed systematically through predictable, describable years, and that students learn science best from direct experiences in which they describe, sort, and organize observations about objects and organisms. Upper elementary students construct more advanced concepts by classifying, testing, experimenting, and determining cause and effect relationships among objects, organisms, and systems.

FOSS investigations are carefully crafted to guarantee that the cognitive demands placed on students are appropriate for their cognitive abilities. Developmental appropriateness and in-depth exposure to the subject matter with multiple experiences give FOSS its "horizontal curriculum" character (numerous activities that provide a great variety of experiences at a cognitive level) as opposed to a "vertical curriculum" design (activities that attempt to take students to inappropriately complex and abstract levels of understanding). A horizontal curriculum provides challenges for all students and results in a much deeper understanding of the subject.

SCIENTIFIC THINKING PROCESSES

Although many programs use thinking processes, FOSS is the only one that has organized them into a developmental sequence specifically related to cognitive stages.

OBSERVING

using the senses to get information

COMMUNICATING

talking, drawing, acting

COMPARING

pairing, one-to-one correspondence

ORGANIZING

grouping, serializing, sequencing

RELATING

cause and effect, classification

INFERRING

superordinate/subordinate classification, if/then reasoning, developing scientific laws

APPLYING

developing strategic plans, inventing

The scientific thinking processes guide the selection of content for FOSS. Although students possess the capacity to use all the scientific thinking processes to some degree throughout their lives, some processes are more powerful at certain ages.

LEARNING WITH UNDERSTANDING

FOSS derives information about learning from both academic sources and practical experience in classrooms.

The academic sources emphasize that:

- Learning moves from experience to abstractions. FOSS modules begin with hands-on investigations, then move students toward abstract ideas related to those investigations using simulations, models and readings.
- A child's ability to reason changes over time. FOSS designs investigations to enhance their reasoning abilities.
- Fewer topics experienced in depth enhance learning better than many topics briefly visited. FOSS provides long-term (8-10 weeks) topical modules for each grade level, and the modules build upon each other within and across each strand, progressively moving students toward the grand ideas of science. The grand ideas of science are never learned in one lesson or in one class year.

Practical experience in classrooms demonstrates that students learn best by doing. When involved in learning something of interest, students come to understand concepts more fully, remember them longer after the experience, and develop confidence in their ability to find things out and to understand science.

Practical experience has taught us that when language arts experiences are embedded within the context of learning science, students improve in their ability to use their language skills. Students are eager to read to find out information, and to share their experiences both verbally and in writing.

Practical experience shows that all children can learn science, that there is no differentiation between genders in interest or ability to understand science concepts, that students with learning difficulties often shine in solving science problems, that students learning English as a second language have success alongside their fellow students, that gifted students are often inspired to "run with the topic" beyond the interests of other students. FOSS is a great way for all students to learn science.

The explicative power of the vector potential for superconductivity: a path for high school

Sara Barbieri¹, Marco Giliberti², Claudio Fazio¹

¹ University of Palermo, Palermo, Italy

² University of Milan, Milano, Italy

Abstract

In the classroom practice the notion of the magnetic vector potential is never introduced, both because it is not contained in secondary school textbooks and because teachers usually associate this concept with complex topics they dealt with in their university courses. In our experience instead, we have found that the introduction of the vector potential can be of great help in students' understanding of electromagnetism and modern physics topics. In this paper we will show how the use of the vector potential allows a phenomenological and consistent explanation of superconductivity at a level suitable for high school students. We will deal with the two main aspects of superconductivity: the resistivity of the superconductor that drops to zero at the critical temperature and the expulsion of the magnetic field from the bulk of a superconductor (Meissner effect). By the use of the vector potential, students can build a phenomenological interpretation of superconductivity, always remaining in the frame of electromagnetism and thus avoiding the use of too complicated mathematical tools that the explanation of the microscopic mechanism would require.

Keywords: secondary education, magnetic vector potential, superconductivity

Introduction

The physics education research group of the University of Milan has been dealing with superconductivity for 8 years with high school students and, despite superconductivity is a very difficult topic, in our experience students have been always interested and involved. Depending on the time that students can spend in our laboratory, we propose two types of interventions: a) an afternoon lab of about 4 hours, just to familiarize with low temperatures physics and some typical phenomena of superconductivity, or b) an educational path of at least 24 hours, including lectures and laboratory.

As superconductivity links electromagnetism, thermodynamics, waves and quantum physics, the educational path of type b), whose main theoretical part we describe in this work, is thought for the final year of a secondary school physics course (12th or 13th grade). In fact, the complexity and the witchery of superconductivity can be a stimulus for students to take up topics covered till that moment, deepen them and frame them in a new light. Before entering the core of our proposal we resume the main prerequisites needed to face superconductivity.

1. Electromagnetism. In particular, the vector potential **A**, through which we can introduce the London equation, as we will see in the next sections.
2. Thermodynamics. In particular, the definition of a thermodynamic state as a function of some variables: temperature **T**, pressure **P**, volume **V** and also the magnetic field **B**.

3. Waves. In fact it is possible to describe the super-current in terms of (material) waves (i.e. to generalize the London equation and to get the quantization of the magnetic flux in a superconductor).

For what concerns this paper only prerequisite 1. is needed, while the others are important for a deeper approach. We have developed our educational path in the frame of electromagnetism, by the use the mathematical tools of flux and circulation that students should have already known from their study when dealing with the Maxwell's equations. In this same framework the introduction of the magnetic vector potential becomes very helpful. Although in this paper we will not treat explicitly how to introduce the vector potential to high school students, as it is described in [1,2], we will use it to develop a consistent phenomenological description of superconductivity.

The two fluid model to explain the experimental evidences of superconductivity

The two main features of superconductivity are:

1. The resistivity ρ of the superconductor drops to zero below a particular temperature T_C , called critical temperature that is characteristic of the given superconductive material.
2. If a magnetic field B_{app} is applied to a superconducting sample, the magnetic field in the bulk of the sample remains always zero, unless the applied field overcomes a critical intensity B_C . This experimental evidence that occurs with sufficiently low applied magnetic fields, is the well-known Meissner effect (discovered by Meissner and Ochsenfeld in 1933).

In order to construct a meaningful path for secondary school, we have to develop a model able to explain the previous features. The theory that inspired our work is the two-fluid theory that has been developed in 1934 by Gorter and Casimir. In this theory the superconductor is treated as containing a mixture of two fluids: the normal fluid, with the same properties of the ohmic electrical current in a metal, and the superconducting fluid, that flows without any friction (see Table 1). The two fluids are always present at the same time, therefore the superconducting sample can be thought as a circuit with two branches in parallel, the superconductive one and the normal one, as can be seen in Figure 1.

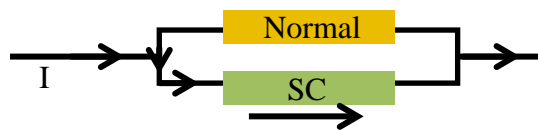

Figure1. Schematic representation of a superconductor, where SC stands for superconductor

Hence, if a constant current I is flowing in the superconductor, than the presence of the superconducting branch shunts the circuit, so that all the current runs in that branch, as the arrows in Figure 1 show.

In this paper we suppose that the properties of the normal fluid have already been treated in the lessons on electrical conduction, as its behaviour is explained by the Ohm laws, that can be summarized in the local formulation $\mathbf{J}_n = \sigma \mathbf{E}$, where \mathbf{J}_n is the density current and \mathbf{E} is

the electric field. The behaviour of the superconducting fluid is, instead, the main fact to be modelled.

Description of the superconducting fluid

In 1935, the brothers F. and H. London proposed for the first time a phenomenological equation for the frictionless motion of the super-current [3]:

$$\mathbf{J}_s + k\mathbf{A} = \mathbf{0}. \quad (1)$$

In fact, taking the time derivative of eq. (1) we get:

$$\frac{\partial}{\partial t} \mathbf{J}_s = k \left(-\frac{\partial \mathbf{A}}{\partial t} \right) = k\mathbf{E}, \quad (2)$$

where \mathbf{E} is the electric field inside the sample.

The Ohm equation (describing the normal fluid) states that the current density \mathbf{J}_n is proportional to the electric field, so that it is the velocity of the fluid that is proportional to the force acting on it: motion in presence of friction. On the contrary, from the equations (1) and (2) we see that it is the time derivative of the current density that is proportional to the electric field, so that it is the acceleration of the superfluid that is proportional to the force acting on it and the superfluid is thus frictionless ($\rho = 0$).

It is interesting to observe that the frictionless condition described by eq.(2) is not equivalent to the London condition given by eq.(1). In fact to deduce eq.(1) from eq.(2) we have to choose the integration constant equal to zero. This is a new phenomenological assumption, made by the London brothers, that is needed to explain the Meissner effect.

It is also necessary to stress that eq.(1) is valid only if the superconductor is simply connected (it has no holes), and therefore it describes only a narrow, although very important, set of experimental situations: roughly speaking, very weak magnetic fields applied to samples without holes. In the following, we will hint the necessity of a generalization of eq. (1) while, in Table 1, we summarize what we have found so far.

Table 1. Characterization of the two fluids

<i>Normal fluid</i>	$\mathbf{v}_n \propto \mathbf{E}$	friction	$\rho \neq 0$	$\mathbf{J}_n - \sigma\mathbf{E} = \mathbf{0}$
<i>Superconducting fluid</i>	$\mathbf{a}_s \propto \mathbf{E}$	no friction	$\rho = 0$	$\mathbf{J}_s + k\mathbf{A} = \mathbf{0}$

The London equation and the Meissner effect

An approach for teachers

Starting from the London equation, through the application of differential operators such as the curl, we can immediately obtain a relation that explains the expulsion of the magnetic field from the bulk of the superconductor. Since differential operators are not known to secondary school students, we address this part only to teachers.

Taking the curl of both members of eq.(1) and using the relation $\mathbf{B} = \nabla \times \mathbf{A}$, we have:

$$\nabla \times \mathbf{J}_s = -k\mathbf{B}. \quad (3)$$

If we now consider the Maxwell's equation: $\nabla \times \mathbf{B} = \mu_0 \mathbf{J}$ from eq.(3), we obtain:

$$\nabla \times \nabla \times \mathbf{B} = -\mu_0 k\mathbf{B}. \quad (4)$$

Hence, recalling that:

$$\nabla \times \nabla \times \mathbf{B} = \nabla \nabla \cdot \mathbf{B} - \nabla^2 \mathbf{B} \quad (5)$$

and taking into account the solenoidality of the magnetic field, from eqs.(4) and (5) we have:

$$\nabla^2 \mathbf{B} = \mu_0 \mathbf{k} \mathbf{B}. \quad (6)$$

Starting from eq.(6) we can discuss the penetration of a magnetic field inside a superconductor. We do this in a mono-dimensional case of very simple geometry: the superconducting sample, in an applied magnetic field, fills a semi-space and its surface is in the yz plane, while the field and the super-current depend only on x , as Figure 2 shows. In this case the solution of eq.(6) is:

$$\mathbf{B}(x) = \mathbf{B}(0) e^{-\frac{x}{\lambda_L}}, \quad (7)$$

where $\lambda_L = \sqrt{1/\mu_0 \mathbf{k}}$ is a phenomenological parameter, called *penetration length*, that is a measure of how much the magnetic field penetrates the superconductor before vanishing. Eq.(7) shows that the magnetic field goes exponentially to zero inside the superconductor, as it is sketched in Figure 2.

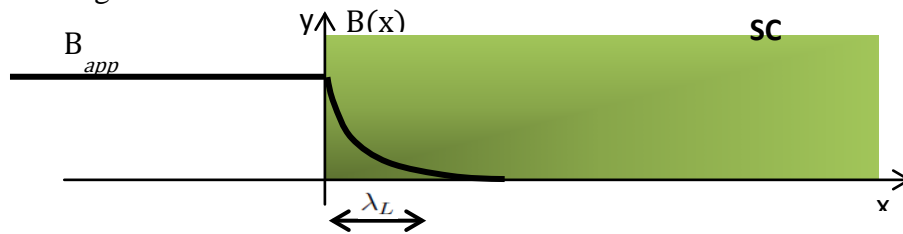

Figure 2. Intensity of the magnetic field: B is uniform outside the superconductor (B_{app}) while it decreases exponentially inside the superconductor

Since λ_L is of the order of 50 nm for most superconductors, we argue that the magnetic field is present only on the surface of the superconductor itself. Being the Meissner effect a fundamental property of superconductors, in the next paragraph we propose a way to describe it, with a simpler mathematical formalism that is suitable also for high school students.

An approach for students

Students can have a mathematical explanation of the Meissner effect using integral operators, such as circulation and flux that they should have already used in their previous path of electromagnetism. It should be convenient to divide this explanation in two parts: (1) the first part is preparatory to the second and pertains the fact that an applied magnetic field orthogonal to the superconductor surface cannot penetrate the sample; (2) the second part pertains the expulsion from the bulk of the superconductor of a magnetic field parallel to the surface.

To follow the sequence that we propose, students have already to know some properties of the magnetic vector potential and some basic properties of the magnetic field that we resume below:

1. $C_\gamma(\mathbf{A}) = \Phi_{S,open}(\mathbf{B}) \quad (8)$

where $C_\gamma(\mathbf{A})$ indicates the circulation of the vector potential along a closed line γ , while $\Phi_{S,open}(\mathbf{B})$ indicates the flux of the magnetic field through the surface that

has γ as a boundary. This property must have already been explained within a path on the vector potential which we cannot treat in this work [2].

$$2. \quad \mathcal{C}_\gamma(\mathbf{B}) = \mu_0 I \quad (9)$$

that is the Ampère-Maxwell law, where I is the current passing through γ .

$$3. \quad \Phi_{S_{\text{closed}}}(\mathbf{B}) = 0 \quad (10)$$

that is the Maxwell's equation that states the solenoidality of the magnetic field.

(1) An orthogonal magnetic field cannot penetrate the superconductor.

We suppose that a uniform magnetic field \mathbf{B} is applied orthogonally to the superconductor surface, as shown in Figure 3(a). We also suppose that the magnetic field can penetrate the superconductor. If the superconductor is homogeneous, isotropic and infinitely extended along the yz plane, then we can conclude that the problem has a symmetry for translation along the y and z axes. For this reason the magnetic field will be uniform over planes parallel to the yz plane, also inside the superconductor. If we consider a closed surface S , for example a parallelepiped, whose section is represented in Figure 3(a), and apply eq.(10), we can immediately deduce that the intensity of the magnetic field \mathbf{B} is also invariant along x , and the magnetic field must therefore be uniform inside the entire superconductor.

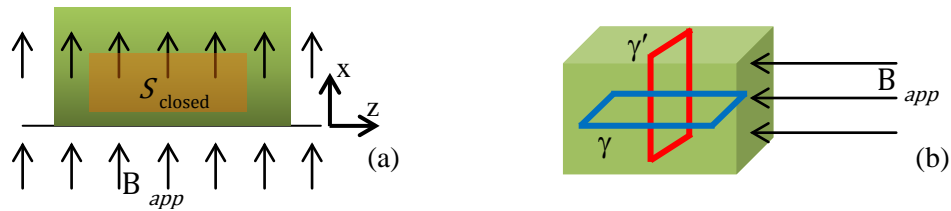

Figure 3. (a) The superconductor, in green, is infinitely extended along the x axis. It is also shown a section of the closed surface S and the arrows indicate the direction of the magnetic field. (b) A portion of the infinite superconductor and the two paths γ and γ' .

Now, if the magnetic field is uniform, for every closed loop γ

$$\mathcal{C}_\gamma(\mathbf{B}) = 0, \quad (11)$$

and, therefore, if we take a little loop γ orthogonal to J , from eq. (9) we get:

$$0 = \mu_0 I = JS, \quad (12)$$

where I is the current passing through the line γ along which we calculate the circulation, that is represented in Figure 3(b) and S is the surface having γ as boundary. Thus, from eq.(12) we have:

$$J = 0. \quad (13)$$

If we recall the London equation (1), we immediately get:

$$\mathbf{A} = 0. \quad (14)$$

We can now apply eq.(8), choosing a closed line γ' parallel to the surface of the superconductor. Being $\mathcal{C}_{\gamma'}(\mathbf{A}) = 0$, we obtain:

$$\Phi_{S'}(\mathbf{B}) = 0, \quad (15)$$

where the surface S' has γ' as a boundary. Therefore $\mathbf{B} = 0$.

Since the surface S' can be taken next to that surface as you want, eq.(15) states that no orthogonal magnetic field can penetrate the sample.

To have a picture of the behaviour of a superconductor it is necessary to consider together the London equation and the equations of the electromagnetism. This is what we did in the previous part (1); we will do the same in the next part (2). We stress this concept here because it is important that students understand that the London equation is the key point in the development of their path on superconductivity and it is important that they are able to recognize where this equation is implied.

(2) The expulsion of a parallel magnetic field from the bulk of a superconductor.

We suppose that a magnetic field is applied parallel to the superconductor surface, as in Figure 4 and that it enters the superconductors.



Figure 4. Section of the superconductor, in green. The red arrow represents the magnetic field applied parallel to the surface.

First of all, if the superconductor is isotropic the field inside will have the same direction as that applied. We want to demonstrate that the inside field cannot be uniform. Let us suppose for absurd that the field inside of the superconductor is uniform, as represented in Figure 5(a).

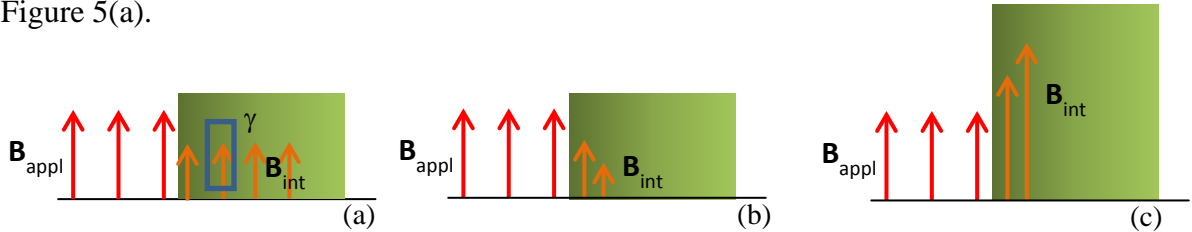

Figure 5. The magnetic field applied is represented in red, while the magnetic field that enters the superconductor is represented in yellow. The three figures show three hypothetical possibilities for the inside field.

If we apply eq.(9) to the closed narrow line γ represented in Figure 5(a) we have, for the uniformity of the magnetic field, that $\mathcal{C}_\gamma(\mathbf{B}) = 0$ and hence:

$$\mu_0 I = 0. \tag{16}$$

Now, we rewrite the current I in terms of the current density J and apply the London equation (1), so to get:

$$-\mu_0 kSA = 0. \tag{17}$$

We must conclude that $A = 0$.

But $A = 0$ implies that also $B = 0$, because we can apply eq.(8). In fact, from $A = 0$ we have $\mathcal{C}(\mathbf{A}) = 0$ and thus:

$$\Phi_{S,open}(\mathbf{B}) = 0. \tag{18}$$

Since S is an open surface that can be chosen as you want, then eq.(18) implies that the magnetic field must be zero.

In other words, there can be no region inside the superconductor where the magnetic field is uniform, or tends asymptotically to a finite value different from zero. Then it is reasonable to suppose that the field increases or decreases with the distance from the surface. For obvious reasons related to the conservation of the energy density, we have to reject the case of an indefinitely increasing field, as represented in Figure 5(b). Therefore the only possibility is represented in Figure 5(c) in which the magnetic field decreases to zero. Referring to what we have just said, we can notice that the slower the spatial variation of the magnetic field, the more the intensity of the field approaches zero. Taking into account that the intensity of \mathbf{B} is different from zero at the surface, it turns out that \mathbf{B} must vanish quickly inside the superconductor. Therefore, the magnetic field \mathbf{B} will be present only very close to the surface where there will be also the current density \mathbf{J} , the source of the magnetic field that the superconductor produces in opposition to the applied field. In fact, we note that the relationship $\mathbf{J} = -k\mathbf{A}$ contains the minus sign just because the current density \mathbf{J} that is established on the superconductor surface, flows in such a way to generate just the magnetic field opposite to the applied field in order to cancel the field inside the superconductor.

By the use of integral tools we have seen that the magnetic field must vanish in a small distance very close to the surface, and this can be considered a meaningful result for the secondary school, although it is not so precise from the mathematical point of view. Nonetheless the concept of penetration depth λ_L can be easily introduced to students all the same. Moreover we note that in the practice the penetration depth is evaluated by experiments because its mathematical expression is often unusable.

A brief comment on the validity of the London equation

As it is well-known, there are many cases in which a magnetic field can penetrate a superconductive sample without destroying superconductivity, giving the so called mixed state [4]. Therefore, the situation described above of the completely expulsion of the magnetic field from the bulk of the sample, is only a limit case that holds for weak magnetic fields and for particular geometries and dispositions of the sample in the field. Most of the lab experiences for secondary school students, that are commonly called Meissner effect, are performed in situations in which the magnetic field does indeed penetrate the sample [5,6] although very weakly. In order to explain these more complex situations, a generalization of the simple London equation (1) is needed. In this paper we have not room to discuss this point but we strongly believe that this generalization is necessary even in secondary school, otherwise the phenomena observed by students could not have a complete explanation.

Conclusions

Educational paths on superconductivity are often based on experimental approaches which are accompanied by a popular explanation of the well-known BCS theory, a theory whose mathematical framework is really beyond the possibilities of secondary school students. For this reason we propose in this work an educational path based on a model (the two fluid model) that we have developed by mean of mathematical tools suited for a secondary school and that is able to explain most of the lab experiences that students perform.

The model proposed is fully set in the framework of electromagnetism and is based on the magnetic vector potential that can be certainly accessible to secondary school students [1] and very useful to better understand electromagnetism, even if, traditionally, it is never treated before the university courses. In our experience, high school students are very involved in superconductivity and for this reason we think that it is possible to exploit this occasion to deepen many topics covered in their physics courses until that moment and also become familiar with the important tool of the vector potential [7].

In this paper, we have listed among the prerequisites for superconductivity the knowledge of the wave behaviour of matter, for which we have developed a separate educational path [8] in order to present the modern physics in the secondary school. The wave behaviour of matter becomes the basis for a deeper understanding of superconductivity in which the superconducting fluid is described by a complex wave field, as in the Ginzburg-Landau theory. Even without taking into account any other equation, the description of the superconducting fluid as a wave field allows a generalization of the London equation in a quite clear and easily understandable way. Moreover, from the same generalization, it becomes also possible the discussion of the quantization of the magnetic field in a superconductor, and the introduction of the concept of fluxoid. We have not enough place here to discuss this topic, but it is part of a more complete path on superconductivity we are working on. In fact, through this last part, students can have an explanation of the phenomenology that they observe in lab, when they perform experiments using YBCO samples in which the magnetic field is not always expelled as in the Meissner effect, but can penetrate in fluxoids throughout the sample in the mixed state.

References

- [1] Barbieri S., Cavinato M., Giliberti M.: An educational path for the magnetic vector potential and its physical meaning, *Eur. J. Phys.* 34 (2013) p. 1209-1219.
- [2] Barbieri S., Cavinato M., Giliberti M.: Riscoprire il potenziale vettore per la scuola superiore, *Giornale di Fisica Vol. LIV, N.2* (2013) p. 111-128.
- [3] London F., London H.: *The electromagnetic Equations of the supraconductor*, Clarendon Laboratory, Oxford (1934). <http://www.w2agz.com>
- [4] Ginzburg V.L., Andryushin E.A.: *Superconductivity*, World Scientific Publishing Co.Pte.Ltd (2004), ISBN 981-238-913-X.
- [5] Peters P.N., Sisk R.C., Urban E.W. et.al: Observation of enhanced properties in samples of silver oxide doped $\text{YBa}_2\text{Cu}_3\text{O}_x$, *Appl. Phys. Lett.* **52** (24) (1988) p. 2066-2067.
- [6] Brandt E.H.: Rigid levitation and suspension of high-temperature superconductors by magnets. *Am. J. Phys.* 58 (1) (1990) p. 43-49.
- [7] Barbieri S., Giliberti M.: *Laboratorio aperto: Superconduttività*, CUSL, Milano (2012), ISBN 88-8132-660-0.
- [8] Giliberti M.: *Elementi per una didattica della fisica quantistica*, CUSL, Milano (2007), ISBN: 97888-8132-473-3.

A keplerian laboratory of didactics

Jorge Barojas Weber¹ and Miguel Cuauhtli Martínez Guerrero²

Centro Virtual de Investigación y Desarrollo en Educación, Mexico

(Virtual Center for Research and Development in Education)

¹jrbw40@gmail.com

²cuauhtli_86@hotmail.com

Abstract

This contribution proposes that learning physics can be didactically promoted and organized like a scientific process when teachers explore, experiment and evaluate in a three dimensional laboratory of didactics with a Keplerian approach. Teachers behaving as “experimenters” in such a laboratory work in the dimensions of individual cognitions, epistemological interpretations, and social interactions. The Keplerian approach implies that teachers develop three characteristics of the scientific process shown by Kepler when he described the trajectories of the planets around the Sun: capacity for synthesis, creativity and open-mindedness. Capacity for synthesis in the dimension of individual cognitions is fostered by guiding the students in problem-solving through appropriate applications of natural, technical, formal and iconic languages and by working on metacognition. Creativity in the dimension of epistemological interpretations is encouraged by promoting in the students the consideration of aspects and factors defining scientific theories. Open-mindedness in the dimension of social interactions is stimulated by creating learning communities where the performance of the students is improved. A concrete example of application concerning the calculation of the trajectory of a spaceship is discussed in the context of an introductory classical mechanics course.

Keywords: University education, individual cognitions, epistemological interpretations, social interactions.

Introduction

Didactics concerns teaching. Although didactics is not a science, the project Investigative Science Learning Environment (ISLE) developed by Etkina and van Heuveling [1] considers teaching as a scientific process. In this project teaching Physics is “*an interactive method of teaching, Investigative Science Learning Environment (ISLE), that helps students learn physics by engaging in processes that mirror the activities of physicists when they construct and apply knowledge*”. What do physicists do when they do Physics? They observe, find patterns, build and prove explanations of those patterns, and use multiple representations to reflect on physical phenomena. In this sense, what is the meaning of a laboratory of didactics that considers teaching physics as a scientific process?

We propose a laboratory of didactics as a scenario created by physics teachers in order to promote learning and create understanding in the students. Before describing the dimensions of this laboratory, as we are interested in a Keplerian approach, in what follows we consider the main characteristics of the scientific process evidenced in the contributions made by Johannes Kepler.

According to Arthur Koestler [2], some patterns of discovery can be tracked through the evolution of man’s changing visions of the universe. In particular, he characterized the works of the Sleepwalkers (Copernicus, Kepler and Galileo) in terms of intellectual

characteristics such as capacity for synthesis, creativity and open-mindedness. By following Koestler, these three intellectual characteristics distinguished Kepler's scientific process:

- Capacity for synthesis: Kepler proposed a new and more coherent theoretical structure of the universe by formulating his three well known laws.
- Creativity: Kepler considered the data obtained by Tycho Brahe and organized them in new contexts by following Copernicus instead of Ptolomeus and by making epicycles and eccentrics obsolete.
- Open-mindedness: Kepler was sceptical with respect to traditional ideas, axioms and dogmas; he broke up a mental habit reluctant to disregard accepted beliefs and surmounted that challenge by proposing new concepts and relationships.

In next section we describe the Keplerian three-dimensional laboratory of didactics and associate to each dimension one of the intellectual characteristics of the scientific process followed by Kepler. In the final section of this paper we include a concrete example of application.

Description of the laboratory of didactics

Dimension of individual cognitions

The Keplerian characteristic of capacity for synthesis is applied where the teacher designs and implements activities in order to explore, recognize and guide in a synthetic way how their students uses different languages to deal with contextualized learning cycles and solve problems including metacognitive reasoning [3].

Contextualized learning comprises three main issues [4]: (1) explanation of a problematic situation, (2) formulation of a series of generating questions describing the context, and (3) description of learning and evaluation activities. The corresponding learning path mostly implies the use of different languages with specific purposes [5]: natural language corresponds to a modern tongue for the description of facts, technical language contains terms employed in the discipline for the specification of concepts, formal language involves mathematical symbols and expressions for the explanation of phenomena, and iconic language relates to drawings, schemes, tables, pictures, films, videos and animations for the formulation of results. Transitions among these languages correspond to the phases that describe the contextualized learning cycle.

- Phase 1-Search: to clearly describe the problematic situation by making the scenario where the problem must be solved; it corresponds to the transit from a preliminary iconic language to a natural one.
- Phase 2-Training: to propose some generating or leading questions in order to guide the exploration of significant details of the context and to develop ancillary concepts and procedures; it corresponds to the transit from natural language to technical language in which the context is now properly described.
- Phase 3-Comprehension: to experiment and evaluate learning activities serving as a diagnostic of what has been understood in connection with descriptive explanations, mathematical calculations and physical predictions; it corresponds to the transit from technical language to formal language.
- Phase 4-Application: to integrate the previous three steps in order to be able to foresee possible future extensions of the context by including more complex situations and

discussing their implications; it corresponds to the transit from formal language to an enriched iconic language in which new and expanded contexts can be proposed.

Dimension of epistemological interpretations

Physics teachers will be working on this dimension with the purpose of considering the building process of the scientific theories related to the Physics contents to be taught. The purpose is to provide the students with appropriate and accessible criteria for understanding the creative aspects of the corresponding styles of reasoning. In this paper we will not go into philosophical considerations and just follow Piaget and García [6] who studied the evolution of concepts and theories in different disciplines. They characterized such evolutions in terms of the following set of aspects (A) and factors (F) describing scientific theories:

A₁: Type of questions to be addressed by the theory.

A₂: Type of non-demonstrated premises that are implicitly or explicitly accepted.

A₃: Type of relationship between theory and experience.

A₄: Role of mathematics in the formulation of a physical theory.

F₁: Methodology or procedure employed in the analysis of facts and in the verification hypothesis.

F₂: Epistemological points of view characterizing general concepts in connection with experimental facts.

F₃: Building a coherent system that logically integrates facts and concepts.

Dimension of social interactions

This dimension relates to the characteristics of open-mindedness by dealing with the operation of a learning community focused on the development of certain competences. As a consequence of this analysis teachers must obtain multiple representations about the teaching and learning processes in which they are involved by perceiving and facing unexpected teaching situations.

A learning community (LC) involves actors or agents and resources aiming to accomplish four main goals: to be informed, to organize communications, to obtain and apply knowledge, and to accomplish transformation activities for specific learning purposes [7]. In order to assess and interpret the efficient performance of the teachers participating in the creation and development of an LC, we propose to apply the following four principles: 1- Make knowledge accessible to all LC members. 2- Make thinking visible for all LC members. 3- Help LC members to learn from each other and 4- Promote continuous learning among LC members. These principles are adaptations from similar principles defined for science education by Linn and Hsi [8].

However, as we are interested in building an LC in which specific capacities or competences will be developed by the students, it is convenient to select the expected results of the application of this dimension of the laboratory of didactics. In our case, we are interested in the development of the capacities or competences (Cp) proposed by the ISLE project [1]: Cp1-to represent physical processes in multiple forms; Cp2-to design an experimental activity; Cp3-to obtain and analyze data; Cp4-to conceive and test a qualitative explanation or mechanism or a quantitative relationship; Cp5-to modify the

explanation or the relationship according to new obtained data; Cp6-to evaluate predictions and experimental results, conceptual affirmations, solutions to problems and models, and Cp7-to communicate what has been done. Capacities Cp2, Cp3 and Cp5 are required only when there is an experimental activity, either in a real laboratory or in a virtual computer simulation; otherwise, the other four capacities apply.

An example of application of the laboratory of didactics

In this section the three dimensions of the laboratory of didactics are applied to the problem of calculating the trajectory of a spaceship going from Earth to Mars. In order to avoid philosophical and pedagogical considerations, only the dimension of individual cognitions is described in detail because it is explicitly related to Physics contents.

Application of the dimension of individual cognitions

The main elements required for learning in the context of an interplanetary travel from Earth to Mars are referred in Table I to each one of the four languages that compose the contextualized learning cycle. This Table describes in a synthetic way the main concepts and procedures required to solve the problem.

Table I. Languages used in the phases of a learning cycle describing the context of an interplanetary travel

PHASES	Description of facts	Specification of concepts	Explanation of phenomena	Formulation of results
LANGUAGE	NATURAL	TECHNICAL	FORMAL	ICONIC
1 - Search <i>Describe the problematic situation.</i>	Structure of the solar system and relative distances between the Sun and each of the two planets.	Description of the orbits of Earth and Mars: angular positions and angular velocities; periods of revolution.	Calculation of appropriate times for departure from Earth and arrival on Mars.	Description of the trajectories of both planets and of the spaceship when it is circumnavigating Earth or Mars.
2 - Training <i>Propose the leading questions.</i>	Kinematics of different motions: linear, circular, parabolic, elliptic.	Forces in interaction: gravity, thrust by burning fuel, friction.	Initial conditions, rate of change of the mass, escape velocity.	Qualitative descriptions for all the complete trajectories.
3 - Comprehension <i>Evaluate the learning activities.</i>	Properties of central forces and of conservative forces.	Conservation of energy and angular momentum.	Connections between different spaceship trajectories.	Detailed formal description of the Hohmann transfer orbit.
4 - Application <i>Integrate previous steps and look for possible future extensions.</i>	Conditions for landing on Mars and for returning to Earth.	Energetic analysis of each step of the travel (work as a measure of energy changes).	Calculation of fuel consumption and of energy efficiency.	Complete formal description of the trajectories of Earth, Mars and the spaceship.

Source: personal elaboration

Corresponding to these phases of the contextualized learning cycle, the following five steps of a problem-solving procedure TADIR [10] are now considered.

Translation (T): The objects, events and agents characterizing the physical system under consideration are described.

- The physical system is made-up by four objects (the spaceship, Earth, Mars and the Sun); their relative positions and velocities are described by time-dependent vectors.
- The event under consideration is the trajectory of the spaceship described in terms of three steps: (S1) departure from the surface of the Earth and taking of a circular orbit circumnavigating this planet, (S2) transference into a Hohmann transfer orbit to approach Mars, and (S3) change into a circular orbit circumnavigating the target planet and descending on it.
- The interactions among the objects belonging to the system are due to the forces of gravity exerted on the spaceship by the Earth (step S1), the Sun (step S2) and Mars (step S3); these binary interactions correspond to central and conservative forces and satisfy a superposition principle.

Analysis (A): All the assumptions or approximations (A) required to interpret the physical system and to build the solution are explicitly described.

A1: The Sun has a constant mass (m_S) and is at a fixed position.

A2: The planets have constant masses (m_E and m_M) and spherical shapes with average radii (R_E and R_M); for the purpose of this calculation they describe circular orbits centered in the Sun with average distances (r_E and r_M). The periods of these orbits correspond to constant angular velocities (ω_E and ω_M); we will disregard the fact that such velocities are different in the aphelion and in the perihelion for elliptic orbits because for steps S1 and S2 the spaceship moves in circular orbits.

A3: In steps S1 and S3 gravitational interactions are only between the spaceship and the corresponding planet; the interaction of the spaceship with the Sun is negligible. The effects of friction are not taken into account and during all the trajectory of the spaceship the Earth-Mars interaction is not considered.

A4: Although both planets have rotational motions around their own axis as well as translational motions around the Sun, only their translational motions will be considered in defining the appropriate moments for departure from Earth and descending on Mars; the rotational motions of the planets are relevant only for defining the places for departure at the beginning of step S1 and for arrival at the end of step S3. This means that concerning translational motions, both planets are regarded as particles. Furthermore, the orbits of the two planets as well as that of the spaceship trajectory are in the same plane.

A5: In step S2 the only gravitational interaction to be considered takes place between the spaceship and the Sun. All along the transfer orbit- the Hohmann transfer orbit- this gravitational force is conservative and central, therefore the mechanical energy and the angular momentum are constant.

A6: The transfer orbit corresponds to an ellipse whose perihelion is the point where the spaceship leaves its orbit circumnavigating Earth and enters the transfer orbit and whose aphelion is the point where the spaceship leaves the transfer orbit and comes into the orbit circumnavigating Mars. At the entrance and at the departure of this transfer orbit, the spaceship velocities need to be changed.

A7: During departure in step S1, the spaceship changes from an initial velocity v_i to a final velocity v_f when the burnt fuel has a velocity v_0 with respect to the spaceship. On

arriving to Mars at the end of step S3, the spaceship mass also changes due to braking procedures. The mass m of the spaceship changes when velocities are modified at the entrance and departure of the Hohmann transfer orbit in step S2. All these velocity changes are obtained by action-reaction while the fuel contained in the rockets attached to the spaceship is fired and exhausted.

Design (D): The following actions are required for the calculation of the interplanetary travel of the spaceship. These actions are indicated in the following diagram (Figure 1).

- ACTION 1:** During the initial vertical departure from a platform on a rotating Earth, the spaceship receives the accelerated effect of two forces: the exhaustion force of the combustion gases that pushes upward and the acceleration of Earth gravity that pulls downward and changes with height.
- ACTION 2:** In order to leave the Earth's atmosphere the vertical path of the spaceship is changed into a parabolic path by adding a horizontal component to the initial vertical velocity; later on, this trajectory is transformed into a circular orbit when the insertion value of the velocity (v_i) is attained at a certain altitude (h).
- ACTION 3:** The spaceship circumnavigates around the Earth and increases its angular velocity until it attains the escape velocity (v_e).
- ACTION 4:** The longest part of the complete trajectory is between two circumnavigating orbits, one around Earth and another one around Mars. Although the shortest path between these two circular orbits will be a straight line, this will imply considerable fuel expenses. Therefore, it is worthwhile to save energy even if the spaceship spends more time; any other trajectory between Earth and Mars will be longer than a straight line. The most efficient trajectory is the Hohmann transfer orbit because during this trajectory there is no energy consumption.
- ACTION 5:** When the spaceship is circumnavigating Mars, in order to descend on the surface of the planet an inverse process to ACTION 2 needs to be worked out.

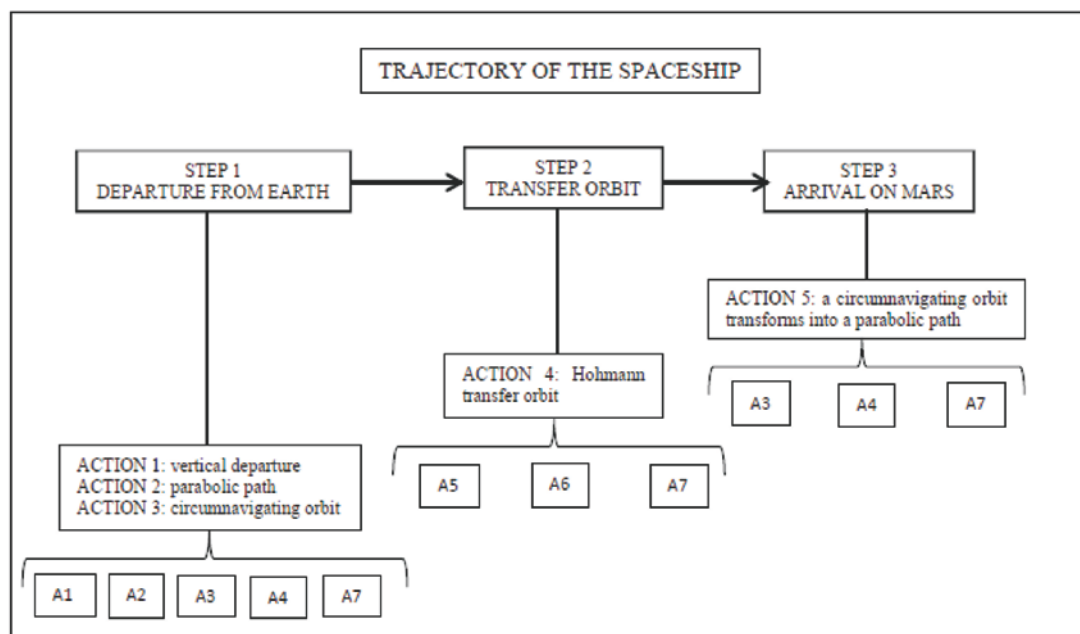

Figure 1. Design of the solution of the problem including Approximations (A1, A2,...A7).

Implementation (I): Appropriate definitions, information and criteria are taken into account and expressed as the basic equations and the mathematical operations required for solving the problem (see the Appendix).

Review (R): Confrontation with predicted answers and results obtained under different conditions are revised by considering possible modifications of the assumptions or by introducing new complications of the statement of the problem. In what follows we comment on those assumptions whose modifications seem to be worthwhile in the context here considered.

A2: The planets describe elliptic orbits with the Sun in one of its focus and their angular velocities (ω_E and ω_M) are different in the aphelion and in the perihelion by following second Kepler's law.

A3: In steps S1 and S3 the effects of friction are taken into account when the spaceship leaves and enters the neighborhood of each planet.

A4: The rotational motions of the planets are relevant for defining the places for departure at the beginning of step S1 and for arrival at the end of step S3. This means that both planets are not regarded as particles but as rigid bodies.

A7: During all the previous calculation the mass of the spaceship has been considered as constant and it does not appear in many equations after simplification processes; however, it must appear in the calculations of energy. When the spaceship changes velocity its mass changes, in particular at departure in step S1, at arrival in step S3 and when the spaceship enters and leaves the Hohmann transfer orbit in step S2.

Application of the dimension of epistemological interpretations

By following Piaget and García [7], next we describe the corresponding aspects (A1 to A4) and factors (F1 to F3) related to the scientific thinking of Galileo Galilei (G) and Johannes Kepler (K). We are interested in describing the role of creativity in their reasoning styles of thinking

A₁: Type of questions to be addressed by the theory.

G: What happens to the motion of a body when there is no interaction modifying its velocity during a certain time interval?

K: Is there any pattern of behavior that can be inferred from observational data concerning the positions and motions of the planets registered by Tycho Brahe?

A₂: Type of non-demonstrated premises that are implicitly or explicitly accepted.

G: Any assumption or prediction concerning physical phenomena needs to be tested by experiments. The validity of the hypothesis depends on how objective the mechanisms interpreting experimental results are.

K: The symmetry and regularity of the platonic solids are also expressed in the harmony and simplicity of the planet trajectories in the sky.

A₃: Type of relationship between theory and experience.

G: Pure theoretical speculations explain almost nothing; logical reasoning is not enough for understanding the physical reality which requires appropriate explanations of measured experiences.

K: What is observed and measured is described by theoretical considerations involving assumptions, concepts and laws.

A₄: Role of mathematics in the formulation of a physical theory.

G: Quantitative formal relationships between physical variables lead to numerical results that can be compared with observational data and experimental measurements.

K: The three laws express the main result, namely, that the trajectories of the planets around the Sun are ellipses: the Sun is in one of the focus; the angular speed of the planet is greater in the aphelion than in the perihelion, and the squares of the periods of revolution are proportional to the cubes of the average distances to the Sun.

F₁: Methodology or procedure employed in the analysis of facts and in the verification hypothesis.

G: The rationality and scope of the theoretical models depend on the fact that calculated predictions must correspond+ up to a certain precision with experimental measurements.

K: Careful analysis of regularities in observational data leads to a new conceptual organization of the positions and motions of celestial bodies according to the Copernican model of the universe.

F₂: Epistemological points of view characterizing general concepts in connection with experimental facts.

G: Asking questions to nature by means of experimental procedures and devices serves to describe natural phenomena by providing asymptotic explanations to physical phenomena.

K: Scientific truths describing natural phenomena are presented in beautiful and precise mathematical forms in order to systematize the observations made by Brahe.

F₃: Building a coherent system that logically integrates facts and concepts.

G: Galileo's law of inertia is a particular case of Newton's first law of motion. This implies that the motion of a body can continue to be rectilinear and uniform if there is no force that modifies that state of motion.

K: Kepler's laws form a coherent theoretical structure that describes but does not explain; it will attain a complete justification only when Newton formulated and applied his theory of gravitation.

Application of the dimension of social interactions

In order to understand the creation and development of the LC under consideration we use as a test the following knowledge management activities (KMA) described by Nonaka and Takeuchi [9]. These authors classify those activities in terms of the four processes defined in the first column of Table II.

Table II. Examples of situations corresponding to knowledge management activities.

Process	Knowledge Management Activities (KMA)	Examples of situations
<p><i>Socialization:</i> It starts by building a field of interaction that facilitates sharing mental models and technical skills.</p>	KMA1 – to communicate with the purpose of sharing skills, mental models, experiences and information.	Describe the initial conditions of both planets and the rate of change of the mass and the escape velocity for the spaceship.
	KMA2 – to include useful observations and practical actions in the knowledge to be shared.	Establish connections between the spaceship trajectories when it is circumnavigating Earth and Mars and during the Hohmann transfer orbit.
<p><i>Externalization:</i> It is triggered by meaningful dialogue or collective reflection.</p>	KMA3 – to explain concepts through metaphors and analogies.	Compare the kinematics of different motions and relate to conic shapes in orbits corresponding to linear, circular, parabolic, and elliptic trajectories.
	KMA4 – to develop concepts.	Apply the principles of conservation of energy and angular momentum.
	KMA5 – to propose hypotheses.	Take into account the properties of central forces and conservative forces.
	KMA6 – to build models.	Perform energetic analysis of each step of the travel.
<p><i>Combination:</i> It is developed through newly created networking knowledge and existing knowledge coming from other places.</p>	KMA7 – to interchange and transform knowledge in order to reorganize, use and share available information.	Calculate the complete trajectory of the spaceship, its fuel consumption and energy efficiency.
	KMA8 – to classify and categorize acquired knowledge.	Describe mathematically the trajectories of Earth, Mars and the spaceship.
<p><i>Internalization:</i> It is promoted by learning by doing.</p>	KMA9 – to communicate what has been learned in practice and to present it as diagrams, texts, narratives....	Explain the conditions for departure from Earth, for landing on Mars and for returning to Earth.

Conclusion

Next we summarize how the three dimensions of the Keplerian laboratory of didactics described in the previous two sections were applied last year in the preparation and teaching of an introductory course on Classical Mechanics for Physics majors in the School of Science at the Universidad Nacional Autónoma de México. In what follows we comment on what was worthwhile developing (Comment 1) and on what was not working in a satisfactory way (Comment 2). Furthermore, we present some recommendations on how to improve what was done (Comment 3). We base our considerations on what the

teaching team has accomplished according to the results obtained by their students. The teaching team was formed by a professor, an assistant professor and a teacher assistant.

Concerning the dimension of individual cognitions and the development of capacity for synthesis

Comment 1: Weekly questionnaires were presented to the students in which they provided examples of the use of languages in understanding the contextualized learning cycle implemented for learning about the spaceship trajectory. Their answers and their corresponding justifications were sent through the platform of the course and served to detect doubts, mistakes and samples of the reasoning of the students that were taken into account by the teachers in forthcoming classroom sessions.

Comment 2: Although gradual applications of the TADIR instrument were explained as exercises and problems in the classroom; students had difficulties to solve homework problems and quizzes when metacognitive reasoning was required. The students were reluctant to follow a structured reasoning procedure in which they were required to incorporate some new elements both in the formulation of the problem and in the solution procedure.

Comment 3: The capacity for synthesis needs to be developed by the teaching team by integrating all the activities during the complete term of sixteen weeks, not only during the eight weeks dedicated to the context of the interplanetary travel. Furthermore, due to time constraints some topics cannot be treated in terms of a contextualized learning cycles. A lot of preparation work needs to be done in order to break bad traditional study habits and the resistance of the students to think by themselves, instead of just looking for good grades and despite the risks of being wrong and making mistakes.

Concerning the dimension of epistemological interpretations and the development of creativity

Comment 1: The use of written notes prepared for the course was a useful tool for motivating and encouraging further work concerning creativity in other related topics. For instance, when there were no notes available the average grade of the group in the first monthly test was 7.2 with respect to 10; afterwards, when the notes were ready to be used, the corresponding averages for the next three monthly tests were in the interval 8.0 – 8.5.

Comment 2: The extra requirement consisting of writing a story in connection with the physics contents of the course and involving some of the aspects and factors describing scientific theories in mechanics was not fully accepted by all the students. This creative activity was not understood as an important means to think and to organize their thoughts.

Comment 3: At the end of the context for the interplanetary travel, the students were asked to complete and discuss in the forum of the course their own answers concerning aspects and factors corresponding to the contributions made by Galileo, Kepler and Newton. The participations of the students were weak due to lack of discussions during the course concerning these epistemological issues.

Concerning the dimension of social interactions and the development of open-mindedness

Comment 1: By being aware of the student's needs and possibilities, the teaching team modified the requirements and resources of the course in order to improve knowledge

accessibility and thinking visibility. Every month the teaching team presented in the forum of the course general comments regarding the performance of the students in connection with their development of competences. As a consequence of being more open-minded, the teaching team was more apt to help those students having low performance or being at risk of dropping out.

Comment 2: The application of the principles associated with continuous learning and learning from each other were much more dependent on the attitudes of the students regarding mutual understanding and possibilities for working together. One term was not enough to build a more permanent change in the behaviors and academic performance of the students. As the course is separated from the laboratory some of the competences related to experimental work were not considered. Furthermore, the suggestions made during classroom dissertations concerning videos and simulations did not have an appropriate follow-up.

Comment 3: It would be better to focus on a reduced number of knowledge management activities in order to have a more precise follow-up of the evolution of the performance of the students and the improvement of their study habits.

Appendix

The main equations and mathematical operations corresponding to the five actions explained in the Design step and used in the Implementation step of the TADIR problem solving procedure are now described. For brevity, we just indicate the required equations and the corresponding results, without going into the details of the mathematical procedures.

ACTION 1

Change in the velocity of the spaceship: $v_f - v_i = -v_0 \left[\int_{m_i}^{m_f} \left(\frac{dm}{m} \right) \right] = v_0 \left[\ln \left(\frac{m_i}{m_f} \right) \right]$

Variation of the acceleration of gravity: $F_G = \frac{GmSm}{(R_E+h)^2} = mg$; $g_0 = \frac{Gm_E}{(R_E)^2}$; $g \approx g_0 \left[1 - \frac{2h}{R_E} + \dots \right]$

ACTION 2

Velocity in a circular orbit: $\frac{mv^2}{R_E} = G \frac{mEm}{(R_E)^2}$, $v = \sqrt{\left[\frac{Gm_E}{R_E} \right]}$

Velocity of insertion into a circular orbit: $\frac{m(v_i)^2}{(R_E+h)} = \frac{GmEm}{(R_E+h)^2}$; $v_i \approx g_0 \left[1 - \frac{h}{2R_E} + \dots \right]$

ACTION 3

Velocity of escape from a circular orbit: $\frac{1}{2}[m(v_e)^2] - \frac{Gmm_E}{R_E+h} = 0$; $v_e = \sqrt{\left(\frac{2Gm_E}{R_E+h} \right)}$

ACTION 4

The spaceship has a mass m and comes from the circumnavigating orbit to Earth with speed $v_A = \sqrt{\left[\frac{Gm_E}{r_E} \right]}$ then it changes to speed v'_A when it enters the transfer orbit in position A; this corresponds to the positive increment $\Delta v_A = v'_A - v_A$. From A to B the spaceship travels half of the ellipse without wasting energy, then leaves the transfer orbit with speed

v'_B and enters a circumnavigating orbit to Mars with a speed $v_B = \sqrt{\left[\frac{Gm_M}{r_M}\right]}$, corresponding to the negative increment $\Delta v_B = v'_B - v_B$. The force between the Sun and the spaceship is conservative, therefore the mechanical energy is conserved in all points of the ellipse such as the perihelion in A (the point nearest to the Sun) and the aphelion in B (the point farthest to the Sun). As this force is also central, the angular momentum is equal in A and in B. Furthermore, the Sun (S) is in one of the foci of the ellipse describing the Hohmann transfer orbit (see Fig. 3). If Earth is in A and Mars is in B, the distances between the Sun and each one of the planets are: $SA = r_E$ and $SB = r_M$; therefore, the mayor axis of the ellipse is $a = (r_E + r_M)/2$.

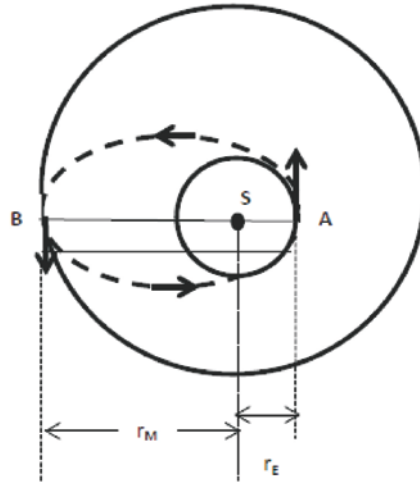

Figure 2. Transfer orbit from A to B to A.

MAIN EQUATIONS

Earth circumnavigating the Sun: $\frac{m_E(v_A)^2}{r_E} = \frac{Gm_E m_S}{(r_E)^2}$

Energy of the spaceship in position A: $E_A = \frac{1}{2}[m(v_A)^2] - \frac{Gmm_E}{r_E}$

Mars circumnavigating the Sun: $\frac{m_M(v_B)^2}{r_M} = \frac{Gm_M m_S}{(r_M)^2}$

Energy of the spaceship in position B: $E_B = \frac{1}{2}[m(v_B)^2] - \frac{Gmm_M}{r_M}$

Conservation of energy ($E_A = E_B$):

$$E_A = \frac{1}{2}[m(v'_A)^2] - \frac{Gmm_S}{r_E} = E_B = \frac{1}{2}[m(v'_B)^2] - \frac{Gmm_S}{r_M}$$

From conservation of angular momentum

$$(L_A = L_B): r_E [m(v'_A)] = r_M [m(v'_B)]; v'_A = \left(\frac{r_M}{r_E}\right)v'_B$$

From conservation of energy: $\frac{(v'_A)^2}{2} - \frac{Gm_S}{r_E} = \frac{(v'_B)^2}{2} - \frac{Gm_S}{r_M}$,

$$(v'_A)^2 = \left(\frac{Gm_S}{a}\right)\left(\frac{r_M}{r_E}\right) \text{ and } (v'_B)^2 = \left(\frac{Gm_S}{a}\right)\left(\frac{r_M}{r_E}\right)$$

Energy expenses: $\Delta E_A = \left(\frac{Gmm_S}{4a}\right)\left(\frac{r_M - r_E}{r_E}\right)$ and $\Delta E_B = \left(\frac{Gmm_S}{4a}\right)\left(\frac{r_M - r_E}{r_M}\right)$, therefore

$$\Delta E_{tot} = \left(\frac{Gmm_S}{4a}\right)\left[\frac{(r_M)^2 - (r_E)^2}{r_M r_E}\right]$$

ACTION 5

The spaceship descends on the surface of Mars after circumnavigating it; this action is similar but in an inverse order as the one corresponding to ACTION 2 when the spaceship leaves Earth.

References

- [1] Etkina E, Van Heuvelen A.: Investigative Science Learning Environment– Science Process Approach to Learning Physics. In Research Based Reform of University Physics, Redish E. F., Cooney P, (Eds.) (2007), [on line]. [cit. 07.02.2013]. Available from: <http://paer.rutgers.edu/ScientificAbilities/Downloads/Papers/ISLE-2007.pdf>
- [2] Koestler A.: The Sleepwalkers. A History of Man’s Changing Vision of the Universe. London: Penguin (1959), ISBN 0-14-02-0972-7.
- [3] Schoenfeld A.: Learning to Think Mathematically: Problem Solving, Metacognition, and Sense Making in Mathematics. In Grouws, D. A. (Ed.), Handbook of Research on Mathematics Teaching and Learning, New York: Information Age Publishing (1992), pp. 334-370, ISBN-13: 978-1593115982.
- [4] Coleman L. A., Holcomb D. F., Rigden J.S.: The Introductory University Physics Project 1987–1995: What has it accomplished? Am. J. Phys. 66 (1998), pp. 124–137.
- [5] Barojas J., Pérez R.: Physics and Creativity: Problem Solving and Learning Contexts, Industry and Higher Education, Vol. 15 No. 6, (2001), pp. 431-439.
- [6] Piaget J, Garcia R.: “Psychogenesis and the History of Science”. New York: Columbia University Press, (1988), ISBN-10: 0231059922.
- [7] Barojas J., Sierra J., Martínez R.: Application of a knowledge management network in education. IV Conferencia Internacional sobre Multimedia y Nuevas Tecnologías de la Información y la Comunicación en Educación (m-ICTE2006). Sevilla, España. Anexo, pp. 11-16. ISBN: 978-84-690-4268-7 (2006). Available from: <http://www.formatex.org/micte2006>
- [8] Linn M. C., Hsi, S.: Computers, Teacher, Peers: Science learning partners. Mahwah, New Jersey: Lawrence Erlbaum Associates (2000), ISBN-10: 1135666652.
- [9] Nonaka I., Takeuchi H.: “The knowledge-creating company”, New York: Oxford University Press (1995), ISBN 0-19-509269-4.
- [10] Barojas J., Problem solving and writing I: The point of view of physics. Latin American Journal of Physics Education. Vol. 1, No. 1 (2007), pp. 4 – 12.

An approach to the concept of statistical distribution: a pedagogical path based on Guided Inquiry

Onofrio Rosario Battaglia, Claudio Fazio, Rosa Maria Sperandeo Mineo

Dipartimento di Fisica e Chimica, University of Palermo, Palermo, Italy

Abstract

This paper describes a teaching approach to the concept of distribution that uses a specific activity related to the field of statistical mechanics. The concept of velocity distribution of a particle system is dealt with using an Inquiry Based approach involving an experimental examination of Maxwell's Distribution. Some outcomes of a teaching experiment are described.

Keywords: Teaching methods and strategies, statistical distribution, Inquiry Based Science Education

Introduction

Mathematical representations are relevant to scientifically describe and explain phenomena, but very often students have difficulty in getting their uses and limits. Many research results have highlighted how much the understanding of the distribution concept in physics can be influenced by the conceptual difficulties connected with its mathematical representation [1,2]. In his classical work "Language of art", Goodman [3] outlines that the mathematical representations concerning drawing and interpreting graphs involve the using/understanding of a "symbol scheme correlated with a field of reference".

The distribution concept is a fundamental component of statistical thinking. It can be seen as a lens through which the variability that exists in various phenomena can be looked at with greater clarity [4].

Here, we propose a learning approach to the concept of distribution in physics based on laboratory and modelling activities aimed at overcoming the above-mentioned difficulties. For this purpose, a specific activity, related to the field of statistical mechanics, is proposed, in which the concept of distribution of velocity/energy of a particle system is dealt with by using an Inquiry Based [5] experimental analysis of Maxwell's distribution.

Inquiry learning environments can be organised in different ways [6,7] in relation with the spectrum of inquiry levels that accounts for the gradual shift of the focus of research control from the teacher to the student. In particular, a Guided Inquiry Approach [6] is intended as an approach where the teacher provides students with the research questions, concerning a problematic situation, and students are requested to design the procedures to conduct an appropriate investigation. Students are encouraged to plan and carry out their laboratory activities by formulating hypotheses, collecting and analysing data, for the purpose of gaining a more meaningful understanding of the proposed problematic situation.

Our learning environment (the Workshop - W) is based on the methodology of the Guided Inquiry Approach and uses experiments and models, previously published [8], for the determination of the velocity distribution of the electron gas emitted by a metal as a result of thermionic effect.

In the following section we report the main characteristics of the workshop. Then, we describe the characteristics of our teaching experiment and some preliminary result of the assessment procedure. In the last section findings and limits of our research are outlined and suggestions are proposed for the improvement of the workshop methodology.

Workshop

The W inquiry context involved the development of methods (experimental and theoretical) aimed at analysing the velocities/energies of a system of particles. As a consequence, the main idea to develop concerned a method to filter particles having a well-defined velocity/energy (or within in a given interval). In the specific context of our research, the idea of “electron velocity filtering” by means of electric fields was the starting point, because it can naturally introduce students to the concept of a distribution of frequencies of particles having velocities in a given interval. The proposed experiments analyse the distribution of energies of thermionic electrons and are discussed in detail in Battaglia et.al [8].

The workshop was developed in different stages characterized by different inquiry procedures. According to Windschitl’s et.al [9] theoretical framework, the different stages focus on different aspects of scientific reasoning and inquiry procedures.

1. The first stage involved the presentation of the inquiry context to the students and the definition of the main problem by setting the broad parameters to be investigated. The problem of identifying methods that can emphasize the distribution of some variables (energy, velocity, etc.) among particles of a system (atom, molecules, electron) was analysed. The most popular students’ ideas and proposals were discussed by the whole class and difficulties in performing experiments making evident the various characteristics were pointed out. The instructor illustrated several scientific publications facing the problem of experimental determination of the velocity distribution of a system of atoms/molecules.

Some historical papers have been described [10,11] and the research was oriented toward the following problem:

“To establish the characteristics of the electrons gas emitted by thermionic effect through the typical variables of statistical mechanics.”

2. The second phase was aimed at summarizing what students knew and what they should know. Class discussion was oriented at identifying and making explicit their representations about the problem and at defining experimental situations able to represent the problem. The awareness of the necessary additional information allowed students to make explicit their research question:

“How it is possible to realise an electron velocity analyser able to show how many electrons have velocities in given intervals?”

3. The third stage begun with a discussion of the different approaches proposed by students aimed at making explicit the design problems of such electron velocity analyser.

4. In the fourth stage students were divided into groups of up to 4 people. The groups worked independently, by designing the measuring apparatus and using the tools (worksheets, circuit diagrams, instructions for fitting procedures) provided by the teacher at their request. Each group was responsible of the experimental setting, as well as of the choice of the different kinds of measurements to be performed.

5. In the fifth stage students were mainly involved in data analysis. After a great group discussion, during which each group compared its apparatus and scheduled measurements with the ones proposed by the others groups, all the students understood the need to perform

a set of measurement maintaining constant the temperature of emitted electrons (and, consequently, the filament temperature), although many students were not fully able to explicitly and formally see the relationship between the values of current and the ranges of electron velocities. Each group independently performed three sets of experiments by fixing, for each set, the filament temperature and varying the retarding anode potential from zero to values that allow a current in the range of sensitivity of our micro-ammeter.

6. The final stage was devoted at pointing out arguments for appropriate explicative model building [12,13]. The starting point was a great group discussion aimed at the formalization of a possible model that would put in relation the current with the electron velocity distribution. By comparing the results of the different groups the limits of the model became explicit.

Methodology

The W experimentation was carried out at the Faculty of Engineering of University of Palermo from March to May 2012 by one of the authors (O. R. B.) and involved 20 hours of students' activities. 43 students, that already completed the curricular mathematical and numerical calculation courses, as well as the general physics courses, participated to the W. In such courses they already faced the problem of statistical distributions, although only from a theoretical point of view.

During the W designing phase, the authors informally interviewed four lectures/professors teaching physics at the engineering faculty, with the aim of collecting information about the typical difficulties encountered by undergraduates on the learning of the distribution concept, during the attendance of a traditional lecture-based physics course. They recognised that this "one-way" teaching approach hardly permits to receive a direct feedback of the students' learning during the course. They identified the greatest learning difficulty of students in their ability to apply their theoretical background of knowledge to the understanding and solution of practical/experimental situations.

The problematic situation proposed at the beginning of our W was really new for our student and, for these reasons, we decided to shape the W by following a Guided Inquiry approach, with the main objective of facilitating the students' understanding about the identification of appropriate selection methods, reading a distribution graph and identification of relevant quantities.

Students' learning was assessed by comparing the answers to a specifically designed questionnaire before and after the W. Moreover, a qualitative analysis of videos registering students' experimental activities and discussions was also performed. In fact, many research papers [14-16] show that a detailed analysis of the phrases or utterances used by students when carrying out an activity involving human-to-human interaction, can provide evidence of the cognitive style(s) used when tackling a given issue or problem.

The administered questionnaire was aimed at investigating the student knowledge with respect to the distribution concept, and to obtain information for the gauging of the interventions. The questionnaire implementation was carried out by following two main steps:

1. The two questions were generated and, then, reviewed during the meeting with the experienced faculty professors. They report experiments and/or simple situations and are organized by following a thematic ordering. We chose an open-answer questionnaire format, as it guarantees the advantage to highlight the spontaneous responses, avoiding the bias that

may result from suggesting responses to individuals, typical of closed-answer items. However, we were aware that the analysis of the outcomes from open-ended questions usually needs an extensive coding of the answers and, for this reason, we performed this action firstly during the questionnaire validation phase (see point II), and, secondly, with the answers provided by the students selected for this study.

2. The second step concerned the questionnaire validation process aimed at evaluating the appropriateness, meaningfulness, and usefulness of the specific items. The researchers first tried to search for all possible answers that a hypothetical student could supply when facing the problematic situations described in each item. This analysis was conducted independently of the observation with our student sample (hence the term ‘a-priori’), in order to provide a reference point for the subsequent study of the observation (‘a-posteriori’) data. According to Brousseau [17], and other researchers [18,19] a search for possible student answering strategies can be very useful to highlight weak points in the questions, and modify them before administering the questionnaire. The answer lists, provided independently by the three researchers, were compared and discussed in a form of content validation [20], and a revised version of the questionnaire and of the answer list were developed. Successively, the questionnaire was administered to a sample of five engineering students not participating to the W, in order to test our pilot validation on learners having received the same traditional physics instruction of our research sample. A focus group was conducted with these students in order to clarify the meaning of some unclear answers.

At the end of the workshop the same questionnaire was re-administered (post-test), in order to verify the instruction effectiveness, but the students were informed of the post test administration only immediately before it was given them.

The analysis of students’ answers was separately performed by the researchers and was based on the careful reading of student answers within a framework provided by domain-specific expertise.

Results of the pedagogical experimentation

Qualitative analysis

The workshop design explicitly requested students to work in small groups, discussing the results within the group itself and/or with the teacher (usually after each measurement or analysis stage). A class discussion was the typical conclusion of each workshop stage.

Below we report some aspects of the learning paths that emerged, mostly during the group discussions, in order to make explicit the students’ learning difficulties and progresses. To do this, we report some transcripts of discussions¹ between students performing a task in the same group, or between students and the instructor, or general questions raised by the students.

A learning difficulty, identified at the beginning of the W, was the understanding of the model of electron gas that describes electrons as a gas similar to the ideal gas studied in thermodynamics.

Students had already studied the thermionic emission, but they had never thought about the characteristics of the emission rate. A few students, in fact, were aware that electrons can be

¹Interview excerpts are not always literally translated from Italian into English. We tried to convey the sense of the originals, rather than reporting the exact terms and expressions used by students. Only the typical expressions we identified as relevant for the analysis are directly translated.

emitted at different speeds, but the majority thought of a single output speed. A large number showed difficulties in giving a meaning to the concept of “velocity distribution of emitted electrons”. In fact, the majority represented the electrons emitted all at the same speed by using a constant distribution. Moreover, some believed that electrons could have velocities distributed according to a specific law, but only when they are within the metal and that they lose this property once out of the metal.

The understanding of the methodology used to select the electrons with velocities in a given range was a fundamental aspect of the learning path. Several students easily identified the voltage or the electric field applied between the two electrodes as the responsible for the selection of the electrons on the basis of their kinetic energy.

A typical student idea was:

"The presence of such a retarding voltage has a filtering effect, in the sense that the higher the voltage, the lower the anodic current, and therefore a smaller amount of electrons will reach the anode. This retarding effect is due to the presence of an electric field between anode and cathode that opposes to the electron motion."

Many students proposed arguments based on the principle of mechanical energy conservation, identifying a value of voltage above which there is no current, but did not identify how it is possible to arrive at this value of zero current.

For example:

"...the electric field between anode and cathode is opposite to the motion of emitted electrons and ...in other words it supplies a way to discriminate electrons with more kinetic energy from those having less energy. By remembering the formula of kinetic energy ($E_k = \frac{1}{2}mv^2$), we can conclude that the electrons arriving to the anode are those with a greater velocity."

By synthesizing, the method of retarding potential was easily understood by the students: they showed to understand that applying a negative potential with respect to the emitter allows us to make a selection of electrons on the base of their speed. Moreover, they were able to deduce from the current-voltage exponential graph that the electrons were not emitted all with the same speed, even if they were not yet able to determine the shape of the distribution.

A typical argumentation was:

"To measure the velocity distribution we apply a field ...: increasing this field, if all electrons had the same speed we should note a zero current, beyond a certain field strength. Actually, since the electrons have different speeds, a number of electrons is still able to reach the anode."

The analytical procedure describing the relationship between the voltage-current characteristic and the velocity distribution of the electrons was a critical aspect of the whole learning path. No student was able to identify it.

It is well known [8] that for high values of filament temperature the agreement between the experimental data and the theoretical curves is not good. Some students developed some argumentations on this issue. For example, some reported as a motivation the high space charge density which leads to a high interaction between the electrons, thus violating the hypothesis of weak interaction of the particles each other. For example:

"When the filament voltage increases, the temperature of the cathode also increases and thus the electron emission is greater. This makes the space charge density no longer negligible, and this implies that the particles begin to interact with each other."

Quantitative analysis: pre/post questionnaire comparison

The pre/post-instruction questionnaire was structured in 2 items. Below, we report the items, our categorization and the results obtained from the pre/post-instruction comparison.

Item n. 1 describes (in a simplified form) a historic experimental apparatus (the Zartman apparatus [21]), which has been used to determine the speed distribution of bismuth gas molecules emitted in a high temperature oven. These molecules, which are emitted at different speeds, can leave a mark on a drum rotating at a constant velocity, on which the shape of the distribution is thus determined.

Figure 1 represents the categorization of students' answers and their distributions in pre/post tests along following categories of students' answers:

Level 0: Not answer or only partial answers.

Level 1: Student describes the apparatus but does not give any information about the method of selection.

Level 2: Correctly identifies the method of selection.

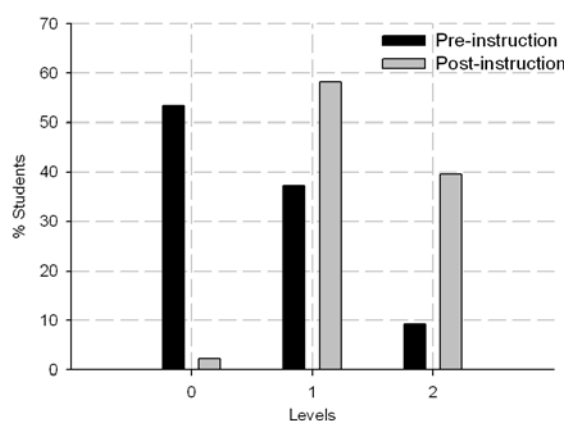

Figure 1. Categories of students' answers in Item 1 and their percentages in each category.

$$\chi^2 = 30.19; p = 2.8 \cdot 10^{-7}$$

By comparing pre-test and post-tests results, we can confidently say that a considerable improvement in the post-instruction answers was obtained. Although the proposed apparatus was never described during the activity, after instruction all the students were able to at least describe it correctly. Furthermore, 40% of them managed to identify the selection method, clearly explaining it in their answers. The post-instruction answers show that the identification of the selection method in the description of the apparatus had attained a considerable improvement, compared with the pre-instruction.

In Item 2 students have to compare three different distributions at three different temperatures. Figure 2 represents the categorization of students' answers and their distributions in pre/post tests along following categories of students' answers:

Level 0: Student does not identify any information about the distribution.

Level 1: Student identifies some information but not the variance or the connection with temperature.

Level 2: Student identifies the variance as a relevant characteristic of distributions and compares them correctly, but does not know the connection with temperature.

Level 3: Student identifies the variances, compares correctly them and knows the connection with temperature.

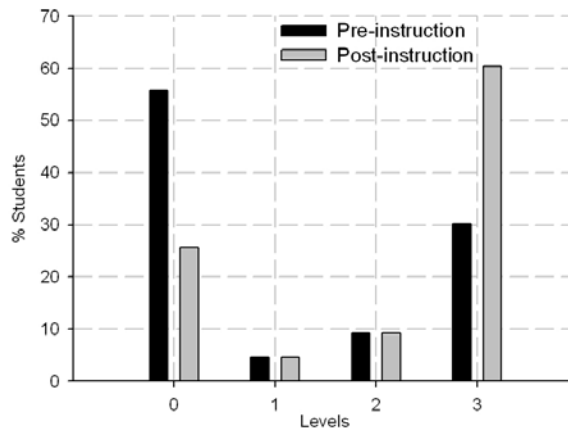

Figure 2. Categories of students' answers in Item 2 and their percentages in each category.

$$\chi^2 = 9.16; p = 0.03$$

As shown in Figure 2, the improvement in post-instruction answers with respect to the pre-instruction ones is considerable. This is highlighted by both the decreasing of percentage of students who did not manage to identify an answer, and the considerable percentage (60%) of students that managed to correctly identify the variance as a relevant quantity, to relating it to temperature. The correct answers were also well explained and complete.

Findings

In this paper we describe a 20 hours' workshop for undergraduate engineering students of University of Palermo that uses an Inquiry Approach aimed at searching answers to a problematic question that involves the understanding of the statistical distribution concept in the field of statistical mechanics.

The majority of students showed a considerable interest with respect to both the subject and the way it was dealt with. Almost all were easily involved by the laboratory measurements, mainly for the character of the approach; they were guided only by the research questions and were free to design appropriate experimental set ups.

Some preliminary results of the students' learning, mainly focused on the comparison of pre and post instruction questionnaire answers and on a qualitative analysis of students ideas discussed during the workshop activities, are reported. These show that students easily understood the use of the method of retarding potential to build distributions. All students showed the awareness of the need for accurate experimental designs and models able to describe the experimental data. Moreover, although a high percentage of students initially showed difficulties especially in the construction of distributions and in identifying the quantity characterizing the distributions, their active construction of distributions, aimed at explaining their experimental data, stimulated their understanding of general concepts.

The analysis of the videos recording the students' behaviours during the group work investigations is in progress. It highlights how students became confident with the investigation methods and the dynamics of their learning. The main point that such analysis is pointing out is how the students during the activities became more and more comfortable with the main characteristics of scientific inquiry and their relationships.

Acknowledgements

This work was partially supported by the FP7/2007-2013 “Establish” project G.A.N. 244749.

Appendix: Questionnaire

1) A historical apparatus for the study of velocity distribution of atoms/molecules is the following: an oven emits atoms/molecules of bismuth, which are collimated on a drum (as a screen) that can rotate at a constant velocity. The surface of the drum is covered with a material that emits light when struck by atoms/molecules of bismuth. In this way the atoms/molecules leave a persistent trace on the drum and can therefore be detected.

Explain why the drum is maintained rotating.

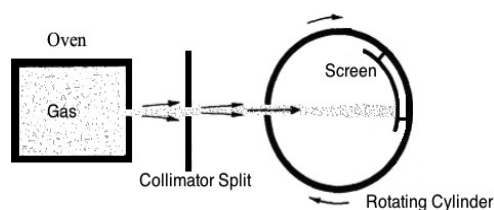

2) Three Maxwellian velocity distributions at three different temperatures are reported. Analyse the plots and state the relation between the temperatures, giving reasons for your answer.

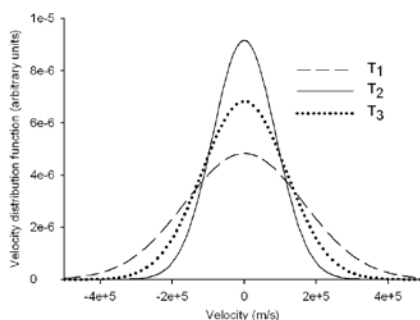

References

- [1] Leinhardt G., Zaslavsky O., Stein M.: 1990. Functions, Graphs and Graphing: Tasks, Learning and Teaching *Review of Educational Research* 60(1), 37-42 Spring.
- [2] diSessa A., Hammer D., Sherin B., Kolpakowski T.: 1991. Inventing graphing: Meta-representational expertise in children *Journal of Mathematical Behaviour* 10 117-160.
- [3] Goodman N.: 1976. *Languages of art* (rev. ed.) (Amherst, MA: University of Massachusetts Press).
- [4] Wild C.: 2006. The Concept of Distribution *Statistics Education Research* 5(2) 10-26.
- [5] Linn M. C., Davis E. A., Bell P.: 2004. *Internet environments for science education* (Mahwah, NJ:Erlbaum).
- [6] Wenning C. J.: 2007. Assessing inquiry skills as a component of scientific literacy *Journal of Physics Teacher Education Online* 4(2), 21-24.
- [7] Banchi H., Bell R.: 2008. The Many Levels of Inquiry *Science and Children* 46(2) 26-29.
- [8] Battaglia O. R., Fazio C., Gustella I., Sperandeo Mineo R. M.: 2010. An experiment on the velocity distribution of thermionic electrons *Am J. Phys.* 78(12) 1302-1308.

- [9] Windschitl M., Thompson J., Braaten M.: 2008. *Beyond the Scientific Method: Model-Based Inquiry as a New Paradigm of Preference for School Science Investigations* Wiley Periodicals, Inc. Sci. Ed.,92 941-967.
- [10] Richardson O. W.: 1921. *The Emission of Electricity From Hot Bodies* (2nd ed. Longmans Green London) www.archive.org/details/emissionelectri00richgoog.
- [11] Germer L. H.: 1925. The distribution of initial velocities among thermionic electrons. *Phys. Rev.* 25 795-807.
- [12] Gilbert J. K., Boulter C. J.: 2000. *Developing Models in Science Education* (Kluwer Academic Publishers, Dordrecht, The Netherlands).
- [13] Greca M., Moreira M. A.: 2002. Mental, physical, and mathematical models in the teaching and learning of physics *Sci. & Educ.* 86 106.
- [14] Berg B.: 1989. *An introduction to content analysis, in Qualitative Research Methods* edited by B. Berg (Allyn & Baron Press, Boston), p. 105.
- [15] Wegerif R., Mercer N.: 1997. Using Computer-Based text analysis to integrate Qualitative and Quantitative Methods in Research on Collaborative Learning *Lang. and Educ.* 11(4) (1997).
- [16] Onwuegbuzie A. J., Leech N. L., Slate J. R., Stark M., Sharma B., Frels R., Harris K., Combs J. P.: 2012. An Exemplar for Teaching and Learning Qualitative Research *Qual. Rep.* 17(1) 16.
- [17] Brousseau G.: 1997. *Theory of Didactical Situations in Mathematics* edited by M. Cooper, N. Balacheff, R. Sutherland, and V. Warfield. Kluwer Academic, Dordrecht.
- [18] Fazio C., Spagnolo F.: 2008. Conceptions on modelling processes in Italian high school prospective mathematics and physics teachers *South African Journal of Education* 28(4) 469-487.
- [19] Fazio C., Di Paola B., Guastella I.: 2012. Prospective elementary teachers' perceptions of the processes of modeling: A case study *Physical Review Special Topics – Physics Education Research* 8(1) 010110-18.
- [20] Jensen M. P.: 2003. Questionnaire validation: a brief guide for readers of the research literature *The Clinical Journal of Pain* 19(6) 345-352.
- [21] Zartman I. F.: 1931. A direct measurement of molecular velocities *Phys. Rev.* 37 383-392.

The “LuNa” Project: experimental didactic modules exploiting portable setups to teach optics in Primary and Secondary Schools

Maria Bondani^{1,2,3}, Alessia Allevi^{2,3}, Luca Nardo⁴, Fabrizio Favale²

¹Institute for Photonics and Nanotechnologies, CNR, Como, Italy

²Dipartimento di Scienza e Alta Tecnologia, Università degli Studi dell'Insubria, Como, Italy

³CNISM UdR Como, Como, Italy

⁴Dipartimento di Scienze della Salute - Università degli Studi di Milano Bicocca, Milano, Italy

Abstract

The “LuNa” (La natura della Luce nella luce della Natura - The nature of Light in the light of Nature) Project is devoted to the experimental teaching of optics in the different school grades. The core of the Project consists of several portable setups that support experimental and interactive lectures covering all the aspects of optical phenomena, from geometrical optics to single-photon interference, including atmospheric optics, spectroscopy, holography and theory of perception. When possible, the setups are realized with simple materials so as to be reproducible by teachers and students. Otherwise, for the most complicated setups (interferometry and holography) research materials are used. Each module is calibrated to fit teachers’ requirements either to be included in the curricula of their classes or to be used to expand the curricular program.

Keywords: Primary and Secondary Schools, optics, portable experimental setups

Introduction

Scientific curricula are often unattractive for students, though they in principle can offer important skills to spend on a professional level. One of the reasons of this could be that science subjects are often experienced by students as too difficult and too “far away” from everyday life due to the kind of lectures they are used to.

On the other hand, the natural curiosity intrinsic to any human being, especially to the youngest, can be used as a trigger to activate the interest in the study of physical subjects. To exploit this possibility, we decided to exploit our experience as optics researchers and teachers to try our personal way to teaching that takes place from the direct observation of physical phenomena reproduced in the laboratory in a controlled way. As a matter of fact, not all educational institutions have the necessary equipment to realize suitable experimental activities and, above all, teachers are not always encouraged to acquire the skills necessary to implement this kind of teaching. The LuNa Project wants to offer teachers some examples of a different way of teaching based on experiments directly performed in the schools.

The objective of LuNa Project [1] is thus twofold: first of all we want to keep alive students' natural interest in the reality of natural phenomena and, second, we want to help teachers improve their level of confidence with experimental activities during lectures.

The Project was financed by both private and public sponsors during the years 2009 and 2010. The sponsorship supported the acquisition of the initial experimental equipment. Unfortunately the Project has not been financed in the last two years and is being sustained on a voluntary base. The Project has involved about 200 classes (more than 4000 students till 2013 (four academic years)).

Methods

The LuNa Project is organized in several independent and modular courses linked by a common thread: the nature of light, its phenomenology and its interaction with matter (see Table 1). The idea of independent modules comes from the attempt of tailoring the activity on the requirements of teachers in order to support their daily work with students.

In fact, some topics can be easily inserted in most school curricula and can be dealt at different levels according to the age of the students. Among them we mention the observation of atmospheric phenomena (rainbow, color of sky, color of shadows) and all the basic phenomena of geometrical optics. All these modules can be inserted in the curricular lectures to support and integrate didactics. Other topics are only suitable to be integrated in the Physics programs of High Schools: spectroscopy, light scattering, non-linear optical phenomena.

Table 1. List of LuNa modules (from the Project website <http://luna.dfm.uninsubria.it/>)

Primary Schools	
E1	Light in natural phenomena
E2	Light and human eye
Middle Schools	
M1	Fundamentals of geometrical optics and wave optics
M2	Vision and image formation
M3	Light-matter interaction
High Schools	
S1	Fundamentals of geometrical and wave optics
S2	Vision and image formation
S3	Color theory
S4	Light-matter interaction – inelastic interactions
S5	Light-matter interaction – elastic interactions
S6	Non-linear optical phenomena
S7	Holography
S8	Demonstration of the optical wave-particle duality
S9	Historical experiments of modern physics

Most of the modules can be implemented as a two-hour interactive lecture but some of them, such as holography, single-photon interference and quantum mechanics experiments, require additional introductory lectures as they require a more specific preparatory knowledge. For this reason these modules are only suitable for expansions of the program in some school grades.

We are aware that any external didactic action is effective for students only if it is perceived as an integral part of their curriculum, or if it is properly prepared and supported by their teachers. For this reason, teachers interested in the various LuNa actions are invited to preparatory lectures during which the content of the different modules is presented for the purpose of being harmonized in the ordinary teaching program. In such a way, the necessary preliminary preparation of the students can be carried out by their own teachers.

Contents

The basic LuNa modules are listed in Table 1. School teachers can choose the activity they want through the Project website [1]. The actual content of each module can be adapted to fit the specific requirements of each class. Moreover, during the years other more specific experiments have been introduced, such as a module on Fourier analysis realized with light.

Each LuNa module is supported by one or more experimental setups that have been developed within the Project. The setups have different structural and conceptual complexity but have all been devised to be easily installed directly in schools. Some optical phenomena can be displayed and studied by using very simple and cheap material (see Figure 1 for samples of the material used for geometrical optics), while others, such as holography and interferometry, require more technically complex and expensive materials.



Figure 1. Simple material to investigate geometrical optics

In the following we present some LuNa activities in more detail to give an idea of the content and the aims of the Project. Note that some activities can be included in different modules.

Natural phenomena

The simplest modules for each school level are focused on some luminous phenomena that are part of our everyday experience and that originate from the interaction of light with materials, such as the colors of objects, sun, sky, air and shadows (see Figure 2). Natural phenomena are reproduced “indoor” by realizing small-scale models [2].

The physical description of the natural phenomena is addressed by introducing the concepts of light beams and waves as interpretative models of the nature of light,

wavelength and color, reflection, refraction and dispersion. High-school students can go through the large part of the mathematical description of the phenomena.

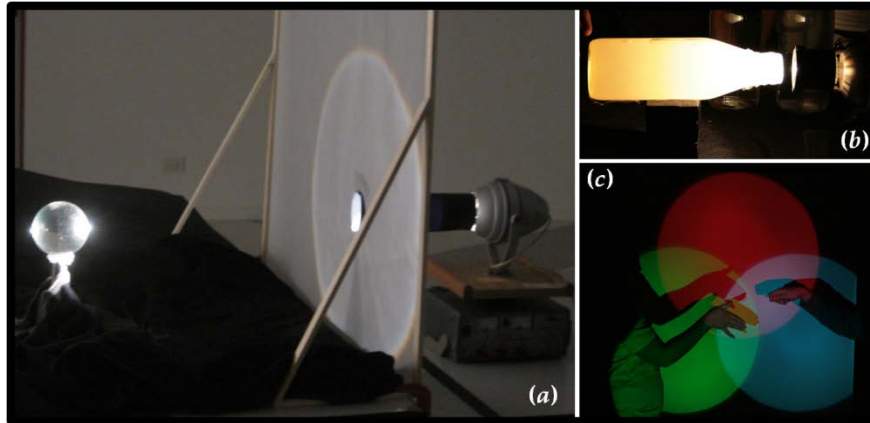

Figure 2. Indoor reconstruction of natural phenomena: (a) rainbow; (b) sunset in a bottle; (c) colored shadows

The main aim of this module is to support introductory lectures to basic optical concepts by using simple experimental setups that could be easily reproduced by teachers.

Reflection, refraction and vision

When discussing the effects of reflection and refraction, simple experiments are proposed, such as the vision of transparent objects embedded in transparent. In Figure 3(a) we see water gel beads immersed in water that become visible by casting shadows, while are invisible when the light is prevented from passing through the object. In Figure 3(b) we show that a Pyrex-glass container filled with glycerol disappears when immersed in glycerol.

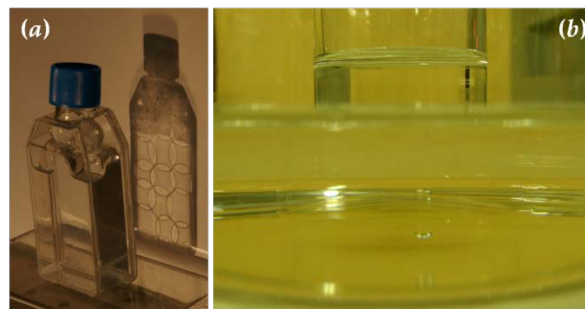

Figure 3. Vision through transparent media: the effect of the refractive index. (a) water gel beads immersed in water; (b) Pyrex-glass container immersed in glycerol

The two examples are used to show the difference between seeing an object through the light it reflects or through the light it transmits [3]. In fact, the objects used in the demonstrations have a refractive index very similar to the environment and thus become invisible if we look at the reflected light (reflection is almost insensitive to small variations in the refractive index). On the contrary, the direction of light refracted through the system changes as a function of the refraction index and allows the recognition of the object.

The main point of these experiments is to have students reflect on the path light has travelled before vision takes place and on the information it carries.

Polarization

As an example of simple investigation of wave properties of light we present some effects of polarization.

By using a LCD laptop screen as the light source and a polarizer we demonstrate that the light from the screen is linearly polarized and that the polarization of the light can change when passing through a plastic sheet. The unexpected appearance of colored light through the polarizer is explained by the effect of the stressed plastic molecules on the linearly polarized light.

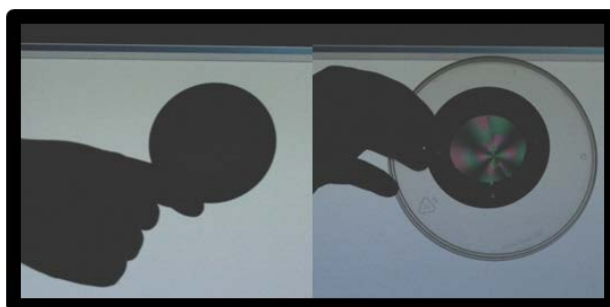

Figure 4. Study of polarization by using a laptop screen as the light source

Fluorescence

The emission of fluorescence by atoms and molecules is presented to support the description of the atomic structure. By using simple spectroscopes or more scientific spectrometers, students can observe the spectral features of the light emitted by different physical systems (atomic and molecular gases, solutions).

As an example we show that some fluorescent dyes become brighter when binding to DNA sequences. To demonstrate the effect, we extract some DNA from fruits (kiwi, banana) and add dye molecules to it. Upon UV-light illumination, the dye molecules fluoresce and reveal the presence of DNA.



Figure 5. Fluorescence of DNA extracted from kiwi fruit

Holography

The words “holography” and “holograms” are commonly known and stimulate students' imagination, but rarely people have a realistic idea of what they really mean: this generates misunderstandings and false expectations. For instance, students are used to 3D image

reconstructions, which they often improperly call “holograms”, but which have nothing to do with true holograms. Moreover, when they think about 3D images, they actually imagine 3D objects freely fluctuating in the space, which is actually only one of the possible holographic images obtainable from a hologram. For this reason, the topic of holography is somehow paradigmatic as it lends itself to a discussion of the proper methodological approach to physics that can be extended to other physical contexts.

Holograms are a kind of image recorded by making the light diffused by an object to interfere with a reference field. The interference pattern is recorded on a photosensitive material and processed like a black-and-white photography. The holographic image is recovered by re-illuminating the holographic plate.

We register, process and reconstruct both transmission and reflection holograms of small objects by using a portable setup featuring a continuous-wave laser (see Figure 6). The system does not require an extreme stability. The entire process of hologram production is performed in the schools [4].

We note that although real holograms are different from those displayed in science-fiction movies, nevertheless they have surprising properties, such as the possibility of reconstructing the entire image from a single fragment of hologram (see Figure 6). The discussion of such peculiar properties is used in the activity to introduce the physical mechanism of image formation.

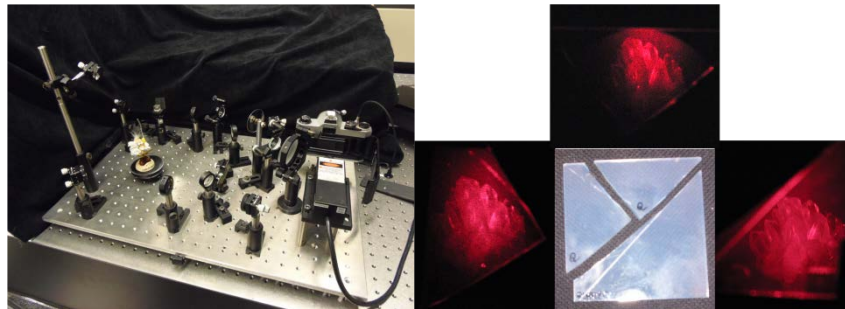

Figure 6. Portable setup for registration of transmission holograms and fragments of a hologram that reconstruct the whole image

Single-photon interference

The demonstration of interference at the single-photon level is included in a teaching path on modern physics based on the properties of light. The module exploits the effects of the superposition principle in a Mach-Zehnder interferometer in which the light is injected at the single-photon level. The light exiting the interferometer is then measured by avalanche photodetectors capable to measure single photons. When both the arms of the interferometer are open, we can reconstruct the fringes of an interference pattern by scanning the output plane by the detector [5].

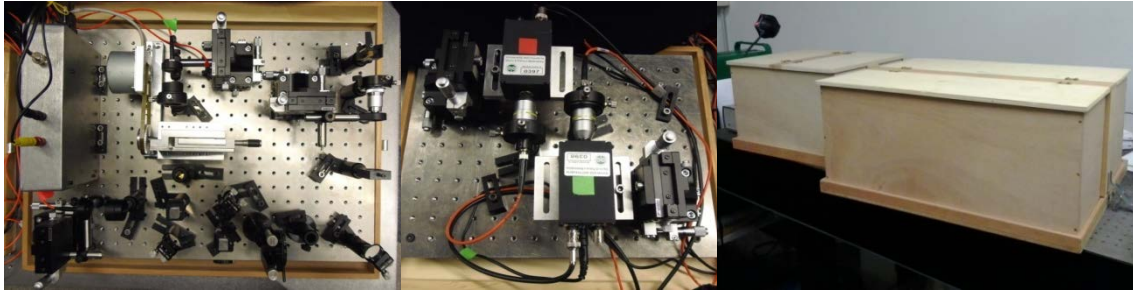

Figure 7. Portable setup for single-photon interference

The logic of the experiment follows the reasoning described by Prof. G.C. Ghirardi in the book “Sneaking a Look at God's Cards” [6]. The experiment is conducted as a “reductio ad absurdum” reasoning that starting from apparently natural observations on the behavior of light at a beam splitter (single photons follow a specific path in the interferometer) leads to the contradictory result (single photons must follow the two paths simultaneously to produce interference). This is a way to introduce the so-called “wave-particle duality”, that emerges from the reconstruction of the interference pattern by the single clicks of the detectors.

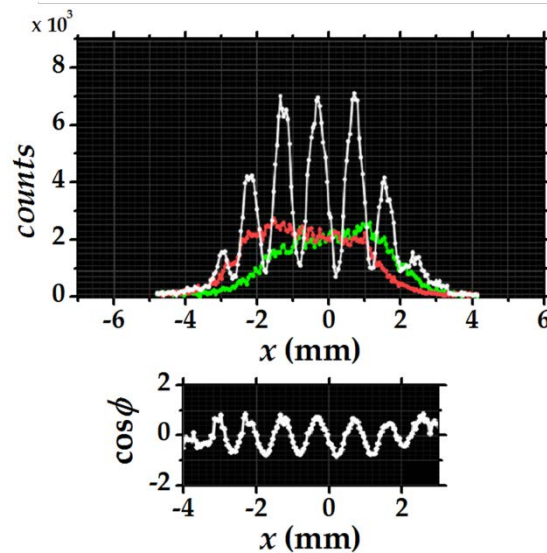

Figure 8. Interference pattern measured by scanning the output plane with the detector and accumulating many single-photon counts

Results and Discussion

The Project was proposed for the first time in 2009 to the schools in the neighborhood of the Department of Science and High Technology of the University of Insubria (Como) and has involved 200 classes (more than 4000 students) ever since:

The large majority of participants in the Project came from Secondary Schools (156 classes), mostly scientifically oriented. This is not surprising because physics is often perceived as too difficult by the largest part of non-specialized teachers, who not even imagine they can propose physical topics to their students. Nevertheless, LuNa modules proposed to Primary and Middle Schools were very effective in raising the interest of the students, as testified by conversations with teachers and by some follow-up of LuNa activities. In fact, entire Middle-School classes of students were involved by their teachers in the preparation of some experimental activities presented during Open Days and School

exhibitions in which they reproduced some experiments, typically atmospheric phenomena, colors and shadows.

We did not make any systematic survey of students' satisfaction, but we know that LuNa activities effectively raised the interest of students from the informal conversations we had with their teachers. During the 4 years of the Project we met about 100 different teachers from different orders of schools and about 25 of them took part in the Project for subsequent years, declaring a great interest in LuNa activities.

Among the different LuNa modules, the most required by High Schools is module S1 (Fundamentals of geometrical and wave optics) that can be used by teachers either to introduce a new topic during curricular lectures or as a summary at the end of the lectures. Holography is also greatly appreciated and required due to the fascination holograms always arise. Several schools required the activity on holograms for all their classes (fourth year course) as a whole-day activity and many students discussed holography at their diploma examination. The other modules are required more rarely and are usually included in non-curricular activities to increase and deepen the knowledge on a particular topic.

Conclusions

Till now, the activities of LuNa Project have had the aim of giving students the opportunity to directly experience some physical phenomena as a support and integration of school lectures. Future improvements of the Project will be in the direction of a deeper involvement of teachers in the development and implementation of the modules. In fact, even if the LuNa communication style could be in principle easily replicated by teachers, this has happened very rarely during the past years, probably due to the lack of familiarity of teachers with experimental activities. For this reason, we judge it necessary to spend more time and energies in the training of the teachers involved in the Project in order to share with them not only the experimental setups but also some research experience.

Aknowledgement

The Authors acknowledge the support of Fondazione Banca del Monte di Lombardia (Pavia), the Rector of the University of Insubria and the Banca di Credito Cooperativo di Cantù that have financed the start-up of the Project in the period 2009-2010.

References

- [1] <http://luna.dfm.uninsubria.it/>
- [2] Bondani M., Favale F.: Dismantling rainbow. Proceedings WCPE2012 (2013). Submitted.
- [3] Bondani M., Favale F.: Following the path of light: recovering and manipulating the information about an object. SPIE Proceedings of ETOP 2013. In press.
- [4] Favale F., Bondani M.: School outreach program for teaching optics: let's start with holography. Proceedings WCPE2012 (2013). Submitted.
- [5] Bondani M.: Single-photon interference experiment for High Schools. SPIE Proceedings of ETOP 2013. In press.
- [6] Ghirardi G. C.: Sneaking a Look at God's Cards, Revised Edition: Unraveling the Mysteries of Quantum Mechanics (translated by Gerald Malsbary, Princeton University Press, Princeton, New Jersey USA, 2007). Original edition in italian: G. C. Ghirardi, “Un'occhiata alle carte di Dio” (Il Saggiatore, Milano, Italy, 2001).

The Predict-Observe-Explain technique as a tool for students' understanding of electric circuits

Joan Borg Marks

University of Malta

Abstract

This paper looks at the learning of the topic of electric circuits by 17-year-old students covering an advanced level course in physics, in Malta. Even if electric circuits are taught in schools both at primary and secondary level, many researchers have reported problems related to the understanding of circuits. The ideas presented during the teaching process are described as 'abstract' by students and the so-called 'simple circuit' is seen as anything but simple. This paper reports the results of a pilot study dealing with the learning of key concepts in electric circuits, focussing mainly on potential difference in simple parallel circuits. Students' understanding was probed using a pre-test and a post-test. Interviews were then conducted using the Predict-Observe-Explain technique to further probe understanding of parallel circuits. The study indicated that all the interviewees made a visible effort to try to correctly explain how the circuit presented to them works. Moreover, about one third of these students managed to bridge the gap between their unscientific intuitions and the scientific view. The Predict-Observe-Explain technique helped students shift their thinking towards the scientific view regarding parallel circuits. The implication is that teachers must not ignore simple but effective teaching techniques which focus on putting the responsibility of learning on the student. Choosing a teaching strategy which helps to arouse students' curiosity by creating cognitive conflicts to make students think, leads the way to a powerful and a qualitatively enriched teaching and learning experience.

Keywords: The Predict-Observe-Explain technique; active learning; thinking for learning; electric circuits.

Introduction

Teachers teach and expect students to learn. Teachers try to use pedagogies that motivate their students towards meaningful learning. This paper emphasizes the idea that unless the teacher as the expert uses methods that make students aware of their responsibility for learning, then it is difficult for students to understand key concepts.

A study conducted with Maltese students at post-secondary level, as they cover the topic of electric circuits, is described. Students hear and deal with ideas related to electric circuits before they start attending school. Moreover, the topic is one which is taught in schools at both primary and secondary levels. Yet, most students still find this topic difficult and abstract. They do not see what is happening inside the circuit wires when a potential difference is applied across two points. By testing students before and after a course of study following traditional teaching methods, students' ideas were probed, gauging students' understanding. Students' ideas were further probed, as they were developing, by conducting semi-structured interviews using the Predict-Observe-Explain (POE) technique [1] – a technique which helped elicit students' intuitive ideas in prediction before doing an experiment, and any changes in these ideas after doing the experiment. The results of the study are discussed to show the effectiveness of simple techniques, in this case the POE

technique, which can be used in the classroom in an effort to make the teaching-learning process more fruitful.

Background

During these last 30 years, many researchers have shown interest and reported results of studies related to students' understanding of electric circuits (see, for example, [2]). Students of different ages have been shown to hold alternative views of how a circuit functions.

A main problem is that students tend to use different mental models to explain the flow of an electric current [3,4]. Millar and King [5] say that 'one consistent finding reported by researchers is that students tend to reason 'locally' or 'sequentially' about the effects of changes in an electric circuit. If a variable resistor is altered, students predict changes in meter readings 'after' the resistor but not 'before'; a change at one point in a circuit is not necessarily seen as causing changes elsewhere in the circuit' (p. 340). Liegeois [6] also emphasises that students often find it very difficult to look at the electric circuit as one whole system.

The idea of potential difference (p.d.) also seems to pose difficulty for understanding. Duit and von Rhöneck [7] indicate that before instruction, some students relate p.d. to 'strength of a battery' or 'intensity of force of the current'. These authors say that, even after instruction, students use the p.d. concept in a way which shows that they believe that it has the same properties as the current concept. This idea is also supported by Eylon and Ganiel [8] who say that students tend to be 'current minded' rather than 'voltage minded', thereby confusing cause and effect, even in simple circuits.

Students have also been found to experience difficulty in the translation of a circuit diagram into practice [9]. Moreover, retention of scientific views after instruction does not last for long with many students. If students do not understand what they are taught, they easily go back to intuitive ideas which make more sense to them [10 - 12].

Aims and Framework

This paper reports the results of a pilot study dealing with the learning of key concepts in electricity, putting a focus on the understanding of potential difference in simple parallel circuits. Vygotsky's theory of learning and development [13] forms the framework for this study. Vygotsky points to the necessity of adult intervention to promote children's learning. Vygotsky [14] refers to the zone of proximal development as '....the distance between the actual development level as determined by independent problem solving and the level of potential development as determined through problem solving under adult guidance or in collaboration with more capable peers' (p. 86). Teaching within this zone is said to help develop students' ideas and foster intellectual growth. It is within this framework that the present study looks into how traditional instruction affects learning and what can make a contribution towards better understanding of ideas related to electric circuits.

The research questions asked were:

- By how far, does traditional instruction help students to progress in their ideas on electric circuits?

- Can an intervention using the Predict-Observe-Explain (POE) technique, help students improve their understanding of electric circuits? If yes, in what way does the POE technique help?

Method and sample

Before instruction in the topic, a group of 61 students in their second year of study at a post-secondary college in Malta were asked to answer some multiple choice questions on basic ideas about simple electric circuits. This constituted the pre-test. At this time, students' knowledge of the topic was based on the ideas which they had retained from their study at secondary level, one year earlier. The study of electric circuits was not part of the syllabus covered by the students during their first year at the college.

Students then attended 2 one hour lectures on electric circuits per week, for two months. They also attended a one hour tutorial a week, helping them sort out difficulties with qualitative and quantitative questions on the topic. Students also attended a 2-hour practical session per week, learning to handle apparatus and do experiments using electric circuits. At the end of the course, the same students sat a post-test. The post-test consisted of some questions on the pre-test which students had found difficult to answer, together with questions based on material covered during the course of study, focussing mainly on ideas related to the understanding of electric potential difference. A question asked in both pre- and post-test, consisted of the two-tier question shown in the next section, based on the circuit in Figure 1. The results of the post-test, and observed students' progress through class discussions, helped in making decisions about students of different ability who would be asked to participate in interviews. Nineteen students from the sample group took part in semi-structured interviews using the POE technique. Students worked hands-on with the circuit, as they were guided and asked questions by the teacher/researcher. Using the POE technique meant that *students were first asked to predict what happens to the ammeter reading once the switch S was closed, giving reasons for their predictions*. Then the experiment was done, with the students being allowed to handle the apparatus. *The result was observed and students had to explain any discrepancies between their predictions and the results, if any existed, once again giving reasons for their explanations*. During this interview, the students' understanding of parallel circuits was thus probed.

Students were interviewed in groups of no more than four students per group, according to their availability during a school day. This study was part of a larger piece of research work and at this stage I was interested in observing the dynamics of peer interaction. The interviews were audio taped and transcripts were then prepared.

The circuit used and questions asked

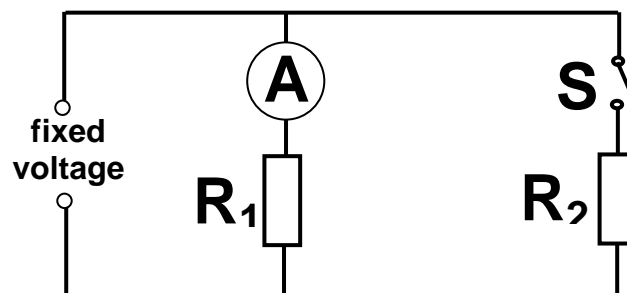

Figure 1. The circuit used

In this circuit, two resistors, R_1 and R_2 are connected in parallel to a power supply. The power supply has a fixed voltage output. The switch S is open. There is a reading on the ammeter.

The switch is then closed

- (a) What happens to the reading on the ammeter? Choose one answer.
- (i) It gets bigger.
 - (ii) It stays the same.
 - (iii) It gets smaller.
- (b) How would you explain this? Choose one answer.
- (i) Some of the current now goes through R_2 , bypassing R_1 .
 - (ii) Two resistors need a bigger current from the power supply.
 - (iii) The voltage across each parallel branch stays the same.
 - (iv) The total R is now bigger, so the current gets less.
 - (v) Other (Please explain your answer).

(Source: [15])

Results

The following are the pre-test results for the whole group of 61 students as they answered the questions posed related to the circuit diagram shown above.

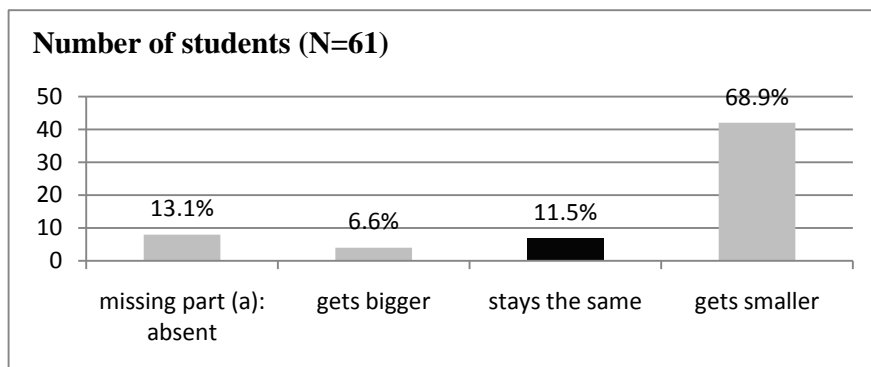

Figure 2. What does the ammeter read when the switch is closed?

Only 11.5% of the students answered correctly to part (a) of the question, saying that the ammeter reading remains the same. The majority of the students (68.9%) said that the reading on the ammeter would be smaller. Students have a correct idea that the current splits at the junction between the two resistors once the second resistor R_2 is in the circuit, but this idea is so predominant that students do not 'see' that the potential difference across the resistance R_1 must remain the same, since this is still connected directly across the battery and that, therefore, the same current as before must pass through R_1 .

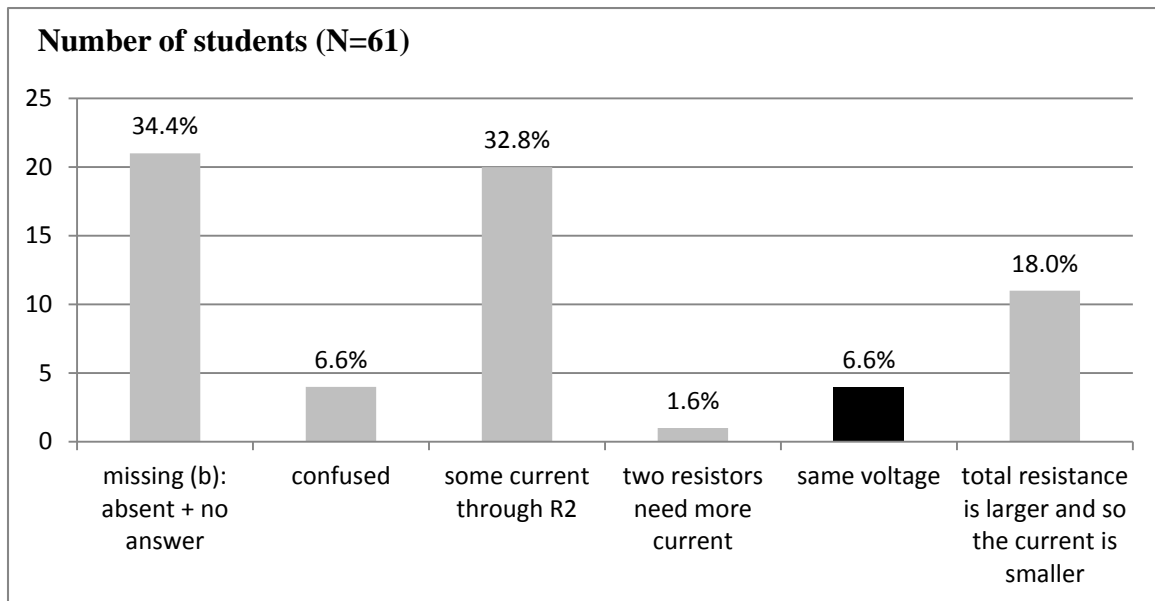

Figure 3. Pre-test justifications given for the change in current when the switch is closed

In the second part of the question, where students were meant to explain the answer they gave to part (a), only 6.6% of the students chose the correct reason. Some of these students had not even chosen the correct response to part (a). A good number of students opted not to answer this question (34.4%), and 32.8% were showing that their concern was to consider the current passing through the second resistor introduced in the circuit, without much thought about the potential difference across the resistors.

The results in Table 1 below, show at a glance which combinations of answers were preferred by the students. Quite a large number of students thought that the ammeter shows a lower reading because some current now passes through R₂ when the latter forms part of the circuit. A good number of students thought that the ammeter shows a smaller value because the total resistance in the circuit increases. It seems that these students were applying the principles of series circuits erroneously to parallel circuits, and concluding that adding a resistor in parallel increases the total resistance of the circuit. Only two students gave the correct answer to part (a), coupled with the correct reason in part (b).

Table 1. Cross-tabulation of results (Note: 8 students were absent for the pre-test)

Answer to part (a)	Reason for answer to part (a)						TOTAL
	no answer	(i) some current through R ₂	(ii) two resistors need more current	(iii) same voltage across parallel branch	(iv) R (total) is now bigger, so current is less	(v) confused others	
(i) becomes bigger	1	-	-	1	1	1	4
(ii) remains the same	3	1	1	2	-	-	7
(iii) becomes smaller	9	19	-	1	10	3	42
TOTAL	13	20	1	4	11	4	53

The answers from the students who were interviewed

The results of the post-test and the interview using the POE technique

Table 2. The results of the post-test and the subsequent interview

Student Code	Post-test / 18	Interview: predictions before observation				Interview: General comments on students' responses after observation
		I less	I more	I same	I changes	
A	9			x		Correct conception from the start
B	10		x			$R_{total} \downarrow$, so $I \uparrow$; disregards experimental evidence
C	10	x				Persistent confusion
D	8				R_{total} changes	Reaches correct conception
E	5		x			$R_{total} \downarrow$, so $I \uparrow$; disregards experimental evidence
F	14		x			Reaches correct conception
G	8				I splits up	Persistent confusion; thinks the ammeter has problems
H	5	x				Persistent confusion; puts the blame on bad teaching
I	5	x				Reaches correct conception
J	16	x				Persistent confusion
K	15	x				Reaches correct conception
L	12	x				Disregards experimental evidence
M	16	x				Reaches correct conception
N	17	x				Reaches correct conception
O	6	x				Persistent confusion
P	12	x				Reaches correct conception
Q	10	x				Persistent confusion
R	12	x				Persistent confusion
S	4			x		Persistent confusion

Table 3. Some general observations from the interview transcripts

Prediction			Explanation after observation					
I subdivides	R_{total} is mentioned	Give correct solution before	Mentions problems with circuit	$R_1=R_2$	Students say that $R_2=0$	Students say R_2 is too large	Back and forth ideas	Reaches correct conception in terms of p.d.
8	3	1	1	1	1	1	2	8

The results in Tables 2 and 3 show that most of the students' first reactions to the question, *in prediction*, after instruction and independent of their test performance, were to say that the ammeter reads a smaller current value. This was much the same result as in the pre-test, showing that students hold on strongly to their intuitive ideas, applying them consistently. For most students, assuming a constant power supply in use, it is the current supplied

which remains the same and not necessarily the potential difference across the supply and the components connected in parallel to it. Moreover, although students saw the ammeter, yet the position where it was connected did not seem to be an important detail for them. *After observing* the change in the circuit and the result of that change, 37% of the students resolved the conflicts which were created, and gave the correct reason to support the result. Others were, however, still confused, offering no real or correct explanation, even after instruction. Some even kept defending their erroneous conclusions. Student H, for example, put the blame of his confusion on bad teaching. Student G thought that perhaps his answer was different from the result of the experiment because the ammeter was not functioning well.

On the other hand, the general observations of the interview transcripts in Table 3 show at a glance that the students who still looked at the current immediately in prediction (saying, 'I subdivides'), outnumbered those who looked at what was happening to the resistance in the circuit (mentioning R_{total}). Moreover, considering those who finally gave the correct explanation after observation, it seems that students did start to note the potential difference effects, but only after they had observed the result of the experiment.

In as far as the student-student interaction, this seemed to have helped to make students more motivated to think and revise their ideas during the interview, in order to understand why the circuit was behaving that way. This positive interaction between students helped to indicate the possibility of using the POE technique on a class-wide scale to structure and guide students' discussions.

Discussion

Confirmation of the literature

One of the main aims for conducting the above study was to see by how far instruction had helped students to progress in their learning of this topic. The results from the pre-test indicate that the instruction students had had at secondary level had not helped much. Moreover, students still found difficulty with key ideas related to parallel electric circuits even after these had been addressed in detail by instruction at advanced level.

The answers provided by the student sample in this study confirmed problems in understanding circuits and learning in general which had been pointed at by previous studies. Some students seemed to have looked at the number of resistances in the circuit and not on the circuit configuration [16]. Students 'saw' the same current coming from the same power supply, even when another resistance was added. It seemed that students saw the splitting of current at the junction, but it was the same current as with one resistor in the circuit that they were imagining was passing through the main circuit [16,17]. Difficulty and confusion were especially evident when students were asked to explain their observations.

Moreover, even after instruction, students held on strongly to their intuitive ideas. White and Gunstone [1] also refer to this common position taken by students. These authors describe an experiment done with their students, with the latter predicting that a bucket would move as a result of changes made to the conditions of the experiment. Even when the bucket did not move, intuitions were held so strongly that some students actually continued to back their argument by saying: '...the bucket moved so little that I could not actually see it!' ([1], p. 51). This was very similar to what students G and H had done (see Table 2). As Schlichting, (cited in [7]), has observed students just 'see' what their conceptions allow them to see.

The use of the Predict-Observe-Explain (POE) technique

The POE technique is a good probe for understanding [1,18]. This study supports the use of the POE technique as a tool to promote students' understanding of electric circuits. Had students' initial response in prediction been taken as their final answer, then some students' ability to develop their understanding of the topic would have been undermined.

The use of the POE technique through the interviews helped some students to grasp the ideas of why the circuit worked the way it did. This pointed towards the importance of having students deal with simple experiments while being asked for predictions with reason, of what is expected to happen, allowing time for ideas to sink in and to develop, reinforcing deeper understanding. The POE task also helped to motivate students to search for a valid reason for why things may not have resulted as predicted. The idea of using these tasks in teaching, helping students to distinguish between their intuitive ideas and the scientific ones, can be an effective way of tutoring students. Students in this study started with their intuitive ideas and were given the space to work on these ideas, clarify their views and develop concepts. Moreover, students' misconceptions were being addressed there and then. This is an important aspect of teaching and learning. It is evident that making students just recall the facts is not enough to motivate them to learn and understand. Students may be externally motivated to recall facts, relying on memory work even if they find that the material has not been understood. Students may find that they still pass exams this way, but once the exam is over, all is easily forgotten. Rosenthal and Henderson [19] likewise stress that "as usual, only telling students has limited effect; they (the students) must struggle with problems on their own or in small groups" (p. 324). True educators should look for ways which make learning last.

Furthermore, this study indicates how by making use of the POE technique, teachers can teach more effectively. POEs can help the teacher to better gauge students' understanding and thus plan lessons that are based on what students already know. Teachers can use the POE technique to induce students to take more responsibility for their learning by having students participate more actively in it.

In this study, the interviews were conducted with a small group of students. However, the POE technique can be scaled up to being used with a whole class. An experimental set-up can be shown to students, or one may even resort to multimedia. Students may then be asked to write down their predictions with reasons of what they expect to happen during the experiment. A discussion can then follow to expose students to the various views from different students. After observing the experiment, some time can be given to students to reflect on why the experiment worked out that way. Reflection can be undertaken either individually, or with students discussing ideas in small groups. A brief teacher guided discussion can then follow, directing ideas towards scientific views. The technique being suggested is similar to the style of presentation used during interactive lecture demonstrations. The latter have been reported to help students' understanding [20].

Having said all this, one must admit that with the claim from teachers that they cannot keep adding more to what they have to do in class, over and above an already overloaded curriculum, the suggestion to introducing the POE technique as a tool to help learning *may* at first appear as an extra burden to carry. Yet, this teaching method, if utilized carefully, only poses a *small* change to a usual lesson plan. Even so, as Viennot [21] says, the 'so-called 'small' changes can do more than commonly expected' (p. 15).

Conclusion

More research guiding us towards the knowledge of how students develop their ideas is required. The findings from such research can better guide us towards making the best use of the right teaching methods. As this study has indicated, the POE technique can help, but which experiment is more appropriate, when is it best to use it, and with whom? All these questions can be answered with the help of further research related to the topic. The POE technique can be used to give that slight *twist* to our teaching, making it more effective. This study has shown that POEs can help students' learning about electric circuits, yet this method may be applied in other topics and other subjects too. The idea is to guide students to take 'active steps to manage their own learning processes to facilitate knowledge acquisition and comprehension' ([22], p. 243). This is when true learning takes place. The emphasis must be on the importance of using teaching methods, which like the POE technique, provide for active learning, offering the key to a powerful and qualitatively enriched teaching and learning experience.

References

- [1] White R., Gunstone R.: Probing understanding. UK, Palmer Press (1992).
- [2] Duit R.: Students' and teachers' conceptions and science education (STCSE) bibliography (2009). Retrieved October 8, 2010 from <http://www.ipn.uni-kiel.de/aktuell/stcse/stcse.html>
- [3] Shipstone D. M.: A study of children's understanding of electricity in simple d.c. circuits. *European Journal of Science Education*, 6, (1984), p. 185-198.
- [4] Fler M.: Determining children's understanding of electricity. *Journal of Educational Research*, 87(4) (1994), p. 248-253.
- [5] Millar R., King T.: Students' understanding of voltage in simple series electric circuits. *International Journal of Science Education*, 15(3), (1993), p. 339-349.
- [6] Liegeois L.: High school students' understanding of resistance in simple series electric circuits. *International Journal of Science Education*, 24(6), (2002), p. 551-564.
- [7] Duit R, von Rhöneck C.: Learning and understanding key concepts of electricity in Connecting research in physics education with teacher education. An I.C.P.E. Book: International Commission on Physics Education (1998). Available from <http://citeseerx.ist.psu.edu/viewdoc/download?doi=10.1.1.95.7608&rep=rep1&type=pdf>
- [8] Eylon B., Ganiel U.: Macro-micro relationships: the missing link between electrostatics and electrodynamics in students' understanding. *International Journal of Science Education*, 12(1) (1990), p. 79-94.
- [9] Gott R.: The place of electricity in the assessment of performance in science. In R. Duit, W. Jung and C. von Rhoneck (Eds.) *Aspects of understanding electricity: Proceedings of an international workshop* Kiel: IPN (1985), p. 49-61.
- [10] Osborne R.: Children's science meets scientists' science. *Lab Talk*, 28(1), 2-7 (Victoria, Australia) (1983).
- [11] Gauld C.: A study of pupils' responses to empirical evidence. In R. Millar (Ed.), *Doing science: Images of science in science education* (pp. 62-82). London: Falmer Press, (1989).

- [12] Gauld C. F.: The cognitive context of pupils' alternative frameworks. *International Journal of Science Education*, 10(3), (1988), p. 267-274.
- [13] Byrnes J. P.: *Cognitive development and learning in instructional contexts*. USA: A Simon and Schuster Company (1996).
- [14] Vygotsky L. S.: *Mind in society*. Cambridge, MA: Harvard University Press, (1978).
- [15] EPSE Project: *Evidence-informed practice in science education*. University of York Science Education Group: UK, (2002).
- [16] McDermott L. C., Shaffer P. S.: Research as a guide to curriculum development: An example from introductory electricity. Part 1: Investigation of students understanding. *American Journal of Physics*, 60(11), (1992), p. 994-1003.
- [17] Licht P.: Teaching electrical energy, voltage and current: An alternative approach. *Physics Education*, 26, (1991), p. 272-277.
- [18] Keamey M.: Classroom use of multimedia-supported Predict–Observe–Explain tasks in a social constructivist learning environment. *Research in Science Education* 34, (2004), p. 427-453.
- [19] Rosenthal A. S., Henderson C.: Teaching about circuits at the introductory level: An emphasis on potential difference. *American Journal of Physics* 74(4), (2006), p. 324-328.
- [20] Thornton R. K.: Interactive lecture demonstrations: Active learning in large lectures and small one-computer classrooms. Paper presented at the GIREP Conference 'Physics Curriculum Design, Development and Validation', Nicosia, Cyprus, (2008, August).
- [21] Viennot L.: Design and evaluation of a research-based teaching sequence: the superposition of electric field. *International Journal of Science education*, 21(1), (1999), p. 1-16.
- [22] Weinstein C. E., Underwood V. L.: Learning strategies: The how of learning. In J. W. Segal, S. Chipman, R. Glaser (Eds.) *Thinking and learning skills Volume 1 Relating instruction to research*, New Jersey U.S.A: Lawrence Erlbaum Associates, Inc. (1985).

Active learning in physics classrooms for enquiry-based instruction: Lessons learned from the PISA 2006 study

Kwok-Cheung Cheung

University of Macau, Macao

Abstract

PISA is the acronym for Programme for International Student Assessment. It conducted its first full-scale scientific literacy study in 2006. Given such a rich and good quality database, the present study seeks to analyze the students' performance on the released PISA 2006 test units from a comparative education perspective so as to allow teachers to know what aspects of scientific literacy are needed fostering in our students so as to help them become scientific literate persons in the new millennium. The analysis results are valuable to guide teachers on how to foster active learning in physics and other science classrooms for enquiry-based instruction.

Keywords: scientific literacy, physics learning, assessment and evaluation

Introduction

OECD's Programme for International Student Assessment (PISA) conducted its first full-scale scientific literacy study for the 15-year-olds studying in secondary schools in 57 participating economies in 2006, see [1]. The research data collected were then made public in the official website (i.e. <http://www.oecd.org/pisa/>). Researchers are welcome to make use of the test and questionnaire data to answer questions pertaining to quality and equity of science education provision in schools of the participating economies. In PISA 2006, both *knowledge of science* and *knowledge about science* are assessed. Students are asked to demonstrate their competence in three aspects of science learning outcomes: (1) *explain phenomena scientifically*, (2) *evaluate and design scientific inquires*, and (3) *interpret data and evidence scientifically*. Earning full credit to the test items necessitate deployment of three types of knowledge, namely *content*, *procedural* and *epistemic* knowledge. The concerned knowledge is drawn from the *physical*, *living*, and *earth science and space* knowledge systems appropriate to the developmental level of the 15-year-olds, see [2]. In addition, students are required to exhibit various types of favorable dispositions and attitudes, such as *interests in science*, *environmental awareness* and *valuing approaches to scientific inquiries*.

Although it has never been the intention of PISA 2006 to link assessment directly to the participating school's physics, chemistry and biology implemented curriculum, students are required to demonstrate their *knowledge of science* and *knowledge about science* by responding to a number scientific and technological issues (e.g. health and diseases, hazards, environmental quality) presented in personal, local, national or global contexts. Given such a rich and good quality database, the present study seeks to analyze the student's performance on the released PISA 2006 test units from a comparative education perspective so as to allow teachers to know what aspects of scientific literacy are needed fostering in our students so as to help them become scientific literate persons in the new millennium. The analysis results are valuable to guide teachers on how to foster active learning in physics and other science classrooms for enquiry-based instruction.

Scientific Literacy Performance of the High-performing Economies in PISA 2006

In the history of PISA literacy assessment, 2006 was the only year hitherto when scientific literacy was the major domain of assessment. The forthcoming PISA 2015 will be the second time when scientific literacy again being the major domain of assessment. In PISA 2006, 15-year-old students of Finland performed exceptionally well in science, not only in the combined scientific literacy scale, but also in all the three scientific competency subscales and the four scientific knowledge subscales (see Table 1).

Table 1. Performance of students in the scientific competency and content subscales of the eleven high-performing economies in PISA 2006

Economies	Combined Scale	Scientific Competencies			Scientific Knowledge Areas			
		Identifying Scientific Issues	Explaining Phenomena Scientifically	Using Scientific Evidence	Knowledge about Science	Knowledge of Science		
						Earth and Space Systems	Living Systems	Physical Systems
Finland	563.3	554.9	566.2	567.4	557.7	554.3	573.8	559.7
Hong Kong	542.2	527.8	549.3	542.4	541.6	525.1	557.7	545.6
Canada	534.5	531.9	530.9	541.5	537.3	540.3	530.5	529.0
Chinese Taipei	532.5	508.6	545.2	531.8	525.4	529.2	549.4	545.5
Japan	531.4	522.1	527.3	544.3	531.6	530.3	526.2	530.4
Estonia	531.4	515.6	540.6	530.9	523.0	540.4	539.8	535.0
New Zealand	530.4	536.2	522.2	536.8	539.1	529.5	528.1	515.7
Australia	526.9	535.3	520.2	531.3	533.4	530.3	521.8	515.1
Netherlands	524.9	532.6	521.8	525.6	530.2	518.1	509.5	531.0
Liechtenstein	522.2	522.3	516.2	534.9	526.4	512.8	523.9	515.1
Korea	522.1	519.1	511.6	538.5	526.5	533.0	498.2	529.8
OECD Average	500.0	498.8	500.4	499.2	499.8	499.5	501.8	500.0

Apart from the top-performing economy, i.e. Finland, the other ten high-performing economies in scientific literacy in PISA 2006 are Hong Kong, Canada, Chinese Taipei, Japan, Estonia, New Zealand, Australia, Netherlands, Liechtenstein and Korea. There are a number of observations:

1. Finland outperformed all other economies participating in PISA 2006 not only in the combined scientific literacy scale, but also in the three scientific competency subscales (i.e. *Identifying scientific issues*, *Explaining phenomena scientifically* and *Using scientific evidences*), as well as in the four scientific knowledge areas (i.e. *Knowledge about science*, *Earth and space Systems*, *Living systems*, and *Physical systems*).
2. Apart from Finland, quite a number of the high-performing economies come from the Asia-Pacific region (i.e. Hong Kong, Chinese Taipei, Japan, Korea, Australia and New Zealand). It appears that the school science curricula for obligatory compulsory education of these high-performing Asia-Pacific economies have served their students well to reach pretty high scientific literacy standards. Apart from Finland, the four western countries, i.e. Canada, Estonia, Netherlands and Liechtenstein, are also high-performing. Likewise, their school science curricula appear to serve their students as well as that of their Asia-Pacific counterparts.

3. Amongst the three scientific competencies it is found that *Using scientific evidence* is generally better developed than *Identifying scientific issues* and *Explaining phenomena scientifically* in six of the eleven high-performing economies in PISA 2006. Regarding this, Canada, Japan, Liechtenstein and Korea are four exemplary cases in point. Admittedly, in spite of the high level of student performance, there are still some room for improvement in *Identifying scientific issues* for the three economies Hong Kong, Chinese Taipei and Estonia. For the two economies New Zealand and Australia, the area for enhancement may be in *Explaining phenomena scientifically*.
4. With the exception of Japan and Netherlands, it is observed that amongst the three scientific knowledge areas *Physical systems* is generally less well developed than *Earth and space systems* and *Living systems*. Regarding this, New Zealand and Australia are two note-worthy cases in point. For student's *knowledge of science* development in *Earth and space systems* the three economies Canada, Australia and Korea are to be commended, whereas in *Living systems* the three economies Finland, Hong Kong and Liechtenstein are to be applauded.
5. All the PISA 2006 high-performing economies generally are doing quite well in *Knowledge about science* which focuses on the procedural knowledge of science that is essential in enquiry-based science instruction.

Scientific Literacy Performance of the High-performing Economies in a Test Unit loaded on the Physical Systems of PISA 2006 Assessment Framework

There are three test items loaded on the *Physical systems* of the PISA 2006 assessment framework. They pertain to the global concern of the effects of acid rain, see [3,4]. Presented below is the stimulus of a released test unit named ACID RAIN:

ACID RAIN

Below is a photo of statues called Caryatids that were built on the Acropolis in Athens more than 2,500 years ago. The statues are made of a type of rock called marble. Marble is composed of calcium carbonate.

In 1980, the original statues were transferred inside the museum of the Acropolis and were replaced by replicas. The original statues were being eaten away by acid rain.



Below are the contents and the associated scoring guide of the first item of the test unit ACID RAIN:

ACID RAIN (S485Q02):

Normal rain is slightly acidic because it has absorbed some carbon dioxide from the air. Acid rain is more acidic than normal rain because it has absorbed gases like sulfur oxides and nitrogen oxides as well.

Where do these sulfur oxides and nitrogen oxides in the air come from?

ACID RAIN (S485Q02) Scoring Guide:

Question type: *Open-constructed response*

Competency: *Explaining Phenomena Scientifically*

Knowledge category: *Physical System (knowledge of science)*

Application area: *Hazards*

Setting: *Social*

Difficulty: *506*

Full Credit:

Any one of car exhausts, factory emissions, burning fossil fuels such as oil and coal, gases from volcanoes or other similar things. For example:

- *Burning coal and gas*
- *Oxides in the air come from pollution from factories and industries.*
- *Volcanoes*
- *Fumes from power plants [“Power plants” is taken to include power plants that burn fossil fuels]*
- *They come from the burning of materials that contain sulfur and nitrogen.*

Partial Credit:

Responses that include an incorrect as well as a correct source of the pollution. For example:

- *Fossil fuel and nuclear power plants [Nuclear power plants are not a source of acid rain]*
- *The oxides come from the ozone, atmosphere and meteors coming toward Earth. Also the burning of fossil fuels.*

No Credit:

Responses that refer to “pollution” but do not give a source of pollution that is a significant cause of acid rain. For example:

- *Pollution*
- *The environment in general, the atmosphere we live in – e.g. pollution.*
- *Gasification, pollution, fires, cigarettes. [It is not clear what is meant by “gasification”; “fires” is not specific enough; cigarette smoke is not a significant cause of acid rain.]*
- *Pollution such as from nuclear power plants.*

Scoring Comment:

Just mentioning “pollution” is sufficient for partial credit.

Table 2 shown below presents frequency distribution of the graded responses (i.e. *no credit*, *partial credit*, and *full credit*) of the constructed response item S485Q02.

Table 2. Distribution of graded responses to the test item S485Q02 amongst the eleven high-performing economies in PISA 2006

ACID RAIN (S485Q02)	% of Response				
	0(no credit)	1(partial credit)	2(full credit)	Missing	Not reached
Finland	20.17	11.59	60.78	6.39	1.08
Hong Kong	20.06	8.35	63.48	7.14	0.97
Canada	22.07	22.35	46.20	8.10	1.28
Chinese Taipei	19.88	11.68	57.38	10.75	0.32
Estonia	19.25	19.09	48.07	13.02	0.56
Japan	19.13	7.02	46.82	25.96	1.07
New Zealand	29.80	18.01	38.68	12.05	1.46
Australia	29.33	18.52	38.63	12.74	0.78
Netherlands	27.44	13.87	55.97	2.52	0.20
Liechtenstein	15.35	11.32	56.91	16.42	--
Korea	25.31	16.48	43.62	14.23	0.36
OECD average	25.73	14.67	42.12	15.83	1.66

The most noteworthy finding stems from Australia and New Zealand. On one hand, approximately 30% of the 15-year-old students of Australia and New Zealand cannot give a source of pollution that is a significant cause of acid rain and hence according to the coding guide receive *no credit* on this item. On the other hand approximately 40% of the sampled students of these two economies know where the sulfur oxides and nitrogen oxides in the air causing the pollution come from and hence their responses are graded by the coders with *full credit*. This result corroborates with that shown in Table 1 that students of these two Asia-Pacific economies do not do that well on items pertaining to *Explaining phenomena scientifically* in the *Physical systems*. Clearly, there is much room for improvement for student learning with regard to explanation of hazards in the social settings scientifically. Below are the contents and the associated scoring guide of the second item of the test unit ACID RAIN:

ACID RAIN (S485Q03):

The effect of acid rain on marble can be modeled by placing chips of marble in vinegar overnight. Vinegar and acid rain have about the same acidity level. When a marble chip is placed in vinegar, bubbles of gas form. The mass of the dry marble chip can be found before and after the experiment.

A marble chip has a mass of 2.0 grams before being immersed in vinegar overnight. The chip is removed and dried the next day. What will the mass of the dried marble chip be?

- A. Less than 2.0 grams
- B. Exactly 2.0 grams
- C. Between 2.0 and 2.4 grams
- D. More than 2.4 grams

ACID RAIN (S485Q03) Scoring Guide:

Question type: *Multiple choice*Competency: *Using scientific evidence*Knowledge category: *Physical system (knowledge of science)*Application area: *Hazards*Setting: *Personal*Difficulty: *460*

Full Credit: A. Less than 2.0 grams

Table 3 presents distribution of the responses of the multiple choice item S485Q03. The most noteworthy finding stems from Japan, of which more than 80% of the sampled students are able to use the given evidences provided in the test item scientifically. This result corroborates with that shown in Table 1 that Japanese students generally are able to do well on items pertaining to *Using scientific evidence* in the *Physical systems*. Unlike Japan, it is uncovered that there is much room for student improvement for Liechtenstein with regard to *Using scientific evidences* applied to the hazards areas.

Table 3. Distribution of responses to the multiple choice test item S485Q03 amongst the eleven high-performing economies in PISA 2006

ACID RAIN (S485Q03)	% of Response						
	A (key)	B	C	D	Invalid	Missing	Not reached
Finland	76.61	7.44	11.15	1.81	0.13	1.05	1.81
Hong Kong	78.44	5.07	12.43	1.72	0.26	0.86	1.23
Canada	71.43	12.43	11.14	1.75	0.13	1.31	1.82
Chinese Taipei	80.35	6.44	9.95	1.82	0.04	0.83	0.57
Estonia	77.82	9.53	10.51	0.69	--	0.59	0.86
Japan	81.89	5.98	7.84	1.33	--	1.18	1.77
New Zealand	71.70	11.06	12.69	1.44	0.06	1.06	1.98
Australia	69.95	13.18	12.62	1.51	0.12	1.34	1.28
Netherlands	69.45	8.59	17.75	3.74	0.14	0.13	0.20
Liechtenstein	62.27	13.65	16.53	2.81	--	3.79	0.95
Korea	83.11	5.24	7.84	1.85	0.28	1.08	0.61
OECD average	65.19	11.49	15.74	3.06	0.14	1.99	2.38

Below are the contents and the associated scoring guide of the third item of the test unit ACID RAIN:

ACID RAIN (S485Q05):

Students who did this experiment also placed marble chips in pure (distilled) water overnight. Explain why the students included this step in their experiment.

<p>ACID RAIN (S485Q05) Scoring Guide:</p> <p>Question type: <i>Open-constructed response</i></p> <p>Competency: <i>Identifying scientific issues</i></p> <p>Knowledge category: <i>Scientific enquiry (knowledge about science)</i></p> <p>Application area: <i>Hazards</i></p> <p>Setting: <i>Personal</i></p> <p>Difficulty: <i>Full credit 717; Partial credit 513</i></p> <p>Full Credit:</p> <p><i>To show that the acid (vinegar) is necessary for the reaction. For example:</i></p> <ul style="list-style-type: none"> • <i>To make sure that rainwater must be acidic like acid rain to cause this reaction</i> • <i>To see whether there are other reasons for the holes in the marble chips</i> • <i>Because it shows that the marble chips don't just react with any fluid since water is neutral</i> <p>Partial Credit:</p> <p><i>To compare with the test of vinegar and marble, but it is not made clear that this is being done to show that the acid (vinegar) is necessary for the reaction. For example:</i></p> <ul style="list-style-type: none"> • <i>To compare with the other test tube</i> • <i>To see whether the marble chip changes in pure water</i> • <i>The students included this step to show what happens when it rains normally on the marble</i> • <i>Because distilled water is not acid</i> • <i>To act as a control</i> • <i>To see the difference between normal water and acidic water (vinegar)</i>
--

Table 4 shown below presents the distribution of the graded responses to the test item S485Q05. To obtain full credits students should be knowledgeable of the reasons behind the use of control groups in scientific experiments.

Table 4. Distribution of responses to the test item S485Q05 of the eleven high-performing economies in PISA 2006

ACID RAIN (S485Q05)	% of Response				
	0(no credit)	1(partial credit)	2(full credit)	Missing	Not reached
Finland	20.81	59.05	8.07	10.26	1.81
Hong Kong	24.59	43.48	20.38	10.32	1.23
Canada	22.49	46.74	20.48	8.27	2.02
Chinese Taipei	22.00	46.11	14.91	16.25	0.74
Estonia	18.05	63.01	10.09	7.81	1.04
Japan	18.22	31.72	18.91	29.22	1.93
New Zealand	16.25	52.85	19.74	9.10	2.06
Australia	18.50	53.95	16.95	9.19	1.42
Netherlands	35.44	39.24	22.13	2.91	0.28
Liechtenstein	21.27	41.24	12.45	23.14	1.90
Korea	29.88	46.77	11.87	10.64	0.84
OECD average	24.92	41.99	13.68	16.79	2.62

Despite Table 1 reveals that the *knowledge about science* performance of all the eleven PISA 2006 high-performing economies are well-above the OECD average, there are three findings of Table 4 worthy of mentioning. First, 29% and 23% of the sampled students in Japan and Liechtenstein did not attempt to answer question S485Q05. This is a very high percentage indeed, considering that the OECD average is only 17%. Second, although the percentage of students in Finland scoring *no credit* (i.e. 21%) is below the OECD average (i.e. 25%), the percentage of students scoring *full credit* (i.e. 8%) is far below the OECD average (i.e. 14%). In fact, this percentage of 8% is the lowest amongst the eleven high-performing PISA 2006 economies. Evidently, Finland students still fall short of identifying certain scientific issues essential in conducting scientific enquires. Third, Netherlands and Korea, despite high-performing in *knowledge about science*, a substantial proportion of their students receive *no credit* (i.e. 35% and 30% respectively for Netherlands and Korea, compared with the 25% of the OECD average) because they cannot explain why a control group is needed for the comparison of experimental results. Clearly, more room for improvement but in different ways should be done for the respective PISA 2006 participating economies discussed above.

Conclusion

PISA will conduct another round of full-scale assessment of scientific literacy in 2015. The scientific literacy assessment framework will be fine-tuned further, and students are asked to demonstrate their competence in three aspects of science learning outcomes: (1) *Explain phenomena scientifically*, (2) *Evaluate and design scientific inquires*, and (3) *Interpret data and evidence scientifically*. Earning full credit to the test items necessitate deployment of three types of knowledge, namely *content*, *procedural* and *epistemic* knowledge. Moreover, students are required to exhibit various types of favorable dispositions and attitudes, such as *interests in science*, *environmental awareness* and *valuing approaches to scientific inquiries*.

Before PISA 2015 completes its data collection and has the dataset released for evidenced-based decision making, it is valuable to analyze in-depth the rich PISA 2006 database that is made public for data analyses on the web. Given such a rich and good quality database, the present study seeks to analyze the student's performance on one of the released PISA 2006 test unit loaded on the *Physical systems* (i.e. ACID RAIN) from a comparative education perspective so as to allow practicing teachers and curriculum designers to know what aspects of scientific literacy are needed fostering in our students so as to help them become scientific literate persons in the new millennium. Admittedly, more analyses are needed to be carried out on larger number of test units and items for expressing more general conclusions and recommendations. Hopefully, the analysis results by then are valuable to guide teachers worldwide on how to foster active learning in physics and other science classrooms for enquiry-based instruction.

References

- [1] OECD: PISA 2006 Science Competencies for Tomorrow's World (Volume 1: Analysis). Paris: OECD Publishing, (2013), ISBN 978-92-64-04000-7.
- [2] OECD: Green at Fifteen? How 15-year-olds perform in Environmental Science and Geoscience in PISA 2006. Paris: OECD Publishing, (2009), ISBN 978-92-06129-3.
- [3] OECD: Take the Test: Sample Questions from OECD's PISA Assessments. Paris: OECD Publishing, (2009), ISBN 978-92-64-05080-8.
- [4] OECD: PISA 2012 Assessment and Analytical Framework: Mathematics, Reading, Science, Problem Solving and Financial Literacy. Paris: OECD Publishing, (2013), ISBN 978-92-64-19052-8.

In-Service Education of University Physics Professors

Beatriz S. C. Cortela, Roberto Nardi

São Paulo State University – UNESP, Bauru, Brazil

Abstract

This paper presents outcomes of a doctoral research that pointed out the main limiting factors to be overcome by an undergraduate physics teachers program of a Brazilian public university, in order to achieve the profile of professional identity proposed by the pedagogical project of this program. From a survey of the intended ideal proposed in this project we analyzed the pedagogical and administrative performed by the subjects in order to implement a new curriculum. Data were collected from the analysis of documents, field notes made during faculty meetings and interviews taken among subjects and professors teaching in the program. It is a research for action, based in Habermasian principles. For data analysis we used analytical devices of Discourse Analysis from Pechêux's French perspective. The limiting factors found were: the identity profile of the program, double and dubious, since even pointing to the formation of a "physicist-educator", it is structured to form the "physicist-researcher"; the teaching plans, which have traits of technical rationality, inconsistent with the discourse of the program pedagogical project, which points to the practical rationality; professional profile of the professors acting in the program, most of them without pedagogical training and that bring the training model received in their undergraduate formation as physicists, which shows insufficient for effectuation of desired changes. The clippings done here aims to present the relationship between the professional profile of professors acting in this program and the marks (or absence thereof) left by an in-service training program offered to these professors during the period from 2006 to 2010 and that are perceived (or not) in their teaching practice and/or in their discourses.

Keywords: physics teaching, in-service training of university teachers, curriculum

Extended Summary

Here is an excerpt from a qualitative, longitudinal and in-action study that investigated the process of implementing a program of initial teacher education in physics at a public university in Brazil. The data were collected from 2006 to 2009, when it was graduated the first class of students within this new curriculum setting. We attempted to answer the question: What are the limiting factors to be overcome by the program in order to achieve the profile of professional identity in his proposed Education Program (EP)?

The limiting factors were: the identity profile of course, double and dubious, at the same time pointing to the formation of physical educator, is structured to form the physicist-researcher; teaching plans, which show traces of technical rationality, inconsistent with this perspective in the discourse of EP, which points to the practical rationality; and the professional profile of professors and trainers, mostly of them suiting the bachelor of physics and so, bringing the model training received in their former degrees, insufficient to effect the desired changes.

In this paper we discuss about the relationship between the professional profile of professors trainers, technical rationality that pervades his work and the marks (or absence of them) left by a kind of in-service training offered by the University during the period

2006-2010. These marks can be detected (or not) in its educational activities in their teaching plans and/or in their speeches.

Gauthier (1998) states that the development of a training program mobilizes various groups seeking to protect their conquest, seeking to adopt formative models by them privileged. This reinforces the idea of Bourdieu (1983) when considering the University as a field, which has its objects, specific interests and its own structure, understood as social space that is the subject of disputes and interests, conflicts between individuals that have the same habits.

Díaz (2010) points out that researches findings indicate that teachers keep the same educational practices of the previous curriculum to work on a supposed "new" curriculum structure. As also consider Penin, Martínez and Arantes (2009, p.36) "the beliefs to which teachers cling throughout his training appear to be strongly influenced by both systematized knowledge as determined by organizational garb which led the operation of the school over generations".

The Research

This is a research developed in action since allowed opening spaces for discussion and reflection among professors, course coordinators and the researcher. There were eleven meetings with professors who taught classes in each semester of the course, which lasts four years. The sample was constituted of 22 professors, who taught in 2009, 16 of them from the physics department, these last ones were also interviewed. Interviews were semi-structured, audio-recorded and transcribed.

The researcher chose to interview only professors of the department of physics for several reasons: because they are responsible for most of the disciplines and course load, because all professors were effective, because the researcher had interviewed most of them in 2003 (in beginning the process of restructuring the course in question, seeking a longitudinal study) and those who participated directly or indirectly in any process of redesign and implementation of the EP (2002-2010).

Aiming to make the contacts free from any stress, it was agreed that the researcher would keep confidential the name of them; make the minutes of the meetings, and that the information collected were in the form of field notes and that they would be sent to all involved for knowledge and revision. These minutes were constituted along with the interviews were taken and analysed.

Zeichner and Pereira (2005) argue that the action research can contribute to the process of social transformation This can occur in several ways, such as improving the training of those involved, enhance the control that these professionals have over their knowledge or theory that guides them in their work, influence the institutional changes in the workplace and contributes to the society to become more democratic, in the sense of social transformation.

This type of research requires a detailed record of the process and activities, in order to provide a systematic data registration and allow the evaluation of the actions developed. Could also be made summaries of discussions between groups and these could be shared among those involved for corrections and / or additions that may be necessary can be effected, aiming not just a collective awareness about the production of knowledge, both in the process investigation of the problem regarding the results.

The researcher based his conduct with the professors in the Theory of Communicative Action Habermas (Habermas, 1987; Gonçalves, 1999). In this theory, some concepts are central. According to it, the individuals communicate with each other mediated by speech acts, which relate to the three worlds: the purpose of things, the social norms and institutions and the world of subjective experiences and feelings. Thus, the language plays important role. And the legitimacy of the truth value, veracity and correctness rules, which are assumptions from the communicative action, can be reached by reasoning among subjects in terms of principles recognized and validated by the group itself.

For data analysis, we chose to use analytical devices Discourse Analysis in Pêcheux French Line (1990), which underlies the work of Orlandi (2002) and Brandão (2002). This was done on three fronts, studying the discourses present: in official documents (EP, teaching plans and texts offered during the in-service training), in interviews and speeches during meetings, recorded in the field notes.

To Brandão (2002, p.15, 83-84) Discourse Analysis (DA) is a discipline that has emerged yet unfinished in the second half of the twentieth century and which aims to analyse the use of language in speeches in context, people who interact. It attempts to address the need to understand the texts in its entirety, seeking to unite the linguistic socio-historical context of its production. To Chizzotti (2006) speech has only one meaning: the language of common sense can mean the dialogue between people, in linguistics, is how the various linguistic elements are connected in order to build a larger structure.

According to Brandão (2002) two concepts are at the core AD: the ideology (Althusser) and discourse (Foucault). In AD there is a separation between transmitter and receiver, nor is this regularity between a speaker and another that decodes. In reality, both are meaning: it is a simultaneous process. And information is not simply that they are changing: identification processes are the subject of argument, subjectivity, among others.

With the raw material collected (interviews transcribed text of EP course, field notes drawn from the senses from their comments during meetings between terms) it was made a first analysis: who said, what he/she said, how it was said, seeking clues which explain how the discourse is contextualized, since the authors leave traces in the thread of the discourse. Orlandi (2002, p.65-67) calls it "de-superficialization". The objective is to seek to build, from the raw material, an object of discourse, and then analyse what is said in that speech and what is said in other, in different conditions, affected by different discursive memories.

Some Results and Reflections

The in-service training offered to all staff of university professors was designed by a group of former professors of the institution in the form of workshops studies. It is developed in classroom and distance learning since 2006, and offered to all teachers from 33 different campuses of the university. There are 30 hours of classroom activities and 60 hours in distance learning basis. The methodology is based on the motion action-reflection-action and the line adopted the historical-critical pedagogy (Saviani, 2002). The themes are: Foundations of Higher Education, Higher Education Epistemology and Methodology of Higher Education.

The researcher had already interviewed 10 of these professors (Cortela, 2004). When asked about the difficulties they felt in performing their teaching, these professors responded, among other things: that they had no pedagogical knowledge (80%) admitted they did not perform a systematic interdisciplinary work together with colleagues (100%), and proved

predisposed to attend in-service training courses (40%). Most professors also claimed to have difficulties in the implementation of didactic contents.

According to the data provided by the university, it were held from 2006 to 2009, twenty-six workshops with the same themes, reaching different groups. The table below indicates the participation of 16 teachers of the physics department.

Table 1. The professors named A to J were also interviewed individually and those indicated by D did not participate of interview and/or professors meetings

Professor	Formation	Participation	Professor	Formation	Participation
A	Bachelor/1989	-	I	Bac/Lic/1977	7
B	Bachelor/1999	11	J	Licensee/1979	-
C	Licensee/1991	-	D ₁	Licensee/1981	18
D	Bachelor/1985	10	D ₂	Licensee/1987	-
E	Bachelor/1985	8	D ₃	Bachelor/1978	2
F	Licensee/1994	5	D ₄	Licensee/1986	8
G	Bachelor/1980	9	D ₅	C. Eng./1983	-
H	Bachelor/1984	1	D ₆	Licensee/1989	-

It was found that 5 of the professors of the sample were graduated between 1970/1980, being today close to retirement, 13 graduated between 1980/1990, and 4 of them after 1990. So, this is an experienced faculty, composed mostly of PhD with research lines related to theoretical or experimental physics, and only 4 of them are dedicated to research in physics education. It was found that only 3 ($\pm 20\%$) had participated in more than ten in-service training meetings; against the speech found in 2004, when 40% of respondents said they would like to participate in this type of activity. Six teachers did not take part of any workshop and only 2 in interviews, justifying their absence.

C: Because – I will be very honest: because I don't know; I doubt if that will improve anything top my teaching practice. The day I convince myself that [the training] will be important to my training, to improve my classroom teaching practice, I will take it. But, while I do not have these elements, I will not take it. (Cortela, 2011, p. 261).

This speech meets what defends Borges (2006), who says that these professionals (university professors and physicists) often have much resistance to update teaching methods and perform pedagogical readings. Justifies that this is because, in general, do not recognize the scientific basis of studies which use these methods, nor the professional competence of those who make this kind of research.

A profile that tends toward the degree, i.e., its characteristics related to the initial and lines of research indicate that approximately 82% of professors trainers identify themselves with the discourse of degree. How corroborates the speech of one of the interviewees.

B: And another thing: in physics we also have this problem ... ahh ... the profile of the Physicist in general, the Department's physicist, the staff that makes research in Physics, Materials ... We have only a professor who researches in physics education. The staff does not have a ... you graduate in Physics! You realize that during the graduation ... handle

their teachers, their teachers ... (He did not finish the sentence, but the idea he passed is that things have not changed in this aspect, since the 80's) (Cortela, 2011, p.254)

Two professors took only one or two meetings and one of them apologized "that flow with that developed the work was not satisfactory" and "that line of work was adopted very deleterious" (in the political sense).

The subjects who took from five to nine workshops (5) found the project interesting, because it allowed them to meet certain forms of approach teaching. Those who made more than 10 workshops were, at some point, course coordinators therefore, compulsory called to such meetings. However, their teaching plans do not show significant changes.

Most subjects criticized the lack of something more specific, in the sense of didactic problems directed to the area of exact sciences and also claimed that it would be interesting to present authors from other pedagogical lines.

I: I thought it was good but ... many questions have not been answered! But when something was referring to didactic or pedagogical, most questions were left unanswered. Why? Everything you study for Letters ... whatever applies to that course, does not apply in physics or mathematics. Then arrives at a point, that in reality the physics department, perhaps along with mathematics should have some things alone! (Cortela, 2011, p.285);

It also raised the devaluation of the academy as investment in pedagogical issues, agreeing with the idea Zabalza (2004), when he argues that what gives credibility and status to a university lecturer is the research and not the teaching.

Comparative analysis was made between the curriculum of disciplines that make up the two structures, aiming to get the changes made by the subjects and seeking justifications for them. They show that between 32 lesson plans that make up the curriculum frameworks (the former one and the actual) indicate insignificant changes regarding the methods and forms of evaluation. Technical rationality is perceived in most plans, evident in the teaching methodologies adopted and also in the choice of the instruments and the evaluation criteria.

Final Thoughts

Agreeing with Borges (2006, p. 135) when, in dealing with the training of physics professors, states that "[...] we need to change the quality of teachers trained. Train more and better training "The researcher believes that the profile of professors engaged in higher graduation directly influences the profile of the student graduates, although not decisive, because of personal issues that could not be raised here. Justifying, professors' trainers who have a line of research related to a specific area seek to bring their students to their research groups and directs it, in a way, the jobs of the former students.

J: And ... this dilemma ... as we do not have bachelor's and most of the people here to guide research, we always give greater guidance for research during the course. It is what they call "bacharelatura", right! So, the impression I have is that there is a lot of people that will actually for schools after ... teaching, working as a teacher. I think most have some making travel to level up at work, going to have some Post-Mat and have some who go to school, but I think a small part. (Cortela, 2011, p 288).

This in-service training provided to professors, despite representing a breakthrough in the sense that institutionalize a continuing education project at university level, which is something unusual in Brazilian universities, need adjustments in order to reach gaps

knowledge identified by the research in relation to this group of professors in particular and also the specific area, which has its proper epistemology.

We conclude that the "marks" of the in-service training in professors' teaching are not noticeable since they did not appear in the collective actions of the professors, are not reflected in the organization of their teaching plans and even technical terms or concepts used in the texts that make up workshops, appear in their speech.

References

- [1] BOURDIEU P.: *Algumas Propriedades dos Campos. Questões de Sociologia.* Rio de Janeiro: Marco Zero, 1983.
- [2] BORGES O.: *Formação inicial de professores de Física: Formar mais! Formar melhor!* Revista Brasileira de Ensino de Física. Brasília, v.28, n.2, p. 135-142, 2006.
- [3] BRANDÃO H. H.: *Nagamine. Introdução à Análise de Discurso.* 6ª ed. Campinas: Editora da Unicamp, 2002.
- [4] CORTELA B. S.C.: *Formadores de Professores de Física: uma análise de seus discursos e como podem influenciar na implantação de novos currículos.* Dissertation. Master's Degree in Science Education. Faculdade de Ciências. Universidade Estadual Paulista (UNESP), Bauru, São Paulo, Brazil. 2004.
- [5] *Formação inicial de professores de Física: fatores limitantes e possibilidade de avanços.* PhD in Science Education. Faculdade de Ciências. Universidade Estadual Paulista (UNESP), Bauru, São Paulo, Brazil. 2011.
- [6] GAUTHIER C.[et.al]: *Por uma teoria da Pedagogia: pesquisas contemporâneas sobre o saber docente.* Ijuí: Ed. UNIJUI, 1998.
- [7] GONÇALVES M. A. S.: *Teoria da Ação Comunicativa de Habermas: possibilidades de uma ação educativa de cunho interdisciplinar na escola.* Escola & Educação, ano XX, n.66, abril/99.
- [8] HABERMAS J.: *Técnica e ciência como ideologia.* Lisboa: Edições 70, 1987.
- [9] ORLANDI E. P.: *Análise do Discurso: Princípios & Procedimentos.* 4ª ed. Campinas, SP: Pontes, 2002.
- [10] PÊCHEUX M.: In: GADET, Françoise; HAK Tony (Org). *Por uma análise automática do discurso: uma introdução à obra de Michel Pêcheux.* Campinas: Editora da UNICAMP, 1990.
- [11] SAVIANI D.: *Pedagogia Histórico-Crítica: primeiras aproximações.* 7ª ed. Campinas, SP: Autores Associados, 2000.
- [12] ZABALZA M. A.: *O ensino universitário: seu cenário e seus protagonistas.* Porto Alegre, Artemed, 2004.

The messy transition from wrong to right: improvements, but persistent inconsistencies on conceptually-equivalent questions after Interactive Lecture Demonstrations

Scott Daniel, Alex Mazzolini

Swinburne University of Technology, Melbourne, Australia

Abstract

Background: Traditional lecture instruction often only leads to minimal improvement in students' conceptual understanding. The use of active learning strategies, such as Interactive Lecture Demonstrations (ILDs), can help. ILDs have been used by the authors since 2010 in teaching alternating current (AC) resonance in a large-enrolment introductory electronics course.

Learning improvements after such educational interventions are typically measured using the average normalised gain (g). This is calculated by comparing total scores on a pre-test and post-test to generate a number between 0 (no improvement) and 1 (maximum possible improvement). It will be argued that this aggregate measure is too general, and that better insights can be gained into students' conceptual change through analysis of individuals' responses to sets of questions that ask about a particular concept in different ways (so called 'expert-equivalent' questions).

Research question: How can expert-equivalent questions be used to better describe conceptual change in pre- and post-testing?

Method: Learning gains were assessed by testing students' conceptual understanding (via a multiple-choice pre-test) after 8 hours of traditional instruction but before the ILD intervention, and again after an additional 2 hours of ILD instruction (via an identical post-test). The responses of individual students were matched across the different sessions using anonymous but unique student-generated codes.

Data were collected in 2010, 2011, and 2012. The tests consisted of multiple-choice conceptual questions that did not require quantitative calculations but instead were designed to assess students' qualitative understanding of various complex concepts associated with resonance in AC circuits. The tests given in each year were slightly different. However, in each case, there was a pair of questions that asked about the same concept in two different ways – graphically and in written form. The multiple-choice responses to these pairs of expert-equivalent questions were mapped to one another, and each student's responses examined for consistency.

Results: The average normalised gain in test scores for students who participated in all active learning ILD activities was significant. However, the analysis of responses to pairs of expert-equivalent questions revealed a much more complex pattern. Most students answered inconsistently in both the pre- and post-tests, that is, their response to the graphical question did not equate logically to their response to the written question, and vice versa.

Nevertheless there was a general shift towards more students answering at least one, and sometimes both, of the questions correctly, and so aligning their understanding with the expert view.

Conclusions: The comparison of aggregated scores in pre- and post-tests is a coarse assessment instrument that hides some unexpected facets of student learning. In the

transition from novice to expert, it seems that learners may understand a complex concept in one context but not in another, even though an expert would consider the two as equivalent. There is not a binary switch from confusion to clarity, but instead an extended intermediate phase of partial or contextualised understanding.

Keywords: expert-equivalent, conceptual change, interactive lecture demonstrations, electronics

Introduction

Students bring their own experiences, understandings, and conceptions of different phenomena into the classroom. Where these conceptions are at odds with the accepted scientific view, they are called alternative conceptions or misconceptions. Variation theory can be used to understand how students develop different conceptions of the same phenomenon [1]. The theory asserts that out of the multitude of features of a particular phenomenon, different people will focus on different aspects and so develop a different partial understanding of the same phenomenon. Conversely, to develop a common understanding, students' attention must be drawn to the particular key features of the phenomenon that underpin the sought-after common understanding. The variety of conceptions that students develop is a reflection of the various possible combinations of features of the phenomenon that the students have attended to and made sense of.

Often, these different conceptions are not consistently applied. That is, even though an expert may recognise two different contexts as different manifestations of the same underlying phenomenon, students may instead not recognise their essential similarity and apply different conceptual frameworks in analysing each case. Such contexts are called expert-equivalent [2]. Where a correct understanding in one context is not generalised to other expert-equivalent contexts, it may be an example of the 'specificity effect' whereby "student's understanding of the principle becomes bound up in the particulars of the example that is used to illustrate the principle" [3]. Students focus on superficial features and fail to identify underlying similarities. More generally, students that apply conceptions inconsistently can be considered to be in a mixed-model state [4], where different features of the different contexts will trigger a particular conception to be applied.

The development of students' abilities to consistently employ the correct conceptual framework on different, but expert-equivalent, test questions will be the focus of this paper.

Challenging misconceptions in electronics using Interactive Lecture Demonstrations

Misconceptions in student understanding of basic electric circuits are well-documented [5-8]. Similar misconceptions have also been found in more advanced electronics topics [9-11].

Interactive Lecture Demonstrations (ILDs), and other active-learning strategies, have been shown to have some success in highlighting, confronting, and correcting student misconceptions, in a range of basic science and engineering topics, particularly in physics [12-15]. ILDs in particular have been used in large-class environments to engage students and improve their conceptual understanding, through prediction, peer discussion, and observation of experiments conducted live in the lecture hall. Their use has been

demonstrated to lead to student learning gains in a range of introductory science and engineering topics [16-18], with varying degrees of effectiveness [19].

ILDs have been used by the authors since 2010 to teach ‘AC circuit operation and resonance’ in a large-enrolment first-year introductory electronics course at Swinburne University of Technology in Melbourne, Australia. These ILDs followed on from, and supplemented, a sequence of traditional instruction, in a ‘blended learning’ approach. The ILDs were revised and implemented again in 2011 and 2012. Results from these interventions are reported elsewhere [20-22] and further analysed here.

The effectiveness of ILDs, and other active-learning lecture strategies, is typically measured by the average normalised gain (g) [23, 24], which is a comparison of aggregate scores on a multiple-choice conceptual test administered prior to, and shortly after, the educational intervention. The average normalised gain is the fraction of maximum possible improvement recorded from the pre-test to the post-test. Such multiple-choice conceptual tests have been shown to be valid and reliable measures of student learning [25]. However, this measure makes two implicit simplifying assumptions. Firstly, it assumes that the same students attend all the sessions. Secondly, it assumes that learning involves a 1-dimensional shift from naïveté to understanding.

However, in this paper we challenge these assumptions and go beyond this conventional measure of intervention efficacy, reported elsewhere for this study [20-22], and instead analyse patterns of response to pairs of conceptually equivalent (i.e. ‘expert-equivalent’) questions. Students’ conceptual consistency between these pairs of questions is analysed, both before and after the ILD intervention, to determine to what extent students have generalised the concept beyond the context within which it was presented.

Research in other physics topics has suggested that in the transition from novice to expert, students can be considered as either “always being in a consistent mental state or as flipping from one mental state to another in response to a variety of cues” [2]. Rather than simply moving from a completely wrong conceptual understanding to a completely right understanding, students can sometimes hold multiple conceptual frameworks, even though these are mutually contradictory from the experts’ point of view [2, 26-28].

Methodology and Assessment

Concept inventories are constructed on the implied assumption, made explicit in variation theory, that different people conceive of the same phenomenon in a small number of qualitatively distinct ways [1, 29]. Responses to the multiple-choice questions typical of a concept inventory, either the correct answer or one of the distractors, are taken to mean that the student holds the corresponding conception (or misconception) [25]. Students that give a different response on successive administrations of the concept inventory are assumed to have undergone conceptual change.

In this study, a short multiple-choice diagnostic test was constructed and refined by the authors and some of their colleagues to assess students’ conceptual understanding of AC circuits and resonance, in a process similar (but on a smaller scale) to that advocated by Streveler et al. [29] for the construction of concept inventories.

The two hours of ILD activities were conducted with the students after eight hours of traditional instruction [20]. The diagnostic test was administered twice: at the end of the eight hours of traditional instruction but before the additional ILD intervention, and again after the two additional hours of ILD activities.

At the start of each ILD session students were prompted to generate their own unique identifying code (for example, one of the questions asked about the last digit of their phone number). These codes allowed individuals' responses to be anonymously tracked across the pre-test, ILD sessions, and finally the post-test, [24], and also offered some serendipitous insights into patterns of lecture attendance [30].

Students' codes from the different sessions were compared to identify the subset of students that attended both testing sessions and all the ILD activities (so called 'Complete Responders'). Overall performance on the pre- and post-test was compared for these groups each year, but in this paper we will be focusing in on two expert-equivalent questions in particular.

One important concept in AC circuits is the resonance relationship between RMS current and the frequency of the voltage source. The RMS current peaks at the resonant frequency, and then tends to zero at the low and high frequency limits. One question asked students to identify this relationship graphically, and the other asked them to identify the correct written description of the effect on the current as the source frequency ω is increased above $\frac{1}{\sqrt{LC}}$ (i.e. the resonant frequency).

Student responses to these 2 expert-equivalent questions were compared to not only determine if they had answered both questions correctly, but to check if they had answered them consistently. That is, if they got them wrong, did they get them wrong in the same way?

Students' pairs of responses on the pre-test and post-test were classified into five categories:

Consistent wrong. Both answers were incorrect but logically consistent.

Inconsistent wrong. Both answers were incorrect but logically inconsistent.

Inconsistent right. Only one of the answers was correct, and the other answer was not logically consistent.

Weak consistent right. Only one of the answers was correct, and the other answer though incorrect was still logically consistent with the correct answer.

Strong consistent right. Both answers correct.

Some examples of these categories are given in Table 1. The first row shows the correct graph, with the current peaking at the resonant frequency and decreasing thereafter. The correct written description of the effect on RMS current of increasing the source frequency above resonance is that it would 'decrease'. This is shown in bold, and this pairing was categorised as 'Strong consistent right'. However if students described the effect on RMS current of increasing source frequency as 'Increases to a maximum then decreases' this does indeed describe the shape of the correct graph, but implies, incorrectly, that the RMS current peaks at a frequency higher than $\frac{1}{\sqrt{LC}}$. Such response pairs were categorised as 'Weak consistent right'.

The next graph shows a flat line, meaning that RMS current is independent of frequency and remains at the same non-zero value. The graph and the written description are both wrong, but are logically consistent with one another, so such a pairing was categorised as 'Consistent wrong'.

The third graph showing a nonsensical sinusoidal relationship between RMS current and frequency is incorrect, and is not logically consistent with the description ‘Increases’, and so this pair was categorised as ‘Inconsistent wrong’.

Table 1. Conceptual comparison of responses to two questions

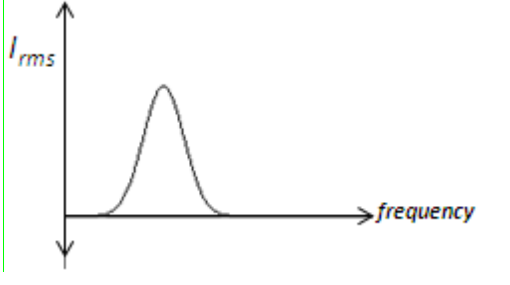
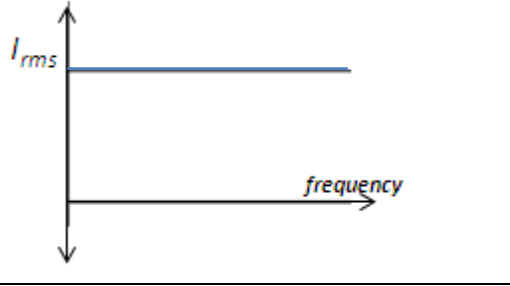
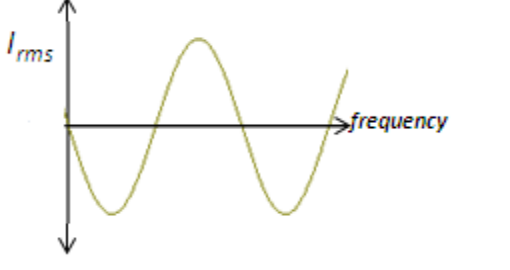
Graphical Representation of the relationship between source frequency and RMS current	Comparison	Written description of effect on RMS current of increasing source frequency above resonance
	Strong consistent right	Decreases
	Weak consistent right	Increases to a maximum then decreases
	Consistent wrong	Remains at the same non-zero value
	Inconsistent wrong	Increases

Results

Overall

The efficacy of educational interventions is often measured by a comparison of aggregate pre- and post-test scores to generate the average normalised gain [23]. This data has been summarised in Table 2 for the three years over which data has been collected.

Table 2. Average normalised gain for all responders

Year	2010	2011	2012	Combined
Average normalised gain	0.22	0.16	0.16	0.19

What this data fails to distinguish between are the scores of those students who only showed up for the pre- or post-test, and those students who showed up for each and every session. The improvement of these students, the so-called Complete Responders, is a better measure of the efficacy of the education intervention, because they were the only ones there to experience the intervention in full.

The overall improvement in performance from the pre-test to the post-test for this subset of students has been reported in detail elsewhere but in each year of the study was substantial (see Table 3 and Figure 1 below), especially when it is noted that these were gains after traditional instruction [20, 21]. Since the tests were multiple-choice, the average score that would result from random guessing has been plotted for comparison.

Table 3. Average normalised gain for Complete Responders

	Average normalised gain (g)
2010 (N=21)	0.32
2011 (N=14)	0.22
2012 (N=42)	0.36

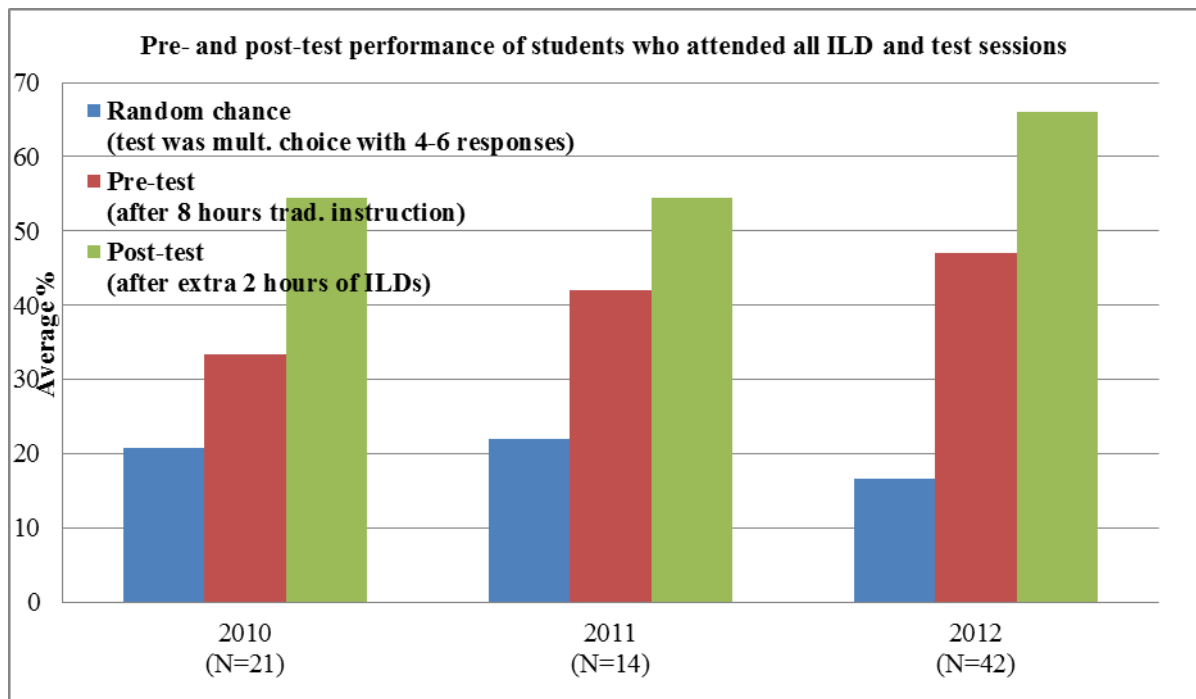

Figure 1. Pre- and post-test performance of Complete Responders

There are two things to notice about Figure 1 above: the low attendance, and the annual improvements in test performance. Each year approximately 150 students were meaningfully enrolled (that is, they sat the final exam) and so the average fraction of students who attended all ILD sessions each year was less than 20%. In fact, analysis of the attendance patterns revealed a close fit to a binomial probability distribution (see Figure 2 below [30]), which suggests that it is as if each student flips a weighted coin in deciding whether or not to attend a particular lecture. Although strict records were not kept, there was not a noticeable drop-off in attendance from the traditional lectures to the ILDs. It seems that such poor attendance is more a feature of the lecture format in general, rather than a lack of interest in the ILDs themselves, as similar attendance patterns have been found in a variety of different lecture contexts that did not include ILDs [30].

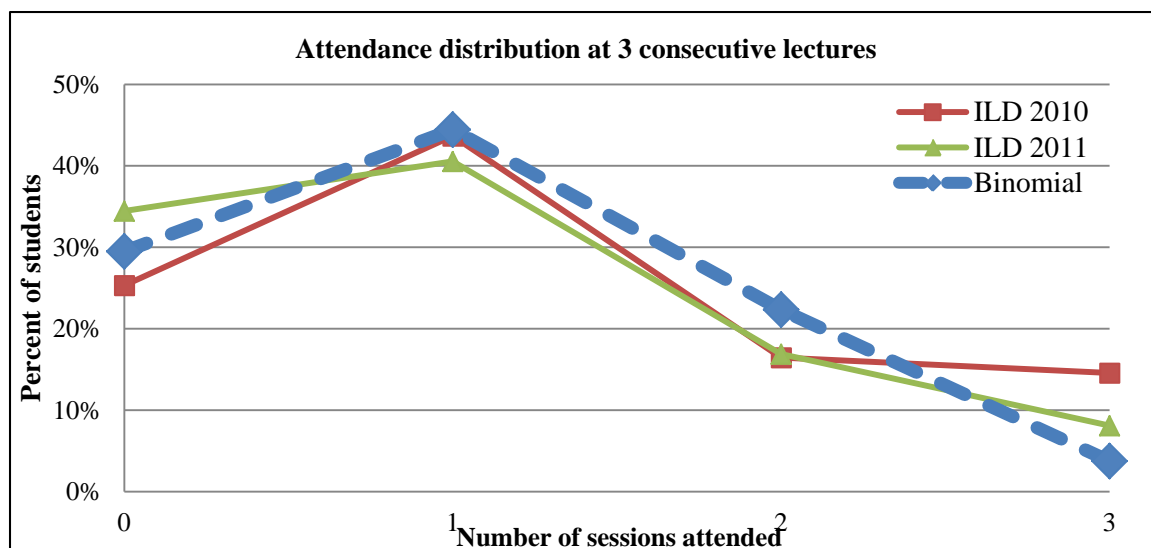

Figure 2. Binomial probability fit to patterns of attendance

The annual improvements in test performance may simply be due to differences between successive cohorts, but perhaps is also in part a result of modifications made by staff. The post-test improvements could be a consequence of the authors developing expertise in facilitating the ILDs, or of improvements in the wording of the concept tests to make them more clear and unambiguous. Conversely, perhaps the poor pre-test scores alerted the course lecturer to the difficulties students still had with the material after traditional instruction and lead them to give greater emphasis to those difficult concepts the following year.

Expert-equivalent question pair

As described above, a pair of questions on the pre-/post-test related to the same concept – the resonance relationship between voltage source frequency, and RMS current. Therefore if students held a structurally coherent conceptual framework for that particular concept, they should have answered both questions consistently. This means not only that if they got one right, they got them both right, but that if they got one wrong, they got the other wrong in the same way.

One question asked about this concept in a graphical way, the other in a written way. Overall, students improved on both questions.

Table 4. Average normalised gain on the two expert-equivalent questions

	Graphical question	Written question	Combined
2010	0.31	0.24	0.27
2011	0.40	0.27	0.33
2012	0.25	0.48	0.37
COMBINED (N=77)	0.30	0.37	0.33

On average, each cohort of students improved substantially from the pre-test to the post-test, on both the graphical question and written questions. To better understand the

students’ conceptual development, each student’s pair of responses was analysed for logical consistency (cf. Table 1 above):

Table 5. Percentage of students answering inconsistently or consistently

		Consistent wrong	Inconsistent wrong	Inconsistent right	Weak consistent right	Strong consistent right
Score out of 2		0		1		2
COMBINED (N=77)	Pre-	9.1	49.4	24.7	2.6	14.3
	Post-	3.9	23.4	39.0	2.6	31.2

In the pre-test, more than half the students answered both questions incorrectly, and almost all of these answered inconsistently. In the post-test, however, there was a shift to more than 70% of student answering at least one of the questions correctly.

How did these changes take place? Because student-generated codes were used to anonymously track individual students, a map of conceptual transitions could be generated (see Figure 3 below).

In the transitions map the area of the circles is proportional to the number of students in the different categories, and the width of the arrows is proportional to the number of students who underwent that change. However, to simplify the diagram, categories or transitions that correspond to less than 4 individuals have been excluded. For example, the category of response ‘Weak consistent right’ has been excluded as it only included 2 individuals. Excluding transitions of less than 4 individuals from the diagram gives rise to apparent inconsistencies, where for example only 4 individuals from the original 7 in the ‘consistent wrong’ category are represented as transitioning to a new category. The transitions of the ‘missing’ 3 individuals to the categories ‘inconsistent wrong’ and ‘strong consistent right’ are not shown in the diagram, but note that they are accounted for in the respective totals for these categories in the post-test.

Discussion

The average normalised gain contains two implicit assumptions. Firstly, it assumes that the same set of students attend all of the sessions. This was certainly not the case for the students in our study. By using anonymous student-generated codes to track patterns of attendance, it was concluded that only a small fraction of students do in fact attend all of the sessions. It is almost as if each student flips a weighted coin (with a probability $P \approx 0.334$) in deciding whether to attend each lecture. This observation has been explored in more depth elsewhere [30].

Secondly, the average normalised gain assumes that learning involves a 1-dimensional shift from naiveté, to competence, to expertise. It is not that simple. The average normalised gain is an aggregate measure that does facilitate broad-brush comparisons of learning interventions (e.g. [23]), but it oversimplifies the complex process of developing conceptual competence and expertise, as represented for example in Figure 3. Learning difficult concepts has been compared to the way a fluorescent light comes on: “It flickers on, then does dark, then goes bright for an instant, then goes dark again...then bright” [31]. The average normalised gain does not capture this messy reality in the same way that Figure 3 does, with arrows tending to the right, but going every which way.

And how to make sense of the transitions represented in Figure 3? There are three key observations. One observation is that for about one third of the students, participation in the ILD sessions had no impact on their conceptual consistency on these two questions – they answered the same way in the post-test as they had in the pre-test.

A second observation is that a large proportion of students were in the ‘Inconsistent right’ category, especially in the post-test. These students have answered one of the pair of expert-equivalent questions correctly, but not the other. It seems that they have understood the phenomenon in one context, but not successfully transferred their understanding to the other context. This may be interpreted as an example of the ‘specificity effect’ [3], in which students have not generalised a principle beyond the examples that were used to present it.

Finally, observe that the only notable transition into the ‘Strong consistent right’ category (apart from a few students that had already answered both questions correctly in the pre-test) was from the ‘Inconsistent wrong’ category. The transitions from the other categories were comparatively insignificant and, since they included fewer than 4 individuals, are not shown in the diagram. In the authors’ view, this can be interpreted as reflecting the malleability of the conceptions held by these different student groups. In this interpretation, the 49% of students that were in the ‘Inconsistent wrong’ category are considered to have naïve, or effectively no, conceptions. Conversely the students in the ‘Strong consistent right’ category held the correct conception. About two-thirds (71%) of the students with naïve conceptions (i.e. those whose answers to the two expert-equivalent questions in the pre-test were ‘Inconsistent wrong’) developed partial or fully correct understandings of the resonance relationship between the two tests.

However, only a fifth (21%) of students that initially answered otherwise (i.e. that either were in the ‘Consistent wrong’ category or answered just one of the two questions correctly) transitioned to the correct conception on the post-test. It seems that the partial understandings or misconceptions that these students hold are ‘robust’ – that is they “persist even in the face of repeated instruction” [29]. The robustness of misconceptions around resonance behaviour may be because the resonance relationship is emergent from the complex interplay of the different behaviours of the capacitor, resistor, and inductor at different frequencies, and is not easily understood with one direct ‘cause-effect’ logical step [32].

From these observations it can be seen how difficult it is to master the concepts of AC resonance. Traditional lecturing, in our case, did not achieve much – over the three years for which data is reported, the average score on the pre-test (which was administered after 8 hours of traditional instruction) was around 40%, not much better than chance. Even the use of the research-based instructional strategy of Interactive Lecture Demonstrations only lifted the post-test average to around 60%. These moderate gains mask the fact that for a third of the students the ILD intervention had no meaningful effect on student performance, at least not on the two questions considered in detail here. And all of this is for the small fraction of students that attended all the sessions, the rest of the students on average performed even worse. These observations raise important questions for educators: how to get more students to attend lectures, but, much more importantly, how to ensure that the time in the lecture theatre actually achieves anything.

From this study, several conclusions can be drawn. Although the average normalised gain can give quick cursory evaluations of the efficacy of an education intervention, it certainly doesn’t offer much insight into the messy process through which students master concepts. Secondly, the misconceptions around complex concepts such as AC resonance are robust

and difficult to overcome. In particular, many students have difficulty generalising their understanding of such concepts from one context to other expert-equivalent contexts. One strategy to address this could be to discuss and explicitly distinguish between surface features and key features when using examples to teach a concept, rather than leaving it entirely up to students.

Conclusion

The average normalised gain is a coarse measure, better suited to comparisons of the overall efficacy of different educational interventions rather than to offering insights into the messy complicated process of how students develop expertise in complex concepts. It makes two unfounded but simplifying assumptions: that the same students attend all the intervention sessions, and that learning is a 1-dimensional switch from naiveté to understanding.

Learning difficult concepts is not like a light-bulb turning on, but rather is more akin to how a fluorescent light flickers on and off before glowing brightly. Many students linger in this intermediate phase of partial understanding and may persist in holding misconceptions despite repeated educational interventions. In learning about complex concepts, students may not be able to easily generalise their understanding from particular examples because of the difficulty in distinguishing the few key conceptual features from the irrelevant surface features. Helping make this distinction explicit could enable more learning.

Acknowledgements

The authors wish to thank the members of the Engineering and Science Education Research (ESER) group at Swinburne University of Technology, in particular Dr Llewellyn Mann, Dr Wayne Rowlands, and Ms Rosemary Chang, and members of the ESER Writing group and the Faculty of Life and Social Sciences Writing Group for their constructive suggestions when reviewing early drafts of this manuscript.

Figure 3. Changes in consistency from pre-test to post-test (transitions of less than four people excluded)

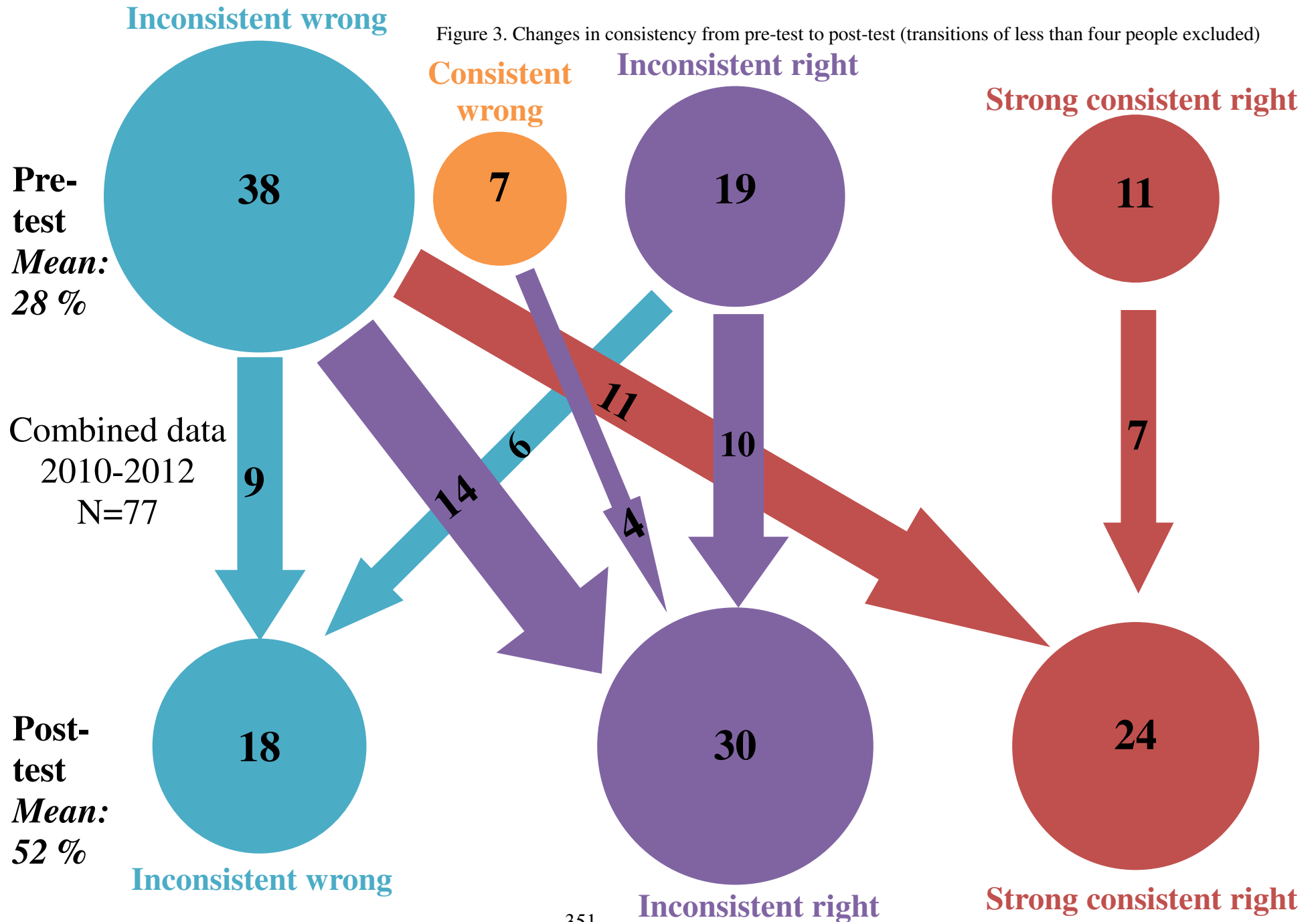

References

1. Bussey T. J., Orgill M., Crippen K. J.: *Variation theory: A theory of learning and a useful theoretical framework for chemical education research*. Chemistry Education Research and Practice, 2013. **14**(1): p. 9-22.
2. Bao L., Redish E.: *Model analysis: Representing and assessing the dynamics of student learning*. Physical Review Special Topics - Physics Education Research, 2006. **2**(1).
3. Brookes D. T., Ross B. H., Mestre J. P.: *Specificity, transfer, and the development of expertise*. Physical Review Special Topics - Physics Education Research, 2011. **7**(1).
4. Bao L., Hogg K., Zollman D.: *Model Analysis of Fine Structures of Student Models: An Example with Newton's Third Law*. American Journal of Physics, 2002. **70**(7): p. 766-78.
5. McDermott L. C., Shaffer P. S.: *Research as a Guide for Curriculum Development: An Example From Introductory Electricity. Part I: Investigation of student understanding*. American Journal of Physics, 1992. **60**(11): p. 994-1003.
6. Engelhardt P. V., Beichner R. J.: *Students' understanding of direct current resistive electrical circuits*. American Journal of Physics, 2004. **72**(1): p. 98-115.
7. Sencar S., Yilmaz E. E., Eryilmaz A.: *High School Students' Misconceptions about Simple Electric Circuits*. Hacettepe Üniversitesi Eğitim Fakültesi Dergisi, 2001. **21**: p. 113-120.
8. Getty J. C.: *Assessing inquiry learning in a circuits/electronics course*, in *39th ASEE/IEEE Frontiers in Education Conference*. 2009, Institute of Electrical and Electronics Engineers: San Antonio, Texas. p. 1-6.
9. Mazzolini A. P. et.al: *Using Interactive Lecture Demonstrations to Enhance Student Learning in Electronics*, in *Australasian Association for Engineering Education Conference*. 2010, Engineers Australia: Sydney, N.S.W. p. 417-422.
10. Itaketo U. T.: *Misconceptions (and Corrections) in the Applications of j-Operator in Electrical/Electronics Engineering*. International Journal of Engineering Science and Technology, 2010. **2**(7): p. 2957-2962.
11. Carstensen A. K.: *Student Learning in an Electric Circuit Theory Course: Critical Aspects and Task Design*. European Journal of Engineering Education, 2009. **34**(4): p. 393-408.
12. Halloun I. A., Hestenes D.: *The initial knowledge state of college physics students*. American Journal of Physics, 1985. **53**(11): p. 1043-1055.
13. Laws P. W.: *Millikan Lecture 1996: Promoting active learning based on physics education research in introductory physics courses*. American Journal of Physics, 1997. **65**(1): p. 14-21.
14. McDermott L. C.: *Millikan Lecture 1990: What we teach and what is learned-Closing the gap*. American Journal of Physics, 1991. **59**(4): p. 301-315.
15. Crouch C. et.al: *Classroom demonstrations: Learning tools or entertainment?* American Journal of Physics, 2004. **72**(6): p. 835-838.
16. Sokoloff D. R., Thornton R. K.: *Using interactive lecture demonstrations to create an active learning environment*. The Physics Teacher, 1997. **35**: p. 340-347.

17. Thornton R. K., Sokoloff D. R.: *Assessing student learning of Newton's laws: The Force and Motion Conceptual Evaluation and the Evaluation of Active Learning Laboratory and Lecture Curricula*. American Journal of Physics, 1998. **66**(4): p. 338-352.
18. Meltzer D. E., Manivannan K.: *Transforming the lecture-hall environment: The fully interactive physics lecture*. American Journal of Physics, 2002. **70**(6): p. 639-654.
19. Johnston I., Millar R.: *Is There a Right Way to teach physics?* CAL-Laborate, 2000. **5**.
20. Mazzolini A. P., Daniel S., Edwards T.: *Using Interactive Lecture Demonstrations to Improve Conceptual Understanding of Resonance in an Electronics Course*. Australasian Journal of Engineering Education, 2012. **18**(1): p. 69-88.
21. Daniel S. et.al: *Addressing student misconceptions of phasors and AC resonance*, in *Australian Institute of Physics 20th National Congress*. 2012: Sydney, Australia.
22. Mazzolini A. P., Cadusch P. J.: *Is collecting anonymous but code-identified intervention assessment data worth the effort? Reflections on a recent study in electronics*, in *Australasian Association for Engineering Education Conference*. 2011, Engineers Australia: Fremantle, Western Australia. p. 160-165.
23. Hake R. R.: *Interactive-engagement versus traditional methods: A six-thousand-student survey of mechanics test data for introductory physics courses*. American Journal of Physics, 1998. **66**(1): p. 64-74.
24. Bao L.: *Theoretical comparisons of average normalized gain calculations*. American Journal of Physics, 2006. **74**(10): p. 917-922.
25. Scott M., Stelzer T., Gladding G.: *Evaluating multiple-choice exams in large introductory physics courses*. Physical Review Special Topics - Physics Education Research, 2006. **2**(2).
26. Steinberg R., Sabella M. S.: *Performance on multiple-choice diagnostics and complementary exam problems*. The Physics Teacher, 1997. **35**(3): p. 150-155.
27. Oliva J. M.: *The structural coherence of students' conceptions in mechanics and conceptual change*. International Journal of Science Education, 2003. **25**(5): p. 539-561.
28. Bowden J. et.al: *Displacement, Velocity, and Frames of Reference - Phenomenographic Studies of Students Understanding and Some Implications for Teaching and Assessment*. American Journal of Physics, 1992. **60**(3): p. 262-269.
29. Streveler R. A. et.al: *Rigorous Methodology for Concept Inventory Development: Using the 'Assessment Triangle' to Develop and Test the Thermal and Transport Science Concept Inventory (TTCI)*. International Journal of Engineering Education, 2011. **27**(5): p. 968-984.
30. Daniel S., Mazzolini A., and Schier M.: *Is lecture attendance just a flip of a coin?*, in *Australasian Association for Engineering Education Conference*, L. Mann and S. Daniel, Editors. 2012, The Engineering & Science Education Research (ESER) group, Faculty of Engineering & Industrial Sciences, Swinburne University of Technology: Melbourne, Australia. p. 573-582.
31. Orlin B.: *Learning is a Flourescent Light*, in *Math with Bad Drawings*. 2013, WordPress.Com.
32. Chi M. T. H.: *Commonsense Conceptions of Emergent Processes: Why Some Misconceptions Are Robust*. Journal of the Learning Sciences, 2005. **14**(2): p. 161-199.

Quantitative and qualitative analysis of the mental models deployed by undergraduate students in explaining thermally activated phenomena

Claudio Fazio, Onofrio Rosario Battaglia and Rosa Maria Sperandeo-Mineo

UOP_PERG (University of Palermo – Physics Education Research Group),
Department of Physics and Chemistry, University of Palermo, Italy

Abstract

In this contribution we describe a research aimed at pointing out the quality of mental models undergraduate engineering students deploy when asked to create explanations for phenomena/processes and/or use a given model in the same context. Student responses to a specially designed written questionnaire are initially analyzed using researcher-generated categories of reasoning, based on the Physics Education Research literature on student understanding of the relevant physics content. The inferred students' mental models about the analyzed phenomena are categorized as practical, descriptive, or explanatory, based on an analysis of student responses to the questionnaire. A qualitative analysis of interviews conducted with students after the questionnaire administration is also used to deepen some aspects which emerged from the quantitative analysis and validate the results obtained.

Keywords: mental models, quantitative data analysis

Introduction

Among many cognitive theories, those explaining student reasoning in terms of structured cognitive conceptions, or mental models [1], are of special interest for physics education. For this reason, many research papers [2-6] studied students' understanding of models in different contexts, the mental models deployed by students in order to make sense of given phenomenology, and their *expressed forms* [7], often using qualitative or quantitative analysis methods.

However, in the last years there has been a move in social science towards multi-method approaches, which tend to emphasize the breadth of information which the use of more than one analysis method may provide to the researcher [8,9]. Research results on eliciting and characterizing student mental models, based on the joint use of quantitative and qualitative methods, can be found in the literature [10,11]. Our paper develops this research context and is mainly focused on the discussion of students' scientific explanations [12] to an everyday life phenomenon, relating it to the physics and chemistry they have already studied in previous courses. The focus is on systems for which a process is thermally activated by overcoming a well-defined potential barrier, ΔE , and is therefore described by an equation containing the Boltzmann factor, $\exp(-\Delta E / KT)$, where T is the system temperature and K is the Boltzmann constant.

The method involves the construction of a tool (a specially designed open-answer questionnaire) and a quantitative analysis of student responses, supported by the qualitative analysis of specifically designed interviews. The questionnaire items are reported in the Appendix and are better discussed in [13], where more detail on the whole research are reported and the related results are studied by using a quantitative method based on

statistical implicative analysis, different from the one we present here. The study is performed by analyzing the expressed forms of the mental models student use when tackling a written questionnaire and interviews, i.e. their “answering strategies”.

The results discussed here have been obtained with students of the 3-year Bachelor Degree Program in Chemical Engineering at the University of Palermo (UniPA), Italy. In the next sections we present the different steps of our research by explaining the research questions, methods and data analysis, and discuss our results.

The research

Research sample

Our research sample consists of 34 freshmen, enrolled in the Chemical Engineering Degree Program during the Academic Year 2010/2011 at UniPA. During the 1st semester of their Degree Program the students attended general mathematics, physics and inorganic chemistry courses, and they had already passed the related exams. When requested to participate in our study, they were attending a 2nd semester Physics course dealing with the fundamentals of electromagnetism, and voluntarily chose to participate in the survey. The total number of students on the course was about 60.

Research questions

Following the general theoretical framework and the research aims discussed above, this paper directly addresses the following research questions:

- What are the characteristics of the mental models students deploy when searching for explanations to phenomena/situations related to real-life and to subjects studied in previously attended courses?
- Do students highlight consistency in their deployment of mental models?

Methodology

The general lines used for this research are summarized in six “steps”, that are shown below. More detail can be found in [13].

- Step 1: The questionnaire items (reported in the Appendix) are formulated on the basis of a review of Educational Research literature and a survey conducted with some UniPA university teachers.
- Step 2: Validation of the questionnaire is performed: 5 physics freshmen, coming from the same secondary schools attended by our student sample, are asked to highlight problems in the questions, like unclear or ambiguous terminology. Then researchers make an independent analysis of the possible (*a-priori*) student responses to the questionnaire items, which results in the singling out of a set of possible answering strategies for each item [14].
- Step 3: After the submission of the questionnaire to the research sample, researchers independently analyze actual student responses to each item and compare them with the *a-priori* found answering strategies, adding new ones as needed. The questionnaire items and the related student answering strategies are reported in the Appendix.
- Step 4: It is assumed that each student has a latent cognitive structure underlying their answers to the questionnaire items, referred to as a “mental model”. Answering strategies are grouped into idealized sets. Each set is synthesized by typical

reasoning procedures that allow us to infer an epistemic category of students' mental models, defined as "practical/everyday", "descriptive", or "explicative".

Step 5: The extent to which actual student answering strategies correspond to the idealized categories is studied by using quantitative analysis methods [15,16].

Step 6: An interview protocol is designed by the researchers and interviews are taken with a subset of the student sample in order to extend and validate the results obtained by means of the quantitative analysis. The interviews are conducted immediately after the questionnaire submission, on a voluntary basis. The interview questions are aimed at supplying relevant information about the meaning of students' answers and at widening the analysis of their answering strategies, highlighting points of interest or unusual elements in the questionnaire answers. Checking the validity of the questionnaire items in actually revealing the students' reasoning when constructing explanations was another aim of the interviews. The interview protocol is pre-designed by all three researchers, but the interviews are conducted by one of them, face to face with the students. In many cases, questions not included in the interview protocol are asked, in order to better clarify specific situations which emerged during the discussion.

Questionnaire analysis

During the analysis of the student answering strategies, each researcher draw up a table summarizing them. Discordances between researchers' tables were found in some cases, when a student answer was classified under not just one of the a-priori/a-posteriori strategies, but two or more of them. In a few cases, discordances were due to different researchers' interpretations of students' statements. This happened 19 times when comparing the tables of researchers 1 and 2, 17 times for researchers 1 and 3 and 16 times for researchers 2 and 3. Hence, a good inter-rater reliability of the analysis is demonstrated, with accordance percentages of about 91-92% between the analysis tables of each pair of researchers. The differences between the three tables were compared and discussed by the researchers to reach a consensus on a common table to use for the study.

The careful reading of the students' answers to the questionnaire items, within a framework provided by domain-specific expertise and previous research in the field of the description of student modelling competencies [17], allowed us to classify students' responses into three phenomenographic [18,19] categories of mental models. They are Practical/Everyday, Descriptive and Explicative, as described in Table 1, where the reasoning procedures representative of each model category are also shown.

Table 1. Categories of mental models deployed by students when tackling the questionnaire and the related reasoning procedures.

Practical/Everyday	Descriptive	Explicative
<i>Reflects the creation of situational meanings derived from practical, everyday contexts. The student uses other situations to try to explain the proposed situations.</i>	<i>The student describes and characterizes the analyzed process by finding/remembering the relevant variables and/or recalling from memory their relations, expressing them by means of different language (verbal, iconic, mathematic). He/she does not explain the causal relations of the physics parameters involved on the basis of a functioning model (microscopic/macrosopic).</i>	<i>The student proposes a model (qualitative and/or quantitative) based on a cause/effect relation or provides an explanatory hypothesis by introducing models which can be seen at a theoretical level.</i>

We then built a table which identifies three ‘idealized sets’ containing the answering strategies that can be considered typical of each mental model category shown in Table 1. Each set defines the ideal profile of a student answering all the questionnaire items always using strategies related to the same category of mental model. These profiles have been used for a similarity analysis between them and the real students, as explained in the following. More detail can be found in [13].

In order to study the “similarity” between the students and the three categories of mental models we identified in Step 4 of our analysis, we compared the answers given by the students with the answers typical of each ideal student profile, and calculated the Pearson’s correlation coefficients, r_{ij} between each students and the three profiles, where i ($=1, 2, \dots, 34$) denotes a generic student and j represents one of the three ideal student profiles. By following a methodology well known in the field of Econophysics [16], where it is common to compare the behavior of real stocks traded in financial markets with the characteristics of “ideal-type” stocks, like banking, industrial, service, etc., the “distances” between each student and the three ideal profiles (i.e. the student mental model profiles) were calculated by using the relationship:

$$d_{ij} = \sqrt{\frac{1 - r_{ij}}{2}}$$

The general idea behind the use of this definition of distance between two elements i and j is that pairs of elements with positive correlation coefficient are “more similar” than pairs with correlation coefficient zero, or negative. In our case, when a student i never answers the questionnaire items by using strategies typical of a given profile j , $r_{ij} = -1$ and the related value d_{ij} assumes its maximum value, 1. When the student answering strategies are always be found in the same ideal profile j , $r_{ij} = 1$ and d_{ij} is 0.

We used the values d_{ij} to build a graph that can easily evidence if the three mental model categories really describe the real student behavior and if it is possible to identity clusters of student behavior with respect to the mental models.

Figure 1 shows the graph obtained by using our data, where each ideal student profile is represented as one of the vertex of a Reuleaux triangle, whose distance from any of the other two vertexes (i.e. ideal profiles) is equal to 1 (i.e. the maximum distance between two elements in our analysis). In this graph students are represented by S_i (where i again goes from 1 to 34) and are placed within the triangle according to their distances with respect to the three ideal student profiles.

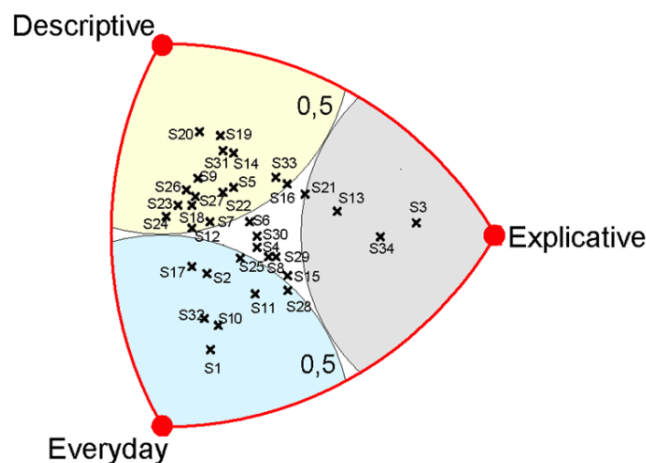

Figure 1. Graph of “distances” between real students and the three ideal student profiles

From Figure 1 it can be seen that many students are far away from a given profile of less than 0.5. This means that they appear to have answered the questionnaire items by putting into action well defined mental models. However, a number of students is distributed in proximity of the centre of the triangle; this means that their distances with respect to the three profiles are comparable, i.e. these students seem to use a variety of mental models when tackling the questionnaire items. Going into detail, 8 students can be classified as mainly putting into action Everyday-type strategies, 16 highlight the use of Descriptive-type ones (although many of them have distances near, or equal, to 0.5 with respect to this profile), and only four can be considered as mainly using Explicative-type mental models.

The analysis here reported is coherent with a more detailed study of the similarity between the students and the three ideal profiles [13] performed by using a more complex approach based on Statistical Implicative Analysis (SIA) [20,21].

Interview analysis

According to many research papers [22,23] a detailed analysis of the language used by each student during an interview, or when carrying out an activity involving human interaction, can provide evidence of the cognitive style(s) used when tackling a given issue or problem. Therefore, the interviews were audio recorded and then analyzed by the three researchers, partly on the basis of a search for ‘indicator words/utterances’ and specific aspects of students’ answers which could help to answer the research questions. The analysis of the semantic properties of the student’s language was based on the distinction made by the French psychologist Frederic Pauslan between the sense and the meaning of a word and considering “the preponderance of the sense of a word over its meaning” [24, p. 244]: *“the sense is ... the sum of all the psychological events aroused in our consciousness by the word. It is a dynamic, fluid, complex whole, which has several zones of unequal stability. Meaning is only one of the zones of sense, the most stable and precise zone. A word acquires its sense from the context in which it appears; in different contexts, it changes its sense.”*

Several methods of analyzing interview excerpts are described in previous research on this subject. One such method involves the use of coding schemes to associate the number of indicator word/phrases that occur with specific forms of reasoning [25,26]. However, we acknowledge that *“the nature of language – in which any one grammatical form can be used to fulfill a range of pragmatic functions – renders any coding scheme of dubious value if used separately from a more contextually sensitive ... type of analysis”* [27, p. 372].

For this reason when analyzing the interview excerpts we tried to make sense of the students’ use of indicator words/utterances in the specific context of the question itself [23,28], in order to highlight points of interest or controversial behavior in the related questionnaire answers. Furthermore, we also allowed the interviews, and the related qualitative analysis, to be driven by particularly relevant strategies used by students when answering the questionnaire items, and by their implications, as reported in the introductory remarks of each interview.

Table 2 shows some examples of key-words and phrases and specific aspects of the students’ answers that we used as evidence of the cognitive style(s) student used when tackling the interviewer answers.

Table 2. Examples of key-words and phrases and specific aspects of the students' answers typical of the three categories of mental model

Everyday/Practical	Descriptive	Explicative
<ul style="list-style-type: none"> . (according to my) experience In real life Normally Real object 	<ul style="list-style-type: none"> . I remember that I studied that I know that The formula says 	<ul style="list-style-type: none"> . Molecular movement... . Is similar to microscopic interaction

Below we report some examples of answers given by our students to the interviewer questions. In them it is possible to recognize some key-words and phrases we identified as descriptors of a given mental model used to tackle the question.

Eleonora: "... *molecules act each other by means of electric forces...*".

Luca: "... *temperature is related to molecular movement , i.e. to molecular energy...*".

Fabiana: "... *as the mathematical formulas are similar, I think that temperature and energy/enthalpy should play the same roles*".

Matteo: "... *I now remember that when studying the vapour pressure equilibrium in liquids*".

Aldo: "... *I know from my experience that ... a minimum temperature must be reached in order to light a real life object, like ... a match, if you strike it*".

Here, Eleonora and Luca highlight clear references to microscopic models (i.e. the use of explicative-type mental model) in answering the interviewer questions. Fabiana and Matteo highlight a Descriptive-like behaviour, with clear references to the use of mathematical formulas, and to the use of memory of studied subjects, to tackle the questions. Aldo shows to recall a real-life experience (striking a match) to tackle the question, highlighting an approach typical of Everyday-type mental model. The first four students can be found in figure 1 graph as actually being classified as Explicative (Eleonora, student S13, and Luca, student S34) or Descriptive (Fabiana, student S23, and Matteo, student S20). On the other hand, Aldo, student S31, is classified as a Descriptive mental model user in Figure 1, that, we recall it, is built only with data coming from the answers to the questionnaire items. This shows that a more in-depth analysis is needed in order to correctly classify a student in a given category, something that can be easily done with the joint use of qualitative interview analysis and quantitative methods. A more complete analysis of Aldo's answers to the interviewer questions, highlighting his use of mixed-type mental models when tackling with problems//situations, can be found in [13], where many excerpts from student interviews, better characterizing the use we do in our study of interview analysis, can be found.

Discussion and conclusions

The quantitative and qualitative data analysis reported above allow us to answer the research questions, which regard 1) the characteristics of the mental models students deploy when searching for explanations to phenomena/situations related to real-life and to subjects studied in previously attended courses, and 2) the consistency in students' deployment of mental models.

The similarity analysis allowed us to identify clusters of students whose answering strategies can be completely included into categories related to three different mental

models. These categories highlight the reasoning procedures "ran" by students when searching for explanations about phenomena and/or proposed situations.

Many of the students, S_i , are plotted in Figure 1 graph with distances less than 0.5 with respect to one of the three profiles, highlighting a consistency in their use of a specific mental model when tackling with the situations proposed in the questionnaire items. On the other hand a significant number of students is distributed in proximity of the centre of Figure 1 Reuleaux triangle; this means that their distances with the three profiles are comparable. So, these students seem to use a variety of mental models when tackling the questionnaire items and highlight a lack of consistency in their deployment of mental models.

The analysis of the interviews allows us to go further and better characterize the student behaviour. Many of them clearly show to have more than one view about the nature and use of explications in science. Often strategies which are inefficient at correctly connecting mathematical modeling to real situations are revealed. Very often, reference to a well known mathematical model seems to stimulate a recalling procedure, i.e. a search in memory for examples that fit in with the formula, without a clear understanding of its physical meaning. Moreover, the analysis of interviews also highlight a significant use of approaches based on common-type knowledge, even in students who generally adopt descriptive strategies.

Our results are consistent with data from the literature [2-6,10,11] showing that the mental models students deploy in creating explanations can be eclectic, and sometimes contradictory. In fact, many students of our sample use different kinds of reasoning, with particular reference to ones which are inefficient for correctly associating explanations to real situations. A significant presence of everyday or descriptive ideas in student answers is highlighted, in some cases even in students who generally use explicative strategies.

Appendix

Questionnaire items and the related answering strategies for each item on the basis of an a-priori/a posteriori analysis. The unforeseen strategies are in italics. In the answering strategies, numbers refer to the item, lowercase letters to the mental model category (practical/everyday (pe), descriptive (de) or explicative (ex)) and uppercase letters to the specific answering strategy.

- 1) **A puddle dries more slowly at 20°C than at 40°C. Assuming all other conditions (except temperature) equal in the two cases, explain the phenomenon, pointing out what the fundamental quantities are for the description of the phenomenon and for the construction of an interpretative model of the phenomenon itself.**

- 1peA The relevant quantities are not identified.
- 1peB The relevant quantities are not identified, but a description/explanation based on common sense is given.
- 1deA The relevant quantities are identified, but they are not used properly to give an explanation.
- 1deB Only temperature is identified as relevant, but the phenomenon is not correctly described.
- 1deC *Only temperature is identified as relevant. It is used to give a rough description of the phenomenon.*
- 1deD The phenomenon is described by means of the macroscopic variables pressure and volume, but a microscopic model is not identified.
- 1deE The phenomenon is described by means of the macroscopic variables temperature, energy and heat, but a microscopic model is not identified.
- 1deF The phenomenon is described by means of a mathematical formula, but a microscopic model is not identified.

- 1exA *The phenomenon is not adequately described (by means of a mathematical formula or verbally), but a microscopic “functioning mechanism” is roughly presented in terms of “molecular collisions”.*
- 1exB The phenomenon is not adequately described (by means of a mathematical formula or verbally), but a microscopic “functioning mechanism” is presented in terms of energy exchange between molecules.
- 1exC The phenomenon is verbally described and a microscopic “functioning mechanism” is roughly sketched.
- 1exD The phenomenon is described by means of mathematical relations between macroscopic quantities and a microscopic “functioning mechanism” is found.

2) **In chemical kinetics it is well known that the rate of a reaction, u , between two reactants follows the Arrhenius law:**

$$u = Ae^{\frac{E}{kT}}$$

Describe each listed quantity, clarifying its physical meaning and the relations with the other quantities.

- 2peA The fundamental quantities are not described and/or only examples of its application to everyday-life phenomenology are given.
- 2peB Some quantities are mentioned, but no description of the process is given.
- 2deA The relevant quantities are found, but only a few are described in terms of their physical meaning.
- 2deB *The relevant quantities are found, but only described in terms of their mathematical meaning in the formula. No relation between them is identified.*
- 2deC The relevant quantities are found and correctly described in terms of their physical meaning. No relation between them is identified.
- 2exA The relevant quantities are found and correctly described in terms of their physical meaning. Some relations between them are identified.
- 2exB The relevant quantities are found and correctly described in terms of their physical meaning. The relations between them are correctly identified.

3) **What do you think the role of a catalyst is, in the development of a chemical reaction?**

- 3peA A definition of catalyst is given, which does not conform to the scientifically correct one.
- 3peB A definition of catalyst based on an analogy with the concept of enzyme is given. The analogy is recalled without providing additional reasoning.
- 3deA The catalyst is described as a substance which speeds up a chemical reaction. No additional explanation is supplied.
- 3deB The catalyst is described as a substance which shifts the chemical equilibrium towards the products. No additional explanation is supplied.
- 3deC The catalyst is described as a substance which speeds up a chemical reaction. An explanation is given using common language.
- 3deD The catalyst is presented as a substance which shifts the chemical equilibrium towards the products. An explanation is given using common language.
- 3deE The catalyst is presented as a substance which speeds up a chemical reaction. The concept is generically described in terms of energy.
- 3deF The catalyst is presented as a substance which shifts the chemical equilibrium towards the products. The concept is generically described in terms of energy.
- 3deG *The catalyst is presented as a substance which speeds up a chemical reaction. The concept is described by simply citing the energy gap concept, without any explanation.*
- 3deH *The catalyst is presented as a substance which shifts the chemical equilibrium towards the products. The concept is described by simply citing the energy gap concept, without any explanation.*
- 3deI *The role of a catalyst in a chemical reaction is discussed referring to the energy gap concept, but only in macroscopic terms.*

- 3exA The role of a catalyst in a chemical reaction is discussed taking into account the energy gap concept. The concept is explained considering a microscopic model regarding collisions between molecules.
- 3exB The role of a catalyst in a chemical reaction is discussed taking into account the energy gap concept. The concept is explained considering a microscopic model which links the energy gap concept with the molecular energy.
- 4) **Can you give your own microscopic interpretation (model) of the Arrhenius law?**
- 4peA Everyday-life concepts are mentioned, without any correct relation to the Arrhenius law.
- 4deA Scientific concepts, such as energy, temperature or molecular thermal agitation, are mentioned, but they are not correctly related to the Arrhenius law.
- 4deB Arrhenius law is described as a mathematical function of T or E. No explanation of the meaning of these quantities is given.
- 4deC Arrhenius law is described as a mathematical function of both T and E. No explanation of the meaning of these quantities is given.
- 4deD Arrhenius law is described as a function of both T and E and the meaning of these two quantities is outlined mainly in mathematical terms.
- 4deE Arrhenius law is described as a function of both T and E. The physical meaning of these two quantities and/or of their ratio in the Arrhenius law is outlined.
- 4deF *Arrhenius law is described outlining the physical quantities involved. Collision theory is sometimes mentioned, but a clear reference to a microscopic model is not always present.*
- 4exA A generic explanation based on a microscopic model of collisions between molecules is given. The activation energy concept is outlined but its relation with kT is not clearly presented.
- 4exB A quantitative explanation in terms of the “collision theory” is given. A correct microscopic model is presented and the role of the activation energy and of kT is clearly expressed.
- 5) **Can you think of other natural phenomena which can be explained by a similar model?**
- 5peA A few phenomena not related to the model are mentioned. No explanation is given.
- 5peB A few phenomena not related to the model are mentioned. An explanation is given using common language.
- 5deA A few phenomena not related to the model are mentioned. An explanation is given using mathematical formulas.
- 5deB Some phenomena related to the model are mentioned, but these are limited to the context of the attended graduation program (chemical engineering). An explanation is given using mathematical formulas.
- 5deC *Some phenomena related to the model are mentioned, and non-chemical phenomena are also taken into account, but a clear explanation is not given.*
- 5deD Some phenomena related to the model are mentioned, and non-chemical phenomena are also taken into account. An explanation is given using mathematical formulas.
- 5exA Some phenomena related to the model are mentioned, but these are limited to the context of the attended graduation program (chemical engineering). An explanation is given outlining a common microscopic model.
- 5exB *Some phenomena related to the model are mentioned, and non-chemical phenomena are also taken into account. An explanation is given outlining a common microscopic model, but energy and temperature are not clearly interrelated.*
- 5exC Some phenomena related to the model are mentioned, and non-chemical phenomena are also taken into account. An explanation is given outlining a common microscopic model. The role of energy and temperature in the model is clearly discussed.
- 6) **Which similarities can be identified in the previous phenomena? Is it possible to find a common physical quantity which characterizes all the systems you discussed in the previous questions?**
- 6peA No similarities are detected and questions 1) and 2) are identified as being related to a different context on the basis of everyday-life reasoning.

- 6deA No similarities are detected and questions 1) and 2) are identified as being related to a different context. An explanation is given, mentioning physical quantities which are not really relevant to the correct explanation of the questions.
- 6deB A few correct similarities are found, but physical quantities are given, which are not really relevant to the correct explanation of the questions.
- 6deC Incorrect similarities are found on the basis of a mathematical formula.
- 6deD A few correct similarities are found on the basis of a mathematical formula.
- 6deE Correct similarities are found, but E and T are not always considered common to all phenomena.
- 6deF Some correct similarities are found. E or T is considered to be characteristic of the various phenomena, but a clear justification is not given.
- 6deG Some correct similarities are found. E or T is considered to be characteristic of the various phenomena, clearly explaining why.
- 6deH Some correct similarities are found. E or T is considered to be characteristic of the various phenomena, but the relevance of their ratio in explaining the energy threshold processes is not clearly presented.
- 6exA Some correct similarities are found. E or T is considered to be characteristic of the various phenomena. The activation energy role is correctly discussed in all the mentioned phenomena, but only in macroscopic terms.
- 6exB Some correct similarities are found. E or T is considered to be characteristic of the various phenomena. The activation energy role is correctly discussed in all the mentioned phenomena, on the basis of a microscopic model.

References

- [1] Johnson-Laird P.N.: *Mental Models*, (Cambridge University Press, Cambridge, England, 1983).
- [2] Bao L., Redish E.F.: Model Analysis: Representing and Assessing the Dynamics of Student Learning. *Phys. Rev. ST Phys. Educ. Res.* **2**, 010103 (2006).
- [3] Maloney D., Siegler R.S.: Conceptual Competition in Physics Learning. *Int. J. Sci. Educ.* **15**, 283 (1993).
- [4] Carley K., Palmquist M.: Extracting, Representing and Analyzing Mental Models, *Social Forces* **70**(3), 601 (1992).
- [5] Corpuz E.D., Rebello N.S.: Investigating students' mental models and knowledge construction of microscopic friction. I. Implications for curriculum design and development, *Phys. Rev. ST – Phys. Ed. Res.* **7**, 020102 (2011).
- [6] Chittleborough G., Treagust D.F.: The modelling ability of non-major chemistry students and their understanding of the sub-microscopic level. *Chemistry Education Research and Practice* **8**(3), 274, (2007).
- [7] Gilbert J.K., Boulter C.: Learning science through models and modelling. In *International handbook of science education*, edited by B. J. Fraser & K. G. Tobin, (Kluwer Academic Publisher, Dordrecht, The Netherlands, 1998), p. 53.
- [8] *Handbook of Mixed Methods in Social & Behavioral Research*, edited by A. Tashakkori and C. Teddlie (Sage Publications, Inc., Thousand Oaks, Ca, 2003).
- [9] Brewer J., Hunter A.: *Foundations of Multimethod Research: Synthesizing Styles* (Sage Publications, Inc., Thousand Oaks, Ca, 2006).
- [10] Hrepic Z., Zollman D.A., Rebello, N.S.: Eliciting and Representing Hybrid Mental Models, Proceedings of the NARST 2005 Annual Meeting (Dallas, TX, USA, April 4-7 2005).

- [11] Bao L.: Dynamics of student modeling: A theory, algorithms, and application to quantum mechanics. Unpublished Ph.D. Dissertation, University of Maryland, College Park, MD (1999).
- [12] Gilbert J.K., Boulter C., Rutherford M.: Models in explanations: Part 1, Horses for courses? *Int. J. Sci. Educ.* **20**, 83(1998).
- [13] Fazio C., Battaglia O.R., Di Paola B.: "Investigating the quality of mental models deployed by undergraduate engineering students in creating explanations: The case of thermally activated phenomena". *Physical Review Special Topics - Physics Education Research* 9, 020101. doi: 10.1103/PhysRevSTPER.9.020101, (2013).
- [14] Brousseau G.: *Theory of Didactical Situations in Mathematics*, edited by M. Cooper, N. Balacheff, R. Sutherland, and V. Warfield (Kluwer Academic, Dordrecht, The Netherlands, 1997).
- [15] Gower J.C.: *Biometrika* **53**, 325 (1966).
- [16] Mantegna R.N.: Hierarchical structure in financial markets, *Eur. Phys. J.* **B11**, 193 (1999).
- [17] Sperandeo-Mineo R.M., Fazio C., Tarantino G.: Pedagogical content knowledge development and pre-service physics teacher education: a case study. *Res. Sci. Ed.* **36**, 235 (2006).
- [18] Marton F.: Describing and improving learning. In *Learning strategies and learning styles*, edited by R. R. Schmeck (Plenum Press, New York, 1988), p. 53.
- [19] Marton F., Booth S.: *Learning and awareness*, (Lawrence Erlbaum Associates, Mahwah, 1997).
- [20] Lerman I. C.: *Classification et Analyse Ordinale Des Données* (Dunod, Paris, France, 1981).
- [21] Lerman I. C., Gras R., Rostam H.: Elaboration et évaluation d'un indice d'implication pour des données binaires I, *Math. Sci. Hum.* **74**, 5 (1981); I. C. Lerman, R. Gras, and H. Rostam, Elaboration et évaluation d'un indice d'implication pour des données binaires 2, *Math. Sci. Hum.* **75**, 5 (1981).
- [22] Berg B.: An introduction to content analysis, in *Qualitative Research Methods*, edited by B. Berg (Allyn & Baron Press, Boston, 1989), p. 105.
- [23] Onwuegbuzie A.J., Leech N.L., Slate J.R., Stark M., Sharma B., Frels R., Harris K., Combs J.P.: An Exemplar for Teaching and Learning Qualitative Research, *Qual. Rep.* **17**(1), 16 (2012).
- [24] Vygotsky L.S.: *Thought and Language*, (MIT Press, Cambridge, MA, 1986).
- [25] Weber R.P.: *Basic content analysis*, (Sage, Beverly Hills, CA, 1990).
- [26] Azmita M., Montgomery R.: Friendship, transactive dialogues, and the development of scientific reasoning, *Soc. Dev.* **2**(3), 202 (1993).
- [27] Mercer N., Dawes L., Wegerif R., Sams C.: Reasoning as a scientists: ways of helping children to use language to learn science , *Brit. Educ. Res. J.* **30**(3) (2004).
- [28] Leech N.L., Onwuegbuzie A.J.: An array of qualitative analysis tools: A call for data analysis triangulation. *School Psychol. Quart.* **22**, 557 (2007).

Student Engagement in a Collaborative Group-Learning Environment

Gerald Feldman, Larry Medsker and Raluca Teodorescu

George Washington University, Washington, DC, USA

Abstract

We have implemented the collaborative group-learning pedagogy known as SCALE-UP in all of the introductory physics classes at George Washington University. This is a fully student-centered active-learning environment that minimizes formal lecture and maximizes “on-task time” for students in the classroom. The class meets for 5 hours each week, and laboratory activities are seamlessly integrated into the classroom time. We began a “phased” approach for the implementation of this pedagogy in Spring 2008, and now all of our introductory classes are offered in this collaborative mode. We have collected a variety of assessment data over this period, and our results indicate higher student gains in performance in the SCALE-UP class as compared to the conventional lecture/lab format.

Keywords: collaborative group learning, student engagement, active learning, SCALE-UP, studio physics, problem solving, conceptual understanding

Introduction

Studies of undergraduate science education have shown that students need to be actively engaged in the learning process in order for it to be effective. Passive lecturing (“teaching by telling”) is known to be ineffective in developing students’ skills in critical thinking [1]. One of the first collaborative group-learning environments (“studio physics”) was developed by Wilson [2] in the mid-1990’s to address this issue — students worked together in small groups and the instructor served as a facilitator or “coach” instead of a lecturer. A critical aspect of the studio approach is the integration of laboratory activities into the classroom — in this manner, class time is filled with a seamless progression of activities, ranging from group problem-solving exercises to lab experiments to short demonstrations to mini-lectures. By merging the collaborative approach with the integration of various pedagogical activities, a dynamic learning environment is created.

A practical limitation of the studio method is the small class size — it is simply not possible to staff multiple sections of a course with limited faculty resources. Beichner at North Carolina State University has pioneered an extension of the studio approach, called SCALE-UP (Student-Centered Active Learning Environment for Undergraduate Programs), which adapts the method for larger class sizes (*e.g.*, up to 99 students) [3]. In this scheme, round tables accommodate 3 groups of 3 students (9 students per table) for all classroom activities. For a class of this size, one instructor and two Teaching Assistants are sufficient to handle questions and to promote useful discussions among the students.

The SCALE-UP pedagogy has several basic characteristics: active learning, collaborative groups, integrated lecture/laboratory and technology assistance. In a SCALE-UP classroom, there is minimal lecturing in the conventional sense. The students are expected to prepare for class by reading the textbook in advance, and then most of the class time is spent enriching the material by engaging the students in a variety of hands-on and “minds-on” activities. In that regard, the activities are built around three fundamental pillars:

(1) *ponderables* are problems to think about, both numerical and conceptual, that students work on together in their groups with portable white boards, (2) *tangibles* are hands-on activities, ranging from short 5-minute demonstrations to more lengthy laboratory experiments, and (3) *computer simulations* that help the students model physical trends and behavior, usually done using the VPython language [4].

There are over 150 institutions around the world that have adopted the SCALE-UP pedagogy. While most of these schools are in the United States, at the present time there are at least a dozen institutions in other countries implementing this approach as well. The SCALE-UP web site at North Carolina State University has a wealth of information about this collaborative approach and the results at various institutions [5].

Implementation

We have implemented the SCALE-UP approach at George Washington University (GWU) for all of our calculus-based and algebra-based introductory physics classes. We have redesigned a classroom with 9 round tables, able to accommodate a total of 81 students. Each group of 3 students shares a laptop computer and has a portable white board to facilitate their work together. The classroom walls have large white boards on which students can display their work, two large projection screens at opposite ends of the room and multiple LCD screens around the other walls for image projection. For a room of this size, one instructor and two Teaching Assistants can provide sufficient coverage for all students. A schematic drawing of our SCALE-UP classroom is shown in Figure 1 below.

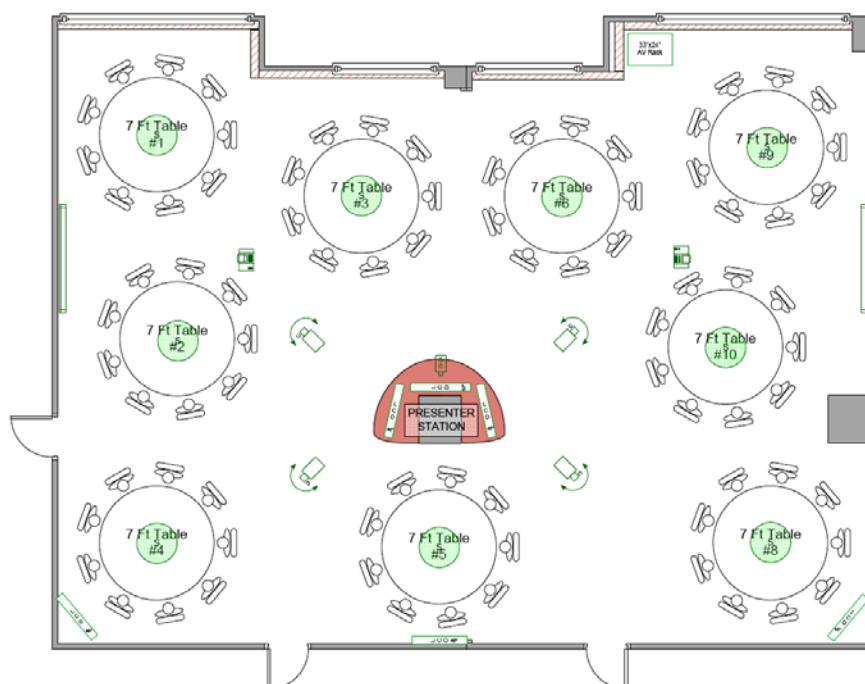

Figure 1. Schematic view of the SCALE-UP classroom. The instructor station is located at the center of the room, wrapping around a central pillar. Large projection screens are located on the right and left walls. Three LCD screens are on the bottom wall and three additional LCD screens are mounted to the pillar in the center of the room.

We instituted SCALE-UP in Spring 2008, and at this point, we now have over 5 years of experience. Our implementation followed a “phased” approach, where we started with the introductory calculus-based classes that are typically taken by science majors and engineers (Phys 21 and 22), and then we later expanded the collaborative approach to our

algebra-based physics courses (Phys 11 and 12) and also to our astronomy classes (Astr 1 and 2). A timeline of the development of SCALE-UP at our institution is given below:

- Spring 2008 – initiate calculus-based Phys 21 and Phys 21 (bio-focused)
- Fall 2008 – initiate algebra-based Astr 1
- Spring 2009 – initiate calculus-based Phys 22
- Fall 2009 – initiate calculus-based Phys 22 (bio-focused)
- Fall 2011 – initiate algebra-based Phys 11
- Spring 2012 – initiate algebra-based Astr 2
- Fall 2012 – initiate algebra-based Phys 12

In our “usual” configuration, the class meets 3 times a week — 2 hours on Monday and Wednesday and 1 hour on Friday — with a weekly 15-minute quiz every Friday. Groups are carefully arranged by the instructor, where each triplet is composed of a balance of high, medium and low performing students, and guidelines are clearly outlined in a “group contract” that is prepared by each group. The group assignments are switched at the mid-point of the semester — the students are reorganized into different groups so as to keep the group interactions fresh and vigorous. In class, students work collaboratively on conceptual questions and numerical problems (*ponderables*) using their portable white boards, in addition to short hands-on activities and longer laboratory experiments (*tangibles*) using real-time data acquisition. It is necessary to point out that so far we have not yet included the computer simulations using VPython, primarily due to lack of time.

Homeworks are delivered via a web-based online system called *MasteringPhysics* [6] which is available through Pearson Higher Education, who is the publisher of the textbook that we use for the calculus-based course (*Physics for Scientists and Engineers: A Strategic Approach* by Randall Knight [7]). We typically assign 14 problems per week, with an additional 2 problems being available for extra credit. These assignments generally take about 3-4 hours to complete. Since lecture is reduced to a minimum, class preparation is an important consideration for students. To gauge their understanding and to motivate their preparation for class, pre-class “Warmups” are available online for students, also through the *MasteringPhysics* system. These consist mostly of about 10 multiple-choice conceptual questions related to the material to be covered in class on that day. The “Warmups” are expected to require about 30-40 minutes for completion and are presented to the students twice a week, before the Monday and Wednesday two-hour classes.

Tangibles are highly beneficial, and it is often a challenge to devise short demonstration exercises that take only 10 minutes or so. One example of a simple tangible is to drop a meter stick between the fingers of a student (see Figure 2) to measure her reaction time using free fall. The distance that the meter stick falls before the student catches it can be converted into a time interval by using free-fall kinematics, giving a rough estimate of the student’s ability to react to the dropped meter stick.



Figure 2. Example of a “tangible” to measure human reaction time. By dropping the meter stick from a fixed position, the time needed to catch the falling stick can be deduced by a direct measurement of the free-fall distance.

Another tangible actually begins with a ponderable, in which students calculate the angle at which a rough surface must be tilted in order to make a metallic block overcome static friction and slide down the plane. This exercise yields the usual $\mu_s = \tan \theta$ result with which we are all familiar. After the calculation, the students try the exercise themselves, using the rough cardboard backing of their own white boards as the inclined plane. Each group member takes a turn slowly tilting the white board until the metal block just begins to slide — then the other group members take length measurements that enable them to determine the tilted angle of the board. After all three group members have tried this, the measurements are averaged and an overall average value of μ_s is obtained. While the actual answer is unknown, the fact that 75% of the groups come up with a value within $\pm 10\%$ of $\mu_s = 0.35$ seems convincing that a consensus value has been reached.

Laboratory experiments also fall into the category of tangibles. For our real-time data acquisition, we use probes and software from Vernier [8]. While these exercises are not so different from a conventional lecture/lab course, the guidelines for conducting the experiments are “streamlined” to leave the exercise a bit more open-ended. Some of the experiments conducted in our SCALE-UP class include the following:

- using motion sensors to measure the acceleration of carts on an inclined plane (along with video analysis of similar motion)
- using motion sensors to analyse elastic and inelastic collisions of carts (along with video analysis of similar motion)
- measuring moment of inertia of a uniform cylinder by wrapping it with a string attached to a mass and letting the mass fall, unwinding the string as it falls
- determining the mass of a car by measuring the tire pressure and contact area
- determining the density of air by floating helium balloons
- measuring the specific heat of an unknown metal sample
- investigating the “coffee and cream” problem to ascertain whether cool cream should be added to hot coffee right away or after a waiting period

It is important for the students to have a means by which they can gauge their overall progress at regular intervals. Since homework assignments are often collaborative efforts (it is entirely acceptable and even encouraged for students to help each other in these

assignments) and since exams are too infrequent and are often high-stakes (and high-stress) events, we have opted to give a quiz every Friday at the beginning of our one-hour class. The quiz lasts 15 minutes and contains one conceptual and one numerical problem (possibly with multiple parts). The main idea is to simulate an exam-like environment so that the students can get a sense of how they are doing on a weekly basis, thus enabling them to take the necessary steps if they feel that they are struggling with the conceptual or the problem-solving aspects of the course. The Friday quizzes have proven to be an excellent predictor of exam performance, as evidenced by the plots shown below in Figure 3 from the Spring 2008 (for Phys 21) and Spring 2009 (for Phys 22) semesters.

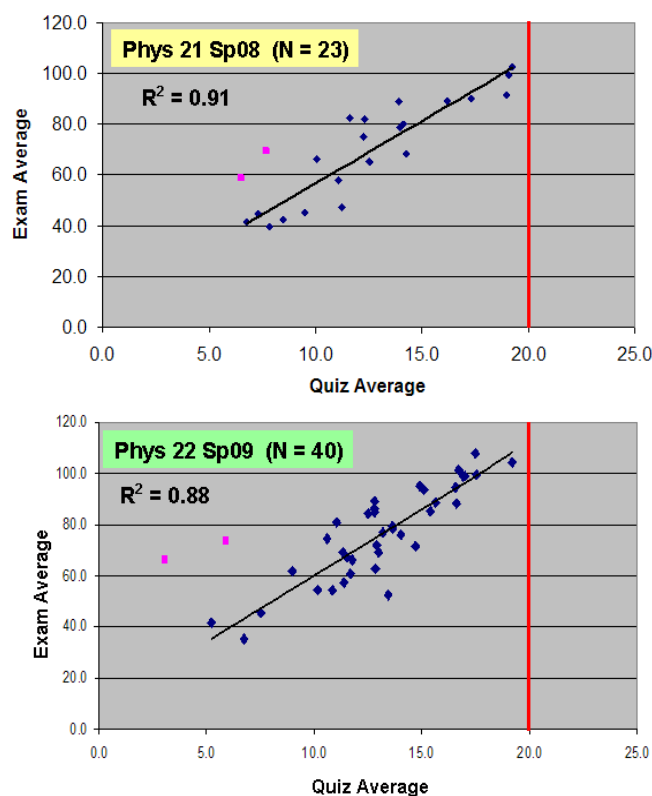

Figure 3. Correlation between quiz grades and exam grades in the Phys 21 and Phys 22 classes. The maximum score on each weekly quiz is 20 points (indicated by the red marker). The pink data points have been omitted from the linear fit, due to the large number of quiz absences for those students.

Results

We have several semesters of data for the Phys 21 class to assess the effectiveness of the SCALE-UP pedagogy at GWU. To monitor conceptual understanding, we have acquired data on the Force Concept Inventory (FCI) [9] in all semesters. In addition, we have used the Colorado Learning Attitudes about Science Survey (CLASS) [10] to examine student attitudes (not shown in the current paper). In two specific semesters of our SCALE-UP deployment (Spring 2008 and Spring 2011), we had a large (concurrent) conventional lecture section take the same assessments for comparison purposes, including common in-class exams (*i.e.* consistent between the sections in the same year, but different between 2008 and 2011). The results of the in-class exams are shown in the tables below.

Phys 21 (Spring 2008)	Exam #1	Exam #2	Final Exam
Standard Lecture (Sec. 10 — N = 50)	63.0	62.4	55.0
Bio-focused SCALE-UP (Sec. 11 — N = 14)	81.0	70.5	60.3
SCALE-UP (Sec. 12 — N = 23)	70.0	72.9	64.0

Phys 21 (Spring 2011)	Exam #1	Exam #2	Final Exam
Standard Lecture (Sec. 10 — N = 120)	68.2	61.8	68.1
Bio-focused SCALE-UP (Sec. 11 — N = 19)	77.2	75.8	81.6
SCALE-UP (Sec. 12 — N = 29)	76.9	71.5	72.4

Both of the SCALE-UP classes (Secs. 11 and 12) exceeded the exam performance of the conventional lecture section (Sec. 10) in all cases. Since the bio-focused class in Sec. 11 (aimed primarily at biomedical engineers and biophysics majors) had additional biological content in the course and in their exams, a more direct comparison can be made between Secs. 10 and 12. It can be seen that the SCALE-UP section had an exam average approximately 8-10 points higher than the corresponding lecture section in most cases.

It should be noted that, to the best of our knowledge, students did not “self-select” the SCALE-UP section over the conventional lecture section. That is, the former did not have “better” students than the latter, based on enrollment data. A review of the overall university academic grade averages of the SCALE-UP students indicated the same range of overall academic performance as for the conventional lecture students.

The Force Concept Inventory (FCI) [9] has been given to the Phys 21 classes in each semester to gauge conceptual understanding. The composite FCI results for seven semesters are shown in Figure 4 below.

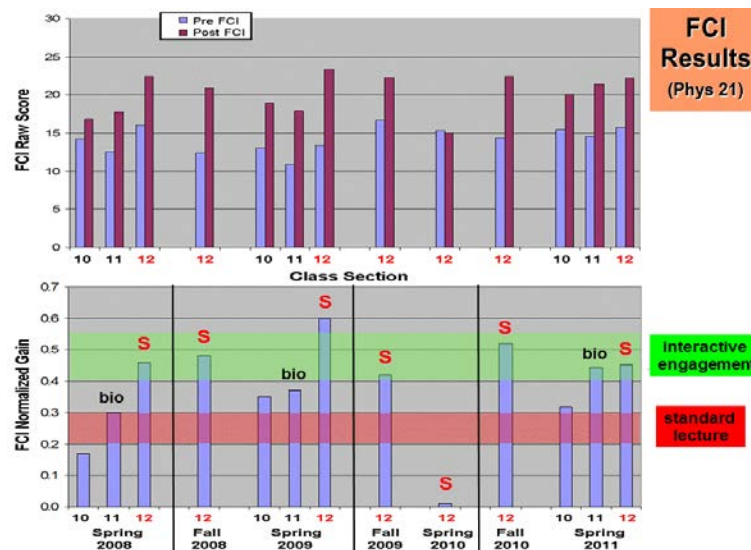

Figure 4. Results from the FCI for seven semesters of Phys 21. The top panel shows pre/post test scores; the bottom panel shows normalized gains. The SCALE-UP sections are indicated by a red “S”; the bio-focused sections are indicated by “bio”.

The top panel shows the pre- and post-test scores, where the maximum score is 30. The bottom panel shows the normalized gain $\langle g \rangle$ defined by Hake [11], such that $\langle g \rangle = \frac{post - pre}{30 - pre}$. Also shown is Hake's estimate of a range indicative of interactive engagement classes (the green band, for $\langle g \rangle = 0.40 - 0.55$) as compared to conventional lecture classes (the red band, for $\langle g \rangle = 0.20 - 0.30$). It is evident that the SCALE-UP classes (marked with a red "S") are performing very well, although the bio-focused SCALE-UP classes (marked by "bio") seemed to require a few semesters before reaching the interactive engagement level. All of the SCALE-UP classes are showing gains well into the interactive engagement domain (green band), with the exception of Spring 2010 when the delivery of the FCI post-test was not allocated sufficient time for completion.

One of our primary objectives in the introductory class is the enhancement of problem-solving skills. In the Spring 2011 semester, we tried a new assessment tool that is being developed by Marx and Cummings [12] to target this skill in particular. Their assessment includes 13 problems on force, energy and momentum, with increasing difficulty in each of these sectors. This is not a multiple-choice instrument – a numerical answer is required for the scoring rubric. The results of our trial are shown below:

Phys 21 (Spring 2011)	% correct	% wrong	% blank
Pre-test (N = 24)	29.2	29.5	41.3
Post-test (N = 24)	48.4	42.3	9.3

In the post-test, we see that fewer students left problems blank (a decrease of 32 percentage points), indicating an increased desire and ability to tackle the problems in the assessment. Out of that amount, 19.2 of those percentage points were correct answers and 12.8 of those percentage points were wrong answers, showing that about 2/3 of these new attempts were converted into correct answers. These results are very encouraging in terms of development of problem-solving skills and confidence in attempting to solve problems. Similar to the analysis used for the FCI, we have used the pre- and post-test scores to calculate a normalized gain $\langle g \rangle = \frac{post - pre}{100 - pre} = 0.27$ which seems to be fairly respectable given the advanced nature of the assessment instrument.

We also have data for assessments related to the second semester course, Phys 22. In this case, the standardized assessment that we used is the Conceptual Survey of Electricity and Magnetism (CSEM) developed by Maloney *et al.* [13]. Our results are compared to those of other institutions in Figure 5 below — our data have been added to the plot from Ref. [13] as the filled green circles. The pre-test and post-test scores are plotted on the x and y axes, and lines corresponding to various values of the normalized gain $\langle g \rangle$ are shown. Note that the four GWU semesters shown are fairly consistent with each other (this includes three different instructors) and that the gain values of 37% – 44% are among the highest values compared to other institutions.

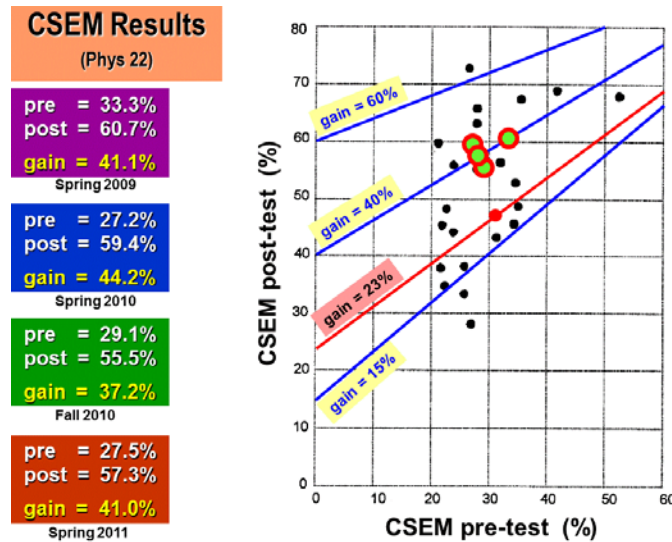

Figure 5. Results from the CSEM for Phys 22, compared to the results from other institutions [13]. The specific pre- and post-test scores (with the corresponding normalized gains) are shown on the left, and these results are plotted as the four green data points. Several different values of the normalized gain are shown as lines of constant slope.

Perspective

As a closing note, it is worthwhile to share some “impressions” from our direct experience in teaching the introductory physics classes utilizing the SCALE-UP pedagogy. Admittedly, the following comments are purely anecdotal, but at some level, the observations and intuition of the instructor have some validity in judging the effectiveness of an educational experience.

- SCALE-UP really squeezes the best out of students
- students work harder, but for greater rewards
- the student working groups actually gel into cohesive units
- the classroom atmosphere is much more dynamic
- instructors get to know the students better (and students know each other better)

In the end, after having experienced SCALE-UP at GWU over several iterations by now, there is one final comment about the approach — it is considerably more satisfying to be a “coach” rather than a lecturer, and the SCALE-UP pedagogy definitely affords that opportunity. Ultimately, this is much better for the instructor and certainly it is more beneficial for the students.

Summary

We have been using the SCALE-UP collaborative group-learning pedagogy for five years at GWU, which now encompasses all of our introductory physics classes, both calculus-based and algebra-based. While our data are not exhaustive, we have evidence that students are performing better in the SCALE-UP class than in a conventional lecture class. Student engagement is high in the SCALE-UP environment, and it seems that students gain a greater facility with the physics material in this collaborative mode compared to less interactive approaches.

Educational trends favoring more interactive engagement techniques have been gaining momentum in colleges and universities in the United States over the past decade. This sentiment concerning the shortcomings of the conventional lecture style of science education has recently been echoed by Eric Mazur in a short and incisive article appearing in a more mainstream forum, namely *Science* magazine [14].

We plan to continue developing our framework for delivering the SCALE-UP pedagogy in our physics classes, and we are working on disseminating the advantages of this approach to other science (biology/chemistry), mathematics, and engineering faculty members on our campus. It is clear that such collaborative techniques are transferable to these other disciplines, and we will continue to promote SCALE-UP as much as possible.

Acknowledgements

The authors gratefully acknowledge funding support from the National Science Foundation (United States) for portions of this work. Some travel support has also been provided by the Columbian College of Arts and Sciences and the Department of Physics at George Washington University.

References

- [1] McDermott L.C.: *American Journal of Physics* **69**, 1127 (2001).
- [2] Wilson J.: *The Physics Teacher* **32**, 518 (1994).
- [3] Beichner R. *et.al.*: “The Student-Centered Activities for Large Enrollment Undergraduate Programs (SCALE-UP) Project,” in *Research-Based Reform of University Physics*, edited by E.F. Redish and P.J. Cooney (American Association of Physics Teachers, College Park, 2007), *Reviews in PER* Vol. 1. Available from: <http://www.per-central.org/document/ServeFile.cfm?ID=4990>
- [4] The VPython web site is located at: <http://vpython.org>
- [5] The SCALE-UP web site is located at: <http://www.ncsu.edu/PER/scaleup.html>
- [6] The *MasteringPhysics* web site is located at: <http://www.masteringphysics.com>
- [7] Knight Randall D., *Physics for Scientists and Engineers: A Strategic Approach* (3rd edition), (Pearson Education, Inc., San Francisco, CA, 2013).
- [8] The Vernier Software and Technology web site is located at: <http://www.vernier.com>
- [9] Hestenes D., Wells M., Swackhamer G.: *The Physics Teacher* **30**, 141 (1992) and Hestenes D., Halloun I.: *The Physics Teacher* **33**, 502 (1994).
- [10] Adams W.K. *et.al.*: *Physical Review Special Topics in Physics Education Research* **2**, 010101 (2006).
- [11] Hake R.R.: *American Journal of Physics* **66**, 64 (1998).
- [12] Marx J., Cummings K.: *Proceedings of Physics Education Research Conference PERC 2010*, pp. 221-224 (2010). See also PERC 2010, pp. 113-116.
- [13] Maloney D.P., O’Kuma T.L., Hieggelke C.J., Heuvelen A.Van: *American Journal of Physics Supplement* **69** (Phys. Educ. Res.), S12 (2001).
- [14] Mazur E.: “Farewell, Lecture?”, *Science*, Vol. 323, p. 50 (2009) and references therein.

Practice and Effectiveness of Peer Instruction in Chinese Introductory Physics Course

Xiumei Feng, Lixia Feng

School of Physical Science and Technology, Central China Normal University, Wuhan, China

Abstract

Peer Instruction (PI), always with Class Voting System, has been developed in the international physics teaching community for more than 20 years. Its effectiveness in increasing students' engagement and comprehension is being tested in various backgrounds. In our introductory physics teaching, peer discussion was adopted when correct percent of individual answers to the ConcepTests was lower than 70% in the first round voting. Students were asked to revote the same question again after discussion. These two round voting results were compared to show how they learn from peer discussion. Meanwhile two exams including multiple choice and conventional problem solving questions were used to test students' learning gains. A questionnaire was used to get students' learning experience and attitudes on Peer Instruction. Our preliminary results illustrate students in PI class are willing to spend more time on physics and understand physics concepts better than traditional lecture classes. However PI students don't show much more advantages in traditional problem solving skill. More incentives or helps are needed to motivate a few passive students to attend peer instruction.

Keywords: Peer Instruction, Clicker System, active learning, introductory physics teaching

Introduction to Peer Instruction

Traditional lectures in large enrollment college physics classes have been criticized for many years because of their low effectiveness in increasing student engagement and comprehension. Recently many interactive teaching methods, such as Tutorial, SCALE-UP, Real Time Physics, Workshop Physics, Interactive Lecture Demonstration (ILD), and Physics by inquiry etc, have been developed and highly recommended due to their higher teaching effectiveness [1].

Among them, Peer Instruction [2], developed by Harvard physics professor Eric Mazur, is one of the most influential active pedagogies in college physics classes and regarded as more easily controllable for novice teachers compared with some other innovated teaching methods [3]. The basic goals of Peer Instruction are encouraging students actively participating in lectures and focusing students' attention on underlying concepts to narrow the gap between students' low ability in concept understanding and their relatively high ability in conventional problem solving observed by E. Mazur.

Peer Instruction includes two main new items absent in traditional lectures: Just in Time Teaching (JiTt, a kind of online Pre-class reading exercises) and peer discussion on ConcepTests (conceptual questions on being discussed topics in lectures). Students are usually required to finish the JiTt before each class. One typical lecture in Peer instruction is divided into several short presentations with separate key points. Every presentation is followed by one ConcepTests (in 5-6 minutes) or two on the subject being discussed. The format could be given as followed [2].

1. Question raised (~1 minute)
2. Students given time to ponder (~1 minute)

3. Students record their answers (optional)
4. Students convince their nearby peers (peer instruction, 1-2 minutes)
5. Students record revised answers (optional)
6. Students provide answers to teacher
7. Explanation of correct answer to class (~2 minutes)

If instructors want to get students' instant responses through Class Voting System and adjust the teaching pace accordingly, extra several minutes are needed in the above optional procedures. Peer discussion generally happened when the percentage of correct answer in the first round of voting is too low (less than 70%).

Peer Instruction has been implemented in large enrollment college physics classes for more than 20 years. Data collected in introductory physics classes of Harvard University during ten years suggest that Peer Instruction has increased student mastery of both conceptual reasoning and quantitative problem solving [2,4-5]. More evidences from instructors other developers indicate Peer Instruction improves students concept gains [6,7]. A couple of years ago Peer Instruction was introduced into a few Chinese introductory physics courses and students' much higher class attendance and improved concept understanding after peer discussion had been reported [8]. JiTT and peer discussion in Peer Instruction are considered to be beneficial to students' physics learning [9]. In this study we compare Peer Instruction and two control classes to discuss students' concept understanding and problem solving skill thoroughly through especially well designed tests.

Study Instruction

This research is based on data collected in our freshman level introductory physics course starting from February 2013 to June 2013. More than 300 students enrolled in this study major in mathematics in a four-year university. Students are randomly divided into three classes. One class was taught by a female teacher using Peer Instruction, and the other two (called control classes) were taught by one female and a male using the traditional didactic lecture method. These three instructors have similar years of teaching in introductory physics course.

The lectures were given 4 periods per week. The teaching content of each class was the same. Student textbooks were the template for course content and review problems. Other course structure variables, such as teaching schedule, homework, grading schemes and exams, were made the same during the whole semester.

In this semester the physics course mainly includes two topics, one is Mechanics and the other is Electromagnetism. Students were assessed by conventional examinations after each topic was finished. Four parts were covered in each test including blank-filling section, multiple-choice section, short-answer section and conventional problem solving section, which is the general test format in the authors' university. Blank-filling questions were mainly about simple quantitative questions and some definitions of physics concepts; Multiple-choice section was particularly designed to assess students' concept understanding. Short-answer questions were to test students' ability to explain descriptively some important physics formula or principles. Students' problem solving skill was tested by the conventional problem solving questions, which need multiple-step calculation with physics formula.

Pre-class textbook reading tasks were required in our Peer Instruction class in order to keep the same teaching pace as the control classes. Pre-class reading task, as suggested by E. Mazur, is the indispensable part of Peer Instruction to solve the tension of less class time for lecture presentation and more time spent on peer discussion [4].

We informed students our grading scheme of Peer Instruction in advance that only degree of participant in ConcepTests would be counted, no matter whether their answers were correct or not. Students didn't need to worry that their wrong answers in ConcepTests may affect their course grade in this kind of low stake course grading scheme [10]. Therefore they were willing to show their own real thoughts instead of just passively following the popular answers. In addition, if the percent of correct answers of ConcepTests was more than 70%, these questions would not be explained to all of class. So if they just follow the majority, they will lose the opportunity to get the explanation of these questions. Moreover, some ConcepTest-like questions would appear in tests to motivate students to response these questions seriously.

Meanwhile a questionnaire with some revision from Mazur' version [2, p.21] was adopted to collect students' views and their study experiences in Peer Instruction at the end of the semester. This questionnaire includes 7 open-ended questions as following:

1. Do you think in this introductory physics class there is something different from other classes?
2. Do you like or dislike them? Why?
3. Does peer discussion deepen your understanding on concepts? Why?
4. Does pre-class reading task improve the effectiveness of your learning physics? Why?
5. How many hours did you study physics outside of class per week? Does Peer Instruction motivate you to spend more time on studying physics?
6. Which methods do you recommend in order to improve your physics learning?
7. What do you want to change most in the physics class if you were the teacher?

Data analysis and results

1. Students' views and study experiences in Peer Instruction

Total 93 students responded to this questionnaire. Students' views about Peer Instruction in the introductory physics course were analyzed from their answers of the first four questions. About 97% thought it was different from other classes and more than 2/3 students liked the differences. But 1/6 didn't like with three reported reasons: 1) they didn't like reading textbooks by themselves, 2) they couldn't follow teaching paces, 3) they thought peer discussion wasted time.

More than 91% students agreed that peer discussion deepen their concept understanding. The typical answers are: "Explaining to others can help me clarify my vague ideas." "Neighbors help me find out where my misunderstanding is." "Discussions lead me to think the questions from different points of view." But about 8% disagreed because "We don't have enough time to discuss it deeply."

About 1/10 students didn't think pre-class reading tasks improved their learning effectiveness. Their views are the lecture presentation became boring if they understood the text content before class. Some others reported they couldn't grasp the point of content by themselves.

It's interesting to analyze students' study experience in Peer Instruction. One question about study time was posed as the fifth question showed above. Students' answers are shown in Table 1. Majority of students (77%) spent more time in physics after Peer Instruction was implemented.

Alternatively those who reported spending less time on physics thought peer discussion helped them clarify their misunderstanding of physics concepts. Therefore they didn't need spend more time on physics outside of class. Table 1 shows on average students spent about extra 4~5 hours outside of class on physics.

Table 1. Extra time on physics in Peer Instruction

Hours	More	Equal	Less
<2	5%	1%	1%
2~4	29%	4%	6%
4~7	38%	2%	8%
>=7	5%	0%	0%
Total	77%	7%	15%

2. Concept understanding

Percentages of correct answers by students to ConcepTests are always found much higher after peer discussion compared with before discussion, which can be easily observed in Figure 1.

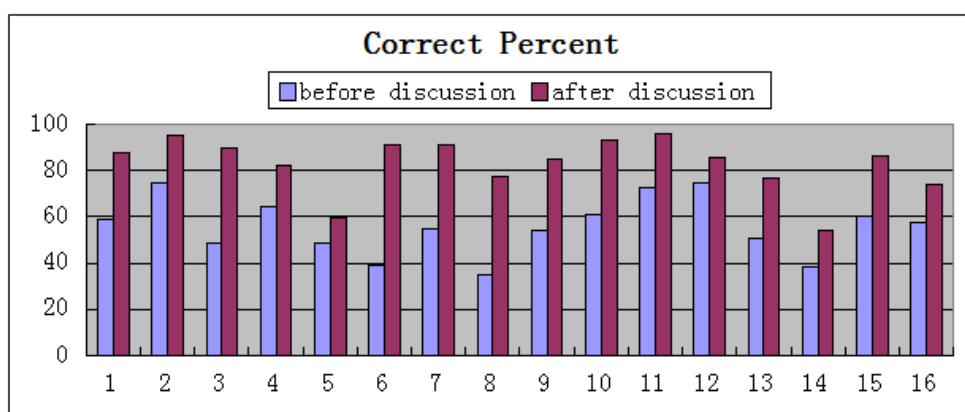

Figure 1. Correct percent of answers of all ConcepTests discussed in this semester

Does this really mean the improvement of students' concept understanding? Surely it is a key point every instructor cares in Peer Instruction. In order to figure out whether some students dominate the discussion and others are forced to follow their answers in peer discussion, we posed one ConcepTest (about the concept of energy storage of capacitor) again twelve days later in the recitation class at the end of that chapter.

Question: An air parallel-plate capacitor has a surface charge Q and $-Q$. A metal slab is inserted between the capacitor plates. Upon the insertion of the metal slab, the energy storage of the capacitor is:

- (A) Decreased, irrespective of the metal slab position.
- (B) Decreased and related to the position of the slab.
- (C) Increased, irrespective of the metal slab position.
- (D) Increased and related to the position of the slab.



In Figure 2 the percent of correct answers was 51% in students' first round of voting (denoted as "vote 1"). After instant discussion the correct percent increased about 26% to 77% (denoted as "vote 2"). This discussion happened in the first teaching on the energy of the capacitor. Twelve days later, the percent increased from 60% ("vote 3") to 86% ("vote 4") after discussion. Though the instant discussion effectiveness is up by 26%, twelve days later students' comprehension decreased from 77% to 60%. Even though 10% more students (87 Students in the first discussion; 96 students in the second) responded to this question in the recitation class, we can't exclude the possibility that some students simply follow others' answers after peer discussion.

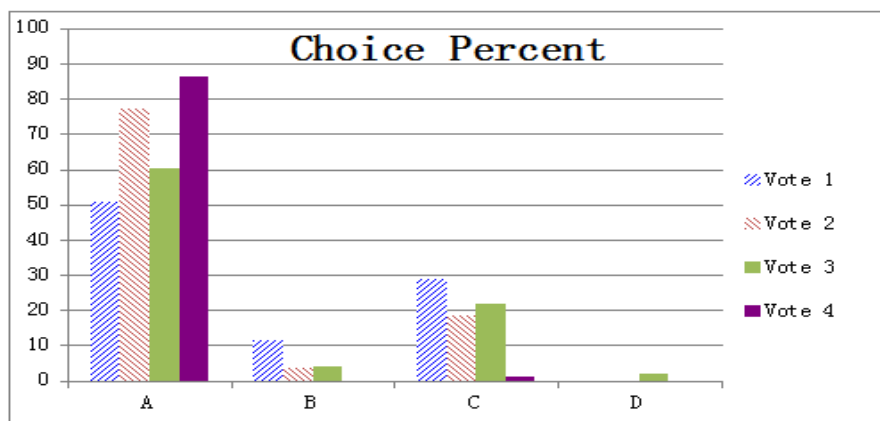

Figure 2. Students' answers to one ConcepTest

However when a ConcepTest-like multiple-choice-question was given in the final exam a month later, 90% PI students answered correctly vs. about 80% in the other two classes. The difference is statistically significant ($p < 0.05$). In fact the statistically significant differences appear not only in this question, but in scores of multiple-choice parts of these two tests between PI class and the two control classes, which can be seen clearly in Table 2.

Table 2. Test results of Mechanics and E&M^a

	Mechanics test							E&M test						
	No.	Total		Multi. Choice		Prob. solving		No.	Total		Multiple choice		Prob. Solving	
		score	p	Score	p	Score	p		Score	p	Score	p	score	p
PI	122	77%	-	85%	-	79%	-	123	65%	-	71%	-	71%	-
Tradition1	106	78%	0.66	77%	0.00**	83%	0.15	105	59%	0.02*	61%	0.00**	63%	0.10
Tradition2	123	78%	0.58	80%	0.02*	81%	0.44	125	63%	0.34	64%	0.00**	70%	0.85

^a Each test includes four parts, that is, blank-filling section, multiple-choice section, short-answer section and conventional problem solving section. Here we choose the scores in multiple-choice and problem-solving sections to analyze students' concept understanding and problem solving skills. The percents in Table 2 are from the ratios of students' mean score over the total score of this section. P values represent statistical differences between PI and each traditional class. Star mark (*) represents $p < 0.05$, double star mark (**) represents $P < 0.01$.

3. Problem solving skill

Traditional problem solving questions were used to test students' problem solving ability in these two tests. Data in Table 2 show no statistical differences in problem solving sections of these two tests between PI class and traditional ones. It means the implementation of Peer Instruction in our introductory courses didn't make considerable impact on students' traditional problem solving skill.

Conclusions

1. Students are interested in Peer Instruction

Most students like the method of Peer Instruction, especially the peer discussion according to the questionnaire. Students are always excited when their answers were quite different from each other. Then they were eager to figure out why other students' answers differed and to express their own opinions and convince their neighbors they were right. It is noted that the majority of PI students were willing to spend more time on physics.

2. Peer Instruction improves students' concept understanding

The great majority of students reported peer instruction deepens their understanding on physics. And this result was tested not only by the increase of the percent of correct answers after discussion, but the significant differences of mean scores of concept understanding in two tests. Michael et.al [11] analyzed evidences from learning science, cognitive science and educational psychology to support active learning, including Peer Instruction in improving students understanding.

3. Students' problem solving skill show no advantages in Peer Instruction

Our PI students didn't show noticeably higher level in traditional problem solving skill. In other words, students' better concept understanding doesn't lead to the increase of traditional problem solving skill under our teaching contexts. The only conclusion we can make is that more time on concepts in Peer Instruction doesn't impede students' problem solving skill. This result is in contrast to the previous research [4], which concludes students' conventional problem solving skill is improved in Peer Instruction regardless of being appraised by Mechanics Baseline Test (MBT) [12] or traditional final tests. Turpen & Finkelstein [13] think there are big variations in different Peer Instruction classes. For instance, whether teachers allocate students with wrong answers equal time to show their reasoning and respond to them can have an influence on the teaching results. These discrepancies may explain why learning results are various in different Peer Instruction classes.

Problems and Discussion

In the questionnaire, we found some students were not used to Peer Instruction, especially the pre-class reading task because they can't grasp the key points of the materials when they read them alone. They preferred teachers explain all materials in textbooks to them in detail. They were accustomed to sitting there, listening to teachers and taking notes without any pre-class preparation for a long time. However college students have to learn self-teaching under the help of instructors. To help students grasp materials better, for example, teachers can make an instructive list of key points, or use popular text and voice web communication tools such as MSN, Skype or QQ to facilitate the procedure of question asking and answering. More face-to-face interaction between teachers and students as well as one-to-one instruction by teaching assistant with students can also help.

References

- [1] Hake R. R.: Interactive Engagement versus Traditional Methods: A Six-thousand Student Survey of Mechanics Test Data for Introductory Physics Courses. *Am. J. Phys.*, 66(1) (Jan.1998): 64-74.

- [2] Mazur E.: Peer Instruction: A User's Manual. Prentice Hall. Upper Saddle River, N.J. 1997.
- [3] Nicol D. J., Boyle J. T.: Peer Instruction versus Class-wide Discussion in Large Classes: A Comparison of two Interaction Methods in the Wired Classroom. *Studies in Higher Education*, 29(4), (October 2003), p.457-373.
- [4] Crouch C. H., Mazur E.: Peer Instruction: Ten Years of Experience and Results. *Am. J.Phys.* 69(9), (September 2001), p.970-977.
- [5] Crouch C. H.: Peer Instruction: An interactive Approach for Large Lecture Classes. *Opt. Photonics News*, 9(9), (September 1998), p.37-41.
- [6] Lasry N., Mazur E., Watkins J.: Peer Instruction: from Harvard to the Two-year College. *Am. J. Phys.* 76(11), (2008), p.1066-1069.
- [7] Fagen A. P., Crouch C. H., Mazur E.: Peer Instruction: Results from a Range of Classrooms. *The Physics Teacher*, 40, (April 2002), p.206-209.
- [8] Zhang P., Tu Q., Zhou J. et.al: Study on Interactive Teaching in College Physics Class-Based on "Class Voting System" (in Chinese). *Chinese University Teaching*, (7), (July 2011), p.21-23.
- [9] Huang H.: Creative Teaching Model in Physics Class: JiTT and PI (in Chinese). *E-Education Research*. 228(4), (April 2012), p.89-94.
- [10] James M. C.: The Effect of Grading Incentive on Student Discourse in Peer Instruction. *Am. J. Phys.* 74(8), (August 2006), p.689-691.
- [11] Michael J.: Where is the Evidence that Active Learning Works? *Adv. Physical Educ.* Vol.30 (December 2006), p.159-167.
- [12] Hestenes D., Wells M.: A Mechanics Baseline Test, *Phys. Teach.* 30(3) (1992), p.159-166.
- [13] Turpen C., Finkelstein N.: Not All Interactive Engagement is the Same: Variations in Physics Professors' Implementation of Peer Instruction. *Phys. Rev. St Phys. Educ.Res.* 5(2) (2009), p.020101-1~18.

Student's Video Production as Formative Assessment

Eduardo Gama¹, Marta F. Barroso²

¹ Colégio Pedro II, Rio de Janeiro, Brazil

² Universidade Federal do Rio de Janeiro, Physics Institute, Rio de Janeiro, Brazil

Abstract

Learning assessments are subject of discussion both in their theoretical and practical approaches. The process of measuring learning in physics by high school students, either qualitatively or quantitatively, is one in which it should be possible to identify not only the concepts and contents students failed to achieve but also the reasons for the failure. We propose that students' video production offers a very effective formative assessment tool to teachers: as a formative assessment, it produces information that allows the understanding of where and when the learning process succeeded or failed, of identifying, as a subject or as a group, the deficiencies or misunderstandings related to the theme under analysis and their interpretation by students, and it provides also a different kind of assessment, related to some other life skills, such as ability to carry on a project till its conclusion and to work cooperatively. In this paper, we describe the use of videos produced by high school students as an assessment resource. The students were asked to prepare a short video, which was then presented to the whole group and discussed. The videos reveal aspects of students' difficulties that usually do not appear in formal assessments such as tests and questionnaires. After the use of the videos as a component of classroom assessments and the use of the discussions to rethink learning activities in the group, the videos were analysed and classified in various categories. This analysis showed a strong correlation between the technical quality of the video and the content quality of the students' argumentation. Also, it was shown that the students do not prepare their video based on quick and easy production; they usually choose forms of video production that require careful planning and implementation, and this reflects directly on the overall quality of the video and of the learning process.

Keywords: assessment and evaluation, video production, learning physics, physics education

Introduction

Teaching and learning – to find out if the connection was made it is necessary to assess learning. In most cases, teachers do not think extensively about how the assess learning; they basically do what they have previously experienced.

But assessment can be a fundamental tool in the learning process. If taken as a formative assessment tool [1], it is possible to retrace steps in teaching, to rethink classroom activities and developments, therefore improving the learning capabilities of the students.

In general, the teaching process does not aim uniquely at content subject learning. It involves skills related to the interaction with peers, with autonomy and intellectual independence, and somehow with the completion of projects and actions, as happens in real life. But assessments in general do not take these complementary and important aspects into account. It is very difficult to develop an assessment action with pencil and paper within a limited period of time.

This paper presents an activity used as a formative assessment tool in high school physics education. The students were asked, after formal instruction, to produce a short video on one of the themes studied during term. They have to work in groups, and also write the conception and production mechanisms of the video.

After the videos were produced, the teacher watches all of them and prepares a video presentation and discussion session. The discussion includes all the students, and the process grades the student with a small part of the final grade.

The posterior analysis of the videos reveal what was an unexpected product of the activity: they produce a fine assessment tool, for they reveal some aspects which cannot be easily assessed in content learning. The videos were analysed in a series of aspects, and the results allow us to conclude that video production by high school students can be used with good results to assess learning.

Preliminary considerations

The new information and communication technology has profound impact on young students. They deal with music, videos, and communication in new ways that are mostly not present at school activities.

The accessibility of mobile phones, tablets, and video cameras to almost every house, even in not rich regions over the world, poses some new possibilities to physics teaching. One of them is the use video production in classrooms. According to Vonk [2]:

“Like it or not, we seem to be using video in almost exactly the same way that we have used writing. And like it or not, a video analog has saddled up next to virtually every form of writing known, except in academia, where most professors I know are still requiring only written work.”

The use of videos in classroom has been subject of many discussions. One of the most interesting ones is related to the use as an approach to laboratory experiments [3].

But there is another possibility, related to learning assessments. The definition of learning is related to the complex construct of understanding. To have a measurement of understanding, an operational definition of it is necessary – and any operational definition needs to be broad enough so that the concept of learning and understanding is not restricted to answering a few simple questions on concepts, or solving some standard exercises, or completing some preordered activity. According to White and Gunstone [4]:

“We contend that assessment in schools is too often narrow in range. The oral questions that teachers ask in class and their informal and formal written tests usually are confined to requiring short answers of a word or two or a number, a choice from a few alternatives, or ‘essays’ of various lengths. While there is nothing wrong with these tests, they are limited in type. Limited tests provide a limited measure of understanding, and, worse, promote limited understanding. We advocate use of diverse probes of understanding as an effective means of promoting high quality learning.” (p. vii)

In particular, when it comes to formative assessment, that is, the assessment during the course, which is intended to diagnose the comprehension of the themes, the progress the students are making, and with that have some tools to reorganize students' learning and teaching activities, video production is a very interesting tool.

In making a video, students have to access their cognitive resources and define the strategies that allow them to fulfill what was asked by the teacher. This activity has some meta-cognitive characteristics, for it makes the students think about their actions, planning

and replanning them, trying different language forms till they find the appropriate one, recognizing and overcoming their limitations in the process of production. It is an assessment tool for the teacher, and much more than that: it is a learning resource, complementing the ones used by teachers. Also, the aspect of socialization between the students, provided by the audiovisual format, can provide new questions, new difficulties and reveal aspects of concepts and contents that were not clear.

Another characteristic of video production by students is that it can be thought as a means of acquiring meaningful learning in the sense of Ausubel's theory [5]. According to it, any new information has to interact with a previous information already present in the cognitive structure of the student. The teacher needs to know what his students know, so that he can provide activities that allow the assimilation and reorganization of their cognitive structure. In producing a video on a physics theme, the students have to access their cognitive resources frequently; the production implies a resignification of concepts and reorganization of the cognitive structure, specially when students have to work collaboratively. Also, it is easier for the teacher to evaluate if learning was mechanical. This evaluation occurs in three occasions: during video production, when students ask the teacher for help, during the analysis of the video by the teacher, and in the classroom discussion of all the videos, when the students have to interact with other groups.

Description of the assessment process with the students

The use of video production by students as an assessment tool took place in a high school in Rio de Janeiro. This school, Colégio Pedro II, named after the second and last emperor of the country, is one of the federal and traditional institutions of basic education in Brazil. The mechanism by which students are accepted in this school is chance, and this means that classes have a multicultural and multieconomic profile.

The themes in physics studied presented to students in high school first year (14-15 years) were geometrical optics and heat, in second year (15-16 years) introductory mechanics, and third year (16-17 years) electricity, oscillations and waves, and sound.

The teacher has some concepts to explore every term, discussed in the physics team of teachers. The presentation of the themes is mainly done in traditional ways: classroom activities based on lecturing, exercises, videos and discussions.

After the term (three months), the students were asked to produce a video that should be used as part of their grades on the term. They should gather into groups of no more than 5, chosen by themselves, and prepare a video on one of the subjects studied. There were no constraints other than the duration (between 1 and 10 minutes) and the character of being a presentation to colleagues. The format, the subject and the means were all their choice. And they should also write a short paper, of no more than 2 pages, describing what was produced, how it was produced, with a brief explanation of the physics involved.

The teacher collects and watches all the videos, and reads all the written texts. He or she presents comments and corrections to the written texts, and prepare comments and discussions on the videos. The analyses involve objective aspects like the technical format, the physics involved, and the connection between the proposal and the final video. Special care was taken the physical content of the theme.

Finally, there was a video session for the classroom. In this opportunity, the teacher uses every chance to improve the learning of the concepts and the interaction of the students with themselves and with physics.

The analysis of the videos

The videos were gathered and analysed. The aspects chosen for the analysis were related to the research question: is video production by students a reliable assessment tool?

With this in mind, the videos were analysed on three main categories: the physics content presented, the format chosen to present this content, and general aspects.

The content of the video regarded basically if the physics involved was correct, if the presentation was clear, if it was compatible with the proposal. The technical format was divided into the type used (a movie, a superposition of slides, an experiment, a cartoon, and some mixed types). The general aspects are related to questions like if the video showed internal logic and / or internal coherence and consistency, if there is an activity like an experiment to present some physics phenomena, if there was an explanation of the results of the experiment and about the quality of the argumentation.

In this paper, it is presented the results obtained with classes during the year of 2011. The use of videos was maintained in the years after, but the analysis is still going on. In Table 1, we present the global data of 2011: 55 videos were produced, and 232 students participate (131 female, 101 male), divided by year in school.

Table 1. The students involved and videos produced in each group

	videos	students
1 st year high school	12	55
2 nd year high school	22	98
3 rd year high school	19	75
missing	2	4
Total	55	232

In Table 2, we show the division of the videos on physics themes. One can notice that elementary dynamics is the content that most videos treat; and this can be seen by the majority of students in 2nd year students, and their main theme is introductory mechanics.

Table 2. The themes of the videos on introductory physics

dynamics	37 (67%)
geometrical optics	7
thermal physics	2
mechanical waves	3
electricity	1
waves and optics	2
contemporary issues	1
generalities	2

In connection to the assessment of the physical content, it was observed that 35% of the productions were correct and 45% were partially correct. Also, the physical ideas were presented clearly in almost half of the videos (47%), the connection between proposal and product was satisfactory in 75% of the videos, and there was a logical sequence in the videos in 87%; these data are shown in Tables 3 and 4.

Table 3. The videos analysed in connection to the physical content

The physical content is correct			The presentation is clear		
correct	19	35%	yes	26	47%
partially correct	25	45%	no	7	13%
incorrect	8	15%	partially	21	38%
not applicable	3	5%	not applicable	1	2%

Table 4. The general aspects of the analysed videos

There is a connection between proposal and product			There is a logical sequence		
yes	41	75%	yes	48	87%
no	3	5%	no	0	0%
partial	8	15%	partial	5	9%
not applicable	2	4%	not applicable	2	4%

The videos were presented in a series of formats; about 33% of them were movies, 27% were a combination of videos and slide presentations, and the rest was presented as a theatrical action scene, comics, only slide presentation in sequence, etc. Almost all of them (84%) used music, but of this use of music was just incidental, background (93%), and not part of the story.

It can also be noticed that although in only 22% of the videos the students prepared an experimental situation, there was some experiment shown in 64% of them, as presented in Table 5.

Table 5. The use of experiments in the images

There was preparation of experiment.			An experiment was filmed.		
yes	12	22%	yes	35	64%
no	43	78%	no	20	36%

The surprising aspect was the correlation observed between the technical quality of the video and the exactness of the physics discussed: only 7% were technically poor. 42% of

the videos were technically very well done; and from these, 90% were entirely conceptually correct.

What the videos reveal about learning physics

The videos provided a very useful assessment tool. The students were given the possibility of talking physics, and in it they revealed what it takes a long and hard way for the teachers to find out. In general, this kind of evaluation is only possible with long individual interviews, or carefully prepared (with the right questions) questionnaires.

As an example of a video with reveals difficulty in learning, a video can be mentioned, one called by the authors "Sports and Physics". The image of the video is a 100m man race, with U. Bolt winning. A small part of the words read can be cited:

"In an athletic race, the athlete shall keep his body upright while he completes the curve. (...) In this case, the centripetal force he produces while on the curve using the incline acts against the centrifugal force that sends him outwards."

In this example, the whole text presents many incorrect conceptions, and it can be noticed the confusion about concepts related with elementary dynamics (on inertial forces, centripetal acceleration, and third law). Also, this video is presented as a reproduction of TV news, technically careless in the production.

Another example shows what can be obtained: in a video named "Law of Gravity", a female student receives his exam graded zero, and a friend teaches her about gravity by rolling down the stairs. She says:

"What is gravity? According to Newton's law, not this Newton, Isaac Newton, gravity is the force of attraction that material bodies exert on one another. (...). Loosely speaking, it is the law of physics that hold things attached to Earth. It is what makes this happen."

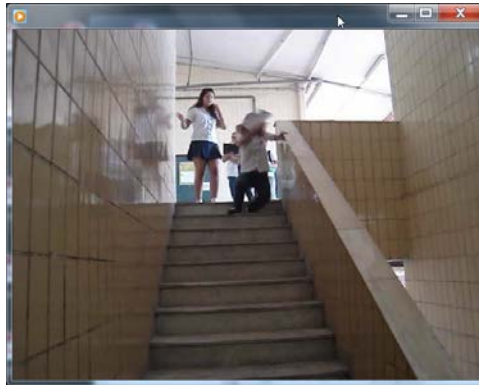

Figure 1. Law of Gravity

In this situation, it can be seen that the students are amusing themselves, and using a language that clearly corresponds to their age. They make a joke with one of the authors, named Newton, and with rolling down the stairs, as shown in Figure 1.

These examples, among many others, reveal aspects of physics learning and of how students considered the task of producing a video that can provide an interesting discussion in the classroom.

Conclusions

This paper proposes that the production of short physic videos is a very appropriate formative assessment tool.

The use of mobile phones, tablets and cameras are disseminated nowadays, and students do use them often. In school, the teachers are still reluctant to understand the possibilities of use of these tools as part of their teaching materials, as suggest by Vonk [2].

In fact, videos can be used for data collection in physics and in physics teaching. And can also provide a very useful assessment tool, another kind of probe as proposed by White and Gunstone [4].

The proposed activity is an extra class activity, producing a video and reporting its production. This activity requires more skills than just learning physics: requires cooperative team work, active participation of the students in their process of learning [5], and are related to the use of technology they are familiar with.

The videos allowed the teacher to check precisely how the students interpreted what he or she teaches, still in time to promote changes. The videos revealed how the students think about the topics, and surprisingly they seem to have spent time in preparing the videos. It was noticed that there is a strong correlation between the high technical quality and the quality of content.

The main conclusion is that the use of video production by students in physics high school classes is a possible and reliable formative assessment tool.

Acknowledgment

This work was done under Brazilian Grant from CAPES / Observatório da Educação.

References

- [1] Black P.: *Testing: Friend or Foe? The Theory and Practice of Assessment and Testing*. London: RoutledgeFalmer, 1998.
- [2] Vonk M.: *Video is the new writing: Are you literate?*. Physics Today 2012, available at http://www.physicstoday.org/daily_edition/points_of_view/video_is_the_new_writing_are_you_literate, accessed Feb22, 2012.
- [3] Pereira M. V., Barros S. S., Rezende Filho L. A. C., Fauth L. H. A.: *Audiovisual physics reports: students' video production as a strategy for the didactic laboratory*. Physics Education 47 44-51, 2012.
- [4] White R., Gunstone R.: *Probing Understanding*. London: Routledge and Falmers, 1992.
- [5] Ausubel D. P., Novak J. D., Hanesian H.: *Educational Psychology: A Cognitive View*. New York: Holt, Rinehart and Winston. 1978.

Considerations on the Possibilities of Cooperation Between the University and Schools: Reflections on Approaching the History and Philosophy of Science to the Physics Teaching

Sandra Regina Teodoro Gatti¹, Roberto Nardi²

¹UNESP/Departamento de Educação

²UNESP/Departamento de Educação

^{1,2}Support: CNPq – National Council for Research and Technological Development (Brazil)

Abstract

The research reported here sought to investigate the possibilities of a training program based on the establishment of collaborative work between University researchers and Physics teachers in a public school in a city located in the State of São Paulo, Brazil. From the results of previous research [1], in which we developed training activities with a group of Physics' teachers, we now developed activities that integrate the initial (prospective) and continuing (in-service) teachers. In this communication we present some reflections on the activities of supervised teaching developed by a student (pre-service teacher) taking the final year of the undergraduate program in Physics, held during the second semester of 2011. The study is centred on reflections about limits and possibilities of approaching History and Philosophy of Science to the classroom. Such activities were guided by the professor at the university and supervised and evaluated by a physics teacher in the high school, providing opportunities for collective moments of reflection on their teaching practices. The results show that the suggested model of training can contribute to break the dichotomy, i.e. the problem of the separation between the scientific and pedagogical training, allowing the future physics teachers actively participate in the internship, living experiences closer to the reality of schools, helping to integrate the processes of initial and continuing training.

Keywords: physics teaching; history and philosophy of science; physics teachers education

Introduction

The importance of education in all the challenges and uncertainties of our time leads us to a discussion in terms of reviewing the pedagogical practices adopted in our schools in order to improve the in-service teachers training needs.

In this sense, rethinking teacher education has proved one of the major demands of the present time, since research has shown that in teaching practices and school organizations, are practiced other theories, in general base on the common sense, not necessarily those produced by the results of the investigations of science education [2].

Several researches have focused on this topic, making important contributions on processes of pre and in-service teachers' education [3,4,5,6,7,8,9,10]. Such discussions converged to new positions, which sought to consider the role of "practice" in teaching, now under a new approach [11]. Some researches in this field led to a strand that proposes the "teacher" as a professional "reflective" [4,7,12].

In recent decades, the model of the reflective teacher suffered a lot of criticism, among them, that reflection to be undertaken by the lecturer does not cover a defined object,

tending to be restricted to immediate issues of classroom situations, ignoring the determining economic, social, political and cultural factors that influence the process of teaching and learning [6].

As a reaction to the technical and traditional model of reflective teacher, many authors prefer the idea of the teacher as a critical intellectual [6,7,10], since the process of critical reflection could allow teachers to advance in their process of transformation of pedagogical practice through its own transformation as critical intellectuals.

Another highlight of this research refers to the importance of collaborative work between the university and schools of Basic Education, seeking to break the barrier that exists between academic researchers and practicing teachers [13,14].

Thus, this research sought to investigate the possibilities of a collaborative work between university researchers and physics teachers on a public school in Brazil.

The main objective was to discuss the approach of history and philosophy of science to science teaching using activities that sought to integrate pre and in-service teachers training, The idea was to help their professional development, through reflections based on authors like the cited above in this study, in addition to investigate the impact of such an experience for the training and practice of teaching of the involved in this study.

History and Philosophy of science and science teaching

History and Philosophy of Science was used to support the discussions that permeate the entire proposal for this continuing education process of teachers. We believe that ignoring the historical dimension of science reinforces a distorted and fragmented vision of the scientific activity [15]. Specifically in the case of teachers' education, Scharmann (1988), cited in [16] concludes that the opportunity for future teachers to understand science as a process and content is a crucial aspect in teachers' training programs. This author points as probable problem the fact that the contents of undergraduate courses rarely present science as a process of construction and this problem could be accentuated by the nature of limitation or "cake recipes" of verification experiments conducted in university level didactical laboratories.

In research completed among Physics undergraduates, [17,18,19,20] some authors reveal the existence of distortions in the views of participants on some aspects of the nature of knowledge construction, such as the idea of Science as an encyclopedia of established facts, ignoring the social nature of its construction, the admission of divine intervention in the natural world, a vision of scientific models as copies of reality, and a picture of the cumulative knowledge.

This approach means an attempt to end the repetition of information that cannot be understood by students and begin to develop strategies and content to enable the student to conduct a cognitive work and be able to overcome some learning obstacles. [21].

Matthews [22] argues that the history and philosophy of science are incorporated into teaching as a way to: 1) contribute to humanize Science, revealing its personal, ethical, cultural and political character, 2) make lessons more interesting, 3) stimulate discussion and thinking and 4) overcoming the mere repetition of formulas and equations, often without meaning to students.

Furthermore, the need to introduce the philosophy of science in science education has been supported by several authors [22,23,24,25].

These purposes are summarized and organized by Aduriz-Bravo et.al [26], such as: 1) the need to discuss the role of science in the history of mankind and not merely the accumulation of scientific contents, with a profile encyclopedic, 2) the importance of theoretical reflection of Science, providing a more dynamic and complete, less prescriptive and dogmatic scientific activity, and the possibility of 3) contribute to a better understanding of scientific content themselves, functioning as assist in the processes of teaching and learning, curriculum development and even in the understanding and use of didactic models based on constructivism.

The discussion on the importance of developing visions on the Nature of Science has been widely punctuated by research, including its implications for teaching. [27].

In this sense, knowledge about the history and philosophy of science are of vital importance to a teaching that is inserted in one orientated socioconstructivist basis and intend to discuss and present an image of science more real, contextualized and less neutral [28].

Research Methodology

In this *case study* [29] presented here, the need to understand potential changes in posture of the participants before the processes of teaching and learning, and to investigate the limits and possibilities of the proposed training model, lead us to decide for a *qualitative methodology*.

Qualitative research, second Bogdan and Biklen [30], has the natural environment as a direct source of data and the justification for direct contact between the researcher and the situation where phenomena occur. So, in this kind of research it is assumed that human behavior is influenced by context.

Our goal in this study was to discuss the approximation of the History and Philosophy of Science of the classroom science through activities that sought to integrate the training and professional development of practicing teachers, according to comments made by the authors cited above in this paper. Thus, we investigated the impact that such an experience could have for training and practice of teaching involved in this process. That is, we seek to follow the process and investigate the trajectory formation also through the reflections of the participants.

So we contacted a group of future teachers who were attending the last year of the undergraduate program of physics during the second half of 2011. Three students (Fernanda, Patricia and Kelly) accepted the invitation to participate in the research. In a first step, we conducted a survey on the views of these participants about the processes of teaching and learning (using open questions questionnaires and *focus group* interviews), on the construction of scientific knowledge (questionnaire based on VOSTS [31]) and about their opinions about the limits and possibilities of the approach of the History and Philosophy of Science in Teaching (*focus group* interviews).

From the outcomes of this data we selected materials for reflection guided sessions. The idea was to hold meetings to study the approximation of the History and Philosophy of Science in education as a starting point for helping the future physics teachers to design a mini-course (a sequence of classes) to be taught in a public high school, in a supervised internship activity. In this school three in-service physics teachers, who had previously attended a course on this subject given by university researchers, agreed to receive these future physics teachers and guide and evaluate their activities.

Selected materials were sent by email to the future teachers so they could read before the meetings. The topics of the lessons to be developed at the high school would be negotiated with the high school teachers, avoiding that the activities could interfere in the normal progress of the contents they were teaching on that semester.

The brainstorming meetings with the pre-service teachers at the university were performed with the aim of reasoning development and reflection activities already recognized as extremely important for learning about science and its nature. [27].

In the first meeting happened the presentation of the project and it was taken a survey of the participants conceptions as mentioned before. The second meeting was devoted to the study of some aspects of the Philosophy of Science, for example, the approach on the differentiation between Myth and Scientific thinking, besides the main conceptions of science: Rationalist, Empiricist and Constructivist [32,33,34]. Afterwards it was discussed with the future teachers some papers written by contemporary philosophers of science [35,36], such as Kuhn, Popper and Lakatos. The aim was to discuss different models that explain how science is developed. In the third meeting the arguments for an approximation of the Philosophy of Science to the physics teaching were discussed [22,26,37].

Some Results

As Denise (high school teacher) eventually teaches Physics, but her initial training was in Chemistry, the teacher suggested that Fernanda (future physics teacher) should prepare a short course on Atomic Models. The proposal prepared by her was discussed with Denise and the professor (researcher) at the university.

We can consider that the work of the future teacher sought to incorporate some of the innovations discussed during the meetings held before at the university.

The planning was done in order to demonstrate the evolution of concepts, in addition to showing students notions historically developed similar to the views held by them in order to arising interest for the subject. The Philosophy of science was introduced seeking to focus scientific models, the construction of knowledge.

The plan arranged by the pre-service teacher (Fernanda) started with the discussion on the issue of models in science (she conducted a survey of students' conceptions about the topic before she starts the activities and used their results in class). The assessment of students proposed by her sought to elucidate till what point there was some evolution in the conceptions of students, both in relation to the concepts studied and in relation to the nature of science.

Fernanda Impressions:

At the end of the activities at the school, it was held another brainstorming meeting at the university. At this time, the future teacher brought us her impressions of the experience carried out, including her main difficulties.

Fernanda held in the school activities of observation and conducting classes. One of the issues that should be observed was the development of classes of Denise (high school teacher who had attended previously, in 2008, the project at the university). We wanted her to investigate if Denise keep including in her classes the discussions held during the course attended at the university in 2008. Fernanda made a narrative about the attempt of the high school teacher observed to insert some discussions on the history of science in her classes:

I realized that she tries to discuss with students some questions, trying to take a little matter about science under construction. But it happened so through isolated [...]. It seems there were a few strokes, you know? I talked to her about it and she said that in everyday life, with the activities and objectives to be met, it is difficult and you have to leave a lot [of intentions] out.

Again the reference appears to be the *Books of the Curriculum of the State of São Paulo* and the pressures to complete on time the program of activities and aspects that hinder the inclusion of activities that take into account more reflection about the construction of scientific knowledge.

Denise's impressions:

At the end of the stage done by Fernanda we conducted an interview with the High school teacher. Denise's participation was very intense. She helped proposing activities, offering support, suggesting other materials and guiding the future teacher.

The exchange of experiences is evident in Denise's speech; for example, when she reported the fact that she didn't know the resources available at the University of Colorado (www.phet.colorado.edu) and his desire to know them and use them in their classes .

With respect to the overall evaluation of the project, Denise says:

The classes developed structure of matter (evolution of atomic models) was well planned, considering the content covered, the methodology and the use of multimedia capability. Were very well covered the historical aspects of the development of different atomic models by different scientists in his time and the reasons that led them to develop different models of atoms. The representational aspect of atomic models to explain the theories about the structure of matter was well explored, making it clear to students that important aspect of science. The pre-service teacher had great aplomb, interacting well with high school students through questions and answers, demonstrating clarity, objectivity in the process of construction of knowledge addressed.

On the inclusion of aspects relating to the History and Philosophy of Science attend classes, the teacher reveals:

This aspect was well discussed, once the future physics teacher asked the students what they thought about the structure of matter throughout the ages, from ancient Greece to the philosophical speculations on the four elements' theory, evolving into the first atomistic scientific conceptions of chemical elements (eighteenth century), based on empiricism. (...).

Denise revealed in her speech the contributions of the approach of the History and Philosophy of Science in education, aspects that were discussed in the course held in 2008, which she attend at the university:

I think it's important to address historical and philosophical aspects in Science Teaching, since these approaches are ways of humanizing science, making clear to the student that science is a human construct that develops along the time. Scientific knowledge is built in different eras and historical and cultural contexts that must be considered and not just presented to students as something done.

Regarding the difficulties involved in this approach, Denise refers to the presentation of content in the books of the Curriculum of the State of São Paulo and the need to prepare students for the exam for university access and for ENEM (National High School Evaluation Exam), for example. To introduce history and philosophy of science would

require much more time. In addition, teachers also reported their need to seek for more knowledge on the subject.

Conclusions

In this research we seek to introduce the discussion on the approximation of the History and Philosophy of Science to the teaching of science in activities that sought to integrate the pre-service teachers' training and the professional development of in-service teachers. In this sense, the pre-service practicum stage is seen as an important space to articulate teaching, research and extension, allowing the development of partnerships between the university and the system of basic education¹, thus, contributing to the initial and continuing training of teachers.

The orientation of the stage of curricular training for pre-service teachers was conducted by researchers at the university, both professors of disciplines Methodology and Practice of Teaching and Supervised Stage. The monitoring was conducted by the Basic Education teacher, showing a real collaborative work, since it avoided a hierarchical relationship among pairs.

The training model suggested here can help to break the dichotomy, i.e., the problem of the separation between the scientific and pedagogical training, developed in undergraduate courses in a completely unrelated basis, allowing the future teacher actively participates in the this internship stage, living experiences closer to the reality of schools, helping to integrate the processes of initial and continuing training. This raises the need to extend the work of cooperation, seeking to involve more students and high school teachers, seen as partners and not as consumers of the results of research carried out in universities.

References

- [1] GATTI S. R. T.: *Práticas pedagógicas e processos formativos de professores de professores na área de ensino de Física: a inserção da História e Filosofia da Ciência no ensino*. Pos-phD (CNPq, grant 150398/2007-7). Pos-Doctoral Research Report. Faculdade de Ciências, UNESP, Bauru, 2008. Supervisor: Roberto Nardi).
- [2] PIMENTA S. G. (Org.): *Saberes pedagógicos e atividade docente*. 3.ed. São Paulo: Cortez, 2002. 246p.
- [3] NÓVOA A. (Org.): *Os professores e a sua formação*. Lisboa: Dom Quixote, 1992. 158p.
- [4] SCHÖN D. A.: *Educando o profissional reflexivo: um novo design para o ensino e a aprendizagem*. Porto Alegre: Artes Médicas, 2000. 256p.
- [5] GOODSON I.: Dar voz ao professor: as histórias de vida dos professores e o seu desenvolvimento profissional. In: NÓVOA, A. (Org.). *Vidas de professores*. Porto: Porto Editora, 1992, p. 63-78.
- [6] CONTRERAS J.: *La autonomía del profesorado*. Madrid: Morata, 1997. 231p.
- [7] GARCÍA C. M.: *Formação de professores: para uma mudança educativa*. Portugal: Porto Editora, 1999.

¹ Basic Education in Brazil refers to the education of students from early childhood up to completion of High School, before accessing the university level.

- [8] TARDIF M.: *Saberes docentes e formação profissional*. 4.ed. Petrópolis: Vozes, 2004. 325p.
- [9] HERNÁNDEZ et.al: *Aprendendo com as inovações nas escolas*. Porto Alegre: Artes Médicas Sul, 2000. 308p.
- [10] GIROUX H. A.: *Os professores como intelectuais: rumo a uma pedagogia crítica da aprendizagem*. Porto Alegre: Artes Médicas, 1997. 270p.
- [11] BASTOS F., NARDI R.: Debates recentes sobre formação de professores: considerações sobre contribuições da pesquisa acadêmica. In: BASTOS, F.; NARDI, R. (Org.). *Formação de Professores e Práticas Pedagógicas no Ensino de Ciências: contribuições da pesquisa na área*. São Paulo: Escrituras, 2008. 223p. (Educação para a ciência, 8). ISBN: 978-85-7531-315-2.
- [12] ALARCÃO I. (Org.): *Formação reflexiva de professores: estratégias de supervisão*. Porto: Porto Editora, 1996.
- [13] REZENDE F., OSTERMANN F.: A prática do professor e a pesquisa em Ensino de física: novos elementos para repensar essa relação. *Cad. Bras. Ens. Fís.*, v. 22, n. 3: p. 316-337, dez. 2005.
- [14] ZEICHNER K. M.: Para além da divisão entre professor-pesquisador e pesquisador acadêmico. In: GERALDI, C. M. G.; FIORENTINI, D.; PEREIRA, E. M. A. (Orgs.) *Cartografias do trabalho docente*. Campinas: Mercado de Letras, 1998.
- [15] CASTRO R. S. E., CARVALHO A. M. P.: The historic approach in teaching: analysis of an experience. *Science Education*, n.4, p. 65-85. 1995.
- [16] COCHRAN K. F., JONES L. L.: *The subject matter*. São Paulo: Brasiliense. 1993.
- [17] GATTI S. R. T.: *Análise de uma ação didática centrada na utilização da História da Ciência*. PhD thesis. Campinas: Faculdade de Educação da Unicamp. 2005.
- [18] GATTI S. R. T., NARDI R.: Práticas Pedagógicas de docentes de Física em exercício: concepções iniciais sobre o papel da História da Ciência no ensino e sobre alguns aspectos dos processos de ensino e aprendizagem. In: XVIII SNEF, 2009, Vitória/ES. *ANAIS...*, 2009.
- [19] GATTI S.T., NARDI R. E., SILVA D.: A História da Ciência na formação do professor de Física: subsídios para um curso sobre o tema atração gravitacional visando mudanças de posturas na ação docente. *Ciência & Educação*, v. 11, n. 3, p. 491-500, 2004.
- [20] GATTI S. T., NARDI R. E., SILVA D.: Evolução das concepções de futuros docentes de Física em um curso de formação inicial. (Comunicação). *Atas... XVII Simpósio Nacional de Ensino de Física*. Sociedade Brasileira de Física, UFMA, São Luís, Maranhão, 2007.
- [21] GAGLIARDI R.: Cómo utilizar la historia de las Ciencias en la enseñanza de las Ciencias. *Enseñanza de las Ciencias*, v.6, n.3, p. 291 – 296. 1988.
- [22] MATTHEWS M. R.: Historia, filosofía e enseñanza de las Ciencias: la aproximación actual. *Enseñanza de las Ciencias*, v.12, n.2, p. 255-271. 1994.
- [23] DRIVER R., LEACH J., MILLAR R., SCOTT P.: *Young people's images of science*. Bristol: Open University Press. 1996.

- [24] DUSCHL R.: Renovar la enseñanza de las ciencias. Importancia de las teorías y su desarrollo. Madrid: Narcea. (Ed. original en inglés, 1990). 1997.
- [25] IZQUIERDO M.: Fundamentos epistemológicos. In: Perales, F.J. y Cañal, P. (comps.). Didáctica de las ciencias experimentales. *Teoría y práctica de la enseñanza de las ciencias*, pp. 35-64. Alcoy: Marfil. 2000.
- [26] ADÚRIZ-BRAVO A., IZQUIERDO M., ESTANY A.: Una propuesta para estructurar la enseñanza de la Filosofía de la Ciencia para el profesorado de Ciencias en formación. *Enseñanza de Las Ciencias*, v. 20, n. 3, p. 465-476. 2002.
- [27] DENG F., Chen D. T., Tsai C. C., Tsai C. S.: Students' views of the nature of science: a critical review of research. *Science Education*, v. 95, 961-999.2011.
- [28] FURIÓ MAS C. J.: Tendencias actuales en la formación del profesorado de Ciencias. *Enseñanza de las Ciencias*, v. 12, n.2, p. 188-199. 1994.
- [29] YIN R. K.: *Estudo de caso – planejamento e métodos*. (2Ed.). Porto Alegre: Bookman. 2001.
- [30] BOGDAN R., BIKLEN S. K.: *Investigação qualitativa em educação: uma introdução à teoria e aos métodos*. Porto, Portugal: Editora Porto. 1994.
- [31] AIKENHEAD G. S., RYAN A. G.: Students' preconceptions about the epistemology of science. *Science Education*. v. 76, n. 6, 559 – 580. 1992.
- [32] CHALMERS A.: *O que Ciência afinal?* São Paulo. 1997.
- [33] CHAUI M.: *Convite à filosofia*. São Paulo: Ática. 2006.
- [34] OMNES R.: *Filosofia da Ciência Contemporânea*. São Paulo: Unesp Editora, 1994.
- [35] OSTERMANN F.: A epistemologia de Kuhn. *Cad. Cat. Ens. Fis*, v. 13, n. 3, p. 184-196. 1996.
- [36] SILVEIRA F. L.: A metodologia dos programas de pesquisa: a epistemologia de Imre Lakatos. *Cad. Cat. Ens. Fis.*, v. 13, n. 3, p. 219-230. 1996b.
- [37] MONK M., OSBORNE J.: Placing the History and Philosophy of Science on the curriculum: a model for development of Pedagogy. *Science Education*. v.81, n. 4, p. 405–424.1997.

Development of interest in particle physics as an effect of school events in an authentic setting

Kerstin Gedigk¹, Michael Kobel², Gesche Pospiech¹

¹Professur Didaktik der Physik, TU Dresden, Germany

²Institut für Kern- und Teilchenphysik, TU Dresden, Germany

Abstract

The Particle Physics Masterclasses are events offered by the “Netzwerk Teilchenwelt”, a German network of particle physicists, students and teachers with the intention to make original data from CERN available for own measurements of students. These events were evaluated in 2011/12. The investigation deals with their effect on the interest development of the youth participants, especially in particle physics. With a focus on the role of different event properties, it can be shown that besides the perceived challenge and comprehension, also authenticity is an important factor for the students’ interest development.

Keywords: interest, evaluation study, Masterclasses, particle physics

Introduction

The aim of physics education consists not only of teaching the physical contents, but also to a large extent of giving an insight into the process of physics research, into recent research topics and into the fundamental nature of physics and thereby developing the interest of students in physics. These objectives strongly correspond to the aims of the ‘Particle Physics Masterclasses’. But it is also well known that “investigations in different countries showed, that the interest in mathematics and in science subjects (...) in the secondary schools decreases” severely (cf. [8], p. 288). How masterclass events and especially the authentic setting of these events have an effect on this interest development of high school students is one of the main questions which should be answered by an evaluation study.

The “Netzwerk Teilchenwelt”

The so called “Particle Physics Masterclasses” are offered by the German “Netzwerk Teilchenwelt” (English: Network Particle World) including 24 German particle physics research institutes and CERN³. It is a network between scientists, high school students and teachers. It was founded in 2010 inspired by the “International Hands On Particle Physics Masterclasses”, with the idea, to open these appreciated annual events (see e.g. [6], p. 640) to more students, all over Germany and throughout the year. Another main concept to bring this network to life was to create a community in which interested students, teachers and particle physicists can be in an active exchange about particle physics, beyond just coming in contact with each other at a one-time event.

The network offers students and teachers the participation in 4 ascending levels. For the school students these different levels are shown in Figure 1. The Particle Physics

³ European Organization for Nuclear Resaerch (near Geneva/Switzerland)

Masterclasses themselves form the basic level of the program. If the students are interested in obtaining a deeper insight into particle physics beyond participation in a Masterclass they can join the higher levels. The possible activities range from transferring their knowledge about particle physics to conducting own research projects linked to (astro-) particle physics. For teachers a similar 4-level program is made available by the network. Further information about this network can be found at [4].

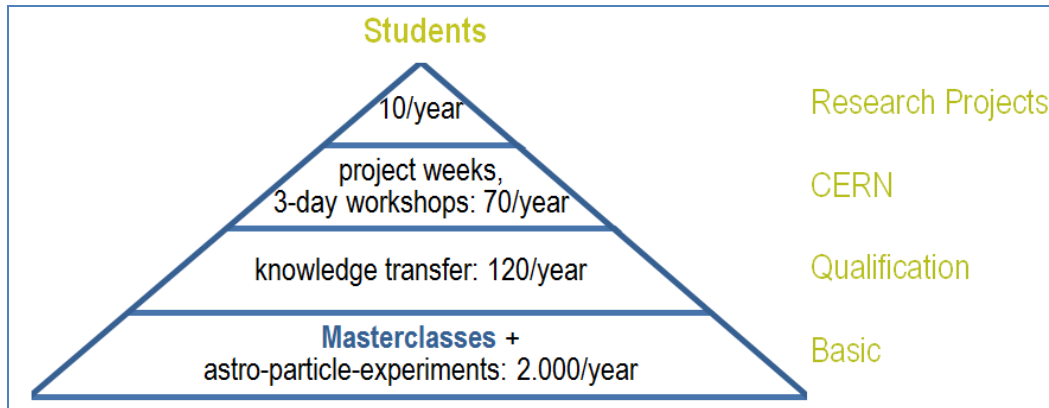

Figure 1. The 4-level programm of “Netzwerk Teilchenwelt”. At each level the typical number of participating students is given.

The Particle Physics Masterclasses

The Particle Physics Masterclasses mostly take place in schools and last between 4 to 6 hours. The facilitators of these events are in most cases young particle physicists, e.g. PhD. or Master students. During a Masterclass the scientists give an introduction into particle physics research, e.g. in the “Standard Model of Particle Physics”, how the research community works together, which questions should be answered by the actual research, etc. Afterwards the young participants get an introduction how to visually identify particles from their traces in the detector. After an introductory exercise the participants make own measurements with original data from CERN. The students work in pairs to classify 50 to 100 events into various categories. Then the results of the groups are combined and discussed. With statistical methods they arrive at fundamental results which can be compared with predictions of the “Standard Model of Particle Physics”.

There are two different kinds of data offered for the Particle Physics Masterclasses: one from CERN’s Large Electron Positron Collider (LEP), which was used from 1989 to 2000 and another from the Large Hadron Collider (LHC), which has been in operation since 2010 at CERN. More information about these measurements can be found at [1].

The aims of the Masterclasses and their authentic setting

The overarching aim of the Masterclasses is to give an insight into the actual particle physics research in an authentic setting. Another goal is to stimulate the interest of individual students to voluntarily join the higher levels of the network program. Although the Masterclasses take place in schools there are different factors which create an authentic learning environment for the participants. Besides the contact with real scientists there is also the measurement with original data from CERN and the work with graphical visualisation software, which is very close to the one used at CERN. Moreover, guided by the scientists, the students use similar methods to interpret and compare their results with the predictions within the Standard Model.

Research questions

In the evaluation study it is investigated, if the authentic setting of this one-day event is suitable to influence the interest of students: Are students' interests in physics as well as in particle physics fostered by a Masterclass participation? Can long-term effects be seen? Are there any differences noticed in the interest development between different participant groups (e.g. gender, age, type of school, etc.)? Which event properties are related to interest changes? Can factors be identified, which are crucial for a positive perception of the events? Moreover the evaluation study, which is presented below, makes it possible to say something about the increase in the participants' knowledge and to compare the Masterclasses' effects with results of other recent studies.

The evaluation study

The evaluation study mainly deals with the students' interest. The person-object-theory by Krapp creates the basis for the current investigation: "Interest designates a relationship of particular importance between a person and an object (...)" (cf. [7], p. 307). The more often and the more intensive a person deals with the object the more stable this relationship becomes. Furthermore, the development of this relationship also depends on the situation or the context in which the person is operating with the object (cf. [7], p. 308). In educational research there is an established distinction between the students' interest in the school subject „physics“ and in the special physical topics (e.g. cf. [5], p.19). For the special interests there are three different dimensions identified: the learning content, the context in which the content appears and the activities which can be connected to the topic (cf. [5], p. 26).

To measure changes in the students' interests the evaluation study is structured in a pre/ post/ follow-up design, which means that the participants were evaluated at the beginning, at the end of the Masterclass and again after a 6 to 8 week period. With the follow-up evaluation the sustainability of the Masterclasses can be investigated.

Description of the Questionnaires

Based on this theoretical basis and recent results on informal out-of-school learning environments (e.g. [3], [9]), the questionnaires were developed. Figure 2 shows a selection of variables.

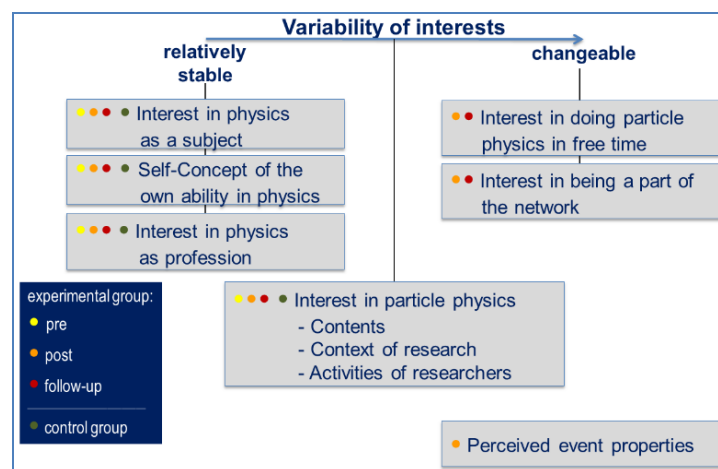

Figure 2. Selection of evaluated variables with the assumed stability

Because particle physics only plays a small role in the German school curricula, the special interest in this topic is assumed to be influenceable. For joining the higher levels in the network program beyond attending a Masterclass, the interest in doing particle physics in free time and in being a part of the network are the crucial variables.

Although the Self-Concept in physics does not directly belong to the interest variables, it is assumed to be relatively stable. Like the interest in physics as a subject and the interest in physics as profession it was created over several years of physics education.

For the questionnaires, which were piloted before, items with a 5-point Likert scale were used. Examples of the items and the computed internal-consistency coefficients (Cronbach's alpha) of the variables can be seen in the tables 3 and 4 in the annex.

Selected results of the study

The evaluation study was conducted from October 2011 until May 2012 in 25 Masterclasses with about 500 students ("experimental group"). Additionally a "control group" has been evaluated, i.e. high school students who did not take part in a Masterclass.

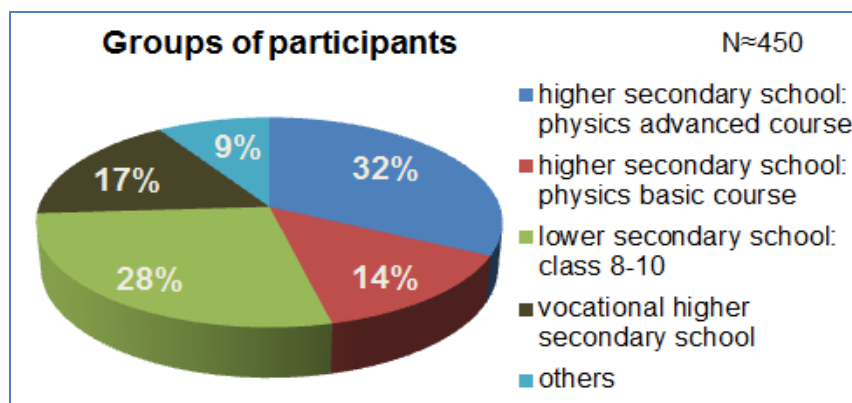

Figure 3. Participants of the experimental group

The "experimental group" consists of four main groups: students of the higher secondary schools (class 11 to 13) divided into the physics advanced and the physics basic course, students who visit the lower secondary school mainly in class 10 and older students who attend a vocational higher secondary school (see Figure 3). About 40 students of the experimental group attend another school form. Excluded were about 40 participants of the study, which already had attended a Masterclass before the evaluation. A fifth of the experimental group is female. The evaluation was conducted in 8 LEP- and 17 LHC-Masterclasses.

Comparisons between the experimental and the control group

For the comparison between the "experimental group" and the "control group" an analysis of variance with repeated measurements is used. Figure 4 shows selected results for participants attending class 10 of lower secondary schools- results of the higher classes are still under study. In these comparisons just students are included, who participated in a Masterclasses with their whole class, implying that the students in experimental group as well as in control group are not selected. Concerning these analyses of variance only the interaction effects between group and time are interesting, because these say something about the effect of the Masterclasses (cf. [10], p. 121). The separate effects of time and group on the mean are given only for information in the following figures.

For quantifying an effect size we calculate in a variance analysis the fraction η^2 of the total variance that is attributed to the effect (cf. [10], p. 115). For the interest in physics as subject the calculated effect size η^2 shows a small positive short-term effect but no long-term effect (cf. [2], p. 606). No effects whatsoever were seen for the class 10 students for the Self-Concept and the interest in physics as profession. The analysis of the amount of the students' interest in particle physics, e.g. in the contents (see Figure 4), show no short-term effects but small negative long-term effects. These developments correspond to the results of similar recent studies ([3], [9]). It is noteworthy that the experimental group shows significant higher interest values in the pre- and post-test, whereas in the follow-up test the values of both groups are similar. It seems that the prospect of participating in a Masterclass causes an increase in the students' physics interests even before they started.

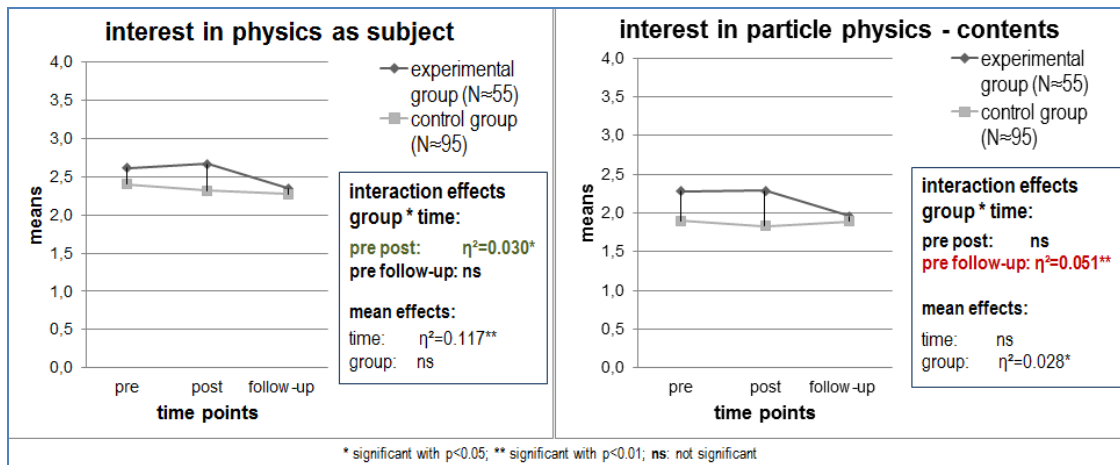

Figure 4. Analysis of variance with repeated measurements for the interest in physics as subject (left) and for the interest in the particle physics' contents (right) for classes 10

The influence of the perceived event features

How the Masterclass' participants perceive the events was also part of the evaluation of the "experimental group". An overview is represented in Figure 5. All features are very positively perceived: they are rated higher than 2 by most participants. The best rated feature is "support and atmosphere", which shows that the young facilitators are able to create an agreeable learning environment. The second best rated feature is "authenticity" which indicates that the authentic setting is noticed as such by the students.

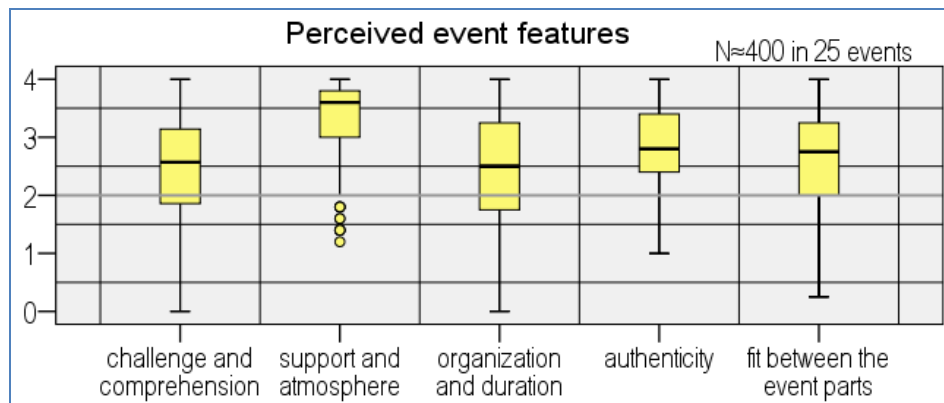

Figure 5. Masterclass' features as perceived by the "experimental group". The yellow boxes cover 50% of the students, the black lines cover 100%, dots are outliers.

Table 1 shows the influence of these perceived event features on the interests beyond the Masterclasses and the short- and long-term development of the particle physics’ interest dimensions (also see Figure 6). “Support and atmosphere” and the “fit between the event parts” are excluded from the regression analysis, because of occurring multicollinearity effects (cf. [10], p. 51-54). For determining the change of interests the difference of the interest values between the respective time points was used. The standardized regression coefficients show that “authenticity” has the most important influence on the short-term change of the interest in particle physics, “challenge and comprehension” on the long-term change and both of them are important for the interests beyond the Masterclass participation.

Table 1. Influence of perceived event features on students’ interests – Multiple regression: standardized regression coefficients

		Challenge and comprehension	Authenticity	Organization and duration
Change of interest in particle physics (pre – post) N≈365	Contents	0.13*	0.23**	ns
	Context of research	0.22**	0.25**	ns
	Activities of researchers	ns	0.19**	ns
Change of interest in particle physics (pre – follow-up) N≈280	Contents	0.16*	ns	ns
	Context of research	0.34**	ns	ns
	Activities of researchers	0.15*	ns	ns
Interest in doing particle physics in free time (post) N=381		0.32**	0.36**	0.11*
Interest in being a part of the network (post) N=375		0.32**	0.35**	ns

* significant with $p < 0.05$; **significant with $p < 0.01$; ns: not significant

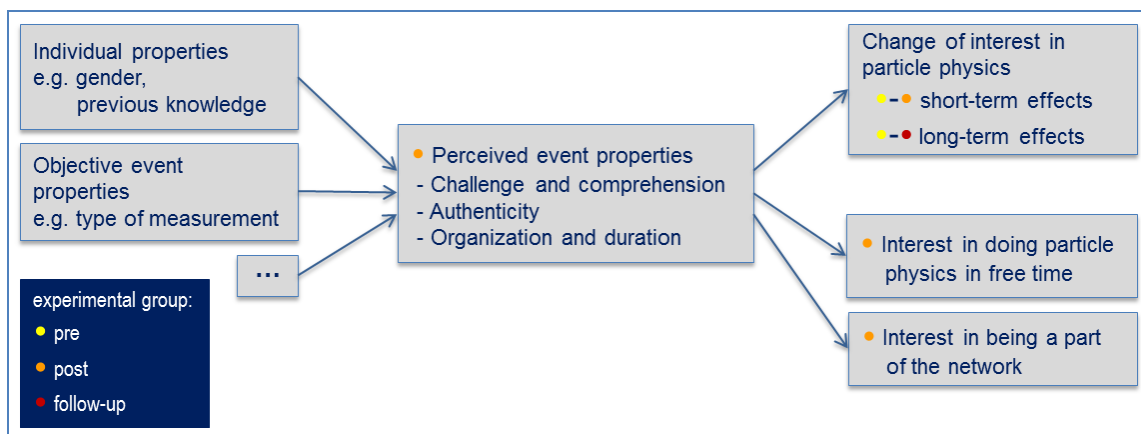

Figure 6. Influencing factors on perceived event features and their influence on interests

For deeper analysis we looked for possible influences on the perceived event features. On the one hand there are the individual properties of the students, which have an influence on the perception and on the other hand there are the objective event features (e.g. duration). Which of the selected factors shown in Figure 6 actually have an influence on the perceived event features is determined via Mann-Whitney-U-tests. Table 2 shows the corresponding results with the related effect sizes Cohen’s d. It is defined as the difference

between two means divided by the square root of their average variance (cf. [2], p. 606). The gender of the participants causes a medium effect size (cf. [2], p. 606) on both of the relevant features. Males rate the perceived features better than females. Furthermore, students with a higher prior knowledge in particle physics show a more positive rating of “challenge and comprehension” with a medium effect size and of “authenticity” with a small effect size. For the type of the measurement there is only a recognizable effect on “challenge and comprehension”. This is not surprising, due to the fact that the LHC measurements are more difficult in comparison to the LEP measurements.

Table 2. Selected factors influencing the relevant perceived event properties

*significant difference between the groups (t-test and U-test) with $p < 0.05$;

**significant difference between the groups (t-test and U-test) with $p < 0.01$;

ns: not significant

		N	Challenge and comprehension			Authenticity		
			Mean	Standard deviation	Cohen's d	Mean	Standard deviation	Cohen's d
Gender	Female	≈ 80	2.17	0.85	0.52**	2.62	0.62	0.40**
	Male	≈ 310	2.61	0.83		2.89	0.67	
Prior knowledge	Little	≈ 210	2.28	0.82	0.66**	2.76	0.65	0.22*
	Medium to high	≈ 180	2.81	0.80		2.91	0.67	
Type of measurement	LHC	≈ 255	2.35	0.87	0.69**	2.80	0.66	ns
	LEP	≈ 120	2.91	0.73		2.92	0.68	

Conclusions and outlook

The participants' assessment via the perceived event features indicates that the Particle Physics Masterclasses are much appreciated by the students (cf. Figure 5). The comparison of the physics interests between “experimental group” and “control group” in class 10 shows a larger interest of the Masterclass' participants at the pre-test time. This difference disappears over the 6 to 8 week period. This corresponds to the expectation that one-time events like Masterclasses have only short-term effects on the students' interests. Recent studies of other one-time events show similar results (e.g. [3], [9]). It implicates the question, if such interest differences appear for all the groups of Masterclass' participants (cf. Figure. 3), which are still under study. Another question is to find a more detailed explanation for this interest difference between “experimental” and “control group”.

The investigation of the influence of the perceived event features shows that “authenticity” as well as “challenge and comprehension” are important properties. Some selected factors which are influencing these perceived event features were illustrated. The effect of the participants' prior knowledge in particle physics, might indicate that a specific preparation of the event in physics lessons could be helpful. Especially concerning the objective event features there should be further factors identified, which have an influence on the perceived event features and thus consequently could improve the effect of the Masterclasses.

References

- [1] Bilow U., Jende K., Kobel M., Pospiech G.: Das Konzept „Masterclass“ – Schüler beschäftigen sich mit dem LHC. In: Praxis der Naturwissenschaften – Physik in der Schule, 60/ 2, p. 22-28, (2011).
- [2] Bortz J., Döring N.: Forschungsmethoden und Evaluation. Springer Verlag. Heidelberg, (2006).
- [3] Engeln K.: Schülerlabors: authentische, aktivierende Lernumgebung als Möglichkeit, Interesse an Naturwissenschaft und Technik zu wecken. Logos-Verlag. Berlin, (2004).
- [4] Gedigk K., Glück A., Kobel M.: Netzwerk Teilchenwelt – Ein mobiler Lernort für Teilchenphysik. In: Praxis der Naturwissenschaften – Physik in der Schule, 60/ 2, p. 29-33, (2011).
- [5] Hoffman L., Häußler P., Lehrke M.: Die IPN-Interessenstudie. IPN, Kiel, (1998).
- [6] Johansson K. E., Kobel M., Hillebrandt D., Engeln K., Euler M.: European particle physics masterclasses make students into scientists for a day. In: Physics Education. Volume 42, Number 6, p. 636-644, (2007).
- [7] Krapp A.: Das Interessenkonstrukt. In: Krapp A., Prenzel M. (eds.): Interesse, Lernen, Leistung. p. 297-329. Münster, (1992).
- [8] Krapp A.: Interesse. In: Rost D.H. (ed.): Handwörterbuch Pädagogische Psychologie. p. 280-290. Beltz Verlag. Weinheim, (2006).
- [9] Pawek C.: Schülerlabore als interessefördernde außerschulische Lernumgebung für Schülerinnen und Schüler aus der Mittel- und Oberstufe. Dissertation. Christian-Albrechts-Universität zu Kiel, (2009).
- [10] Rudolf M., Müller J.: Multivariate Verfahren. Hogrefe Verlag. Göttingen, (2012).

Annex

Table 3. The relatively stable and the changeable interest variables (answer options: (0) I totally disagree - (4) I totally agree)

Variable	Examples for Items	Number of Items	Cronbach's α
Interest in physics as subject	I enjoy physics lessons.	4 Items	$\alpha = .861$
Self-Concept in physics	I don't have talent for physics.	4 Items	$\alpha = .880$
Interest in physics as profession	I can imagine to work in a profession, which has something to do with physics	4 Items	$\alpha = .914$
Interest in doing particle physics in free time	I will spend more free time on particle physics.	4 Items	$\alpha = .862$
Interest in being a part of the network	I plan to get involved in the „Network Particle World“.	6 Items	$\alpha = .898$

Table 4. The different particle physics interest dimensions (answer options: my interest is (0) very low - (4) very big) and of the perceived event features (answer options: (0) I totally disagree - (4) I totally agree)

Variable	Dimensions	Examples for Items	Number of Items	Cronbach's α
Interest in particle physics	Contents	what are the fundamental building blocks of matter; what really is the „Higgs“	6 Items	$\alpha = .881$
	Context of research	how research at CERN is organized; which phenomena scientists still can't explain	7 Items	$\alpha = .835$
	Activities of researchers	how physicists at CERN discuss measurement results; how experiments at CERN are performed	5 Items	$\alpha = .877$
Perceived event features	Challenge and comprehension	The introductory presentation was too complicated for me; The aim of the measurement was clear to me.	7 Items	$\alpha = .886$
	Support and atmosphere	I liked the working atmosphere during the measurement; I felt that the tutors were helpful.	5 Items	$\alpha = .846$
	Authenticity	I got a feeling, how research is conducted. Today I learnt something about the aims of physical research.	5 Items	$\alpha = .786$
	Organization and duration	The introductory presentation took too long for me; I would have liked to identify fewer events during the measurement.	4 Items	$\alpha = .774$
	Fit between the event parts	I felt prepared for the measurement through the event identification exercise.	4 Items	$\alpha = .826$

A guided inquiry based teaching and learning sequence on oscillations based on experiments and data-logging techniques

Marco Giliberti¹, Enrico Rigon², Marco Stellato¹, Marina Tamborini³

¹ Dipartimento di Fisica, Università degli Studi di Milano, Milano, Italy

² ISIS “Daniele Crispi”, Busto Arsizio, Varese, Italy

³ Liceo Scientifico “P. Bottoni”, Milano, Italy

Abstract

We present here a teaching and learning sequence on oscillations entirely based on experiments and data logging techniques. The sequence has been proposed to three different groups of students during curricular and extracurricular lessons. The purpose of this paper is to discuss a way to introduce upper secondary school students to complicated topics, such as those of coupled oscillations, avoiding the use of too much mathematics and calculus, but with an intense use of data logging techniques.

Keywords: oscillations, harmonic motion, coupled oscillators, normal modes, data logging, video analysis

Introduction

In the Italian school students face the topic *oscillations* between the 11th and 12th grade, that is between the third and the fourth year of upper secondary school, as an introduction to the wider topic of *waves*. Generally, in teaching practice, only short time is devoted to harmonic motion, rarely coupled oscillators are treated and almost never normal modes of oscillation are presented. Moreover harmonic and coupled oscillations are rarely supported by experiments in lab activities. Not only in Italian school, but also in the literature it is difficult to find out teaching paths on normal modes for secondary school with a detailed analysis of disciplinary knots and learning problems. As harmonic oscillations and normal modes of oscillations have a great importance for the understanding of many fundamental topics such as acoustic and optics and, moreover, they are fundamental for the approach to modern physics [1], we present here a guided, inquiry based sequence on oscillations, together with some preliminary results coming from two experimentations. The path we have developed has been tested on three different groups of students. It is entirely based on an experimental approach using two different data logging and data analysis systems: the commercial Vernier Logger Pro system [2] and the Tracker video analysis free software [3].

The context

The path on oscillation has been proposed to three different groups of students: two classes of 30 students each, during curricular lessons, and a group of 40 students during extracurricular activities in the framework of “Milan open labs” of PLS (Scientific Degrees Plan). PLS is an Italian national project that the Ministry of Education has created to promote the collaboration between upper secondary school and University in order to increase the interest of young students for science [4]. The curricular classes were composed of students attending the third year of scientific oriented high school. They had

only a relatively poor mathematical background (little trigonometry, second degree equations and no calculus) and they had not previously studied waves.

A pre-test and a final questionnaire have been given to students. The final test has been administered five weeks after the end of the sequence, to verify medium term effectiveness. Due to the preliminary nature of the study, only qualitative research methods have been used to analyse the data [5].

The teaching and learning sequence

The teaching and learning sequence is based on a number of experiments. The experiments are supported by the use of data logging [2,3], video analysis [3] and applet simulations [6,7]. For the sake of brevity we describe here only the most significant: *the vertical mass-spring oscillator*, *the bouncing disk*, *the rotating disk*, *the coupled pendulums* and *the Shive wave machine (many coupled torsional pendulums)*. Each topic is introduced starting from a brainstorming in the form of interview where the teacher/interviewer tries to understand students' individual conceptions as it is foreseen in teaching experiment design [8]. All these experiments are meant to introduce the harmonic oscillations and, through harmonic oscillations, the normal modes of oscillation of complex systems. In our path the harmonic oscillation is seen as a privileged type of oscillation among all the periodic oscillations [1,9,10,11]. It allows describing the motion of almost all oscillating systems provided you comply with some constraints [10]. In this context the harmonic motion is introduced from the dynamic point of view as the motion a body performs when it is subject to a restoring force [10]. That is, a force whose graph lies between the second and the fourth quadrant of the diagram force vs displacement, passing through the origin of the axes and that is differentiable in the origin. All these forces can be approximated to their tangent line in the origin provided the amplitude of oscillation is small enough. So the central point is that any body subject to a restoring force, for small amplitude of oscillation, is governed by forces of the kind $F = -kx$ which generate harmonic motion.

The vertical mass-spring oscillator and *the bouncing disk* are designed to investigate different types of periodic oscillations and to identify the characteristics of the harmonic motion. *The rotating disk* is used to solve graphically the equation of harmonic motion [10]. *The coupled pendulums* are designed to study the properties of simple systems of coupled oscillators and to introduce the normal modes of oscillation for such systems, with the aim of showing how every oscillation of a complex system can be seen as a superposition of simple harmonic oscillations at fixed frequencies: those of the normal modes of the system. *The Shive wave machine*, with so many coupled torsional pendulums, is designed to study the normal modes of a discrete but more complex system of oscillators. This may help the transition to a continuous system such as the vibrating string and the comprehension of stationary waves as normal modes of the string (instead of the more usual superposition of travelling waves).

The experiments

The vertical mass-spring oscillator and *the bouncing disk* (Figure 1).

The vertical mass-spring oscillator is a typical example of harmonic oscillator while *the bouncing disk* is an example of periodic but non-harmonic oscillator.

The mass-spring oscillator consists of a mass appended at the bottom of a vertical spring (see Figure 1). The vertical configuration avoids the problem of the friction with surfaces. The mass is chosen so as to have a stable vertical oscillation, that is: the system has an

almost linear behaviour and there is no coupling between the vertical spring mode and the transverse pendulum mode. Nonetheless, the same care must be taken in choosing the mass, because the spring mode and the pendulum mode do indeed become resonant when the spring oscillation frequency doubles that of the pendulum [12,13].

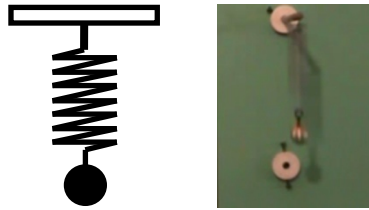

Figure 1. The vertical mass-spring system

The bouncing disk consists of a disk moving on an air table, so to reduce friction, and bouncing between two elastic edges (see Figure 2).



Figure 2. The bouncing disk on an air table, it is well visible the target object (black ball)

At the very beginning some experiments, concerning periodic oscillations, have been shown to the students: a pendulum, a ball bouncing vertically on the floor, a slinky oscillating vertically, a rod tilting on a flat pivot, a ball running back and forth along a semi-circular rail and many other real periodic oscillations. A brainstorming on what students saw followed. Then the first task for students has been to describe and categorize the previous oscillating systems that they observed by the naked eye. The students have been asked to group the oscillating systems according to some properties they decided by themselves. In a second moment students, divided into small groups of three-four, have been asked to analyse the forces acting on oscillators. They had to provide some qualitative graphics to be discussed inside each student's group, among different groups and with the teacher. This guided procedure, allowed the students to make a new categorization based on the analysis of the forces acting on each oscillator, thus giving the hint to define as harmonic oscillations those that are driven by a restoring force. At this point the students were ready to perform a quantitative analysis of the vertical mass-spring motion and of the bouncing disk motion, via two different data logging techniques. The goal, in first instance, was to verify that only the motion of the oscillator driven by a restoring force is harmonic like. In a second instance students could analyse the data and the graphics provided by the data logging to fix the properties of the harmonic motion. The students analysed the motion of the vertical mass-spring via the sonar detection and Logger Pro analysis while they studied the bouncing disk, after filming by smartphones the experiment, via the video analysis software Tracker. In Figure 3 are reported the graphs for the mass-spring provided by the logger pro: a) displacement vs time; b) velocity vs time and c) acceleration vs time.

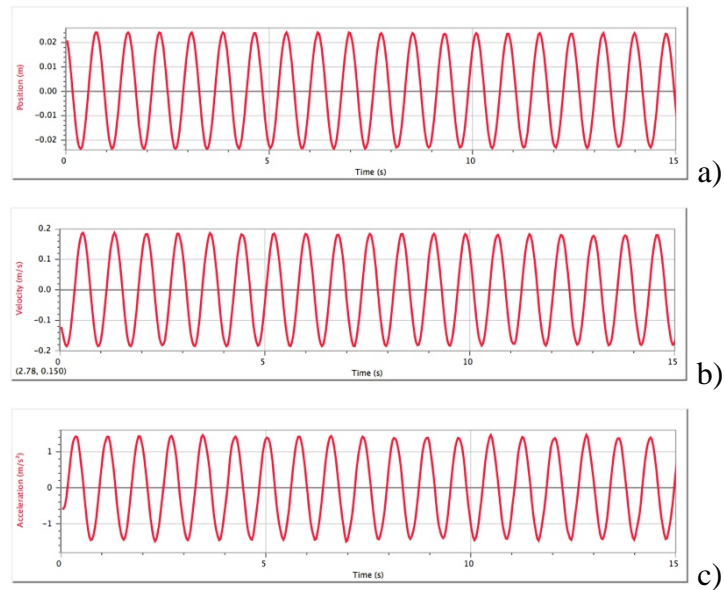

Figure 3. The mass-spring system: a) displacement, b) velocity, c) acceleration vs time

Students were able to see that the motion law is sinusoidal-like. In fact position and velocity as functions of time have the same sinus-like shape, but they are shifted of a quarter of a period. Furthermore, the acceleration vs time graph is still a sinus-like function and results, at each time, opposite to the displacement one according to $F = -kx$ law stating harmonic motion. Moreover, the Logger Pro provides also the acceleration versus position diagram (Figure 4) which results in a straight line lying in the second and fourth quadrant and passing through the origin of the axes. Using position vs time diagram (Figure 3a), students could verify the important property of harmonic motion that the frequency of the oscillation is amplitude independent, that is it is fixed by the parameters of the system. In fact the amplitude of oscillation registered by the sonar decreases with time due to the air friction.

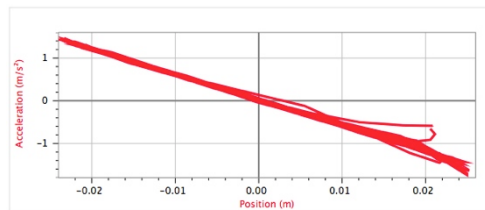

Figure 4. Acceleration vs position for the mass-spring oscillator

In this case the restoring force no longer depends only on position, but also on velocity. This situation has not yet been faced by students. Nonetheless, from an experimental point of view, for small amplitudes and for not too large time intervals, the damping is very small so that we can neglect the dissipative contribution and consider the force as being dependent only on position thus giving a precise sense to measurements of the period. Obviously, waiting a long enough time, the amplitude of oscillations decreases and the damping becomes evident. One can thus perform a new measurement of the period of our motion in a new situation when the amplitude has diminished, but always remaining in the approximation of friction-less motion. The students could measure the period (and consequently the frequency) of the oscillation directly in different sections of the diagram with different amplitudes and verify it is constant. The Logger Pro provides another

powerful tool to confirm that the frequency of the harmonic oscillation is fixed: the FFT (Fast Fourier Transform). The FFT of the motion waveform results a sharp line (Figure 5) at the same frequency the students found directly by measuring the period on the diagram. Of course our students did not possess yet the mathematical background for understanding how FFT works. They just knew it is a tool, a kind of button to push, that is able to find all the frequencies present in a waveform. To make this clear to students we showed them, with a simulation, the complicated waveform resulting from the sum of two (and three) sinusoidal function with different frequency. Then applying the FFT to the waveform we obtained the frequencies we mixed.

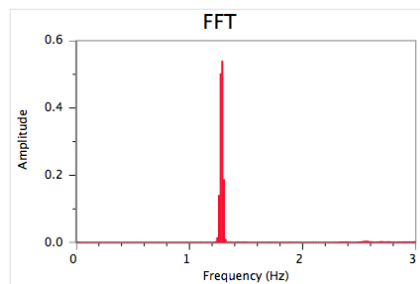

Figure 5. The Fast Fourier Transform of the waveform obtained for the mass-spring oscillator

After this, the students analysed the motion of the bouncing disk. This requires the use of Tracker because it is difficult to target, by sonar, the motion of an object which can have two motion components. As shown in Figure 2, it is necessary to mark the tracked object by a well contrasted target. The Tracker software can provide the same diagram as the Logger Pro. This time the analysis of the diagrams as the ones of Figures 3 and 4, clearly shows that the motion is no more governed by a restoring force and it is no longer harmonic as in the previous case. See Figure 6: a) position vs time, b) velocity vs time and c) acceleration vs time. In Figure 7 it is reported the diagram of acceleration vs position that clearly does not represent a restoring force.

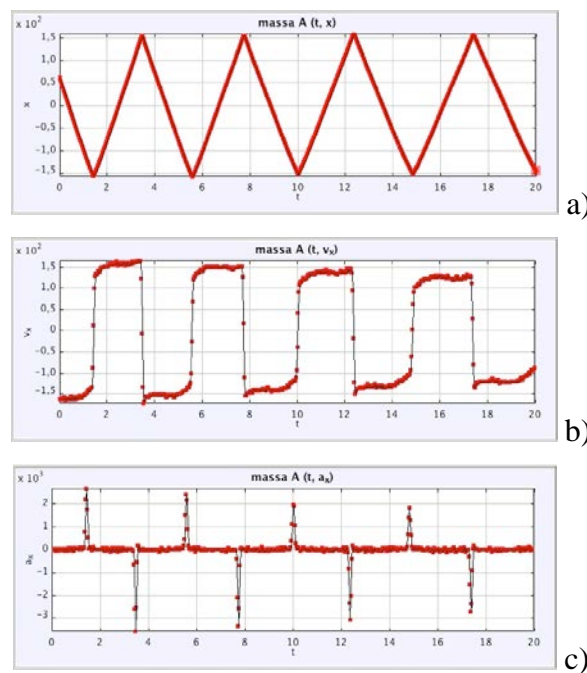

Figure 6. The bouncing disk of: a) displacement, b) velocity, c) acceleration vs time

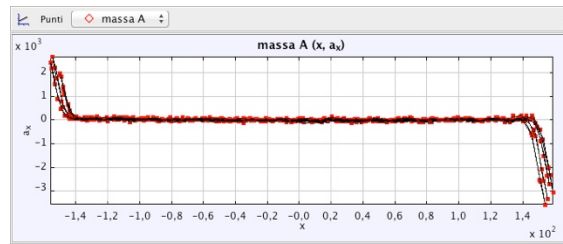

Figure 7. The acceleration versus position for the bouncing disk

The rotating disk

Once the definition of harmonic motion, as the one ruled by the dynamical law $F = -kx$, has been given, one has to face the problem of finding a way to integrate the differential equation $a = -k'x$ to obtain x as a function of t (with students that have no calculus background). Our strategy has been to use the projection on a diameter of a point-mass moving in circular motion. In fact, in this way it is easy to observe that the projection of the acceleration is given by $a = -k'x$ and that the projected velocity and position have a sinusoidal dependence on time.

Most of the Italian text-books define harmonic motion just as the projection of a circular motion over a diameter in a cinematic perspective. We, on the contrary, have chosen a very different dynamical approach and use circular motion only as a device to integrate a differential equation.

Moreover this is quite simple to obtain tracking the motion of a target dot on a rotating disk.

The coupled pendulums

The system consists of two to five physical pendulums coupled by identical springs [1,9,11,14]. These experiments (and the following one), together with the data logging techniques, turn out to be particularly useful because they allow: *i)* to easily introduce some particular (a student said “spectacular”) motion configurations of the entire system: the *normal modes*; *ii)* to recognize that when such a complex system oscillates in one of its normal modes, there is no energy exchange between the single parts (oscillators) of the system; *iii)* to see that every casual motion configuration of the system is simply a superposition of its normal modes.

Each pendulum consists of a plastic disc stuck to the terminal part of a metal rod. Quantitative measurements are taken by using Vernier Logger Pro and Tracker video analysis as well. Tracker is more suitable when there are more than two coupled pendulums because it allows tracking simultaneously any number of bodies while Logger pro is limited to two bodies at once. The setup used for this experiment is shown in Figure 9.

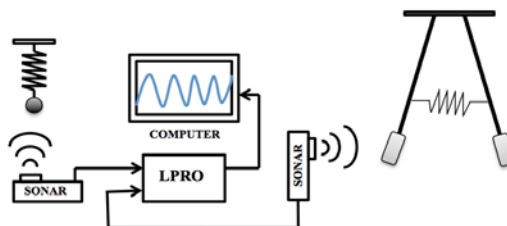

Figure 9. The experimental setup with sonar motion detection e Logger Pro software

As a first step, the students were asked to try and guess to imagine some “special ways of movement” of the system of two and three coupled pendulums. Surprisingly most students were able to predict which are the two normal modes of the two coupled pendulums. On the contrary, most students found it difficult to predict which are the normal modes higher than the second one for more complex systems (three to five pendulums). To get through the difficulty of predicting the motion configuration of a given normal mode, we proposed, as a very useful strategy, an analogy with stationary waves on a string (see Figure 10):

n coupled oscillators are represented by n equally spaced points on a string

the n^{th} normal mode configuration of the oscillators is recognizable by n^{th} stationary waves on the string, as Figure 10 clearly shows.

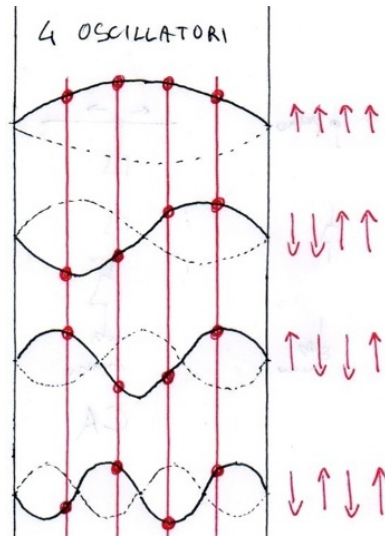

Figure 10. The sketch a student made to use the analogy with stationary waves to predict the shape of the four normal modes of a system with four coupled oscillators

In the case of mass-spring oscillators, this graphic analogy allowed students not only to predict the motion configuration of each normal mode but also to have a hint of the relative amplitude of oscillators in that mode. The further step has been to let the students “play” with the two-coupled pendulums, trying with different initial conditions. They easily realized that if one starts with a normal mode, the system continues moving that way and, besides, that looking at just one oscillator, while hiding all the others, one can’t understand whether it is coupled or not. This happens because there is no energy transfer (some students used the expression: “the pendulums do not exchange motion to each other”). The further step has been to perform a quantitative analysis via the data logging. Students tried to put into motion the three coupled pendulums (Figure 11) in the first, the second and the third normal mode and obtained the respective frequencies via the FFT (Figure 12). Then they put into motion the system in many randomly chosen different ways. From the analysis of the waveform, in both cases of normal mode and random motion configuration, the students could see that when the system oscillates in one of its normal mode, each of its parts (pendulums in this case) oscillates with harmonic motion at the same frequency and with a fixed phase relation with the others. The amplitude of oscillation of each pendulums doesn’t change, except for friction with the air, to indicate that there is no energy exchange between parts of the system. In addition, the higher the mode is, the higher is the frequency.

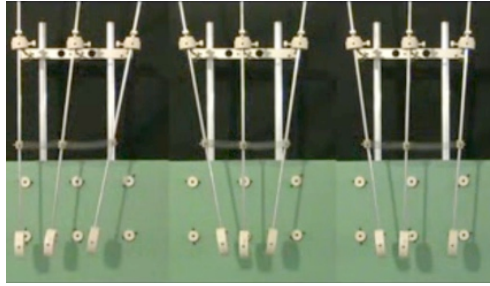

Figure 11. The three coupled pendulums. From left to right: first mode, second mode and third mode configuration.

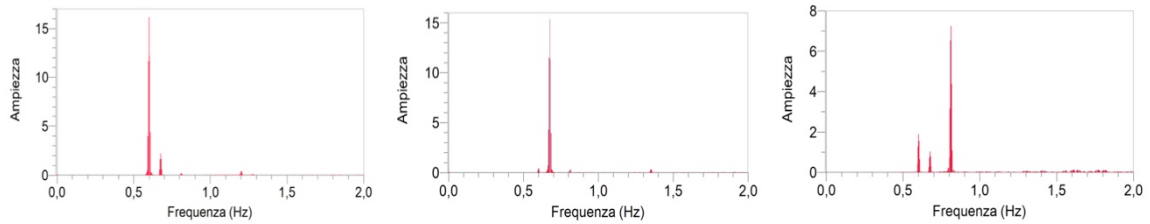

Figure 12. The three coupled pendulums. From left to right: the frequencies of the first, the second and the third normal modes.

On the other hand, if the system is put into motion randomly, we can see that there is energy exchange between the pendulums. In fact the motion waveform of each pendulum clearly presents the beat phenomenon and the amplitude of oscillation varies in time. The more relevant didactic issue here is that, if we perform the FFT of each pendulum waveform, we obtain exactly the same frequencies of the normal modes previously measured (see Figure 13). Each frequency peak, given by the FFT, has, in general, a different amplitude according to the way the normal modes superimpose, depending on the initial conditions. This allowed to show to the students that all the oscillations of the system are a linear combination of its normal modes.

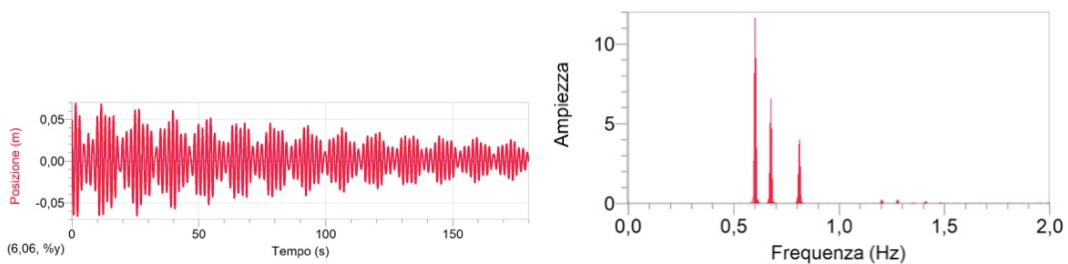

Figure 13. On the left: the waveform of a system of three coupled pendulums excited randomly, with the typical beats. On the right: the frequency of the normal modes superimposed.

In Figure 14 is shown a system of five coupled pendulums together with the motion waveforms of each pendulum. It is also shown the FFT some students performed for one of these waveforms with the frequencies of the five normal modes mixing.

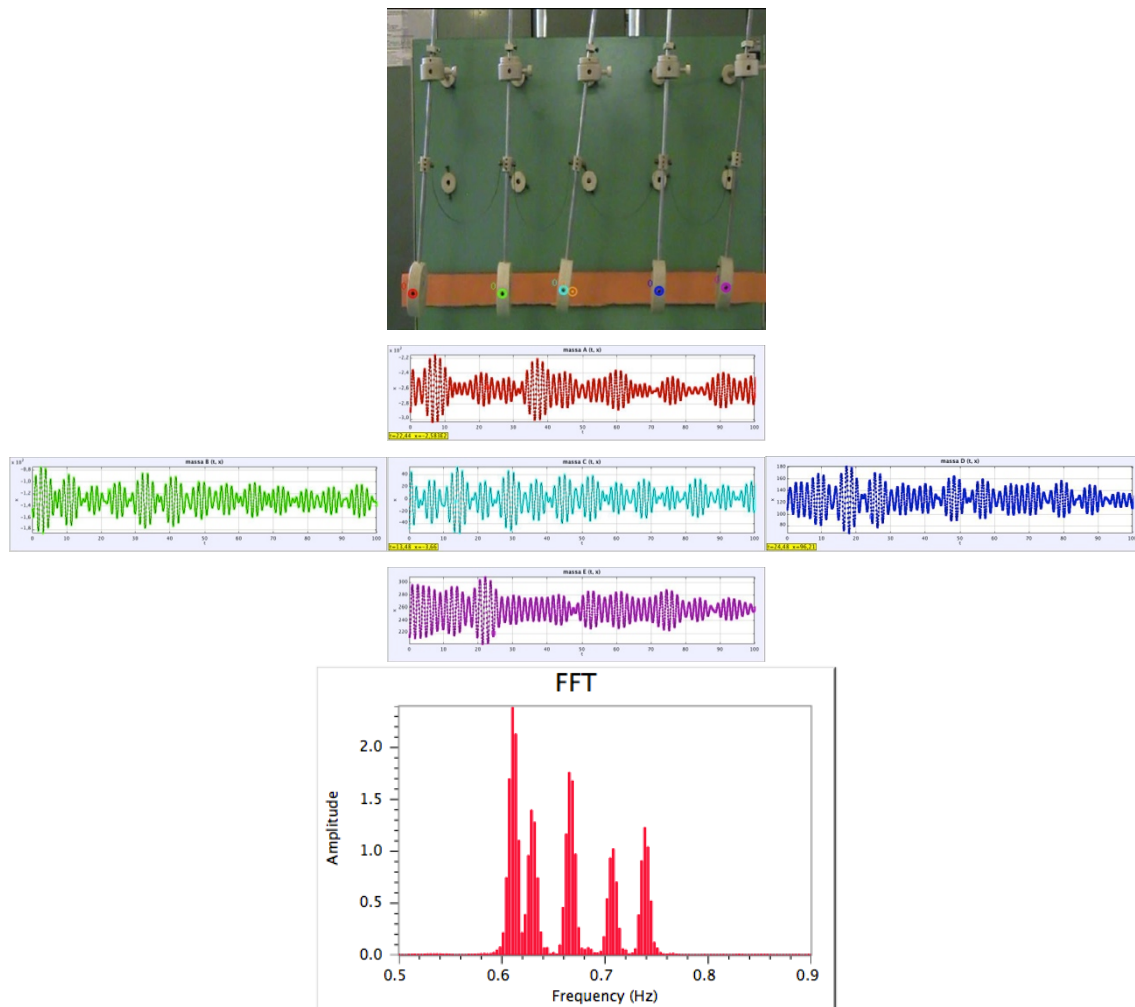

Figure 14. Five coupled pendulums. From top to bottom: the system, the waveform of each pendulum and the FFT related to one of the waveforms.

These modes superimpose to give the motion of each pendulum. Moreover, when the system is excited randomly, the motion of each pendulum, being a linear combination of harmonic motions (the normal modes) is no more harmonic and generally neither periodic. In this case Tracker allows to plot the motion waveform of the centre of mass which appear to be harmonic. See Figure 15.

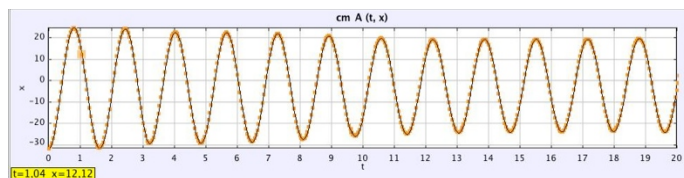

Figure 15. Five coupled pendulums: the waveform of the motion of the centre of mass

The Shive wave machine

The Shive machine is a system of many torsional pendulums, as in Figure 16. In our case we reduced the system to 18 pendulums to have them spaced enough. This was required for better data logging. In fact the sonar detector can't distinguish between two objects if they are too close. This experiments turns out to be of didactic interest because it can

facilitate the conceptual transition from the discrete to the continuous case (for instance the vibrating string). In Figure 17 it is reported the motion waveform obtained by a group of students tracking the complicated motion of one pendulum. This data collection has been performed with the sonar and the Logger Pro software, but comparable results have been obtained with Tracker as well. The FFT, as depicted in Figure 17, shows the frequencies of all the eighteen normal modes of the system. In this case it results evident that the first four normal modes are those that mostly contribute to the motion of the tracked pendulum. Furthermore, the more the number of pendulums the more the normal modes tend to be equally spaced in frequency. In fact, in the limit case of a continuous system, as the vibrating string, the frequency of each mode is an integer multiple of the frequency of the first normal mode.



Figure 16. The Shive machine

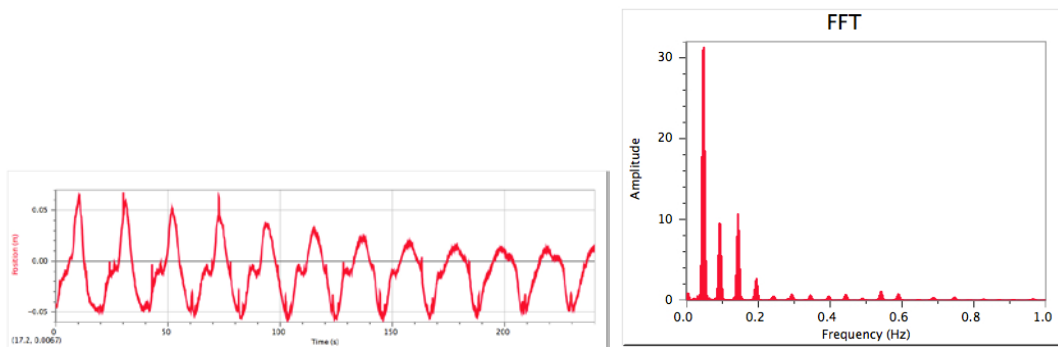

Figure 17. The Shive machine. From left to right: the waveform of one of the pendulums and its FFT.

Results

In the initial brainstorming, students were asked to group the oscillating systems they observed by the naked eye. Most of them decided to put together oscillators with similar trajectories. For instance, the vertical mass-spring, the ball bouncing on the floor and the bouncing disk were grouped together “*because all move along a straight line*”; the simple pendulum, the rod tilting on a flat pivot and the ball running along a semi-circular rail, were grouped together “*because they describe an arc*”. In the final test, on the contrary, over 60% of the students grouped oscillators taking into account the forces acting on the system, being them restoring forces or not.

Another interesting fact emerged from the initial brainstorming is that about 80% of the students thought that the oscillation frequency of a vertical mass-spring oscillator does depend on the initial displacement. In particular, they thought that the greater the initial amplitude, the greater the frequency. Some students said: *“when the amplitude is bigger, the frequency is higher because the movement of the mass is faster”*. A few students thought that the frequency of oscillation decreases with the initial displacement because: *“the velocity is the same but the space is longer, so the oscillation takes more time”*. Only less than 20% of the students decided that the frequency is constant, regardless the initial displacement. They stated this fact on the base of direct observation by naked eye: *“looking at the oscillation I can’t see difference”*.

Analogous results and similar comments were obtained with the simple pendulum, despite the fact that almost all the students already knew the pendulum isochronism law.

The situation greatly changed after the didactical intervention as at the end of the path nearly 90% of the students were able to recognize that the frequency of a harmonic oscillator does not depend on amplitude.

Regarding normal modes, while many students were able to imagine “some special motion configurations” of a system of two coupled pendulums before the topic was introduced and the experiments performed, only a couple of them were also able to predict the motion of the third normal mode of a system of three coupled pendulums. None could predict higher modes in more complex systems (five pendulums). Anyway, after introducing the graphic technique (see Figure 13), the number of students able to predict the motion of all normal modes increased significantly. In the final test and in the interviews was proposed a question on a system of five coupled oscillators. All the students were able to describe the motion configuration of the first normal mode by words and/or by sketches. Over 80% described correctly the second normal mode, over 60% the third and the fourth and nearly 50% the fifth one. Most of the wrong answers on higher normal modes were due to inaccuracy in drawing the sketches.

Conclusions

This experimental approach here described, allows to overcome most of the mathematical difficulties that one encounters in treating coupled oscillations with secondary school students. Moreover, the use of data logging software can also help students to get over some difficulties in representing and interpreting graphics. In addition, in our experience, we have noticed that the use of techniques, such as video-tracking generates great enthusiasm in students. In fact it needs only a smartphone as “probe”, and we all know that smartphones represent a technology very friendly to young students. This is further proved by the many works students performed at home, by themselves, even without having been asked.

References

- [1] Smith W.: Waves and Oscillations-a prelude to quantum mechanics, Oxford University Press (2010), ISBN 978-0-19-539349-1, preface.
- [2] Logger Pro software and reference manual (2013). Retrieved from www.vernier.com/products/software/lp/
- [3] Tracker software and reference manual (2013). Retrieved from www.cabrillo.edu/~dbrown/tracker

- [4] Guidelines of *Piano Lauree Scientifiche (2013)*. Retrieved from www.progettolaureescientifiche.eu
- [5] Erickson F.: Qualitative research methods for science education. International Handbook of Science Education ed B J Fraser and K G Tobin (Dordrecht: Kluwer1998), p. 1155-73.
- [6] Online simulation applets (2013). From www.falstad.com/mathphysics.html
- [7] Online simulation applets (2013). From www.fisicaondemusica.unimore.it
- [8] Komorek, Mand, Duit R.: The teaching experiment as a powerful method to develop and evaluate teaching and learning sequences in the domain of non-linear system. Int. J. Sci. Edn. 26, (2004), p. 619-33.
- [9] Fitzpatrick R.: Oscillations and Waves, CRC Press (2013), ISBN 978-1-4665-6608-8, p. 1-45.
- [10] Barbieri S. R., Giliberti M. Laboratorio aperto: Oscillazioni e Onde, Cusl Milano (2012), p. 1-30.
- [11] Georgi H.: The physics of waves. Prentice Hall, Englewood Cliffs, New Jersey (2007), p. 2-8 and 53-58.
- [12] Olsson M. G.: Why does a mass on a spring sometime misbehave? Am. J. Phys. 44, (1976), p. 1211-1212.
- [13] Boscolo I., Castelli F., Stellato M.: An undergraduate study of harmonic and parametric motion of a simple spring-mass system from motion waveforms. Submitted to Am. J. Phys. (June 2013).
- [14] Crawford F. S. Jr.: Waves, Berkeley Physics Course vol. 3, McGraw-Hill, New York NY, (1968). Chapters 1-3.

Magnetic vector potential in secondary school: a teachers' path

Marco Giliberti¹, Michela Cavinato¹, Sara Barbieri²

¹University of Milan, Milano, Italy

²University of Palermo, Palermo, Italy

Abstract

The magnetic vector potential is traditionally presented only at university level and is widely considered as a pure mathematical tool to calculate the magnetic and the electric fields, i.e., a device without any (or at least with very poor) physical meaning. Even if, also in recent literature, many papers can be found which, on the contrary, clarify the physical meaning of the vector potential, to the best of our knowledge a clear and complete educational path on it is still missing. Our experience and some pilot experimentations with secondary school students and teachers, however, have driven us to seriously consider the opportunity to introduce the magnetic vector potential also at secondary school as a way both to better understand some fundamental aspects of classical electromagnetism and to open a door for a simple and a direct way of introducing important aspects of modern physics (i.e. the notion of the photon and the London equation of superconductivity). In this paper we'll discuss the motivations that led us to develop an educational path for the introduction of magnetic vector potential in upper secondary school, some considerations in order to clarify general aspects of its physical meaning with examples, and the framework of our course on magnetic vector potential for pre-service teachers training at the Milano TFA (Formative Active Training) course.

Keywords: secondary education, magnetic vector potential, classical electromagnetism

Introduction

The Physics Education Research Group of the University of Milano (UMIL-PERG) has been studying for many years' ways and paths for a meaningful introduction of modern physics in secondary school. For this purpose, the general framework of field theory appears more and more fruitful, and therefore an educational reconstruction of many physics topics has become a necessity. At the moment, UMIL-PERG is especially developing paths on normal modes of oscillations [1], superconductivity [2,3] and basic aspects of electromagnetism [4,5]. The educational path for the magnetic vector potential \mathbf{A} is aimed at pre-service physics teachers and is part of this general research [4,5].

The magnetic vector potential \mathbf{A} is very useful to treat many important quantum physics aspects, for instance the quantization of the electromagnetic field, the electromagnetic gauge theories and the Aharonov-Bohm effect [6]. Moreover it is also fundamental to understand classical phenomena, for instance the Maxwell-Lodge effect [7,8].

In dealing with superconductivity one has to face the phenomenological London equation [9]:

$$\mathbf{B} + \lambda^2 \nabla \times \nabla \times \mathbf{B} = \mathbf{0}, \quad (1)$$

where \mathbf{B} is the magnetic field and λ is a constant called *penetration depth*. Due to the presence of differential operators, eq. (1) is too much difficult to be presented in secondary

school. With the use of the vector potential \mathbf{A} , we can write the substantially equivalent equation:

$$\mathbf{J}_s = -k\mathbf{A}, \quad (2)$$

where \mathbf{J}_s is the superconductive current density and k is a constant related to λ . To be noted that eq. (2) is much simpler than eq. (1) and is formally equal to the well-known Ohm law:

$$\mathbf{J} = \sigma\mathbf{E}. \quad (3)$$

Therefore, the introduction of the magnetic vector potential \mathbf{A} can give the opportunity to discuss London equation at secondary school level.

It is also interesting to point out that Maxwell, in his “Treatise” on electromagnetism [10], widely used the potentials, not only the electric scalar potential, but also the magnetic vector one and that, before him, also Faraday often reasoned in terms of a so called “electrotonic state” [11] that is the actual vector potential.

But nowadays \mathbf{A} is generally presented only at university level and only as a useful mathematical tool, disregarding its physical meaning. In fact it is generally said that the electric and magnetic fields, \mathbf{E} and \mathbf{B} , and the electric scalar potential φ do have a clear physical meaning (even if φ is not uniquely defined). On the contrary, the vector potential \mathbf{A} is regarded only as a simple mathematical device, useful to perform calculations, but without a physical interpretation, even if some papers can be found in the literature [12-14] that try to clarify that vector potential does indeed have a physical meaning. What, to the best of our knowledge, is still missing, is a clear educational path on vector potential.

In the following we will present an educational path on the magnetic vector potential addressed to pre-service physics teachers with examples of teaching sequences for secondary school.

Magnetic vector potential: our educational path

Teachers’ path

It was through an integral relation that Maxwell introduced the notion of vector potential ([10], p. 405). Given a magnetic field \mathbf{B} , the magnetic vector potential \mathbf{A} is a vector such that the flux of the magnetic field \mathbf{B} through any surface Σ is equal to the circulation of \mathbf{A} around the boundary $\partial\Sigma$ of Σ , that is with modern symbology:

$$\int_{\Sigma} \mathbf{B} \cdot \mathbf{n} d\Sigma = \oint_{\partial\Sigma} \mathbf{A} \cdot d\mathbf{s}. \quad (4)$$

Most of the textbooks introduce \mathbf{A} through the following local relation:

$$\mathbf{B} = \nabla \times \mathbf{A}. \quad (5)$$

Therefore, as it is well-known, \mathbf{A} is not univocally defined by \mathbf{B} , as can be inferred by eqs. (4, 5). This fact is at the basis of the so-called gauge invariance and is one of the main reasons of the difficulties in understanding the physical meaning of \mathbf{A} .

When dealing with slowly varying time-dependent fields, that is when we can neglect terms multiplied by $1/c^2$, we can express the magnetic field \mathbf{B} at position \mathbf{r} and time t , in vacuum, in terms of the conduction current density \mathbf{J} at position \mathbf{r}' and time t' :

$$\mathbf{B}(\mathbf{r}, t) = \frac{\mu_0}{4\pi} \int_{\tau'} \frac{\mathbf{J}(\mathbf{r}', t') \times \Delta\mathbf{r}}{(\Delta r)^2} d\tau', \quad (6)$$

where τ' is the region containing the currents, $\Delta\mathbf{r} \equiv \mathbf{r} - \mathbf{r}'$ and $\Delta r \equiv |\mathbf{r} - \mathbf{r}'|$.

With rather simple calculations [5], eq. (6) can be rearranged as:

$$\mathbf{B}(\mathbf{r}, t) = \nabla \times \left(\frac{\mu_0}{4\pi} \int_{\mathbf{r}'} \frac{\mathbf{I}(\mathbf{r}', t)}{\Delta r} d\tau' \right), \quad (7)$$

that clearly shows that the vector:

$$\mathbf{A}(\mathbf{r}, t) \equiv \frac{\mu_0}{4\pi} \int_{\mathbf{r}'} \frac{\mathbf{I}(\mathbf{r}', t)}{\Delta r} d\tau' \quad (8)$$

is a magnetic vector potential because it satisfies eq. (5). Moreover, in the framework of our slowly varying time-dependent approximation, it is *the* magnetic vector potential to which one is naturally led. As it is seen in eq. (8), the potential \mathbf{A} is explicitly expressed in terms of its empirical references, that are the conduction currents, and its behavior follows that of the currents.

It is interesting to observe that eq. (8) has the same structure of:

$$\varphi(\mathbf{r}, t) = \frac{1}{4\pi\epsilon_0} \int_{\mathbf{r}'} \frac{\rho(\mathbf{r}', t)}{\Delta r} d\tau', \quad (9)$$

where φ is the electric scalar potential and ρ is the charge density.

Eq. (8) tells us that, once the currents are known, \mathbf{A} is univocally determined. Instead, if we would start from eq. (5), \mathbf{A} would not be unique. To completely determine \mathbf{A} one has to choose a gauge condition and this is generally done by arbitrary fixing the divergence of \mathbf{A} . In our approach, on the contrary, we have no necessity of fixing a gauge. By directly calculating the divergence of \mathbf{A} given by eq. (8), always in the limit of slowly varying fields, we find that we are in the Coulomb gauge, that is:

$$\nabla \cdot \mathbf{A} = 0. \quad (10)$$

The Coulomb gauge can therefore be seen as the ‘natural’ gauge for slowly varying fields.

It is now important to give a physical meaning to the magnetic vector potential. Suppose that in a certain space region a slow varying magnetic field, generated by a distribution of currents, is acting. If $\nabla\varphi = 0$, as for instance when no free charges are present, the electric field is linked to \mathbf{A} by the following relation:

$$\mathbf{E}(\mathbf{r}, t) = -\frac{\partial \mathbf{A}(\mathbf{r}, t)}{\partial t}. \quad (11)$$

Let us now consider a point-like charge q , in the position \mathbf{r} at a time $t = -\infty$, when the currents, and consequently both the magnetic field and the magnetic vector potential are zero. When we slowly switch the currents on, they will generate a magnetic field \mathbf{B} , a magnetic vector potential \mathbf{A} and therefore, according to eq. (11), an electric field \mathbf{E} which will act on the charge q . If we want to keep the charge fixed in \mathbf{r} , we must apply an impulse against the field forces, given by:

$$\mathbf{I}_q(\mathbf{r}, t) = -\int_{-\infty}^t q \mathbf{E}(\mathbf{r}, t') dt' = -\int_{-\infty}^t -q \frac{\partial \mathbf{A}(\mathbf{r}, t')}{\partial t'} dt' = q \mathbf{A}(\mathbf{r}, t). \quad (12)$$

The magnetic vector potential can be thus interpreted as the total momentum per unit charge that must be transferred to a charge, during the time interval $(-\infty, t)$, in order to keep it at rest at the point \mathbf{r} , while the field slowly varies from zero to the value \mathbf{B} .

The analogy between the structures of the scalar and the vector potentials, as given by eqs. (8, 9), is also reflected in their physical interpretations. When the magnetic vector potential is time-independent, the potential energy $U_q(\mathbf{r}, t)$ of a point-like charge q set at position \mathbf{r} at time t , is given by:

$$U_q(\mathbf{r}, t) = - \int_{\infty}^{\mathbf{r}} q \mathbf{E}(\mathbf{r}', t) \cdot d\mathbf{r}' = q\varphi(\mathbf{r}, t). \quad (13)$$

Therefore the electric scalar potential represents the work (independent of the chosen path), per unit charge, done to move the charge from infinity, where the electric field is zero, to the point \mathbf{r} , against the forces of the electric field, at a given time t .

Eqs. (12, 13) have a dual structure, in the sense that in the former the integration is performed over time at a fixed position, while in the latter the integration is performed over space at a fixed time. In other words, the roles of space and time are interchanged. The magnetic vector potential can therefore be seen as a ‘momentum vector’ per unit charge, while the electric scalar potential is an energy component per unit charge. As $q\varphi$ is called potential energy, $q\mathbf{A}$ can be called potential momentum (of the charge q , at point \mathbf{r} and time t).

The vector potential gives also the possibility to write some physical relations in a more understandable way, deepening the physical meaning previously discussed. For example, let’s consider an electromagnetic, linearly polarized, harmonic, plane wave of amplitude E_0 and angular frequency ω , propagating in vacuum. Its intensity is usually written as:

$$I = \frac{1}{2} \varepsilon_0 E_0^2 c. \quad (14)$$

In terms of the vector potential, eq. (14) can also be written as:

$$I = \frac{1}{2} \varepsilon_0 A_0^2 \omega^2 c, \quad (15)$$

where A_0 is the amplitude of the vector potential. This last equation reflects in a complete way that giving the intensity of a mono-dimensional mechanical wave:

$$I = \frac{1}{2} \rho S_0^2 \omega^2 v, \quad (16)$$

where ρ is the linear mass density, S_0 is the wave amplitude and v the propagation velocity. Eq. (16) shows that \mathbf{A} plays for the electromagnetic field the same role of the displacement S for a mechanical wave. Moreover, in this simple case, eq. (15) gives also a way of measuring the vector potential; in fact since the intensity, the frequency and the velocity of a wave are measurable quantities, from eq. (15) we can determine A_0 [12].

Students’ path

In secondary school, the scalar potential plays an important role but, of course, only a simplified version of eq. (9) is presented. In general, with obvious symbology, in the case of a continuous charge distribution, the electric scalar potential (that we assume to go to zero at infinity) can be written as:

$$\varphi(\mathbf{r}) = \frac{1}{4\pi\varepsilon_0} \left(\frac{\Delta Q_1}{|\mathbf{r}_1 - \mathbf{r}|} + \frac{\Delta Q_2}{|\mathbf{r}_2 - \mathbf{r}|} + \dots + \frac{\Delta Q_N}{|\mathbf{r}_N - \mathbf{r}|} + \dots \right), \quad (17)$$

where it is clear that the sources of the potential are the electric charges. In complete analogy with eq. (17), we propose to introduce the new vector, related to magnetic effects:

$$\mathbf{A}(\mathbf{r}) = \frac{\mu_0}{4\pi} \left(\frac{i_1 \Delta \mathbf{l}_1}{|\mathbf{r}_1 - \mathbf{r}|} + \frac{i_2 \Delta \mathbf{l}_2}{|\mathbf{r}_2 - \mathbf{r}|} + \dots + \frac{i_N \Delta \mathbf{l}_N}{|\mathbf{r}_N - \mathbf{r}|} + \dots \right), \quad (18)$$

where i_k is the current circulating in the section $\Delta \mathbf{l}_k$ of the circuit and $\Delta \mathbf{l}_k$ is a vector oriented as the current.

One of the most important theorem about the electric field is the Gauss theorem that is widely used to calculate the electric field in presence of particular symmetries. However,

in secondary school this theorem is generally only stated without demonstration, except for the case of a point-like charge in the centre of a spherical surface. For what concerns the magnetic vector potential, eq. (4) may be written with a notation more suited to secondary school. In fact, if we denote with $C_\gamma(\mathbf{A})$ the circulation of the magnetic vector potential \mathbf{A} along the closed line γ and with $\Phi_\Sigma(\mathbf{B})$ the flux of the magnetic field \mathbf{B} through any surface Σ with boundary γ and oriented like γ , we can write:

$$\Phi_\Sigma(\mathbf{B}) = C_\gamma(\mathbf{A}), \quad (19)$$

and this equation allows to calculate \mathbf{A} in some simple cases.

As an example, let us consider an infinite solenoid of radius a , carrying a current I that generates an internal magnetic field of intensity $B = \mu_0 nI$, where n is the number of turns per unit length, while the external magnetic field is zero. We want to calculate \mathbf{A} both inside and outside the solenoid.

Eq. (18) indicates that the field lines of \mathbf{A} follow the current direction, therefore, for symmetry reasons they are circumferences co-axial with the solenoid (Figure 1).

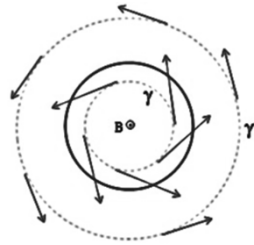

Figure 1. Section of an infinite solenoid, carrying a current, with the field lines of \mathbf{A}

Inside the solenoid, if r is the distance from the symmetry axis, from eq. (19), taking the field lines of \mathbf{A} as lines to calculate circulation, we get:

$$\pi r^2 B = 2\pi r A, \quad (20)$$

giving:

$$A = \frac{1}{2} B r = \frac{1}{2} \mu_0 n I r. \quad (21)$$

Outside the solenoid, the same procedure leads to:

$$\pi a^2 B = 2\pi r A, \quad (22)$$

giving

$$A = \frac{1}{2} \frac{a^2 B}{r} = \frac{1}{2} \frac{a^2}{r} \mu_0 n I. \quad (23)$$

Eqs. (21, 23) show that the magnetic vector potential grows linearly, while approaching the current, inside the solenoid, whereas it decreases as $1/r$ going away from the current, outside the solenoid. Figure 2 displays the r -behaviour of \mathbf{A} both inside and outside the solenoid.

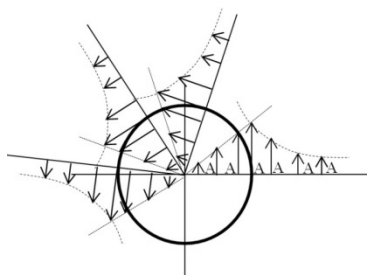

Figure 2. Behaviour of \mathbf{A} both inside and outside the solenoid

Other examples of calculation of the magnetic vector potential can be found in [3-5].

Conclusions

Two main facts hinder the comprehension of the magnetic vector potential:

- the non-univocity of \mathbf{A} implied by its definition (eq. (5));
- the lack of discussion traditionally devoted to its physical meaning.

Convinced of the educational value of the vector potential in dealing with many physical situations, we have developed a path which, in our opinion, can overcome the above stated difficulties.

We attained a particular expression of \mathbf{A} in terms of its empirical referent, i.e. the conduction current density, for slowly time-dependent electric and magnetic fields.

We found a privileged gauge (the Coulomb gauge) and the physical meaning of \mathbf{A} was discussed in a way similar to that of the electric scalar potential, another fact which can help comprehension.

In some circumstances, the use of the vector potential allowed us to highlight interesting parallelisms with mechanical situations.

To conclude, we firmly consider the introduction of the magnetic vector potential in electromagnetism not only a good tool for making calculations, but also a useful way to better understand many physical phenomena.

References

- [1] Barbieri S., Giliberti M.: Laboratorio aperto: Oscillazioni e Onde. CUSL, Milano (2012). ISBN 88-8132-655-6.
- [2] Barbieri S., Giliberti M.: Laboratorio aperto: Superconduttività. CUSL, Milano (2012). ISBN 88-8132-660-0.
- [3] Barbieri S., Giliberti M., Fazio C.: Vector potential at high school: a way to introduce superconductivity and to review electromagnetism, WCPE: The World Conference on Physics Education (Istanbul, 1–6 July 2012) submitted.
- [4] Barbieri S., Cavinato M., Giliberti M.: Riscoprire il potenziale vettore per la scuola superiore, G. Fis., Vol. LIV, N. 2 (2013) p. 111–128.
- [5] Barbieri S., Cavinato M., Giliberti M.: An educational path for the magnetic vector potential and its physical meaning, Eur. J. Phys. 34 (2013) p. 1209-1219; Barbieri S., Cavinato M., Giliberti M.: Corrigendum: An educational path for the magnetic vector potential and its physical meaning, Eur. J. Phys. 35 (2) (2014).

- [6] Aharonov Y., Bohm D.: Significance of electromagnetic potentials in quantum theory, *Phys. Rev.* 115 (1959) p. 485–491.
- [7] Iencinella D., Matteucci G.: An introduction to the vector potential, *Eur. J. Phys.* 25 (2004) p. 249–256.
- [8] Rousseaux G., Kofman R., Minazzoli O.: The Maxwell-Lodge effect: significance of electromagnetic potentials in the classical theory, *Eur. Phys. J. D* 49 (2008) p. 249–256.
- [9] London F., London H.: The electromagnetic equations of the superconductor, *Proc. R. Soc. A* 149 (1935) p. 71–88.
- [10] Maxwell J. C.: *A Treatise on Electricity and Magnetism*, Vol. II, Oxford: Clarendon (1873).
- [11] Bork A.: Maxwell and the Vector Potential, *Isis*, Vol. 58 (1967) p. 210-222.
- [12] Giuliani G.: Vector potential, electromagnetic induction and ‘physical meaning’, *Eur. J. Phys.* 31 (2010) p. 871–880.
- [13] Konopinski E. J.: What the electromagnetic vector potential describes, *Am. J. Phys.* 46 (1978) p. 499–502.
- [14] Semon M. D., Taylor J. R.: Thoughts on the magnetic vector potential, *Am. J. Phys.* 64 (1996) p. 1361–1369.

Coding scheme for assessment of students' explanations and predictions

Mihael Gojkošek¹, Gorazd Planinšič¹, Josip Sliško²

¹Faculty of Mathematics and Physics, University of Ljubljana, Slovenia

²Facultad de Ciencias Fisico Matematicas, Benemerita Universidad Autonoma de Puebla, Mexico

Abstract

In the process of analyzing students' explanations and predictions for interaction between brightness enhancement film and beam of white light, a need for objective and reliable assessment instrument arose. Consequently, we developed a coding scheme that was mostly inspired by the rubrics for self-assessment of scientific abilities. In the paper we present the grading categories that were integrated in the coding scheme, and descriptions of criteria used for evaluation of students work. We report the results of reliability analysis of new assessment tool and present some examples of its application.

Keywords: coding scheme, assessment, rubrics, explanation, prediction

Introduction

Fundamental features of scientific work in physics are building explanations and on them based testable predictions [1]. Therefore, in order to learn science by doing, students should be involved in authentic scientific tasks that include construction of explanations and predictions. Especially students, who are proficient in science, should be able to generate and evaluate scientific evidence and explanations [2].

More than 600 high-school and university students from Slovenia and Czech Republic were tested during several phases of the extended research on students' ability to construct explanations and predictions for an unknown physics phenomenon. Consequently, the need for robust and reliable assessment tool arose. In this paper we present the process of development of the coding scheme that was used to evaluate the quality of students' explanations and predictions. The paper also addresses the reliability of the coding scheme and demonstrates some examples of its application.

Theoretical framework

In the process of development of the coding scheme we were mainly inspired by previous work of Eugenia Etkina and her co-workers. They have developed the tasks and rubrics for formative self-assessment in order to help students to perform better and thus develop scientific abilities [3]. Their rubrics are based on cognitive apprenticeship theory and address 7 areas of scientific abilities that scientists use when they construct knowledge and solve problems. These areas include the abilities (1) to represent information in multiple ways, (2) to design and conduct an observational experiment, (3) to design and conduct a testing experiment, (4) to design and conduct an application experiment, (5) to collect and analyze experimental data, (6) to engage in divergent thinking, and (7) to evaluate models, equations, solutions, and claims. Each of 7 rubrics consists of multiple categories that assess specific subabilities (e.g. "Is able to make a reasonable prediction based on a hypothesis.") Each category is further supplemented with detailed description of qualitative criteria that one should possess to be classified in one of four grading levels:

“Missing”, “Inadequate”, “Needs some improvement” and “Adequate”. Rubrics for assessment of scientific abilities were later used in several other studies (e.g. [4,5]) and turned out to be a highly efficient tool. Although the purpose of our assessment differed from the Etkina’s, we found the basic form of the rubrics very useful. We have re-designed the set of categories (subabilities) included in rubrics and adapted the criteria descriptions to best fit our needs.

Research instruments

Brightness enhancement film (BEF)

Brightness enhancement film is an interesting optical element that can be used in several demonstrational experiments suitable for introductory optics course [6]. It is one of the thin transparent foils from the backlight system in LCD monitors and can be easily obtained by dismounting any used monitor. The main advantages of using BEF in demonstrational experiment are a) it is an unknown element to vast majority of students and experts, and b) its structure cannot be seen with naked eye.

We integrated two demonstrational experiments with BEF in our testing procedure. Both experiments include a beam of white light (produced by a flashlight) incident perpendicularly to the sides of the film. On one side, the beam of light is split into two symmetrical beams (Figure 1a), while the beam incident perpendicularly to the other side of the film is mostly reflected into the direction of origin (Figure 1b).

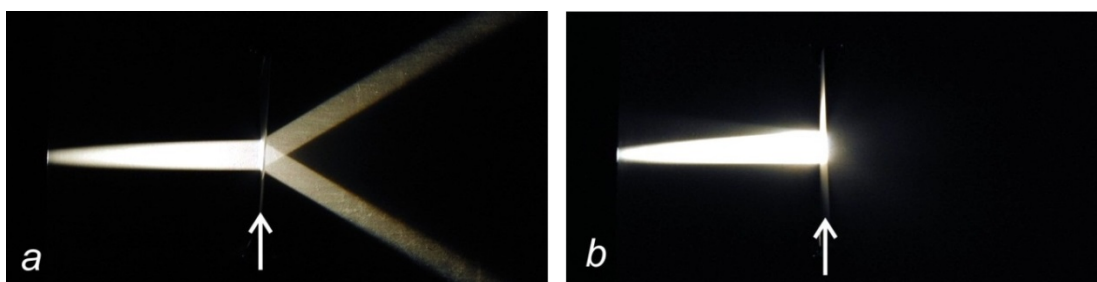

Figure 1. a) The split of the light beam incident perpendicularly to one side of the film, and b) the reflection of the light beam incident perpendicularly to the other side. The arrows show the position of the brightness enhancement film.

The structure of the film can be easily revealed using the school microscope. A magnified cross-section shows that BEF is flat on one side and has microscopic prismatic ridges with the apex angle of approx. 90° on the other side (Figure 2).

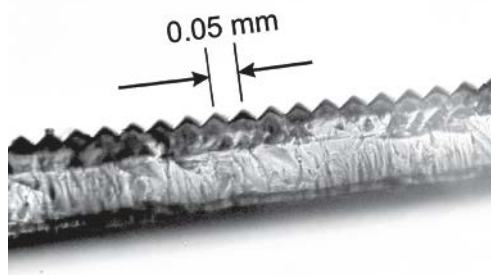

Figure 2. Cross-section of the brightness enhancement film under the microscope reveals prismatic structure.

Now we can also explain observed outcomes of both demonstration experiments. Light incident perpendicularly to the prismatic side of BEF is refracted in two directions – depending on which side of the prisms the beam strikes (Figure 3a). The light beam incident perpendicularly to the flat side of BEF undergoes double total internal reflection and returns back into the original direction (Figure 3b). Note that these demonstrational experiments can be combined into two different two step sequences, depending on which experiment is first shown to students. We named them split-reflection (or shorter SR) task sequence (when first the split of light beam was shown to students and then the reflection) and reflection-split (RS) task sequence (when first experiment demonstrated the reflection and second the split).

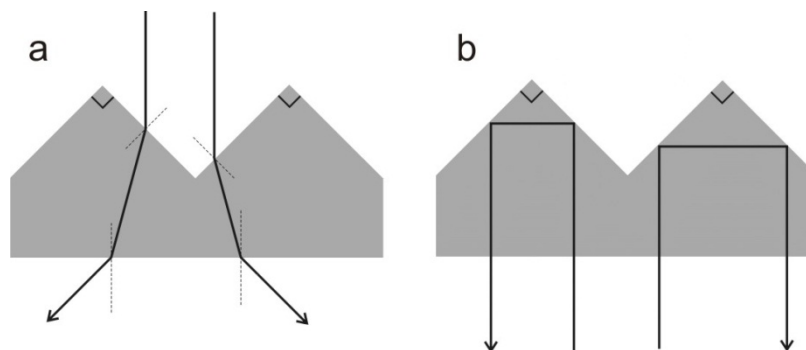

Figure 3. a) Double refraction of the light beam incident on the prismatic ridges, and b) double total internal reflection of the light beam incident perpendicularly to the flat side of BEF.

Foil test

Students were tested with foil test, which was designed by our research group. One part of the foil test was two demonstrational experiments with the BEF described above. First, a teacher showed students one of both experiment (split in SR and reflection in RS task sequence). Then they were asked to construct one or more explanations for interaction of light beam and the BEF on the basis of observed outcome. We encouraged them to present their explanations verbally (text description) and graphically (sketch). Additionally, students had to name optical phenomenon/a, that is on their opinion involved in observed experiment.

Next, students were informed about the second experiment, in which light beam will be incident perpendicularly to the other side of the BEF. They were asked to construct a prediction for experimental outcome on the basis of their previously proposed explanation. Again, their prediction should consist of verbal and graphical part. Teacher later performed second demonstrational experiment (reflection in SR and split in RS task sequence) and asked students, whether their prediction agrees with observed outcome. Finally, students had one more opportunity to construct the improved explanation compatible with the outcomes of both demonstrational experiments.

Lawson's Classroom Test of Scientific Reasoning

As a reference test, Lawson's Classroom Test of Scientific Reasoning (CTSR) was used. A 24-item multiple-choice version of the test was translated into Slovene and used to classify students as concrete-operational, transitional and formal-operational reasoners according to their scores.

Development of coding scheme

Purpose

Previous research showed that majority of students is not able to reveal the actual structure of the BEF on the basis of two demonstrational experiments. Even more, the proportion of those who manage to do so remains low (less than 5%) even if students are previously involved in pedagogical activity with macroscopic prism and laser ray-box [7]. Therefore, we wanted to construct a reliable and objective tool for assessment of the quality of students' explanations regardless of their (mis)match with the actual structure of the BEF. Note that observed experimental outcomes can also be explained e.g. with suitable arrangement of reflecting surfaces. Our goal was to develop a set of categories, with which students' explanations and predictions could be easily assessed, and would allow obtaining overall quality grade and further calculation of students' average success.

Grading categories

Our coding scheme consists of three main parts that are formulated for assessment of initial explanation, prediction and improved explanation, respectively. Each part further consists of 4 or 5 categories that assess students' abilities that are needed to solve the task successfully. Assessment categories are presented in Table 1.

Table 1. Categories for assessment of initial/improved explanation and prediction

Initial explanation
Graphical representations Verbal representations Correct use of physics Consistency between outcomes predicted by explanation and observed outcomes Number of different models
Prediction
Graphical representations Verbal representations Consistency with initial explanation Ability to evaluate agreement of prediction and observed outcome
Improved explanation
Graphical representations Verbal representations Correct use of physics Addressing asymmetry Consistency between outcomes predicted by explanation and observed outcomes

Devising code descriptions

After selection of grading categories included in our coding scheme, we devised detailed descriptions of codes. We decided to keep 4-level coding scale used by Etkina et.al as well as descriptive names of grading levels: 0-Missing, 1-Inadequate, 2-Needs some improvement and 3-Adequate. Descriptions of students' work that merit a particular grading level can be found below.

Grading categories for initial explanation

In category “graphical representations”, basic drawing elements of the sketch were assessed. We were looking for the structure of the foil (its cross-section), light rays and majority of labels. If these were present, sketch was coded with 3, while the sketch without labels was coded with 2. Any other sketch was coded with 1 and no sketch with 0.

Also in the category “verbal representations”, we expected from students to describe foil structure and name involved optical phenomenon. When both included, code 3 was assigned, while for one of them code 2 was used. Other verbal descriptions were considered as “inadequate” and no text was coded with “missing”.

When assessing correct use of physics, both graphical and verbal parts of explanation were considered. When optical phenomenon was applied without mistakes, code 3 was used. Misapplication of the phenomenon was coded with 2. Typical students' mistakes include split of the light beam by diverging lens or diffraction grating and total internal reflection of the light incident perpendicularly to the inner surface of a medium. Confusing, contradictory or incomprehensible application of optical phenomenon (e.g. “lens reflects light”) were coded with 1 and when no optical phenomenon was included in explanation code 0 was assigned.

We also assessed the consistency between outcomes predicted by explanation and observed outcomes. Particular attention was devoted to the direction of incident and outgoing light rays. If explanation and observed result were consistent, code 3 was assigned, while discrepancy between them was coded with 2. When student's explanation failed to reproduce the main experimental result (split or reflection) code 1 was used, while code 0 was given to explanations that had nothing in common with observed experimental result.

In the grading category “number of different models”, two or more explanations that employed different optical phenomenon merit code 3. When the same phenomenon was applied in several explanations, code 2 was assigned. One explanation was coded with 1 and no explanation with 0.

Grading categories for prediction

In assessment categories “graphical and verbal representations”, evaluation criteria for prediction were the same as for initial explanation coding. Next grading category assessed consistency between prediction and initial explanation. Prediction that was consistently derived from previously proposed explanation was coded with 3. Inconsistent derivation from initial explanation merit code 2, while any other prediction was coded with 1 and no prediction with 0.

Grading category “ability to evaluate agreement of prediction and observed outcome” assessed students' report about (mis)match of predicted and observed outcome of second experiment. Reasonable decision about agreement/disagreement was coded with 3, while code 2 was assigned when one made a decision about agreement/disagreement that

evaluator was unable to judge due to imprecise prediction. When this decision was clearly incorrect, code 1 was assigned, while no agreement assessment was coded with 0.

Grading categories for improved explanation

Similar to previous grading, in assessing graphical representations we were looking for structure of the film, light rays describing both experimental results and majority of labels. Sketch that included all these elements was coded with 3. Film's structure and light rays for both experiments were enough for code 2, while the sketch without one of these elements was coded with 1. For no sketch code 0 was assigned.

Category "verbal representations" addressed presence of verbal description of film's structure and optical phenomena involved in both experiments. When all these elements were present, explanation was coded with 3. If only description of the structure or only optical phenomena was present, or there were both for explanation of just one experiment, code 2 was assigned. Every other verbal explanation was coded with 1, and code 0 was used when no text was present.

For assessment category "correctness of physics" we used the same criteria as for initial explanation coding. With category "addressing asymmetry" we assessed the way in which asymmetrical behavior of the BEF was explained. Code 3 was assigned when film's asymmetrical properties were explained in consistent way. If asymmetry was provided through mechanical composition of two optical elements, explanation was coded with 2. Code 1 was used when asymmetry was granted but not explained, and code 0 was assigned when asymmetry was not addressed.

In improved explanation, we also assessed consistency between outcomes predicted by explanation and observed outcomes. Similar to coding of initial explanation, code 3 was assigned when explanation and observed results were consistent. Code 2 was used when direction of incident/outgoing light beams were misinterpreted, while code 1 was assigned to explanatory models that failed to reproduce main experimental outcomes – split and reflection of incident light beams. If incident or outgoing light beams were not drawn, code 0 was assigned.

Analysis of reliability

Tests of 197 students from Slovenian high-schools were assessed with described coding scheme. Approximately 20% of all tests were independently evaluated by two researchers. Their coding matched in 90% of all cases. Also inter-rater agreement coefficients like Cohen's kappa ($\kappa = 0,87$) and Pearson's correlation coefficient ($r = 0,92$) indicate high reliability of this assessment tool.

Combined grades

As mentioned, one of our goals was to obtain combined grades for overall quality of students' explanations and predictions. Before that, some assumptions needed to be taken into account. First, we assumed scale nature of grading levels. As a consequence of that assumption, one can summarize and calculate average grades for different categories. And secondly, weights suitable to importance of each grading category needed to be set. Since in our opinion all addressed categories play similarly important role in overall quality of explanations and predictions, all weights have been set to 1. Combined grade for the quality of initial explanation is consequently calculated as a sum of grades of all five categories that assess this explanation. Similarly combined grades for the quality of

prediction and improved explanation are calculated by summarizing grades of individual categories.

Some examples of application and obtained results

Using grades achieved in single grading category and combined grades, we were able to compare different groups of students according to scientific reasoning ability level (concrete/transitional/formal) and task sequence they were involved in (SR/RS). Our results suggest that difference between concrete-operational and formal-operational reasoners is statistically significant for some categories and insignificant for others. An example of grading category in which this difference was among highest is correct use of physics in improved explanation. Average grades achieved in this category can be found in table 2. Mann-Whitney nonparametric U-test revealed that difference between concrete- and formal-operational groups are highly statistically significant in both, SR and RS task sequences ($U = 50, p = 0,002$, and $U = 137, p = 0,001$, respectively). On the other hand, in the category “number of different models” no significant difference between these groups was observed ($U = 126, p = 0,31$ in SR, and $U = 276, p = 0,75$ in RS task sequence).

Table 2. Average grades achieved in the category “correct use of physics” in improved explanation and “number of different models” in initial explanation.

	split-reflection (SR)		reflection-split (RS)	
	concrete thinkers	formal thinkers	concrete thinkers	formal thinkers
improved explanation: verbal representations	1,4	1,8	1,2	1,5
initial explanation: number of different models	1,3	1,2	1,2	1,2

Significant difference between concrete-operational and formal-operational thinkers was found also by comparison of combined grades for the quality of improved students’ explanations (Table 3). Again, Mann-Whitney U-test was used to calculate the significance of these differences in SR ($U = 55,5, p = 0,010$) and RS task sequences ($U = 115,5, p = 0,000$).

Table 3. Average combined grades for the quality of improved explanation.

	split-reflection (SR)		reflection-split (RS)	
	concrete thinkers	formal thinkers	concrete thinkers	formal thinkers
improved explanation: combined grade for quality	5,7	8,5	4,1	7,4

Conclusions

In our study, high-school students’ ability to construct explanations and on them based predictions was taken under examination. For that purpose students were involved in testing procedure with two demonstrational experiments, in which interaction between brightness enhancement film (BEF) and beam of white light was presented. Students were asked to propose possible explanations for observed interaction and to predict the outcome of the second experiment. During the analysis of students’ tests the need for objective

assessment tool arose. We decided to develop a coding scheme based on the rubrics for assessment of scientific abilities [3-5] that would allow obtaining reliable grades for the quality of students' explanations and predictions.

Developed coding scheme consists of three separate rubrics that assess students' initial explanation, prediction and improved explanation, respectively. Each rubric further consists of grading categories that assess students' work in explanation and prediction formation. Four-level grading scale is used to evaluate each grading category. Categories are equipped with detailed descriptions of essential elements that need to be present to merit a particular level. Combined grades for the quality of students' explanations and predictions are obtained by summarizing grades of categories in one rubric.

We conclude that rubric-like coding scheme is an effective tool for assessment of students' explanations and predictions. Developed coding scheme shows high level of reliability assessed through inter-rater agreement coefficients. Under some assumptions, grading categories of the coding scheme can be used to evaluate overall quality of students' explanations/predictions and their average performance.

Acknowledgements

Authors would like to thank Bor Gregorčič for the help with evaluation of students' tests, and Eugenia Etkina for helpful discussion in the process of development of coding scheme.

References

- [1] Giere R. N.: *Understanding Scientific Reasoning*, 4th Edition. Orlando: Harcourt Brace College Publishers (1997).
- [2] Duschl R. A., Schweingruber H. A., Shouse A. W.: *Taking science to school: Learning and teaching science in grades K-8*. Washington, DC: National Academies Press (2007).
- [3] Etkina E., Van Heuvelen A., White-Brahmia S., Brookes D. T., Gentile M., Murthy S., Rosengrant D., Warren A.: Scientific abilities and their assessment. *Phys. Rev. Spec. Top.-Ph.* 2 (August 2006), 020103.
- [4] Etkina E., Karelina A., Ruibal-Villasenor M.: How long does it take? A study of student acquisition of scientific abilities. *Phys. Rev. Spec. Top.-Ph.* 4 (December 2008), 020108.
- [5] Etkina E., Karelina A., Murthy S., Ruibal-Villasenor M.: Using action research to improve learning and formative assessment to conduct research. *Phys. Rev. Spec. Top.-Ph.* 5 (June 2009), 010109.
- [6] Planinšič G., Gojkošek M.: Prism foil from an LCD monitor as a tool for teaching introductory optics. *Eur. J. Phys.* 32, No. 2 (March 2011), p. 601-613.
- [7] Gojkošek M., Sliško J., Planinšič G.: Do Learning Activities Improve Students' Ability to Construct Explanatory Models with a Prism Foil Problem? *CEPS Journal* 3, No. 3 (September 2013), p. 9-28. Available from: http://www.cepsj.si/pdfs/cepsj_3_3/cepsj_pp_9-28_Gojkosek.pdf

Effective use of interactive whiteboards – a design based research approach

Bor Gregorcic¹, Gorazd Planinsic¹, Eugenia Etkina²

¹University of Ljubljana, Faculty for mathematics and physics, Slovenia

²Rutgers University, Graduate school of education, USA

Abstract

As interactive whiteboards become more and more common in high school classrooms, there is great need for studies that address their use for instruction in specific subject, including physics. However, research in this field remains scarce. We describe the patterns documented in an observational study in a Slovene high school, fully equipped with IWBs. We observed, that the board is mainly used as a regular board with some enhancements. These include saving board content, enhancing the content with images and the use of colour. Many of the enhancements help to save time in the classroom and help teacher preparation. Teachers generally perceive the adoption of IWB as beneficial. However, advanced use of the touch sensitive surface that would also engage students in the interaction with the IWB was very limited. Our future work will include designing instructional materials that will take advantage of the interactive surface of the IWB. The materials will engage students in kinaesthetic and creative activities.

Keywords: IWB, observational study, interview, activity theory, design based research, interactive whiteboards, Algodo, kinesthetic activity, student activity, touch sensitive

Introduction

Interactive whiteboards (IWB) are a relatively new piece of technology that is being introduced into schools at an accelerating rate in the last decade. However, research on IWB use is still relatively scarce. There is great need for studies that would address IWB use for teaching particular subjects, specifically physics. In our study, we made preliminary exploration of different ways of using IWB.

Situation in Slovenia

IWB are being gradually introduced into primary schools and high schools across Slovenia. Approximately 200 schools already have an IWB in at least one classroom. This means that teachers are sharing one or several boards. The IWB companies or enthusiastic teachers who already master the basic use of the board usually provide professional development for IWB use for teachers. These professional development courses put emphasis on using the basic features of the IWBs and their accompanying software, using the software for preparing materials at home and getting familiar with the technical aspects of classroom use of the software and hardware combined, but they give very little or no suggestions for its use in specific subjects.

Some schools have gone further and made a more profound investment in the IWB technology; the school, where we perform our study is one example. The school has approximately 1000 students, 85 teachers and 43 IWBs, one in every classroom. All teachers have been using the IWB exclusively in all their lessons for more than 2 years already. This environment offers a great opportunity for us to explore the IWB use where it

is not considered a novelty anymore. However, the school, being fully equipped with IWB technology, stands out in Slovenia. Nevertheless, there are schools elsewhere, that also use the IWB technology extensively and as the price of the technology decreases with time, we can expect more schools all over the world to adopt it in the future. Many schools in Western Europe and the USA have already done so. The development of the IWB technology and its implementation into schools calls for studies that address the use of the board in specific circumstances. This kind of research has, to our knowledge, been very limited specifically for high school physics instruction.

Previous research

Little research has been done on the use of IWB in teaching physics. Most of the research so far has been fairly general and not subject-specific. To our knowledge there has been a single study in the last years that has addressed the effectiveness of IWB in teaching high school physics [1]. Few studies have addressed the process of adaptation to IWB teaching by science teachers [2][3].

It has been shown that teachers that are generally enthusiastic about the use of ICT in class are usually the first to use it [4]. This may cause the first wave of positive feedback on the use of IWB. Other research says that the improvement in learning is not directly attributable to the use of IWB [5], but is rather a function of the way the IWB is used [6][7]. This will also be the focus of our future research. However, IWB has been shown to have motivational benefits for students [5] and a positive effect on junior high-school students' engagement and behaviour [8]. It attracts more attention and increases students' interest and participation. Some caution is needed here, as this could be due to the novelty effect of the boards and could fade away with time as students get used to them. There are also a number of technical advantages offered by the IWB. Their effectiveness is however still a subject of research.

Van Veen [1] did a crossover study, where two groups were taught the same content by the same teacher, one with the IWB and the other without it. The performance results were somewhat in favour of the IWB group. It is, however, clear that the teacher was fairly enthusiastic and skilled in its use. The study also proposes some ways of using the IWB that the teacher and/or students perceived as productive.

Our observational study

Our study investigates the IWB use in the classroom and the impact of advanced interactive use on the classroom practice, teacher and student perceptions and attitudes. In the first part of our study, we observed 25 high school lessons and documented patterns of IWB use. We observed 3 physics teachers, 1 music teacher and 1 Slovene language teacher. They have all had 3 years of previous IWB experience. The Slovene and music teachers were in their late thirties, while two of the physics teachers were in their fifties and one in his early sixties. They have all received some formal IWB training, but have learned most of the useful features though independent exploration and informal cooperation with each other. We conducted pre and post lesson interviews with teachers before and after each lesson. The interviews were usually no longer than 15 minutes and were performed directly before and after the lessons, observed by the researcher. The interviews were semi-structured and were mainly concerned with particular uses of IWB, motives and goals behind particular uses and perceived advantages of IWB use in those situations. The collegiality and close cooperation of the researcher with the school also allowed for regular meaningful discussion between the teachers and the researcher.

Discussion revealed more general attitudes and perceived advantages of IWB use. Through observations and note taking during the classes and interviews with the teachers, we have documented the usual practice of IWB use in the school. We must note, however, that the school where the research took place is fairly progressive regarding the use of ICT in the classroom in Slovenia. It was selected for the study, as our faculty has a long lasting cooperation with the school in pre-service teacher training. Also, the researcher is well acquainted with the school staff, since he also taught a first year physics class there as an apprentice for a year.

In the following sections we describe the ways of using the IWB that were documented in our observational study. The categories emerged through analysis of observational and interview data, written down by the researcher who was present in the class and performed the interviews. We have categorized the documented patterns in 6 groups:

1. Time saving

Allowing teachers to return to past slides, immediately (without wiping) access new slides and quickly add graphing grids, task text and other visual material, saves a lot of time. This allows them to spend more time on meaningful activities. Teachers agree that this is beneficial and these features are commonly if not constantly used in the classroom.

2. Visual enhancement and better clarity

Teachers tend to use colour in writing and drawing much more often than on regular boards, because it is readily available through the IWB native software. This allows for better clarity when drawing complex diagrams, thus is especially useful in physics instruction. Adding images, such as photographs, drawings from books or videos and animations allows them to add a multimedia component with very little effort. Most teachers are taking advantage of the use of colour, however, adding images and videos was, to our surprise, much more common in music and Slovene classes than in physics classes.

3. Lesson preparation

In an interview, one of the physics teachers said that initially, when they got the IWB's, he was preparing his flipcharts in advance. This has, as he said, worsened his lesson's dynamics. After some time, he stopped preparing the flipcharts or started to only partially prepare them, leaving room for spontaneity – improving the dynamics of his lessons. He now uses his resource library to access images and other content on the fly. This shift was also noted in the literature [2]. Overall, music and language teachers tend to have most of their flipcharts prepared in advance, but still leave room for annotations or comments and use the marker tool to highlight parts of the text, etc. This difference in use, regarding the preparations of flipcharts may also be a result of the fact, that in physics lessons, procedural knowledge is of central importance and drawing images - sketches from scratch is an important part of learning physics. This was also put forward by two of the physics teachers in an interview.

4. Responding to student requests and questions using computer resources

There have been a couple of instances where students suggested or asked a question that was then answered by bringing an image into the flipchart. This puts the on-the-fly resource access in a new perspective. In a classroom where students are actively engaged

and are asking meaningful questions, student questions or suggestions can be responded to using multimedia.

5. Saving IWB lesson material

The ability to save and share IWB content is beneficial for lesson or board content analysis in professional training. This is especially useful in discussing lessons with pre service teachers. Other purposes put forward by teachers are more organizational and administrative in nature. This includes checking the previous lesson material before preparing for the next or showing evidence to a student or a parent that something was indeed written on the board. The saving feature also allows teachers to reflect on their work, get feedback from other teachers and share good practices in a teaching community. The IWB archived data can also serve as an excellent source of data for educational research.

6. Using the interactive potential of the touch sensitive surface

IWB was used by students only on rare occasions. Student use was limited to drawing and writing, there were a few instances of spontaneous use of colour by the student and there were 4 instances of resizing and moving a part of the board content by students. In music and language lessons there were a few cases of drag and drop activities on the board, where students had to sort the words or images into categories. Other than that, and especially in physics lessons, the IWB was rarely used by students and most of the time the interactive affordances of the touch sensitive surface connected to the computer were not taken advantage of.

Besides what we have found and described in the categories above, the interactive surface of the IWB enables physics teachers and their students to do more than just write or draw. It also works as a large touch screen. It enables input into physics applets such as Phet simulations (<http://phet.colorado.edu>) and manipulation of their parameters on the board surface as well as manipulation of dynamic interaction software. Dynamic interaction software is basically a highly modifiable simulation where a series of physical laws govern interactions of objects in a virtual environment. A case of such software, also called 2-D physics sandbox software, is Algodoo. The input can for example consist of drawing an object that becomes a part of the interactive virtual world. The user can draw an object and interact with the simulation by manipulating (e.g. grabbing or throwing) objects in the virtual world. Thus, it provides a personalized graphic and kinaesthetic experience and a substantial enhancement of the lesson.

Future work

In the future, we plan to investigate how the use of advanced interactivity features influences different aspects of classroom practice and teacher and student perceptions, attitudes. We are interested in changes in classroom dynamics in terms of student-student, student-teacher, teacher-computer and student-computer interactions.

We will design lesson materials for high school classroom use and introduce teachers to Algodoo. After implementing the designed materials in the classroom, we will adjust and improve them on the basis of teacher and student responses. We will perform in-depth interviews with teachers before and after the implementation, as well as student interviews with some students and give out shorter questionnaires to all participating students. We anticipate that some sort of design principles will emerge in this multiple iteration design

based research approach. The goal is to test highly interactive lesson materials and get teacher and student feedback, as well as observational data for more detailed analysis.

We also plan to observe small groups of students working on a task using the IWB and perform in-depth interviews with them. The materials will be adjusted for use in small groups of students. Seeing how students interact in small groups can give us important information for designing student activities that do not take the form of a traditional class.

Activity theory

Due to the complexity of the environment we are working in and the relatively small sample of participants, the approach to the study will be mainly qualitative. We will perform an in-depth investigation in a naturalistic setting. The study will resemble a case study. Thus, we do not expect conclusions that could be generalized to all school environments. However, in order to better understand and use the IWB in a more productive way, studies of concrete cases are of great importance. Also, in such studies, unexpected outcomes may be observed that give suggestions for further study. In order to have our data, analysis and conclusions comparable to other similar studies, we have chosen for our research a theoretical framework called Activity theory.

Activity theory (AT) is an observational framework. It is a tool mainly used in studies of human-computer interaction and studies of human activity in real life contexts, where it is impossible to neglect the influence of physical and social context on the observed activity [9][10]. In fact, AT goes so far to regard these factors as integral parts of activity. The assumption of AT is, that individuals, their environments, society and tools they use are not disjoint entities, but rather construct an interconnected web, called the activity system (figure 1). As activity is performed, the integral parts of the activity system evolve and thus the activity constantly changes. To understand the activity, we must know all its integral parts. In AT, the activity is divided into [9][11]:

Subject – the person or group of persons that consciously perform actions. **Object** – the goal of the subject's effort. **Community** – the social context in which the subject acts.

The subject, object and community do not interact directly, but through mediators. These are: **Tools** (subject-object): artefacts (mental or physical) that the subject uses in order to achieve the goal (object). **Rules** (subject-community): formal or informal laws of behaviour. **Division of labour** (community-object): the structure of the community when it strives to achieve a goal collectively.

All the parts and mediators strongly depend on other parts of the activity system. To illustrate the interconnectedness of the activity system, let us consider tools as mediators between subject and object. The use of the tool is determined by the community – ways of using the tool are, for example, taught in schools. Tools also shape the way we think about problems. A simple illustration of this is the saying: If all you have is a hammer, every problem starts to look like a nail. Tools also change the formal and informal rules in a community and the way community divides labour. An example of this is emergence of specialists for the use of specific tools. Even a novel way of using of a familiar tool can result in notable changes in an activity system.

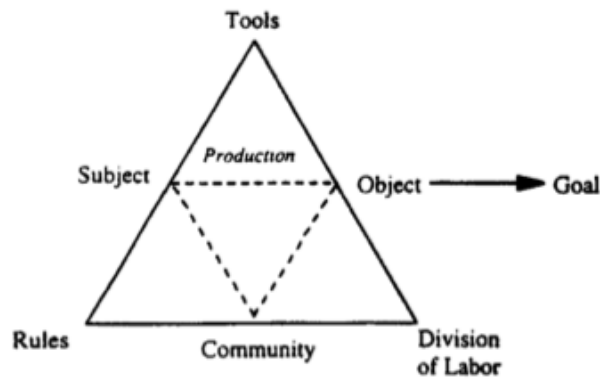

Figure 1. Activity theory splits the activity into components (corners of the dotted triangle) and mediators (corners of the uninterrupted line triangle). Together they form the activity system. Changes in any of the components or mediators result in a transformation of others and as a result, a transformed activity [11].

As an observational and analytical framework, AT is useful in investigating complex systems, such as classrooms or working groups, where the whole activity system has to be understood in order to have a clear insight into the activity [10]. By observing how the activity system evolves, we can gain an insight into tensions between different parts of it. This can be useful in resolving these tensions and improving the activity system as a whole. AT can be used in design-based research. An example of this would be a researcher observing and analysing classroom activities to inform decisions on the design of curriculum materials [11]. AT stresses the importance of specific situations, as small differences in activity systems can lead to considerably different activities. Therefore AT is mainly used as a descriptive framework for case studies. It is a prism, through which activity can be viewed in order to make analysis more organized.

Conclusion

Our observational study found that the IWB is being used by teachers to improve teaching in a number of ways. We summed up these in 6 categories: Time saving, visually enhancing lessons, helping teachers with lesson preparation, allowing teachers to respond to student suggestions with computer based resources, saving and sharing board content and lastly and the least commonly, engaging students in meaningful interaction with the IWB. Studies of the use of IWB in specific situations have so far been relatively scarce. Our study will attempt to fill this void by analysing how advanced interactive use of the IWB's interactive surface influences high school physics classroom practice. Through a design based research approach, we plan to design lesson materials, test them and improve them. As this iterative process unfolds, we expect certain design principles to emerge, which could help future designers and teachers in similar situations. The planned outcomes of our investigation thus are a detailed analysis of the impacts of advanced IWB use and possible curriculum material design principles.

References

- [1] Van Veen N.: Interactive White Board in Physics Teaching; beneficial for physics achievement? Master thesis. (2012), [online], [cit. 3. 9. 2013]. Available from <http://www.science.uva.nl/onderwijs/thesis/centraal/files/f1045808677.pdf>

- [2] Sweeney T.: Transforming pedagogy through interactive whiteboards: Using activity theory to understand tensions in practice, *Australian Educational Computing* 24, No 2 (Feb 2010), p. 28-34.
- [3] Morais B.: Learning to use interactive white boards in the science department: A case study. Master thesis. (2005), [online], [cit. 3. 9. 2013]. Available from http://www.ore.org.pt/filesobservatorio/pdf/Teses_IWBs_and_ACTIVITY_THEORY.pdf
- [4] Shieh S. R.: The impact of Technology-Enabled Active Learning (TEAL) implementation on student learning and teachers' teaching in a high school context. *Computers & Education* 59, No 2, (Sept. 2012), p. 206-214.
- [5] Quashie V.: How interactive is the interactive whiteboard? *Mathematics Teaching* 214, (May 2009), p. 33-38.
- [6] Schneiderman M.: What does SBR mean for educational technology? *T.H.E. Journal* 31, No 11, (June 2004) p. 30-36. Retrieved from <http://thejournal.com>
- [7] Kennewell S., Tanner H., Jones S., Beauchamp G.: Analysing the use of interactive technology to implement interactive teaching, *Journal of Computer Assisted Learning* 24, (May 2007), p. 61–73.
- [8] Morgan G. L.: Improving student engagement: Use of the interactive whiteboard as an instructional tool to improve engagement and behavior in the junior high school classroom. Doctoral dissertation. (October 2008), [online], [cit. 3.9. 2013]. Available from: <http://digitalcommons.liberty.edu/cgi/viewcontent.cgi?article=1140&context=doctoral>
- [9] Engestrom Y., Miettinen R., Punamaki R.: *Perspectives on activity theory*. Cambridge: Cambridge University Press (1999), ISBN 052143730X.
- [10] Kaptelinin V., Nardi B.A.: *Acting with technology: activity theory and interaction design*. Cambridge, MA: MIT Press (2006), ISBN 9780262112987.
- [11] Jonassen D., Rohrer-Murphy L.: Activity theory as a framework for designing constructivist learning environments. *Educational Technology, Research and Development* 47, Iss 1, (March 1999), p. 61-79.

Students' Conceptions on the Nature of White Light

Claudia Haagen-Schützenhöfer

Austrian Educational Competence Centre, University of Vienna, Vienna, Austria

Abstract

The quality of learning processes is mainly determined by the extent to which students' conceptions are addressed and thus conceptual change is triggered. Colour is one topic within initial instruction of optics which is extremely challenging. A physical adequate concept of white light is crucial for being able to grasp the processes underlying colour formation. In the evaluation process of year 8 student learning materials on optics we encountered the conceptual shortcomings many students have concerning the idea of white light. This contribution is meant to give an overview of three different studies related to the topic of students' conceptions on white light. Firstly, findings on students' conceptions concerning white light extracted from post instructional student interviews are reported. Secondly, representations for white light in Austrian year 8 school textbooks are analysed. In addition, results achieved in micro-teaching teaching interventions (teaching experiments) focusing on white light are summarized.

Keywords: colour addition, students' conceptions of white light, teaching colour phenomena

Introduction

Although optical phenomena are part of teenagers' everyday lives, it is often very difficult for them to explain such phenomena using correct physical concepts. Physics Education Research (PER) of the last decades has investigated a vast number of students' alternative conceptions in different fields of physics [1], which influence learning processes. In the field of basic optics for example, students' conceptions and resulting learning difficulties are well known and documented in numerous papers (cf. e.g. [2,3,4,5]).

Currently, our working group is developing student materials for optics in lower secondary (year 8) ([22,23]) based on research on students' conceptions in this field. The design process of the materials can be summarized as follows: The materials are based on an already empirically evaluated content structure, which proved to be more effective than conventional instruction in optics ([6,7]). In our project this content structure is transformed into a students' text, which fits the Austrian curriculum for year 8. To empirically test the quality of the material developed, we investigate learning processes and learning outputs with the help of teaching experiments [8]. The results of these teaching experiments are then used for a new design circle, where the existing materials are improved and redesigned.

In the course of evaluating the material's section on colour phenomena, we encountered some severe learning difficulties concerning white light. Students' utterances showed that their ideas conflict in many cases with the scientific concept of white light. One characteristic student's utterance is used in the following to illustrate the kind of problems we came across: "The colour of light of a bulb?? It is yellow. Ah, but physicists call it white." However, if students do not accept a physical concept of white light, it is difficult to promote the idea of selective reflection as the crucial process for colour vision.

This contribution gives an overview on three research strands related to the problem of students' conceptions on white light. It focuses on students' conceptualizations of white light after basic instruction, the forms of representations in materials (school textbooks) used for conventional instruction and the effectiveness of our teaching materials.

Theoretical Background – Educational Reconstruction

Learning is an individual and complex process influenced by numerous variables. Learning theories of the last decades focus on a constructivist approach stating that each individual constructs his or her own knowledge depending on pre-knowledge, interest and other factors [9]. As a consequence of this constructivist approach of teaching, an efficient learning environment does not only need to contain all the facts and scientific concepts students should learn. Additionally, it is of high importance that these facts and concepts are based on and aligned to students' learning needs. The model of educational reconstruction [10] interlinks these three components and emphasises their mutual dependence (cf. Figure 1).

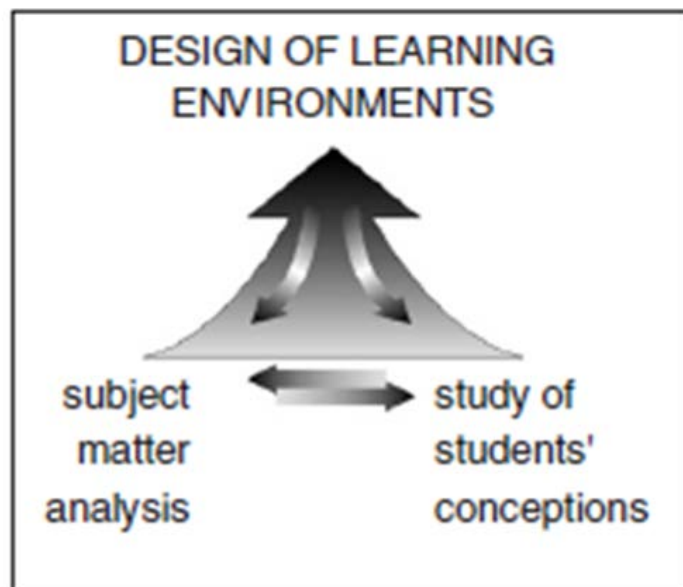

Figure 1. The model of educational reconstruction [10]

Van Dijk and Kattmann summarize the process of educational reconstruction as follows: “Firstly, the similarities between students’ conceptions and the scientific conceptions must be considered mutually. Secondly, the educational objectives and the students’ ideas have to be put in a context that is understandable for students. The abstract scientific conceptions have to be enriched and embedded in the science content for teaching.”[11].

The field of learner’s perspective is a core interest of conceptual change research. PER has already thoroughly investigated students’ conceptions concerning different content fields of physics. Next to mechanics and electricity, optics is among the most researched topics and consequently much is known about students’ alternative ideas in different subdomains of optics. For this paper the relevant subdomain of student conception research is colour phenomena. The framework of educational reconstruction functions as research design for our project. It describes an iterative procedure which underlies the development of our learning environment on colour phenomena. In a first development cycle, the topic colour

phenomena was reflected from the perspectives of all three components of the model (cf. Figure 1):

- (1) Elementary key concepts were isolated based on a clarification of the science content matter (colour phenomena) and on an analysis of its educational significance.
- (2) Students' conceptions and learning problems known from PER were analysed and reflected in the light of the intended educational aims.
- (3) A first version of a learning environment was constructed based on the findings of the first two components.

This first version of a learning environment was then evaluated with teaching experiments [8]. The findings of this evaluation serve as basis for revising and redesigning the materials.

Reconstruction of White Light for year 8 students

After encountering students' problems with the concept of white light, we decided to enter a new cycle of educational reconstruction. The following section focuses on the educational reconstruction of the concept of white light and portrays the processes carried out within all three components of the model (cf. Figure 1).

A special emphasis was put on the second component, on the learners' perspectives as well as on the third component, the learning environment itself. The learning environment was of high interest in two respects: Firstly, we were interested in the quality of conventional learning environments (= school books) especially in the forms of representations of white light used there. The idea behind this was to get an impression of the visual stimuli students are most likely confronted with during their instruction in basic optics. Secondly, the design of our learning environment should be guided by the findings from the school textbooks analysis and by students' ideas on white light identified after their conventional instruction in basic optics.

We based our clarification of the science content matter on the physical concept of white light as defined by Hecht [12, p. 77]:

White light is actually a mixture of all the colours of the visible spectrum. [...]. [T]he very concept of whiteness seems dependent on our perception of the Earth's daylight spectrum – a broad frequency distribution that falls off more rapidly in the violet than in the red [...]. The human eye-brain detector perceives as white a wide mix of frequencies, usually with about the same amount of energy in each portion. [...]. Nonetheless, many different distributions will appear more or less white. We recognize a piece of paper to be white whether it's seen indoors under incandescent light or outside under skylight, even though those whites are quite different.

As elementary key concepts we isolated the ideas that:

- a. White light is a mixture of all colours of the visible spectrum.
- b. The distribution of energy across the frequency spectrum of white light is usually evenly spread.
- c. Colours are subjective human physiological responses to the reception of various frequency regions.
- d. Many different frequency distributions appear as white when human physiological conditions are taken into account.

These elementary key concepts on white light were compared to the directives of the national curriculum. In Austria, colour phenomena are for the first time subject of formal instruction in year 8 in the context of initial instruction of geometrical optics. The Austrian Physics curriculum for year 8 does, however, exclude the wave aspect of light. This fact limits the set of core ideas (see elementary key ideas a-d) on two levels: On the one hand, it is not possible to base instruction of colour phenomena on the idea that the spectral distribution of frequencies determines the characteristics of light. On the other hand, human colour sensations cannot be explained as “a manifestation of the electrochemical sensing system - eye, nerves, brain” which is for example responsible for the fact “that a variety of different frequency mixtures can evoke the same colour response from the eye-brain sensor” [12].

After going through this clarification of subject matter, the second phase of educational reconstruction relates the elementary key ideas identified to students’ perspectives.

First of all, research literature was analysed. The findings can be summarized as follows: Colour phenomena are regarded as one of the most difficult ideas within basic optics even by researchers. Existing research on children’s notions of colour is sparse and limited to work with white light. The most important student conceptions on light¹ are summarized here:

- Light is transparent, you can see through it. [13]
- Light is colourless, light is bright. [14,15]
- Ordinary "white" light is pure, clear, or colourless. [16]
- White light / sunlight is not composed of different colours. [15]
- White light is “bright” and lets you see the colours of the object. [15]
- Light from the sun is mixed with all sorts of other lights, you know, ultraviolet light and radioactive light. [13]
- Yellow is light like the sun, bright and warm. [15]

This short overview of findings indicates that students hold different ideas about light (sunlight, white light) which are not necessarily congruent with a physical concept. Taking the idea of constructivist learning and educational reconstruction seriously means that the issue of white light needs to be investigated in more detail. In terms of our project, we decided to dig deeper and to find out more about students’ ideas on white light after their formal instruction in geometrical optics. For this clarification of the students’ perspectives on white light explorative interviews needed to be carried out.

As already mentioned for the third component of the model, the design of learning environments, two different aspects were regarded as relevant for our project. On the one hand, we were interested in facets of conventional instruction on colour phenomena, since they may be regarded as one factor for students’ post instructional ideas. For this paper, we will only concentrate on the way (white) light is represented in school textbooks. Next to this retrospective analysis of already existing learning environments and their implications for students’ conceptions, the design of an alternative, research based learning environment was in the focus of our project.

¹ The term light is synonymously used to white light, sunlight, daylight, ...

Bringing all the considerations discussed in this section together, our basic set of core ideas for the concept of white light for year 8 students can be put as follows:

- a. White light is a mixture of all prismatic colours.
- b. White light can be split up in different prismatic colours.
- c. An addition of all prismatic colours results in white light.
- d. “We recognize a piece of paper to be white when it’s seen indoors under incandescent light or outdoors under skylight, [...]” [12]. A light source emits white light, when it illuminates such a piece of paper and when we still recognize it as white.
- e. White light and sunlight (daylight) are similar in their composition. White light is “sun-like” light.

The instructional module was based on this set of core ideas as well as on learning difficulties and students’ conceptions distilled in component two of the model (cf. Figure 1). In addition, findings concerning weaknesses in existing learning environments manifested in school textbooks, respectively in their visual representations of white light, were also considered.

Research Questions

The intention of this paper is to give a broad overview of three intertwined studies connected to the topic of white light, since a detailed description would by far exceed the limits of this contribution. For details on each individual research strand we would like to refer the reader to our previous articles [19,20,22,23].

As already mentioned in the introduction, when we worked with year 9 students who just had had their instruction in optics in year 8, we found a number of ideas concerning the term “white light”. These ideas were, however, rarely in harmony with elementary key concepts which should be a solid basis for teaching colours (see e.g. key ideas isolated in the course of educational reconstruction of white light). So the overall aim of these investigations were to explore issues related to the concept of white light and its representation on three different frontiers. Here, just the main research questions of the three research strands are reported:

1. Which concepts do students have about “white light” after basic instruction in optics?
2. How is “white light” represented in Austrian school textbooks?
3. a) Do students accept the term “sun-like” light better than “white light”?
b) Are students after our instructional module more willing to accept the key idea that sun-like light (\equiv white light) is a mixture of prismatic colours than after their conventional instruction in geometrical optics?

Research Design & Research Methods

According to the three main research questions, the research design of this project is split into three strands:

- 1) Investigations on students’ conceptions about white light.
- 2) Analysis of representations of white light in school textbooks
- 3) Instructional intervention to promote conceptual understanding of white light.

The first two strands were meant to analyse the status quo we find in teaching reality, while the third one was an attempt to find ways out of the problem areas identified in the first and the second strand (cf. Figure 2). In the following, an overview on the research methods used within these three strands is given.

The first strand of research focuses on students' conceptions about white light. Here interviews with year 9 students (N=12, 5 male, 7 female) were conducted. The sample was randomly chosen in a vocational school. Students coming from different school types of lower secondary enter vocational schools in year 9. The reasons for the choice of this school type for our sample were twofold: on the one hand, we wanted to find out students' ideas about "white light" right after their instruction in basic optics, which takes place at the end of year 8. On the other hand, we wanted to have students with different educational backgrounds, different year 8 teachers and different cultural and language backgrounds.

In these interviews, the main focus was put on the concepts students relate to the term "white light". Other issues were to identify sources which emit white light and finally, to identify which light colours students attribute to the light emitted by different light sources like the sun, light pulps etc.

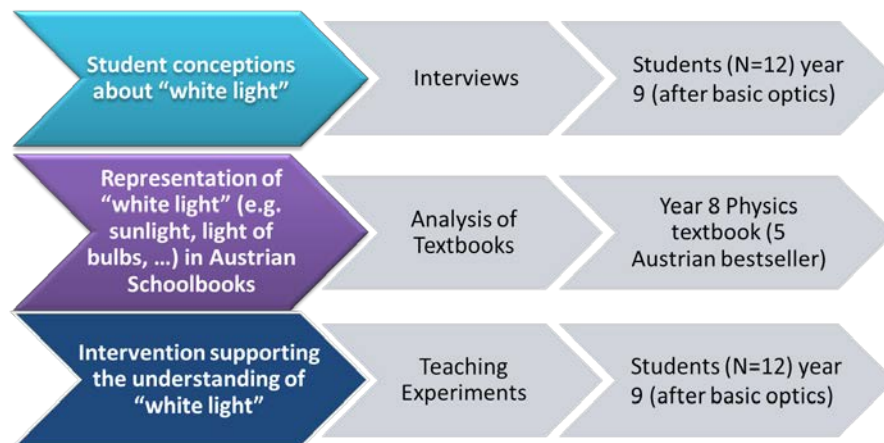

Figure 2. Research Design – Methods – Sample

The second strand of research focuses on representations of white light used within learning environments. As corpus data we chose the five bestselling Austrian physics school textbooks of year 8, which are a quite representative selection of all physics textbooks approved for schools.² Treagust describes [18], conceptions as "the learner's internal representations constructed from the external representations of entities constructed by other people such as teachers, textbook authors or software designers". Following this definition, visual representations play a crucial role for the way students conceptualize e.g. light. In the course of the second strand, we analysed all the visual representations in the optics chapters of the five top selling year 8 school textbooks. In addition, we searched the optics chapters for any explanations concerning the choice of colours used to represent white light [20].

In strand three, an interventional strategy on white light was tried out with year 9 students (N=12) and evaluated with the help of teaching experiments [8]. Teaching experiments are

² In Austria, school textbooks are provided by the state and parents have to contribute only a small percentage of the costs. Austrian schoolbooks have to be approved by a commission appointed by government. Usually there are school textbooks for all classes and research shows [17] that school textbooks are frequently used by Austrian teachers.

a combination of interview and micro-teaching setting, with single students or pairs of students who work through student materials section by section. The instructor of such a teaching experiment takes simultaneously the role of an interviewer. After each input phase he tries to find out if the students have understood the key ideas of the material on a conceptual level and whether the text input and the representations used in the text are understandable and helpful for the learning processes. So, each instructional phase is followed by an interview phase which focuses directly on students' ideas connected to the key ideas conveyed in the previous instructional phase. The aim of this procedure is to get insight into students' learning processes and to identify learning difficulties. Finally, it is tested whether the students are able to transfer the concepts conveyed in a section to related phenomena [21]. After this, another input – interview – transfer cycle, which is based on the next section of the student materials, starts. The method of teaching experiments allows to portray students' learning processes and, above all, to identify obstacles in the learning process. The results of the teachings experiments are used to redesign and improve the student material [20].

The core idea of our intervention on white light is to substitute the term “white”, which obviously evokes the idea of white light having a colour – namely white – and thus having equal characteristics as prismatic colours (like red, or green, or blue, etc. light). Using a “colour name” to describe white light seems to put it in the same category as yellow light or red light etc. The components of this category (different prismatic light colours) are thought to be at an equal hierarchical level (white light is similar to red light in its characteristics etc.). Instead, a relationship at different hierarchical levels (white light consists of blue and red light etc.) needs to be established to portray the concept of white light in an adequate way.

Based on these considerations we searched for a term substituting “white”. In an expert panel we finally arrived at the term “sun-like” and based our intervention on it. Figure 3 shows the content structure of our intervention:

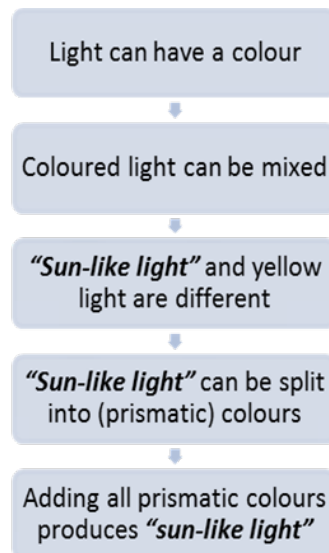

Figure 3. Flow chart of key ideas in the intervention on white light

Selected Results

Selected results of all three research strands are presented and discussed in the following sections. The results presented here are just a selection of relevant findings from each individual research strand [19,20,22,23]).

Students' ideas on the nature of white light

The results presented here refer to the strand on students' conceptions on white light. They follow from students interviews.

The analysis shows that the majority of the students of our sample are not able to name sources of white light (cf. Figure 4), although they had already had instruction in basic optics. One student even strongly denied the existence of any light source that produces white light. Those students who named sources of white light mentioned next to the sun, artificial light sources like spot lights, neon tubes and pocket lights. Interestingly UV light, lasers and death (near death experiences) were also identified as sources of white light.

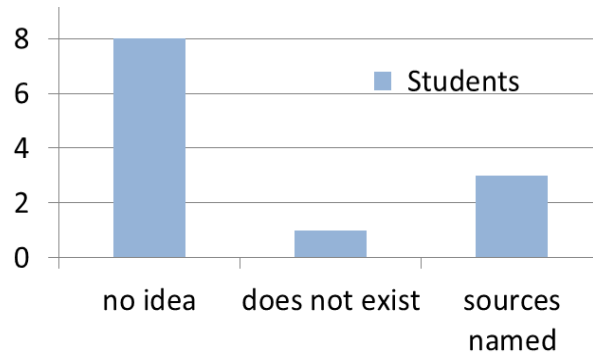

Figure 4. Sources of white light

Next, the students were asked about the colour of sunlight³. The majority of students' answers (cf. Figure 5) contained yellow (9 out of 12), either pure yellow, a mixture of red and/or orange with yellow, or they describe sunlight as a transparent, yellowish entity. In contrast, only two out of 12 students identified sunlight as white or whitish.

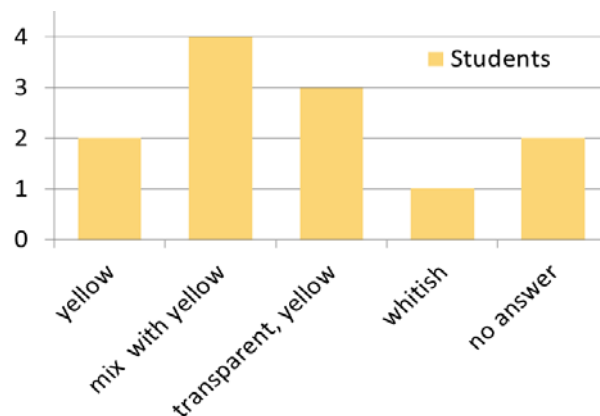

Figure 5. Colour of sunlight

³ Sunlight is categorized in many physics books as white light. Hecht [12] for example states: “[...] the very concept of whiteness seems dependent on our perception of Earth’s daylight spectrum [...].”

Visual representations of white light in school textbooks

The analysis of the five bestselling year 8 physics school textbooks revealed that white light is represented either by red light rays or by yellow ones (cf. Figure 6). Two books even use both types of representation. Interestingly, in none of these school textbooks did we find any kind of verbal statement that white light is represented in red and/or yellow, nor is any explanation given why white light is represented that way.

Textbook	Representation of „white light“	Explanation
IP	red	X
P4	red/yellow	X
PV	red	X
PH	red/yellow	X
PÜ	yellow	X

Figure 6. Representations of white light

These findings were included in our teaching materials. White light or light emitted from the sun, light bulbs and the like were represented in white.

Evaluation of the instructional model with teaching experiments

As mentioned above, one of our strategies to support students in understanding the physical concept of white light is to substitute the term “white” with “sun-like”. About two thirds of the students accept this term as adequate for describing the light emitted by bulbs, candles etc. after the teaching experiment. There is, however, one quarter of students who shows resistance to use this term (cf. Figure 7).

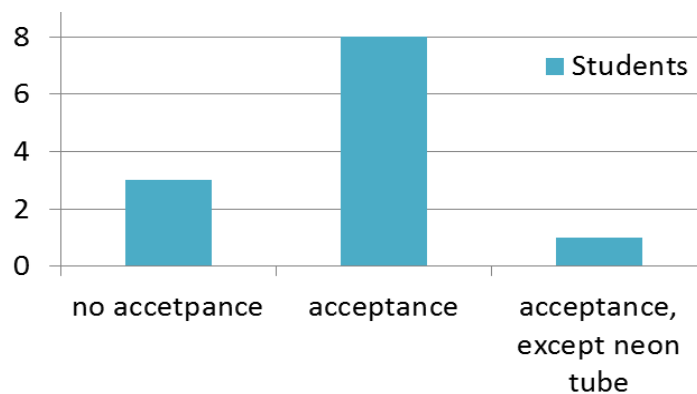

Figure 7. Acceptance of the term “sun-like” light for light of bulbs, candles etc.

The results of the teaching experiments show that the intervention succeeds in promoting the key idea that sunlight or “sun-like” light (\equiv white light) is composed of coloured light. After the intervention more than two thirds of the students are able to transfer this key idea to related phenomena (cf. Figure 8, POST-bars). In contrast, before the intervention only a quarter of the students accepted the pure fact that white light is composed of coloured light (cf. Figure 8, PRE-bars), although they had already had conventional instruction in optics. This means that students, who rejected this idea before the intervention, do not only accept it afterwards, but they are also able to argue related problems based on this concept.

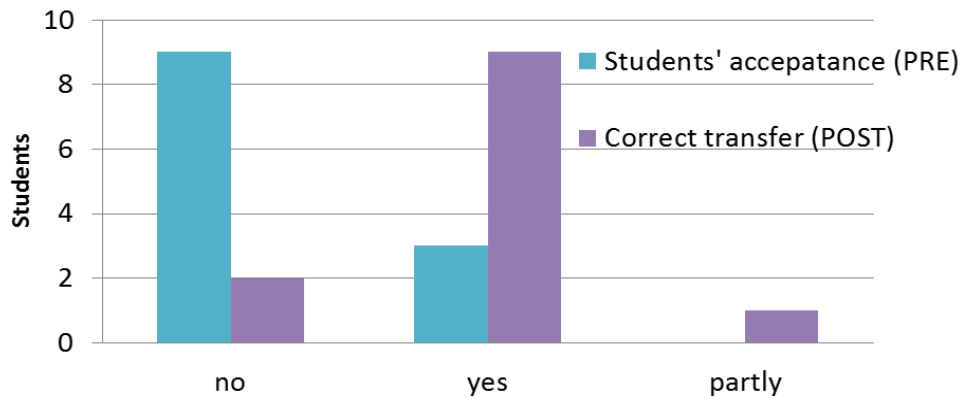

Figure 8. Student's ability to transfer the key idea "sun-like" light is composed of coloured light

Conclusion

The model of educational reconstruction emphasises the importance of students' conceptions for triggering conceptual change. The student interviews reported here, show that students of our sample have even after their optics classes severe problems in conceptualizing white light in a scientific adequate way. A solid physical concept of white light is, however, necessary for the understanding of colour phenomena in general. Visual representations in Austrian school textbooks seem to contribute to the confusion that sunlight is actually yellow but physicists call it "white". The problem of visual representation of white light seems to be even deeper rooted. It is not only a misleading representation in school textbooks but starts in early childhood, since children's drawing use to include a sun or lamps or similar light sources emitting yellow light.

The strategy to emphasise the status of white light as not being of the same category as prismatic colours, by substituting the colour word "white" with "sun-like" proved to be partly effective. The idea of denoting different categories of light with different names seems to be a viable concept. However, the choice of "sun-like" may be counterproductive in some respect, as students tend to associate sunlight with the colour yellow. Although the intervention, especially the term "sun-like", leaves room for improvement, the educational reconstruction and the instructional strategies used, support students in grasping the idea of white light as a composition of different prismatic colours.

In conclusion it can be said that the small sample definitely is a limitation of this study. However, the intervention carried out worked well for the students of the sample and was quite effective in addressing their alternative conceptions. In order to be able to generalize the findings further interviews and teaching experiments are needed, yet.

References

- [1] Duit R.: Bibliography—STCSE: Students' and teachers' conceptions and science education. Retrieved October 20, 2009; 2009.
- [2] Andersson B., Kärrqvist C.: How Swedish pupils, aged 12-15 years, understand light and its properties. *International Journal of Science Education* 1983;5(4):387–402.
- [3] Driver R., Guesne E., Tiberghien A. (eds): *Children's ideas in science*. 1993rd ed. Buckingham, Open University Press, 1985.
- [4] Jung W.: Fallstudien zur Optik. *physica didactica* 1982;9:199–220.

- [5] Fetherstonhaugh T., Treagust D.: Students' understanding of light and its properties: Teaching to engender conceptual change. *Science Education* 1992;76(6):653–672.
- [6] Herdt D.: Einführung in die elementare Optik. Vergleichende Untersuchung eines neuen Lehrgangs. Essen: Westarp-Wissenschaftsverlag 1990.
- [7] Wiesner H., Engelhardt P., Herdt D.: Unterricht Physik, Optik I: Lichtquellen, Reflexion. Köln, Aulis Verlag Deubner & Co, 1995.
- [8] Komorek M., Duit R.: The teaching experiment as a powerful method to develop and evaluate teaching and learning sequences in the domain of non-linear systems. *International Journal of Science Education* 2004;26(5):619–633.
- [9] Duit R., Treagust D.: Conceptual change: a powerful framework for improving science teaching and learning. *International Journal of Science Education* 2003;25(6):671–688.
- [10] Kattmann U., Duit R.: The model of educational reconstruction. Bringing together issues of scientific clarification and students' conceptions. In Bayrhuber B(ed): *What-Why-How? Research in Didaktik of biology*, 1998, pp 253–262.
- [11] van Dijk, Esther M., Kattmann U.: A research model for the study of science teachers' PCK and improving teacher education. *Teaching and teacher education* 2007;23(6):885–897.
- [12] Hecht E., Zajac A.: *Optics*. Addison-Wesley 2002;2:163–169.
- [13] Gilbert J., Watts D.: *Concepts, misconceptions and alternative conceptions: Changing perspectives in science education* 1983.
- [14] Blumör R.: *Schülerverständnisse und Lernprozesse in der elementaren Optik: Ein Beitrag zur Didaktik des naturwissenschaftlichen Unterrichts in der Grundschule*. Magdeburg, Westarp Wissenschaften, 1993.
- [15] Feher E., Meyer K.: Children's conceptions of colour. *Journal of research in Science Teaching* 1992;29(5):505–520.
- [16] Eaton J., Anderson C., Sheldon T.: *Light: a teaching module*, Institute for Research on Teaching, 1986.
- [17] Rechberger V., Livitzis M., Aldrian J. et.al: Perceptions of teachers and learners about the mathematics, science and technology curricula in two European countries. ESERA conference, Nikosia, August 2013.
- [18] Treagust D. F., Duit R.: Conceptual change: A discussion of theoretical, methodological and practical challenges for science education. *Cultural Studies of Science Education* 2008;3(2):297–328.
- [19] Haagen-Schützenhöfer C., Holzmeier S.: Wodurch unterscheiden sich Physikschulbücher und forschungsbasiert entwickelte Lernmaterialien zum Themenbereich geometrische Optik? ÖFEB Symposium, Klagenfurt, 2013.
- [20] Haagen-Schützenhöfer C., Fehringer I.: Akzeptanzbefragung zu Optikunterrichtsmaterialien. GDCP, München, 2013.
- [21] Jung W.: Probing acceptance, a technique for investigating learning difficulties. In Duit R., Goldberg F., Niedderer H. (eds): *Research in physics learning: Theoretical issues and empirical studies*. Kiel, Institut für die Pädagogik der Naturwissenschaften an der Universität Kiel, 1992.

- [22] Haagen-Schützenhöfer C., Rottensteiner J., Hopf M.: Akzeptanzbefragung zu Optikunterrichtsmaterialien. In Bernholt, S. (Hrsg.), GDCP Jahrestagung in Hannover 2012: Inquiry-based learning - Forschendes Lernen. Münster/New York: LIT Verlag, 2013.
- [23] Haagen-Schützenhöfer C., Wallner B.: Hands-on supporting students in understanding the process of vision. In Taşar, M. (Hrsg.), World Conference of Physics Education 2012 in Istanbul: Book of Proceedings. Ankara, 2014.

Experiments with Cosmic Rays in out-of-school settings and their impact on interest

Martin Hawner^{1,2}, Sascha Schmeling², Thomas Trefzger¹

¹Faculty for Physics and its Didactics, University of Würzburg, Germany

²CERN, Geneva, Switzerland

Abstract

Since 2010, the German network „Netzwerk Teilchenwelt“ (english: particle world network) has been built up in order to promote particle and astroparticle physics in Germany. The two main activities, which are mostly done in out-of-school settings, are the particle physics masterclasses and measurements with cosmic ray muon detectors. This article focuses on the experiments with cosmic rays. Using these experiments, the University of Würzburg is offering one-day out-of-school activities, which are the basis for an evaluation study on the development of science interest (as defined by Krapp [1]) in out-of-school laboratories. After giving an introduction to the network and the experiments, the evaluation methods and the results of the pilot study will be presented.

Keywords: astroparticle physics, out-of-school activities, evaluation

Promotion of particle and astroparticle physics

In order to promote particle and astroparticle physics, a network in Germany called “Netzwerk Teilchenwelt” [2] (english: particle world network) was founded in 2010. There are 24 institutes and universities participating in the project. The goal is to get students, teachers and also the general public interested in modern particle physics. This is accomplished through two main activities: particle physics masterclasses and the cosmic ray experiments.

The masterclass is a half-day to daylong workshop, in which the participants can learn more about LHC experiments (the LHC is the Large Hadron Collider at CERN in Geneva [3]) in general and how data collected in the collider is analysed by scientists. The participants actually have the opportunity to conduct data analysis with real data sets themselves.

In the context of astroparticle physics, the students can use two different types of detectors to discover cosmic ray muons. These are the so-called “coffee pot” experiment ([4] and [5], see Figure 1), which uses the Cherenkov effect to detect particles and the “Cosmic Muon Observer” experiment [6] (CosMO-experiments), which uses the scintillation counter that is shown in Figure 2. It is important to notice that the same measurements can be performed with both setups. Both experiments are quite authentic since they use detection methods similar to those used in modern particle and astroparticle physics.

In the M!ND-Center [7] of the university of Würzburg and at CERN, these experiments are used in out-of-school activities. These workshops take a bit longer than half-a-day and are subject to an evaluation study on interest development (the evaluation study is described later in this article). The out-of-school activities will be further specified below.



Figure 1. One set of the “coffee pot” experiment with a power supply, two coffee pots filled with water, two photomultipliers screwed on top and a data box



Figure 2. A set of the “CosMO” experiment with a notebook for the data analysis, a data acquisition card and three scintillator plates

Out-of-school activity for astroparticle physics

The out-of-school learning environment for astroparticle physics of the University of Würzburg and CERN was developed for students of ages 15 years and older. So far, the “CosMO” experiments have been used most often. Working with the detectors provides a good insight into the methods of modern science. The participants perform all the necessary steps from assembling the detectors to generating hypotheses and proceed to taking and analysing data. During the workshop, the students will do different measurements. Every measurement will be discussed and checked for validity. This way, students learn how to critically test their hypothesis. In addition, they can learn about the measurement limits of the experimental instruments as well as about statistical uncertainties.

The workshop day starts with an introductory lecture about cosmic rays in general. Afterwards, the students build a cloud chamber themselves, in which they can observe the tracks of muons with their own eyes. This procedure helps as an introduction to the often mysterious and, for students, abstract topic of particle physics. The cloud chamber workshop is followed by a short briefing on how to assemble the experimental setup and how to start the measurement along with its different modification possibilities (such as threshold levels and modulations for coincidence measurements). Once this has been done, the participants start their own measurements. So far, the following exercises have been involved:

- *Introductory measurement of the rate of cosmic muons:*
The goal of this measurement is to get to know the statistical characteristics of cosmic rays. This is achieved by measuring the rate multiple times while keeping the threshold levels and all the other modulations constant. In this context, further aspects such as measurement time interval can be discussed.

- *Getting to know the detector geometry:*
This exercise allows students to learn more about the meaning of coincidence measurements and the influence of the distance and angle between the detection volumes (the coffee pots in the case of the “Coffee pot” experiment and the scintillation plates in the case of the “CosMO” experiments). This exercise complements the previous measurements in terms of (measuring) uncertainties and characteristics of the cosmic ray muons.
- *Absorption of muons:*
Cosmic ray muons travel with almost the speed of light and are about 200 times more massive than electrons. That’s why they can travel such long distances, for example from the beginning of the atmosphere to the Earth’s surface. So they are quite hard to stop. However, materials such as thick concrete or lead can slow them down or stop them completely. An easy way to observe this effect is to measure the rate (by using constant measuring conditions) in all floors of the university building. The fewer concrete ceilings there are above the detectors, the higher the count rate is.
- *Measuring the angle distribution of the incoming muons:*
This measurement combines the knowledge gained in the previous exercises. The rate’s dependence of the incoming angle has to be measured. This allows us to find out where the greatest number of muons come from. One has to take into account the way the muons travel. Moreover, a differentiation between primary and secondary cosmic rays needs to be considered. The participants have to find out, whether this measurement is sufficient enough to determine the direction of the muons and what conclusion they can draw from their data.

Of course, other measurements can be done with the detectors, but often this would require more time than is available. Further interesting measurements are the determination of the lifetime of muons and the velocity of the muons. To answer both questions, long data-taking is required which cannot be done within a day. However, these measurements can enrich longer lasting projects involving fewer students.

Evaluation study on interest development

The out-of-school activity is accompanied by an evaluation study. The goal is to evaluate the effectiveness of this study. The main focus lies on the development of interest and academic self-concept. Furthermore, we want to identify the underlying factors. In addition to that, the long-term development of student interest will be observed. Previous studies (for example, Engeln [8] or Pawek [9]) discovered that hardly any effects can be observed after a couple of weeks have passed. In order to examine and counteract these effects, a short wrap-up will be integrated in the school lessons afterwards. The theory behind the study is presented below.

Interest

The fundamental theory used in this study is the “person-object-theory of interest” by Krapp [1]. He defines interest as follows: “An interest represents a more or less enduring specific relationship between a person and an object in his or her ‘lifespace’” [1]. An object of interest can be a concrete thing, certain topics, persons or different fields of knowledge.

Three different features define the relationship between a person and an object of interest: the *epistemic* component, the *feeling-related* component and the *value-related* component. The epistemic component induces a person to try to gain more profound knowledge about

the object of interest. If positive feelings come up during an activity of interest, one speaks of feeling-related facets. Under extreme conditions, a certain flow might be experienced. If a person-object-relationship is personally significant, it can be described as a value-related facet.

Two types of interest can be differentiated. One type is the personal or individual interest, which is connected to latent dispositions. Personal interest means that a person is interacting with an object out of his or her own accord. This is a long-term interest, which changes only slowly. On the other hand an interest can be actualized or provoked by a certain situation. It is a momentary interest caused by a situation of interest. There are two different ways in which this kind of interest can arise. If an interest is triggered by a specific situation, it can be characterized as a situational interest. The situation that caused the interest can be a learning environment, a new teaching method, a surprising experiment, or a new teacher, just to name a few. If the actualization of interest is mostly induced by a pre-existing personal interest and not so much by a specific situation, one talks about actualized situational interest. Since it is very hard to distinguish these characteristics, we will just consider actualized interest in general.

Academic self-concept

Like personal interest, the academic self-concept is known to be a latent disposition, which does not easily change. Moreover, the interest and the academic self-concept related to physics correlate with each other [10]. So they both influence the interest in physics and the motivation to further deal with the subject. The academic self-concept is enhanced mainly through feedback of the social environment and through comparison of one's own academic achievement with the academic achievement of classmates. So it is a very important disposition, which constantly changes through self-reflexion and comparison with others.

Creating long term effects

A recurring, enduring activity of a person and an object leads to a stable relationship. This causes latent dispositions; in fact, it leads to a development of personal interest. So how can actualized and personal interest develop during an out-of-school activity? In order to create personal interest out of actualized interest certain conditions have to be achieved. This can be done with the help of Mitchell's theory of catch- and hold-facets [11].

The catch-components are supposed to arouse curiosity and attention. As already indicated, these can be new teaching methods, exiting and surprising experiments, phenomena that cause cognitive conflicts, but also unknown learning environments or even new teachers. Thus, out-of-school environments offer a lot of catch-components. However, in order to create an enduring personal interest, so-called hold-facets need to stabilize the momentary interest. This is a lot harder to achieve. According to Mitchell, students need to recognize a meaningfulness of the potential object of interest. Since the out-of-school intervention usually only takes place over a short time, it is unlikely that a change in latent dispositions happens. This has already been observed in previous studies (for example [8], [9]). A wrap-up of the out-of-school day could create this meaningfulness and enforce long-term effects.

Because only the pilot study with a pre- and post-test has been conducted so far, no results of long-term effects can be presented in this article. However, first insights from the pilot study will be presented in the following section.

Pilot study

The pilot study was conducted with 61 students. The pre- and post-questionnaires were distributed right before and right after the out-of-school day. The scales of the paper-and-pencil test are based on scales of other studies like Engeln [8], Pawek [9] or Sommer [12].

Scales

The scales were tested with a factor and a reliability analysis. Some of the scales can be seen in Table 1. In addition to that, scales such as comprehensibility, openness, or active participation were surveyed in order to find out which event properties influenced possible effects. Furthermore, scales measuring student attitude towards physics and their subjectively experienced learning achievement were implemented in the survey. All in all, the test has high Cronbach α scores as well as high item discrimination scores, which means that the scales are reliable. The factor loadings could also be reproduced. Only the experimental dimension of objective interest didn't score well in terms of reliability and factor loadings. Reasons for this could be the relatively small sample size [13] and the problematic wording of one item. This is going to be corrected for the main study by generating a higher number of participants, changing the problematic item, and by adding two more items to the concerned scale.

Table 1. Scales of the questionnaire. The value of the item discrimination corresponds to the smallest value of all items of the (sub-) scale.

Scale	Dimension	#	N	Item discrimination		Cronbach α	
				t ₁	t ₂	t ₁	t ₂
objective interest	<i>physics</i>	4	60	> 0.58	> 0.64	0.80	0.86
	<i>experimental</i>	3	60	> 0.26	> 0.16	0.54	0.50
	<i>independent activity</i>	3	60	> 0.58	> 0.67	0.78	0.85
interest (in subject)	<i>physics</i>	3	61	> 0.58	> 0.58	0.76	0.78
academic self-concept	<i>physics</i>	7	60	> 0.60	> 0.61	0.90	0.91
actualized interest	<i>feeling-related</i>	4	61	-	> 0.61	-	0.81
	<i>value-related</i>	3	61	-	> 0.47	-	0.70
	<i>epistemic</i>	5	60	-	> 0.57	-	0.88

First results

A first look into the data of the post-test revealed quite high scores for the actualized interest (see the left side of Figure 3). On a normalized 5 point Likert scale from 0 (fully disagree) to 1 (fully agree), the feeling-related component of the actualized interest scores 0.78, the value-related component scores 0.75 and the epistemic component scores 0.56 points. This is a very good result for the out-of-school learning environment. The students seem to be pleased with what they have learned. These results are similar to Pawek [14].

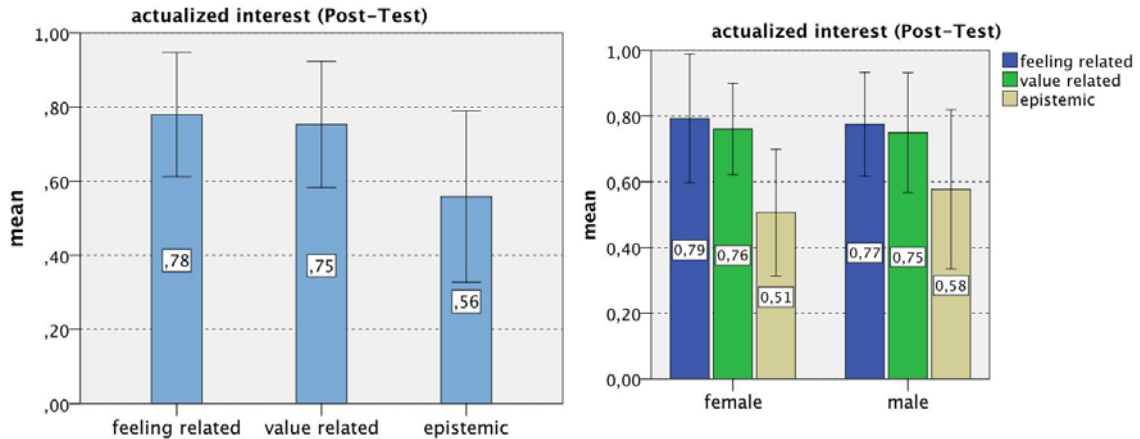

Figure 3. The mean and standard deviation of the actualized interest is displayed on the left. On the right, the actualized interest of female and male students is given.

If we look at the actualized interest by gender (Figure 3 on the right), no significant differences between male and female students can be observed in any of the three dimensions. As described by Engeln [15], there is no gender gap, which is one of the big advantages of out-of-school learning environments. How the actualized interest develops in the follow-up tests, especially under different conditions (with and without a wrap-up) still needs to be investigated.

The academic self-concept is slightly higher in the post-test than in the pre-test (Figure 4 on the left). Since it is very hard to influence self-concept within a couple of hours, the observed gain can be considered a success. The effect size is very small ($d = 0.12$), but the difference is significant. This was tested with the t-test for paired samples ($p < .03$) and the Wilcoxon-test ($p < .006$).

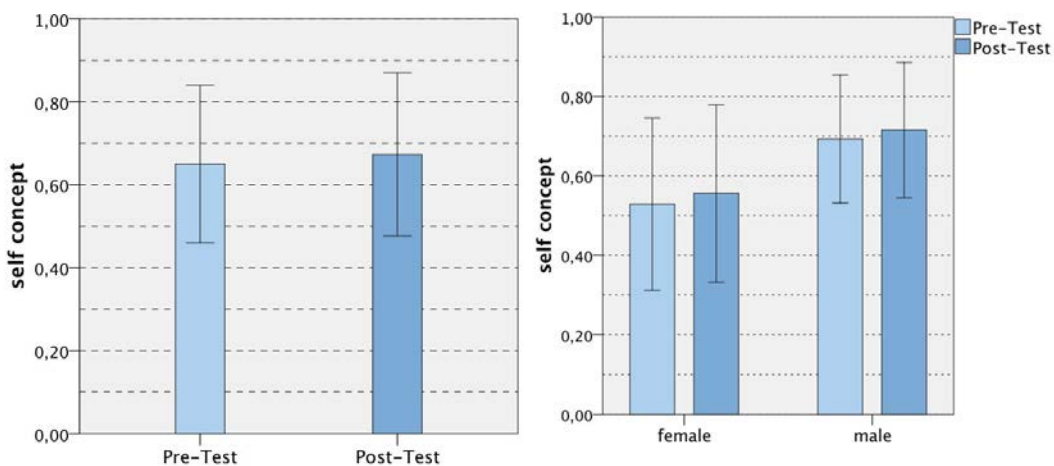

Figure 4. On the left, pre- and post-scores of the academic self-concept are displayed. On the right figure, the scores are separated according to gender.

Looking at self-concept for female and male students separately, it becomes apparent that a gender gap exists (Figure 4, right side). This is due to the fact that the self-concept is a disposition that changes only slowly. The self-concept of girls is significantly lower than that of boys. The difference in the pre-score has an effect size of $d = 0.86$ (independent t-test: $p < .013$ and Wilcoxon test: $p < .012$) and post-score difference has an effect size of $d = 0.79$ (independent t-test: $p < .017$ and Wilcoxon test: $p < .015$).

Conclusion and perspective

The first results of the pilot study are promising. However, a more detailed analysis is still to be done. The factors that influence interest as well as self-concept still have to be identified. Moreover, the event properties haven't been included in the analysis yet.

The main study is running right now and more data has to be collected. With regards to the long-term effects, the follow-up questionnaires are particularly interesting. It remains to be seen if the wrap-up phase can contribute positively to the long-term interest development.

References

- [1] Krapp A.: Structural and dynamic aspects of interest development: theoretical considerations from an ontogenetic perspective. In: Learning and Instruction, Vol. 12 (2002), p. 383-409.
- [2] Homepage of the "network particle world". [online]. [cit. 13. 9. 2013]. Available from: <http://www.teilchenwelt.de>
- [3] CERN Homepage. [online]. [cit. 13. 9. 2013]. Available from: <http://home.web.cern.ch>
- [4] Homepage of the "coffee-pot"- experiment of the University of Göttingen, Germany. [online]. [cit. 13. 9. 2013]. Available from: <http://kamiokanne.uni-goettingen.de>
- [5] Fuidl M.: Kosmische Myonen in Schulversuchen. Staatsexamensarbeit, University of Mainz. [online]. [cit. 13. 9. 2013]. Available from: <http://www.iph.uni-mainz.de/551.php>
- [6] Homepage of the „network particle world“ for the CosMO-experiments. [online]. [cit. 13. 9. 2013]. Available from: <http://www.teilchenwelt.de/angebote/astroteilchen-experimente/>
- [7] Homepage of M!ND-Center of the University of Würzburg, Germany. [online]. [cit. 13. 9. 2013]. Available from: <http://www.mind.uni-wuerzburg.de>
- [8] Engeln K.: Schülerlabors: authentische, aktivierende Lernumgebungen als Möglichkeit, Interesse an Naturwissenschaften und Technik zu wecken. Logos-Verlag Berlin (2004), ISBN 3-8325-0689-6.
- [9] Pawek C.: Schülerlabore als interesselördernde außerschulische Lernumgebungen für Schülerinnen und Schüler aus der Mittel- und Oberstufe. Dissertation, Universität Kiel (2009).
- [10] Köller O., Trautwein U., Lüdtke O., Baumert J.: Zum Zusammenspiel von schulischer Leistung, Selbstkonzept und Interesse in der gymnasialen Oberstufe. In: Zeitschrift für Pädagogische Psychologie. Vol. 20 (2004), p. 27-39.
- [11] Mitchell M.: Situational interest: Its multifaceted structure in the secondary school mathematics classroom. In: Journal of Educational Psychology. Vol. 85 (1993), p. 424-436.
- [12] Sommer S.: Interessengenese durch Interaktion – Das Interventionsprojekt der Miniphänomena in quasiexperimenteller Langzeitevaluation. Dissertation, Universität Flensburg (2010).
- [13] Backhaus K., Erichson B., Plinke W., Weiber R.: Multivariate Analysemethoden – Eine anwendungsorientierte Einführung (13. Aufl.). Berlin: Springer (2011), ISBN 978-3-642-16490-3.

- [14] Pawek C.: Schülerlabore als nachhaltig das Interesse fördernde außerschulische Lernumgebung. In: *Ausserschulische Lernorte - Beiträge zur Didaktik. Kompetenzentwicklung an außerschulischen Lernorten*, (2012).
- [15] Engeln K., Euler M.: *Forschen statt Pauken*. In: *Physik Journal*. WILEY-VCH (2004), p. 45-49.

Innovations in physics' teacher education – how to educate GEN Y teachers

Renata Holubová

Faculty of Science, Palacky University, Olomouc, Czech Republic

Abstract

The purpose of the pre-service teacher training at our university is to make sure that students will become competent teachers and skilled members of the society. We can see that one of the most important educational goals of education at our faculty is improving the quality of teaching. Our pre-service teachers must be prepared for a different style of work at secondary and high schools. The aim of the paper is to discuss the outcomes of the project focused on the innovation of the professional teacher training. A new programme of the physics teacher study was started and new subjects and modules were prepared. It will be shown that all the innovations are based on learner-centred methods (active learning, PBL, interdisciplinary relations) and technology-based lessons aimed at improving pre-service teachers' skills and knowledge.

Keywords: teacher education programme, physics, gen Y teacher, gen Y learner

Introduction

Present-day youth, either school students or graduates coming into their first job, is being called a new generation or Generation Y. The term Generation Y refers to that part of population that was born in the time period from the seventies up to now. Sometimes it is also referred to as Generation WHY (why). It is the most global generation, especially due to the development of communication technologies impact.

Each generation is formed on the background of social and historical events based on which its members develop their values that they keep throughout their lives.

Generation Y population characteristics

According to Hunt [1], Generation Y can be described as follows: children born into affluence told that they can achieve everything they dream about. They have got increased confidence and use technical equipment. They can follow the events in the world (and tragic ones) directly through the Internet, they are becoming "immune" and less sensitive to bad news. Current negative phenomena – terrorism, financial crisis, shooting at schools – reinforce their sense of community. A network of Internet friends helps them to deal with adverse events. Enabled by information and communication technologies, they are able to communicate directly with people around the world. Generation Y has moved from books and the written text in general to the virtual world – television, the Internet, video games; films played on computers have a central position. In terms of education, it is important to remember that today's generation does not read the text but rather scans it, preferring complexity to simplification and thus often evaluates information faster than its teachers.

Generation Y and learning

Research devoted to Generation Y students teaching and learning has shown some important characteristics of the learning process as well as some problems that it has in this respect. Awareness of these factors is important for the work of teachers in today's schools.

Students are demanding and vigorous and have high expectations, even in terms of learning. We can then summarize this attitude as follows [2,3]:

- Activities are more important than knowledge (technological progress results in the situation when the ability to find the right information at the very moment one needs it is much more important than having encyclopedic knowledge itself). What is really important is the result.
- The need for immediacy – little tolerance for delays, the need to have information immediately (just in time). As a result, learning is becoming rather superficial; what is really important is the amount of information regardless of their accuracy or correctness.
- Interest in solving problems – hence the requirement for the application of problem teaching. This is influenced by a large number of computer games in which an immediate solution to a problem and momentary reaction are required.
- Lowering the threshold of boredom, i. e. the ability to concentrate only during a short time. Students receive information from various sources – in part from television, but mostly from chatting on the Internet. They are not able to follow a lecture for a long time. This applies to all levels of education, from primary school to university.
- More parallel activities – students are motivated when they can perform multiple activities simultaneously, such as listening to music, reading, counting. This corresponds to their way of life. Most students prefer visual style of learning. The use of chalk and blackboard significantly reduces the success of learning [2,3].
- Joint learning – authoritative style of learning (top - down) should be replaced by interactive methods, active approaches, continuous contact with students.
- Constructivist approach – a combination of personal and social learning; thereby knowledge and skills are introduced during an active and creative students' activity.

Missing skills among Generation Y students include an ability to examine a problem thoroughly and reflect on it. The use of the Internet has shifted learning from "WHAT" to "HOW". Superficial knowledge leads students to a very shallow perception of the world around us, as they just want to learn things necessary in a given situation or to pass exams.

The operational approach of our schools has changed very little over the years; one of the reasons is that our institutions used to be rather successful. That is how we teach, where we teach, what we teach, who teaches and who ensures the operation of schools remain practically the same. A fundamental change in this approach is the idea of active learning (in English literature also participatory learning). Teaching techniques based on traditional methods discourage students of present-day generation. The new approach should become a challenge to every educational institution and every teacher.

Background and Methodology of Research

The project is focused on solving the following set of problems:

1. How to increase the effectiveness of undergraduate physics teacher training.
2. How to upgrade the contents of the compulsory subjects at the Bachelor or Master's stage program of study.

These sets of problems have been solved at the Department of Experimental Physics, Faculty of Science, at Palacky University, Olomouc, within the framework of EU projects in the years 2012 - 2014 (projects Modularization and Modernization of a Teacher of Physics Initial Training Study Program CZ.1.07/2.2.00/18.0018 and Modules as Tools of Innovation in Integrating the Teaching of Modern Physics and Chemistry CZ.1.07/2.2.00/28.0182).

Drawing on the analysis of the approach used to teach physics during a basic course of Bachelor stage of study at the Faculty of Science and evaluating the way of teaching students, we could show that it is becoming more and more difficult to maintain the teaching of the basic physics course in its current form. Lectures including tasks and laboratory work conducted jointly for students specialized in a professional degree in physics (single-subject study of applied physics, optics, general physics and mathematical physics, biophysics, molecular biophysics) as well as for students specialized in teaching of physics (double-subject study). Taking into consideration that double-subject students have in their curricula another discipline distinct from their chosen field (mathematics, geography, biology, computer science, etc.), we can see that they practically have double burden compared to students of professional studies. This situation is enhanced by the fact that the scope of knowledge required for teachers of physics differs from the one for the students specialized in professional degree of physics.

In recent years this reason has also led to a large percentage of failed students after the first year of study (accounting for about 65%), increased the number of re-examinations at the initial stage of study and added problems with final state examinations for undergraduates, both in physics and in the second certified discipline.

Therefore the project managers decided to innovate the undergraduate training of students - future teachers of physics in two steps.

1. Diversification of study – for students specialized in teaching of physics a new study program has been prepared and teaching of a basic physics course has been conducted separately for students of physics and students specializing in teaching of physics – problem 1.
2. Within the innovation of the content of required courses modules, containing in particular an application of modern parts of physics to the content of lectures and a demonstration of newly acquired knowledge applications in everyday life, have been developed – problem 2.

The use of activation methods in teaching – experiments, problem tasks, project-based learning was an internal part of the innovations mentioned above.

Teaching by the redesigned curricula that were accredited in 2012 was running for the school year 2012/2013. At the end of each semester, a questionnaire survey was conducted; the aim was to find out how teaching was evaluated by the students. In addition to evaluating the teaching concept, it was also possible to evaluate individual courses and teachers.

In the program of double-subject study of physics a certain number of lecture hours was reduced; on the contrary, the number of seminar hours, especially practice in a laboratory, was reinforced. In addition, classes were organized in modules, which allowed a parallel running of lectures, numerical tasks and a practicum in one semester. In an earlier program as well as in the program of professional studies, the physics practicum for the lecture was always included the following semester, i. e. after the students were examined on the subject. This arrangement of teaching has also become a subject of discussion: the course

of Mechanics and Acoustics (first year and first semester) for a single-subject study allocates six hours of lectures, 2 hours of numerical tasks. In the following semester the course continues with Physical Laboratory Practice 1 (mechanics) with 3 hours in a week. In the program of double-subject study lectures, seminars and practicum are combined into one module (3 lecture hours, 2 hours of numerical tasks and three hours of laboratory practice). Teaching takes place in the first semester of the first year of Bachelor studies.

Results of the survey

Questionnaire survey – students were asked to answer the following questions:

What are your expectations of this module and how is it organized to meet your requirements?

Please rate the following items from 1 to 5: (circle one) - 1 very high × 5 very low

Module Content	1 2 3 4 5
The methods and strategies for teaching	1 2 3 4 5
Cooperation with teacher	1 2 3 4 5
Cooperation with other students	1 2 3 4 5
Rating educational support	1 2 3 4 5

What do you rate positively about the module?

What do you rate negatively about the module?

What changes do you suggest?

The following graphs show the students' evaluation of Mechanics teaching module (Figure 1) and Molecular Physics and Thermodynamics modules (Figure 2).

As can be seen, students evaluated the teaching module positively. The individual answers show that in particular the use of activation methods, availability of learning materials and the use of computers in education (Moodle, presentations with interactive whiteboards, the lab reports using a computer-controlled experiment, data loggers Vernier, Pasco, Remote laboratories) were evaluated positively. The use of inter-disciplinary links, inclusion of everyday life topics, problem solving tasks, experiments during presentations and project preparation were also evaluated positively. Solving Fermi questions plays an important role among solving tasks (<http://isouteze.upol.cz/fermi/aktroc.html>).

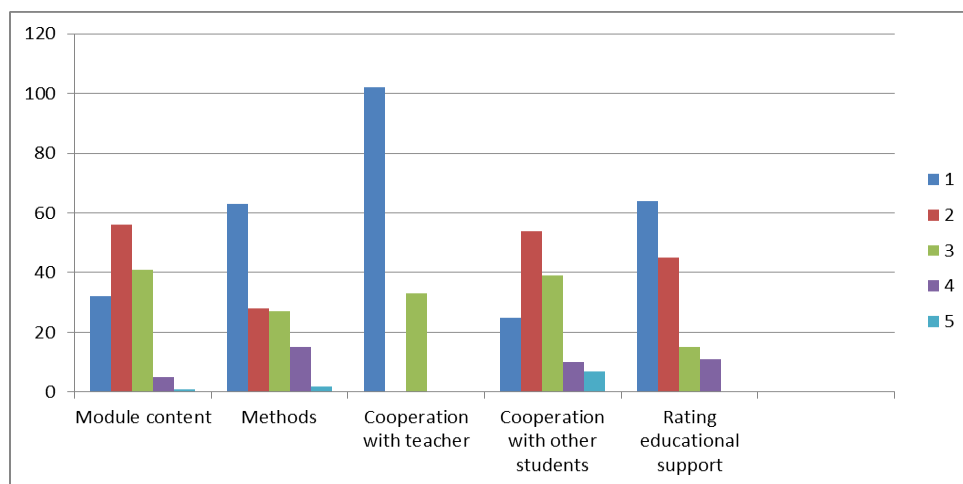

Figure 1. Evaluation of Mechanics teaching module (135 respondents)

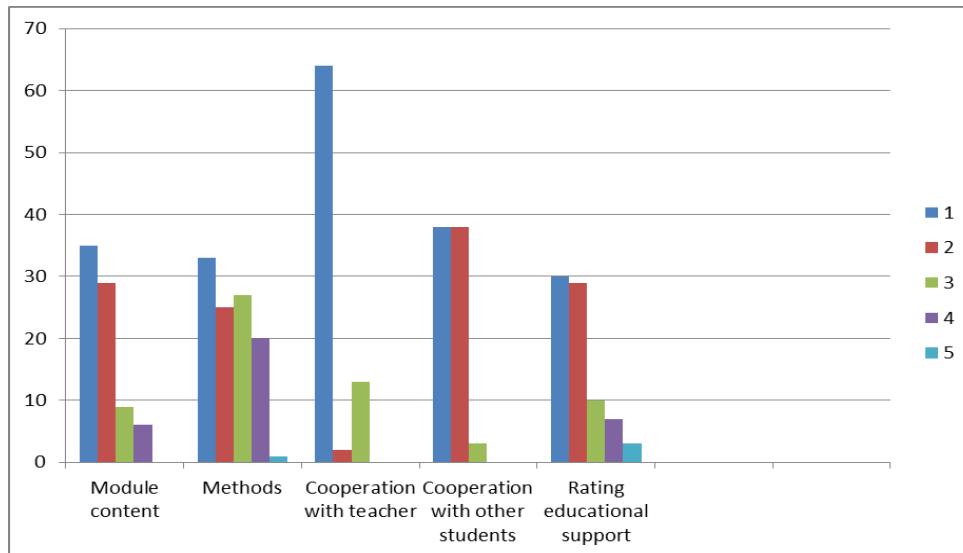

Figure 2. Evaluation of Module Molecular physics and thermodynamics teaching (79 respondents)



Figure 3. Computer based laboratory – electronics

The need to undergo tests before each laboratory practice and the need to process measurement protocols were evaluated negatively.

The proposed amendments concern mainly the course Introduction to Physical Measurement - it should contain a thorough description of measuring protocols processing principles. The issue of including laboratory work in the same semester as the lecture met with a negative response. The problem was that practical tasks involved also those ones which had not been lectured on yet. These problems mainly concerned students in the first semester. In the second semester students did not complain about this organization of teaching and more than 50% of the students evaluated this arrangement positively.

Innovation scope

While preparing the individual modules for basic physics course teaching themes using interdisciplinary links, applications to problems of everyday life of students and topics of „modern" physics have been developed and elaborated. The following topics were prepared: The workings of science, rheology, nanotechnology, physics and criminology,

physics in the kitchen, environmental physics. The evaluation of the modules and their content revealed that physics in the kitchen and rheology got the highest ranking. For illustration two examples are presented.

The use of interdisciplinary links of physics and chemistry – topic physics in the kitchen

In the theoretical part we present culinary physics as a scientific discipline, which includes all research stages in the natural sciences – formulation of hypotheses and their testing, planning and realization of the experiment, technical support of experimental activity, processing and interpretation of experimental results, formulation of conclusions and a discussion. It is an obvious connection to the teaching of physics – transport of heat, the principle of cooling food, eddy currents, magnetization (induction cooker), electromagnetic radiation, standing waves, absorption of electromagnetic radiation in fabrics, the speed of light (microwave). The experimental part contains tests with the induction cooker and the microwave. It also includes a number of simple experiments with eggs (moment of inertia, distribution of force – crushing a raw egg, shell strength, denaturation of proteins, the age of eggs, eggs in acetic acid). Students deal with problem solving tasks – „why? “ (why is the milk white, why sausages burst during cooking, why is it necessary to pierce boiled dumplings, etc.). The experiments with the microwave and experiments performed by students (crushing an egg, cooking a scrambled egg with ethanol, breaking spaghetti, drinking with two straws, making a hedgehog of potatoes and straws, burning tea bag) were met with the greatest response.

Interesting behavior of non-newtonian fluids – rheology

We explain the properties of dilatants on starch slurry. The theory is complemented by experiments demonstrating the change in viscosity with strain rate (walking in a starch bath, Weissenberger effect). Students are intrigued by the Barus effect (Merrington phenomenon or swell/displacement). The phenomenon can be observed in the outflow of liquid through a narrow opening. As the laboratory is equipped with high-speed camera, the Kaye effect can also be demonstrated to our students.

Conclusion

Based on our research, we can say that the modules that have been prepared with regard to the characteristics of the educational needs and the learning style of Generation Y are beneficial to the education of future physics teachers. It turns out that knowledge must be applicable and directly related to real life experience. Since presentation of the material should be interactive, it is essential to use activating teaching methods. During their studies students – future teachers of physics are gaining competence and skills needed for successful educational work in different types of schools. In order to make sure that the current Generation Y students are successfully educated, they must get equipped with knowledge and skills necessary for the twenty-first century school. Technological advances have opened new possibilities for studying and have provided us with the ability to change our approach to teaching and learning, giving our students important tools they will need to be successful in the labor market. Secondary school students as well as university students must understand why they are doing something and what they are doing it right at the moment. As it turns out that students cannot digest huge amounts of information they should not be overload with a lot of contact lecture hours. A more positive impact is achieved by an inclusion of activation methods, experiments, discussion seminars, e-learning, project learning, teaching students to search for information, sort it out and use it both in the learning process and in everyday life.

The paper is supported by the project OPVK CZ. 1.07/2.2.00/15.0310 and CZ.1.07/2.2.00/28.0182

References

- [1] HUNT J., TUCCIARONE J.: The Challenges and Opportunities of Teaching „Generation Y“. *Journal of Graduate Medical education*, December 2011, p.458.
- [2] LAU A., PHUA L. K.: Transforming Learning Landscapes for Generation Y and Beyond. 2010 International Conference of e- business, management and economics, IPEDR, vol.3 (2011), IACSIT Press Hong Kong.
- [3] SCHOFIELD C. P., HONORÉ S.: Generation Y and learning. *The Ashridge Journal Generation Y and learning*. Winter 2009-2010.
- [4] DAVIDSON C. N.: [The future of learning institutions in digital age](#). Forums on February 8, 2007, in Chicago, Illinois; April 21, 2007, at Duke University in Durham, North Carolina, at Electronic Techtonics: Thinking at the Interface, the first international HASTAC conference; and on May 11, 2007, at the University of California's Humanities Research Institute (UCHRI), in Irvine, California. [online]. [cit. 1.3. 2014]. Available from: www.futureofthebook.org/HASTAC
- [5] GRUBER W.: *Die Genussformel*. Ecwin Salzburg 2008.
- [6] SCHORN B. et.al: *Physik in der Küche*. *Praxis der Naturwissenschaften.*, 3, 35 (2008).
- [7] NEZVALOVÁ D., LAMANAUSKAS V.: *A constructivist approach for the improving quality of science teacher training: an experience of IQST project*. VUP Olomouc 2009. ISBN 978-80-244-2340-1.
- [8] TIBERGHIE A. et.al: *Physics teaching sequences and students' learning*. [online]. [cit. 1.3. 2014]. Available from: <http://gric.univ-lyon2.fr/membres/lemarech/Publications/KalamataTibEnv.pdf>

Car Braking Distance

Peter Horváth

Faculty of Mathematics, Physics and Informatics, Comenius University, Bratislava, Slovak Republic

Abstract

This report describes a summary of analysis and video measurements researching braking distances of cars with various initial velocities. The main purpose of this experiment is to demonstrate students the wrong conceptions of the relation between the braking distance of a car and its initial velocity. A large number of young drivers involved in car accidents. This situation is partly due to young drivers' ignorance of traffic regulations, while they are often not fully aware of possible consequences of their actions. This could be because of the underestimation of traffic events, or bad judgement, which can also derive from their wrong conception of the car braking distance.

Keywords: Tracker, video analysis, braking distance, pupil's conceptions

Pupils' wrong conceptions of car braking distances

A remarkable and useful activity, aimed at the traffic safety and also motivated by meaningfulness of the educational content and teaching activities in physics education, was conducted in Germany. Police, in cooperation with rescue personnel and fire-fighters organized lecturing shows for 16 to 20-year-old students on the causes of traffic accidents of young drivers [1]. Correspondingly our paper is focused on the issue of traffic safety of young drivers.

Many students start driving very young. One of the most frequent causes of serious car accidents by young people is high velocity, which does not correspond with their driving skills and experience. Insurance companies keep records of accidents caused by young drivers. Hence, one of the insurance companies has decided not to sign any contracts with drivers under the age of 24. From this experience, we assumed that many students do not have any idea about the distances needed for stopping cars with various velocities. This thesis is supported by two short tests given to pupils.

Table 1. Their task was to fill in the gaps

Initial velocity	Braking distance
20 km/h	m
40 km/h	m
60 km/h	m
80 km/h	m
100 km/h	m
50 km/h	m

The test was for pupils of 17-18 years (senior year of 5-year high school). Pupils had to answer what was the braking distance of a car with different initial velocities. We were interested solely in the braking distance on a dry road without any other factors that might affect the braking distance, such as the ABS system and the reaction time of a driver.

In 2011-2013 exactly 100 pupils took the situation with test. In the Figure 1 we show graphically processed results of pupil's responses for the situation with initial velocity of 50 km/h. The horizontal axis shows the value of braking distance and the vertical axis the number of pupils, indicating particular braking distance. For example, 7 pupils indicated that the braking distance at 50 km/h is 10 meters.

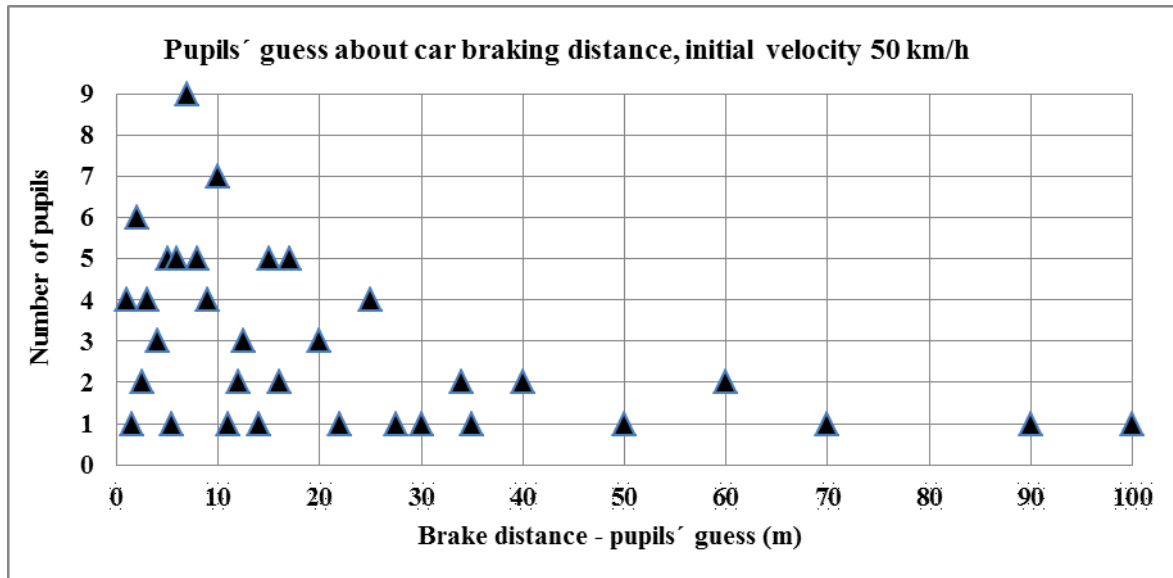

Figure 1. Graphical representation of pupils' conceptions of braking distance at initial velocity of 50 km/h

The calculations (based on the static friction coefficient of "tire – rough asphalt" 0,9 [2,3], omitting driver's reaction time) for initial velocity of 50 km/h give the braking distance of about 11 metres. On the wet asphalt or with worn-out tires the braking distance can increase considerably, easily by 2 times (or much more).

Approximately one third of tested pupils (31) indicated in their responses that the braking distance is 6 meters or less. 24 pupils made a guess in the range of 7 to 10 meters, 27 pupils (correctly) indicated one of the values in the range of 11 to 25 meters. Five pupils had their estimates in the range of 27 to 35 metres and three of them guessed 40-50 meters. Seven pupils showed an extremely unrealistic conception of braking distance, e.g. above the 60 meters or as much as 150 to 500 meters. The latter values are not shown in the graph.

The Figure 2 shows pupils' conceptions of braking distance at initial velocity of 80 km/h.

If we again consider the ideal conditions (the static friction coefficient of 0,9), we get the braking distance of not less than 27 meters. In our measurements, at this velocity we got the braking distance value of about 70 m.

Pupils' conceptions were as follows: 14 guessed values less than 4 meters, four of them estimated distance of 6 to 7 meter, total of 12 students stated that it is 8 or 10 meters, sixteen had their responses in the range of 12 to 14 meters, seven of them made guess in the range of 15 to 18 meters, six indicated the value of 20 meters and finally seven were in

the range of 22 to 25 meters. 15 of the pupils (correctly) indicated the value in the range of 30 to 40 meters. 13 of the pupils had their estimates in the range of 45 to 85 meters; three of them indicated the value of 100 meters. The answers of three pupils, who indicated 170 meters, 250 meters and 800 meters, are not shown in the graphical representation below.

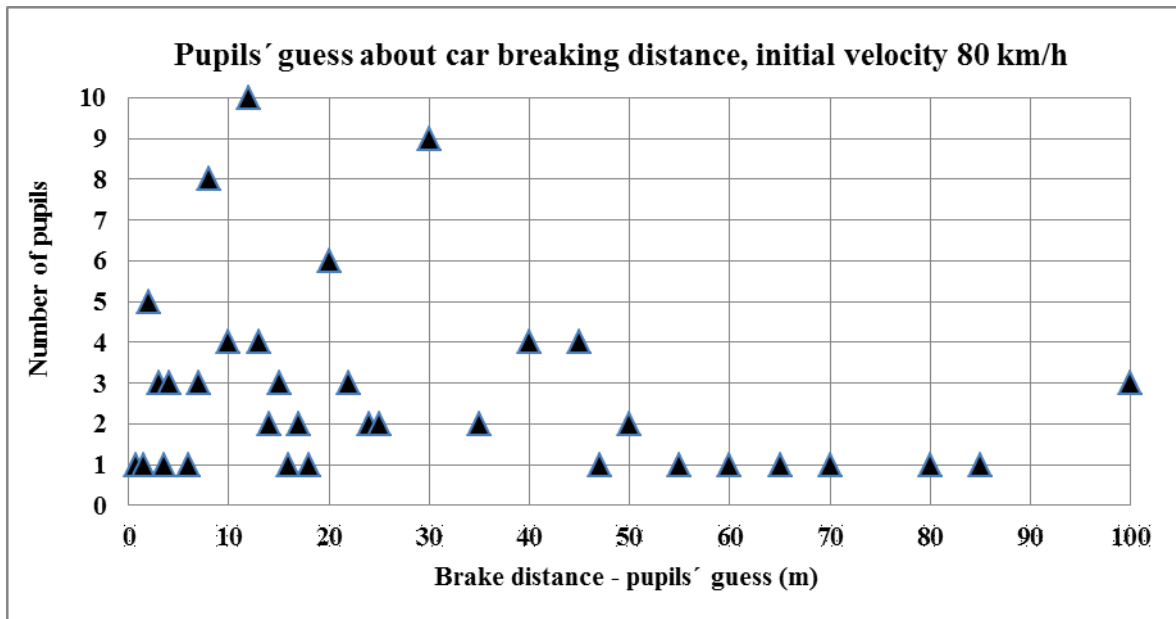

Figure 2. Graphical representation of pupils' conceptions of braking distance at initial velocity of 80 km/h

In the Figure 3 we show pupils' conceptions of car braking distance at initial velocity of 100 km/h. Considering the ideal conditions (the static friction coefficient of 0,9) we get the calculated distance of about 45 meters (omitting reaction time of a driver).

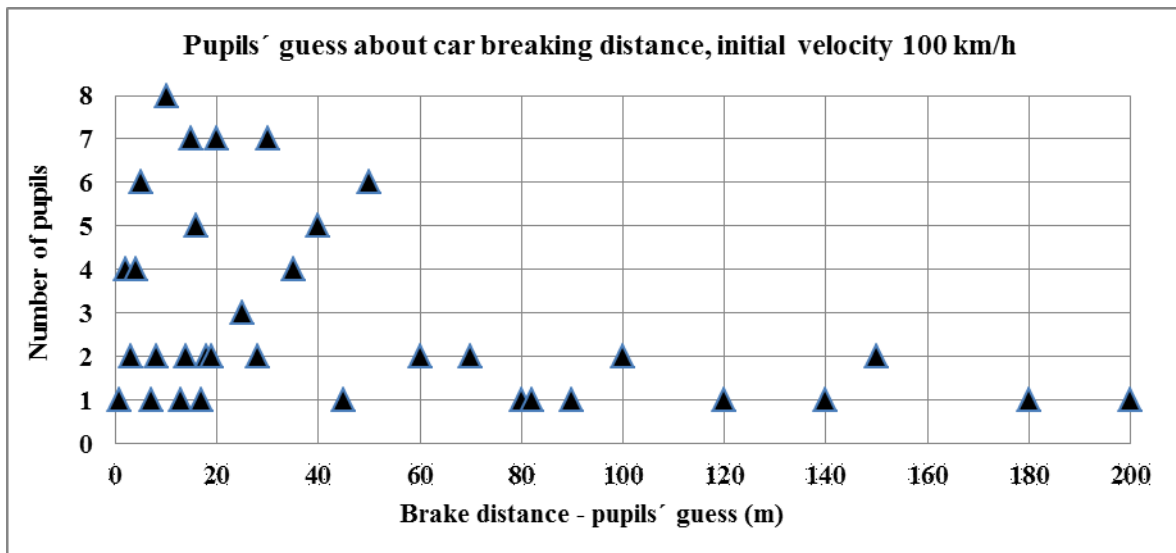

Figure 3. Graphical representation of pupils' conceptions of braking distance at initial velocity of 100 km/h

As we can clearly see, the pupils again indicate the lower values, than it is in the real world. For example, 28 of the pupils indicated the value of 10 meters or less, another 27 of them made a guess in the range up to 20 meters and another 21 pupils indicate the values

less than 40 meters. Total of 16 pupils indicated the values from 45 to 100 meters, 6 of the pupils have their estimates in the range of 120 to 200 meters. The estimates of another two pupils, who guessed values of 300 and 1000 meters, are not shown in the graph.

The second test was quite similar and was administered after the collection of pupils' responses, immediately after the first test. Students were given one information: the braking distance is 8 meters and the initial velocity is 40 km/h. Their task was to answer, what are the other braking distances of given initial velocities.

The objective of this part of the test was primarily to give the pupils the essential conception of braking distance and then to find out, how many of them think, that the dependence of the braking distance on the initial velocity is linear.

This test was answered by 99 students. According to the results, the majority of students misconceive the reality about the braking distance. 62 pupils answered that the braking distance of a car with the initial velocity of 100 km/h would be smaller than 25 meters. 39 pupils thought that the dependence of the braking distance on the initial velocity is linear.

Video analysis of braking distances of a car

The used method was the video measurement (video analysis). The video analysis is a process whereby we use a video to determine the relation between time and corresponding position, velocity and the accelerated speed of a particular object. The result of this video analysis is depicted on a graph, demonstrating the time relation of the kinematic variables. To conduct this video analysis we could either use given videos or actually tape our own in class and then analyze them.

Nowadays, many authors deal with this issue. Many possibilities of using the computer program Tracker (<http://www.cabrillo.edu/~dbrown/tracker/>) are described by its author D. Brown [4]. Currently, this program is really popular and widely used, many authors and scholars dedicate their time to it. An example of such approach is the analysis of the soccer kick with the use of Tracker, as described to detail by Logiurato, Graatton and Rossi [5]. Description of using the video analysis in active learning in the topic of projectile motion is the main objective of the paper by a collective of authors from Singapore [6]. Some interesting ideas for various video measurement activities (such as the capillary action, oscillations on elastic bands) can be found in the article by Kíreš and Ješková [7].

For our video analysis we used the program Tracker and a couple of videos that had been recorded by Andrej Karlubík as a part of his master's thesis [8]. He recorded 5 brakings of a car with different initial velocities, from (approximately) 20 km/h to (approximately) 80 km/h. Initial velocities were measured by the video analysis, down below. The driver's task was to start stopping the car always at the same spot, where the camera started recording. This took place on an airport apron.

Each of the five videos captured the car with different initial velocities. You can find them on this website <http://www.ddp.fmph.uniba.sk/horvath>. Pupils had to analyze each video and depict the time relation of the position and velocity on a graph.

We used the information that the length of the car was 4.5 meters in order to calibrate the distances.

Pupils could read the braking distance from the graph that demonstrates the time relation of its position, and the initial velocity of the car from the graph that shows the time relation of

velocity. The values can slightly vary. The most significant effect on the results is the accuracy of the determination of the car length in the calibration of our measurement.

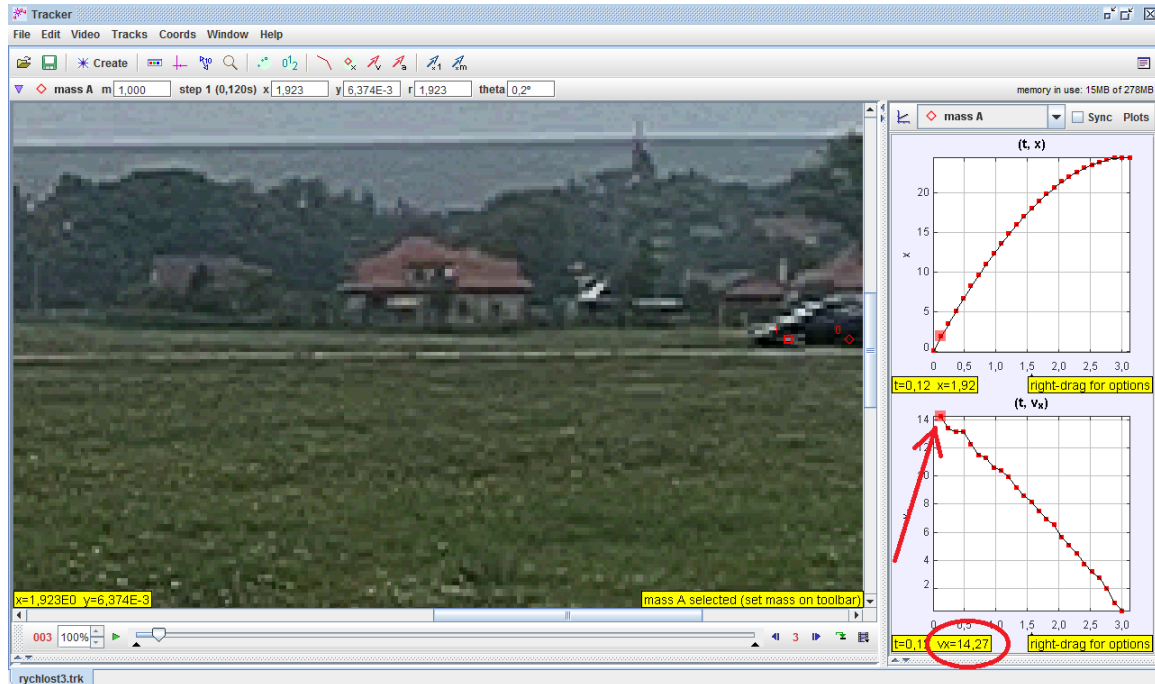

Figure 4. We determined the initial velocity of the car from the time relation of velocity. In our case, the initial velocity is approximately 14 m/s.

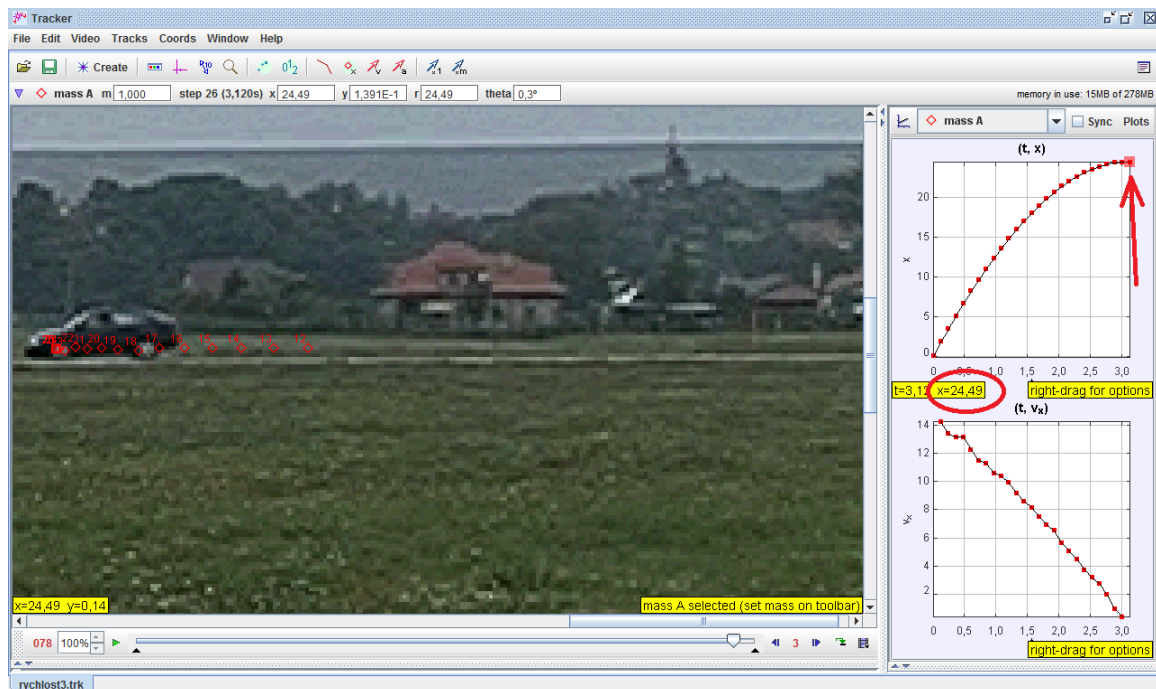

Figure 5. We determined the braking distance of the car from the time relation of the position. In our case, it is approximately 25 meters.

Pupils collected necessary data and put them in the table below in order to draw a graph that would represent the relation between the initial velocity and the braking distance. The

first column contains data about the initial velocity in m/s, the second contains the same data but in km/h and the third column has data about the braking distance.

Table 2. Values of initial velocities and braking distances

Initial velocity/ m.s ⁻¹	Initial velocity/ km.h ⁻¹	Braking distance/ m
0	0	0
5	18	2,5
10	35	10
14	51	25
18	66	44
23	83	72

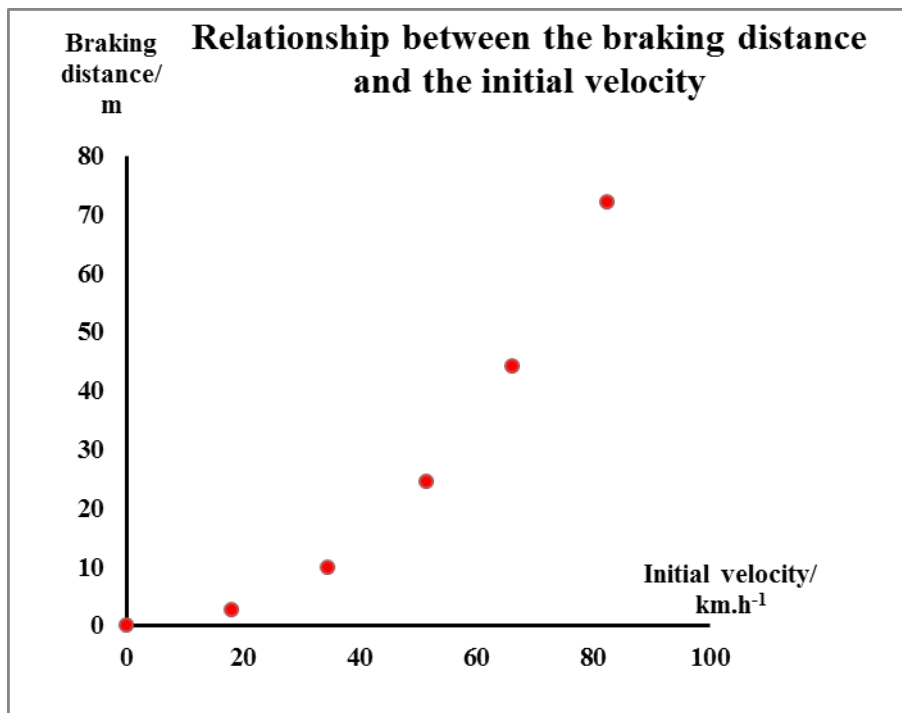

Figure 6. Values of measurements, analysis, relation between the braking distance and the initial velocity

After completing the graph and our class discussion, we came to a conclusion that the relation is not linear, but quadratic. If we assume that the braking force is constant, then the relation between the braking distance and the velocity should be quadratic.

We also focused on the values of braking distances of the car with various velocities and pointed out the fact, that the braking distances were measured without any other possible factors that might have affected the braking distance, such as the reaction time of a driver. What is more, we emphasized the importance of driving safely with permitted speed. If we drove somewhere where the permitted speed is 40 km/h, with the speed of 60 km/h, which

is quite common in Slovakia, our “pure” (without other factors) braking distance would be two times of the braking distance of the permitted speed.

Conclusions

This activity was a student experiment where students had to search information from a text, analyze collected data from a graph, synthesize data and explain the relationship between the braking distance and the initial velocity.

It is really important to draw attention of the pupils, the prospective drivers, to some certain points concerning the braking of the car. By means of activities described above they have the opportunity to discover how the braking distance depends on the initial velocity of the car. They are also given the possibility to measure the velocity dependence of the „pure“ braking distance, that means the distance from the moment when the car starts braking. It is also really important to discuss with the students the necessity to consider the driver’s reaction time and that this reaction time has the effect on the total braking distance.

This activity can be included as the practical application in the conclusion of the topic – dynamics of the decelerated motion and the friction, including the calculation of the static friction coefficient. It would be a good idea to start by teaching some facts about the accelerated rectilinear motion, including the calculation of the braking distance. Then students could do the experiment with the car, analyze the footage and compare their previous calculations with the experiment (also determining the coefficient of friction, how good the assumption of the constant deceleration is etc.).

We have included this activity in the form of motivation to the deeper analysis of the relation between the distance of decelerated motion and the initial velocity. We were dealing with the question – why is there the quadratic relation between the initial velocity and the braking distance?

Our plan is to develop this experiment further. We would consider other factors that play role in stopping the car. Such as the ABS system, stopping on a wet road, the difference between braking the car with winter and summer tires and the reaction time of a driver.

Acknowledgements

This report was created as a part of the project *KEGA 035ŽU-4/2012 forming of physical concepts using video analysis and video measurements with the aim to popularize physics and make it more attractive*, of which expenses were covered by a participation in a conference in Prague.

References

- [1] Weber J., Bresges A. (2014): Authentic Problems for authentic assessment in Physics. In: Proceedings of The World Conference on Physics Education 2012, Istanbul, Turkey, PEGEM AKADEMI, 2014, p. 763 – 773. [online]. [retrieved 11-04-2014]. Available at: http://www.wcpe2012.org/WCPE_2012_proceeding_book/10-WCPE2012%28747-904%29.pdf
- [2] Muller S., Uchanski M., Hedrick K. (2003): Estimation of the Maximum Tire-Road Friction Coefficient. In: Journal of Dynamic System, Measurement, and Control, Vol. 125, December 2003, p. – 607 – 617. [online]. [retrieved 11-04-2014]. Available at: <http://bse.srv214.bse.vt.edu/Hop/Papers/Tire-Road%20Friction%20Coefficient.pdf>

- [3] Ghandour R., Victorino A., Doumiati M., Charara A. (2010): Tire/road coefficient estimation applied to road safety. In: 18th Mediterranean Conference on Control & Automation, Morocco, June 23 -25 2010. [online]. [retrieved 11-04-2014]. Available at: <http://gipsa-www.ampere.inpg.fr/~moustapha.doumiati/MED2010.pdf>
- [4] Brown D., Cox A. (2009): Innovative Uses of Video Analysis, *The Physics Teacher* 47, 145-150.
- [5] Logiurato F., Gratton L., Rossi M. (2014): Teaching Physics with Soccer. In: Proceedings of The World Conference on Physics Education 2012, Istanbul, Turkey, PEGEM AKADEMI, 2014, p. 397-404. [online]. [retrieved 11-04-2014]. Available at: http://www.wcpe2012.org/WCPE_2012_proceeding_book/7-WCPE2012%28353-498%29.pdf
- [6] Wee L. K., Chew Ch., Goh G. H., Tan S., Lee T. L.: Using Tracker as a Pedagogical Tool for Understanding Projectile Motion. [online]. [retrieved 11-04-2014]. Available at: <http://arxiv.org/ftp/arxiv/papers/1206/1206.6489.pdf>
- [7] Ješková Z., Kíreš M. (2007): Videomeasurements as a means of physical phenomena visualization, In: Electronic Conference Proceedings 12th International Conference on Multimedia in Physics Teaching and Learning, MPTL 12 meeting, Wrocław, Poland, September 13-15., 2007. [online]. [retrieved 11-04-2014]. Available at: <http://www.mptl12.ifd.uni.wroc.pl/papers/37.pdf>
- [8] Karlubík A. (2010): Videomerania vo vyučovaní fyziky [master thesis]. Bratislava, FMFI UK, 2010.

Exergy in school?

T. Kranjc, N. Razpet

Faculty of Education, University of Ljubljana, Ljubljana, Slovenia

Faculty of Education, University of Primorska, Koper, Slovenia

Abstract

Students at all levels of physics instruction have difficulties dealing with energy, work and heat in general and, in particular, with the concepts of efficiency and ideal heat engine, and the maximum performance of refrigerators and heat pumps [6,16]. The reason for the difficulties is an insufficient understanding of the second law of thermodynamics [14]. In order to make these topics less difficult, the concept of exergy — well established as a powerful analytical tool in technical thermodynamics — describing the “quality” of energy, seems in our judgment to be worthy of inclusion in the physics curriculum at all levels. Its introduction does not add another law. It facilitates the understanding of irreversibilities (as the destruction of exergy) and gives a deeper meaning to the second law. In the treatment of heat engines the second-law efficiency throws a new light on the notions of an ideal and a real engine (similarly for a refrigerator or a heat pump). Exergy introduces, in a natural way, a distinction between various forms of energy according to its quality — availability for performing work. “Energy reserves”, which can be better understood with the help of exergy, are of practical interest. From the thermodynamic point of view, a more correct term would be “availability reserves”; all around us, there are huge quantities of energy (in atmosphere, in oceans etc), but of very limited availability, i.e., of limited exergy.

In order to identify common misconceptions and difficulties encountered by students in the learning of the first and second law of thermodynamics, particularly in connection with heat engines and similar cyclic devices, we conducted a combined research among students of the Primary School Education at the Faculty of Education (UP PeF) and of Biodiversity, Bioinformatics and Mediterranean Agriculture at the Faculty of Mathematics, Natural Sciences and Information Technologies (UP FAMNIT) of the University of Primorska. Based on interviews and questionnaires given to two groups of students — an experimental and a control group — in the beginning and the end of the semester, we investigated the influence (and possible advantages) of the introduction of the concept of exergy and the second-law efficiency.

In the presentation, we show a few examples that were treated with the experimental group in order to motivate the students and to make them familiar with the concept of exergy: the “energy losses” of a car engine and an analysis of improvements still allowed by nature; exergy loss associated with heat conduction; a simple exergy analysis of a heating house system (considering energy and exergy fluxes). We list some of the problems encountered by the students and the most common misconceptions as could be identified from the tests, questionnaires and interviews. An additional goal of the investigation is to test a longer-term knowledge of students.

From our research it would appear that exergy and the second-law efficiency are useful concepts which make it possible for students to get a better grasp of the material and to not only obtain a clearer understanding and knowledge of standard topics like heat engines, but also a broader view and insight into the meaning of energy and both the first and the second law, and their interrelation.

Keywords: Heat, exergy, second-law efficiency

Introduction

In physics instruction, the chapter on heat is considered difficult and abstract, despite its usefulness and broad applications in technology. For the understanding of the laws of thermodynamics one needs to know and understand the concepts of work, heat, energy, and entropy, and develop an intuitive feeling for them. Heat engines and similar cyclic devices (refrigerators, heat pumps, gas turbines, fuel cells, rocket engines, etc.) are important examples of technology based on thermodynamics and, in fact, one of the goals of teaching thermodynamics is “an appreciation of the limits to efficiency” [1]. The school physics instruction is usually limited to heat engines, refrigerators, and heat pumps [2–5]. Their efficiency (or a suitable measure of their performance) is introduced and calculated and a comparison is made to the efficiency of ideal (Carnot) engines. For engines using (the ideal) gas as their working substance the efficiency can be determined by a direct calculation of cyclic changes. But it is more important for students to understand the limits of the functioning of heat devices as imposed by the laws of thermodynamics.

In physics instruction at the high school level or in university programs that include an introductory course of physics for non-physics majors (e.g. chemistry, biology, mathematics, etc. majors) one again and again sees that students have not learned certain simple facts and/or have not understood them. In order to achieve better results numerous methods were developed and applied [1,5–14]. They were supposed to help gain a better understanding and a higher level of competency in applying the laws and methods of thermodynamics.

In view of a small success of these methods and efforts, we join proposals aiming at introducing the concept of exergy into the instruction of thermodynamics (from the elementary school level on) (see [15]), together with related notions and quantities. We believe that, based on the concept of exergy and the second-law efficiency, students can better understand and memorize the functioning and the underlying principles of heat devices and, at the same time, largely extend their understanding of some relevant topics of the present days. Besides, a study of a much broader spectrum of devices, device parts, and processes is made possible.

Heat engines and student understanding

Among the main instructional tools illustrating cyclic changes repeated by heat engines and similar devices are diagrams of heat flows and work. Schematic presentations of heat flows and work (as in Figure 1) are easy to read but students often do not see connections to real engines — they do not know where the system (heat engine, refrigerator, heat pump) is “hidden” or where in the real device are the heat reservoirs.

An additional problem occurring with this kind of presentation of a heat device is the fact that it is not obvious from it how the supplied heat divides between the produced work and exiting heat. This is not determined by the energy but by the entropy law which has to be additionally built into the diagram.

Cochran and Heron [6] assessed the knowledge and understanding of the second law among different groups of students and presented the responses to questions that they posed based on heat flow and work diagrams (Figure 1). Students received three different diagrams (for a heat-engine, refrigerator and a “strange device”, Figure 1); for each of them they had to tell if such a device could function and explain why they thought so. The results obtained at final exams gave only about 30% correct answers.

Testing second year students of the Primary school Education at the Faculty of Education (UPR PeF) and Biodiversity, Bioinformatics and Mediterranean Agriculture at the Faculty of Mathematics, Natural Sciences and Information Technologies (UPR FAMNIT) of the University of Primorska (in the academic year 2011/2012) we obtained similar results as in [6] (between 30 % and 40 % correct answers).

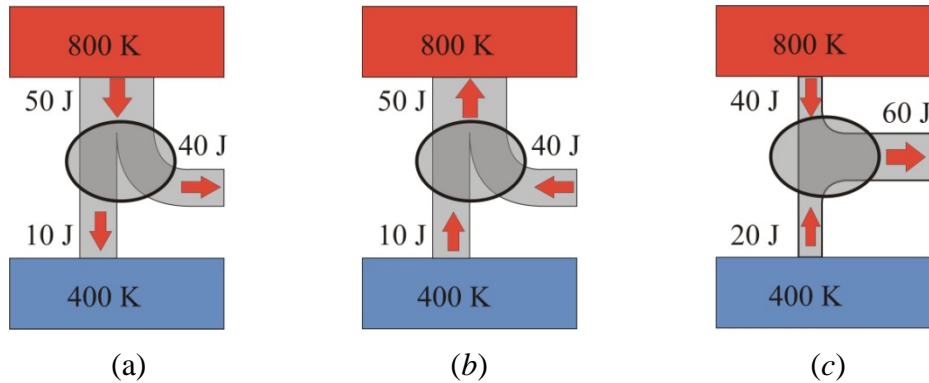

Figure 1. Heat devices for test questions (Ref. [6]). (a) A proposed heat engine, (b) a proposed refrigerator, (c) a “strange device”. Students had to determine if the devices could function and why. (Figure 1 in Ref. [6]).

Three additional questions were about the “ideal” heat engine for which it was repeatedly emphasized in class to be a synonym for the Carnot heat engine. The first question asked for the efficiency of an ideal heat engine, the second, what would be the efficiency of an imaginary heat engine operating between the extreme temperatures of 300 K and 299 K (the example was solved in the class), for the third question students had to draw the heat and work flow diagram of an ideal engine.

The portions of correct answers were as follows. The first question: 35%, the second question: 44%, the third question: 21%, the total number of students: 34. 53 percent (18 students) gave 100% as the answer to the first question (i.e. they wrote that the efficiency of the ideal heat engine is 100%). It is interesting that none of the students who claimed the efficiency of an ideal heat engine to be 100% drew as the answer to question 3 the diagram on the right of Figure 2, which would be a logically consistent answer. 62% drew approximately the diagram in Figure 2 left (with the line showing the flow of emitted Q_L being more or less thin), which does not correspond neither to the example of the first nor the example of the second question.

It is obvious that students are not really able to use the second law when they think about cyclic heat devices. Bucher [16] proposed and other authors [17-24] subsequently further developed a new type of diagrams (Bucher diagrams), which include both the first and the second law of thermodynamics. However, the new diagrams do not seem to have enough appeal and visualizing force to be adopted in school curriculum.

In presenting any study material, the choice of basic concepts is of utmost importance. In the treatment of thermodynamic systems such a new quantity could be *exergy* [25]. Not only it allows a more reliable analysis of heat engines and similar devices, but also offers a better insight into the role of energy of arbitrary processes and into the very understanding of energy and its uses. It could be characterized as a concept for the *valuation of the quality of energy*. We believe it to be a useful, effective and at the same time a sufficiently simple concept and therefore appropriate to be introduced in a sensible way into the school physics curriculum.

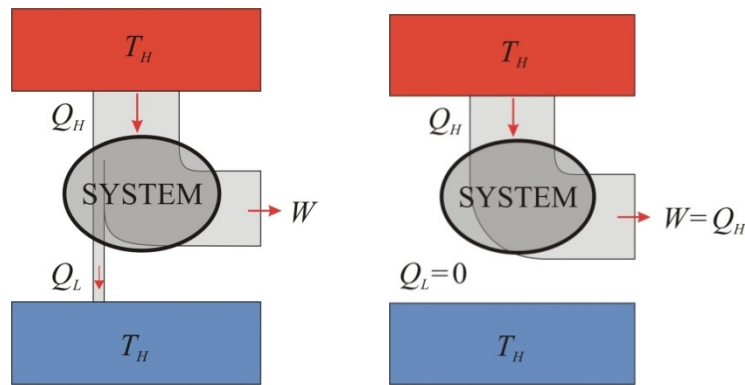

Figure 2. Left: Flow of heat and work in an ideal heat engine as shown by a majority of students. Right: None of the students who answered that the efficiency of the ideal heat engine is 100% drew a diagram with $Q_L = 0$, which would correspond to 100 % efficiency.

Exergy and the second law-efficiency

Energy has two facets, *quantity* and *quality*. The first law of thermodynamics states that energy is preserved, i.e., that it “cannot be destroyed or come out of nothing”. Energy appears in many different forms, like kinetic, potential, elastic, electric, chemical, atomic, thermal, etc., and it can change from one form into another. Regardless of the processes and transformations the amount of energy stays the same.

Since energy is preserved we really should not be talking about “energy losses”. However, energy that is preserved in its amount and is therefore not lost does not have “the same value” in every form. In all real processes its “*quality*” decreases. For example, possibilities of using the (potential) energy of a weight hanging above the ground are greater than possibilities for using its internal energy coming from the change of the potential energy when the weight falls on the ground and warms up a little bit.

Let us call *exergy* the quantity which expresses the quality of energy. We can say that exergy (E^k) is the energy that can be, in given circumstances, transformed into an arbitrary other form of energy. We often say that exergy is the part of energy that can be used for work in its entirety or, represents the available work. Exergy is therefore the “useful” part of energy. The remaining — useless part — is called *anergy* (E^a). The entire energy (E) can be written as $E = E^k + E^a$.

Different forms of energy can then be divided into three classes, depending on the “quality”:

- Energy that can be completely used for work = exergy
- Energy that can be partly used for work = exergy + anergy
- Energy that cannot be transformed into work = anergy

Mechanical, electric and (approximately) chemical energy can transform into work in its entirety (if we ignore irreversibilities which are part of any real process and are a consequence of different dissipation processes like friction). In the case of an electric engine the electric work can be (almost) completely transformed into the mechanical work. The thermal energy can be (partly) transformed into work in the case where the system is not (yet) in equilibrium with its environment.

What is the exergy of a certain amount of heat (Q_H) that can be taken from a heat reservoir at temperature T_H ? A Carnot heat engine is the most efficient device for converting heat

into work. The exergy of heat Q_H is the portion which is available for work and this is $|W| = Q_H(1 - T_0/T_H)$ (T_0 being the lower reservoir temperature). The partition of Q_H into exergy and anergy is therefore $Q_H = |W| + Q(T_0/T_H)$.

This result shows that exergy is not an “absolute” quantity depending only on the quantity of invested energy but is also dependent on circumstances: it depends on the temperatures at which a Carnot heat engine absorbs and emits heat. Efficiency $\eta_C = 1 - T_L/T_H$ is greater if the temperature at which the Carnot engine emits heat is lower. This is often (though not always) the temperature of the environment T_0 ($T_L = T_0$).

Efficiency tells us what limitations for converting heat into work are imposed by nature under given circumstances (T_0 and T , say). For given T_0 and T the work ($|W_{max}|$) that can be obtained from heat Q in the best case scenario (reversibility of the process) equals $|W_{max}| = \eta_C Q$. In the hypothetical example where $T_0 = 299$ K and $T = 300$ K, η_C would equal $1/300$ or about 0.3%. Even though this is not much it is the most allowed by nature in given circumstances. Therefore this is the “ideal” efficiency of an “ideal” heat engine.

Due to unavoidable irreversibility of real processes and also for other reasons the work ($|W_{real}|$) is actually smaller than the maximum ($|W_{max}|$) and the same holds true for the actual efficiency (η), $\eta < \eta_C$. Therefore it seems reasonable to compare the actual efficiency of a device with the maximum possible. To do that we introduce the *second-law efficiency of a heat engine* (ν) [26] as $\nu = \eta/\eta_C$. In the “ideal” case $\nu = 1$.

The information about the second-law efficiency of a heat engine is important because it tells us what the “reserves” are when one gets work out of heat. If $\nu = 1$, there is no “reserve” left (i.e. nature does not allow any improvement), even though the efficiency η might be small. If, however, $\nu < 1$, nature still allows improvements in the engine’s efficiency.

Let us formulate the Second Law of Thermodynamics in terms of exergy instead of entropy:

- Exergy is preserved under all reversible changes.
- In irreversible transformations exergy decreases (“exergy losses”) and changes into anergy.

Introducing exergy into the teaching of thermodynamics

In school year 2012/2013 we again tested second-year students of the Primary school Education at the UPR PeF) and Biodiversity, Bioinformatics and Mediterranean Agriculture at the UPR FAMNIT.

Students were divided into two groups. With one of them we used the standard approach to cover the chapter on heat engines, refrigerators, and heat pumps (without introducing exergy). With the other one we introduced exergy and, besides the standard thermal efficiency for heat engines ($\eta = |W|/Q_H$) or coefficient of performance (COP) for refrigerators ($Q_L/|W|$) and heat pumps ($Q_H/|W|$) we also introduced the second-law efficiency, $\nu = \eta/\eta_C$. The second group, according to our observations, obtained a better insight into the understanding of energy and its consumption and uses, and with that of energy issues in general (which implicitly includes the issues concerning ecology). In testing, however, we were interested how the students from the second group were able to answer questions which belong to the standard coverage of thermodynamics.

The whole group had 43 students who were divided into two groups, the first one (for the standard approach) had 21 students, the second (for the introduction of exergy) had 22 students. The obtained results (Figure 3) show a convincingly better answers of the second group to the first three questions. It appears that through the treatment of heat devices with the help of exergy they obtained a better insight and feel for the content of especially the second law of thermodynamics.

Also with the three additional questions about the “ideal” heat engine (cf. the text after Figure 1) the second group did much better. The results are shown in Figure 3. The example from the second question was not solved in class this time, and in question 3 they had to add an explanation of the diagram that they drew.

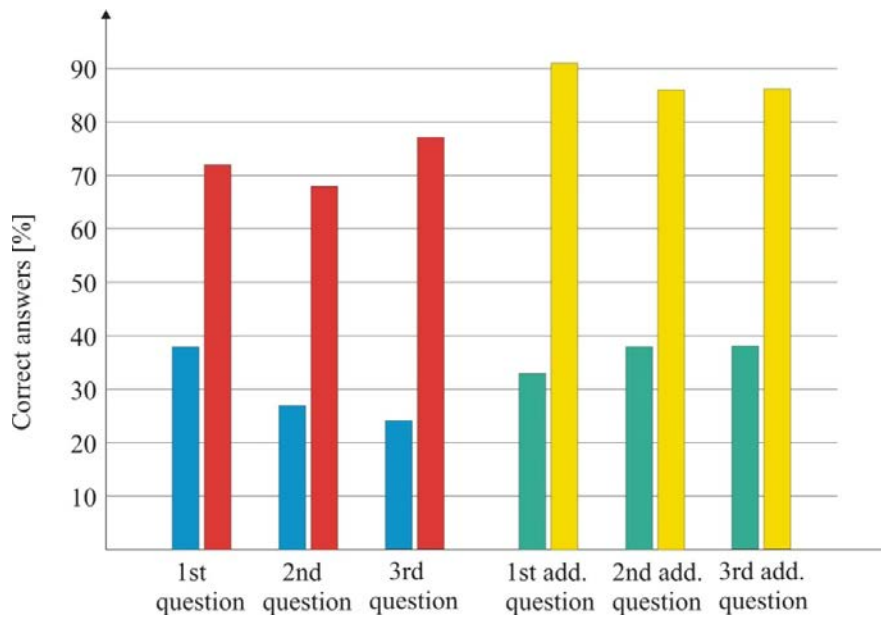

Figure 3. The correct answers to questions from Fig. 1 and to the three additional questions. The first column of each question refers to the first group, the second to the second group.

Conclusions

Thermodynamics is both an abstract (and for this reason difficult) and a technologically important chapter of physics. It is therefore worth making an effort to acquaint students with some basic concepts and ideas and also with the simplest information about technical applications. Among these the most important in school are cyclic heat devices (heat engines, refrigerators, heat pumps).

Even though it is difficult to introduce innovations in the time when the scope of physics instruction is diminishing at all levels, we believe that after several decades [25] or even more of a successful introduction especially in the field of technical thermodynamics it is reasonable to think about introducing the concept of exergy into the physics curriculum at all levels.

It appears that with the help of exergy it is possible to better understand the First and the Second Law of Thermodynamics and the limitations to transforming heat into work set by nature. At the same time one can better understand where it is possible to further improve one’s devices (where nature still allows it) and what is the meaning of exploitation of energy and energy reserves.

After instruction of thermodynamics based on the concept of exergy, students have

- showed a better understanding of the significance of the two laws of thermodynamics,
- got to know and appreciate the concept of the *quality* of energy,
- acquired a better insight into the restraints put by the second law on natural processes,
- arrived at a better understanding of reversible and irreversible processes in terms of exergy losses,
- got to understand much better cyclic devices (heat engines, refrigerators, heat pumps),
- got to understand the meaning of “ideal” devices in terms of the 1st law efficiency and the 2nd law efficiency,
- were able to do simple energy-exergy analyses,
- arrived to understand better terms like “energy reserves”, “energy crisis”, “energy degradation”, “waste of energy”, “lost work”, “renewable energy sources”, “availability” etc., and to build a better attitude toward ecological issues connected to energy needs.

With the use of exergy it was demonstrated at least on the experimental groups of students that the exergy concept helped them to a better understanding of the material which already is a part of the existing school curriculum and has to be mastered by students.

It is our opinion that the introduction of the concept of exergy leads to a better and deeper students’ understanding and insight of the fundamental laws of thermodynamics as well as of their use in many technical and social applications. At the same time, it does not require changes of the curriculum (but the introduction of a new concept), it requires no extra time and no increase in the study input. Therefore we expect a serious discussion and consideration about a suitable introduction of exergy into the classroom instruction.

References

- [1] Baierlein R.: Entropy and the second law: A pedagogical alternative. *Am. J. Phys.* 62, No 1 (January 1994), p. 15-26.
- [2] Arnaud J., Chusseau L., Philippe F.: A simple model for Carnot heat engines, *Am. J. Phys.* 78, No 1 ((2010)), p. 106-110.
- [3] Bartlett A. A.: Introductory experiment to determine the thermodynamic efficiency of a household refrigerator, *Am. J. Phys.* 44, No 6 (1976), p. 555-559.
- [4] Leff H. S., Teeters W. D.: EER, COP, and the second law efficiency for air conditioners, *Am. J. Phys.* 46, No 1 (1977), p. 19-22.
- [5] Tobin M. C.: Engine Efficiencies and the Second Law of Thermodynamics, *Am. J. Phys.* 37, No 11 (1969), p. 1115-1117.
- [6] Cochran M. J., Heron P. R. L.: Development and assessment of research-based tutorials on heat engines and the second law of thermodynamics, *Am. J. Phys.* 74, No 8 (2006), p. 734-741.
- [7] Das S. K.: Comment on “Entropy production and the second law of thermodynamics: An introduction to second law analysis,” by Thomas V. Marcella [*Am. J. Phys.* 60 (10), 888-895 (1992)], *Am. J. Phys.* 62, No 12 (1994), p. 1151-1152.
- [8] Fingeld C., Machlup S.: Well-Informed Heat Engine: Efficiency and Maximum Power, *Am. J. Phys.* 28 (1960), p. 324-326.

- [9] Leff H. S., Teeters, W. D.: EER, COP, and the second law efficiency for air conditioners, *Am. J. Phys.* 46, No 1 (1977), p. 19-22.
- [10] Marcella T. V.: Entropy production and the second law of thermodynamics: An introduction to second law analysis, *Am. J. Phys.* 60, No 10 (1992), p. 888-895.
- [11] Reif F.: Thermal physics in the introductory course: Why and how to teach it from a unified atomic perspective, *Am. J. Phys.* 67 (1999), p. 1051-1062.
- [12] Reynolds R. E.: Comment on "Entropy production and the second law of thermodynamics: An introduction to second law analysis," by Thomas V. Marcella [*Am. J. Phys.* 60 (10), 888-895 (1992)], *Am. J. Phys.* 62, No 1 (1994), p. 92.
- [13] Samiullah M.: What is a reversible process? *Am. J. Phys.* 75(7) (2007), p. 608-609.
- [14] Kesidou S., Duit R.: (1992): Students' conceptions of the second law of thermodynamics: An interpretative study, *J. Res. Sci. Teach.* 30 (1992), p. 85-106.
- [15] Viglietta L.: 'Efficiency' in the teaching of energy. *Phys. Educ.* 25 (1990), p. 317-321.
- [16] Bucher M.: New diagram for heat flows and work in a Carnot cycle, *Am. J. Phys.* 54, No 9 (1986), p. 850-851.
- [17] Wallingford J.: Inefficiency and irreversibility in the Bucher diagram, *Am. J. Phys.* 57, No 4 (1989), p. 379-381.
- [18] Yan Z., Chen J.: Modified Bucher diagrams for heat flows and works in two classes of cycles, *Am. J. Phys.* 58, No 4 (1990), p. 404-405.
- [19] Yan Z., Chen J.: New Bucher diagrams for a class of irreversible Carnot cycles, *Am. J. Phys.* 60, No 5 (1992), p. 475-476.
- [20] Bucher M.: Diagram of the second law of thermodynamics, *Am. J. Phys.* 61, No 5 (1993), p. 462-466.
- [21] Bucher M.: Comment on "Development and assessment of research-based tutorials on heat engines and the second law of thermodynamics," by Matthew J. Cochran and Paula R. L. Heron [*Am. J. Phys.* 74 (8), 734-741 (2006)], *Am. J. Phys.* 75, No 4 (2007), p. 377-379.
- [22] Wallingford J.: Inefficiency and irreversibility in the Bucher diagram, *Am. J. Phys.* 57, No 4 (1989), p. 379-381.
- [23] Yan Z., Chen J.: Modified Bucher diagrams for heat flows and works in two classes of cycles, *Am. J. Phys.* 58, No 4 (1990), p. 404-405.
- [24] Yan Z., Chen J.: New Bucher diagrams for a class of irreversible Carnot cycles, *Am. J. Phys.* 60, No 5 (1992), p. 475-476.
- [25] Rant Z.: (1956): Exergie, ein neues Wort für 'Technische Arbeitsfähigkeit', *Forsch. Ing. Wes.*, Vol. 22, p. 36-37.
- [26] Backhaus U., Schlichting H. J.: (1984). Der exergetische Wirkungsgrad, *Der Physikunterricht* 18/3, p. 58-61.

E-Learning in Physical Science Through Sport: Learning objects and their dissemination

Robert Lambourne

Department of Physical Sciences, The Open University, United Kingdom

Abstract

E-Learning in Physical Science through Sport, the ELPSS project, was part of the first generation project strand of the UK's National Teaching Fellowship Scheme. The main aim of the project was to design, produce and disseminate a range of reusable learning objects (RLOs) that would encourage and enhance the teaching of various aspects of physical science using examples and contexts drawn from the field of sport, and particularly from the various Olympic sports. A supporting aim was the production of dissemination materials that would inform academics of the existence of these (non-commercial) RLOs and explain how they could be down-loaded from digital repositories and incorporated into a range of courses at a variety of levels. This paper briefly introduces the ELPSS RLOs and discuss the principles that guided their design; it then goes on to describe the dissemination of information about the project, the special efforts that entails, and the challenge of bringing about changes in pedagogic culture in an established area such as physical science.

Keywords: sport, basic physical science, dissemination

Introduction

The ELPSS project, E-Learning in Physical Science through Sport, was one of the first generation of institutional projects supported by the project strand of the National Teaching Fellowship Scheme [1]. Its main aim was the creation of a large number of free-standing interactive teaching packages that introduce a wide range of important ideas in the physical sciences (physics, chemistry and materials science) using examples taken from the world of sport. When the production phase of the project came to an end a total of 45 reusable learning objects (RLOs) that can be incorporated into lectures, courses, and programmes had been produced and made were made freely available to all publically funded universities in the UK via a password protected website. (This limitation was necessary because of copyright restrictions on some of the images that had been used.) However, all those RLOs that were not subject to such restrictions were also made separately available via an Open University website [2] and through a widely distributed CD that was sent to all the secondary schools in the UK that were members of the Instsute of Physics Affiliated Schools Scheme. Any readers desiring a copy of this CD should contact the author.

The ELPSS project began in mid-2007 and was completed by the end of July 2011. However, following the submission of the final report, the UK Higher Education Academy which had managed the funding of the National Teaching Fellowship Scheme generously made available an additional sum of money to further support the dissemination of the ELPSS materials. This paper reports on the original outputs and the use made of the additional dissemination resources.

What is an ELPSS RLO?

Each ELPSS RLO is a free-standing computer-based learning package with a specific learning goal and integrated self-assessment material. Each has a high level of interactivity, and includes, where appropriate, activities designed to develop key skills and general science literacy as well as subject knowledge and skills. Each is based on a sporting example but is also suitable for reuse in a variety of different courses or modules.

Typically, an ELPSS RLO requires about 25 minutes of student study-time. Why 25 minutes? It's long enough to: how students that it is a serious learning activity. It provides the time required to include; an introduction and a statement of learning outcomes, the learning activity required to achieve those outcomes, the assessment activities that check the outcomes and a closing summary.

The Range of ELPSS RLOS

A total of 45 RLOs have been produced. Here is a list of some representative examples, identified by code number and title, together with a very brief indication of content.

01 Measurement and accuracy – timing a run, grouping of arrows in an archery target

03 Understanding tables – Olympic records

05 Plotting graphs – long jumping, distant records against year

11 Average speed – sprinting

12 Instantaneous speed – sprinting

14 Acceleration (includes gradient analysis) – sprinting

15 Motion of falling objects – platform diving

24 Reaction forces – running, starting from blocks

25 Frictional forces – skating, running and tennis

26 Centre of mass – high jumping and other examples

27 Linear momentum – billiards and other ball games

29 Potential energy and kinetic energy – skiing

30 Potential energy and work – weightlifting

41 Atoms, ions and electrolytes – sports drinks and electrolyte balance

As this partial listing makes clear, sport is a very fertile area for finding interesting examples to illustrate physical principles and help develop a wide range of skills.

S172: Sport; the Science Behind the Medals

The ELPSS RLOs do not constitute a course or module. Rather, they are a learning and teaching resource that has been designed to facilitate the efficient production of a wide range of courses in physical sciences, mainly but not exclusively at the introductory level. In this spirit, more than 20 of the RLOs have been used to aid the production of a 10 point Open University level 1 module with the designation S172 The Science Behind the Medals. This module was first presented in the run up to the London Olympics of 2012. It provides an example of how the RLOs might be integrated into a coherent course but it is certainly not intended to indicate any essential sequencing of RLOs or even a unique way

of combining ELPSS resources with other educational resources. The whole spirit of ELPSS is to broaden approaches to the teaching of physical sciences, not to restrict them.

S172 The Science Behind the Medals was presented on-line using the Open University's Moodle based Virtual Learning Environment. The nine chapters of the eBook that constitutes the 'spine' of the module had the following titles:

- 1 Sport, science and the Olympic Games
- 2 Running fast: the science of sprinting
- 3 Into the water: the science of swimming
- 4 Into the air: the science of jumping
- 5 Making a splash: the science of diving
- 6 Rolling fast: the science behind wheeled sports
- 7 Bouncing, spinning and swerving: ball sports
- 8 Going on and on: the science of endurance events
- 9 The final lap: summary and review

Clearly, this particular structure was chosen to offer obvious opportunities to incorporate ELPSS RLOs and confirm their effectiveness and viability as flexible learning resources. Each chapter provided the opportunity to use two or three RLOs, and generally followed each RLO with a text-based set of questions designed to ensure that students really had obtained from the RLO those elements of knowledge and skill that would be required in their continued study of the module and the associated eBook.

Dissemination routes

As noted in the introduction, all 45 of the ELPSS RLOs produced are freely available to members of the UK publically funded higher education community through a password protected web site (initially via the the Jorum web depository <http://resources.jorum.ac.uk>). In addition, those RLOs that can be distributed without password protection can be freely downloaded from <http://ELPSS.open.ac.uk>. A substantial subset of ELPSS RLOs has also being made available to schools, colleges and other interested parties through a purpose made ELPSS CD distributed to more than 1600 schools affiliated to the UK Institute of Physics. For a copy of this disc, please send a request to robert.lambourne@open.ac.uk. However, these dissemination efforts are only part of the total dissemination effort made by the project team.

An important additional element of dissemination was based on published papers and conference presentations in the UK and overseas, together with more informal dissemination through contacts formed via the Institute of Physics, the European Physical Society and the International Commission on Physics Education and similar bodies.

However, despite all of these efforts the project team still felt that the dissemination of such an unusual approach to course production would benefit from still wider dissemination provide some extra resources could be found to make such an effort possible and sufficiently notable to have a good chance of success. Thanks to the continued support of the UK Higher Education Academy this ambition has now been realised.

The Football Science dissemination resource

The “Football Science” dissemination resource is now at an advanced stage of production. It consists of five short films that have been produced by the ELPSS project in collaboration with Great Central Consulting (a professional educational consultancy) and the MK Dons Football Team through the MK Dons Sports and Education Trust. Each film addresses a specific topic in physical science. The selected topics are:

Speed and acceleration

Momentum and impulse

Energy and power

Force and strength

Friction and resistance

Following the usual ELPSS approach, each film illustrates the importance of its topic through a footballing example or context. These films are not intended to act as RLOs in the usual sense, they are too short for that, but thanks to their brevity and relevance to football it is expected that each will be widely used in a variety of conference presentations and other contexts and will thereby help to disseminate ELPSS in professional educational circles. In addition, it is expected that the films, when finalized, will reach a new audience by being shown on the ‘Big Screen’, during the intervals of football matches staged at the MK Dons stadium in Milton Keynes. Following this it is intended that all five of the films will be made available via iTunesU.

Conclusions

Though modest in scale the ELPSS project, along with many similar efforts [3], is part of a wide movement engaged in the promotion of cultural change in education. The challenges of bringing about cultural change on almost any scale are well known. They generally arise from a lack of time, lack of resources, lack of motivation and so on, to say nothing of the inerte caution found in many parts of the physical science community. For ELPSS the challenge is doubled since there is not only the desire to change at least some aspects of the teaching of physical science but also the need to do so using only electric resources which are still far from universally popular. Despite this ELPSS continues to try to reach wider audiences. Football Science is the latest part of that effort.

All those involved in the project thank The UK Higher Education Academy for their continued support. We also thank our new partners in the MK Dons Sports and Education Trust. We look forward to further fruitful collaborations in the future.

References

- [1] <http://resources.jorum.ac.uk> – password required
- [2] <http://ELPSS.open.ac.uk> – open access
- [3] Rehak D. R., Mason R.: (2003), "Engaging with the Learning Object Economy", in Littlejohn, Allison, *Reusing Online Resources: A Sustainable Approach to E-Learning*, London: Kogan Page, pp. 22-30.

Using Online Interactive Physics-based Video Analysis Exercises to Enhance Learning

Priscilla W. Laws¹, Robert B. Teese², David P. Jackson¹, Maxine C. Willis¹, and Kathy Koenig³

¹Dickinson College, Carlisle PA, United States

²Rochester Institute of Technology, Rochester, NY, United States

³University of Cincinnati, Cincinnati, OH, United States

Abstract

As part of our new digital video age, physics students throughout the world can use smart phones, video cameras, computers and tablets to produce and analyze videos of physical phenomena using analysis software such as Logger Pro, Tracker or Coach. For several years, LivePhoto Physics Group members have created short videos of physical phenomena. They have also developed curricular materials that enable students to make predictions and use video analysis software to verify them.

In this paper a new LivePhoto Physics project that involves the creation and testing of a series of Interactive Video Vignettes (IVVs) will be described. IVVs are short web-based assignments that take less than ten minutes to complete. Each vignette is designed to present a video of a phenomenon, ask for a student's prediction about it, and then conduct on-line video observations or analyses that allow the user to compare findings with his or her initial prediction. The Vignettes are designed for web delivery as ungraded exercises to supplement textbook reading, or to serve as pre-lecture or pre-laboratory activities that span a number of topics normally introduced in introductory physics courses. A sample Vignette on the topic of Newton's Third Law will be described, and the outcomes of preliminary research on the impact of Vignettes on student motivation, learning and attitudes will be summarized.

Keywords: video analysis, interactive curricular materials, web-based assignments

Introduction

Video expositions are already available to help students solve problems, listen to lectures, view demonstrations, and perform virtual laboratory experiments. Although video analysis is becoming popular, materials that combine short video expositions with data collection and the analysis of real phenomena are not yet widely available. The Interactive Video Vignette project (a.k.a. IVV project) involves the creation of a new genre of educational materials. Information on how each student interacts with a Vignette can be tracked automatically, so PIs are acquiring a large body of data on how students interact with a Vignette with regard to: (1) preconceptions; (2) data interpretation abilities; and (3) conclusions. This ongoing research enables the IVV team and others to revise Vignettes to render them then more effective.

As a result of funding from the U.S. National Science Foundation [1] The *LivePhoto Physics Group* [2] is working on the creation and testing of about 25 short single-topic video expositions. A typical Vignette, designed to take students less than ten minutes to complete, starts by asking students to observe a video of a phenomenon and formulate

preliminary predictions about it. After observing to phenomenon more carefully, sometimes in slow motion, or using video analysis to make associated measurements, students are invited to draw conclusions. A physics instructor then summarizes the outcomes of the experiment and briefly discusses how the experimental results exemplify a particular law or phenomenon.

Each vignette is designed for web delivery to supplement textbook reading or serve as a pre-lecture or pre-laboratory activity. These Vignettes are designed to address topics covered in introductory physics courses that can be illuminated with videos and address student learning difficulties identified by Physics Education Research and Cognitive Science [3,4]. This four-year project began in late 2011. Vignettes that are slated to be available for use by teachers and publishers during 2014 at the comPADRE website [5] are listed in Table 1.

Table 1. Interactive Video Vignettes slated for distribution in 2014

Projectile Motion	Newton's First Law
Ball Toss Dynamics	Newton's Second Law
Slinky Drop Dynamics	Newton's Third Law
Ball Drop	Bullet/block experiment

A Sample Vignette on Newton's Third Law

In order to give readers a better idea of what a Vignette is like, we have chosen to describe our Vignette on Newton's Third Law. This law can be stated quite simply.

Newton's Third Law: *If one object is exerting a force on a second object, then the second object is also exerting a force back on the first object. The two forces have exactly the same magnitude but act in opposite directions.*

But, we know from the outcomes of physics education research that even when introductory physics students can recite Newton's Third Law, very few of them believe it [6,7].

Our Vignette on the Third Law provides a dramatic demonstration of the difficulties students and other people have in understanding this simply stated Law. The Vignette features a series of "person on the street interviews" which demonstrate that most people do not believe Newton's 3rd Law, whether or not they have taken introductory physics.

The Vignette starts by asking several interviewees independently what the interaction forces would be like if two identical carts move toward each other at the same speed and collide. Every person who was interviewed said the forces would be equal and opposite. Our "professor" who interviewed people individually did so by showing a video of carts outfitted with forces probes colliding. This video display allowed each person who was interviewed to confirm whether or not he or she was correct.

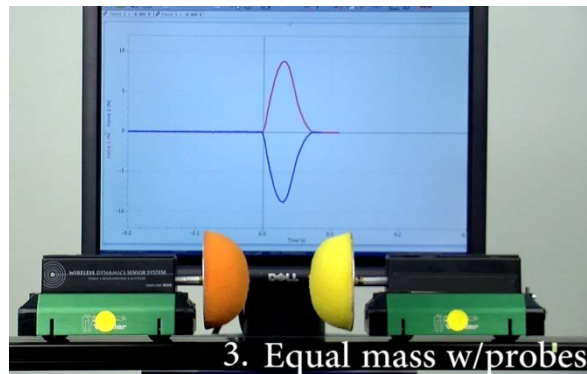

Figure 1. Two identical carts move toward each other at the same speed, collide and then recoil. Force probes readings show that the interaction forces have equal magnitudes on a moment-by-moment basis.

In order to consider a more complicated situation that tests people's belief in the Third Law, the professor showed interviewees a video of a real head on car crash in which a larger, faster car collides with a smaller slower car.



Figure 2. Video frames of two cars undergoing a head on collision

When these interviewees are asked to predict whether there were differences in the interaction forces, if the car on the left has more mass *and* is moving faster. The IVV team found that ten out of eleven people, who were asked if the forces were different, predicted that the faster more massive car exerts more force on the slower less massive car. The only interviewee who made the "correct prediction" turned out to be a recent secondary school graduate who had just passed an advanced placement examination in physics - not a typical "person on the street" and was, most probably, an above average physics student.

Since there were no force sensors on the real cars, we showed our interviewees a collision between a cart with extra mass loaded on it and a slower, less massive cart. These interviewees were asked to predict the relative size of interaction forces when one object has more mass than the other *and* is moving faster. Ten out of eleven of them predicted that the faster more massive cart exerts more force on the slower less massive cart. Next we proceeded to show each interviewee a video of a more massive faster lab cart outfitted

with a force sensor exerting an equal and opposite force on a slower, less massive cart that was also outfitted with a force sensor. This result is illustrated in Figure 3.

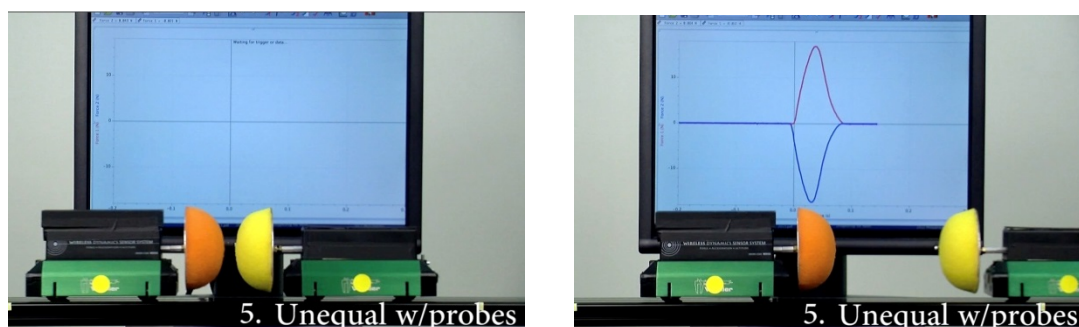

Figure 3. The two video frames show cars of unequal mass just before and after a head on collision. Before the collision the carts move toward each other at the same speed. After the collision the more massive cart on the left slows down while less massive cart on the left recoils to the right very rapidly.

Since the lighter cart recoiled rapidly, it is obvious that in a real situation the driver in the lighter car would feel much more impact. If the passengers are not wearing seat belts, we are also able to demonstrate that the passenger in the slower moving and lighter cart will suffer more damage. This is in spite of the fact that Newton's Third Law still holds for the contact forces between the fronts of the carts!! However, our interviewees intuition is correct -- the driver in the smaller, slower cart will indeed be at more risk for injury even though the interaction forces between the two colliding carts are the same! This demonstrates that common beliefs about forces in this situation are generally wrong. However, the driver in the smaller car is still at a higher risk for injury! This is shown in Figure 4 that displays the more massive cart on the left hitting the less massive cart on the right. The rapid recoil of the right cart jolts its driver who falls forward.

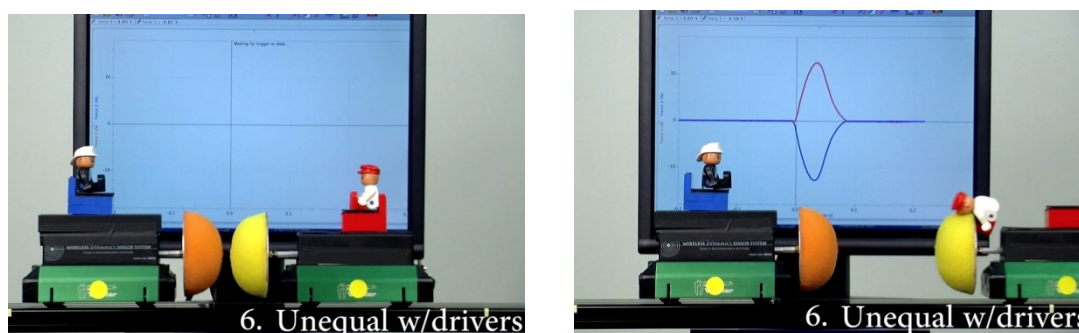

Figure 4. Video frames showing the unequal mass cars and their "drivers" just before and after a head on collision. The driver in the less massive cart shown of the right falls over while the other driver on the left merely slides forward a bit.

Preliminary Research on IVV Use

Since Interactive Video Vignettes are being designed to address scientific phenomena and principles that many students tend to misunderstand, the *LivePhoto Group* recommends that instructors arrange to give their students credit for *completing a Vignette*. But, our group did not feel that student predictions and other answers to questions should be graded. This led the group to conduct research on how to motivate students to do a vignette that is "assigned by an instructor."

Although the Rochester Institute of Technology and Dickinson College students tested some of the Vignettes, most of the early motivation research was done at the University of Cincinnati in the Winter and Spring Quarters of 2011 and 2012.

- (1) In the winter quarter 610 students taking one of the sections of calculus-based introductory physics received an email suggesting that they view IVV on Projectile Motion as an optional homework assignment to "help them understand the topic better." *Only 28% of students completed the "suggested" IVV.*
- (2) In the spring quarter 127 students in one of the sections of calculus-based introductory physics received an email suggesting that viewing the IVV on Projectile Motion IVV as an optional homework assignment would help them understand the topic better AND that there would be a related **exam** question. *This time 39% of the students completed the IVV.*
- (3) In another section at the University of Cincinnati the final exam included a question on the nature of the vertical component of motion associated with the trajectory of a projectile. It turned out that 92% of the students who had completed the projectile motion IVV answered an exam question about the vertical component of the projectile's motion correctly. On the other hand, only 71% of the students who *didn't complete the related IVV* answered the vertical motion question correctly.

A new project involving the impact of student use of IVVs on Projectile Motion and Newton's three laws of motion is underway in introductory classes at University of Cincinnati, Rochester Institute of Technology and Dickinson College. In this study students are being given homework credit for completing each of the four vignettes but not graded on their answers. A pre- and post- test is being administered to the participating students at all three institutions with questions of each of the four topics.

Students who complete IVVs seem to enjoy them. Some of the *optional comments* collected from students as part of completing their IVV assignments during the Spring of 2012 at the University of Cincinnati include:

"There should be more videos like this to understand concepts."

"Worked Great! Informative and easy to understand!"

"Great! Good way to show proof of concept, I would like for every chapter to have one of these."

"It would be good if there was closed captioning on the video for the hearing impaired."

"GREAT VIDEO!!! WOOOHOOO PHYSICS!!!"

"I thought the interactive video was very well made. I can't wait to see and learn more."

Conclusions

Members of the *LivePhoto Physics Group* who have participated in the design and testing of the Interactive Video Vignette Project remain enthusiastic about the potential of Video Vignettes as a viable alternative to on-line lectures and other on-line teaching modalities

that are primarily passive. In addition, our group is optimistic that the ongoing research on the effectiveness of IVVs on classical mechanics topics will yield good results. Group members expect that IVVs will prove to be superior to many conventional out-of-class assignments and in some cases augment or replace other forms of out of class learning experiences.

References

- [1] Supported by NSF grants DUE-1122828 and DUE-1123118.
- [2] Muller D. A.: “Designing Effective Multimedia for Physics Education”, Ph.D. Dissertation, U of Sydney, 2008.
- [3] Roth K. J.: “Conceptual Change Learning and Students’ Processing of Science Texts”, Annual Meeting of the American Educational Research Association, Chicago, 1985.
- [4] The LivePhoto Physics group includes Priscilla Laws, David Jackson & Maxine Willis (Dickinson College), Robert Teese (Rochester Institute of Technology), Patrick Cooney (Millersville University), and Kathy Koenig (University of Cincinnati). A collection of educational videos is available on the group’s website <<http://livephoto.rit.edu/>>
- [5] As materials become available they can be accessed at <http://www.compadre.org/>
- [6] Maloney D. P.: “Rule-governed approaches to physics: Newton’s third law,” *Phys. Educ.* **19**, 37-42 (1984). More than 100 university students with different background in physics were asked to compare the forces that two interacting objects exerted on each other. About 2/3 of the students thought that they would be of different magnitude in some circumstances.
- [7] Boyle R. K., Maloney D. P.: “Effect of written text on usage of Newton’s third law,” *J. Res. Sci. Teach.* **28**:2, 123-140 (1991). The investigators examined the beliefs about Newton’s third law of 100 university students before instruction. Half of the students were given a handout describing forces with explicit statements of the third law. No student without the handout applied the third law correctly and of those with the handout, fewer than half applied it correctly.

Teachers' concept image of energy: a challenge for curriculum development

Yaron Lehavi^{1,2} and Bat-Sheva Eylon¹

¹The Weizmann Institute of Science

²The David Yellin Academic College of Education

Abstract

The present study examined 54 mid-school science teachers' views and knowledge with respect to the nature of energy and how this nature is manifested in the language by which processes (changes) are described. As a reference for studying the nature of energy and its linguistic use in science education, we used the Girep 2010 position paper (GiPP 2010), which summarized the workshop on teaching about energy (Eylon and Lehavi, 2010). Our findings indicate that the teachers hold a fragmented image of the concept of energy and have difficulties in justifying their views.

Keywords: curriculum, teachers' knowledge, energy, energy change, concept image

Introduction

Teaching energy, a fundamental concept in any science education curriculum, is known to present a great challenge (Duit, 1984, Trumper, 1990; Solomon, 1992, Goldring & Osborne, 1994; Kaper & Goedhart, 2002; Papadouris et.al., 2008, Lindsey et.al, 2009, Lindsey et.al. 2012). The literature indicates the lack of students' proper understanding of what energy is and the meaning of the special vocabulary used. Students also have difficulties related to the interrelation of work and energy and to the role of a system in this regard (Lindsey et.al. 2009; Lindsey et.al. 2012). In the past, many doubts were raised about the use of energy forms in teaching (Summers, 1983; Mak and Young, 1987; Ellse, 1988).

There is a lack of consensus among physics educators as to the meaning of the terms used in the 'energy language' (Wolter et.al. 2002). In particular, the meaning of 'energy forms', 'energy transformations/conversions/transfer', and 'energy conservation' is not clear. It can be argued that this lack of consensus may be related to the difficulty in defining energy and to its abstract nature (Millar, 2005; Galili and Lehavi, 2006).

The Girep 2010 position paper (GiPP 2010) suggests addressing these difficulties by putting more emphasis on processes and thus on the concept of 'energy change' (Eylon and Lehavi, 2010). The GiPP 2010 paper also suggests introducing energy change as a measurable quantity in order to render the energy concept less abstract. The possibility of measuring energy change in different processes, e.g., by performing Joule-like experiments, can be regarded as an operational definition of the concept of energy change (Galili and Lehavi, 2006). Thus, the GiPP 2010 approach may possibly assist in unifying the concept of energy. Hecht (Hecht, 2007) also advocated emphasizing energy change, but unlike the GiPP 2010 view, regards it as an abstract concept, not a measurable one. The abstract and mathematical nature of energy was claimed to be one of the main reasons for the difficulty to understand it (Millar, 2005). The following are the guiding principles presented in GiPP 2010:

Energy change: Although energy itself cannot be determined without ambiguity, since it has no absolute zero value, a change in the quantity of energy can be measured and thus it is of physical importance (Reif, 1967, p. 202; Reif, 1965, p. 129). Thus, 'Energy change' refers to measuring the change in a system when it is transformed from one state to another.¹ According to the 'Energy Change' approach, energy can merely increase or decrease. Note that the role of a system is central in this approach.

(A1) **Processes and energy forms or types:** Various processes can be characterized by a change in the value of variables such as height, temperature, speed, etc. The value of these characterizing variables can either increase or decrease, indicating a parallel change in the value of the energy corresponding to the process. Thus, one can attribute a label for the change in the amount of energy corresponding to the changing variable: a change in kinetic energy, a change in height energy, a change in chemical energy, etc. Note that these are only labels that indicate the *nature of the process* by which the energy either increased or decreased. There are no different forms of energy — only different types of processes by which the value of the energy can change.

(A2) **Co-varying changes:** Observing various processes in nature reveals that they cannot be described by a change in a single variable. This observation enables one to relate energy changes in simultaneous processes. For example, changes in the amount of energy corresponding to the change in the height and speed of a falling apple (the 'height energy' and the 'kinetic energy') occur simultaneously. Simultaneous changes can occur solely within a system or, in parallel, in the system and in its surroundings. A further observation reveals that simultaneous changes always represent opposing tendencies: they occur in such a way that some of them are described by an increase in energy and others by its decrease.

(A3) **Energy conservation:** If experiments (or calculations based on generalizing experimental findings) indicate that changes in energy corresponding to co-varying changes within a certain system are mutually counterbalanced, we say that energy is conserved in this system. Such a system is called an isolated system.

The view advocated by GiPP 2010 has implications regarding how energy conservation might be presented and regarding the meaning of the terms often used with regard to energy. The following are the GiPP 2010 interpretations of the meaning of terms often used in teaching energy:

(B1) **Energy transformations.** When two different variables (e.g., height and speed) characterizing different types of processes change simultaneously, one corresponding to energy decrease and the other to its increase, we say that the decreased 'type of energy' is transformed into the increased 'type of energy'.

(B2) **Energy transfer.** When one characterizing variable changes simultaneously for two different systems, we say that the energy of a certain 'type' is `transferred` from one system to the other (Wolter et.al. 2002).

In summary, energy, according to the GiPP 2010 guiding principles, is a unified, relative, system-related and empirically based concept. If one aims at designing a curriculum based on these principles, it is important to examine teachers' pertinent knowledge and views. We therefore designed a questionnaire in order to address teachers' image of energy with respect to the GiPP 2010 guiding principles.

¹ Hecht (2007) defines energy as the conserved scalar measure of the ability of a system to produce a change.

The Study

Method

In order to examine teachers' knowledge and views of energy with respect to the GiPP 2010 guiding principles, we designed a questionnaire and administered it to middle school science teachers (N=54) who participated in several workshops around the country. Most of the teachers were biology graduates with more than 9 years of teaching experience. The questionnaire addressed the following aspects: (a) energy as a unified concept; (b) energy as a relative, system-related property; (c) energy as an empirically based concept; and (d) the energy conservation law.

The questionnaire included two parts composed of statements to which the teachers provided their degree of agreement:

1. Statements that directly addressed views regarding the above-mentioned aspects such as the relative or absolute nature of energy. This enabled us to examine the teachers' declarative knowledge of such topics.
2. Statements regarding concrete phenomena or situations that also addressed the same aspects. For instance, we asked our subjects to respond to statements such as "an apple on a tree, absolutely has height energy" or "a moving car, absolutely has motion energy".

We asked the teachers to add their reservations regarding their responses (represented here as the "But..." response). However, in almost all cases the teachers who chose that option provided no further clarification. We therefore regard this response as an indication of confusion or lack of confidence.

The reliability of the questionnaire as a whole was found to be rather good (Cronbach's $\alpha = 0.88$). Note that the yes/no/but scale that we used is a limitation to our study. Future work on this subject should employ a questionnaire with a broader Likert-type scale.

We describe the statements in the questionnaire in conjunction with the teachers' responses.

Findings and preliminary interpretations

1. **Energy as a unified concept.** The statements regarding the unity of energy (see Figure 1a) consisted of general declarative statements (the first three from the left) and declarative statements relating to specific cases (the last three statements). Figure 1b shows the distribution of teachers' responses to the combined list of six statements in Figure 1a.

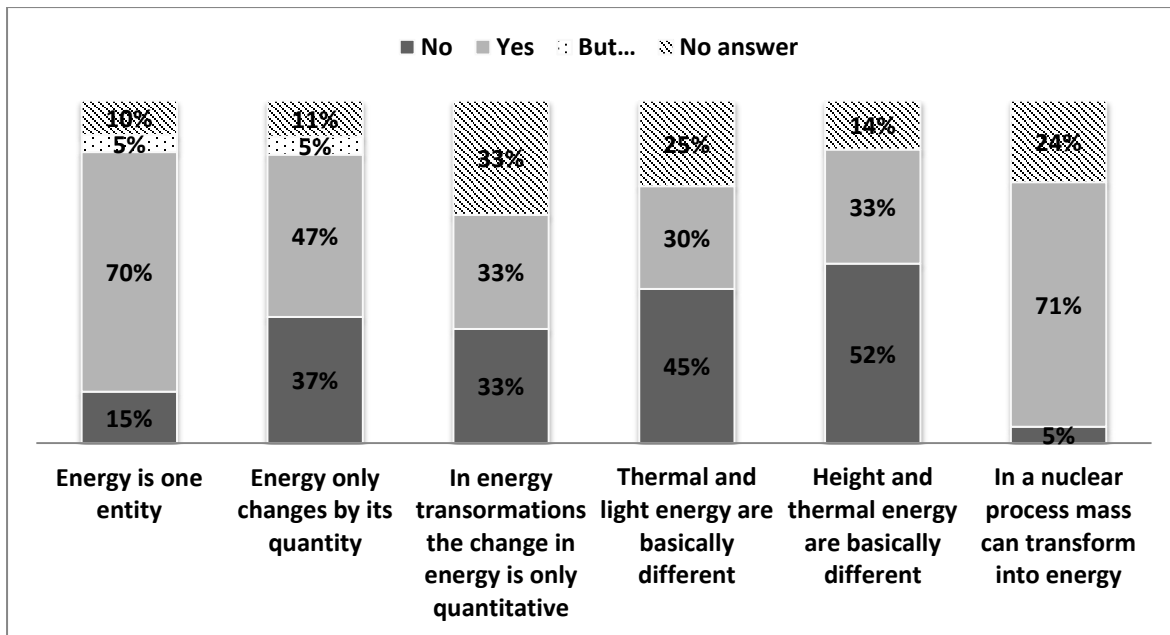

Figure 1a. Distribution of teachers' responses to declarative statements concerning the unification of Energy types/forms (N = 54)

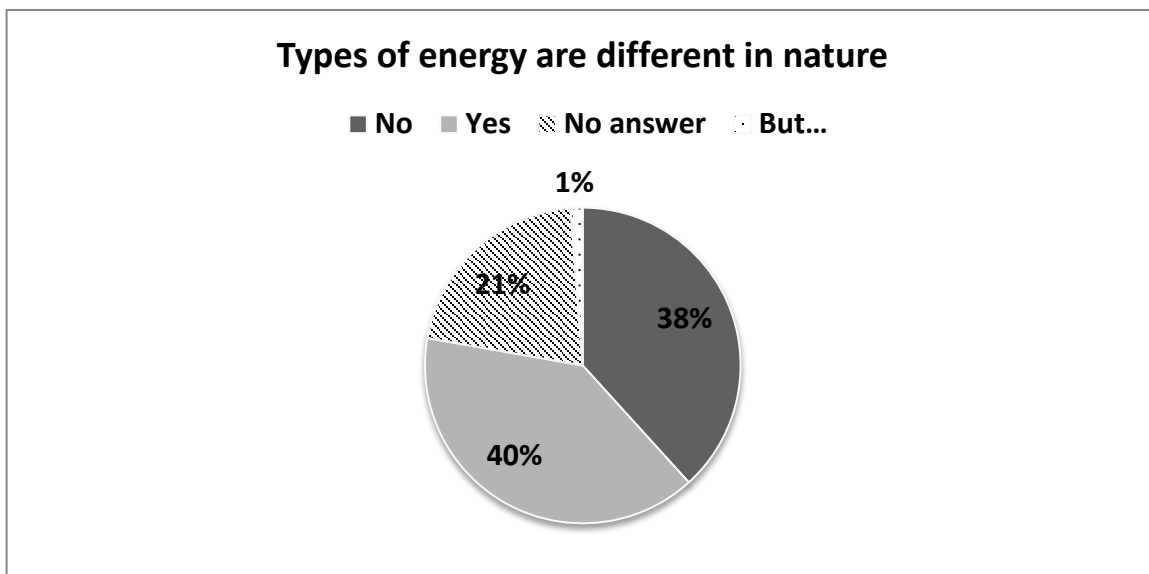

Figure 1b. Distribution of teachers' responses to the combined list of six statements in Figure 1a concerning the unification of Energy types/forms

Interestingly, more than two thirds of the teachers considered energy to be one entity, but less than half of them agreed with the statement that energy only changes in its quantity. Moreover, regarding energy transformations in general, the level of agreement among the teachers as to the unity of energy was considerably lower. A similar picture of teachers' views was observed in their responses regarding specific cases of energy forms or types. There is an apparent gap between the teachers' statements regarding the unity of energy and their opinion of statements regarding energy transformations and forms. This gap may indicate that the idea that energy is a unified concept is fragile and is not clearly related to terms such as energy transformations and forms.

2. **Energy as a relative, system-related property.** About two thirds of the teachers indicated that the energy of an object is a relative quantity, whereas most of the others did not respond to this statement. In order to examine the teachers' systemic view of energy, we asked them to respond to statements that refer to energy as a single-valued property of a single object in various cases (Figure 2a) and as something being contained (Figure 2b).

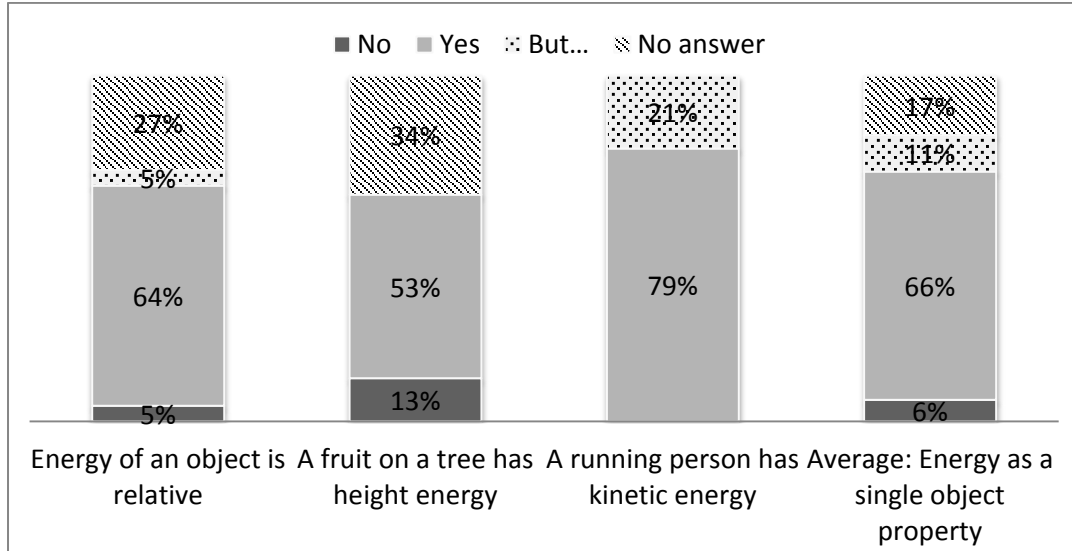

Figure 2a. Distribution of teachers' responses to statements about energy as an object property (N = 54)

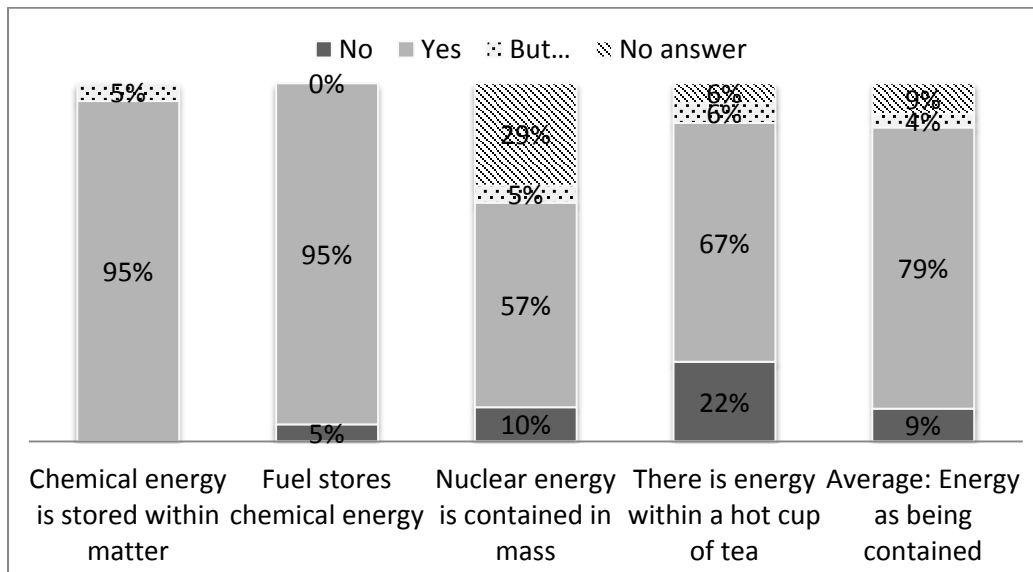

Figure 2b. Distribution of teachers' responses to statements about energy as being contained

Although the majority of the teachers agreed with the statement that energy is relative, many abandoned this idea in favor of the idea that energy is a property of a single object that is absolutely determined. This view ignores the systemic view of energy as is apparent in the case of an object's height energy, which disregards the Earth as a part of the system. In addition, most of the teachers hold the view that energy is contained within an object, which further weakens the relativistic view of energy.

3. **Energy as an empirically based concept.** The majority of the teachers decided not to refer to the statement concerning the measurability of energy (Figure 3). Only a few of them agreed with the statement that a single procedure of measurement can be used to measure energy changes. This may indicate that the teachers are confused with regard to the idea of unifying the concept of energy via measurement or they may even reject it. This, together with the confusion regarding the possibility of measuring energy changes by a single procedure, may have implications regarding the ability of many teachers to teach their students about the unification of energy.

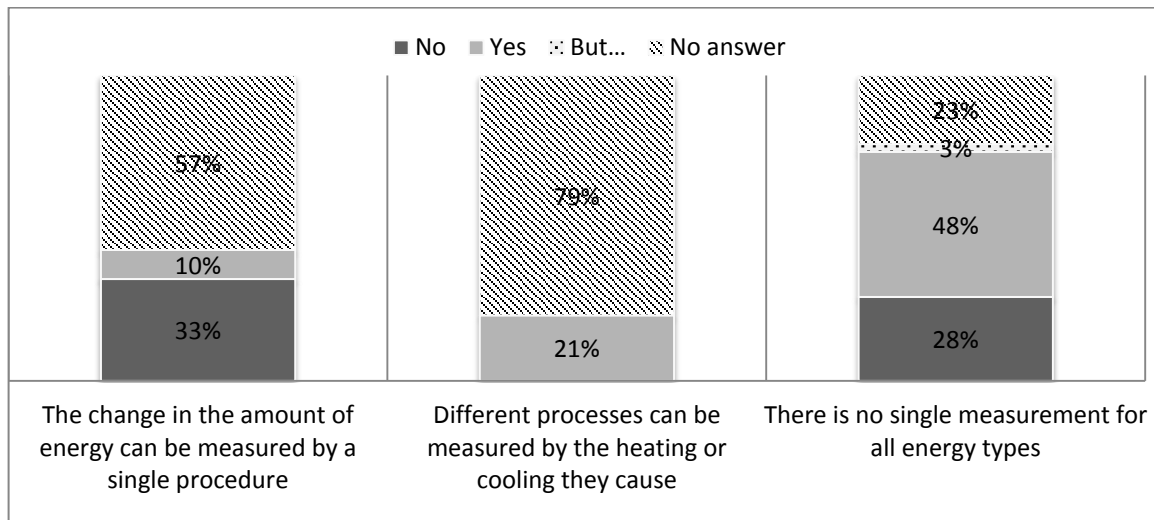

Figure 3. Distribution of teachers' responses to statements about energy as an empirically based concept (N = 54)

4. **Energy conservation.** The findings presented in Figure 4 indicate that the energy conservation law (ECL) is perceived by the teachers in this study as an irrefutable law. This is supported by the teachers' view of the limitations of measurement with regard to energy. Such an image of the conservation law assigns it a special status as a scientific law. Furthermore, the view that energy cannot be created or destroyed does not support the systemic view of the energy conservation law and might actually strengthen the material view of energy. We can see here that energy conservation and energy transformations nearly mirror each other. It seems as if one is the reason for and the result of the other. This view may suggest that some teachers regard ECL not as a basic law but as being derived from energy transformation. Such views possibly hinder a coherent justification of both energy transformation and the energy conservation law.

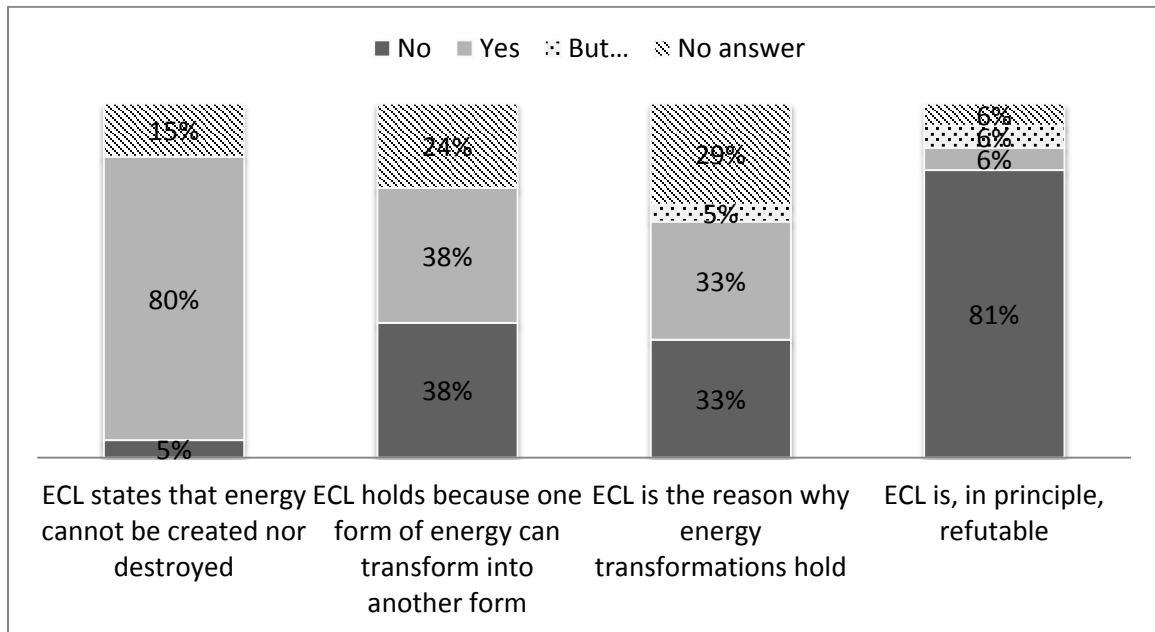

Figure 4. Distribution of teachers' responses to statements about the energy conservation law

Discussion and some suggestions

Our findings indicate that the teachers hold a fragmented image of the concept of energy. For example, many responses suggest that teachers believe that various forms of energy are inherently different from each other. Thus, many teachers may have difficulties in justifying the view that energy is one concept. The teachers also seem to hold an incoherent view regarding energy conservation: the energy conservation law is apparently regarded both as the reason for energy transformations and transfer and their result. These findings may indicate the need for coherently constructing the energy concept in such a way that energy forms (or types) together with energy transformation and transfer will be consistent with the unity of energy and its conservation, as suggested by GiPP 2010. Our research raises the need to construct coherently the energy concept as one concept. Such a construction may regard energy types/forms as labels of different processes in which energy changes rather than perceiving the existence of different types of energies. Furthermore, employing the approach that energy can only change by its value (i.e. increase or decrease) may also strengthen the unification of the energy concept. The notion of energy increase/decrease in simultaneous processes may also assist in providing coherent meaning to confusing concepts such as energy transformations, energy transfer, and energy conservation. We also found that the teachers' declarative knowledge was not always in accordance with their deep-rooted beliefs and knowledge. For example, many teachers viewed energy as relative but exhibited difficulties in applying this view to specific situations.

The abstract and mathematical nature of energy can be one of the main reasons for students' difficulty in understanding the concept and thus, presents challenges in developing learning sequences on this topic (Millar, 2005). GiPP 2010 suggests addressing this challenge by focusing on energy change - a measurable concept. However, the teachers' responses indicate that they doubt whether it is possible to construct an energy concept on the basis of experiments or they may not be aware of such experiments. Introducing Joule-like experiments may provide a possible remedy for this (Lehavi, 2012).

Our study of teachers' knowledge might be viewed with respect to some of the findings concerning students' difficulties in constructing a coherent understanding of the concept of energy. For example, students' difficulties in adopting a systemic view with regard to energy (Lindsey et.al. 2009; Lindsey et.al. 2012) might be related to the teachers' tendency to regard energy as a property of a single object. The reservations with regard to energy forms (Summers, 1983; Ogborn, 1986; Mak, 1987; Ellse, 1988; Wolter et.al. 2003; Millar 2005) are clearly reflected in the teachers' knowledge in this study.

In summary, the present study suggests that the principles advocated in GiPP 2010 may be challenging for many science teachers. We found that in general the teachers' views are apparently not in accordance with the idea that energy is a unified, relative, conserved, and system-related concept that can be related to concrete measurements. However, in some cases the teachers' declarations are in better agreement with the GiPP 2010 principles than with their deep-rooted beliefs and knowledge. This finding may suggest that, although the teachers lack in many respects a good understanding of the full ramifications of the GiPP 2010 principles, they are willing to consider them as an alternative to their current views. These findings are relevant to curriculum development concerning energy and in particular, a curriculum that follows the GiPP 2010 guiding principles (Lehavi et.al. 2012). For instance, employing a set of simple Joule-like experiments, as suggested above, may assist in developing the concept of energy as a more concrete, measurement-based concept. We received some encouraging feedbacks from teachers who attended workshops in which the GiPP 2010 principles were presented together with a set of supporting experiments and activities.

Finally, our findings bear some implications for training teachers, both in-service and pre-service. More specifically, teachers may be encouraged to ask their students to observe the changes that occur in a certain process and tell first the 'story of events' without referring to energy at all and only later add 'energy changes' to that story. The training may emphasize the importance of employing measurements in order to 'normalize' the energy concept and render it more concrete and scientific. Thus, teachers may encourage their students to look for a common measurable feature (e.g., heating/cooling) that can link different processes in which energy changes. The measurements should provide the basis for discussing and arriving at the correct conclusions. It is further suggested that teachers also be trained to call their students' attention to the system in hand and emphasize its importance when using the 'language' of energy to describe various processes.

References

- [1] Duit R.: Learning the energy concept in school — empirical results from the Philippines and West Germany. *Physics Education*, No 19 (1984), P. 59–66.
- [2] Ellse M.: Transferring, not transforming energy. *School Science Review*, No 69 (1988), p. 427-437.
- [3] Eylon B-S., Lehavi Y.: Position paper: Energy as the language of changes. In: Heron P. R.L. Micheline M. (Organizers): "Teaching about energy. Which concepts should be taught at which educational level?" A workshop held within: GIREP – ICPE – MPTL, University of Reims, France (2010). Retrieved from: http://www.univ-reims.fr/site/evenement/girep-icpe-mptl-2010-reims-international-conference/gallery_files/site/1/90/4401/22908/29702/30688.pdf

- [4] Galili I., Lehavi Y.: Definitions of Physical Concepts: A study of physics teachers' knowledge and views. *International Journal of Science Education*. No 28 (5) (2006), p. 521–54.
- [5] Goldring H., Osborne J.: Students' difficulties with energy and related concepts. *Physics Education*, No 29 (1994), p. 26–32.
- [6] Hecht E.: Energy and Change. *The Physics Teacher*. No 45(2) (2007), p. 88-92.
- [7] Lehavi Y.: Reproducing Joule's Experiment(s) in Teaching the Concept of Energy. In: Michelini M. and Heron P. R.L. (Organizers): "Teaching and learning the concept of energy from early childhood school through university" A symposium held within: GIREP - WCPE, Istanbul, Turkey (2012).
- [8] Lehavi Y., Eylon B-S., Hazan A., Bamberger Y., Weizman A.: Focusing on changes in teaching about energy. In: Michelini M. and Heron P. R.L. (Organizers): "Teaching and learning the concept of energy from early childhood school through university" A symposium held within: GIREP - WCPE, Istanbul, Turkey (2012).
- [9] Lindsey B. A., Heron P. R. L., Shaffer P. S.: Student ability to apply the concepts of work and energy to extended systems. *American Journal of Physics*. No 77(11) (2009), p. 999–1009.
- [10] Lindsey B. A., Heron P. R. L., Shaffer P. S.: Student understanding of energy: Difficulties related to systems. *American Journal of Physics*. No 80(2) (2012), p. 154-163; doi: 10.1119/1.3660661.
- [11] Mak S.Y., Young K.: Misconceptions in the teaching of heat. *School Science Review*, No 68 (1987), p. 464- 470.
- [12] Millar R.: Teaching about energy. Research Paper 2005/11. York: Department of Educational Studies, University of York. Retrieved October 30, 2012 from: www.york.ac.uk/education/research/research-paper
- [13] Ogborn J.: Energy and fuel: The meaning of the go of things. *School Science Review*, No 68 (1986), p. 30–35.
- [14] Papadouris N., P. Constantinou, CP., Theodora Kyratsi T.: Students' use of the energy model to account for changes in physical systems, *Journal of Research in Science Teaching*, 45(4) (2008), p. 444–469.
- [15] Reif F.: *Fundamentals of Statistical and Thermal Physics*. NY, McGraw-Hill (1965).
- [16] Reif F.: *Statistical Physics*. NY, McGraw-Hill (1965).
- [17] Solomon J.: How children learn about energy — or: Does the first law come first? *School Science Review*, No 63 (1982), p. 415–422.
- [18] Summers M. K.: Teaching heat - an analysis of misconceptions, *School Science Review*, No 64 (1983), p. 670- 676.
- [19] Trumper R.: Children's energy concepts: A cross-age study, *International Journal of Science Education*, No 15(2) (1993), p. 139-148.
- [20] Wolter H. Kaper, Martin J. Goedhart.: 'Forms of Energy', an intermediary language on the road to thermodynamics? Part I, *International Journal of Science Education*, 24(1) (2002), p. 81-95.

The Preparation of Physics Teachers and the Next Generation Science Standards in the United States

Ramon E. Lopez¹, Greg Hale², Ann Cavallo³

¹Department of Physics, Univ. of TX at Arlington

²College of Science, Univ. of TX at Arlington

³Department of Curriculum and Instruction, Univ. of TX at Arlington³

Abstract

In the United States, individual states establish their own state science standards that guide school instruction. In March of 2013, the Next Generation Science Standards (NGSS) were released after more than two years of development with the participation of several states. Twenty-six states have indicated that they would adopt these standards as their state standards over the next few years. Such a wide-scale adoption of a common set of science education standards will be a major milestone in US science education. It will also have an enormous impact on US physics education, teacher preparation, and the agencies and programs that fund science teacher preparation, such as the National Science Foundation Noyce Program. In this presentation we will discuss the structure of the NGSS and examine a variety of issues that have significant implications for the preparation of future physics teachers. Among the issues are the inclusion of scientific and engineering practices and crosscutting concepts, engineering as a discipline within the NGSS, the emphasis on fields, and the possible inclusion of significant amounts of Earth and Space Science content in physics courses. These developments are likely to influence other countries contemplating a more holistic view of science education.

Keywords: standards, teacher preparation, physics education

US education: The Primacy of States and Local Control

Elementary and secondary education in the United States is delivered through a complex system of 98,817 public elementary and secondary schools that in 2011 served 49.4 million students, along with 33,366 private schools that in 2011 served 5.3 million students [1]. Public schools are managed by 17,011 local education agencies (LEAs) that vary enormously in size and composition [2]. The LEAs themselves are governed by locally-elected school boards. The LEAs have considerable autonomy to determine instruction, but they are guided by state policy.

Individual states specify a range of educational requirements through legislation, including the number and kind of courses required for high school graduation, what instructional materials may be purchased by schools, standards for teacher preparation and licensing, standards for learning, and the testing of students to determine how well they have met those standards. These requirements vary significantly from state to state, and LEAs can have considerable flexibility within those requirements. The Federal government, on the other hand, plays only a minor role in U.S. education and accounts for only 8.3% of total spending on publicly funded elementary and secondary education [3]. Thus the control of education policy in the U.S. is at the state level.

In the 1990s there was an attempt to bring more uniformity to science education standards in the states, as part of a broader effort in science education reform [4]. Two

non-governmental scientific organizations that broadly represent the U.S. scientific community, the American Association for the Advancement of Science (AAAS) and the National Academy of Sciences (NAS), produced a series of documents to help guide the development of state science standards. These documents [e.g. 5,6,7] outlined what a scientifically literate citizen should know and at what point in schooling students should learn these concepts. However, those documents were not intended to be directly adopted by states. Instead, individual states used them (to greater or lesser degree) as guides in the development of their own state standards.

The Next Generation Standards Movement

Some twenty years after the beginning of the standards movement, the National Governors Association (NGA), an organization founded in 1908 by the governors of the states [8], decided that states should collaborate more and produce common education standards that would be adopted by most states. The first fruit of this effort was a set of standards for English language arts and another set of standards for mathematics known as the Common Core standards [9].

Science was not far behind, but unlike the Common Core, the development effort was not led directly by the NGA. Instead, the National Academy of Sciences was tasked to create a document that identified what was important in science and engineering that all students should know, and when they should learn these things. In 2010, the National Research Council (the operating agency of the NAS) formed a committee that was chaired by Dr. Helen Quinn, a distinguished theoretical physicist and a former president of the American Physical Society. Other members included distinguished scientists (including two Nobel laureates), educators, and experts in cognitive science. The document they produced would be then be turned into a standards document that individual states could adopt through their normal legislative procedures.

The Framework

The NRC committee produced a report titled *A Framework for K-12 Science Education: Practices, Crosscutting Concepts, and Core Ideas* [10] that was released in July 2011 after extensive review by scientists, educators, and a variety of organizations and professional societies. This document has three dimensions, as indicated by the title. It also incorporates engineering as distinct from science, both in the practices and in the content.

The first of these dimensions, the scientific and engineering practices, are those behaviors that are at the core of what is meant by engaging in science and engineering. These practices are found in all fields of science and engineering, and they are enumerated here:

- 1) Asking questions (for science) and defining problems (for engineering)
- 2) Developing and using models.
- 3) Planning and carrying out investigations.
- 4) Analyzing and interpreting data.
- 5) Using mathematics and computational thinking.
- 6) Constructing explanations (for science) and designing solutions (for engineering).
- 7) Engaging in argument from evidence.
- 8) Obtaining, evaluating, and communicating information.

Practices 1 and 6 have somewhat different interpretations for science versus engineering, reflecting the differences between the disciplines. While engineers might ask scientific questions, their focus is defining a problem and designing a solution to that problem. Scientists may also design solution to a problem (such as when space scientists design scientific instruments that minimize mass and power requirements). But such design solutions are steps along the way to answering scientific questions, not end goals in and of themselves. The practices can be seen as the behaviours that make up “scientific inquiry”, which the previous standards documents stressed as the way to learn science [6,7].

The second dimension in the *Framework* is the notion of a crosscutting concept. The crosscutting concepts are found in all aspects of science and engineering, and the authors of the *Framework* wanted to emphasize the unity of science by viewing science through this lens. Moreover, research in cognitive science indicates that expertise in science is grounded in the development of coherent conceptual frameworks around topics. For example, novice physics students will organize problems by surface features, such as the presence of an inclined plane, while experts organize problems through principles such as conservation of energy [11]. Thus an emphasis on crosscutting concepts could help students develop more expert-like scientific thinking.

The crosscutting concepts are:

- Patterns.
- Cause and effect: Mechanism and explanation.
- Scale, proportion and quantity.
- Systems and system models.
- Energy and matter: Flows, cycles, and conservation.
- Structure and function.
- Stability and change.

One of the crosscutting concepts, energy, is also a disciplinary core idea in the physical sciences. However the concept of energy as an organizing principle extends through all of science and engineering.

The third dimension of the *Framework* is the content, the Disciplinary Core Ideas (DCIs). This is what people usually think about as “science”, though the *Framework* argues that without the other two dimensions one does not have an adequate or realistic depiction of science and engineering. The DCIs are divided by discipline:

- 1) Physical Science.
- 2) Life Science.
- 3) Earth and Space Science.
- 4) Engineering, Technology, and Applications of Science.

A narrative for each of these major divisions outlines the big ideas for each topic. For example, in Physical Science (PS), topic 2 is titled “Motion and Stability: Forces and Interactions.” This topic is further subdivided into sections such as “PS2.A: FORCES AND MOTION.” The *Framework* discusses learning progressions throughout the document and it organizes the content along these lines. For each section of the DCIs (such as PS2.A), a set of grade-band endpoints are specified, outlining what a student should be able to know and do as a result of instruction at the end of that grade-band. The *Framework* also discusses other topics, such as integrating the three dimensions. However, the *Framework* by itself is not a document that states could adopt to guide instruction. That set of documents, known as the Next Generation Science Standards (because they are

a generation removed from the first set of U.S. science standards), would be developed next, using the *Framework* as the guide.

The Next Generation Science Standards

The development of the Next Generation Science Standards (NGSS) was led by Achieve, which is a non-profit organization founded in 1996 by governors and business leaders to help states improve education [12]. Achieve established a collaboration with the 26 lead state partners, states that committed early on to eventually adopting the NGSS as their state standards. The AAAS and the National Science Teachers Association (NSTA) also joined the partnership.

A writing team of 41 scientists, science educators, teachers, and state leaders was formed, with a leadership committee of 9 (including the lead author of this paper). These individuals were nominated by organizations including AAAS, NSTA, and the NAS, as well as by state leadership groups. Several members of the *Framework* committee were also included on the writing team. Over the next two years the writing team produced the NGSS [13]. Extensive feedback was provided to the writing team by the lead state partners, AAAS, NSTA, and many others throughout the process, which included several private and public releases of drafts of the NGSS.

One of the first decisions to be made concerned the architecture of the NGSS. The purpose of the standards is not to directly guide instruction, but to guide the assessment of students. Thus it was determined that the NGSS would be written as a set of performance expectations (PEs) for students – things that students should be able to do as a result of instruction. Each performance expectation needed to combine the Practices and Crosscutting Concepts with the Disciplinary Core Ideas in a way that student understanding all three dimensions could be assessed. For elementary grades, the PEs were grouped by grade level, from Kindergarten through 5th grade. For secondary school, the PEs were grouped by grade band: Middle School and High School. The PEs can be organized by DCI (so, for example, all of the High School PS2.A content can be placed in one document) or by a topical arrangement (for example, High School: Forces and Interactions). These decisions were made to accommodate as best as possible the different state legislative requirements for their standards.

An example of a portion of the NGSS, arranged by topic, is presented in Figure 1. The upper box contains the PEs. Each PE addresses selected, related DCIs (the text of which is taken from the *Framework* grade-band endpoints), one Practice, and one Crosscutting Concept. It is critical to understand that the PEs are guides to assessment, not guides to instruction. Thus while HS-PS2-1 points the assessment toward the practice *Analyzing and interpreting data*, it is expected that students will be doing additional things, such as designing and conducting investigations that would provide them with the data they are to analyze. Each PE also has some clarifying statements and assessment boundaries (if needed), appended in red. Assessment boundaries are always written as negative statements indicating what information exceeds the standard that all students are expected to meet. Some PEs are marked with an asterisk (*). Those PEs integrate engineering content.

The middle boxes show the three dimensions of the *Framework* that are addressed by the PEs above, with each PE coded to the corresponding DCIs, Practice, and Crosscutting Concept that it assesses. The bottom box presents connections: How the topic contributes to topics within that grade band, what prior topics contribute to the topic, what the topic

contributes to later topics, and what connections exist to the Common Core Standards. The connections to the Common Core Standards have been added and were not present in the document as released in May, 2013.

HS.Forces and Interactions		
<p>HS.Forces and Interactions Students who demonstrate understanding can:</p> <p>HS-PS2-1. Analyze data to support the claim that Newton's second law of motion describes the mathematical relationship among the net force on a macroscopic object, its mass, and its acceleration. [Clarification Statement: Examples of data could include tables or graphs of position or velocity as a function of time for objects subject to a net unbalanced force, such as a falling object, an object rolling down a ramp, or a moving object being pulled by a constant force.] [Assessment Boundary: Assessment is limited to one-dimensional motion and to macroscopic objects moving at non-relativistic speeds.]</p> <p>HS-PS2-2. Use mathematical representations to support the claim that the total momentum of a system of objects is conserved when there is no net force on the system. [Clarification Statement: Emphasis is on the quantitative conservation of momentum in interactions and the qualitative meaning of this principle.] [Assessment Boundary: Assessment is limited to systems of two macroscopic bodies moving in one dimension.]</p> <p>HS-PS2-3. Apply scientific and engineering ideas to design, evaluate, and refine a device that minimizes the force on a macroscopic object during a collision.* [Clarification Statement: Examples of evaluation and refinement could include determining the success of a device at protecting an object from damage and modifying the design to improve it. Examples of a device could include a football helmet or a parachute.] [Assessment Boundary: Assessment is limited to qualitative evaluations and/or algebraic manipulations.]</p> <p>HS-PS2-4. Use mathematical representations of Newton's Law of Gravitation and Coulomb's Law to describe and predict the gravitational and electrostatic forces between objects. [Clarification Statement: Emphasis is on both quantitative and conceptual descriptions of gravitational and electric fields.] [Assessment Boundary: Assessment is limited to systems with two objects.]</p> <p>HS-PS2-5. Plan and conduct an investigation to provide evidence that an electric current can produce a magnetic field and that a changing magnetic field can produce an electric current. [Assessment Boundary: Assessment is limited to designing and conducting investigations with provided materials and tools.]</p> <p>The performance expectations above were developed using the following elements from the NRC document <i>A Framework for K-12 Science Education</i>:</p>		
<p>Science and Engineering Practices</p> <p>Planning and Carrying Out Investigations Planning and carrying out investigations to answer questions or test solutions to problems in 9–12 builds on K–8 experiences and progresses to include investigations that provide evidence for and test conceptual, mathematical, physical and empirical models.</p> <ul style="list-style-type: none"> Plan and conduct an investigation individually and collaboratively to produce data to serve as the basis for evidence, and in the design: decide on types, how much, and accuracy of data needed to produce reliable measurements and consider limitations on the precision of the data (e.g., number of trials, cost, risk, time), and refine the design accordingly. (HS-PS2-5) <p>Analyzing and Interpreting Data Analyzing data in 9–12 builds on K–8 and progresses to introducing more detailed statistical analysis, the comparison of data sets for consistency, and the use of models to generate and analyze data.</p> <ul style="list-style-type: none"> Analyze data using tools, technologies, and/or models (e.g., computational, mathematical) in order to make valid and reliable scientific claims or determine an optimal design solution. (HS-PS2-1) <p>Using Mathematics and Computational Thinking Mathematical and computational thinking at the 9–12 level builds on K–8 and progresses to using algebraic thinking and analysis, a range of linear and nonlinear functions including trigonometric functions, exponentials and logarithms, and computational tools for statistical analysis to analyze, represent, and model data. Simple computational simulations are created and used based on mathematical models of basic assumptions.</p> <ul style="list-style-type: none"> Use mathematical representations of phenomena to describe explanations. (HS-PS2-2),(HS-PS2-4) <p>Constructing Explanations and Designing Solutions Constructing explanations and designing solutions in 9–12 builds on K–8 experiences and progresses to explanations and designs that are supported by multiple and independent student-generated sources of evidence consistent with scientific ideas, principles, and theories.</p> <ul style="list-style-type: none"> Apply scientific ideas to solve a design problem, taking into account possible unanticipated effects. (HS-PS2-3) <p>Connections to Nature of Science</p> <p>Science Models, Laws, Mechanisms, and Theories Explain Natural Phenomena</p> <ul style="list-style-type: none"> Theories and laws provide explanations in science. (HS-PS2-1),(HS-PS2-4) Laws are statements or descriptions of the relationships among observable phenomena. (HS-PS2-1),(HS-PS2-4) 	<p>Disciplinary Core Ideas</p> <p>PS2.A: Forces and Motion</p> <ul style="list-style-type: none"> Newton's second law accurately predicts changes in the motion of macroscopic objects. (HS-PS2-1) Momentum is defined for a particular frame of reference; it is the mass times the velocity of the object. (HS-PS2-2) If a system interacts with objects outside itself, the total momentum of the system can change; however, any such change is balanced by changes in the momentum of objects outside the system. (HS-PS2-2),(HS-PS2-3) <p>PS2.B: Types of Interactions</p> <ul style="list-style-type: none"> Newton's law of universal gravitation and Coulomb's law provide the mathematical models to describe and predict the effects of gravitational and electrostatic forces between distant objects. (HS-PS2-4) Forces at a distance are explained by fields (gravitational, electric, and magnetic) permeating space that can transfer energy through space. Magnets or electric currents cause magnetic fields; electric charges or changing magnetic fields cause electric fields. (HS-PS2-4),(HS-PS2-5) <p>PS3.A: Definitions of Energy</p> <ul style="list-style-type: none"> ...and "electrical energy" may mean energy stored in a battery or energy transmitted by electric currents. (secondary to HS-PS2-5) <p>ETS1.A: Defining and Delimiting Engineering Problems</p> <ul style="list-style-type: none"> Criteria and constraints also include satisfying any requirements set by society, such as taking issues of risk mitigation into account, and they should be quantified to the extent possible and stated in such a way that one can tell if a given design meets them. (secondary to HS-PS2-3) <p>ETS1.C: Optimizing the Design Solution</p> <ul style="list-style-type: none"> Criteria may need to be broken down into simpler ones that can be approached systematically, and decisions about the priority of certain criteria over others (trade-offs) may be needed. (secondary to HS-PS2-3) 	<p>Crosscutting Concepts</p> <p>Patterns</p> <ul style="list-style-type: none"> Different patterns may be observed at each of the scales at which a system is studied and can provide evidence for causality in explanations of phenomena. (HS-PS2-4) <p>Cause and Effect</p> <ul style="list-style-type: none"> Empirical evidence is required to differentiate between cause and correlation and make claims about specific causes and effects. (HS-PS2-1),(HS-PS2-5) Systems can be designed to cause a desired effect. (HS-PS2-3) <p>Systems and System Models</p> <ul style="list-style-type: none"> When investigating or describing a system, the boundaries and initial conditions of the system need to be defined. (HS-PS2-2)
<p>Connections to other DC Is in this grade-band: HS.PS3.A (HS-PS2-4),(HS-PS2-5); HS.PS3.C (HS-PS2-1); HS.PS4.B (HS-PS2-5); HS.ESS1.A (HS-PS2-1),(HS-PS2-2),(HS-PS2-4); HS.ESS1.B (HS-PS2-4); HS.ESS2.A (HS-PS2-5); HS.ESS1.C (HS-PS2-1),(HS-PS2-2),(HS-PS2-4); HS.ESS2.C (HS-PS2-1),(HS-PS2-4); HS.ESS3.A (HS-PS2-4),(HS-PS2-5)</p> <p>A correlation to DC Is across grade-bands: MS.PS2.A (HS-PS2-1),(HS-PS2-2),(HS-PS2-3); MS.PS2.B (HS-PS2-4),(HS-PS2-5); MS.PS3.C (HS-PS2-1),(HS-PS2-2),(HS-PS2-3); MS.ESS1.B (HS-PS2-4),(HS-PS2-5)</p> <p>Common Core State Standards Connections:</p> <p>ELA/Literacy –</p> <p><small>*The performance expectation marked with an asterisk was developed through a process of triangulation across data.</small></p> <p>The section titled "Disciplinary Core Ideas" is reproduced verbatim from <i>A Framework for K-12 Science Education</i>, for each Science Classroom Practice, Crosscutting Concept, and Core Idea. Integrated and connected with permission from The National Academies of Sciences.</p> <p>May 2013 18</p>		

Figure 1. A sample of the NGSS from High School Physical Science, organized by topic

Challenges and Implications for Physics Teacher Preparation

The NGSS present many challenges to the states that will adopt them. One critical issue to understand is that the PEs are a guide to assessment, not a directive for instruction. And each PE is intended to guide assessment of student understanding of all three dimensions

of the *Framework*. This integration of the dimensions will be a big challenge to all teachers since they are not used to thinking explicitly along these lines. Even those teachers who were using an approach of teaching science by doing science (thus utilizing the Practices in instruction) will still initially have difficulty understanding how to weave in the Crosscutting Concepts. Energy is both a DCI and a Crosscutting Concept, and physics teachers will need to know how to teach about energy as such and also know how to use the concept of energy as a unifying theme across physics instruction.

A second issue is the distinction between science and engineering. Engineering takes a much more prominent role in the *Framework* than in previous documents of this type, and the NGSS reflect this emphasis. While engineering content is distributed throughout the NGSS, physics is a particularly good area in which to embed engineering. The PE HS-PS2-3 in Figure 1 is an example of this. In fact, High School Physical Science has five PEs that are tagged as engineering PEs, while Life Science and Earth and Space Science have only two each. So physics teachers will be responsible for a large fraction of engineering content in High School and they will have to become much more familiar with the engineering design process.

A third issue is that the NGSS contain much more Earth and Space Science content than is now typically taught in schools at all grade levels. Where is this Earth and Space Science content going to go? Some states still require a minimum of only 2 years of science to graduate from High School. That will have to change because it is impossible to accomplish the goals of the NGSS without at least 3 years of science classes. Furthermore, many schools will want to offer additional, higher-level courses that can sometimes be counted for college credit (as they do now). So it is likely that in most NGSS states there will be three basic science courses taken by all students (with additional advanced science courses for students who want them), and that the ESS content will be distributed across Physics, Chemistry, and Biology. Actually, many Space Science topics lend themselves well to inclusion in physics, such as HS-ESS1-1, given below (note that the assessment boundary puts a limit on the kind of content that can be assessed).

HS-ESS1-1. Develop a model based on evidence to illustrate the life span of the sun and the role of nuclear fusion in the sun’s core to release energy that eventually reaches Earth in the form of radiation. [Clarification Statement: Emphasis is on the energy transfer mechanisms that allow energy from nuclear fusion in the sun’s core to reach Earth. Examples of evidence for the model include observations of the masses and lifetimes of other stars, as well as the ways that the sun’s radiation varies due to sudden solar flares (“space weather”), the 11-year sunspot cycle, and non-cyclic variations over centuries]. [Assessment Boundary: Assessment does not include details of the atomic and sub-atomic processes involved with the sun’s nuclear fusion].

Another ESS PE that would readily be included in physics is: **HS-ESS1-4: Use mathematical or computational representations to predict the motion of orbiting objects in the solar system.** However, many physics teachers might not have taken an astronomy course and might not be very familiar with Kepler’s Laws, or they might be unfamiliar with the sunspot cycle or space weather. There are other topics in Earth and Space Science that are even further from typical physics content that could find their home in a “physics” course. Thus professional development and teacher preparation programs will have to provide additional scientific and pedagogical content knowledge on these topics so that physics teachers are able to teach them effectively.

A final challenge to consider here is the issue of fields. The *Framework* puts considerable emphasis on the reality of fields, especially in forces and conservation of energy. Beginning in 4th grade, students learn that objects can exert forces on each other without touching. In Middle School, students explore action at a distance and identify the thing that exerts the force, the field, as a real entity. In High School, the principle of conservation of energy includes the field energy (at a rudimentary level) as a means of explaining everyday phenomena, as well as invisible phenomena such as chemical bonds. This new emphasis on fields will not be familiar to physics teachers. Conceptually, this may be one of the most challenging additions to the science content in the NGSS. Teacher preparation and professional development programs will have to address this issue, and it may also require some rethinking of the standard undergraduate physics curriculum to provide future teachers with the conceptual knowledge of fields that they need.

Conclusions

The *Framework* and the NGSS represent a significant change in U.S. science education. For the first time, many states will have a common set of science standards based on the latest research on learning and a consensus of what science and engineering knowledge all students should learn. Originally, 26 states pledged to implement the NGSS, a process that takes time since it involves legislation. As of February 2014, eight states (including California) had adopted the NGSS, which represents very rapid progress, and more states will be adopting the NGSS in the years to come. Because the *Framework* and the NGSS contain much that is new, this widespread adoption presents real challenges to current and future physics teachers.

Physics teachers will require much more knowledge about the nature of engineering, a broad view of science that allows them to see how material can be organized by crosscutting concepts, and an understanding of the clear and explicit use of the scientific and engineering practices in instruction. Physics teachers in states that adopt NGSS are likely to be responsible for teaching a considerable amount of Earth and Space Science content that they do not currently teach and which most did not study in school. They will also need to gain a much deeper understanding of fields (a generally unfamiliar concept).

In the U.S., the National Science Foundation funds activity and research in science teacher preparation through the Noyce Program [14]. There are also innovative science teacher preparation programs like UTeach [15] and PhysTEC [16] that are serving as national, replicable models, and professional societies like the American Association of Physics Teachers [17] that will be responding to these challenges. It is likely that over the next few years these programs will develop effective models for physics teacher preparation that are aligned with the NGSS. Furthermore, it would not be surprising if the national standards in other countries are influenced by the NGSS, and that the models developed in the U.S. to deal with the challenges of physics teacher preparation have a commensurate influence.

Acknowledgements

This work was supported by the U.S. National Science Foundation grant #0833343 under the Robert Noyce Scholarship Program for Teachers of Science and Mathematics.

References

- [1] U.S. Department of Education, National Center for Education Statistics. (2012). Digest of Education Statistics, 2011 (NCES 2012-001). Available from: <http://nces.ed.gov/programs/digest/d11/index.asp>
- [2] U.S. Department of Education, National Center for Education Statistics. (2012). Numbers and Types of Public Elementary and Secondary Local Education Agencies, From the Common Core of Data: School Year 2010-11 - First Look (NCES 2012326REV). Available from: <http://nces.ed.gov/pubs2012/pesagencies10/index.asp>
- [3] U.S. Department of Education, Available from: <http://www2.ed.gov/about/overview/fed/10facts/index.html>
- [4] Lopez R. E., Schultz T.: Two revolutions in K-8 science education, *Physics Today*, September, p. 44-49, (2001).
- [5] Rutherford F. J., Ahlgren A.: *Science for All Americans*, Oxford University Press, New York, (1989), ISBN 0195067712.
- [6] *Benchmarks for Science Literacy*, AAAS, Oxford University Press, New York, (1993), ISBN 0195089863.
- [7] *National Science Education Standards*, National Committee on Science Education Standards and Assessment, National Academy Press, Washington, DC, (1995), ISBN 0309053266.
- [8] <http://www.nga.org/cms/home.html>
- [9] Common Core Standards. Available from: <http://www.corestandards.org>
- [10] National Research Council. *A Framework for K-12 Science Education: Practices, Crosscutting Concepts, and Core Ideas*. Committee on a Conceptual Framework for New K-12 Science Education Standards, Board on Science Education, Division of Behavioral and Social Sciences and Education, Washington, DC, The National Academies Press, (2012), ISBN 0309217422.
- [11] Chi M. T., Feltovich P. J., Glaser R.: Categorization and representation of physics problems by experts and novices, *Cognitive Science* 5 (2), p. 121–152, (1981) doi:10.1207/s15516709cog0502_2.
- [12] <http://www.achieve.org/history-achieve>
- [13] Next Generation Science Standards. Available from: <http://www.nextgenscience.org>
- [14] http://www.nsf.gov/funding/pgm_summ.jsp?pims_id=5733
- [15] <http://uteach-institute.org>
- [16] <http://www.phystec.org>
- [17] <http://www.aapt.org>

Effect of collaborative learning in Interactive Lecture Demonstrations (ILD) on student conceptual understanding of motion graphs

Erees Queen B. Macabebe¹ and Eleanor Alma D. Jugueta^{2,3}

¹Department of Electronics, Computer and Communications Engineering, Ateneo de Manila University, Philippines

²Computer Science Department, Faculty of Engineering, University of Santo Tomas, Philippines

³Department of Physics, Ateneo de Manila University, Philippines

Abstract

To assess effectively the influence of peer discussion in understanding concepts, and to evaluate if the conceptual understanding through Interactive Lecture Demonstrations (ILD) and collaborative learning can be translated to actual situations, ten (10) questions on human and carts in motion were presented to 151 university students comprising mostly of science majors but of different year levels. Individual and group predictions were conducted to assess the students' pre-conceptual understanding of motion graphs. During the ILD, real-time motion graphs were obtained and analysed after each demonstration and an assessment that integrates the ten situations into two scenarios was given to evaluate the conceptual understanding of the students. Collaborative learning produced a positive effect on the prediction scores of the students and the ILD with real-time measurement allowed the students to validate their prediction. However, when the given situations were incorporated to create a scenario, it posted a challenge to the students. The results of this activity identified the area where additional instruction and emphasis is necessary.

Introduction

Lecture is more often than not the most common method in teaching introductory physics. It has a relatively standard format: the teacher introduces the concept in class, solve sample problems, give practice problems to students and then give a test to assess student learning. Traditional physics instruction tends to lead students to focus more on the mathematical aspects of physics rather than on deeper conceptual understanding. It also fails to provide an active learning experience, which is essential to student learning.

One strategy that has been found effective in improving students' conceptual understanding is through interactive learning demonstrations (ILD). Various studies conducted by Thornton and Sokoloff have shown that ILDs enhance conceptual learning by motivating students to generate their own predictions and collaborate with their peers by explaining their predictions [1–4]. This engages the students to be more involved in their learning and helps them address their own misconceptions.

In most ILDs, the demonstration is set-up in front of the class with the computer display projected on a screen. The demonstration is then described to the students and they are asked to predict the outcome of the demonstration. After their prediction, the demonstration is then performed. The students immediately validate their answers whether or not they are correct by reconciling their predictions based on their observation of the demonstration.

In this study, group prediction was also employed after the individual predictions to further increase student learning of physics concepts. Before the demonstration, the students were divided into pairs or groups to discuss their individual predictions. Discussion with peers helps students learn about their own cognition given a situation. It also helps them search for alternative explanations of their predictions and modify their own thinking. Collaborative learning enhances student learning because it makes them conscious of their own thought process and helps them see how others perceive the same situation [5]. However, not all collaborative learning activities will result in positive learning gains. In attaining the group goal, some group discussions may be influenced by a more dominant member who does not necessarily have the correct answer. Thus, group members must be encouraged to give their maximum effort to ensure effectiveness of collaborative learning.

This study aims (1) to assess effectively the influence of peer discussion in understanding concepts presented in Interactive Lecture Demonstrations (ILD) and (2) to evaluate if the conceptual understanding through ILDs and collaborative learning can be translated to actual situations such as in human and objects in motion.

Interactive Lecture Demonstrations

The ILD designed for this study followed the procedure: (1) description of the demonstration, (2) prediction - individual and group predictions were conducted with each group composed of 2 or 3 students, (3) demonstration (4) discussion of results, and (5) assessment.

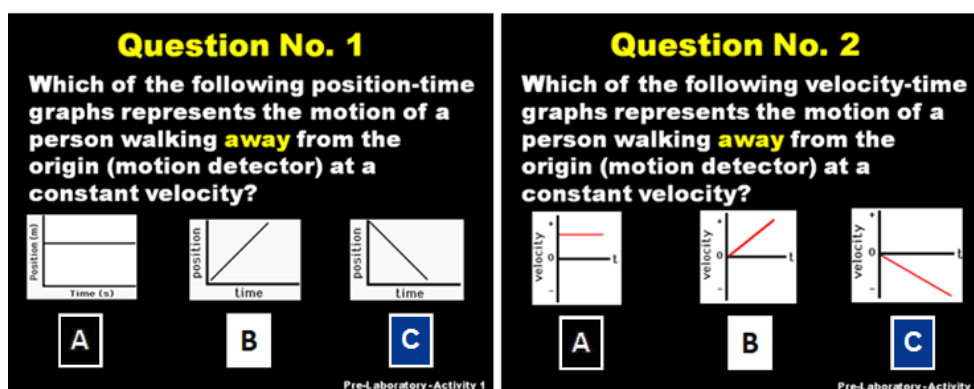

Figure 1. The slides for human motion showing how the questions were presented to the students during the individual and the group prediction

Human motion and cart in motion were the two set-ups considered in the ILD. Three situations were presented: (1) a person walking away from or toward the origin, (2) a cart given an initial gentle push or strong push, and (3) a mass attached to the cart and then the cart is released from rest. Ten (10) questions on the motion graphs of these situations were asked during the individual and group prediction. Figure 1 contains two slides with questions pertaining to human motion graphs. It shows how the questions and the situations were presented to the students. Figure 2 is the diagram shown to the students to illustrate the third situation.

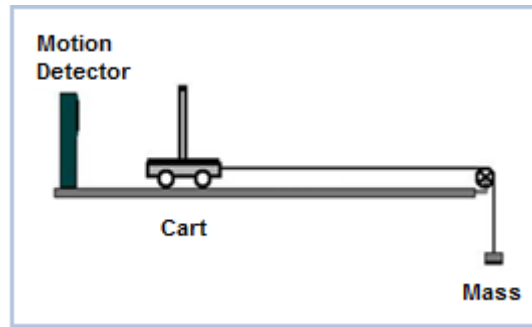

Figure 2. Set-up for cart in motion showing the mass attached to the cart

In the individual prediction, the students were asked to choose from a given set of graphs the one which represents the motion being described. They were then grouped and the same slides with the question and the choices were shown. This time the students were allowed to discuss their individual prediction and based on their discussion, they were required to come up with a common answer.

To understand the different motion graphs and, to analyze and interpret the motion graphs, real-time data acquisition tools were utilized in the ILD. A motion sensor interfaced to a computer with LoggerPro™ via LabPro™ was used to obtain the motion graphs. During the lecture demonstration, the position vs. time ($p-t$) and the velocity vs. time ($v-t$) graphs of each situation were plotted. The real-time graphs provide the correct answer to the prediction question. A discussion of the graphs and analysis of the motion in relation to the graphs followed after each demonstration.

To evaluate the conceptual understanding of the students, an assessment that integrates the ten situations into two scenarios was given. This was conducted immediately after the ILD so no reinforcement or in-class discussions were conducted prior to assessment. In the assessment, they were asked to draw the $p-t$ and the $v-t$ graphs.

The first scenario was described as follows: A person (1) walks from the detector slowly and steadily for 6 sec, (2) then stands still for 6 sec, (3) and then walks toward the detector steadily about twice as fast as before. The set-up for the second scenario is shown in Figure 3 where a string with a hanging mass at one end was attached to a cart giving it a constant force. The scenario was described as: the cart was given an initial push towards the left. (1) At t_0 , the cart is at x_0 and moves toward the motion detector from t_0 to t_1 . (2). Then, the cart moves away from the motion detector from t_1 and is back at x_0 at t_2 , (3) Passing through x_0 , continues to move away from the motion detector until t_3 .

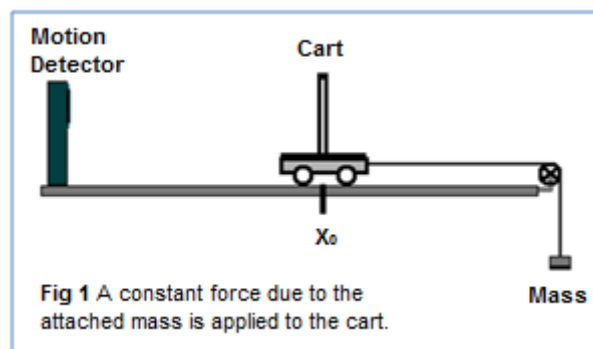

Figure 3. Illustration and caption of the second scenario in the final assessment

The ILD and the corresponding assessment were administered to 151 university students comprising mostly of science majors but of different year levels. This was conducted within the first week at the beginning of their first Physics course in the university. Thus, we assume that the students did not receive introductory lecture on motion graphs prior to the ILD.

Individual and group predictions

Analysis of the results shows a significant increase in the number of correct answers after peer discussion. Figure 4 shows the graphs of (a) the percentage of students and their answer in each item in the individual prediction and (b) in the group prediction. In human motion, questions 1 and 2 are shown in Figure 1, and questions 3 and 4 asked the students to choose the $p-t$, and the $v-t$ graphs, respectively, of a person walking towards the motion detector. From an average of 85.26% in the individual prediction, the average number of correct answers increased to 99.01% after peer discussion, an improvement of 16.12%.

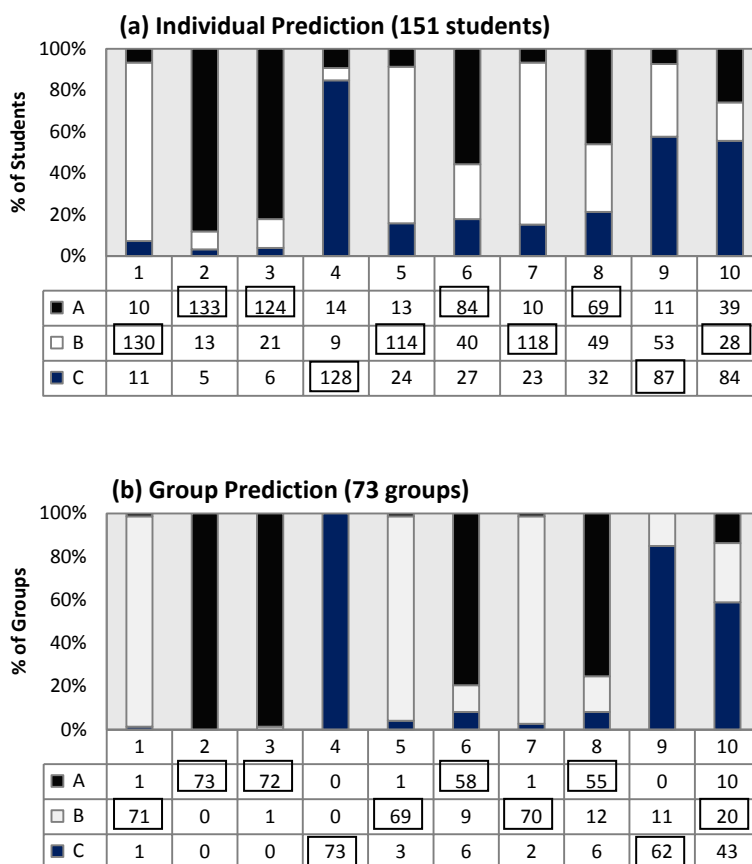

Figure 4. Plots of the percentage of students who answered either A, B, or C, in each question (x -axis), (a) in the individual prediction and (b) in the group prediction. The boxed numbers indicate the correct answers.

From the individual prediction, many found difficulty in visualizing the $v-t$ graph of an object given an initial push (questions 6 and 8) moving along a frictionless track as described by the second situation. It is possible that the students failed to connect the meaning of “initial push” in this situation. Thus, their answers to the questions were derived from a possible misconception which implies that an external force is always

present in this scenario. The said external force can be due to the initial force which, by Newton's Laws of Motion, causes the object to accelerate thereby increasing the velocity of the cart. After the group discussion, the number of students with correct answers in these questions increased by 23.18% and 29.80%, respectively.

Questions 9 and 10 pertain to the third situation shown in Figure 2. Of the 87 who answered (C) nonlinear increase in question 9, the $p-t$ plot of the cart, only 17 answered (B) linear increase in question 10 which asked for the $v-t$ plot of the motion. After the group discussion, there is a significant improvement in the number of correct answers in question 9, 85.43% from 57.62%. However, the increase in question 10 is only 9.27%, from 18.54% to 27.81%. Also, of the 17 who got the correct answer in question 10 in the individual prediction, 5 changed their answers in the group prediction. It means that these students were not confident with their answer and was easily convinced by their peer in the group prediction. Overall, however, the improvements observed in the total score of the groups and the item scores seen in Figure 4 indicate the positive effect of collaborative learning.

Assessment

The achievement gain between prediction and assessment were obtained and analyzed. In the assessment, some items were similar to the situations given in the prediction and ILD. They were the basis for the achievement gain analysis.

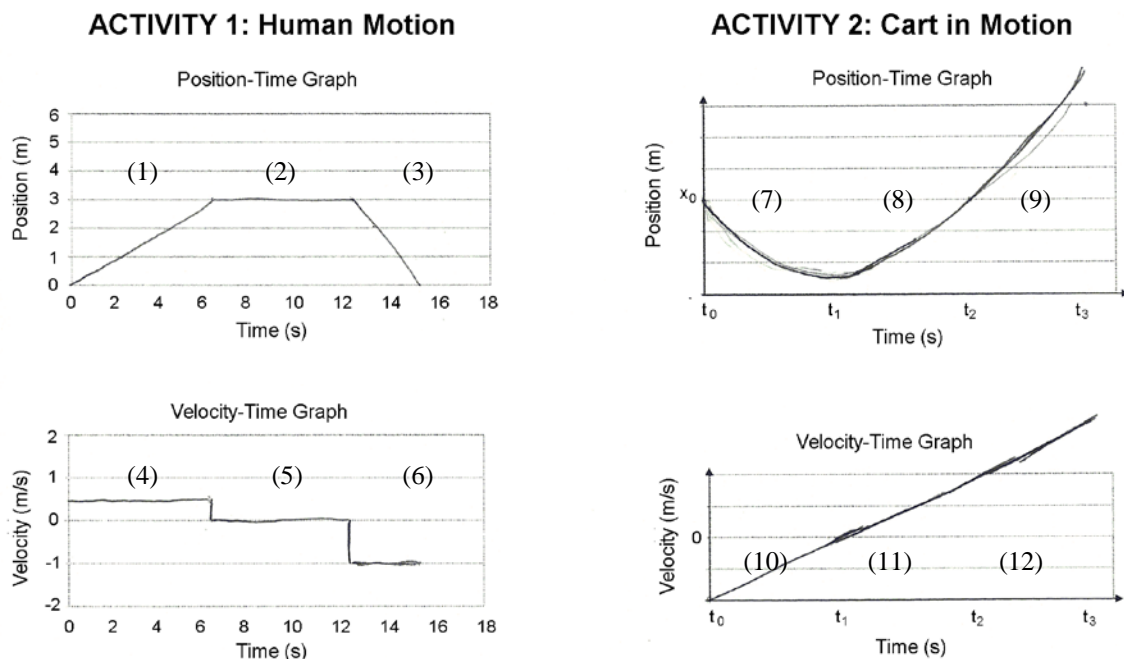

Figure 5. The graphs drawn by one of the students in the assessment. Each segment of the plots was given a corresponding item number

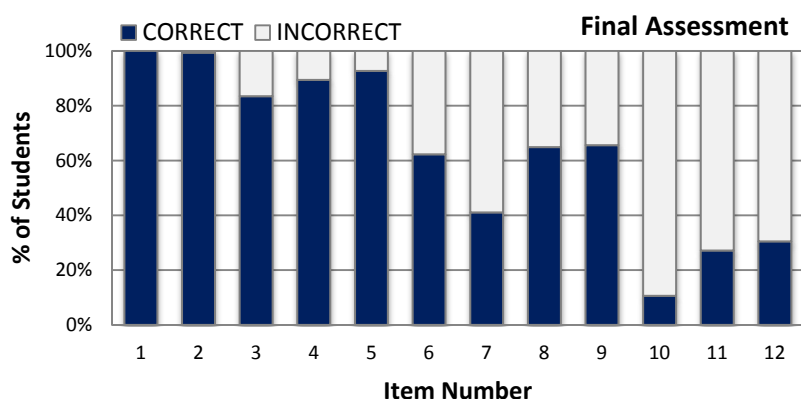

Figure 6. The graph of the percentage of students with correct and incorrect answers for each item in the final assessment

Figure 5 shows the assessment sheet with the correct answers. In Figure 6, the graph of the percentage of students with correct and incorrect answers in the final assessment is presented. The segments of the motion graphs in Figure 5 were assigned a number which corresponds to the x -axis of the graph in Figure 6. Table 1 shows the items in the assessment that correspond to or are similar to the questions in the prediction part of the ILD. Also, the percentage of the number of students with correct answers in the assessment and in the individual prediction are shown in the table, as well as the achievement gain for each corresponding items.

Table 1. Mapping of the items in the assessment that correspond to or is similar to the questions in the prediction part of the ILD, the percentage of students with correct answers and the achievement gain for each corresponding items.

Item	1	3	4	6	8	9	11	12		
Assessment (%)	100	83.44	89.40	62.25	64.90	65.56	27.15	30.46		
Question	1	3	6	2	4	7	9	10		
Ind. Prediction (%)	86.09	82.12	55.63	88.08	84.77	78.15	57.61	18.54		
*Gain (%)	13.91	1.32	27.81	1.32	-22.52	-15.90	7.28	7.95	8.61	11.92

*Gain = (Assessment – Ind. Prediction)

Assessment item 3 (see Figure 5) corresponds to prediction questions 3, which pertains to the trend of the p - t plot, and 6, which pertains the magnitude of the plot when the velocity is doubled. The same goes with items 6, questions 4 and 7 but they refer to v - t plots. In assessment item 3, 10.60% of the students' answer have the correct trend (linear, + y -axis, - slope) but incorrect magnitude of the slope. If we take this into account, then the achievement gain between item 3 and question 3 is actually 11.92%.

In item 6, the achievement gains from questions 4 and 7 are both negative. Although 100% and 96.03% of the students were correct in questions 4 and 7, respectively, in the group prediction, the achievement gains are negative. The assessment shows that the students know that for constant velocity, v - t plot is a straight horizontal line. However, 18.54% did not take into account the direction of the motion even though this was emphasized in the discussion that followed the demonstration.

In the second scenario, items 7 and 10 were introduced to evaluate if the students can already integrate the motion towards the origin while a constant force in the opposite direction is in effect. Although the percentages of correct answers in this scenario are low as seen in Figure 6, the achievement gain is positive. About 25.83 – 33.78% of the students considered the $p-t$ plot to be linear, which was the common mistake in these items. In the $v-t$ plot, 39.07% of the students represented item 10 as a linear plot with negative slope located below the x -axis. As a result, their plots in items 11 and 12 were automatically shifted although it is evident in their answers that they remember the trend of the $v-t$ graph of the cart being pulled by the hanging mass.

Figure 7 shows the plot of the raw score the students obtained in the assessment. It also shows the raw score these students obtained in the individual prediction (indicated in the legend). The minimum score in the assessment should be four (4) since items 1, 3, 4, and 6 were in the ILD. Unfortunately, this is not the case as seen in Figure 7. Also, some students achieved negative gain between the individual prediction and the assessment scores. One possibility is that their predictions were just guesses since the choices were given and, when asked to draw the graph, they failed to interpret the motion because they did not grasp the concepts during the group discussion and even after ILD. Looking at the figure, 72.41% who got a score of 6 were correct in items 1-6 only, while 72.73% of those who got 7 were correct in items 8 and 9. However, their plots in items 11 and 12 were shifted down but followed the correct trend. This is also true for the $v-t$ plots of 65.45% of those who got a score of 8 or 9. This could indicate that those students with scores falling between 7 and 9 learned from the group discussion and the ILD but did not know how to plot the motion of item 10. In general, the assessment results show improved scores for most of the students.

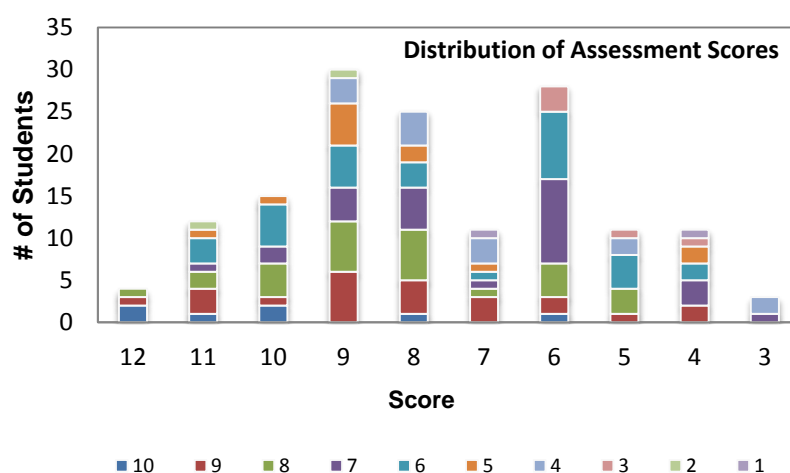

Figure 7. Plot of the raw scores that the students obtained in the assessment. The legend at the bottom of the graph indicates the raw score of the student in the individual prediction.

Conclusion

In an Interactive Lecture Demonstration, collaborative learning produced a positive effect on the prediction scores of the students. The ILD with real-time measurement allowed the students to validate their prediction. However, when the given situations were incorporated to create a scenario, it posted a challenge to the students. The results of this activity identified the area where additional instruction and emphasis is necessary. In particular, Newton’s second law of motion, in relation to the situation where the acceleration due to

the applied force and the velocity of the body are in the opposite direction, needs to be elaborated.

References

- [1] Thornton R. K., Sokoloff D. R.: Learning motion concepts using real-time microcomputer-based laboratory tools. *American Journal of Physics*, Vol. 58, No. 9 (September 1990), p. 858-867.
- [2] Thornton R. K., Sokoloff D. R.: Using Interactive Lecture Demonstrations to create an active learning environment. *The Physics Teacher*, Vol. 35, No. 6 (September 1997), p. 340-347.
- [3] Thornton R. K., Sokoloff D. R.: Assessing student learning of Newton's laws: The Force and Motion Conceptual Evaluation and the evaluation of active learning laboratory and lecture curricula. *American Journal of Physics*, Vol. 66, No. 4 (April 1998), p. 336-352.
- [4] Thornton R. K., Sokoloff D. R.: *Interactive Lecture Demonstrations: Active Learning in Introductory Physics*. Wiley, Hoboken, NJ (2004), ISBN 978-0-471-48774-6.
- [5] Slavin R. E.: When does cooperative learning increase student achievement? *Psychological Bulletin*, Vol. 94 (1983), p. 429-445.

Using Pencasts to find out how students think about physical ideas

James Mackay¹, Mary Fawcett²

¹School of Engineering, Wellington Institute of Technology, Wellington, New Zealand

²School of Health and Social Services, Wellington Institute of Technology, Wellington, New Zealand

Abstract

Common alternative conceptual frameworks dictate much of the way students approach their understanding of physical ideas. Over the last thirty years, research into these common preconceived ways of thinking, points to strategies that include their diagnosis and identification as important steps in their amelioration. However, common pen and paper diagnostic tests often do not provide as much detail as do in depth interviews in terms of quality and depth of data collected. In this paper, we make the case for using a new technology, the Livescribe smartpen, which records both the script written on a piece of paper as well as the accompanying audio file of the conversation that accompanies writing the script (commonly called a pencast) and we outline and give examples of three ways in which we have used pencasts to affect conceptual change in the classroom. The first is by making pencasts that specifically address particular preconceived ideas. The second is to require students to make pencasts about particular ideas and then have these pencasts reviewed by their peers. The third is to use pencasts made by students as a way of diagnosing conceptual difficulties. In this last way, student explanations of simple physical phenomena were recorded and then revisited during an interview process that in itself involved the recording of a conversation about a particular instance. Examples of the analysis of these student pencasts from electricity and magnetism, mechanics, thermodynamics as well as from basic physics ideas in anatomy and physiology suggest that the pencasts made by the students can be used to collect valid and reliable data about how they think.

Keywords: Pencast, diagnostic test, interviews, alternative conceptions

Introduction

In this paper, we describe the use of the Livescribe smartpen, which records both the written script as well as the accompanying audio file of the conversation that accompanies this script, commonly called a pencast, as a tool to enhance students understanding of physics ideas and conceptual thinking. The predominant use of Smartpens in education thus far has been by students who have found them useful in recording their lectures and making notes that have both an audio as well as a written text component used them to record lectures and by lecturers who have found them useful as an aid to enhancing their lectures. This is confirmed by Stasko and Caron (2010) [1] who have described the use of pencasts in teaching and use by students in lectures. However, recent literature has reflected a change in the use of the smartpen and the associated pencasts as not so much a learning tool used by students, but rather a teaching tool where specialized pencasts can be made to address particular concepts, processes, issues or topics. Murray (2012) [2] has used pencasts to complement face to face lectures by providing short explanations of concepts, worked out examples of a calculation and “how to” explanations. In his research he has found that due to the friendly and inviting style of the pencasts, students have

a positive attitude to learning in this medium. Similarly, Powers et al. (2010)[3] describe how they have used pencasts to help teach pharmacological calculations to great effect, with students reporting that the pencasts produced helped them considerably with their learning.

In the last year, we have trialed a number of different ways in which Smartpens and the associated pencasts can be used by students. These include using Smartpens for recording assessments, group or team work on a project as well as in the identification and discussion around preconceived ideas. Work by Linenberger and Bretz (2012) [4] on their investigation into the way students understand enzyme representations has expanded the use of digital pen-and-paper technology as a means for collecting data. In their data collecting, they identified students' interaction with diagrams during semi structured interviews as being problematic in that often the original markings were destroyed. In order to deal with this methodological problem, the researchers introduced the use of the Livescribe smartpen. The use of this technology was found to be helpful in their collection of detailed data from semi-structured interviews, particularly where there was discussion around a diagram. This power to include not only an audio explanation, but also text as well as diagrammatic information has made the pencast a useful teaching tool as well as a useful tool for recording data about student learning.

The considerable body of research into student's preconceived ideas in physics in the last thirty years has led to the development of strategies that include both their diagnosis and identification as important steps in their amelioration. Traditionally, this data has been collected using mostly pencil and paper tests [5], because diagnostic tests are convenient and data is easily processed. Many such diagnostic tests such as the Force Concept Inventory (FCI) and Mechanics Baseline Test (MBT) that were developed by Hestenes and Halloun (1992) [6] have become useful to physics teachers worldwide, not only as a way to gauge the conceptual understanding of their classes as a whole, but also to identify the conceptual status of individual students who might need help. This however has not been as simple as it might seem and there has been some disagreement about the use and meaning of diagnostic tests for such purposes. Heller and Huffman (1995) [7] have pointed out that while the FCI is useful for developing an overall diagnostic picture of a class, there should be caution in using the test scores to make a diagnosis about an individual student. Their reasons for this are that while the tests ask questions about pieces of student knowledge, there is no unified test for a specific force concept, for example the *Impetus* idea. In addition, it seems reasonable that the constraint of assessing in a multiple choice format as so many diagnostic tests do provides only a set number of alternative distractors. Any student's conception might in fact be a lot more complicated than that.

Juxtaposed to the diagnostic test approach, is the use of interviews to probe in depth students ideas about how the world works. Early researchers in this in physics education are Osborne and Gilbert (1980) [8], who pioneered their "interviews about instances" technique. Using line drawings about instances where different physical principles might be at work, they interviewed both children and adults to compile an inventory of the way people in general saw the world and what exactly they believed about it. These semi-structured interviews have been used since the 1980s to research and develop models of alternative conceptual frameworks that students bring into the physics classroom as well as how persistent these frameworks are [9].

Brief overview of how pencasts work

Both Stasko and Caron (2010) and (Murray 2012) have described the use of digital pen-and-paper technology. The Livescribe Smartpen is able to interact digitally with specialized paper that can record the writing of text and the drawing of diagrams simultaneously. The resulting product is termed a *pencast* and has the following features that make it versatile as both a teaching tool as well as a data recording device.

- Simultaneous recording of video and sound.
- Can be converted into a pdf flashmovie.
- Students / researchers are able to play the pencast and simply click on the part of the conversation they want to listen to. It is easy to go back and listen again and again.
- Interviewers and interviewees are able to interact with any diagram or the text on an ongoing basis and this interaction through the pen is recorded.

In this way it is possible to record a conversation that involves an explanation of a scientific concept or a process. Figure 1 below shows the visual image of a pencast.

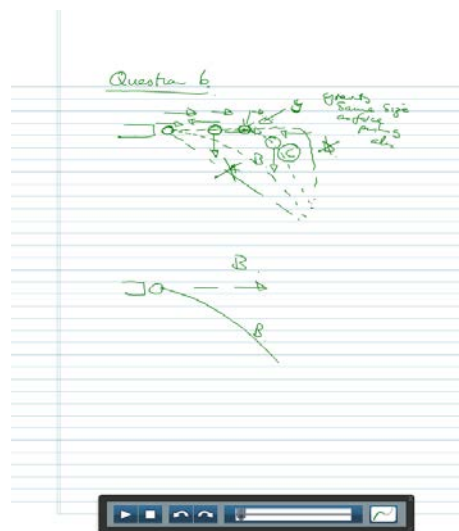

Figure 1. Example of the visual output from a Pencast recording

In our research, we have used Smartpens to make pencasts as a means to collect and analyse data as well as to develop a fundamental understanding of ideas in Physics, of concepts and ideas, processes and ways in which physics problems can be approached.

Ways in which we have used pencasts for conceptual diagnosis as well as amelioration of preconceived ideas

We have taken the view that the diagnosis and amelioration of preconceived ideas form part of a continuum of intervention that starts with noticing the use of incorrect preconceived ideas, moves on to initial diagnosis and then through intervention to the amelioration of these preconceived ideas. Within this process, the use of the smartpen and the associated pencasts play a continuously changing role, from a powerful diagnostic tool to one that provides easy to access explanations of how things work.

With the advent of smart pen-and-paper technology, practical difficulties researchers have had in the past with recording semi-structured interviews have to some extent been addressed through the use of the smartpen as a data collecting device. Following the

pattern of Osborne and Gilberts (1980) interview about instances approach in conjunction with the development in conceptual diagnosis through testing, we have developed three ways in which we can use pencasts to affect conceptual change in the classroom. The first is by making pencasts that specifically address particular preconceived ideas, based on the diagnostic performance of the class as a whole. In this way, a test such as the FCI is used to inform what kind of pencast we make. The second is to require students to make pencasts explaining a process or an idea to their peers. These pencasts are then reviewed by their peers as an assessment task. The third is to use pencasts made by students as a way of diagnosing conceptual difficulties by having a “conversation around a specific instance”.

Pencasts that address a particular concept

In these pencasts, explanations of phenomena or instances are provided through a pencast for students to access and look at in their own time. Typical topics include:

- The acceleration of a particle at the top of its trajectory.
- The development of a free body diagram.
- An explanation of how the eye works.
- A simple DC motor.

Pencasts that address a problem

In these pencasts, the underlying alternative framework that the student has affects the interpretation of the problem and the pencast is designed to ameliorate the conceptual difficulty through solving the problem:

- Solving a free-fall problem using a multi-flash iterative approach so that students realize that the acceleration at the top of the trajectory cannot be zero.
- Solving a force problem that involves Newton’s third law by explicitly discussing the building of the free body diagram for interacting objects.

Pencasts that simply explain a process or a procedure

These are particularly useful in practical sessions:

- Providing a brief overview of an experiment.
- Explaining how to calculate uncertainties.

Students learning by making pencasts

With a class set of Smartpens, we are able to get students to make pencasts that can be assessed by ourselves or by their peers. A good example was a pencast on the physics of hearing in animals by veterinary nurse students who needed to learn how to explain a complex idea such as hearing in animals. This was implemented as shown in Table 1.

Table 1. Students learning by making pencasts

Step A	Step C
Students are given a pre prepared Pencast to view, answer questions on prepare them for a particular area of learning This can be of a concept, a calculation or a process, such as the steps in taking a particular measurement.	Students are asked to complete a pencil and paper diagnostic (conceptual usually) test and then have a conversation which is recorded through a Pencast and later analysed about the way they answered the questions. The main purpose of the conversation is that of a conceptual change process where students confront their ideas and the inconsistencies that they currently accommodate in their thinking.
Step B	
Students are required to engage in further research of a topic previously taught, and required to make their own Pencast which will be reviewed by another group;	

The Pencast data is made available to all students on a semi-public forum and all results are collected and analysed with a view to adapting and developing methods of teaching and enabling students to learn more effectively. Common misconceptions of certain topics are highlighted and analysed. This is a supplement to formal teaching.

Creating Pencasts through learning conversations with a students

In this last way in which we use pencasts in teaching physics, students are confronted with an instance where a concept has been used (based on the interviews about instances technique). For example the pencast shown in Figure 1 above shows a projectile being shot horizontally and four alternative paths have been provided for the student to select. A common choice is C, which is incorrect of course, but in this particular pencast we were able to capture the exact reasoning behind the students selection of distractor C. Information which would not be available were she being simply asked to choose an answer. What was also evident was that she had a sophisticated sense of how things worked that in her mind, it was only further along that the impetus force would be “overcome by gravity”. The fact that these two forces would have been orthogonal did not concern her, which in fact led to another conversation about vectors. Such conversations that allow the student to interact with the diagram and explain their thinking are powerful in a number of ways. The first is that the student’s expression of their thinking is easier to analyse because one is able to link exactly what they are saying to the diagram under discussion. Secondly they seem to like the technology and the excitement of using it seems to outweigh their fear of being interviewed. In the end it becomes a low key informal conversation about some ideas. Not a “high stakes” interview or diagnostic test. From this point of view it was excellent as a data capturing device. Lastly, the agreement by some students to have their conversations placed on the learning management system for others to look at was an additional benefit to the class and a good learning tool.

Overview of the research methodology

So far, we have used a qualitative approach to eliciting the responses of participants to the use of Pencasts in identifying, recording and ameliorating preconceived ideas in physics was used.

Currently, we have three main projects running that use pencasts. The first is an investigation of how to use pencasts to detect and ameliorate common preconceived ideas in mechanics. This is a well-researched area and as such, there is plenty of data available to validate the Pencast data collected. The students used are first year engineering students.

They are required to write a diagnostic test on entry into a course on Engineering Fundamentals. Based on their performance on different questions in the test, they are then asked explain their answers to particular questions through the medium of a Pencast. This Pencast can then be analysed.

The second project is one which also focuses on a well-researched area, but one in which we are looking for differences in approach different tutors of electrical engineering degrees, diplomas, trades as well as auto electricians and automotive trade tutors who need to explain basic electrical concepts. Tutors were asked to explain to both a novice as well as an expert particular fundamental DC circuit concepts.

The third project is the use of pencasts in looking at non-physics students understanding of physical ideas that pertain to their area of study. In this case we are looking at the way veterinary nursing students understand the physics of the eye and the ear as well as concepts like osmosis and diffusion. In all three projects, we ask students to watch pencasts that explain ideas, make pencasts to explain ideas and have learning conversations about a conceptual issue which will result in a pencast. The sequence of steps in each project is shown in Table 2 below.

Table 2. Research Plan

Project 1: Ideas about Mechanics	Conceptual Pretest in Physics (e.g. Force Concept Inventory)
	Learning conversation with student about their answers
	Reflection by student on how useful the Pencast was in helping them get through their conceptual change process
	Post-test
	Written Reflection and Interview
Project 2: Ideas about Basic Electricity in DC circuits (current, potential difference and resistance)	Tutors are given concepts to explain as they would for a student
	Reflection and Interview with the person being “explained to” (novice)
Project 3: Physics ideas in veterinary science	Conceptual Pretest about fundamental concepts such as osmosis and diffusion, hearing and sight
	Learning conversation with student about their answers
	Reflection by student on how useful the Pencast was in helping them get through their conceptual change process
	Post-test
	Written Reflection and Interview

Initial results and preliminary discussion

Research on all three projects is ongoing; however, there is sufficient evidence (qualitative feedback) to suggest that the use of pencasts as a teaching tool has been successful. So far there have been 19 pencast interviews and these all been successful in eliciting information about the way students think about different ideas. Students particularly in the veterinary groups were very positive about having pencasts being added to their formal curriculum and appreciated the informal nature of the medium.

Project 1

It is clear from the data gathered so far that the students like the use of pencasts as a teaching add on. They are also open to using the pen to explain their ideas and this has made interviewing them through the making of an informal pencast quite a lot easier. When compared with the interviews about instances technique, there are a number of ways in which using pencasts appears to enhance a semi structured interview.

- The pen itself and the way it works adds to the enjoyment of the process for both interviewer and interviewee. In fact the novelty of the pen detracts from the formality of the situation and this puts both interviewer and interviewee at ease.
- It has the same advantage over pen and paper tests as an interview in that it is more flexible and allows for greater depth of investigation. For example, in much the same way as a conversation wanders, so can the discussion about a concept. In the case shown in Figure 1 above, the conversation wandered onto a short discussion of orthogonal forces, even though this was not the main conception under discussion at the time.
- Like the interviews about instances technique, the conversation takes an ordinary diagnostic question and transforms it from a situation where the student feels the need to give the right answer to one where the student feels they want to explain their point of view. This happens perhaps when they take control of the pen.
- The transcription and analysis of the interviews is made easier, because they are easier to follow and also because one is able to see the visual position of the cursor at any time in the conversation. This acts as a marker, particularly if a diagram is being analysed.

Project 2

The preliminary data has revealed a number of incorrect ideas used by the trades tutors in explaining the concepts of current, potential difference and resistance. These have stemmed from the use of the flowing water analogy for circuits. So what comes out most frequently is that voltage is a force. The term “electromotive force” is used more frequently by trades tutors. While the novices who were explained to reflected that they understood electrical concept much better, most were unable to explain the ideas back coherently and on two occasions the concepts of the analogy (flow rate, pressure, force etc.) were confused with the electrical concepts.

Project 3

Students who have gone through various aspects of the “pencast process” have reported mixed responses to pencasts. However, they overwhelmingly loved listening and watching pencasts made to explain things. In general the popularity of a pencast depended on whether the diagram was any good. It appears that the visual element is important in a pencast.

Conclusion

In this project, student explanations of simple physical phenomena were recorded and then revisited during an interview process. Often we chose an instance from a diagnostic test or some other test where answers revealed particular preconceived ideas. Examples of the analysis of these student pencasts from electricity and magnetism, mechanics, thermodynamics as well as from basic physics ideas in anatomy and physiology suggest that the pencasts made by the students can be used to collect valid and reliable data about how they think. An analysis of the pencasts, has revealed that this process contributes substantially to the identification and amelioration of the common errors detected in the explanations generated by the students. Implications of this approach to teaching are that it can contribute substantially to conceptual change in the classroom.

In summary, the use of digital pen-and-paper technology like the Livescribe smartpen as a data collecting device has provided an easy way to record and analyse interviews as well as opened up a way in which we can easily connect the way students think conceptually about diagrams in particular. The interview-about-instances technique was developed as a methodology to explore the way students applied their preconceived ideas about how the world worked. We feel that this technology enhances the semi structured interview about instances technique.

References

- [1] Stasko D., Caron P. G.: 2010. Digital notes and lecture capture: pencasts as electronic copies of live STEM lectures and student access to digital lectures. *In Proceedings of World Conference on Educational Multimedia, Hypermedia and Telecommunications 2010* (pp. 1868-1876). Chesapeake, VA: AACE. Retrieved from <http://www.editlib.org/p/34891>
- [2] Murray J.: 2012. Pencasts for Introductory Macroeconomics. *The Journal of Economic Education*, 43:3, 348.
- [3] Powers M. F., Bright D. R., Bugaj P. S.: 2010. A brief report on the use of paper-based computing to supplement a pharmaceutical calculations course. *Currents in Pharmacy Teaching and Learning* 2 (2010) 144-148.
- [4] Linenberger K. J., Bretz S. L.: 2012. *Journal of College Science Teaching* 42.1 (September – October 2012) p.45.
- [5] Odom A. L.: 1995. Secondary & College Biology Students' Misconceptions about Diffusion & Osmosis. *The American Biology Teacher*, Vol. 57, No. 7 (Oct., 1995), pp. 409-415.
- [6] Hestenes D., Halloun I.: 1992. Interpreting the FCI. *The Physics Teacher*, 33. 502-506.
- [7] Heller P., Huffman D.: 1995. Interpreting the Force Concept Inventory. *The Physics Teacher*, 33. 503-511.
- [8] Osborne R. J., Gilbert J. K.: 1980. A technique for exploring students' views of the world. *Physics Education*, 15, 376-379.
- [9] Bowen C. J.: 1994. Think-aloud methods in chemistry education. *Journal of Chemical Education*. 71.3 (March 1994): 184-190.

Pedagogical Content Knowledge through video-based lesson analysis of a Colombian high School Physics Teacher on Electric Fields

Lina Melo, Florentina Cañada, Vicente Mellado, Esther Marín

Dept. Science and Mathematics Education, Faculty of Education, University of Extremadura, Badajoz, Spain

Abstract

In view of the current debate in Colombia about training science teacher, a qualitative study was undertaken involving a purposeful sampling pedagogical content knowledge (PCK) of a Colombian high school physics teacher that he have do numerous innovations about physics teaching. Data were obtained using video recordings from 6 classroom observations of the teaching and learning of the following topics/concepts: (1) methods of charging (2) Coulomb's Law, (3) superposition of electric forces (3) electric field, (4) electric potential. This video analysis was triangulated using data from an interview, an open choice questionnaire, the planning template, and, the matrix designed by Loughran, Berry & Mulhall [1] to represent content (CoRe). The findings revealed a static PCK with tendency to traditional model of teaching.

Keywords: pedagogical content knowledge, electric field, video-based analysis of practice

Introduction and Background

The foundation of science teachers' professional development lies in their own education in science since the content they have to teach conditions both their role in class and the teaching strategies they use [2]. Shulman [3] noted that, together with general psychopedagogical knowledge and knowledge of the subject matter, teachers develop a specific body of knowledge concerning the form in which they teach their subject – their 'pedagogical content knowledge' (PCK).

Pedagogical content knowledge is specific to how each particular subject is taught, and is a form of reasoning and educational action by means of which teachers transform the subject matter into representations that are comprehensible to the pupils. PCK is not a static mixture of knowledge from different areas. Rather, it is the teacher's transformation and integration of this knowledge into an active and dynamic process [4-6], based on reflection-in-action [7].

In view of the current debate in Colombia about training science teacher, a qualitative study was undertaken involving a purposeful sampling pedagogical content knowledge (PCK) of a Colombian high school physics teacher that she has do numerous innovations about physics teaching. We have focused on the electric field due to its importance in physics. It has been described as one of the most valuable achievements in the history of thought [8]. The general acceptance of its importance has meant that there has been little discussion of its teaching in pre-university secondary education despite the many difficulties students find in learning the concept. It is hardly surprising if few studies have addressed to determine the ideas that teachers reinforce on the electric field and the models, they bring their students.

We adopted Magnusson et.al [9] model. They claimed that PCK is composed of five components a) orientation toward science teaching, b) knowledge of science curriculum

c) knowledge of student's' understanding of science d) knowledge of student's' understanding of science and e) knowledge of science assessment. In addition, these components were our categories. We consider teachers participants of this study such as part of the investigation and not as data alone.

Research Questions

The overall objective of the present work was to characterize the initial PCK of Colombian high school physics teacher about the electric field, through of the content of the PCK components. This overall objective was broken down into the following five research questions:

- What are the participating teachers' orientations (i.e. visions and goals) in teaching physics?
- What knowledge do they have about the pre-university secondary education physics curriculum whit relationship to electric field teaching?
- What knowledge do they have about pupils' understanding of the electric field?
- What knowledge do they have about instructional strategies for teaching the electric field?
- What knowledge do they have about evaluation of the electric field?

Methodology

The study began with 10 high school teachers, all they trained as teachers of physics, mean age 26 years, and with 3-7 years teaching experience. Their pupils' ages were in the range 17-19 years and they taught groups of 15 to 40 students. The background of the teachers varied. We present one of these cases (*Mabel Teacher*) now in the first years before intervention program. Mabel had taught physics for five years, and this was his first year in a girls' secondary school.

Teacher responded an open choice questionnaire, the planning template, and, the matrix designed by Loughran, Berry & Mulhall [1] to represent content (CoRe), to which some modifications were made in the number of questions and the form of selecting the core ideas on teaching electric.

After, we formed a discussion group, we conducted an in depth interview and record their classes about: (1) *methods of charging* (2) *Coulomb's Law*, (3) *superposition of electric forces* (3) *electric field*, (4) *electric potential*, and then we analyze all the information with them, and after teacher creates a new unit for teaching this concept. This process is representing in the Figure 1.

Data were analyzed following an iterative and systematic procedure that included both inductive and deductive processes. The coding scheme was based on Magnuson et.al model [9] and on the common components reported in research on physics PCK. For the description of each component, we took into account the evidence provided by the information analyzed and by science teaching models [10-12].

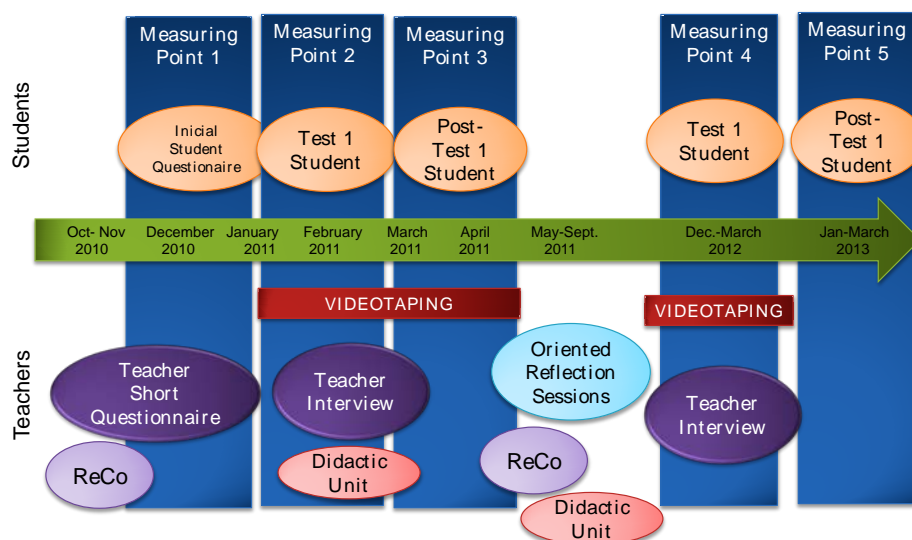

Figure 1. Methodological Process

The Table 1 shows the coding system used and a description of each category. The coding was performed following the method of content analysis. We used Nvivo-10 for coding all data. That is, the information in each instrument after successive readings was divided into different units of information (IU). They were subsequently assigned to each category. The criteria for selection of each IU were the theme and not its linguistic composition.

Table 1. Some categories and subcategories used in this research

Category	Subcategory	Code	Traditional Trend	Intermediate Trend	Constructivist Trend
<i>Physics teaching orientations (A)</i>	Vision of the electric field	A3	Electric field in terms of action at a distance and the electric force as central force and vehicle interaction.	The electric force is an effect of the electric field.	Recognition of the interpretation of the energy aspects of electrostatic interactions.
<i>Knowledge of the curriculum (B)</i>	Organization and relationship of contents	B2	Updated and simplified version of scientific knowledge.	There is a relationship with other subjects and contexts, but maintaining a rigid schedule.	Integrating the academics with the contextual.
<i>Pupils' knowledge when learning about the electric field</i>	Difficulties and limitations in understanding the electric field.	C2	They are due to the characteristics of the students and conditions beyond the classroom	They predict the difficulties but are not used during the planning	They identify with the proposals in the literature on teaching content and are used in planning.
<i>Knowledge of teaching strategies (D)</i>	Level of difficulty assigned to the teaching/learning sequence	D3	The number of steps involved, amount of knowledge involved and the time available to address the pupil activity.	Derivative of the scientific complexity and the time available for the pupil to resolve activity	Derivative of the scientific complexity, how to teach the content, and the disposition of the pupil
<i>Knowledge of evaluation (E)</i>	Purpose of evaluation	E1	Measure the minimum knowledge acquired by the student.	Corroborate the degree of achievement of the proposed objectives versus those achieved	Serve as a tool for self-regulation in the learning process and encourage learning to learn.

Results

We divide and classify all information according to the content units, according to each category. We divide our analysis in three levels: declarative, design and action. This correspond, what does the teacher believe or think, what does the teacher advance and plan and, what does the teacher do.

Orientations to the Teaching of Physics

This component is described from three subcategories: vision of physics, vision of teaching and vision of learning. Vision of physics is shown in Figure 2. The radio of the spheres represents the density of the frequencies found for each trend. We have interpreted the proximity of the spheres or overlaps as the coherence between, teacher says, designs and makes.

The vision of physics is governed by traditional trend in design and action. This trend is characterized by displaying a cumulative nature of physics through an insistent need to cover the conceptual or procedural content. During the development of the classes, the teacher devotes a 57.75% of its actions to develop conceptual content, and 41.02% to procedural development (main emphasis is the execution and exercises from the textbook).

A declarative level, teacher shared what does she think between traditional and constructivist trend. The number of units categorized into these trends, differs about 40% of the maximum level quantifications achieved for design and action. It confirms, results of other research which shows the inconsistencies between, teacher says; she says that she will do and she does.

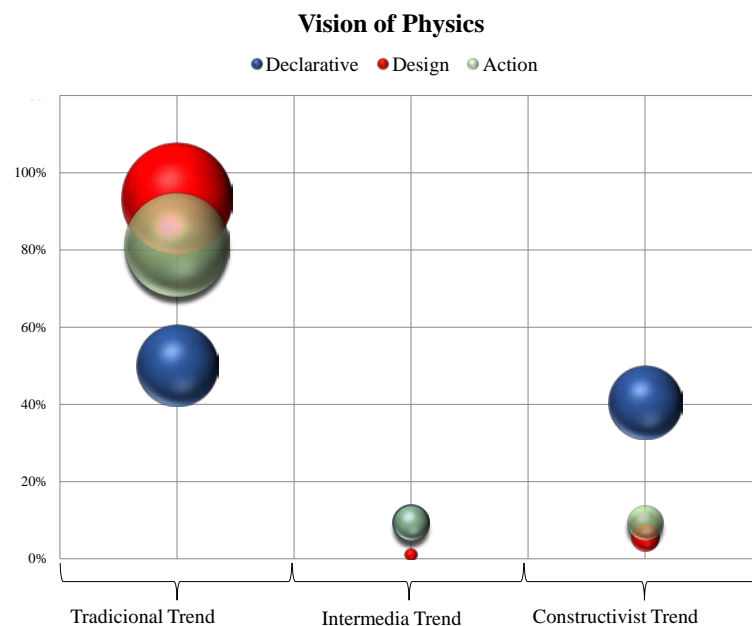

Figure 2. Vision of Physics

Learning physics is assimilating and applying the content that the teacher has explained, and knowledge is understanding and relating the corresponding key concepts. Teaching physics is therefore a matter of presenting the key content, with explanations being the axis of his teaching. Nevertheless, she was aware of the importance of motivating the pupils and of the teacher's knowledge of the pupils' ideas in the development of the class.

Knowledge of the Curriculum on Electric Field

Knowledge of curriculum is characterized to declarative and design level by traditional trend. Figure 3 shows a description of this category. The traditional trend of declarative level is characterized by maintaining a sequence similar to the proposal contained in a lot high school texts and general physics books for university level. The fundamental difference is the teacher interest to convince all students that space is the seat and source not only of electrical forces but also charged bodies.

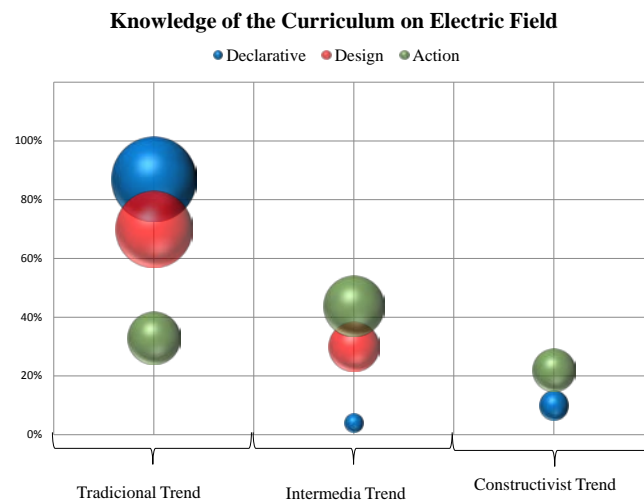

Figure 3. Knowledge of the Curriculum on Electric Field

In terms of action, she opts for intermediate trend, with some modifications in the traditional and constructivist trend. The intermediate trend in action level is characterized by using little content related to the context of the student. Mabel describes a linear sequence for content structure. She always uses the exhibition as a key strategy in the development of the classes.

Traditional trend shows consistency against teacher says and designs but teacher says and designs have different she does in class. For the intermediate trend, consistency is maintained against teacher designs and she does. The constructivist tendency does not show overlap. This means that everything the teacher says is not translated into action, however there are elements close between what the teacher says and what she does.

Knowledge of pupils' understanding relative to learning the electric field concept

In a first contact teacher recognizes little learning difficulty about the content. She justifies her lack of knowledge about the difficulties of their students for she lacks of experience in teaching this content. But throughout the interview, teacher says other specific difficulties and its nature.

Table 3 gives an overview of the situation. The reasons most often lie outside the teacher, such as the characteristics of the content, the ideas that prevail after instruction and cognitive strategies used by students while performing different tasks.

In the context of the difficulties of psychological origin, for example, we placed those related to the process of problem solving, willingness to learn and negative emotions towards mathematics that students report. The difficulties relate to the strategies that students use when they solve problems on the electric field, it does not far from those related to other content of her curricula. Some of these difficulties are:

- Do not relate various concepts to respond to a situation given.
- Tendency to memorize content.
- Tendency to find recipes to apply problem solving.
- Hinder in understanding graphs, tables , or other graphic elements.
- Difficulty in identifying what is asked and the information needed to solve a problem.
- Lack of understanding of the exercises solved by the teacher in class.
- Lack of understanding of the deductions did by the teacher in class.

Table 3. Difficulty of learning on Electric Field, teacher declares

Origin	Nature of the difficulty	Frequency
Epistemological	Learning insignificant or insufficient, retention of alternative conceptions after instruction	7
	Complexity own content	3
Psychological	Cognitive strategies used by the students	8
	Willingness to learn	1
	Negative emotions towards mathematics	1
Didactic	Curriculum	4
	Methodology	4
	Teaching Strategies	1

In terms of action, the reasons for learning difficulties that she declares, it focus on the characteristics of the content, the skills of the students to perform calculations and in the attitude and / or willingness to learn of the students along classes. The will is exemplified by the little attention that some students pay over explained, and especially their ability to recall and use appropriate formulas and calculator.

Mabel: In what did you miss Virginia, what, in the Blackberry conversation?

Student: No, no.

Mabel: That's hard to concentrate. Save this apparatus [Reference 1, Lesson 6 Cat. Difficulties].

Knowledge of teaching strategies

The teaching sequences followed by the four teachers were determined from an analysis of instruments (b) and (c) above. They consisted of successive blocks or microsequences describing the ways the teacher planned the instruction of each topic of the content that was related to understanding the electric field.

The sequences started with an introduction, followed by a space for the pupils to assimilate and apply the theme. The aim was to facilitate this assimilation during the teacher's further explanations.

After the introduction, continued by reminding the pupils about the ideas on models of the atom, the electron, and conductors. This was followed by the presentation of a laboratory practical of a "demonstrative nature" for the pupils to be able to see properties that had not been part of their everyday experience. She used the traditional sequence to present the electric field: explanation, application of the definition, and evaluation of what has been seen.

Knowledge of evaluation

There is not a definite trend from declarative level. The description holds undertakes different faces. On the one hand the teacher describes a formative evaluation of character that evaluates not only content but skills and on the other hand, evaluation is a institutional requirement and, a social necessity that she can not be abolished even though she wants, but she clearly considers to be amended she does not know not how it is possible.

She designs the assessments in funtion of content and not on the skills she described in her program, she always tries to assess she teaches, and the result of the ratings are the sum of the various evaluations conducted. Especially she evaluates through exercises similar to those she did in class. This is a category where there are several inconsistencies. This is due to the way the teacher interprets the policy and requirements intitucionales.

The institution poses a more formative assessment with feedback spaces. But the action times and precise tolerance for external examinations to make favors more content than skills when teacher evaluates.

Conclusions

PCK characterization is a complex exercise; it requires more information and protagonist in the case of physics teaching in secondary and high school. This article contributes to this end. Here in detail how to make explicit the PCK for physics content. We show in detail, how can you explicit the PCK for physical content.

Although teacher has some years of experience in the teaching of physics, she does not transpose causally all her constructs acquired in previous years of professional practice to new content that she teaches. However it is the fundamental pillar upon which rests its PCK on the electric field. Mabel PCK has the following characteristics:

- A. Teacher knows the students need new experiences “enlarge phenomenological field”, for understanding the electric field, but she feels that all proposals are ineffective, so, they continue privileging an electric field model focused on the electric charges and central forces.
- B. School history of the teacher, especially the relationship between physics and mathematics, it influences significantly on teacher idea of learning, the ideas of physics that she expresses, and strategies that she selects for the teaching of the electric field.
- C. Logic that articulates the proposition of the contents, it does not take into account the reflections teacher does on the needs and difficulties on the learning of the electric field of her students.
- D. Although she maintains ideas on active participation for students in the classroom, only teacher validates the school knowledge and she takes into account the answers and ideas raised by the students in relation to the subject matter, Mabel teach in class.
- E. Teacher strategy reinforces the idea, math is a tool for physics, and therefore students should acquire in advance a certain amount of mathematical content to address a problem of study in physics, without prior justification of their need.
- F. Teacher ideas on learning are not reflect how she thinks different assessments and selection criteria to define the difficulty of the evaluation strategies.

In summary, the factors which condition their personal teaching models are their interpretation of the institutional curriculum, the time available to develop the topic, the

relationship between physics and mathematics, and consideration of the most effective strategies for teaching physics.

Acknowledgements

This work was financed by Research Project EDU2012-34140 of the Ministry of Economy and Competitiveness of Spain. L.M. wishes to express her gratitude to the Universidad de Extremadura for the award of a pre-doctoral studentship and to the project GR1075 of Govern of Extremadura supports of this work.

References

- [1] Loughran J., Berry A., Mulhall P.: (2006). (Eds). *Understanding and Developing Science Teachers' Pedagogical Content Knowledge*. Rotterdam: Sense Publishers (2006).
- [2] Abell S. K.: in *Handbook of Research on Science Education*, edited by Abell, S.K. and Lederman, N. G. New Jersey: Lawrence Erlbaum Associates Inc. (2007) Preface.
- [3] Shulman L. S.: Those who understand: Knowledge growth in teaching. *Educ. Res.* 15, No 4 (1986), p. 4-14.
- [4] Gess-Newsome J.: in *Examining pedagogical content knowledge: The construct and its implications for science education*, edited by J. Gess-Newsome and N. G. Lederman. Dordrecht: Kluwer Academic Publishers, (1999), p. 3-17.
- [5] Mellado V., Blanco L. J., Ruiz C A.: framework for learning to teach sciences in initial teacher education. *Journal of Science Teacher Education.* 9, No. 3 (1998), p. 195-219.
- [6] Nilsson P.: Teaching for understanding: The complex nature of pedagogical content knowledge in pre-service education. *Int. J. Sci. Educ.* 30, No. 10 (2008), p. 1281-1299.
- [7] Park S., Oliver S.: Revisiting the conceptualization of pedagogical content knowledge (PCK): PCK as a conceptual tool to understand teachers as professionals. *Res. Sci. Educ.* 38, No. 3, (2008), p. 261-284.
- [8] Berkson W.: *Las teorías de los campos de fuerza. Desde Faraday hasta Einstein*. Madrid: Alianza Editorial (1985) p. 20.
- [9] Magnusson S., Krajcik J., Borko H.: in *Examining pedagogical content knowledge: The construct and its implications for science education*, edited by J. Gess-Newsome and N. G. Lederman. Dordrecht: Kluwer Academic Publishers, (1999), p. 95–133.
- [10] Jiménez Alexandre M. P.: in *Didáctica de las Ciencias Experimentales. Teoría y práctica de la enseñanza de las Ciencias*, edited by Perales, F.J. y Cañal P. (Eds.) Spain: Marfil. Alcoy (2000), p. 165-186.
- [11] Martín del Pozo R, Rivero A.: (2001). Construyendo Conocimiento Profesionalizado para Enseñar Ciencia en la Educación Secundaria: Los ámbitos de Investigación Profesional en la formación Inicial del Profesorado. *Revista Interuniversitaria de Formación del Profesorado* 40, p. 63-79.
- [12] Porlán R., Martín del Pozo R., Rivero A., Harres J., Azcárate P., Pizzato M.: El cambio del profesorado de ciencias II: Itinerarios de progresión y obstáculos en estudiantes de magisterio. *Enseñanza de las ciencias.* 29, No. 3, (2011), p.353–370.

Chaos at High School

Tamás Meszéna

Nagy Lajos High School of the Cistercian Order, Hungary

Physics Education PhD Program Eötvös University, Budapest, Hungary

meszena.tamas@gmail.com

Abstract

We are faced with chaotic processes in many segments of our life: meteorology, environmental pollution, financial and economic processes, sociology, mechanics, electronics, biology, chemistry. The spreading of high-performance computers and the development of simulation methods made the examination of these processes easily available. Regular, periodic motions (pendulum, harmonic oscillatory motion, bouncing ball), as taught at secondary level, become chaotic even due minor changes. If it is true that the most considerable achievements of twentieth century physics were the theory of relativity, quantum mechanics and chaos theory, then it is presumably time to think about, examine and test how and to what extent chaos can be presented to the students. Here I would like to introduce a 12 lesson long facultative curriculum framework on chaos designed for students aged seventeen. The investigation of chaos phenomenon in this work is based on a freeware, „Dynamics Solver“. This software, with some assistance from the teacher, is suitable for classroom use at secondary level.

Keywords: chaotic process, numerical simulation, nonlinear oscillators, Dynamics Solver

Introduction

It was a common opinion at the end of the 19th century that, in physics, what could be found out, it had been done. For this reason, the young Max Planck was advised by his teacher to choose some other profession, not physics [1]. However, it didn't take more than a few years, and a convincing reply was given to this thoughtless opinion. Since then no physicist would think that physics will ever be fully known. Nevertheless, it seems, the same mistake has been made again and again. At the end of the 20th century, perhaps, not many people expected any discoveries in classical physics. But chaos theory is just such a thing.

Teaching chaotic phenomena at high school

Why to teach chaos at high school?

Chaos, in mechanical motion, for example, is not just a scientific peculiarity. In contrast, chaotic motion is found nearly everywhere, if our world is investigated in fine detail.

„From 20th century science three concepts will be remembered only: theory of relativity, quantum mechanics and chaos theory.“ wrote James Gleick in his book, Chaos [2]. It might be an exaggeration to some extent, since while the first two theories brought new equations of motion, basically, the theory of chaos revealed new depths of an equation of motion known for a long time. The fundamental observations of the first two theories (born 90-110 years ago) have been incorporated in secondary education curriculum. The real development of chaos theory started some 30 years ago. The investigation of chaotic phenomena has brought such a fundamental change in the interpretation of nature, that is

undoubtedly reasonable and, luckily, possible to deal with in secondary education. However, very few secondary school text book includes these subjects. In Hungary, actually, there is none at all. For this reason, a syllabus suitable for facultative classes is suggested in this work.

Regular motions taught in secondary school, strictly speaking, do not exist in nature. They can be treated as exceptions, perhaps. Chaotic motion is widely spread. It takes an eager pupil to follow text book concepts enthusiastically. Others loose interest towards physics partly due to the many simplifying assumptions made (needed be able to describe motion mathematically). As a result, pupils do not feel that their real-life observations would be delt with in physics classes. It is a real joy to both teacher and pupils when such a subject is lectured that is possible to observe in nature approximately in the same way as in the theory.

Chaos is interesting, beautiful and it has the sense of mistery. Features that come very useful in education. Some of the first occasions when the subject is mentioned for an average pupil probably include the chaos researcher, a main character of Steven Spielberg's film, Jurassic Park, or the fractals of sprawling plants mimicing human soul in Paul Young's novel, The Shack.

In Figure 1 the path of a magnetic pendulum above a plane containing three attractive magnets can be seen. Figure 2 shows the complex geometric structure characteristic of chaos in the mixing process of dyes.

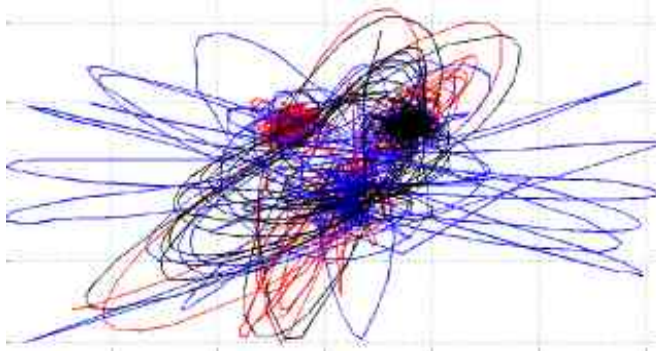

Figure 1. Path of a magnetic pendulum



Figure 2. Chaotic mixing of dyes

What to teach from chaos theory?

Let us consider a few simple examples where regular motion studied at school becomes chaotic with little modification. Pendulum motion shows this behaviour. The motion of a simple pendulum is regular. However, if the point of suspension is moved periodically (driven pendulum), or two pendulums are coupled (double pendulum), or magnets are placed next to the pendulum (magnetic pendulum), see Figure 3, the motion becomes typically chaotic.

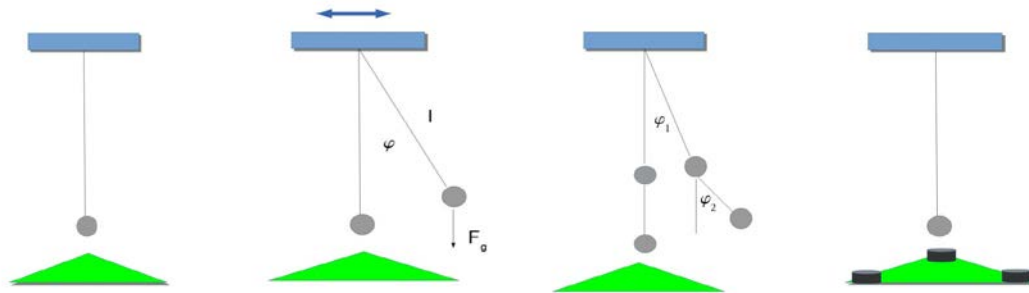

Figure 3. Mathematical pendulum, driven pendulum, double pendulum, magnetic pendulum. The latter three systems are chaotic.

Another example of a simple regular motion is a bouncing ball on the table. A bouncing ball on an oscillating plate, on a double edge or on stairs (Figure 4) may turn to be chaotic.

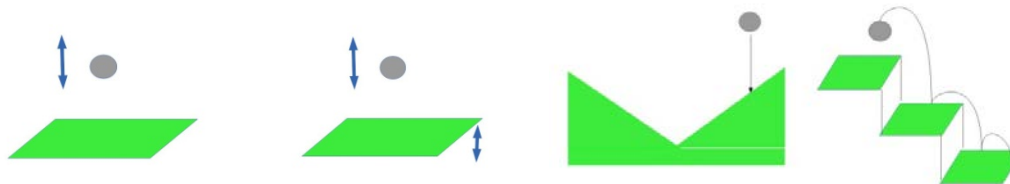

Figure 4. Bouncing ball, bouncing ball on an oscillating plate, on a double edge, on a stairway. The latter three systems are chaotic.

Let us investigate the motion of a driven oscillator in detail. If a driven oscillator is based on a spring that obeys Hooke's law, the resulting motion will be a regular motion that is easy to describe. With a nonlinear spring (Figure 5), however (and real springs are never perfectly linear), motion may become much more complicated: it may show chaotic behaviour.

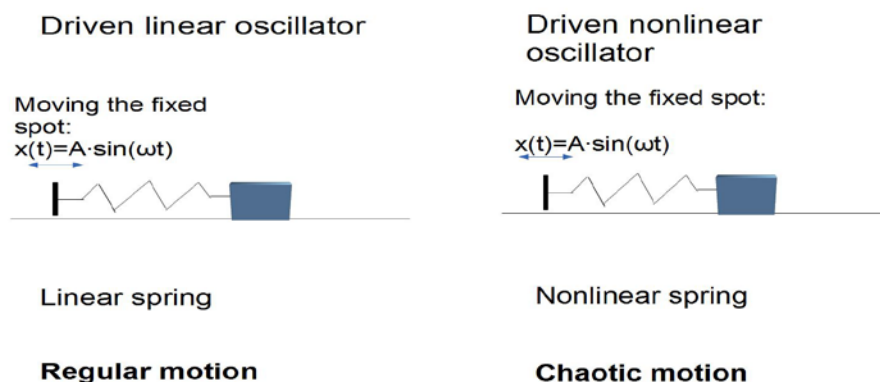

Figure 5. In spite of the identical sinusoidal driving, the motion of a body fixed to a linear spring is always regular, whereas that with a nonlinear (i.e. realistic) spring is typically chaotic.

The description of chaotic motion can be well explained by the concepts used for the example of nonlinear oscillators. Regular motions are normally described in terms of position versus time, velocity versus time (and acceleration versus time) functions. In case of chaotic motions, these functions are so complicated and irregular that by graphing these

functions it is hard to recognize the surprising order that is inherent in these motions. Before chaos theory appeared, such motions were simply considered irregular. A more appropriate representation is needed that reflects the properties of such motions better, and makes it possible to reveal the order underlying chaos.

No information or systematic behaviour can be deduced from the investigation of the usual functions since the periodicity of the original oscillator is entirely lost (Figure 6).

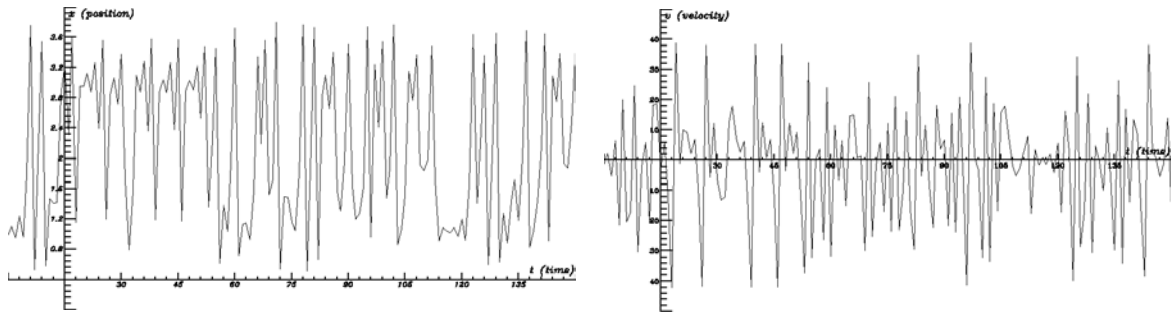

Figure 6. Position-time and velocity-time representation of a driven nonlinear oscillator.

Information needs to be condensed and represented in another way. To represent chaotic motion, a velocity versus position graph (called phase space) is used, since it provides a better overview of such motions. The complicated geometrical structure, characteristic of the motion, is revealed by taking samples at regular intervals (at that of the driving period), and by plotting only these points on the plane of the phase space (Figure 7). This procedure is called a stroboscopic map.

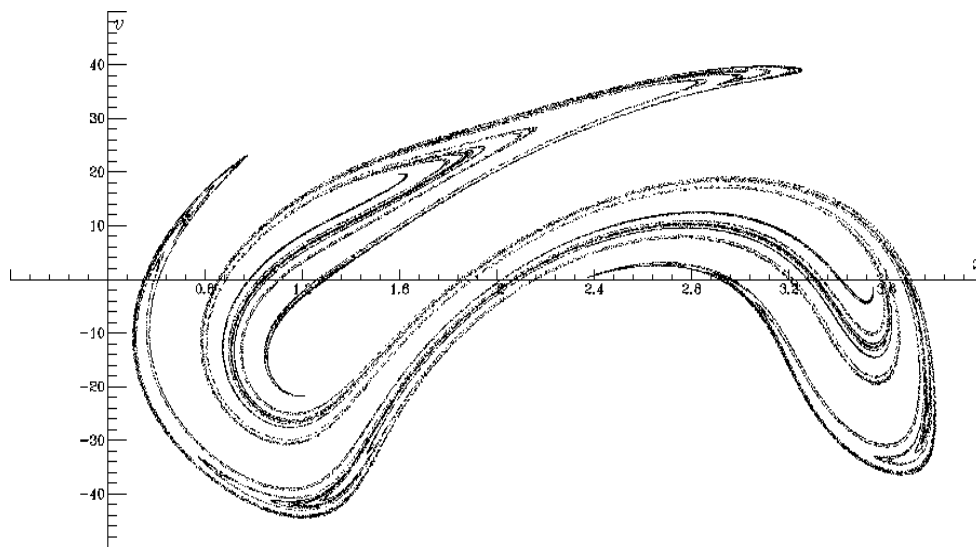

Figure 7. The stroboscopic mapping on the phase space of a driven nonlinear oscillator. This presentation exhibits the unusual pattern underlying chaotic motion.

Note that in this representation the image of a periodic motion is a single point, since the location and the velocity would be always the same, period by period. It is obvious from Figure 7 that, although chaotic motion never repeats itself, it cannot be considered completely irregular, it is not like white noise. It has a clean-cut, profound order, just a much more complex one than that of the periodic motions.

Chaos can be described as the “complex temporal behaviour of simple systems” [3,4]. It is highly instructive to realize the fact that even simple mechanical systems, known for a long time, can be chaotic.

In the following section the focus is on a method we propose to produce, in cooperation with the pupils, Figure 7, and make them understand the equation of motion used for this phenomenon.

The equation of motion for the position x of the driven nonlinear oscillator is:

$$\ddot{x} = -\omega_0^2 x + \varepsilon x^3 - \alpha \dot{x} + A_0 \cos \omega t.$$

Here \ddot{x} is the second time-derivative of the position, ω_0 is the frequency of the oscillator, ε is the parameter of the nonlinear spring, \dot{x} is the velocity, α is the parameter of the drag coefficient, and A_0 and ω are the amplitude and frequency of the driving, respectively.

Secondary school pupils are not aware of differential equations, most probably they don't even know what differential calculus is. However, the meaning of the above equation can be unfolded by using the concept of velocity (v) and acceleration (a) instead of time derivatives. With properly chosen units the above equation can be written in a simpler form:

$$a = -A^2 x - A^2 x^3 - Bv + C \cos (2\pi t)$$

Measuring time in units of driving period $2\pi/\omega$ and distance in suitable units, quantity a (v) represents the dimensionless acceleration (velocity). Parameters A , B and C are numbers characterizing the spring's strength, the drag and the driving amplitude, respectively. In this form the physical meaning of the four terms on the right hand side are: linear and nonlinear spring force, drag, and driving. This way a sufficient interpretation is given for the equation, even if not all details are fully explained.

For the description of various dynamics two fundamentally different methods are used:

- 1) Forces acting on the object are known, and the functions describing the path can be explicitly given. Everything is known, basically. Examples are motion with constant acceleration, and harmonic oscillation:

$$a = \frac{F}{m} \text{ const} \Rightarrow s(t) = \frac{a}{2} t^2 + v_0 t$$

$$a = -\omega^2 y \Rightarrow y(t) = A \sin(\omega t + \varphi_0)$$

The trajectory cannot be explicitly given due to nonlinear forces, it can be numerically calculated only, step by step. This is the case for chaotic motion.

A numerical solution should be performed, for example, by means of the Dynamics Solver program.

The Dynamics Solver program

Dynamics Solver is a freeware, developed for the numerical integration of sets of differential equations by Juan M. Aguirregabiria in Spain. The software can be freely downloaded from several websites (see e.g. [5]).

Input data for the calculations are the number of equations, the number and notation of variables, functional relationships, parameters of the equation, initial conditions, and the parameters of the visualization.

Second order equations are solved as a set of first order equations. The format of equations is the one used in secondary schools:

$$\frac{dx}{dt} = v$$

$$\frac{dv}{dt} = -A^2x - A^2x^3 - Bv + C \cos(2\pi t)$$

The Dynamics Solver program starts with the screen shown in Figure 8: here the various parameters and initial values can be specified and, at the same time, the results of calculations are presented. The chaotic attractor of Figure 7 was obtained with $A = 6$, $B = 0.6$, $C = 1800$. The initial values were taken as $t_0 = 0$, $x_0 = 1$, $v_0 = -1$ and the simulation was run over 1000000 dimensionless time units. The chaotic attractor is reached after about a single time unit, the pattern seen in Figure 7 is therefore independent of the initial conditions.

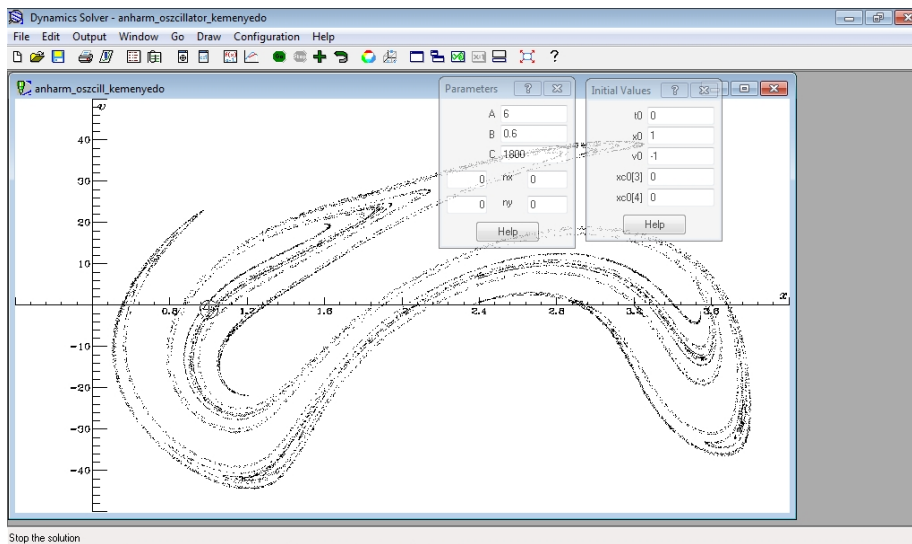

Figure 8. The screen of the Dynamics Solver program. The boxes in the right upper corner contain the parameters and the initial values. The data appearing with zero values in the boxes are irrelevant for our purposes.

The program is user friendly, easy to understand. The only problem to overcome is the huge number of choices.

The graphs shown in Figure 7 and 8 have been produced by specifying the presented results as snapshots taken in every driving period on the x - v plane. The resulting complex shape is called the chaotic attractor. The filamentary structure of the attractor is infinitely complex, it is a fractal.

Once the necessary equations have been entered and settings have been made, it is very easy to test the effect of changing parameters and initial conditions. This can serve as the pupils' own research activity, even with the possibility of some significant achievements.

Various motions can be studied with the method described. First, motions studied in the standard curriculum should be simulated. Results already known can be checked and, at the same time, sufficient skills can be gained in using the software. Once the software is familiar, various chaotic motions can be studied.

Syllabus of a chaos-teaching program

Facultative program for 17 year old students with a sum of 12 teaching hours. The topics of the classes are the following:

Class 1-2. Introduction, demonstrating a few chaotic phenomena: chaotic pendulums, bouncing balls, driven nonlinear oscillator. Equations of motions, solving simple equations of motion. Homework: home-made chaotic tools.

Class 3-4. Examination of chaos with computer: generating chaotic attractors (of e.g. the driven pendulum), discussing the necessary concepts: chaos, phase space, stroboscopic mapping, attractors. Solving differential equations numerically by means of Dynamics Solver.

Class 5-6. Fractal properties of chaotic attractors. Mathematical fractals, interpretation of fractal dimension, examples. Physical fractals, examples from biology and geography.

Class 7-8. Examination of further chaotic phenomena, computer simulations.

Class 9-10. Computer simulations. Chaotic phenomena in other disciplines: biology, chemistry, meteorology, geography, astronomy, sociology and economy.

Class 11-12. Summary, „final assessment”. Summing up experiences, discussion.

Attempts to teach chaos in Hungary and in other countries

In 2003 Ildikó Szatmári-Bajkó developed a similar chaos teaching program, based on the use of a chaotic motion simulation program, developed at the Department of Theoretical Physics of Eötvös University [6]. In 2008 and 2010 József Jaloveczki published articles on numerically solving equations of motion with students at high schools [7].

In Italy, I am aware of two books which mention chaotic phenomena, such as molecular and deterministic chaos [8,9]. The basic characteristic features of a chaotic system are mentioned in a textbook of physics in Austria [10]. Some elements of chaos theory are relatively detailed in a textbook in Romania [11].

Conclusions

It's worth teaching chaos theory at high school level since it gives an insight for the students into a recently discovered feature of physics, this may raise further the interest towards science. The widespread popularity of informatics also helps us to direct students towards an important field, to give opportunity of creative work, and to provide artistic facets of scientific activities.

The Dynamics Solver freeware is an appropriate program for work with students. Its use is simple and easily overcomes any lack of knowledge in math acquired in secondary school. It gives opportunity to design independent experiments and may lead to results, as well as, to aesthetic joy.

It's a striking experience seeing how the chaotic attractor of a driven nonlinear oscillator or pendulum emerges from thousands of points on the screen. The latter is shown in Figure 9.

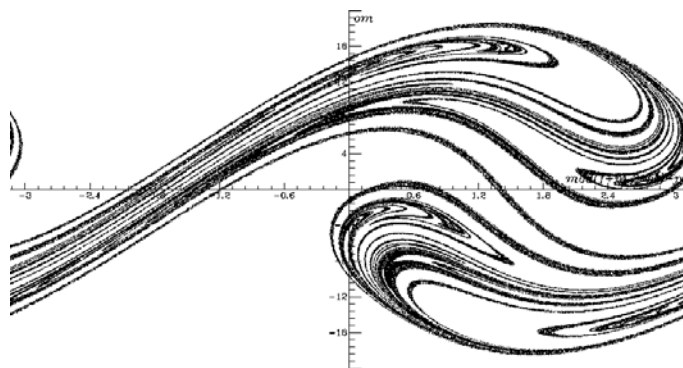

Figure 9. The chaotic attractor of a driven pendulum in the stroboscopic map generated by Dynamics Solver.

The equation of motion of the driven pendulum is:

$$\ddot{\varphi} = -\frac{g}{l} \sin(\varphi) - \alpha \dot{\varphi} + \frac{A \omega^2}{l} \cos(\omega t) \cos(\varphi)$$

Measuring time in units of the driving period and distance in the unit of the pendulum's length l , three parameters remain. The dimensionless equation of motion is:

$$\ddot{\varphi} = -a \sin(\varphi) - b \dot{\varphi} + c \cos(2\pi t) \cos(\varphi)$$

Parameters a , b , c are numbers characterizing the frequency, the drag and the driving amplitude, respectively. The simulation is run with $a = 4\pi^2/9$, $b = 0.2\pi$, $c = 8\pi^2$, and with the initial values $\varphi_0 = 1$ and $\omega_0 = 0$ for a time of 1000000 dimensionless units.

Acknowledgements

Special thanks are due to my PhD supervisors Márton Gruiz and Tamás Tél for their useful pieces of advice.

References

- [1] Planck M.: *Physikalische Abhandlungen und Vorträge*, Friedrich Vieweg und Sohn, Braunschweig, 1958.
- [2] Gleick J.: *Chaos. Making a New Science*, Penguin Books, 1988.
- [3] Ott E.: *Chaos in Dynamical Systems*, Cambridge University Press, 1993.
- [4] Tél T., Gruiz M.: *Chaotic Dynamics*, Cambridge University Press, 2006.
- [5] <http://tp.lc.ehu.es/jma/ds/ds.html>
- [6] Szatmári-Bajkó I.: *Iskolakultúra*, 2010/I., *Fizikai Szemle*, 2006/11. p. 376 (in Hungarian).
- [7] Jaloveczki J.: *Fizikai Szemle*, 2008/9. p.311, *Fizikai Szemle*, 2009/10. p.348 (in Hungarian).
- [8] Caforio A., Ferilli A.: *Physica 2*, Le Monier, Firenze, 1993.
- [9] Violino P., Robutti O.: *La fisica e i suoi modelli*, Volume 3, Zanichelli, Bologna, 1995.
- [10] Jaros A., Nussbaumer A., Kunze H.: *Basiswissen Physik-compact*, Öbv&hpt, Wien, 1999.
- [11] Tellmann J., Darvai B., Kovács Z.: *Fizika XI*, Ábel Kiadó, 2006.

Exploration of students' ideas about superconductivity

Marisa Michelini¹, Alberto Stefanel¹, Antonio Vanacore^{1,2}

¹PERG, University of Udine, Udine, Italy

²Physics Department, University of Salerno, Salerno, Italy

Abstract

Superconductivity is an important context in order to be introduced in the high school because it involves relevant technological applications and different levels of interpretation. Therefore it can be integrated in ordinary electromagnetism in upper secondary schools programs to renew the school curricula expanding the areas of physics of the twentieth century and rethinking the ordinary curriculum interpreted in a new perspective. An educational approach to superconductivity was designed exploring the magnetic properties of superconductors as a consequence of those of ideal conductors. A research experiment was done with a class of 16 students (18 years old) in Udine. In 10 hours of laboratory activities conducted using IBL stimuli Worksheets and a questionnaire, used as pre and post tests, have been studied how students modelize the process of magnetic levitation.

Keywords: superconductivity, upper secondary school, student learning

Introduction

Superconductivity is an important context of the physics of the 20th century because of its relevant applications [1-3]; it can be interpreted on different levels [4-5], it offers bridges from classical to quantum physics and to modern physics of fields [6]. In the perspective to renew the school curricula expanding areas of modern physics and rethinking the curriculum several contributions in literature stress the possibility to explore this phenomenology in lab of high school level [7-11]. However, few studies have been done about pupils' learning in this area and how they use relevant concepts of electrodynamic and electromagnetism to analyse electrical current and magnetic field inside the matter [6].

In a long term research project educational paths integrating superconductivity in electromagnetism courses were designed and experimented [12-13]. These paths activate student learning processes with phenomenological and experimental exploration, in particular measuring the breakdown of resistivity [14]. Research experiments have been conducted, proposing an approach to superconductivity centred on the magnetic properties. It emerged that the students using especially the representation of the field lines are able to give account consistently Meissner effect [12-13, 15].

A research experiment was done with 16 students (18 years old) of a class of a scientific Lyceum of Udine in 10 hours of laboratory activities conducted using Inquiry Based Stimuli Worksheets and a questionnaire used as pre and post tests and have been studied how students have enabled a dynamic view of the process of magnetic levitation and activated the link between electrical and magnetic properties of superconductors.

Research questions

RQ1. How students characterize the SC levitation and the Meissner effect?

RQ2. What conceptual references are used in their description?

RQ3. How they distinguish the Meissner effect and the pinning effect?

The context

The experimentation was carried out in the framework of the project IDIFO4¹ by one of us² as part of his project of PhD course and was integrated and implemented in the ordinary school week time of a cooperating teacher³ in a last grade class composed by 15 students (13 female and 2 male). In the previous evaluation of the teacher, performed according to standard monitoring tools [16], the class was valued of middle level in Physics. Before the experimentation the students have done an ordinary three-year physics course (3 hours per week) based on traditional teaching and some sessions of demonstrative laboratory experience. The students faced the path on superconductivity after an introduction on magnetic interaction, magnetic field and flux, magnetic properties of material, electromagnetic induction and the Faraday-Neumann-Lenz law guided by their own class teacher. The educational laboratory activities were conducted using 4 tutorial IBL worksheets in 7,5 hours and 2 hours was devoted to the pre/post test.

Instruments and methods

The steps of the educational path followed

The path implemented started with a preliminary phenomenological exploration of the magnetic properties of matter, to characterize ferromagnetic, paramagnetic, diamagnetic materials according to the interaction type and strength between a (strong) magnet and objects of different materials. The phenomenological analysis of the magnetic property of an YBCO disc at room temperature completed this introductory part. This exploration was repeated when the YBCO disc was cooled in liquid nitrogen. The diamagnetic property of the YBCO emerges not only by the systematically repulsive interaction between magnet and YBCO disc, but also observing that the YBCO disc screens the magnetic field at $T=T_N$, when it is interposed between a magnet and a little ferromagnetic ring. The link between the typical characteristic of the superconductor ($R = 0, B = 0$) was proposed analyzing the falling of a magnet on ordinary conductors of different material, and therefore resistivity, and on a superconductor, and therefore of null resistivity.

An analysis of the different forms of levitation and suspension by pinning effect was performed, stressing the strong link between the magnet and the YBCO disc occurring also at a distance. It aims at distinguishing the pinning effect and the Meissner effect.

The strategy adopted consisted in the activation of the construction of models by means of analogy emerging comparing the superconductive levitation and other situations as, for instance, two constrained magnets with opposite poles faced, an ordinary diamagnet object and a magnet, the falling of a magnet over/inside an ordinary conductor. The concepts of field, its formal representation by field lines, the magnetization concept and the magnetic

¹ The project IDIFO4 (Innovazione Didattica in Fisica e Orientamento 4 – Didactic Innovation in Physics and Guidance 4) is the 4th edition of a national project coordinated by Marisa Michelini, proposed by the Research Unit in Physics Education of the University of Udine with the collaboration of 19 Italian Universities. It involved different actions: a national Master on didactic innovation in teaching-learning Physics, focussed on Modern Physics and innovative methodologies based on ICT in lab and IBL. The IDIFO Project is developed in the context of the national plane PLS (Scientific Degree Plane), focussed on the diffusion of scientific culture and guidance in scientific university curricula.

² Antonio Vanacore

³ Giorgia Lauzzana of the Lyceum G. Marinelli of Udine

dipole vector were re-constructed through and for the analysis of the interactions occurring between ordinary systems. The aim of the present work is to study how students use these concepts as conceptual reference in the analysis of the Meissner and the pinning effects.

The educational materials and monitoring tools

The phenomenological exploration of the superconductivity was conducted using the High Tech Kit and Low Tech Kit developed in the projects Mosem (fig1) [17-18].



Figure 1. The HTK of the project Mosem and some examples of materials for Meissner effect, magnetic levitation, MAGLEV model [17-18].

The personal involvement of students was activated by IBL tutorial worksheets (WS hereafter), designed in previous research [19] and modified to fit the educational path followed (in fig. 2 an example). These were designed to implement the rationale of the path presented in the previous section, through open questions and tasks related to conceptual microsteps. Below it will be presented the knots proposed to students in the two WSs (WS1 and WS2) here analyzed, the situations analyzed by students, the questions they are requested to answer, and the related research questions focused.

WS1a-Magnetic properties of materials – A preliminary exploration on magnetism in the matter and electromagnetism found the following interpretation of superconductivity and therefore are here included aiming to the students ways of looking at magnetic properties of ordinary materials and the related field lines representation. The students, considering an object immersed in the magnetic field produced by a magnet are requested to answer the following questions: about the field lines representation, the dipole vectors, the observed behavior in the experimental exploration, trying to justify the behavior observed in the case of a) ferromagnetic; b) paramagnetic; c) diamagnetic objects. The focus is on how students characterize the different materials and the conceptual reference they used.

WS1b-Magnetic properties of YBCO at $T = T_{env}$. Analyzing the interaction of a magnet and a YBCO disc fixed at the ends of a suspended juke, the students are requested to classify operatively the magnetic properties of the YBCO. The focus is on: how students characterize the magnetic properties of YBCO? What conceptual reference they used?

Unità di Ricerca in Didattica della Fisica, Università di Udine
 Mettersi in gioco nell'explorare e interpretare fenomeni di superconduttività
 Scuola L.S.E. MARINELLI Classe 503
 Cognome Nome MARGHERITA Sede, data

SCHEDA 2

2.1. - 2.2. - 2.3. Consideriamo un oggetto che viene immerso in un campo magnetico. Tenendo conto del rappresentazione per linee di campo, di quelle per vettori di dipolo e del comportamento osservato nella esplorazione sperimentale, prova a giustificare il comportamento osservato nel caso dei:
 a) ferromagnetici,
 b) paramagnetici,
 c) diamagnetici.



2.4. Hai a disposizione un campione di superconduttore YBCO (YBa₂Cu₃O₇). Hai il compito di classificarlo. Fai una proposta operativa. (MATERIALE SOLIDO, COLORE NERO.)
 IL MATERIALE NON PESO IN UNA STRUTTURA ADEGUATA RISULTA PARAMAGNETICO (cattolto dal magnet) e FA PASSARE LE LINEE DI CAMPO

2.5. Prova.
 IL MATERIALE E' ATTRATTO DAL MAGNETE

2.6. Che tipo di materiale e'?
 PARAMAGNETICO

2.7. - Disegna le linee di campo del sistema

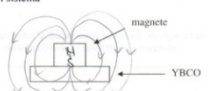

2.8. Esploriamo il suo comportamento all'abbassarsi della temperatura. Versa dell'azoto liquido sul sistema YBCO-magnete e aspetta che la temperatura si abbassi. Descrivilo osservi

LA RISPOSTA DEL MATERIALE ALL'AVVICINAMENTO DEL MAGNETE E' DI FORTE REPULSIONE AVVIENE INFATTI UNA LEVITAZIONE!

2.9. Come te lo spieghi? Fai delle ipotesi e prova a spiegare cosa è cambiato anche aiutandoti con un disegno
 A CAUSA DELL'AZOTO LIQUIDO LA TEMPERA DEL MATERIALE E' STATA RAGGIUNTA: ESSO SI COMPORTA COME UN SUPERCONDUTTORE CON $R=0$

2.10. Secondo te, l'YBCO ha cambiato le sue proprietà?
 NON E' PIU' UN PARAMAGNETE, MA SI COMPORTA COME UN DIAMAGNETE (?)

2.11. Come?
 LE LINEE DI B' NON ATTRAVERSSANO PIU' LA SUPERFICIE (E' POSSIBILE VISUALIZZARLO TRARTE L'ESPERIMENTO CON MAGNETE E FERROMAGNETI)

2.12. Disegna nuovamente qui sotto i due oggetti e il campo magnetico risultante, dopo la transizione. Questo è chiamato Effetto Meissner



2.13. Cosa puoi concludere?
 LE LINEE DEL CAMPO MAGNETICO B' NON ATTRAVERSSANO LA SUPERFICIE DI YBCO

L'YBCO è un materiale che, al di sotto di una certa temperatura, detta temperatura critica, acquista delle particolari proprietà elettriche e magnetiche (diamagnetismo perfetto), per le quali viene detto superconduttore.

2.14. Confronta ciò che hai osservato in questo esperimento e negli altri riguardanti materiali diamagnetici (grafite pirolitica): è lo stesso tipo di comportamento? Cosa c'è di uguale e cosa di diverso?
 LA GRAFITE PIROLITICA E' UN DIAMAGNETE INDIFFERENTEMENTE DALLA TEMPERATURA AMBIENTALE

Figure 2. Tutorial WS1 for the exploration of the Meissner effect.

WS1c-Field lines of a magnet and a YBCO at $T = T_{env}$, in connection with the previous activity, student consider the situation at room temperature T_{env} , and are request to draw the field lines for the system. Particular attention was devoted on how students draw the field line outside and inside the different objects involved.

WS1d-Phenomenology of SC levitation at $T=T_{NL}$, student are request to answer the following questions, concerning the situation ...Pour the liquid nitrogen on the system YBCO-magnet and wait for the temperature decreases, Describe what do you observe? How do you explain it? Make assumptions and tries to explain what has changed also helping with a drawing. Which aspects are focalized by students? What concepts they used? The RQs focalized are: How students explain the observed phenomena? They remain at descriptive level or introduce conceptual reference to explain some aspects?

WS1e. Magnetic properties of YBCO at $T=TLN$. Move the magnet, change the angle of approaching. Are changed the properties of YBCO? How? Which properties they attribute to YBCO? How they motivate the attributed properties? how they explain these changes?

WS1f. Field lines of the system. The magnet levitating on the YBCO. Draw the field lines for the system . How students draw the field lines outside and inside the involved systems? How YBCO modify the field lines? The field lines cross the YBCO?

Concerning the WS3 here will be considered just two points related to the pinning effect:

WS3 Characterize Pinning effect. How do you describe the pinning effect? How do you discriminate pinning effect by Meissner effect? In the present work we focus on how students describe pinning effect, which aspect of the phenomenology they focalize; how they explain the phenomenon and distinguish by the Meissner effect.

A second source of data, to acquire information on how students organize their knowledge on the superconductive effects, is an home-work written individual composition performed answering to the open questions: "Concerning the Meissner effect: A) What do you observed? B) Explain it in term of field lines and/or magnetic dipole momentum vector".

The third source of data here analyzed is constituted by the answers of students given to two questions concerning the representation of field lines and magnetic dipole momentum vector inside the matter, for ordinary material materials (Q10) and in particular inside a conductor with null electrical resistance (Q11).

Methodology of analysis

The analysis of the open responses was performed according to the criteria of qualitative analysis [20-21], to individuate qualitatively different alternative ways [21-22] in which students conceptualise the superconductive phenomenon, in the perspective of the phenomenographic methodology of analysis [23]. The categories were constructed identified the interpretative responses (which scientific models [4, 18] or elements of its are included? how extensive is the range of coherence with respect to the sequence of phenomena explored?), descriptive ones (which aspects are focalized), naive responses (typical students answers), stressing in particular how students analyze the $T=T_{NL}$ situation; how they characterize the superconductive state, the Meissner effect, the pinning effect and how they distinguish it from the Meissner effect?

Data analysis

In the following, the data collected by the three monitoring tools here considered are presented and discussed for each specific conceptual knot considered.

WS1a Magnetic properties of materials. After a free exploration of the interaction of a strong magnet with bars made by aluminum, copper, iron, wood, students are request to classify the magnetic properties of materials. They classified these properties according to three criteria: A) property assumed with respect an approaching magnet: "to become" good or not good magnets (7/15 – ferro "becomes good magnets, attraction is strong"; para- "it remains weak magnet"; dia-"weak magnetic field"); B) explication of effects (attraction/repulsion) and integration of the field lines and magnetic dipole vector representations (4/15, as in the reported fig. 4); C) Type of interaction with a magnet (4/15 – "Attraction; weak attraction; repulsion").

The focus, in characterizing univocally the type of material, is on a single aspect a part the 1/4 students (criteria B) linking phenomenon, interaction model, magnetic properties.

WS1b Magnetic properties of a YBCO at $T = T_{env}$. The classification of the YBCO at $T = T_{env}$ was proposed analyzing the interaction of a magnet and YBCO discs suspended at the extremity of a yoke.

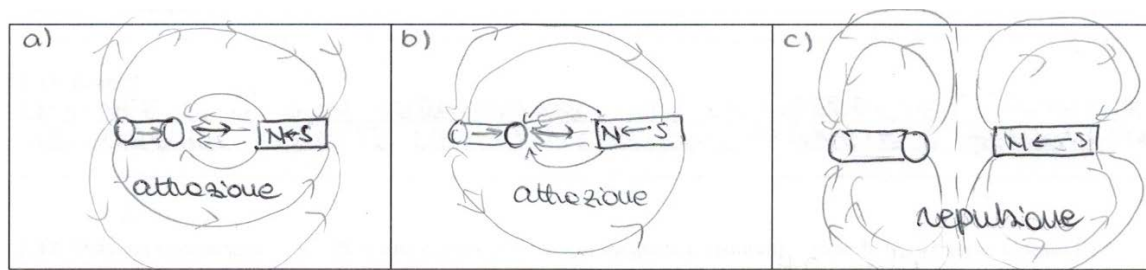

Figure 4. Example of criterion B of classification of magnetic properties: the field lines and magnetic momentum vector representation is accompanied by the observed phenomenon (attraction, attraction, repulsion respectively).

All students classify YBCO at T_{env} as a paramagnetic material, dividing into two ways: A) Interaction with a magnet and a field lines around (8/15), as in following example: "the

material suspended in a suitable structure is paramagnetic (attracted by the magnet) and lets the field lines pass”.

B) magnetic behavior change with temperature (7/15), being a "variable magnetism" material, because "it depends by the temperature": "At T_{env} has a paramagnetic behavior. It becomes diamagnetic at low temperatures”.

WS1c- Magnet and YBCO at $T = T_{env}$: field lines representation. All students represent the field lines outside the magnet, including the inner zone of the YBCO. In most cases, the YBCO does not influence the field (11/15 – fig 5a), in some cases, it influence the field, cause the presence of an induced magnetization vector in the material (4/15 – fig.5b).

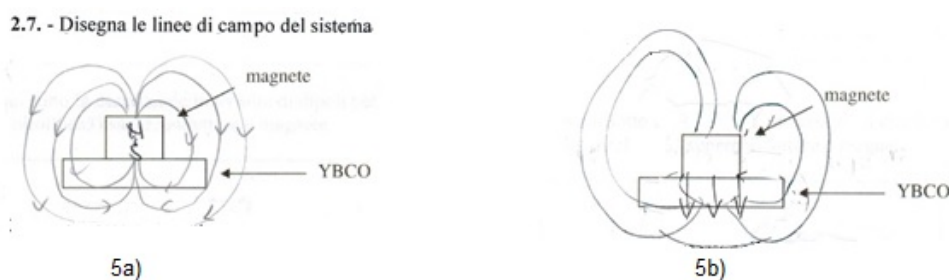

Figure 5. A magnet on a YBCO disc at room temperature: examples of field lines.

It can be observed that students do not represent any field lines inside the magnet, coherently with the fact that the continuity of the field lines inside the magnet do not emerge from phenomenology, despite being related to the dipolar nature of magnets.

WS1d-e-f - Magnet on a YBCO disc at $T=T_{NL}$. Students explored the interaction between a little magnet and an YBCO disc, when it is cooled in liquid nitrogen ($T=T_{NL}$). They answered to three questions: 2.8 Description of the phenomenon observed. 2.9 How change the interaction? 2.10 how and why change the magnetic properties of the YBCO?. The students' answers can be divided in three groups:

- A) (9/15) there is a "strong repulsion" (2.8: "The response of the material at the approach of the magnet is a strong repulsion, in fact the levitation occurs"), and therefore YBCO has changed "2.9: from paramagnet to diamagnet". Three different explanations are given: because 2.10: "It is no more crossed by the field lines, you can view it through the experiment with magnet and ferromagnetic ring" (5/9), "change the Weiss domains, but I don't know how" (2/9) or simply "it becomes a diamagnet" (2/9).
- B) (3/15) the YBCO acquire diamagnetic properties (2.8: "The sample of YBCO becomes diamagnet and a small magnet placed above remains suspended"), 2.9: "It changed its resistivity", 2.10: "changing its temperature", "it becomes a superconductor".
- C) (3/15) 2.8: "the magnetic attraction increases", 2.9: "the properties of the magnet increase"(2/3), the properties of YBCO changes (1/3), 2.10: "the properties of YBCO change, it acts as a magnetic screen", "it becomes diamagnetic".

Students prevalently (cat A) stress the type of interaction ("strong repulsion"), the absence of field lines through a YBCO disc at T_{NL} and justifying this with a change of the magnetic properties of the YBCO. In some cases (cat B) they ascribe the phenomenon classifying the new magnetic properties of the material linking magnetic and electric properties.

The remaining (cat. C), answering to 2.9 question, do not stress on the evident repulsive effect, but rather emphasize the presence of an attractive effect, effectively present in this

type of superconductors as residual pinning, in some cases adding that also the properties of the magnet are enhanced. For these students seems that the stability of levitation is a crucial problem, rather than the evident repulsion in itself. The analysis of the stability conditions of levitation is important but involves geometrical/contextual aspects not crucial to understand the process at the base of superconductivity. To build a conceptual model able to describe the phenomena, it is necessary to distinguish the two different processes involved: the Meissner effect and the pinning effect and the role of the two effects in relation with the type of superconductor. Two different reasoning paths could be individuated on how students link phenomena and models: the phenomenon guides the model (cat A prevalently – the diamagnetic property of YBCO is related to the recognition of the repulsive effect, which is associated to a diamagnetic behavior); The model guides the analysis of the phenomenon (cat B and C – the recognition of diamagnetic properties explains the observed levitation).

The 1/3 of the sample evoking the changes in the resistivity of the YBCO and in the Weiss domains going beyond the simple phenomenological description suggests possible interpretative models. Modeling activities can help them to clarify the consistency of their models. These activities are useful for all students to overcome the pure phenomenological descriptive approach evidenced in 2/3 of the sample and distributed on the three groups.

Homework – answer to the questions: *Concerning the Meissner effect: A) What do you observe? B) Explain in terms of field lines and/or magnetic dipole momentum.*

Students analyze the situation at $T=T_{NL}$, using the following ways:

A) according to the chain: observation of levitation \rightarrow change in the YBCO properties \rightarrow repulsion \rightarrow diamagnetic properties («The levitation observed indicates that the properties of YBCO are changed. As the effect is repulsive it follows that it has become diamagnetic») (6/15);

B) according to the connection YBCO becomes diamagnet \rightarrow levitation, that is the YBCO becomes diamagnetic and this is the origin of the phenomenon of the levitation of the magnet (5/15), in 3/5 cases, adding also that $r = 0$.

C) according to a single sentence as the “YBCO repels the magnet with a force that is equal to the weight force” (2/15) or the “YBCO becomes diamagnetic” (2/15).

A total of 12/15 students stress the diamagnetism of YBCO.

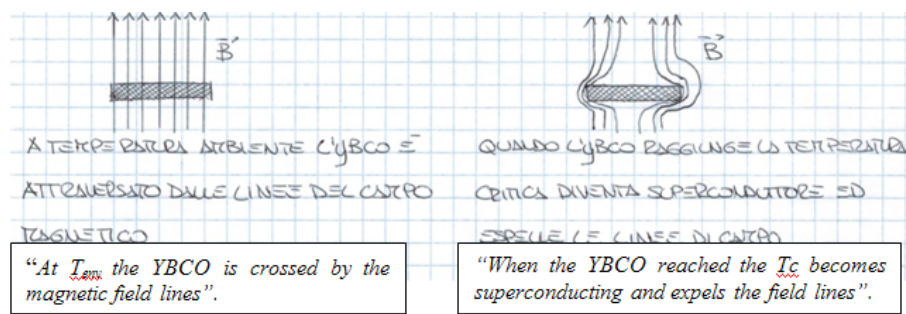

Figure 6. Typical drawing explaining answers of a and b ways.

An explanation has been included by 12/15 students, more frequently in terms of field lines (8/12): the YBCO at $T = T_{env}$ was passed by field lines (was paramagnetic) in T_{NL} it expels the field lines, in 3 cases adding that this is due to surface currents (5/8); the field lines do not cross over the YBCO, the YBCO screened the field lines (2/8); field lines trapped (1/8). In some cases it is just recall: “it becomes diamagnetic” (3/12) or simply that «this

effect [levitation] called Meissner effect» (1/12). The other 3/15 of students describe just the repulsive effect between magnet and superconductor.

Post test. Here is considered only how 11/5 students in the post-test represent the field lines and explain the case of a disc with null resistance inserted in an homogenous field

- A) “Because of zero resistivity we can say that the material is a superconductor. This means that achieves a perfect diamagnetism: therefore generates a magnetic moment that is opposed to the external magnetic field, so as to completely expel. Inside not have field lines” – in original in fig.8 (6/15)
- B) “A material with zero resistivity is a body in which all the domains are oriented toward the magnetic field. There it is immersed and then the resulting magnetic field is equal to the external lines and heading to the right then the north pole of the body will be at the left and the South on the right. The vector magnetic dipole will have a direction parallel to the magnetic field and the opposite direction” (2/15).

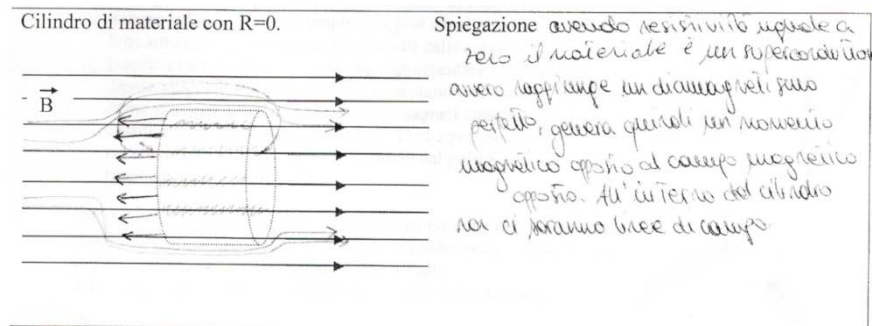

Figure 8. Answer to the post test question

- C) “Having no resistivity it will not interact with the field”.

The answers of types A) and B) evidence the link between electric and magnetic properties of YBCO. The third type evidence the connection electrical resistance/mechanical friction, no-resistance/no-interaction, emerged in other study (3/15) [15].

WS2 – Pinning effect. All students characterized the pinning effect, evidencing that "the magnet remains attached to the 'YBCO'", differentiating it in most cases (12/15) from the Meissner effect as such is manifested always in a repulsion, both when the magnet is initially on 'YBCO, both whether it is brought after $T = T_{NL}$. In the YBCO evidencing pinning effect, if it is cooled far from the magnet, it is repelled by the YBCO, otherwise it remains "attached". 12/15 students stress also that the effect Meissner is still present, but the pinning effect prevails. If students distinguish the two effects in their description, the representation of the field lines evidence that students do not elaborated an independent model to account the pinning effect, as emerge in the figure 9.

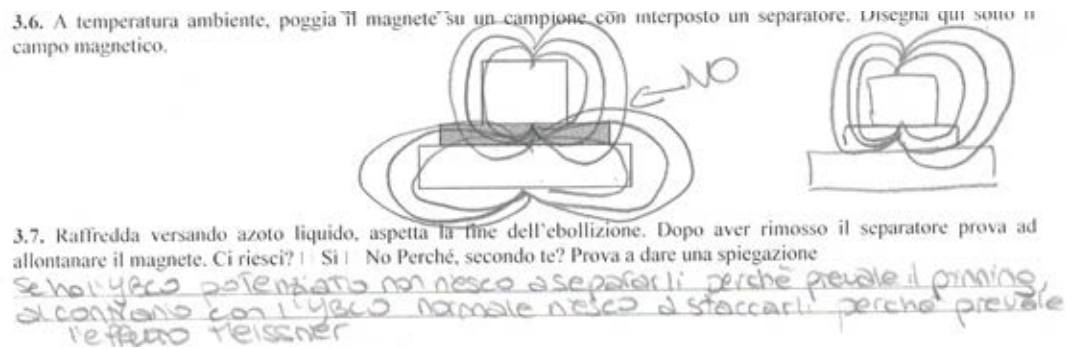

Figure 9. Representation of the field line in the case of the pinning effect.

Results

From data emerge that prevalently (12/15) students characterize the SC levitation as consequence of the diamagnetic properties acquired by the YBCO explaining also in some cases that the sample becomes a superconductor or that his resistance falls down to zero. In some cases (3/15) they remain at a phenomenological level individuating just the system of forces that can guarantee the levitation condition (YBCO repels the magnet with a force that is equal to the weight force). For some students the problem of stability is crucial and they emphasize the presence of the residual pinning effect also when the Meissner effect is prevalent. This indicate the need to stress on the presence of the two effects in the case of the high temperature superconductor as YBCO, but at the same time to distinguish between the two effects and construct a simple interpretative approach to the phenomena.(RQ1)

Student used as conceptual reference in their description of the interaction prevalently the concept of field. Concerning the description of magnetic properties, the systematic exploration of interactions of a magnet with different objects activates a prevalent use of the magnetic dipole vector representation, aspect not used in previous researches. The two descriptions are equivalent but are used by students looking at different contexts (RQ2).

As emerged in previous studies [15], some students indicate that a conductor with zero resistance is transparent to the magnetic field. These typical ideas, evidenced by students before analyzing the superconductive phenomena, remain also after the exploration in laboratory when students do not connect magnetic and the electric properties of YBCO (RQ2).

Finally students were able to distinguish the Meissner effect and the pinning effects but they do not construct models characterizing the pinning effect (RQ3)

Conclusion

In the perspective to renew upper secondary school curricula, superconductivity is a challenging phenomenological context that can be approached by IBL activities in school, important both for technological application, both on the theoretical point of view, both to bridge from classical to quantum physics. Educational path were designed integrating superconductivity al curricular electromagnetism topics, using a phenomenological approach based on real explorative activities and experiments. Test of feasibility was performed with more than 350 students of last classes of Italian schools. To evidence the models activated by students facing the superconductive phenomenology a research experiment were done in a class composed by 16 students (18 aged) of

a scientific Lyceum of Udine, in 10 hours of laboratory activities. IBL Stimuli Worksheets and pre-post test were used to monitor the conceptual development of student learning.

It emerged that students prevalently activate the link between the appearance of superconductivity state and the diamagnetic properties acquired by YBCO under the critical temperature. To account this change, the students searching an explanation activates also the link between magnetic and electric properties of superconductor, link not emerged in generalized way. In general students used model based on magnetic field lines or on magnetic momentum dipole vector according to the perspective they look respectively: the superconductive levitation in its phenomenological evidence; the changes in the properties of YBCO when cooled in liquid nitrogen. Finally they distinguish phenomenologically the pinning effect by the Meissner one, but do not produce an independent model to account the differences. This point will be particularly explored in future researches from a side to individuate students learning difficulties and learning path and modify the path focussing on the pinning effect. From the present work it emerges the need to stress on the presence of the Meissner and the pinning effect at the same time in the case of the high temperature superconductor as YBCO, but at the same time to distinguish between the two effects and construct a simple interpretative approach to the phenomena.

References

- [1] Aubrecht G.: Redesigning courses for the 21st century. *AJP*, 57 (1989)p. 352-359.
- [2] Gil D. P., Solbes. J.: The introduction of modern physics. *IJSE*, 15, (1993) p.255-260.
- [3] Hake R.R.: Is it Time to Implement Curriculums? *AAPT Ann.* 30(4) (2000), p. 103.
- [4] Badía-Majós A.: *AJP* 74 (12) (2006), p. 1136-1142.
- [5] Ostermann F., Ferreira L.M., Cavalcanti C.J.H.:Tópicos de física contemporânea no ensino médio. *Revista Brasileira de Ensino de Física*, 20 (1998), p. 270-288.
- [6] Ostermann F., Moreira M.A.: Física Contemporânea em la escuela secundaria. *Revista de Enseñanza de las Ciencias*, 3 (2), 18 (2000). p. 391-404.
- [7] Guarner E., Sánchez A.M.:The SC bird. *The Phys. Teach.*,30 (1992), p. 176-179.
- [8] Gough C.: High temperature SC take off. *Phys. Educ.*, 33 (1998), p. 38-46.
- [9] Brown R.: *The Physics Teacher*, 38 (3) S. (2000),p. 168.
- [10] Strehlow C. P., Sullivan M. C.: *AJP* 77 (2009), p. 847-851.
- [11] González-Jorge H., Domarco G.: *Phys. Educ.* 39(2004), p. 234 198.
- [12] Corni F., Michelini M., Santi L., Stefanel A., Viola R.: Curricular Paths in the Supercomet2 Experimentation in Italy. In *Physics Curr. Desig.* Ed.Constantinou CP,Papadouris N (2009) <http://lsg.ucy.ac.cy/girep2008/intro.htm>.
- [13] Viola R., Michelini M., Santi L., Corni F.: The secondary school experimentation of Supercomet in Italy. In *Frontiers of Physics Education.* Ed. RajkaJurdana-Sepic et al., p.190-196. Girep-Epec, Zlatni. Rijeka (CRO), (2008). ISBN 978-953-55066-1-4.
- [14] Gervasio, M., Michelini, M.: A USB probe for resistivity versus temperature, [http://www.fisica.uniud.it/URDF/mpt14/contents.htm\(2010\)](http://www.fisica.uniud.it/URDF/mpt14/contents.htm(2010)).
- [15] Stefanel A., Michelini M., Santi L.: High school students analyzing the phenomenology of SC. In sel. Paper of WCPE. Ed, Tasar F. (in publication).

- [16] Aiello Nicosia M.L., et al.; Teaching mech. oscill. using an integrate curriculum. *IJSE*, 2 (1997).
- [17] Greczylo T., Bouquet F., Ireson G., Michelini M., Engstrom V.: High-Tech Kit, *Il Nuovo Cimento C*, (33) 3 (2010), p. 221-229.
- [18] Kedzierska E. et al.: *Il Nuovo Cimento*, 33 (3) (2010), p. 65-74.
- [19] Michelini M., Viola R.: Esplorare la SC. in *Proposte didattiche su fis. mod.* Ed. Michelini M. p. 279-295. MIUR-UniUD, Udine, (2010). ISBN 978-88-97311-04-1.
- [20] Erickson, F.: Qualitative research methods for Sci. Educ. In *Int.H. of Sci. Educ.. Part 2.* Ed Fraser B. J., Tobin K. G., p. 1155-1174. Dordrecht, Kluwer Ac. Publ., (1998).
- [21] Niedderer, H.: Qualitative and quantitative methods of investigating alternative frameworks of students. Paper presented to the AAPT-AAAS meeting (1989).
- [22] Stephanou A.: The Meas.of Conc. Understanding in Phys., Early conf., (1999).
- [23] Marton F.:Phenomenography—describing conceptions of the world around us. *Instructional Science*, 10(1981), p. 177-200.

Pedagogical Content Knowledge research based module formation of prospective primary teachers on energy

Marisa Michelini¹, Lorenzo Santi¹, and Alberto Stefanel¹

¹PERG, University of Udine, Udine, Italy

Abstract

Primary teacher education is a challenge through which passes the formation to an integrated scientific culture of the future generation. In the perspective of the Pedagogical Content Knowledge (PCK), the cultural aspects, the conceptual and professional ones have to be integrated. As a result of a research conducted over several years, a formative intervention module (FIM) on energy has been designed and experimented by 114 prospective primary teachers at the University of Udine, in the a.y.2011-2012. The FIM includes two parts: in the subject matter content knowledge (CK) part, a traditional approach to the concept of energy was proposed starting from the concept of work; in the Pedagogical Content Knowledge part, a PCK laboratory integrates the analysis of a teaching/learning proposal based on experimental exploration and an inquiry strategy. CK-PCK questionnaires, appositely designed, were administered during and at the end of the different stages. Answers to CK and PCK questionnaires were analyzed as well as the worksheets (tutorials) filled in during the PCK Lab. The different kinds of data analysis evidence that the reflection in teaching perspective of the conceptual knots (integrating CK and PCK items) produces PCK in designing educational teaching/learning proposals. The quality of proposals designed depends on the experience made in the analysis of a research based proposal on teaching / learning energy.

Keywords: PCK, Primary Teacher formation, Energy

Introduction

Primary Teacher education involves the challenge of informing future generations about scientific culture so that teachers help students face the actual challenge to our actual society [1-2]. Results from research on primary teachers' growth as teachers, carried out from different perspectives and in different contexts, show a "fragile" formation of ideas on subject matters, on educational proposals for pupils, and on didactic strategies, methodologies, tools and instruments able to activate effective students learning and to help them to overcome typical and crucial difficulties in these different topics [1-5]. In-service teachers have experience on how activate and engage pupils. The prospective primary teachers (PPT) have the same lack of subject-related competence as in-service teachers and manifest also marked gaps particularly involving educational strategies [6-11], and Inquiry Based Learning (IBL) approaches [12]. From the perspective of the Pedagogical Content Knowledge (PCK) [13-14], crucial for teacher growth and, in particular, for PPT growth is the integration of the cultural aspects, both conceptual and professional ones [1-2, 6, 11-12]. The subject matter related nature of the PCK [13-14], implies that the specific ways this integration takes place must be specifically translated in the construction of specific thematic issues [5, 14-15].

In a research project running from more than five years [16-19], framed in the Model of Educational Reconstruction [20], a research-based Formative Intervention Module (FIM)

on energy has been designed and experimented with 114 PPTs of the studying for a degree in primary education at the University of Udine, during academic year 2011-12.

In this paper, framed in the Girep Thematic Group on Energy [21], we will analyze how this learning process is activated. Below the FIM designed will be presented, with related educational instruments and monitoring tools. The data collected using these monitoring tools will be presented, collecting results and conclusions emerging from the analysis.

The structure of the FIM on energy

In Figure 1, the structure of the FIM on energy for PPTs is shown, including two parts: 1) CK part - a traditional lecturing approach to the concept of energy, starting from the concept of work; 2) PCK laboratory integrating the analysis of a teaching/learning proposal based on experimental exploration and inquiry strategy by means of tutorials [16,17] and the analysis of the main conceptual problems emerging from literature [22].

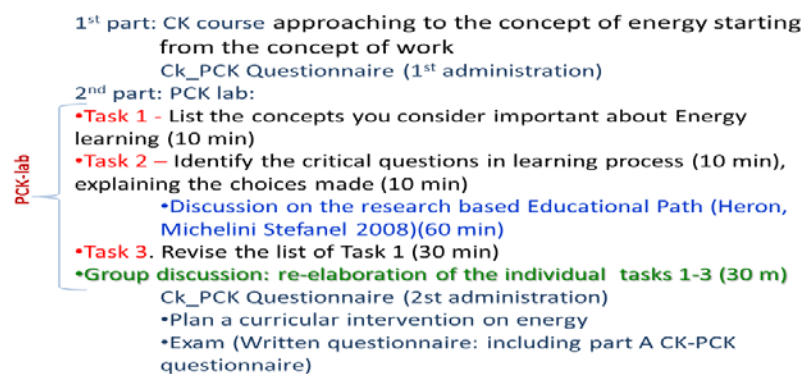

Figure 1. Schema of the formative module on energy

A CK-PCK questionnaire was given at the end of the first part of the FIM and a cluster of items from the questionnaire was included in the final written examination. The questionnaire, as will be discussed in section 4.3, from a side focus on the way in which the PPTs discuss the conceptual meaning of the everyday verbs related to energy: to conserve, to transform, and to lose, from the other side invites PPTs to discuss typical educational situations, conceptual problems on energy documented in literature [24-29].

Research questions

Among the many aspects involved in the FIM and discussed in previous researches [16,17], we focus on the following problems.

RQ1. How educational reconstructions of subject matter activate a scientific view on energy in PPTs?

RQ2. What role does the discussion of a research based path play in promoting PPTs' competencies for teaching/learning energy?

RQ3. How can we test the PCK gained by teachers?

Instruments and methods

The core of the FIM is the educational path, designed in previous research and tested in different primary schools [16,17], offered to PPTs through interactive lecture demonstrations. The main goals and peculiar characteristics are presented in the Section

4.1. The worksheets used during the laboratory as well as the educational materials used in activities to monitor and to collect data are describe in 4.2-4.3. In each subsection we present the methodology of analysis of data based on the different monitoring tools used.

The research-based path on energy for primary

The active role living and analyzing a research based educational path on energy [16,17] offers to the PPTs the opportunity to understand the conceptual difficulties that students encounter during the learning process and focuses the PPTs' attention on methodological choices and the ways in which to produce a consistent problem-based path. Simple apparatuses consisted of toys or inexpensive, easy-to-find, familiar materials are used.

The major goals of the path are summarized in the following.

Students should know that energy exists in different types: kinetic energy, potential energy, internal energy and energy associated with light. The sequence, extensively described in other papers [16,17], begins with the idea, common in children, that the "human energy" needed to allow us to move increases as a result of eating food.

Students should recognize that energy is a property of a system in a particular condition (a state property, described in everyday terms) and is not a material substance, as often conceptualized by pupils, but not consistent with the thermodynamic view of energy.

Students should be able to identify the transformation of energy in everyday processes and in significant examples related to large-scale energy production. Carr [30] points out that questions about energy in static situations often cause confusion among students. The energy concept can be better recognized in situations in which observable *changes* are taking place [31]: wheels spinning more quickly, objects falling from higher to lower positions, temperatures increasing, etc. Following the recommendation of Carr [30], the initial and final states of the systems be clearly identified to focus students' attention on specific changes, also in the cases of internal energy changes.

Students should know how some forms of energy (or at least changes in energy) can be observed and measured. The usefulness (and in some sense the meaning) of energy is tightly linked to our ability to measure it and thus keep track of it as it undergoes transfer and transformation. Quantitative experiments were not stressed for this age group, but the idea of measurement is introduced exploring some situation (as pendulum, bouncing ball).

The strategy adopted using this path activates PEC cycles in the analysis of energy transformations, by means of IBL tutorial worksheets [16,17].

The PCK-lab and the tutorial worksheet for teacher formation and monitoring

The second part of the MIF activate a reflection on contents, on related conceptual problems and on the active IBL strategies for learning/teaching energy at primary level and in particular to bridge common sense reasoning with the scientific ones. The structure of the lab, named PCK-lab for this reason, focused on the integration of subject contents and related didactic aspects considered fundamental in the topic for teacher knowledge in the PCK perspective [13,14, 18,19]. Three individual steps and one group step are included: Step 1 (10 min - individual) – Task 1: list the concepts considered important about energy learning; Step 2 (20 min-individual) – Task 2: Identify the critical questions in the learning process, explaining the choices made; Step 3 (60 min – lecture) – Discussion about the research-based educational path [16,17]; Step 4 (30 min – individual) – Task 3: Revise the

list of Task 1; Step 5 (30 m – group) – reanalysis of the individual tasks 1-3 with the groups constructing shared answers (30 m).

Data were collected by means of two worksheets: the first includes the tasks 1-2-3; the second was designed to promote group discussion and construction of shared conclusions from re-analysis of the tasks 1-3. In the present work, the individual PPT's answers to the worksheet 1 are analyzed for what the person chose to the list as issues considered important in teaching energy, as emerged: at the beginning of the PCK lab, after the step 4, at the end of the FIM. The analysis was performed first individuating the elements considered important, then clustering these elements, categorizing PPTs' answers giving their initial vision on the didactics of energy and how that vision changes.

The CK-PCK questionnaire

The CK-PCK questionnaire [16-19], was organized into two parts: Part A – focused on the way in which the PPTs discussed how conserve, transform, and lost energy change meaning in passing from their everyday meaning to their scientific meaning; Part B – focused on typical pupils' ideas and conceptual problems on energy, to explore the ways of focusing on pupils' learning problems by the PPTs, as for instance: energy associated with human or living being or as a fuel-like substance that is possessed by living things [22-27]; energy possessed only by moving objects [24, 28]; energy as the product of some process, existing only during this process [22-26].

The questionnaire was administered at the end of the 1st part of the lab, at the end of the PCK lab. The questions of part A were administered also in the final exam.

In the present work, only answers to the questions “Q1. What do you know about Energy?”, “Q2. As far as you know, are there things that make energy?” will be considered. The first question Q1 gives information on intension and extension of the concept of energy. The answers were categorized individuating criteria produced by PPTs to identify energy and what sort of changes will happen during the different stages of the FIM. The question Q2 provides information on the crucial point concerning the meaning of energy sources and energy forms, in the perspective of the transformative and conservative nature of energy. The responses were divided according to two perspectives: those who look to the types of source or to what is able to produce energy (systems, substances) and those who look to the processes or transformations as the site of energy production.

For the scope of this work, the following PCK-item of the part B will here analyze: «In an interview in class the question is asked: “As far as you know, are there body that make energy?” Three children respond as follows: Giuseppe: “energy is not possessed by bodies, but is only developed in the instant in which it is produced as in the explosion of a bomb; Davide: energy is possessed by some bodies such as fuel, heater, radiators, the sun, the water of a river; Sara: energy is possessed by bodies when they move or when they do something”». PPTs are request to answer to the following two questions: D1. What are the learning problems underlying each of the students' answers? D2. What activities can be proposed to children to deal with each of the individual learning problems?

The analysis of the answers to this question, administered at the beginning and at the end of the PCK lab, will focus on attention to student reasoning, rather than their mistakes.

Data analysis

Data from the CK-PCK questionnaire: questions Q1-Q2

Previous any formation, as shown in Figure 2, PPTs stressed on forms of energy prevalently involved in electrical energy production. There is no distinction among the types of energy (kinetic, potential, internal, and associated to light energy) and the forms of energy (wind, solar, nuclear...energy). Energy is often identified as the “capability to do work” or that is conserved because “nothing is destroyed and created”, being often not distinguished by force or power, or considered as a substance, as fuel. Unclear distinction between potential energy and internal energy was observed. The meaning of conservation and transformation often appears far different from the scientific one [17,18].

In the present study the scenario of answers at the end of the CK part of the formative module and before starting the PCK lab is quite different (Figure 2). In their answers, PPTs proposed criteria to identify energy, and in particular: 60% proposed three or more criteria; 30% - proposed two criteria; and 10% - proposed only one criterion.

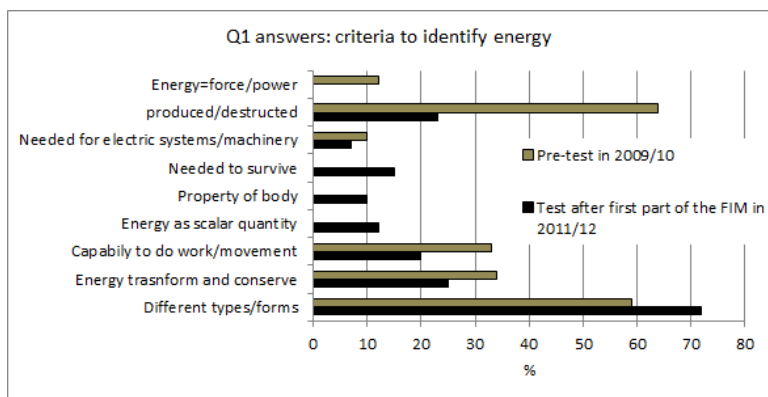

Figure 2. Criteria for identification of energy (not exclusive categories), administrating question Q1 in a pre-test (a.y. 2009/10) and in an intermediate test (a.y. 2011/12).

After the discussion of the reference path (step 3 of the PCK-lab). The new elements stressed are that sources don't exist, that there are just sites of transformation (66%), that energy is a property of state of all bodies (32%), that standing bodies possess potential or internal energy (25%), and moving ones possess kinetic energy (17%).

The answers at the end of the final exams focused on the properties identifying energy in operative way, with 80% of PPTs proposing three to four criteria, and 20% proposing two criteria. Energy as property possessed by bodies (68%); Different types/forms (66%); energy transforms, conserves (57%); Energy is transferred (34%) or not dispersed (22%).

Concerning the answers to Q2 on “things making energy” before the PCK lab and in the final examination. In the first administration of the test, PPTs quoted: entities involved in transformation, as heat, work (91%); phenomena as electricity (11%); substances (79%); systems as power central (11%). When the same question was administered in the final exam the answers were of just two categories: “energy is not created, but transformed” (88%); Power central are energy transformation sites (38%).

Data from the CK-PCK questionnaire: PCK questions

The analysis of the answers to the questions D1 (conceptual problems), and D2 (related didactic strategy to face the specific learning problem), highlights the upgrading of the skills of PPTs in identifying the reasoning behind the conceptual knots of students and how PPTs are much more focused on conceptual aspects in their intervention proposals for overcoming the students difficulties. Before the PCK lab, few PPTs (less than 10%) were able to focus the learning problems underlying the Giuseppe, Davide, Sara sentences (see part B of the PCK questionnaire and propose some didactic strategy to overcome the problems identified (22%). Prevalently PPTs stressed on what is wrong in the sentences of students (69%) or not answered (31%) and suggested "explaining" what is wrong in the students' sentences. After the PCK lab all PPTs analyzed the student's answers stressing on the learning problems at the base of students sentences (100%), proposing in half cases specific strategies to overcome it (53%).

Data from the work sheet used in the PCK lab

Finally, we report here how the aspects considered important about teaching energy changed. In Figure 3, we report the distribution of the main aspects evidenced by PPTs at three stages of the PCK-lab: at the beginning, after the discussion of the reference educational path (step three of the PCK lab), and at the end of the lab, in the documentation produced by PPT as part of their portfolio on the FIM.

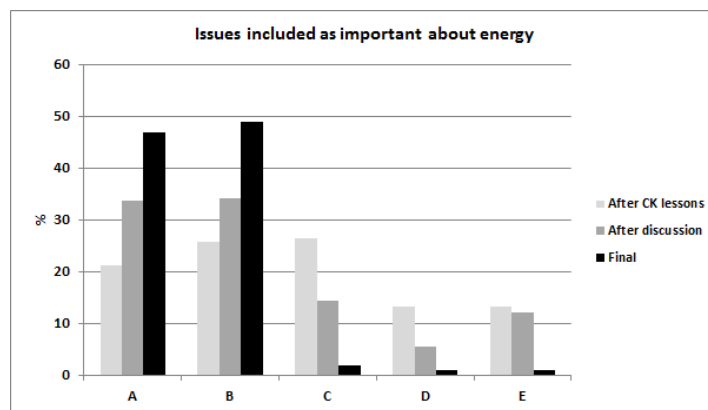

Figure 3. Issues included as important aspects to be considered for teaching energy.

Legend: A - Operational definition of energy; conservativity, transformability, examples, types; B - Types/forms (including KE, EP); Transformability or conservation; C- Standard definition/types/conservation or transformation; D - Identification of energy in a specific way (types); E – Need to construct an operative definition.

The systematic change in the distribution shows the impact of the PCK lab and in particular of the role of the group interaction (the last step of the PCK lab), in producing an organic view of the concept of energy.

Main Results and concluding remarks

Concerning the competencies developed by the Prospective Primary teachers, from study of PCK questions, analyzed before and after the discussion of a research based path, we find a gain both in CK competences (distinction between types and forms of energy; concepts of energy transformation, conservation, transfer, loss) and in PCK competencies:

knowledge about pupils ideas about energy and related learning problems; operative/explorative approach to energy introduction with pupils (RQ2). These aspects are also evidenced in the educational projects on energy included in the portfolios, coherently on what emerged in previous works, in particular in the introduction of an operative approach to energy, with respect to a descriptive approach to energy forms production that constitute the initial way in which PPTs approach the teaching of energy without any formation on the theme [17,18]. (RQ2).

For achieving a scientific point of view on energy, two elements of the PCK lab appear crucial: the analysis of a research-based path and the Group Work carried out at the last step of the PCK lab, where a re-analysis of the individual work was integrated with the discussion with peers in the group. The final work documents are richer in understanding than the union of the single one original answers produced by the individual students in the class (RQ1).

The results show that the formative module for prospective primary teachers as designed and implemented appears to be useful in teacher education for professional development, particularly as related to student development of specific PCK on energy. Reflection on relevant concepts, and problems from different perspectives (CK – PCK), offering research-based IBL educational path analysis and discussion, the group discussion of concepts and problems; the PCK questionnaires (Conceptual CK and integration with PCK), attention to and reflection on pupils reasoning, coherence in teaching/learning path planning, implementing microteaching monitoring learning processes, and on each task and experience led to the growth of the students during the proces. (RQ3).

References

- [1] Michelini M.: New approach in physics education for primary school teachers. In: *Inquiries into European Higher Education in Physics*. Vol. 7. Ed. Ferdinande H., Valcke E., Formesyn T., p. 180-198. EUPEN (2003). ISBN 90-804859-6-9.
- [2] Michelini M. ed.: *Quality Development in the teacher Education and Training*. Udine: GIREP, Forum (2004). ISBN: 88-8420-225-6.
- [3] Viennot L.: *Teaching physics*. Dordrecht: Kluwer Publ. (2003), ISBN 1-4020-1276-4.
- [4] Abd-El-Khalick F., Akerson V. L.: Learning as conceptual change. *Science Education*, 88 (5) (2004), p. 785-810.
- [5] Abell S. K.: Research on science teacher knowledge. In: *Handbook of Res. on Sci. Educ.* Ed. Abell S. K., Lederman N. G., p. 1105-1149. Mahwa: Erlbaum, (2007).
- [6] Appleton K.: Science PCK and elementary school teachers. In: *Elementary science teacher education*. Ed. Appleton K., p.31-54. New York: Elbaum, (2006).
- [7] Patchen T., Cox-Petersen A.: Constructing cultural relevance in science: A case study of two elementary teachers. *Science Education*, 92 (6) (2008), p. 994-1014.
- [8] Schwarz C.: Developing Preservice Elementary Teachers' Knowledge and Practices Through Modeling-Centered Scientific Inquiry. *Sci. Educ.*, 93 (4) (2009), p. 720-744.
- [9] Spirtou A., Koumaras P.: Educating primary teachers in science: The case of energy. In: *Europ. Res. in Sci. Educ.* Ed. Lijnse P. L., p. 259-265. Utrecht: CDß Press, (1994).

- [10] Viennot L.: The contents of Physics. In: Thinking Physics for Teaching. Ed. Bernardini C. et al., p. 67-76. New York: Plenum, (1995), ISBN 978-1-4613-5786-5.
- [11] Corni F., Micheline M., Stefanel A.: Strategies in formative intervention modules for physics education of primary school teachers. In: Quality develop. in teacher educ. and training. Ed. Micheline M., p. 382-386. Udine: Forum (2004), ISBN: 88-8420-225-6.
- [12] Samarapungavan A., Mantzicopoulos P., Patrick H.: Learning science through inquiry in kindergarten. *Science Education*, 92 (5) (2008), p. 868-908.
- [13] Shulman L. S.: Those Who Understand: Knowledge Growth. *Educational Researcher* 15, 2 (1986), p. 4-14.
- [14] Gess-Newsome J.: Pedagogical content knowledge. In: Examining PCK. Ed. Gess-Newsome J., Lederman N. G., p. 3-17. Dordrecht: Kluwer, (1999).
- [15] Grayson D. J.: Disciplinary Knowledge from a Pedagogical Point of View. In: Connecting Research in Physics Education with Teacher Education. Vol. 2. Ed. Vincentini, M., Sassi, E., p. 171-185. New Delhi: ICPE, (2010). ISBN 0-9507510-5-0.
- [16] Duit R.: (2006) Science Education Research – An Indispensable Prerequisite for Improving Instructional Practice. Paper presented at Summer School, Braga. 1-15.
- [17] Heron P., Micheline M., Stefanel A.: Teaching and learning the concept of energy in primary. In *Phys. Curriculum Design*. Ed.: Constantinou C. P., Univ. Cyprus (2008).
- [18] Heron P., Micheline M., Stefanel A.: Teaching and learning the concept of energy at 14 years old. In *FISER09*. Ed.: Garip M. et al., p. 231-240. Famagusta: E.M.U, (2009).
- [19] Heron P., Micheline M., Stefanel A.: Evaluating pedagogical content knowledge of energy of prospective teachers. In: *Community and Cooperation, Vol II*. Ed. Raine D., Hurkett C., Rogers L., p. 147-161. Leicester: Lulu, (2011). ISBN: 978-1-4466-1139-5.
- [20] Stefanel A., Micheline M., Santi L.: PCK formation and evaluation of prospective primary teachers on energy. In: *Proceedings of the WCPE 2012*. Ed. Tasar F. Pegem Akademi, Istanbul, (2014), pp. 473-478.
- [21] Micheline M., Heron P., McDermott L. C.: Teaching and learning the concept of energy, report of the Symposium, in *Proceedings of the WCPE 2012*, Tasar F. Ed., Pegem Akademi [ISBN 978-605-364-658-7], p. 449.
- [22] Millar R.: Teaching about energy. (2005). [online]. Available from: <http://www.york.ac.uk/media/educationalstudies/Paper11Teachingaboutenergy.pdf>
- [23] Solomon J.: Learning about energy: How pupils think in two domains. *European Journal of Science Education* 5, No 1 (1983), p. 49-59.
- [24] Watts D.: Some alternative views of energy. *Physics Education*, 18 (1983), p. 213-217.
- [25] Watts M., Gilbert J. K.: Appraising the understanding of science concepts: "Energy". Guildford: Educational Studies (1983).
- [26] Nicholls G., Ogborn J.: Dimensions of children's conceptions of energy. *International Journal of Science Education*, No 15, 2 (1993), p. 73-81.
- [27] Trumper R.: Children's energy concepts: A cross-age study. *International Journal of Science Education*. No 15, 2 (1993), p.139-148.
- [28] Stead B.: Energy. Working Paper No.17, Learn. in Sci. Project, Waikato Univ (1980).

- [29] Duit R.: Learning the energy concept in school — empirical results from the Philippines and West Germany. *Physics Education*, No 19 (1984), p. 59-66.
- [30] Carr M., Kirkwood V.: Teaching and learning about energy in New Zeland secondary school junior science classrooms. *Phys. Educ.* 23 (1988), 86-91.
- [31] Brook A. J., Wells P.: Conserving the circus? An alternative approach to teaching and learning about energy. *Phys. Educ.* 23 (1988), p. 80-85.

Climate Change Education for Physics Teachers

Tomáš Milář, Jan Hollan, Jindřiška Svobodová

Faculty of Education, Masaryk University, Czech Republic

Abstract

Climate change science is a multidisciplinary field. Many important functions of the climate system are domain of Climate physics. We claim that physics teachers should have good understanding of basic principles of climate physics, e.g. greenhouse effect and causes of sea level rise, in order to transmit the knowledge towards their pupils. Dozens of studies have shown that people (mostly students or pupils) confuse greenhouse effect with ozone hole. To investigate the roots of misconceptions, we interviewed students at Masaryk University, Faculty of Education, who supposed to become physics teachers. We found their understanding of greenhouse effect is poor, ozone holes are out of their scope. Our results are being utilized to design a university course using laboratory and outdoor experiments and measurements, explaining vital concepts thoroughly – some examples are here too.

Keywords: university education, physics, climate change, greenhouse effect

The importance of Climate Physics

Climate change theme is present in media and politics quite a lot. However, even people with good science education may not really understand the mechanism controlling the Earth temperature – the greenhouse effect. And if they don't, the very reason why the enthalpy (and, therefore temperature) of the Earth is rising now, is obscure to them, they can but believe what some experts are saying – or not believe them.

The primary group, who *should* understand, are physics teachers of course. Then the understanding may spread to their colleagues and pupils, and, hopefully, to most people at last. Being sure why the Earth is warming, may enhance their motivation to slow it down, stop it or even reverse it.

We won't repeat here, why climate change is caused by Earth radiative imbalance so extremely serious for the mankind. Excellent review articles, reports and books exist on this topic. If we should recommend a single book describing how the state of our planet has changed already and what should be our strategies for the future, it might be [1] (Czech remarks to its Czech version are at [2]). A recent appeal by prominent scientists is [3], two reports for the World Bank are [4] and [5].

Climate physics is *the* tool for quantitative and qualitative understanding to global warming and climate change. The most basic parts of it can be somehow learned even on elementary schools. We shall show some hints how to achieve it.

Pupils from 10 years on should be aware of importance of greenhouse gases for Earth's climate, of the reality of Global climate disruption and of Adaptation (a large one, transformational [6]) and Mitigation, which should go hand-in-hand.

For students at the beginning of university studies, climate change education is an opportunity to integrate many disciplines [7].

An obstacle to understanding: misconceptions

Several false conceptions regarding climate change are reported in [8], as:

“One of the most popular persistent misconceptions is that the ozone hole plays a major role in global warming (e.g., [9]).”

“More than half of the students in a Swedish study believed that the greenhouse effect is only a human-induced phenomenon. They did not distinguish between the natural greenhouse effect necessary for life on Earth and its human enhancement [10].”

Our research started with a question: What misconceptions about greenhouse effect do pre-service physics teachers have?

We have interviewed six PhD students of didactics of physics, meetings lasted on average 20 min. Students were informed in advance only about the topic of interview – Greenhouse Effect. They were not trained or prepared for it. Interviews were conducted following a structured set of 17 questions or tasks, were recorded and analysed.

The tasks and questions

Four tasks/questions were based on such pictures, which are rather typical in texts or web pages which try to explain the phenomenon. *All of them are of no real help, or even worse, they are misleading.* But we did not comment on those pictures when showing them to the post-graduate students. Nor did we comment on their answers during the interview and even after the interview. We just thanked them for devoting their time and expressing their own thoughts to us.

1. Use the following picture to explain the greenhouse effect:

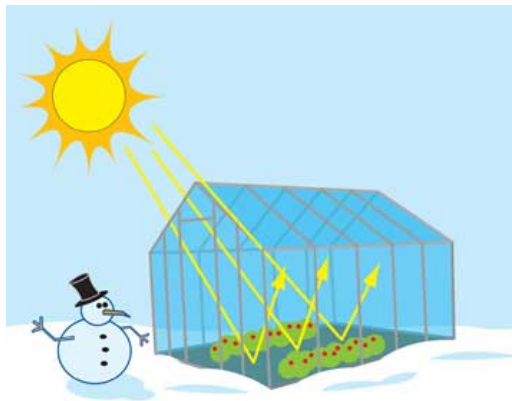

Figure 1. A (useless) illustration of a greenhouse

2. Use the following picture to explain the greenhouse effect in the Earth's atmosphere:

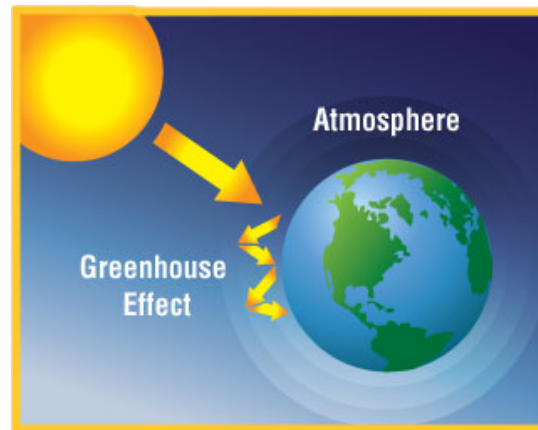

Figure 2. A (misleading) illustration of radiative fluxes over Earth

3. What differences can you see for those two cases?
4. How does foil greenhouse work?
5. Estimate an average surface temperature of the Earth.
6. Estimate an average surface temperature of the Earth without atmosphere.
7. What are the most significant greenhouse gases in the Earth's atmosphere?
8. Where are the greenhouse gases in the Earth's atmosphere located?
9. When concentration of atmospheric greenhouse gases increases, what happens to the temperature of (a) Earth's surface, (b) stratosphere?
10. What you think the picture below represents?



Figure 3: Guess what...

11. Use the following picture to explain the function of ozone layer:

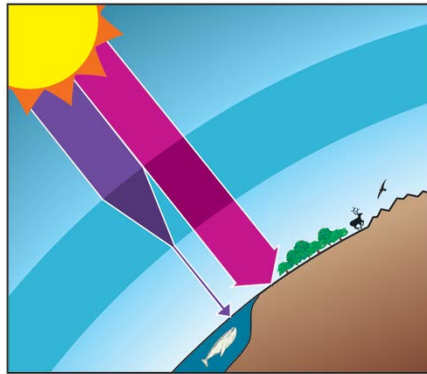

Figure 4. UV and longer wavelengths, for sure, but... UV makes *far less* than half of solar irradiance

12. Where in the atmosphere is ozone located?
13. What is the cause of ozone layer depletion?
14. Where in the atmosphere are ozone holes located?
15. Why do ozone holes form above poles?
16. Can global warming somehow contribute to depletion of ozone layer? (How?)
17. Can depletion of ozone layer somehow contribute to global warming? (How?)

Findings

House envelope as an air flow barrier

The students guessed somehow that glass blocks longwave infrared radiation, in spite of the pictures served to tasks 1 and 2 giving no hint for that. However, they were unable to explain why even under foil-greenhouse, the temperature is higher than outside, in spite of foil being non-opaque for long wave infrared. To put it otherwise, they might not realize why the inside of the house is “naturally” kept warmer than outside even in those mild months when no heating is used. Or, in very hot days, a house can be kept a lot colder than outside air. Just the air flow is to be either allowed or blocked by using windows and doors cleverly... They would surely come to the conclusion that (green)house envelope primary function is separating the air inside and outside, if it would be discussed with them. So it seems they did not exercised such thinking during their lives, in spite of being graduates in physics teaching.

This difference between a greenhouse and the Earth surrounded by its atmosphere, was not identified by the students (questions 3 and 4).

Hesitation whether Earth without atmosphere would be warmer or cooler

The students estimated the average Earth surface temperature well. But just one student, after thinking aloud for a while, came to the conclusion that without any atmosphere, Earth would be a lot cooler and gave a value (probably remembered it) that it would get to some -18°C . Another speculated mostly, that without atmosphere, there would be more sunshine and therefore the Earth surface would be warmer. Evidently, the pair of words

“greenhouse effect” was just something that they hear often, but have little idea what it is in reality and how huge it is. Probably, they connect it, like the Swedish respondents in [10], just with the recent alteration of atmospheric composition due to anthropogenic emissions.

No misconception of greenhouse gases being located somewhere in the height

Names of several greenhouse gases and the fact that apart from water vapour they are well mixed in the atmosphere were known to all students. However, the opposite temperature change in troposphere and stratosphere due to their rising concentration was not known to them.

Common conclusion of similar studies that people believe that greenhouse gases are located in a single layer (as many misleading illustrations show, trying to “simplify”), was not found here. This may be due to the fact that respondents were graduates in physics. Even if they had been offered a single layer model to explain greenhouse effect, they did not really believe it is so in case of atmosphere (we asked them explicitly).

No idea about location of ozone holes etc. (question 10 to 16)

All students guessed that the picture at question 10 may illustrate the ozone hole. They knew ozone is mostly high in the atmosphere, is absorbing UV radiation and its depletion was due to halocarbons.

However, they had no idea “ozone holes” are local minima over Earth poles. Therefore the mechanism of its enhanced destruction, needing surface of solid phase (ice crystals) to mobilize chlorine or bromine compounds was also alien to them. It seems that the topic of ozone depletion is so old already, that the students never encountered or remembered any explanation what happens in reality. The holes were discussed in media when they were discovered, before the halocarbon emissions were greatly reduced thanks to Montreal protocol.

No wonder they did not know the current cause of non-healing Arctic ozone hole – falling temperature of stratosphere, leading to larger amounts of ice crystals there, causing more ozone depletion even without rising amounts of Cl and Br atoms.

Confirmed conception that ozone hole allows more solar radiation to penetrate the atmosphere and heat Earth's surface

Although in principle this idea is right, the heating effect due to diminished shortwave absorption is small and the cooling effect due to diminished longwave absorption and emission probably prevails [11]. Influence of changes in stratospheric ozone is, in any case, an order of magnitude lower than the total anthropogenic influence on Earth's radiative balance. In fact, interviewees have probably never investigated the problem before – they fabricated this (mis)conception during the interview. This idea is connected with the mostly wrong answer to q. 6 – atmosphere being considered just like a sunshine blocking medium.

Our hints how to teach these topics

An illustration of GH which might help

Greenhouse effect is... a process, in which the Earth surface is irradiated not only by Sun, but by the atmosphere too. Spectral selectivity of the air (shortwave radiation goes mostly through, longwave is absorbed and emitted) is the key for it.

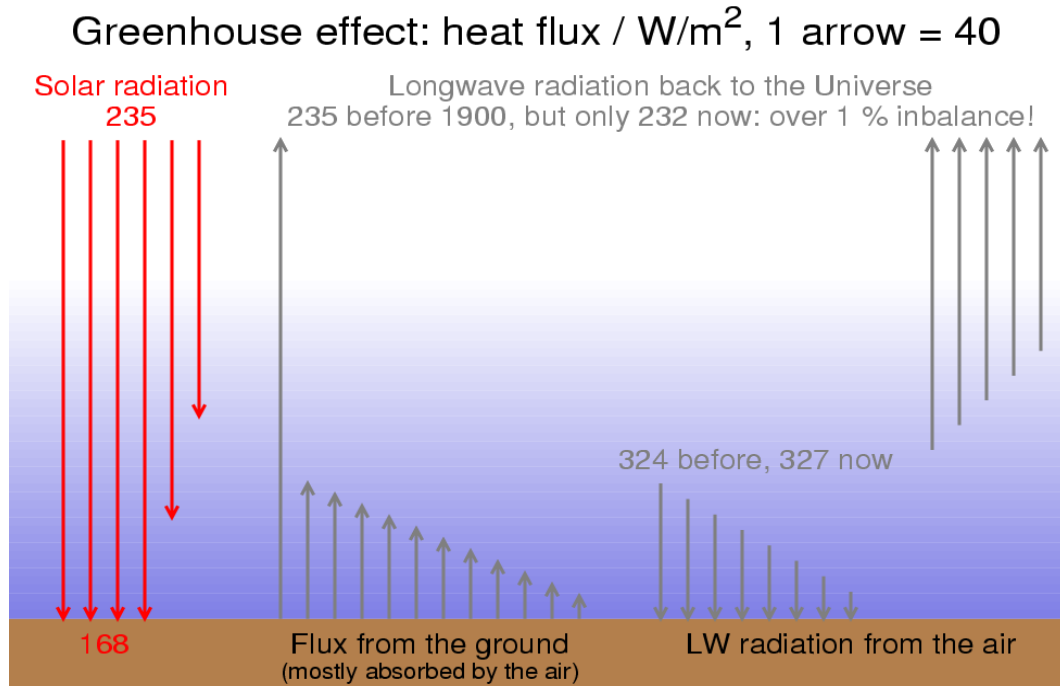

Figure 5. The huge invisible fluxes of longwave radiation near the ground are much larger than solar input; the radiative imbalance of 3 W/m^2 would hold for a non-real case when no cooling aerosols would be produced by mankind and the air would be no warmer

The longwave ($> 3 \mu\text{m}$) infrared flux down to the Earth is almost twice larger than solar radiation, taken as an average over the globe. It is really huge. A slight increase of longwave opacity due to higher concentration of greenhouse gases means a serious change of those longwave fluxes, to the surface and to the space. Visualizing the greenhouse effect seems to be not easy, as we did not find any illustration which would help – we had to make our own. A larger illustration with a lot of text is available (in Czech only, will have an English version) at the end of [12].

If greenhouse gases would cease to exist, the temperature would drop by 100 K

The usual answer the Earth surface would be some 33 K cooler, *is a misconception* which is universal indeed. Such a value would hold if the Earth would retain its albedo. With the existence of water, this is of course impossible. The Earth would freeze, continents would be covered by snow, the oceans by ice and snow too. It would be much much cooler than “snowball Earth” that really existed in some geological periods in distant past. The temperature would drop by a good 100 K from our $\sim 288 \text{ K}$!

How can we say? This is the equilibrium temperature / 1 K, provided the albedo stays the same – Earth absolute temperature would be such that it would radiate the same amount it absorbs from the Sun:

$$4 \pi \rho T^4 = \pi \cdot (1 - \text{albedo}) \cdot \text{solar flux density}$$

$$((0.7 \cdot 1361 / 4) / 5.67\text{e-}8)^{1/4} \sim 255$$

(the numbers represent the current Earth absorptivity of 0.7, “solar constant” 1361 W/m² [13], factor 4 as a ratio of radiating Earth surface area (sphere) and its sun-lit cross-section (circle), and the the numeric value of Stefan-Boltzmann constant ρ).

Actually, this is also the temperature the Earth in a steady state seemed to have if observed from the space – as most of longwave radiation there comes from high in the troposphere, which is really that cool.

The snowball Earth would have a much higher albedo, say, 0.8, so the absorptivity would be just 0.2 and the temperature / 1 K would drop to

$$((0.2 \cdot 1361 / 4) / 5.67\text{e-}8)^{1/4} \sim 186$$

So, it is really some 100 K below the current surface temperature of 15 °C!

Above troposphere, GHGs cool the air

This is difficult... One obvious reason is the troposphere radiates upwards less than before, due to its increased opacity.

The other reason is that the so-called pressure broadening of molecular spectral lines is no more present in stratosphere and higher (too few molecular encounters, enough time to radiate at the exact frequency). So the gasses absorb little of the upwelling LWIR, but still do emit at full Planck strength...

(Still larger decline of stratospheric temperature is due to stratospheric ozone depletion, leading to less solar heat being absorbed in those heights.)

What is the solar heat...

As mentioned in the caption of Fig. 4, showing the UV part of solar radiation as something very strong is very misleading. It's but a tiny part of solar radiative flux density. From the UV, visible an infrared spectral regions, most solar heat flux hitting the surface is within the visible region. The Sun warms us mostly by light! Such wrong pictures as Fig. 4 may have resulted in a blunder which can be found in an (otherwise excellent) book [14]:

“As we’ve seen before, the incoming radiation is *mainly ultraviolet (UV) radiation*. *This UV radiation heats the Earth* which causes it to re-radiate heat in the form of infrared (IR) radiation. Much of this IR radiation is trapped near Earth’s surface by the greenhouse gases that in turn re-radiate some of this back to the surface.”

It would be nice, for simplicity, if we could neglect the IR wing of solar spectrum, but we cannot. It represents a half of solar irradiance, see Figure 6.

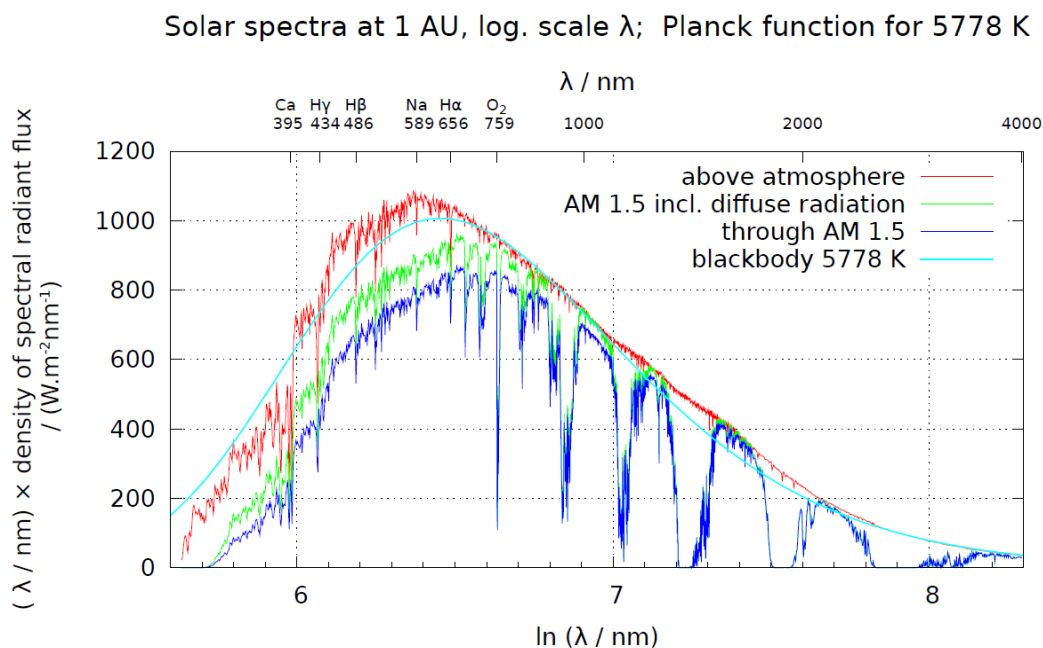

Figure 6. The visible part of solar spectrum called light spans roughly from the pair of calcium spectral lines at the far violet end of the visible range to a terrestrial O_2 molecular spectral band at its far red end. Wavelengths over 760 nm are infrared, the pair of strong Ca lines, named K and H by Fraunhofer, are at the beginning of UV range. The curve for “incl. diffuse radiation” concern a direction pointing to the Sun being at 42° of angular height, with its rays going through 1.5 more air than the vertical direction would imply, this is denoted as AM 1.5; they include radiation coming from the terrain (“light soil”) as well. See details of air+ground conditions at the source of data, <http://rredc.nrel.gov/solar/spectra/am1.5/>. The gnuplot script for the graph is http://amper.ped.muni.cz/gw/aktivita/graphs/sources/sol_eng.gnp; the employed axes are the proper ones for Planck curves to visualize the course of spectrum and being able to guess the integrals over various spectral ranges, as the area below the curve represents really watts per square metre in a chosen range [15].

Conclusions

Even the post-graduate students of didactic of physics miss the most basic physics of what makes the Earth habitable. No wonder, the information they may have encountered is confusing. On the other side, learning it properly should be not difficult, if good illustrations and texts would be available. Pre-service physics teachers should be provided with comprehensive course about physical background of climate change and related issues.

We developed a study material (textbook) for pre-service physics and chemistry teachers, describing also a couple of phenomena which the students should learn by observations and experiments. The textbook [12] should be available in English in 2014.

References

- [1] B. McKibben, *Eaarth: Making a Life on a Tough New Planet*. New York: Times Books, 2010. <http://www.billmckibben.com/eaarth/eaarthbook.html>.
- [2] J. Hollan, “Poznámky ke knize ZEEMĚ,” 02-Aug-2013. http://amper.ped.muni.cz/gw/aktivita/daile_ctete/.
- [3] J. Rockström, H. J. Schellnhuber, M. J. Molina, B. Hoskins, G. Brasseur, C. Nobre, P. Schlosser, V. Ramanathan, N. Nakicenovic, Y. Sokona, L. Srivastava, and J. Morgan,

- “Are we heading towards 4-degrees warming? And if yes, should we be concerned?,” 16-Sep-2013. http://www.hzg.de/mw/earthleague/036338/index_0036338.html.en.
- [4] T. W. Bank, “Turn down the heat : why a 4°C warmer world must be avoided,” The World Bank, 74455, Nov. 2012
<http://documents.worldbank.org/curated/en/2012/11/17097815/turn-down-heat-4%C2%B0c-warmer-world-must-avoided>.
- [5] A. Bondeau, A. Svirejeva-Hopkins, S. Schwan, J. Schewe, B. Hare, K. Frieler, M. Rocha, M. Schaeffer, F. Piontek, R. Donner, H. J. Schellnhuber, O. Serdeczny, F. Baarsch, A. Robinson, J. Runge, J. Rogelj, M. Perette, C.-F. Schleussner, S. Adams, K. Rehfeld, L. Warszawski, D. Coumou, M. Vieweg, and A. Menon, “Turn down the heat : climate extremes, regional impacts, and the case for resilience – full report,” The World Bank, 78424, Jun. 2013; <http://documents.worldbank.org/curated/en/2013/06/17862361/turn-down-heat-climate-extremes-regional-impacts-case-resilience-full-report>.
- [6] R. W. Kates, W. R. Travis, and T. J. Wilbanks, “Transformational adaptation when incremental adaptations to climate change are insufficient,” *Proc. Natl. Acad. Sci.*, p. 201115521, Apr. 2012 <http://www.pnas.org/content/early/2012/04/13/1115521109>.
- [7] A. M. McCright, B. W. O’Shea, R. D. Sweeder, G. R. Urquhart, and A. Zeleke, “Promoting interdisciplinarity through climate change education,” *Nat. Clim. Change*, vol. 3, no. 8, pp. 713–716, Aug. 2013
<http://www.nature.com/nclimate/journal/v3/n8/full/nclimate1844.html>.
- [8] E. Uherek and E. Schüpbach, “European Efforts in Earth Science and Climate Change Education,” *Phys. Geogr.*, vol. 29, no. 6, pp. 545–560, 2008
<http://www.tandfonline.com/doi/abs/10.2747/0272-3646.29.6.545>.
- [9] J. A. Rye, P. A. Rubba, and R. L. Wiesenmayer, “An investigation of middle school students’ alternative conceptions of global warming,” *Int. J. Sci. Educ.*, vol. 19, no. 5, pp. 527–551, 1997 <http://www.tandfonline.com/doi/abs/10.1080/0950069970190503>.
- [10] B. Andersson and A. Wallin, “Students’ understanding of the greenhouse effect, the societal consequences of reducing CO₂ emissions and the problem of ozone layer depletion,” *J. Res. Sci. Teach.*, vol. 37, no. 10, pp. 1096–1111, 2000
[http://onlinelibrary.wiley.com/doi/10.1002/1098-2736\(200012\)37:10<1096::AID-TEA4>3.0.CO;2-8/abstract](http://onlinelibrary.wiley.com/doi/10.1002/1098-2736(200012)37:10<1096::AID-TEA4>3.0.CO;2-8/abstract).
- [11] G. Myhre, D. Shindell, F. M. Breon, W. Collins, J. Fuglestedt, J. Huang, D. Koch, J.-F. Lamarque, D. Lee, and B. Mendoza, “Anthropogenic and natural radiative forcing - part 8.3.3, Ozone and Stratospheric Water Vapour,” in *Climate Change 2013: The Physical Science Basis. Contribution of Working Group I to the Fifth Assessment Report of the Intergovernmental Panel on Climate Change*, Cambridge, UK and New York, NY, USA: Cambridge University Press, 2013, pp. 679–681
http://www.climatechange2013.org/images/report/WG1AR5_Chapter08_FINAL.pdf
- [12] T. Milěř and J. Hollan, *Klima a koloběhy látek*. Masarykova univerzita, 2013
<http://amper.ped.muni.cz/gw/aktivity/>.
- [13] G. Kopp and J. L. Lean, “A new, lower value of total solar irradiance: Evidence and climate significance,” *Geophys. Res. Lett.*, vol. 38, no. 1, p. n/a–n/a, 2011
<http://onlinelibrary.wiley.com/doi/10.1029/2010GL045777/abstract>.
- [14] G. T. Farmer and J. Cook, *Climate Change Science: A Modern Synthesis - Volume 1 - The Physical Climate*. Springer Netherlands, 2013
<http://www.springer.com/environment/book/978-94-007-5756-1>.
- [15] J. M. Marr and F. P. Wilkin, “A better presentation of Planck’s radiation law,” *Am. J. Phys.*, vol. 80, no. 5, p. 399, 2012
<http://link.aip.org/link/AJPIAS/v80/i5/p399/s1&Agg=doi>.

Active learning in pre-service science teacher education

Vera Montalbano, Roberto Benedetti

Department of Physical Sciences, Earth and Environment, University of Siena,
Siena, Italy

Abstract

We report a course on teaching in physics lab for teachers enrolled in Formative Active Training, which actually allows to obtain the teacher qualification in Italy. The course was designed with the purpose of showing in practice what means active learning in physics and how effective activities can be realized. Two different type of teachers attended to the course, a small group, with physics or mathematics degree, for teacher qualification in secondary school of second grade (age 14-19) and a more numerous group for qualification in secondary school of first grade (age 11-14), usually with a different science degree such as biology, environmental sciences and so on. We compare the training in physics lab between the two groups and with other experiences we performed in previous years in pre-service education and updating courses for teachers in-service.

Keywords: Lifelong learning, active learning in physics laboratory, Secondary education: lower (ages 11-15)

Introduction

Physics plays a fundamental role in science education as an accessible context for experimental design, scientific argumentation, problem solving, and the development of multi-step reasoning skills. Especially in the physics lab, students can actively develop scientific processes and mind habits typical of physics and science in general. However, undergraduate and graduate students in higher education have limited opportunities to experience topics meaningful for secondary education. Therefore, an unavoidable aim of pre-service education is to improve and develop teachers' skills in this direction. The most effective way seems to propose carefully design sequences of active physics learning in laboratory [1-4]. Thus, teachers can have a direct experience of the powerful support in comprehension of physical concepts and laws that can derive from active learning. At the same time, they can test in the laboratory some relevant experiments for teaching in secondary school.

After a period of pre-service education lack, the first course in Formative Active Training for obtaining teacher qualification started in Italy one years ago. In the following, we present the context in which an innovative course on Physics Laboratory Didactics was designed and realized. The participants were characterized by mean of an initial questionnaire, as shown in the next section. Actions for promoting active learning in science in designing and realizing the course and methods for assessment are given in the successive section. Finally, some preliminary results are presented and discussed.

Many laboratory activities were inspired by laboratories realized in an effective way [4] within the Italian National Plan for Science Degrees [5,6].

National Plan for Science Degrees and pre-service science teacher's education

In the last years, the decline of students' interest in learning physics and the consequent decrease of enrolments in physics in Italy have been contrasted by the Ministry of Education and Scientific Research through the promotion of a wide national plan [5] (Piano nazionale per le Lauree Scientifiche, i.e. PLS).

The main PLS actions have been professional development for teachers and students orientation, essentially through laboratory activities focused on orientation to a science degree by training and considering laboratory as a method not as a place. Student is considered the main actor of learning and joint planning by teachers and universities is encouraged.

An active learning path on active learning

Despite a long experience in pre-service education where focus was on improving disciplinary contents and teachers' competences, we fully realized such a powerful tool active learning can be only when we were engaged in realizing effective laboratories within PLS. In this context, we utilized a summer school of physics for a pre-service training and for professional development of young teachers [7,8].

A selection of more effective activities developed in PLS [4,7,8] was the starting point for designing a learning path for teachers enrolled in Formative Active Training course. The aim was to engage teachers directly in active learning on meaningful topics, such as introducing to measure and evaluation of uncertainties. They worked in small groups, often in an inquiry-based activity performed sometimes in conditions very similar to those usually found in schools (few and poor materials, missing or ill-equipped laboratories). The next step was to render teachers aware of which activities had been effective and the active role played by the teacher (one of the authors) in favoring this achievement, i.e. a metacognitive reflection on the activity was encouraged.

Preliminary analysis on assessment shows that the goal of the learning path seemed achieved for science teachers in secondary school of first grade. On the contrary, mathematics and physics teachers in secondary school of second grade were still too focused on disciplinary contents and less aware of active learning.

Pre-service science teacher education context

In order to describe how pre-service science teacher education is evolved to the actual organization, let us give a brief survey of recent reforms on this issue in the last years.

A brief history of teaching qualification in Italy

For decades, there was no pre-service teacher education in Italy. All university graduates in a disciplinary degree could participate to a professorship by a competitive examination and obtain a teaching qualification and a permanent position at school.

In 1999, the Advanced School for Teaching in Secondary Schools (Scuola di Specializzazione all'Insegnamento Secondario, SSIS) became the only way for obtaining qualification for teaching in secondary schools of first and second grade. A limited number of students were admitted by exam and training at school was introduced. The SSIS management was regional and teaching sites were distributed in each university (in Tuscany at Pisa, Florence and Siena).

From the beginning, a team of mathematicians, physicists and expert teachers (both authors too) were involved in all teaching sites and elaborated together an effective educational program for SSIS of Tuscany in pre-service mathematics and physics teacher in secondary school of second grade. On the contrary, mathematician and physicists involvement in science teacher education was marginal because of prevalence of life sciences researchers.

After ten years of activity, SSIS was closed awaiting a new pre-service education course, i.e. Formative Active Training (Tirocinio Formativo Attivo, TFA) that finally started the last year.

Table 1. Teacher education in Italy in last decades

	Admission degree	Adv Course	Adm exam	Pre-service training	Teaching Qualification
Before 1999	disciplinary degree	none	no	none	Professorships competitive examination for qualified participants
From 1999 to 2009	disciplinary degree	biannual SSIS	yes	290 hours exp teach	Exam for teaching qualification written and oral exam
2012	disciplinary degree	annual TFA	yes	475 hours exp teach	Exam for teaching qualification final report on training and oral exam
Next future	teach. disc. degree	annual TFA	yes	475 hours exp teach	Exam for teaching qualification final report on training and oral exam

The main steps in reforming pre-service teacher education are summarised in Table 1. In the next future teaching disciplinary degree will precede TFA.

Formative Active Training framework

The main educational program in TFA is outlined in Table 2, where students' work is assessed by credits, not present in SSIS. Both curricula for science teachers and mathematics and physics teachers are presented. The actual credit system allows less time to each course. For example, in SSIS Math & Phys teachers have activity for 4 full afternoons per week (1 for pedagogical course, 1 for mathematics and 2 for physics if they had a math degree) for four semesters. In TFA, for the same teaching qualification a student is occupied for 3 afternoons per week for slightly more than one semester.

Table 2. Formative Active Training education program

Pedagogical competences	18 credits	Education Science	12 credits
		Education Science for special needs	6 credits
Disciplinary contents	18 credits	Math & Phys	Math & Sciences
		Math Didactics 6 credits	Math Didactics 6 credits
		Math Education 3 credits	Phys Lab Dida 3 credits
		Phys Lab Dida 3 credits	Chem. Lab 3 credits
		Classic & Mod Phys lab 6 credits	Bio Lab 3 credits
		Earth Sc Lab 3 credits	
Observative and active training at school	19 credits	training under supervision of an expert teacher at school 400 hours teaching practice education 75 hours dedicated to students with special needs	

The real novelty in TFA is the strong reinforcement of training at school, underlined by the relevance of a final report on training (see Table 1) that must be presented and discussed by candidates in the examination for teaching qualification. Moreover supervision on final report is requested by an expert teacher and by an university supervisor.

All public universities of Tuscany decided to affiliate in order to maintain the regional coordination. The small number of students allowed by the Ministry implied to reduce teaching locations. Thus, for Math & Science teaching in secondary school of first grade the TFA management is at the University of Siena with teaching locations in Siena and Pisa. For Math & Phys teaching in secondary school of second grade the management is at the University of Pisa with teaching locations in Pisa, Florence and Siena.

Admission examination for TFA was done in 2012, courses started in 2013 (on February) and examination for qualifications was held in July. In Siena, TFA disciplinary courses for Math & Science were borrowed by other TFA courses.

On characterizing in-training teachers

The learning path on active learning was attended by Math & Science teachers (34) and Math & Phys teachers (11) in Siena. Since it was easy to collect data (final reports and examinations) for Math & Science teachers (26) from Pisa, we can consider them like a control group because no active learning was introduced in the physics course in Pisa.

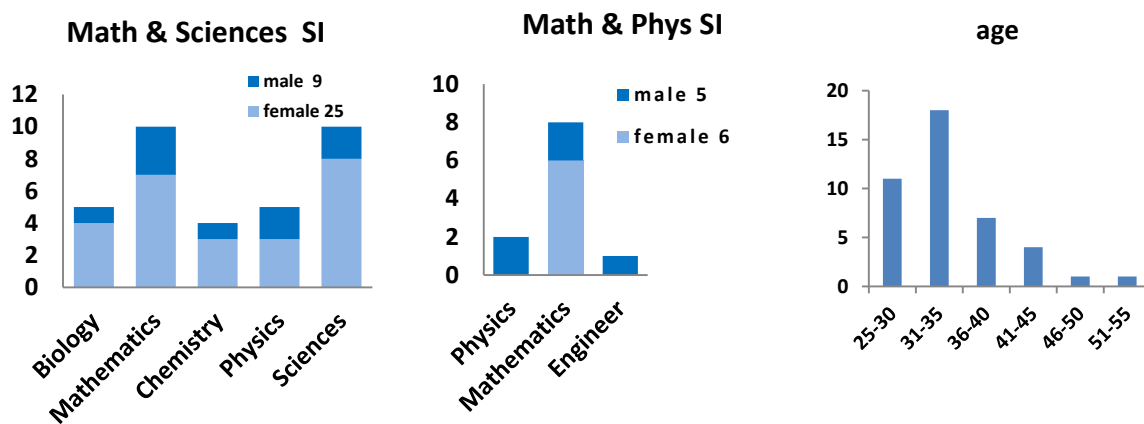

Figure 1. Types of disciplinary degree owned by participants separated by sex and teaching matter on the left and centre, participants age distribution on the right

In Figure 1 the distributions of disciplinary degree of participants and their age are shown.

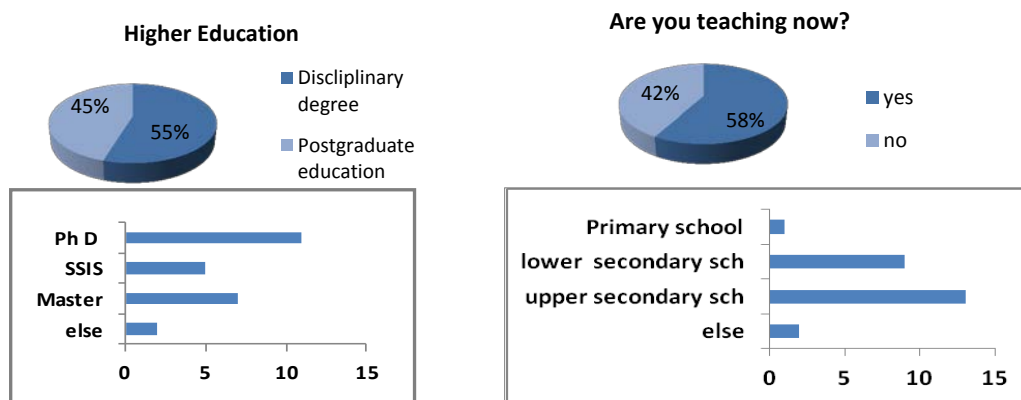

Figure 2. Participants' higher education on the left and actual position at school on the right

The number of women is about double compared to men. The most of them have a degree in mathematics. There is a numerous group of people which have obtained their degree recently, but many got it five, ten and even fifteen years ago.

In the first lesson a questionnaire was completed by all participants in Siena, in order to have more information on the previous education and on their teaching experience. In Figure 2, previous higher education of participants is shown. Moreover, the most part (58%) were working at school with a temporary position.

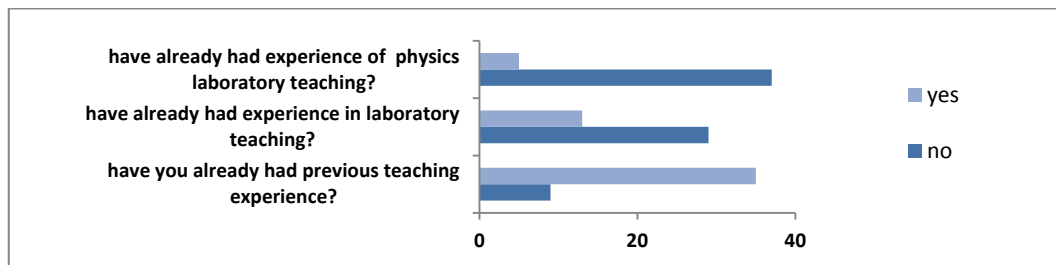

Figure 3. Participants' experience in teaching

A set of questions is dedicated to previous experiences in teaching. As shown in Figure 3, although 83% just have had at least one teaching experience, only 12% have got one in physics laboratory.

Actions for promoting active learning in science teacher education

The active learning path was carried out in a 30 hours course entitled "Physics Lab Didactics".

Designing and realizing a learning path on active learning

Since the course was attended by two different kinds of students, it was necessary to split the class into two groups for many activities in laboratory in order to give for secondary schools of second grade some example of disciplinary lab useful for the last years of high school. The complete articulation of the course and disciplinary contents are given in Table 3.

Table 3. Physics Lab Didactics: organization and contents

	Math & Science	Math & Phys
lessons with discussion 8 h	how to work in lab, safety management, how to organize a lab, how to write an effective lab report, a survey on reformed school, role of interdisciplinary in math/sciences, introduction to measure, etc.	
laboratory 22 h	1. introduction to measure (mass, volume, density, direct and indirect measurements) 2. Measures of times (pendulum) 3. A qualitative path on friction	
	4a Introduction to sky observation 5a Orders of magnitude, estimates, measures 6a Qualitative and quantitative lab	4b A quantitative path on friction 5b Measurements through video and Picture analysis 6b Calorimetric meas. 7b Electron's electric charge meas. 8b Measures of lengths by using light

In laboratory, participants worked in small groups (4 components) with minimal initial instruction in order to be introduced to physics lab and measure, evaluation of uncertainties in measurements, measures of some basic physical quantities (act 1, 2, 3). A topic was focused on an experimental situation which can be suitable for students of different ages,

and in this case the two groups faced different experiments (e. g. qualitative exploration on friction [9] was proposed to both groups but the quantitative lab [9] was performed only for secondary school of second grade). A great attention was put in rendering teachers aware of which activity could be effective in improving active learning and reflecting about the role assumed by the teacher in getting this achievement (meta cognitive elaboration).

Special care was put in introducing active learning examples, focus on behavior that can facilitate or inhibit it in lessons and especially in lab designing and execution. Many participants had few or no experience at all in phys lab or so few topics were discussed in university course in their degree so that active learning in disciplinary contents was really effective. Also physicists had usually such a deep specialized and different background that could discover a lot of unexpected details in direct experience in lab in the proposed basic topics. Groups were formed in an inhomogeneous way in order to stimulate cooperative learning [10]. Focus was put on their engagement, how to work in a group, how cooperative learning can be checked and facilitated.

As it is usual in the laboratory, everything could go in a wrong or unexpected way. These were the cases in which it was useful to underline how discussions can arise in groups and how to interact with students (a lot of good examples usually happens in lab and we discussed together how to manage them).

Assessment

For the assessment of the course, participants presented before the exam two reports on lab activity (an explicit request was that reports were written for peer readers) with a brief final educational discussion or one report and a proposal for an active learning activity in lab for a well-defined class. Reports were discussed in an informal way, before exam, focusing on active learning aspects.

Table 4. Methods to assess the effectiveness on participants

Methods & Materials	Participants Math & Sc SI	Participants Math & Sc PI	Participants Math & Phys SI	state
2 Lab reports with did. analysis or 1 lab report + 1 proposal focused on active learning in phys lab	34	-	11	done
Interviews on lab reports	34	-	11	done
Final report on training	34	26	-	in progress
Oral examination for teaching qualification	32 mixed PI/SI		-	in progress

In Table 4, all possible assessments are presented. Final reports acquisition and oral examinations in final exam will be completed for few last students at the end of October.

Preliminary Results

The first two methods of assessment showed in table 4 have been completed and the results are summarised in Figure 4. The learning path seemed more effective for Math & Science teachers respect to Math & Phys teachers.

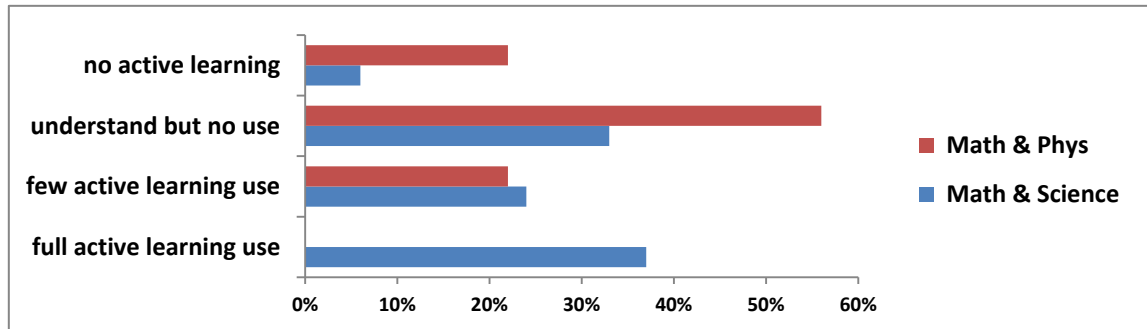

Figure 4. Results from lab reports and interviews for the two groups of participants

Math & Phys teachers remained still too focused on disciplinary details and some of them seemed to have understood what active learning is only during the discussion in the exam of the course.

An example of teacher's elaboration

Many secondary school teachers of first grade showed a personal elaboration on active learning in proposals of other learning paths, in their final reports on training and in the oral exam for qualification. Some teachers tested successfully new learning paths in their training at school. Others use properly active learning in elaborating learning paths in sciences different from physics.

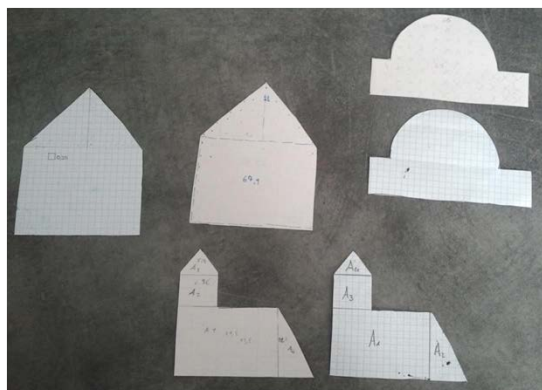

Figure 5. Examples of areas proposed in class for introducing the concept of measure, evaluation of uncertainties and measurements with different sensibility. Figures can be recognized like composed by adding simple geometrical figures, like triangles, squares and so on. Direct and indirect measures of areas can be done and compared.

A teacher presented her experience in training at school in which an introduction to measure was realized by proposing measurements of an area by direct comparing with different units of area (by using paper with a size grid of mm or cm). Not integer units must be estimated in different ways by students starting an interesting discussion which

bring to introduce in a correct way the concept of uncertainty. Another way can be to measure lengths and perform a calculus (how can uncertainty be estimate in this case?). The subject was proposed in the course, but some actions, such as to propose area for measurements in the form of stylized buildings for a better motivation of students (see Figure 5) or to explain how different units can be relevant to achieve a more precise measurement by measuring the blackboard by means of sheets of different sizes, was proposed by the teacher.

Conclusions

Sharing expertise and creating knowledge in a group is a continuous process, in which members must be aware of their roles and how to monitor the work in an effective way. Some experiences of active learning in physics laboratory followed by metacognitive reflection on the role of teacher in favouring this process seem to be useful in pre-service teacher's education. Moreover, some secondary school teachers of first grade transferred active learning directly in training at school and in teaching other sciences, some students became enthusiastic for active learning, others began to enjoy physics and phys lab.

From preliminary results it is possible to outline that physics lab designed for promoting active learning can be useful in inducing a deeper awareness on this issue. Even though, few teachers failed to distinguish between activity in the laboratory and active learning. Secondary school teachers of second grade remained still too focused on lab skills and disciplinary details and a careful reflection must be done in order to propose a different organisation of TFA courses and more effective activities in this case.

References

- [1] Meltzer D. E., Thornton R. K.: Resource Letter ALIP-1: Active-Learning Instruction in Physics, *Am. J. Phys.* 80, 478 (2012); doi: 10.1119/1.3678299.
- [2] Niemi H.: Active learning — a cultural change needed in teacher education and schools, *Teaching and Teacher Education* 18 (2002), p. 763–780.
- [3] Laws P., Sokoloff D., Thornton R.: Promoting Active Learning Using the Results of Physics Education Research. *UniServe Science News*, Volume 13, July 1999. [online]. [cit. 4. 10. 2013]. Available from: http://sydney.edu.au/science/uniserve_science/newsletter/vol13/sokoloff.html
- [4] Benedetti R., Mariotti E., Montalbano V., Porri A.: (2011), Active and cooperative learning paths in the Piggelleto's Summer School of Physics, in *Frontiers of Fundamental Physics and Physics Education Research*, eds S. Burra, M. Michelini, L. Santi, p. 573-577, *SPRINGER PROCEEDINGS IN PHYSICS*, vol. 145, MILANO: Springer-Verlag Italia (2014).
- [5] PLS Website, (in Italian) [online]. [cit. 30. 6. 2013]. Available from: www.progettolaureescientifiche.eu
- [6] Montalbano V.: Fostering Student Enrollment in Basic Sciences: the Case of Southern Tuscany, in *Proceedings of The 3rd International Multi-Conference on Complexity, Informatics and Cybernetics: IMCIC 2012*, ed. N. Callaos et al, 279, (2012), arXiv:1206.4261 [physics.ed-ph], [online]. [cit. 4. 10. 2013]. Available from: <http://arxiv.org/abs/1206.426>
- [7] Montalbano V., Benedetti R., Mariotti E., Mariotti M. A., Porri A.: Attempts of Transforming Teacher Practice Through Professional Development, in *Proceedings of*

- The World Conference on Physics Education 2012, ed. M. F. Taşar, p. 433-442, Ankara, Turkey: Pegem Akademi (2013).
- [8] Montalbano V., Mariotti E.: A multipurpose action for learning/teaching process: the Pigelleto's Summer School of Physics, to appear in: Science Education Research for Evidence-based Teaching and Coherent Learning (Proceedings of ESERA 2013), Nicosia, Cyprus, 2-7 September 2013. arXiv:1401.1929 [physics.ed-ph] [online]. [cit. 10. 4. 2014]. Available from: <http://arxiv.org/abs/1401.1929>.
- [9] Montalbano V.: An inquiry-based laboratory on friction, ICPE 2013 The International Conference on Physics Education.
- [10] Cuseo J.: Cooperative learning vs small group discussions and group projects: the critical differences, Cooperative Learning and College Teaching, 2(3) (1992).

Application of Cues, Prompts, Probes, Questions and Gestures (CPPQG) in Physics Teaching and Learning

Ugwumba Augustine Okoronka¹, Kodjo Donkor Taale^{2, 3}

¹Department of Science Education, Adamawa State University, Mubi, Nigeria.

²Department of Physics Education, University of Education, Winneba, Ghana.

Abstract

This study was an action research using cues, prompts, probes, gestures and questioning strategy to remediate some learning difficulties of students in some physics concepts. This was done by collecting both quantitative and qualitative data using teacher constructed test. Pre-test, was used to assess students' prior knowledge and post-test to determine the final state of the learners. A sample of 40 Level 200 Geography Education students of the Department of Science Education, Modibbo Adama University of Technology, Yola, Nigeria, participated in the study. The data collected were analysed using descriptive statistics, percentages, paired sample t-test and the correlation statistic. The results obtained showed an improvement in students' understanding on basic concepts in optics, heat and mechanics. Students performed relatively better in optics (80% of the students) scoring 45% and higher; followed by thermal physics (heat) (70 %) and mechanics (50%). The post-test mean score was higher than the pre-test. Also, paired sample t-test was significant at 0.05 alpha level and df of 39. Similarly, a moderately high and significant correlation coefficient of 0.70 was calculated between the pre and post test scores. Based on the findings, it is recommended that teachers should integrate CPPQG into all forms of physics instruction in today's changing world of technologies. This is the only way to make its learning "interesting" to the average learner who ordinarily may not be able to make the kind of "connections" expected in maximizing physics teaching and learning.

Keywords: cues, prompts, probes, gestures, Instructional Decision Making Tree, The Transactional Model of Direct Instruction, physics teaching and learning.

Introduction

Over the last two decades, trends in science pedagogy have focused on methods and techniques which tend to emphasize Science as an inquiry that is activity based, learner centred and socially contextualised (Bostock, 1998; Duffy & Jonassen, 1992). The extent to which students are allowed to engage actively in the learning process involves their active participation in the teaching and learning process. Academic performance and achievement of students is by inference highly dependent on the approach of presenting information and how it is received by the students. The need for the learner's active engagement in the learning process (personal construction of knowledge) is the hallmark of the theory of constructivism. This is with a view not only to arouse interest and inculcate positive attitude towards Science but also to improve students' performance as well as create better understanding (Okoronka, 2011). These ideas are in consonance with Ausubel's (1963) principle of meaningful learning as opposed to the old order of rote

³ Dr. Kodjo Donkor Taale was on Sabbatical leave at the Department of Science Education, Modibbo Adama University of Technology, Yola, Adamawa State, Nigeria from February 2012 –February 2013)

learning. Dollard and Miller (1950) had long identified three learner characteristics which account for about 25% of variance in school achievement attributable to the quality of instruction which students receive as cues, reinforcement and participation. Also, a primary purpose of providing quality instruction is for students to be successful on academic tasks (Darling-Hammond, 2000; Walberg & Paik, 2000).

While cues deal with the clarity, variety, meaningfulness and strength of the teacher's explanations; reinforcement refers to the amount of acknowledgement or social support which the learner receives for learning. Participation includes the extent to which students are allowed to engage actively in the learning process. Cues, Prompts and Probes readily perform these functions by facilitating and optimising Science/Physics teaching and learning.

What are Cues, Prompts, Probes, Questions and Gestures?

When a teacher begins a lesson and poses a question to his/her students, he/she is checking the students' understanding. He /she may do this by using cues, prompts, probes, questions or gestures or a combination of these. **Cues**, also referred to as clues, are secondary stimuli which function as guides to response by way of perception or action to situation. In this respect, cues are techniques which teachers may use to trigger the previous knowledge of students thus functioning as hints to what students are about to experience. Cues when used in the classroom form part of the tacit or unspoken knowledge of the learner and shift his/her attention to the required information source. Cues are more direct and specific than prompts as they point attention to invisible/not so obvious details to a novice. **Prompts** are efforts/actions intended to instigate/move learners into action. They are intended to elicit written or oral/verbal responses on the part of students. They could come in form of questions (what, why, how, who, which, etc.) meant to guide students' inquiry. Here, the teacher may supply the student with forgotten words or suggest to his/her mind (act prompting). Prompts are useful and necessary in a Physics/ Science classroom to the extent that they help students develop skills such as listening, concept association, comparing and contrasting as well as making of inferences. Prompting / pretesting of relevant knowledge is said to be one of the general models of direct instructions, (Frey & Fisher, 2011). Visual prompts and demonstrations are examples that have been applied to mediate between concrete and abstract concepts (Gage & Berliner, 1998). **Probes** (diagnostic probes) are prods or investigations which enable learners to examine an issue or topic at hand searchingly. They motivate students to focus clearly on the expected learning outcomes since they help to elicit and sustain interest. Probes provide explanation regarding students' initial/previous understanding and form part of formative assessment activities. They should be quick and short and inform the teacher if students are acquiring the concepts being presented or not. **Questions** are interrogative comments/sentences which inquire from a learner. It is a direct demand for an answer from the student by the teacher. Questions are used to assess what initial learning has taken place or stuck and what has not. Question of who, what, when, where and which (often called reproductive/recognition recall questions) draw on the first three lower levels of Bloom's Taxonomy namely: knowledge, understanding and application. Tienken, Gold-berg and DiRocco (2009) have submitted that 85% of novice teachers use this type of questions while experienced teachers ask these questions 68% of the time. On the other hand, questions of why, how, suppose, justify and give an example (also referred to as higher order questions) are used less often in the classroom as they draw on the top three levels of Bloom's Taxonomy viz.: analysis, evaluation and creativity. Questions in general should be used for elicitation, elaboration, clarifying, inventive/divergent and heuristic purposes (Frey & Fisher, 2011).

Questions can also stimulate deeper thinking, arouse curiosity, provoke and stimulate interest and inquiry and motivates students to seek new information, and spark additional questions, allowing for greater intellectual focus (Wiggins & McTighe, 2005; Caram & Davis, 2005); for effective use of questioning enable students to be engaged in the questioning process. The resultant effect is the benefit of clarification of concepts, emergence of key points, and enhancement of problem-solving skills. In using questions, teachers assess students' knowledge, determine needs for focused re-teaching and remediation, and encourage students to think at higher cognitive levels (Caram & Davis, 2005). According to Chuska (1995), all learning begins with questions and that thinking is not driven by answers but by asking quality and thought-provoking questions (Elder & Paul, 2003). Also, according to Orlich, Harder, Callahan, Trevisan and Brown (2010), by classifying questions according to a particular system, a teacher may determine the cognitive level at which his/her class is working and make adjustments as needed and such questions should be adapted to students' level of ability. As such, questioning techniques that encourage the widest spectrum of student participation should be used. **Gestures** are non-verbal/spoken (symbolic) expressions used by the teacher for communicating, negotiating, understanding and reasoning. Specifically, a gesture is a posture or body movement, an action especially of the hands expressing /intended to show inclination or disposition. Together with cues, prompts, probes, and questions, gestures assist students in making connections or associations which facilitate correct responses (Walsh & Sattes, 2005).

Functions of Cues, Prompts, Probes, Questions and Gestures

- Makes an object or phenomenon in focus possible since meaning is attached to sensory cues.
- Creates understanding in learners through the integration of subsidiary cues.
- Produces a comprehensive entity in form of a skill as a result of combining both internal and external cues in the learner.
- Enhances students' problem-solving skill/ability through usage of pictorial representations integrated in verbal representations and gestures.
- Supports students in developing meta-cognitive skills.
- Activate/engineer students to learn.
- Focus less on presenting a subject content/material but more on engineering learning experiences as well as guiding.
- Provides motivation for the student as they have appeal for the eye and ear when used in oral/verbal protocol.
- Serves as tools to identify students' initial/prior knowledge before learning.
- Diagnosis of students understanding, stimulate thought/interest and challenge ideas during the course of teaching.
- Evaluation of students' understanding and teaching in comparison to objectives stated at the beginning of a lesson.
- Supports students in developing meta-cognitive skills.
- Activate/engineer students to learn.
- Focus less on presenting a subject content/material but more on engineering learning experiences as well as guiding.

Common Cues, Prompts and Probes in the classroom

Some commonly used Cues, Prompts and Probes are Non-spoken representations which include: gestures, pictures, symbols, objects, diagrams, graphs, writings, and icons, spoken/verbal representations such as okay, well done, yes/yeah, no, try again, you've got the answer now explain how you got it, could you be more specific, give an example, describe, and explain further.

Role of the teacher in the classroom

The tools/techniques of cues, prompts, probes, questions and gestures demand that the teacher functions to: design the learning environment; manage problem solving; and focus on how learners can make connections so as to foster new understanding in students.

The teaching methods adopted by the Physics/Science teacher in conjunction with these techniques should ultimately be geared towards students' responses, e.g. their ability to analyse, interpret and predict information. These are critical traits to meaningful learning in Physics in particular and Science in general.

The Problem

It is a challenge to most students taking high school and further physics but it is well worth the effort because most modern technology involves Physics, that is any technology involving for example electricity, magnetism, force, pressure, heat, light, sound, optics comes from physics. Even though the basic knowledge required for products like fertilizers, drugs, plastics, and chemicals comes from chemistry and biology, these items have to eventually be manufactured, and manufacturing is dominated by physics-based technology (Hart & Cottle, 1993; Alters, 1995; Stahl, 1997). Also, an understanding of physics leads to a better understanding of almost any other science. Like technology, virtually all branches of Science contain at least some physics. Physics has been called the most basic science and in many cases is required in order to understand concepts in other Sciences. Physics therefore is the basis for all types of analytical and measuring systems (Hart & Cottle, 1993; Alters, 1995; Stahl, 1997). The current study investigated the effect of the application of cues, prompts, probes, questions and gestures in the instruction of Level 200 Geography Education Students of Modibbo Adama University of Technology, Yola, Nigeria. The research sample consisting of 40 students had little or no secondary school Physics background who were required to take Level 200 General Science course with Physics as a core course based on the following curriculum: Mechanics, optics and heat (thermal physics). The purpose of the study was to determine the effect of integrating CPPQG into instruction by adopting Huitt, Monetti and Hummel (2009) Transaction Model of Direct Instruction (TMI) and the Instructional Decision Making Tree (IDMT) by Fray and Fisher (2009). For more details see Figs 1 and 2 respectively. This was done based on the assumption that these tools are capable of making Physics learning interesting to these learners who ordinarily are not capable of making the kind of connections expected in maximizing Physics teaching and learning due to their poor background in secondary school physics. It is anticipated that this will ultimately lead to improved performance of the students in the course.

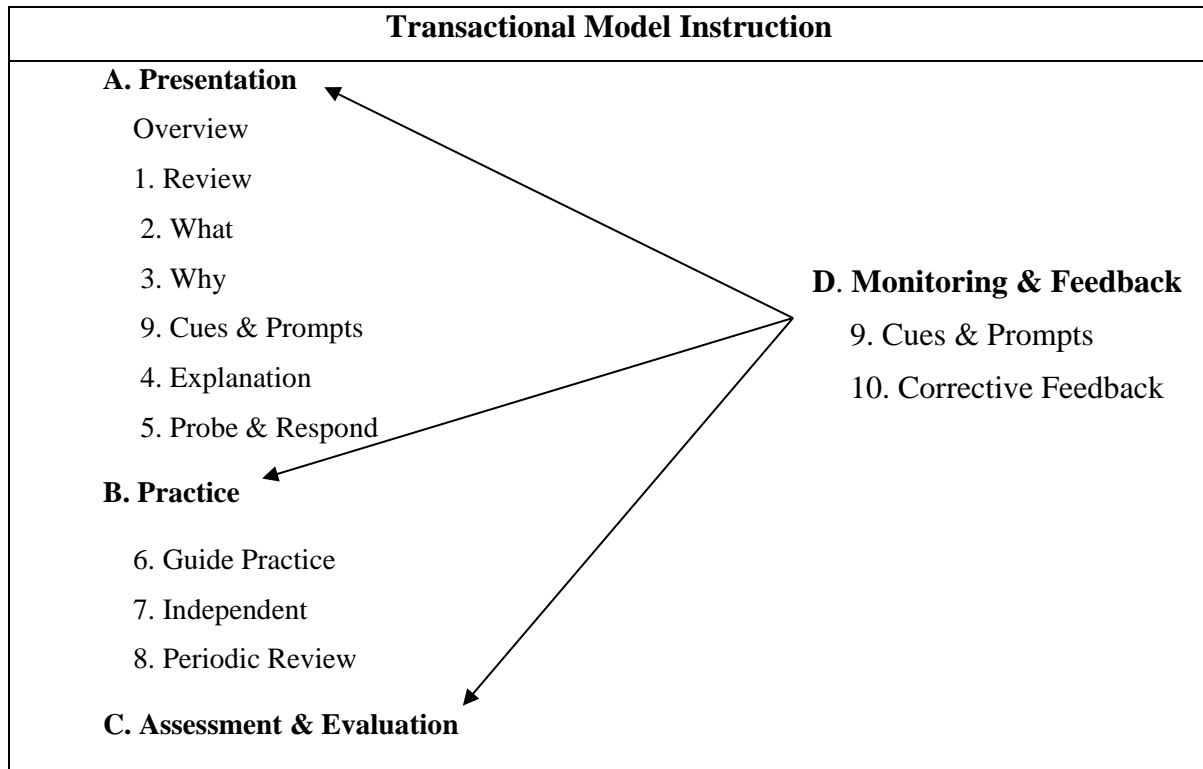

Figure 1. **The Transactional Model of Direct Instruction** (source: Huitt, Monetti, Hummel 2009 in Regeluth & Carr, Carr, Chellman)

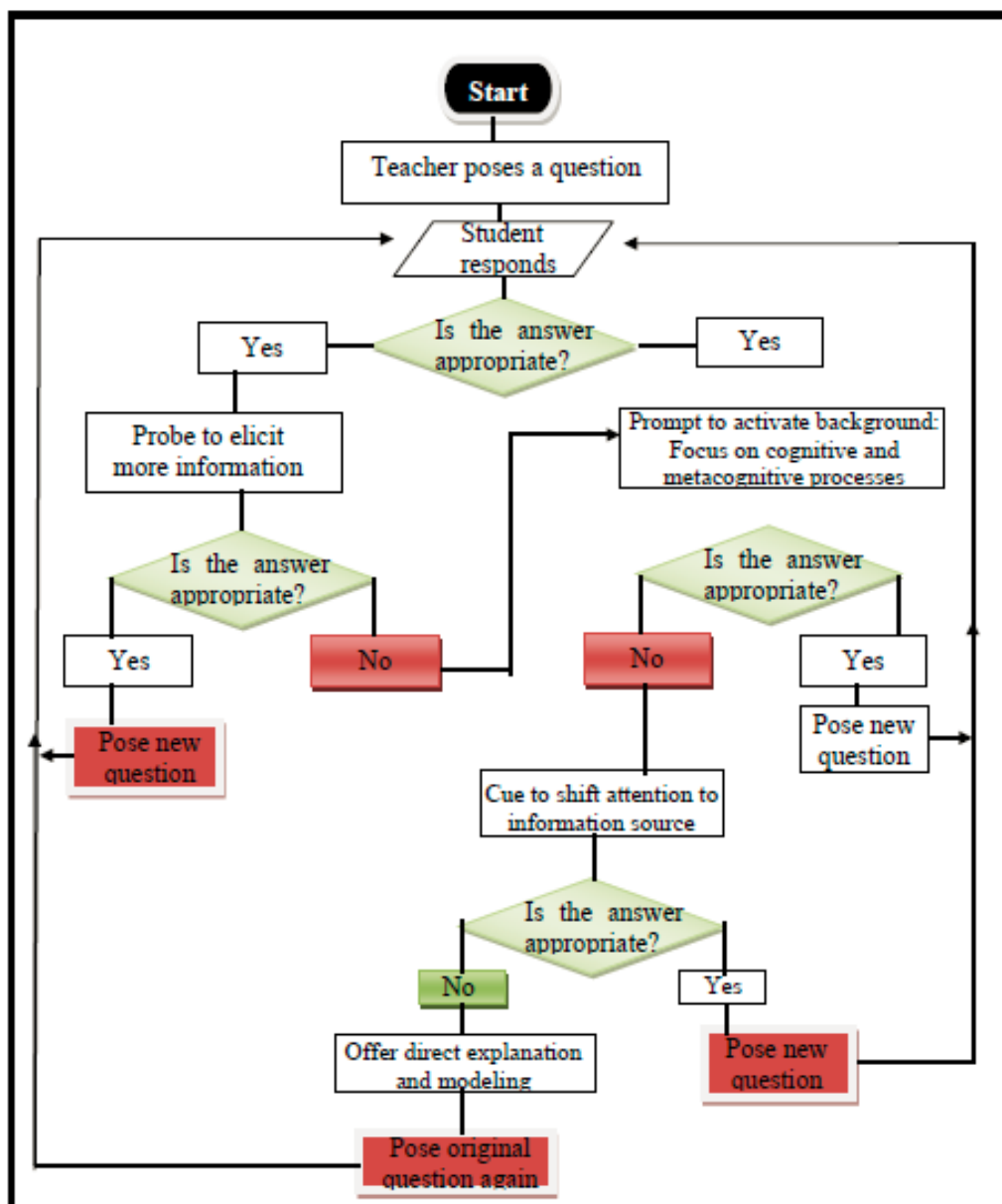

Figure 2. Instructional Decision – Making Tree (IDMT) [Source: Frey, N., & Fisher, D. (2010)].

Methods and Instrument

The study involved an action research in which 40 Level 200 Geography Education Students (intact group) of Department of Science Education, Modibbo Adama University of Technology, Yola, Nigeria participated in. CPPQG were integrated into the face-to-face instructional format which is still very prevalent in the Nigerian University System. They were applied to remediate learning difficulties of this student set as opposed to other Level 200 students in the Department specializing in Mathematics, Statistics, Physics, Chemistry and Biology Education who have strong a Physics background based on their secondary school certificate examination results. The General Science Course (SE 203) contains concepts in the following topics of Physics: mechanics, optics and thermal physics. Teacher used short answer tests to periodically gather quantitative data using pre and post-tests to assess students' prior knowledge and final state respectively before and after

instruction. Qualitative data were obtained by analyzing students' explanations for their answers/ solutions in the post-test. These are however not reported in this paper.

Data Analysis and Results

Data collected were analysed using percentages, descriptive statistics, paired sample correlation and paired sample t-test.

Table 1. Average performance of Periodic Tests on the concepts of mechanics, heat and optics using the Modibbo Adamawa University of Technology (MAUTECH)'s grading system (A:70-100%; B: 60-69%; C: 50-59%; D: 45-49%; E: 40-44%; F: below 40%).

Concept	A	B	C	D	E	F	Total
Mechanics	0	0	11	9	11	9	40
Heat	0	0	15	13	7	5	40
Optics	0	3	18	11	5	3	40

The result from Table 1 indicates students' relative performance.

- (i). Optics: 80% of the student scored 45% and higher.
- (ii). Heat: 70% scored 45% and higher.
- (iii). Mechanics: 50% of the students scored 45% and higher.

Table 2. Paired sample statistics.

	Mean	N	Std	Std error mean
Pair pretest 1	31.555	40	15.117	2.390
Post-test	47.718	40	14.217	2.248

Table 2 shows that the mean score of the post-test ($\bar{x} = 47.718$) is greater than the mean score of the pretest ($\bar{x} = 31.555$). This resulted in a mean gain of 16.163, showing an improvement in students' scores. This could be attributed to the application of CPPQG.

Table 3. Paired sample t-test.

	Paired Differences					t	df	Sig. (2-tailed)
	Mean	Std. Deviation	Std. Error Mean	95% confidence interval of the difference				
				Lower	Upper			
Pair 1 pretest-post-test	-16.163	11.422	1.806	-19.816	-12.509	-8.949	39	.000

However, in order to determine whether the mean gain recorded was significant or not at alpha level = 0.05, a paired sample t-test was carried out. The result of the paired sample t-test is as shown on Table 3. The result indicates a significant t-test value of -8.949 for the degree of freedom 39.

Table 4. Summary of paired sample correlations

	N	Correlation	Sig.
Pair pretest & post-test	40	.698	.000

Furthermore, a paired sample correlation coefficient was computed (Table 4) to ascertain the relationship between the pretest and post-test performance of the students. A significant correlation of 0.698 was recorded. This moderately high value suggests that students across the board improved from the pretest to post-test which could be attributed to the instructional tool of CPPQG applied.

Conclusion

The improved performance of the Level 200 Geography Education students as recorded in this study in optics, thermal physics and mechanics components a science education course SE 203 for non-science major students' provide empirical evidence which tends to indicate the potency of CPPQG not only in improving the performance of students but also in changing the negative attitude and low interest in physics by students. We therefore share the views of Frey and Fisher (2011, p.58) that "*teachers must ensure that students have a successful learning experience, even if that means providing a direct explanation and giving the students the answer*". Based on the result, it is our view that if physics teachers integrate the tools of cues, prompts, probes, questions and gestures into physics instruction, students' performance through active engagement may be improved. For quality questioning enhances both teacher and student thinking and learning (Walsh & Sattes, 2012) and as observed by Walberg (1999), students' achievement increases when teachers asked quality questions.

References

- Ausubel, D.P (1963). *The Psychology of Meaningful Learning* Newyork: Grune and Stratton
- Alters, B. J. (1995). *Counseling Physics Students: A Research Basis*. *The Physics Teacher*, 1995, pages 413-415.
- Bostock, J. (1998). *Constructivism in Mass Higher Education: A case study*. *British Journal of Educational Psychology*, 29 (3), 225-240
- Caram, C.A. & Davis, P.B. (2005). *Inviting student engagement with questioning*. *Kappa Delta Pi Record*, 42(1), 19-23.
- Chuska, K.R. (1995). *Improving classroom questions*. Bloomington, IN: Phi Delta Kappa Educational Foundation.
- Darling-Hammond, L. (2000). *Teacher quality and student achievement: A review of state policy evidence*. *Education Policy Analysis Archives*, 8(1). Retrieved November 2009, from: <http://epaa.asu.edu/epaa/v8n1/>
- Dollard, J & Miller, N. (1950). *Personality and Psychotherapy*. New York: Mc Grew Hill.
- Duffy, T.M & Jonassen, D.H (1992). *Constructivism: New implication for instructional technology in constructivism and the technology of instructional technology*, T.M. Duffy and D.H. Jonassen (Eds). Hillsdale, N.J: Erlbaum (p.1-16)
- Elder, L. & Paul, R. (2003). *Critical thinking: Teaching students how to study and learn*. *Journal of Developmental Education*, 27(2), 36-38.
- Frey, N., & Fisher, D. (2011). *Guiding learning: Questions, prompts, and cues*. *Principal Leadership*, 11(5), 58-60.

- Frey, N. & Fisher, D. (2010). Identifying instructional moves during guided learning. *The Reading Teacher*, 64 (2).
- Gage, N. L., & Berliner, D. C. (1998) *Educational psychology* (6th ed.). Boston, MA: Houghton Mifflin.
- Hart, G. & Cottle, P. (1993). Academic backgrounds and achievement in college physics *The Physics Teacher*, 1993, pages 470-475.
- Huitt, W., Monetti, D., & Hummel, J. (2009). Designing direct instruction. In C. Reigeluth and A. Carr-Chellman, *Instructional-design theories and models: Volume III, Building a common knowledge base* [73-97]. Mahwah, NJ: Lawrence Erlbaum Associates. Retrieved from <http://www.edpsycinteractive.org/papers/designing-direct-instruction.pdf>
- Okoronka . U.A (2011). The place of cues, prompts, and probes in Science/Physics Classroom. Workshop paper presented at the 52 nd Annual Conference of the Science Teachers' Association of Nigerian held at Akure from 15-21 August, 2011.
- Orlich, D.C., Harder, R.J., Callahan, R.C., Trevisan, M.S. & Brown, A.H. (2010). *Teaching strategies: A guide to effective instruction*. Boston: Wadsworth Cengage Learning.
- Stahl, F. A. (1997). Physics Language and Literature, *The Physics Teacher*, March 1997, pp. 143-145.
- Tienken, C.H., Goldberg, S. & DiRocco, D. (2009). Questioning the questions. *Kappa Delta Pi Record*, 46(1), 39-43.
- Walberg, H.I. (1999). Productive teaching. In H.C. Waxman and H.J. Walberg (Eds.), *New directions for teaching practice and research* (pp. 75-104). Berkeley, CA: McCutchan Publications.
- Walberg, H., & Paik, S. (2000). *Effective educational practices*. Brussels, Belgium: International Academy Education. Retrieved September 2009 from: http://www.ibe.unesco.org/fileadmin/user_upload/archive/publications/EducationalPracticesSeriesPdf/prac03e.pdf
- Walsh, J.A. & Sattes, B. (2011). *Thinking Through Quality Questioning Activity Packet*. Retrieved from: <http://brainchildblog.com/wp-content/uploads/2012/02/Walsh-Sattes-PDF.pdf>
- Walsh, J.A. & Sattes, B. (2011). *Thinking through quality questioning: Deepening studentengagement*. Thousand Oaks, CA: Corwin Press.
- Walsh, J. A. & Sattes, B. D. (2005). *Quality questioning: Researchbased practice to engage every learner*. Thousand Oaks, CA: Corwin Press.
- Wiggins, G. & McTighe, J. (2005). *Understanding by design*. Alexandria, VA: ASCD.

Appendix 1

MODIBBO ADAMA UNIVERSITY OF TECHNOLOGY, YOLA

School of Science and Technology Education

Department of Science Education

Pre-test

Duration: 1 hour

Each question in this section is followed by *four options* lettered *A-D*. Select the correct option and write it down. *In questions 2, 4, 6, 9 & 10, show how you arrived at the correct option.*

- Which one of the following is an SI base unit?
A. gram B. newton C. kilogram D. centimeter
- The mathematical relationship between three physical quantities is given by $a = \frac{b^2}{c}$. If the dimension of $b = \frac{[L]}{[T]}$ and the dimension of $c = [L]$, which one of the following choices is the dimension of a ?
A. $[L]$ B. $\frac{[L]}{[T]^2}$ C. $\frac{[L]^2}{[T]^2}$ D. $[T]$
- Which one of the following quantities is a vector quantity?
A. The age of the earth B. The number of people attending a soccer game
C. The temperature of hot cup of coffee D. The earth's pull on your body
- Starting from rest, a particle confined to move along a straight line is accelerated at a rate of 5.0 m/s^2 . Which one of the following statements accurately describes the motion of this particle?
A. The speed of the particle increases by 5.0 m/s during each second.
B. The particle travels 5.0 m during each second.
C. The particle travels 5.0 m *only* during the first second.
D. The acceleration of the particle increases by 5.0 m/s^2 during each second.
- Which one of the following statements concerning the buoyant force on an object submerged in a liquid is true?
A. The buoyant force depends on the mass of the object.
B. The buoyant force depends on the weight of the object.
C. The buoyant force is independent of the density of the liquid.
D. The buoyant force depends on the volume of the liquid displaced.
- An object weighs 15 N in air and 13 N when submerged in water. Determine the density of the object.
A. 330 kg/m^3 B. $1.2 \times 10^3 \text{ kg/m}^3$ C. $7.5 \times 10^3 \text{ kg/m}^3$ D. 500 kg/m^3
- Which one of the following temperatures is approximately equal to "room temperature?"
A. 0 K B. 293 K C. $100 \text{ }^\circ\text{C}$ D. 100 K

8. Two cubes, one silver and one iron, have the same mass and temperature. A quantity Q of heat is removed from each cube. Which one of the following properties causes the final temperatures of the cubes to be different?
 A. specific heat capacity B. density C. volume D. latent heat of vaporization
9. A ray of light is reflected from two plane mirror surfaces as shown in the figure below. Determine the correct values of α and β ?

<i>Value of α</i>	<i>Value of β</i>
A. 26°	26°
B. 26°	64°
C. 38°	52°
D. 64°	26°

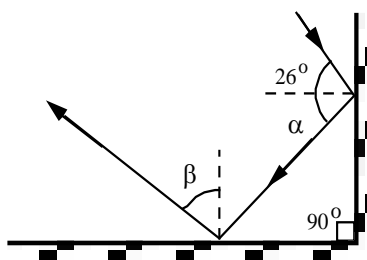

10. An object is placed in front of a concave spherical mirror as shown opposite. The three rays **1**, **2**, and **3**, leave the top of the object and, after reflection, converge at a point on the top of the image. Ray **1** is parallel to the principal axis, ray **2** passes through F , and ray **3** passes through point C .

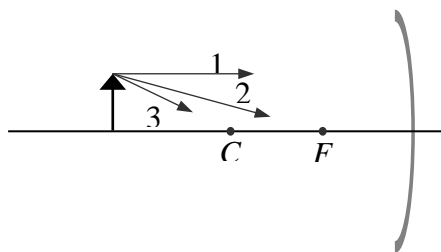

Which ray(s) will pass through F after reflection?

- A. **1** only B. **2** only C. **3** only D. both **1** and **2**

Appendix 2

MODIBBO ADAMA UNIVERSITY OF TECHNOLOGY, YOLA

School of Science and Technology Education

Department of Science Education

Post test

Duration 1 hour

Instructions: Answer **all** questions

1. A car starts from rest and accelerates in a straight line at 1.6 ms^{-2} for 10s.
 - i. Calculate its final speed?
 - ii. How far has it travelled in this time?
 - iii. If the brakes are then applied and it travels a further 20m before stopping, calculate its deceleration?
2. (i) State the law of conservation of energy.
(ii) Show that an object of mass, m , as it falls through a height h , its **potential energy** is converted to **kinetic energy**, but the **mechanical energy** has a constant value, namely, **mgh** .

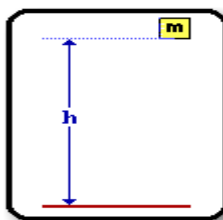

3. (a) Sketch and explain the heating curve of water at -20°C to 120°C .
(b) An object is placed 30 cm in front of a concave mirror of focal length 15 cm. By means of a ray diagram, determine the position of the image formed by the mirror.

Teacher roles during amusement park visits – insights from observations, interviews and questionnaires

Ann-Marie Pendrill^{1,2}, Cecilia Kozma³ and Andreas Theve⁴

¹Department of Physics, University of Gothenburg, Gothenburg, Sweden

²The Swedish National Resource Centre for Physics Education, Lund University, Lund, Sweden

³The House of Science, Stockholm University, Stockholm, Sweden

⁴Gröna Lund, Stockholm, Sweden

Abstract

Amusement parks offer rich possibilities for physics learning, through observations and experiments that illustrate important physical principles and often involve the whole body. Amusement parks are also among the most popular school excursions, but very often the learning possibilities are underused. In this work we have studied different teacher roles and discuss how universities, parks or event managers can encourage and support teachers and schools in their efforts to make amusement park visits true learning experiences for their students.

Keywords: amusement park physics, forces, PCK, informal learning, teacher CPD

Learning opportunities in an amusement park

Roller coasters and other amusement rides involve unusual motions in one, two and three dimensions. These motions often illustrate common textbook situations, such as free fall, circular motions, parabolas and pendulums, where the forces act on the human body of the rider [1-4].

A teacher can make use of amusement rides for physics teaching in many different ways. Even without amusement park visits, the rides can often be used as a "previous shared experience", supported by authentic data, photos and movies to illustrate different phenomena. How the teacher chooses to integrate the visit with the curriculum, including preparation and follow-up of the visit, is known to play a large role for the learning outcome [5]. However, many factors influence if and how teachers choose to bring their classes outside the classroom [6], and it is known that other parts of the planning for the visit often overshadows the curriculum integration [7].

Amusement park visits can be arranged during regular opening hours, and possibilities for experiments and measurements may be negotiated, as well as access to power supplies and tables for equipment during the visit. The threshold for a visit can be lowered by making suitable data and possibly worksheets available on-line [8]. For first-timers, a quiz and joint class focus on 2-3 familiar rides can be a reasonable level of ambition, possibly combined with a preparatory lesson on force and motion in a playground [9]. With more experience, the teacher may choose to divide the class into groups of 3-6 students, focusing on 1-3 rides each and reporting back to the rest of the class after the visit. Electronic data collection is an option made easier with increased access to sensors in advanced mobile phones.

This paper focuses on teacher roles during organized science activities in an amusement park. We have been involved in Science days at Liseberg and Gröna Lund since 2002 and

2009, respectively. We continue to develop materials and format for the days, using observations, interviews and questionnaires to guide the development. We also build on research from other informal science learning environments, including studies of teacher roles in science centers [5,7], as well as models of effective professional development for teachers [10].

Force and motion in amusement rides

Our everyday motions are rarely limited to one dimension, and rarely uniform or uniformly accelerated, as in common examples used to introduce velocity and acceleration in school physics (and math). Amusement rides, on the other hand, offer many full-scale implementations both of these and other textbook examples, including the weightlessness in free fall, rotating coordinate systems and built-in parabolic "flights". However, in contrast to common textbook examples, where forces are rarely exerted on human bodies, the forces needed for the accelerated motions in amusement rides are experienced throughout the body of the rider. The vector character of velocity and acceleration are obvious to the person who is moving. Acceleration introduced through Newton's second law, $\mathbf{a}=\mathbf{F}/m$, is accessible also to young learners. By focusing on forces acting on the human body, also the traditionally difficult centripetal forces enter with the correct sign.

In many ways, the experiences of "holiday physics" in the idealized motions of amusement rides may be a more suitable concrete introduction to Newtonian mechanics than the special cases of rest or uniform rectilinear motion: Newton's first law seems to contradict the everyday experience, where a rolling ball comes to a stop on a horizontal surface and you need to keep pedalling your bike to keep it moving, even when there are no hills.

The ride experience of the body can be complemented with measurements and experiments using simple toys or mobile phones (after discussions with those responsible for rider safety). However, for minds trained to think of acceleration as a mathematical description from outside the moving system, the interpretation of the resulting accelerometer data from commoving sensors can be quite confusing. In spite of their name, accelerometers do not measure acceleration but the "g-force", $(\mathbf{a}-\mathbf{g})/g$, as a vector in a coordinate system that accelerates and rotates along with the rider. Trying the equipment in everyday motion and in ordinary playground swings [9] is a good preparation for measurements in amusement parks. The combination of many different representations of acceleration offers a number of qualitatively different ways of experiencing the phenomenon, and can be expected to lead to deeper understanding, that can be transferred to new situations [11,12].

The development of amusement park science days in Sweden

In 1995, rides in the Liseberg amusement park were used by university students in an introductory physics course, for investigations inspired by material from the US [8]. A first web site was created by students for us in later courses. This site has moved, and been updated and expanded into a large www site [13], used in many university courses as well as in schools. Student teachers at Stockholm university performed experiments and measurements at Gröna Lund and presented photos and results as inspiration [14]. For a number of years, school visits to have been arranged by individual schools. University and engineering students have done projects at Liseberg and we have converged on a format with 3-6 students, looking at 2-3 rides, with written reports, opposition and presentations following the visit. The discussions during the project work offer many opportunities for "elicit-confront-resolve" concerning force concepts. In 1999, a collaboration was initiated

with zoophysicists who measured heartbeat in a supervised pilot class visit at Liseberg. Supervised visits for pupils aged 10-16 became part of the school program in the Gothenburg international science festival 2000-2001. The experiments were developed in collaboration with park administration for safety and logistics, and with external financial support for graduate students to supervise class visit. In this close contact, experiments could be tried out, as well as questions and discussions before and after the rides. After these visits we felt ready for a larger science day. In 2002, 600 pupils had exclusive access for two hours to five rides, expanding to 2000 pupils with 14 rides for three hours in 2004. Students from physics, teaching and engineering education programmes at several west Swedish universities acted as observers and provided support at several rides [15]. Observation forms and reports from the participating students gave insight into the significant variations of teacher preparation and class interaction - and the difficulty to ensure that all classes came well prepared. Some of the material developed has later been adapted and integrated in activities at Tusenfryd [16] in Norway and Tivoli Gardens and Bakken in Copenhagen [17]

Science days at Liseberg resumed again in a smaller format in 2012, with enhanced teacher involvement, is discussed more below.

During recent years, the project has been taken up in the form of "Edutainment days" at Gröna Lund, in collaboration involving the House of Science in Stockholm and the Swedish National Resource Centre for Physics Education. Up to 3000 students and their teachers have had exclusive access to the park for three hours before opening. Questionnaires concerning preparation, visit and planned follow-up have been collected. However, getting responses directly from teachers is not always easy – in 2012 they were also actively solicited in informal interviews during the visit.

Table 1 summarizes the development since the year 2000, including types of data collected during the events. In this paper we present an analysis of evaluations, including interviews, observations and questionnaires, from these events, and also show how the results have been used for continued development.

Table 1. Data collection in connection with the development of physics, science and Edutainment days in Sweden

Period	Description	Data collection
2000-2001	Liseberg, supervised class visits, age 10-16, as part of the Gothenburg Science Festival. Continued development of web site and format in close interaction with a group of teachers.	Guide reflections. Focus group interviews with one group of 10-year olds.
2002-2004	Liseberg links physics material to liseberg.se. Science days, up to 2000 pupils + 200 students assisting	Student observation protocols + reports + informal discussions with teachers and summaries from park personnel.
2005-2012	University student groups at Liseberg. Independently planned class visits at Liseberg and Gröna Lund.	Student reports. Informal discussions and contacts with teachers.
2009	Separate teacher workshop at Gröna Lund.	Questionnaires and

Period	Description	Data collection
	1900 pupils at Gröna Lund. Detailed schedule: lecture on history, hands-on demonstration show from university + measurements in rides, with possibility to borrow accelerometers	observations
2010	Worksheets developed. Introductory activity at the House of Science	Discussions during a teacher follow-up meeting at the end of the Edutainment day
2011	Worksheets available at gronalund.com. Presented in some detail during workshop as teacher preparation for Edutainment day.	Questionnaires
2012	2900+1500 students at Gröna Lund. Technology table added Small-scale (600) physics day at Liseberg, with required teacher manning of ride stations.	Questionnaires, actively collected on-site. Dinner discussions after visit + e-mail follow-up
2013	Small-scale (600) physics day at Liseberg, with required teacher manning of ride stations. Individual e-mails to teachers.	Discussions + web questionnaire.

Teacher roles during class visits outside school

Teachers take on a number of different roles in connection with a visit, as known also from research at science centres [5]. Teachers may leave the class to roam around, possibly agreeing on meeting time, including a snack – described as a "soda pop visit" in [7]. Teachers may use the visit as an appetizer to start up an area of work - or as a resource or laboratory providing equipment not found in school. Lessons may be offered by the teacher or as a packet offered by the amusement parks [4], in which teachers may take part together with the students or choose to be absent [7]. We have seen all these roles taken on by teachers during different forms of amusement park visits. Amusement park visits also invite additional roles, e.g. as "bag guards", as an "equipment center" or "electronics support centre".

During the early science days at Liseberg, student teachers assisted at different rides, observed and discussed with teachers. Some of the responses during these early science days emphasized the need for additional support for curricular integration:

- The kids were only interested in the rides. The only discussions were about riding again or moving to another ride. The only preparation was travel information.
- "We prepared a little, but we will get most of the experience here. I suppose we should do some follow-up." He did not care about the experience of the kids.
- The teacher was a passive viewer, just making sure the groups followed the schedule. The kids were only interested in the rides. I could not observe any learning.
- The teachers we interviewed had no science background and couldn't answer the questions coming up.

The reports and discussions after the event showed that the student teachers were well aware of the importance of preparation and follow up. Meeting unprepared teachers and classes can be demoralizing, both for pupils and students. However, the students also met many well-prepared classes during the science days. Some classes came prepared with worksheets, sometimes based on questions formulated by the children before the visit.

- The children have made hypothesis to test. It is obvious that they use each other. Those who have experimented tell the others and those who haven't get more curious and have to try it for themselves.
- The children have written down hypotheses and are well prepared. The teacher poses questions and discussed with the children without giving answers. The intention is that the children think for themselves.

In some classes, the visit was part of a physics theme:

- The science teacher had told the class about the physics in various rides and what would happen. They had also experimented in swings.

Some classes had prepared their visits by doing research into various rides, working with potential and kinetic energy and building an amusement park in the classroom. Sometimes the teacher was observed to available for discussion at the end of the ride. In other cases, the teacher relied on the worksheets. Encountering many different teachers interacting in different ways with their classes gave the students an unique experience of a "teacher observatory", and of the importance of the teacher. One group reflected after the visit: "We knew that teachers play a role – but not that much".

Science day organization and teacher roles

During the first science day at Liseberg in May 2002, a relatively detailed schedule was suggested for the 600 pupils aged 10-19, as a way to obtain an even load on the five rides available and also to minimize interference between the different age groups. Reports from participating student teachers showed that this arrangement often prompted a teacher role focusing on keeping the schedule, and that many classes came unprepared for the physics activities and were more interested in the rides. During a couple of subsequent science days, classes were given a short introductory lecture in the park, but we found this format difficult to scale up. With an increased number of participants we chose instead to recommend different starting areas for different schools, and suggested worksheets with exercises related to a variety of rides. Seminars and workshops presenting the physics in the rides were offered as part of the Gothenburg international science festival.

Gröna Lund adapted the concept in 2009, in collaboration with the schools in Stockholm. During the first Edutainment day, the classes were divided into different groups, spending half the time on rides and the other half on presentations and experiment shows. Again, this prompted teacher preparations to focus on scheduling, and this format was abandoned, in favour of recommendations to assign different worksheets [13] to groups of 4-6 pupils and let them report back in class after the visit. This recommended format is based on many years of experiences or working with large groups of students following the development work in a new education programme in 1995 [18].

Teacher roles and Integration in the school curriculum

There are many thresholds to a visit [6]. Before the visit, many practicalities must be dealt with, including financial arrangements, scheduling, transport, information to students, colleagues and parents and collecting permissions needed. For the visit to contribute to student learning, the teacher must also become familiar with possible tasks in different rides and select and prepare assignments for the students, including equipment to be used.

From questionnaires and interviews during the days, we discern differences in the pattern of integration between classes in lower and upper secondary school (ages 13-16, and 16-19, respectively), as seen from Table 2.

One of many: Flow Analysis and Safety

Although planning is essential for a successful learning experience in an amusement park, not everything can be planned in detail. The time required for rides depend on choices of other visitors in the park, and the important safety regulations may get into the way of some creative experiments.

We found many frustrated upper-secondary students in queues, during an early Edutainment day, with the single assignment from their teacher to bring an accelerometer onto one of the two large drop towers at Gröna Lund while their teachers guarded their bags. When 3000 students share the park for three hours, not everyone can expect to go on a ride with a capacity of less than 400 riders/hour! At the same occasion, we met a large number of enthusiastic students, who had finished assignments for 3-4 rides, as we had recommended, and were moving onto a quiz and other shorter tasks.

During early stages of the development, participating students found pupils who tried to bring large mugs full of water along in high drop towers or to take a giant toy or beer can on a 1m string, rather than the recommended cuddly animal on a 30-40 cm string. We have seen attempts to bring graphing calculators with large sensors without any way to securing them to the body. Large elevations, high speeds and strong forces can cause as much damage on science days as every other time: Although some open-park safety rules may have be alleviated for the special days, Newton's laws still hold - they are usually what prompted the visit.

Table 2. Typical replies from lower and upper secondary school teachers concerning preparation and follow-up

	Age 13-16	Age 16-19
Preparation	<ul style="list-style-type: none"> • Go through force and motion concepts • Work through exercises from the www page • Groups have chosen topics 	<ul style="list-style-type: none"> • Review equipment to be used • Go through what observations and measurements to perform in park
Follow-up	<ul style="list-style-type: none"> • Report + oral presentations in groups • Discussions in mixed groups • Individual responses to written 	<ul style="list-style-type: none"> • Reports • Presentations • Hand in assignments

	<p>questions + discussion in class</p> <ul style="list-style-type: none"> • Discuss answers and solutions in groups • Orally with powerpoint • Discuss the ride experiences and try to understand the connection to the forces in different rides 	
--	--	--

Supporting the teachers, before, during and after visits

How do we best support teachers to make use of the learning opportunities in an amusement park? Sagar et.al [6] have investigated what barriers and requirements teachers perceive for integrating collaborations outside school into the school curriculum, and identified a number of factors, including requirements on time, school leadership, scheduling and opportunities for professional development. During the early development of science days at Liseberg, we focused on the learning and involvement of students, and found that students who were uncertain about the physics involved were often reluctant to pupils' observations at the rides.

During the last few years, we have further developed the format for Edutainment days and Physics days at the Gröna Lund and Liseberg amusement parks in Stockholm and Göteborg, Sweden, building on experiences and materials from science days arranged at these and other parks. We have emphasized the recommendations to use worksheets and encouraged teachers to divide the class in groups of about 4 pupils who focus on 2-4 different rides. The groups then report back to the rest of the class, providing a richer experience. We have found that the use of worksheets with different rides helps circumventing long queues, where students cluster on a few popular rides. A technology table was added to the Edutainment day in 2012.

Information about rules, activities and recommendations do not automatically reach all participating teachers. It is common for one teacher to sign up several classes for a school, and be the one receiving all information. Unprepared classes not only miss out on learning opportunities, but also clog up popular rides, and change the general atmosphere of curiosity and excitement over new ways to experience familiar rides, including physics, math and technology. An important aspect of our development of the design of Edutainment days is the emphasis on the role of the teacher, supported not only through worksheets, but also by a workshop, where teachers have a chance to get familiar with the rides, as well as sharing and discussing previous experiences from working with the material, before during and after the visit. Schools participating for the first time in the Edutainment days are required to send at least one teacher to the workshop.

During recent Edutainment days at Gröna Lund tutors from the House of Science have been stationed at rides to help distribute and inspect any material going on the the ride. Since 2012 we also invited teachers to assist at some of the stations with tags showing their role. In this way teachers get to share experiences and discuss with pupils from different schools, as well as with tutors and graduate students. For the smaller Physics Days at Liseberg, e-mail addresses were collected for all physics teachers taking part, and they were assigned one hour at a ride station, together with a couple of colleagues from other schools, to discuss with all students going on that ride. Teacher instructions and dialogue suggestions (1-2 pages) for individual rides were made available before the visit and

teachers did come prepared. Pre-visit e-mail contacts with all participating teachers seems to lead to increased involvement and sense of shared responsibility for the success of the day. The work continues, in international collaboration [19], to adjust the format to ensure that the days become optimal and enjoyable learning experiences, both for the classes, and their teachers.

Acknowledgements

We would like to express our appreciation of the continued support from the Gröna Lund and Liseberg amusement parks, who have opened their parks for physics investigations and provided data and other details about rides. Financial support for curriculum development has been provided by FRN, VR, University of Gothenburg, Chalmers (project CSELT), The Council for Renewal of Higher Education (HGUR, later RHU) and The Swedish National Agency for Education (Skolverket).

References

- [1] Bagge S., Pendrill A-M.: (2002), *Classical physics experiments in the amusement park*, Phys. Ed, **37** 507-11.
- [2] Pendrill A-M.: (2008), *How do we know the Earth spins around its axis?* Phys. Ed. 43 158.
- [3] Pendrill A-M., Karlsteen M., Rödjegård H.: (2012), *Stopping a roller coaster train*. Phys. Ed. 47 728.
- [4] Alberghi S., Foschi A., Pezzi G., Ortolani F.: (2007), *Is it More Thrilling to Ride at the Front of the Back of a Roller Coaster?* The Physics Teacher, Volume 45 (9) pp. 536.
- [5] Rennie L. J., McClafferty T. P.: (1995), *Using visits to interactive science and technology centers, museums, aquaria, and zoos to promote learning in science*. Journal of Science Teacher Education, **6** (4) 175.
- [6] Sagar H., Pendrill A-M., Wallin A.: (2012), *Teachers' Perceived Requirements for Collaborating with the Surrounding World*, NorDiNa: Nordic Studies in Science Education, 8, 227-243.
- [7] Sørensen H., Kofod L.: (2004), *Experimentarium og skole*. In: E. Henriksen & M. Ødegaard (Eds.), *Naturfagenes didaktikk - en disiplin i forandring?* (p. 517–532).
- [8] Physics, Science & Math Days and California's Great America. <http://physicsday.org>
- [9] Pendrill A-M., Williams G.: (2005), *Swings and Slides*, Phys. Ed. 40 527.
- [10] Clarke D., Hollingsworth H.: (2002), *Elaborating a model of teacher professional growth*. Teaching and Teacher Education, **18**, 947-967.
- [11] Marton F., Booth S.: (1997), *Learning and awareness*, Mahwah, New Jersey: Lawrence Erlbaum Associates, Inc.
- [12] Airey J., Linder C.: 2009, *A disciplinary discourse perspective on university science learning: Achieving fluency in a critical constellation of modes*, J. Res. Science Teaching, **46**, 2749.
- [13] <http://physics.gu.se/LISEBERG/> and <http://tivoli.fysik.org>
- [14] Stockholm university (1999), Department of Physics, Physics at Gröna Lund <http://www.fysik.su.se/gronalund/>

- [15] Pendrill A-M., Lindberg L.: (2011), Assessment in mathematics teacher education. In "Voices on learning and instruction in mathematics", Ed: Jonas Emanuelsson, et.al 331-350 University of Gothenburg.
- [16] Fysikkfryd på Tusenfryd, <http://www.naturfag.no/uopplegg/vis.html?tid=39320>
- [17] Tivoli Gardens, Faglige Dage, <http://www.tivoli.dk/da/skoler/faglige%20dage/>, Bakken, Natur&Fag, <http://www.bakken.dk/festpaabakken/skoler-børn/item/555-natur-fag-på-bakken>
- [18] Wistedt I.: (1996), Gender-inclusive higher education in mathematics, physics and technology:Five Swedish Development Projects, HSV.
- [19] Pendrill A-M., Pezzi G.: (2013), Amusement parks support physics education, Phys. Ed. 48, 3-5.

The evolution of future teachers' imaginaries about teaching physics for young and adult students

Andréa Cristina Souza de Jesus¹, Roberto Nardi²

^{1,2}UNESP – São Paulo State University, School of Sciences, Science Education Graduate Program, Science Education Research Group, Bauru, São Paulo, Brazil. Support: CAPES¹ and CNPq²

Abstract

The research aimed to investigate the imaginary of undergraduate physics students, future high school physics teachers, about the supervised teaching practices designed for a specific public of students. These students are young and adults that don't completed compulsory education at convenient age. For these persons, there is, in Brazil, a modality of education called Young and Adult Education (YAE). According to this research, the undergraduate physics students show - through their discourses - that they changed their initial ideas (some of them prejudiced) and approached their imaginaries to the real characteristics of YAE, so they could re-elaborate their teaching practices for this educational context.

Keywords: Youth and Adult Education, Physics Teaching, Initial Teachers Education

Introduction

In Brazil, there are few studies about teaching for people who have not completed compulsory education. However, data of 2010 from the Brazilian Institute of Geography and Statistics (IBGE) [1] show that almost half of the population (49.3%) aged 25 or over has not completed elementary education. The percentage for people who have not completed high school is 14.7% for the same age group. These data indicate millions of people without access to the right to education. So, in Brazil, it justifies to have a Young and Adult Education modality (YAE) is designed for those who did not have access or permanence in elementary and high school at convenient age, for different reasons like work, distance from home to school, disinterest, and discouragement and family problems.

The term "Young and Adult Education (YAE)" was officially adopted in Brazil after the publication of the Law of Guidelines and Bases of National Education, in 1996. According to this document, the YAE can be understood as a modality of education for those who did not have access or permanence in studies at elementary and high school at convenient age.

Currently, in Brazil, there are two ways to attend young and adult students who wish to complete the elementary or high school education: courses offered by schools and certification exams. Usually the courses offered by schools aim to meet the specific daily routine of these students, who are mostly student-workers. Thus, these schools have an organization and specific methodologies. In these courses, the students enroll in one subject at a time, and get study material to prepare for the exams and if they encounter difficulties, there are teachers to guide them.

As for certification exams are multiple-choice tests which the student needs to achieve the required score to get the certificate of basic education.

Many governments justify the low financial investment in YAE classrooms because there are few enrolments in this education modality. However, Haddad [2] argues about the importance of government policies that aim to increase enrolment in YAE. He explains that, unlike

education for children and adolescents, there is not a consolidated social consensus about the need for education for youth and adults. Therefore, it is urgent and necessary to provide spaces for public and quality education for youth and adults who did not complete the compulsory education.

To talk about the quality of YAE, it is necessary to consider the specific characteristics of this education modality, such as specific methodologies and curriculum that respects the learning time, the knowledge constructed by students and especially teachers trained to teach these people. It is responsibility of the teacher education courses "to provide a professional and quality training for teachers within a pedagogical project that consider the profile of young and adult students" [3]. However, there are few training courses for teachers who consider the specific characteristics of the YAE, also there are few researches investigating this modality of education. Thus, in this paper, we present results of a research developed with future physics teachers on supervised teaching practices occurred in classes for young and adult education.

The research

The participants of this research are 17 pre-service physics teachers, aged between 21 and 29 years, taking their initial teachers' education undergraduate program in a Brazilian public university. The proposal is that the future teachers prepare and teach a didactic sequence of physics teaching according to the specific characteristics of YAE classes using their knowledge acquired in initial teachers' education course. The research occurred at three stages, after each stage the future teachers reported their views about the YAE and teach physics in this education modality, as the following description:

First stage: at the beginning of the school year was applied to these pre-service physics teachers a survey with important issues for didactic planning for teaching in YAE, such as criteria used by the teacher in the selection of physics content, teaching methodology, types of approaches in the classroom, the profile of students who attend YAE and the meaning of learning physics to young and adult people.

Second stage: after the future teachers have observed several classes for youth and adults education in the city schools, and interviewed the teachers of these classes, we conducted a focus group interview with them. In this interview the undergraduates reported facts and situations which they highlighted during the period of observation in YAE classes.

Third stage: this stage we analyzed the discourses of undergraduates throughout their classes in YAE. Through their discourses we can describe aspects of their imaginary.

The research is characterized as a case study. This approach emphasizes the natural complexity of situations and demonstrates the interrelationship of the participants [4]. Furthermore, the object of study should be treated as one and it is considered a singular representation of a multidimensional and historical reality.

The aim of this research is to analyze the discourses of future teachers to understand their imaginary about the YAE and teaching physics in this education modality in different stages of this case study. The collected data were analyzed using concepts of Discourse Analysis (AD) released by Eni Orlandi [5] which develops in Brazil AD studies in the French line, having Pêcheux as reference.

About the Discourse Analysis

Discourse analysis (DA), in its French line, has in Michel Pêcheux one of its main founders and has been developed under certain principles about the relationship between discourse and the social-historical context in which it was produced [5].

Eni Orlandi (1999), one of the main researcher of French Discourse Analysis in Brazil, defines discourse as "the effect of meanings between talkers", considering that a speech is not just the linear transmission of information, because each speaker will understand an information according to the constructed knowledge about the subject throughout his life story and experienced contexts.

In our analysis, we will consider the following concepts to AD [5]:

- *Conditions of production*: it is the relationship between discourse and the social-historical context and the immediate context in which the discourse is produced;
- *Discursive formation*: it is a determination of what can and should be said in a discourse or not, from a socio-historical situation and the dominant ideology;
- *Imaginary*: the imaginary that a person has about something can be understood as a representation elaborated from his/her knowledge about that. It acts in discourse giving an illusion about the correspondence direct between what is said and what really is. This relationship is illusory, because in AD, there is not transparency in the language. In other words, the meaning is not the only one, always there is a possibility for interpretation.

Analyzing the conditions of production in which the discourses of future physics teachers were produced and the discursive formation which they are inserted, we can cross the imaginary that conditions the subjects and explain how the meanings are being produced.

Thus, we assume that the future teachers' imaginary have about the youth and adults, the configuration of this education modality and the importance of teaching physics for these students will condition their positioning in the classroom.

Results and discussion

When we read the speeches of pre-service physics teachers in the different stages of the research it was possible to observe changes in their imaginary about the YAE and physics teaching in these classrooms. In the following sections, we present some analysis.

The First Stage

At this stage, the future teachers demonstrated to not know well about the structure and function of this education modality, even being a possible future field of work for them. This fact can be seen in the following statements:

Yes, I've already heard the YAE expression, but I do not have knowledge about its structure ... [P₉]¹.

I do not know much about the YAE, but I imagine the classrooms have few students, and the teaching of physics is very superficial. [P₁₄].

¹ Number indicated randomly according to each future teacher who participated of this research.

These speeches confirm the lack of discussion about the YAE classes in the initial teachers' education course, indicating that the future teachers' imaginaries about this education modality are little related to the knowledge developed in this course.

It was possible to verify a negative aspect in the last speech [P₁₄], of the superficiality, connected to teaching in youth and adult education. According to Arroyo [6], the YAE teachers affirm that there is a devaluation of teaching in this education modality, which has been considered as a field work less important. Throughout its history, the YAE has received little government investment and it is constantly related to an idea of superficial and low quality teaching. This idea seems to be present in the discourse of undergraduates analyzed.

It was also noted that the image of poor quality teaching was related to the fact that these courses have lower workload, compared with the compulsory education. The idea of YAE as a short course or condensate was the main characteristic that the future teachers attributed to this education modality, as we exemplify in the speeches below:

The classes are much more summarized than of students in elementary and middle school, because they require less class time to complete the YAE. [P₂].

What I know is that it is a way of teaching in which teachers discuss the concepts of physics summarized in a short time. [P₈].

The Second Stage

In this second stage, the future teachers had already observed YAE classes during one semester. Through their speeches, the undergraduates have demonstrated to recognize some specific characteristics of young and adult classes. One of them refers to the diversity and conflict among people of different ages; the YAE classes receive from teenagers to elderly students.

... you see a different culture because of people's age. There was a boy of 20 years and a lady of 60! [P₁].

This statement relates to researches about adult education that claim the need to recognize and respect different identities, knowledge and stories of young and adult students [7].

However, despite the future teachers admit that there is a conflict among students of different ages; it does not mean they know how to deal with this problem. In the following statement, they admit that would have difficulty to reconcile the tensions between the students of different age groups:

Because the difficulty that exists in the age differences. Sometimes a younger person is far from the school only two or three years and an elderly person had no contact with any school subject for about 20 years, so she does not remember much of anything. [P₂].

About the Physics teaching in YAE classes, the future teachers highlighted the difficulty of the young and adult students to use mathematical tools and understand basic concepts of physics.

One day, the YAE teacher taught to the students a super simple exercise about calorimetry, right? She wrote an example on the blackboard and then asked for the students to do the same exercise, only changed the numbers. Only changed the calculation, the rest was all the same ... all the same. But the students could not do it, they did not understand it, did not know where to start! [P₁].

[The students] cannot divide or multiply. He [the YAE teacher] wrote only this: the electric current, in brackets, "i". But when students were writing, they did not know the value of the electric current. [P₂].

And the YAE teacher taught physics using a simpler math. Only multiplication and division. [P₂].

These speeches show that future teachers evaluate students' difficulties from their own perspective (position of the subject in discourse). They do not consider the life histories and school trajectories of the students, possibly marked by school evasions, reproves in school exams and other problems that result difficulties to these young and adult students adapted to school procedures. Can the concept of calorimetry be considered "super simple" to YAE students, as stated [P₁]? Or can multiplication and division be considered simple for those students?

Looking at the first speech of [P₂], the future teacher demonstrates to not understand the difficulty of the students towards the concept of electric current. However, the expression "electric current (i)" is a notation that belongs to the scientific discourse and also a formal school. Thus, depending on the way in which the concept of electric current is taught, it can be results in greater difficulties for students who have been out of school.

The third stage

In this last stage, we analyzed the discourses of future teachers in their supervised teaching practices classes. There were four hours of classes in a public school, which has only elementary and high school YAE classes.

We highlight the intention of future teachers to use teaching methodologies that approach the physics' contents to the students' everyday life. This concern may be result of the use or dissemination of the GREF's books (Group of Redesigning Physics Teaching) [8] in initial physics teachers' education courses. The GREF's books consider the students' everyday life in its teaching methodology. Their activities are based on situations and everyday elements, widely accessible to most students. It is possible to notice that the future teachers, participants on this research, used as a reference to prepare their lessons the GREF's books and involve students' everyday situations to teach the physics' contents of heat (for example the function of a blanket, the operation of the refrigerator or of a car engine). This approach was present in most of the future teachers' speeches and their discussions in classrooms.

Is the car engine hot? What is the relation of heat with the car engine? [P₁].

The refrigerator has heat. Everything is working with the heat, so the heat is more present in our daily life than we realize. [P₁].

Despite the future teachers' intention to relate the physics' contents with the students' everyday life, and this being a fundamental characteristic of teaching in YAE, they have made a mistake. It is the idea of taking a "routine standardized" [9] to prepare their classes, in other words, a general everyday life, not necessarily related to the life stories of the specific young and adult students.

Finally, we present the speech of one future teacher occurred at an informal conversation with the researcher. The research participant praised the supervised teaching practices occurred in YAE classes, but said it was annoyed because the students have answered correctly to questions asked by future teachers.

The students already knew everything; we prepare the class for someone who knew nothing about physics concepts. [P₃].

Thus, we observe that future teachers prepared their lessons very simplified, teaching only an introduction to the physics' contents. However the young and adult students answered correctly the questions asked by the future teachers demonstrating that they understood the concepts of physics. This contributed to the future teachers overcome the idea that, due to the students' difficulties with mathematical tools, it would not be possible to deepen discussions about concepts of physics.

Conclusions

In this research it was concluded that there was an evolution in future teachers' imaginary about teaching physics in YAE. This can be attributed to the way that the supervised teaching practices were organized and conducted in university and YAE school. This organization provided an opportunity that the research was planned in three stages, it was important to us to get the following observations:

First stage: the future teachers had little knowledge or common sense knowledge about the YAE classes, despite being a possible future field of work for them. They defined this education modality as short courses and low-quality teaching.

Second stage: the undergraduates recognized some specific characteristics of the YAE as the diversity of students, who are young, adults and also elderly people, each with different interests and difficulties.

Third stage: the future teachers planned their lessons trying to relate the physics' contents with the students' everyday life. Despite some mistakes committed, the future teachers had the intention to develop lessons that would take into account some specific characteristics of the students.

The changes in the future teachers' imaginaries can help them to develop a professional practice that approximates the needs and interests of young and adults students.

We also note that the realization of supervised teaching practices in YAE classes allowed the future teachers to know and think about an education reality not discussed earlier in their initial teachers' education course. The reflections occurred during this research period allowed undergraduates to revise and expand their imaginaries about the student profile they will work.

Thus, the research has shown the importance of including in initial physics teachers' education discussions about teaching in young and adult education. The specific teachers' education to teach to young and adult students will contribute to a better teaching to this significant portion of the population who were earlier excluded from school and access to education. [10].

References

- [1] Brasil: *Censo Demográfico 2010: educação e deslocamento*. (IBGE, Rio de Janeiro, 2012).
- [2] Haddad S.: *A educação de pessoas jovens e adultas e a nova LDB*. In: Brzezinski, I. LDB interpretada: diversos olhares se entrecruzam. 7^a ed. (Cortez, São Paulo, 2002).
- [3] Brasil: *Resolução CNE/CEB N° 1, de 5 de julho de 2000*. Estabelece as Diretrizes Curriculares Nacionais para a Educação e Jovens e Adultos. (CNE, Brasília, 2000).

- [4] Lüdke M., André M. E. D. A.: *Pesquisa em educação: abordagens qualitativas*. (EPU, São Paulo, 1986).
- [5] Orlandi E. P.: *Análise de Discurso: princípios e procedimentos*, 4ª Ed. (Pontes Editores, Campinas, 1999).
- [6] Arroyo A.: *Formar educadores e educadoras de jovens e adultos*. In: Soares, L. (org.). *Formação de educadores de jovens e adultos*. (Autêntica, Belo Horizonte, 2006).
- [7] Di Pierro M. C.: *Balanço e desafios das políticas públicas de educação de jovens e adultos no Brasil*. In: XV ENDIPE – Encontro Nacional de Didática e Prática de Ensino. (Autêntica, Belo Horizonte, 2010).
- [8] Grupo de Reelaboração do Ensino de Física: *Física 3: eletromagnetismo*, 5ª Ed. (EDUSP, São Paulo, 2002).
- [9] Fracalanza H., Amaral I. A.: Gouveia, M. S. F. *O ensino de ciências no primeiro grau*. (Atual, São Paulo, 1987).
- [10] Soares L.: *O educador de jovens e adultos em formação*. In: 29ª. Reunião anual da ANPED. (ANPED, Caxambu, 2006).

Informal Teaching of Special Theory of Relativity

Jindřiška Svobodová¹, Jan Novotný¹, Jana Jurmanová²

¹Faculty of Education, Masaryk University, Brno, Czech Republic

²Faculty of Science, Masaryk University, Brno, Czech Republic

Abstract

In the present Case Study we explore the comprehension levels of relativity theory in prospective science teachers who take the introduction to physics lesson at the Faculty of Education. Special Theory of Relativity multimedia animation was used to illustrate basic relativistic consequences. The effect of it for learning was researched. In the research, a case study was used. Research data were obtained by interviews and using open-ended questions prepared by the researcher.

Keywords: informal science education, animation, courseware, special relativity

Introduction

Nowadays Special Theory of Relativity (STR) is important for our understanding of time, space, matter and energy. It represents an example of creative and analytical thought. Although some of the consequences of the basic ideas may seem intuitive, there are various pitfalls not only for beginners. Many students are looking forward to lessons of STR. They often have high expectations for this topic, but soon they turn that the understanding STR is quite difficult task in practice. Every physicist probably had met with STR insistent critics who claim that STR leads to the absurdities. Physics teacher should be able to vindicate the theory at least for himself (because an effort to convince is usually fruitless). This ability to oppose the critique represents a real touchstone in understanding STR.

When the STR is taught in schools, it is not possible to carry out real experiments. We have prepared several multimedia animations giving a brief overview of relativity as stand alone content files. These short animations were complemented by various questions and problem tasks and were presented to students.

The aim of our study was to find indications and patterns which can help an understanding starting points of the theory of relativity [1].

For research purpose we decided to realize a Case Study focused on student's reading, math, science skills and creative abilities to solve problems. In spite of an increasing availability of animations for science education, there has been little research into the value of animations in science teaching. Stith (2004) [5] has reviewed this issue with a focus on cell biology teaching animations. A review of the literature covering all educational disciplines has indicated that there are certain parameters that need to be considered when making a teaching animation [7].

STR Flash Animations

The textbook "Special Theory of Relativity 2005" is available as downloadable PDF course material for students was prepared several years ago [1,2]. This textbook is still quite popular among physics students and teachers. The carefully structured text and number of explanations make that educational material is suitable for a self-study.

The authors have developed set of cartoon-style multimedia animations illustrated STR. Since this year there is an independent access for animations. We offer free streaming animated files as well as commentary text (this time in Czech only) with a written explanation, all of which explore the STR realm [3]. The production altogether was simply titled The Cartoon Guide to Relativity.

Every animation is narrative, combining story-telling and visualization. Theory and experiments are appearing on background story. The story begins meeting an Alien (from an advanced civilization that STR applied in everyday practice) and Professor of theoretical physics. Alien traveling at high speed rocket informs Professor of his observations. All measurements and observations of natural phenomena are based on determining the spatial and temporal relations. The main characters Alien and Professor are guides through all manifestations of STR ideas that are away from common sense. The processes in space-time are described from point of view of different frames of reference (we restrict ourselves on inertial systems of reference).

The following thematic sections are available:

- The Basic Science Terms.
- Time Synchronization.
- Adding velocities.
- Time Dilatation.
- Length Contraction.
- Twin Trip.

Much of the material was prepared at level suitable for high school students. This approach is designed for those students who desired better understanding the STR. Students can clarify special relativity terminology in conversation between Alien and a Professor and they can compare their ideas to the processes modeled in animation.

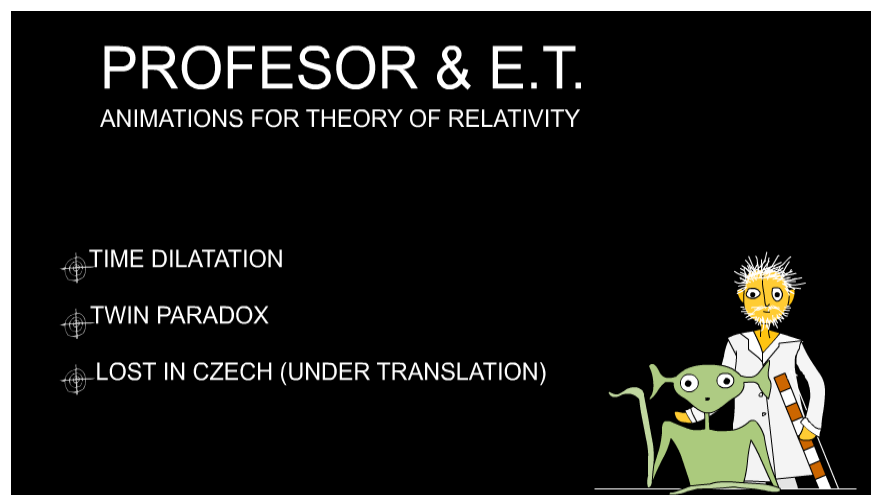

Figure 1. Internet portal design



Figure 2. Sample captions of the STR animation

The Research Design

The primary goal of our case study was to determine whether the results of students who saw the animation are different from other. We wanted to find out how the observation of animations affects student's approach to perform their solution of requested tasks.

We were looking for factors that could enhance the learning process of STR. From written tests inspired [6], [8] we could evaluate student's knowledge and skills and we could identify an incomplete treatment in areas that may prevent from misunderstandings in STR concepts. Test questions were intentionally assigned more generally. Test assignment was designed so that it examined the prerequisites of math, geometry and graphics. Figure 3.

Moreover, we have used the case study research method. The advantage of case study methods is that it provides detail information about a particular case. This helps to set the groundwork for future strong studies. The Case Study is an empirical inquiry allows a rich exploration of student perceptions into common situations.

The research questions we were set: What indicators are changed after student's observation of cartoon animation? Is there a relationship between graphical and geometrical competence and ability to solve the set of tasks? Does the student's ability to clearly formulate their own approach affect the result of test?

Sample Questions and Tasks

Is the nonsimultaneity of hearing thunder after seeing lightning similar to relativistic nonsimultaneity?

Firecracker *A* is 300 m from you, firecracker *B* is 600m from you in the same direction, You see both explode at the same time.

Define event *A* to be „firecracker *A* explodes“ and event *B* to be „firecracker *B* explodes“.

Does event *A* occur before, after or at the same time as event *B*?

Event *A* occurs at spacetime coordinates (300m, 2us).

Event *B* occurs at spacetime coordinates (1200m, 6us).

Could *A* possibly be the cause of *B*?

Event *C* occurs at spacetime coordinates (2400m, 8us).

Could *A* possibly be the cause of *C*?

Figure 3. Test questions example

The Case Study method Study Design 2013

Participants were university students, mostly future physics teachers. 16 students attending university physics course took part in the study. They fulfilled given test (a set of 15 tasks) in sufficient time.

Students were divided into 2 groups: AA students were shown an animation before their test work, the other group NA only wrote a test without any animation. After that interviews for each student about their worksheets were audio recorded. Records were transcribed and coded. The method of categorization into indicators emerged during the analysis of records. We recombine data to address the initial purpose of the study. In several cases a short interview to gather additional data to verify key observations was necessary.

These observed symptoms and indicators were selected: careful reading, initial acceptance of the task (without any intervention), a clarity in student's explanation, an ability to reformulate task by own words, adequacy of graphic representation, use knowledge of STR, transfer of knowledge and skills from math, geometry and other disciplines, value judgment – a solution based on reasoning, limitation of own approach, creativity, success in task solution, ability to focus and maintain attention.

Results

The outputs are charts and brief descriptions of detected remarkable answers. Several graphs were constructed for comparative analyses. The graph shows (Figure 4) the different distribution of "performance" indicators for the first (AA) and the second (NA) group.

We can see that the most differences are in the categories of knowledge use STR (although most of these tasks and questions don't require knowledge STR) transfer of knowledge from different disciplines and creativity. The length of red arrows (Figure 4) corresponds to increase of the indicator. Shift is in transfer of knowledge from different disciplines and for creativity. The first group shows greater courage to accept tasks and have a better ability to reformulate task in own words. They were more successful in solution tasks.

The comparison of both groups indicates that the influence of fun animations is significant in the majority of items. The most pronounced influence is in indicator transfer of knowledge.

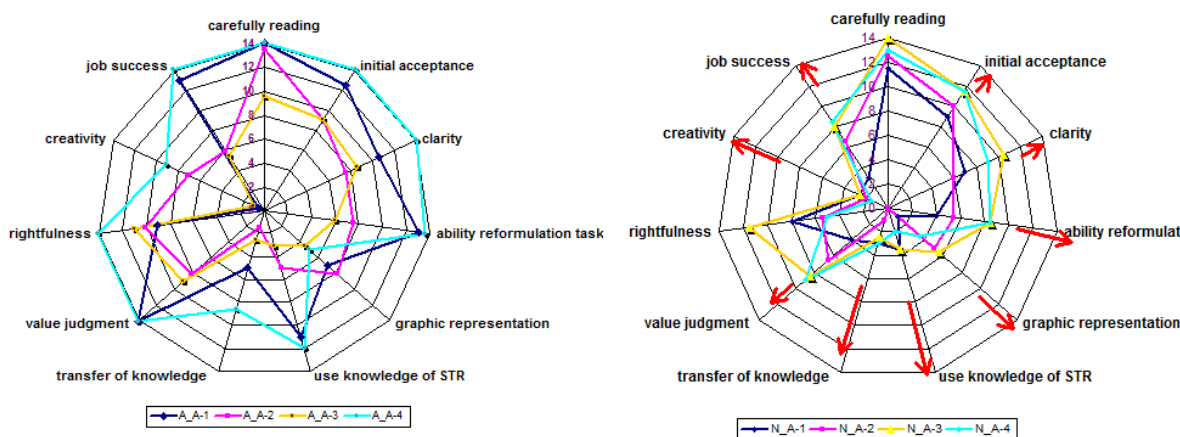

Figure 4. Graphic comparison of both groups

The content analysis of the answers (for example Figure 3) reveals that: students meet difficulties in grasping the relativity of motion and in using the frames of reference properly, several students didn't seem to be able to answer the question about the speed of light.

Conclusions

The students, who have undertaken STR cartoon multimedia stories, have reported shifts in values our indicators. Students have demonstrated more enthusiasm for the subject matter and their results were better. We can conclude that viewing animation is certainly not a wasting time in the classroom.

The STR Animations website provides the animations as downloadable, re-usable, learning objects that teachers can use however they like. In further refinement of improved cartoon animations, authors will work on suggested worksheets and instructor notes.

Next research is now focusing on deeper analysis of the student's concept development when experimenting with STR animation.

Acknowledgements

Support for this study has been provided by EP project OPVK Moduly jako prostředek inovace v integraci výuky moderní fyziky a chemie reg. č.: CZ.1.07/2.2.00/28.0182.

References

- [1] Novotný J., Jurmanová J., Geršl J., Svobodová M.: (2006) Základy teorie relativity. Elportál, Brno: MU. ISSN 1802-128X.
 - [2] Jurmanová J., Novotný J., Geršl J.: (2006) Multimedia CD Úvod do speciální a obecné teorie relativity. Scientific Pedagogical Publishing, ISBN 80-85645-56-4.
 - [3] STR Cartoon Project Website, (2013), Svobodová M., Available from: http://www.ped.muni.cz/wphy/C_R/ [visited 30-June-2013].
 - [4] Novotný J., Svobodová J.: (2013) 10th International Conference On Hands on Science, Educating for Science and through Science, ISBN 978-989-98032-2-0.
 - [5] Stith B. J.: (2004) Use of animation in teaching cell biology. Cell Biol. Educ. 2004;3:181–188. [PubMed].
 - [6] Hewitt P. G.: (2011) Conceptual Physics, Addison-Wesley; 11th edition.
 - [7] Tversky B., Morrison J. B.: Animation: can it facilitate? Int. J. Hum. Comput. Stud. 2002;57:247–262.
 - [8] Sherr R.E.: (2001) An Investigation of student understanding of basic concepts in STR, University of Washington.
-

Email Contacts:

Jan Novotný, Jana Jurmanová, Jindřiška Svobodová

novotny@sci.muni.cz, janar@sci.muni.cz, svobodova@ped.muni.cz

Extended project work for school physics students

Elizabeth Swinbank¹, John Taylor², Charles Barclay³

¹University of York, UK

²Rugby School, Institute of Education (University of London) and Edexcel, UK

³Marlborough College and Edexcel, UK

Abstract

This paper focuses on individual extended project (EP) work undertaken by school physics students aged 16-19 and presents guidelines for helping such project work to be successful.

Keywords: Extended project, independent learning, project work in schools

Introduction: extended projects

A key word here is 'extended'. The project work considered in this contribution involves about 80-90 hours of class time, plus a similar amount of private study time, and preceded by a taught course of about 30-40 hours. For comparison, a UK A-level course in a single subject, e.g. physics, needs around 240 hours of class time. An Extended Project (EP) is thus far more extensive and demanding than the individual 'investigations' requiring 10-20 hours over the course of 2-3 weeks, which have for several decades been part of some highschool physics curricula such as the UK Nuffield, Advancing Physics and Salters Horners programmes.

In the UK, extended project work is recognised through a new qualification, the Extended Project Qualification (EPQ), which is part of the national qualification framework used for university entrance. Since its introduction, uptake of the qualification has grown rapidly (Figure 1) and in 2013 over 30 thousand students undertook an EPQ.

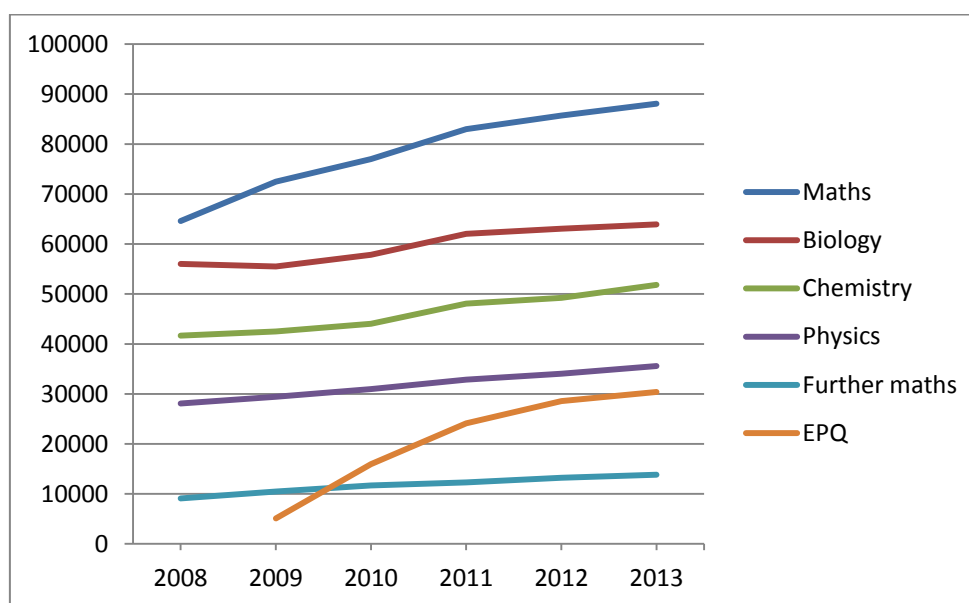

Figure 1. Uptake of the EPQ since it was first awarded in 2009, shown alongside uptake of science and maths A-levels for comparison

Key features of the EPQ can be summarised thus:

- For students age 16 and over
- Taken in addition to 3-4 content-based qualifications ('A-levels')
- For teaching and for university entrance EPQ = 0.5 A-level
- About 120 hours of class time and supervised study time over 1-2 years, plus a similar amount of private study time
- No specified content
- Individual choice of project topic
- Assessment criteria relate to quality of work and evidence of skills
- Supervised and marked by teachers
- A national qualification awarded by England's Awarding Organisations

The EPQ is distinct from problem-based learning (PBL). There is no specified material that students are expected to study and it is *not* a content-based qualification. Rather, students are assessed on the quality of the work they produce and the skills they develop and demonstrate. Also, while an EP will probably relate in some way to the subjects that a student is studying at A-level, it is expected that the project will also demonstrate *extension* in one or more dimensions (Figure 2).

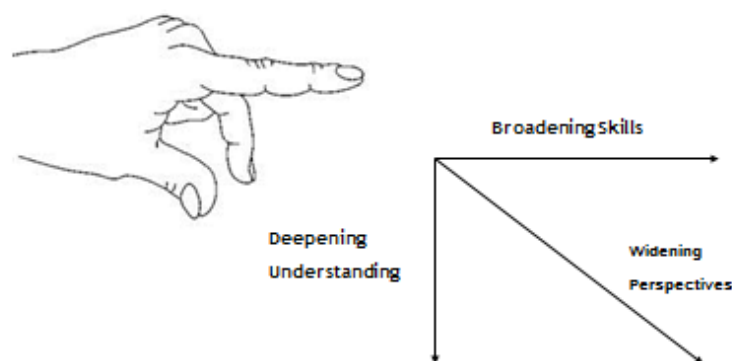

Figure 2. A definition of extension for the EPQ

- Deepening understanding – the student explores a topic in greater depth than would be expected at A-level.
- Broadening skills – the student learns how to do something. In a physics-based project, this might involve learning to assemble and manipulate an unfamiliar piece of apparatus, or learning advanced data-handling techniques.
- Widening perspectives – the student works outside conventional subject boundaries. This might involve discussing historical, philosophical or ethical aspects of a physics-based topic, or making links with other subject areas such as chemistry or economics.

Physics-based Extended Projects

It is convenient to define different types of EP according to the nature of the work undertaken and the outcome of the project. A Dissertation EP involves addressing a research question through literature research and argumentation, while an Investigation or Field Study involves data collection and analysis; both lead to a substantial written report of around 5000 words. An EP centred on developing a Performance or Event as its main

outcome requires a shorter report, as does an EP whose main focus is the design and making of an Artefact. In all types of project, students are expected to use relevant published resources as well as carrying out their own original work.

The Dissertation is the most popular type of EP among students and teachers, as it is the easiest to resource (though not necessarily the easiest to do well). Physics-based Dissertation projects can cover a wide variety of topics, as these examples illustrate:

- Why did the Titanic sink?
- Are wind turbines a good solution to the energy crisis?
- Can we justify human space exploration?
- Is it possible to believe in God and the Big Bang?
- Were the moon landings fake?
- Are we alone in the universe?
- How did the Copernican paradigm shift affect subsequent developments in cosmology?
- Is wi-fi safe?

A student with an interest in physics might choose to do an Investigation EP. Here are just a few examples of this type of project:

- How does solar activity affect weather?
- Do 'sharkskin' swimsuits give the wearer an unfair advantage?
- Would reclaiming and reusing the rare earth elements from iPads be economically viable?
- Over its working lifetime, does the energy output from a photovoltaic solar panel exceed the energy required to make, install and operate it?

All of these would involve collecting and analysing data, and can demonstrate extension (Figure 2). For example, 'sharkskin' swimsuits can be bought quite cheaply from internet auction sites, and investigated using simple laboratory apparatus e.g. involving water flow over the material. There is also the possibility of using published data from professional trials of the swimsuits. It would be relevant for the student to research rulings on the swimsuits by the sport's governing body, and perhaps to extend the discussion by considering what's meant by 'unfair' in this context.

There is also plenty of scope for physics-based Artefact EPs. For example, a student might set out to design, make and test an item of apparatus such as a sundial or a spectrometer. Perhaps less obviously, EPs involving a Performance or Event can also be physics-based. For example, an incident or issue could be explored through drama (as Berthold Brecht did with the Trial of Galileo), or a concept might be explored through an exhibition of images.

Feedback and research study

The development of the EPQ was informed by experience with Perspectives on Science (PoS), a one-year course in History, Philosophy and Ethics of Science for post-16 students, assessed by a Dissertation project. PoS began in 2004, and its assessment has subsequently been absorbed into the EPQ framework. PoS was the subject of a research study by Levinson et.al. [1,2] that focused on good practice in managing the research project and on the promotion of high quality discussion.

The response to the EPQ from teachers, students, universities and even government, has been very positive.

Students recognise the value of the EPQ in preparing for higher education and for employment. For example in 2009 a former EPQ student wrote to his teacher:

"I was just writing to let you know how useful the EPQ was in setting me up for any sort of systematic review and extended research. Although I still felt thrown in at the deep end with this job I am sure that:

"1. I would not have had as good chance of even getting an interview let alone getting the job without the background I had in extended research and

"2. I would have not been able to cope anywhere near as well had I not done my project..."

Teachers are enthusiastic not only about the benefits to their students, but about the impact on their own teaching as expressed by this physics teacher quoted in Levinson et al. [2]:

"I am really enthusiastic. I think it's probably the most enjoyable teaching I've ever done in my whole teaching career. I think it's because for once the students and I are actually exploring knowledge, for the love of exploring knowledge, rather than trying to prove that Ohm's Law is still Ohm's Law."

And here is a government minister [3] talking in 2013 about the EPQ:

"[The EPQ] develops and rewards creative and independent thought as well as research and planning. It represents the best of education, in that it is rigorous and demanding as well as adaptable and fun."

"Universities speak positively about the EPQ, and recognise it gives applicants the chance to develop research and academic skills that are highly relevant for study at higher education."

Strategies for successful project work

An EP is a major piece of work that presents many challenges to the student, and indeed to the teacher. Our experience in teaching, supervising and examining EPs, and working with other EP teachers, leads us to set out several recommendations which echo and extend the findings of Levinson et al.

The taught course

Students need support and guidance if they are to complete their EPs successfully. This is best done through a taught course of about 30-40 hours' duration (i.e. a substantial fraction of the total 120 hours) before students embark on their individual project work.

A key part of the course is that it should engage students in **activities where they learn relevant skills**, which might be as diverse as data handling, designing a questionnaire, or compiling a bibliography. Activities such as a focused literature search can be valuable here: ask students to research and summarise information relating to a specific question.

The course should introduce students to **key ideas and theoretical frameworks** that are likely to relate to their project work. For example, an introduction to the writings of Popper and Kuhn would help science students to bring a philosophical dimension to their projects. Not least, the course should also give students opportunities to explore potential project topics by carrying out **mini projects and pilot studies**, some of which might later be developed into a full EP.

For the teacher, the challenge is gradually to step back and allow students to work increasingly independently, acting ultimately as a 'guide on the side' rather than a 'sage on the stage'.

The research question or project brief

The most successful EPs are those that have a **clear and focused** research question or project brief. The project work is then readily directed towards addressing the question, and is likely to reach a definite conclusion.

Students rarely propose a good project question initially. Often a student's first ideas relate to a broad area of interest, rather than a specific research question, so the teacher needs to work with them to develop their suggestions. For example, a student who suggests 'cosmology' as a project topic might be guided to develop a more focused question such as the example given earlier.

It is important that the research question or project brief for an EP should be **'owned' by the student**. It should relate to their own interests, perhaps linked to their plans for a career or more advanced study. A student is more likely to sustain a high level of commitment to an EP if it genuinely holds their interest.

Ideally, the project question or brief should be **controversial**, or relate to an area of **uncertainty**. This enables the student to develop their own ideas, put forward their own solution to a problem, and argue for their own point of view, which is much more rewarding than merely confirming a well-established result.

The project should also be linked to an existing **body of literature** that is accessible to students. Researching and drawing on what other people have written about a topic is an important aspect of any EP.

Finally, the project must be **sustainable over time** and capable of further extension and development. Students are expected to spend about 80-90 hours of class time on their projects, plus a similar amount of private study time.

Project execution

After an introductory taught course, students work on their individual projects. But that doesn't mean they should be left to work alone and unsupervised.

At the outset, the teacher should work with students to ensure that each has a **clear structured plan** for their project work. It is very helpful to set **intermediate goals** with definite deadlines. For example, a student might agree to produce a literature review by a given date, or produce a report on a preliminary experiment.

The aim should then be to establish a pattern of **supported independent study**. The teacher needs to **meet regularly** with each individual student to monitor and guide their progress, offering advice where appropriate. It can also be very helpful to hold **seminars** where students report their work to the whole class; the ensuing discussion can often help a student to overcome obstacles or to identify new lines of enquiry.

One-to-one meetings and class seminars also help to guard against **plagiarism**. The teacher can keep track of the ways that students are working, and it is quite difficult for students to pass off plagiarised work as their own if they are being asked to discuss it in detail.

The project report

We recommend that the project report is **structured** in a similar way to an academic paper:

Abstract / Outline

Introduction

Literature / Research Review

Discussion / Development / Analysis

Conclusion / Evaluation

Bibliography

One reason for this recommendation is that the structure helps students to identify and report on various aspects of their project work. For example, the structure highlights the need to state a conclusion rather than simply presenting information.

A second reason is that writing the report can be a daunting part of a project, and students are often tempted to leave it too late before they start writing. By breaking the report into well-defined sections, students can be encouraged to **write up as they go along** and complete one section at a time. For example, students can research and write a review of published literature at an early stage, before they have carried out their own original work. Towards the end, after they have worked on the main discussion/development section and reached their conclusion, students are then able to write the introduction and finally the abstract.

Scheduling EPs in a school timetable

There is no one best way to schedule an EP in a school timetable. However, an important guiding principle is that students need time to develop and reflect on their project work, so a few hours per week over an extended period is to be recommended, whereas devoting a few weeks to intensive project work is less satisfactory.

Levinson et.al. recommend at least four terms altogether for the taught course plus project work, but that is not always feasible and other models can work well, such as the following:

Two full academic years (2 x 30 weeks): 2 hours per week

or

Two full academic years: 1 timetabled hour per week plus 'twilight' sessions (e.g. at lunchtimes and after school)

or

One full academic year (30 weeks): 4 hours per week

or

Year 1 June-July: 4 hours per week (taught course)

Summer vacation: independent preparation and research

Year 2 September-March: 2 hours per week

Ideally, the teacher/supervisor's time for the taught course and for project supervision is scheduled as part of their normal teaching timetable (e.g. 4 hours per week for a full

academic year). But this is not always possible, and in some schools and colleges teachers supervise project work as an extra-curricular activity in addition to their normal timetables.

Conclusion

An Extended Project (EP) enables students to pursue a special interest that might link to a future career or area of study while at the same time developing valuable transferable skills such as time management, critical thinking, focused reading, extended writing. For students with a particular interest in physics, it is an opportunity to explore an aspect of the subject in depth.

Extended project work is challenging, and places demands on both the student and the teacher/supervisor. However, experience has shown that such work is very worthwhile and we hope that increasing numbers of schools, both in the UK and overseas, will enable their students to benefit from an extended project.

In order to encourage the uptake of the EPQ, and to support students in their project work, we have been involved in developing a range of resource materials.

The Perspectives on Science course in the History, Philosophy and Ethics of Science provides materials for a taught course and includes guidance on Dissertation projects for students and for teachers. The materials are presented in a Student Book [4] accompanied by a spiral bound Teacher Resource File [5].

The Edexcel Level 3 Extended Project Guide [6] is a handbook for students that gives advice and guidance on project work which is not related to any specific subject area. The accompanying Teacher Resource Disc [7] provides materials relating to a wide variety of curriculum areas and to various types of project (Dissertation, Investigation etc.) which can be used to construct a taught course.

Additional EP resource materials relating to genomics and to the 'circular economy' are available for free download from the University of York website:

<http://www.york.ac.uk/education/projects/project-qualifications/>

Guidance on EPs, and examples of project reports, are available free of charge from the Edexcel website:

<http://www.edexcel.com/quals/project/level3/Pages/documents.aspx>

References

1. Ralph Levinson, Michael Hand and Ruth Amos: *A Research Study of the Perspectives on Science AS-level Course*. Institute of Education, University of London, 2008.
2. Ralph Levinson, Michael Hand and Ruth Amos: *What constitutes highly quality discussion in science? Research from the Perspectives on Science course*. *School Science Review* **344** pp114-120 March 2012.
3. Elizabeth Truss MP: *Reforming qualifications and the curriculum to better prepare pupils for life after school* Speech delivered at Institute of Education, University of London, 17 March 2013.
4. John Taylor, Elizabeth Swinbank, Michael Reiss, David Harrison, Peter Ellis, John Cartwright and Jonathan Allday: *Perspectives on Science* Heinemann 2007.

5. John Taylor, Elizabeth Swinbank, Michael Reiss, David Harrison, Peter Ellis, John Cartwright and Jonathan Allday: *Perspectives on Science Teacher Resource File* Heinemann 2007.
6. Elizabeth Swinbank and John Taylor (eds): *Level 3 Extended Project Student Guide* Heinemann/Pearson Education 2009.
7. Elizabeth Swinbank and John Taylor (eds): *Level 3 Extended Project Teacher Resource Disc* Heinemann/Pearson Education 2009.

Transforming the Learning Environment of Undergraduate Physics Laboratories to Enhance Physics Inquiry Processes

Gregory P. Thomas¹, Al Meldrum², & John Beamish²

¹Department of Secondary Education, ²Department of Physics, The University of Alberta, Edmonton, Canada

Abstract

Concerns persist regarding the lack of promotion of students' scientific inquiry processes in undergraduate physics laboratories. The consensus in the literature is that, especially in the early years of undergraduate physics programs, students' laboratory work is characterized by recipe type, step-by-step instructions for activities where the aim is often confirmation of an already well-established physics principle or concept. In response to evidence reflecting these concerns at their university, the authors successfully secured funding for this study. A mixed-method design was employed. In the 2011/12 academic year baseline data were collected. A quantitative survey, the Undergraduate Physics Laboratory Learning Environment Scale (UPLLES) was developed, validated, and used to explore students' perceptions of their physics laboratory environments. Analysis of data from the UPLLES and from interviews confirmed the concerns evident in the literature and in a previous evaluation of laboratories undertaken in 2002. To address these concerns the activities that students were to perform in the laboratory section of the course/s were re/designed to engage students in more inquiry oriented thinking and activity. In Fall 2012, the newly developed laboratory activities and tutorials, were implemented for the first time in PHYS124; a first year course. These changes were accompanied by structured training of teaching assistants and changes to the structure of the evaluation of students' laboratory performance. At the end of that term the UPLLES was administered ($n = 266$) and interviews with students conducted ($n = 16$) to explore their perceptions of their laboratory environments. Statistically significant differences ($p < .001$) between the students in the PHYS 124 classes of 2011/12 and 2012/13 across all dimensions were found. Effect sizes of 0.82 to 1.3, between the views of students in the first semester physics classes of 2011/12 and 2012/13, were also calculated suggesting positive changes in the laboratory inquiry orientation. In their interviews, students confirmed and detailed these positive changes while still noting areas for future improvement.

Keywords: Undergraduate Physics Education, Inquiry, Laboratory Learning Environments

Introduction: The Problem Facing Us at The University of Alberta

Undergraduate science laboratories are major teaching components within university science faculties worldwide. In the Department of Physics at the University of Alberta the annual budget for undergraduate laboratories is approximately \$1.6M for teaching assistants' (TAs) and staff salaries, and space is allocated within the new Centennial Centre for Interdisciplinary Science with a capital cost of over \$13M. Equipment maintenance adds around \$50,000 per annum. Annually, over 2,000 undergraduate students pass through these laboratories. The cost, effort, and time involved are considerable. Obviously, laboratories are a key element of the undergraduate physics learning experience at the University of Alberta. This situation is the same at many universities, worldwide.

However, despite their importance, the quality and extent of student inquiry in first-year undergraduate Physics laboratories is a long-standing issue across universities in Canada

and internationally. This, in part, is due to diverse opinions regarding the purpose/s of such activities, ranging from the development of critical thinking skills to equipment manipulation. Key objectives reportedly range from ‘developing ‘critical thinking skills’ to ‘glassware manipulation’ [1]. Many students believe the primary objective of labs is to “reinforce the lecture material,” [2] developing a ‘confirmation’ expectation through their high school experiences [1]. Recipe-like laboratory formats persist as the dominant element of instructional design, but these formats do not adequately support the development of students’ inquiry processes. To determine the objective of labs, the National Research Council commissioned a detailed investigation [3], asking what the primary motivation of the undergraduate laboratory should be. Contrary to most traditional views, it is increasingly acknowledged that ‘*science as inquiry*’ should pedagogically guide laboratory-based instruction, [3] and that labs should engage students in thinking processes and activities similar to practicing scientists [4].

At high-school and undergraduate levels, many teachers and students believe, that science advances linearly, following the ‘hypothesis-testing model’ [5]. In classrooms this is called *the scientific method*. This view is an inadequate representation of scientific inquiry and reasoning. Many scientific advances have been made without following this so-called method. Sometimes scientists have no hypothesis. Other times, discoveries are made serendipitously. It would be a challenge to find evidence of a linear ‘scientific method’ in much of advanced physics research, not to mention in many great scientific advances of the past century. Contemporary education literature suggests that a universal scientific method does not exist at all, and that inquiry proceeds in many, varied ways [6, 7, 8]. Importantly, recent literature also strongly advocates an *inquiry-based approach* to laboratory pedagogy and learning. Inquiry-oriented laboratories stimulate learners to develop increased independence and are more epistemologically and practically aligned to authentic science. Students focus on independently devising experimental methods and arriving at reasoned findings. Inquiry-based labs can enhance subject understanding and foster positive attitudes toward science and science learning [9, 10]. The position in this paper is in accord with that of the NRC and other contemporary science education literature; that the development of student’s inquiry processes is of primary importance in university level science laboratories.

A clear indication that the undergraduate Physics labs may not be adequately challenging students to become independent, inquiry oriented thinkers came in 2002 in a report [11] to the curriculum committee of the Department of Physics from a team led by Beamish, a co-author of this paper. The committee’s findings were worrying. Students were, “uniformly negative about their overall laboratory experience, despite liking the hands-on aspects of the lab, the opportunity to work in groups, and their TAs.” First year students were especially critical. Only 3 of 240 students considered the lab component of the course excellent. In PHYS 124, the largest first-year physics course with over 1,000 registered students in 2011, 73 out of 87 students rated the lab component at 3 or lower on a 5-point scale. Only 14 out of 87 students found the labs interesting and stimulating. The report proposed that “significant changes” were needed.

From a perusal of the 2011/12 PHYS 124 laboratory manual it was obvious that the labs were almost entirely confirmatory in orientation and therefore unsatisfactory as authentic physics inquiry learning experiences. For each lab, students received a set of instructions that they were expected to follow closely. There was little stimulus or opportunity for independent thought, and little authentic inquiry. Other problematic issues were also evident regarding the operation of these laboratories. Firstly, the laboratories and the

lectures were not well sequenced, with the material being introduced in lectures sometimes weeks after the related lab. Secondly, there was no interaction between the class lecturer and the laboratories. Finally, there was a vast difference in teaching ability and performance of the TAs in different lab sections. Therefore, the situation as it existed was contrary to and unsupportive of inquiry-based approaches that have been shown to foster creativity, interest, enhanced understanding and positive attitudes. Our funded project aimed to begin to address these issues.

The Team Building Process and Member Roles

The second and third authors of this paper are both Professors within the Physics Department at the University of Alberta, and are closely involved in teaching within the Department. Both were highly interested and invested in addressing the issues raised in the earlier evaluation/s of the first-year physics laboratories. In November 2010 they approached the first author to ascertain his interest in being involved in the project primarily as an evaluator of the curricular and pedagogical changes that they envisioned. Together, the three authors submitted a funding proposal that was successful.

There was a quite clear distinction in the roles of the authors and such role differentiation contributed to the overall smooth operation of the project. Authors 2 and 3 led the development of the new laboratory curriculum including the activities and tutorials, liaised between the non-academic members of the Physics Department responsible for day-to-day laboratory management, engaged in the training of the TAs regarding the new laboratory activities and tutorials, and organized access to students for the first author. The first author took responsibility for conducting the evaluation of the changes to date. It enabled the Physics Department members to initiate changes to their program and pedagogies, and the external evaluator from the Education Faculty to undertake the evaluation research in an ethical manner that did not compromise the anonymity or confidentiality of the students who provided feedback on those changes.

The Proposed Solution: The Plan and its Enactment

The extent to which laboratories are inquiry-oriented laboratories varies along a continuum. At one end of the continuum is the ‘confirmation,’ recipe-like or method-based lab, within which students have limited responsibility for independent thought or inquiry. At the other end are ‘research apprenticeships’ within which students, typically post-graduates, are expected to show evidence of considerable independent thought and inquiry as they progress to answer a question that they themselves pose using methods they devise [5]. This level most closely resembles authentic scientific research. Located between these ends of the continuum are ‘*guided inquiry*’ laboratories. Here, the procedures to solve a problem are decided upon by the student, who receives partial guidance from the instructor. They represent a balanced pedagogical approach for first-year undergraduate laboratories that are populated mainly by students whose experiences are grounded in high school, confirmatory-type studies. ‘*Guided inquiry*’ labs can promote independence and creativity and provide support and intellectual scaffolding for students from instructors.

The team received funding support to introduce A *guided inquiry* based teaching and learning in the first-year physics labs at the University of Alberta. Guided inquiry meant that the students were not to be left to flounder in a ‘sink or swim’ environment when engaging with the new activities. Rather, they were to be supported by the TAs whose role it was to scaffold their thinking and provide guidance. The implementation of such

a philosophy to the laboratories brought with it challenges. There was considerable variation in teaching skill amongst our TAs; we faced highly questionable conditioning and preparation in many students coming out of high school; and it was anticipated that instructors and TAs would encounter the need to address different pedagogical issues than they would in more traditional, 'confirmatory' labs. Inquiry-based learning implies significant changes to existing methods and it was imperative to increase the pedagogical awareness and capabilities of our instructors and TAs.

To begin to address these issues, TA meetings were conducted every Friday at 2PM for the following week's lab. Each meeting lasted about an hour. These meetings were made mandatory for all TAs whereas, in the past, they were optional. The purpose of the meetings was to discuss the pedagogical objectives of the following week's labs, ensure the TAs were familiarized with the equipment to be used, and to discuss any issues or comments the TAs had about the lab that had been completed during the week of the meeting. Suggestions for improvements, for example, to marking, or means to enhance efficiencies were encouraged and often discussed. Four-to-five slide PowerPoint presentations for the TAs regarding forthcoming laboratory and tutorial activities were developed by the instructors, shown at the meeting, and emailed to all TAs for their information and use. The TAs were permitted to make modifications as they saw fit according to their individual teaching styles.

In determining which activities were to be conducted by students in the laboratories the key criteria was that the labs and tutorials needed to be based in engagement in guided inquiry, and not on rote, recipe-following as in the past. The activities needed to link to modern work in physics as much as realistically possible given the low level (first year). They needed to be able to accommodate students who varied considerably in their previous access to and/or experience conducting physics experiments in high school. They needed to avoid 'magic formulas' that the students simply had to be told, without any understanding of where they come from, which was a significant issue in the previous lab format. The question that was to be put to students in the laboratory and tutorial activities was to be, "How, do I solve the problem?" rather than "What is the final answer?" The activities also needed to continually reinforce students' data presentation and data-handling skills, and encourage students' independence though the use of their own portable computers as much as possible, even though lab computers were provided for those needing them. A key variation between 2011/12 and 2012/13 classes was that students in the 2012/13 classes were allowed to take their data and complete their laboratory reports after the lab session had concluded. This was in contrast to previous practice in which they were expected to complete their lab reports prior to leaving the laboratory session.

Tutorials were added to the laboratory schedule, replacing some experimental sessions, with the main intention to provide a source of questions or problems that would be relevant to modern happenings in the field of physics. These were intended to capture the students' imagination, while providing challenging material for independent thought. Additionally, they were meant to push the students' computational and data-handling skills. For example, one tutorial included calculations about the transits of Venus, the most recent transit occurring to great fanfare in 2012, only a few months prior to the tutorial. Another asked students to download images of the Sun from the week prior to their tutorial, taken by NASA's SOHO satellite, and to use the images to calculate the Sun's rotation rate. Therefore, the tutorials offered a flexibility that a lab could not always offer, especially with regards current happening in the physics 'world.' The eventual aim is for future instructors to invent one or two new tutorials each semester, to be added to a collection of

such activities for future use and reference. Over the course of the 2012/13 fall term students engaged in 4 tutorials and 6 laboratory activities, compared with 10 laboratory activities and no tutorials in the previous year and for several years before.

The Evaluation of the Changes Made

A mixed-method methodology was selected for the evaluation of this project and the effect of the curricular and pedagogical changes. Mixed-methods research is a pragmatic approach to research that allows researchers to “select methods and approaches with respect to their underlying research questions, rather than with regard to some preconceived biases about which research paradigm should have hegemony in social science research” [12]. This evaluation involved the development and use of a learning environment survey, custom-oriented to undergraduate physics laboratories [13], and interviews. A 23-item instrument, the UPLLES (Undergraduate Physics Laboratory Learning Environment Survey) was developed and validated through (a) factor analysis, using responses of 476 students, and (b) semi-structured interviews with 19 of those students [13]. The five sub-scales of the UPLLES are Inquiry Orientation (5 items), Integration (5 items), Material Environment (4 items), Student Community (6 items), and Instructor Support (3 items). Each item on the instrument is scored on a 5-point Likert scale (1 = Almost Never to 5 = Almost Always). Table 1 [13] is a description of each of the five subscales and the learning environment dimensions they represent. Table 2 shows the item-mean values (Min = 1, Max = 5), Cronbach’s alpha values, and effect sizes for each of the sub-scales, pre- (2011/12, N = 269) and post- change (2012/13, N = 265).

Table 1. Description of Scales and a Sample Item for Each Scale on the UPLLES

Scale Name	Description (Extent to which students consider:)	Sample item (In my physics laboratory classes:)
Integration	...that laboratory activities and content are integrated with non-laboratory & theory classes.	...students understand the relevance of what they are learning in their physics lectures.
Student Community	...that students are helpful and supportive of each other and their physics learning.	...students carefully consider the ideas of others in the class.
Inquiry Orientation	...they are asked to engage in inquiry-type investigations and thinking to learn about physics.	...students design their own ways of investigating problems.
Instructor Support	...they are supported and encouraged by laboratory instructors to engage in and improve their physics learning.	...instructors encourage students to think about how to improve their lab performance.
Material Environment	... that the material resources in the physics laboratories are adequate for the performance of the required tasks.	...the materials that students need are readily available.

The UPLLES was used, with interviews, to evaluate the 2011/12 first-year Physics laboratory environments at the University of Alberta, i.e., pre-pedagogical change.

Table 2. Pre- and Post- Item mean Scores, Cronbach Alphas and Effect Sizes for PHYS 124 Students' Responses to UPLLES Classroom Environment Scale

		Inquiry Orientation	Integration	Material Environment	Student Community	Instructor Support
Pre (2011/12)	Mean	2.410	3.155	3.725	3.641	2.870
	S.D.	0.749	0.909	0.743	0.733	0.983
	α	0.75	0.76	0.66	0.84	0.71
Post (2012/13)	Mean	3.379*	4.005*	4.316*	4.135*	3.627*
	S.D.	0.739	0.696	0.541	0.589	0.871
	α	0.77	0.85	0.62	0.80	0.75
	Effect size	1.30	1.05	0.85	1.19	0.82

* $p < .001$

The data analysis confirmed their lack of inquiry orientation. Table 2 shows the pre-pedagogical statistical findings. In summarizing the interviews, students confirmed the 'recipe-like' format of the experiments; "Mostly, we just follow the procedure in the lab manual...much like high school physics, still...we don't get to design anything on our own," and "when you are doing the experiment it's like a step-by-step of what you are supposed to do so that you get close enough to the proper results." They bemoaned the intense nature of the lab experience and the pressure on them to complete all work in three hours; "You were just focusing on rushing and writing up the conclusion as quickly as you can and you're not really thinking about the science behind it, and "The labs are kinda rushed...they don't let you completely immerse yourself in the experience that you are having." Further, they criticized the lack of connection and integration between the lectures and the lab component; "The labs are quite a bit ahead of the class. So sometimes we'll be doing something in the lab and we haven't even touched (it) in class...we were doing waves for the last couple of labs and in class we just started on labs" and "There was a bit of an issue where we were working on a problem in the lab, but that is three weeks ahead and we hadn't talked about it yet...the frustrating part about that is when you haven't learned the concepts and you're being graded on those mistakes." Students confirmed our existing views that the laboratory activities and students' experience with those activities was inadequate to foster the cognition and dispositions we were interested in developing.

Analysis of the statistical data between pre- and post- student populations (Table 1) using independent samples t-test/s shows that the changes initiated by the Physics Department had a significant positive effect on students' perceptions of their experiences and the nature of their laboratory learning environment. The large effect sizes confirm marked changes in students' perceptions. While these findings might seem predicatble, there are very few if any studies that provide anything other than anecdotal evdienvce on the effect of such changes, especially with such large student cohorts. In interviews, the students described the type of thinking they considered was required of them in the 2012/13 laboratories and tutorials. They reported that they were given a starting point, a problem to solve, and from there they had to determine how to proceed, how to make sense of the problem, how to

bring their learning from lectures, e.g., equations, to bear on the problem, and how the TAs, in general, provided guidance through scaffolding support without ever ‘telling them the answer,’ so that the students had to arrive at the end point themselves. Students in 2012/13 were much more satisfied with their experience than those the previous year, even though the thinking they were asked to undertake might be considered more challenging, and certainly more inquiry orientated, than previously asked for. Examples of the 2012/13 students’ intimations during the interviews, woven together from their interview transcripts are immediately below. These clearly help identify differences between the perceptions of the 2011/12 and 2102/13 cohorts regarding their physics laboratory learning environments.

My labs take the whole three hours and all of the lab report is done after. They don’t give you any guidelines. It’s like, “This is the answer we want, here’s maybe a hint, and then you have to go and figure it out by yourself. In the solar rotation lab, they basically told us what they wanted, with no hint of all of the math behind it and what we needed to use and what different equations to use. We had nothing to start with, just what they wanted [asked for]. And so, most of the stuff that we used was our own thinking...and then the laboratory instructor ended up helping us a lot because we were all clueless as to where to start to approach it. So, it was all very much starting from scratch. [There was] a lot of talking and trying to figure it out. We take what we have done and what we can measure...there were about five of us trying to work it out together.

I found that the way the labs were set up in Physics 124, it made me so relaxed that when I came into the labs I was encouraged to to learn about what the topic of the day was. Our laboratory instructor was really good, [saying] “This is a calm environment; you don’t have to rush through the three hours.” So, you can actually ask questions and learn more about it and learn things that you want to learn out of it, not just the basis of what the lab’s about. The procedure for the labs is pretty much left to you. A good thing with the physics labs was that you could read ahead with the notes that your prof posted or you could refresh from the notes that you had already gone through, and then apply that to the lab that you’re doing. You had that knowledge and it wasn’t just coming out of random places that you had never experienced before.

I think they were looking for us to do a lot of critical thinking, not just how to plug numbers into formulae and spit out more numbers, but [to look at] the concepts behind it and how certain discoveries were made and how we could use these in our daily lives. In physics [labs] there’s no ingredient list, there’s no formula to follow. You have to figure out what you’re doing.

Most of the thinking was, “How do you take a problem and work through it?” Most of it was word problems. They didn’t just give you a formula and say “Go with it.” YOU had to decide which formula you had to use, because sometimes they gave you a lot of formulas and you had to use one of them. Or sometimes they only gave you one formula and you had to derive the others. So YOU had to figure out which formulas to use and how to do it. I remember one lab, in particular. The quantum tunneling lab. There were a lot of theoretical questions about that, and you really had to think totally ‘outside the box’ as to how it happens or could possibly happen. In our group it sparked some pretty good discussions.

Concluding comments and Implications

This study suggests that substantial change/s can be effected in undergraduate physics laboratory classes in settings where there are large numbers of students taking first year courses and multiple laboratory sections. This is an important finding for undergraduate science education nationally and internationally. It is also clear that new collaborations, in

this case those linking Physics and Education faculty can result in positive outcomes for students, faculty and the university and that such collaborations should be promoted within universities. Further activities and studies are planned to build on these results from across other first year physics courses, to refine the activities already developed, and to develop and evaluate training programs for graduate teaching assistants.

References

- [1] Weaver G. C., et.al: (2008). Inquiry-based and research-based laboratory pedagogies in undergraduate science. *Nature chemical biology*, 4, 577-580.
- [2] Russell C. B., et.al: (2008). Student perceptions of the purpose and function of the laboratory in science: A grounded theory study. *International Journal for the Scholarship of Teaching and Learning*, 2, 1-14.
- [3] National Academy of Sciences. (1996) *The National Science Education Standards*. National Academy Press, Washington; DC.
- [4] National Research Council. (2000). *Inquiry and the National Science Education Standards: A Guide for Teaching and Learning*. Center for Science, Mathematics, and Engineering Education. Washington, DC.
- [5] Windschitl M.: (2002). Inquiry projects in science teacher education: What can investigative experiences reveal about teacher thinking and eventual classroom practice? *Science Education*, 86, 112-143.
- [6] Alters B. J.: (1997). Whose nature of science? *Journal of Research in Science Teaching*, 34, 39–55.
- [7] Knorr-Cetina K.: (1999). *Epistemic Cultures: How the Sciences Make Knowledge*. Harvard University Press, Cambridge: MA.
- [8] McGinn M. K., Roth, W. M.: (1999). Preparing students for competent scientific practice: Implications of recent research in science and technology studies. *Educational Researcher*, 28, 14–24.
- [9] Chang C. Y., Mao S. L.: (1999). Comparison of Taiwan science students' outcomes with inquiry-group versus traditional instruction. *Journal of Educational Research*, 92, 340-346.
- [10] Luckie D. B., et.al: (2004). Infusion of collaborative inquiry throughout a biology curriculum increases student learning: a four-year study of “Teams and Streams.” *Advanced Physiology Education*, 28(4), 199-209.
- [11] Beamish J., et.al: (2002). Report to the Curriculum Committee of the Undergraduate Laboratories Review Committee. Department of Physics, University of Alberta.
- [12] Johnson R. B., Onwuegbuzie A. J.: (2004). Mixed methods research: A research paradigm whose time has come. *Educational Researcher*, 33(7), 14-26.
- [13] Thomas G. P., Meldrum A., Beamish J.: (2013). Conceptualization, development and validation of an instrument for investigating elements of undergraduate physics laboratory learning environments: The UPLLES (Undergraduate Physics Laboratory Learning Environment Survey). *European Journal of Physics Education*, 4(4), 28-40.

Development of a Pre-service Course on Integration of ICT into Inquiry Based Science Education

Trinh-Ba Tran¹, Ed van den Berg¹, Ton Ellermeijer², Jos Beishuizen¹

¹VU University Amsterdam, the Netherlands

²Foundation CMA, the Netherlands

Abstract

In order to be able to integrate ICT into Inquiry Based Science Education (IBSE), teachers need much time and support for mastering ICT tools, learning the basis of IBSE, and getting experience in applying these tools in pupil investigations. For this purpose, we have developed a course within the teacher education program of universities in the Netherlands. During the course, pre-service teachers learn to use and apply one of three ICT tools i.e. data logging, video measurement, or modeling to design and implement an inquiry-based lesson in the classroom. The course participants are expected to study on their own most of the time through a blended setting including life sessions, in-between tasks, and an online platform with support materials and with close supervision. The challenges are the lack of time and the heterogeneous background of pre-service teachers, many of whom opted for teaching later in life, not immediately after university and already hold first year teaching jobs.

This paper presents the first case study on implementation of the course in early 2013 with 12 pre-service teachers. The learning scenario was implemented quite faithfully as the life sessions were executed pretty smoothly, and finally, almost all participants went through a complete cycle of designing, implementing, and evaluating an ICT-IBSE lesson. Within a limited time, the heterogeneous group of pre-service teachers achieved a reasonable level of competence regarding the use of ICT in IBSE. There was still a considerable difference between intended inquiry activities and actual realized inquiry which parallels result from the literature [1], [8]. The blended setting with support materials contributes to this result if course participants really spend considerable time outside the life sessions. Also discussed in this paper are revision for further rounds of development based on case studies in the Netherlands and investigation on applicability of the course setting and materials in different contexts e.g. in-service training, other countries.

Keywords: Coach, IBSE, ICT, Pre-service Teacher, Teacher Education

1. Introduction

1.1. Boundary conditions of the course

As in many other countries, the Netherlands has two tracks for physics teacher education:

- A bachelor-level physics-teacher education degree at a College for Professional Studies where students study both physics and education and which certifies graduates to teach at the lower secondary level.
- A postgraduate program at Universities where students must have a bachelor degree in physics and take two years of the master-level physics program, before taking one year (60 ECTS points) of teacher education including the school internship. All coursework is scheduled on one day per week; 3 days are spent in the school; and one day is for assignments. Graduates of this program are certified to teach at the upper secondary

level. Another option is to integrate the one-year teacher education into the 3 + 2 year Bachelor – Master program.

That postgraduate program is very full and does not allow much room for contents on ICT in science education. This paper is about development of a one-EC course for pre-service secondary-science teachers on the application of ICT in inquiry-based lessons. Introduced in this course are the ICT tools integrated in the Coach learning environment, including:

- **Data logging** tool which enables students to collect data via sensors.
- **Video measurement** tool which enables students to measure on videos.
- **Modeling** tool which enables students to create numerical models of changing systems.

More detail about these Coach tools can be found in Heck et al. (2009) [7].

During the course, the participants will learn:

- To use the Coach tools in Physics/Chemistry experiments – Technical Content Knowledge (TCK) domain.
- To apply them to teach inquiry-based Physics/Chemistry lessons – Technical Pedagogical Content Knowledge (TPCK) domain [11].

The dilemma is that both participants and their pupils have to learn many technical details (just think of video measurement as an example), and yet the focus should be on inquiry and concept learning rather than on following recipes (for doing video measurement). Furthermore, in Dutch physics and chemistry teacher education, most pre-service teachers already have a teacher appointment rather than only a guided internship due to a shortage of physics/chemistry teachers. They experience all the pressures of a first year teacher. The course participants, therefore, need not only the ICT facilities but also much guidance and time for their learning. The time constraint issue should be taken into account for the course design.

The student population in teacher education programs in the Netherlands has changed. Twenty years ago all students were fresh master graduates. Now the majority of students obtained their master degree many years ago, then worked for 5-25 years in a research or an industrial job, and either by choice or through reorganizations decided to opt for teaching. As a result, participants in pre-service teacher education are very heterogeneous in terms of:

- age (24-50 years old),
- subject background (from just graduated to a PhD or even years of research experience in physics or chemistry),
- experience with the ICT tools (most participants know very little about video measurement and modeling; some are quite familiar with data logging; some have no experience with these Coach tools at all).

Teaching conditions in their schools are different as well. Most, but not all, have sufficient software, sensors, interfaces, computers for ICT-integrated lessons, but in some schools these are rarely used. The course participants teach at various levels: first or last years of HAVO (general education) or VWO (pre-university), so possibilities and demand for application of the ICT tools in the class are also different. In brief, the pre-service teachers turn out to have heterogeneous backgrounds and different teaching situations. The challenge is how to design the ICT-IBSE course that fits both participants' heterogeneity and the time constraint.

1.2. Principles underlying the course design

1.2.1. Being aware of possibilities of the ICT tools and learning only one tool by choice

The first level of integration of ICT into IBSE is awareness of the possibilities of using various ICT tools in science lessons. The second level is technical mastery of the tools. The third level is the ability to integrate the tools into the lessons to achieve minds-on inquiry and meaning making. In a course restricted to one credit point, participants cannot learn all of the ICT tools deeply. Consequently, we decided to aim at level 1 for all tools but to aim at levels 2 and 3 only for one of the three tools: data logging **or** video measurement **or** modelling. The participants can choose which tool they want to master and include in an inquiry-based lesson they will teach. Learning only one tool by choice during the course, the participant will have more time to achieve real mastery of the particular tool in both technological (TCK) and pedagogical (PCK) aspects.

Furthermore, the three ICT tools, taught in the course, are integrated in an Open Learning and Authoring Environment, Coach [7]. This environment started with a vision of a hard- and software environment in which tools for measuring, data processing, and modeling are integrated in a single system that supports student learning in an inquiry-based approach of science education [6]. Therefore, a user, who has experience with one tool, can learn other tools easier and faster. The assumption is then that once the participant specializes in one of the Coach tools, the perspective of using Coach and experiences of deeply learning in one tool make it possible for her/him to learn and apply other tools on her/his own. We will check this assumption through follow-up research.

1.2.2. Trying out classroom activities through a complete cycle of designing, implementing, and evaluating an inquiry-based lesson integrated ICT activities

In a review of decades of research on laboratory use in science education, Hofstein and Lunetta (2004) [8] reported that many activities in laboratory guides continue to offer “cook-book” lists of tasks for pupils to follow ritualistically. They do not engage pupils in thinking about the larger purposes of their investigation and of the sequence of tasks they need to pursue to achieve those ends. Pupils often perceive that the principal purpose for a laboratory investigation is either following instructions or getting the right answer. Pupils often do not connect the experiment with what they have done earlier. Abrahams and Millar (2008) [1] summarized results of observations in 25 typical laboratory lessons in the UK as follows:

The teachers' focus in these lessons was predominantly on developing students' substantive scientific knowledge, rather than on developing understanding of scientific enquiry procedures. Practical work was generally effective in getting students to do what is intended with physical objects, but much less effective in getting them to use the intended scientific ideas to guide their actions and reflect upon the data they collect.

How can we support teachers dealing with this issue through the training course? Literature on effectiveness of teacher professional development shows that a traditional training course will only be effective when supplemented by expert or peer coaching and other school-based activities [4]. It is essential to create the proper conditions for teachers individually to prepare work plans and lesson materials for their pupils [2]. In our course, the teaching of mastery and use of ICT tools is combined with the issue of minds-on inquiring and meaning-making in the laboratory. Therefore, it requires a priority for participants to go through at least one complete cycle of designing, implementing, and evaluating an ICT-IBSE lesson. It creates opportunities for the course participants to

recognize and cope with the issue of cookbook-versus-inquiry use of the ICT tools or with science & ICT conceptual issues in using a particular Coach tool in the science class.

1.2.3. Learning through a blended setting including life sessions, in-between tasks, and an online platform with support materials and with close supervision

A training course often offers few opportunities for choice or individualization, so it may not be appropriate for varied levels of teacher knowledge and skills [5]. In addition, the application of skills is much higher when teacher professional development includes theory, demonstration, practice with feedback, and peer coaching with follow-up [9]. In order for participants to retain and apply new strategies, skills, and concepts, they must receive coaching while applying what they are learning. Training sessions, therefore, must be extended, appropriately spaced, and supplemented with additional follow-up activities to provide the feedback and coaching necessary for the successful implementation of new ideas [5].

A blended setting, which consists of life sessions, in-between tasks carried out in participants' classrooms with individual feedback from the teacher educators and with ample support materials, suits the boundary conditions of the course. It will accommodate the considerable differences of participants' background and teaching conditions in schools. The participants can choose among flexible options of the Coach tools, lesson topics, levels of inquiry, and time etc. with which they feel most confident, convenient, and effective. However, the in-between tasks require much time, and working alone is hard for the pre-service teachers whereas they may struggle with general time pressure and typical technical difficulties in mastering a new tool. The crucial issue is how to keep participants on task while they mostly work in distance learning mode. In this case, participants need an online platform (<http://ibse.establish-fp7.eu/>) where they can access support materials and receive timely supervision from the teacher educators.

2. Course design

2.1. Teacher learning scenario

The teacher learning scenario elaborated from the design principles includes a sequence of life sessions (in contact time) and in-between tasks (out of contact time). The course participants will go through main activities as follows:

- *Pre-course preparation* (1-3 hours): Installing the Coach software; getting started with Coach basic activities; reading the course program, background articles, and PowerPoint slides.
- **Session 1** (3 hours): Learning basic concepts, skills related to the Coach tools and becoming aware of possibilities of using these tools in science education (Figure 1a).
- *Task 1* (3-5 hours) within 2-3 weeks: Practicing with only one tool (data logging or video measurement or modeling) by choice to acquire the advanced skills.
- **Session 2** (3 hours): With the chosen tool, preparing an inquiry-based lesson plan which consists of ICT activities.
- *Task 2* (7-11 hours) within 3-4 weeks: Accomplishing the lesson plan, trying it out in the class (Figure 1b), and then self-evaluating the tryout.
- **Session 3** (3 hours): Reporting and discussing ICT-IBSE tryouts (Figure 1c).

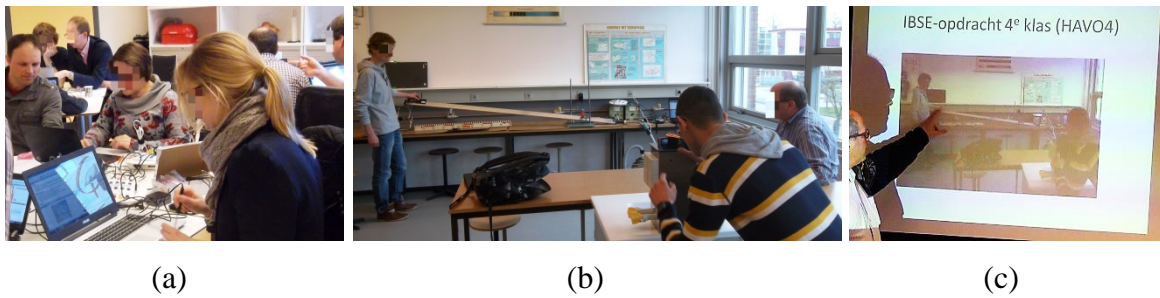

Figure 1. Photographs of participants' activities in the course (a), in their classrooms (b), and reporting back in the course (c)

2.2. Support materials

To learn using a particular tool both in life sessions and for in-between tasks, participants are advised to practice the given Coach activities which are divided into three categories:

- Coach basic activities (Figure 2) are ready-to-use activities, which introduce simple manipulations and elementary concepts related to a particular tool. Practising these basic activities does not require any previous experience with the Coach platform.
- Coach tutorial activities help to improve skills and concepts corresponding to a particular tool through step-by-step written instructions (Figure 3a) or video tutorials (Figure 3b).
- Coach subject activities are ready-to-use activities focussed on a particular topic (e.g. electromagnetic induction), which serve as a source of ideas or as a resource for further development.

To learn applying a particular tool, participants are provided references (e.g. background articles, PowerPoint slides) on the basics of IBSE and the Coach tools; forms for designing and evaluating ICT-IBSE lessons; and examples of ICT-IBSE activities.

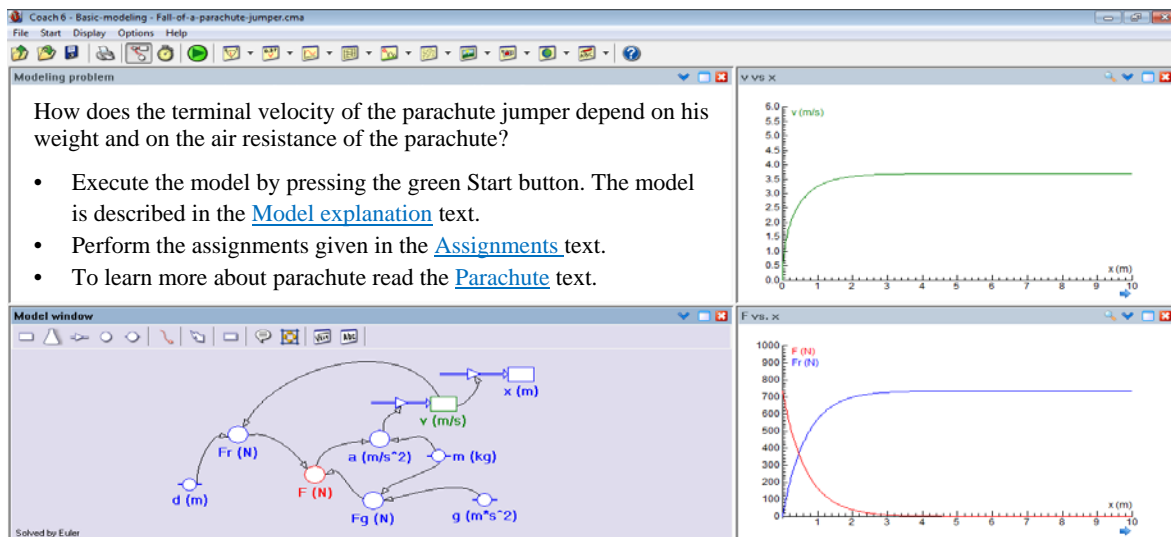

Figure 2. Screenshot of a Coach basic modeling activity: Fall of a parachute jumper

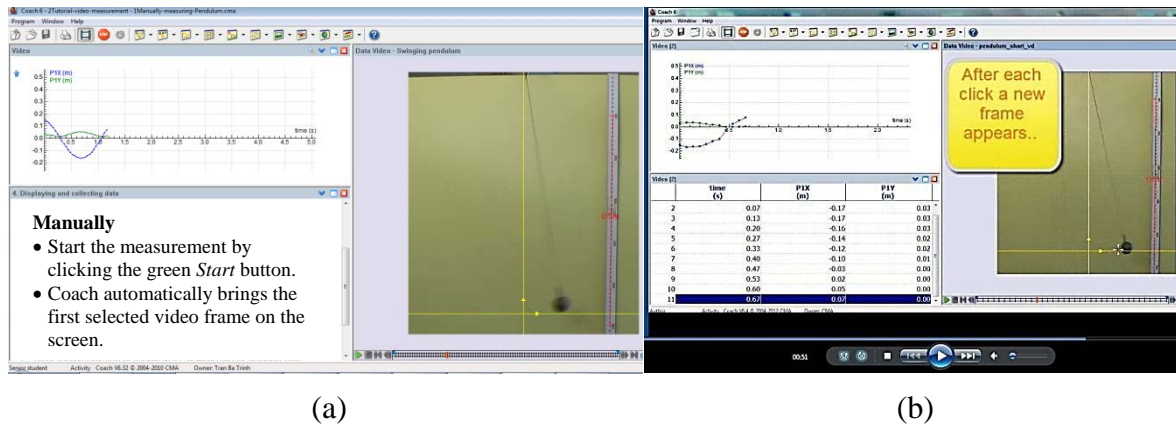

Figure 3. Screenshots of written instructions (a) and video tutorials (b) for a Coach tutorial video-measurement activity

2.3. Research instruments

Our research aims to evaluate faithful implementation and effectiveness of the course through assessment of the participant's learning processes and outcomes. In execution of the course in a case study, we focus on the following main questions:

- To what extent is the course implemented as intended?
- To what extent does the course have the effects as expected?

The case study approach allows using a variety of sources, types of data, and research methods. Observations of events can be combined with the collection of documents from formal activities and informal interviews with people involved. Questionnaires might be used to provide information on particular points of interest. Findings from one method can be compared and contrasted with the findings from another [3]. Following this approach, we designed and used a set of assessment instruments including four categories i.e. questionnaires, observation, documents, and interviews (Table 1). The use of these multiple methods and data sources allows us to validate data through triangulation.

Table 1. The course assessment instruments (The labels about data sources e.g. Q1, O2, D3 etc. are referred from Section 3 about implementation of the course)

Category	Assessment instruments
Questionnaires	Q1. Pre-course questionnaire Q2. Post-course questionnaire Q3. Follow-up questionnaire
Observation	O1. Observation of course sessions O2. Observation of classroom tryouts
Documents	D1. Reports on practice with the Coach tools (Task 1) D2. Lesson plans (Task 2) D3. Reports on tryout evaluation (Task 2) D4. Pupils' assignment reports (Task 2) D5. Discussions between participants and teach trainers via Internet D6. Coach activities and results
Interviews	I1. Interviews with participants I2. Interviews with teacher trainers

3. Implementation of the course: Outcomes from the first case study

The course is offered jointly by Dutch universities. Pre-service teachers, who are interested in the contents, will enrol in the course which is counted as a one credit point of their teacher education programs. In this paper, we present data from the first case study with 8 physics and 4 chemistry pre-service teachers of VU University Amsterdam and Utrecht University from *January 28 to March 4, 2013*. 75% of participants had just taught less than one year as an internship and/or paid teacher, and others had a-few-year teaching experience (less than 5 years). Before the course, they were moderately familiar with data logging, data processing and analysis; slightly familiar with video measurement and modeling (Table 3). Their theoretical knowledge about the intentions of IBSE was good (Q1).

3.1. To what extent the course was implemented as intended

3.1.1. About implementation of life sessions

Life sessions went quite smoothly, and all planned contents were covered. The biggest unexpected problem occurred in Session 3 as only two participants had finished their tryouts, and 7 out of 12 participants had submitted their lesson plans (O1, D2, D3). The schedule for Session 3, therefore, was revised. Eventually, 11 participants did manage to implement their ICT-IBSE lesson plans in the class, but 9 of them did not have an opportunity to present their tryouts and receive feedback.

Most plenary presentations and discussions lasted longer, so time for hands-on, in-group activities was less than intended (Table 2) (O1). The Coach trainers claimed (I2) that plenary time was too short. In other trainings they often spend almost a day of introduction and demonstration to make teachers aware of possibilities of the Coach tools and provide them basic guided practice, whereas here they only had 45 minutes in Session 1 for this task with the similar goal.

Table 2. Time used for main activities (Act) during the life sessions (O1) and changes suggested by participants (Q2)

Sessions	Activities	Intended	Implemented	Participants preferred	
1	Act1	Plenary introduction and demonstration about the ICT tools	45 minutes	55 minutes	Less time
	Act2	In-group practice of basic skills with particular tools	90 minutes	70 minutes	More time
2	Act3	Plenary discussion on the first in-between task	40 minutes	50 minutes	Less time
	Act4	Plenary instruction to develop IBSE lesson with the tools	50 minutes	55 minutes	Less time
	Act5	Individual/ group preparation of a Coach activity and an IBSE lesson plan	90 minutes	60 minutes	More time
3	Act6	Plenary discussion on the second in-between task	100 minutes	70 minutes	Less time
	Act7	Plenary discussion on added values of the ICT tools to IBSE	15 minutes	15 minutes	Less time
	Act8	Plenary presentation on developing the curriculum line for modeling at lower secondary	20 minutes	45 minutes	Less time

The mean of weight of each rating (Q2) for each activity showed that the course participants desired more time for **hands-on activities** such as in-group learning of basic skills with particular tools (Act 2) in Session 1 and **in-group** preparation of a Coach activity and an inquiry-based lesson (Act 5) in Session 2. Discussions with the whole class (Act 3, Act 6 & Act 7) were lengthy for them. Q2, I1, and I2 responses yielded the same results. The participants also wanted us to give detailed feedback on individual participant's reports rather than just only in the plenary discussion.

In both the program and Sessions 1 & 2, participants were suggested to choose only one particular tool to practice and apply during the course (O1). In reality, many participants did not follow. For Session 1 and Task 1, they learnt to use a new tool to them (video measurement or modeling) (D1, I1), but for application, they chose a more familiar tool to them and their pupils (data logging) (O2, D2, I1).

3.1.2. About implementation of the course assignments

The course assignments were fulfilled quite well in general as finally, 11 participants (out of 12) already implemented their IBSE-ICT tryouts at a certain level of inquiry and with good ICT integration. The course required a total of 28 hours, of which 9 hours were for attending life sessions, and other 19 hours were for working individually on assignments. Time investments of participants (Q2, D1, D3) varied a lot and deviated much from what we had anticipated. On average, the participant spent about 2.2 hours for pre-course preparation, 3.6 hours and 8.2 hours for Task 1 and Task 2. The time spent on independent study (14 hours) was less than we expected (19 hours). However, we were quite content with this number, because pre-service teachers' workloads are high and demanding. A participant wrote in the cancellation email after attending Session 1 as follows: *"Unfortunately, I would like to cancel my participation due to my current workload and objectives. Another reason is that the remainder of the course is aimed at preparing and developing an ISBE lesson plan and to tryout in school before March 4th. Unfortunately, this course objective is not feasible for me at this stage"*. This teacher cancelled participation in the first course, but took part in the second.

By Session 1, just a half of the participants had fulfilled pre-course preparation. Most of the participants just prepared themselves for the course a half day or several hours beforehand. A few participants after Session 1 were still not clear about the main task of preparing and implementing an ICT-IBSE lesson in their own classes. Moreover, 5 participants were absent at Session 1 for various reasons. These facts had some negative effects on the fulfillment of the ICT-IBSE tryouts.

Participants' tryouts were extended still for one month and a half beyond the course (not as intended). From Q2, D5, I1, we found out several obstacles to their preparation and implementation of ICT-IBSE tryouts as follows.

- Lack of Windows PCs, the Coach interface and sensors in some schools (I1). For instance, because of the school using MacBook instead of PC, a participant could not try out his planned lesson. Coach is still not compatible with Macintosh yet. Another participant had to borrow voltage and current sensors from the CMA foundation for his tryout.
- Room in the physics curriculum and school agendas for 3 weeks in between Sessions 2 & 3 (including a one-week school vacation) turned out to be too limited for tryouts of some participants (I1). For example, a teacher chose to use the data logging tool to teach the topic of ultra sound. In these 3 weeks, he had to finish other planned contents

for the school exam and teach prerequisite concepts about sound waves. Another teacher had to borrow a class from a colleague for tryout because his class already completed the topic of his ICT-IBSE lesson plan.

- Although the course participants, working in school as teachers, are quite independent in teaching, they still have to consult the mentor teacher for lesson plans; contact the technical assistants for arrangement of PCs, lab apparatus; and discuss with their pupils for planning. These appointments and preparations also took time (I1). Another inconvenient case for instance was that due to the school not having Coach available in PCs yet, a participant had to ask the technical assistant to install Coach (a teacher was not allowed to install any software in the school computers), but the assistant could not manage to do it in the intended weeks for some reasons.
- Secondary pupils are quite familiar with data logging, but slightly familiar with video measurement, and especially unfamiliar with modelling (I1). Consequently, participants choosing video measurement or modelling faced extra difficulties.

Besides regular lessons with a whole class, there were tryouts in context of a school project or with a small group of students (O2, D2, D3, I1). With these choices, the participants can enlarge the range of topics for tryout and overcome the lack of equipment. For example, with a group of only 2 students, the pre-service teacher could use her/his PC with the Coach software and a few sensors available in the school or borrowed from the CMA foundation. In this case, positive motivation helped participants dealing with difficulties about the tryout condition as mentioned above. The participants ranked (Q2) the three most influential factors on their distance learning i.e. "*awareness of benefits of performing the tasks*", "*sufficient working conditions such as time, equipment, and school support*", and "*timely help from teacher trainers*". The online platform did not really make a reasonable impact. The history section of the Moodle platform showed that the participants only logged on the Moodle platform to download the support materials and upload their reports as we suggested. More work is needed to make the online platform more instructive and accessible (Q2, I1).

With regard to the blended setting, the participants found it suitable for them. Following are some comments (Q2), "*The blended setting offers you the opportunity to work in your own time*", "*I prefer the longer timeframe. It gives you time to work at home and make a real product instead of rushing through something*", "*With the blended setting, you have more time to actually develop and carry out a lesson plan*". Data from observation (O1), interviews (I1), questionnaires (Q2) were in line with each other, showing that the Coach activities, among other support materials, contributed positively to implementation of the blended setting.

3.2. To what extent the course had the effects as expected

3.2.1. About the TCK domain: Learning to use the ICT tool

According to self-reports via the pre- and post-course questionnaires (Q1, Q2), the participants' familiarity with the Coach tools (Table 3) increased during the course as well as their confidence with particular manipulations with the Coach tool. This was supported by evidence from our observation of participants' manipulation with the tools (O1, O2) in both life sessions and the classroom and their Coach result-files (D6).

Table 3. Level of participants' familiarity (self-report) to each Coach tool

	Mean for all participants (sample 1)		Mean only for participants who chose the tool to learn in depth (sample 2)	
	Pre-course	Post-course	Pre-course	Post-course
Data logging	2.6	3.3	2.5	3.4
Video measurement	1.8	3.0	1.9	3.0
Modeling	2.0	3.4	2.3	4.0

From the participants' responses (Q1, Q2) about the familiar level: 5-point scale (1 = not at all familiar and 5 = extremely familiar), we calculated the mean for familiarity with each tool (Table 3) for all participants (Sample 1) or only for those who chose the tool to learn during the course (Sample 2). Familiarity increased less for data logging and much more for video measurement and modeling. Because many participants learnt two or even three tools during the course, there were no differences between the total group (Sample 1) and the ones specializing in one tool (Sample 2), except for modeling.

To individual level, participants' mastery of the chosen Coach tool after the course varied considerably (Q1, Q2, O1, O2, D6). A few participants reached the advanced level of using their chosen tool. For instance, one teacher developed a complex modeling activity on chemical equilibrium by himself. Another participant wrote lab instructions for her pupils to carry out a data logging activity about discharging a capacitor. Some participants only gained basic skills and just modified the existing Coach activity for their tryouts. In addition to typical beginner's technical "how-to" issues, the participants faced science and ICT conceptual problems of using a particular ICT tool. A list of observed science-ICT problems will be described in a separate paper.

3.2.2. About the TPCK domain: Learning to apply the ICT tool in inquiry-based lessons

Participants' lesson plans (D2) showed quite clear inquiry ways by which they aimed to teach a certain topic with a particular ICT tool. Most participants set up their tryouts in the context of one regular lesson with a whole class. In inconvenient situations as mentioned above, two participants had to ask a small group of pupil volunteers for their tryouts. The selection of the topic, the level of inquiry, and the Coach tool for the ICT-IBSE lessons was flexible (Table 4), based on many factors such as availability of Coach tools and PCs in the school; room in the curriculum and the school agenda for the intended time; levels of pupils, etc.

Table 4. Participants' ICT-IBSE tryouts

	Tool	Context	Planned lesson	Implemented lesson
Participant 1	Data logging	School project	Guided inquiry	Cookbook lab /Guided discovery
Participant 2	Data logging	Small group	Guided discovery	Guided discovery
Participant 3	Modeling	A lesson	Guided inquiry	Guided inquiry
Participant 4	Data logging	A lesson	Guided inquiry	Guided inquiry
Participant 5	Data logging	Small group	Guided inquiry	Guided inquiry
Participant 6	Data logging	Small group	Guided discovery	Guided discovery
Participant 7	Data logging	A lesson	Guided inquiry	Guided inquiry
Participant 8	Data logging	A lesson	Bounded inquiry	Interactive demonstration
Participant 9	Data logging	A lesson	Bounded inquiry	Interactive demonstration
Participant 10	Modeling	A lesson	Interactive demonstration	Interactive demonstration
Participant 11	Data logging + Video measurement	School project	Bounded inquiry	Bounded inquiry

Through O2, D3, and I1, we could judge how the lesson plan was executed in the class. Data showed that there was still a gap (Table 4) between lesson plans and lesson implementations just like in most literature [1], [8]. Some ICT-IBSE lessons were implemented not as intended by participants. Following are observed problems:

- As part of a school project, Participant 1 required pupils to design an experiment to measure capacitance by discharge of a capacitor through a resistor (phase 1), and then with given equipment (circuit components, sensors, software, etc.) they had to execute the experiment design to measure some capacitance and write reports (phase 2). Some pupils accomplished the phase 1 with concrete theoretical preparation and the experiment design, but others did not have feasible plans. Before attending the lab section (phase 2), pupils had to submit their plans. To make sure all pupils would complete the project with good reports, Participant 1 gave them a very clear cookbook instruction for the experiment set-up and execution. Consequently, for pupils who had not prepared a plan, this became a cook-book experiment rather than inquiry. In this case, the teacher's plan was guided inquiry, but in the implementation, most pupils actually carried out cook-book lab activities.
- Participant 3 arranged three ICT tasks, but the pupils could complete one or two. The main reason was that the teacher did not give sufficient time for explanations of assignments and for pupils to familiarize themselves with the modeling tool.
- Participants 8 and 9 prepared ultra sound sensors for groups of pupils and asked them to design an experiment to determine the shapes of some hidden objects. In the tryout, pupils did not come up with the idea of the experiment and were not familiar with the software as well, so the teacher had to come to each group for explaining and raising detailed questions to motivate them to get involved in the inquiry process. Consequently, the plan was bounded inquiry, but the implementation was an interactive demonstration.
- Technical troubles with computers happened in the tryout of Participant 10, and he could not fix it. The ICT part of the tryout did not work at all, so an important idea of the lesson was not tried out.

The participants had to deal with the issue of getting their pupils to mainly focus on minds-on science learning and meaning making in parallel with solving ICT technical problems. Some pre-service teachers still had to struggle so much with first year teaching problems so that they could not implement IBSE until perhaps the second or third year of teaching.

Although application of the new ICT tool in inquiry based lessons was a demanding objective for many pre-service teachers within a 1-EC course, almost all participants were interested in the IBSE part of the ICT course and the classroom tryout (I1). This provided a condition for hands-on practice and classroom experiences for participants with all aspects of integration of ICT as lab tools into IBSE. They became aware of the added value of the ICT tools in science teaching. Their efforts during the course proved that they were motivated to apply the ICT tool they had learnt in teaching. Most of the participants were confident, on their own, to learn and apply later the other tool(s) which they had not studied yet within the course (Q2).

4. Conclusion and discussion

4.1. Conclusion

The learning scenario was implemented quite faithfully as the life sessions were executed pretty smoothly, and finally, almost all participants went through a complete cycle of designing, implementing, and evaluating an inquiry-based lesson integrated with the ICT tool. The blended setting with support materials, especially the Coach activities contributed to this result under the condition that the course participants really spent considerable time outside the life sessions. Sending reminder emails in relevant time was important to keep participants on task. The considerable deviation was that the majority of participants did not manage to accomplish their tryouts before Session 3, so the course was extended for a few following weeks. In addition, many participants did not follow our suggestion of choosing only one tool to learn in depth. There was a need for more time for hands-on, in-group activities in life sessions (e.g. practicing basic ICT skills, preparing ICT-IBSE lesson plans) and more detailed feedback on individual reports of participants. This was in line with a conclusion in Thurston et.al (1997) [12], "*As much hands-on experience as possible with technology, as opposed to lecture/demonstration, is critical.*"

This case study showed us that it is possible within a limited time to bring pre-service teachers to a reasonable level of competence regarding the use of the ICT tools in inquiry-based lessons. The course participants became aware of educational benefits of data logging, video measurement, and modeling. Most of them were motivated to apply their chosen ICT tool in their classroom and confident to study other tools on their own later on. Although participants' experiences with the ICT tools before the course were very different, after the course all of them mastered the tools to some extent; a few participants even reached the advanced level. The majority of the pre-service teachers designed a lesson plan aimed at a certain inquiry level with integration of ICT, but just a few could implement it faithfully in the class. The participants had to struggle with science - ICT conceptual issues, the demand of getting pupils to focus on inquiry and concept learning, in addition to first year teaching problems. Therefore, the aim at inquiry-based application of the ICT tool in the class within such a short course turns out to be very demanding. IBSE really fits better in an induction period after initial teacher education.

In a case study, data analyses will help to answer the research questions and provide evidence for revising the course design, which will be subsequently executed and then assessed again in a next case study (Figure 4). In order to be implemented more faithfully and effectively, the course design will be revised as follows.

- About the time frame, the duration for classroom tryouts between Sessions 2 and 3 will be extended to give more room for tryout. Furthermore, Session 1 should take place in a whole day instead of a half day as collective practice with the tools in groups with direct support gives much faster progress than individual practice at home.
- About the learning process, we should focus on the participants' hands-on activities i.e. practicing with the Coach tool and preparing the lesson plan in life sessions. The draft version of lesson plans should be ready before Session 2.
- About the online platform, the course website and Q&A forum should be changed to be more instructive and accessible.

4.2. Discussion

Final conclusions on the effects of the pre-service course aimed at ICT-IBSE contents in the Dutch boundary conditions will be based on long-term effect measurements: *Will the teachers be able to master the other tools on their own? How much do they really implement ICT in the inquiry way in their lessons?* If the outcomes (effectiveness and faithful implementation) of the course are not yet satisfying, further cycles of the optimization process: revision, execution, and assessment (figure 4) need to be implemented.

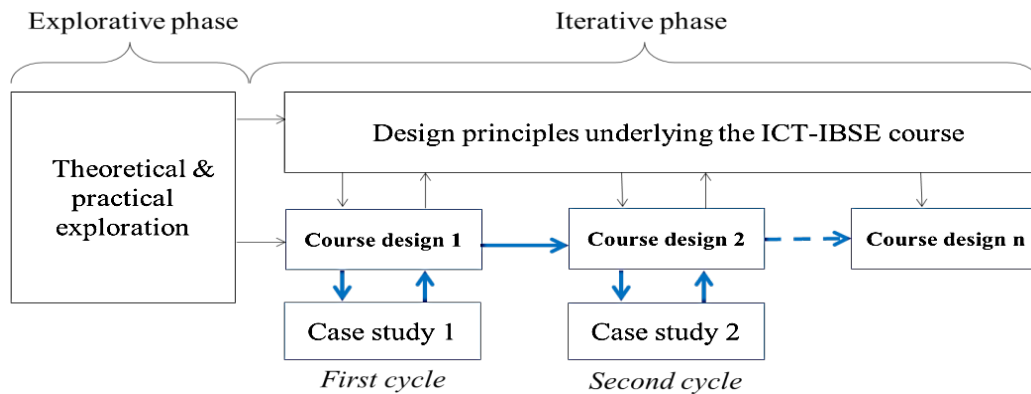

Figure 4. Optimization process of the course, adjusted from Knippels (2002) [10]

The use of ICT for IBSE as well as preparation and support for effective teacher learning on this issue are common needs, globally recognized across different educational contexts. In many countries, ICT tools such as data logging, video measurement, and modeling are also known and to some extent used. Besides further rounds of development based on case studies in the Netherlands, we plan to investigate the applicability of the course design in several other countries with adaptations geared to a different context and educational system.

Already the course was trialed as in-service teacher training in University of Kosice, Slovakia. The course ICT-IBSE contents, blended setting, and support materials were applicable to the experienced teachers. Another case study is planned in Hanoi National University of Education, Vietnam in 2014. The involvement of colleagues at these institutes will also contribute to the quality of course materials. Furthermore, the outcomes of these case studies at the international level may reveal some limitations of the course design in the Netherlands and provide recommendations for adaptations to other contexts and countries.

Acknowledgement

Development and delivery of the course was carried out in the framework of the ESTABLISH project with the support of Foundation CMA, the Netherlands and with the cooperation of teacher educators and pre-service teachers from VU University Amsterdam and Utrecht University. The development of the course materials was done by Ewa Kedzierska, Vincent Dorenbos, Ron Vonk, Ton Ellermeijer (CMA), Zuzana Ješková, and Marian Kires (University of Kosice). The course was taught by Vincent Dorenbos, Ron Vonk (CMA), and Ed van den Berg (VU).

References

- [1] Abrahams I., Millar R.: Does Practical Work Really Work? A study of the effectiveness of practical work as a teaching and learning method in school science. *International Journal of Science Education* 30(14) (2008), p. 1945-1969.
- [2] Borghi L, Ambrosio A., Mascheretti P.: Developing relevant teaching strategies during in-service training. *Physics Education* 38(1) (2003), p. 41-46.
- [3] Denscombe M.: *The Good Research Guide: for small-scale social research*, 4th edition. Maidenhead: Open University Press (2010), ISBN-13: 978 0 335 24140 8 (ebk).
- [4] Fullan M.G.: *The new meaning of educational change* (4th ed.). New York: Teachers College Press (2007), ISBN 978-0807747650.
- [5] Guskey T.R.: *Evaluating professional development*. Thousand Oaks, CA: Corwin Press (2000), ISBN 9780761975618.
- [6] Heck A., Ellermeijer T.: Mathematics assistants: Meeting the needs of secondary school physics education. *Acta Didactica Napocensia* 3(2) (2010), p. 17-34.
- [7] Heck A., Kedzierska E., Ellermeijer T.: Design and implementation of an integrated computer working environment for doing mathematics and science. *Journal of Computers in Mathematics and Science Teaching* 28 (2) (2009), p. 147–161.
- [8] Hofstein A., Lunetta V.N.: The laboratory in science education: foundation for the 21st century. *Science Education* 88 (2004), p. 28-54.
- [9] Joyce B., Showers B.: *Student achievement through staff development* (3rd ed.). Alexandria, VA: Association for Supervision and Curriculum Development (2002), ISBN 978-0871206749.
- [10] Knippels M.C.P.J.: *Coping with the abstract and complex nature of genetics in biology education: The yo-yo learning and teaching strategy*. PhD dissertation in University of Utrecht (2002), ISBN 90-73346-50-9.
- [11] Koehler M., Mishra P.: What happens when teachers design educational technology? The development of technological pedagogical content knowledge. *Journal of Educational Computing Research*, 32(2) (2005), p. 131–152.
- [12] Thurston C.O., Secaras E.D., Levin J.A.: Teaching teleapprenticeships: An innovative model for integrating technology into teacher education. *Journal of Research on Computing in Education* 29(4) (1997), p. 385-391.

Developing the course of “Practical Theoretical Physics” for high school students

Mikhail Tyntarev

Academic University. Lyceum “Physical-Technical High School”, St.Petersburg, Russia

Abstract

The course of the approximate methods of solving the physical equations was developed. It is meant for the high school students, who want to become physicists. The possible use of some ideas of the course, such as using of the most general physical laws for problem solving, for the ordinary physics teaching is discussed.

Keywords: theoretical physics at high school, approximate calculus, classroom experience

Introduction

Approximate calculus is very essential tool for physicist-theorist. Physicists usually say: “The last real physical problem, which has a simple rigorous solution, had been solved more than 100 years ago”.

Unfortunately, high school students usually do not know how to solve the problems approximately, trying to calculate “the right answer”. Even the university students often have the same troubles.

The most of the existing courses of approximate methods in physics are either elementary, based on scaling and dimensional analysis, *e.g.*, [1], or too complicated, appropriate for university students, rather than for school ones, *e.g.*, [2]. The new course was intended for filling this gap.

Boundary conditions

The work was carried out in the Physical-Technical Lyceum, St.Petersburg. This high school is a department of Academic University. The physics teachers, including the author, have an experience of scientific work in laboratories of Ioffe Institute and Academic University.

The course is 2-semester long and is aimed on the students of 10-11 class.

The course

The core of the course is the system of problems worked out to cover the main approximate methods. In these problems we tried to avoid specially invented situations and used simple phenomenon of nature, most of which can be illustrated by in-class experiment. Nevertheless, the quantitative solutions of these problems are not very simple and require some estimations and approximations based on the fine understanding of the process.

The problems refer to different fields of physics. Some of the problems require only algebraic equations and these ones are analyzing at the beginning of the course. At the second semester the differential equations are analyzing.

Every lesson is a model of a scientific research: it begins from the qualitative analysis of the phenomena, then its mathematical model is created and then the equations are solved with a proper precision. Finally (if possible) the theoretical results are compared with experimental ones.

Simple problems

At the beginning some simple problems are used. For example, well-known problem: „The stone was dropped into the well and the sound returned in 6 seconds. What is the depth of the well?”

This problem can be solved rigorously, only quadric equation is used. But this is also a good example for teaching approximations. As a first step the time sound needs to travel from the bottom to the ground level (t_s) is neglected. Thus the depth can be obtained in the first order of approximation. Using this depth t_s can be calculated and then desired depth can be obtained in the second order of approximation. Comparison of t_s with the time of the stone falling proves the validity of approximation.

Not very simple problems

Mathematical pendulum is the example of more complicated problem. The equation of its motion is:

$$\varphi = -g/l \sin(\varphi)$$

It has no rigorous analytical solution. In zero-order approximation (for small oscillations) the substitution

$$\sin(\varphi) \approx \varphi$$

helps to obtain the well-known result where oscillation is harmonical and its period

$$T = 2\pi\sqrt{l/g}$$

Is this result satisfactory? Usually the students answer that this period does not depend on amplitude of the oscillations. Careful analysis of the angle variation of force helps to understand that period increases when amplitude increases. This dependence is small for small oscillations, but it is very interesting to find it out.

In order to do it one has to solve the equation of motion with the next order of accuracy.

Mathematically it means: to use the next term in the Taylor's series:

$$\sin(\varphi) \approx \varphi - \varphi^3/6.$$

The equation becomes non-linear and it can be solved approximately using Taylor's series for the integral or using the method of successive approximations.

If there is enough time it is interesting to solve the equation using both methods and compare results. The calculations are not very simple and the probability of mistake is high.

Finally, the result is:

$$T = 2\pi\sqrt{\frac{l}{g}}\left(1 + \frac{\varphi_0^2}{16}\right)$$

where φ_0 is the amplitude of the oscillations.

Is it necessary to find next-order approximation? In this problem there are no other parameters the period depends on. So there is no use in look for the more precise solution.

This non-linear effect can be observed experimentally although the experiment requires a great accuracy and the rope more than 10 meters long.

Some other problems

Water is flowing out of the vessel through the hole. How does the velocity of water depend on the area of the hole? This is a good example for studying the successive approximations method.

The pendulum with the variable length of the rope helps to study WKB-approximation, a very powerful method used in quantum mechanics and electrodynamics.

Fall of a body in presence of air resistance force, fall of a body from height comparable with the Earth radius, charging of a capacitor and many other simple phenomena can be used.

The aims of the course

There are three main aims: to learn the approximate calculus, to make an introduction to the work of physicist-theorist, to improve general understanding of physics.

Students are supposed to learn how to estimate all the necessary values, to find small parameter, to prove the validity of approximation, to determine the extreme cases of the problem, to make series expansion and to use the method of successive approximations.

The very important point is the reasonable precision of calculations. Analytical approach (unlike computations) is usually applied in order to obtain some simple result which helps to understand phenomena. So precision should not be increased by all means. The order of approximation, which helps to obtain all the interesting dependencies, is enough.

Unexpected results and possible use for the general curricula

In the school physics course many special cases of the laws of nature are studied. Sometimes it is not good for the integrity of understanding of the world.

The physical problems which are solved at class usually require remembering this or that formula instead of the understanding of general laws. Partly it is so because only the problems based on the most simple special cases can be solved using the “school” mathematics. This situation is not helpful for understanding of physics because the problems solving is possibly the main part of physics education.

The course presented above teaches students to use the most general physical laws for problem solving and probably it can help to improve situation.

Conclusions

The course was given four times. Although the consistent educational research was not yet made, the feedbacks from the students (including ones now studying physics at university) show that the course helps to improve general understanding of physics and to prepare to the future studies of theoretical physics.

The further development of the work includes:

- 1) working out the methods of analyzing the educational effect of the course;
- 2) developing different courses with different levels of complexity for high school students, specialized in physics theory, high school students specialized in natural sciences and humanities, university students;
- 3) developing the integrated course of theoretical and experimental physics for high school students;
- 4) inclusion of the methods of the course in the general high school curricula.

References

- [1] Sanjoy Mahajan: *Street-Fighting Mathematics*. The MIT Press (2009).
- [2] Migdal A. B., Krainov V. P.: *Approximation methods in quantum mechanics*. (1968).

Sequential Reasoning in Electricity: Developing and Using a Three-Tier Multiple Choice Test

Hildegard Urban

University College of Teacher Education Lower Austria

Abstract

Electricity is one of the areas in physics most studied in terms of learning difficulties. Misconceptions are strongly-held, stable cognitive structures, which differ from expert conception and affect how students understand scientific explanations. Therefore, there is a need for tests of conceptual understanding tests which are useful in diagnosing the nature of students' misconceptions related to simple electric circuits and, in consequence, can serve as a valid and reliable measure of students' qualitative understanding of simple electric circuits. As ordinary multiple choice tests with one-tier may overestimate the students' correct as well as wrong answers, two - and three - tier tests were developed by researchers. Although, there is much research related to students' conceptions in basic electricity, there is a lack of instruments for testing basic electricity concepts of students at grade 7, especially addressing an electric circuit as a system for a simple circuit of resistors and lamps in series. To address this gap, the context of the present study is an extension to the development of an already existing instrument developed by the author for testing electricity concepts of students at grade 7, specifically focusing on only two specific aspects in depth: first, to develop three-tier items for figuring out sequential reasoning, and second, to distinguish between misconceptions and lack of knowledge. The participants of the study included 339 secondary school students from grade 7 to 12 after instruction on electricity. Surprisingly, there are no dependences on students' misconceptions either according to their gender or to their age. In conclusion, the findings of the study suggest that four items for uncovering students' sequential reasoning can serve as a valid and reliable measure of students' qualitative understanding of the systemic character of an electric circuit.

Keywords: three-tier concept test, sequential reasoning in electricity, uncovering students' conceptual understanding

Theoretical background

Research findings suggest that there are three categories of student difficulties in basic electricity: inability to apply formal concepts to electric circuits, inability to use and interpret formal representations of an electric circuit, and inability to qualitatively argue about the behavior of an electric circuit [1]. In general, students come to the classroom with various misconceptions which may critically influence their understanding of scientific concepts and explanations [2]. In other words, students may have various, often pre-conceived misconceptions about electricity, which stand in the way of learning. The most two resistant obstacles seem to be to view a battery as a source of constant current and to not consider a circuit as a system [3]. Closset introduced the term *sequentialreasoning* which appears to be widespread among students [4,5]. There is some evidence that sequential reasoning at least partially is developed at school [6] and reinforced by the teacher [7]. Using the metaphor of a fluid in motion [8] and highlighting that electricity leaves the battery at one terminal and goes to turn on the different components in the circuit successively does not support students in viewing a circuit as a

system [9]. On the contrary, this linear and temporal processing prevents students from making functional connections between the elements of a circuit and from viewing the circuit structure as a unified system [10]. Surprisingly, research findings do not indicate a different development of sequential reasoning according to age [11]. Similar conceptions are also held by adults and some teachers [12].

Therefore, there is a need for a diagnosis instrument to get information about students' preconceptions and also to evaluate the physics classroom. In order to identify and measure students' misconceptions about electricity different approaches have been made. In contrast to interviews, diagnostic multiple choice tests can be immediately scored and applied to a large number of subjects. Pesman and Eryılmaz [13] used the three tier test methodology for developing the SECDT (Simple Electric Circuits Diagnostic Test). In order not to overestimate students' right as well as wrong answers, researchers developed two - and three - tier tests [13,14]. Starting from an ordinary multiple choice questions in the first tier, students are asked about their reasoning in the second tier, and students estimate their confidence in their answers in the third-tier.

An extensive review of literature according to appropriate test instruments showed that they either did not achieve psychometric requirements or were developed only for high school or college students. In view of a lack of instruments for testing electricity concepts of students at grade 7 and for being suitable for the Austrian physics curriculum, the author developed a diagnostic instrument with some two-tier items for assessing students' conceptual understanding as well as its potential use in evaluating curricula and innovative approaches in physics education [14].

Aim and Research Question

Many students seem to be unable to consider a circuit as a whole system, where any change in any of the elements definitely affects the whole circuit. In consequence, they often demonstrate 'local reasoning' by focusing their attention only on one specific point in the circuit and by ignoring what is happening elsewhere in the circuit. In circuits with resistors in parallel students often believe that the current is divided into two equal parts at each junction neither taking into account the values of the resistors nor concentrating on the whole number of resistors. Additionally, students show 'sequential reasoning', by which they believe that for example, if a resistor in a circuit is replaced by a resistor with higher value, only elements coming after the resistor are affected.

For gaining a correct vision of student understanding, it is crucial to discover what students actually do not know and what kind of alternative conceptions they have. Therefore, also for the researcher the wrong answers and the associated explanations of the students are much more interesting and usable than the correct answers. Consequently, the context of this study is an extension to the development of an already existing instrument for testing the concepts of electricity of students at grade 7 in two specific aspects: first, to develop items for figuring out sequential reasoning, and second, to distinguish between misconceptions and lack of knowledge. The following broad research question was addressed:

Can a three-tier multiple choice test be developed that is reliable, valid, and uncovers certain students' misconceptions related to sequential reasoning?

Method

In order to develop a reliable tool to identify students' misconceptions related to sequential reasoning and in addition to previous studies [14], the author first conducted interviews based on a literature review, using both structured and open-ended questions. In an initial stage a 10 - item questionnaire was developed, including 10 two-tier items (meaning question plus follow-up question, an example is provided in Figure 1). Subsequently, only four out of those ten items finally constituted the test instrument used in this present study, assessing students' understanding of the systemic character of a simple electric circuit with three-tier items.

In the first round of evaluation with 10 teachers and 113 students (grade 8, 58 female), the questionnaire was reduced to 7 items, each extended with a third tier asking for students' confidence in answering each question. After a test run with 339 students of grade 7 to grade 12 from secondary schools across Austria following formal instruction (183 female, mean age 14.7 years, standard deviation 1.7 years) results were evaluated with the software programs SPSS and AMOS. In a polishing round, additional interviews were used to optimize the test items. To get the score for a two-tier item, a value of '1' was assigned when both responses were correct. Furthermore, by examining specific combinations of answers other relevant variables were calculated to address students' misconceptions. Finally, for constituting the latent variable „sequential reasoning“, four items were used.

In the following, we present a three-tiered item (see Figure 2), asking questions related to very simple electric circuits; as we will see, there is ample space for misconceptions despite their simplicity. We need to add here that the answers provided have not been thought up by the researcher but are based both on literature review [3,4,5,6] and clarifying interviews with students.

A lamp and two resistors are connected to a battery.	
a) What will happen to the brightness of the lamp if R_1 is increased and R_2 remains constant?	
<input type="checkbox"/> The brightness of the lamp decreases. <input type="checkbox"/> The brightness of the lamp remains constant. <input type="checkbox"/> The brightness of the lamp increases.	
b) How would you explain your reasoning?	
<input type="checkbox"/> It is the same battery. Therefore, the same current is delivered. <input type="checkbox"/> A change of the resistor only influences the brightness of the lamp if the lamp is behind the resistor. <input type="checkbox"/> Any change of the resistor influences the brightness of the lamp independently of its position in the circuit.	
c) Are you sure about your answer to the previous two questions?	
<input type="checkbox"/> highly certain <input type="checkbox"/> rather certain <input type="checkbox"/> rather uncertain <input type="checkbox"/> highly uncertain	

Figure 1. Sample Item A

Participants and Setting

The participants of the study included 339 secondary school students from grade 7 to 12 (183 female; mean age = 14.7 years, SD = 1.7; 18 forms, 7 schools) after instruction on electricity. Nine teachers were randomly asked to administer a paper and pencil test to their students with 7 three-tiered items related to sequential reasoning. Figure 2 shows the distribution of the students amongst grades.

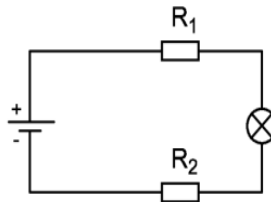
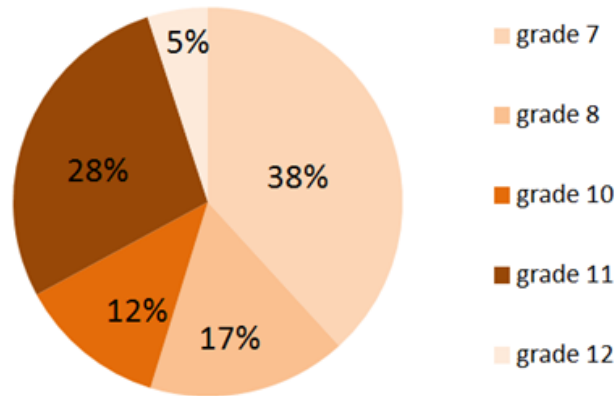

Figure 2. Distribution of students and grades

Data Analysis

Starting with descriptive analyses, analyses of variance, confirmatory factor analyses, and regression analysis using the software SPSS and AMOS were conducted.

Results

Obviously, the correct answer for item A (see Figure 2) would be a1 and b3. 108 students out of 323 who answered all four items (33.4%) provided a correct answer to the first two tiers of item A. A closer look at the numbers in table 1 shows that 51.7% or 167 students actually answered the first tier correctly, but 59 out of these 167 students or 35.3% provided a wrong reason. Consequently, more than one third of the correctly responding students on the first tier can be added to so-called false positives. On the other hand, 153 students chose the right explanation, whereas only 70.6% of these students also gave a correct answer on the first tier. Therefore, we critically overestimate students' knowledge if we only look at one tier. Overall, 30 students are highly certain, 105 are rather certain, 88 are rather uncertain, and 100 are highly uncertain about their answers. 11 of the highly certain students and 27 of the rather certain ones give the correct answer for the first and the second tier, whereas only 8 of the highly uncertain students answer this item correctly. In other words, the results suggest that some students may be presumably guessing and sometimes they indeed guess right on both sections. Consequently, if we want to completely exclude guessing anyway we have to focus only on students with high certainty reported.

Table 1 gives an overview of the three answer options a1, a2, and a3 and the three associated alternatives b1, b2, and b3 for the reasoning.

Table 1. Distribution of answers and reasons for item A

	a1	a2	a3	
b1	4	49	1	54
b2	55	36	25	116
b3	108	7	38	153
	167	92	64	323

Next, three misconceptions which were derived connecting specific answers and explanations will be illustrated here:

Misconception #1 (Answers a1, b2)

In this misconception the student chooses the right answer, but based on the observation that the lamp is behind the resistor when electricity is moving round the circuit from the positive to the negative terminal. More than a third of students who identified that the bulb will be dimmer gave this erroneous explanation. This is a prime example that a correct test answer is not yet proof that the student had really understood the underlying concept.

Misconception #2 and #3 (Answers a2, b2 or b1)

Here, the student probably thinks that a constant amount of current leaves the battery at the negative end and reaches the lamp before it arrives at the increased resistor. 36 out of 92 students think sequentially. 49 students out of those 92 view the battery as a source of constant current not considering any influence from the resistance on the intensity of current. 38 students respond in a false-negative way as they choose the correct explanation but think that an increased resistor produces an increased brightness of the lamp.

Construct validity was evaluated through factor analysis. Confirmatory factor analysis with AMOS, using the maximum-likelihood-method and including specific combinations of answers due to the first and second-tier of four different test items, resulted in a χ^2 -value of 5.805, which was not significant ($p = .221$). Therefore, a latent variable ‘sequential reasoning’ could be established (see Figure 3).

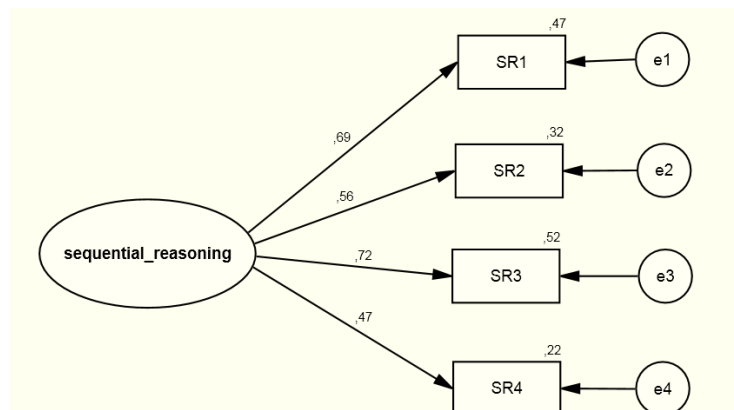

Figure 3. Latent Variable ‘sequential reasoning’

As mentioned above, students from 18 forms in 7 schools took part in the study. Consequently, nine teachers were involved. Findings from ANOVA reveal a main effect for correct answers concerning all four items A to D on the particular school, respectively on the particular teacher. Surprisingly, there are no dependences on students' conceptions both related to correct answers and misconceptions neither according to their gender nor to their age.

A resistor and two lamps are connected to a battery.

a) What will happen to the brightness of the lamps if R is increased?

- L₁ remains constant, L₂ decreases.
- L₁ decreases, L₂ remains constant.
- The brightness of both lamps increases.
- The brightness of both lamps decreases.
- The brightness of both lamps remains constant.

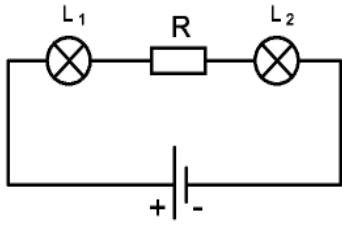

b) How would you explain your reasoning?

- A change of the resistor only influences the brightness of the lamp if the lamp is behind the resistor.
- Any change of the resistor influences the brightness of both lamps.
- It is the same battery. Therefore, the same current is delivered.
- Both lamps have a direct connection to the battery. Therefore, the resistor has no effect on the lamps.

c) Are you sure about your answer to the previous two questions?

highly certain certain rather uncertain rather highly uncertain

Figure 4. Item D

Furthermore, regression analysis, where items A to C⁷ were used to predict sequential reasoning for item D, suggests that those three factors together explain 31% of the variance for item D ($F(3, 338) = 49.89, p < .0001$) and are significant individual predictors of students' sequential reasoning for item D (see Figure 4).

Conclusions and Implications

In conclusion, the findings of the study suggest that four items for uncovering students' sequential reasoning can serve as a valid and reliable measure of students' qualitative understanding of the systemic character of an electric circuit. Obviously, if researchers or teachers use only one tier in a multiple choice instrument, they definitely overestimate

⁷ Colleagues interested in items B and C are encouraged to ask the author.

correct answers and in consequence, gain of a wrong impression of student understanding. The present instrument can be used as a tool both for teachers and researchers to gain a correct vision of student understanding. It can be easily administered to a large number of students and could be used as a research tool for assessing new curriculum materials or teaching strategies. Although there is some evidence that the conceptual test is reliable, valid and objective, there have to be a few improvements. Additional interviews highlighted that the wording on the first tier may not be perfectly comprehensible to students. A student may be very confident about his or her answer on the third tier but not about his or her given explanations on the second tier. Furthermore, the interviews which were carried out to develop the distractors for the explanations revealed that some of the teachers tend to introduce the direction of the current from the positive to the negative terminal of the battery, whereas others use the direction of the negative charges from the negative to the positive pole. Therefore, further improvements of the conceptual test instrument will take these limitations of the present study into consideration by using an arrow to indicate the direction of the current.

References

- [1] McDermott L. C., Shaffer P. S.: (1992). Research as a guide for curriculum development: An example from introductory electricity. Part I: investigation of student understanding. *American Journal of Physics*, 60, 11, 994-1003.
- [2] Hammer D.: (1996). More than misconceptions: Multiple perspectives on student. Knowledge and reasoning, and an appropriate role for educational research. *American Journal of Physics*, 64(10), 1316-1325.
- [3] Dupin J. J., Johsua S.: (1987). Conceptions of French pupils concerning electric circuits: Structure and evolution. *Journal of Research in Science Teaching*, 24, 9, 791–806.
- [4] Closset J. L.: (1983). Sequential reasoning in electricity. In: *Proceedings of the International Workshop on Research in Physics Education*, La Londe les Maures, Paris: Editions du CNRS.
- [5] Shipstone D. M.: (1984). A study of children's understanding of electricity in simple DC circuits. *European Journal of Science Education*, 6, 185-198.
- [6] Shipstone D. M.: (1988). Pupils' understanding of simple electric circuits: Some implications for instruction. *Physics Education*, 23, 92-96.
- [7] Sebastia J. M.: (1993). Cognitive mediators and interpretations of electric circuits. In: *The Proceedings of the Third International Seminar on Misconceptions and Educational Strategies in Science and Mathematics*, Misconceptions Trust: Ithaca, NY (1993).
- [8] Rosencwajg P.: (1992). Analysis of problem solving strategies on electricity problems in 12 to 13 year olds. *European Journal of Psychology of Education*, VII,1, 5-22.
- [9] Brna P.: (1988). Confronting misconceptions in the domain of simple electric circuits. *Instructional Science*, 17, 29-55.
- [10] Heller P. M., Finley F. N.: (1992). Variable uses of alternative conceptions: A case study in current electricity. *Journal of Research in Science Teaching*, 29, 3, 259-275.

- [11] Riley M. S., Bee N. V., Mokwa J. J.: (1981). Representations in early learning: the acquisition of problem-solving strategies in basic electricity and electronics. In: Proceedings of the International Workshop on Problems Concerning Students' Representations of Physics and Chemistry Knowledge, Ludwigsburg (Ludwigsburg, West Germany: Pädagogische Hochschule) 107-173.
- [12] Bilal E., Erol M.: (2009). Investigating students' conceptions of some electricity concepts. *Latin American Journal for Physics Education*, 3, 2, 193-201.
- [13] Pesman H., Eryilmaz A.: (2010). Development of a three-tier test to assess misconceptions about simple electric circuits. *Journal of Education Research*, 103:3, 208-222.
- [14] Urban-Woldron H., Hopf M.: (2012). Entwicklung eines Testinstruments zum Verständnis in der Elektrizitätslehre [Developing a multiple choice test for understanding basic electricity]. *Zeitschrift für Didaktik der Naturwissenschaften*, 18, 201-227.

Using Class-room Communication System in Physics Laboratory

Ajay Wadhwa

Department of Physics, SGTB Khalsa College, University of Delhi, India

ajayw3@gmail.com

Abstract

Class-room Communication System (CCS) refers to a combination of electronic hardware and its associated software that can be used to support communication in a classroom to make it more interactive and student-centric. Use of CCS in class-room lectures has been quite common in most institutions imparting science education. Like any science stream, physics is a subject where Laboratory activity is an integral component of the curricula. We intend to present a CCS-based laboratory activity to emphasize the utility of technology in promoting physics education. For a student of physics, a laboratory experience is different than a class-room lecture experience because during experimentation the student encounters nature as it 'really' exists and not in an idealized form as projected in a class-room lecture. We selected a simple experiment that involves the measurement of 'g' by measuring the time-intervals between two initial successive bounces of a vertically dropped ball on a floor from a given height. A class of about 50 under-graduate students of 4th semester was asked to perform the experiment which was integrated with the CCS device (NETGEAR WGR614 wi-fi N150 router) in their physics lab. The students were divided into 25 groups with two students per group. Each group was assigned a computer terminal for doing analysis and to communicate through CCS with the instructor. Due to limited resources we could set up two experiment-terminals where the experiments were performed by the students and observations saved for further analysis on their respective computer terminals. The experiment was discussed in the class and each group was given a set of formulas related to the experiment. Based on the activity and results obtained by them the students were given a questionnaire to respond and communicate to the instructor in a specified time (about 30 minutes). The questionnaire contained questions that tested a student's knowledge about basic concepts like conservation of momentum and energy, elasticity of matter, damped oscillatory motion etc. The results obtained by different groups of students were compiled and then analyzed.

Experiment/Activity: A vertically dropped ball bouncing-off a rigid floor is a two-body system that is characterized by the value of coefficient of restitution (CoR) of the ball-surface combination. Using the laws of physics we can express the CoR in terms of physical quantities like 'g', initial height 'h' and time-interval 't' between the first two successive bounces. For experiments we asked the students to choose from different types of sports balls-tennis, squash basket-ball etc. Using the standard values of CoR and by measuring the time-intervals, the value of 'g' can be obtained. For measuring time-interval 't' we made use of Vernier audio sensors interfaced with the USB port of computer.

Keywords: CCS, Physics Laboratory, CoR, Sensors, Computer interface

Introduction

Class-room communication system (CCS) [1, 2] is a technology product that has been used to support communication and interactivity in large lecture class-rooms. The CCS device helps the instructor to present an interactive questionnaire for assessment and receive answers to the asked questions instantly. The instructor immediately aggregates, summarizes and displays the results of students' responses through histograms. The CCS device provides an integrated environment for the creation, management, display and archiving of questions. The instructor can set multiple-choice questions as well as other type of questions for assessment and evaluation.

We can classify CCS devices into two types:

- (a) Keypad-based
- (b) Network-based

Commercially different forms of Keypad-based and network-based CCS devices have been available. The first generation of CCS were introduced in 1985-86 through NSF, USA and named as CLASSTALK. These were used for commercial applications till the year 1999 after which the two 2nd generation CCS devices called EduCue PRS and elnstruction CPS were introduced. These were mainly used for educational purposes.

The present day 3rd generation network-based CCS devices use PCs, laptops and tablets along with wifi 802.11 ADSL-Routers to set up wireless connectivity within a certain region like class-room or labs.

In the most common form of the keypad-based CCS, the hardware consists of an infrared receiver and remote keypads (one instructor keypad and any suitable number of student keypads). The CCS comes with communication system software for installation on the computer to be used in the classroom.

The instructor prepares questions using the software and each student is given a remote keypad that is compatible with the software installed on the computer.

Each keypad is marked with a *remote number* that corresponds with the student who possesses it. The computer is connected to a projector to display the questions on the projector screen.

Students are then asked to respond to the questions through their keypads. The response data from the software system is collected for analysis.

The two drawbacks of the keypad based CCS device are its cost (one keypad cost is about \$80 to \$100 approx.) and limited uses. For instance students' responses cannot be taken in the form of graph plots in excel files or in any other formats.

In the network based CCS we make use of the computers and the networking device called Router. Computers may be chosen from many different forms available – IPADS, Tablets, laptops, desktops etc.

An advantage of the network based CCS is that it makes use of the installed software-windows O/S, Android O/S etc. for communication. In this way it proves to be more economical than the keypad-based CCS.

In order to use a network based CCS following steps are taken to establish a wifi network (without Internet) in the class-room: Suppose we wish to establish a network between two computers C-1 and C-2 as shown in figure 1.

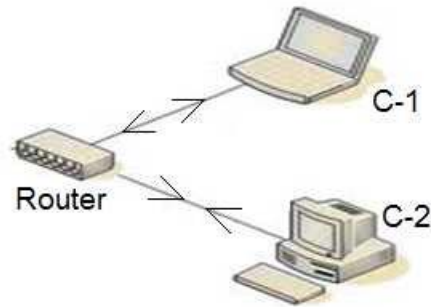

Figure 1. Network configuration

1. Establish a networking device-Router Netgear, DLINK or TPLINK brand on the instructor computer (named C-1).
2. In the windows O/S establish a 'workgroup' by giving a name to it on the instructor's computer C-1. Click on the 'network' icon to check the name of the instructor computer and its workgroup name. The network folder will show all the computers connected with the instructor's server computer.
3. Make a new folder as a 'shared' folder in C-1 using 'advanced' sharing option. The 'shared' folder appears inside the 'network' folder.
4. Inside the shared folder one can make any ms-office file to store the questions to be asked for students.
5. On C-2 click on the 'network' icon wherein it shows the name of the server computer C-1 as well as its own C-2.
6. On C-2 click on C-1 icon; a dialog box pops up which asks for the username and password. Input the username and password of C-1. Now the 'shared' folder of C-1 appears in C-2 computer.
7. The student using C-2 will now be able to access the questionnaire file present in the 'shared' folder. The C-1 and C-2 are now connected and ready for further file sharing. Students can now make an ms-office file containing the answers and save it in the 'shared' folder. The saved file now becomes accessible to the instructor computer C-1 for evaluation. The students can also include graph plots using excel files and save them in the 'shared' folder.

Application of network-based CCS

Measurement of 'g' using ball-bounce experiment

In laboratory students make use of oscillating bodies like simple pendulum, physical pendulum etc. for the determination of acceleration due to gravity 'g'. In these methods the time-period of oscillations is measured experimentally for the calculation of 'g'. Though the actual experiment is simple but the underlying theory of oscillating system proves to be a drawback in these methods. We have used a commonly used activity of dropping the ball on a floor to determine the value of 'g'. The main advantage of this method is that it is a direct method involving simple equations of physics which a student can assimilate more easily than the differential equations of an oscillating body.

A ball drop experiment to determine the value of 'g' is simple and useful if we can restrict measurements to the least number of bounces. For a ball dropped from height 'h' we can express the initial speed of the ball as

$$v=(2gh)^{1/2}$$

After the 1st bounce we get the final speed as $v' = ev$ where e is the coefficient of restitution of the ball-surface combination.

The time interval between the 1st and the 2nd bounce is given by [4,5]

$$\begin{aligned} t &= 2v'/g \\ &= 2ev/g \\ &= e(8h/g)^{1/2} \end{aligned}$$

This implies that $t^2 = h(8e^2/g)$ (1)

Equation (1) represents a linear relationship between ' t^2 ' and initial height ' h '. By plotting ' t^2 ' as a function of ' h ' we can determine the value of ' g ' by calculating the slope of the straight line.

In order to measure the time-interval ' t ' we used high quality vernier sensors for the detection of sound on impact and for the determination of initial heights.

We formed 25 groups of students with two students per group to perform experiments and then reporting their findings on the CCS network. The students were also given a questionnaire (shown in the appendix) in which questions were designed to test the basic knowledge of physics laws related with this experiment. The students were given a time of 1 hour to perform the experiment and another half-hour to answer the questionnaire. In figure 2 we show the apparatus used in the experiment:

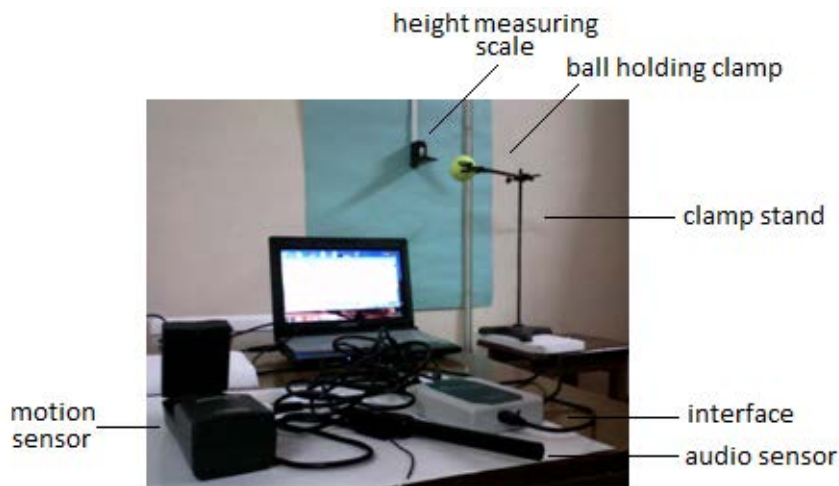

Figure 2. Experimental apparatus

The observations for the three types of balls-squash (SQ), table-tennis (T.T) and lawn tennis (L.T) is shown in figures 3, 4 and 5 respectively.

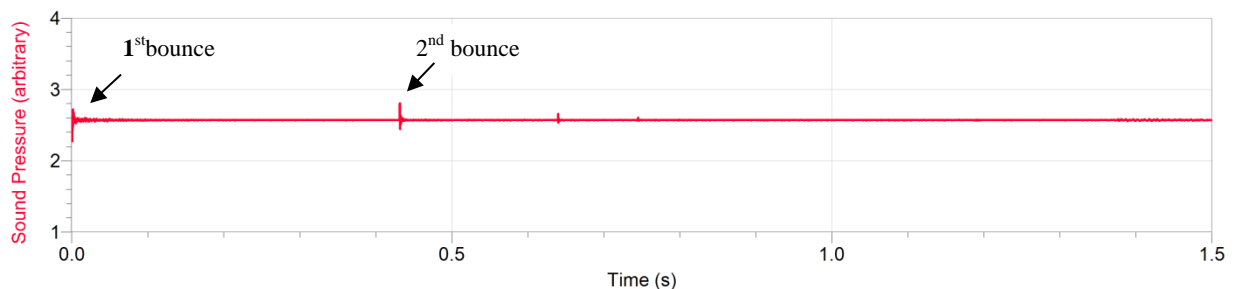

Figure 3. Time-interval for squash ball for $h = 1.25$ m

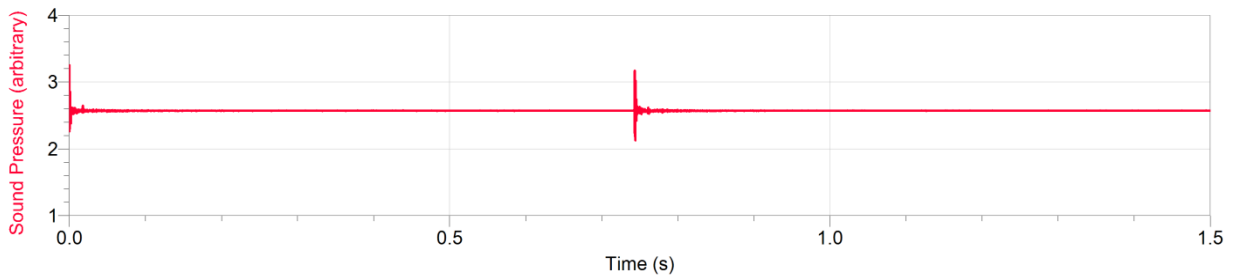

Figure 4. Time-interval for table-tennis ball for $h = 1.25$ m

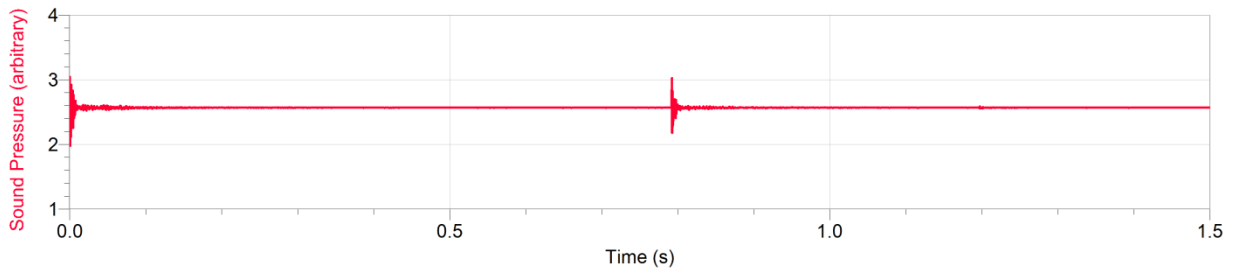

Figure 5. Time-interval for lawn-tennis ball for $h = 1.25$ m

Results and Discussion

Students recorded audio signals for heights $h = 0.25$ m to 2.0 m and measured the time-intervals between the first two bounces of the ball. Using these time intervals students made a plot of ' t ' v/s ' h ' and obtained the slope of the straight line graph. Using Eq. (1) the value of ' g ' is calculated for the three types of balls and then its mean value is obtained. In figure 6 we show the results obtained for the three balls.

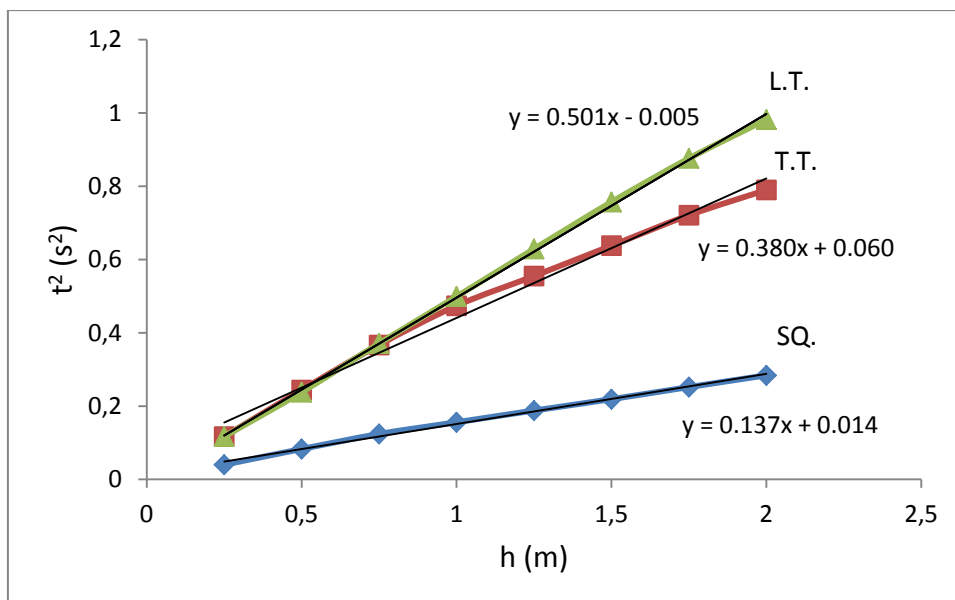

Figure 6. Measurement of slope

The values of the coefficient of restitution ' e ' have been obtained by using the spring model [6] for the bouncing ball. For the ball-surface combination used in the experiment the values of ' e ' are shown with error limits in table 1.

Using these values of the coefficient of restitution 'e' for the balls in the expression (1) we obtain the values of 'g' shown in table 1.

Ball type	'e'	calculated value of 'g' (m/s ²)
Squash	0.415±0.012	10.057
Table-tennis	0.690±0.021	10.023
Lawn-tennis	0.780±0.019	9.715

Table 1. Determination of 'g'

Using the standard value of 'g' as 9.806, from the above table the mean value of 'g' with error limits is obtained as **9.932 ± 0.013** (m/s²). The difference in the values of 'g' obtained in the experiment from the standard value is attributable to its crucial dependence on the coefficient of restitution ($\propto e^2$) which in turn depends on experimental conditions like surfaces of contact.

Most of the groups were able to finish the experiment within the time allotted. However the use of known applications like MS Excel (for plotting of graphs) was not known to many of the students.

The answers to the questions asked in the questionnaire (shown in the appendix) revealed that majority (about 80%) of the students correctly interpreted the laws of conservation of energy and momentum during collisions between two objects. About 95% of the students did not know the value of excess pressure inside the balls. Therefore the cause of different amounts of bounce of the balls was not known to them. Almost all the students found the experiment very innovative and interesting to perform.

Acknowledgement

The author wishes to acknowledge the contributions of under-graduate class of B.Sc.(Hons) Physics 2nd year 2012-13 batch in conducting the experiment and giving useful feedback. We also wish to thank the UGC, India for providing financial assistance for the project.

References

- [1] Betty I.: Transforming student Learning with CCS, (2004) Research Bulletin, ECAR,UMPERG, USA.
- [2] Escalada L.T., Grabhorn R., Zollman D.: Applications of IDV in physics classroom,(1996), Journal of educational multimedia and hypermedia, vol. 5 73-97.
- [3] Paulis J., Massen C., Robens E., Gilbert M.: Physics lecturing with AR feedback, (1998), *American J. Physics* **66**439-441.
- [4] Wadhwa A.: 2009 *Phys. Ed. (UK) IoP Sci.* **44**.517.
- [5] Wadhwa A.: 2012 *Phys. Ed. (UK)***47** 620-626.
- [6] Wadhwa A.: 2013 *Eur. J. Phys.* 34 703-713.

Questionnaire for the experiment on bouncing ball

Max. time: 30 minutes

1. What is the aim of your experiment?
2. How do you find the experiment:
 - (a) boring
 - (b) interesting
 - (c) innovative
 - (d) innovative but boring
3. You performed a physics experiment with the computer interface:
 - (a) for the 1st time
 - (b) for the 2nd time
 - (c) many times before
 - (d) none of the above
4. Would you like to perform experiments with interfacing and data networking in preference to the conventional way:
 - (a) yes, with interface and networking
 - (b) no, I will prefer the conventional way without interface and without networking
5. Which physical quantities did you measure?
6. Distinguish between elastic and inelastic collisions?
7. What is law of conservation of linear momentum (LCLM)?
8. What is law of conservation of energy (LCE)?
9. In your experiment, during collision time
 - (a) LCLM is obeyed
 - (b) LCE is obeyed
 - (c) LCLM and LCE not obeyed
 - (d) LCLM obeyed; LCE not obeyed
10. What is the order of collision time?
 - (a) few milliseconds
 - (b) few microseconds
 - (c) few nanoseconds
 - (d) few seconds
11. The coefficient of restitution:
 - (a) should be constant
 - (b) may vary with height
 - (c) depends on type of ball
 - (d) all of the above
12. What is atmospheric pressure?
 - (a) pressure of air
 - (b) pressure of compressed air
 - (c) pressure of water vapor in air
 - (d) pressure of mercury in manometer
13. Why does a rubber ball bounce back from solid ground?
 - (a) because of internal pressure

- (b) because of rubber elasticity
- (c) because of force experienced from solid ground
- (d) all of the above

14. The bounce of a ball

- (a) depends on internal pressure
- (b) does not depend on internal pressure
- (c) depends on whether ball is hollow or solid
- (d) all of the above

15. How does the audio sensor detect the sound of bounce?

- (a) it has a capacitive circuit
- (b) it has a resistive circuit
- (c) it has inductive circuit
- (d) all of the above

Oral presentations

classroom ideas papers

Some lessons from a 3-year experiment of Problem-based learning in Physics in a French School of engineering

Philippe Ageorges, Adriana Bacila, Géraldine Poutot, Bernard Blandin
Cesi School of Engineering, Paris, France

Abstract

In this experiment, a Problem-based learning methodology (PBL) is used to teach physics to engineering students. The efficiency of PBL is measured and compared to traditional teaching methods. Our experiment shows no major differences in terms of knowledge acquisition, conceptualization and physical reasoning. On the other hand, PBL shows an influence on cross-knowledge acquisition.

Implementing PBL with large groups of students has faced many human difficulties. PBL is a highly destabilizing and demanding method for students. To make them accept the method and the effort, PBL method has been adapted with closer guidance from tutors. A preparatory program has also been set up.

The experiment also shows that the lecturers' acceptance and understanding are key success factors. It is a long process for experienced lecturers to move from a teacher-centered teaching method to a student-centered pedagogy. Lecturers need strong support and guidance from PBL experts but also from the faculty itself.

More complex timetables have been designed to manage large groups of students with limited staff. The constraint is to maintain the same number of teaching hours as for traditional teaching.

If difficulties have appeared throughout this experiment, benefits have been noticed over time. Students develop problem solving methodologies as well as communication and organizational skills. These benefits have been noticed by companies and students' acceptance has improved over time.

Keywords: problem based learning, Physics, School of engineering

Introduction

For the past three years, CESI, a School of engineering in France, has developed a Problem-based learning methodology (PBL) in the field of physics. The main objectives are to make physics more attractive to students as well as helping them to develop professional skills. The first steps of this development program have been presented at the GIREP conferences in 2010 [1] and 2012 [2]. This program has been further developed in all fields of physics and extended to a larger group of students. Organizational and human problems as well as the efficiency of the PBL method are presented in this paper.

1) The background

Problem one

Over the years, lecturers noticed a declining interest in studying sciences. If students are keen to discover new subjects, they are not motivated to understand basic concepts of science. In most cases, they are unable to use them in real-life situations.

Another important issue for teachers is to keep students' attention while competing with modern distractions. Students cannot listen and concentrate for more than 30 to 45 minutes, and they almost constantly connect to their mobile phone and other portable devices during class.

For all these reasons, we wanted to find a way to stimulate students' interest and increase students' skills in physics.

Problem two

Students involved in this experiment are engineering students at a Bachelor level. They are all enrolled in a specific Master of engineering program that combines full-time periods of study and full-time periods of work in a company. Because they are employed by a company, students are expected to quickly develop professional skills in order to complete their work experience with success.

The most common skills required by companies are not only technical expertise, but also reasoning abilities, communication skills and organizational skills. All these skills could not be developed with traditional teaching methods. Common feedback from companies is: "*your students know things but cannot use them*".

All these facts pushed us to explore teaching methods that would help students develop professional skills. This is why an active learning approach based on Problem Based Learning (PBL) was chosen and developed.

The objectives and the hypotheses of this experiment are:

- PBL will be tested in physics during the first year,
- PBL's efficiency will be measured and compared to traditional methods,
- PBL should improve conceptualization and comprehension in mechanics, thermodynamics and electromagnetism,
- PBL should improve students' motivation.

2) PBL implementation

The PBL sequences

Six specific problem situations were developed to cover the physics program of a whole semester (two in mechanics, two in electricity and two in thermodynamics). For each problem, the PBL Session was divided into five sequences. At first, the class was divided into groups of 10 to 12 students and each have to precisely define the issues which are to be addressed in the problem (1). In the second sequence, students have to use given materials to learn all the physics principles required in the problem (2). The third sequence is devoted to the resolution of exercises based on the physics principles (3). In the fourth sequence, students have time to solve the problem individually (4). The final sequence allows students to synthesize answers and demonstrate that the required learning outcomes are acquired (5). All sequences are supervised by a tutor.

The following table shows the timetable for two problem situations.

Table 1. The five PBL sequences for two different problem situations conducted consecutively

	Monday	Tuesday	Wednesday	Thursday	Friday	Monday
8 - 9 am						
9-10 am		(1)		(5)		(5)
10-11 am		(2)	(4)	(1)	(4)	
11-12 am				(2)		
1-2 pm		(2)		(2)		
2-3 pm						
3-4 pm		(3)		(3)		
4-5 pm						

Implementing PBL with a large class

The development of the PBL methodology has faced difficulties due to the large number of students, the limited number of teaching staff and the school’s economic constraints. The number of teaching hours cannot be higher with PBL.

In traditional teaching, one person can easily teach to 75 students sitting in a lecture theater. Then the class is divided into 2 or 3 smaller groups for problem classes and practical work. With the PBL approach, it is not straightforward to handle 6 groups of 12 to 13 students.

To solve these difficulties, one has to consider the role of the PBL tutors. The efficiency of the methodology relies on the people in charge of it. All PBL tutors must agree with the PBL methodology. Most of them have been used to traditional teaching and they usually enjoy it. Their role differs drastically in an active learning approach. Their role is to facilitate and guide students by means of questions. No answers should be given, students should find solutions by themselves. Tutors have to accept that they are not the heart of the learning process.

Therefore, one has to realize that certain sequences require close supervision by a tutor (sequences 1, 3 and 5) while others require less assistance (sequence 4) or even no assistance at all (sequence 2). For instance, sequence 1 and 5 last one hour each. Two tutors can repeat these sequences with different groups at a time. Sequence 3 lasts two hours and can be seen as a more traditional exercise session. The tutor runs the sequence with 3 groups at the same time. In sequence 4, tutors are present but assist students on demand only. To make all that fit with the same teaching hours and the same number of staff as used for traditional teaching requires specific timetables for each group and for each tutor. When tutors have to repeat the same sequence several times in a row, each group has to go from one sequence to the next. As a consequence, groups will not start a particular PBL session at the same time. The class timetable turns out to be much more complex with the PBL methodology.

Table 2. PBL Timetable for 3 different groups and one lecturer following two consecutive exercises

Groups	Monday	Tuesday			Wednesday	Thursday			Friday	Monday			Tuesday
		Gp 1	Gp 2	Gp 3		Gp 1	Gp 2	Gp 3		Gp 1	Gp 2	Gp 3	
8 - 9 am		(1)				(5)				(5)		(4)	
9-10 am			(1)		(4)	(1)	(2)				(5)		
10-11 am			(2)	(1)		(2)	(5)		(4)			(5)	
11-12 am							(1)						
							(5)						
1-2 pm			(2)			(2)	(1)						
2-3 pm													
3-4 pm			(3)			(3)							
4-5 pm													

Example of a PBL study case

In mechanics, students solved a problem that occurred in one of the French railway hump yard. Wagons rushed down the hump with a final velocity that was too high. They ended their course with too much energy for the bumpers. Students were able to analyse the problem using data provided by the railway company and the wagon manufacturer. One expected learning outcomes was: potential energy is independent of the path taken by the wagon.

All PBL study cases were based on real company problems.

3) Quantitative results of the experiment

The experiment aimed at comparing the PBL method with traditional teaching. The program in mechanics was chosen for this quantitative experiment [2].

Three different campuses participated in this experiment: Campus 1 with 120 students, Campus 2 with 30 students and Campus 3 with 60 students. In each campus, students were divided into two groups of identical size. One of the groups did traditional teaching while the other group participated in the Problem-Based Learning sessions. To compare both approaches, the following protocol was set-up: The students take the same exams, one after each module, and take a test in order to evaluate progress in mastering the concepts and principles of Newtonian physics: the Force Concept Inventory (FCI) developed by Hestenes [3]. The FCI was taken by all the students before and after the course. The results are presented in Figure 1.

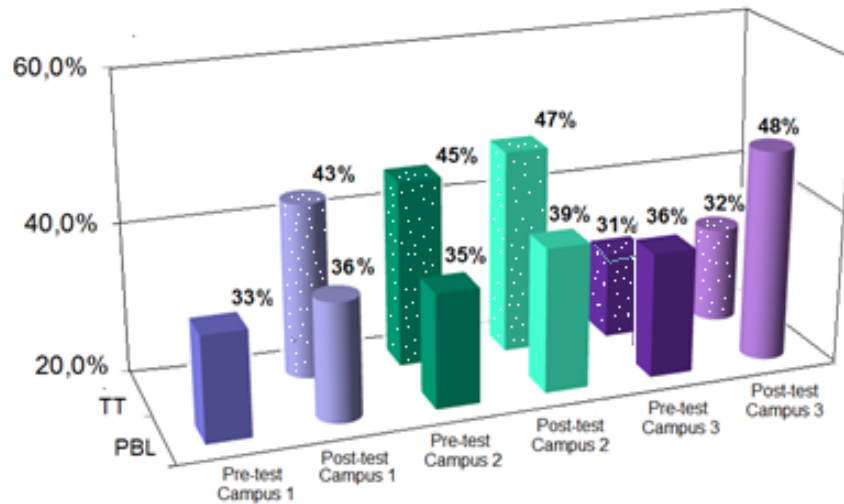

Figure 1. Results of the FCI before (Pre-test) and after the course (post-test) for both traditional teaching (TT) and PBL [2] (No TT Pre-test data available for campus 1)

Acquired competences are validated by the exams. The evaluation of the learning outcomes uses a Rubrics grid [4] which measures the achievement of each learning objective. This grid is based on Bloom's taxonomy [5]. Marks obtained for the exam after the course are synthesized below for each campus. The PBL group is noted PBL and the traditional teaching group is TT. Results are presented in Figure 2.

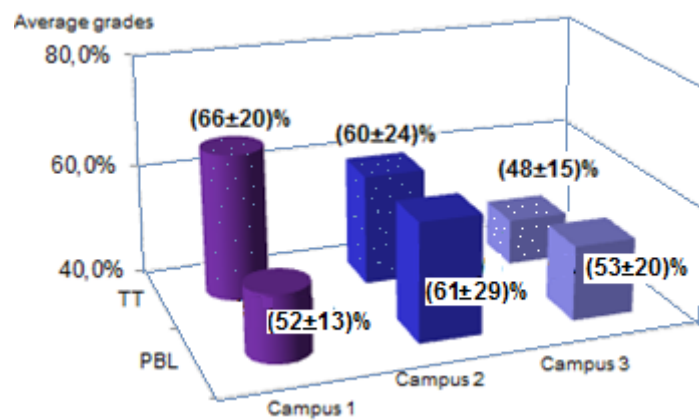

Figure 2. The exam results for both traditional teaching (TT) and PBL [2]

When comparing these two methods, results in mechanics show that PBL does not improve knowledge acquisition, nor does it have an influence on conceptualization [2]. These results do not show us that PBL is more efficient than traditional teaching. Major influence is seen on a qualitative point of view.

4) Qualitative results

Students' attitude with PBL

Compared to traditional teaching, the majority of students are highly involved in solving PBL problems. Students recognise that they have never worked that much in sciences. Solving problems is seen as a challenging task, however, moving from a comfortable

passive methodology to an active one has been extremely demanding and tiresome for most of them. One major difficulty in this experiment was the students' negative reaction to PBL. Common complaints are: "*We need lectures to learn*"; "*We need teachers to learn*"; "*Tell me what I should do?*"; "*What is the answer?*"; "*I have to learn by myself, teachers are doing nothing*".

To improve students' acceptance and, therefore, the efficiency of active learning, it is important to prepare them for this new methodology. A preparatory course is necessary to make them move from the long-term use of traditional teaching to a scheme that best fits company needs. In this course, students experience PBL with two problem situations and then, they have to analyze and identify the strength of the PBL methodology in relation to the skills of an engineer. As soon as they understand the use of PBL, students will accept the efforts required. This acceptance may take some time for certain students, so the tutor has to regularly explain and justify the different steps. At the very least, a group discussion has to take place at the end of each sequence 5. Individual feedback is also a key element to reassuring destabilized students.

Students' acceptance in adapting the PBL methodology has also improved over the years. Feedback from student showed the necessity for having more guided exercises on the learning outcomes. This is why sequence 3 has been enriched with a series of exercises and stronger guidance from tutors.

The students' acceptance improved with time. Those who criticized the PBL method while there were doing it realized its benefits afterwards. Working in a company enhances the acceptance process. Companies often mention that PBL students are more autonomous in solving complex problems. They develop pro-active behaviour as well as good professional skills in terms of communication and methodology to organize their work [6].

Over three years, students' appreciation of PBL has moved from 65% of acceptance to 93%.

Lecturers' new role

With PBL, lecturers have to understand and accept a new role. PBL tutors organise the learning process and facilitate students in their learning. Experienced lecturers find it hard to move from a "one man show" teaching approach to a PBL one. PBL is centred on the student and on the problem. PBL tutors do not transmit knowledge but enable students to acquire knowledge. PBL students learn in small groups guided by a tutor. Tutors guide the group in defining self-directed learning objectives. These objectives guide students throughout their learning process. PBL tutors guide the group with provoking comments or counter-questions. They must use their expertise in a subtle and limited way. Experience shows that it is often tempting to intervene when students' discussions enter tutors' field of expertise. Tutors should not control the learning process. This experiment shows that most lecturers used to the traditional approach often find it inconceivable to not interfere in an authoritarian way.

Creating PBL problems is an extremely stimulating activity but requires a lot of time and energy. A good PBL problem involves a real situation that engages students to acquire different learning outcomes. A PBL problem does not have one solution [7]. It is a real challenge to write problems that stimulate students' curiosity and encourage learning. The time it takes to create a problem and select all appropriate resources leads to lecturers being discouraged.

Moving away from traditional teaching to PBL is like moving to a completely new teaching paradigm for experienced lecturers. They need to be guided and supported in this

new approach. Support and understanding must also come from the faculty heads and administrative staff. This experiment shows that working in teams is the best way to understand and move on with the PBL methodology.

Conclusion

Traditional teaching and PBL results show similar knowledge acquisition and similar level of conceptualisation. However, PBL helps develop problem solving and professional skills.

Students have never worked that much. Most of them are stressed because of the necessity to adapt to new ways of learning. However, the more they work with PBL, the better, faster and easier it becomes for them. They develop a high level of autonomy.

Implementing PBL requires the whole institution's support, and a high involvement of tutors.

PBL methodology is now used by many physics tutors in CESI. Different classes have practiced the methodology, and the "guinea pig" feeling of first generation students is over. The school's future project is to develop problem situations in other fields as well as project-based learning in physics and technology.

References

- [1] Blandin B.: (2010), Learning Physics: a Competency-based Curriculum using Modelling Techniques and PBL Approach. *Oral presentation at the GIREP – ICPE – MPTL International Conference, Reims, 22-27 August 2010*. [Online] accessed on 2012-04-20 at: http://www.univ-reims.fr/site/evenement/girep-icpe-mptl-2010-reims-international-conference/gallery_files/site/1/90/4401/22908/29321/29590.pdf
- [2] Bacila A., Poutot G., Ageorges P., Blandin B.: (2012) *Problem-based Learning in mechanics : some results of a controlled experiment*, The International Conference On Physics Education, Istanbul, 1-6 July 2012, [online]. Available from: <http://www.icpe2013.org/>
- [3] Hestenes D., Wells M., Swackhamer G.: (1992). Force Concept Inventory, *The Physics Teacher* 30, 141-151.
- [4] Allen D., Tanner K.: (2006) Rubrics: Tools for Making Learning Goals and Evaluation Criteria Explicit for Both Teachers and Learners, in CBE—Life Sciences Education, Vol. 5, p. 197–203.
- [5] Bloom B. S., Krathwohl D. R.: (1956), *The classification of educational goals, by a committee of college and university examiners*, New York, Longmans.
- [6] Drohan S., Maufette Y., Allard J.-L.: (2011) Employers perspectives on Problem-Based Learning Initiatives, in Barrett, T. & Moore, S. *New Approaches to Problem-Based Learning: Revitalizing your Practice in Higher Education*. New-York: Routledge, p. 87-99.
- [7] Savery J.R.: (2006) Overview of Problem-based Learning: Definitions and Distinctions, in *The Interdisciplinary Journal of Problem-based Learning, Vol. 1 n°1*, p. 9-20.

Impact of Project Based Learning of Physics in a Technical Institution, Karachi

Syed Rehan Ali¹, Syed Naseem Hussain Shah²

¹Department of Basic Science, Aligarh Institute of Technology, Karachi, Pakistan

²Department of Physics, Federal Urdu University of Arts, Science and Technology, Karachi, Pakistan

Abstract

Project Based Learning (PBL) is a comprehensive strategy of teaching and learning that engages students in investigation of authentic problems. In traditional teaching methodology, the students are not expected to think about what they are doing; rather, they are interested in getting it done. In Project-based learning our goal is to involve our students in activities that develop creativity and critical thinking by engaging them in substantial opportunities. Once students experience such opportunities, their ability to understand physical phenomena is also increased. Projects organize the activities of the students, and allow them to share their knowledge, conduct research, solve different types of problems, and synthesize information. Usually, students at technical Institutions are matriculates and a majority of them are average. It is very difficult for teachers to make their concepts of physics clear through the traditional lecture method only. The project-based method adopted in our Institute plays a vital role in removing students' physics misconceptions and developing a solid in-depth understanding of the physics involved in their curriculum. We introduce a way of teaching in which teachers divide the course content into small tasks, use modelling, build from small student projects in the class to large-scale projects. A variety of assessment tools have been used to evaluate the performance including the exhibitions of student projects.

Keywords: project base learning, technical institutes, learning motivation

Introduction

"Tell me and I'll forget
Show me and I may remember
Involve me and I'll understand" (*Chinese Proverb*).

This proverb has become the source of our inspiration for adopting project based learning. As we all know, creation comes from inspiration and inspiration is the result of influence. Learning is based on this fact [1]. In our life we see, hear and observe and some of this is engraved in our mind and developed into ideas. Every child learns by doing himself and observing what he sees.

Project based learning is a powerful tool that helps students learn by involving them in hands- on practices that develop their critical thinking and provide for the solution of their problems by sharing knowledge [2]. Progress is the continuous process involving the efforts of many individuals and groups of coworkers.

Physics is a compulsory subject for almost all the technologies offered in the Diploma of Associate Engineering (DAE) Program of Technical Institutions. The syllabus designed for students of Technical Institutions consists of 60% practicals and 40% theory. Here in our Institute we have four technologies; namely, Electronics (ELT).

Electrical (ET), Computer Information (CIT) and Biomedical (BMT). We introduced Project Based Learning in our Institute to involve the students in physics learning by increasing their interest and to remove their misconceptions about physics by providing them a concrete understanding of their subject. This is done by keeping in view the relationship of their physics curriculum with their technology.

Background of Technical Institutions

Most of the students enrolled in technical Institutions are aged 15 to 17 years (having 10 years of education). These students do not have an acceptable knowledge of physics and, therefore, the traditional lecture method does not fulfill the requirement of in-depth understanding of the physics relevant to their careers. As a matter of fact, the curriculum of technical Institutions places more emphasis on practical knowledge than the theoretical sort, which is why project based learning is very effective in these institutions.

The aims of this approach

Following are the main aims of this approach:

1. To engage students full time in their studies, infusing higher-order thinking skills, guiding students in life choices, providing them experiences, motivating them, providing core knowledge of the subject, integrating the concepts from a number of disciplines or fields of study, and providing opportunities for solving real problems.
2. The students will be able to understand the fundamental principles and concepts of physics and use this understanding to solve problems in practical situations and in their technological courses and to understand concepts to learn advanced physics through their technical courses by applying this comprehensive approach of learning.
3. To encourage students to encounter the central concepts and principles of a discipline.

Approach applied in our Institute

Our teachers applied the following approach to implement these goals:

4. Divide the course contents into sets of small tasks.
5. Use modelling.
6. Have the students do small projects in class.
7. Discuss ideas with students [3].
8. Introduce large-scale projects as the final projects.
9. Exhibit of their Projects.
10. Write reports on their projects.
11. Interaction with the legends of the market of the related field.
12. Prepare student for the professional field.

Tools used for the Assessment

In project-based learning, performance is assessed on an individual basis (although the projects are done by students working in groups). A variety of assessment tools have been used to evaluate the performance including the exhibitions of their projects. We assessed the students on the basis of multiple choice questionnaires, viva voce, and the final projects judges' evaluation (judges are from a relevant field) [4]. Multiple assessors have been

invited from different fields to improve assessment of the quality of work as well as to expose students to the world outside the classroom.

Impact of project based learning in our Institute

- Students improve their test scores.
- Get better final results.
- Become more regular and punctual.
- Debating ideas.
- Designing plans.
- Drawing conclusions.
- Creating artefacts.
- Better understanding of physics than the other Institute's students.

Some of Our Projects

1. Distance and angle detector

In this project we calculate the distance of an obstacle and its relative position with respect to the magnetic north and getting the information to display on LCD as well as on computer. We calculate the distance by transmitting ultrasonic waves and receiving back after reflection from the obstacle.

2. Solar mobile charger

This project shows the conversion of solar energy into electrical energy. This charger is very useful in the countries where we have electricity problems and it is sunny for very large periods of time throughout the year.

3. Solar cooker

Here we have a conversion of solar energy into thermal energy. It attains the temperature required for the cooking of food.

4. Alternate energy

In this particular project we introduce the generation of electricity by the motion of the wheels of a bicycle, i.e., conversion of mechanical energy into electrical energy. This project provides example of alternate energy.

5. Optical voice communication system

It is a project of voice communication in which transmission of sound energy through modulation of a light signal takes place. It shows communication with and without optical fiber.

Students at their Projects

The photos below have shown the students exhibiting their projects in front of experts from relevant fields.



Strength of Students in different Technologies

In our institute the electronics and computer information technologies are the dominant technologies. Technology-wise distribution of students during last 5 years is shown in the pie chart below.

Graph 1. Contribution of Technologies (2008-2011)

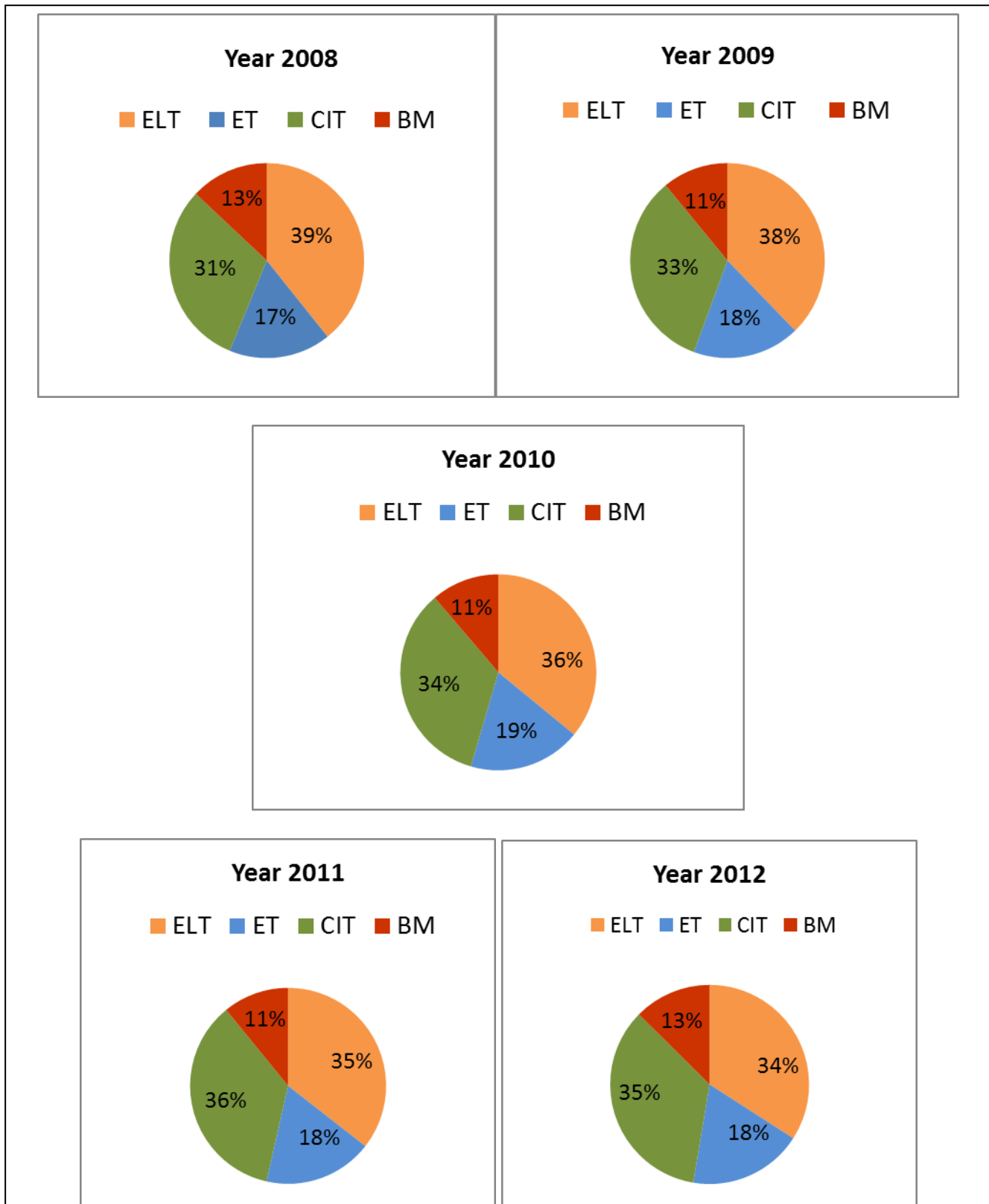

Performance of students in our Institute before applying the PBL technique

In our Institute, we started project based learning of physics from 2008. The graph below shows the results of last five years (2003-2007) of national final board examinations before applying this technique.

Graph 2. Consolidated performance of students before PBL technique by choice of technology area (2003-2007)

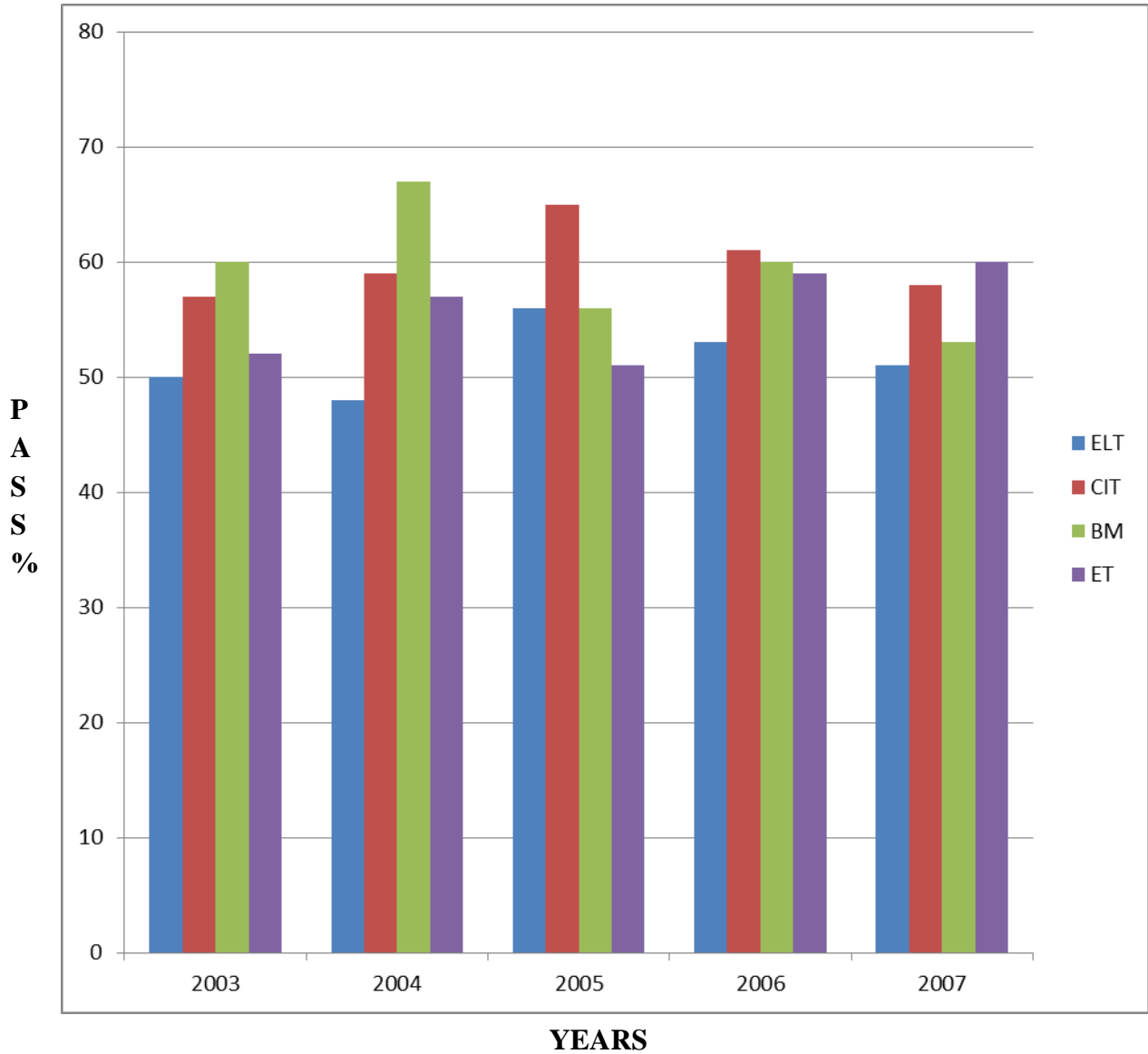

Results of national final board examinations from the past five years (2008-2012) after applying project-based physics in our institute shows that the performance of students increasing every year in all technologies. Project based learning has more impact on electronics technology students than the other technology students.

Graph 3. Consolidated performance of students by choice of technology area (2008-2012)

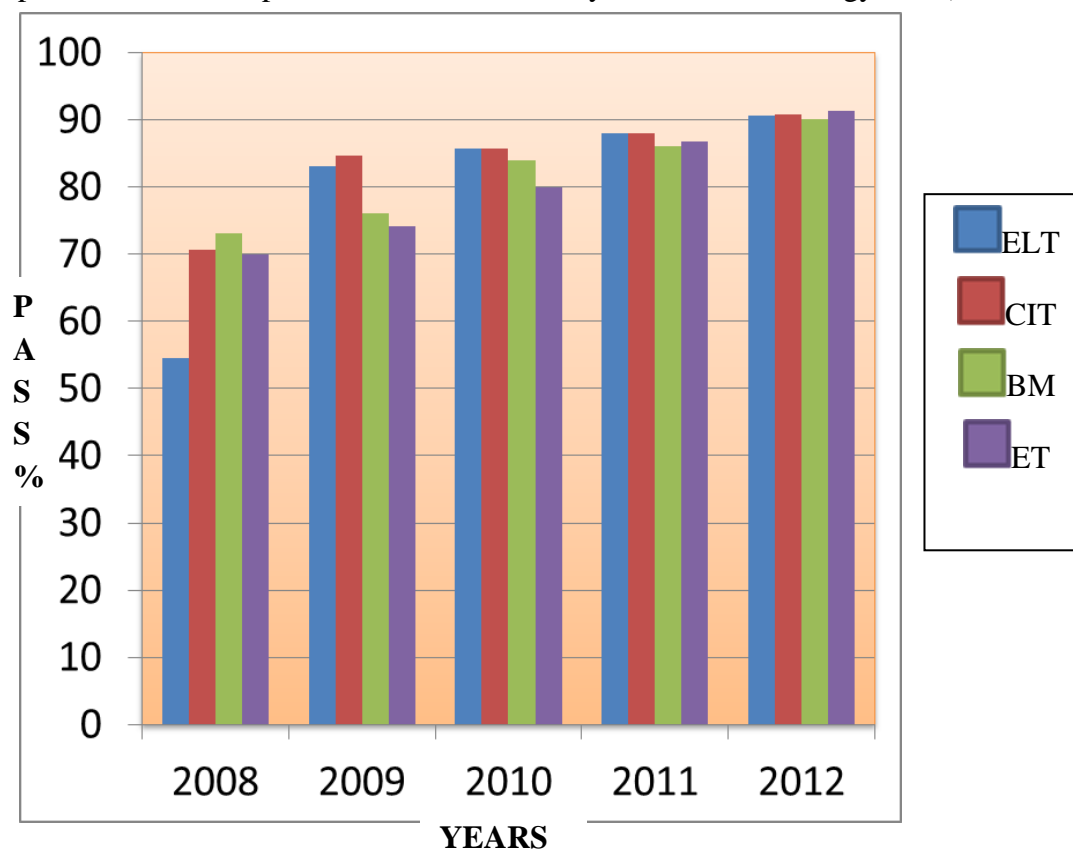

Conclusion

The students of our Institute have better understanding of physics after the implementation of project based learning. Comparison of graph 2 and graph 3 clearly indicates the success of this technique. It is concluded that the implementation of PBL in our Institute not only motivated the students but also enhanced their knowledge of Physics and contributed to their rational approach. Moreover, the statistical analysis of last five years results of physics in our Institute shows that pass percentage has noticeably increased due to project based learning.

References

- [1] Grant M. M.: Getting a Grip on project-based learning: Theory, cases and recommendations. Meridian; 5:1-17, (2002).
- [2] Harris J. H, Katz L. G.: Young investigators: The project approach in the early years. New York, (2001).
- [3] Tynjälä P., Tourunen E.: 'Three-way partnership assessment in working life oriented project-based learning,' in Benton, N. and Benton, R. (eds.), Te Rito o te Matauranga. Experiential Learning for the Third Millenium. Selected papers from the Seventh Conference of the International Consortium for Experiential Learning, Vol. 2, Auckland: James Henare Maori Research Centre, pp. 47-58, (2002).
- [4] Segers M., Dochy F., Cascallar E. (Eds.): Optimizing new modes of assessment: In search of qualities and standards Vol. 1, (2003).

Transforming Engineering Physics Tutorials with Cooperative Learning and Learning Assistants: A First-Hand Experience

Sheh Lit Chang, Leiju Qiu, Nidhi Sharma

Department of Physics, National University of Singapore, Singapore

Abstract

Our engineering physics course (Physics IE) on mechanics and thermodynamics is the first calculus-based physics course which most engineering students enroll in. It is offered in both semesters and the contact sessions are lecture, tutorial and laboratory. In this article, we focus on changing the way we conduct the tutorial sessions, from the traditional lecturing style to cooperative learning with both teaching assistants and undergraduate students as learning assistants. The objectives of this transformation are to promote active learning among the students and provide more effective instruction to them.

In order to improve students' problem solving performance, we adopted Heller's suggestions and groups of 3 students are formed, resulting in having 6-8 groups in each tutorial class. We also adopted the learning assistant model from University of Colorado, Boulder in our course by recruiting our 2nd year and 3rd year undergraduate physics students as learning assistants (without prior training) in our tutorial class, to assist the teaching assistant to handle the student groups more effectively.

The purpose of this paper is to share our first-hand experience in implementing cooperative learning and learning assistants in our course. Assessment on effectiveness showed that around 60% of students surveyed felt that this style is effective to their learning on a 4-point Likert scale in mid-semester survey. However, most of them still felt that teaching by telling was more effective and efficient in terms of time usage in the end-of-semester survey.

Keywords: University education, cooperative learning, learning assistant, engineering physics

Introduction

Numerous physics education research articles have highlighted the undesirable student outcomes of traditional introductory college physics instruction, such as poor conceptual understanding [1-2] and problem-solving skills [3-4]. To improve these outcomes, innovative instructional strategies and materials are developed by physics education researchers and they have been proven to be effective. These include cooperative learning [5], peer instruction [6], the CU Boulder learning assistant model [7], Tutorial in Introductory Physics [8], etc. Among these approaches, cooperative learning and learning assistants were selected to improve the tutorial instruction in our course.

Problem solving through cooperative learning in physics classrooms was suggested by Heller et.al [5], 1992. This involves putting students in groups and each group works on the problem together. The learning assistant model was initiated by Otero et.al [7], 2010 in the University of Colorado, as an experiential learning program to aid in the preparation of future physics teachers. If the tutorial instruction of a large-enrollment introductory physics course were to be done by cooperative learning effectively, it was recommended to have a second facilitator in large classes [9]. In a typical class of 20-25 students, the involvement of learning assistants will certainly remedy the situation.

In this paper, the implementation of the 2 approaches in our course will be discussed. Then, the effectiveness of this transformation will be evaluated via mid-semester survey, end-of semester survey, teaching feedbacks and instructors' experience.

Background Information

Physics IE (PC1431) is a calculus-based, introductory physics course covering mechanics and thermodynamics [10], mainly for 1st year engineering students at National University of Singapore. It is a four-credit course, with weekly 3-hour lectures and 1-hour tutorial sessions once a fortnight, enrolling about 800 students in Semester 1 (August to November) and 200 students in Semester 2 (January to April). The students are also required to attend two 3-hour laboratory sessions in the semester. The tutorial sessions are taught by full-time teaching assistants (TAs) and the laboratory sessions are handled by lecturers, TAs and graduate students. In addition to that, students are required to complete weekly online assignments via the MasteringPhysics platform.

In the past, tutorials were conducted much like the traditional style: TAs go into the class, conduct the tutorial like a mini-lecture, demonstrate how to solve problems on the board and complete solutions are posted after the tutorial. Students are told to attempt the tutorial before the class, fill up their blanks with the TA's explanation and compare their own solutions with the TAs'. Also, they could refer to solutions if they can't follow the class.

The problems with the traditional tutorial teaching style are the following: (i) most of the students stepped in the tutorial room without attempting tutorial questions because they are too difficult to attempt and they knew that teaching assistants will be presenting the solutions and they will be passive listeners; (ii) due to time constraints, there is not much time for the students to think; (iii) TAs could not tell whether the students have really understood the solutions, as there is not much interactions between them. We tried to use the cooperative learning system to address these problems and improve conceptual understanding and problem solving skills in the students.

Methodology

The basis of our methodology is to encourage students to attempt the tutorial problems before they attend the tutorials and to prepare questions for class discussion. In order to achieve these goals, we have implemented the following teaching methodology:

(i) Changed Frequency of Tutorial Sessions

The tutorial sessions were changed from once a fortnight to a weekly basis.

(ii) Providing Tutorial Problems with Hints

The problems given in tutorial are mainly end-of-chapter kind, with 5 – 7 questions in each problem set, difficulty level ranging from intermediate to high. Based on past experience, students face difficulties in understanding the questions and solving them. To encourage them to attempt the problems before they attend the sessions, hints or steps to solve the problems are prepared for harder questions. A sample question with hints is given below:

In Figure 1, a cable pulls a skier up a hill inclined at 10° above the horizontal. The skier starts from rest and the cable exerts a tension T at an angle 30° above the surface of the hill. The mass of the skier is 60 kg and the effective coefficient of friction between the skier and the snow is 0.10. What is the maximum tension in the cable if the starting acceleration (along the slope) does not exceed $0.40g$? (Answer: $T_{\max} = 431\text{N}$).

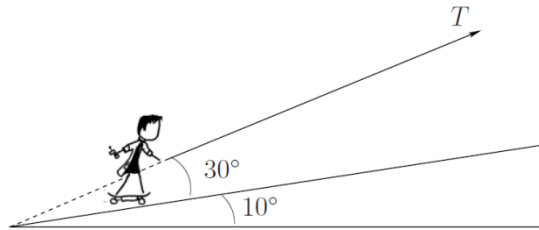

Figure 1

Hint 1: Draw the free body diagram of the skier.

Hint 2: Choose a suitable coordinate system, preferably one with acceleration, the other one having no acceleration.

Hint 3: Resolve the forces in x and y -directions.

Hint 4: Apply Newton's 2nd law to write down 2 equations of motion in x and y -directions.

Hint 5: Find the maximum tension.

(iii) Hiring of Learning Assistants (LAs)

An announcement was made to 2nd year and 3rd year physics undergraduates to volunteer as learning assistant in PC1431 tutorial sessions. They went through a simple test using the Force Concept Inventory [11] to check for their conceptual understanding. They were briefed about the roles as LAs: to assist students with their queries. Before every tutorial session, they were provided with the problem sets to solve. Each tutorial class is assigned with one LA to work with the TA. There were no prior training for the LAs and no weekly meetings with them to discuss the problems before the actual tutorial. But if they have questions regarding to the related physics concepts and tutorial questions, they are encouraged to ask the TAs.

(iv) Grouping of Students

Students are put in groups of 3 in the 1st tutorial session, and they remain in the same group throughout the semester. Since, the contact tutorial hours were only 10 over the entire term, and certainly these are barely enough to build good rapport, thus we decided to keep the groupings same throughout the term. With each class of 20 – 25 students, there are about 6 – 8 groups. They are not given any roles in the group, as opposed to what has been suggested by Heller [5].

(v) Tutorials

Each problem set is used for 2 tutorial sessions. During the 1st tutorial session, the TA and LA walked around the class to answer students' queries when the students were discussing their solutions. If they don't, TA and LA helped to facilitate their discussion. While doing so, the TA will take note of the common difficulties students faced and these will be addressed during the 2nd tutorial session. There were a total of 10 tutorial classes, out of which 6 were under me, Nidhi and Leiju took 2 classes each.

Results

(i) Mid-semester Survey

A total of 126 students (out of 213) are surveyed to evaluate our methodology in the mid-semester via 4-point Likert scale for the following 5 statements:

1. I am able to complete the tutorials with minimal help.
2. The hints provided in the tutorial templates are helpful.
3. I can get help from my peers during tutorial discussion.
4. I managed to clarify my misconceptions with the tutors during class.
5. I feel that this tutorial style is effective for my learning.

The survey results are summarized in Figure 1 below.

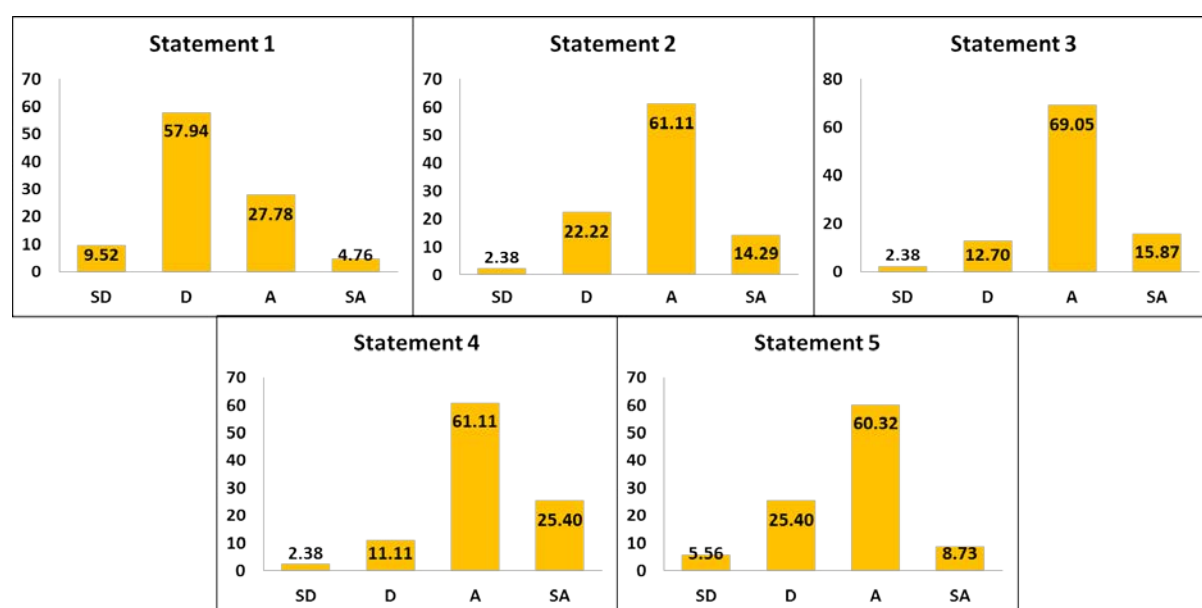

Figure 1. Students' perceptions on the reformed tutorial instruction during mid-semester. The numbers shown are in percentages, SD, D, A, SA stand for Strongly Disagree, Disagree, Agree and Strongly Agree respectively.

Although we only surveyed around 60% of the class population, the number of students surveyed is large enough to make some conclusions. Based on the results, more than 60% of students felt that they need assistance in the tutorial problems and the hints provided are helpful for them. This shows that our problems in general are of intermediate and high difficulty level, as perceived by the students in our class. More than 80% of the students felt that they are able to get help from peers and clarify their misconceptions from TAs or LAs in class. Lastly, more than 60% of the students felt that this tutorial instruction is effective for their learning.

Despite the fact that more than 60% of the students felt that this is effective, there are some students who responded in our open-ended questions, showing their discomfort in this learning style. One student wrote: "I don't think this teaching method (peer to peer discussion) works very well in Singapore/Asian countries in general. We are more used to sitting and hearing / looking at the answers." This seems to suggest that this student is

feeling denial and skeptical to this teaching approach, which is one typical response traditional students have in a non-traditional class, as highlighted by others also [12].

(ii) End-of-semester Survey

The end-of-semester survey comprises of 5 open-ended questions, targeting students' perceptions on the cooperative learning strategy and learning assistants. It is conducted at the last tutorial session of the semester.

Out of the 139 students surveyed, 70% of them expressed that teaching by telling works best for them, citing reasons that teaching by telling is more efficient, saves time, while cooperative learning is time consuming and they may end up with more confusions after discussions. These responses reflect a few things: (i) the instructors have to polish their approach to handle cooperative learning settings effectively; (ii) most students do expect the tutors to cover tutorial problems within the stipulated time, explain the concepts involved in each and every question clearly; (iii) most students have not yet reached the stage of return of confidence in their thinking ability as suggested by Felder and Brent [12]; (iv) one possible reason for the students' preference for conventional teaching was the more difficult content in rotation and rolling, as compared to the linear motion in the beginning of the course.

Since most of the students still prefer the traditional mode of tutorial instruction, they felt that having a teaching assistant in the class for the tutorial session is sufficient, so the presence of LA in the class is unnecessary. One student commented, "Rarely see the learning assistant helping", which further corroborates the point that it is redundant to have the learning assistant in class. There could be a few reasons account for such response from students: (i) students do not see the relevance in discussion based tutorials and hence the need of LA in class; (ii) we did not adopt *Tutorials in Introductory Physics* [8] in our tutorials, which involves conceptual questions. The questions used by us are end-of-chapter kind involving long calculations as well as multiple concepts, which students generally feel difficult and thus they prefer traditional approach.

(iii) Teaching Feedback & Instructors' Experience

The teaching feedback pertaining to this mode of instruction was mostly written on my teaching evaluation, probably because there were more classes under me. One student wrote under my strengths:

"He makes us think and try to arrive at the solution ourselves, rather than giving us the worked solutions. Also, he goes through concepts and makes sure that we are sure of what we are learning."

This comment is certainly encouraging and that's what most teachers are trying to achieve in their class. There are also some students who voiced out their discontent in this mode of instruction in the teaching evaluation, which one of them wrote:

"He should conduct tutorials in the teaching style instead of peer tutor style, because that way we will be able to be presented with an actual standard solution and compare with what we need to improve on in our own solution."

This comment reflects a few things: (i) we have not communicated our intention to do cooperative learning effectively to them; (ii) such student feels that it is more important for the tutor to present the actual solution to them rather than solving themselves.

All of us generally felt that the students are not convinced that the reformed instruction is going to help them in their understanding. This was reflected in the drop of class

attendance in cooperative learning sessions and for those who attended, some felt restless and disengaged in the class activities.

Discussions

This first-hand experience in our reformed tutorial instruction reflects the process of instructional change in higher education. In the standard models of the educational change, instructors should learn about all of the options and then make a choice within them with minor changes. Clearly, we had deviated from this model by making quite significant changes in adopting them. The change process of reinvention of existing techniques was not studied extensively in literature, so our work is an addition on to this research.

Our implementation of cooperative learning did not incorporate the five essential components (positive interdependence, individual accountability, face-to-face interaction, social skills and group processing) of cooperative grouping [13], and this accounts for the breakdown of the group dynamics in our tutorial sessions. We felt that this aspect is particularly important, which we need to take note of in the future. Furthermore, our choice of tutorial questions as lengthy end of chapter problems which involves multiple steps and application of formulae instead of conceptual questions has not given them enough room to involve in discussion.

One of our students highlighted that this reformed instruction may not be suitable in Asian context, which we find that it could possibly lead to another research direction to study the cooperative learning approach in Singapore's context at the tertiary level. Similar studies have been reported by many Asian countries with mixed experiences [14].

A more thorough investigation into this aspect will be more fruitful as we get more experienced in implementing cooperative learning. Also, students who are generally weaker in physics are more likely to get withdrawn from this approach as they prefer the instructors to impart knowledge to them.

Future Work

Suggestions provided by in Charles' study [15] are potentially helpful in the continuation of our efforts in improving our PC1431 tutorial instruction. There are plenty of lessons that can be learnt in this initial phase of implementation, such as the inclusion of the 5 essentials for successful cooperative learning, better communication with students about the rationale of the change in instruction and gain as much knowledge and experience as possible to promote instructional change.

Conclusion

In this work, we presented our first-hand experience in implementing cooperative learning and hiring learning assistants in engineering physics tutorials. Students are generally not receptive with our approach, as they indicated their preference over teaching by telling in the end-of-semester survey. There are a few reasons which could be attributed to this negative feedback: irrelevance of cooperative learning in students' perspective, insufficient communication with the students, missing elements in cooperative learning setting, significant deviation to the approach presented in physics education research and lastly, lack of experience in implementation. Once these are incorporated, we believe that students will be able to appreciate the strength of these methods and the tutorial settings will meet the anticipated objectives.

References

1. Halloun I. A., Hestenes D.: The initial knowledge state of college physics students. *Am. J. Phys.* 53, No. 11 (1985), p. 1043 – 1055.
2. McDermott L. C.: Research on conceptual understanding in mechanics. *Phys. Today* 37, No. 7 (1984), p. 24 – 32.
3. Van Heuvelen A.: Learning to think like a physicist: A review of research-based instructional strategies. *Am. J. Phys.* 59, No. 10 (1991), p. 891 – 897.
4. Larkin J. H., McDermott J., Simon D. P., Simon H. A.: Expert and novice performance in solving physics problems. *Science* 208, (1980), p. 1335 – 1342.
5. Heller P., Keith R., Anderson S.: Teaching problem solving through cooperative grouping. Part 1: Group versus individual problem solving, *Am. J. Phys.* 60, No. 7 (1992), p. 627 – 636.
6. Mazur E.: *Peer Instruction: A User's Manual*: Prentice-Hall, Upper Saddle River, NJ (1997), ISBN: 978-0135654415.
7. Otero V., Pollock S., Finkelstein N.: A physics department's role in preparing physics teachers: The Colorado learning assistant model, *Am. J. Phys.* 78, No. 11 (2010), p. 1218 – 1224.
8. McDermott L., Shaffer P. S.: *Tutorials in Introductory Physics*: Prentice-Hall, Upper Saddle River, NJ, (1998), ISBN 978-0130653642.
9. Redish E. F.: *Teaching Physics with the Physics Suite*: Wiley, Hoboken, NJ (2003), ISBN: 978-0471393788.
10. PC1431 Syllabus, [online]. [cit. 20. 7. 2013]. Available from: http://www.physics.nus.edu.sg/student/module_level1.html#pc1431
11. Hestenes D., Wells M., Swackhamer G.: Force concept inventory, *Phys. Teach.* 30 (1992), p. 141 – 158.
12. Felder R. M., Brent R.: Navigating the Bumpy Road to Student-Centered Instruction. *Coll. Teaching* 44, No. 2 (1996), p. 43 – 47.
13. Johnson D. W., Johnson R. T.: Making Cooperative Learning Work, *Theory into Practice* 38, No. 2 (1999), p. 67 – 73.
14. Thanh P. T. H., Gillies R., Renshaw P.: Cooperative Learning and Academic Achievement of Asian Students: A True Story, *Intl. Edu. Studies* 1, No. 3, (2008), p. 82 – 88.
15. Henderson C.: The challenges of instructional change under the best of circumstances: A case study of one college physics instructor, *Am. J. Phys.* 73, No. 8 (2005), p. 778 – 786.

Competitions of the Young Debrouillards Clubs – an Interesting Way of Active Learning

Zdeněk Drozd, Jitka Houfková

Department of Physics Education, Faculty of Mathematics and Physics, Charles University in Prague, Czech Republic

Abstract

The main objective of the Association of Young Debrouillards worldwide is to encourage children by entertaining ways to focus on science and technology. The Association of Young Debrouillards of the Czech Republic has a long experience in the organization of various competitions focused on children from pre-school age up to upper secondary school students. The contribution brings information about last two years of National competition and an invitation to a new year of it as it is open internationally now. The authors of this contribution are active members of the steering group of these competitions and authors of the competition's tasks.

Keywords: science education, physics, competition, simple experiments, active learning, Young Debrouillards, kindergarten, pre-school, primary school, secondary school

The Association of Young Debrouillards

The Association of Young Debrouillards (Federation Internationale des Petit Debrouillars - FIPD) is a non-profit organisation that conceive and carry out science activities for young people and the general public since 1984. Association of Young Debrouillards of the Czech Republic (AMD) is a part of FIDP since 1992.

The goal of FIDP/AMD is to introduce the sciences with the help of simple educational experiments. The participants observe, handle, and experiment. By means of this hands-on approach, they build their own knowledge and investigate the world that surrounds them. Doing simple and funny scientific experiences help young people to be curious and well informed, to develop a critical vision about the world and to be active citizens. The experiments rely on low-cost or found material. They offer anyone access to scientific thinking and techniques, with an underlying theme of respect for the environment

The concept of Young Debrouillards came from Quebec and has been developed in different places all over France and other countries (Belgium, Germany, Czech Republic, Morocco...). (Information from on-line resource [1].) The movement works in more than 49 countries on all continents.

The idea of establishing the clubs of Young Debrouillards became popular in last years in some countries, but still is not known in many others. However, the clubs' activities are very developed and attract more and more resourceful and ingenious children and youths.

The National Competitions of Association of Young Debrouillards of the Czech Republic

The Association of Young Debrouillards of the Czech Republic has a long experience in the organization of various competitions focused on children from pre-school age up to upper secondary school students. Since 1995 is the main event of all yearly arranged

projects and activities a national competition for Czech clubs of Young Debrouillards. That makes this coming year competition the twentieth annual competition. Last year the schools from Sweden as well as from Great Britain have joined these competitions. For the coming year five more foreign countries joined the competition, so we are on the beginning of a new type of an international activity for youngsters that represents also an interesting example of active learning.

The authors of this contribution are active members of the steering group of these competitions and authors of the competition's tasks.

A huge increase of the solvers occurred in the year 2012 as the competition was open to non-Debrouillards members. The number of participating teams and children doubled in 2013 when almost 1500 children grouped in nearly 150 teams from the Czech Republic and others from Sweden and Great Britain competed at the "Nobel 2013".

The competition in the year 2014 is called "Kvark 2014" and teams from Canada, Germany, Italy, Slovakia and Turkey want participate in it.

The topics of the individual tasks represent various interesting physics problems (self-made electromotor, dynamometer, thermometer, camera obscura, etc.).

There are four age-categories:

- kindergarten and pre-school children: age 2 – 6 years
- primary school pupils: age 7 – 10 years
- lower secondary school students: age 11 – 14 years
- upper secondary school students: age 15 – 18 years.

The tasks for individual categories are based on individual approach to each age group and on adequate working methods. The preschoolers work a lot with observing of their direct surrounding and drawing of pictures, the primary school pupils are led to more detailed descriptions and explanations, lower secondary school students have to add calculation and draw conclusions, and upper secondary school students deal with complex problems.

The competition consists of two parts. First part is the corresponding and the second part, the final, is a weekend meeting and competition of teams that were among the best in their categories in the first part. During the corresponding part the teams fulfil tasks in four rounds. Each round for each age category has the same parts:

- Creativity
- Theory and Investigation
- Practise and Project.

Creativity part is not related to the science but to creativity and team building of the research team. In the Theory and Investigation part the teams do some research, observing or investigation. The part Practise and Project is the most important part in which the teams use the knowledge obtained in the previous part and they do their own experimenting.

Example of tasks for the primary school pupils at “Nobel 2013”

SCIENCE CUP - 2nd year - „NOBEL 2013”

ASSIGNMENT

2nd round (February) - COMPETITION CATEGORY 2 - SOPHOMORE

1. Creativity

Create a logo and a flag of your team.

2. Theory and investigation

Topic of this competition round is a measuring of temperature. Temperature is an interesting quantity. If it was 10°C outside now in February, you would probably say: “It is so cosy outside.” If you had a swim in 10°C cold water, you would probably say: “That is bloody cold.” You would probably stay in a sauna heated to 100°C for a moment; you would be boiled in water heated to, as well, 100° . That is interesting, what does it cause? There is another one. There is no problem to put our arm to an oven heated to 150°C (or higher); however, water heated to 60°C hurts you. Find out the cause of these “mysteries”.

And investigate another thing. Go into a bath, take a thermometer with you and measure the temperature of water in which you are able to sit (lay). Be careful! Do not try to be a record-breaker, it is only about investigation! If you have an interest in this issue, investigate when the temperature of water in a bath is comfortable for you, when is cool for you or when the temperature of hot water is uncomfortable. Compare your findings with findings of your team-mates. Well, when you have not bath at home (in a shower it is not easy to do this experiment), do the same but use a big pot and put your hand in it. CAREFULLY!

3. Practice and project

You are going to create a historical fridge in the practical part of this competition round. And you will measure a temperature in the fridge. How did the age-old fridge look? It is easy.

Prepare:

- big plastic yogurt cup
- salt
- glass container which goes into the plastic cup (e.g. olive jar)
- thermometer which is able to measure a temperature below 0°C
- skewer
- crushed ice or snow



Instruction for an experiment

Put the crushed ice or snow into the cup and add table salt. Do not be sparing with salt, use e.g. table spoon of salt. Stir the blend in the cup by a skewer and put the thermometer in it. Maybe you will be surprised by the temperature of the freezing mixture. Do not forget to write down the temperature of the icy mash.

Now try to freeze water using the cup fridge. Pour a little into an olive glass or some similar container (e.g. glass of medicine) and put the glass container in the freezing mixture in the cup. Put the thermometer in the glass container and write down how the temperature changes. Measure it, for example, every 30 second. Take notice of the way how the temperature changes all along the cooling and freezing water. Describe it or draw a graph of the changing temperature (if you do not know how to draw a graph, find it).

That is the way how the fridge worked in the old days. In these days we do not use sated snow for freezing; however, we use the process which runs in the cup. Do you know for what?

What does freeze of salted snow or crushed ice cause? Ice gets hot and melts in a warm room and salt dissolve in run water. Heat energy is consumed during dissolving salt. It means the icy mash is getting cold. Maybe it occurred to you that the icy mash should freeze again, because it is getting cold. Salted water freezes at much lower temperature than unsalted water.



Assignment consultant: RNDr. Jitka Houfková, Ph.D. and Doc. RNDr. Zdeněk Drozd, Ph.D.

You can consult your work, write your remarks, experiences and questions at

<http://www.debrujar.cz>

MENU – Akce debrujárů 2012 - KOUMES 2012 – KONZULTACE – Přidat komentář

<http://www.debrujar.cz/2010/comment.php?akce=new&cislocclanku=2012010012>

You can see all the tasks of the “Nobel 2013” competition at [2-5] (each link leads to one round with all four categories, in Czech as well as in English) and preschoolers investigating heat and measurement of temperature on the pictures below.



Figure 1 and 2. Preschoolers doing hands-on experiments at “Nobel 2013”

The second part of the competition, the final, has two competition sections and a lot of fun, social and sport activities. On Friday evening each team must in five minutes on stage introduce itself and demonstrate and explain given experiment, the topics of the experiments are known in advance. On Saturday morning each team present at stand their work from the corresponding part of the competition, experimental diaries, their products and findings. The jury consist of experts and science teachers as well as leaders of all teams that are in the finals. Saturday afternoon is dedicated to non-competition activities, and evening brings the award ceremony.

Information about forthcoming competition “Kvark 2014” can be found at [6] and the tasks in English can be downloaded from [7] as they will be published from January 2014 to April 2014.

References

- [1] Available from:
http://ec.europa.eu/youth/evs/aod/hei_form_en.cfm?EID=14001257241
- [2] <http://www.debruar.cz/2010/view.php?navezclanku=pohar-vedy-nobel-2013-1-kolo-ukoly-leden&cisloclanku=2012120035>
- [3] <http://www.debruar.cz/2010/view.php?navezclanku=pohar-vedy-nobel-2013-2-kolo-ukoly-unor&cisloclanku=2013010025>
- [4] <http://www.debruar.cz/2010/view.php?navezclanku=pohar-vedy-nobel-2013-3-kolo-ukoly-brezen&cisloclanku=2013020024>
- [5] <http://www.debruar.cz/2010/view.php?navezclanku=pohar-vedy-nobel-2013-4-kolo-ukoly-duben&cisloclanku=2013030035>
- [6] <http://www.poharvedy.cz/local/staticpage/view.php?page=about>
- [7] <http://www.poharvedy.cz/local/staticpage/view.php?page=tasks>

UNDERWATER LABORATORY: Teaching physics with diving practice

F. Favale¹, M. Bondani^{1,2}

¹ Dipartimento di Scienza e Alta Tecnologia, Università degli Studi dell'Insubria, Como, Italy

² Istituto di Fotonica e Nanotecnologie, Consiglio Nazionale delle Ricerche, Como, Italy

Abstract

The interest in sport-related activities in teaching elementary physics is well known as simple physical examples taken from sports can be of great help in particle-dynamics, fluid-mechanics and thermodynamics lessons. This may be the case of diving. Diving education and diving science and technology may be useful instruments in teaching physics both in scientifically and non-scientifically oriented High School courses. We describe an activity that puts together some simple theoretical aspects of fluid statics, fluid dynamics and gas behavior under pressure with the diving experience, where the swimming pool and the sea are used as a laboratory.

Keywords: secondary schools, teaching methods and strategies, hydrodynamics, hydraulics, hydrostatics.

Introduction

Teaching physics, mathematics and chemistry in Italy seems to be particularly unattractive. One reason for the above-mentioned phenomenon is that scientific subjects are often perceived as too difficult by students. Moreover, in their opinion the presentation of the content, usually performed through frontal lectures, is not very attractive. On the other hand, the wonder and curiosity about natural phenomena and the discovery of the mechanisms that govern them are inherent features of all human beings, especially the youngest ones. Many authors in educational research consider it necessary to identify innovative teaching methods and paths in the transmission of knowledge and expertise in natural sciences, encouraging the natural curiosity of students, by starting, for example, from the observation of natural reality by an intensive use of laboratory [1] and direct experience. Unfortunately, not all schools actually have the necessary equipment to implement laboratory teaching in science education. Thus the most active teachers try to make their lessons more efficient with hands-on experiments.

The interest in sport-related examples supporting the teaching of elementary physics is well known [2]. Very often, a simple physical example taken from sports can be of great help in particle-dynamics, fluid-mechanics and thermodynamics lectures. This may be the case of diving. In recent decades, diving has become a popular and widespread leisure. Usual references to this sport in most elementary-physics textbooks deal with buoyancy equilibrium and with the limitations imposed by hydrostatic pressure.

Young people often approach diving without a real comprehension of its physics principles, and this may turn an exciting sport into a dangerous activity. Actually, every diving course includes at least one lesson and some activities about physical concepts, but very often divers forget about them or do not take them into account when diving. Divers

use regulators, manometers, BCDs (Buoyancy Control Device), but they have poor understanding of the inner workings of these devices. In this paper a teaching path about fluid statics stemming from diving is described.

A recreational sport like diving and a difficult school subject are connected in this path, whose novelty is that some of the practical activities are performed in a swimming pool.

Methodology

The path was performed with 40 students in the framework of the project Piano Lauree Scientifiche (PLS). All the students, boys and girls, were attending the last two years of the high school, so they were 17-18 year old. The teaching path took 16 or 20 hours overall. The lessons were performed as seminar demonstrations providing hands-on experience of basic fluid-mechanics principles, so the most important aspects of the course can be illustrated in a practical, relevant way. This makes the few hours of the course more effective. The demonstrations must be relevant and illustrative, not just visually appealing. They must be simple to run and easy to remember. Learning may be enhanced by increasing students' engagement [3]. Before developing the object of the study, students were surveyed by means of a preliminary entrance test not only to find out an overview of their previous knowledge, but also to raise more interest and expectation about the topics to be presented. A post-test was submitted to find out the achievements coming from the experience. The same test was used both before and after the activity.

Table 1 shows a very short scheme of the connections between the program topics and the activities both in classroom and in swimming pool. To highlight the originality of this program, only the activities performed in swimming pool are described in this paper.

Activities and experiments in the swimming pool

The activities in the pool were divided into two sessions: without and with SCUBA (Self Contained Underwater Breathing Apparatus) diving gear. The measurements performed during the activities are qualitative and the approximations do not permit any error estimations though some statistics considerations can be done.

Activities without diving equipment

One of the first experiments aimed at the measurement of the equivalent pressure generated by our respiratory system with a U-manometer (Figure 1).



Figure 1. Measuring the equivalent pressure generated by our respiratory system with a U-manometer

At the beginning of the experiment, the levels of the coloured water in the right and left side of the tube are equal. When the students blow into the tube, one end of the water column rises and the other decreases proportionally to the blow strength.

In this way we obtain a rough estimation of the equivalent pressure generated by each student. We found for males a mean pressure (expressed in meters of water units) of 1.3 m and for females 0.8 m.

Table 1. Summarizing scheme of topics, class demonstrations and pool activities

Topics	Demonstrations	In swimming pool
Pressure definition		
Pascal Principle	Pascal' apparatus, Hydraulic Press with syringes.	
Stevin law	Communicating vessels, U manometer, Hydrostatic paradox, Bottle with holes at different level, Heron' fountain, Bubble level.	Lung volumes measurement, Absolute and relative pressure.
Absolute and relative pressure calculation		Different lungs power needed to inflate a balloon inside and outside the water (diver out – balloon in; out – out; in – in; in - out).
Atmospheric pressure	Magdeburg Hemispheres, Torricelli experiment, Upside down water glass, Pressure over a newspaper, Suction cup, Some experiences with vacuum bell jar.	Alexander' bell, Gas behaviour in oil well on sea platform, Ear equalization during diving, Mask emptying for cleaning.
Upthrust force and buoyancy	Archimedes' upthrust force, Cartesian diver, Objects floating in fluid with different density, Horizontal and centrifugal Archimedes' force.	Buoyancy and our body, Changing the mass and the distribution of the masses, Changing volumes, The submarine, Cartesian diver, Visualizing the origin of upthrust force (Archimedes' force), Pivoting e hovering in diving.
Gas law	Demonstrations with syringes, Bottle and rubber balloon.	Boyle' law verification with a test tube submerged upside down at different depths in water.
Dalton' law and Henry' law		
Action and reaction principle		Tug of war inside the water.
Fluid dynamics: Bernoulli' law	Venturi' tube, Coanda' effect, Magnus effect. Heron' fountain.	The regulator

Mask clearing

All scuba divers will need to be able to efficiently get the water out their mask without surfacing and without panicking. Mask clearing consists in taking a deep breath from the regulator and exhaling it slowly but firmly through the nose while tilting the head up and pressing the top of the mask. Air from the nose bubbles upwards and fills the mask increasing the pressure inside and forcing water out from the bottom. We can create an analogue situation in the school laboratory. Take a glass test tube about $l = 20$ cm long with internal diameter a . Fill the tube with water. Plug the other end and invert the tube, placing the open end in a basin of water. Upon removing the plug, no matter the internal diameter, depth, angle of inclination of the tube, the height of water in the basin or whether you have partially filled the tube, the water level in the tube will come to rest at a certain height above the level of the water in the basin. The space in the tube above the column will be filled with air. Then you can inflate some air into the tube with the help of a thin cane and you will see the water level in the test tube going down. In the pool we have used a 10-liter tank with (Figure 2).

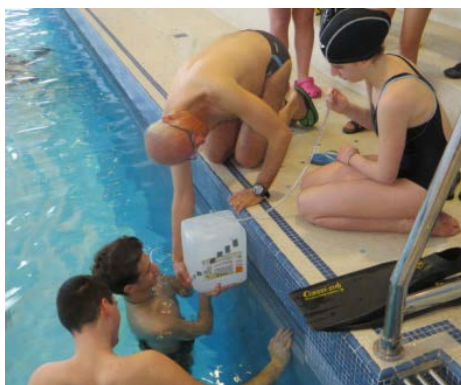

Figure 2. Rough measurement of vital capacity of lungs

The tank, which was filled with water and turned upside down in the pool taking care of avoiding water leakage, was maintained with the opening just few millimeters below the water level and a tube was inserted in it. Students were then invited to inflate air into the tank using the tube. The water level in the tank decreased due to the pressure increase inside the tank. It is possible to calibrate the volume of the tank and mark a scale in liters. In this way, the vital capacity of lungs can be measured.

Pressure increases with depth

The pressure a diver experiences at a certain depth is the sum of all the pressures above from both the water and the air. This is strictly related to Stevin's law for hydrostatic pressure. In a school laboratory we have proved Stevin's law with a funnel immersed upside down in a tall pot and connected to a pressure measuring device like a u-tube. In the water, pressure increases by one bar every ten meter depth. Divers do not feel the large pressure because the tissues of the human organism contain 65% of liquids that virtually do not shrink. During descent, divers usually do not feel the increasing pressure except for the ears, due to the air spaces in the middle ear. They only find breathing slightly more difficult because the gases they inhale have the same pressure of the surrounding water and thus a higher density. The increased pressure also acts on lungs during the inhalation making it more difficult to breath. Students can experience this difference in breathing in and out the water trying to blow a balloon fixed on the top of a 2m rigid tube in three

different situations. In the first, both the student and the balloon are outside the water. In the second, the student is outside and the balloon is in the water and finally the student is under water and the balloon in air (Figure 3). This experiment demonstrates that it is very difficult to blow up the balloon if it is immersed more than 0.8-1 m under the water. In fact, not only the force due to the tension of the rubber wall of the balloon but also the pressure around the balloon must be won. In this way, students experience that it is easier to blow up the balloon when they are under the water and the balloon is out, thanks to the pressure over their bodies.



Figure 3. How to experience difference in breathing inside and outside the water

Lung-regulated buoyancy control

Underwater diving is a common example of the problem of unstable buoyancy due to compressibility. Divers swimming in mid-water desire to achieve neutral buoyancy, but this condition is unstable, so divers need to make constant fine adjustments through the control of lung volume and through the adjustment of the contents of the buoyancy compensator (BCD) if the depth varies. Our lungs are a natural buoyancy compensator with about 5 kilograms of buoyant lift. A normal, resting breath expands our lungs by about one half liter, giving us half a kilo more buoyancy. So as long as we are nearly neutral with a half-breath, we can rise or fall at will just by controlling our lungs. Students know that buoyancy is due to an upward force exerted by a fluid that opposes to the weight of an immersed object. They also know that buoyancy depends on the volume of the displaced fluid. In this activity students experience the buoyancy law directly on their bodies. They have to keep arms, legs and feet still, than they exhale slowly and by doing that they begin to sink. This is also a basic skill in diving with equipment. We can observe that with completely filled lungs, the entire head emerges from the water. The rough estimation of the head volume fits lungs capacity.

Activities with diving equipment

For this part it is necessary to use a deep pool with at least 4 m depth to better understand and experience the effects of pressure difference. Students are involved in two different situations. At the beginning they are introduced to the safety rules and to the use of the equipment by specialized instructors. Diving in a 4 meter pool, students experienced a pressure difference of about 0.3–0.4 bar, just enough to be constrained to equalize the ears and the mask too. After a theoretical introduction, the instructors guided the students to their first dive. They try the mask, the fins and the snorkel. They breathe through the

regulator outside the water and then under the water. Many students experience ears pain due to pressure increase with the depth for the first time and the instructors explain them how to equalize the pressure inside the ears.

Archimedes' Law

People are curious about floating and sinking and most of them believe that small objects float and large objects sink [4]. There are also some alternative conceptions that are generally resistant to change and are often incompatible with currently accepted scientific knowledge. Students at the primary grades often predict if an object sinks or floats basing their reasoning solely on its weight, without considering its volume. Many students also focus on specific features of objects, such as air trapped inside or holes in the object, and make predictions based on these features [5]. A typical explanation widely presented in Middle and High School is the bottom-up derivation [6] involving a balance between surface and body forces [7]. The Archimedes' upthrust force originates from the difference between the force acting on the bottom and the upper surface.



Figure 4. Box with the bent rubber wall

In order to enhance the visibility of the theoretical explanation, we realized a simple device made of a Plexiglas box sealed with rubber lateral walls (Figure 4) following the suggestion of a didactic video from the 1980s [8]. As the box was completely immersed in water, the bottom rubber wall was bent more than that on the top (see Figure. 4). As expected, the left and the right rubber sides were bent equally.

Archimedes' Law and buoyancy

During laboratory lessons we can use the well-known Cartesian diver demonstration to illustrate the relation between Archimedes' Law, buoyancy and Boyle's Law. In the pool, that relation can be illustrated by simulating how a submarine works. In order to float, a submarine must experience a buoyant force equal to its weight. In other words, the density of the submarine has to be equal to the density of the water around it for it to float, and greater than the density of water to dive. In our simulation we use a graduated cylinder partially filled with air and immersed upside down in the pool. The cylinder being moved vertically up or down in the pool, the air volume inside changes according to Boyle's law in which the pressure is a function of the depth. In this way the total mean density of the submerged cylinder can be adjusted until we find the equilibrium, and the cylinder floats in middle water.

Other interesting exercise to illustrate Archimedes' Law and buoyancy is the Fin Pivot and Hovering that can be more difficult to perform. As said above all these exercises have been performed under the supervision of the instructors.

Test results

At the beginning of the activities, students were asked to answer some questions dealing with hydrostatic pressure, buoyancy and Archimedes's force. Far from the idea to be a part of a systematic research, the questionnaire was not only a tool to assess naïve ideas and misconception of the students but also a cue to raise their interest and expectation about the topics to be presented. Students were tested twice with the same questions: the second time they have the chance to correct their answers giving the reasons for the change. It consisted of eleven specific multiple-choice questions No direct reference to questions was done during the lessons and the swimming pool activities. As results of the course, most of the students changed their wrong responses giving the right one. It could be extremely interesting to perform a long-term test over the same topics with different questions, to investigate how deep and permanent become the understanding of the physical situations.



Figure 5. Two fishes: one in a submerged cave and one free in open sea water. Is the pressure felt by fishes different?

The test gave also the possibility to assess some common misconceptions about pressure and correlated phenomena. For example we asked the students to think about the following situation: we consider a submarine cave, in communication with the open sea, with an opening large enough to suggest that water can circulate between the inside and the outside of the cave, and at the same time small enough to give the sensation that the cave is a protected and limited place. Two fishes (Figure 5) are swimming one in the cave and the other in the open sea both at the same depth with respect the level of the sea. We ask if the water pressure is: (a) equal for the two fishes (b) larger for the fish in the cave (c) larger for the fish in the open sea. Less than 50% of students think that the pressure was equal for both fishes.

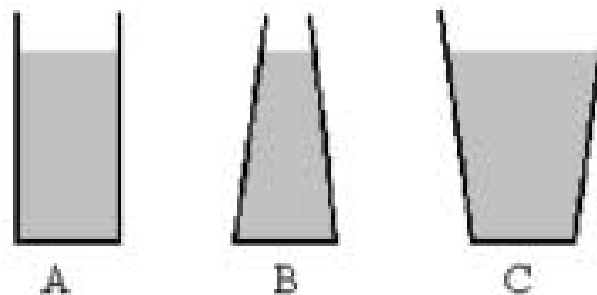

Figure 6. Three differently shaped containers: compare the forces over the basis

In another question students were asked to predict the force pushing the basis in the containers in Figure 6 filled with water. The basis of the containers and the level of the water were equal. Also in this case, only 50% of students gave the correct answer.

After the course the right answer raised up to 60% for the question about the cave and 80% for the question about the containers. These misconceptions are strong and difficult to eradicate. The usual formulations of the hydrostatics' law in terms of 'weight of fluid column', coupled with the students' prior conceptions, can generate not only the idea that pressure in fluids is related to the weight of fluid that is directly over the considered point [9] but also that the pressure acts normally in vertical direction.

Conclusions

The teaching path described in this paper was highly motivating for all kind of students and especially for students attending non-science-oriented curricula. The statics of fluids might look easy, but it is not, as highlighted by research [9]. The topic under study is very close to students' everyday life and, like other sport-related educational paths, it is useful for a better comprehension of this simple but not trivial physics subject. The course is based on solid physics background and gives many ideas for further in-depth analysis. Furthermore, the direct experience of the effects of pressure and pressure variations on the body might prevent students' misconceptions and naïve ideas about fluid behaviour. Unfortunately some constraints must be taken into account. It is important to provide a training period for the teachers if they are not already divers. It is also important to have a good feeling with the diving instructors. Although all the demonstrations during class lessons and pool activities are performed with cheap material, the access to swimming pools and the instructors' presence may generate some difficulties. It is important, especially in pool activities, to go beyond excitement by helping students to understand and learn as much as possible from the simple experiences they perform. Further development of the presented path will be aimed at performing more accurate measurements.

References

- [1] Hofstein A., Lunetta V.: *Sci. Educ.*, 88 (2004) 28.
- [2] Aguilera V., Aguilera-Arzo M.: *Phys. Educ.*, 31 (1996) 34.
- [3] Crouch C., Fagen A. P., Callan J. P., Mazur E.: *Classroom demonstrations: Learning tools or entertainment?* *Am. J. Phys.*, 72 (June 2004) 835.
- [4] Moore T., Harrison A.: *Floating and sinking: everyday science in middle school. Doing the Public Good; Positioning education research*, Melbourne. Available from <http://www.aare.edu.au/04pap/moo04323.pdf>
- [5] Wong D., Lim C. C., Munirah S. K., Foong S. K.: *Student and Teacher Understanding of Buoyancy*. Available from: www.per-central.org
- [6] Lange M.: *Philos. Sci.*, 78 (2011) 333.
- [7] Leroy B.: *Eur. J. Phys.*, 6 (1985) 56.
- [8] *Scopriamo la fisica Roma: Mastervideo (1980) Vhs n.9.*
- [9] Besson U.: *Students' conceptions of fluids*. *J. Sci. Educ.*, 26 (2004) 1683.

Chain reaction: the use of interactive kits to create a physics popularization network

Miguel Garcia-Guerrero, Edgar Ramos-Rambaud, Bertha Michel-Sandoval

Grupo Quark, Museo de Ciencias, Universidad Autonoma de Zacatecas

Abstract

Interactive experimental workshops are excellent activities to get the public, especially young students, involved with physics in a participative manner. They allow participants to interact physically, mentally and emotionally in order to build knowledge through fun experiences. These activities are centred on users and based on experimental devices that show physical principles in action. At the Science Museum at the Universidad Autonoma de Zacatecas, in Mexico, we're working on a project that involves ten states in Mexico through a network of science popularization institutions, based in an interactive kit for the knowledge society. This kit features activities on four physics related lines of work of great relevance in today's world: Nanoscience and nanotechnology, Alternate Energy Sources, Thermodynamics and Telecommunications. Each line involves 5 different interactive activities that provide participants with a general perspective of the subject. Our main goal is to create a self-replicating network: prepare teams that will be able to develop activities and create new teams that will carry the effort even further in what we intend to be a physics-learning chain reaction.

Keywords: science popularization networks, interactive physics kits, recreative physics

Introduction: physics popularization workshops.

Communication processes and scientific education for the general public facilitate access to physics only partially. Most outreach efforts focus on the cognitive aspect; we present the knowledge in a finished form, beyond its dynamic essence and the mechanics that made them possible. Furthermore, "... traditional treatments of scientific make a clear separation between knowledge producers and consumers. This is related to a unidirectional view of the activity in which information flows from gifted individuals to a mass that lacks knowledge" [1].

It is necessary to complement this work, through the dissemination of practical aspects for people to experience and become familiar with how physics is created. This requires a dynamic able to transcend mere information transmission for users to build experimental recreational experiences, assigning an active role for people in their approach to physics.

We intend to promote physics workshops as re-contextualization processes, which exploit direct contact with people to adjust dynamically to their needs and interests. And also assign the user an active role at the experimental, intellectual and emotional levels, as it hardly happens in any other means of science popularization.

Physics workshops use a dual recreational interactive approach: by building fun scientific experiences for the people involved and promoting a process in which participants recreate physics knowledge in their own context. All of this is possible with the use of experimental apparatus as a starting point for the social construction of scientific knowledge [2].

The workshop team

Workshops are characterized by their group nature, both in their development and the methodology of people who perform them: most outreach efforts are collective. They reflect, in this respect, the approach of the dynamics performed with the public and the scientific enterprise itself. Responsibility for carrying out these activities is rarely undertaken by individuals, often the efforts are the work of specialized groups.

In order to develop this kind of activities we require a team able to exchange ideas, build knowledge, and formulate and solve problems. Even before involving non-specialists in the construction of physics concepts, the group needs to convey to its members to enjoy physics activities. To meet their objectives workshops teams depend on three main factors:

- 1) A common goal. All people involved should agree on the main objective of their effort, this will help people to commit on the effort required to reach it.
- 2) Condensation nuclei. It's an individual, an institution or even a learning kit that will serve as cornerstone for the physics popularization effort.
- 3) Critical mass. The team should have enough members to accomplish its goals and even aspire to an incremental growth of the activities.

Even though all three aspects are important, the condensation nuclei remains fundamental for the creation of a physics workshops team. It helps integrate people interested, prepare them, make sense of their work and provide the conditions for the start of the team's activities. Often people or institutions capable of operating as condensation nuclei have not considered the possibility of becoming actively involved in recreational physics activities. It is necessary to draw their attention through an attractive proposition to become popularization agents.

In our experience, recreational physics devices are excellent agents to perform the function of "bait": either through science popularization exhibits or kits. These devices play a dual role of mediation: first with the public by becoming instruments of physics recreation and secondly with potential new popularizers, who will engage in public communication of physics based on the apparatus. Since 2006, Grupo Quark and the Science Museum of the Universidad Autonoma de Zacatecas began work on the use of recreational equipment to encourage the creation of groups and networks dedicated to the development of scientific outreach workshops. We will describe the three projects that have been developed for this purpose.

Physics popularization exhibits and kits

The first project involved the creation of "Fantastica" a travelling interactive science hall, created with the goal to provide recreational science activities within the state of Zacatecas. The second goal, and perhaps the key to this project, was to use the hall as a pretext for creating science popularization teams and also create a network of groups in Zacatecas. The underlying idea was that fun physics activities didn't have to cease when "Fantastica" left a town, but rather, use it as a platform to train individuals who would perform physics workshops in their home towns. Between 2007 and 2009 "Fantastica" had 32,000 visitors, we trained over 200 guides -with no prior experience with science popularization- and helped create 12 science popularization groups, that received materials to start activities with people in their communities once the science hall left.

Unfortunately most teams lacked the essentials to survive. Once "Fantastica" left few groups had goals or condensation nuclei, this resulted in the people involved leaving them

and the lack of a critical mass led most of the groups to collapse. With this experience in mind we developed a complementary project, intended to create condensation nuclei that would help revive the popularization teams and create new ones. Thus we created the “Fantastic Box”: a kit of recreational physics models in a box that included the materials needed to use them in workshops. In most cases activities were easy to reproduce and used cheap materials. The package included a reference material for the development of the activities and also discussed the scientific concepts involved, in the form of a book called “*Para jugar con la ciencia*” [3] (To play with Science).

Sixteen *Fantastic boxes* were distributed with some of the groups created in “Fantastica” and in public libraries in 11 towns in Zacatecas. Also we established the work of other four *Fantastic Boxes* through centres of the Universidad Autonoma de Zacatecas. In total 30 people were trained to act as developers of the educational kits activities, who in turn have involved new human resources to work in their centres. We conducted a monitoring program through feedback meetings, monthly at first and then on a bimonthly basis. After the first year of operation, the 20 boxes have conducted an average of 3 workshops per month, for a total of more than 700 workshops that have impacted more than 10,000 people in Zacatecas. Of the 20 core centres, 12 keep working on a permanent basis and the rest is used in special events.

The Scientific Adventures Box

The results obtained with the previous project motivated us to seek further in this line of work, with a new kit structured around themes and aimed at the local, state and national levels. With the support of the National Council for Science and Technology (CONACYT), we are currently leading a new project to work in parallel with the local municipalities, and several institutions in ten different states in Mexico.

The *Scientific Adventures Box* is being built to become a teaching and popularization kit for the knowledge society, structured around four main topics of current interest to the citizens of the twenty-first century: Telecommunications, Energy Sources, Nano-science and Nanotechnology, and Thermodynamics. Each axis includes five workshop models to develop re-creative activities with the public. The considered topics have been identified as important elements for development in the context of the knowledge society and the knowledge economy. Just as we did in the previous project, we published a book to explain how to develop the activities and discuss the main scientific principles involved: “*Para jugar con la ciencia y la tecnología*” [4] (To play with science and technology).

Activities included intend to provide a general scope of the subject. For example, Telecommunications workshops are: “Modulated Laser”, which shows the principles used in the transmission of data through electromagnetic waves; “Travelling Laser”, a violet laser combined with a fluorescent liquid (tonic water) to show total internal reflection and the basis for optical fibre; “Thread Phone”, to make an example of analogical forms of information transmission; “Binary Code”, shows participants the principles of the language of computers; and “Pixels” is a game that helps understand how pictures are transformed into computer files and then back again in images to show on a screen.

Energy Sources activities include: “Electric Engine”, which shows how electricity can generate movement and how movement, along with a magnetic field, can produce an electric current; “Solar Cells”, shows how we can produce electricity with some kinds of radiation; “Excited Electrons” is a game that helps understand the energy levels structure in atoms and the basis for the photovoltaic effect; “Wind Blowers” uses a small computer

fan, connected to a voltmeter, to challenge participants to blow and produce as much electricity as they can; and “Chain Reaction” explains the basic principles of nuclear energy.

Nano-science and Nanotechnology workshops are: “Scales and Powers”, intended to clarify how small is the nano-scale compared to the size of things we know; “Nanoscope” is a game that allows participants to understand the basic principles of the atomic force microscope (AFM); “Uncertainty” helps discuss some quantum mechanics principles and how they are relevant for nanotechnology; “Graphene and Nanotubes” uses carbon as an example of the novel properties of nano-structured materials; and “Who Stops Nanoparticles?” gets people to understand the risks associated with nanotechnology.

Thermodynamics activities are more related to how different devices work: “Hot or Cold?” is about the necessity and principles of the thermometer; “Freezing Balloon” explains how refrigerators work; “Vortex Cannon” creates flying smoke rings to show the vortex creation process; “Ludion” is fun game that allows people to understand the workings of submarines; “Fire in water” shows how hot metals can separate water into oxygen and hydrogen.

The national institutional collaboration has allowed us to expand our parameters of action and empower the implementation and evaluation of testing activities with selected groups; also we will be able to reach broader conclusions. One great advantage with the new project is now we're working with institutions dedicated to science or science communication instead of groups with no prior experience, which will greatly improve our results.

The project will develop workshops, in its first phase, from November 2013 to June 2014 with the idea of establishing effective centers for the development of these activities at eighteen sites: eight in Zacatecas and 10 in other states – Baja California, Oaxaca, Veracruz, Tabasco, Estado de México, Guanajuato, San Luis Potosí, Michoacán and 2 in Mexico City – with high impact on their respective communities. It intends to conduct a monitoring program to support the activities at all locations and, at the same time, improve the workshops through a feedback with the practical experience of all the people involved.

In case of a successful development of the activities, it is contemplated to promote a second phase of the project in each of the work sites to try to create new recreational outreach centers through Scientific Adventures box. This way we intend to set the new kit as the catalyst for a chain reaction for recreational physics workshops.

References

- [1] Massarani, L., Moreira, I. D. C., & De, I.: Divulgación de la ciencia: perspectivas históricas y dilemas permanentes. *Quark* (2004), 32, 30-35.
- [2] García Guerrero, M.: Los talleres de divulgación científica como agentes para el desarrollo de una cultura científica (2010). Bernal: Universidad de Quilmes.
- [3] García Guerrero, M. (Editor): *Para jugar con la ciencia* (2011), Zacatecas: UAZ.
- [4] García, M. y Michel B.: *Para jugar con la ciencia y la tecnología* (2013), Zacatecas: Texere Editores.
- [5] García Molina, R.: Ciencia recreativa: un recurso didáctico para enseñar deleitando. *Revista Eureka sobre Enseñanza y Divulgación de las Ciencias-2011*, 8 (Extra), 370-392.

The drinking bird engine

Andrea Gróf

Karinthy Frigyes Gimnázium, Budapest, Hungary

Abstract

The drinking bird is a popular toy. The working of the bird has been discussed in literature, including quantitative considerations. This paper shows a possible approach at high-school level: how data are collected and processed to determine the power and efficiency of the drinking bird toy as a heat engine. The results raise questions on the factors influencing the power, and the answer obtained from data analysis demonstrates the increase of efficiency with temperature difference: a fact that only appears in text books in the context of idealized engines.

Keywords: toy as heat engine, simple measurements, data analysis, synthesis of knowledge, relative air humidity

Introduction

From an educational perspective, the drinking bird is worth more than just being used to grab attention in the classroom, by stating qualitatively that it is powered by evaporation. The in depth explanation of its operation is not simple. By doing measurements with the bird and drawing quantitative conclusions, students have an opportunity to synthesize knowledge from various chapters of mechanics and thermal physics. In addition, the investigation of the bird's operation and observing dry-bulb and wet-bulb temperatures also leads to a deeper understanding of the idea of relative air humidity, a term familiar from weather reports but only superficially touched on in class.

Part of the measurements and quantitative analysis in this paper have been carried out with students, and the rest, at the moment, is under development to be used as classroom activities, too.

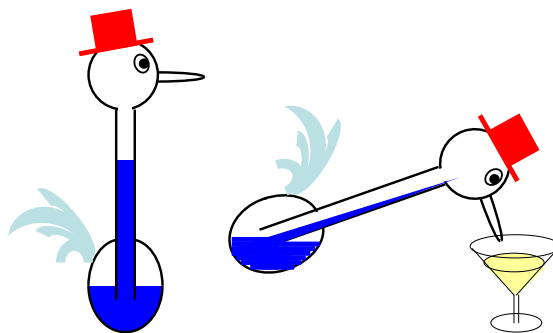

Figure 1. The structure of the drinking bird

The operation of the bird

Observation

The bird consists of two glass bulbs connected by a tube that reaches down almost to the bottom of the lower bulb (Figure 1.). The bottom is filled with a volatile liquid (usually methylene-chloride, or ether). The head is covered with felt. If it is dipped in water, the

liquid slowly rises in the tube. As the bird becomes top-heavy, it tips over as if drinking from a cup. In the forward-leaning position, the liquid flows back to the bottom, and the process starts all over again. (See [1] and [2] for details of the mechanics of the bird as a physical pendulum.)

A lot of questions are raised that need discussion. Students quickly recognize that the temperature difference brought about by evaporation counts. (The bird will dip with a dry head, too, if its bottom is warmed with a lamp or by touching it.) They also observe, that the rate of evaporation may be important, since the bird will “drink” more frequently if offered some strong alcoholic drink instead of water. (The use of the denaturated spirit from the physics storage room is not only less exciting for students, but it will also contaminate the bird since the added substances will not evaporate properly).

The bird as a heat engine

The bird uses temperature difference to do mechanical work. Therefore it is a heat engine. Figure 2 shows the regular textbook diagram of hot and cold reservoirs and energy transfers in heat engines, and the adaptation of the diagram to the bird engine.

According to observation, the more evaporative cooling, the better the bird performs. This is what the measurements and analysis below aim to quantify.

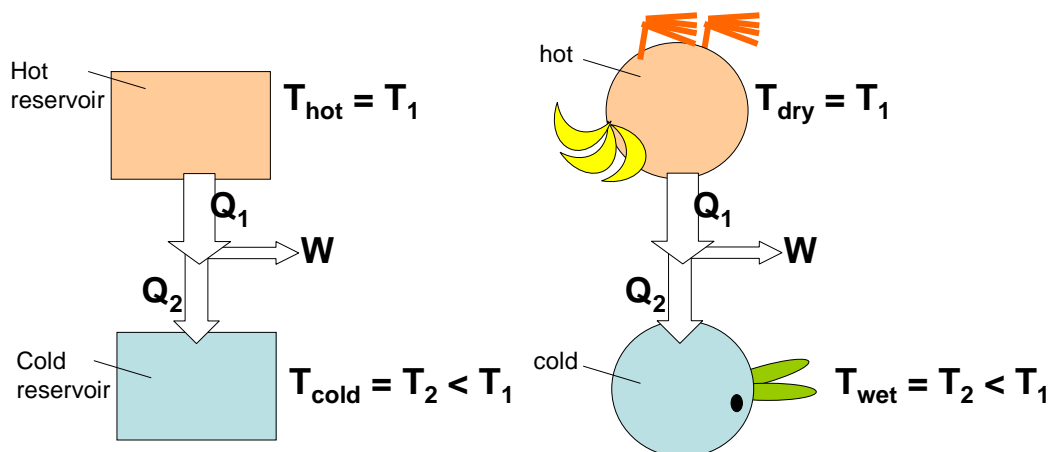

Figure 2. The bird engine

Work, power, and the factors that determine them

Estimating work and power

The work done by the engine, in the stricter sense would mean having the bird perform a task like lifting paper clips, for example. Now we will simply consider the increase in the potential energy of the liquid column raised, since that is what keeps the bird going. The inner diameter d of the tube and the height h of the column can be estimated by inspection, the density of the liquid (CH_2Cl_2 this time), is taken from tables e.g. [3].

$$W = mg \frac{h}{2} = \rho \frac{d^2 \pi h}{4} g \frac{h}{2} = \frac{\rho g \pi d^2 h^2}{8} = \frac{1330 \cdot 9.8 \cdot \pi \cdot 0.006^2 \cdot 0.07^2}{8} \approx 0.90 \text{ mJ}$$

This work is always the same, so power is inversely proportional to the dipping period (the time between two successive dips). Periods were measured with a stopwatch, and they proved to be fairly constant under the same circumstances, making the bird worth

investigating. With 50 successive periods, standard deviations of 7 to 8 percent were obtained. See Figure 3 for a typical distribution of drinking times. Later on, in classroom and home environments in November, the periods were found to be 25-45 s, that is, power varied in a wide range. For example, with a choice of 36 seconds that represents a kind of mean value and is easy to calculate with, the useful power is:

$$P = \frac{W}{t} = \frac{0.0009}{36} = 0.025 \text{ mW}$$

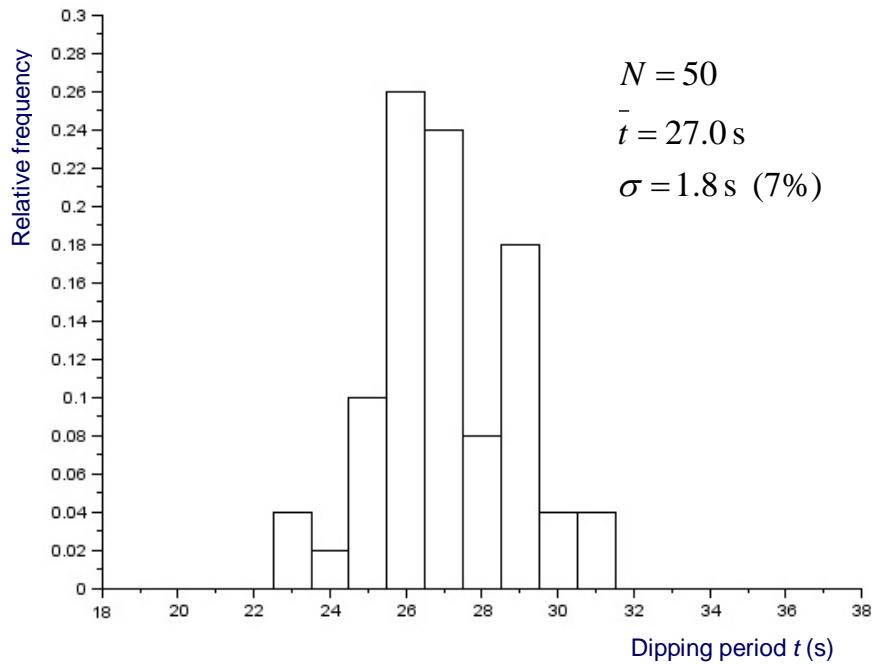

Figure 3. Relative frequency histogram (an example)

What does the power of the bird depend on?

Power is inversely proportional to the dipping period, so this is equivalent to asking what the dipping period depends on. Some student name temperature, some name air humidity. To see whether one quantity or the other, or perhaps both are responsible, both quantities were measured under various circumstances, with a digital instrument from a baby store. Since one cannot freely vary classroom temperature or humidity, all we can do is use given differences available in various parts of the school and / or wait for another day with different weather and heating conditions. In order to still achieve some variation of humidity, the bird was sometimes placed in the microclimate provided by a washing bowl with a wet tea towel in it. However, when bird and instrument are moved to a different environment, measurements should not be started immediately since they both have an adaptation time. Such technical issues make data collection a lengthy process, hard to plan but all the more exciting. To provide more data, I also added the results of my home measurements.

The same periods t are represented in Figures 4 and 5a against classroom temperature (with humidity disregarded), and against percentage humidity (with temperature disregarded). They reveal that neither temperature nor humidity is the only factor. Both are important, as shown by Figure 6, where the red numbers are the dipping periods in seconds, written in the positions corresponding to the appropriate temperature–humidity pairs.

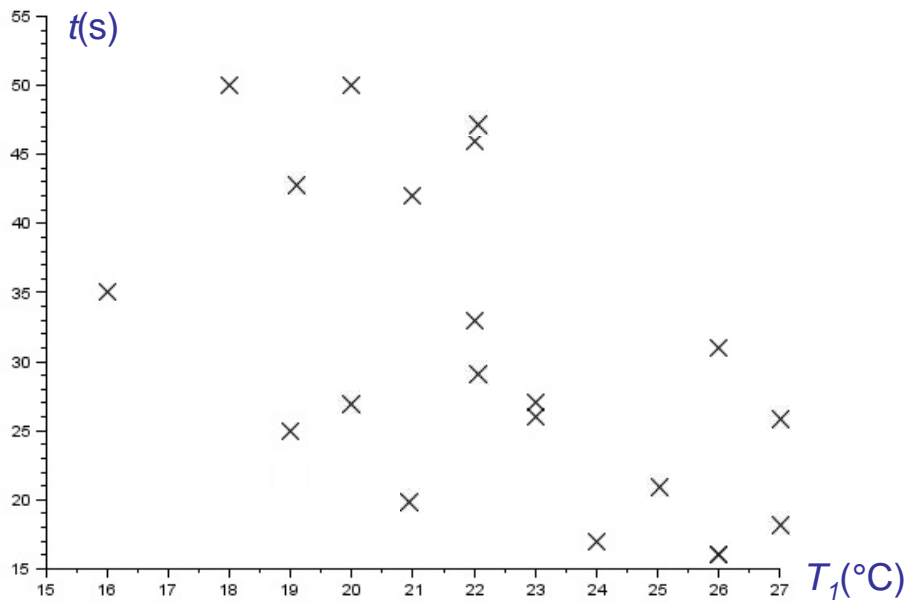

Figure 4. Dipping period versus room temperature

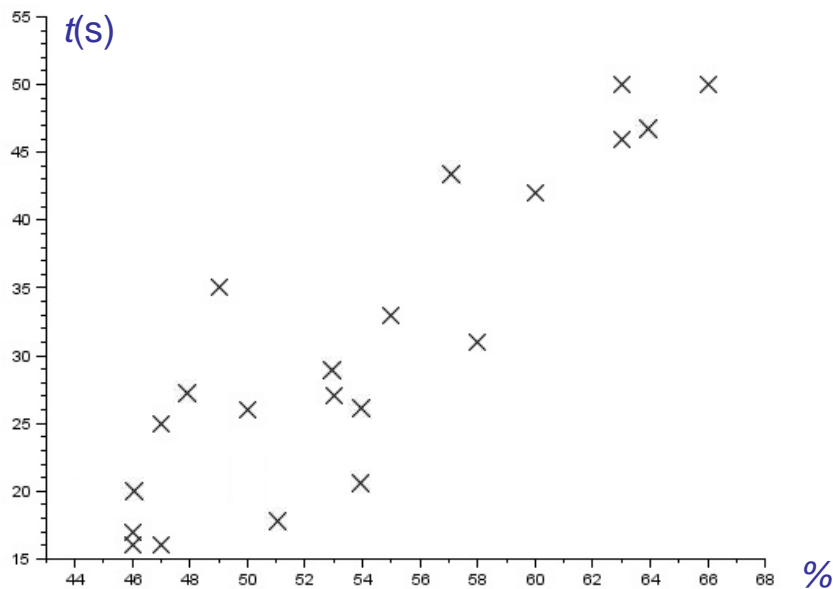

Figure 5a. Dipping period versus relative air humidity

The examination of Figure 6 reveals that periods increase with humidity and decrease with temperature. Thus, readings at constant humidity would form falling curves in figure 4, and readings at constant temperature would form rising curves in Figure 5a. Since, as one may expect, a lot of readings took place at normal room temperatures, there is indeed a conceivable trend in Figure 5a: To visualize, Figure 5b only contains those readings that belong to temperatures of 20 – 23 °C. (The labels are temperatures in °C).

Dry-bulb and wet-bulb temperatures: finding a single relevant quantity

Every text book states theoretically that power increases with temperature difference. The bird can provide experimental evidence. The temperature drop owing to evaporation is easy to demonstrate and measure. Just wrap the bulb of a common physics storage room thermometer in tissue paper, fix with a rubber band, wet with water and swing to avoid the

surrounding air getting saturated. You can soon observe a temperature drop of a few degrees Celsius. We can investigate how period depends on the wet bulb temperature drop.

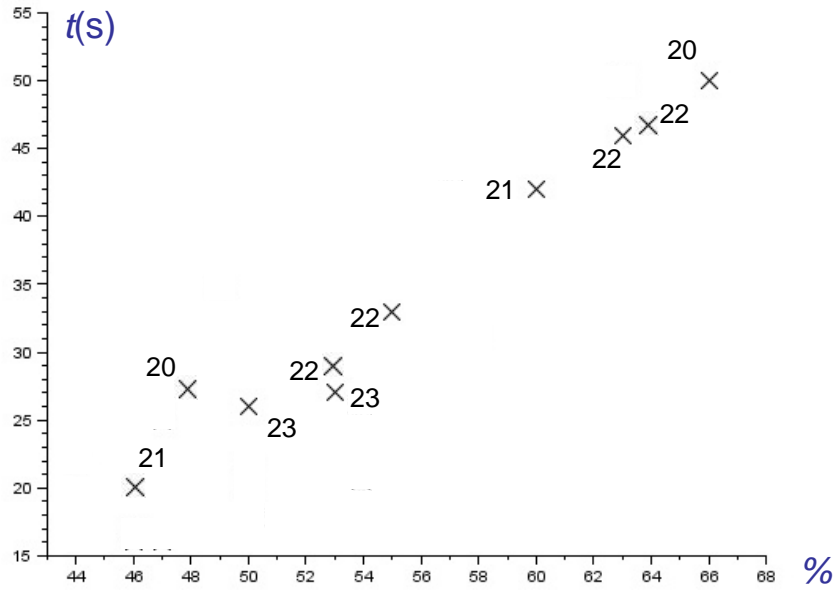

Figure 5b. Dipping period versus relative air humidity at 20-23 °C only

Instead of swinging thermometers, we can use the temperature drop values versus dry-bulb temperature and humidity that are available in tabular form on homepages of weather institutions. (See [4] for an example.) The black curves in Figure 6 were constructed from data published in such tables. They connect temperature-humidity pairs corresponding to the same wet-bulb temperature drop (green labels). The trend is clearly visible.

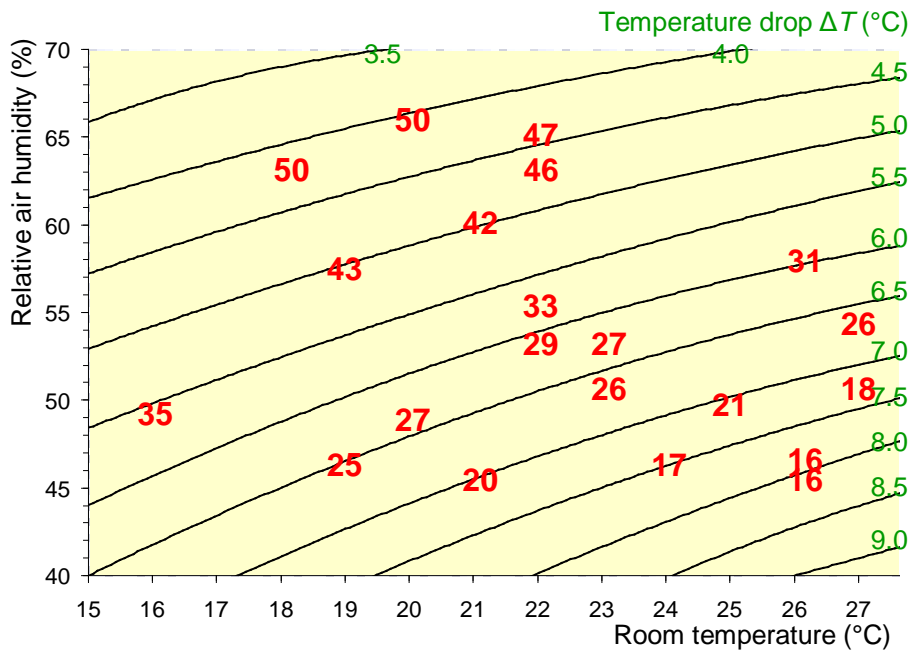

Figure 6. Wet-bulb temperature drop curves and dipping periods

To visualize even better, Figure 7 represents the same results in a period versus temperature drop plot, with error bars. This is clear experimental evidence for the power of a heat engine increasing with temperature difference.

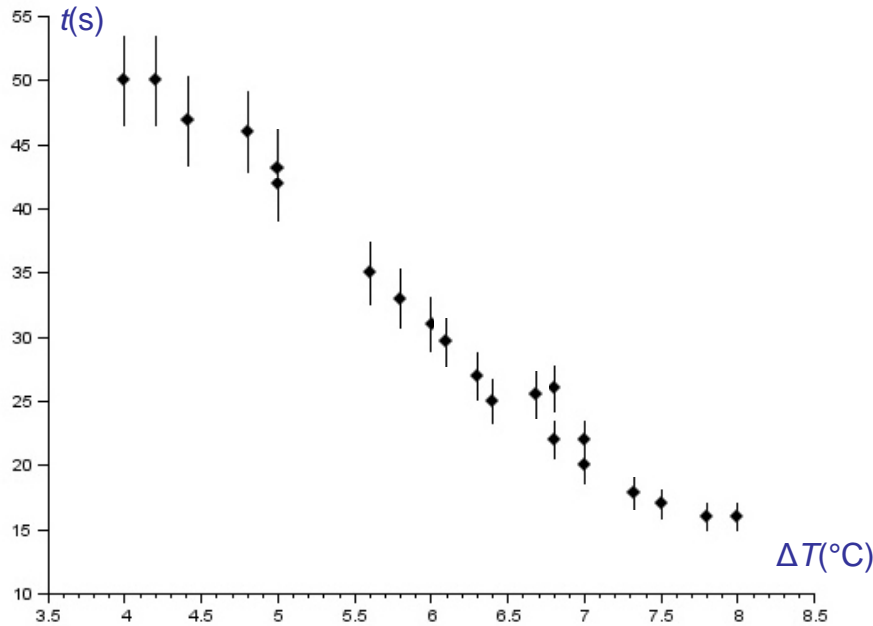

Figure 7. Dipping period versus wet-bulb temperature drop

Efficiency

Estimating efficiency

The estimation below is an adaptation of the ideas described in [5] to high school physics. To get an order-of-magnitude estimate of efficiency, work needs to be divided by the heat absorbed. Instead of the heat absorbed, let us consider the heat extracted from the bird. That is obtained from the quantity of water evaporated by the bird. Using a measuring cylinder with millilitre divisions, it was found to be 6 grams during 6 hours. However, the bird was only responsible for 5 grams, since 1 gram evaporated from an identical cup with no bird as well. That extracts heat at a rate of:

$$P_{\text{evaporation}} = \frac{mL}{\Delta t} = \frac{0.005 \cdot 2260 \cdot 10^3}{6 \cdot 3600} = 0.52 \text{ W} \gg 0.000025 \text{ W}$$

which is about 20 joules per cycle, a lot larger than the work done, so the rate of heat absorption is also about half a watt. Thus the efficiency is about:

$$e = \frac{W}{Q_1} \approx \frac{W}{Q_2} = \frac{P}{P_{\text{evaporation}}} = \frac{0.000025 \text{ W}}{0.52 \text{ W}} \approx 0.005\%$$

Comparison to the Carnot efficiency

The maximum theoretical (Carnot) efficiency is that of a reversible cyclic process that takes an infinite amount of time. Since the bird goes through an irreversible cycle, its efficiency is lower. The Carnot efficiency under the same circumstances, that is, about 5 degrees temperature difference at room temperature, would be almost as large as 2%. The bird's efficiency is nowhere near that. It is important to remark that this Carnot efficiency is an over-estimation since the true temperature difference is less than we assumed: The bottom of the bird must be cooler than the (dry-bulb) classroom temperature, since heat flows to it from the surroundings. On the other hand, the air immediately surrounding the head (even though it is swinging) probably contains more vapour, than the

air next to the instrument. Owing to the reduced evaporation rate, the head is probably warmer than the true wet-bulb temperature.

A closer look at energy transformations

Water is not the only substance the bird evaporates. For a thorough understanding, students need to see that the spaces in the head and belly are filled with the vapour of the coloured liquid inside. A significant part of the heat absorbed by the liquid is spent on evaporating it. It is this vapour that acts as the working substance of the engine since it is responsible for the work raising the liquid column.

As seen above, only 0.9 mJ of work was done per cycle on the rising liquid column by the working substance, that is, methylene chloride vapour. How does that compare to the heat used to produce it and how does that heat compare to the total heat of about 20 J absorbed by the bird from the surroundings (also calculated above)?

In the head, owing to the cooling of the vapour there is net condensation, pressure in the head drops. The larger pressure in the belly pushes the liquid up the tube. Since the volume of the liquid column raised is about 2 cm^3 , an equal volume of methylene chloride vapour forms in the belly to take its place.

According to tables, the vapour pressure of CH_2Cl_2 vapour is about $5 \times 10^4 \text{ Pa}$ (at 20°C). Although the vapour in the bird is not likely to be an ideal gas (see [1] and [2] for a more sophisticated treatment), in high-school physics we may use the gas equation for a rough estimation of the amount of vapour involved:

$$n \approx \frac{pV}{RT} = \frac{5 \cdot 10^4 \cdot 2 \cdot 10^{-6}}{8 \cdot 300} = 4 \cdot 10^{-5} \text{ mol.}$$

Multiplying by the molar mass and the latent heat of evaporation (obtained from tables), it is found that about 1.4 J of heat is used to evaporate that quantity. This is a lot larger than 0.9 mJ, but significantly smaller than 20 J.

As the bird tips over, the bottom end of the tube emerges from the liquid, the two vapour compartments are connected, pressure and temperature equalize, and the process starts all over again. It is probably this direct connection between the hot and cold reservoirs that makes the bird a rather inefficient heat engine. (Note that the balancing is not perfect, the liquid level is not fully restored.)

Some heat is also lost owing to friction. When wet-bulb temperature drop is so small that there is enough time for frictional damping to stop the swinging of the bird altogether, the relative standard deviation of dipping times grows very large, and results become unreliable.

A note on percentage humidity

Air humidity is one of the key concepts in the considerations above. However, it is a hard concept for students. In addition, geography texts or the media may have conveyed to them a mistaken interpretation that needs clarifying.

Humidity is expressed as a percentage, relative to air saturated with water vapour. It seems that it is the technical term “saturation” that is often misunderstood: It is known that saturation vapour pressure increases quite rapidly with temperature. As for the reasons, even educated people like authors of geography text books discussing the formation of

precipitation tend to give the wrong explanation that warm air can hold more water. Some will even explain that there is more room for water molecules since warm air expands. This reveals a misunderstanding: the idea of air “holding” the water is taken too literally.

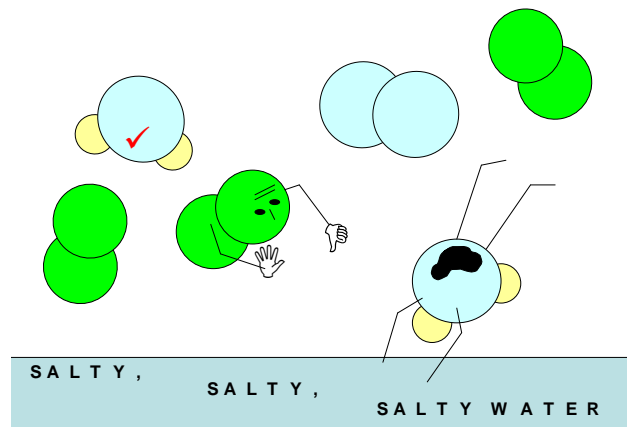

Figure 8. Discriminating behaviour of air molecules?

The fallacy is even more apparent if we consider the fact that equilibrium vapour pressure of water is lower over concentrated solutions than over pure water. If air molecules could be held responsible for letting fewer water molecules among themselves, this fact would mean that air molecules can discriminate against “dirty” water molecules that come from salty water (Figure 8). See [6] for a detailed explanation.

Equilibrium vapour pressure would be a better term than saturation since saturation suggests that it depends on how much water the air molecules allow among themselves, while in fact the presence of air molecules is irrelevant: see Dalton’s law on partial pressures. (In the case of the water evaporating from a cup or from our bird, the air of the room only counts because, acting as a practically infinite heat reservoir, air temperature is the temperature at which evaporation is taking place.) Dynamic equilibrium sets in when the rate of evaporation equals the rate of condensation. At a higher temperature, particles are more energetic, the probability of leaving the liquid is larger, and therefore more molecules are needed in the gaseous phase to maintain the equilibrium.

Conclusion

Although the efficiency of the drinking bird toy as a heat engine is low, and it will certainly not solve the energy crisis, it is worth investigating in the physics classroom. As an activity closing the thermal physics chapter, it makes students apply and synthesize knowledge across a large section of the curriculum: work, energy and power, communicating vessels and possibly pendulum motion from mechanics with gases, changes of state, heat engines and their efficiency, vapour pressure and relative air humidity from thermal physics.

The activity does not only improve data collection, processing and evaluation skills, but also provides experimental evidence for the increase of engine power with temperature difference and an opportunity to achieve a deeper understanding of concepts and physical laws through quantitative treatment.

References

- [1] Güémez J., Valiente R, Fiolhais C., Fiolhais M.: Experiments with the drinking bird. *Am. J. Phys.* 71, No 12 (December 2003), pp. 1257 - 1263.
- [2] Ng L. M., Ng Y. S.: The thermodynamics of the drinking bird toy. *Phys. Educ.* 28, No 5 (September 1993), pp. 320 - 324.
- [3] Properties of dichloromethane [online] Available from:
<http://en.wikipedia.org/wiki/Dichloromethane>
- [4] Relative Humidity Derived from Wet-Bulb and Dry-Bulb Temperatures, condensed from the Bulletin of the US Weather Bureau No. 1071. [online] Available from:
<http://www.novalynx.com/reference-rh-table.html>
- [5] Lorenz R.: Finite-time thermodynamics of an instrumented drinking bird toy, *Am. J. Phys.* 74 No 8 (August 2006), pp 677 - 682.
- [6] Bohren C. F.: *Clouds in a glass of beer. Simple Experiments in Atmospheric Physics.* J.Wiley and Sons (1982), ISBN 1-4020-1276-4.

Increasing Physics Teacher Production by Replicating the UTeach Preparation Model and Awarding Noyce Scholarships

Gregory R. Hale, Ramon E. Lopez, Ann M.L. Cavallo,
Erin E. Gonzales

UTeach Arlington, The University of Texas at Arlington, Arlington, TX, USA

Abstract

In order to improve the production of physics teachers, and high school science teachers in general, at The University of Texas at Arlington, the authors obtained grant funding to offer National Science Foundation Robert Noyce Teacher Scholarships and to support a replication of the successful UTeach science and mathematics teacher preparation program. The Noyce grant was obtained first, and a modest increase in science teacher production was seen. The UTeach replication has been implemented on a four-year schedule, culminating in the establishment of a new student teaching program in January 2014. The combination of an UTeach replication and availability of Noyce Scholarships has UT Arlington poised to improve its science teacher production by an order of magnitude.

Keywords: teacher training, teacher preparation, university education, secondary education: upper

Introduction

The preparation of an adequate number of very well qualified secondary science and mathematics teachers is a well-publicized problem in the United States. In particular, the preparation of physics teachers has greatly lagged the need for highly qualified classroom instructors. The state of Texas, home to the authors, is not immune from this issue. In fact, physics teacher production in Texas (Table 1) is far from in line with what should be expected from a state with a population of over 26,000,000.

Table 1. Physics and Other Physical Science Teacher Production in Texas, 2006 to 2012

Academic Year	8-12 Physics-Math Teacher Production	8-12 Physical Science Teacher Production	8-12 Physical Science-Math-Engineering Teacher Production	8-12 Chemistry Teacher Production
2006-07	20	88	NA	49
2007-08	27	74	3	68
2008-09	17	56	5	72
2009-10	31	55	9	60
2010-11	37	34	8	59
2011-12	27	24	7	36

While it would be nice to say that our institution, The University of Texas at Arlington (UT Arlington) had been a shining example during this period, we cannot. Our production of teachers in the physical sciences was similarly lacklustre (Table 2).

Table 2. Physics and Other Physical Science Teacher Production at the University of Texas at Arlington, 2006 to 2013

Academic Year	8-12 Science Teacher Production	8-12 Physics Teacher Production	8-12 Physical Science Teacher Production	8-12 Chemistry Teacher Production
2006-07	1	0	0	0
2007-08	2	0	0	0
2008-09	1	0	0	0
2009-10*	1	0	0	0
2010-11	6	0	1	1
2011-12	5	1	0	0
2012-13 (partial)	3	0	0	0

* first year Noyce Scholarships awarded at UT Arlington

Author Hale began to explore options for improving secondary math and science teacher production at UT Arlington in late 2006. Soon thereafter, the UT Arlington Provost, Dean of Science and author Hale met with the Dean of Natural Sciences from the University of Texas at Austin (UT Austin) to learn about the UTeach program. Author Hale then visited UT Austin and spoke with UTeach Co-Directors and Master Teachers about the program. (Coincidentally, author Lopez, then with the Florida Institute of Technology, was visiting UTeach Austin as a seminar speaker at the same time.) Upon learning that a competition would be announced in the coming months for UTeach replication grants, authors Hale and Cavallo began preparing a submission. Author Lopez was hired by UT Arlington in the midst of this process, and he contributed to the preparation prior to his arrival on campus for the 2007-2008 academic year.

To help illustrate why the UTeach teacher preparation approach was attractive to the authors, provided below is a description of the origin of UTeach from the UTeach Austin web site [1].

Beginning in 1997, The University of Texas at Austin set out to effect long-term, systematic change in the way science and mathematics majors were being prepared for careers in secondary math or science education. The Dean of the College of Natural Sciences, Mary Ann Rankin, brought together a group of experienced secondary teachers and administrators and charged them to design an innovative teacher preparation program based on national standards, educational research, and their years of experience in the K-12 setting. As part of a substantially revised approach to teacher education called UTeach, the College of Natural Sciences employs several of the best high school science and math teachers in the state to lead the introductory UTeach courses and coordinate a range of on-going field-based experiences. To reinforce the value of such a career choice for students, the College of Natural Sciences offers a rebate for these introductory courses.

At the same time, the Dean of the College of Education, Manuel Justiz, undertook a major commitment to rebuild and strengthen the College's program in mathematics and science education. Under the leadership of Dr. Jere Confrey, mathematics and science education faculty made the decision to completely revise the professional development courses. They developed a three-course sequence that builds on research on student learning, the examination of standards-based curricula, the study of effective classroom interactions, and the development of models of teaching. Issues of technology use and effective approaches to equitable participation are embedded in all aspects of the program, culminating in students' teaching an entire unit in Project Based Instruction. In addition, the mathematics and science education faculty place students in high-need schools, where they learn firsthand of the needs, challenges and opportunities involved in these settings.

The UTeach program at UT Austin was successfully producing dozens of secondary math and science teachers instead of the low single digits that UT Austin had been producing before 1997. Even more impressive to the authors was the improved longevity that UTeach prepared math and science teachers were exhibiting. Back in 2006, the data showed that more than 80% of UTeach Austin prepared teachers were still in the teaching profession after four years [2]. Compared to Ingersoll's data published in 2003 which showed that the four-year retention rate for all teachers was 60%, it seemed that the UTeach approach was not only preparing more teachers, it was producing better prepared teachers [3].

At the same time that the authors were preparing the UTeach replication proposal, funding was also sought from the National Science Foundation's (NSF) Robert Noyce Teacher Scholarship program [4]. From 2008 to 2010, the authors had two Noyce proposals funded. The first was for candidates seeking certification as physics, chemistry or math secondary teachers, and the second covered candidates seeking secondary life science or middle level math and science teacher certification.

Methods

The NSF Noyce Scholarship grants allowed UT Arlington to offer full tuition scholarships to junior and senior science and math majors preparing for teacher certification, renewable for up to two years of support. In addition, post-baccalaureate candidates could also be supported for one year as they worked towards teacher certification. Scholarships were awarded to math, chemistry and physics teacher certification candidates beginning in 2009. Scholarships were awarded to life science and middle level teacher certification candidates beginning in 2011.

These scholarships were marketed with flyers on our campus, classroom visits by grant personnel in classes where sophomore and junior science and math majors were in high proportion, and flyers at the nearest community college to reach transfer students. Once our UTeach replication was running sophomore level courses (2011-2012 academic year), marketing efforts were also made to particularly target these students.

Authors Hale, Lopez and Cavallo as Co-Directors received an UTeach Replication Grant from the National Math and Science Initiative in September 2009, and the program recruited its first 89 students in the fall of 2010. Between September 2009 and August 2010, the Co-Directors hired the initial UTeach Arlington staff and began revising degree plans and creating new coursework. That is to say, the Co-Directors started to put in place the Elements of Success [5] of an UTeach replication.

- Distinctive Program Identity.
- Cross-College and School District Collaboration.

- Long-Term Institutional and Community Support.
- Compact and Flexible Degree Plans.
- Active Student Recruitment and Support.
- Dedicated Master Teachers.
- Rigorous, Research-Based Instruction.
- Early and Intensive Field Experiences.
- Continuous Program Improvement.

Special emphasis was placed on certain elements of success at UT Arlington. For example, the Co-Directors immediately created an UTeach Arlington identity by designing a logo and launching a program web site (<http://www.uta.edu/uteach>). In addition, contiguous space in the university's oldest science building was allocated to UTeach Arlington. Once renovations were complete, the UTeach Arlington logo (Figure 1) was installed by the entrance to each office, conference room, classroom, and even storage rooms to give UTeach Arlington students the feeling of being at their academic home when they were going to their UTeach classes. To reinforce this sense of identity, UTeach Arlington students are provided with a student lounge, equipped with computers, a scanner, a printer, education journals, and other resources. The lounge is well attended by students looking to get some work done and students that simply want to relax and socialize until their next class starts.



Figure 1. Distinctive program identity: UTeach Arlington logo

The Co-Directors extended the Dedicated Master Teachers element of success to all UTeach Arlington hires. The first four hires were for a business manager, academic advisor, science master teacher and math master teacher. All four hires proved to be extremely dedicated personnel. All have contributed mightily to the sense of community that UTeach Arlington students experience. The master teachers were veteran classroom teachers that each also had administrative experience. Their expertise and network of colleagues in area school districts proved to be invaluable in continuing to fulfil another UTeach Element of Success – School District Collaboration. Subsequent hires of two master teachers and an accountant proved to be equally strong. All of the UTeach Arlington master teachers and staff are solutions-focused and student-centered.

The Active Student Recruitment and Support Element of Success is anchored at UTeach Arlington by the dedicated academic advisor (author Gonzales). The UTeach Arlington academic advisor is dedicated in two senses of the word. Firstly, she only advises UTeach Arlington students. Secondly, she works exceptionally hard to keep UTeach Arlington students on the path to success. To date, author Gonzales has also been responsible for the most effective recruiting strategy. She visits each College of Science freshman and transfer student orientation (mandatory for UT Arlington students) and makes a three-minute pitch to the students and their parents. The presence of the parents during this recruiting pitch appears to be important. When the recruiting pitch mentions a strong job market for math

and science teachers and the availability of substantial financial aid, the parents are observed to be paying close attention. The typical result of this recruiting strategy is full sections of the first course in the UTeach sequence. The original master teacher hires, subsequent master teacher hires (also very experienced in the classroom and administration), and subsequent office staff hire have formed a very dedicated and enthusiastic team. Wherever a potential UTeach Arlington student turns for help, he or she will find someone more than willing to resolve his or her questions.

The UTeach Arlington team has also worked hard to ensure that we offer Compact and Flexible Degree Plans. Whether an UTeach Arlington student joins us as a first-time freshman or a transfer student, they will find a pathway through our program already mapped out for them (Figure 2). Our academic advisors also prepare a customized plan for each student, outlining the courses he/she should take each semester until graduation.

UTeach Arlington Entry Points

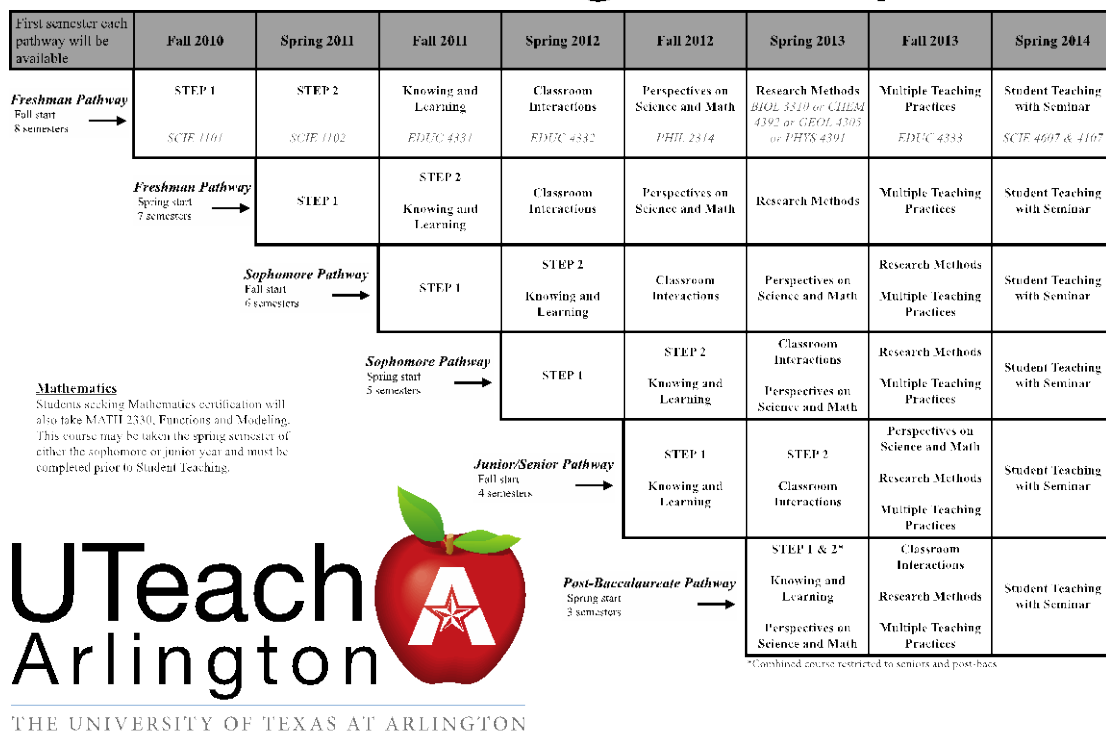

Figure 2. UTeach Arlington Entry Points

As far as Rigorous, Research-Based Instruction is concerned, our pedagogical methods are centered on the learning cycle and its 5E lesson plan implementation. The Master Teachers provide a basic introduction to the Learning Cycle in the STEP 1 and STEP 2 recruitment courses. UTeach Arlington students put this knowledge into field practice in these first two UTeach courses, delivering 5E lessons in the classroom of a mentor elementary or middle school teacher. Subsequent UTeach coursework provides the learning research and educational psychology foundation of the learning cycle, further training in learning cycle teaching methods, and classroom management skills. In all, there are four courses in the UTeach program prior to student teaching that have field experience components. All courses in the UTeach Arlington program are described in Table 3.

Table 3. UTeach Arlington Course Descriptions

Course Name	Course Description
STEP 1	Introduction to mathematics and science teaching as a career. Discussions include standards-based lesson design and various teaching and behavior management strategies. Fieldwork consists of planning and teaching three inquiry-based lessons to students in grades three to six in local elementary schools. One and one-half class hours a week for one semester; at least ten hours of fieldwork a semester are also required.
STEP 2	Topics may include routes to teacher certification in mathematics, computer sciences, and science teaching; various teaching methods that are designed to meet instructional goals; and learner outcomes. Students develop and teach three inquiry-based lessons in their field in a middle school, and participate in peer coaching. One and one-half class hours a week for one semester; at least twenty hours of fieldwork a semester are also required.
Knowing & Learning	Restricted to students in the UTeach Arlington program. Psychological foundations of learning; problem solving in mathematics and science education utilizing technology; principles of expertise and novice understanding of subject matter; implications of high-stakes testing; and foundations of formative and summative assessment. Three lecture hours a week for one semester; additional hours may be required.
Classroom Interactions	Restricted to students in the UTeach Arlington program. Principles of delivering effective instruction in various formats (lecture, lab activity, collaborative settings); examination of gender, class, race, and culture in mathematics and science education; overview of policy related to mathematics and science education. Three lecture hours a week for one semester; additional hours may be required.
Perspectives on Science And Mathematics	An examination of five notable episodes in the history of science: Galileo's conflict with the Catholic Church, Isaac Newton's formulation of the laws of motion, Charles Darwin's proposal of the theory of evolution by natural selection, the development of the atomic bomb, and the discovery of the double helix structure of DNA. Three lecture hours and one discussion hour a week for one semester.
Research Methods	Primarily a laboratory course where students develop and practice skills fundamental to the scientific enterprise. Research Methods is organized around four independent inquiries that students design and carry out. The course emphasizes the use of mathematics to model and explain both the natural and man-made worlds, and requires a substantial amount of writing. Research Methods emphasizes the development of skills that are directly applicable in teaching secondary science and mathematics (e.g. use of equipment, preparation of lab materials, safety issues, use of technology).
Multiple Teaching Practices	Foundations of project-based, case-based, and problem-based learning environments; principles of project-based curriculum development in mathematics and science education; classroom management and organization of project-based learning classrooms.

	Three lecture hours a week for one semester with additional fieldwork hours to be arranged.
Student Teaching	Supervised and directed practice in an approved field setting. The student will be assigned based on the cooperating school district calendar. Required seminars will provide students with theory to integrate and apply during residency.

Results

While students supported by Noyce Scholarships have finished their preparation programs, no UTeach Arlington student has graduated yet. The 2013-2014 academic year is the last year of our new course rollout. UTeach Arlington students will have their first opportunities to enter into Student Teaching in January and August of 2014. The first impacts of the Noyce Scholarships are evident in Table 2. Whereas typically one high school science teacher was prepared per year at UT Arlington, and zero physics teachers, awarding Noyce Scholarships moved the total up to five or six science teachers per year, including the first physics teacher produced in a number of years. The effectiveness of our UTeach replication can be seen in our secondary science and math teacher pipeline data (Table 3). There are approximately 60 students on track to enter into secondary science and mathematics student teaching in 2014.

Table 3. Secondary Science and Math Teacher Pipeline at UT Arlington

Major	Fall 2010	Spring 2011	Fall 2011	Spring 2012	Fall 2012	Spring 2013
Physics	2	3	4	12	12	11
Biology	48	36	71	59	79	54
Chemistry	7	5	15	10	12	5
Geology	2	1	1	3	9	8
Math	12	15	33	33	69	59
Other	18	34	30	30	26	25
Total	71	60	124	117	182	137

Conclusions

The introduction of NSF Robert Noyce Teacher Scholarships on the UT Arlington campus did drive an increase in the production of science teachers. While that increase looks impressive on a percentage basis, it moved UT Arlington only into the mid-single digits of science teacher production, and physics teacher production was still rare. While this improvement was welcome, it was much more modest than our goals. Our Noyce Scholarship intervention would have likely produced a larger increase if the authors were not also actively working on the UTeach replication project. Once the UTeach replication was begun, the Noyce Scholarship program became a more complementary project than a stand-alone effort.

The combined approach of a UTeach replication supplemented with a Noyce Scholarship program is poised to produce dramatic results at UT Arlington. Our first class of UTeach

Arlington trained secondary math and science teachers will enter student teaching the spring and fall of 2014. It is anticipated that there will be more than 50 student teachers. Approximately half will be science teachers and half math teachers, and there will be multiple physics majors in the group. While the authors do not feel that we will be producing enough physics (or chemistry) teachers yet, this is a very promising start.

Acknowledgements

This work was supported by, Texas Instruments, AT&T, the Michael and Susan Dell Foundation, the Texas Education Agency, the Sid Richardson Foundation, the George and Fay Young Foundation, and the U.S. National Science Foundation grant #0833343 under the Robert Noyce Scholarship Program for Teachers of Science and Mathematics.

References

- [1] UTeach Natural Sciences web site. The University of Texas at Austin. [online]. [cit. 15. 9. 2013]. Available from: <https://uteach.utexas.edu/About/Program%20History>
- [2] Rankin M. A.: UTeach Natural Sciences Overview Presentation. 29 November 2006, Fort Worth, TX.
- [3] Ingersoll R.: Is There Really a Teacher Shortage? A Research Report Co-Sponsored by The Consortium for Policy Research in Education and The Center for the Study of Teaching and Policy. September 2003.
- [4] National Science Foundation web site. [online]. [cit. 15.9.2013]. Available from http://www.nsf.gov/funding/pgm_summ.jsp?pims_id=5733.
- [5] UTeach Institute web site. The University of Texas at Austin. [online]. [cit. 15. 9. 2013]. Available from: <http://uteach-institute.org/publications>

Experiments in Science at Preschool/Kindergarten and in Primary School

Jitka Houfková, Dana Mandíková, Zdeněk Drozd

Department of Physics Education, Faculty of Mathematics and Physics, Charles University in Prague, Czech Republic

Abstract

The Department of Physics Education, Faculty of Mathematics and Physics, Charles University in Prague, offers a lot of activities designed to promote physics education to students of different types of schools and to pre-service and in-service teachers, as well as to the general public.

The contribution gives information about two long-term activities focused on children and youngster pupils and on their teachers. Courses for pre-school/kindergarten children and seminars for future primary school teachers are introduced.

Keywords: experiments, science, physics, preschool/kindergarten, primary school

Introduction

Main goals of The Department of Physics Education, Faculty of Mathematics and Physics, Charles University in Prague, are preparation of high school physics teachers, help for in-service physics teachers, research in physics and physics education, outreach and popularization.

But we believe that it is important to work with the youngsters, too. Therefore we among others developed two long-term activities focused on children and youngster pupils and on their teachers: Seminar Experiments in Science at Primary School and Workshops for Preschool/Kindergarten children. The seminar Experiments in Science at Primary School is designed for pre-service teachers who can later influence the youngest pupils at primary schools. The Workshops for Preschool/Kindergarten children are designed for children under the age of school attendance, who consequently by their questions and interest influence their teachers (in the Czech Republic is Kindergarten an integral part of Preschool).



Figure 1 and 2. Playing with magnets

Workshops for Preschool/Kindergarten children

Young children are very inquiring, they want to know how things work and they love to do experiments. Therefore it is important to catch their interest and motivate them to persist in science explorations and experimenting.

The preschool/kindergarten in the Czech Republic is for three to six year old children. The class size reaches up to 28 children and there are usually two teachers per class who alternate during the day.

Majority of preschool/kindergarten teachers do not have training in science or science education. If there is any science done in preschool/kindergarten, it is mostly biology.

Organisation of the workshops

The approach for the preschool/kindergarten children must be different from the approach for older children and students. Young children learn best by exploring of their own surroundings that they know and where they feel safe. That is the reason why the courses are done in the preschools/kindergartens and not in our university facilities. The lector comes to the pre-school/kindergarten classes and works with the children there. In the school year 2012/2013 almost forty workshops with children were accomplished.

The whole course is highly interactive, it is based on doing hands-on experiments, on observing and on discussions with children.



Figure 3. Investigation of lenses



Figure 4. Investigation of density of water

The session is led by a teacher from the Department of Physics Education. Because the majority of preschool teachers do not have any training in science or science education they do not have an active role during the session. They help with organisation, take care of the children and, what is very important, they learn about the physics concepts themselves together with children. Before each session the preschool teachers obtain handouts about topics discussed in the session. Their active role comes after the session when children draw pictures about what they had seen and done during the session. Every session begins by viewing of pictures from previous session and discussions about them. That is important for correction of the misconceptions the children may have and to fixing of knowledge they developed. Also a flyer for parents with short description of the lecture content and a contact to the lector for future questions is every time displayed at preschool.

Content of the workshops

The courses are aimed on basic physics topics concerning air and its properties, water and its properties, optics, heat, magnetism and electricity. Some topics are covered in one lecture, some need more time.

Follow up activities

After each session the children draw pictures of experiments they liked. Children at this age can not write and drawing is natural way for them to express themselves. Some examples of those pictures are on Figures 5, 6, 7 and 8. The children are instructed to draw a picture of a thing or things they liked most during the session. They usually draw the pictures shortly after the session, with their preschool teacher. In case of pictures of smaller children (three and four years old) it is useful that the teacher notes what is drawn.

There are two main groups of reasons for drawing pictures. First, it is significant for children. It is to fix the new findings, to have something to remember later and to start discussion with parents later. Second, it is important for development of the workshops. The pictures bring valuable feedback, information about what children liked most and how they understood it. The pictures can be used as a source for future research, too.



Figure 5, 6, 7 and 8. Examples of childrens' drawings

Seminars for future primary school teachers

Primary school teachers are the first ones in the school system who introduce pupils to natural science. Thus it is very important to encourage them to do hands-on experiments

and to motivate them to pursue future studies so that they are able to gain the interest of their pupils and to present scientific phenomena correctly.

Primary school in the Czech Republic lasts for five years and children begin school at the age of six. They usually have one teacher who teaches them all subjects. The class size reaches typically from twenty to twenty-five pupils.

Origins of the seminar

The seminar *Experiments in Science at Primary School* is designed for future primary school teachers, students of the Pedagogical Faculty, Charles University, Prague. It is an example of cooperation between two faculties – staff of Faculty of the Mathematics and Physics teach students of the Pedagogical faculty. Primary school teachers have to teach some physics phenomena though they do not have any practical classes to prepare for it. The formation of this seminar was a respond to a direct request of a group of students of Pedagogical Faculty in the year 2007.



Figure 9. Self made toy – Cartesian diver



Figure 10. Looking for the net force

Goals of the seminar

Our seminar provides the opportunity to familiarize the future teachers with experiments from the parts of natural science that are taught at primary school and gives them an opportunity to try them themselves. The emphasis is put on hands-on activities of the future teachers and on their ability to make simple teaching aids for themselves, as well as on correct explanations of the phenomena demonstrated and on ways how to present them to young pupils. What we consider very important is that the most common misconceptions are mentioned, discussed, and (we hope) corrected, too.

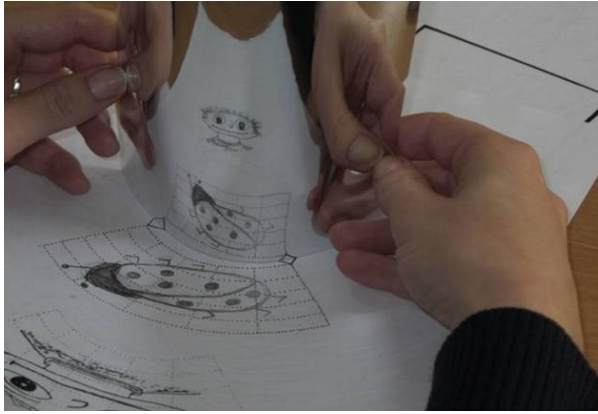

Figure 11. Self made toy – Cylindrical mirror

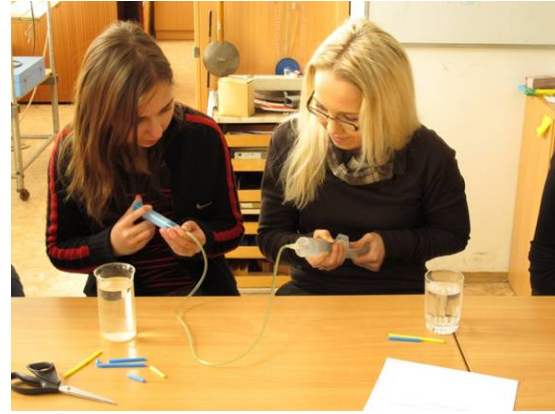

Figure 12. Investigation of the principle of hydraulic press

Organisation of the seminar

The seminar takes 135 minutes every week during two semesters. There are approximately ten students in one group and two to three teachers from the Faculty of Mathematics and Physics. Depending of the number of enrolled students there are one to four groups every semester. The students of Pedagogical Faculty are coming to the special students' laboratories of Faculty of Mathematics and Physics that are designed and equipped for training them in school physics experiments.

Content of the seminar

- motivational experiments
- air - its properties and characteristics
- another gasses
- water and its properties
- sound
- light
- heat
- electrostatics
- electric circuits
- magnetism
- forces and motion, friction
- simple engines, centre of gravity
- cosmic flights, weightlessness
- physics of the human body
- various problems (according to the questions and wishes of participants)

For each topic supporting materials, mainly handouts, were prepared, and every time the students make simple teaching aids or toys for themselves that they can immediately use.

Conclusion

Our aim for the workshops for Preschool/Kindergarten children is to catch the interest of children and motivate them to look around them to see and to appreciate natural phenomena, and to start and to persist in science explorations and experimenting. The side effect is for Preschool/Kindergarten teachers, the majority of whom do not have training in science or science education, and who are forced to get some basic orientation in science by the children's questions and interest. The positive response the little children give after participating at the workshops, even some years later, and their demand for follow-up workshops, is rewarding and inspiring.

The aim of the seminar Experiments in Science at Primary School is to give to the pre-service primary school teachers the basis for teaching physical science, to develop their experimental skills, to help them understand the basic laws of physics and to correct their misconceptions. We also want to show students that they do not need to fear physics and that doing of experiments can be informative and entertaining at the same time. Students' interest in the seminar and the delight, with which they work, ensures us that our work is meaningful and useful.

In-Service Teachers' Training Creative Physics Workshops at the National Polytechnic Institute in Mexico

Alexander Kazachkov¹, Abraham Salinas Castellanos²

¹Karazin Kharkov National University, Kharkov, Ukraine

²C E C y T Carlos Vallejo Márquez, Instituto Politécnico Nacional, Mexico

Abstract

Too many of the science teachers fail to convey the fascination of science to their students. This causes, among other things, the fall in the popularity of science among pupils. There is a substantial need of an in-service training for teachers on the basic education levels. We present here experiences from a series of strongly contents-oriented workshops for physics teachers at the National Polytechnic Institute (IPN) of Mexico. Our main goal is to implement these workshops among science teachers on a regular basis at the IPN, not only for physics, but also for chemistry, mathematics and biology.

Some of the trainees' suggestions are presented in the report.

Keywords: Science Teachers, popularity of science, Contents-Oriented Workshops.

Introduction

In Mexico, as in many other countries, science has suffered a decline in its popularity among young students [1-6]; one of the consequences is that the number of students studying science at universities has also decreased [7]; many developing countries have a deficit of scientists and science teachers.

It is a well-known fact that if teachers are competent in the subject they teach, they are also able to convey the fascination of science to their students [8,9], otherwise they communicate little or none interest to their pupils in the classroom.

Both authors have attended the Heureka workshops at Nachod, Czech Republic whose organizers are prof. Leoš Dvořák and prof. Irena Dvořáková since more than 20 years. In these meetings teachers share experiences and teaching ideas during two days of intensive workshops, they participate actively discussing the different hands-on experiments led by some teachers [10,11]. A rich academic environment is created among the participants (Figures 1,2).



Figures 1, 2. Teachers at Heureka workshops discussing a hydrostatic problem after a workshop led by Dr. A. Kazachkov.

Although some universities and research institutes like the Institute of Astronomy, Optics and Electronics (INAOE) in Mexico, Perimeter Institute in Ontario, Canada, the European Organization for Nuclear Research (CERN), etc. offer annual physics workshops for High School teachers, a careful selection of attendees is made and it is expected that they share the resources and experiences in their workplaces, however, this does not always happens and most teachers keep the resources and acquired knowledge for themselves.

Based on these problems and considering the Nachod experience, the authors developed a series of physics workshops for high school teachers at the National Polytechnic Institute (IPN) in Mexico City in order to share experiments using low cost materials with Mexican physics teachers, promoting their participation in the workshops, and creating an academic environment similar to that at Nachod, Czech Republic. In what follows, we first briefly describe the IPN schools and the Mexican population of high school students. Afterwards our experience in the workshops and teachers' enthusiastic participation is described.

IPN Schools. Mexican population of students in Mexico City and surrounding areas

In this section we describe briefly the academic organization of the Institute. IPN is one of the two largest educational institutions in Mexico (the other one is the National Autonomous University of Mexico, UNAM), which offers over 30 undergraduate programs in engineering and basic sciences, 18 health and biology and 7 social and administrative undergraduate degrees; IPN offers also graduate programs in all these fields.

The Institute has 18 vocational schools (senior high schools), 16 of them located in the metropolitan area (Mexico City and the neighbor state Estado de Mexico). These vocational schools offer different technical programs. On the other hand, in the Metropolitan Area there are around 5 million youngsters 16-19 years old (high school students) [7]. There are also 1883 high schools in the metropolitan area, which means that the number of schools is small compared to the number of students in this region.

On the other hand, in Mexican high schools there are no special requirements to hire teachers; the main requirement is to own a bachelor degree in a related area they wish to teach. In the case of physics, most teachers own a mechanical, industrial or electrical engineering degree. Also many chemists are teaching physics. Extreme cases are also found: some journalists teach mathematics or physics in junior and senior high schools. It is noted that very few teachers with a physics or mathematics degree are teaching in high schools. IPN authorities have been focused on promoting in-service workshops and courses for teachers on the educational model based on competencies and constructivism, which has been implemented since the 1990's, but until now no significant good results have been obtained.

It is very important that teachers master the science subjects they teach and also that they show a good attitude in the classroom in order to increase the enjoyment and interest of students towards science and help them to acquire a critical thinking.

Main Objectives of the Workshops

Among the main objectives of the workshops were:

- a. To motivate teachers to update their knowledge in the physics subjects they teach.
- b. To apply physics principles to predict the outcomes in the experiments.

- c. Interaction of teachers from different schools to exchange teaching ideas and experiences.
- d. To show teachers that significant and interesting physics experiments can be performed easily with low cost materials.
- e. To convince IPN authorities that the realization of these workshops is important and necessary to increase the quality of physics education in high schools.
- f. To suggest teachers how they can convey the fascination of science and how their students can experience science anywhere if they use their imagination and creativity.

These workshops are very useful for teachers because they offer an opportunity to re-examine what they have been teaching to their students, and analyze physics problems together. Their physics preconceptions are also tested.

The workshops

Our aim here is to describe our experience after leading these Heureka-type workshops in Mexico City. Description of experiments can be found elsewhere [12-15].

Teachers from 16 out of 18 IPN vocational high schools participated in the workshops; most of the schools are located in Mexico City. In order to shorten distances, three schools were chosen as hosts to provide a place for the workshops; teachers from neighboring schools attended the workshops. There were around 25-30 participants in each workshop. Teachers who attended the workshops were chosen strategically taken into account their enthusiasm, attitude and willingness to share the contents of the workshops with peers in their workplaces.

Each workshop lasted 6 hours for 3 days, totaling 18 hours. IPN academic authorities assigned 2 assistants who supplied the material needed for each workshop. At the end of each workshop, participants were asked to share experiments they mastered with the rest of the teachers and interact with each other by asking questions and suggesting ideas for future workshops.

A variety of hands on experiments were presented to the participants, many of them found in references [12-15], covering many topics mainly from mechanics (Newton's laws, linear momentum, angular momentum, hydrostatics, hydrodynamics, etc.). Physical concepts were analyzed both qualitative and quantitatively. The analysis of the experiments favored discussion and reflection on the knowledge shared by teachers. Attendees enjoyed experiments which, in many cases, were totally new to them. Figures 3-11 show aspects of the workshops in the different locations.





Figures 3-11. Teachers were very enthusiastic with the experiments presented. In some cases students requested to participate in the workshops.

Participants ranged from the very experienced to beginners and both groups showed interest and enthusiasm. In some venues students asked to participate in the activities and assisted in the realization of experiments (see figures 3-11).

Some of the experiments were chosen to analyze them quantitatively by the whole group. For instance, an Eratosthenes calculation was made using a styrofoam sphere with a pair of toothpicks playing the role of the poles that project their shadow on the surface of the sphere when this is placed in the sunlight. A careful measurement and a simple trigonometric calculation give a good approximation of the radius of the sphere [15]. A spring of water using difference of pressures caused by a difference of temperature was also fully analyzed mathematically with great interest by the attendees.

At the end of the workshops, questionnaires were given to the participants to evaluate the impact of the program in their teaching, to know how these workshops upgraded their conceptual understanding in physics and how useful would the experiments be in their classes.

Sessions in each venue were recorded by a TV crew sent by IPN authorities. These recorded sessions were distributed among teachers who could not attend these first workshops.

It is important to mention that IPN authorities (general head of IPN high schools, general Academic Secretary, principals, etc.) inaugurated each event at the host schools and provided the authors with materials, convoking teachers and selecting the schools where the workshops took place.

Conclusions

There is no doubt that in-service workshops are very necessary for the improvement of both the learning and teaching of sciences. Sometimes teachers have erroneous preconceptions which they can test with the experiments and discuss with their peers. In the questionnaires handed in to the attendees, the claim was almost general: teachers want these workshops on a regular basis; they urged us to organize these events at least once a year. Although pedagogical knowledge is important for teachers, they considered that

acquiring new physics information is very important to help them teach more effectively or to enhance and clarify information they already possess.

Teachers showed interest also in a handbook of experiments, which one of the authors is already working on. They pointed out the importance of using low cost materials because in many cases their schools do not have good equipment in the laboratories. Students get the feeling that physics experiments can be performed only with expensive equipment and apparatuses.

Contributions made by some teachers at the end of each workshop were very significant; they enjoyed sharing experiments with their colleagues and explain them in detail. We can say that the Heureka project was revived among Mexican teachers.

These workshops created also proper academic conditions for teachers to discuss problems found in their classrooms.

A follow up was made for some teachers. It has been found that most of them apply the experiments they learned in the workshops and ask for advice in some situations. Also it is observed that teachers' reflection increased their confidence in designing teaching strategies for their students.

A new workshop is being organized by one of the authors at an IPN vocational school outside of Mexico City whose teachers could not participate in this first event. Our goal is to convince IPN authorities and other stakeholders to implement science workshops for teachers in every scientific discipline taught in high schools.

Finally, these workshops seem to confirm that an effective way to improve the quality of science lessons and to help students to become interested in science is to present them simple but significant experiments which can be performed easily together with their teachers.

Presence of IPN authorities and the recording of the workshops was clear indicator that there is a substantial necessity to implement science courses and workshops for high school educators.

Acknowledgements

Authors wish to thank the support of IPN authorities for the realization of these workshops and the assistance of María de Jesús Arellano Mejía and Deyanira Rivera Flores.

References

- [1] Svein Sjoberg, Camila Schreiner: How do learners in different cultures relate to science and technology? Results and perspectives from the project ROSE (the relevance of science and education). Asia Pacific Forum on Science Learning and Teaching, volume 6, issue 2005.
- [2] Nuño Domínguez: Los jóvenes ya no quieren hacer ciencia, Spanish Newspaper Público (09/09/2009), available in <http://www.publico.es/250008/los-jovenes-ya-no-quieren-hacer-ciencia>
- [3] Yasushi Ogura: OECD/Japan Seminar, June 23-24, 2005, Tokyo. Available in <http://www.oecd.org/fr/education/scolaire/programmeinternationalpourlesuividesacqui sdeselevespisa/10thoecdjapanseminar-23-24june2005.htm>

- [4] George Varghese: Declining Trend in Science Education and Research in Indian Universities. Available in <http://portal.unesco.org/education/en/files/51677/11634979955Varghese-EN.pdf/Varghese-EN.pdf>
- [5] Edgar W. Jenkins: Student opinion in England about Science and Technology, *Research in Science & Technological Education* Vol. 24, No. 1, May 2006, pp. 59–68.
- [6] Ford P. J., Wilde A. J.: The Decline in the Study of Physics, *Fizika A (Zagreb)* **8** (1999) 4, 215-222.
- [7] Instituto Nacional de Estadística y Geografía, Mexico. <http://www.inegi.org.mx/>
- [8] Voltaire Mistades: Physics Teachers' Beliefs and Their Performance in an In-service Training Program, *Science Education International*, Vol. 18, No. 3, September 2007, pp. 173-187.
- [9] Bloom B. et.al: *Developing Talent in Young People*. New York, Ballantine, 1985.
- [10] The Heuréka Project. <http://kdf.mff.cuni.cz/heureka/en/index.php?page=annual-conference>
- [11] Rod Milbrandt: Innovative Physics Teaching Conferences in the Czech Republic, *The Physics Teacher*, Vol. 48, September 2010.
- [12] Gardner M.: *Entertainment Science Experiments with Everyday Objects*, Dover Publications, Inc. New York, 1960.
- [13] Kazachkov A., Castellanos A. S.: Atmospheric pressure in low-cost demonstrations and measurements, *Proceedings of the 17th Physics Teachers' Invention Fair 17*, 2012. Prague Czech Republic. Available from <http://vnuf.cz/papers/>
- [14] Kazachkova D., Kazachkov A., Kireš M.: Balancing with Archimedes and Roberval on a classboard, *Proceedings of the 17th Physics Teachers' Invention Fair 17*, 2012. Prague Czech Republic. Available from <http://vnuf.cz/papers/>
- [15] There are many references for the calculation of the Earth's radius using Eratosthenes method. An excellent and interesting calculation is given in the webpage Brilliant: <https://brilliant.org/discussions/thread/calculating-the-size-of-the-earth/>

How to use data from Catalogs of Astronomical objects in Education

Ota Kéhar and Miroslav Randa

Faculty of Education, University of West Bohemia, Czech Republic

Abstract

This contribution contains attractive examples that use catalogs of astronomical objects available at Astronomia web pages (astronomia.zcu.cz). Hertzsprung-Russell diagram will be created online from stars catalogue HIPPARCOS or SIMBAD. It is possible to change the star distance used for diagram creation. List of numbered minor planets is used to demonstrate the current position of objects in the Solar system, to construct a Kirkwood gap graph or to interactively verify Kepler's laws. On Night sky application should be demonstrated progress chart of Sun below horizon during the night. It can be used to explain twilight, sunrise and sunset. For a particular moment there can be found a list of brightest stars, constellations visible above the horizon or Messier or NGC object visibility.

Keywords: catalogs, HR diagram, Kepler's law, minor planets, stars, Kirkwood gap, interactive, application, multimedia

What is Astronomia?

Web pages Astronomia is a multimedia textbook established in 2000 available online at Astronomia.zcu.cz. It contains sorted information about planets of solar system, deep-sky objects, stars and other objects in the Universe. These pages are mostly collected from many relevant sources, usually translated from English ones. There is no plan to create an English version of these pages. On the other hand, one unique part is prepared also in English mutation. It is focused on catalogs of astronomical objects; it is integral part of Astronomia web pages. There are more than six hundred thousand objects in total volume of about 180 MB of data. Catalogs should be divided into three categories – deep-sky objects (nebulae, stars clusters and galaxies) are located in three of them – NGC, Messier and IC catalogs. The second area are stars, there is a list of constellations (88 items), Gliese catalog (contains 3803 nearby stars), Hipparcos catalogs (118218 stars) and a part of astronomical database SIMBAD (118171 stars with HIP equivalent). The third area is a list of minor planets; currently (in Oct 2013) we know more than 376 thousand numbered minor planets.

A very important issue is to update values in catalogs from credible sources with the permission of their authors, e.g. SIMBAD database directly from French source and minor planets from Minor Planet Center. These data should be used effectively in education process. In this contribution I would like to introduce several astronomical exercises based on catalogs of astronomical objects.

Online applications using data from catalogs

I have prepared several online interactive applications, available from Astronomia web pages, which are using data from catalogs of astronomical objects. These applications can be used for demonstration of following issues (in the brackets is name of used catalog):

- Analysis of Minor planets parameters (minor planets)
- Kirkwood gaps (minor planets)
- Historical development of Minor planets (minor planets)

- Current location of Minor planets in the Solar system (minor planets)
- Kepler's laws demonstration (minor planets)
- Apparent magnitude of Minor planet calculation (minor planets)
- Surface temperature of Minor planet estimation (minor planets)
- Online HR diagram construction (stars)
- Sun below horizon, Sunset and sunrise, Twilights (stars)
- (Circumpolar) constellations (stars)
- Length of (astronomical) night (equinox, solstice) (stars)
- Sidereal and solar time (stars)
- Nebulae, star clusters and galaxies on the sky (deep-sky)

It is not possible to describe all possible options and features of these applications in this contribution. Use it as an overview to be able to decide which application you use for education at your classroom. And not only at school, some of the applications can be used before visiting observatory or observing the sky at night. For more detailed description visit Astronomia's web pages on English guidepost that is available at link: astronomia.zcu.cz/katalogy/education/.

Minor planets

There are several interesting examples of using catalog of numbered minor planet. For a first example we should consider the following question: “*The minor planet (15925) Rokycany is in opposition. Is it visible by telescope located on Rokycany Observatory?*” Anyone can choose any minor planet for this task. To solve this task we have to find date where the considered minor planet is in opposition. We can do it on the page astronomia.zcu.cz/katalogy/minorplanet-15925 by changing the day, the month and the year (see Figure 1). Then we can calculate (by simple formula or it is written on the image with location of minor planet in solar system) apparent magnitude of minor planet and compare it with limiting magnitude of telescope.

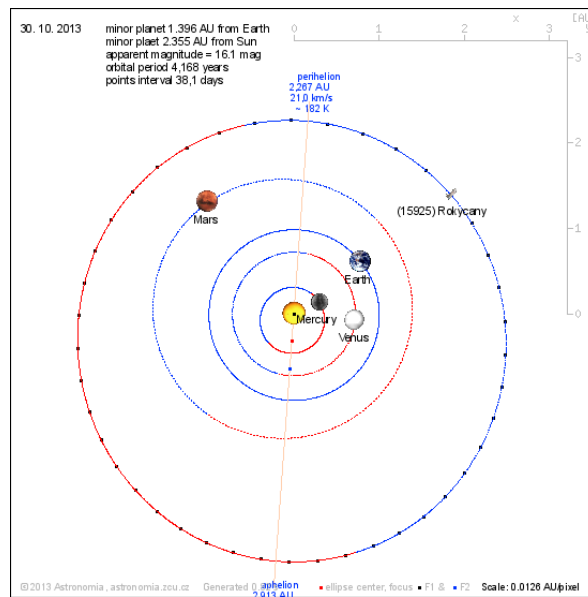

Figure 1. Minor planet Rokycany in opposition

On Figure 1 it is possible to demonstrate all Kepler's laws, including the location of focuses and the center of the ellipse, perihelion, aphelion, mainly the law of equal areas (using the interactive behaviour with area calculation – see Figure 2), and more. There is also calculated apparent magnitude for given Earth, Sun and minor planet configuration. This value should be also calculated from knowledge of the absolute magnitude of minor planet and its distance from the Earth and the Sun.

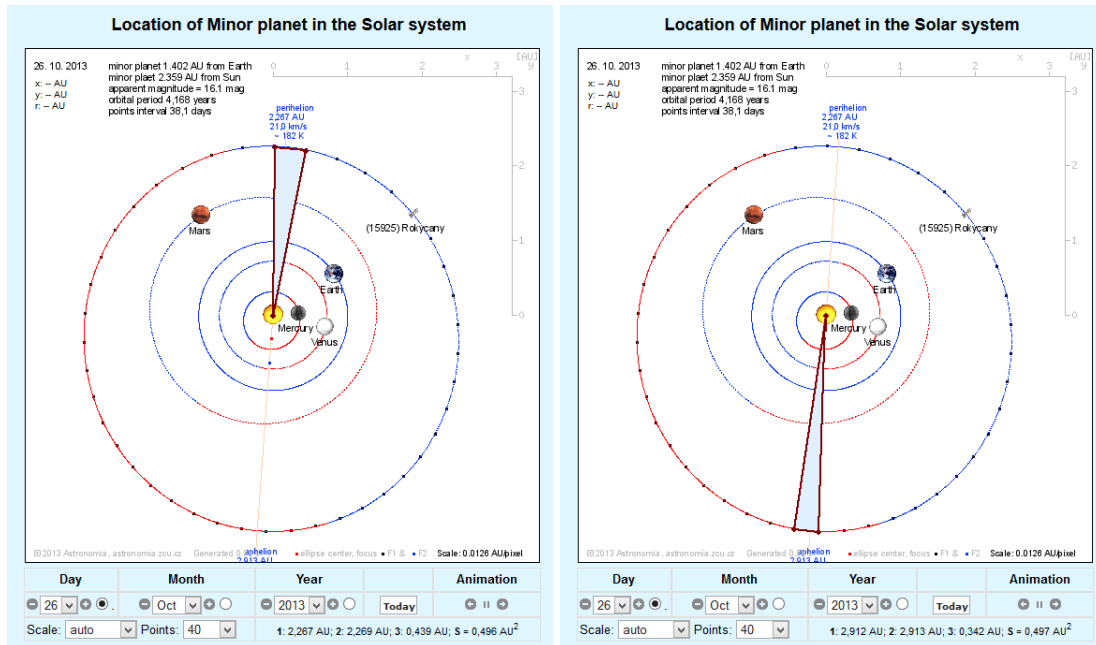

Figure 2. Comparison of area in perihelion (left) and aphelion (right).
The area is almost same = 0,496-0,497 AU².

Part of Analysis of Minor planets parameters is a special Data Export. It shows graph of semimajor axes on quantity of minor planets. There can be found several gaps (e.g. at 2.5 AU or 2.83 AU), see Figure 3. They correspond to the location of orbital resonances with planet Jupiter.

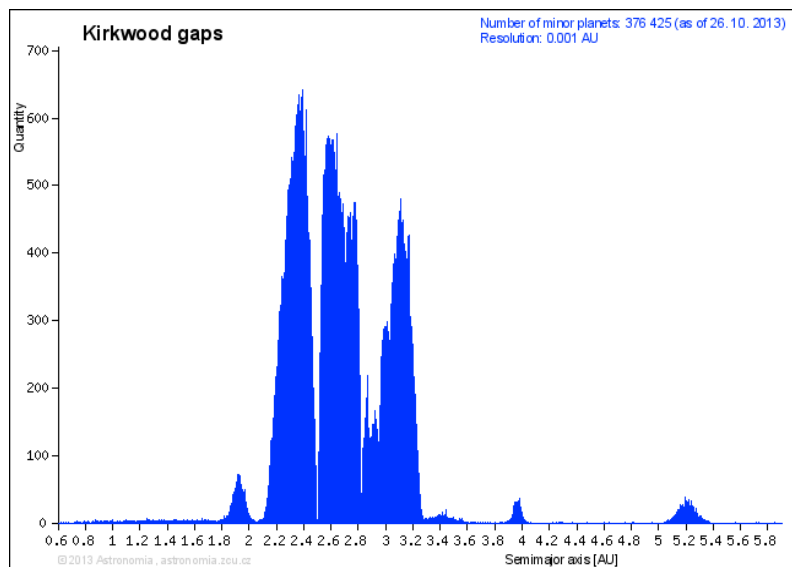

Figure 3. Kirkwood gaps

There are two areas on Figure 3 where orbital resonance with Jupiter create stable group of minor planets. They are located around 4 AU (2:3, Hilda family) and around 5.2 AU (1:1, Trojan group). Long-term distribution of Hilda family in the solar system produces approximate shape of an equilateral triangle (see Figure 4 right). Trojan minor planets orbit around one of the two Lagrangian points of stability (see Figure 4 left).

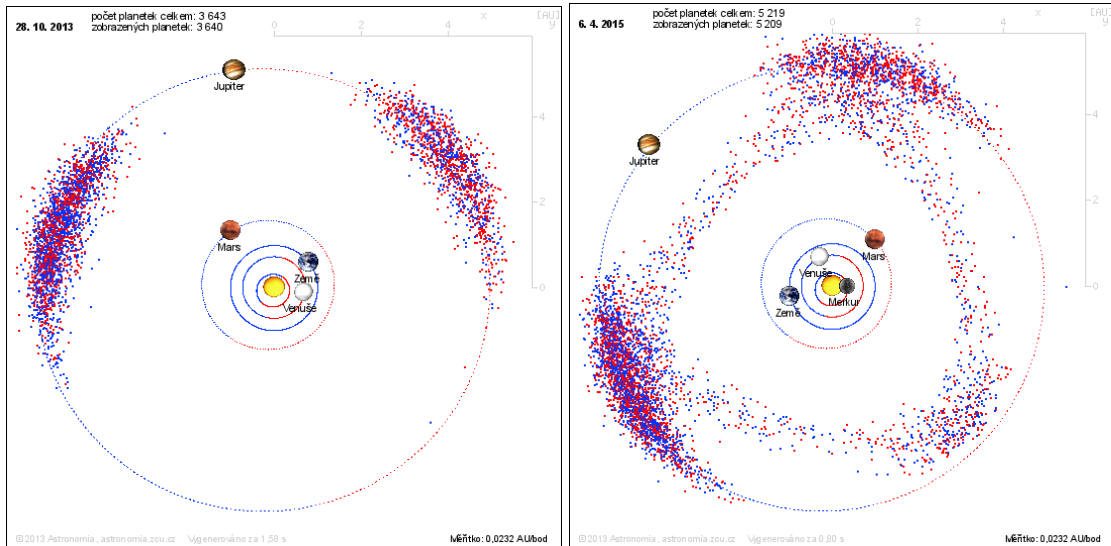

Figure 4. Trojan group (left) and Hilda family with Trojan group (right)

Stars

Hertzsprung-Russell diagram (HRD) is generated directly from the Hipparcos star catalog (this one is not updated) or the SIMBAD astronomical database (regularly updated on week bases). This application allows viewing of HRD for stars in selected distances (nearby – see Figure 5 left and far – see Figure 5 right) and it displays the location of the selected stars in the diagram.

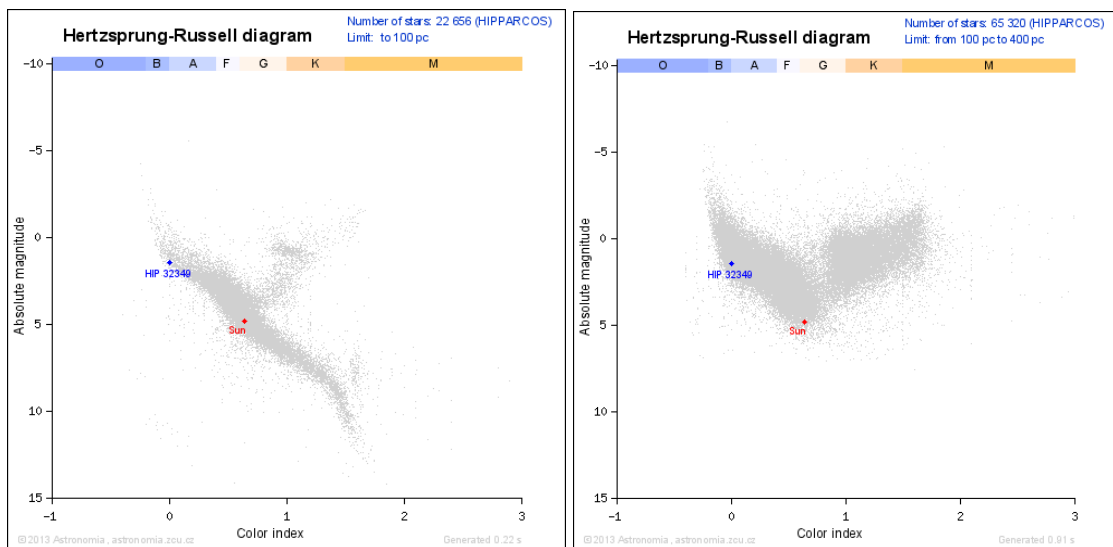

Figure 5. HR diagram for nearby stars (left, up to 100 pc) and far stars (right, from 100 pc to 400 pc)

Another application shows (see Figure 6) graphical representation of the sun below the horizon to the chosen location (currently restricted to the Czech and the Slovak republic) for a selected time. It begins before sunset and ends after sunrise next day. There are highlighted all twilights. For selected day it is calculated length of night (from sunset to sunrise) and length of astronomical night (interval, when the sun is more than 18° below the horizon). It is possible to demonstrate the situation for equinox whether night and day is really equal; it means both have 12 hours, less or more?

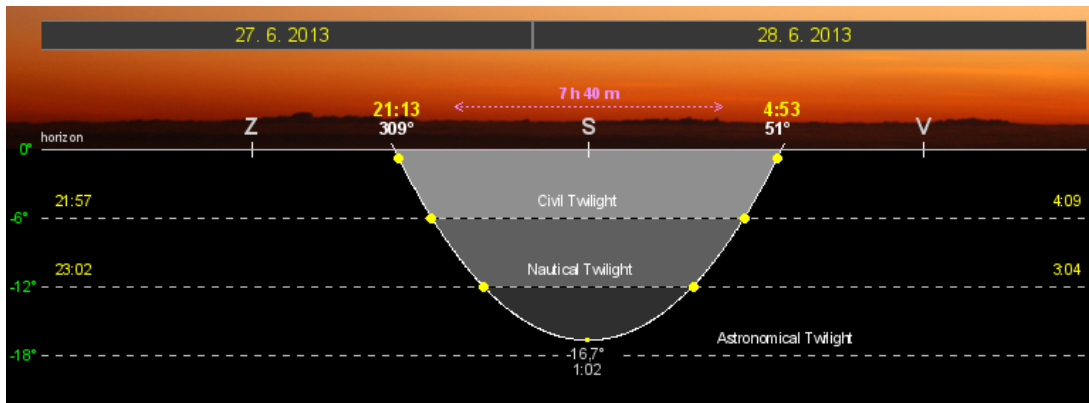

Figure 6. Night sky available on astronomia.zcu.cz/katalogy/education/2410-night-sky

For each point on the line of sun; list of constellations visible at a given time and place on the sky including an indication of circumpolar constellations is calculated. There are only five constellations assigned as circumpolar for the Czech Republic, see Figure 7.

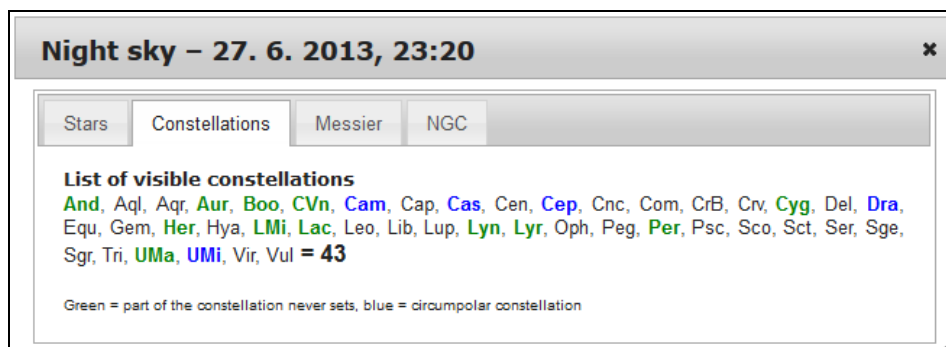

Figure 7. List of visible constellations

Conclusions

Any experiences with the above applications, comments, ideas or suggestions, please, let me know (kehar@kmt.zcu.cz). I will keep the applications updated and fully working as long as it will be possible. It means you can implement them in your education process. My near future plan is to extend Night Sky apps to world coordinates (currently they are limited to the Czech and the Slovak republic), introduce new application (e.g. Daytime Sky) and prepare more Worksheets & Instructions mainly in English language.

References

- [1] Multimedia text book Astronomia [online]. [cit. 8.8.2013]. Available from: astronomia.zcu.cz

It is never too late to introduce procedural understanding: a case of physics laboratory course for undergraduate students

Rajesh B. Khaparde

Homi Bhabha Centre for Science Education, Tata Institute of Fundamental
Research, Mumbai, INDIA

Abstract

Procedural understanding is the ‘thinking behind the doing’ or the ‘decision-making’ required in performing scientific experimental activities. It is necessary for designing experiments, planning observations/measurements, collecting and analysing data etc. Often, the significance of procedural understanding is subsumed and therefore lost under the rubric of ‘experimental skills’. It is a kind of cognitive understanding in its own right and hence fostering procedural understanding should be an important goal of physics laboratory courses at school and college level.

Training of students in experimental science continues to be the Achilles’ heel of Indian school system. Unfortunately, very little emphasis is given to students individual experimental activities at the school level and thus there is hardly any scope to introduce and foster procedural understanding. Even at the university level, a common practice of ‘mechanically’ performing a set of experiments, in a ‘cookbook’ mode, hardly help students appreciate and develop procedural understanding during their physics laboratory courses.

As an attempt by the author to introduce and foster procedural understanding, a novel laboratory course titled ‘Summer Course in Experimental Physics’ was developed for undergraduate students and teachers. In this paper, the author reports a fairly successful laboratory course for introducing procedural understanding at the second (sophomore) year of (3 or 5 year) university undergraduate degree course. Further, the paper offers some details of this course organized every year during the summer vacations in India. The course is designed as an enrichment course and is based on “experimental problem solving” approach. In this approach, students are encouraged to carry out independent experimental work on a set of ‘experimental problems’ in Physics. The emphasis is on students’ own thinking and planning, on moving them away from ‘cookbook’ instructions and from spoon-feeding. Based on the assessment and feedback of this course, the author suggest that even though usually procedural understanding should be introduced at the high school level, it is never too late to introduce and foster procedural understanding even if it at the undergraduate level.

Keywords: Procedural understanding, experimental skills, training in experimental physics, laboratory course, experimental problem solving, summer course in experimental physics

Introduction

It is no exaggeration to say that physics is the most quantitative of sciences. It is strongly based on observations, measurements, data collection, analysis and interpretations. Hence the teaching and learning of physics is incomplete and inadequate unless students gain a significant experience in experimental physics through well-planned laboratory courses. The goals of physics laboratory courses include fostering conceptual understanding and

development of several important cognitive, psycho-motor, attitudinal and affective abilities related to experimental physics, which include, procedural understanding, experimental skills, experimental problem solving ability, etc.

Let us first discuss what procedural understanding is and how it is different than 'knowledge about common procedures' followed in experimental physics. According to Gott and Duggan [1] procedural understanding (PU) is the 'thinking behind the doing' or the 'decision-making' that is required in performing scientific experimental activities. It is the thinking behind design, measurements, data collection, analysis of data and observations, results and conclusions [2]. It involves understanding a set of ideas (e.g. variable identification, sample size, variable types, relative scale, range and interval, choice of instruments), which are termed as 'concepts of evidence', related to the 'knowing how and why' of science and required to implement science in practice. It is distinct from, yet complimentary to, conceptual understanding.

Gott, Duggan and Roberts [3] have identified more than 50 concepts of evidence, which form the knowledge base of procedural understanding. It covers 17 areas related to planning and design, observations and measurements, data collection, analysis of data and observations, results, conclusions and evaluation.

For example, suppose a student is asked to study the motion of a freely falling body, with respect to its changing velocity; then the understanding required for planning the experiment, deciding which quantities are to be measured, the appropriate range of values, the accuracy with which they are to be measured, the intervals at which the measurements are to be carried out and how one may derive meaningful outcome from the measured data constitute procedural understanding.

To illustrate this further, let us understand and analyse the following three questions on procedural understanding. These questions are based on conceptual understanding related to experimental problems and require cognitive abilities like analysis, application and synthesis to provide the satisfactory answer.

- 1) A rectangular body of material with known density has a cubic cavity inside it. Design and explain an experimental method to determine the size of this cavity and locate its position.
- 2) You are given a spring, known masses and a meter scale. Suggest an experimental method to determine the mass of the spring.
- 3) In an experiment, you are supposed to study the variation of resistance of a thermistor with temperature. In this experiment, which instruments will you need? Which parameters will you keep the same? Which parameters will you change and the change in which parameters will you record?

It is very well accepted that Physics education should be more than just teaching about 'facts, concepts, principles and laws' that the physicists know or have discovered. It should also enable students to 'think and work like physicists'. Hence it is important to emphasize teaching of ideas and development of abilities which students will need to design experiments, and collect, analyse and evaluate the resulting experimental evidence.

Also note that the procedural understanding develops the ability to 'think scientifically' and foster scientific experimental method. It plays a critical role in experimental physics, and is necessary to solve simple as well as complex real life experimental problems [4]. The significance of procedural understanding is subsumed and therefore lost under the rubric of 'experimental skills'. It is a kind of cognitive understanding in its own right and

hence fostering procedural understanding should be one of the goals of physics laboratory courses at school and university level.

Laboratory training in Indian schools and universities

Training in experimental science continues to be the Achilles' heel of India's educational system and is thus a matter of long-standing concern in India. Today, in most of the Indian schools, a very little emphasis is given to students individual experimental activities and thus it is very difficult to introduce suitable laboratory courses to foster procedural understanding at the school level.

Most of the early universities in India were constituted on the model of London University. As far as physics laboratory training in Indian colleges and universities is concerned, these universities largely adopted the strategies, content and the courses, which were designed for universities and colleges in England. Over the past 60 years, the number of students has increased manifold and the overall quality of science education has gone down considerably. At present, in most of the colleges and universities, it is a common practice to ask students to 'mechanically' perform a set of experiments, in a 'cookbook' mode, [5] which hardly help in achieving the goals (cognitive, psycho-motor and affective) of the physics laboratory courses. It has been observed that the teachers tell students too much in order to complete the experiment in the specified time. In doing so they deprive students of the opportunity to learn by themselves, for example they are likely to tell students just about everything how to assemble an apparatus, how to perform an experiment, what observations are to be taken and even what outcomes to expect. With this 'cook book' type of laboratory instructions, students frequently leave the laboratory having performed the 'mechanical exercise' well, but with low retention of information and even lower comprehension of the significance of that information. Thus the laboratory training fails to develop in students various cognitive and other abilities required in experimental physics.

The laboratory training in most of the Indian colleges and universities provide the students with very little or no opportunity to discover information rather than to simply use the laboratory as a centre for verification of information they already have. Students do not find any charm and interest in the given experiments. This present practice hardly help students appreciate and develop procedural understanding during their physics laboratory courses. A need was felt to initiate and promote well-planned laboratory programmes for students and teachers to introduce procedural understanding and develop instructional strategies appropriate for university level. In response to this need, a "Summer course in experimental physics" was designed by the author.

Summer course in experimental physics (SCEP)

The prime objective of the summer course in experimental physics was to introduce and put forward a need for the development of procedural understanding among students and teachers. The course was designed as a 12 day (78 contact hours) intensive enrichment course for undergraduate students and teachers and was based on "experimental problem solving" approach. This approach is designed by the author to encourage students' active participation and independent thinking in physics laboratory and offer an opportunity to learn 'how to think scientifically'. During this course students are mentored by a team of invited teachers and encouraged to carry out independent experimental work on a set of 'experimental problems' in Physics.

SCEP is held every year during the summer vacations for about 55 students and 10 teachers. The course is announced on the websites and the announcement leaflets are

sent to number of colleges and universities in India. Second year (Sophomore) undergraduate students of Physics (who have completed 2 years / 4 semesters) of their university course [BSc/BS/Integrated MS/MSc] from any college or university are encouraged to apply.

Teachers, educators and researchers who are involved in physics laboratory courses at the undergraduate level are invited to attend a 3 day 'Exposure cum Preparatory Workshop for Teachers' and subsequently be a mentor for the students during the summer course. During the preparatory workshop teachers are introduced to procedural understanding, guided experimental problem solving approach, strategy for training in experimental physics and other aspects of the course.

The course consists of orientation sessions (during the first two days) on introduction to experimental physics, procedural understanding, experimental problem solving in physics, essentials for experimental physics. During the next ten days, there are experimental practice sessions, discussion sessions, several experimental/laboratory sessions and student presentation sessions.

Typically about 35 experimental setups are arranged in physics training laboratories. The experimental problems are based on oscillations of a soft massive spring, physical pendulum, Newton's laws, Maxwell's wheel, electromagnetic damping, Fourier analysis, free falling and projectile motion, bending of beam, coupled strip oscillator, magnetic circuits, coupled coils with ferrite core, mechanical black box, introduction to experiments, diffraction of light, formation of rainbow and polarization of light.

Salient features of SCEP

1) The 'guided experimental problem solving' approach is developed by combining 'problem-solving' and 'guided design' modes of instruction. In this approach an experiment is presented as an 'experimental problem'. Here an experimental problem is presented as a sequence of interrelated subsections, each subsection being a small activity, through which the students are stepwise guided to the complete solution. Thus, students solve the experimental problem in graded stages. Each subsection/stage may have a different focus, may involve a different type of experimental activities and may aim at different learning outcomes.

2) Students are expected to work independently with a minimum of guidance from the mentor, but they are 'guided' in graded stages through a carefully written 'student handout' for each experimental problem. The student handout gives a brief conceptual introduction to the problem, the necessary description of apparatus and the experimental setup and the theoretical basis. Here, the students are given a few procedural instructions to think of and design their own method, perform measurements, collect and analyze data and thus 'solve' the experimental problem. These instructions guide students' on possible way to solve the problem and at the same time offer a room for their independent thinking, designing and planning of actual procedures. These instructions run like, "You may have to use law of Malus; plot an appropriate graph to determine Z; record the necessary data to study the inter-dependence of X and Y; determine the value of X graphically". Here, the emphasis is on students' own thinking and planning, on moving them away from 'cookbook' instructions and from direct spoon-feeding.

Students are expected to read the student handout and understand the necessary details of the problem. They are expected to understand the use of different apparatus and the related warnings or precautions. Students are expected to broadly use the procedural instructions,

design an appropriate method on their own, carryout the necessary measurement, record the data, carryout the necessary analysis of the data, derive meaningful results and conclude.

3) The approach encourages a 'free laboratory ambiance' where students are made to think about the design and procedural aspects of experimentation, with a least possible guidance from the mentor. Students are encouraged to carry out self-designed and independent experimental work. The 'free' laboratory ambiance does not refer to an open ended or exploratory type of experimental activities. The idea of 'free' laboratory ambiance is that the students are told about the desired final outcome of each part of experimental problem, but they are given autonomy with respect to, choice of variables, choice of range of values of variables, use of instruments and experimental techniques, method of data handling and analysis etc. For example, in an experimental problem if the students are asked to study the relation of incident intensity to the output current of a photodetector, then they may be given a starting instruction on the possible use of inverse square law for establishing linearity, they may be asked to identify the necessary apparatus with their detailed specification, they may be given some hints for the experimental arrangement, and asked to identify the dependent, independent and control variables, construct a fair test, identify the sample size, understand the types of the variables involved and thus in short design the detailed 'solution' for the experimental problem. Further, they may be asked to choose sensible values of variables or parameters, proper range and interval between different values of these parameters. They may then be asked to record the desired data and analyse the data using tables and graphs to derive meaningful and expected results. Thus, in this approach the students are provided a freedom with respect to finer procedural stages, but are still guided with respect to the approach or a possible method of solving the given experimental problem.

4) Students are provided with the required apparatus and are given a free hand to work in the laboratory. They are also given some extra apparatus and instruments to choose the most appropriate instrument for a particular measurement. Students are supposed to assemble various instruments and make the necessary experimental arrangement on their own. Students are also given an instruction sheet specifically prepared for the experimental setup. This instruction sheet has information on the use of different instruments and apparatus, the adjustment of the apparatus and the necessary safety instructions and warning. The user manuals of various instruments published by the manufacturers are made available to the students on request.

5) Students are given a set of preliminary questions (often referred to as pre-lab questions) for each experimental problem. Each student is required to independently answer these questions prior to the actual experimental work. These questions are based on the basic concepts, laws, principles, their applications, experimental techniques, use or care of apparatus and a variety of procedural aspects related to the design, measurement and data handling. These preliminary questions play a very important role in preparing the students to efficiently carryout the experimental work.

6) There are some important aspects related to measurements, statistical treatment of data, graphical representation and analysis of data, significant figures and estimation of uncertainties which are essential tools of experimental physics. Students' should have a good knowledge and understanding of these tools before taking the summer course in experimental physics. A detailed reading material on all these aspects is prepared and made available to the students well in advance. Students are expected to read this material and use other resources to develop the desired knowledge about these tools. During the first few days of the course, a considerable amount of time is spent on developing students confidence to use and regular practice of all the above listed essential tools for experimental physics.

7) Another aspect of this approach is minimal intervention by the mentor. Students are not offered any direct advice from the mentor with respect to designing aspects in solving the experimental problem instead the mentor play a role of a silent observer, motivator and facilitator. The mentor at times needs to force students so that they plan and take decisions individually on their own. On the other hand, mentors help students in understanding the use of various apparatus and instruments or even the theoretical basis of the problem. Students are expected and allowed to take their own decisions about design, methods, measurements, data collection, analysis and interpretation.

Assessment of learning effectiveness of SCEP

The learning effectiveness of the course was assessed using a single group pre-test - post-test approach. A set of equivalent pre and post tests on 1) conceptual understanding, 2) procedural understanding and 3) experimental test, were developed, validated and administered for two batches of students. The pre-tests were given to the students on the first day and the post-tests were administered on the last day of the course. The answers/response was collected from 93 students and evaluated and analysed in terms of numerical scores in all the three pre and post-tests. It was noted that the mean and individual scores in each of the test were higher in the post test than the pre-test by a percentage variation in the range 37% to 82%. This suggests that the course help students significantly in development of their conceptual understanding, procedural understanding and experimental problem solving abilities.

Conclusion

It is believed that students should be introduced to aspects of procedural understanding at an early stage of their education, preferably at the secondary school level (age 10-16 years). In India, most of the students never get opportunities to design their own experimental approach, decide about the measurements, collect and analyse their data during their school education. The author emphasizes much needed “freedom” in the undergraduate laboratories so that students can develop procedural understanding (along with other abilities and skills) during their undergraduate physics laboratory courses. The author in this paper described one such fairly successful laboratory training course to introduce procedural understanding at the undergraduate level and suggest that it is never too late to introduce procedural understanding.

References

- [1] Gott R., Duggan S.: *Investigative Work in the Science Curriculum*, Open University Press, Buckingham, 1995.
- [2] Rajesh B. Khaparde, Pradhan H. C.: Procedural Understanding: A Neglected Aspect of Physics Laboratory Training, *Physics Education*, 19(2), 2002.
- [3] Gott R., Duggan S., Roberts R.: University of Durham, <http://www.dur.ac.uk/rosalyn.roberts/Evidence/cofev.htm>
- [4] Rajesh B. Khaparde, Pradhan H. C.: *Training in Experimental Physics Through Demonstrations and Problems*, Penram International Publishing (India) Pvt. Ltd., 2009.
- [5] Khandelwal D. P.: Physics Education in India-Challenges and Opportunities, *Physics Education*, 6 (1), 1989, pp. 44-52.

Checkpoint Leonardo – combining informal science and art education to primary and science teacher education

Anssi Lindell, Marjo Autio-Hiltunen, Anna-Leena Kahkonen and Antti Lokka

University of Jyväskylä, Finland

Abstract

Both artists and scientists want to make the invisible world visible. Checkpoint Leonardo (CPL) is a project for teaching and learning the art and science ways to gain knowledge of the world in informal museum and school education simultaneously. It consists of a series of art exhibitions with tailored workshops based on the scientific and artistic perspectives of the exhibit artworks. The first four workshops were designed and instructed for the conceptual level of 6th grade pupils by interdisciplinary groups of physics student teachers and elementary school student teachers. These workshops studied different ways of perceiving (related to cubism), infrared imaging, oxidation as a source of color, and acid-base indicators. The basis for all workshops was to use the techniques and represent the results in an aesthetic manner. As the work continues and accumulates, the representations combine into an artistic project as well as a scientific body of results. This project was a volunteer part of pedagogical studies covering courses of pedagogy of arts and science and it was co-instructed by lecturers of pedagogy of science, art and museum pedagogies at the University of Jyväskylä and Jyväskylä Art museum, and the regional artist group Live Herring. Also, a series of lectures in the theme of different ways of perceiving the world was included in the Checkpoint Leonardo project. During the project we acquired and analyzed essays on students' ideas of nature of science and aesthetic and empirical ways of knowing world and their development in this project. Only 41% of the student teachers mentioned the empirical nature of scientific knowledge prior the project and 16% of them claimed that scientific process does not permeate creativity.

Keywords: Nature of science and art, museum pedagogy, teacher education

Introduction

Finnish primary schooling is rated as a first class system by the Pisa exam, yet many Finnish children do not enjoy school. An extensive study performed by the Finnish Ministry of Education looked into the subjects of music, visual arts, and crafts [1]. It shows how the learning in these subjects is far from the criteria of the curricula. The saddest part of this study shows how boys, in particular, dislike and have difficulties learning in the art classes. At the same time, the universal problem of girls disliking the science classes is regrettably true also in Finland [2]. On the other hand, children do enjoy both science and art museum visits. Still, we observe daily that many science and elementary school teachers experience art and science museums as unfamiliar and uneasy to approach and apply as a learning environment.

The usability and the aesthetics are important qualifications of the modern products, just as the science and the technology behind them. Early learning to understand different ways to perceive the world, benefits the later education of work force to the thinking of modern cross disciplinary research and development processes. An integrated curriculum could

help making students to bridge a scientific meaning and other meanings, artistic and non-artistic, in their studies [3]. However, there is little – if any – discourse between the arts and sciences, for example, at school.

From these points of view the science and art educators of the University of Jyväskylä approached the Jyväskylä Art Museum to construct an exhibition combining the resources of the three parties. The idea was to combine our elementary school student teachers in the courses of art pedagogy (EAT) and science pedagogy (EST), and physics (single subject) student teachers (SPT) to work together in order to learn to instruct pupils in the two disciplines simultaneously; and in the museum environment. The artworks of the exhibition were suggested first by the members of the Art Museum, taking into account the science integrating nature and the resources of this project. After a short introduction to the exhibition and the idea of combining science and art education, an open task was given to the student teachers: “construct and instruct an intervention to teach something meaningful in science and arts for 6th grade students in the museum”. Our town region defines museum pedagogy as a key point in education for that age group in the curricula.

The basic purpose of this Checkpoint Leonardo (CPL) project is to offer a challenging authentic environment for student teachers to develop their skills in multi professional co-operation, diverse learning environments and cross subject themes. The name Checkpoint Leonardo refers not only to contact of science and art in Leonardo da Vinci, but also to node of science, art and mathematics by Leonardo Pisano, known better as Fibonacci whose sequence of numbers may be used to approximate the golden spiral or golden ratio.

Theoretical background

Albert Einstein has said that the common feature of science and art is the spirit of mystery. To go slightly further from the spirit, artists and scientists share a common interest to make visual representations of the world, both visible and invisible. The ancient Greek mathematics, the language of science, was based on geometry, in which the rules were explained and demonstrated by visible forms. An invisible branch of mathematics, algebra, with concepts such as polynomials with high dimensions, negative numbers and zero and infinity, developed in India later in the 8th century. The efforts to visualize zero or infinity lead to the vanishing point imagery and development in the renaissance arts [4].

In physics, visible are the phenomena (“which appears”), which are directly observable by our senses. A beam of light travelling through a dust cloud is an example of these. It can be investigated in a concrete way by direct observations. On the other hand, everything cannot be sensed directly. A wave of light is an example of a noumenon (“which is thought”), an event of the invisible physical world. Constructing representations of these requires creativity, higher cognition and use of analogies. In his philosophy [5], Immanuel Kant wanted to separate these two “ways of seeing”. As first coined by Kant, these are frequently referred to by German words “anschaulichkeit” (visualizability) and “anschauung” (visualization) respectively [6]. Kant’s Philosophy was an integral part of German school education in the early 1900s and it has been considered to have a significant role in the construction of modern physics, as many of the pioneering scientists were brought up in that environment. In agreement with this philosophy we want our students to learn to identify the difference between an observation and an inference. We believe that this understanding can be developed in combined education of science and art.

The strict distinction between observation and inference is also one of the key issues in nature of science (NOS). NOS refers to epistemology and sociology of science as a way of knowing but also the values, beliefs inherent to scientific knowledge and its development [7]. To map our student teachers' ideas of knowing the science we used six core ideas defined for 6th grade teachers to understand NOS: scientific knowledge is tentative, empirical, theory-laden, partly the product of human inference, needs imagination, and creativity, and lastly, socially and culturally embedded [8].

Description of the Project

The CPL project was a volunteer part of pedagogy of science and art, integrating separate courses. The courses and their resources are presented in the Table 1.

Table 1. The Physics subject teacher and elementary teacher courses of the University of Jyväskylä having resources for integrated CPL project. See more about the curricula: [9].

Name of the Course	Extent (CPL/The whole course) [ECTS]	Code and # of Students in CPL	Tasks in CPL	Other parts of the Course
Pedagogy of elementary school Science	3/9	EST 8	Workshop design and instruction	Lectures, hands on workshops, Exam
Pedagogy of Physics	3/7	SPT 4	Workshop design and instruction	Lectures, Finnish as a second language project
Research Methodology and Communication	1/3	SPT 4	Teaching experiment	Lectures
Instructed Advanced Teaching Practice	1/7	SPT 4	Data collection	Lessons in the Teacher training School
Visual Arts and Pedagogy	1/7	EAT 11	Exhibition guide	Methods of visual arts and pedagogy
Art Workshop	1/1	EAT 9	Exhibition guide, workshop design and instruction	Lessons and auxiliary program.

The SPT students and the EST and EAT students formed four integrated groups of four students (1 PST and 1-2 EATs and ESTs in each). The four SPTs integrated three of their courses in CPL. For nine students, the CPL-project was an optional Art Workshop course including also introduction to the exhibition and lessons and other auxiliary program and guiding of several groups. In addition, eleven first-year elementary school student teachers taking the Visual Arts and Pedagogy-course acted as exhibition guides: they participated in a two-hour introduction at the museum, two hours of guiding groups of pupils and were given extra independent work materials making them better acquainted with the artists and their work.

The exhibition

The Exhibition Checkpoint Leonardo was displayed in the Jyväskylä Art Museum 15.3.-28.4.2013. The six artists of the exhibition were chosen among those who are known to employ science in their works. The project included an exhibition café where the audience could turn the phenomena of natural sciences into artistic experiences (see below for the workshop descriptions). During the display period, also a fleet of 8 general lectures were given by artists, scientists, education pioneers and an art historian. The brand of CPL propagates now in University towns in Finland (Tampere, Oulu, Joensuu).

Thermo Image Inquiry

The starting point of this Inquiry was Terike Haapsalo's artwork "In and Out of Time", in which a calf, deceased shortly before recording began, was filmed parallel with a visible light (normal) and infrared (thermo) camera. The original teaching/learning intervention idea of the students was to use a thermal camera to record dynamic changes of different objects such as a hot water bottle, a thermal plate etc. However, thermal cameras were too expensive for the budget of the project and the group tested a possibility to use an infrared filter on the lens of normal digital video camera. The filter was fabricated by just buying a slide film from a photo shop and giving it immediately back for development. Positive slide film develops opaque for visible light (black) while unexposed but the material needs to pass infrared as it would otherwise melt in front of a hot lamp of a slide projector. However the quality of this kind of filter was not good enough for the students' purposes and they ended up using a raster scan of a thermal image using normal infra-red thermometers. In the inquiry, pupils raster scanned the body of a classmate or, alternatively, their own hand. They then arranged their color pencils according to what they experienced the temperature order of each color to be. Finally they divided the measured temperature range into classes per color to draw a thermal image of their measurement. The objectives of this inquiry were to understand the concept of color temperature, modeling and visualizing the observations of the nature, the resolution of an image and thermal conductivity and insulation. A common misconception among the pupils came up in this inquiry. Most of the students believed that the temperature measured on a spot covered by clothes would be higher than on a naked skin. The thicker the cloth, the higher the temperature should be – according to their thinking. This inquiry seemed to be effective in helping them reason how clothes and thermal insulation work.



Figure 1. In Terike Haapsalo's artwork "In and Out of Time" the body of a dead, cooling calf has been imaged simultaneously by a video camera and infrared camera (left). In the workshop, students first measured temperatures on spots of their bodies by an infrared thermometer (middle). Finally they chose colours representing different temperatures and draw a raster thermo image according to their measurements.

Red cabbage art

This workshop was based on the artwork by Jeanette Schäring from Gothenburg, Sweden. It was an arrangement of transparent containers of water from different urban sources, which turned to hues of yellow due to a natural indicator and the acidity of the water.

In the workshop, pupils inquired the acidity of common domestic chemicals and registered the color changes for each liquid when added into red cabbage juice. After that they were given a piece of paper saturated with red cabbage juice to create art using the domestic chemicals as dyes.

Kinetic artwork by electrolysis

This workshop was based on an installation by Päivi Hintsanen, which gradually changes the color of pieces of metal oxidizing in acid tanks. The pupils tried electro coating different materials and inquired their color changes in copper sulfide. The successive workshops constructed a progressive kinetic artwork from the materials. The core idea of this workshop was that a single color perception may be due to different phenomena in the nature, and may origin of the properties of the bulk material or its size: oil film on a sub phase of water, fluffy wing of a butterfly or a spray of water to make a rainbow. Another objective of this workshop was to learn a method to fabricate color pigments.

Sensory perceptions

The starting point to inquire the nature of sensory perceptions was the series of cubistic paintings by three artists: Mikko Ijäs, Liisa Lounila and Sami Lukkarinen. In the workshop, pupils constructed visual models of sensory data gained by an optical microscope, touch, and smell. The optical microscope was used to inquire the raster character of printed images on newspapers. They were compared to the cubistic paintings and the concept of resolution was discussed. The pupils also practiced acquisition of data from a “topographical black box” by touching. The box included materials of different hardness and thermal capacity, like cotton balls, stones, hairbrushes etc. The students were then to represent the result of the manual scanning on a piece of paper. The objectives were to learn the advantages and the disadvantages of a model made by mechanical probing compared to a direct visual image. The advantages reported included the data of hardness, temperature and topography, and no need of illumination. The disadvantages were the lack of sense of color and poor lateral resolution, among others.

The third part of this workshop was to smell vials of different samples, such as garlic and tar. The original idea was to construct a lateral “odor black box” of different smells in a pizza case with a matrix of holes on the cover. However teacher students considered this task too difficult for 6th graders, and in the final version they drew their experience of smelling each different vial on a paper for other pupils to interpret. The core ideas to learn in these inquiries were that gaseous substances are mixed and the particles will drift to nose to generate a sensation. Also the memory and the limitations in the resolution of human sense of smell compared to dogs, for example, were discussed.

Teaching and learning in the new surrounding – a day at the art museum

Almost forty 6th grade primary school groups from Jyväskylä (about 1000 pupils) visited Check Point Leonardo workshops and the guided exhibition tour. Each group participated

in a single workshop. The program at the art museum took altogether four school lessons (1 lesson is 45 minutes). The teachers were able to load the materials of the exhibition and the workshops from the internet in advance.

Impact of the Project

In the CPL project we were interested about the student teachers' ideas of the nature of science and art and how do they change after participating this project? To find this out we asked the student teachers (N=32; 20 EAT, 8 EST and 4 SPT) to write down their ideas on three questions prior and after the project:

- 1) Describe the process of arts
- 2) Describe the process of science
- 3) What is similar and what is different between science and arts

We searched the NOS core aspects for 6th graders from the pre-project answers in questions 1 and 3. This analysis is based on the comparison of expert and novice group responses to the VNOS-B questionnaire in [7]. Sentences like “science is based on empirical investigations” were interpreted to be in agreement with expert response, while a claim like “there is no place for creativity in science” is an example of an opposite (to expert) response. These analyses were carried out by three of the authors (MA, AL and AL) independently and those suggested responses to an aspect which were noticed by just one of us (20%) were rejected. Table 2 shows the distribution of the relevant (at least two marks) responses.

Table 2. The NOS aspects mentioned in student teachers' pre-CPL essays. The expert response refers to ideas similar to the majority of experts and the opposite response to ideas that disagrees with those in [7].

NOS Aspect	Expert response	%	Opposite response	%
Empirical nature of scientific knowledge				
Observations used to make scientific claims	13	41	0	0
Science does not rely solely on empirical evidence	7	22	1	3
Supports rather than proves scientific claims	1	3	1	3
Inference and theoretical entities in science				
Inferential nature of atomic models	5	16	0	0
Nature of scientific theories				
Theories change due to new evidence	4	13	1	3
Theories change due to new ways of looking at existing evidence	4	13	2	6
Explanatory power of scientific theories	6	16	0	0
Theories are well-substantiated	2	6	0	0
Theories provide a framework for current knowledge and future investigations	2	6	1	3
Scientific theories vs. laws				
Nonhierarchical relationship	0	0	0	0
Laws may change	2	6	2	6

Creativity in science				
Creativity permeates scientific processes	3	9	5	16
No single scientific method	1	3	1	3
Subjectivity in science (theory-ladenness)				
Differences in data interpretation	1	3	0	0
Science is necessarily a mixture of objective and subjective components	3	9	3	9
Social and cultural influences				
Science as a culture within itself	0	0	1	3
Peer review limits subjectivity	0	0	0	0
Society as an influence on science	0	0	0	0

From these answers we nominated three types of student teachers: the novice teachers represent the ideas of the novice group and the expert teachers represent the ideas of the expert group in Ledermann's investigation. In addition, there are in-between student teachers, whose ideas agree with the expert groups' ideas, except for those regarding the subjectivity and the role of creativity in science.

According to a sample novice teacher (EST) pre-CPL answer a scientific process was "a phenomenon which typifies the reactions of the world", while in the post project essay "these phenomena occur according to laws of the nature". In the pre project essay, (s)he makes the claim that "science is concrete and art is abstract". After the project, however, the both are "generated by a reaction which has been observed and recorded consciously or unconsciously and may be represented according to one's own desire". We interpret here a developing understanding of the Kant's higher cognition or "anschauung" and also the effects of the social and cultural context in which scientific investigations are embedded.

An "in between" student teacher (SPTa) shows understanding the empirical and tentative nature of science already in the pre project essays. However in these "science must be based on the reality, while art may be whatever". In the post project essays there is a new step in the scientific process, "trying to understand" which may show the use of creativity during a scientific process. Also the "whatever" has now turned into "more freedom" and evaluation has become a part of the process of art.

An expert student teacher's (SPTb) pre-project ideas followed the expert groups ideas in the Ledermann's investigation also in the aspects where the expert group was not in consensus: the effects of the social and cultural context. This expert student teacher used the concept of world view: "In the scientific process, the researcher's own world view should not affect to the research, while in the arts the point is to interpret phenomena through artist's own world view". In his post project essay, this expert student teacher writes: "both hypothesis and the initial idea (or inspiration) of the artist are visions of something which does not exist yet".

Conclucions

Only 41% of the students to teach science later in their careers, routinely noticed it as an empirical subject. This alarming low number is probably due to the selection system to our elementary teacher education, which emphasizes applicants' verbal skills over reasoning. The numerous thoughts of science not allowing creativity reflect naive conceptions of science as a set of eternal truths to be distributed in school education. In CPL we wanted to challenge these stuffy attitudes.

The very open nature of the assignment was a little confusing to some of the student teachers, but the written information of the artworks and the artists was considered very helpful. After a little stress at the beginning, the groups learned to self-organize their work well and the atmosphere was remarkably better in every group than in most of the groups of traditional courses, according to our experiences. The active learning combining science and art rose spontaneous questions in pupils, which are quite rare in Finnish schools. In many feedback sheets the active atmosphere was suggested to be due to the different learning environment. Some of student teachers considered the project too demanding and long-lasting, but the majority of them appreciated the authentic task, environment and the responsibility of the project over the efforts. The student teachers appreciated that they were given free hands and the authority.

The in-service teachers were quite passive and kept on the background, leaving their pupils to work alone. We have also observed this problem in our earlier science road show projects: teachers are active leaders in their classroom but they stay in the background while outside the school environment. The age of children suited very well for this kind of combined inquiry of something visible and something imaginable.

Good practice and ideas are distributed on the project web site Checkpoint Leonardo www.checkpointleonardo.fi (unfortunately only in Finnish so far).

References

- [1] Laitinen S., Hilmola A., Juntunen M-L.: Primary/Middle school's music, fine arts and crafts evaluation results of students in grade 9. The education's follow-up report 2011:1. Opetushallitus (2011), ISBN 897-952-13-4625-5.
- [2] Lavonen J., Byman R., Uitto A., Juuti K., Meisalo V.: (2008). Themes in Science and Technology Education 1(1), 7-36.), [online] [cit. 30.9. 2013] Available from: [Students' Interest and Experiences in Physics and Chemistry related Themes: Reflections based on a ROSE-survey in Finland](#)
- [3] Eisner E. W.: The Arts and the Creation of Mind. New Haven and London: Yale University Press (2002), p. 153-156, ISBN 0-300-09523-6.
- [4] Seife C.: Zero, the Biography of a Dangerous Idea. Viking Penguin, Penguin Putnam Inc. (2000), ISBN 951-0-25065-1.
- [5] Kant I., Guyer P., Wood A. W.: Critique of pure reason. New York: Cambridge University Press (2008).
- [6] Miller A. I.: Insights of genius, Imagery and creativity in science and art. First MIT press (2000), ISBN 978-0-262-63199-0.
- [7] Ledermann N. G., Abd-El-Khalick F., Bell R. L., Schwarz R. S.: Views of Nature of Science Questionnaire: Toward Valid and Meaningful Assessment of Learners' Conceptions of Nature of Science. J. of Res. in Sci. Teach. 39, No 6 (2002), p. 497-521.
- [8] Abd-El-Khalick F., Bell R. L., Lederman N. G.: The nature of science and instructional practice: Making the unnatural natural. Sci. Educ. 82, No 4 (1998), p. 417-436.
- [9] University of Jyväskylä, Dept. of Teacher Education: Teacher Education Curriculum, (2007), [online] [cit. 25.9. 2013] Available from: <https://www.jyu.fi/edu/laitokset/okl/en/curriculum/curriculum%20pdf/view>

What, if anything, is entropy trying to tell us?

Rainer Müller

Technische Universität Braunschweig, Germany

Abstract

The notion of entropy is commonly regarded as one of the most challenging concepts in classical physics. Many learners have difficulties to develop an intuitive understanding of entropy as a physical concept. Some of the difficulties originate from the fact that in the thermodynamic definition of entropy $dS = dQ/T$, a state variable (entropy) is defined via a process variable (heat). The entropy definition of Lieb and Yngvason (1999) which is based on the concept of "adiabatic accessibility" has been a major advance in the foundations of thermodynamics. Unfortunately, because of its mathematical complexity, it is hardly accessible for students. We present a variant of this new entropy definition in an elementary formulation that should be accessible to undergraduate students. In this formulation, a direct link can be established to the idea of "quality of energy". With simple examples, we give an operational meaning to this term and point out how it is related to the traditional entropy definition.

Keywords: Entropy, Thermodynamics, Student Understanding

Introduction

Many students would agree that the notion of entropy is one of the most difficult in the entire physics curriculum. Indeed, a growing body of empirical research on student understanding indicates that entropy is a highly challenging concept for learners [1–5]. These findings immediately raise the question whether the traditional way of teaching entropy is the most appropriate one. Several authors [6–8] favour a microscopic approach to thermodynamics with a statistical interpretation of entropy. The “spreading and sharing of energy” [9–10] provides a physically satisfactory description of the second law at the microscopic level. Although the “spreading and sharing” approach has hardly been empirically tested, it certainly deserves a wider recognition than it has obtained until now.

This paper deals with the entropy concept in macroscopic thermodynamics. Here, the problems are even larger than in the microscopic approach. They may be traced back to a severe deficiency of the traditional definition of entropy. Entropy is a *state variable*. Like other state variables (e.g. temperature, pressure, or internal energy), it should represent a certain property of the state. There are not many students (or professional physicists, for that matter) who are able to give an adequate description what kind of property it is that is represented by entropy. The traditional approach does its best to hinder the appreciation of entropy as a property of a state because it defines entropy via the *process variable* heat. The entropy of a state B is defined by:

$$\Delta S_{AB} = \int_A^B \frac{dQ_{\text{rev}}}{T}, \quad (1)$$

where A is a reference state, and Q_{rev} is the heat transferred when going reversibly from A to B. Most textbooks merely show that the integral in (1) is independent of the path between A and B (so that entropy is a state variable) but do not give any further interpretation that would facilitate the comprehension of the new thermodynamic variable.

For the interpretation of entropy, we revive an old idea: Entropy measures the quality of energy. This view is commonly attributed to William Thomson (Lord Kelvin) but has never been formulated mathematically in a convincing manner. In this paper we show that the “quality” (or accessibility or usability) of energy is more than just a metaphor. With physical arguments and thought experiments, we can give a mathematical basis for this interpretation. The first and second law can then be formulated qualitatively in a simple and unified manner: The first law deals with the quantity of energy, while the second law describes the quality of energy. Remarkably, similar lines of reasoning show up in some early references [11, 12] but were apparently never pursued further.

Ordering of thermodynamic states

An essential element in our entropy definition is the fact that the equilibrium states of a system can be *ordered* according to their mutual *adiabatic accessibility*. This term belongs to an important strand of thought that was pioneered by Carathéodory [13], elaborated by Buchdahl [14], Falk and Jung [15], Giles [16], Landsberg [17], and Backhaus [18]. It culminated in the seminal 1999 paper of Lieb and Yngvason [19] which many consider the “last word” on entropy. A more accessible presentation of their ideas is given in [20].



Lewis Hine, Library of Congress

Figure 1. Children can be ordered according to their size without using a measuring stick

The idea of adiabatic accessibility provides a means for *ordering* the states of a system. Entropy will later be defined so that the states ordered in this manner are arranged in the order of increasing entropy. At the moment, however, we do not assign a number S to a state. As an analogy, we can think of children which can be ordered according to their body size without actually quantifying their size with a meter stick (Figure 1).

Lieb and Yngvason [19] define adiabatic accessibility as follows: “*State A is adiabatically accessible from a state B, in symbols $A \prec B$, if it is possible to change the state from A to B by means of an interaction with some device (which may consist of mechanical and electrical parts as well as auxiliary thermodynamic systems) and a weight, in such a way that the device returns to its initial state at the end of the process whereas the weight may have changed its position in a gravitational field.*”

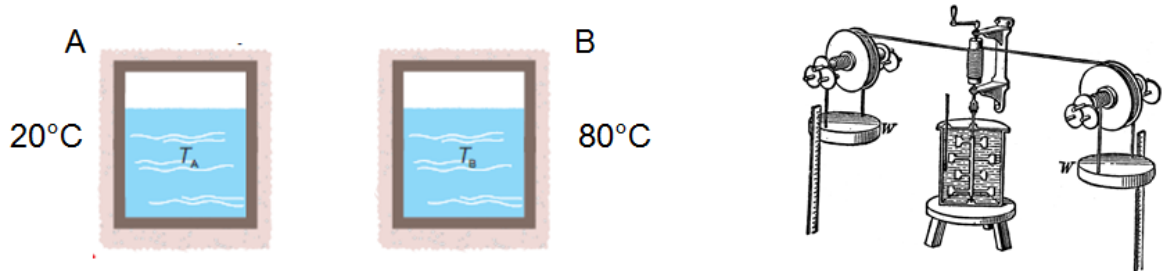

Figure 2. Joule's experiment as an example for adiabatic accessibility

The important point is that the transition from A to B has to be realized without the transfer of heat across the system boundaries – only raising or lowering a weight is allowed. Lieb and Yngvason show that all equilibrium states of a system can be ordered in this way. For any two states, one of the relations $A \prec B$ or $B \prec A$ always holds true. If both are true, the two states are said to be *adiabatically equivalent*. Two states of an ideal gas that are connected by a reversible adiabatic process ($p V^\kappa = \text{const.}$) are an example of the latter case. The ordering induced by adiabatic accessibility is the first step towards entropy: $A \prec B$ implies $S(A) \leq S(B)$. If A and B are adiabatically equivalent, then, by definition, $S(A) = S(B)$.

Two examples

Let us illustrate the concept of adiabatic accessibility with two concrete examples. First consider a system that consists of a vessel with water. In state A, the temperature of the water is 20°C, in state B it is 80°C. It is easy to see that B is adiabatically accessible from A: By lowering a weight, the water in the vessel can be stirred so that the temperature rises (Joule's experiment; Figure 2). On the contrary, nobody has ever found a way to “unstir” the water. It is an experimental fact that it is not possible to reach A from B without the transfer of heat across the system boundaries. Thus, we conclude that $A \prec B$ but not $B \prec A$ and consequently $S(A) < S(B)$.

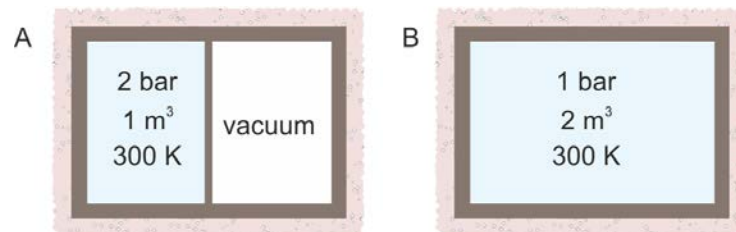

Figure 3. Adiabatic accessibility in the free expansion of a gas

As a second example, consider an ideal gas in a box with a removable partition. The states A and B are defined as indicated in Figure 3. Again, it is easy to adiabatically reach B from A: it is sufficient to remove the partition. However, it is impossible to go from B to A without transferring heat. The use of a piston does not help: Although it is possible to compress the gas adiabatically from 2 m³ to 1 m³, in this process the gas temperature will rise. Thus, even with the help of a piston, A cannot be reached from B without the transfer of heat. Again we conclude that $A \prec B$ but not $B \prec A$ so that $S(A) < S(B)$.

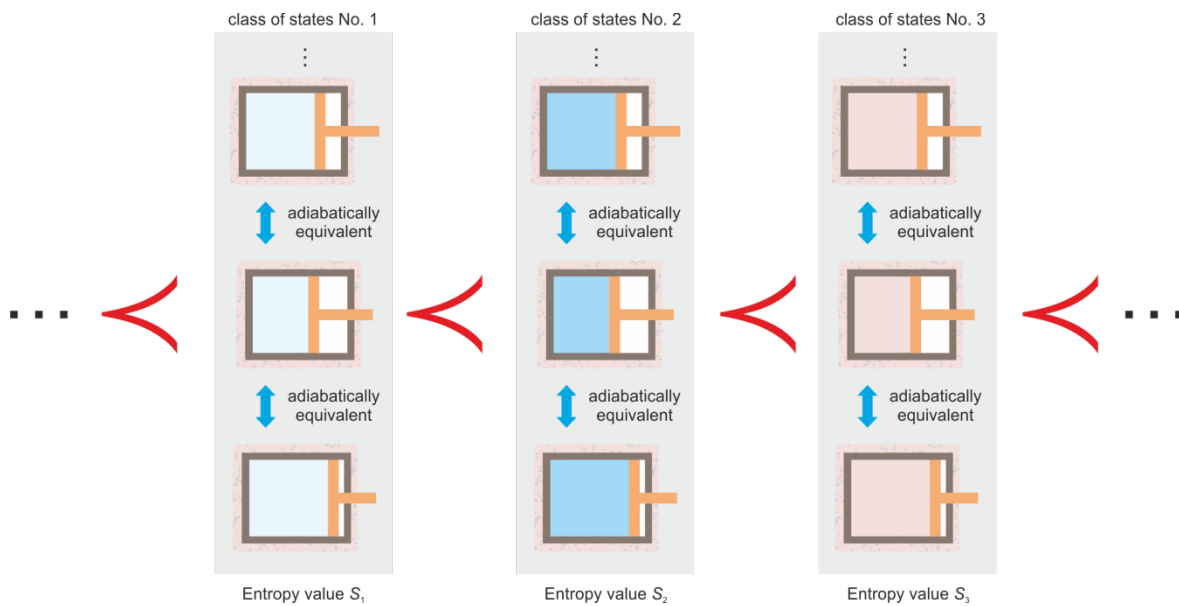

Figure 4. Adiabatic accessibility defines an order relation for classes of system states. To each of the classes, an entropy value S can be assigned.

The quality of energy

The procedure outlined above defines classes of system states (Figure 4). Within each class, the states are adiabatically equivalent (and thus have the same entropy [21]). The classes are ordered according to their relative adiabatic accessibility. The major part of our task is completed with this ordering of states. We only have to assign to any state a number S (the value of the entropy). To do this, we propose a different procedure than Lieb and Yngvason (who determine S by comparing the system in question with scaled copies of two reference systems). In order to facilitate the interpretation of entropy we base our definition on the idea of S representing the quality of energy (one could also use the terms usability or availability of energy). We define this term operationally by the ability to lift a weight as high as possible with a given amount of energy [22].

Let us illustrate the concept with a few examples:

1. Energy stored in a spring is “high-quality energy” – if 10 kJ of energy are stored in the system, all of it can be used to raise the weight with a suitable mechanism.
2. Energy stored in an adiabatically compressed gas is high-quality energy, too. In a reversible adiabatic compression of the gas, all of the work is stored as internal energy, while the temperature of the gas rises. The stored energy can be completely retrieved by the reverse process. This example shows that – contrary to a common belief – “thermal energy” is not *per se* low-quality energy.
3. Heated water in a thermally isolated vessel is an example of lower-quality energy. If the internal energy of the water is increased by 10 kJ (e.g. with an electric heater), it is not possible to use this energy completely for doing work. Even with a heat engine, it is not possible to lift the weight to the same height as in the case of the spring or the compressed gas. The height to which the weight can be lifted depends on a variety of variables, including the temperature of the environment.

In order to describe the “quality of energy” quantitatively, we have to find a way to relate the operational procedure outlined above to the state variables of the system. From the

examples we see that it is reasonable to consider *finite* systems – it doesn't make much sense to ask how high a weight can be raised with the energy stored in an infinite system.

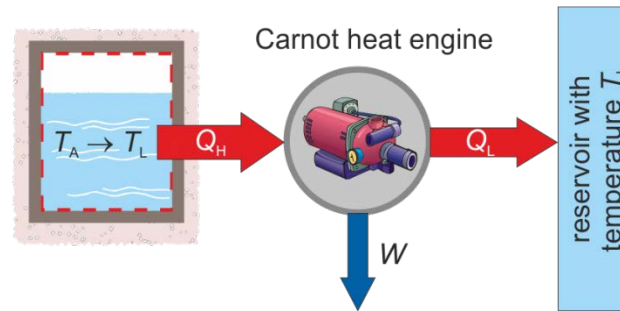

Figure 5. Heat engine with a finite source

Digression: Heat engine with a finite source

Let us analyse Example 3 in more detail. Consider the situation shown in Figure 5. A vessel is filled with water of temperature T_A . The water is used as the high-temperature “reservoir” of a Carnot heat engine. The temperature of the infinitely large low-temperature reservoir is T_L . Because the amount of water in the vessel is finite, it cools down while driving the Carnot engine. The engine ceases to work when the water has cooled to the temperature T_L . We ask: What is the total work output of the Carnot engine while the water in the vessel cools down from T_A to T_L ?

We consider a small portion of the process in which the temperature of the water can be assumed to have a constant temperature T . The portion of the process should comprise an integral number of cycles of the Carnot engine. The work extracted is related to the heat ΔQ_H delivered by the water by:

$$\Delta W = -\eta_{\text{Carnot}} \cdot \Delta Q_H = -\left(1 - \frac{T_L}{T}\right) \cdot \Delta Q_H. \quad (2)$$

While the water gives off the heat ΔQ_H , its temperature changes by ΔT according to $\Delta Q_H = c m \Delta T$, where m is the mass and c the heat capacity of the water. Eq.(2) becomes:

$$\Delta W = -\eta_{\text{Carnot}} \cdot \Delta Q_H = -\left(1 - \frac{T_L}{T}\right) \cdot c \cdot m \cdot \Delta T. \quad (3)$$

The total amount of work done by the Carnot engine while the water cools down is obtained by integrating from T_A to T_L :

$$W_{A \rightarrow L} = -\int_{T_A}^{T_L} \left(1 - \frac{T_L}{T}\right) \cdot c \cdot m \, dT. \quad (4)$$

We obtain:

$$W_{A \rightarrow L} = \Delta U - T_L \cdot \int_{T_L}^{T_A} c \cdot m \frac{dT}{T}, \quad (5)$$

where $\Delta U = c m (T_A - T_L)$ is the difference of the internal energies in the initial and final state of the water. Eq. (5) can be readily interpreted: ΔU is the total energy “stored” in the water. Even with a heat engine, not all of it can be used to do work. The second term is the

“unavailable energy” (often called *anergy*). The percentage of the energy that cannot be used depends not only on the initial temperature of the water but also on the temperature of the environment.

Quality of energy: Incompressible substance

To clarify the concept of quality of energy let us first illustrate what we have *not* in mind. Consider again the two vessels of water shown in Figure 2. Ask an engineer which of the two is the more valuable for the purpose of doing work. Of course he will choose the one with the higher temperature (which also has a higher U). The engineer’s answer is simply a matter of *quantity* (which is governed by the first law). However, the quantity of energy is not our aim – we are interested in *quality*. The question we have asked was too simple.

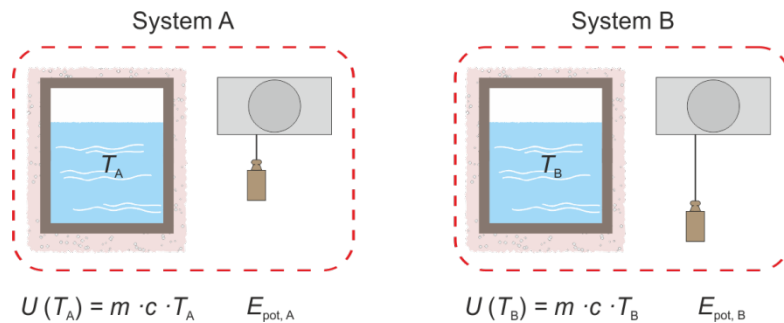

Figure 6. Comparing systems at constant total energy

We have to modify our question slightly to aim at the quality of energy. For the moment, we restrict ourselves to incompressible systems (i.e. liquids or solids). To get rid of any first-law issues, we only compare systems with the same mass and the *same total energy*. Each system is equipped with a weight (Figure 6) which is adjusted so that for all systems under consideration, the sum of internal and potential energy is the same:

$$E_{\text{total}} = U(T_A) + E_{\text{pot, A}} = U(T_B) + E_{\text{pot, B}} \quad (6)$$

Again we ask: Which of the two systems is the more valuable for doing work? Now the engineer’s answer will be different. To extract work from the system, he can now (a) lower the weight and (b) cool down the vessel to the environment temperature T_L with Carnot efficiency. The sum of both contributions has to be compared to assess the quality of the energy stored within each system. While the potential energy of the weight is fully usable, the maximal work output from cooling down the vessel is given by Eq. (5). Adding both contributions, we obtain for system A:

$$\begin{aligned} W_{\text{max}}(\text{A}) &= E_{\text{pot, A}} + W_{\text{A} \rightarrow \text{L}} \\ &= E_{\text{total}} - \cancel{U(T_A)} + \cancel{U(T_A)} - U(T_L) - T_L \cdot \int_{T_L}^{T_A} c \cdot m \frac{dT}{T} \end{aligned} \quad (7)$$

An analogous expression is obtained for system B. Eq. (7) does not look very helpful, because $W_{\text{max}}(\text{A})$ depends on the environment temperature and on the total energy E_{tot} which can be arbitrarily chosen. It is remarkable, however, that the combination

$$\Delta S_{\text{AB}} = \frac{W_{\text{max}}(\text{A}) - W_{\text{max}}(\text{B})}{T_L} = \int_{T_A}^{T_B} c \cdot m \frac{dT}{T} \quad (8)$$

is independent of both. It depends only on the properties of the two states A and B. Thus, it can serve as a measure for comparing the quality of the energy in the two systems. We define the entropy difference for two states of an incompressible substance by Eq. (8). Note that with $dQ = c \cdot m \cdot dT$, this equation can be written in the traditional form:

$$\Delta S_{AB} = \int_{T_A}^{T_B} \frac{dQ}{T}. \quad (9)$$

Defining entropy in general

If we had to deal only with incompressible substances, Eq. (8) would give a satisfactory definition of entropy. However, the whole argument breaks down for gases (or generally, for systems with variable volume). The interpretation of Eq. (8), which rests on comparing the maximal amount of obtainable work, becomes less straightforward if additional work can be done by changing the volume.

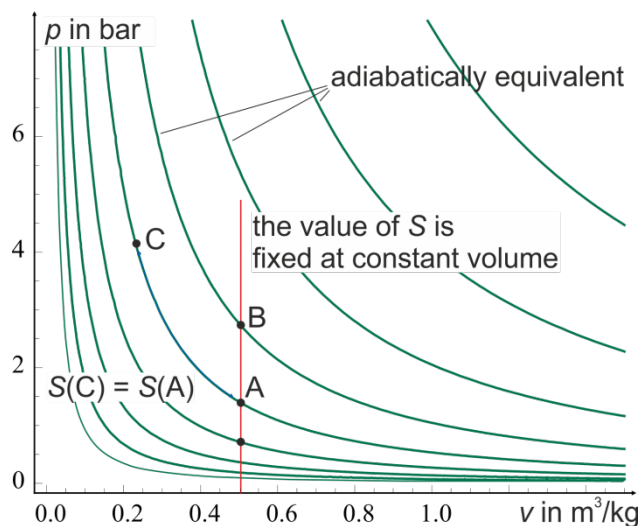

Figure 7. Defining entropy: Example of an ideal gas

At this point, we have to return to the ordering attained by adiabatic accessibility. To be more specific, we consider the case of an ideal gas (Figure 7). Adiabatic curves ($pV^\kappa = \text{const.}$) are shown in green. All states on the same adiabatic curve are adiabatically equivalent and thus have the same entropy. For example: $S(C) = S(A)$. The adiabatic curves represent the equivalence classes of states shown in Figure 4. The crucial point is: It is sufficient to analyze just one state in order to determine the numerical value of S for the whole equivalence class. This observation completes our definition of entropy because with Eq. (8), we can compare two states with the same value of V (red line in Figure 7) and calculate their entropy difference. In this way, a numerical value of S can be attributed to all states belonging to the corresponding equivalence class.

Thus, in order to calculate the entropy difference of the two states B and C in Figure 7, we identify the state A which is adiabatically equivalent to C and has the same volume as B. The entropy difference ΔS_{AB} can be determined with Eq. (8), while A and C have the same entropy.

Because, by definition, A and C are connected by an adiabatic process ($Q = 0$), we arrive at the well-known formula:

$$\Delta S_{CB} = \int_{T_c}^{T_B} \frac{dQ}{T}. \quad (10)$$

The argument not only holds for gases, but for simple thermodynamic systems in general. It is not necessary to prove that the integral in Eq. (10) is path independent so that S is a state variable. This result is guaranteed by the existence of an order relation because the position of the state within the order is already a property of the state. Eq. (10) just quantifies this property.

Conclusion

We have shown that entropy can be interpreted as the quality of energy by giving an operational definition that leads to the same mathematical expression as the traditional approach. We hope that this line of reasoning makes it easier for students to develop an intuitive feeling for this central concept in thermodynamics. We do not pretend that by using our approach, entropy suddenly becomes an “easy” subject. However, students can now assign a physical interpretation to an otherwise fairly abstract concept. We are planning empirical studies that will show whether the approach proposed in this paper leads to an improved understanding of thermodynamics.

With the “quality of energy” approach, not only the definition of entropy but also the second law can be consistently interpreted. Entropy is a non-conserved quantity: It can cross the system boundaries, but it can also be created by irreversible processes within the system. The generation of entropy corresponds to lowering the quality of the system’s energy. Often, the term “degradation of energy” is used to describe this process. Thus, our interpretation of entropy facilitates a discussion of the second law that focuses on this aspect.

References

- [1] Kesidou S., Duit R.: Students' conceptions of the second law of thermodynamics — an interpretive study. *Journal of Research in Science Teaching* 30 (1993), p. 85 – 106.
- [2] Cochran M. J., Heron P. R.: Development and assessment of research-based tutorials on heat engines and the second law of thermodynamics. *Am. J. Phys.*, 74 (2006), p.734 – 741.
- [3] Christensen W. M., Meltzer D. E., Ogilvie C. A.: Student ideas regarding entropy and the second law of thermodynamics in an introductory physics course. *Am. J. Phys.* 77 (2009), p. 907 – 917.
- [4] Bucy B. R.: Investigations of student understanding of entropy and of mixed second-order partial derivatives in upper-level thermodynamics, doctoral dissertation, U. Maine (2007).
- [5] Loverude M. E.: They still remember what I never taught them: Student understanding of entropy. *AIP Conference Proceedings*, Vol. 1513 (2013), p. 266 – 269.
- [6] Baierlein R.: Entropy and the second law: A pedagogical alternative. *American Journal of Physics*, 62 (1994), p. 15 – 25.

- [7] Reif F.: Thermal physics in the introductory physics course: Why and how to teach it from a unified atomic perspective. *Am J. Phys* 67 (1999), 1051 – 1062.
- [8] Styer D. F.: Insight into entropy. *Am. J. Phys.* 68 (2000), p. 1090 – 1096.
- [9] Leff H. S.: Thermodynamic entropy: The spreading and sharing of energy. *Am. J. Phys.* 64 (1996), p. 1261 – 1271.
- [10] Lambert F. L.: Entropy is simple, qualitatively. *Journal of chemical education*, 79 (2002), p. 1241 – 1246.
- [11] Goodenough G. A.: *Principles of thermodynamics*, 3rd Edition, New York: Holt (1920). Available from: <http://www.archive.org/details/cu31924004617167>
- [12] Klein J. F.: *Physical Significance of Entropy or of the Second Law* (1910). Available from: <http://archive.org/details/physicallsignific00kleirich>
- [13] Carathéodory C.: Untersuchungen über die Grundlagen der Thermodynamik. *Mathematische Annalen*, 67 (1909), p. 355 – 386.
- [14] Buchdahl H. A.: A formal treatment of the consequences of the second law of thermodynamics in Carathéodory's formulation. *Zeitschrift für Physik*, 152 (1958), p. 425 – 439.
- [15] Falk G., Jung H.: *Axiomatik der Thermodynamik*. In: Flügge S. (Ed.): *Handbuch der Physik*. Bd. III/2 Springer, Berlin (1959).
- [16] Giles R.: *Mathematical foundations of thermodynamics*. Oxford: Pergamon Press (1964).
- [17] Landsberg P. T.: Main ideas in the axiomatics of thermodynamics, *Pure and Applied Chemistry* 22 (1970), p. 215 – 228.
- [18] Backhaus U.: *Die Entropie als Größe zur Beschreibung der Unumkehrbarkeit von Vorgängen*. Dissertation, Universität Osnabrück (1982).
- [19] Lieb E. H., Yngvason J.: The physics and mathematics of the second law of thermodynamics. *Physics Reports*, 310 (1999), p. 1 – 96.
- [20] Thess A.: *The Entropy Principle. Thermodynamics for the Unsatisfied*. Heidelberg: Springer (2011).
- [21] More precisely, adiabatic accessibility orders the states according to their entropy per unit mass or specific entropy $s = S/m$.
- [22] For brevity, we use the term “work” to denote energy that can be used to lift a weight. It is known that many students have difficulties with the concept of work. Alternative expressions would be “available energy” or “generally usable energy”.

Searching for models and guideline for effective Teaching-Learning using investigation and peer education

Susanna Occhipinti

Regional board of education – Autonomous Region of Aosta Valley – Italy;
PhD - School of Science and Technology, Geology division University of
Camerino- Italy

Abstract

This research presents the Expo-Laboratory, which is a learning path of several exhibits proposed each year in Aosta Valley (Italy), dealing each year with a different topic. This exhibit is addressed to the students of all the levels of education: its aim is to present theoretical definitions together with virtual examples which are implemented through simple tools in order to be easily repeatable. These proposed experiments require different levels of expertise according to the level of education of the different students (i.e. from kindergarten to high school). In 2013, at its tenth edition, the Expo-Laboratory was entitled "Exploring Energy and its transformations: from flint to renewable energies". This topic is particularly important to the scholars in Italy due to the fact that the Italian Ministry of Education requires that a student at the end of the compulsory education must be able "to analyze qualitatively and quantitatively phenomena related to the transformation of energy from the experience". The 2013 Expo-Laboratory included about 30 exhibits concerning several types of energy: mechanical, chemical, thermal, biological, nuclear, and renewable energy.

Within the Expo-Laboratory learning path are presented problem-situations and cases which need to be solved by the students that have to be able to perform simple connections of cause and effect, with the aim of promoting scientific investigation.

Each activity of the exhibit is presented by a student of the secondary level of education to all the visiting students, using peer education approach. With this approach, the presenting student needs to know what are the theoretical contents of the laboratory and the correct scientific language suitable to the target of the audience. Moreover, this presenting student must also learn how to organize the laboratory in order to perform an effective lesson. This experience provides several new skills to the presenting students: i) they become aware of the fact that to provide an effective communication in the scientific field, it is required to deeply know the subject of the lesson; ii) they learn how to attract and retain the attention of the classes, if they are not fully involved.

The goal of the peer education approach is to build a shared knowledge among all the students and to stimulate both passion and students' interest in the field of physics. The evaluation questionnaires provided at the end of the Expo-Laboratory experience proves that such goals have been achieved.

Keywords: Expo-lab, problem based learning, peer to peer

Introduction

The well known lack of interest of young people towards science, particularly related to the educational approach is at the centre of our work. As requested by the Rocard report, [12] our effort aims to improve hands-on activities, inquiry approach, and problem based learning within the teaching process.

Then, the objective of our research is to share instruments, tools, and primarily educational approaches among science teachers. Moreover, we aim at spreading the interest towards science education in our schools of the Aosta Valley (in the north west of Italy) involving our working group of science teachers.

Our effort is now to open our positive experience to other contests, to improve our repertory of instruments and, if possible, to compare different approaches.

This is the reason why, even if we are not specialized in physic sciences, we are glad to be positively welcomed in this international congress, with the aim to offer our experience, as well as to exchange opportunity in Science.

Our problems are the same that in many other contest: i) the laboratories, which are not always present in the schools, are scarcely furnished or are furnished with obsolete laboratory equipments. ii) There is a lack of technical support. iii) Teachers are not strong familiar with teaching approaches that have to be used within a laboratory. This short analysis comes directly from data collected by different sources [10] is clearly showed that Italy is the first country over 24 considered where direct transmission beliefs overcome constructivist beliefs.

In [14] is shown that in the 76% of schools the most widely used method is the frontal lecture, while group work does not exceed 17%, the individualized paths is used in the 25.8% of cases. The teaching workshop method is used in the 18.3%, while peer education only in the 6.3%. This analysis comprised 4436 primary schools and colleges with more than 60,000 classes involved.

Thanks to a personal experience in international Olympiads (particularly International Olympiad of Earth Science) it was possible to analyze the involved countries and the numbers of won awards by each country. Data were summarized in a “qualitative” histogram which is useful to understand that the most important factors of result in science subjects and competitions are the motivation of participants and the competence of the teachers. In particular, it is important for the teachers to attend a training period in a university, where they can acquire knowledge, they can learn how to work in a laboratory and how to use effective educational approaches.

The international community [7-9] is now realizing that new approaches are needed to fascinate the student and to make them more involved with the subject. These new teaching methods require the students to inquire and to discover the different subjects, in order to provide them solid skills. Moreover, in order to effectively use such new teaching approaches, teachers have to be highly competent in the field, certainly more than in a normal frontal lecture.

It is well known that knowing about a topic does not mean automatically be able to teach it. In fact, even simple hands-on activities require the organization of an educational path. It is important that the laboratory activities are properly structured so that is possible to transform the traditional presentation from the teacher or, even worse, by the school technician, in an activity involving the whole class group.

We have realized with the teachers involved in this project that it is difficult to switch from the typical transmissive-deductive approach, where the teachers have a central role, to the inductive-active approach, which is more student-centered. Within this inductive-active approach, the teacher loses his central place, but he keeps his role of conductor [5-11]. The teacher is no longer the holder of the power of knowledge, he plays a key role as

a mediator, and when necessary he takes again the command of the boat. What it is proved is that a student-centered approach requires time, patience, trial and error, and especially coaching and sharing.

The Regional Science Centre

Then we started to work on the easiest front: we decided to organize a central lab, located in a technical school (the I.S. Corrado Gex, in Aosta). This lab had to be well equipped with all instruments and tools necessary for the teaching/learning in all fields of sciences: Biology-biotechnology, Earth sciences, Physics and Chemistry in all levels of education. This choice was necessary because the schools in Aosta Valley, from primary, and even kindergarten, to high schools are speared all over the region, even in small villages up on mountains.

It was even amusing, manufacture those “learning objects” that, based on our personal experience as teachers, we think could be useful, even necessary to explain different scientific subjects.

The biggest challenge was on Earth science and geophysics, where the Author is involved in a PhD in Educational approaches in Camerino University - Italy, because of the lack of educational tools in the common teaching culture in this field. In fact, in the Earth science and geophysics field, teachers have a weak competence. Moreover, the general idea is that Earth science is mainly based on “stones and catastrophes”. On the contrary many useful and effective tools open our schools and our students to a new idea of Earth Science, developing a sensitivity towards the exploitation of the landscape and a new acquired respects towards natural phenomena and, accordingly, on natural risks and hazards. For the Expo-Laboratory, were built more than 150 activities every year, in the different fields of science. These materials were, when possible, organized in transportable kits which were necessary to bring them up in the smallest schools.

The idea was not to replace teachers, but to work alongside them, and to make them understand the possibilities of the proposed kits or approach paths.

Each year, more and more teachers were involved in the project. Nonetheless, we realized that we needed a theoretical support to the model of the teaching approach that we wanted to use, which was centered on inquiry and on the Problem Based Learning (PBL) approach [6]. The PBL approach allows students to work on a progressive growth of competence, based on a Driving question. For this reason, we decided to send our application to became, as Regional Science Centre, twin centre 3 in the Fibonacci project. This project of the European FP7 was promoting an increasing network with the aim of sharing and providing effective know-how transfer at European level that requires a dissemination model based on a systematic approach of IBSE at grassroots level ensured by intermediary structures (universities, teachers training centre, research institutions...) with successful experience in local IBSE implementation. The project, now concluded, involved 60 centre of excellence, only two in Italy, and allowed us to meet and exchange experiences and instruments, particularly with the LUB – University in Bruxelles.

The next step requested to inform teachers of the existence of scientific materials, available to them in the Regional Science Centre. Then it was necessary to explain to the teachers how the materials of the Regional Science Centre could be used and especially it was important to explain why the PBL approach could be more effective.

A useful instrument was represented by a working booklet where several practical activities were collected and explained. For each scientific field exists a different working

booklet which is freely downloadable from the official website of the regional structure supporting teachers work [13]. For example the booklet called “*Accadueò*” contains several activities related with water, the one called “*Paramecio*” regards the Biology, “*Accacielle*” contains the activities about Chemistry, while “*Viaggio al centro della Terra*” is about Earth science. Every booklet contains from fifty to seventy activities, structured in clear and easy scientific protocols, each activity requiring specific expertise, goals and skills. The working booklet on physics is now in progress.

The Expo-Laboratory

Our best results were obtained thank to the Expo-Laboratory (or Expo-Lab), an interesting and effective educational instrument, which is particularly effective to share materials and approaches. Our Expo-Lab, in the last ten years, involved nearly all the schools of all levels of educations, all over the Region. The Expo-Lab is realized with 15 positions each of which contains a certain numbers of activities, centered on a particular subject, i.e. those proposed by UNESCO, such as Earth’s Health or Darwin year.

This year the choice fell on Energy, “From flint to renewable energies”. Energy is a subject that involves different educational disciplines, for this reason the Expo-Lab was opened to contributions of local facilities, such as the Regional Centre for renewable energies, or the Astronomic Observatory in St. Barthélemy, or the Regional Office for environmental protection.

The proposed labs were organized in a logical path, composed by several steps with different contents. The path shows the different types of energy (i.e. mechanical, chemical, thermal, biological, nuclear, and renewable energy) using gadgets and everyday objects or models built, where the students learn to distinguish and recognize these different types of energy. It also shows the different properties (e.g. energy transformations, energy conservation) through traditional experiments of physics, such as Wan der Graaf Generator, Wimshurts discs, Newton's cradle, or simple demonstrations in which they must recognize the different transformations. In the activities of the Expo-Lab are proposed problem situations and cases to solve, even with simple connections of cause and effect, to promote the investigation.

What we needed was a kit of useful instruments, enough robust but not trivial to be used direct by the students.

Particularly amusing was the building of 3D model for a dam, transforming potential energy into light energy, passing through kinetic, mechanic, hydroelectric, electric, and magnetic energy. Figure 1 shows three different steps of the building process for the model of the dam. Others 3D models was constructed: for a volcano, with the aim of explaining geothermal energy and a model for a “risky valley”.



Figure 1. Building a dam

All the materials of the exhibition serve to further increase the amount of practical activities of the Science Centre and are themselves kit for the creation of interactive lessons in schools. In Figure 2 are shown two different activities of the Expo-Lab where students are teaching to other students.

The Expo-Lab is peculiar for many technical and educational aspects. For example, it changes from four to six different locations to be reached by all the schools, even the small schools of mountain villages.

Outcomes of the Expo-Laboratory

It was thanks to the Expo-Lab that some years ago we started to investigate new educational approaches, since our working group was well impressed by the effectiveness of the instruments involved in our Expo-Lab.

The educational path within the Expo-Lab is always presented to visiting groups by students generally belonging to Colleges or high schools, which explains contents and instruments in a peer educational approach. We could appreciate sometimes a deep change in the behavior of students, becoming more responsible, more respectful of rules, understanding what it means speaking while others are not listening because not careful or chatting with their friends.

We also observed weak students becoming stronger because realizing that they were able to face a new challenge: they become protagonists, responsible, and committed.

The result has been a significant increase in the involvement, in the awareness, and also in the disciplinary skills of the students.

Thanks to the Fibonacci project experience, we decided to follow a note of the Italian Ministry of Education, [d.l. 6/2000] which aims to support and to spread educational culture, in the schools and within the public. The project was on “The Science Centre of Aosta: a mobile laboratory for an active teaching-schools, teachers, and materials in a network”, and we obtained founding, with the aim of supporting a working group, to produce educational kits, dedicated this year to Energy, and the next one to “unexpected connections in the regional landscape”.



Figure 2. Peer to peer: involving and amusing

This found prompted us to go deeper on educational approaches, as we were particularly interested in inquiry, on which we have been working for the last two-three years, as the inductive approach was developed in various teachers' training. But we have discovered more recently the effectiveness of the PBL, the approach based on the abduction, that allow students to work on a progressive growth of competence, based on a Driving question, necessary to promote first, the desire to investigate, the curiosity, then the skills necessary to find the right answer.

Students find the work more meaningful if they conduct a real inquiry.

Finally we discovered that sometimes it is not possible to find only one right answer, that science is not always absolute, which is the core of Nature of science theory, so charming because revolutionizes the traditional scientific method by opening to new and exciting hypothesis. Nothing is sure, so we can again question old and new theories, and carefully evaluate which ones can really be questioned, and those that are certainties, axioms.

We are now facing a new problem: students presenting the expo lab are generally proud of their role, then they try to present everything they know, even their personal research on the subject that they had to present. Then it is very difficult trying to promote PBL, or at least the inquiry approach, that needs to leave the centre of the action to visiting public. It is evident that the model that they use is directly derived from their daily model: their teachers and the frontal lecture.

For future works, we are now collecting data about the result that it is possible to obtain by using different education approaches. A problem for this comparison is that it is very difficult to compare different contents, classes, approaches, but we are working seriously in that direction.

References

- [1] Bybee R.W., DeBoer G.E.: Research on Goals for the Science Curriculum, 1994.
- [2] Committee on Science Learning: Taking Science to School: Learning and Teaching Science in Grades K-8 - Kindergarten through Eighth Grade, 2007.
- [3] European Commission, Europe needs More Scientists: Report by the High Level Group on Increasing Human Resources for Science and Technology, (2007), [online]. Available from: http://ec.europa.eu/research/conferences/2004/sciprof/pdf/final_en.pdf
- [4] Directorate General Education and Culture, Eurydice: Key Data on Education in Europe, 2005.
- [5] Hmelo-Silver C.E.: Problem-based learning: What and how do students learn? Educational Psychology Review, 2004.
- [6] MIUR: Indicazioni ministeriali Nuovi licei da “Revisione dell’assetto ordinamentale, organizzativo e didattico dei licei ai sensi dell’articolo 64, comma 4, del decreto legge 25 giugno 2008, n. 112, convertito dalla legge 6 agosto 2008, n. 133.
- [7] Nuffield Foundation: Science Education in Europe: Critical Reflections, 2006.
- [8] OECD: PISA - Technical report Valutare le competenze in scienze, lettura e matematica, 2006.
- [9] OECD: TALIS, Creating Effective Teaching and Learning Environments, 2008.
- [10] OCSE, Country profiles of beliefs about the nature of teaching and learning - 2007-08 (11).
- [11] Osborne J. F., Simon S., Collins S.: Attitudes towards Science: A review of the literature and its implications. International Journal of Science Education, 2003.
- [12] European Commission, Science education NOW: A Renewed Pedagogy for the Future of Europe, (2007), [online]. [cit. 15. 1. 2010]. Available from: http://ec.europa.eu/research/science-society/document_library/pdf_06/report-rocard-on-science-education_en.pdf
- [13] Official website of science education in Aosta Valley: <http://www.scuole.vda.it/scienze/index.php/quaderni-di-lavoro>.
- [14] Italian Minister of Education: “Esiti del monitoraggio sulle indicazioni” art.1 c.4 DPR 89/2009, 2012.

Experiments with CanSat

Mária Pető

Székely Mikó High School, Romania

Abstract

Spaces researches, satellites, speed of the light are all notions that are interesting to almost everyone but they seem to be very distant and inaccessible. However, this is just the appearance because even the 9th or 10th grade students' knowledge, curiosity, fantasy and inquisitive attitude are enough to bring these notions closer in the classroom.

This presentation is meant to show a measuring device, a measuring and a data processing technique, which allow the expansion and development of knowledge on thermodynamics and electricity on a high school level in a completely new environment with the help of a new unit called „CanSat”. The aim of the technique is to form skills and competences which allow students to solve scientific tasks, to do individual research and raises their interest in natural science.

Keywords: CanSat, speed of the light, measurement, pollution, arduino, atmosphere, outdoor activities

Introduction

Thermodynamics and electricity are part of the 10th grade physics curriculum in Romania, and they offer many opportunities to try new ways of teaching. In the course of the last school year during the activities of the Science Club together with my students I built a mini satellite called “CanSat”. With this satellite our “Bolyai”- team participated in the **2012 European CanSat** competition held by ESA (European Space Agency) and NAROM (Norwegian Centre for Space-related Education). This device is similar to a real satellite, but it must fit inside a 330 ml soda can. On the day of the launch campaign at Andoya Rocket center the CanSat was delivered by an “Intruder” rocket up to a height of 1 km and then was dropped off. During the descent we made certain measurements, like: temperature, pressure, dust and solid particle density in the atmosphere.

For me, this competition was the first step towards trying new methods in the classroom activities during thermodynamics and electricity. The results obtained and student's inquisitive attitude motivated me to continue this project with other measuring tasks, in different environment and more improved devices. In this context this school year we measured the speed of the radio waves in the air and tried to find the connection existing between the speed of propagation and atmospheric parameters.

In this paper I will present this experiments and Science Club activities.

The CanSat project

At the beginning of the project my students did not learn much (only basic concepts) about atmosphere parameters, measuring techniques of pressure, pollution, electronic circuits, etc., therefore the pre-research phase of our work consisted of mainly documentation.

After this we chose two scientific missions: to measure the pressure, air temperature, humidity and the air quality by detecting the dust particles in the proximity of our CanSat with an optical dust sensor.

We chose to measure dust density since we know that our region (being situated near Brasov city) is highly polluted, the density of dust is very concerned in the atmosphere. Our main goal was to form a proper image of the situation and therefore to increase public awareness of this issue. We proved that in our region in different meteorological conditions the air pollution is considerable. In my opinion, protecting the environment and establishing an environmental education, behaviour are possible only if we are aware how we harm it.

With our device we measured the PM10 ($< 10 \mu\text{m}$) and PM2,5 ($< 2,5 \mu\text{m}$) air pollution. The PM10 could be: cadmium, Cu, Ni, Zn, Mo, Pb, etc. The PM2,5 is very dangerous because it is not well known and viruses, fungus spores, and other toxic substances can easily attach themselves to it. According to the National Institute of Environmental Health, to the inhaled dust particles often bacteria, viruses, fungus spores, and other toxic substances are attached to the PM2,5 helping them enter the body and organism. Possible health effects are: eye conjunctivitis, irritation of the upper respiratory tract's mucous membranes; it may cause coughing, difficulties in breathing and other diseases after it is absorbed by the lungs.

We started the construction phase with developing the primary CanSat kit in such a manner that it would be able to measure air temperature and pressure, altogether with dust density (in equal periods of time). The measurement would take place after having been launched and deployed from an Intruder type rocket until the point when it touches the ground. The device is to descend at approximately 5-8 m/s from an altitude of 1km. The cansats main recovery system was planned to be a parachute, which will enable it to land safely. When designing the parachute we took into consideration all the data about the rocket, which we were provided by ESA and NAROM: gravitational influences, the forces that occur during descent and the CanSat aerodynamic characteristics. Having all these data, we made calculations and designed more parachutes so that the device would land at a proper speed. The outer shell was made of special steel, which is quite light, but resistant and also flexible enough.

The next step was to calibrate the sensors and test them, at a height of about 100-500 meters. The dust and pressure sensors have also been calibrated. We visited the local station of the National Agency for Protecting the Environment (ANPM) and there we managed to obtain the data necessary for calibrating the two sensors. This was tested and it proved to be most appropriate. We established a radio connection between the CanSat and the ground station. We stored all the received data in a text file using an appropriate programme developed by the students.

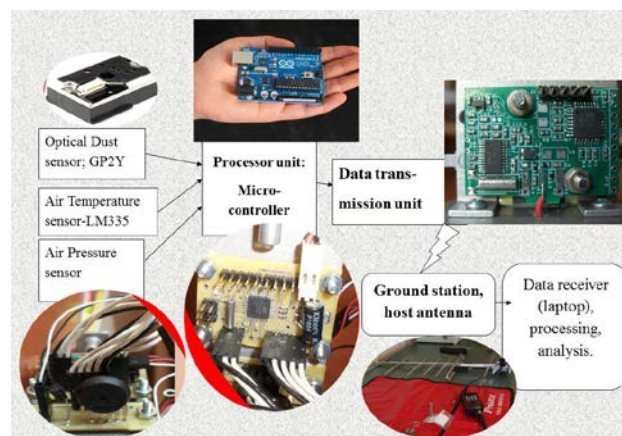

Figure 1. The block diagram of CanSat

This block diagram of device shows his parts:

- a Philips LM 335 temperature sensor; sensitivity 10mV/Celsius degree
- Optical Dust sensor type SHARP GP2Y1010AU0F. The sensor detects the amount of light reflected from particles in the air. It contains some infrared LEDs and optical lenses arranged so that the light emitted by the emitter LED irradiates the pollution particles (PM10 and PM2.5) and it is reflected to the light receiving elements.
- Pressure sensor (5V DC, sensitivity 45,9 mV/kPa);
- Battery: Type: alkaline; Voltage: 9V; Capacity: 500 mAh
- Microcontroller, Software: We used the Arduino development environment (based on Processing) and the Arduino programming language (an open-source programming framework for microcontrollers).
- Radio transmission unit, connection with the ground station by an antenna; frequency of 434.150 MHz.

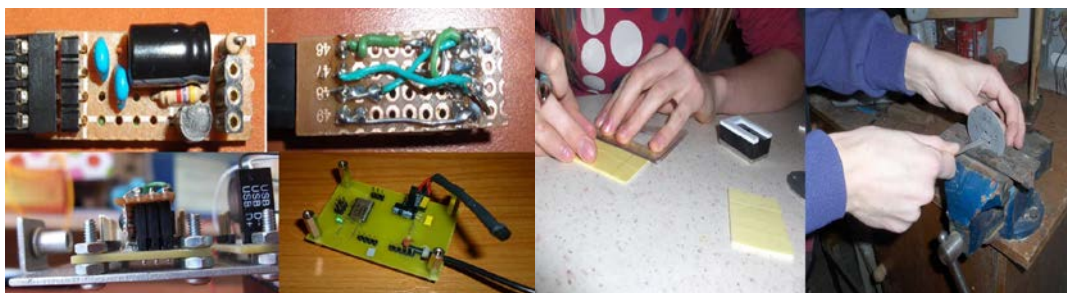

Figure 2. Build the internal circuits of CanSat

A small equipment was attached to the Arduino board in order to work with our sensors correctly. We put a filter capacitor after the stabilizer in order to smooth the pulsating DC power. This additional equipment was necessary for the optical dust sensor according to its data sheet. In order to ensure that the air will flow through the CanSat, four little holes are drilled into the top of the cover.

We created the database and we tested data import and enquiries using the measurements logged in text files, which we received during the tests. After the launch campaign we transferred all the data in our Acces database to an SQL database and created a webpage where everyone had acces to our results.

CanSat post – flight data analysis

The European CanSat2012 took place at Andoya Rocket Range (Norway 70⁰ N, 16⁰ E). On the day of the launch campaign the cansat was delivered by an “Intruder” rocket (1.5 m length, 3,3 kg weight, maximum speed 550 km/h and acceleration 11G) up to a height of 1 km and then was dropped off. At 1 km altitude the rocket deployed the cansat kit, and the devices landed on the ground with (5-8) m/s speed. During the descent we made certain measurements, like: temperature, pressure, dust and solid particle density in the atmosphere. We received all the radio packages which were sent from the cansat until the landing, and all the data we got were sensible to be able to logically explain. Due to these reasons, we consider our mission a full success, as far as temperature, air pressure and dust density data is considered. Throughout the descent we received a total of 216 readings, which were analyzed with Microsoft Access and Excel programs.

After we processed the data we got the following diagrams for temperature and pressure.

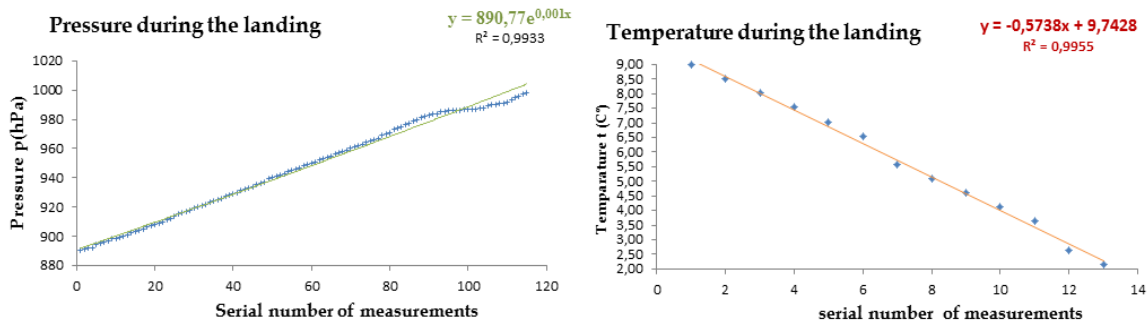

Figure 3. Pressure and temperature measured with CanSat during the landing

These values show that the **temperature decreased according to the gradient law** because the diagram is almost linear.

$$0,65 \text{ } ^\circ\text{C}/100 \text{ m}; \quad \text{grad } T \sim \text{grad}T_z = dT/dz \sim \Delta T/\Delta z \quad (1)$$

When analysing the obtained data we observed an interesting fact: the air located at the altitude of 1 km was warmer than the one near the surface of the Earth. The explanation is the phenomenon of temperature inversion. According to weather forecasts for Andoya the temperature measured near the ground (last measurements) are right, which also proves that our measurements were correct and precise.

The readings from the pressure sensor were in agreement with **barometric formula** (an exponential curve), where z stands for the altitude. We estimated the max. altitude of the rocket to be about 930 metres.

$$p = p_0 e^{-\frac{gH}{RT}} \quad (2)$$

Our secondary mission objective was to determine if there exists a certain variation pattern in the readings. Unfortunately, we couldn't detect any, but we still consider this mission succesful as well, since the data received were correct. During the cansat landing our optical sensor detected all particles in the air that reflect the infrared waves.

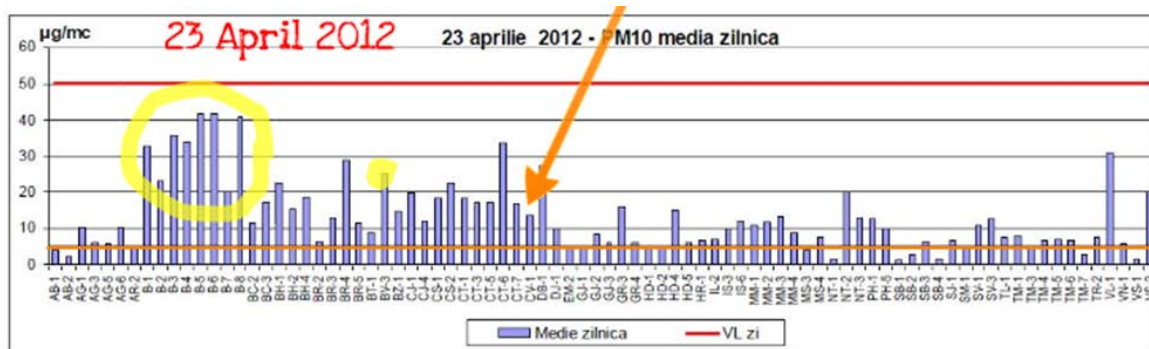

Figure 4. Air pollution in Romania at the launch day; PM10 dust pollution is concerned in the main industrial regions and big towns.

The red line marks the $50 \mu\text{g}/\text{m}^3$ air pollution limit, the orange line the average of our measurements (about $6 \mu\text{g}/\text{m}^3$). The circled readings are from Bucharest, our country's capital city, yellow dot – Brasov, whereas the arrow shows the reading for our town, Saint George.

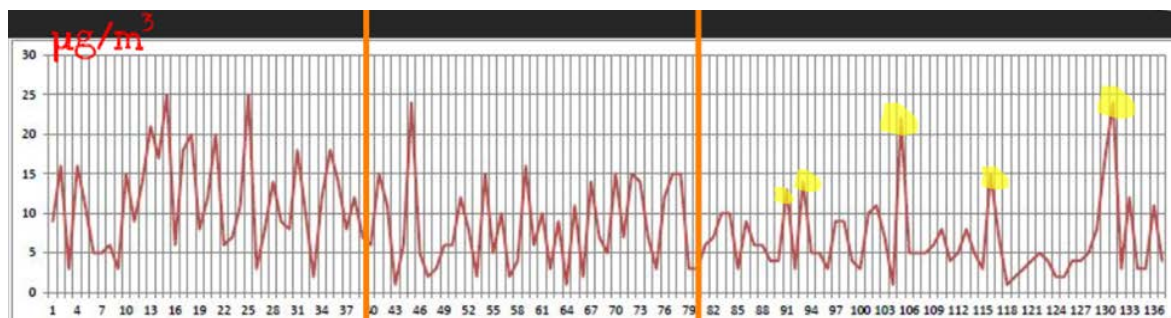

Figure 5. Air pollution at Andoya measured with the cansat PM10-2,5 ($\mu\text{g}/\text{m}^3$)

The graph above shows all our dust measurements, without any filtering. The extremely high values can be explained with our sensor's characteristics, so in order to work properly the particle density in the measuring zone should be constant for at least 5 microseconds, which in our case of course didn't happen because of the descent and the strong winds. In conclusion, we can say that Andoya is not affected by dust and solid particle pollution (is located near the sea, and has very limited car traffic).

After the European CanSat2012 contest we continued the measurements in the school yard, science lab and Science Club on several occasions. The measurement technique and data processing helped my students to understand better the basic notions of thermodynamics and air characteristics.

Measuring the speed of the light

To measure the speed of the light in the air we combine our cansat device with a handheld emitter-receptor device which is suitable for the direct estimation of the velocity of radio-waves. For this project we collaborated with the Physics Department of the Babes-Bolyai University Cluj Napoca. Our goal was to estimate the speed of the 433 MHz's frequency radio waves in the air and demonstrate the existing correlation between the air pressure, temperature, humidity and this velocity.

Romanian Physics curricula teach basic notions of special relativity in the final school year (12th grade) for students who learn at math-science classes. For this part of physics are allocated 9 hours, which include the Einstein postulates, Lorentz transformations and relativistic kinematics and dynamic. So during the normal class activity we had no time for special tasks, lab experiments, etc. Our measurements which could also be performed in the school yard, were able to help students understand better the scientific measuring method and the fact that the value of speed of the light is independent from reference frame hold. Due to this fact the value of this speed is extremely large ($c=3 \cdot 10^8$ m/s), it is quite difficult to measure directly because the reaction time of electronic devices is very slow in comparison with this value. So it needs to fit the measuring device for this condition but for learning value also it is very important that the device could be made by students with low budget in the school lab.

Our device is a simple walkie-talkie system which is appropriate for obtaining the speed of electromagnetic waves in air by the flight of time method for a direct estimation combined with the cansat to measuring the atmosphere parameters (pressure, temperature, humidity).



Figure 6. Measuring device for the speed of the light

Two simple emitter-receiver (ER) devices were built based on transceiver chips. The basic component of the ERs is a cheap integrated circuit, type RFM12BP. This element is perfect for being used in simple experiments for direct time measurement, and it is suitable both for sending and receiving data. So the same circuit is fitted for ER1 and ER2. ER1 is connected to the computers (we used two laptops) USB port, these send continuously the measured time-lag data on the frequencies: 433 MHz. [1].

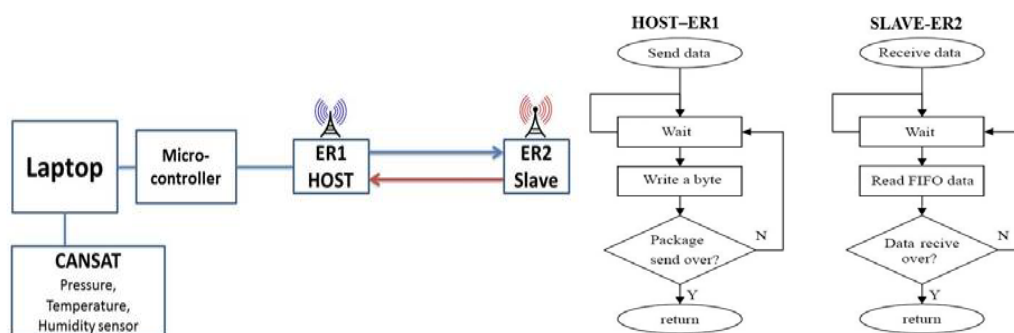

Figure 7. Block diagram of the measuring system. Emitter/Receiver protocol [5,6]

The ER1 (which is connected to the computer, named host) sends successive packages to the other, like ER2 (named slave). After ER2 detects the first package coming from ER1, it responds with another 1 byte length signal data package. If the first response package returns to ER1, it records the time elapsed between the original package and the response with a $1/8 \mu s$ accuracy. The received and recorded time is sent than to the laptop, where it is registered. If the ER1 doesn't detect the first response package, it will emit a second signal package. With the settings of the microcontroller we could define the functions of the ERs, which is the host – emitter and which is the slave-receiver.

The ERs are running a program written in C++, which commands their communication. The algorithmic representation of their communication is sketched below in Figure 7.

This is a simple operation protocol: ER1 sends a signal, and starts the clock. If this signal reaches ER2, then ER2 responds with another 1 byte length signal. When the response signal reaches to ER1, this stops the clock, writes the elapsed time to a file on the attached computer, and sends another signal, starting the clock again. During every 20 minute measurement, for a fixed position of ER2, we recorded continuously 35-40000 flight time

data. To improve the speed results we measured many flight times for fixed positions of slave ER, on different places near our town and analyzed them statistically.

Experiment

We started our measurements in the school yard. With this measurement we wanted to calibrate the device. We put the two ERs at 100-110 meter distance, installed the microcontrollers, cansat sensors and power suppliers. For the first setting we collected data 30 minutes, after than we moved closer the ER2 and restarted the flight time measurements again for 30 minutes. We repeat this procedure for 4 different positions of ERs.

The second and the third measurement days were in open-air, at a camp near our town. The team was divided in two groups. The first group determined the position of ER2, installed the power supply for this unit. During the measurement this unit would be moved to different positions regard the ER1. The other group would install the sensor, microcontroller, Arduino – board, run the data collector programmes. For the first measurement the distance between ER1 and ER2 were nearly 1 km, after 20 minutes we moved closer the ER2. So, we recorded data from 5 different distances for more than 100 minutes, this means more than two hundred thousand data.



Figure 8. The Science Club team measuring the speed of the light

We processed roughly 30000 different measuring results for each particular distance. The challenge was to separate the real, finite spread-time of the electromagnetic waves from the electronic delay of the ER device. Assuming that the average delay on the ERs is same every time (we compared numerous graphs plotted with the recorded data), differences between the real flight times help us determine the velocity of the radio waves from the different distance measurement.

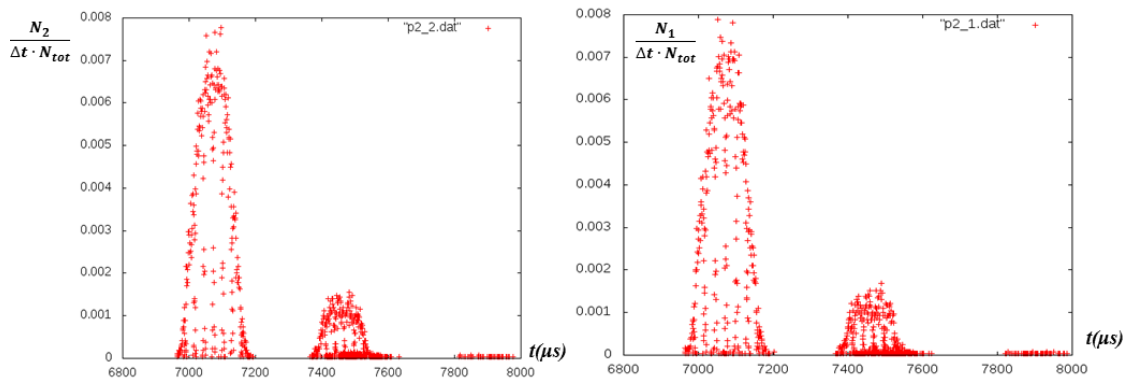

Figure 9. Histograms of the recorded flight times for a fixed position of ER2

The distributions of the light flight time for one fixed location of the ER don't show a normal distribution around the mean (real) value. We got two, very well separated peaks on the distribution – graph, the second peaks are shifted with a constant time-set. [Figure 9.] We used a statistical function for this data processing. For our graphs we eliminated the data that did not fit the first peak of the distribution function and the rare events data. By this we eliminated the influence of the digital components. For this data we calculated the characteristic mean-flight time. We plotted the mean-flight time for each measurement as function the distance between ER-s.

Table 1. Flight time measurement data

Day2/measurement	1	2	3	4	Day1/measurement	1	2	3	4
d-distance between ERs (m)	680	725	785	825	d-distance between ERs (m)	696	726	885	928
mean time (μs)	7087,047	7101,316	7142,055	7134,75	mean time (μs)	7103,847	7118,826	7160,875	7192,725
a (10 ⁻² μs/m)-day2	0,38215	0,36851	0,32987	Average- C	a (10 ⁻² μs/m)-day1	0,346197	0,318833	0,35081	average- c
c *(10 ⁸ m/s)	2,616776	2,713630566	3,031497256	2,7873014	c *(10 ⁸ m/s)	2,888531	3,136438198	2,85054588	2,9585049

Considering the linear regression on these points, the tangent of the slope will give the invers value of the velocity of the radio waves in air. [Figure 10].

$$a = \frac{t_2 - t_1}{d_2 - d_1} = \frac{1}{c} \quad f(x) = ax + b$$

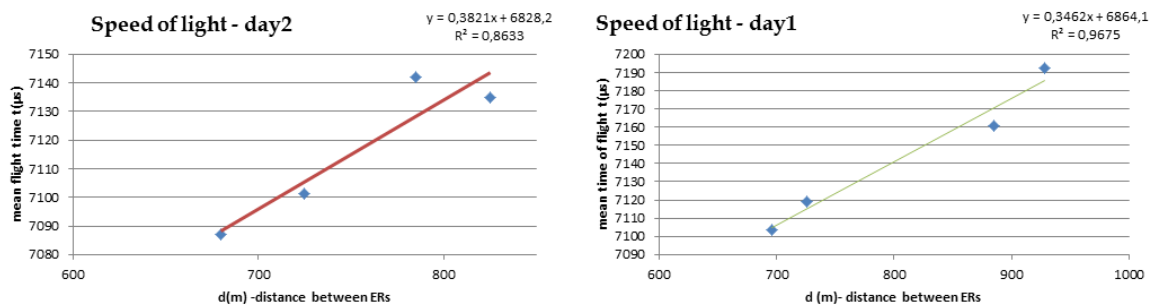

Figure 10. Average flight times as a function the distance between the two ERs. The obtained trend could be approximated with a linear fit.

The correlation between the speed of the light and air humidity was determined in collaboration with the Babes-Bolyai University Team (Benedek Elek-Zalán measurements, Sipos Lehel programming) during January. The team collected data continuously for 72 hours at distance 800-500 m, in winter on a hillside. Some series of measurements shows a connection between the velocity and air humidity, atmospheric parameters. Our sensor registered the pollution and humidity of the air. This measurement is not finished; we will continue this autumn and winter with more and improved sensors.

Conclusions

Our CanSat worked properly both at home and at Andoya during the launch campaign. We verified the barometric pressure formula, the temperature gradient from the ground to 1 km altitude. The pollution, dust measurement were good enough, we could compare the air pollution level at Andoya and Romania for the launch day. Our measurements prove that in

Brasov, due to it's being an industrial town, and in the surrounding area, thus our town as well, air pollution reaches significant levels, which is in connection with the weather conditions.

We could determine the speed of light with this experimental device. The next step of our project will be to improve the quality and accuracy of the measurement, write proper PC programs for data analyzing. We got more than 25 000 packages of data every 20 minutes, but that the distribution of the flight times for one fixed location does not show a simple normal distribution around a mean value. Instead of one peak we get other well-separable and much smaller peaks which are shifted with a constant offset. In the autumn and winter we will make long time determination, measuring continuously for 48-72 hours. We hope this data will help us find a connection between the value of electromagnetic wave speed and atmospheric parameters, particularly refractive index.

This project was successful, because my students enjoy these measuring and gladly take part in planning, programming, data processing or building phases of the project. With this work we realized a connection between different school tasks like mechanics, thermodynamics, electromagnetism, computer programming, IT.

This measuring device, measuring method and a data processing technique using computer software allows improving and developing the knowledge on thermodynamics and electromagnetism on a high school level, in a completely new environment. The aim of this technique is to form skills and competences that allow students to solve scientific tasks, to do individual research and raises their interest in natural science or IT.

References

- [1] Dombi A., Tunyagi A., Néda Z.: Walkie-talkie measurements for the speed of radio waves in air, iopscience.iop.org/0031-9120/48/1/80.
- [2] Farkas Zs., Hebling J.: Fizikai laboratóriumi gyakorlatok, JATEpress, 2001, Fénysebesség mérése levegőben, szilárd testben és folyadékban, from: titan.physx.u-szeged.hu/~labor2/01fenysebesseg.doc
- [3] Dombi A., Tunyagi A., Néda Z.: Rádióhullámok terjedési sebességének direkt mérése, *Műszaki Szemle*, 53/2011, p (3-7).
- [4] Budó Á. - Mátrai T.: Kísérleti fizika III., Budapest, 1987, 246.§, 248.
- [5] Benedek E-Zalán, Néda Z.: A fénysebesség mérése rádióhullámok segítségével, 2013, Babes-Bolyai University, Cluj-Napoca, final examination paper.
- [6] Direct measurement of the speed of radio waves in air; online from: <http://www.phys.ubbcluj.ro/~zneda/rv>
- [7] Szász Á., Néda Z.: Hálózati ping-pong- avagy a fény sebességének számítógépes mérése, *Természet Világa*, 2007/4, p. (132-133), online from (Measuring the speed of light by computer ping): <http://www.phys.ubbcluj.ro/~zneda/ping.html>
- [8] Carl B. Boyer: Early Estimates of the Velocity of Light, *Isis*, 1941, Vol. 33, No. 1, p. (24-40).
- [9] Jean M. Rueger: Refractive Index Formulae for Radio Waves, FIG XXII International Congress, 2002/apr/19-26, http://www.fig.net/pub/fig_2002/js28/js28_rueger.pdf

Physics on a Shoestring: Experiments with Soap Films

Jeremy I. Pfeffer

Hebrew University of Jerusalem, Israel

Abstract

A simple apparatus is described which directly demonstrates the ability of a liquid surface (a soap film) to perform useful work as it contracts; the stability and self-repairing property of soap films can also be demonstrated. The mechanism by which the work is done and the motion arises as the film contracts is also discussed. In a quantitative extension, the free surface energy of the soap film can be estimated by measuring the kinetic energy made available from the work done by the film as it contracts. The shapes adopted by constrained soap films, the dynamics of their formation and contraction, and the draining and thinning of vertical soap films can also be studied with this simple apparatus.

Keywords: Surface tension, surface free energy, adhesive and cohesive forces, soap films, Laplace-Young equation, interference phenomena in soap films

Introduction

The study of the “sensible forces” that act at “insensible distances” within fluids is sadly neglected in many contemporary physics courses. *Surface Tension* does not even appear in the indices of many widely used textbooks. Notwithstanding, the interpretation of these important phenomena in terms of the underlying cohesive and adhesive forces is an instructive topic and provides a basis for the study of many physical principles. Furthermore, the role these effects play in living systems, such as in lung function and mammalian membrane structure and behaviour, is central to an understanding of their workings.

Apparatus

A rigid sheet metal frame (approx. 30 cm × 10 cm) that stands on two small blocks; glass rods or tubes of length 15-20 cm and radius 0.1 to 2.0 cm (Figure 1); a 1litre beaker or a section of a large cylindrical glass tube; a soap solution that forms lasting films (2% – 5% solutions of quality household washing-up liquids in tap water are generally suitable).

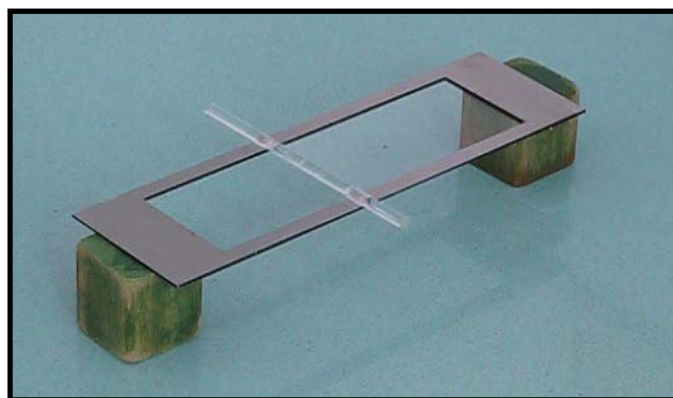

Figure 1. The basic apparatus

Definitions

Surface Tension is the tendency of liquid surfaces to contract to the minimum area possible. It is caused by the cohesion of the liquid molecules.

The *surface tension* γ , of a liquid is the force per unit length acting in its surface perpendicular to one side of an imaginary line drawn in the surface: $\gamma = F/l$.

Alternatively, γ is defined as the work done in isothermally creating unit area of new surface: $\gamma = W/\Delta A$.

A soap film is considered to possess two air/liquid surfaces, thus, $\gamma = W/2\Delta A$

The Experiments

Expt. 1: Useful Work from a Soap Film

The rod and frame are first thoroughly wetted with the soap solution; this is best done by pouring an excess of the soap solution onto one end of the frame, placing a glass rod/tube in the soap solution at that end of the frame and gently drawing it back along the frame. A soap film forms between the rod and the three inside edges of the frame. The adhesive forces between the soap film and the metal frame and glass rod/tube are stronger than the cohesive forces within the fluid.

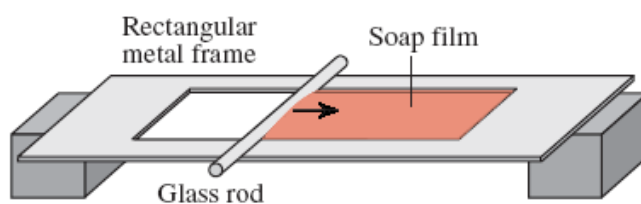

Figure 2. A Soap Film Motor. The glass rod rolls back as the film contracts.

If the rod is released it rolls back, accumulating kinetic energy as the film contracts (Figure 2); the apparatus acts like a “Soap Film Motor.” By inference, this also shows that energy must be provided to create or extend a liquid surface.

Expt 2: Horizontal Soap Films in Equilibrium

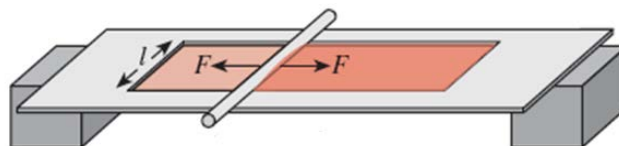

Figure 3. The rod remains stationary at equilibrium

Drawing the glass rod/tube all the way to one end of the frame and then back to some position along the frame, produces two separate films, one on each side of the rod/tube; the films are not necessarily of the same area (Figure 3). If the rod/tube is now released, it remains stationary at equilibrium. Equal forces are exerted by the two horizontal films even though they have not been stretched to the same extent and possess different amounts

of free surface energy. The surface tension is the same in the two films. If the film on one side of the rod is punctured, the rod will roll towards the other end of the frame.

Expt. 3: Rolling the Rods/Tubes on an Incline

The ability of the soap film to perform useful work is demonstrated still more convincingly by slightly raising the end of the frame from which the glass rod/tube is drawn (Figure 4). The rod/tube rolls back up the incline and as it does so it accumulates both kinetic and gravitational potential energy.

With light rods or tubes, inclines of up to 10° can be achieved.

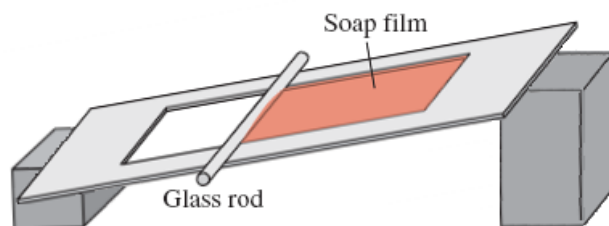

Figure 4. The Soap Film Motor on an incline

This demonstration can be made more entertaining by holding the raised end of the frame in one's hand, removing the block at that end and gently lowering and raising the end so as to alternately increase and decrease the angle of the incline. Increasing the angle causes the rod/tube to roll down; decreasing the angle makes it roll back up. This can be repeated again and again, the film contracting and reforming repeatedly, until it finally evaporates.

A critical angle, α , at which the rod is held stationary, neither rolling up or down the incline, may be found. An estimate of the surface tension of the soap solution can be made by measuring this angle. At that point, the upward force, $2\gamma l$, parallel to the plane of the frame due to surface tension balances the downward force, $mg \sin \alpha$, parallel to the plane of the frame due to the weight of the rod/tube, where m is its mass (Figure 5.). At equilibrium $mg \sin \alpha = 2\gamma l$.

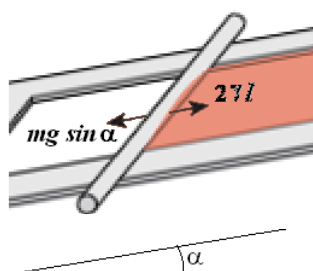

Figure 5. The forces acting on the rod on an incline

A value for γ , the surface tension of the soap solution, can be estimated from the mass m and the width l of the film.

Expt. 4: The Stability and Self-repairing Property of Soap Films

A sufficiently copious horizontal soap film can be pierced without it puncturing; if the object – a knitting needle for instance – is subsequently withdrawn, the soap film repairs itself.

Starting with a good excess of soap solution, the arrangement of two films on opposite sides of a glass rod/tube shown in Figure 3 is set up. A thick plastic knitting needle is then gently pushed through the soap film on one side of the rod; with care and experience this can be done without the film puncturing (Figure 6). The needle is then withdrawn and the film will be seen to repair.

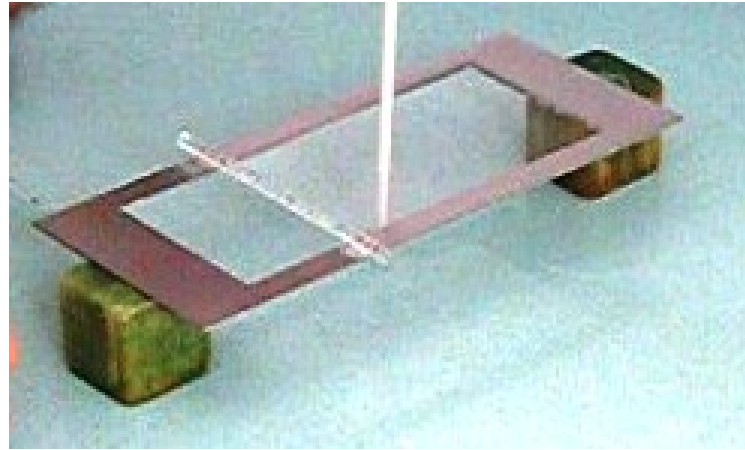

Figure 6. A thick plastic knitting needle piercing the soap film without puncturing it

In an extension of this experiment which requires some dexterity, the film on the other side of the glass rod/tube – say the left side – is deliberately punctured. The rod/tube begins to roll to the right towards the knitting needle, but before reaching it, the needle is pulled out. The film instantly repairs leaving the glass rod/tube to continue rolling unhindered to the end of the frame.

Expt. 5: Determination of the Surface Tension by Energy Considerations

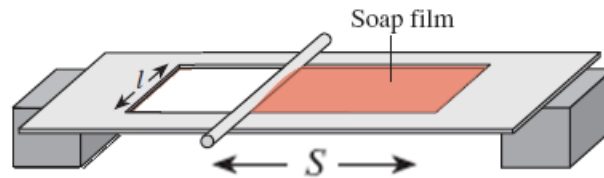

Figure 7.

The kinetic energy of the rolling rod/tube in Expt. 1 is provided by the work done, $W = 2\gamma\Delta A$, as the soap film contracts where $\Delta A = Sl$ is the reduction in its area (Figure 7). The surface tension of the soap solution can be found by equating the work done, W , with the kinetic energy, K , acquired by the glass rod/tube. This gives $\gamma = \frac{K}{2Sl}$. In the case of a rolling rod, $K = \frac{3}{4}mv^2$ (see box) from which

$$\gamma = \frac{3mv^2}{8Sl} \quad (\text{Eq. 1})$$

Assuming that the force that propels the rod forward across the rectangular frame remains constant throughout its motion – at this stage we assume that surface tension is not

a function of the thickness of the film – its velocity, v , after moving a distance S from rest is given by $v = \frac{2S}{t}$ where t is the time taken. Substitution in (Eq.1) gives

$$\gamma = \frac{3mS}{2lt^2} \quad (\text{Eq.2})$$

In experiments performed by the author, using glass rods of different lengths and radii, but all having a mass in the range of 0.005 – 0.02 kg, values between 0.015 and 0.02 J m⁻² were found for the surface tension of the soap solution used. The value generally given in the literature for the surface tension of soap solutions is about 0.025 J m⁻².

The kinetic energy, K , of a rolling rod is given by $K = \frac{mv^2}{2} + \frac{I\omega^2}{2}$ where m is its mass, I its moment of inertia, v its linear velocity and ω its angular velocity.

For a solid rod rolling about its central axis, $I = \frac{mr^2}{2}$ where r is its radius.

Given that $\omega = \frac{v}{r}$, we obtain by substitution $K = \frac{3}{4}mv^2$

Expt. 6: The Shape of the Soap Film

Because of its tendency to contract to the minimum surface area possible, the soap film rises up the side of the rod/tube. This can clearly be seen with a large round object such as a 1 litre beaker; the film rises about 2 cm above the plane of the frame at its highest point. As a result the soap film assumes a curved shape (Figures 8 & 9).

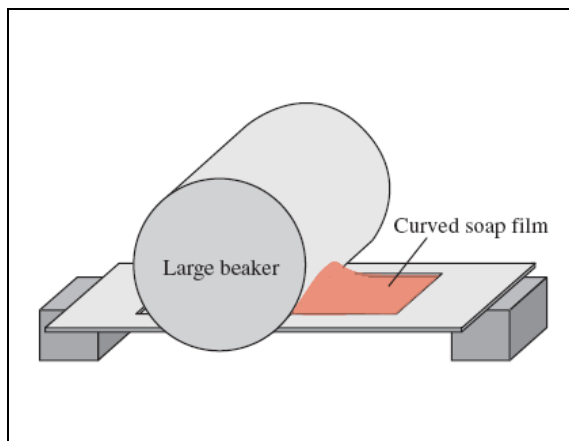

Figure 8. The soap film rises up the side of the beaker due to its tendency to assume a minimal surface area

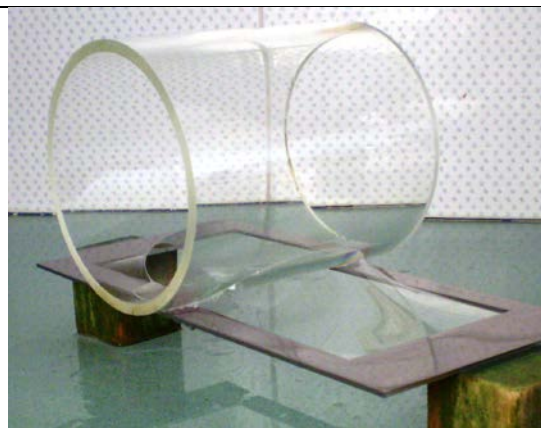

Figure 9. The shape of the soap film produced with a large cylindrical glass tube

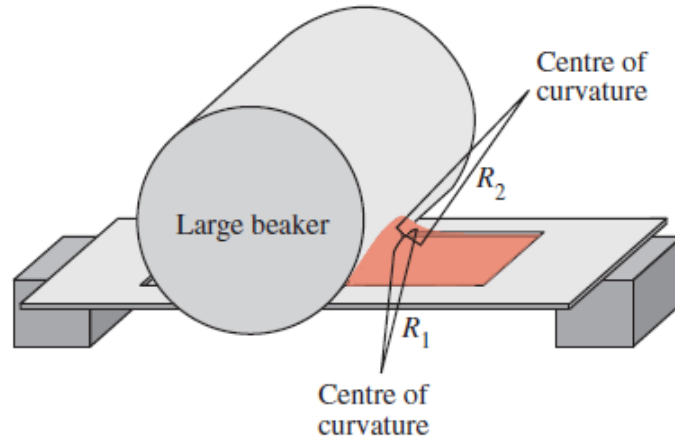

Figure 10. The two principal radii of curvature at a point on the surface of the soap film

The curvature of a soap film is given by the Laplace-Young equation $\Delta p = \gamma \left(\frac{1}{R_1} + \frac{1}{R_2} \right)$, where Δp is the pressure difference across the film and R_1 and R_2 are the two principal radii of curvature at any point on its surface. Where the pressure difference across the film is zero, as it is in this case, the equation takes the form $\left(\frac{1}{R_1} + \frac{1}{R_2} \right) = 0$. The film has the shape of a *minimal surface* such that if R_1 is positive, R_2 is negative. This is verified by the shape observed (Figure 10).

Expt 7: The Mechanism of the Rod/Tube's Motion

Given that the length of the line of contact between the soap film and the rod/tube $l \approx 0.1\text{m}$ and the surface tension of a typical soap solution $\gamma_{\text{soap}} \approx 0.025\text{ N m}^{-1}$, the force, F , exerted by the film on the rod by surface tension is approximately

$$F = 2\gamma l \approx 2 \cdot 0.025 \cdot 0.1 = 0.005\text{N}$$

This is too small a force to drag an object of mass $m \approx 0.02\text{ kg}$, such as the rods used in these experiments, across a horizontal metal surface where the coefficient of friction between the object and the surface is say $\mu = 0.1$. The frictional force, f , is an order of magnitude greater:

$$f = \mu mg \approx 0.1 \cdot 0.02g = 0.02\text{N}$$

However, even a very small tangential force can cause a circular object to rotate.

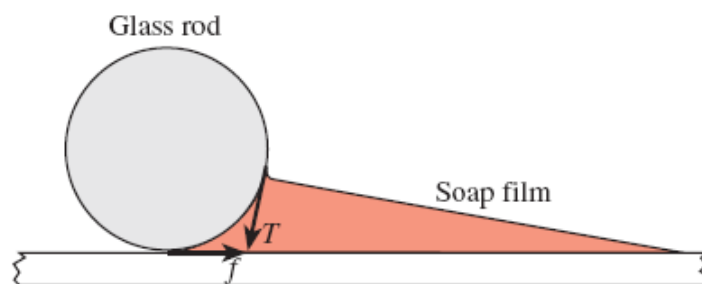

Figure 11. The rod/tube is propelled along the frame by the frictional force, f

Taking the *angle of contact* between the soap solution and the glass rod to be zero, we can say that a tangential force, T , acts on the surface of the rod across the line of contact with the soap film. The torque that rotates the rod arises from this tangential force (Figure 11).

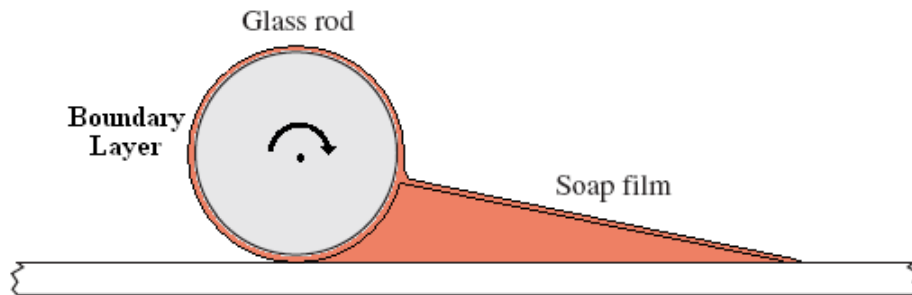

Figure 12. The relative motion between the *boundary layer* and the soap film

The wetted rod/tube, does not tear the film as it advances across the frame. Evidently, there is no actual direct contact or relative motion between the rod/tube and the contracting soap film. The relative motion is entirely within the fluid itself, between the *boundary layer* that coats the rod's surface and the adjacent curved edge of the soap film. It is an example of *laminar flow* (Figure 12).

Expt. 8: Vertical Soap Films

The Soap Film Motor can be adapted to demonstrate vertical soap film phenomena by replacing the simple block supports with two holders into which slots have been cut to hold the metal frame in place (Figure 12a).

With the frame in a horizontal position, a soap film is formed along its full length using the same procedure as that described above in Expt. 2. The whole assembly is then carefully raised into a vertical position and stood on one of the holders; if this is done carefully, the soap film will not puncture (Figure 12b).

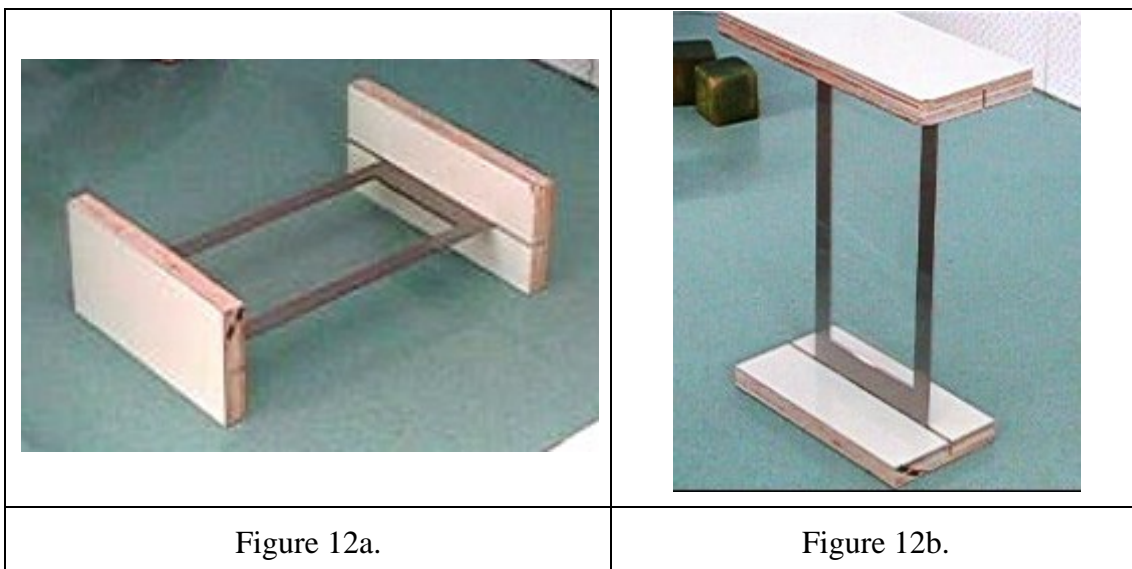

In contrast with the situation in a horizontal soap film, the surface tension of a vertical soap film is not uniform: it must be greater at its top than at its bottom (typically by up to 1.5%) in order to support the additional weight of the lower regions of film.

When illuminated with diffuse white light and viewed against a black background, an pattern of horizontal coloured bands (interference fringes) is observed in the vertical film (Figures 13a & 13b). The assembly can be moved or turned relative to the ambient light sources so as to obtain the best display.

The colour of the interference fringes is a function of the film's thickness in the particular region. The thickness may vary from 50 times the wavelength of visible light down to a few molecular distances. The pattern of colours changes over time as the film drains. Mathematical analysis of this changing interference pattern provides information about the draining and thinning mechanisms.

The dynamics of the draining and thinning mechanisms is a complex subject. For a comprehensive treatment of the phenomenon, the reader is referred to Isenberg's (1978) classic text.

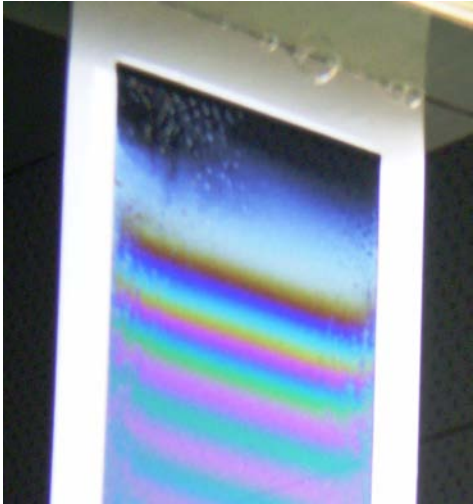
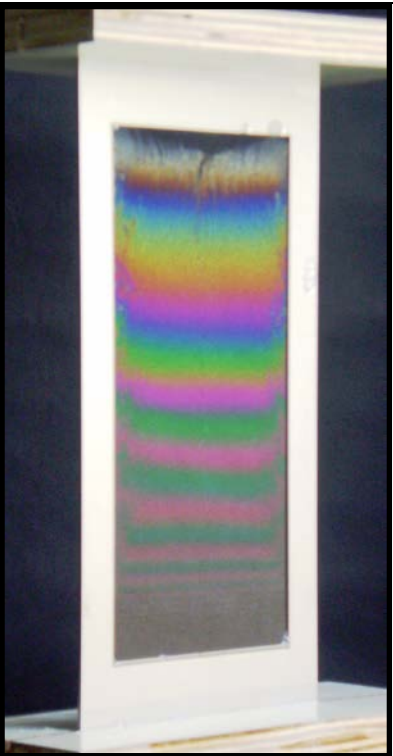
	
<p>Figure 13a. Note the <i>Black Film</i> at the top of the film (typically 50\AA to 300\AA thick), where only destructive interference occurs; no light is reflected from that part of the soap film. Note too the turbulent rising motion along the vertical edges of the film.</p>	<p>Figure 13b. Note the sharp change from black to silver near the top of the film; this is attributed to a sudden change in the film's thickness in that region. Note too the "river" of black film breaking through the silver band and into the coloured region. This <i>critical fall</i> is attributed to convection due to the presence of the lighter black film in the region of the heavier coloured film.</p>

References

Berg S., Adelizzi E. A, Troian S. M.: Images of the Floating World: Drainage Patterns in Thinning Soap Films, *Phys. Fluids* 16, S6 (2004).

Courbin L., Stone H. A.: Impact, puncturing, and the self-healing of soap films, *Phys. Fluids* 18, 091105 (2006).

Isenberg C.: *The Science of Soap Films and Soap Bubbles*. Tieto Ltd. Avon, England (1978), ISBN 0-905028-02-3.

Román F. L., Faro J., Velasco S.: A simple experiment for measuring the surface tension of soap solutions, *Am. J. Phys.*, Vol. 69, No. 8, 920-921 (2001).

Gratton L. M., Oss S.: Soap, Colors, Holes, and Much More, *Phys. Teach.* 43, 338 (2005).

Assessment of Just-in-Time-Teaching (JiTT) Approach Integrated into the Newtonian Mechanics Lecture Class Using a Model Analysis Technique

S. Puttisanwimon, S. Rakkapao and T. Pengpan

Department of Physics, Faculty of Science, Prince of Songkla University, Hat Yai, Songkhla, 90112, Thailand

Abstract

Just-in-Time-Teaching (JiTT) is one of interactive instructional methods in physics education research (PER). Web-based questions and in-class activities based on misconceptions are the key elements of JiTT. It can be applied to a small or large class with a single instructor, and is easy to combine with other methods. This study aims to evaluate JiTT method integrated into a large lecture class of force and motion, by using a model analysis technique, which is based on a matrix mechanics of quantum physics. Samples are 567 science freshmen from Prince of Songkla University, Thailand. The well-known research-based multiple choice test, force and motion conceptual evaluation (FMCE), was administered to the students both pre and post instruction. Based on the class density matrices of the model estimation, it revealed that after the instruction the percentage of the students using the correct model to solve the questions has increased. But there was a slight change from pre to post class model points shown by the model plot. This suggests that more active learning activities are still required for the class. Moreover, by using the model analysis instructors can investigate students' misconception and students' model states. It will benefit instructors in designing and modifying their instructional materials and processes.

Keywords: University Education, Misconception, Forces and Motions, Just-in-Time Teaching, Model Analysis

Introduction

In Thailand, large classes of an introductory physics course at university level are common [1]. One instructor confronts with more than 200 students in a class, which a lecture-based instruction is unavoidable. To promote students understanding in such classes an active learning approach, just-in-time-teaching (JiTT), has been suggested in physics education research (PER). The JiTT, developed at Indiana University-Purdue University Indianapolis, and the United States Air Force Academy in USA, is a pedagogical strategy for using the World Wide Web to create an active learning environment in classrooms [2,3]. The distinguished feature of JiTT approach is using a series of questions to monitor the student understanding in one concept before and after the instruction via online system. This is a way to extract students' prior knowledge before the starting of the class. The prior knowledge is a primary resource for instructors to design in-class activities and instructional evaluation. The JiTT encourages students to construct their own body of knowledge through classroom discussion, including use other supplement instructional materials. It promotes students' learning from the view of constructivist theory [4,5]. Moreover, JiTT is suitable for a large class with one instructor [6,7].

Therefore, this study aims to integrate JiTT approach into a traditional lecture physics class for science freshmen. The force and motion is the first required concept [8]. Before and after the instruction, the samples are asked to fill out the force and motion conceptual

evaluation (FMCE) test. Then, collected data are analyzed via a model estimation of a model analysis technique to assess students' understanding after the instruction.

Materials and Methods

1. Data collection

The data were collected both pre and post instruction around 4 weeks from 567 complete responses of science freshmen (24% male) at Prince of Songkla University, Thailand, by using the Thai version of the FMCE. Forty-three items of the FMCE, a research-based multiple-choice instrument, were categorized into four content clusters namely velocity, acceleration, the Newton's first and second laws and the Newton's third law of motion [9]. Only data of the Newton's first and second laws of motions were presented in this article.

2. Just-in-Time-Teaching (JiTT)

The JiTT is a teaching and learning strategy comprising two elements: 1) online questions, which are used to survey students exist ideas and 2) classroom activities, which promote active learning process [2]. This method exposes the students' prior knowledge by "*Warm up* questions" and the students' improvement at the end of classes by "*Puzzle* questions". Examples of the questions used in this study are shown in the following.

2.1 *Warm up Questions*

Warm up questions were used to extract students' prior knowledge before the beginning of the class, in order to use as key resources to design the classroom activities. There are three types of *Warm up* questions: 1) an essay question, 2) an estimation question, and 3) a multiple-choices question. All questions are put on the classroom's website for students to response before the starting of the class around one week. In this study, *Warm up* questions were developed from PER articles, academic websites and classroom experiences of researchers. The questions were validated and modified following suggestions of students and physics experts. An example of *Warm up* questions for the first law of Newton's motion, placed on the website called "LMS@PSU E-Learning Management System", is shown in Figure 1 [10].

2.2 *Classroom Activities*

Students' responses for the *Warm up* questions were used to plan active classroom activities for JiTT integrated into the traditional lecture. In the class, firstly, the instructor shows the students' responses of the *Warm up* on the screen in front of the class, and discusses each other the prior knowledge. Secondly, students learn from free online video clips or interactive simulations, which are from well-known academic websites such as Physics Education Technology: University of Colorado, Boulder (*PhET*) [11]. After that, the instructor asks questions relating to the video clip, engages students to share their ideas with neighbors and the discussion, in order to help students to reorganize and to construct their own ideas. Examples of instructional materials are shown in Figure 2.

(a) Essay question: During the motion of a spacecraft far away from the planets, if the spacecraft's engine is not used, can the spacecraft move? Why? (Explain and give your reasons.)

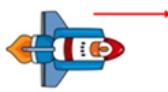

(b) Estimation question: A boy pushes the wooden box rested on the frictionless floor moving with a constant speed of 2 m/s. When the wooden box out of the boy's hand, calculating the net force acting on the wooden box if no air resistance. (Define any mass of the wooden box and show the calculation, if any.)



(c) Multiple-choices question:



A car, moving with a constant speed of 100 km/h, overtakes a truck, moving with a constant speed of 40 km/h. Which is the correct answer involving the net force acting on the vehicles?

(A) The net force acting on the truck is greater than that of the car because of its larger mass.
 (B) The net force acting on the car is greater than that of the truck because of its smaller mass.
 (C) The net force acting on the car is greater than that of the truck because of its higher speed.
 (D) The net forces acting on the car and the truck are equal because of the constant speeds.
 (E) Other.

Figure 1. Warm up questions for the Newton's first law of motion used in this study

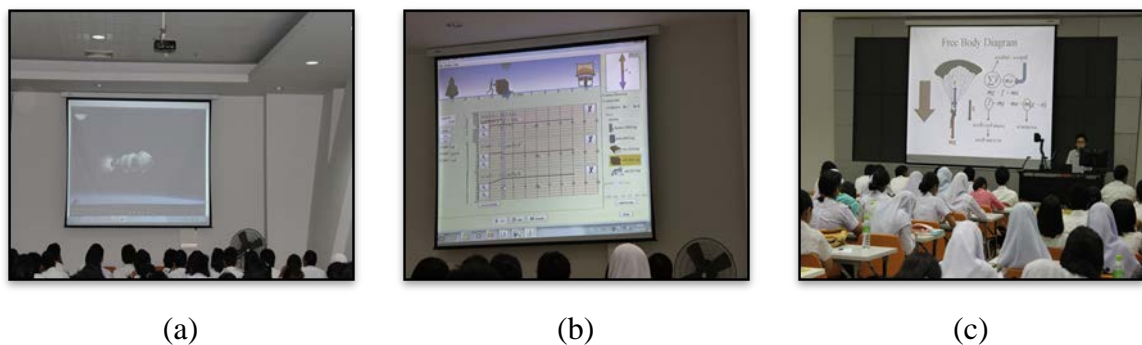

Figure 2. Instructional materials for active classroom activities: (a) video clips, (b) interactive simulations and (c) animation pictures

2.3 Puzzle Questions

Puzzle open-ended questions were used to examine both students' understanding and the instruction as a formative evaluation. One week after ending the topic, *Puzzle* questions were put online and students' feedbacks were analyzed. An example of *Puzzle* questions for the Newton's first law of motion is shown in the Figure 3.

The ice-skater used one foot to push 10 Newton force to move herself out of the field edge. She is sliding with a constant speed of 5 m/s on frictionless ice, shown in the figure. Describe the net force acting on the ice-skater and her movement.



Figure 3. The *Puzzle* question for the Newton's first law of motion used in this study

3. Model analysis

The theoretical framework of the model analysis technique is based on scientific researches of neuroscience, cognitive science and education [12,13]. It takes advantage of qualitative researches to design quantitative parameters. The model analysis consists of two algorithms; concentration factor and model estimation. This study focuses on model estimation, which is used to investigate student misconceptions and students' model state of knowledge. Because student understanding depends on the context of a question we can use a set of equivalent concept questions to activate student understanding. The probability for students to apply different concepts in solving these questions can be measured by using model estimation [12,13,14]. This process is analogous to that of a quantum measurement. The different common models with context dependence are defined as mental model states. Each common model is associated with an element of an orthonormal basis (\hat{e}_w) in a linear vector space. Its mathematical representation is shown in formula (1).

$$\hat{e}_1 = \begin{pmatrix} 1 \\ 0 \\ \vdots \\ 0 \end{pmatrix}, \hat{e}_2 = \begin{pmatrix} 0 \\ 1 \\ \vdots \\ 0 \end{pmatrix}, \dots, \hat{e}_w = \begin{pmatrix} 0 \\ 0 \\ \vdots \\ 1 \end{pmatrix} \quad (1) \quad |u_k\rangle = \begin{bmatrix} \sqrt{q_1^k} \\ \sqrt{q_2^k} \\ \sqrt{q_3^k} \end{bmatrix} = \frac{1}{\sqrt{m}} \begin{bmatrix} \sqrt{n_1^k} \\ \sqrt{n_2^k} \\ \sqrt{n_3^k} \end{bmatrix} \quad (2)$$

Responses from a single student to the research-based multiple-choice questions are used to construct a single student model state with a vector of unit length in the model space ($|u_k\rangle$). The model state for the k^{th} student in a class, which focuses on three common models, is shown in formula (2), where n_1^k, n_2^k and n_3^k mean the numbers of the k^{th} student answers corresponding with model 1, model 2 and model 3, respectively, and m means the total number of questions in that concept.

The individual student model state is used to construct a single student density matrix (D_k), where $D_k = u_k \otimes u_k^T$. For the entire class it is combined to create the class density matrix (D).

$$D = \frac{1}{N} \sum_{k=1}^N D_k = \frac{1}{N.m} \begin{bmatrix} n_1^k & \sqrt{n_1^k n_2^k} & \sqrt{n_1^k n_3^k} \\ \sqrt{n_2^k n_1^k} & n_2^k & \sqrt{n_2^k n_3^k} \\ \sqrt{n_3^k n_1^k} & \sqrt{n_3^k n_2^k} & n_3^k \end{bmatrix} = \begin{bmatrix} \rho_{11} & \rho_{12} & \rho_{13} \\ \rho_{21} & \rho_{22} & \rho_{23} \\ \rho_{31} & \rho_{32} & \rho_{33} \end{bmatrix} \quad (3)$$

The diagonal elements of the class density matrix reflect the percentage of the responses generated with the corresponding models used by the class. The off-diagonal elements reflect the consistency of the individual students' use of their models. Large off-diagonal elements signify low consistency (large mixing) for individual students in their model use. This is computed to find out the eigenvalues and eigenvectors for showing the students' distribution in each mental model. The largest eigenvalue (> 0.65) was selected and used to establish the primary eigenvectors (v_μ). These can be presented in a model plot with a model point expressing the class model state as shown in Figure 4(a). The model plot is a two-dimensional graph to represent the class use of two models (correct and incorrect). It is divided into 3 regions accounting for the class model state in each concept, which model 1 as correct model, model 2 as incorrect model, and the middle as mixed model state. The

two axes represent the probabilities that students in the class will use the corresponding models. The largest eigenvalue (σ_μ^2) and its primary eigenvector, denoted by $v_\mu = (v_{1\mu} \ v_{2\mu} \ v_{3\mu})^T$, are pointed on the model plot with a coordinate (P_2, P_1) , where $P_1 = \sigma_\mu^2 v_{1\mu}^2$ and $P_2 = \sigma_\mu^2 v_{2\mu}^2$.

Results and Discussion

1. Results from JiTT questions

Students' responses to the *Warm up* and *Puzzle* questions of JiTT were analyzed and grouped following the main idea. In this article, we present only students' answers from the *Warm up* questions (shown in Figure 1), and the *Puzzle* question (shown in Figure 3).

1.1 Results from the Warm up Questions

Table 1(a). Students' responses to the essay question (spacecraft situation)

Group	Can the spacecraft move?	Reasons	Percentage
1*	Yes.	It is not necessary to have a force to maintain the spacecraft's motion.	29%
2	Yes.	The spacecraft is still moving because of the gravitational interaction between the spacecraft and the planets.	38%
3	No.	There is no force acting on the spacecraft./ A force is needed to maintain its motion.	31%
4	Yes./No.	Others	2%

Table 1(b). Students' responses to the estimation question (wooden box situation)

Group	The net force acting on the wooden box is...	Reasons	Percentage
1*	Zero	The box is moving with a constant speed.	46%
2	Not zero	There is a pushed force by the hand calculated by the Newton's second law.	48%
3	Zero/Not zero	Others	6%

For the students' responses to the multiple-choice question (car & truck situation), there were 17%, 16%, 34%, 25%, and 8% of the students selected choice (A) to (E), respectively. Only 25% of them chose the correct choice D. But it displayed that 67% of these students believed that the net force acting on the constant speed object is varied by mass and speed. Moreover, students' answers for the three types of the *Warm up* questions showed that more than a half of these students brought the alternative concepts involving the Newton's first law of motion into classroom. Thirty-one percent of these students believed that during the motion far away from the planets of the spacecraft, if the spacecraft's engine is not used, it cannot move because of none force acting on the spacecraft. This strongly agrees with the misconception that a force is necessary to maintain the object's motion [12]. Furthermore, for the wooden box situation shown in Figure 1(b) and Table 1(b), 48% of the students answered that there is net force acting on the wooden box moving with a constant speed on the frictionless floor, by which most

believed there is a pushing hand force. This implies the misunderstanding of the contact force that the force still exists during no contact between the two objects. These alternative concepts disclosed by the *Warm up* questions were used as key resources to set up active classroom activities of JiTT combined with lecture.

1.2 Results from the Puzzle Question

Students' responses to the *Puzzle* question (shown in Figure 3) were demonstrated in Table 2. We found that after this instruction 81% of the students answered the correct idea that the net force, acting on the ice-skater moving with a constant speed, is zero. It indicates that the teaching method helps students to reorganize their ideas from several different ideas to more consistency one idea. However, there were 19% of the students still held the alternative concepts. Some believed that there is a kind of foot forces.

Table 2. Students' responses to the *Puzzle* question (ice-skater situation)

Group	The net force acting on the ice-skater is...	Reasons	Percentage
1*	Zero	The ice-skater is still moving with a constant speed.	81%
2	Not zero	There is a pushed force by her foot.	12%
3	Zero/ Not zero	Others	7%

2. Results from FMCE

Students' model states for the Newton's first and second laws were calculated by the model estimation. There are three common models of this concept: *Model 1*) It is necessary to have a force to maintain motion and there is no such a thing as a force in the direction of motion (correct model).; *Model 2*) A force is needed to maintain motion and is always in the direction of motion. The force is directly related to the velocity of motion (incorrect model).; and *Model 3*) Other ideas and incomplete answers (null model) [12,13].

Table 3. Results of pre-and post class density matrices, dominant eigenvalues, and primary eigenvectors

Results	Pre-	Post-
Class density matrix	$\begin{bmatrix} 0.10 & 0.12 & 0.07 \\ 0.12 & 0.60 & 0.32 \\ 0.07 & 0.32 & 0.30 \end{bmatrix}$	$\begin{bmatrix} 0.16 & 0.18 & 0.09 \\ 0.18 & 0.60 & 0.27 \\ 0.08 & 0.27 & 0.24 \end{bmatrix}$
Dominant eigenvalue	0.83	0.80
Primary eigenvector	$\begin{pmatrix} 0.19 \\ 0.83 \\ 0.52 \end{pmatrix}$	$\begin{pmatrix} 0.29 \\ 0.84 \\ 0.45 \end{pmatrix}$

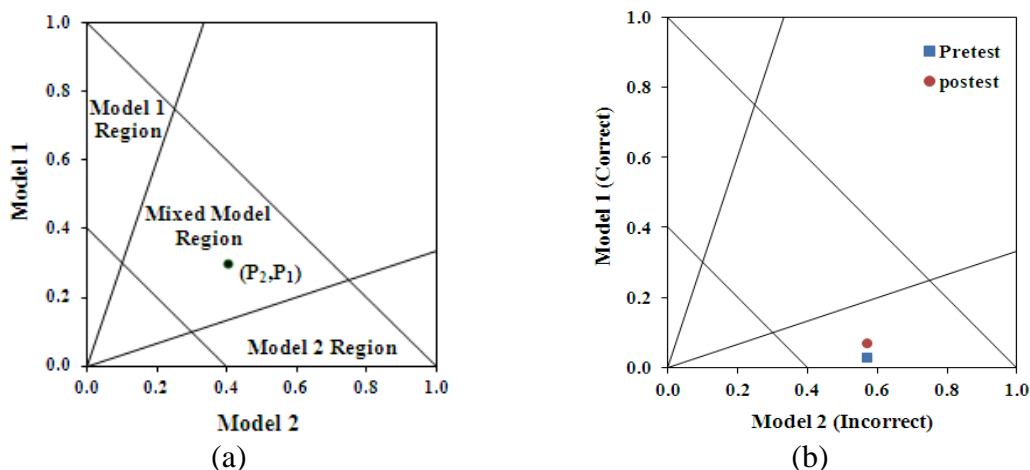

Figure 4. (a) Model plot and model regions, (b) Pre-and post class model states on the Newton's first and second laws for the instruction

In this study, we employed question 2, 5, 11 and 12 of the FMCE as the typical items associated with the concept. Results were shown in Table 3, and the class model states were shown in Figure 4(b). After the instruction, the percentage of students, who used the correct model to solve the questions, has increased from 10% to 16%, shown by the diagonal elements of the class density matrices. Moreover, the percentage of students, who held the null model, has decreased from 30% to 24%. The percentages of students, who used the incorrect model, before and after the instruction, were equal. Additionally, the off-diagonal element ρ_{23} in the pre-and post-class density matrices showed the significant large mixing between the incorrect and null models. It moved from 75% to 71% of mixing ideas after the instruction. It means that after the instruction, amount of students, who used the correct model, is higher; who used the mixing of incorrect and null models is lower. The shift of the class model states is shown in Figure 4(b). There was a slight change from pre to post model points, but all were in the incorrect model region. From the results it is possible that although, the instruction cannot force students to reach the pure correct model, it has made some changes to the students. This can be a part of learning.

Conclusions

This study assesses the effectiveness of using JiTT integrated into the traditional lecture class of the Newton's first and second laws of motion. The FMCE data were analyzed via model estimation of the model analysis technique to examine students' conceptual model states. Research results revealed some changes of the students' model states of knowledge after this instruction, but in a small scale. To help students learn more, JiTT should be combined with other active methods, such as Peer Instruction (PI) [15]. The more interactive activities of JiTT in lecture classes, the more benefit to students' learning in science and mathematics [16,17]. It is an interesting future work in enhancing students' learning in large introductory physics lecture classes.

Acknowledgments

The authors would like to thanks all participating students and all colleagues. This work was supported by graduate school, department of physics, and faculty of science at Prince of Songkla University, Thailand, budget year 2013.

References

- [1] Soankwan C., Emarat N., Arayathanitkul K., Chitaree R.: Physics Education in Thailand. *International Newsletter on Physics Education*. (October 2007), p. 6-8.
- [2] Novak M. G., Patterson E. T., Gavin A. D., Christian. W.: *Just-in-Time Teaching: Blending Active Learning with Web Technology*. Upper Saddle River, New Jersey: Prentice Hall, (1999).
- [3] Novak G. M., Patterson E. T., Gavrin A. D., Christian W., Forinash K.: *Just in Time Teaching*. *Am. J. Phys.* 67, (1999), p. 937-938.
- [4] Gavrin A. D., Novak G.: *What is Physics Good For? Motivating Students with Online Materials*. In: *IASTED International Conference on Computers and Advanced Technology in Education*. Philadelphia, Pennsylvania, (1999).
- [5] Novak G. M., Patterson E. T., Gavrin A., Enger R. C.: *Just-in-Time Teaching: Active Learner Pedagogy with WWW*. In: *IASTED International Conference on Computers and Advanced Technology in Education*. Cancun, Mexico: Eds. J., (1998), p. 1-5.
- [6] Gavrin A.: *Just-in-Time Teaching*. *Metropolitan Universities Journal*. 17, 4, (2006), p. 9-18.
- [7] Redish E. F.: *Teaching Physics with Physics Suite*. New Jersey: John Wiley & Sons (2003).
- [8] Puttisanwimon S., Rakkapao S., Pengpan T.: *Investigation of Freshmen Conceptual Understanding of Forces and Motions by Using the Model Analysis Technique*. In: *The 8th Annual Conference of Thai Physics Society*. Chiang Mai, Thailand, (2013), p. 413-416.
- [9] Smith T. I., Wittmann M. C.: *Applying a resources framework to analysis of the Force and Motion Conceptual Evaluation*. *Phys. Rev. ST Phys. Educ. Res.* 4, (2008), p. 1-12.
- [10] PSU: *LMS@PSU E-Learning Management System. FUNDAMENTAL PHYSICS 1 (332-101)*. (2012), [online]. [cit. 8. 9. 2013]. Available from: <http://lms.psu.ac.th/>
- [11] University of Colorado Boulder: *PhET Interactive Simulations*. (2013), [online]. [cit. 3. 4. 2013]. Available from: <http://phet.colorado.edu>
- [12] Bao L.: *Dynamics of student modeling: a theory, algorithms, and application to quantum mechanics*. Doctor of Philosophy. University of Maryland, (1999).
- [13] Bao L., Redish E. F.: *Model analysis: Representing and assessing the dynamics of student learning*. *Phys Rev ST Phys Educ Res.* 2, (2006), p. 1-16.
- [14] Hogg K., Bao L., Zollman D.: *Model analysis of fine structures of student models: An example with Newton's third law*. *Am. J. Phys.* 70, (2002), p.766-787.
- [15] Watkins J., Mazur E.: *Just-in-Time Teaching and Peer Instruction*. In: Simkins, S., Maier, M., editors. *Just in Time Teaching: Across the Disciplines, and Across the Academy*, p. 39-62: Stylus Publishing, (2010).
- [16] Mzumara H. R.: *Web Science: Assessment of Just-in-Time Teaching at IUPUI*. In: *The EDUCAUSE 2001 conference*. Indianapolis, (2001). p. 1-19.
- [17] Luo W.: *Just-in-Time-Teaching (JiTT) Improves Students' Performance in Classes - Adaptation of JiTT in Four Geography Courses*. *Journal of Geoscience Education*. 56, 2, (2008), p. 166-171.

Computer modelling in some Czech Physics Olympiad problems and Easy Java Simulations

Lukáš Richterek, František Látal, Zdeněk Pucholt, Jan Říha

Faculty of Natural Sciences, Palacký University, Olomouc, Czech Republic

Abstract

The Physics Olympiad is a well known annual physics competition for secondary school students. Its aim is also to systematically develop the skills of the participants through more complex problems that sometimes require more self-study endeavour and – namely in the case of the first school run – also simple computational dynamical modelling. The equations derived from laws of dynamics often do not have an analytical solution for the monitored physical quantities and their dependency on time (especially on the secondary school level), which helps quite naturally to introduce the principles and usage of dynamical models at an appropriate basic level.

Certainly, there are many software products for building mathematical models and animations based on them. In our case the Easy Java Simulations package has been chosen as an available modelling and authoring tool that allows an easy creation of interactive graphical simulations in Java for non-expert programmers with a broad international community support. We would like to present a set of simulations based on the Czech Physics Olympiad problems and self-study texts. The models cover various parts of secondary-school physics (especially mechanics and electromagnetism) and are also used for short training workshops during our annual summer school for secondary schools students. This topic is also used as an additional module in our university courses for future teachers.

Keywords: dynamic modelling, Physics Olympiad, Easy Java Simulations

Introduction

The International Physics Olympiad (IphO, <http://ipho.phy.ntnu.edu.tw>) was first organised in 1967 in Warsaw. And while in that year only five countries participated in the event (Bulgaria, Czechoslovakia, Hungary, Poland, Romania), in 2013 up to 900 participants from more than 80 countries were involved in the 44th IPhO in Denmark (for more details see its website <http://www.ipho2013.dk>). Naturally, various forms of national Physics Olympiads are held in the participating countries.

In this contribution we report briefly about the Czech Physics Olympiad (CzPhO). Next, we summarize the principles of numerical modelling and list some suitable software tools for this purpose pointing out the useful features of Easy Java Simulations (EJS). We illustrate the use of this program by three examples based on the CzPhO tasks from recent years.

Czech Physics Olympiad

The Czech Physics Olympiad [5] has been held since 1959 and it enters its 55th year in September 2013. Organised under the patronage of the Union of Czech Mathematicians and Physicists, the competition has 8 categories (labelled A – G) for students in the age from 13 to 19. Every year it brings over 80 different problems and four study materials,

experiments are also included during the school and the national runs. Altogether, about 4000 or 5000 pupils take part in it. An important part of the supporting activities are summer school and a camp before the IPhO every year.

The CzPhO as well as the IPhO are mainly intended for talented students: to provide them with interesting, stimulating problems at an appropriate level, to support their motivation and interest in their future career in physics, related technical branches or engineering. Another aim is to attract more pupils to solving physics problems, to practice and improve their skills. Therefore, the CzPhO central committee takes great care during the problem selection process, trying to supply relevant tasks, which are often interdisciplinary with the background in real life. The problems solved by means of various ICT tools are considered too.

Dynamical modelling

One of the important characteristics of physics is the construction of more or less simplified mathematical models of real phenomena. To predict the future evolution we employ the dynamical (computational, numerical) models that give the time evolution of physical quantities in the form of tables or graphs. Such mathematical models very often contain differential equations arising from the application of the physical laws; as a typical example we can mention the problems based on Newton's second law in classical mechanics. Working with those differential equations we sometimes cannot come to their analytic solutions or it can be very tedious, especially at the secondary school level.

In such a case, we must apply numerical algorithms repeatedly and gradually, calculating the changes of the physical quantities within short time intervals. Taking the above mentioned example from dynamics, we usually start with a set of 2nd order ordinary differential equations (ODEs) and their initial conditions that are determined by the acting forces in the following form

$$\frac{dp}{dt} = m \frac{d^2r}{dt^2} = F(t, r, v) \quad r(t=0) = r_0, \quad v(t=0) = v_0.$$

These can be solved e.g. with the simplest Euler method, when we choose a sufficiently short time step $h = t_{i+1} - t_i$ and then we calculate the sequences of values for the acceleration, the velocity and the position vector

$$a_i = \frac{F(t_i, v_i, r_i)}{m} = a(t_i, v_i, r_i), \quad v_{i+1} = v_i + a_i h, \quad r_{i+1} = r_i + v_i h, \quad t_{i+1} = t_i + h.$$

The precision of the calculated values and the time consumption required by the computer cycle depend on the time increment h and the integration method. More sophisticated Runge-Kutta algorithms can be also used (see e.g. [9,12]).

The simulations and computer models seem to play an increasingly important role also in education. Certainly, they represent extremely useful tools in many part of science such as weather forecasting, flight simulators, molecular protein models, neural networks, etc. As a didactic tool it is successfully used in some undergraduate physics courses [1] with several potential benefits – students can engage in the modelling process to make complex problems tractable ('learning-by-making'), they can also use computations to explore the applicability and utility of physical principles. Moreover, the graphical visualisations of the models can improve students' conceptual understanding. We believe this all worth the time spent on the programming.

Certainly, there exist many of on-line resources with applets and ready-to-use simulations, but creating one's own always gives a deeper understanding of how the physical laws are involved and what might be model errors and limitations. Involving the students also helps them develop important ICT skills. In the CzPhO the numerical modelling was used in the category B (41th year, 1999/2000) and in the category A (52th year, 2010/2011). Most pupils managed to develop a running application successfully using various tools.

There is still one rather sensitive, subjective point – the choice of the suitable software tool. This always depends on the personal experience, operating system, etc. During the regional and national runs of the CzPhO only pocket calculators are allowed, but this is definitely not the most effective approach to the more complex problems. Besides robust commercial tools like Mathematica, Maple or Matlab we can also use e.g. spreadsheet applications (Excel, Calc), GNU Octave (<http://www.gnu.org/software/octave/>), Modellus (<http://modellus.fct.unl.pt>; see e.g. [13]) or employ standard programming languages directly (PHP, variants of C, Java, Fortran, Python, etc.). In the following text, we would like to show, why we decided to introduce EJS during our local CzPhO seminars.

Easy Java Simulations

According to the website [7], EJS is a free authoring tool written in Java that helps non-programmers create interactive simulations in Java, mainly for teaching or learning purposes. It was developed primarily for students and teachers of science or researchers with basic knowledge of computer programming, who are more interested in the content, and much less in the technical aspects needed to build simulations. As a Java code generator it can also be used as a teaching tool itself – students can create simulations themselves following some guidelines and EJS can help them make their conceptualizations explicit, especially when used and discussed in groups.

EJS also makes the sharing and the distribution of the created models quite easy: as a source file, as an executable JAR file or in a form of a website with applets. The latest versions came with special features for embedding the exported applets into Moodle e-learning platform. The author, Francisco Esquembre (University of Murcia, Spain), released this tool under GNU GPL license making it freely available. Being supported by a large community of contributors, it is build on the Open Source Physics project libraries, the current version 5.0 (valid for 13th September 2013) requires Java Runtime Environment 1.5 or later, which also means it is a multi-platform program (running in Windows, Linux, etc.). EJS provides quite an intuitive graphical user interface and satisfying choice of pre-defined integration methods. It is also employed in building interactive distant or virtual laboratories (see, e.g. [2,8]).

The program itself and some examples have been already described by its author and other contributors (see, e.g. [3,4,6]). Let us concentrate on the tasks from the CzPhO, that can be also (though certainly not exclusively) solved using it in the form accessible to the secondary school students.

Example 1: school run of CzPhO

Problem: A capacitor with the capacity $C = 1.0$ mF was charged from a source with the voltage $U = 10.0$ V and at the moment $t = 0$ s it was connected with two resistors with the resistance $R = 1.0$ M Ω and another capacitor with the capacity $C = 1.0$ mF (Figure 1).

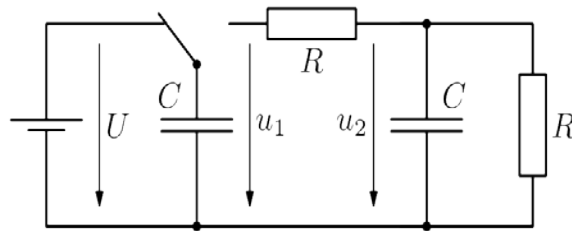

Figure 1. The circuit schema for example 1 (available in Czech from: [6])

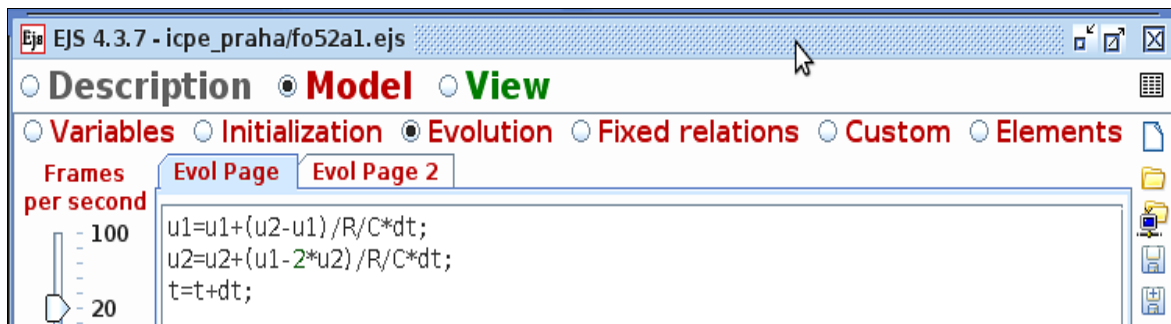

Figure 2. The cycle corresponding to the simplest Euler method in EJS

Through the numerical modelling find the dependencies of the capacitors voltages $u_1(t)$, $u_2(t)$. In the table find the time of the maximum value of u_2 and this maximal value u_{2m} .

Solution

Denoting the charges on the capacitors q_1 , q_2 and the currents through them i_1 , i_2 respectively, we obtain the system of ODEs

$$dq_1 = Cdu_1 = -i_1 dt = -\frac{u_1 - u_2}{R} dt,$$

$$dq_2 = Cdu_2 = (i_1 - i_2) dt = \left(\frac{u_1 - u_2}{R} - \frac{u_2}{R} \right) dt = \frac{u_1 - 2u_2}{R} dt,$$

which can be written in the form

$$du_1 = \frac{u_2 - u_1}{RC} dt, \quad du_2 = \frac{u_1 - 2u_2}{RC} dt$$

with the initial conditions $u_{10} = 10$ V, $u_{20} = 0$ V at $t = 0$ s. For the corresponding model using the simplest Euler method in EJS, see Figure 2.

In the table in Figure 3 we can find the maximum value $u_{2m} = 2.75$ V and the corresponding time $t = 0.86$ s. The time step chosen during the integration cycle was $h = 0.001$ s.

Example 2: national run of CzPhO

Problem: A steel athletics shot (heavy ball) with the mass $m = 7.26$ kg and the density $\rho_k = 7,800$ kg·m⁻³, is sunk under the water surface and then released.

- What is the limiting velocity during its fall to the bottom?
- What is the velocity of the shot and the position after the first second of its motion?

Part b) should be solved via the Euler method with the time step $h = 0.1$ s. For water resistance use the Newton formula

$$F_o = \frac{1}{2}CS\rho S^2.$$

Water density is $\rho = 1,000 \text{ kg}\cdot\text{m}^{-3}$, the coefficient $C = 0.48$.

Solution

The limiting velocity is determined by the balance of the downward gravity force F_G and upward buoyancy and resistance F_o forces F_b and F_o , i.e.

$$mg = V\rho g + \frac{1}{2}CS\rho v_m^2.$$

Substituting for the ball volume $V = m/\rho_k$, its cross-section $S = \pi r^2$ and determining the radius from the mass and density $r = \sqrt[3]{3m/(4\pi\rho_k)}$, we obtain

$$v_m = \sqrt{\frac{mg(\rho_k - \rho)}{K\rho_k}} = 4.74 \text{ m}\cdot\text{s}^{-1}, \quad \text{with} \quad K = \frac{1}{2}C\pi\rho\left(\frac{3m}{4\pi\rho_k}\right)^{2/3} = 2.766 \text{ N}\cdot\text{s}^2\cdot\text{m}^{-2}.$$

From the Newton's second law we obtain the resulting acceleration

$$a = \frac{F_G - F_b - F_o}{m} = \frac{g(\rho_k - \rho)}{\rho_k} - \frac{K}{m}v^2,$$

with the initial conditions $a_0 = g(\rho_k - \rho)/\rho_k$, $v_0 = 0 \text{ m}\cdot\text{s}^{-1}$ and $x_0 = 0 \text{ m}$.

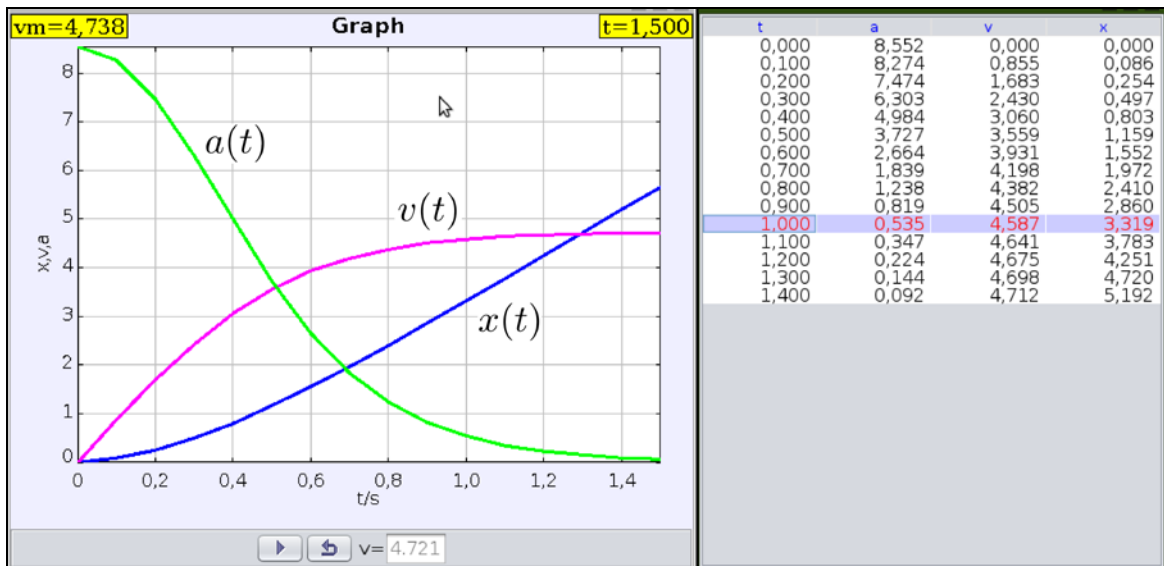

Figure 4. The graph and table of calculated values in example 2

As during the national run the students are allowed to use only pocket calculators, and not computers or notebooks, the task is designed in the way, that expected results can be obtained after several steps with a relatively large time increment $h = 0.1$ s. At $t = 1$ s the velocity is about $4.6 \text{ m}\cdot\text{s}^{-1}$, the position about 3.3 m below the starting point (Figure 4). The graphs also illustrate the fact, that the acceleration comes down to zero, the velocity

reaches the limiting value v_m and the dependence of the position on time $x(t)$ comes close to the linear one typical for the uniform rectilinear motion.

Example 3: Comet Hale-Bopp (CzPhO study text)

Problem: Comet Hale-Bopp discovered on 23th July 1995 passed the perihelion of its trajectory on 1st April 1997 at a distance 0.9141 AU from the Sun. The semi-major axis is $a = 187.8 \text{ AU} = 2.809 \cdot 10^{13} \text{ m}$. What was the comet's distance and velocity at the moment of its discovery? *Let's reformulate the task:* What is its distance and velocity now?

Solution

The problem was originally suggested for the approximate numerical solution of the transcendent Kepler's equation (see, e.g. [11], p. 34). Below we use the numerical modelling again.

This case represents a planar motion governed by the dynamic equations

$$a_x = -\frac{GM_s}{(x^2 + y^2)^{3/2}} x, \quad a_y = -\frac{GM_s}{(x^2 + y^2)^{3/2}} y,$$

with the gravitational constant $G = 6.67 \cdot 10^{-11} \text{ N} \cdot \text{m}^2 \cdot \text{kg}^{-2}$ and the solar mass $M_s = 2 \cdot 10^{30} \text{ kg}$.

We need to perform some calculations to find the initial conditions, setting $t = 0 \text{ s}$ at the time, when the comet is passing through the perihelion of its trajectory. Choosing the date just before the ICPE conference (4th August 2013) as “now”, we come to the “current” time 5969 days. From the ellipse geometry with the linear eccentricity e and eccentricity ε it follows that

$$e = a - r_p = 186.9 \text{ AU} = 1.3675 \cdot 10^{11} \text{ m}, \quad \varepsilon = \frac{e}{a} = 0.99513.$$

The conservation of mechanical energy and angular momentum enables us to derive the relation for the perihelion velocity (see, e.g. [11], p. 31)

$$v_p = \sqrt{\frac{GM_s}{a} \frac{r_a}{r_p}} = \sqrt{\frac{GM_s}{a} \frac{1 + \varepsilon}{1 - \varepsilon}} = 44.003 \text{ km} \cdot \text{s}^{-1}.$$

Therefore, orienting the x -axis from the focus to the perihelion along the ellipse semi-major axis, the set of the initial conditions reads as $x_0 = r_p = 1.3675 \cdot 10^{11} \text{ m}$, $y_0 = 0 \text{ m}$, $v_{x0} = 0 \text{ m} \cdot \text{s}^{-1}$, $v_{y0} = v_p = 44,003 \text{ m} \cdot \text{s}^{-1}$.

The EJS enables us also to rewrite the system of second-order ODEs as a set of first-order ODEs in the way similar to the Figure 5. We can see that for the exponentiation Java's Math.pow function has to be used. Then we can also choose one of the predefined integration methods, either with a fixed or adaptive step.

One of the very interesting features of the EJS is a possibility to export the model as an applet which can be embedded into a website (Figure 6); the time increment is set to $h = 5 \text{ days}$ in this case. We can compare the model with the Small-Body Database Browser provided by Jet Propulsion Laboratory (JPL, available from: <http://ssd.jpl.nasa.gov>). Our result for the Sun distance 34.589 AU (Figure 6) differs from the JPL value 34.597 AU only by about 0.02%. As in the simplified case of our simulation, this NASA's applet is implemented using 2-body methods (neglecting the influence of the other solar system bodies), and hence it should not be used to determine accurate long-term trajectories (over several years or decades). Instead, for such a purpose the NASA's Horizons system

(available from: <http://ssd.jpl.nasa.gov/horizons.cgi>) should be used. For the distance from the sun and the date 4th August 2013 the Horizons system returns the value 34.578 AU, so the difference from the NASA's two-body model represents 0.019 AU, i.e. about 0.05%. It may be assumed, that such a small difference is connected with a large inclination of the trajectory plane (about 89°) with respect to the plane of the planets of the Solar System.

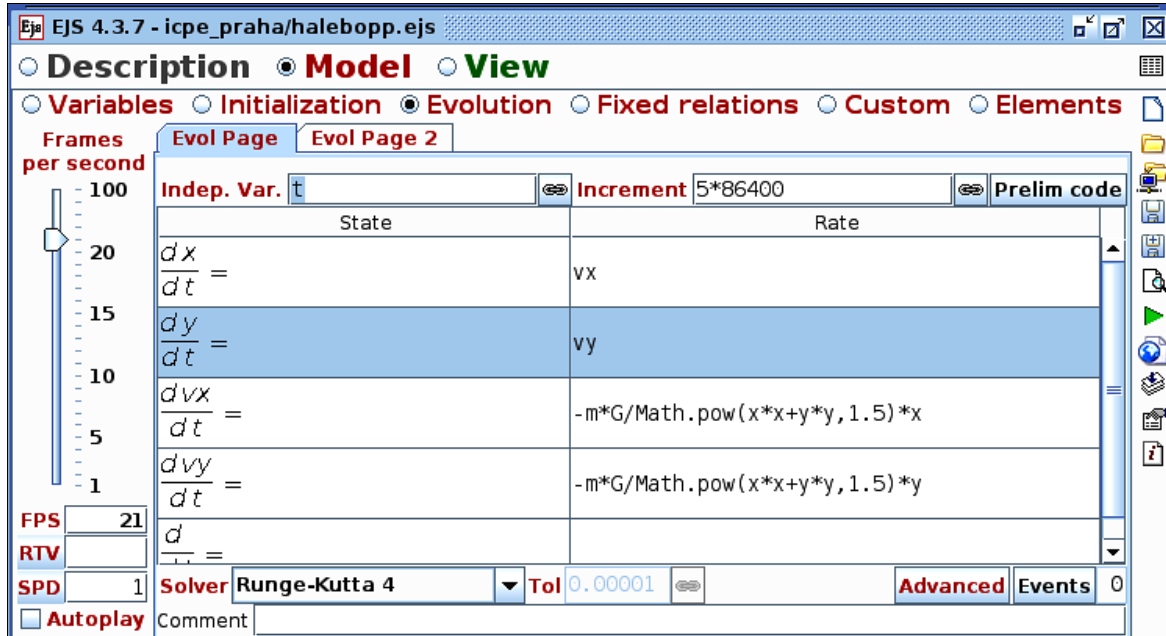

Figure 5. Another way of setting the system of ODEs in EJS

Conclusion

We have included problem solving with EJS in several situations: in local CzPhO seminars, in regional teacher's seminars, in a university course for prospective physics teachers and in summer schools for secondary school students. Generally, students find the tool relatively easy and powerful enough for the tasks they are supposed to solve. EJS was also used as a basic tool for two bachelor thesis. Only recently a very useful program to study modern cosmology based on the EJS engine was developed and described [10]. Thus, also taking into account the live community support, EJS seems to have a really interesting and promising educational potential.

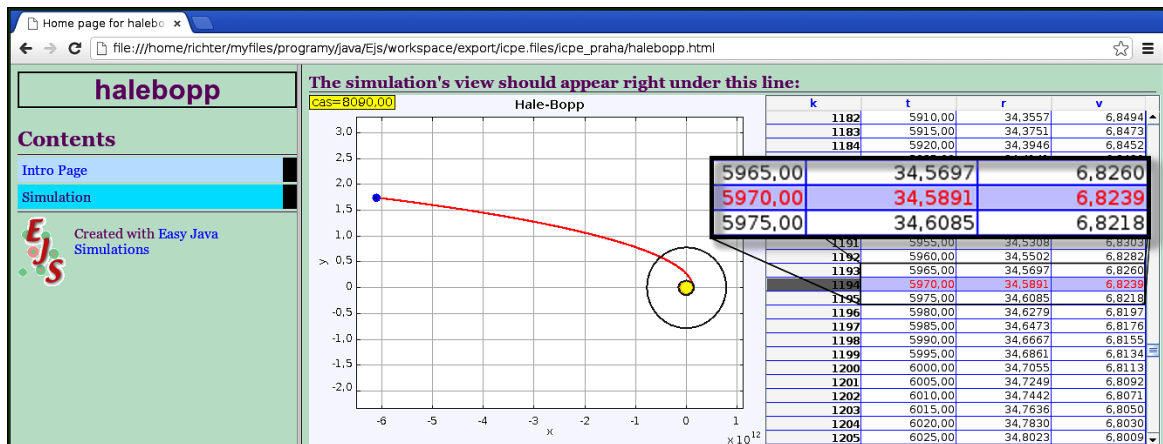

Figure 6. An exported model running as a Java applet in Google Chrome web browser

Acknowledgement

The support of the ESF project No. CZ.1.07/2.2.00/28.0168 is gratefully acknowledged. The project is co-financed by the European Social Fund and the state budget of the Czech Republic. The authors are obliged to doc. Oldřich Lepil and to dr. Přemysl Šedivý for fruitful discussions and encouragement.

References

- [1] Caballero M. D. et.al: Implementing and assessing computational modelling in introductory mechanics. *Physical Review Special Topics – Physics Education Research* 8, No 2 (2012), 020106, DOI 10.1103/PhysRevSTPER.8.020106.
- [2] Chaos D. et.al: Virtual and Remote Robotic Laboratory Using EJS, MATLAB and LabVIEW. *Sensors* 13, No 2 (2013), p. 2595–2612, DOI 10.3390/s130202595.
- [3] Christian W., Esquembre F.: Modelling Physics with Easy Java Simulations. *The Physics Teacher* 45, No 8 (November 2007), p. 475–480, DOI 10.1119/1.2798358.
- [4] Christian W., Esquembre F.: Modelling Science Textbook Chapter 2: Introduction to Easy Java Simulations. In: *Modelling Science: From Free Fall to Chaos*, [on-line]. [cit. 6. 9. 2013]. Available from: <http://www.compadre.org/Repository/document/ServeFile.cfm?ID=7306&DocID=479>
- [5] Czech Physics Olympiad, [on-line, in Czech]. [cit. 4. 9. 2013]. Available from: <http://fyzikalniolympiada.cz>
- [6] Esquembre F.: Easy Java Simulations: a software tool to create scientific simulations in Java. *Computer Physics Communications* 156, No. 2 (January 2004), p. 199–204, DOI 10.1016/S0010-4655(03)00440-5.
- [7] Esquembre F.: Easy Java Simulations, [on-line]. [cit. 4. 9. 2013]. Available from: http://www.um.es/fem/Ejs/Ejs_en/index.html
- [8] Fabregas E. et.al: Developing a remote laboratory for engineering education. *Computers & Education* 57, No 2 (2011), p. 1686–1697, DOI 10.1016/j.compedu.2011.02.015.
- [9] Landau R. H. et.al: *A survey of computational physics: introductory computational science*. Princeton University Press (2008), ISBN 978-0-691-13137-5.
- [10] Moldenhauer J. et.al: Modern cosmology: Interactive computer simulations that use recent observational surveys. *American Journal of Physics* 81, No 6 (June 2013), p. 414–420, DOI 10.1119/1.4798490.
- [11] Murray C. D., Dermott S. F.: *Solar System Dynamics*. Cambridge University Press (2000), ISBN 978-0-521-57597-3.
- [12] Ralston A.: *A First Course in Numerical Analysis*, McGraw-Hill, New York (1965), ISBN 978-0-070-51157-6.
- [13] Teodoro V. D., Neves R. G.: Mathematical modelling in science and mathematics education. *Computer Physics Communications* 182, No 1 (2011), p. 8–10, DOI 10.1016/j.cpc.2010.05.021.

A novel undergraduate experiment in birefringence using single-mode optical fibre

Ivan S. Ruddock

Department of Physics, University of Strathclyde, Glasgow, UK

Abstract

The polarisation properties of single-mode optical fibres are described and used as the basis for a novel undergraduate experiment in birefringence.

Keywords: university education; laboratory experiment; optical fibre; optics; birefringence

Introduction

The study of polarised light and birefringence in uniaxial crystals has long been a feature of optics classes and the corresponding sections of senior undergraduate laboratories. A thorough understanding of such topics is an essential prerequisite for postgraduate research in optics, nonlinear optics and the applications of lasers; for example, efficient second harmonic generation depends on achieving phase-matching where the incident laser beam and the generated frequency-doubled beam propagate with the same phase velocity within the doubling crystal, a situation only properly achievable when the beams are orthogonally polarised [1]. Other important examples include the control of lasers using Pockels cells based on the electro-optic effect [2], and the assessment of the optical homogeneity of crystals.

The classic undergraduate experiment in birefringence normally involves the identification of the birefringent axes of a uniaxial crystal and then the measurement of the retardation, i.e. the phase difference between the fast and slow axes by one or more methods. To bring it up to date and to demonstrate its continuing importance in physics, the version in the University of Strathclyde's Department of Physics exploits the birefringent properties of single-mode optical fibre as an alternative to those of a crystal.

Apart from being an experiment demonstrating birefringent components and measurements in a novel context, it is also a good exercise in basic laboratory technique. Students employ two independent methods of determining the retardation of wave plates and single-mode optical fibre and, since both have resolution limits and uncertainties, students must be able to reconcile their pairs of calculated values. In addition, the experimental study of birefringence trains students to work systematically as components must be placed in the light beam in a particular order and they must be adjusted in a logical fashion such that their polarization axes are aligned, orthogonal or at 45° to each other when appropriate.

Light propagation in birefringent media

The well-known description of light propagation in uniaxial birefringent media is summarised in Figure 1, but can be found in almost all textbooks on optics suitable for undergraduate students [2]. In the general case, for a beam of linearly polarised light travelling through a positive uniaxial crystal in a direction perpendicular to the optic axis, the light is resolved into orthogonal fast and slow components, separated by a phase difference ε . The locus of the tip of the electric vector of the emergent light scribes an ellipse given by

$$\left(\frac{E_y}{E_{oy}}\right)^2 + \left(\frac{E_x}{E_{ox}}\right)^2 - 2\left(\frac{E_y}{E_{oy}}\right)\left(\frac{E_x}{E_{ox}}\right)\cos\varepsilon = \sin^2\varepsilon \quad (1)$$

where E_{ox} and E_{oy} are the amplitudes of the fast and slow components. Note that, if the incident linearly polarised light is aligned with one of the crystal's birefringent axes, it emerges linearly polarised again since there is no orthogonal component with which to recombine.

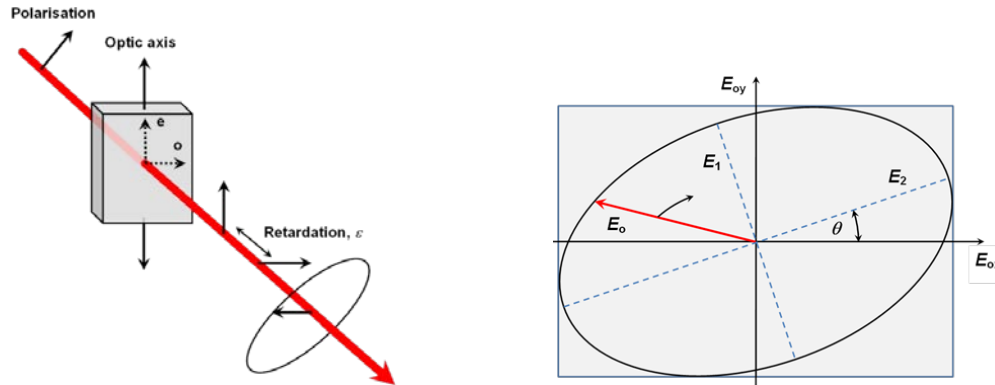

Figure 1. Left: A beam of plane polarised light travelling through a positive uniaxial crystal in a direction perpendicular to the optic axis. Right: The orthogonal components recombine to give light of linear, circular and elliptical polarisation depending on ε and their relative amplitudes. The semi-minor and semi-major axes of the elliptically polarised light are E_1 and E_2 respectively.

Measurement of retardation

Retardation may be measured by two different techniques: (i) intensity analysis of the light following propagation through a birefringent crystal [3], and (ii) compensation [4]. The first method is simple to perform and clearly demonstrates the elliptical polarisation state of the light. The compensator is a professional instrument which, although it dates back to the nineteenth century, is still manufactured and is routinely used in the calibration of electro-optic crystals and optical fibres.

Analysis of intensity

When the amplitudes of the fast and slow components, E_{ox} and E_{oy} , are equal, it can be shown via an instructive exercise in co-ordinate geometry that the relative intensities, I_1 and I_2 , associated with the emergent semi-minor and semi-major axes of the elliptically polarised light are related to the retardation, ε , by

$$\cos\varepsilon = \frac{I_1 - I_2}{I_1 + I_2}. \quad (2)$$

Experimentally this situation is achieved by ensuring that the incident linearly polarised light is orientated at 45° to the birefringent axes of the medium. The relative intensities can then be easily measured by a basic photodiode behind a polariser rotated in the emergent light to transmit the maximum and minimum. The precision of this technique depends on the accuracy with which the orientation and the intensities can be measured, for example, an error of 2° in the 45° produces an error of 0.1% – 2% in ε depending on the value of ε ; likewise, an error of 5% in I_1 and I_2 results in a 3% error in ε . Clearly, by its nature the “intensity” method also demands a stable laser and very careful alignment and adjustment.

Babinet-Soleil compensator

The Babinet-Soleil compensator is a variable waveplate whose retardation can be set positive, zero, negative. It is used to cancel the unknown retardation (ε), thus restoring the elliptically polarised light emerging from the birefringent crystal to the original linear polarisation; then from its calibration equation, the measured ε can be deduced. When introduced into the experiment, the compensator's birefringent axes must be parallel to those of the crystal, and thus to the fast and slow components making up the emergent elliptically polarised light. Success is only possible if great care is taken by working from extinction at each stage and then turning the compensator by an appropriate angle and so on.

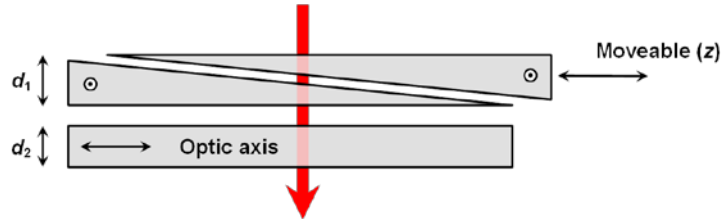

Figure 2. A beam of linearly polarised light travelling through a Babinet-Soleil compensator comprising two blocks of uniaxial crystal in a direction perpendicular to their optic axes. The lower block is of thickness d_2 and the upper is of total thickness d_1 which is adjustable by a micrometer moving the upper wedge to the right or left. The birefringent axes are reversed in both parts of the compensator, i.e. the fast polarisation in the upper block is the slow in the lower and vice-versa.

By simple analysis of the situation illustrated in Figure 2, the total retardation of the compensator is

$$\varepsilon = \varepsilon_1 + \varepsilon_2 = \frac{2\pi}{\lambda} [(n_o - n_e)d_1 + (n_e - n_o)d_2] = \frac{2\pi}{\lambda} (n_o - n_e)(d_1 - d_2) \quad (3)$$

where λ is the wavelength of the light and n_o and n_e are the ordinary and extraordinary (or fast and slow) refractive indices of the crystal at this wavelength. Because of the wavelength dependence, a compensator must first be calibrated by placing it at 45° between crossed polarisers and adjusting the micrometer until extinction is observed. The values of z obtained correspond to phase differences of an integral multiple of 2π and the light emerging from the compensator is thus linearly polarised in the original orientation, Figure 3.

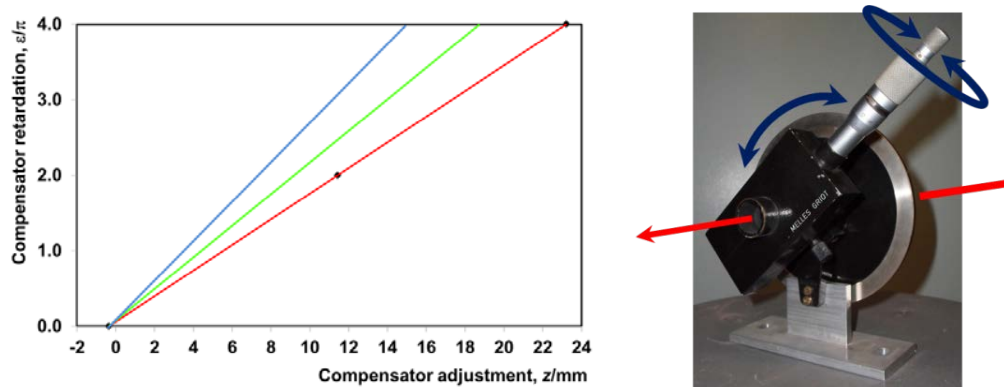

Figure 3. Left: Calibration plot for the Melles–Griot 04 SBC 001 compensator. The line of lowest slope is for 632.8 nm with equation, $\varepsilon = 0.17\pi \text{ rad. mm}^{-1}z + 0.06\pi \text{ rad}$ (4). Right: The Melles–Griot 04 SBC 001 compensator.

In taking a set of repeat readings, it is not unusual to record readings with a range of

~ 0.04 mm, due to backlash in the micrometer and the subjective element in judging the point of extinction. Nevertheless, a typical standard deviation is only ~ 0.01 mm (0.0017π), the same as the resolution uncertainty.

Single-mode optical fibre

Most optical fibre used for scientific purposes is simple ‘step index’ in which there is an abrupt but small increase in refractive index of ~ 0.01 on going from the surrounding cladding to the core, produced by doping the silica in the core with impurities during the manufacturing process. Light striking the core-cladding boundary at an angle of incidence greater than the critical angle experiences total internal reflection and is confined giving rise to discrete modes as in a waveguide, identifiable in the spatial pattern of the emergent light.

The elementary treatment of light propagation in optical fibres is usually based on a ray model in which the rays are normal to the wave fronts and the mode observed at the exit is caused by the interference of the intersecting wave fronts. On account of the three dimensional nature of an optical fibre, rays are classified either as meridional, when they cross the fibre’s axis after each reflection and propagate in a plane, or skew, when they spiral about the axis. Both cases give rise to a set of modes of increasing complexity as the angle of incidence at the core–cladding boundary varies between 90° and the critical angle. In real fibres however, the refractive index step is sufficiently small that the true modes represented by meridional and skew rays cannot always be separately resolved as the fibre diameter varies. The actual modes are linearly polarised (LP_{lm}) and are either individual modes or superpositions of two or three modes; the subscripts in the LP notation describe the azimuthal and radial distribution of the composite electric field respectively.

Single-mode operation is essential in high capacity communication applications to avoid modal dispersion and is obtained by decreasing the fibre diameter until only the lowest order mode, LP_{01} , can propagate. For the fibre used in this experiment, a core diameter of $3.5 \mu\text{m}$ ensures it is single-mode for wavelengths greater than ~ 600 nm, Figure 4.

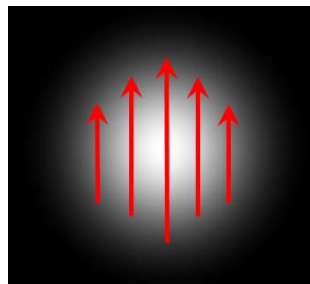

Figure 4. A schematic representation of the lowest order linearly polarised LP_{01} mode with its Gaussian intensity profile

The linearly polarised LP_{01} mode may be launched and transmitted in a perfectly cylindrical fibre with its polarisation in any direction. However, due to manufacturing tolerances and mechanical strain at bends, the longitudinally integrated refractive index signature is not azimuthally uniform and gives rise to propagation characteristics analogous to those of a uniaxial crystal. Hence, there are orthogonal fast and slow axes along which incident linearly polarised light is resolved, and the state of polarisation at the exit depends on the relative amplitudes of these two components and the accumulated phase difference between them. These birefringent axes are stationary in the fibre unless it is disturbed. Specialised single-mode fibres in which the birefringent axes are locked into

the fibre (high birefringence) or are completely absent (low birefringence) are available for specific applications in lasers and sensing.

Experimental setup

The general arrangement for studying and measuring the birefringence in a single-mode optical fibre is shown in Figure 5. The entire experiment can be mounted on a basic triangular optical bench using saddles and rods. The microscope objective ($\times 10$) at the input end must be coaxial with the laser beam and so needs to be held in a gimbal mount providing tilt about two axes, and fixed to a saddle with horizontal and vertical adjustment. The only high quality component required is the input fibre mount which must possess axial control to optimize the focusing of the light into the fibre's end-face, in addition to the same four adjustments of the microscope objective for positioning it normal to the beam. Only very crude control is necessary at the output end of the fibre as the second lens is just used to collimate or focus the diverging light. A quarter wave plate/polariser combination allows the direction of polarisation of the incident light to be rotated through 360° to aid the location of the axes.

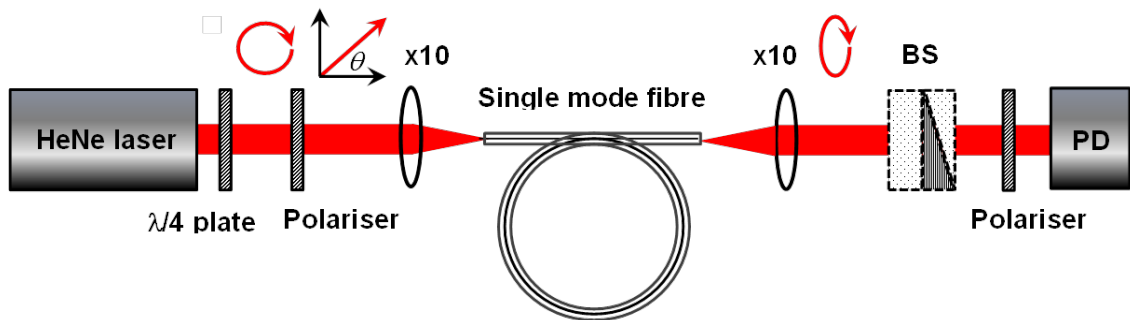

Figure 5. A schematic of the experimental arrangement for studying and measuring the birefringence in a single-mode optical fibre. BS is the Babinet-Soleil compensator and PD, the photodiode.

The Babinet-Soleil compensator is by far the most expensive component in the setup, but if one is unavailable, measurements of retardation can still be made by the ‘intensity’ method described above. For this, any cheap general purpose photodiode suffices as long as its active area is larger than the focused spot of light from the fibre. Likewise, ‘Polaroid’ or equivalent can be used for the polariser and analyser if mounted on a simple graduated rotatable screen.

Before it can be used, both ends of the fibre must be properly prepared. One way is to use a fibre cleaver as marketed by many of the optical component companies, but an alternative and low-cost method, is to stress the fibre with heat. The ends of the fibre are first gripped in their respective chucks with approximately 4 mm protruding from each. The coating from these sections is then burnt away by a small flame and the brittle tip is ‘cleaved’ by touching it with the blade of a knife. If the procedure has been successful, the light beam emerging from the fibre should be free from coarse speckle and be similar in character to an expanding laser beam. Suitable single-mode fibre at 632.8 nm, for example SM600, is available from ThorLabs for a few euros per metre, and a few metres will be enough for the apparatus to be used weekly over a few academic years.

Experiment

In performing this experiment, the following lists what a student is expected to complete in one or two laboratory sessions:

- Identify the birefringent axes in a sample of uniaxial crystal of any thickness and type.
- Calibrate the Babinet-Soleil compensator (if available).
- Measure the birefringence (ε) of the crystal sample using the “intensity” and compensator methods.
- Align the optical fibre apparatus, prepare the fibre tips and succeed in transmitting light through a length of a few metres.
- Identify the fibre’s birefringent axes and observe the effects of stress birefringence on their orientation.
- Measure the birefringence (ε) of the optical fibre by the two methods.

A competent experimenter should have no trouble in obtaining reproducible values for the birefringence measurements; for example, nine repeat pairs of intensity readings gives $\varepsilon = 0.38 \pm 0.01 \text{ rad}$ using (2), and six repeat settings of the compensator gives, $\varepsilon = 0.371 \pm 0.001 \text{ rad}$ using the calibration plot and equation in Figure 3.

Conclusions

An undergraduate experiment concentrating on birefringence has been described. It is an alternative to the traditional experiment on birefringence in crystals and serves as an inexpensive introduction to single-mode optical fibre technology. Because components must be placed into the laser beam in the correct order, their birefringent axes found and aligned by locating extinction etc., it is also an exercise in laboratory skills demanding a logical approach and precision. The topics covered include the location of the birefringent axes in crystals and fibres, the calibration of a Babinet-Soleil compensator, and its use together with intensity analysis of elliptically polarised light for measuring retardation; procedures with which a physics undergraduate intending to specialise in optics, lasers or optoelectronics should be familiar.

References

- [1] Ruddock I. S.: Nonlinear optical second harmonic generation. *Eur. J. Phys.* 15, No.2 (March 1994), pp. 53-58.
- [2] See for example, Pedrotti F. L., Pedrotti L. M., Pedrotti L. S.: *Introduction to Optics*, third edition, Pearson Prentice-Hall International (2007), ISBN 0-13-197133-6 or Bennett C.A.: *Principles of Physical Optics*, Wiley (2007), ISBN 13 978-0-470-12212-9, or equivalent undergraduate optics textbooks.
- [3] Smith A. M.: Polarisation and magneto-optic properties of single mode optical fibre. *Appl. Opt.* 17, No.1 (January 1978), pp. 52-56.
- [4] Longhurst R. S.: *Geometrical and Physical Optics*, third edition, Longman (1973).

Physics during Sightseeing in London and Paris

Dorothy Sebestyen

Kandó Faculty, Obuda University, Budapest, Hungary

Abstract

According to my personal experiences I can say that during a foreign journey we can discover a lot of interesting sights that can be related to physicists or the laws of physics. Buildings, bridges, churches, sundials, monuments, tombs can be found among these sights just as paintings or sculptures in the museums, or anything else that can be related to physics. We can also inspire the students to look for such sights in their town, or during a tour in a foreign country, or at the Internet. This technique of education can be a small contribution to the active learning. The possibilities to apply the traditional methods in active learning are severely limited during the Physics or History of Physics courses at our university, but I think, this task and the possibility to have particular and interesting lectures give some solution for this important problem.

Keywords: history of physics, sundial, art

Introduction

During a national or foreign journey we can discover a lot of interesting sights that can be related to physicists or the laws of physics. Application of one of these sights and its explanation at the lectures does not serve as an explanation of a physical law, but can be used as an illustration to the given law, or at the history of physics course it can illustrate the life of a physicist. This presentation would like to be a small “collection of illustrations” which could be the origin of inspiration for the colleagues to make more colourful their lectures.

At our university the students of electrical engineering have a two-semester Introductory Physics course. Following this compulsory course, they can attend an optional course, The Cultural History of Physics. Using the presentations of the sights can be especially useful in the mentioned optional course.

The examples are divided into two groups from both of towns: sights to illustrate some topics of physics, and sights to illustrate a topic of history of physics.

I. Sightseeing in London

1. Sights to illustrate some topics of physics

A special sight can be found in the Trafalgar Square in one of the most beautiful square in London: the Imperial Standards of Length. (Figure 1) The three tables were mounted here in 1876, at temperature 62 Fahrenheit degrees, as it is written there. The main plaque shows British imperial standards of length. Shown are one foot, two feet and a yard. The inch is marked as well. Along the bottom of the wall are marked other standard units.



Figure 1. The Imperial Standards of Length

After the measures of length I have to mention that the sundials had important roles in the history of measurement of time. Four interesting sundials can be found on the tower of the Saint Margaret's church, and also a guide to help reading time and reading off the correction. (Figure 2) Although this arrangement of sundials is not so old, it was designed in the 20th century, it is a very good illustration how the appearance of a vertical sundial depends on the direction in which the wall is facing.



Figure 2. One of the sundials on the tower of the St Margaret's church

The London Eye, located on the South Bank of the Thames, is a 135 m high carbon steel wheel rim. 32 passenger capsules are attached to the outside of the rim. (Figure 3) Its motion illustrates the difference between the translation along the circular track and rotation. We also can use this construction to create good problems for the physics classes in connection with forces, velocity, energy, circular motion, or we can mention that the capsules have a special shape in order to decrease the air resistance.



Figure 3. The London Eye

The Millennium Bridge is a suspension bridge crossing of the Thames exclusively for pedestrians. I heard that its nickname is “wobbly bridge” and I was looking for the origin of this name. During the first days after its opening large number of people crossed the bridge producing a pendulum-like sway. The bridge's movements were caused by a 'positive feedback' phenomenon. The natural sway motion of people walking caused small sideways oscillations in the bridge, which in turn caused people on the bridge to sway in step, increasing the amplitude of the bridge oscillations and continually reinforcing the effect. After the first days, anxiously from the resonance, the bridge was closed for almost two years and putting dampers on it, the modifications successfully eliminated the wobble.

2. Sights to illustrate the history of physics

In the famous Westminster Abbey the Newton's grave is a compulsory sight for the physics teacher. (Figure 4) Here is a reclining figure of Newton, his elbow is resting on his four most important books and the most interesting part of this monument is the sarcophagus. It depicts boys using instruments related to Newton's work in mechanics, optics and chemistry (alchemy) and his activity as Master of the Mint.



Figure 4. Newton's grave in the Westminster Abbey

The so-called Great Fire of London destroyed the city in 1666. The memorial of the Great Fire bears the name: The Monument. (Figure 5) It was built by Christopher Wren and Robert Hooke. I mention this memorial because of Hooke, whose name is known for us only from the Hooke's law, although he had many contributions to the different part of science and rebuilding of London as the Surveyor of the City of London. The Monument consists of a Doric column topped with a gilded urn of fire, which was designed by Robert Hooke. Hooke designed the central shaft for use as a zenith telescope and in gravity and pendulum experiments that connects to an underground laboratory. The steps in the shaft of the tower are all six inches high, allowing them to be used for barometric pressure studies.

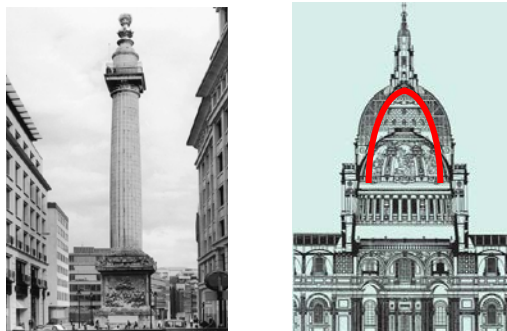

Figure 5. Hooke in London: The Monument and the Saint Paul's Cathedral

The Saint Paul's Cathedral was designed by Wren, but it was Hooke who found the optimum shape of the masonry arch (the inverted catenary) to carry the heavy dome. (Figure 5) He wrote: "How the flexible chain hangs, the inverted rigid arch stays".

Being a Hungarian physics teacher I have to mention the corner of the Southampton Row and the Russel Square. This was the place, where Leo Szilárd in 1933, waiting for the stoplight to change, conceived the idea of the nuclear chain reaction, using recently-discovered neutrons.

II. Sightseeing in Paris

1. Sights to illustrate some topics of physics

In connection with the name of Léon Foucault as a matter of course the Foucault pendulum comes into our mind. "Have you seen the earth go round? Would you like to see it rotate? Go to the Pantheon on Thursday ... from ten a.m. to noon. The remarkable experiment devised by M. Léon Foucault is carried out there, in the presence of the public, under the finest conditions in the world; and the pendulum suspended ... from Soufflot's dome clearly reveals to all eyes the rotational movement of our planet." This description of the Foucault pendulum was written by the scientific correspondent, on the front page of *Le National* on 26 March 1851. [1] The pendulum which can be seen today was installed there in 1995. (Figure 6)



Figure 6. The Foucault-pendulum in the Pantheon

The booklet "The Foucault pendulum at the Pantheon" [1] also includes the surprising text: "Not long ago, a survey revealed that of 55 million French people who have received a normal education, 5 million diehards firmly believed that it is the Sun which continues to pass its time by revolving around us." [1]

In Paris we have to bring up the memory of Blaise Pascal. It is well worth seeing the nice Saint Jacques tower, which belonged to a church in Pascal's days. (Figure 7) In 1648 Pascal made his experiments here to prove that the change of the atmospheric pressure can be measured by the change of the height of the mercury column, and the distance of the top and the bottom of a church tower is enough to experience the difference between the measured values.



Figure 7. The Saint Jacques tower and Pascal's statue under the tower

George Seurat's painting, "The Eiffel Tower" can be used to model the wave-particle duality of light. This painting consists of tiny dots of pure colours (particles) and shows continuous picture (wave), so we can recognize the tower (Figure 8). According to some art historians Seurat's technique of pointillism was inspired by his understanding of the physical nature of light. [2]

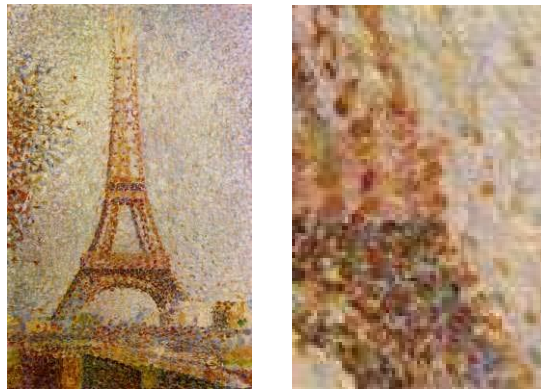

Figure 8. George Seurat: "The Eiffel Tower" and its detail

Concerning the connection of the Eiffel Tower and physics, we can create problems in different topics. We can ask questions in connection with the structure of it: its reaction to the change of the temperature, its shape and stability, its reaction to the wind, or problem can be constructed in connection with its height and a distance from where we can see it in a given angle, combining this question with some motion, etc.

2. Sights to illustrate the history of physics

Probably most of us miss the fact that on the sides of the Eiffel Tower names of scientists can be read. (Figure 9) Among to the 72 scientists well-known physicists are: Clapeyron, Fourier, Fresnel, Coulomb, Foucault, Poisson, Gay-Lussac, Fizeau, Becquerel, Coriolis, Ampere. (Here, Carnot's name does not refer to Sadi Carnot, but to his father, the mathematician Lazare Carnot.) [3]



Figure 9. Some names on the Eiffel Tower

In one of the museums of Paris we find Raul Dufy's *Le Fée Electricité*. This painting of gigantic size consisting of 250 panels, was created in 1937 to the World's Fair to the wall of the palace of the Light and electricity. On the lower part of the painting portraits of 100 scientists and inventors can be seen. (The Greek scientists remind us the Greek origin of the name of electron.)

Conclusions

In this presentation I wanted to remind you that during a foreign or national journey, we can look around not the same way as usually. Getting home then we can further investigate our experiences using the Internet and we can interpret the observed sights to our students from a wider aspect.

Collecting our "physical" experiences we also can create interesting physics problems in connection with some of these sights, for example from my previous examples in connection with the London Eye, or the Eiffel tower, or Foucault pendulum.

The important message of my presentation is that the colleagues and students can collect similar experiences not only during their foreign journeys, but also in their own homelands. The Internet also provides possibility to find such examples undertake a "visual journey".

In order to confirm the acceptance of this type of lectures from the students' side, I would mention here some results from the survey made by me at the end of my History of Physics course. In connection with a similar presentation (that time the title of the presentation was: From Milan to Florence from the point of view of a physics teacher) 89% of the participant students found that the presentation was interesting for him/her. 26% of these students answered that this presentation helped him/her improving the physics knowledge. 68% of the responders would likely participate on similar presentation talking about different cities.

References

- [1] Deligeorges S.: *The Foucault Pendulum at the Pantheon 1851 - 1902 - 1995* (Paris, 2008).
- [2] Kemp M.: *The science of art* (Yale University Press, New Haven and London, 1990).
- [3] http://en.wikipedia.org/wiki/List_of_the_72_names_on_the_Eiffel_Tower

Web Database of Solved Problems Encourages Students' Active Learning in Physics

Marie Snetinova, Zdenka Koupilova, Dana Mandikova

Department of Physics Education, Faculty of Mathematics and Physics, Charles University in Prague

Abstract

To solve physics problems is a key ability which students should reach during their physics education. There is usually lack of time to solve enough problems during lessons especially for students with worse previous education or mathematical skills. And moreover, there are hardly any suitable materials for home study of these students. For this reason we have developed a collection of fully solved problems. The structure of problems' solutions is specially designed to substitute tutor's help during lesson and encourage students to solve at least some parts of a problem independently. The development of the database started in 2005. Nowadays it contains more than 800 tasks in Czech, 90 tasks in Polish and 60 tasks in English. The database is available at the website <http://www.physicstasks.eu/> [1].

Keywords: Web-based learning, solved problems, structured help, physics.

Introduction

The paper is a follow-up to the contributions presented at GIREP-ICPE-MPTL 2010 [2] International Conference and GIREP-EPEC 2011 Conference [3], where the electronic collection of fully solved problems in physics was presented. The collection is being developed at the authors' department since 2005.

The electronic collection is designed primary for students in introductory university physics courses to practice and deepen the knowledge gained at high school. It is suitable also for high school students with a deeper interest in physics. Because we want to enlarge the usability of the collection, simpler high school tasks as well as junior high school tasks are also gradually inserted into the database.

All tasks in the collection contain detailed commented solutions, various hints, notes and other tools to help users with self-study and to lead them to active thinking about presented physics problems. Availability on public web pages enables usage of the collection by both students and teachers not only at our faculty but also at other universities and high schools.

We did not find any other extensive collection of physics tasks designed in a similar way.

How the collection looks like

The page with task is divided into several parts (see Figure 1). A drop-down menu with tasks list can be found on the left side. Tasks in each part of physics are structured into chapters and subchapters. The task itself is located on the right side of the web page. Ribbons with individual sections of the solution are placed under the assignment of the task. The required section is displayed only after clicking on the ribbon. Further clicking on the ribbon hides the section again.

Tasks are classified according to difficulty into four categories: L1 – L4 (secondary school level, upper secondary school level, high school level and university level). Level of the

task is indicated by an icon in the right upper corner. Each task can be included into special categories if it is solved using some special way (qualitative task, graphical task, task with unusual solution, complex task or task with theory). These special categories are indicated at the right side of the page as well.

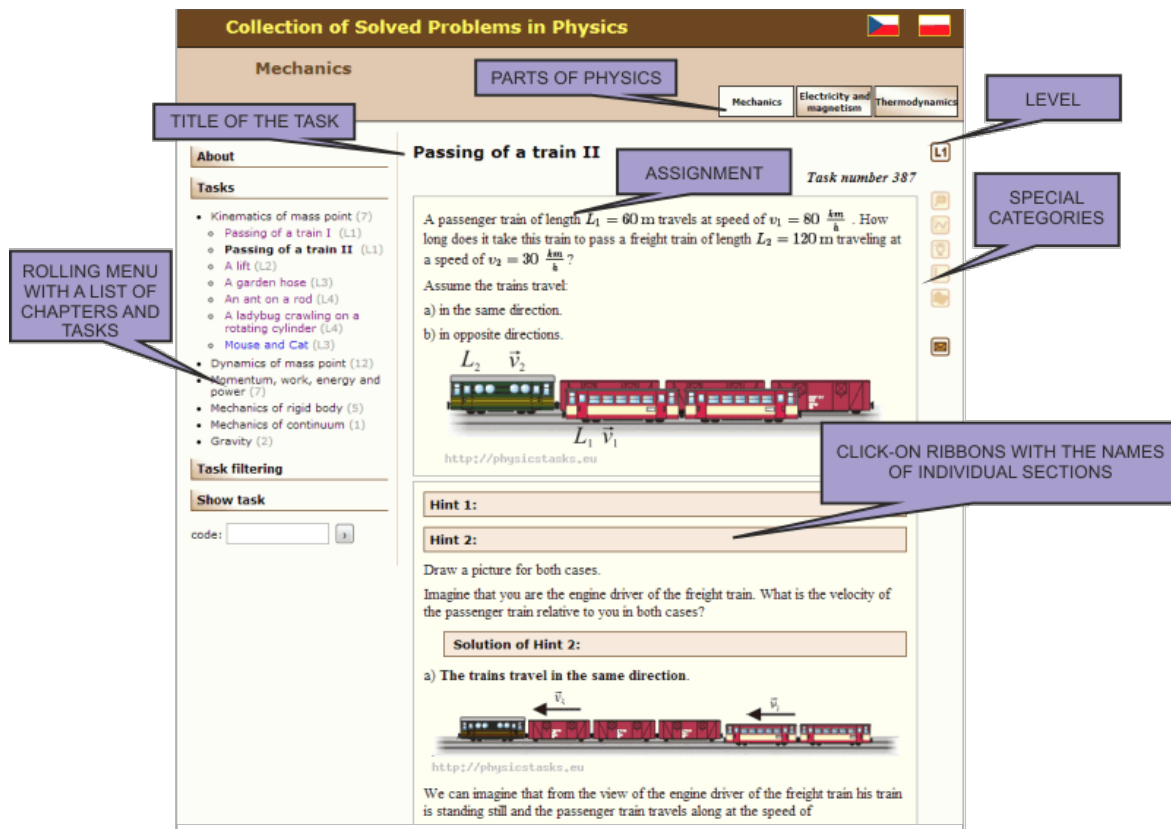

Figure 1. Appearance of the collection

The main advantage of the collection is seen in the possibility to reveal the parts of the solution item-by-item. Such a structure is more likely to motivate students to an active approach to solving of the task than printed solution used in textbooks (which often leads to a simple reading of the solution without deeper thinking about the problem). The users themselves appreciate the usefulness of this structure as well as of the presence of sections with hints and analysis (see chapter Usage of the collection).

Current content

Nowadays the Czech version of the database contains more than 800 published tasks. About 60 tasks are in the English version of the collection and the Polish version contains 90 tasks. Tasks in other languages arise by translating from Czech. The number of tasks in each subject is shown in Table 1. From the Table 1 can be seen that the collection contains apart from physics parts two mathematical parts as well – Mathematical analysis and Linear algebra.

The administrator interface is written completely in English, so the collection is prepared for extension to other languages. Most of the tasks in the collection are arising within the students' bachelor and diploma theses.

Table 1. Number of tasks in each subject

<i>Language version</i>	<i>Part of physics/ mathematics</i>	<i>Number of tasks</i>
Czech version	Mechanics	200
	Electricity and magnetism	215
	Thermodynamics and molecular physics	140
	Physics of microworld	60
	Theoretical mechanics	35
	Mathematical methods	18
	Mathematical analysis	120
	Linear algebra	50
English version	Mechanics	32
	Electricity and magnetism	28
	Thermodynamics	20 in progress
Polish version	Mechanics	31
	Electricity and magnetism	24
	Thermodynamics	36

Usage of the collection

The collection is used in universities during seminars aimed to problem solving, which support compulsory physics lectures. Students who cannot attend seminars regularly – especially part-time students – appreciate this material very much. Also high school teachers and students like the project and see it as very helpful and useful.

Because we feel that it is important to monitor the usability of the collection, we placed a feedback questionnaire at the web pages of the collection. Completion of the questionnaire is voluntary. Therefore, in interpretation of data, it is necessary to take into account that the questionnaire was not assigned to a representative sample. Up to the date of July 30, 2013, 172 questionnaires have been completed and processed. The collection is also positively assessed in personal as well as in e-mail communication.

About 49% of respondents who filled in the feedback questionnaire stated that they use the collection of problems regularly during the term. Users appreciate the structure of the tasks (especially hints and analysis) and the database interface as shown in Figure 2.

We started to use GoogleAnalytics tools at the beginning of the spring 2013 to monitor accesses to the collection and its usability. From the gained data follows, that there are 200 to 1000 unique visitors per day. In Figure 3 you can see the pattern of the working week as well as the decrease of the visitors during Czech summer holiday in July.

The demographic distribution of the users can be also very interesting. Accesses from individual countries are shown in Figure 4. We want to use these data for targeted propagation and presentation of the electronic collection in areas, where it is not known very well.

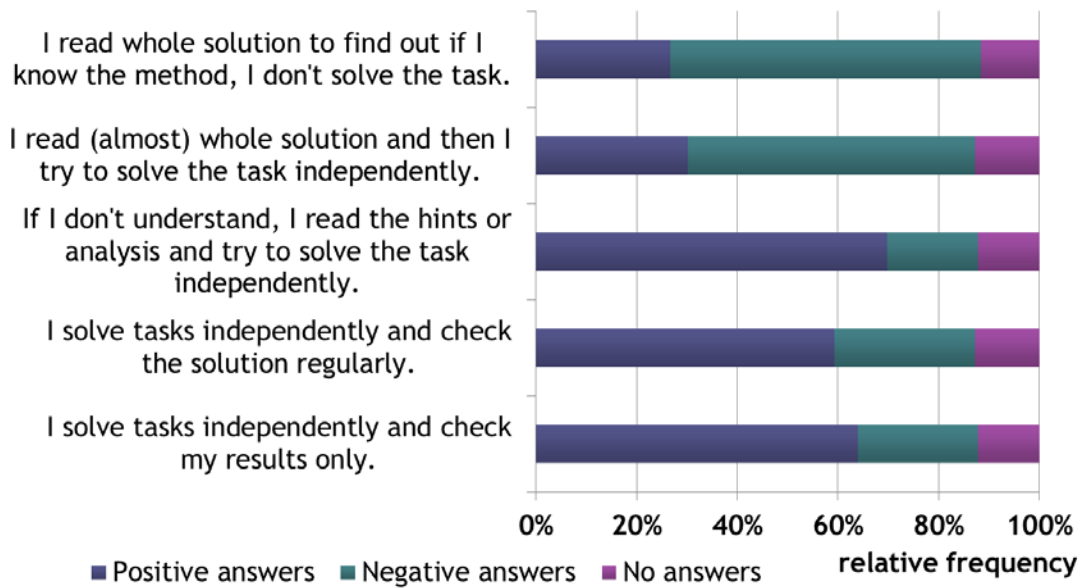

Figure 2. Reader's behaviours during problem solving



Figure 3. Unique visits to the collection (with highlighted holidays) per day

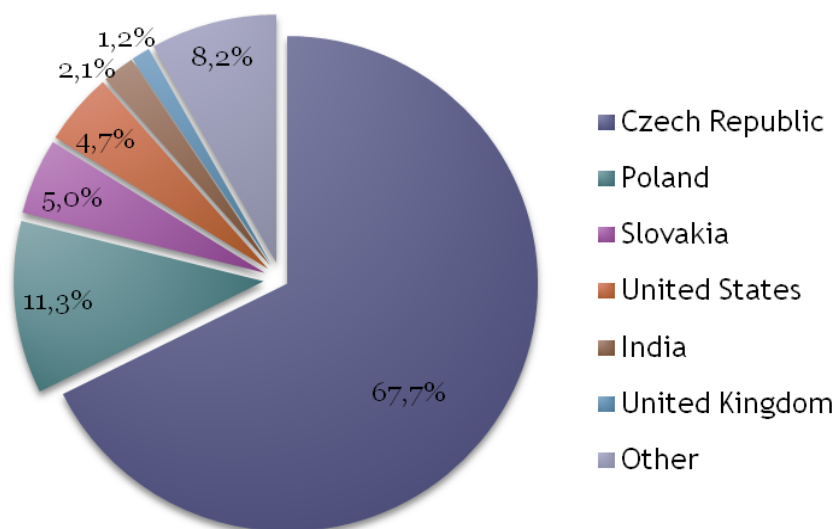

Figure 4. Where are the users from

Future plans

New tasks will be added into already existing parts and the tasks will be also continuously translated into English. Apart from creating new tasks, we want to get to work a new function that allows teachers to create worksheets and assignments of written exams compiled from the tasks in the electronic collection.

The collection will be also divided into physical and mathematical part because of expanding number of the tasks in mathematical subjects.

Conclusion

Most users of the collection believe that further development of new tasks would be a beneficial goal. Therefore, we would like to extend and improve the electronic collection in the future. We believe that it will become a good assistant for all students and physics teachers. Suggestions to other tasks or remarks to the present state of the collection can be sent at the address: *sbirka@kdf.mff.cuni.cz*.

References

- [1] Collection of Solved Problems in Physics, (2013), [online], [cit. 29. 8. 2013]. Available from: <http://physicstasks.eu>
- [2] Koupilova Z., Mandikova D., Snetinova,M.: Electronic Database of Solved Tasks in Physics. Proceedings GIREP-ICPE-MPTL 2010, in print.
- [3] Koupilova Z. et.al: Electronic Collection of Solved Physics Problems – How to Create Your Own New Problem. Proceedings GIREP-EPEC Conference 2011, Physics Alive, (2012), p. 226-229.

Workshops

Semiconductors at Work

Leoš Dvořák

Faculty of Mathematics and Physics, Charles University, Prague, Czech Republic

Abstract

In the workshop its participants practically created some simple low-cost tools with basic semiconductor components (namely LEDs and bipolar transistors). This paper shortly describes reasons why it is useful to build and use such tools in physics education and mentions how such activities were applied in in-service teacher training. Some examples of tools that proved to be useful are presented and a feedback from teachers is discussed.

Keywords: semiconductors, electric circuits, simple experiments, teacher training

Introduction

In our modern world, semiconductors are around us in great numbers in practically all devices more sophisticated than a hammer. Though most such devices are just “black boxes” for their users, physics education can (and should) provide at least some knowledge about how semiconductor components work. However, quite often the information on semiconductors is presented rather theoretically and even physics teachers do not have much practical experience with behaviour of basic semiconductor components.

This paper briefly describes how we tackled this problem in in-service teacher training, presents some simple tools that proved to be useful in courses for physics teachers and indicates how they can be used so that teachers really feel they can master to “let semiconductors work”, at least at the basic level.

Our approach

Our basic principle can be expressed as “*practical experience first*”. Of course, our approach is not “just hands-on”, it is not just playing. Surely, teachers and students have to think why simple circuits with semiconductor components behave as they behave. The “minds-on” element is very important. However, it proved to be really useful to start with practical investigation of behaviour of semiconductor components and also with practical building of simple circuits and tools. Our approach can be called “inquiry based”, but it is a *guided* inquiry – neither wild experimenting without boundaries nor mindless construction of some circuits without understanding of their function.

Stating that, we surely do not say that all our understating of semiconductors should end at the level of circuits. (For example, after measuring the voltage at LED’s of different colours, teachers discuss why it is different at blue, red and IR LED, how this is related to the energy of photons etc.) Nevertheless, basics of the theory concerning semiconductors are described in many books and other resources and teachers can either study or recall this part of physics even individually – after they practically familiarize with semiconductor components and stop to perceive them as something strange and alien.

Where it was used

We have used this approach consistently for more than 5 years in our seminars for physics teachers in the Heureka project (see [1]). During the two-year course for new Heureka

participants we devote one whole weekend seminar to investigating semiconductors. This represents about 16 hours of rather intensive activities. We used it also in several shorter (one day) courses of in-service teacher training in Czech Republic. Even shorter seminars (half day) are also possible and we organized a few of them. However, in case of shorter seminars the content should be limited.

At one occasion we also led a shorter workshop for Slovenian physics teachers (see [2]). Also, participants of a small international workshop *PhysHOME 2012* [3] built their own electrostatic indicator [4] at the workshop led by the author.

The workshop at the conference ICPE-EPEC 2013 was one of shortest presentations of the approach mentioned above. In fact, only part of our approach, just construction of selected simple semiconductor circuits, could be presented in the limited time. Nevertheless, even this gave the participants some idea about the whole character of our seminars and courses. During the workshop the participants built some simple circuits and tools with semiconductors – and mastered it very well!

Concerning *feedback* from teachers, it is very positive. It is standard at Heureka seminars that teachers fill in a short questionnaire after each seminar evaluating every activity at the scale from -2 (“complete disaster”) to +2 (“super!”). They can also add free comments. Apart from very good “marks” (which are rather standard at Heureka seminars, though we know that teachers can be also very critical) the teachers appreciated very much that they can develop practical skills, really build something that works and take devices they built to their classes. By working with semiconductor components from the very beginning, from investigating the simplest circuits they build their own understanding and at the end they do not fear these components and circuits, they feel competent. Similar feedback was received from teachers at other courses and seminars. Therefore, it seems that our approach and style really fulfils some teachers’ needs.

Not only experiments and measurements – build some tools by yourself!

Why it is important

Similarly as was demonstrated at the workshop, teachers at the courses and seminars not only do experiments, discuss their results and measure data; they also build some simple tools by themselves. Why is it important?

One reason is the fact that it is better to use simple transparent tools rather than “black boxes” in physics education. Of course, multimeters we use are also, in a sense, black boxes. Yet, teachers and students get used to them and the function of multimeters is, in general, quite simple, just to show values of voltage or current. In a sense, also batteries are “black boxes”, but also with clear purpose and, if we do not go into details, with rather simple features. Batteries and multimeters are our (already known) tools. However the simple circuits with components we just start to investigate should be as transparent as possible. The circuits teachers build *are* very simple and transparent.

The other reason was already briefly mentioned above. Teachers gain healthy self-confidence when they build some tools and they work(!). They enjoy it, they are proud of their work. We can say that they experience the “ownership” of both the process of creating the tools and of the results. In fact, the tools they build are theirs also in a formal sense; they take them away to their schools and they use them in their teaching. The whole process can have also some multiplicative effect. Some teachers reported they subsequently built more those simple tools, sometimes with their students.

We can also remind a quote of a famous physicist Piotr Kapitza (that I, unfortunately, cannot find now, so I quote him just roughly) that the best way how students can learn is when they build their own instruments for experimenting.

Low cost “technology” used

The “technology” we use for building simple circuits and tools uses wooden boards and small brass nails. Terminals of components (LED’s, diodes, transistors, resistors etc.) or connecting wires are soldered to the brass nails. For attaching a battery or other external component cables with small crocodile clips are used.

As a comparison of Figure 1 a) and b) shows, the arrangement of components on a wooden board can correspond to the circuit diagram, so it can be very transparent to both teachers and students.

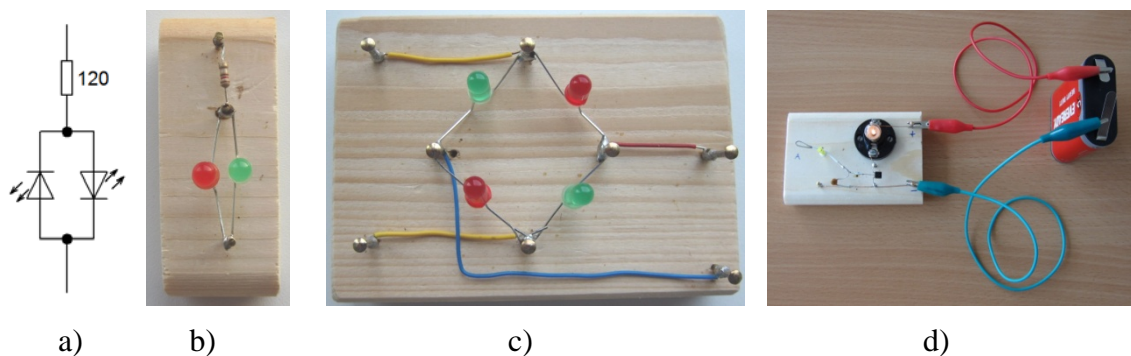

Figure 1. Examples of simple circuits on wooden boards

Simplicity and transparency are not the only advantages of our “technology”. The other strong point is the fact that these instruments and tools are *really low-cost*. The price of semiconductor components (LEDs, bipolar transistors, etc.) and also resistors are very low. For example, you can get more than 20 pieces of the transistor BC547 for one USD. Brass nails are not very cheap but some 50 small nails can cost also about one USD. Wooden boards are also not expensive. Therefore students and teachers can build such simple tools for much lower cost in comparison to prices of similar tools in catalogues of suppliers of educational equipment.

Let’s add two technical notes: 1. Brass nails proved to be very good for easy soldering wires and component terminals to them. Nails from some other materials can be much less satisfactory. 2. Wooden boards should be from soft wood because brass nails are also rather soft and trying to nail them into hard wood is an unpleasant experience resulting in a lot of curved brass nails.

Examples of simple tools teachers and students can build by themselves

Simple indicators with one or two LEDs

One of simplest possible tool is an indicator at Fig. 1 a). An even simpler version can contain just one LED; the variant with two LEDs with reversed polarities and different colours (Figure 1 b) is more universal. This tool can be built by teachers or students as the first “instrument” they create. In spite of its simplicity it can serve to several purposes:

- as a voltage indicator, indicating voltages from about 3 V to 6 V or even more,

- as a current indicator, indicating currents from about 0,1 mA to 20 mA,
- as a polarity indicator, or as an indicator distinguishing AC and DC,
- with a battery attached, it can check cables, semiconductor diodes, etc.

Last but not least: Attach the indicator to AC of about 3-5 V/50 or 60 Hz and move it with your hand quickly from side to side. The colour stripes you see are probably the simplest proof that in AC the polarity changes regularly. You can discuss the inertia of our vision etc. Also, if the voltage is low (3 V or even less) there are “dark parts” between the colour stripes. If the voltage is higher, the dark parts nearly disappear. You can present it as a problem to your students and subsequently discuss what voltage is needed for a LED to shine.

Also, you can modify the circuit. For example, to indicate greater voltages (and not to overload the LEDs) it is necessary to use a resistor of higher resistance. This also brings the possibility to discuss the application of Ohm’s law in our circuit. The voltage at LEDs is about 2 V (slightly less at a red LED, slightly more at a green one); the current through small LEDs should not exceed about 20 mA. (Of course, they can survive more, at least for a short time, but it may not be good for their “condition”.) So, in case we should indicate the voltage of about 10 V, the voltage at a resistor in series should be about 8 V; the current through the resistor being 0.02 A. Therefore, the resistance should be about 400 Ω , the standard value of 390 Ω will suit well. Of course, we do not present here all the discussion and calculations you can do with students and teachers. It is up to each teacher or teacher educator what she would like to discuss and which teaching method she applies. Let’s just mention that simple tools and instruments provide great potential for active learning (or for IBSE if you would like to choose this term). One further advantage connected with a low price of our circuits lies in the fact that if something is destroyed, there is nearly no harm – we just solder in a new LED and a work can continue.

Simplest demonstration that a bipolar transistor amplifies current

Of course, a transistor does not “amplify” current. Rather, using a small current into its base a much larger current in a collector circuit can be controlled. Figure 2 shows a very simple tool that can demonstrate this behaviour.

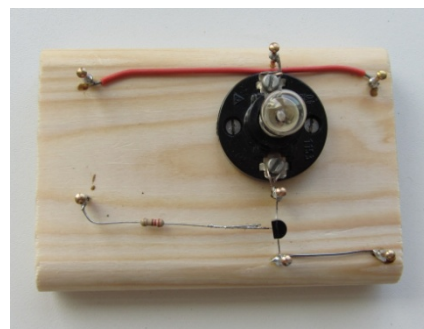
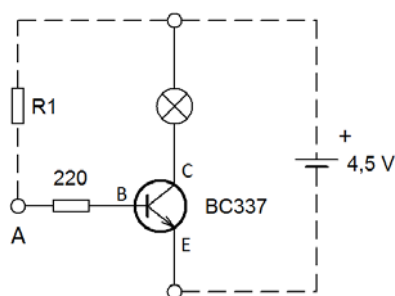

Figure 2. A tool that demonstrates that small current into the base can control large current in the collector circuit of a transistor

As a transistor, a cheap type, as for example BC337 can be used. It can withstand currents up to 0,8 A. A small light bulb (for example 3,5 V/0,3 A) is used in the collector circuit. If we connect this light bulb to the battery 4.5 V by a resistor 220 Ω , the light bulb does not shine. (We can easily calculate that the current is about 20 mA, too low for the light bulb to

shine perceivably.) However, connecting the terminal A of the circuit to the plus terminal of the battery makes the light bulb shine. Instead of connecting A and the + terminal by a piece of wire we can connect them by a resistor R1 with a resistance up to about 4.7 k Ω or even more. (The typical current gain of the transistor BC337 is about 400, so a current of about 1 mA can control a current up to 0,4 A in the collector circuit. Technical note: When using transistor BC337, use its “subtype” BC337-40, it has the largest current gain).

Again, there are various possibilities how to use this tool in teaching basics of transistor behaviour, common emitter circuit, current gain, etc. Also, it offers many possibilities for experimentation, active learning or IBSE. All this can be done without a necessity to use any multimeters, though, of course, parameters of the circuit can be also measured quantitatively. However, even without qualitatively or semiquantitative investigation of properties and behaviour of the circuit requires not only hands-on but also a lot of “minds-on” activity.

Two bipolar transistors can indicate very small currents

An indicator with three bipolar transistors was already described in [4]; for experiments with that indicator see [5]. Here we describe a simpler version of the indicator, with two bipolar transistors and LED, see Figure 3.

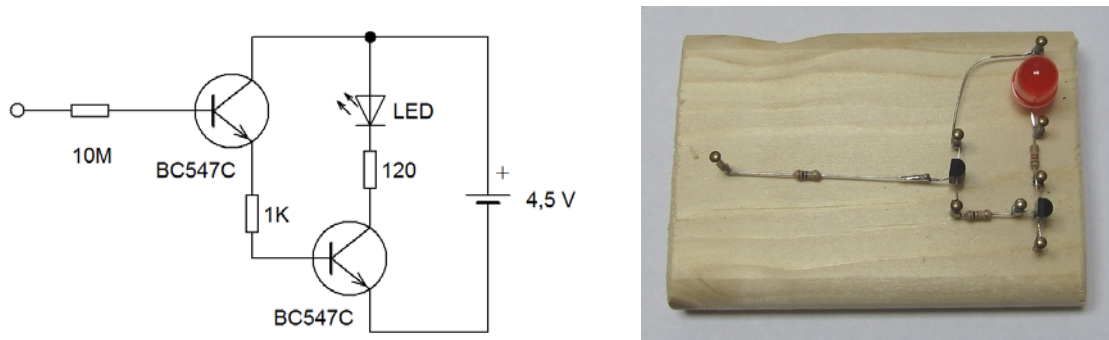

Figure 3. A simple indicator that can be used also in electrostatic experiments

Let us note that this type of combination of two transistors has been known for a long time under the name Darlington circuit. What is more important for us: This type of indicator proved to be very popular among teachers. Also, the building of this circuit formed, in fact, the core task of the workshop “Semiconductors at work” at ICPE-EPEC 2013. All participants were able to construct this circuit in less than one hour, some were even much quicker.

What is attractive about such a simple circuit? It can indicate very simple currents flowing into the “input terminal” (at the left-hand side of the circuit), of the order of several nanoamps. Again there is an opportunity to discuss why it is so sensitive: Current amplified by the first transistor is amplified by a second one, so their current gains multiply. A current gain of a transistor BC547 is typically roughly 500, so the total current gain is about $2.5 \cdot 10^5$. Input current of, say, 4 nA, is therefore amplified to 1 mA, which already makes the LED to shine.

To let the LED shine it is sufficient to connect the input terminal with the + battery terminal by your fingers or by touching one of those terminals with your finger and the other with, say, your nose, forehead etc. Also, if you attach a short cable or wire to the input terminal and move a charged rod closer to it or farther from it, the LED will indicate

this. If the rod is charged negatively, the LED will shine if we move the rod farther from the terminal. (For the explanation, see [4]. Let us just note that this indicator enables us to distinguish the sign of the charge at the rod.) A motion of a larger charged rod can be indicated at the distance of more than one meter.

Again, this circuit provides a lot of opportunities for further experimentation, modifications etc.

Further possibilities

Other simple circuits that demonstrate the behaviour of semiconductor components and enable to investigate “semiconductors at work” can be built – and were built at our courses and seminars. Let us mention just two or three more examples that can be used for different types of activities.

Demonstrations

To demonstrate a function of a Graetz rectifier the circuit in Figure 1 c) can be used. Here, LEDs are used instead of ordinary diodes. (The author saw this idea many years ago at a conference of Czech physics teachers.) If you use a low frequency AC generator as a source and put some “appliance”, for example the circuit shown in Fig. 1 a), at the output, the LEDs in the rectifier circuit show where the current flows in which part of the period.

A low frequency AC generator is not so much low-cost equipment. So, it may be preferable to use a normal DC battery (or two batteries) and a switch to produce “AC voltage”. Of course, its time profile is not harmonic but square. However, for demonstration purposes it is often sufficient.

Measurements

At teacher training courses we usually start quantitative measurements with the task to measure a volt-ampere characteristics of a LED. (To be precise, as a “starter” we use a task to measure the characteristics of an ordinary resistor, i.e. the task where the result is well known to all participants. The purpose is to check whether all multimeters work, the cables are not broken, batteries are sufficiently fresh, participants can set the right ranges on multimeters, read the data, put the results in a graph, etc. Just then, being sure that all this works, we continue to investigate an “unknown” component, a LED.)

We will not describe the measurement of LED characteristics in any detail here. We just mention a simple tool we use to control the current through the LED. An ordinary rheostat may be too expensive, at least if we need one for each teacher or student group. A simple device with six resistors shown in Figure 4 can do the same task. It enables to control the current in rather rough steps (more than 1:2), but this is just what we need when we measure the characteristics of a LED: to set the current over broad range of values.

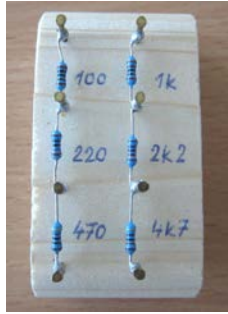

Figure 4. A “triade resistor”

To set the resistance to a precise value, decade resistors (called also resistance decade boxes) are used in labs. Our device is much simpler and has just three resistors in each decade. So we tentatively call it a “triade resistor”. It proved to be useful in many measurements. In Figure 4, the triade resistor that can set the resistance from 100 Ω to nearly 10 k Ω is shown. We also use triade resistors covering the range 10 k Ω to nearly 1 M Ω and other for resistances below 100 Ω .

... up to ICs

The “technology” described in this paper is not limited to very simple circuits with transistors. More than thirty teachers participating in the author’s workshop at the conference “Heureka Workshops 2012” (see [1] for a short information on these conferences) managed to build their own simple stroboscope using an integrated circuit 555. Most of them mastered it in less than 90 minutes, the record time being just about 30 minutes, something unbelievable even to the author himself.

The purpose of the workshop was not just to build something that flashes but also to explain the principle of relaxation oscillators, especially timers with IC 555. Therefore not only the construction of the device but also detailed explanation of its function was described in a paper in the proceedings of the conference. Because the paper was in Czech we will not cite it here. We just present the photo of the stroboscope in the Figure 5 to demonstrate that also a bit more complicated circuits can be built on wooden boards.

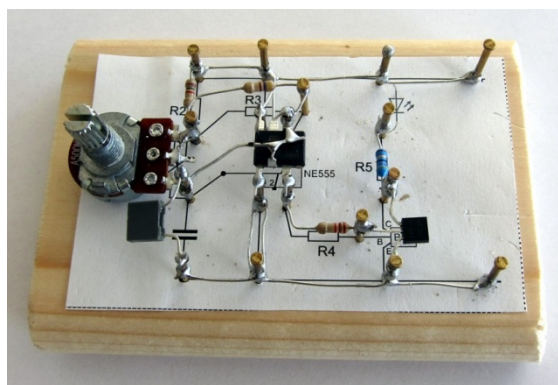

Figure 5. A simple stroboscope with IC 555

Do not forget to start from the very beginning

Though, as we can see from the last example, more sophisticated tools can be constructed, it is good to keep in mind that the purpose of above mentioned tools and devices is not to build more and more complicated circuits. Such approach could be interesting just for

some teachers and students. (Namely for those who probably can find their way to semiconductors and electronics anyway.) The purpose is to learn some basic facts concerning features and behaviour of semiconductor components – and to learn them in an active way, by active experimenting and by active thinking what really happens in the circuits we build and investigate.

Conclusions

Let us conclude this paper by reminding again the feedback from teachers. They appreciate that our approach enables them to develop some skills – as soldering – they have not used for years or never before mastered sufficiently. Also, they cease to fear semiconductor components, at least some of these components became for them rather familiar. The other aspect of this familiarization may concern the fact that the teachers who participated in our workshops and courses are not anymore afraid, at least to some extent, of making mistakes. If some mistake happened and even some component was destroyed, well it was an opportunity to learn and to avoid the same mistake next time!

An important factor appeared to be the fact that all tools and devices teachers built at the courses and workshops were theirs. They took them to their schools and later used them in their teaching. As was already mentioned, some teachers – and not only those “born to be electronic geeks” – reported that they subsequently built, sometimes with their students, these and similar simple tools and devices and used them in their classes.

Also, an important aspect of our approach is that it is not strictly fixed to one age group or to one specific curriculum. It can be used at the level of both lower and upper secondary school and even at a university level, especially in pre-service teacher training. All educators can “tune it” according their own needs and the needs of their students. The author hopes that also participants of the workshop at ICPE-EPEC 2013 and other readers of this paper will adapt this approach according to their own needs and aims.

References

- [1] Dvořáková I.: *Active learning in the Heureka Project – teachers in the role of students*. Keynote at ICPE-EPEC 2013. In this Proceedings.
- [2] Koudelková V., Faletič S.: *Teachers explore electronics*. Physics Education 45 (March 2010), p. 125.
- [3] PhysHOME 2012. Available on-line: <http://kdf.mff.cuni.cz/physhome/>
- [4] Dvořák L.: *Bipolar transistors can detect charge in electrostatic experiments*. Physics Education 47 (July 2012), p. 434-438.
- [5] Dvořák L., Planinšič G.: *Experiments with charge indicator based on bipolar transistors*. Phys. Educ. 47 (Sept. 2012), p. 721-727.

Simple and Beautiful Experiments VI by LADY CATS and Science Teachers' Group

Kyoko Ishii¹, Fumiko Okiharu², Masako Tanemura³, Mika Yokoe⁴, Haruka Ohnishi⁵, Masa-aki Taniguchi⁶, Tatsuhiro Uchida⁶, Junichiro Yasuda⁷, Shinjiro Ogawa⁸, Kazuhiro Tokuda⁶, Shinnosuke Suzuki⁶, Takahiro Shogenji⁹, and Hiroshi Kawakatsu⁶

¹Fukui University, ²Niigata University, ³Osaka Kyoiku University, ⁴Daishogakuen High School, ⁵Nishinomiya-inazu Senior High School, ⁶Meijo University, ⁷Gifu University, ⁸Waseda University Senior High School, ⁹Kyoto Tachibana University

Abstract

LADY CATS (LADY Creators of Activities for Teaching Science) is an organization of science teachers. Our group includes a lot of female teachers, which is rather unusual in the field of physics.

Our concepts of experiments are follows: the “simple” experiments which the teachers in the world can utilize by lesson easily, the “beautiful” experiments that children get interested, and the “essential” experiments which can demonstrate the principles of physics. We aim to develop excavate and spread such experiments.

Effective teaching materials are presented on our hands-on workshop.

Keywords: Educational Experiments, Workshop

Introduction

LADY CATS (LADY Creators of Activities for Teaching Science) is an organization of science teachers from high school teachers to university researchers [1-3]. Our group includes a lot of female teachers, which is rather unusual in the field of physics.

The aim of our activities is to encourage students and teachers who are not good at physics. Usually female students in Japan are less interested in Physics, and they do not take physics lesson in high school or in university. Therefore, female physics teachers in educational field are few in Japan. On the other hand, there are many female teachers at primary schools. They feel uncomfortable to teach science, especially physics field. In order to change this situation, we have formed LADY CATS since 2005. It is important to show how women are enjoying physics.

We have performed workshops "Simple and Beautiful Experiments" in several international conferences. In these workshops, we demonstrated and explained our experiments and the participant made the experimental device from the material which we had prepared. The international conferences in which we have participated are WCPE 2012 (Turkey), ICPE 2010 (France), ICPE 2009 (Thailand), ASE 2008 (Britain), ICPE 2007 (Morocco), ICPE 2006 (Japan), and ICPE 2005 (India). Recently we have opened our website [4].

Our concepts of experiments are follows: the “simple” experiments which the teachers in the world including Japan can easily utilize by their lesson, the “beautiful” experiments which children get interested, and the “essential” experiments which can demonstrate the principles of physics.

OUTLINE OF OUR TEACHING MATERIALS

We held a workshop of interesting physics experiments and teaching materials at 16:40-18:00 on Aug. 6th in ICPE-EPEC 2013. We explained each experiment at each table. More than 100 people participated in our workshop. In the following we briefly show the outline of our experiments. More detailed handbook on each experiment can be found in our website [4].

Paper craft balance beam scale (Kyoko Ishii)

The educational aim of this project is to make a balance beam scale, perform experiments with it, and discuss the findings [5]. This project provide the experience of inquiry and examine the scientific concepts of “mass,” “turning effect,” “principles of balancing,” and “control of variables.”

A balance beam scale is not only the simplest tool for measuring weight; it is also an ideal tool for discussing mass, measurement, and the basic concepts of statics. This paper craft beam is simple and easy to make. Teachers can arrange learning programs according to their students' grades and abilities.

Examples of statements or questions are as follows:

- a) “Which button is heavier?” (Figure 1(a))
- b) “How can you balance two Snoopies (objects) with one Snoopy (object)?” (Figure 1(b))
- c) “Why does two Snoopies balance with one Snoopy? Explain.” (Figure 1(c))



Figure 1. (a)



Figure 1. (b)



Figure 1. (c)

Newton's Cradle (Fumiko Okiharu)

Newton's Cradle (Executive ball clicker) is a popular teaching material to study physics principles, conservation of energy, conservation of momentum and friction [6].



Figure 2.

If one ball strikes rest of four stationary balls, one ball on the opposite side swings out and back. Two balls strike three balls; two balls on the opposite side swing out and back. In this motion, we see elastic collisions, kinetic and potential energy.

Because of interesting motion of Newton's Cradle, even pupils have fun to play with. Instead of the same size of balls, we can choose number of balls and its mass. For example, prepare two balls with mass M and $3M$. Once one ball hit the other ball, motion of swing will be different from one of five balls.

Figure 2 is shown handcrafted Newton's Cradle. A bead is pasted on a marble and a piece of string is threaded through the bead. Each the end of a piece of string is fixed by the polystyrene foam board. Four bamboo skewers are used as support rods and inserted into wooden board. (The four holes were made with the gimlet on the wooden board in advance.) We use these cheap materials for small children to make easily. Therefore, it needs some creative thinking to keep its quality as Newton's Cradle. You may use ready-made beaded weights and stable foundation.

As development of this equipment, the periodic motion and resonance of a pendulum are considered [7].

Soap Films in Frameworks (Masako Tanemura)

In 1873, Belgian physicist, Joseph Plateau, proved that the area of a soap film becomes the minimum from a mathematical point of view [8,9]. The surface area of a soap film is minimized by the action of surface tension.

(1) Tetrahedron and Cube

- Make a Tetrahedron with some fuzzy wires (Figure 3(a)). Before you conduct the experiment, please predict how the soap film will adhere to the tetrahedron frame.
- Dip the frame into a soap solution. How did the soap film actually form to the frame?



Figure 3. (a)



Figure 3. (b)

(2) Prisms

- Make two prisms with some fuzzy wires (Figure 3(b)). The height of a prism is small. The height of another prism is large.
- Dip frames into a soap solution. How did the soap film form to frames?
- By the difference of height, there are two types of soap films (Figure 3(c)).

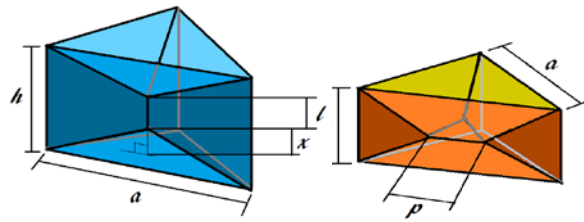

Figure 3. (c)

These experiments are not only visually appealing, but experimental results are not in agreement with anticipations. The experiments with soap film grow students' interest in surface. Even children can make a framework easily using color wires. It is also useful for raising children's spatial perception.

SO-MA-TO (Mika Yokoe)

SO-MA-TO is a kind of revolving lantern which was invented in the middle of Edo period (18 Century) in Japan. A toy as shown in Figure 4 (a) is also seen in the West. This teaching material would provide students with a visible effect in learning on the rising air current and the thermal power generation [10].

In SO-MA-TO, a heat source, such as a filament lamp, is contained. The windmill is attached to the upper part of the outer frame of a cylinder type. The warmed air goes up and the outer frame itself rotates in response to a rising air current. If the picture is drawn on the outer frame, a shadow picture will rotate such as Figure 4(b).



Figure 4. (a)



Figure 4. (b)

Geiger-Müller Counter Made of a Film Case (Masa-aki Taniguchi)

Geiger-Müller counter (GM counter) is a detector that measures ionizing radiation. We can make this apparatus with daily uses [11,12].

GM tube is made of a film case in which the butane gas is put. The anode is arranged at the center of the film case and the cathode is arranged in its surroundings, and a high voltage is applied between them. A condenser is made of plastic cups and aluminium foil. In order to supply enough electricity, we use a kind of van de Graaff generator with a hand crank.

When an ionizing radiation enters into the GM tube, the butane gas is ionized. The positive and the negative ions move to the cathode and anode, the pulsed current flows, and the electromagnetic radiation is generated. This is picked up by the AM radio.

With this experiment, students can learn that a radiation makes a substance ionize and how we can detect the radiation with a GM tube.

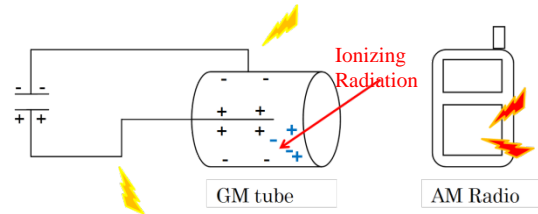

Figure 5.

Simple Transistor Circuit (Tatsuhiko Uchida)

A transistor can function as a switch or amplifier. However a transistor much more performs when combined with other devices. We will show a simple transistor circuit which can function as not only switch but also a timer, vibrator, others.

This circuit is a module, which consists of a transistor, a resistor, a variable resistor, a capacitor, a LED and some terminals. Figure 6 (a) is a circuit schematic and Figure 6 (b) is a layout of the circuit module.

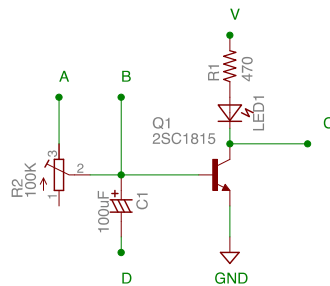

Figure 6. (a)

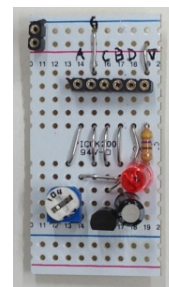

Figure 6. (b)

We can make some circuits.

- Touch switch: touch terminal B and V by fingers then the LED lights (Figure 7(a)).
- Timer: connect terminal G and D using a wire. The LED gives a delay of few seconds after connecting between terminal A and V. The delay time is tuned using the variable resistor R2 (Figure 7(b)).
- Blinking lights: joint two circuit modules M1 and M2. Connect A of M1 and V of M1, A of M2 and V of M2, C of M1 and D of M2, C of M2 and D of M1 (Fig. 7(c)). Then both LED will blink alternately.
- Flip-flop: prepare two circuit modules M1 and M2. Connect A of M1 and C of M2, A of M2 and C of M1 (Fig. 7(d)). LED of M1 lights when connected B of M2 and GND using a wire. The light is not off when removed this wire.

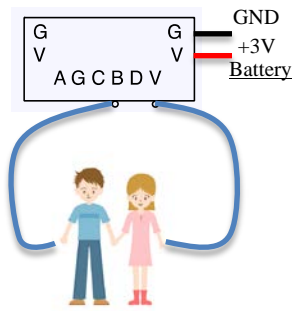

Figure 7. (a) Touch switch

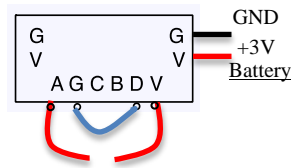

Figure 7. (b) Timer

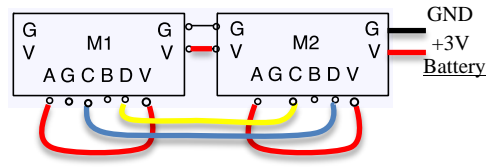

Figure 7. (c) Blinking lights

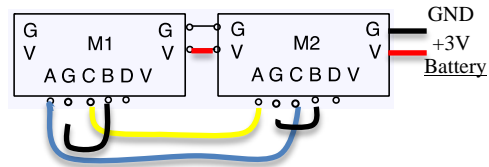

Figure 7. (d) Flip-Flop

Rolling Paper Roll on Valley (Jun-ichiro Yasuda)

If you pull the edge of the paper rolls [13] in front, which do you think the paper rolls will roll, in front or in back?



Figure 8. (a) Concavely attached rolls on a box valley.



Figure 8. (b) Convexly attached rolls on a box valley.



Figure 8. (c) Convexly attached rolls on carpet.

Students feel these experiments interesting since the results of the experiments are counter-intuitive and the touches to pull the tapes are strange. With these experiments, students can understand a phenomenon where the moment, the balance of forces, and the friction are concerned.

Versatile Japanese Yen (Shinjiro Ogawa)

To learn electromagnetic phenomena, you need visible movement of objects caused by the micro-scale change inside. Japanese one yen coins are light enough for showing its internal electromagnetic changes to your eyes.

One yen coins are made from almost pure aluminium and are very light coin. Their density is 2.7 g/cm^3 and their mass is 1.0 g. Piled 10 yens have a height of 1.5 cm and when placed in a straight line they measure 20 cm across.

You can find its electrostatic, electromagnetic and paramagnetic property with charged rod or magnet when put on the water surface or suspended [13,14].



Figure 9.

We explain how to experiment with Yen in the following.

- a) Estimation of the molar heat capacity
Add 27 yens (= 1 mol) at room temperature to hot water and note the temperature change.
- b) 'Floating' on the surface of water using the surface tension
Place yen on water after rubbing the coin with your fingers to put sebum on it.
- c) Observing electromagnetic induction
If we raise a neodymium magnet rapidly off a pile of yens, we can lift some yens from the pile. Also, yen sliding down a slope will stop as it passes on a hidden magnet beneath the slope.
- d) Observing paramagnetic property
Yen floating on water comes near a neodymium magnet, when you hold it near the coin. (the diamagnetic repulsion of water should be considered too).
- e) Observing electrostatic induction
Yen balanced on their edge or suspended move to a charged rod but a floating yen moves away from the rod (!?). Because the water is attracted to the rod and created a difference in surface tension which moves a coin away while the coin is attracted.

Twin Helicopter (Kazuhiro Tokuda and Shinnosuke Suzuki)

We introduce a twin helicopter made by simple materials. Usually children love what flies in the sky and this twin helicopter can also capture children's heart.

We prepare only the following materials to make this twin helicopter: 2 plastic bottles, 1 big straw (ex. Tapioca straw), 5 rubber bands, and 2 clips [15]. We cut two plastic bottles and make two wings. We attach a clip at the axis of a wing and attach five elastic bands to the clip. We let elastic bands pass through a thick straw and attach another wing at the opposite side.

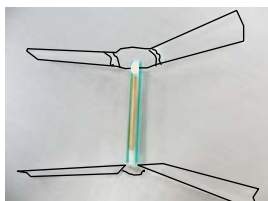

Figure 10.

Simple Dynamo to Light a Miniature Electric Bulb (Takahiho Shohgenji)

In order to teach the elementary schoolchildren an electric law to generate electricity by moving a magnet in a coil, we need the experiment to show them to light a miniature electric bulb by the generation of electricity. Therefore we tried to make a simple dynamo to light a miniature electric bulb [16].

In the following pictures, we use the acrylics pipes which outside diameter is 20 mm and which inside diameter is 17 mm. A neodymium magnet ($\phi 16 \times 30$ mm in length) is put in

to inside, and we shake at right and left and make them generate electricity. The scale of a grid in each photograph is 1 cm.

a) Two hump camel type dynamo

The ϕ 0.60 mm PVF magnet wire is rolled 250 times. Electromotive force is 0.6 V. The miniature bulb for 1.5 V is merely lighted for a while.



Figure 11. (a)

b) 2 block type dynamo

The ϕ 0.60 mm PVF magnet wire is rolled 250 times 2 each volumes. Electromotive force is 1.2 V. A miniature bulb is ordinarily lighted. The point is a coil around two places. Having generated electricity can be shown. However, it is difficult to roll coils.

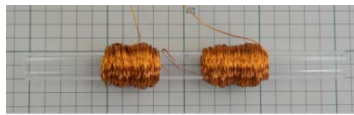

Figure 11. (b)

c) 2 bobbin type dynamo (shaker dynamo)

The doughnut type acrylic board with a ϕ 40 mm thickness of 5 mm was pasted up on two places at intervals of 15 mm, and the bobbin was made. The size from the left is 50 / 5 / 15 / 5 / 40 / 5 / 15 / 5 / 50 mm respectively. The ϕ 0.60 mm PVF magnet wire is rolled 250 times each. Electromotive force is 2.0 V. A miniature bulb is lighted with BRIGHTLY. It is electric power generation teaching tools which all people can make successful and principle is bare.

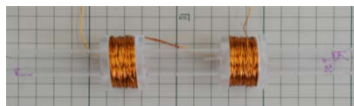

Figure 11. (c)

Paper Whistle (Hiroshi Kawakatsu and Haruka Onishi)

Paper whistle is a good teaching material which is very popular among a child. The principle of a paper whistle is as follows: the air which passes along a reed part serves a turbulent flow, air is vibrated, and sound comes out.

We prepare 4 cm \times 1 cm and 3 cm \times 1 cm of the cardboard. Make the longer cardboard round using a pencil (Figure 12(a)). Twist the shorter cardboard around the longer one (Figure 12(b)), and fix with a Scotch tape. Make a space through which air flows when you blow a breath (Fig 12(c)).



Figure 12. (a)



Figure 12. (b)



Figure 12. (c)

Summary and Discussions

We introduced these teaching materials at the hands-on workshop in ICPE-EPEC 2013. Some of experiments which we have introduced in the workshop are famous in Japan, but some are not well known outside of Japan. We think that it is meaningful to spread good experiment teaching materials to the world and share them with teachers in the world.

In this workshop, we have chosen these experiments which were well received by children among what were actually used in our lessons or events in Japan. We think "if these teaching materials are used, children are glad and have the interest in science more." We consider that this is a kind of hypothesis in science education research.

In order to prove this hypothesis, the same teaching materials need to be used in the world, and its education effect needs to be measured. It is difficult to judge whether the education effect goes up or not for each teaching material. However, if many teachers which are professional of education in each country come to take a certain teaching material in their lessons, the teaching material will be considered as a very "good" teaching material. Its popular degree becomes one index of an education effect. This is a kind of "experiment" in the science education research.

In order to observe the result of this "experiment", the questionnaire to participants will be useful. In the questionnaire, it is interesting to ask which experiment teaching materials is impressive. At the same time it is necessary to ask whether he or she would like to use it in his or her lesson. It is also important to conduct a follow-up survey, after a certain fixed period passes. These are future work.

References

- [1] Tanemura M. et.al: "Simple and Beautiful Experiments by LADY CATS" Proceedings of the International Conference on Physics Education 2006, Journal of the Physics Education Society in Japan Supplement, (2008) pp. 392-401.
- [2] Tanemura M. et.al: AIP Conf. Proc. International Conference on Physics Education: ICPE-2009.
- [3] Taniguchi M., et.al: International Conference on Physics Education: GIREP-ICPE-MPTL 2010.
- [4] You can see the record of our activities in our web site, <http://www.osaka-kyoiku.ac.jp/~masako/exp/ladycats/index.html>
- [5] McDermott L., Physics Education Group at the University of Washington: (1996), Physics by Inquiry Volumes I, John Wiley & Sons, Inc., New York.
- [6] Fumiko Okiharu *et.al*: presented at Scientific Festival in Niigata in Japan, 2009.
- [7] Harvard Natural Sciences and Lecture Demonstrations, "Pendulum Waves", <http://sciencedemonstrations.fas.harvard.edu/>
- [8] Stefan Hildebrandt and Anthony Tromba: "Mathematics and Optimal Form (Scientific American Library)" Tokyo Kagaku Dojin (1994), in Japanese.
- [9] Tanemura M. et.al: "Soap Films with Variable Frames of Prisms" the International Conference on Physics Education 2013.
- [10] Atsugi City Child Museum, <http://www.city.atsugi.kanagawa.jp/acsc/index.html>
- [11] Yano A.: Journal of the Physics Education Society of Japan, 38, p.38 (1990).

- [12] Yonemura D.: Journal of the Physics Education Society of Japan, 41, p.192 (1993).
- [13] Anzai Y.: “Psychology of Problem Solving” Chuokoronsha (1985), in Japanese.
- [14] Kawakatsu H.: “Kawakatsu-sensei no butsuri jugyo Vol.3” Kaimeisha (1998), in Japanese.
- [15] Ogawa S. et.al: “101 things to do with Japanese Yen,” Physics Education, vol.44, p.234 (2009).
- [16] JAXA Space Education Center, “Uchu no Tobira,” March, 2013, in Japanese.
- [17] Ryosuke Kinosita: "Manufacture of the method dynamo of which can be made also from whom," Graduation thesis of the Kyoto Tachibana University (2010).
Instruction: Takahiro Shohgenji.
- [18] “Science Play’s Dictionary,” Edited by Y. Tsuda, Ohtsuka Shoten, in Japanese.

Physics Lab with Modern Technology

Radim Kusak

Faculty of Mathematics and Physics, Charles University, Prague, Czech Republic
Dvorakovo gymnazium a SOSE, Kralupy nad Vltavou, Czech Republic

Abstract

In 2012 we realized the project e-VIM (Interactive and Modern Education) at our high school. The project focused on usage of modern technology in Science lessons – Physics, Chemistry and Biology. As part of this project we created many resources focused on lab activities.

In the first part of our paper the reader was given an opportunity for readers to see some of these activities e.g. - Physics with iPad, USB microscope in physics, Physics in Slow motion, Wolfram|Alpha, Mobile phone in physics and Physics with Vernier probes. The second part discussed concepts and issues of the lab activities with modern technology and also about feedback and evaluation of the students.

In 2013 we continued the usage of modern technology in project e-VIK (education, individualization, coaching) focused on usage of notebooks and tablets in classrooms. At the end of the workshop we gave a comment about this project and its first results.

Keywords: Secondary education: upper, Physics lab, USB microscope, iPad, Physics in Slow motion, Wolfram|Alpha, Mobile phone in physics

Introduction

Projects in our High School

Dvorakovo Gymnazium a SOSE has realized many projects to improve lessons in the classrooms. One of them was also project eVIM (Interactive and Modern Education), that was focused on science. As part of this project students were on the science field trip, in the science center IQ Park and some of them also attended night lab activities and completed students projects.

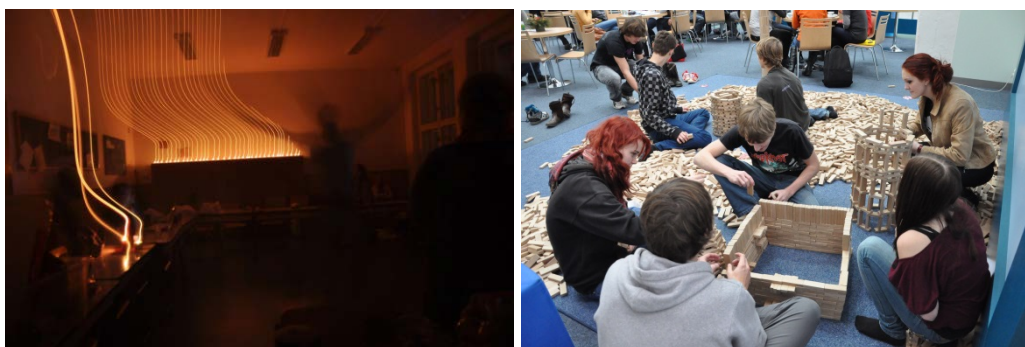

Figure 1. Left – light effects during the night lab activities, right – building the towers during the visit of the IQ Park

Physics Lab with Modern Technology

Structure of the Lab Activities

All of the lab activities consisted of 3 parts – presentation, worksheet and protocol. Presentation consisted of 15 slides, which introduced a topic and also showed the workflow of the lab activity. Resources in Czech are available at eVIM webpage [1], in English available at my personal Dropbox folder [2] - it's fastest way to make newest resources available to others.

8 Top Modern Lab Activities

Most of lab activities listed below shows the summit of the current modern lab activities in our country. Inspiration for those lab activities was found at national and international conferences such as Physics teachers' inventions fair [3] and ICPE [4]. But others for example USB Microscope, Physics with iPad and Wolfram|Alpha were made solely by the author of this article.

- USB Microscope
- Physics with iPad
- Videoanalysis
- Wolfram|Alpha
- Physics with Mobile Phone - Surface Tension
- High Speed Physics
- Spring constant
- Don't be scared of the Soldering

USB Microscope

This lab activity gives students an opportunity to see the world that cannot be seen by the naked eye. Magnification of the USB Microscope is about 50x and 200x. A comprehensive article about the USB Microscope in physics is available in [5]. Some interesting pictures and movies are available in [6]. In time the USB Microscope became available to Czech teacher via the Regional centers of the Depositum Bonum Foundation.

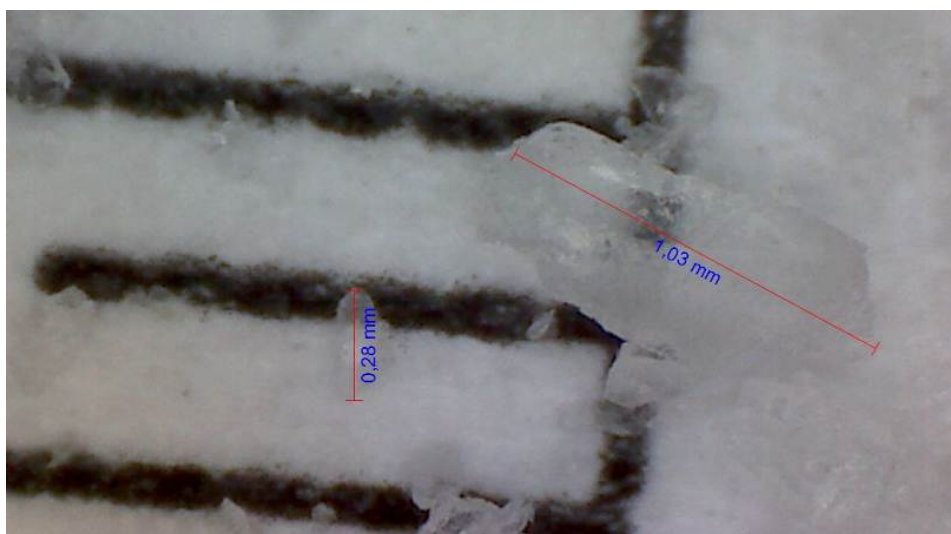

Figure 2. Measurement of the salt crystals (Magnification 200x)

Physics with iPad

IPad or any other tablet is a very useful tool in physics. Its usage can be divided in four main usages:

- Data mining via the internet.
- Using the camera to take a pictures and movies.
- Apps with respect to physics.
- Using the internal probes via some special apps – e.g. Graphical, MagnetMeter, AccelMeter, and Gyroscope.

Data mining is a common usage of the mobile devices. Unfortunately this way is the most popular usage of the mobile devices in the classrooms. It's possible to use the web browsers to search the data in Google and Wikipedia.

Advanced search can be done also in the Wolfram|Alpha which is also mentioned below. Also the physics apps like Algodoo or Wind Tunnel (Figure 3), can transform the iPad into a simulation tool – e.g. to simulate the air flow around the airfoil in Wind Tunnel or light reflection in Algodoo. There are many other very interesting apps like Cardiograph, MyScript Calculator, Solar Walk, Tone Generator, Khan Academy etc. but their usage and description is out of the range of this article. Some of these apps can be found in article [7].

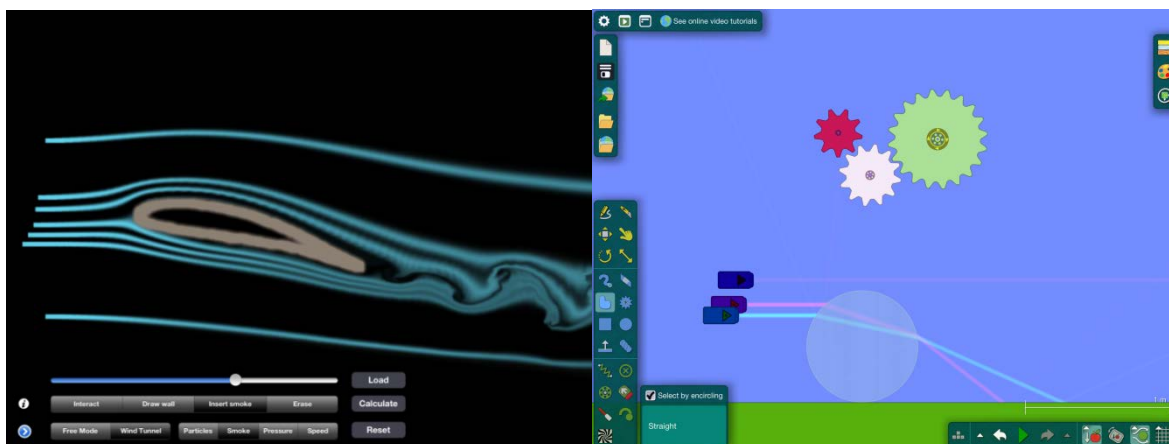

Figure 3. Screenshots of the iPad's apps. Left – Wind Tunnel, right – Algodoo

Videoanalysis

The concept of this lab activity is known more than 10 years but in many schools in Czech Republic it is still not used, or is not even known. However with the tablets, especially iPad it can be done very easily by some special app like Vernier Video Analysis. It is also possible to use the programs like LoggerPro or the free software Tracker. In the field of the videoanalysis the program Tracker is very advanced – e.g. is possible to let the program automatically generate the trajectory of the given object. This software is also available for common OS in computers – Linux, Mac and Win. To our students this part was a first opportunity to try videoanalysis, but in international level it is possible to find more advanced and comprehensive work on this topic – e.g. PhD thesis done by Andre Heck [8].

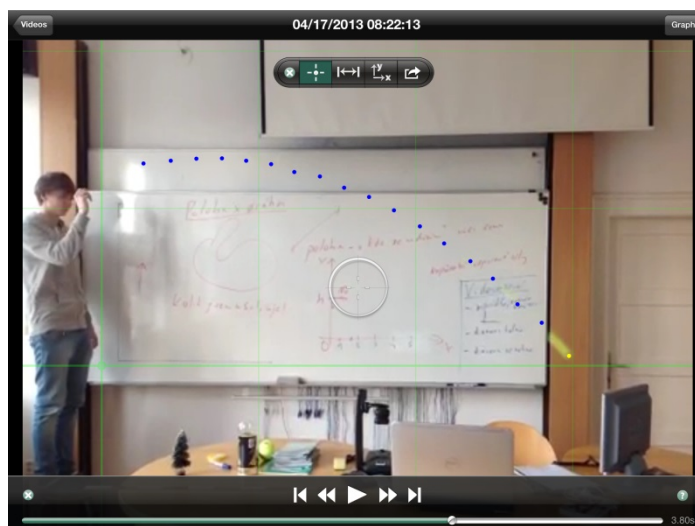

Figure 4. Videoanalysis in the Vernier Video Analysis. Each of the blue points is a point of the ball's trajectory with the equidistant time.

Wolfram|Alpha

This is one of the most power tools in physics calculations. Its core is based on Wolfram Mathematica – Computer Algebra System. Thus is possible to solve linear, quadratic, differential equations. Also it is possible to access the real-time data – e.g. where is ISS now, or long-term data e.g. – Temperature in Prague 1970-2010. In the end it can also be used as “Common Sense Search Engine” – e.g. to ask the question like “where am I?”

Wolfram|Alpha is available via webpage [9] or as an app in tablets or mobile phone.

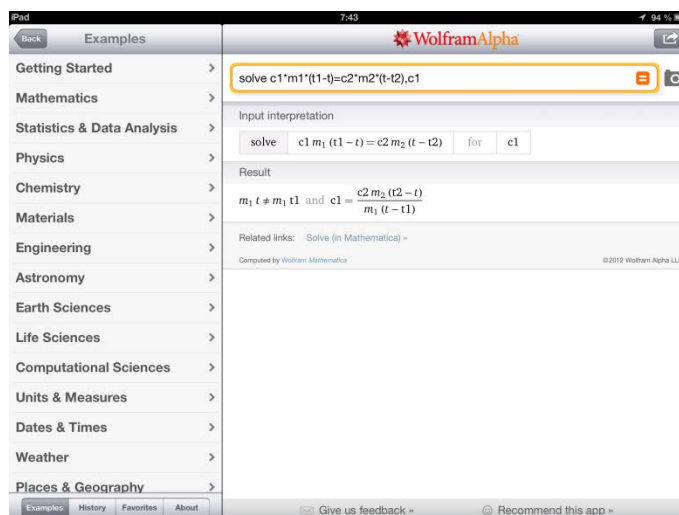

Figure 5. Wolfram|Alpha screenshot on the iPad. Wolfram|Alpha is solving the calorimetric equation with respect to c_1

Physics with Mobile Phone - Surface Tension

One of the usages of the mobile phone or the tablet in physics can be for the measurement of a picture. With a given scale it is possible to measure the size of the objects in the picture (Figure 6). The original article about this method can be found in article [10]. A similar method can be also used with the USB microscope in (Figure 2).



Figure 6. Measuring surface tension via the water drop

High Speed Physics

One of the modern lab activities is definitely High Speed Physics, sometimes known also as Physics in slow motion. Our camera was CASIO EX-ZR300. Its price is about 200€ thus it is available to ordinary people. For physics teacher it gives great opportunity to record video in 1000 fps. But in this frame rate it's a video with small resolution (224x24px), thus it is more useful to use 480 fps or 240 fps (because the data flux is constant, higher frame rate cause lower resolution). Interesting experiments are e.g. - re-lightening the candle (Figure 7), popup water balloon, video of the fluorescent lamp or hits and kicks in martial arts.



Figure 7. Re-lightening the candle. Video is available in [11].

Many experiments in this field were done by J. Koupil during his studies at our faculty. His videos are available at [12].

Spring constant

This lab activity shows the power of the data-loggers like the Vernier probes. Usually it is possible to measure time dependence of a given variable – position, force, voltage etc., but it's also possible to measure the dependence between two variables. To be more accurate, the program generates a parametric plot of those two variables with respect to time.

In our case in the first part of the lab activity time dependence of the position (or velocity, acceleration, force) and mass of the object is measured. In the second part force with respect to position is measured.

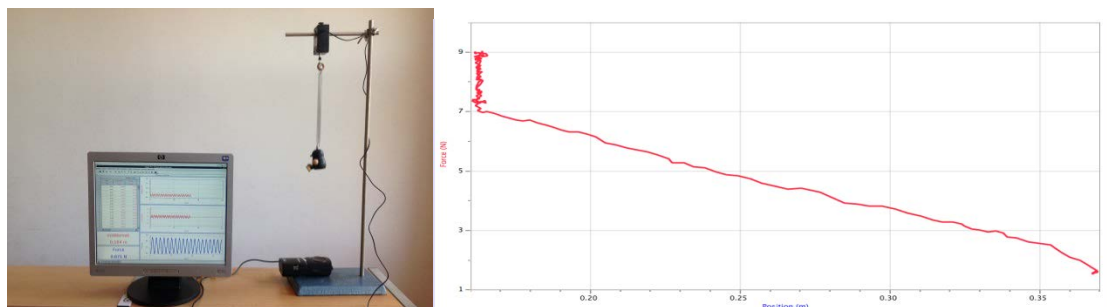

Figure 8. Force-position dependence taken by the Vernier Go!Motion sensor and DualRange Force sensor. Left – arrangement of the experiment, right – plot of the collected data.

Don't be scared of the Soldering

This lab activity could be called modern maybe 50 years ago. But nowadays it is also very inspirational for students, because students at our high school don't have any experience with soldering.



Figure 9. Soldering during the night lab activities. Left – detail of the soldering, Right – assembly of the lightsaber done by Karel Novotny (one of the students).

Concepts and Issues

Concepts

Labs activities with modern technology also lead teachers to change the concepts of their classrooms. In the first place it was a new concept to use presentation, worksheet and protocol. For students it brings a given structure of lab activities, which have been shown to be very useful in the beginning. But in long term it seems to them as a stereotype.

Some teachers also change the workflow of the lab activities. For example in my lab activities one group of students became the reporters – one was taking photos, another was recording movies with the camera. Thus students have many pictures of their successes and failures during the lab activities.

New concepts were also applied to protocols. One of the teachers used the Google Apps; other used the Dropbox and for feedback comments in Microsoft Word. In both cases students don't have to print protocols anymore.

One of the new concepts was also to take a feedback via the Google Form. A similar form in English was also prepared for the participants of the workshop at ICPE2013. Link is available in [13].

Issues

During the project we also faced some issues. One of them was that students had to learn how to work with new probes and how to measure with them. Also with using it for a long period of time seemed to them like a "black box". One issue was also the internet connection. When it was lost we had to use Hotspots to send their protocols.

Conclusions

Physics lab activities with the modern technology can be very inspirational for students. One of the reasons is because it's with technology they use in their everyday life. On the other hand if modern technology is used in the wrong way, students can see only a "black box" measuring "something" – especially with the data-loggers. Thus there still remains the important role of the teacher and his ability to use and adapt new technologies in the classroom.

eVIK Project

To be able to be in touch with the newest technology our school started project eVIK. Main parts of this project focus on individualization, mentoring and modern technology like tablets and notebooks.

Although our school in project eVIK uses an Android tablets – physics apps and concepts are very similar to iPad. A very useful step was also to give the tablets to the teachers during the holidays - they were given an opportunity to learn how to use it. But "our" greatest success was to see our students to help each other during the lessons with tablets.



Figure 10. Students are helping each other during the lesson with tablets

Acknowledgments

In this place I want to give acknowledgments to the e-VIM (Interactive and Modern Education) project, CZ.1.07/1.1.06/03.0057, which was done in 2012 and also the project e-VIK (Education, individualization, Coaching), CZ 1.07/1.1.32/02.0132 which is right now in progress in Dvorakovo Gymnazium a SOSE, Kralupy nad Vltavou. Those projects were/are funded by the European Social Fund and the Czech Republic.



Also I would like to give acknowledgments to the project “Studentsky vyzkum v oblasti didaktiky fyziky a matematickeho a pocitacoveho modelovani” SVV nr. 267310, which gave me the opportunity to look deeper into some of the topics mentioned above.

References

- [1] Project eVIM webpage [online], available from: <http://evim.cfme.net/> [cite 2013-10-09].
- [2] eVIM resources in English [online], available from: <https://www.dropbox.com/sh/jcv1hzkai88v1qt/opkbnMMErz> [cite 2013-09-29].
- [3] Physics teachers’ inventions fair [online], available from: <http://vnuf.cz/index-en.html> [cite 2013-08-13].
- [4] ICPE-EPEC 2013. The International Conference On Physics Education 2013, [online]. [cite 2013-06-30]. Available from: <http://www.icpe2013.org/>
- [5] Kusak R.: How to Look into the Microscopic world (in Czech), Dilny Heureka 2012, Ed.: Koudelkova V., Dvorak L., Nakladatelstvi P3K s. r. o., Praha 2012, p. 89-100.
- [6] Kusak R.: USB Microscope (in Czech), available from: <http://www.radim-kusak.net/vyuka-temata/fyzika/usb-mikroskop> [cite 2014-04-14].
- [7] Kusak R.: Lab Activities with Modern Technology (available in Czech), Conference Moderni trendy v priprave ucitelu fyziky 6, in proceedings.
- [8] Heck A.: Perspectives on an Integrated Computer Learning Environment, Duivendrecht, 2012.
- [9] Wolfram|Alpha [online], available from: <http://www.wolframalpha.com/> [cite 2013-10-09].
- [10] Jilek M.: Playing with Digital Camera (in Czech), in Dilny Heureka 2003-2004, Conference proceedings of the project Heureka, Ed. Dvorak L. Prometheus, Praha 2005 str. 91-94.
- [11] Re-lightening the candle [online], available from: <http://youtu.be/ApZ7DkUEsFY> [cite 2013-09-30].
- [12] Koupil J.: Slow Motion & Physics, available from: <http://www.youtube.com/fyzikarjanek> [cite 2013-09-30].
- [13] Feedback for the lab activities [online], available from: <https://docs.google.com/a/dgkralupy.eu/spreadsheet/embeddedform?formkey=dGkyRXFBT2NYb0RkZVVvQ1ZwUGU5SIE6MA> [cite 10-09-2013].

Teaching particle physics in a research laboratory

Mária Éva Oláh¹, Csilla Fülöp²

¹ Mechatronics Vocational School, Budapest

² Trefort Ágoston Bilingual Vocational School, Budapest

^{1,2} ELTE TTK, Physics PhD School, Physics Education Program

Abstract

Conveying the key messages of contemporary particle physics at secondary school level is highly challenging. The subject is not included in the normal syllabus, most textbooks actually ignore the existence of subatomic particles. Particle physics on the other hand appears regularly and successfully in public press and media, therefore it seems mandatory to bring the subject closer to the students.

Seven volunteers from the „Mechatronics” Secondary Technical School in Budapest are lucky enough to have the possibility to participate in the activities of Department of High Energy Physics at the Wigner Research Centre of Physics.

Experience gathered during the implementation of the projects and from feed-back from students, the question is raised: to what extent actual experimental participation is necessary in raising motivation for the study of high energy physics phenomena.

Keywords: particle physics, secondary school students

Particle physics is not in the national syllabus of secondary education for physics in Hungary, like in most of the countries. We can study this topic typically only in optional classes. Still, we can insinuate more elements into most of the themes we study. When studying kinematics, especially when we mention noteworthy speeds, we can talk about sets of protons travelling close to the speed of light in the LHC. In thermodynamics we can point to the LHC as the hottest and – oddly – the coldest point of the Universe. In electromagnetic studies we can mention the huge electromagnets which are superconductors. In modern physics we can set as examples the radiation emitted by the particles.

It is possible to organise trips to the CERN, based on personal experience the main event is to visit the CMS detector: sluicing and lifting 100m down to the tunnel remains an experience, for sure. Still, a visit can remain a long lasting experience even if the accelerator is in use, so there is no chance to visit the detectors.



Figure 1. The „Mecha” group in CERN in 2010



Figure 2. Seven future researchers

In the academic year of 2012/13 in the Mechatronics Vocational School seven students decided to have additional, optional classes in physics. They had a chance to go to the Wigner Research Centre for Physics. There they could participate in the current research work within the Detector Physics Group of the department of High Energy Physics. They participated in a project for Research Based Teaching.

These seven students formed two teams, as this is how they could work. First, Professor Dezső Horváth, who is the former leader of the department, gave them a general introduction on particle physics. Second, Dezső Varga, who is the leader of the Detector Physics Group, introduced the work carried out in the laboratory. He also talked about the operation of the detectors. The youngsters were a bit afraid by the first glance: they could not imagine themselves being able to fulfil any task in the laboratory. Finally they did very useful work. During their work, which lasted four months, they were not even being aware of learning. They just got involved in certain areas of modern physics, and in it, some special problems of particle physics. They arrived with joy every occasion to the lab. They never needed goading. Sometimes they didn't even realize how soon time passes by, and remained till evening if the measurements required their extra time beyond the double school lessons.

MULTIPLE SCATTERING EXPERIMENTS

One of the teams performed multiple scattering experiments, with devices already pre-assembled. The main point was not what they were doing, but to what purpose. They learned that some devices in the detectors are essential, including a variety of films that are incorporated into the detectors. The testing of these materials is a very important, but time consuming task. The students in this team were asked to do this task for those who are working as researchers. Using the measurements they could check the data found in the literature, and were able to accurately identify the materials used in the films. The students did a great job, so all benefited from this project.

The measurement was actually about the scattering of particles on films. These particles are electrons, since they are coming out from a beta radiation source. They travel through films. Besides looking at the angle of scattering, the focus was to measure the number of the generated particles, and the number of counts in scintillators.

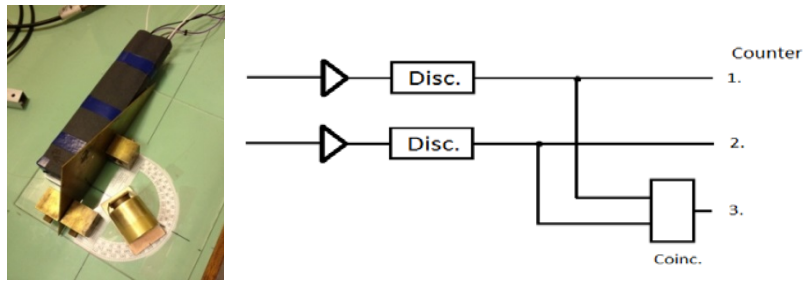

Figure 3. The measurement setup

In the bottom right hand corner of the photo is a cylindrical object, it is the beta-ray source. The triangular shape made of copper is a collimator. In the gray box there are the two scintillators. Furthermore, there is a schematic illustration of a theoretical circuit. From the two scintillators the signals go into the amplifiers, then into a discriminator. This is intended to distinguish incoming signals from noise. Signals can only pass above a certain voltage. Conducting them into the counter, the number of counts can be examined. The coincidence of these measurements will be important, because with this we can distinguish and hold back the background radiation noises, so called clutter.



Figure 4. Settings



Figure 5. The table



Figure 6. The old tv monitor

The lab is shown in figure 4. One of the boys is just doing the settings on the picture. This process is important, because we need high voltages to work on. We definitely need to be very careful at 950 V. With the discriminator we selected a 0.1 volt signal, and another at 0.3 V. The photo in Figure 5 shows a part of the lab, and on the table you can see the experimental setup. Reading the data happened from an old television monitor shown in Figure 6. In channel 1 and 2, all the counts were observed, the direct signs of the scintillators, whereas on channel 3 the number of coincidences. During the measurement, from the value of coincidences, we also noticed that the observations should be made in a given range of angles. This was typically between 0° to 40° . In channel 12 the built-in counter's clock was used as a timing device. The duration was 100 seconds. One of the important tasks was to process the data. That wasn't a problem for these students, because they have a subject in school called Electrical Measurements. In those classes they also practice similar tasks.

The team, which carried out the scattering experiments, is of 4 persons. They divided the jobs among themselves. One carried out the measurements, he changed the angle from 0° to 40° . Another one dealt with the counter. One of them wrote down the results on

paper. Also, one of them entered the data into the computer, he can be seen in Figure 7. Thus, immediately we could see and verify the test results.



Figure 7. Our IT

At first the students did not understand the theoretical background of the measurement, but slowly they learned also that changing the thickness of the foils the width and height of the curve will change. If the thickness changes by n times the width of the curve changes \sqrt{n} times. Scattering can also be measured only on air, this is characterized with the blue line in the graph shown in figure 8. The red line shows a visible difference, it is the case of a single layer, 35 μm thick copper adhesive film.

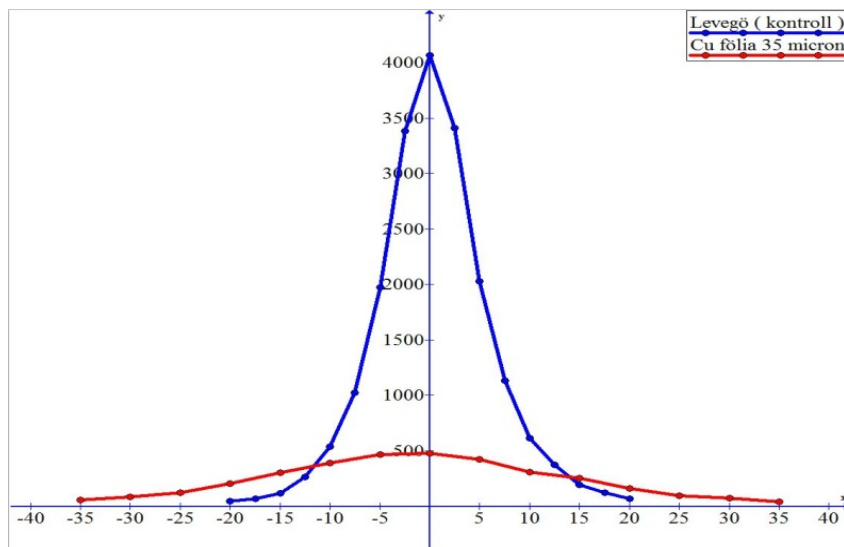

Figure 8. Air — single layer measurement

The other test was one of the most important of our measurements. The same films were used in both cases, but different number of layers. The red line is the 4 layers of aluminium foil 25 μm thick, and the blue one is the same, but in 9 layers. Seemingly the curve widened, and gave the same result as the subsequent calculations.

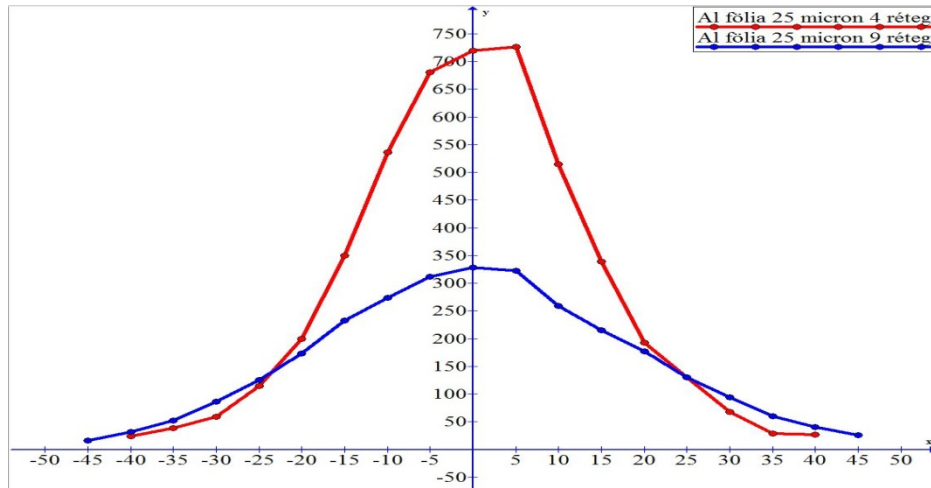

Figure 9. Measurement with different layers

Those detector laboratories are relatively small labs, this means relatively small detectors can be built. We have learned that some important elements are required for the operation of the detectors. These include a variety of films that are incorporated. And also some measuring instruments, which are monitoring during the operation of the detector. The LHC detectors are much bigger than those in our lab. If they happen to fail, disassembling them is very complicated, and expensive. For providing data continuously, the aim is enable them work without stopping for a longer period of time.

PLANNING AND BUILDING SENSITIVE AMMETER

The other team's work is related the idea mentioned above. They were given the task to design and build an ammeter that is able to measure the current in the detector.

But really see why this is so important, let's take a closer look at the theoretical background and the purpose of measuring the electric current.

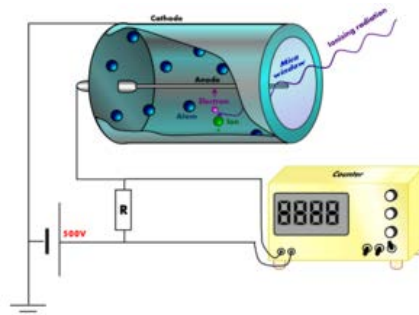

Figure 10. The Geiger-Muller Counter [1,2]

In Figure 10 we can see a Geiger-Muller Counter. This was the first to measure radioactivity in the 1930's. And then the proportional counters came: George Charpak in 1992 received the Nobel Prize for developing this device.

Inside the detector in the middle is an anode-wire. It is arranged coaxial in a cylinder. Outside, the cylindrical wall is the cathode. Inside of this case there is argon gas. For this gas we know that at even high voltages it remains an insulator, doesn't turn to be a

conductor. Technically, when a radioactive particle enters, it ionizes the atoms of the gas that are in there.

The second team dealt with the preparation of an ammeter suitable to measure the current in the detector. A question may arise. Why should we fiddle with a device? Why do not we easily buy some in a store, especially knowing that ammeters are not even expensive? There is big problem with those: they are not planned to be used at 3-4000 V. They couldn't stand this high voltage. So our task was to make an ammeter that can measure nanoamps under thousands of volts.

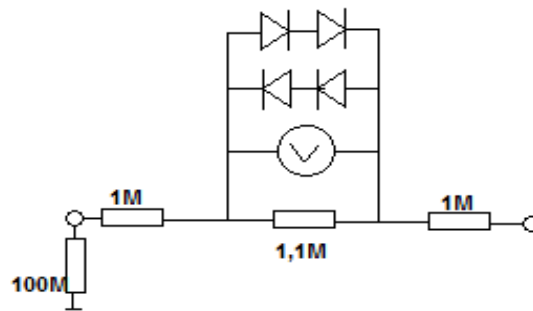

Figure 11. The planned circuit diagram

On the top of the circuit-diagram (in Figure 11) we can see diodes put parallel and opposite. Their task is something like fusing. If there was too big voltage on the meter, then these would drain some current to prevent the meter from damage. On the right and left sides there are two, 1M Ω resistors each. They also provide protection by decreasing the voltage. The 100M Ω resistor assists to achieve the nanoamp-scale. In the middle, a 1 M Ω resistor is the coupling resistor, on this the current is measured.

One might ask why such a meter is good for in the detectors. The so-called leakage current of the detectors can be eliminated. You can specify the size of the resulting electron avalanche and its properties. But the most important advantage is that it can increase the life of the detector to multiples, which is a huge cost saving factor for a detector sized CMS or ALICE.

Some team members dealt with the electronic parts of the ammeter. Fortunately, in school they had gained experience, so it was not unknown for them to use a soldering iron or the resistor color code. They took these steps easily, they routinely used the pliers, wire stripper pliers and other tools.

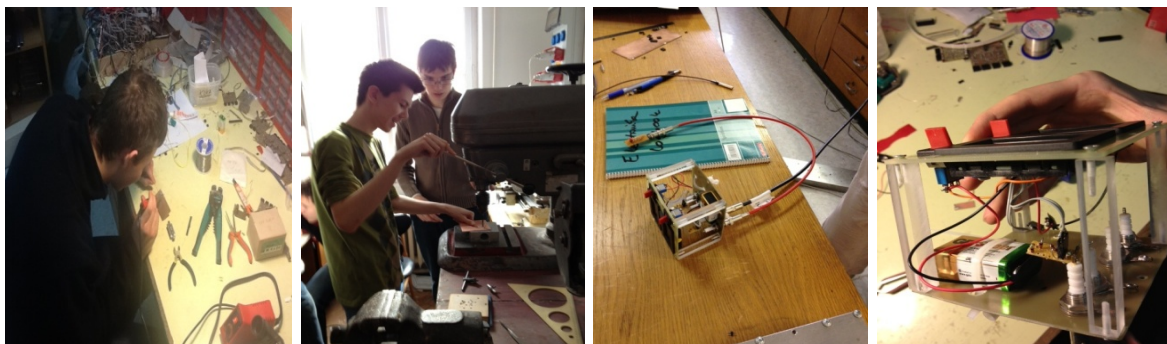

Figure 12. The steps of the work

Two boys created the container of the measuring instrument. On figure 12/b one of the students is drilling the bottom plate of the instrument, making given size holes for the high-voltage connectors. First, they used a smaller drill to prevent too big holes. The size of the holes was crucial for the punctual fit. We can see the assembly process. on figure 12/c. We can see that the high-voltage terminals are already installed. The other four holes were needed to keep the batteries fixed. They installed the four plastic columns into the container, which provided the box shape. On the other side of the box digital display measuring instruments are located, and also on-off switch buttons. We wanted to measure only for a short time, so we did not want to exhaust the batteries quickly. Then soldering the two IC-s followed. Finally the most exciting task in the experiment came. We connected our device to 4000 V, and as you can see, there was no disaster.

We were still facing the task of calibration in order to set the exact values. Of course, that was done not in high voltage. It is simply not advisable to turn on a potentiometer while under high voltage, so we switched to low voltage, put in the load, and at the range of 6 to 8V we completed the calibration. We set it to the calculated values and measured the current from 1V to 24V.

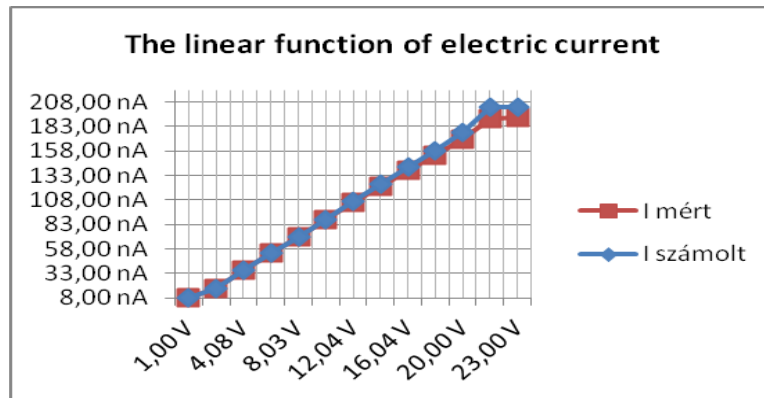

Figure 13. The resulting graph of calibration

Up to 16 V the measured and calculated values were completely matching. The following minimal differences occurred because the diodes have started to open up at the increasing voltage. A small part of the voltage began to flow in the opening direction, it caused a small current escaping, but it was just nanoamperes, which is irrelevant from the measurement's point.

THAT IS IT?

During the academic year our time was only enough for these two projects. The students became so fond of this kind of learning combined with research that they didn't want to stop. They were also willing to sacrifice a few weeks from their summer holidays: they were going to work in self-organization at the Wigner Centre. Those researchers who work there work with great knowledge and patience with the future scientists.

We, secondary school teachers did our mission, worked like ambassadors. We have shown the way for young people to physics and also for those with interest the way to research. We did so, for sure, to at least these seven young people. But every year new students come, and we can just hope that we will regularly find students who show interest in work of this kind.

SPECIAL THANKS

We would like to express our thanks to all the employees of the Department of High Energy Physics of Wigner RCP. They gave us the opportunity to glimpse into research work. Special thanks to Dr. **Dezső Horváth**, and to Dr. **Dezső Varga**. Thanks to Dr. **Gergő Hamar** that we could work with his leadership in the detector-laboratory. Thanks to **Erzsébet Szokolainé Takács**, who is the Headmistress in the Mechatronics School, especially for her permission so that the students could do research work during school time.

References

- [1] http://www.particle.kth.se/TEACHING/laboratory/xray/xray_instr.html
- [2] Jim Breithaupt: Understanding Physics for Advanced Level (28.3), Stanley Thornes Ltd., Cheltenham, 1990.

Embedding formative assessment and promoting active learning

Elizabeth Swinbank, Mary Whitehouse, Robin Millar

University of York, UK

Abstract

In this contribution we outline how the York Science project is using a 'backward design' approach to teaching science to students aged 11-14. We then present some examples of formative assessment tasks and show how simple selected-response questions can be modified to provide teachers with detailed information about students' ideas. Finally we indicate how such tasks can help promote active learning.

Keywords: Formative assessment, diagnostic questions, backward design

Introduction: the York Science project

York Science [1,2] is a project based in the University of York, UK, which is developing a large package of resources to support the teaching of science to students age 11-14. The project's guiding principles are:

- What matters in science education is what students learn.
- The aim of teaching is to promote learning.
- We need to shift the focus from what is taught to what is learned:
 - from activities to outcomes
 - from the intended curriculum (what teachers teach)
 - to the attained curriculum (what students actually learn)

A key component of the *York Science* resource package is a wide variety of assessment tasks and questions which can be embedded in normal classroom practice and provide evidence of successful learning, or of learning difficulties to which teachers can respond.

The positive impact of formative assessment on student learning has been well established, for example by Paul Black and Dylan Wiliam [3,4]. John Hattie's synthesis of over 800 meta-analyses [5] identifies 'feedback' as one of the most effective interventions relating to student achievement. Hattie points out that feedback is most powerful when it is *from the student to the teacher*: "When teachers seek, or are at least open to, feedback from students as to what students know, what they understand, where they make errors, when they have misconceptions – then teaching and learning can be synchronised and powerful." [5, p173].

However, teachers are not always aware of research evidence, and even if they are aware, they might not have the time or resources to reflect fully on its implications or to make appropriate changes to their practice. As Smith and Gorard [6] showed, even though research indicates the benefits of formative feedback, it may not be implemented effectively.

The *York Science* project is drawing on the research findings to inform the development of resource materials, with the aim of helping science teachers to incorporate effective formative assessment into their teaching.

York Science and backward design

The term *backward design* was used by Wiggins and McTighe [7] to describe a process of curriculum design that puts the emphasis on student learning outcomes, rather than starting by developing student activities or focusing on the transmission of content.

Backward design is the process adopted by *York Science*. The first step is to decide what it is that we want students to learn – the Learning Intentions. To help us identify these for a chosen area of science, we begin by writing a progression that shows how knowledge and understanding can be built up over time through the development of increasingly sophisticated concepts. We start by listing the most basic ideas and observations that would be introduced to young children and continue some way beyond the level that would usually be reached by a fourteen-year-old student. This is similar in many respects to the approach described by Wilson [8]. Writing a progression draws on research evidence where available and typically requires several stages of drafting and redrafting.

Once the progression has been written, we identify the part that is appropriate for students in the 11-14 age range. We can then begin to write a framework for the *York Science* topic, starting with a concise narrative summarising the intended learning and a list of what we want students to know and understand – the Learning Intentions.

Next, we consider how we might find out whether the intended learning had taken place – what the Evidence of Learning might be. In order to elicit this evidence, we need to devise tasks and questions, which we call Evidence of Learning Items (ELIs). Only when the Learning Intentions and ELIs are in place are we, and teachers, in a position to develop learning activities that focus on the Learning Intentions, and whose efficacy can be evaluated using the ELIs.

The process of developing the Learning Intentions and ELIs is iterative (Figure 1). In trying to specify the desired Evidence of Learning it sometimes becomes apparent that the Learning Intention needs to be modified because it is ambiguous, or inappropriate, or assumes some prior learning that we had not previously identified. Similarly, writing ELIs often helps to clarify the Intentions and the Evidence.

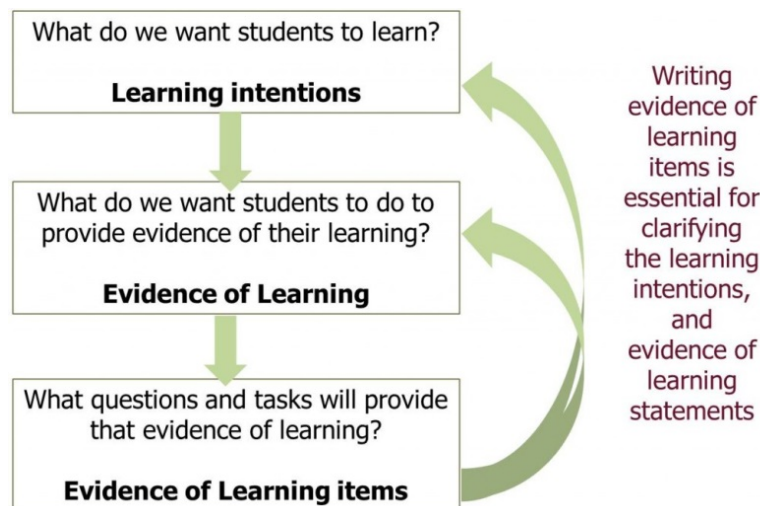

Figure 1. The *York Science* approach

Evidence of Learning Items (ELIs)

The ELIs used by *York Science* include a wide variety of tasks, such as:

- predict the outcome of a practical task, then explain-observe-explain;
- discuss, evaluate and select alternative explanations for an observation;
- make a physical model (e.g. particles in a solid, a liquid and a gas);
- construct a concept map to show relationships between ideas;
- sort and select statements to produce an explanation or argument;
- free writing in response to a question or stimulus.

While many of the ELIs have been devised specifically for *York Science*, some are based on situations used in published assessment schemes such as the Force Concept Inventory [9], the CLIS [10] and EPSE [11] projects, and the Assessment of Performance Unit [12].

A key feature of many *York Science* ELIs is that they are *diagnostic*. As well as showing the teacher whether a student has learnt what was intended, they provide evidence about how a student might be thinking and the alternative conceptions that they might hold. This feedback is immensely valuable to the teacher, who can then plan the next stage of teaching and learning in order to help the students make progress.

Many ELIs are presented as selected-response questions, as these provide feedback quickly and concisely. This can be done in a pencil-and-paper test, but there are other ways in which a teacher can gather feedback from a class; students can for example be asked to:

- stand in different areas of the classroom to indicate their chosen response;
- write the letter of their response on a small whiteboard and hold it up;
- use an electronic voting system.

However, a single selected response provides only limited information to the teacher, so the *York Science* team have been exploring ways of 'adding value' to such questions so as to elicit more information. Approaches used by *York Science* include:

- add a free-response question after the students have made their choice, asking them to explain their reasoning;
- add a second part that asks students to choose from some suggested explanations for their first answer.

In the latter case, the suggested explanations draw on research evidence about common misconceptions (for example, the incorrect idea that current diminishes around a simple series circuit, or that motion at constant velocity requires the action of an unbalanced force).

Another approach is to start with a simple multiple-choice question but ask students how sure they are that each response is right or wrong. Figure 2 shows an example. The correct answer is D, but many people would choose one or more of A, B or C. Asking students to use the grid in Figure 3 provides much more information than asking them to select a single response.

What can you see in the dark?

Imagine you go into a cupboard under the stairs and close the door. There are no windows and the door is a very tight fit.

You switch off the light.

After sitting there for a while, what will you be able to see?



- A** After a while, you will be able to see everything, but very dim.
- B** The only thing you will see is the cat's eyes shining.
- C** You will see the mirror shining dimly, but everything else will be dark.
- D** You won't be able to see anything at all, no matter how long you wait.

Figure 2. A York Science selected-response question from the *Light and colour* topic

Statement		I am sure this is right	I think this is right	I think this is wrong	I am sure this is wrong
A	After a while, you will be able to see everything, but very dim.				
B	The only thing you will see is the cat's eyes shining.				
C	You will see the mirror shining dimly, but everything else will be dark.				
D	You won't be able to see anything at all, no matter how long you wait.				

Figure 3. Answer grid for use with the question in Figure 2

(A cupboard under the stairs seems to be a peculiarly British thing. Delegates at the conference discussed how the question in Figure 2 could be adapted for other nationalities by referring to other completely dark spaces such as a cellar, a bathroom without windows, an underground cave or a remote, unlit, rural location on a cloudy night).

Another way to gather information about students' thinking is to allocate each student 100 points and ask them to distribute them between answers A, B, C and D. Tell them that they will score all the points that they give to the correct answer (or answers). For example, a student who is very confident might give 100 points to a single response, whereas someone who is undecided between two responses might give 50 points to each one.

Figure 4 shows another variation on the selected-response question. This item presents a sequence of choices and the selected responses build up an explanation, so the ELI tests understanding of the whole 'story' of how we see.

Imagine you are in a room lit by sunlight and you are looking at a book on the table.

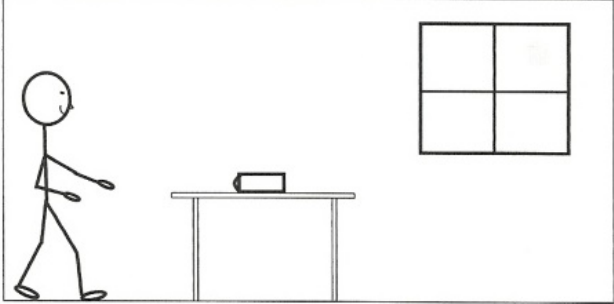

The statements in the boxes below link together to form an explanation of how you see the book.

Some boxes contain more than one statement. In each of these boxes, pick the statement that you think is **correct and fits into the whole explanation**. Indicate your choice by putting a line through the other statement(s) in the box.

Continue until you have chosen one statement from every box, to produce a complete scientific explanation for how you see the book.

1 Light travels out in all directions from the Sun.

2 Sunlight passes through the window into the room.

3a Some of this light from the Sun falls on the book.
3b Some of this light from the Sun goes into my eyes
3c Sunlight fills the room and makes it bright.

4a Light is emitted by the book.
4b Light is scattered by the book.
4c Light is absorbed by the book.

5a As a result, some light travels from the book to my eyes.
5b At the same time, some light goes from my eyes to the book.

6a I see the book because it is lit up.
6b I see the book because this light enters my eyes.

Figure 4. Constructing an explanation

Using ELIs

The *York Science* project is encouraging teachers to use ELIs in a wide variety of ways, with regard to both *when* they are used and *how* they are used.

ELIs can be used:

- at the start of a lesson, or sequence of lessons, to assess students' prior knowledge and understanding;
- part way through a lesson, or sequence of lessons, to assess progress and to help the teacher plan what to do next;
- at the end of a topic, for summative assessment and to gauge the overall effectiveness of the teaching and learning.

While ELIs can be used by individual students to inform a teacher about their own learning, there are many more productive ways to use them with a class. Here are just a few of the ways that *York Science* teachers have used ELIs:

- Project the ELI onto a whiteboard. Ask students to indicate, by raising their hands, what they think is the correct response.
- Give the same ELI to each small group of 2-4 students. Ask them to discuss and decide what they think the answer should be. Tell them that each student should be able to explain their group's answer to the rest of the class.
- Instead of telling students the right answer, follow the ELI with a practical activity so that they can find out the answer for themselves.
- Display an answer grid (Figure 3) on a large flipchart or on a whiteboard. Give each student some Post-it stickers and ask them to place a sticker in their chosen cell for each response. After discussion and teaching, which might include practical work and demonstration, repeat the process.

As these suggestions illustrate, ELIs can lead naturally to active learning, where students are involved in discussing and refining their ideas, and in hands-on exploration. So, while the backward design approach focuses initially on outcomes and assessment, there is no clear dividing line between formative assessment and learning, and a task designed for assessment can be used as the starting point for actively engaging students in exploration of scientific concepts and principles.

Teachers are responding very positively to *York Science* and are seeing the benefits to their teaching, like this teacher who remarked "The materials have caused me to reconsider my approach to lesson planning, and have been an excellent aid."

It is particularly pleasing that teachers are using the *York Science* materials as a model for devising their own ELIs then sharing their ideas with the *York Science* project team and with other teachers. This is a comment from the teacher who thought of using Post-it stickers for 'What can you see in the dark?' (Figures 2 and 3) and went on to write her own similar ELIs for other topics:

"The students enjoyed the hubbub of getting four (what, miss, four EACH?) post-it notes and sticking them to the part of the board that represented their answer. A benefit of doing it like this is that you can get the class to stick up their responses, teach the lesson, then ask if they would like to change their answers making the process more of a demonstration of their progress and less of a snapshot of their misconceptions. Thank you twitter and York Science, I can see this idea being adapted for many, many lessons!"

Conclusion

So far, *York Science* Learning Intentions and ELIs have been drafted for six topics – two for each of physics, chemistry and biology (the physics topics addressed to date are *Light and Colour* and *Electric Circuits*). Each ELI is accompanied by notes for teachers which include a summary of relevant research evidence, for example highlighting common misconceptions.

More information about the project and samples of these materials are available from the 'Resources' pages of the *York Science* website [1]. You can also subscribe to the *York Science* blog and follow us on Twitter to hear about new posts and updates. The aim is eventually to produce Learning Intentions and ELIs for all science topics commonly taught in the UK to students aged 11-14.

References

- [1] The *York Science* project website: <http://yorkscience.org.uk/>
- [2] Millar R., Whitehouse M.: (2012). The York Science Project – embedding assessment for learning. *Education in Science 250 (EiSExtra)*. Available for download from: <http://yorkscience.org.uk/wp-content/uploads/2013/03/1211-YS-in-EiSextra1.pdf>
- [3] Black P., Wiliam D.: (1998). Assessment and classroom learning. *Assessment in Education: Principles, Policy & Practice*, 5(1), 68.
- [4] Black P., Wiliam D.: (1998). *Inside the black box: Assessment for learning in the classroom*. London: Kings College London.
- [5] Hattie J.: (2008). *Visible Learning: A synthesis of over 800 meta-analyses relating to achievement*. London: Routledge.
- [6] Smith E., Gorard S.: (2005). 'They don't give us our marks': The role of formative feedback in student progress. *Assessment in Education: Principles, Policy & Practice*, 12(1), 21-38.
- [7] Wiggins G.P., McTighe J.: (2005). *Understanding by Design*. Alexandria, VA: ASCD.
- [8] Wilson M.: (2009). Measuring progressions: Assessment structures underlying a learning progression. *Journal of Research in Science Teaching*, 46(6), 716-730.
- [9] Hestenes D., Wells M., Swackhamer G.: (1992). Force concept inventory. *The Physics Teacher*, 30, 141-157.
- [10] Children's Learning in Science Project (1980-9). *Resource archive*. York: National STEM Centre. Retrieved 08 October, 2013 from www.nationalstemcentre.org.uk/elibrary/collection/464/children-s-learning-in-science-project
- [11] Millar R., Leach J., Osborne J., Ratcliffe M.: (2006). *Improving subject teaching. Lessons from research in science education*, Chapters 3 and 6. London: Routledge.
- [12] Black P.: (1990). *APU Science: The past and the future*. *School Science Review*, 72 (258), 13-28.

Investigating with Concept Cartoons

Practical suggestions for using concept cartoons to start student investigations in elementary school and beyond

Ed van den Berg, Patricia Kruit

Vrije Universiteit Amsterdam and Hogeschool van Amsterdam

Abstract

Concept cartoons can be used to diagnose misconceptions and stimulate discussion of basic concepts and phenomena. However, the teacher can also present a cartoon and then ask students to think of experiments to further investigate the phenomenon shown in the cartoon. Our experience is that students from age 9 - 18 very quickly come with creative ideas and start investigations. That is, of course, only the beginning. The teacher will have to follow the work of the students closely and help them to develop their investigation skills and critical thinking. In the workshop you will experience how to start an investigation with the cartoon and then we will focus on how to use formative assessment to improve the work of students.

Keywords: concepts, evidence, reasoning, inquiry, designing experiments, concept cartoons

Introduction

Concept cartoons (Naylor & Keogh, 1999; 2012; Naylor et al, 2007) are a popular means to stimulate reasoning with science concepts among children from the age of 8 – 18. The concept cartoons also provide a natural context for children to design their own experiments rather than do cookbook experiments.

During my first experience in grade 4 I showed them a glass with cold water and added some ice cubes. They reacted well with observations and experiences. Then I introduced the cartoon (see appendix) and asked them whether they could think of experiments to further investigate the phenomenon. They decided in no time what they were going to do and rushed off to search for beakers and other things they needed. When they were together again, and I asked a few questions, it quickly became obvious to them that their original idea was not good enough and that they had to do some more thinking. They thought more and came up with interesting and meaningful experiments.

Show children a concept cartoon, have some discussion, and then ask them to design an experiment to provide evidence for or against one of the statements in the cartoon, and the children rush off to set up an experiment. They get into the activity so quickly that the teacher even has to slow them down and force them to think through their ideas more carefully and that is where the challenge is, to get them to think and to reason and yet maintain the enthusiasm.

Key objectives of learning science are *learning to reason with evidence and learning to reason with concepts and theories*. For a long time science curricula limited reasoning in elementary science curricula due to boundaries which had emerged from the work of Piaget. However recent studies have shown young children arguing well in advance of curriculum expectations (Tytler & Peterson, 2003). Young children may not be able yet to control variables, but they are capable of reasoning with evidence and concepts to some extent. The questions are what reasoning can they do potentially at their age and to what extent can this be achieved in typical classroom conditions?

Inquiry methods have been promoted for elementary science and technology education since the early 1960s (or even Dewey’s time) and recently (Rocard et.al, 2007) a strong plea for inquiry science was made at a European level. However, real implementation in the classroom is quite limited in most countries. Textbook science dominates and activities are more likely to be only hands-on than also minds-on. There is a need for inquiry teaching methods which have a lower threshold for teachers, which teachers are confident to start using and which still have the important key features of *reasoning with evidence* and *reasoning with concepts* and *recognizing and understanding different points of view*.

Exactly for that purpose Naylor and Keogh (1998, 1999) introduced first the concept cartoons and later the puppets (Simon et.al, 2008). In concept cartoons characters hold incompatible views/claims about an everyday phenomenon. Children then are asked to argue about these claims using their own experiences as “evidence”. This is what is mostly done in concept cartoon activities used around the world. **However, one could go one step further and ask children to design experiments to support or falsify statements in the cartoons. Then the cartoons in a very natural way lead to inquiry.**

Naylor et.al. (2007) tried concept cartoons with children of age 8 and 9 and found that children were capable of supporting their views with arguments and listening and responding to arguments of others. An analysis scheme of arguments derived from Toulmin did not work, but a simple classification of interactions provided useful information. Children can argue about the cartoons based on their own everyday experiences, most children do use arguments and react to arguments of others and children co-construct arguments in their small groups without teacher support. However, also 18-year olds react well to concept cartoons as Naylor & Keogh point out in their 2012 review of concept cartoon studies.

Although there are many reports of teachers and researchers using concept cartoons to get students to design investigations, we have not yet found research reports except for our own (Berg et al, 2012). This workshop paper is intended to provide practical suggestions for how to use the cartoons to get students and teachers into investigations, based on our experiences in different schools and at different levels (grades 4 – 6). Some background knowledge on concept cartoons is assumed.

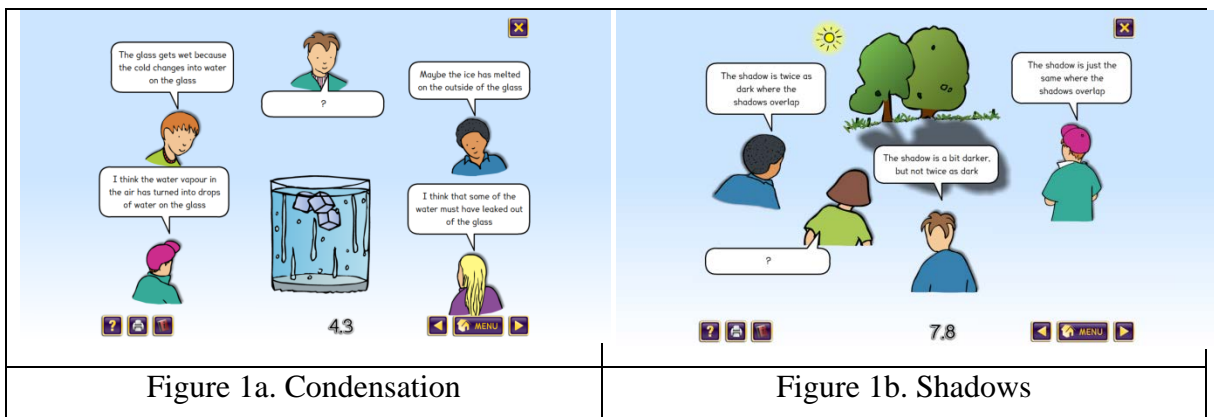

Figure 1a. Condensation

Figure 1b. Shadows

Preparation for the teacher

1. Choose a cartoon which provides sufficient possibilities for experimenting. Not all cartoons are appropriate. Identify the basic concepts and expected preconceptions and do a little bit of exploring the phenomenon in the cartoon.

The condensation cartoon (Figure 1a and see appendix for bigger version) always works very well. The cartoon about whether two overlapping shadows from the same light source are darker or not, did not lead to much creativity. On the other hand, a cartoon we made about skate boards getting off inclined planes spawned a great variety of experiments.

2. Think of some experimental ideas students might come up with and which materials might be needed for that.
3. Always have some extra materials as students might come up with unexpected ideas and we like to stimulate their creativity.
4. What are the key concepts and what are the main process skills you will pay attention while the students are at work? Is it reasoning with evidence, or will you focus on correct measurement this time, or on properly describing design/results/conclusions? In an investigation all of these will occur, but not all can be singled out for special attention. Prioritize and create a learning trajectory across the school year.
5. Make a list of questions the teacher can ask about the concepts and about the experiments. Some questions will be used by the teacher in plenary discussion before and after the activity, other questions will be used while the students are at work and the teacher goes around observing and reacting to the students' work.

The lesson

6. *Whole class.* Getting acquainted with the phenomenon

Condensation example (appendix): put a glass of cold water from the refrigerator on the table and add some ice cubes. Let children observe, what happens? Do they see the water on the outside? Have they seen something like that before? Are there related experiences (car windows getting foggy, windows when taking a shower)? What are their experiences?

7. *Children individually.* Present the cartoon and let children answer individually on a worksheet whom they agree with and why. See example worksheet in the appendix.
8. *Whole class:* Make an inventory of the different opinions, experiences, and arguments. The teacher leads the discussion and assists students to present their ideas and explanations but remains neutral. The discussion ends with a list of questions which can be asked about the phenomenon.
9. *In small groups.* Divide the students in groups and (if the teacher chooses to) assign roles for cooperative learning. Ask children to think about experiments which can help them to find answers to one of the questions or to further investigate the statements in the cartoon. Let them describe the experiment briefly on the group worksheet (appendix).
10. Some groups have a tendency to right away start experimenting with the first idea that comes up. Try to get them to think a bit deeper about the experiment they propose. Let them fill in the worksheet (appendix) and question them critically. We ourselves usually postpone the actual experiments to the next lesson. There are two reasons for this: 1) we want the students to think deeper about what they are going to do, 2) students can list what equipment/materials they need and bring that to class next time. With some cartoons, for example those about falling motion, it is not feasible to

postpone the actual experiments but with most cartoons the split in a preparation lesson and an experimental lesson works quite well.

Grade 5: With a cartoon on bungee jumping in which the characters wondered whether heavy people would fall faster and farther, the children thought of building towers of lego or blocks, using rubber bands of equal lengths, and comparing a full water bottle (heavy person) with a half filled bottle (light person). Then they were going to do a fair comparison. One girl emphasized that the rubber bands for the heavy and the light bottle should be exactly equal length.

11. *Next lesson in small groups*: students carry out their experiments.
12. *In groups*. In elementary school the children probably have little experience in describing the set-up and results of their experiments. A worksheet helps to give structure. Michael Klentschy (2008) developed a notebook method where children from 6 – 14 develop their skills in documenting their reasoning from expectation to observation and conclusion. His book shows nice examples of progression across the ages and this method has positive results both for science and language skills of students.
13. *Whole class*. Presentation of results during which other students and the teacher can ask critical questions. The two leading questions are: a) what have we learned about the phenomenon (e.g. condensation) and what is our evidence for that? And b) what did we learn about experimenting and doing research? To let all groups make oral presentations can be too time-consuming unless the teacher wants to practice oral presentation skills. Instead the teacher can lead a discussion about the two main questions in which the students introduce their evidence and reasoning.
14. Assist the class in the interpretation of research results after all groups have presented and then link back to the preconceptions at the start and point out what the class has now learned from the experiments. And certainly some new questions will come up.

Experiences and solving problems when teaching with concept cartoons

The try-out of concept cartoons generates a lot of enthusiasm and is usually successful. However, we also ran into problems for which we constructed solutions which have been tested in the classroom. The following points show both problems and solutions.

Designing experiments. Children are creative in thinking of experiments. When there are more variables, children have trouble to limit themselves to manipulate only one of these variables.

When we asked how the melting of ice could be accelerated, they wanted to change everything to get the fastest melting while we wanted them to investigate the variables one by one. With some clever guidance this can be solved.

Quite frequently the research question and the proposed experiment do not fit.

With the condensation cartoon one group claimed that water vapor from the air would condense on the outside of the glass. However, in their experiment they proposed to fill their glass with coca cola. So as if they wanted to investigate whether condensation also happens with other liquids than water.

If you do investigate this, it turns out that every liquid will work as long as the temperature is lower than that of the air. Water and water-based liquids such as Coca-Cola do particularly well as the specific heat of water is high and it takes a long time before the liquid reaches room temperature.

Predicting with reasons. Children can predict quite well but they cannot formulate their reasons well on paper and it helps if the teacher questions them and looks critically at their formulations. Obviously the skill of predicting and supporting the prediction with reasons requires a long learning trajectory.

Classroom management and cooperative learning. We usually use groups of 3. In every group one student is responsible for any communication with the teacher, one takes care of the equipment, and a third is responsible for good reporting. This prevents the problem that 30 children would line up for assistance of the teacher. In the next activity children get assigned to a different role. The roles are based on the Australian Primary Connections program (2008).

Designing en executing experiments. Children think of an experiment and too quickly get on with it. This can be prevented by doing the designing in one shorter lesson and the executing and reporting in the next and longer lesson. However, in the design lesson it is helpful to have some of the experimental materials in the room to help children in thinking about the design of their experiments. With the cartoon about falling motion, it will be difficult to stop children from trying out immediately, but do force them to think about what they are doing.

Executing experiments (1): Some children are busy reasoning and then conduct their experiment only once. Others go through many repetitions. With questions like “*How can you be sure of your results?*” you can let children think about the power of their experimental proof and how this could be enhanced by repetition or varying conditions.

Executing experiments (2): During the experiment children often change so many things that their experimental set-up no longer matches with the research question they started with. Of course there will be (and should be) improvements as they get more experience with their experiment, but they should not forget their main research question. The set-up of the worksheet (appendix) helps with that.

Final presentation: Groups of 4th grade children right away applauded their class mates when presenting instead of having a critical discussion. Solution: let children from the audience give a ‘*tip*’ and a ‘*top*’. The *tip* is a suggestion for improvement. The *top* is about something the presenting group has done well. Even better is to let the audience indicate what they learned from the presentation that they did not know before. Of course one could also opt not to have final presentations by the groups but instead to have a post-lab discussion where all can contribute and the teacher keeps a clear focus.

In the post-lab discussion there are two central questions: a) *What did the group learn about the phenomenon and the major concepts?* and b) *what did the group learn about investigation/research.* At the end of the discussion, the teacher summarizes the answers to these two questions.

Worksheet or notebook: Carefully choose priorities for written reporting.

In one group with selected talented grade 4 students we had a very ambitious worksheet where children had to predict, provide arguments, reason with those arguments and answer other questions about the experiment they were going to do. Our elaborate worksheet killed the motivation.

So carefully select priorities and keep the writing limited as in the example worksheet.

To conclude an interesting experience:

Four talented grade 4 children (age 10-11) experimented with condensation (see cartoon in the appendix). Their first hypothesis was that the outside of the glass could only get wet

inside the refrigerator. But in their first experiment with a glass that was dried on the outside, water still formed. Their second hypothesis was that the condensation water would come out of the glass. They put on a lid and predicted the outside would remain dry. However, it still became wet. They went through a series of experiments and discussions of everyday experience with windows fogging up. They observed that with hot water in the glass, the inside would get foggy. I demonstrated to them that my breath also creates water on the outside of a glass filled with water of room temperature. Then Emma made the big jump. She said that water vapor will form liquid water when it hits a colder surface. When asked how to test this, she suggested that if the water temperature in the glass would be above 37 degrees, then our breath would not form water on the glass. And she was right!!

References

- Berg E. van den, Kruit P., Wu F.: (2012). Getting children to design experiments through concept cartoons. EU Fibonacci conference on Inquiry Based Science & Mathematics Education: Bridging the gap between education research and practice, Leicester, 25-27 April 2012 (~50) <http://www.fibonacci-project.eu/resources/events/leicester-conference-2012.html>
- Chin C., Teou L. Y.: (2009). Using Concept Cartoons in Formative Assessment: Scaffolding students' argumentation. *International Journal of Science Education*, 10(1), 1307-1332.
- Keogh B., Naylor S.: (1998). Teaching and learning in science using concept cartoons. *Primary Science Review*, 51, 14–16.
- Keogh B., Naylor S.: (1999). Concept cartoons, teaching and learning in science: an evaluation. *International Journal of Science Education*, 21(4), 431-446.
- Klentschy M. P.: (2008). Using Science notebooks in Elementary Classrooms. Washington: NSTA Press.
- Naylor S., Keogh B.: (2000, 2011). Concept cartoons in science education. Sandbach, UK: Millgate House.
- Naylor S., Keogh B., Downing B.: (2007). Argumentation and primary science. *Research in Science Education*, 37, 17-39.
- Naylor S., Keogh B.: (2012). Concept cartoons, what have we learnt? Paper presented at the Fibonacci Conference, Leicester, 26 – 27 April 2012. Retrieved from <http://www.millgatehouse.co.uk/research/concept-cartoons-research-ongoing> on April 29, 2012.
- Primary Connections (2008). Science Teacher Guides for Age 4 – 12. Canberra, Australian Academy of Science.
- Rocard M et.al: (2007). Science Education Now: a renewed pedagogy for the future of Europe. Brussels: European Commission Directorate-General for Research.
- Simon S., Naylor S., Keogh B., Maloney J.: Downing, B. (2008). Puppets Promoting Engagement and Talk in Science. *International Journal of Science Education*, 30 (9), 1229–1248.
- Tytler R., Peterson S.: (2003). Tracing young children's scientific reasoning. *Research in Science Education*, 33, 433-465.

Appendix: Example worksheets ICPE Prague August 2013

Wet Glasses

Worksheet 1 Individual

Name: _____

A glass of water from the refrigerator with some ice cubes is put on the table. The outside of the glass becomes wet.

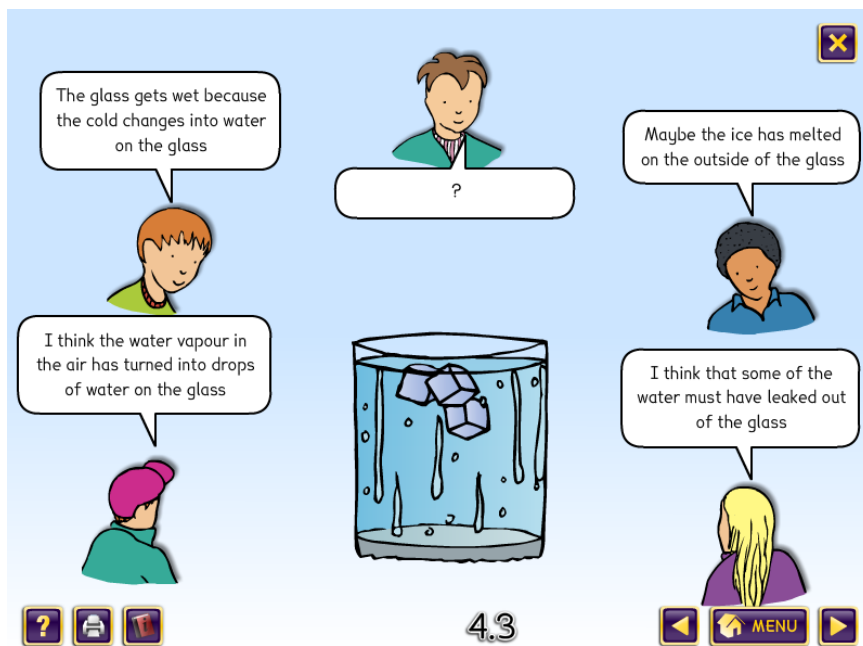

- | |
|--|
| 1) Who do you agree with? Why do you think so? |
| 2) Could it be that one of the others is right? Explain. |

Workheet 2 Group

With your group think of an experiment to further investigate the phenomenon in the cartoon or to collect evidence for or against one of the statements in the cartoon.

What is your research question?
What do you expect as an answer?
How are you going to do the experiment? (make a sketch)

What do you think will happen?
What do you need for the experiment?
How will you record the observations/measurements?

Worksheet 3: Group or individual

Remember, what did you expect?
What did you measure or observe?
How is that different from what you expected?
How do you explain what happened?

Posters

research papers

A Case Study of a Preservice Physics Teacher's Practical Knowledge about Students

María Cristina Cifuentes Arcila¹, Carlos Julio Uribe Gartner²

¹Universidad Pedagógica Nacional, Bogotá D.C., Colombia

²Universidad del Valle, Cali, Colombia

Abstract

The purpose of this study was to explore the development of a preservice physics teacher's practical knowledge over the course of a high school practicum experience. The framework of the study includes the Teacher's Practical Knowledge concept, which views teacher's knowledge as action oriented and context-dependent, which has experiential origins as well as emotional and moral dimensions. To capture this complex type of knowledge, a narrative inquiry approach guided data collection, organization, and analysis. One preservice physics teacher, Alicia, participated in this study over the first year of her practicum, during which she was attending an assigned classroom to observe and provide help to her mentor during his physics classes, two mornings weekly for 16 weeks, and afterwards she took the lead in teaching fulltime for 16 weeks. We collected many types of data, including audiotaped interviews and conversations, written documents, and field notes. In the paper we present the conclusions of a narrative analysis of these data, with comments and reflections that show how Alicia's practical knowledge developed. In particular, we will describe Alicia's changing understandings about her students, as individuals and as members of informal groups, changes that took place as a result from interactions with them in physics class situations and her reflections about these interactions. We discuss some implications of our results for physics teachers' initial training.

Keywords: preservice physics teachers, practical knowledge, knowledge about students, Narrative Inquiry

Introduction

Recently, educational researchers and science teachers' educators are calling for systematic studies on how the aspiring teachers develop their practical knowledge about science teaching, in particular over their practicum experiences [1,2], and about the type of opportunities that can be provided in order to help them more effectively in this challenge. What can we do as teachers' educators to foster their professional development so they can respond to the specific and ever more complex needs of their future working scenarios?

In this direction, we report a case study of one preservice physics teacher enrolled in a physics teacher education program at a national pedagogical university in Bogotá, Colombia, aimed at a better understanding on the change of physics teachers' practical knowledge over their practicum. The main research question we addressed was: *How does the practical knowledge of a preservice physics teacher develop over her teaching experiences during the practicum?*

For trying to answer this large overall question, we addressed four specific questions: a) *What is the kind of practical knowledge that has the more pronounced development over the course of preservice physics teacher's practicum experience?* b) *What are the main characteristics of this kind of practical knowledge?* c) *What relationships can be identified*

between this practical knowledge and the preservice physics teacher's experiences as a physics student? and d) How does the practicum experiences enhance, limit and constrain this practical knowledge development?

Theoretical Perspective

We characterize teacher's practical knowledge as the one that: a) arises from the different kinds of experience, standing out that from one's family and from one's life as student in elementary, secondary and university education, and as teacher [3,4,5,6]; b) is oriented toward the solution of the practical problems at work, which are complex, uncertain, changing, and unique, involving value conflicts, and which are not amenable to general rules [6,7]; c) is expressed in life story and in actual teaching [8,9]. In addition, such a knowledge has the following traits: a) is personal, being embodied in individual social actors and having unique shades related to the biography of teachers [3,4]; b) is sociocultural, being built, constrained, naturalized and reinforced within the professional collective of teachers and the multiple cultural communities that cross at school [5,8,9]; c) is temporal, being developed and transformed in the continuum past – present – future [3,4]; d) is mainly tacit, inasmuch many elements are a kind of active, not propositional understandings [9]; e) is situational, being defined within and adapted to the singular situations at work; f) is content specific, because the subject impresses a hallmark to teachers' knowledge [10].

Methodology

In order to understand how a preservice physics teacher, Alicia (a pseudonym), developed her practical knowledge about science teaching over the course of her practicum experiences we adopted a narrative inquiry approach [11]. In this approach, narrative acts as both phenomenon and method. Narrative serves as a source of information through teachers' storytelling, as well as a method of interpretation and reinterpretation of teachers' experience. Alicia told us stories about her practicum experiences, and we wrote a narrative about Alicia's practicum experiences.

Alicia was a preservice physics teacher enrolled in a physics teacher education program at a national university in Bogotá, Colombia, devoted to teacher education. There were several reasons for selecting her: her enthusiasm and willingness to learn, to teach physics and to participate in this study. But in many respects she was a typical preservice physics teacher, for example in terms of age and years in university. At the time of her participation in this study, she was a 19-year-old fourth-year student. Additionally, Alicia's practicum placement and assignment also were typical. At the beginning of this investigation, Alicia started to assist to a public urban school located in a low SES neighborhood in Bogotá in order to perform her practicum. Her assignment for the first half of the practicum, lasting 16 weeks, was to attend to an assigned classroom to observe and provide help to her mentor during his physics class, two mornings weekly. For the second half, lasting also 16 weeks, she took the lead in physics teaching fulltime, two mornings weekly.

We had four separate sources of data. The first one consisted of four semi-structured interviews conducted with Alicia throughout the course of the 2009 school year, in February, March, July, and December. During the interviews, Alicia described her experiences as a physics teacher student and as a pre-service physics teacher. The second source of data consisted on weekly informal conversations about Alicia's practicum experiences. In these Alicia reflected about what seemed to her to be her most significant

classroom experiences. The third source of data consisted on reflections that one of the researchers (Cristina) wrote about Alicia's classes observations. The four source of data consisted of weekly reflections that Alicia wrote about her practicum experiences.

Field notes, interview and conversations data were initially organized and divided into content units, coded by brief descriptive phrases, by one of the researchers (Cristina). This first interpretative process was enriched by a "theoretical memo" process in which preliminary interpretations and comments on each segments of the data were written [12]. Then the other researcher (Carlos) provided feedback and enriched this interpretative process. This process revealed us three intertwined topics in Alicia stories: classroom management, physics teaching and student's characteristics. However, students were the main topic because Alicia's most significant concern, during her practicum experiences, was connecting to and developing greater understanding about her students, both as individuals and as members of diverse social and cultural groups. Therefore, we selected students as our narrative's topic.

A preliminary narrative was prepared by one of the researchers (Cristina), who accompanied Alice along her practicum experiences. Then this preliminary narrative was shared with the other researcher (Carlos), who evaluated it in terms of the coherency, verisimilitude and transferability [11]. As a result of this evaluation a new and definitive narrative was wrote. This narrative was designed to capture Alicia's practical knowledge development by detailing her students' images and their practical expression in classroom, conversations and interviews. Accordingly, the narrative plot was configured in the pattern situation-transformation-situation, starting from Alicia's image about her students at the beginning of her teaching experiences, the transformation this image underwent once the teaching practices started, and her final image at the end of her teaching experiences. This narrative, also, was designed to describe some relations between: a) Alicia's images about her students, b) Alicia's experiences as a physics student, and c) Alicia's practicum context. Unfortunately, in this article we will not present the narrative because it is a short communication. The narrative can be found in [13]. Next, we will present only the most relevant conclusions of our research.

Alicia's Practical Knowledge Development about her Students

The difficulties and tensions, which Alicia experimented during her practicum, defined the development horizons of her practical knowledge. Those tensions forced her to direct a big amount of her effort in build, re-build, enrich, and transform her primary practical knowledge. Specifically, Alicia had trouble to arranging the classroom environment, and its physical structure, in order to satisfy the general expectations of the educational system, and the particular expectations of her school, classroom, students, mentor and lessons [14,15,16]. Also, she had many problems to set teaching-learning goals, organize a sequence of lessons into a coherent course, and select, construct and use the more appropriate physics teaching strategies for each lesson [14,15,16]. Additionally, she experienced tension between her stereotyped and little realistic students' images and the behaviors, knowledge, abilities, interests, learning styles, inter alia, that most of her students showed in her classroom [14,15,16].

Accordingly, the areas that had the most pronounced development along her first practicum year were Alicia's practical knowledge about her students, and about physics teaching and classroom management. However, the former developed more deeply than the latter. The apparent reason of this asymmetry could be attributed to the fact that the interactions of Alicia with her students were one of the aspects that most influenced the

development of her teaching knowledge. We make this assertion from an analytic perspective, because in reality and in the narrative the different realms of practical knowledge are interwoven. She get to know her students reflecting about the difficulties and strengths they experimented in learning physics, and about the more appropriate teaching and controlling strategies, considering their students' characteristics. In figure 1 we represent these analytic relations among practical knowledge realms.

The fact that Alicia's practical knowledge about her students was which has the most prominent development along her teaching experiences calls attention about how learning to teach is not an individual enterprise, but one that happens through interactions and relationships with people inside and outside the class. Consequently, these are one of the most important dimensions of teacher training.

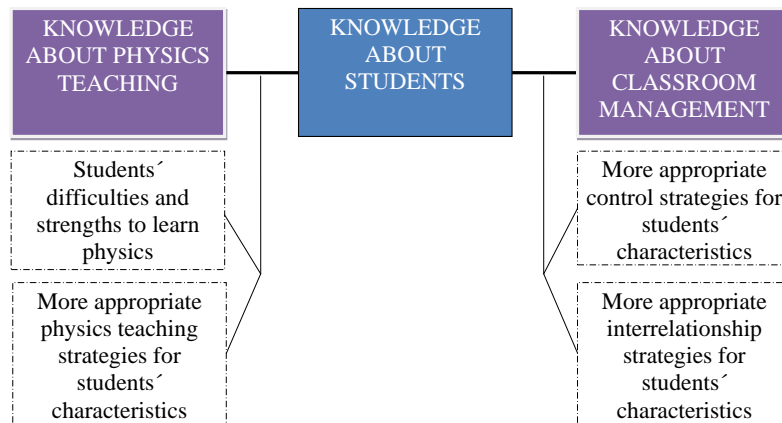

Figure 1. Relations among the realms of Teachers Practical Knowledge

The development of Alicia's practical knowledge about her students was historical, in the sense that it implied rethinking and rebuilding her past in accordance to her present experiences [3]. When Alicia entered her classroom for the first time, in order to observe her mentor lessons, she used her biographic experiences to make sense of the realities lived there [14]. Eventually she made a new sense of those realities, after her scrutiny of the mentor lessons and his verbal reports to her mentor [14]. Finally, when Alicia started her own lessons, she started quickly to develop the knowledge of her students from her own experience with them, and the processes of "anticipatory" and "retrospective" reflection that she undertook based on those experiences [14]. This does not mean that the teacher was not using her biographic knowledge, but rather that she transformed it as a result of her observations, her mentor's storytelling and her own teaching experiences.

Alicia's talk about her students, at the beginning of her teaching, did reference – mainly – to the student dispositions toward learning (motivated-unmotivated), academic performance (high-low) and behavior in class (positive – negative) that characterized the different groups of students in which she mentally divided her class [17,18,19]. However as she was getting more work experience, her talk included more and more understandings about teaching-learning activities, the patterns of communication and the ways to control the negative behaviors. We have named those comprehensions as the pedagogical dimension of students' images, to emphasize that they correspond to teacher knowledge about physics teaching and classroom management focused in the varying characteristics of students.

Near the end of the practicum, when the teacher achieved a general panorama of the different students groups in her class, she started to use the chief part of her time and effort

to comprehend her students in relation with their difficulties about learning physics. For that reason, in that stage, the comprehensions of the teacher about the general students difficulties to perform physics teaching-learning activities and to learn specific physics content, which so much investigators has referred to as Pedagogical Content Knowledge [1], had have a pronounce development. We will refer later to this kind of knowledge.

In general terms the Alicia's practical knowledge about her groups is characterized for:

- *Including the most representative features that distinguish the different students informal groups*, but, without including a description of the class as a whole, nor of the singular students, but for some few exceptional cases of students with a very notable performance or with aggressive or/and defiant behavior. It is not fortuitous that this image does not include a description of the class as a whole, as the experimented teachers usually do, inasmuch as they build it based on previous experiences in other classes [18,19,20], experiences that Alicia did not have. Nor is accidental that this image does not include descriptions of the different people which belong to her class, given that getting to know all the students, as individual persons, it is complex and takes too long, even more with a class with a large number of students as this one.
- *Having a moral and an emotional dimensions intrinsically and reciprocally related*: The ways in which Alicia got to know her students as a whole and the particular students who took a protagonist role in her thought, were related with her moral judgments and the emotional and relational links that she established with them [3,21,22]. For example, Alicia ended up knowing better those students that in her judgment showed attributes near her archetype of the good student, which collected her deepest beliefs about what is morally good, righteous and virtuous in a physics student. This fact seems to be an outcome of the positive feelings and cognitive security those students generated in her. Those feelings led little by little to the establishment of positive student-teacher relationships, founded in care, affinity, connection, and sympathy.
- *Having a practical dimension*. The ways the teacher got to know her students: a) oriented her processes of selection, adaptation, and/or construction of teaching content strategies and of classroom management, taking into account the characteristics of her students [14,15,16,23]; b) allowed her to anticipate the student mood dispositions, its academic performance, and the probable ways the lessons went on [24]; c) those ways served as an interpretative framework to give sense to the different incidents with her students [24,25,26]; d) framed the kind of relationships that the teacher established with the different groups of students in her class [21].

Regarding Alicia's practical knowledge about her students' difficulties in learning physics it is important to highlight that, at the beginning of her teaching experiences, it pointed mainly to their struggles performing the learning activities privileged in physics lessons, such as solving pencil and paper end-of-chapter problems and reading school textbooks. Eventually, as her experience grew, she started to develop a series of practical insights about her students' difficulties to understand some kinematics and dynamics concepts and the relationships among them; besides, she clearly refined her understanding about those central aspects of physics teaching (problem solving and textbook reading).

Of course, her emergent understandings about students' general difficulties to learn specific physics concepts were intimately related with the subject content covered in the lessons. In her first two months of teaching, she delved about her students' difficulties to understand kinematical spatial-temporal relations, and mass and weight distinction, as the

subject matter was kinematics of uniform circular motion and Newton's laws of motion. In the next two months, when her lessons were about work, energy and power, her reflections turned around her students' difficulties to understand and differentiate these scientific concepts. In Table 1 we synthesize the pedagogical content knowledge that Alicia developed about general and specific student difficulties to understand some kinematics and dynamics concepts and their relationships. In Table 2 we sketch her reflections about some of the general student difficulties in solving standardized problems and in reading textbooks, the privileged types of work in physics lessons.

Table 1. Insights Alice expressed about students' difficulties in understanding some physics concepts and the relations between them

STUDENTS' GENERAL DIFFICULTIES	STUDENTS' SPECIFIC DIFFICULTIES
Difficulties in distinguishing and relating every day and scientific meanings and contexts.	<ul style="list-style-type: none"> • Students associate the scientific meanings of the mass and weight concepts with the everyday meaning of mass and weight as the quantity of matter of a body. • Students associate the scientific meaning of the work concept with the everyday meaning of work as physical effort to lift, push or pull a body. • Students associate the scientific meaning of the power concept with the everyday meaning of power as a capacity of a person or a machine to exert a strong force.
Difficulties to infer the meaningful relations between scientific concepts.	<ul style="list-style-type: none"> • Students do not comprehend the power concept due to their not understanding the scientific concepts of force and work from which its meaning is built, nor the relation between those concepts.
Difficulties to understand the operational definitions as proportion (ratios) between physics magnitudes.	<ul style="list-style-type: none"> • Students do not comprehend the power concept due to their lacking the scheme of proportional reasoning, interpreting its operational definition as a chain of arithmetical operations (multiplication and division) between magnitudes.

Conclusions

The preservice education of science teachers is one of the key aspects of science education reform, because it is essential to really transforming teaching practice in schools [2,27]. Therefore, we as teacher educators must reflect insistently on the kind of formation that we are giving. Our results are relevant for this purpose, primarily because they invite to recognize that the stories about teachers' life and their "stories-in-action" constitute two of the principal scaffoldings to learn how to be a science teacher, and that the practicum is the privileged place for preservice teachers to learn through their own experience and build their practical knowledge.

Table 2. Insights Alice expressed about student's difficulties in solving physics standardized problems and in reading physics textbooks

KIND OF KNOWLEDGE	STUDENTS' GENERAL DIFFICULTIES
<p>Knowledge about student's difficulties in solving physics standardized problems</p>	<ul style="list-style-type: none"> • Lack of mastery of the mathematics required to solve the problems. • Difficulty in comprehending problem statement, both at the reading level and at the physics conceptual level. • Blind use of algorithmic techniques, which generates: <ul style="list-style-type: none"> ○ Inability to solve different problems to those exemplified by the teacher. ○ Inability to solve problems which imply predicting and explaining the behavior of complex systems. ○ Little disposition and skill in representing and organizing the information given in the problem statement, and in doing a previous qualitative analysis ○ Little disposition and skill in evaluating the final result
<p>Knowledge about student's difficulties in reading physics textbooks</p>	<ul style="list-style-type: none"> • Low motivation towards scientific texts, associated with the utilization of technical terms, complex discursive operations, and extensive sentences and paragraphs. • Difficulty in comprehending the meaning of scientific terms, because they packed too much information. • Lack of background knowledge required to comprehend the text. • Problems to relate the ideas of the author, the scientific ideas worked in previous lessons, and their own ideas about events or natural phenomena.

Acknowledgments

The first author is greatly indebted to the Universidad Pedagógica Nacional for its financial support during her doctoral studies, in which this research was conducted. The second author acknowledges the financial support from the Universidad del Valle for attendance to the ICPE-EPEC conference.

References

- [1] Abell S.: Research on Science Teacher Knowledge. In: Handbook of Research on Science Education, vol. 36. Ed. Abell, S., Lederman, N. p. 1105–1149. New York: Lawrence, (2007).
- [2] Russell T., Martin A. K.: Learning to teach science. In: Handbook of Research on Science Education, vol. 37. Ed. Abell, S., Lederman, N. p. 1151–1176. New York: Lawrence, (2007).
- [3] Clandinin J.: Personal practical knowledge. Curriculum Inq. 15, No 4 (1985), p. 361–385.
- [4] Clandinin J., Connelly M.: Stories to Live by. Curriculum Inq. 28, No 2 (1998), p. 149–164.
- [5] Connelly M., Clandinin J.: Teachers' professional knowledge landscapes. Stories of schools. Educ. Res. 25, No 3 (1996), p. 24–30.
- [6] Elbaz F.: The Teacher's "Practical Knowledge". Curriculum Inq. 11, No 1 (1981), p. 43–71.
- [7] Schwab J.: The Practical. Sch. Rev. 78, No 1 (1969), p. 1–23.

- [8] Schön D.: *The Reflective Practitioner*. London: Temple Smith (1983).
- [9] Van Manen M.: On the Epistemology of Reflective Practice. *Teachers Teach. Theor. Pract.* 1, No1 (1995), p. 33–50.
- [10] Shulman L.: Those Who Understand. *Educ. Res.* 15, No. 2 (1986), p. 4–14.
- [11] Clandinin J., Connelly M.: *Narrative Inquiry: experience and story in qualitative research*. San Francisco: Jossey–Bass (2000).
- [12] Glaser B. G., Strauss A. L.: *The discovery of grounded theory: Strategies for qualitative research*. Chicago: Aldine Publishing Company (1967).
- [13] Cifuentes M.C.: *Estudio narrativo de los conocimientos prácticos: el caso de una profesora de física, en formación inicial, durante su prácticum*. Unpublished PhD thesis, Universidad de Valle, Cali, Colombia.
- [14] Eick C., Dias M.: Building the authority of experience in communities of practice. *Sci. Educ.* 89, No 3 (2005), p. 470–491.
- [15] Geddis A., Roberts D.: As Science Students Become Science Teachers. *J. Sci. Teach. Educ.* 9, No 4 (1998), p. 271–292.
- [16] Powell R.: Building a Personal Practical Philosophy for Classroom Curriculum. *Curriculum Inq.* 26, No 2 (1996), p. 147–173.
- [17] Kagan D., Tippins D.: How student teachers describe their pupils. *Teach. Teach. Educ.* 7, No 5/6 (1991), p. 455–466.
- [18] Calderhead J.: A psychological approach to research on teachers' classroom decision-making. *Educ. Res–UK.* 7, No 1 (1981), p. 51–57.
- [19] Mayer D., Marland P.: Teachers' knowledge of students: a significant domain of practical knowledge? *Asia Pac. J. Teach. Educ.* 25, No 1 (1997), p. 17.
- [20] Berliner D. C.: In pursuit of the expert pedagogue. *Rev. Educ. Res.* 15, No. 7 (1986), p. 5–13.
- [21] Chang M.–L., Heather D.: Emotion management and display in teaching. In *Advances in teacher emotions research*, Ed. Schutz, P. y Zembylas, M., p.95–128. New York: Springer, (2009).
- [22] Panti N., Wubbels T.: Teachers' moral values and their interpersonal relationships with students and cultural competence. *Teach. Teach. Educ.* 28, (2012), p. 451–460.
- [23] Bianchini J., Cavazos L.: Learning from students, inquiry into practice, and participation in professional communities. *J. Res. Sci. Teach.* 44, No 4 (2007), p. 586–612.
- [24] Mulholland J., Wallace J.: Facilitating Primary Science Teaching. *Teachers Teach. Theor. Pract.* 9, No 2 (2003), p. 133–155.
- [25] Doyle W.: Learning the classroom environment. *J. Teach. Educ.* 28, (1997), p. 51–55.
- [26] Newberry M.: Identified phases in the building and maintaining of positive teacher–student relationships. *Teach. Teach. Educ.* 26, (2010), p. 1695–1703.
- [27] Fullan M.: *Change Forces: Probing the Depths of Educational Reform*. London: Routledge Falmer, (1994)

Impact of teaching practice on academic self-concept of pre-service physics teachers

Markus Elsholz¹, Thomas Trefzger¹

Faculty of Physics and Astronomy, University of Wuerzburg, Germany

Abstract

This study is about academic self-concept of pre-service physics teachers at university of Wuerzburg. In a special seminar at university school-like interactions between pre-service physics teacher and school students take place. Pre-service teachers' academic self-concept is assessed with a paper and pencil test in pre-post design. This paper focuses on the assessment method and reports first results indicating an increase in pre-service teachers' academic self-concept after a 15 week course.

Keywords: physics teachers education, out-of-school activities, academic self-concept

Introduction

Content knowledge (CK), pedagogical content knowledge (PCK), and pedagogical knowledge (PK) form teachers' professional action competence [1]. Although highly skilled in theoretical issues, i.e. content knowledge, applying this knowledge in teaching practice is often difficult for future physics teachers. School-like interactions with school students in a special course already at university level shall provide appropriate learning opportunities, which might help raise pre-service teachers' academic self-concept thereby supporting professional action competence.

Structure of the Teaching-Learning-Lab

In 2009 the M!ND-Center was initiated as an interdisciplinary center for science teacher education at the University of Wuerzburg. Its major task is to improve science teacher education. A certain course type called teaching-learning-lab (TLL) has been implemented to pursue that goal. The main goal of this course is to strengthen the relations between pre-service teachers' content knowledge, pedagogical content knowledge, and pedagogical knowledge. For school students TLL is an attractive out-of-school learning environment (,learning-lab'). For pre-service teachers TLL provides a simulation of a school-like setting, in which they can enhance teaching practices and strategies (,teaching-lab'). The TLL-course spans 15 weeks of university training and is split into two larger periods.

Preparation Period

The preparation period covers the first 10-12 weeks of the TLL-course. During that period the participating pre-service teachers (about 25 per course) work together in small groups and design experiments and learning material for a certain physics unit (e.g. quantum physics, biophysics, optics) which focuses on inquiry based teaching. They have to recapitulate the underlying physics, choose content and experiments according to the school curriculum and agree to appropriate simplification and teaching strategies. The TLL-course lecturers thereby ensure the material to be appropriate in form and content. The preparation ends in a session of role play, in which half of the pre-service teachers enacting school students conduct the other group's experiments and provide feedback.

Practical Training

The remaining 3-5 weeks of the TLL-course are spent in practical training. A couple of school classes (about 6-8 classes) visit the M!ND-Center on different dates for about 3-5 hours each. Pre-service teachers thereby supervise small group sessions with school students at their own particular setup each time. After each session, pre-service teachers receive feedback from their fellow students as well as from experienced experts and revise their units if necessary. Because pre-service teachers have dealt intensively with the physics of their setup during the preparation period they can thoroughly focus on their teaching strategy and the school students' reactions to it during the practical training sessions. The practical training therefore offers a mock teaching situation to test different strategies teaching on a particular physics topic.



Figure 1. Pre-service teacher supervising a small group of school students in the practical training period of TLL-course

Research interest

An interview based pilot study [2] showed that after a TLL-course pre-service teachers state that their preparation and instruction techniques improved. We assume that the reflective practical training period of the TLL-course supports them to find and shape appropriate teaching strategies and to derive professional acting routines. As a first step, the research interest therefore focuses on the impact of teaching practice in the frame of the TLL-course on the academic self-concept of pre-service teachers in physics teacher education.

Academic self-concept

The self-concept is seen as a hierarchically ordered construct with the general self-concept on its top level and academic self-concept and further non-academic self-concepts (e.g. social self-concept) one level below [3]. The formation of self-concepts is the result of self-rating processes in different reference norms [4]. Dickhäuser et.al [5] found four distinct reference norms. They propose to assess academic self-concept in relation to the peer group (social reference frame), in view of individual achievements (individual reference frame), regarding specific requirements (criterion-oriented reference norms) and in terms of absolute statements (without an explicitly given reference norm). Their scales are adopted in that study because they are constructed to assess academic self-concept of university students.

Design and Methods

From April 2013 to August 2013, data from $N = 21$ pre-service teachers has been assessed in a pre-post design. They had to answer a paper and pencil questionnaire at the beginning and the end of the TLL-course, respectively. In addition they had to keep records of the development process of their particular setups in a logbook. The main study will range over three assessment phases to July 2014. Then data of about $N = 70$ pre-service teachers will be assessed.

Questionnaire

At assessment points T1 (week 3 of TLL-course) and T2 (week 15 of TLL-course) academic self-concept [5] has been assessed. Personal data (e.g. age, gender), educational level (school leaving certificate), teaching experience, generalized self-efficacy [6], and self-concept [7] has been assessed as control variables at T1. The self-concept scale is adopted from Marsh and O'Neill [8]. In this paper we focus on academic self-concept. Table 1 states some example items for the different reference norms in the scales of Dickhäuser et al. [5], respectively. The original scales had been slightly adapted to cover the different demands of the three-factor structure in physics teacher education at university (i.e. CK, PCK and PK). Any item had to be answered with respect to CK, PCK and PK domains of the course of study on a seven-point Likert scale.

Table 1. Example items for the use of different reference norms in the assessment of academic self-concept (translated by the authors)

reference norm	example items
without explicitly given norm (5 items)	„Neues zu lernen im Studium fällt mir . . . schwer/ leicht.“ “In my course of study I learn new things ... with great effort/without effort.”
individual reference norm (6 items)	„Wenn ich meine Entwicklung über die Zeit meines Studiums betrachte, dann fällt mir das Lernen von neuen Dingen heute . . . schwerer als früher/leichter als früher.“ “Considering my progress during the course of studies up to now, learning new things today is ... harder/not as hard ... as in the past.”
criterion-oriented reference norm (5 items)	„Gemessen an den Anforderungen des Studiums fällt mir das Lernen von neuen Dingen . . . schwer/leicht.“ “Considering the demands of my course of studies, it is ... hard/easy ... for me to learn new things.”
social reference norm (6 items)	„Etwas Neues zu lernen fällt mir . . . schwerer als meinen Kommiliton(inn)en/leichter als meinen Kommiliton(inn)en.“ “Compared to my fellow students it is ... harder/easier ... for me to learn new things.”

Logbook entries

Beside the questionnaires, pre-service teachers had to answer specific questions in a logbook to document their progress. The logbook entries were placed at the end of the preparation phase (e.g. What experiments did you choose and why? How do you ensure that your learning material fits the experiments?), after the first session with school students (e.g. Do you think your design suits the school students' cognitive level? How do you plan to improve the material?), and after the last session (e.g. Which of your experiences during the practical training are probably most meaningful for your future career?).

First Results

Table 2 displays the mean and standard deviation of the academic self-concept scales for the pre-test ($N = 21$, 45% female, 55% male, all in their third year at university). Subscales are labeled by the letters 'a' (no explicitly given reference norm), 'i' (individual reference norm), 'c' (criterion-related reference norm) and 's' (social reference norm).

At first it can be stated that domain specific skills are rated significantly different (paired t-test) dependent on the reference norm. Significant deviations in the rating distributions are indicated in Table 2. The mean rating values in the social reference norm (s) are significantly lower (at least on 5% level) compared to the individual (i) and the criterion-related (c) reference norm for all of the three domains (CK, PCK and PK). Ratings without any given reference norm (a) are only slightly higher compared to the social reference norm and differ significantly (5% level) from the distribution of the criterion-related

subscales in all domains. In the CK domain, the high ratings in the individual reference norm differ significantly (1 % level) from the distributions in all the other reference norms.

The results of pre-post comparison (paired t-test) of academic self-concept scales are reported in table 3. On a 10 % level there is significant increase of academic self-concept in all subscales and domains with the exception of the (i)-subscale: no significant increase in the individual reference norm can be stated (neither in CK, PCK, nor PK domain). In contrast there is a remarkable increase in the social reference norm (s) in all domains, highly significant ($p < .01$) in CK and PK. A further increase can be observed in the CK domain measured in criterion-oriented reference norm (c) and also measured without any given reference norm (a), respectively.

Table 2. Mean (M) and standard deviation (SD) of the academic self-concept ratings in the domains CK, PCK and PK. Letters ‘a’, ‘i’, ‘c’ and ‘s’ indicate the different reference norms (see text for details). In each domain the deviations of the distributions related to different reference norms are reported. Significance levels are indicated by ‘-’ ($p > .1$), ‘*’ ($p < .1$), ‘#’ ($p < .05$) and ‘+’ ($p < .01$).

CK domain						PCK domain						PK domain					
	M	SD	i	c	s		M	SD	i	c	s		M	SD	i	c	s
a	3.24	1.06	+	#	*	a	3.70	0.82		#	+	a	3.26	1.20	*	#	
i	4.16	0.83		+	+	i	3.94	0.93			+	i	3.54	0.92			+
c	3.49	0.98			+	c	3.94	0.79			+	c	3.56	1.16			#
s	3.07	0.91				s	3.32	0.73				s	3.10	0.89			

Table 3. Statistics of paired t-tests for the pre-post comparison of academic self-concept in the domains CK, PCK and PK. Letters in second row indicate the different reference norms – a: no explicitly given reference norm, i: individual reference norm, c: criterion-oriented reference norm, s: social reference norm. Significance levels are indicated by ‘-’ ($p > .1$), ‘*’ ($p < .1$), ‘#’ ($p < .05$) and ‘+’ ($p < .01$).

	CK domain				PCK domain				PK domain			
	a	i	c	s	a	i	c	s	a	i	c	s
pre	3.24	4.16	3.49	3.07	3.70	3.94	3.94	3.32	3.26	3.54	3.56	3.10
post	3.86	4.11	3.78	3.52	3.89	4.17	4.13	3.58	3.53	3.78	3.82	3.47
t	-3.19	-0.29	-2.47	-3.83	-1.78	-1.26	-1.81	-2.76	-2.04	-1.48	-1.81	-3.39
p	+	-	#	+	*	-	*	#	*	-	*	+

Conclusion

In this early stage of data analysis we found first hints that pre-service teachers’ domain specific academic self-concept increases during a 15 week TLL-course – at least in three of four reference norms.

At the beginning of the TLL-course pre-service teachers attest themselves pronounced skills in all domains in reference to their individual development over the last time (individual reference norm) and in reference to the requirements of the course of study. This is particularly obvious in the CK domain. In contrast, their ratings are much more cautious in relation to their fellow-students (social reference norm) as well as in terms of absolute statements.

Ratings in the social reference norm show the most pronounced growth during the TLL-course. This may be explained by the fact that both teamwork and peer observation of teaching yield more realistic grading of individual skills. Even though pre-service teachers apparently don't identify their abilities growing over the time-span of the TLL-course (individual reference norm), the comparison with their fellow-students even might encourage them to rate their skills higher in relation to the requirements of their course of study (criterion-related reference norm) and in terms of absolute statements.

In that point of view the dominant effect of the TLL-course is not a growth but the reassessment of individual skills.

Outlook

Further correlation analysis as well as detailed analysis of the logbook entries might help to identify crucial determining factors. In addition a control group undergoing a conventional practical training in school classrooms will be surveyed to ensure causal inference to the specifics of the TLL-course.

References

- [1] Baumert J., Kunter M.: Stichwort: Professionelle Kompetenz von Lehrkräften, *Zeitschrift für Erziehungswissenschaft*, 9(4), 2006, p. 469-520.
- [2] Trefzger T., Völker M.: Ergebnisse einer explorativen Untersuchung zum Lehr-Lern-Labor. In S. Bernholt (Ed.), *Konzepte fachdidaktischer Strukturierung für den Unterricht* (2012), p. 134-136. Münster: LIT-Verlag.
- [3] Shavelson R. J., Hubner J. J., Stanton G. C.: Self-concept: Validation of construct interpretations. *Review of Educational Research*, 46, 1976, p. 407-441.
- [4] Marsh H. W.: Verbal and math self-concepts: An internal/external frame of reference model. *American Educational Research Journal*, 23, 1986, p. 129-149.
- [5] Dickhäuser O. et.al: Die Skalen zum akademischen Selbstkonzept. *Zeitschrift für Differentielle und Diagnostische Psychologie*, 23(4), 2002, p. 393-405.
- [6] Schwarzer R., Jerusalem M. (Ed.): *Skalen zur Erfassung von Lehrer- und Schülermerkmalen. Dokumentation der psychometrischen Verfahren im Rahmen der Wissenschaftlichen Begleitung des Modellversuchs Selbstwirksame Schulen*, 1999, Berlin: Freie Universität Berlin.
- [7] Schwanzer A. D. et.al: Entwicklung eines Instruments zur Erfassung des Selbstkonzepts junger Erwachsener. *Diagnostica*, 51(4), 2005, p. 183-194.
- [8] Marsh H. W., O'Neill R.: Self Description Questionnaire III: The Construct validity of Multidimensional Self-Concept Ratings by Late Adolescents. *Journal of Educational Measurement*, 21(2), 1984, p. 153-174.

Students' Epistemological Beliefs – adapting the EBAPS instrument in the Czech Republic

Martina Kekule, Blanka Zajacova

Charles University in Prague, Faculty of Mathematics and Physics

Abstract

The paper describes adapting the instrument Epistemological beliefs assessment for physical science instrument in the Czech Republic. The tool has been created by a group of scientists at the University of California, Berkeley, and it assesses the students' beliefs along five dimensions: structure of scientific knowledge, nature of knowing and learning, real-life applicability, evolving knowledge, source of ability to learn. In contrast to the MPEX or VASS survey, items of the EBAPS tool try to eliminate students' expectations of a particular science course from their epistemological beliefs. Despite the effort, the authors in their own critique of the instrument state the possibility of triggering the expectation sometimes for some students. That is why, when using the tool in a (slightly) different cultural and educational environment the proper adapting of the tool is needed. The adaptation includes not only meaningful translation into the native language, but above all appropriate statistical data processing (including for example item analysis, etc.) followed by interpretation and adjustment of the instrument. The tool was addressed to almost 200 high school students in the Czech Republic during physics lessons. After the assignment of the questionnaire, discussion about the tool was held with the students. We present the results obtained by both methods.

Keywords: epistemological beliefs, EBAPS, physical science, questionnaire adaptation

Introduction

The paper describes adapting of the EBAPS questionnaire (Epistemological Beliefs Assessment for Physical Science) focused on epistemological beliefs of high school students in the Czech Republic. The adapted tool will be used during a larger research project concerning learning styles in physics education, planned to be carried out in 2014. The detailed description of the whole project is available for example in [1] or in [2]. In order to find what students think about the nature of science, the nature of learning of science, etc. other tools exist as well. The most known are probably MPEX [3] and VASS [4]. Why have we decided to use the EBAPS tool? In contrast to the MPEX or the VASS surveys, items of the EBAPS tool try to eliminate students' expectation of a particular science course from their epistemological beliefs. Mainly, the form of the items which are mostly designed as a natural interview between two students ensures this characteristic of the tool. The tool has been created in the USA, which means in a (slightly) different cultural and educational environment so the proper adapting of the tool is needed.

Particularly, when adapting the tool we followed these two goals:

- to verify, that the translation into the native language is accurate and meaningful,
- to find the appropriate range of the questionnaire, so that it can be assigned during one lesson.

About the EBAPS questionnaire

The Epistemological Beliefs Assessment for Physical Science questionnaire (EBAPS) was originally developed and validated by researchers at the University of California, Berkeley. It was designed to probe students' *epistemologies*, their views about the nature of knowledge and learning in the physical sciences (EBAPS, 2011).

EBAPS is aimed at high-school and college students who are taking introductory physics or chemistry courses. It's optimized for algebra-based courses.

It is a forced-choice instrument and consists of 30 items divided into 3 parts (I-III). Components of EBAPS are also divided in five non-orthogonal dimensions: *Structure of scientific knowledge*, *Nature of knowing and learning*, *Evolving knowledge*, *Real-life applicability* and *Source of ability to learn*. Each dimension can be scored separately.

The tool contains items of two types:

- Likert scale items (Part I) which are answered via 5-point Likert scale, where A stands for “strongly disagree” and E means “strongly agree.”
- Multiple choice items (Part II, III) which are answered by choosing the best fitting option.

Each item choice is scored on a scale from 0 (least sophisticated) to 4 (most sophisticated). The scoring scheme takes into account differences between individual questions; for instance neutrality is more or less sophisticated answer to different items. For this reason it is non-linear. A subscale score is the average of the student's scores on items in one dimension.

Methodology

We carried out the pilot study in two steps. Firstly, we assigned the translated tool to respondents. Secondly, after the assignment we led discussions with groups of students about particular items of the questionnaire. The goal of the discussion was to uncover possible unclear meanings of items.

Sample and the questionnaire assignment

The research sample consisted of 193 high school students from 4 high schools (9 classes) in Prague, Czech Republic. The participants were students of academic and technical secondary schools from 15 to 17 years of age.

The data for our research were collected during 2 months (May and June 2013).

Table 1 characterises the gender of the participants of our research. Some participants did not state their gender; we mark this case as the “Missing“ row.

Table 1. Gender stated by the participants

Gender	Count	Percentage
Male	94	49
Female	87	45
Missing	12	6

The two following tables (Table 2, Table 3) sum up the degree of agreement of the participants with two statements that were put in the introductory part of the questionnaire.

These two statements are not part of the original version of EBAPS. We asked them to characterise the sample in more detail. Participants used the Likert scale from “strongly disagree“ (categorised with 1 in following two tables) to “strongly agree“ (categorised with 4 in following two tables). Category 9 in the following tables represents missing or unclear answers again.

Table 2. Degree of agreement

Statement: I enjoy physics.		
Category	Count	Percentage
1	12	6
2	65	34
3	80	41
4	31	16
9	5	3

Table 3. Degree of agreement

Statement: Physics is useful.		
Category	Count	Percentage
1	4	2
2	6	3
3	97	50
4	82	42
9	4	2

Data processing

During the pilot study we obtained two kinds of data. Firstly, the quantitative data when students completed the translated questionnaire. Secondly, qualitative data – review of items of teachers and researchers involved in physics education and expressions of students during discussions mentioned above. The goals of quantitative data processing was inspired by TIMSS 1999 Technical Report [6] and included:

- time needed to complete the questionnaire,
- omitted items,
- consistency of results,
- survey of problems and their solutions.

For statistical processing we used program Statistica by Statsoft, Inc. Company [6]. We carried out descriptive statistics, item analysis and correlational analysis. Particular mathematical tools used are described within results and findings. The qualitative data, students' opinions expressed during the discussion, were transcribed and coded. For coding we considered the following categories:

- statements about properties of the general questionnaire,
- statements about particular tasks – explicit statements that they do not understand an item or a comment about an item,
- other statements.

Results and Findings

A. Item analysis

For every task we counted the relative frequency of particular answers and we scored them according to the EBAPS scoring scheme. On the basis of these scores we evaluated the difficulty of each task. The difficulty is connected with the scoring guide of the EBAPS instrument, so that choosing of a particular option was scored with more or less points.

The task difficulty was measured by two methods:

1) *Task difficulty as the relative frequency* of participants who did not answer the task correctly or did not answer it at all. The task difficulty was evaluated as a percentage Q :

$$Q = (1 - P) \times 100 \%, \quad (1)$$

where P stays for students who solved the task correctly. According to the tasks difficulty we mark two groups of tasks:

- very easy: with difficulty $< 20 \%$,
- difficult: with difficulty $> 80 \%$.

For our research sample only one task (no. 26) was very easy for the students. 84% of them answered correctly, that putting things in their own words helps them learn science concepts better than learning things the way the textbook presents them. Seven tasks were evaluated as difficult for our participants. Difficulties of these tasks are illustrated by Table 4.

Table 4. Difficult tasks

Task number	2	3	7	13	15	18	22
Task difficulty	96%	90%	84%	87%	95%	89%	85%

Our participants attributed relatively high importance to the teachers' work during lessons and clearness of the lectures. Together 51% of students agreed (strongly or somewhat) that in the case of clear lectures with plenty of real-life examples most good students could learn physics without doing lots of sample questions and practice problems on their own. 33% had the opposite opinion and 16% answered neutrally (Task 13). The most difficult was task no. 2. The relative frequency of the answers is illustrated by the graph within Figure 1 below.

As we can see in the graph within Figure 2 most participants state that remembering facts is important for understanding physics. The graph of the relative frequencies of answers to another difficult task (no. 15) shows that 47% of participants agreed that for solving problems knowing the methods for addressing each particular type of question is the key thing, while understanding the big ideas might be helpful only for specially-written problems.

We also noticed that the participants somewhat prefer less extreme answers ("somewhat dis/agree") to the extreme ones („strongly dis/agree“) as we can see, for instance, in Figure 2. We wanted to take this answers into account so we evaluated the difficulty of each task also in another way described below.

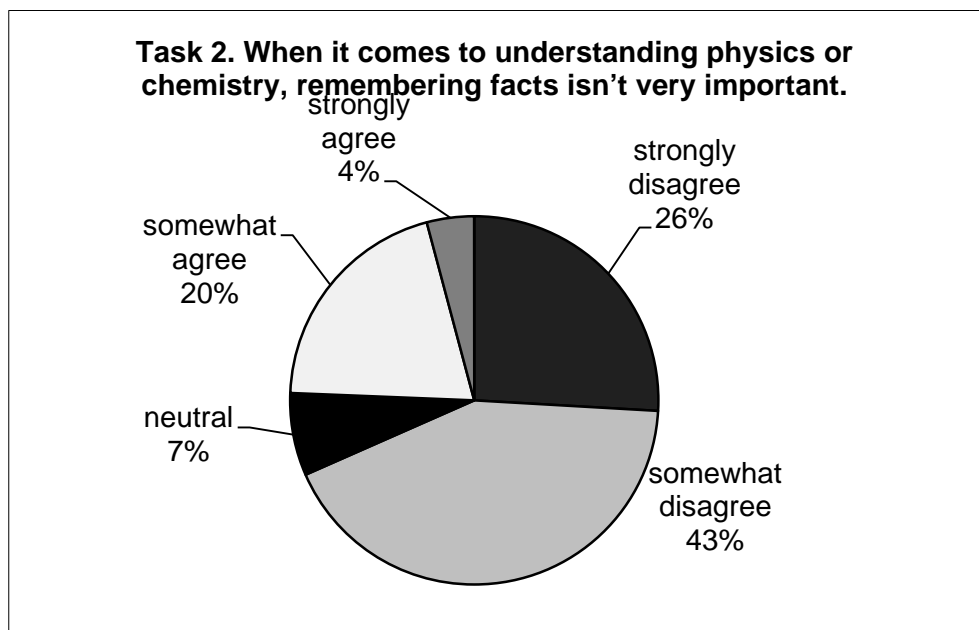

Figure 1. Task 2

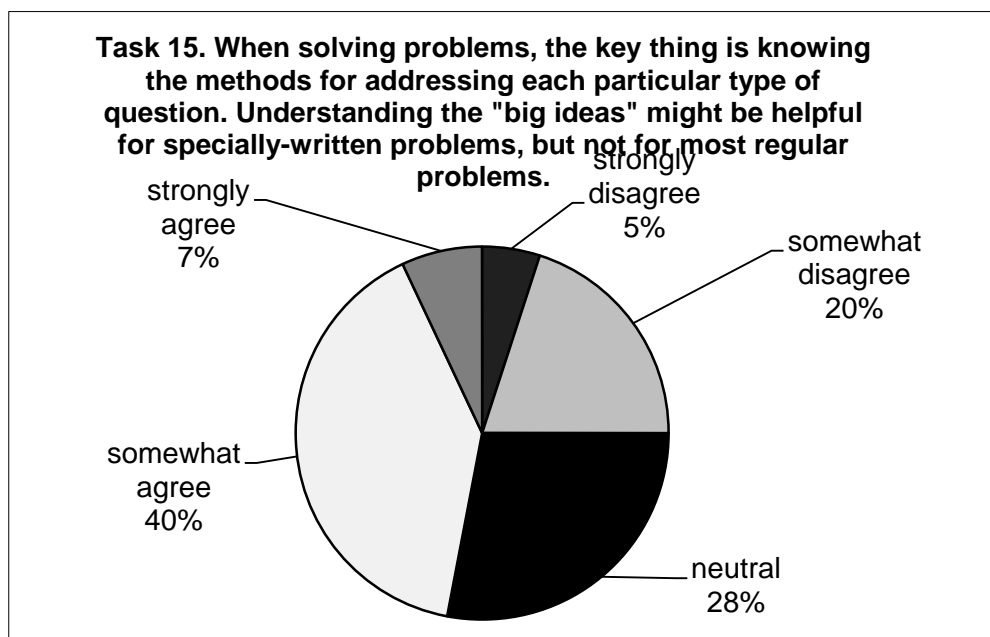

Figure 2. Task 15

2) *Task difficulty as average score* of all participants gained per item.

Score of each item could be in the range 0.0 – 4.0. According to this method we mark two groups of tasks:

- very easy: average score above 3.0,
- difficult: average score below 2.0.

There were 3 tasks with the average score below 2.0: 2, 13 and 15. Tasks with very good average score (above 3.0) were: 12, 26 and 27. Table 5 illustrates the difficulty of tasks in dependence on the method used for its calculation.

Table 5. Difficulty of tasks for above mentioned methods

Method	Method 1)	Method 2)
Very easy task	26	12, 26, 27
Difficult task	2, 3, 7, 13, 15, 18, 22	2, 13, 15

Tasks no. 2, 15 and 28 do not correlate with the total score. The coefficient is in the range from – 0.1 to 0.1. If they were omitted, the Cronbach’s alpha would decrease the most in comparison to omitting other items. Tasks no.8, 14, 25 and 30 correlate the most with the total score. Their item-to-total-score correlation coefficient is above 0.3.

The participants gave unclear or no answer in relative frequency below 2% for each task.

The time needed to complete the questionnaire by grammar school students is 20 minutes or less for 90% of students.

B. Consistency of the results

The authors discussed the validity and reliability of the tool. The validity testing was focused on the content of the testing matter, where the authors stressed their intention to test pure epistemological beliefs as distinct from students’ expectations about a particular course, their goals as learners etc. As for reliability: the authors want to enable students so to speak not to agree with themselves. For this reason, there is not much sense in checking the reliability of the tool by common sense (e.g. by numerating Cronbach’s alpha). However, the obtained value 0.69 would indicate quite good coherence of the tool.

If we want to know what and how the tool works, we need to find out some relation among the questionnaire items. For our purpose, we used correlational statistics which we counted with help of Statistica by Statsoft, Inc. Company. The questionnaire contains items which belong to one of five dimensions. When the dimension would clearly measure the “same belief”, naturally, we would expect a high correlation among items belonging to the same dimension. On the contrary, we would expect less correlation among items from different dimensions. The statistically significant correlations of items are presented in the Table 6. As we can see, 90% of items belonging to the Axis 5 (Source of ability to learn) correlate with each other. This dimensions “Source of ability to learn” is from this point of view the most consistent. The items correlate with items from the other dimensions as well, but much less. Items belonging to the Axis 3 and 4 (Real life applicability and Evolving knowledge) even correlate only with items from the other dimensions. Generally, the coefficients are low, usually in the range of very slight correlation about or under the value 0.3. However, we can at least identify items which contribute the worst to the whole dimension. These are task 2, 15 and 28 for dimension 1 and probably tasks 12 and 13 for dimension 2. When they are omitted, the Cronbach’s alpha would decrease the most. For better analysis, factor analysis would be a more appropriate method. During further study we expect to collect data from much larger sample of students and that it is why we will carry out the analysis for the data.

Table 6. Correlational analysis for items belonging to the Axis 1 - 5. The mark field mean that items correlate with each other and the correlation is statistically significant. By programme Statistica.

	Axis 1	Axis 2	Axis 3	Axis 4	Axis 5
Axis 1					
Axis 2					
Axis 3					
Axis 4					
Axis 5					

C. Student's feedback

Discussion with students was held after completing the questionnaire. Students' opinions expressed during the discussion were transcribed and coded. The results are presented in the table below.

Table 9. Students` statements about the questionnaire obtained during discussions

Category of the statement	Students` expression	Number of an item	¹
statement about the general questionnaire property	to include just one subject (either physics or chemistry)		5
	to reverse a scale		4
	inappropriate distractors which do not cover student`s opinion	29 / 6	2
	the 3 rd part not in a form of interview		1
statements about particular tasks	explicit statements that they do not understand	6 / 15 / 7	5
		20 / 18 / 19	2
		3 / 10 / 12 / 13 / 16	1
	comment about an item	13	4
		9 / 21 / 22	3
		3 / 4 / 14 / 19	2
		1 / 2 / 5 / 24 / 25 / 29 / 30	

¹ Number of students who expressed the opinion.

Conclusion

To adapt the EBPAS instrument for our national context has been the aim of presented survey, so that it can be used as a valid and reliable tool for a following research. Our main conclusions regarding the issue are:

- Length of questionnaire is appropriate for the age level.
- Students sometimes perceive physics and chemistry as very different fields so that they would prefer to have chance for expressing their opinions about the fields separately. That is why we will omit the chemistry field.
- More natural for students is to operate with a scale from I agree... to...I do not agree, so that we will reverse the scale.
- Several percent of students do not understand the meaning of several tasks, above all tasks no. 6, 7, and 15. Based on the further discussion about the tasks, we will rephrase the tasks so that the basic essence is clearer.
- Based on item and correlational analysis, task 13 is probably misunderstood by students and we will rephrase it as well.

In addition, as we got data from almost 200 high school students, it can be interesting to present summary of the obtained data. Main results concerning students` opinions about nature of science, ability to learn science etc. are:

- Students perceive relating their own ideas with new knowledge as very helpful when learning to science.
- Respondents attached higher importance to the natural ability over the hard work when it comes to being good at science.
- According to students, remembering facts is important for understanding physics or chemistry.

References

- [1] Zajacová B.: Learning Styles in Physics Education: Introduction of Our Research Tools and Design. Contribution within INTE conference (June 2013), Rome.
- [2] Zajacová B.: Learning Styles: An Overview of Concepts and Research Tools and Introduction of Our Research Design in Physics Education Field. Contribution within WDS conference, (June 2013), Prague.
- [3] Redish E. F., Saul J. M., Steinberg R. N.: Student expectations in introductory physics. American Journal of Physics, No 3 (1998), p. 212-224.
- [4] Halloun I., Hestenes D.: Interpreting VASS Dimensions and Profiles. , No 6 (1998), p. 553-577.
- [5] Elby A.: Another reason that physics students learn by rote. American Journal of Physics. Physics Education Research Supplement, No 7 (1999), p. 52-S57.
- [6] Martin M. O.; Gregory K. D., Stemler S. E. (eds.): TIMSS 1999 Technical Report. International Study Center, Lynch School of Education, Boston College. IEA, (2000), ISBN 1-889938-17-3.
- [7] EBAPS tool, [online]. [cit. 8. 9. 2013] Available from: <http://www2.physics.umd.edu/~elby/EBAPS/home.htm>

Appendix

Some items included in the EBAPS instrument discussed in the paper. All items including scoring guide are available on-line here:

<http://www2.physics.umd.edu/~elby/EBAPS/scoring.htm>

Scale: A: *Strongly disagree* B: *Somewhat disagree* C: *Neutral* D: *Somewhat agree* E: *Strongly agree*

No 2.

When it comes to understanding physics or chemistry, remembering facts isn't very important.

Scoring: A = 0, B = 1.5, C = 2.5, D = 3.5, E = 4

No 13.

If physics and chemistry teachers gave *really clear* lectures, with plenty of real-life examples and sample problems, then most good students could learn those subjects without doing lots of sample questions and practice problems on their own.

Scoring: A = 4, B = 3, C = 1, D = 0.5, E = 0

No 15.

When solving problems, the key thing is knowing the methods for addressing each particular type of question. Understanding the "big ideas" might be helpful for specially-written problems, but not for most regular problems.

Scoring: A = 4, B = 3, C = 2, D = 1, E = 0

No 26.

Justin: When I'm learning science concepts for a test, I like to put things in my own words, so that they make sense to me.

Dave: But putting things in your own words doesn't help you learn. The textbook was written by people who know science really well. You should learn things the way the textbook presents them.

- (a) I agree almost entirely with Justin.
- (b) Although I agree more with Justin, I think Dave makes some good points.
- (c) I agree (or disagree) equally with Justin and Dave.
- (d) Although I agree more with Dave, I think Justin makes some good points.
- (e) I agree almost entirely with Dave.

Scoring: A = 4, B = 4, C = 2, D = 1, E = 0

No 28.

Leticia: Some scientists think the dinosaurs died out because of volcanic eruptions, and others think they died out because an asteroid hit the Earth. Why can't the scientists agree?

Maria: Maybe the evidence supports both theories. There's often more than one way to interpret the facts. So we have to figure out what the facts mean.

Leticia: I'm not so sure. In stuff like personal relationships or poetry, things can be ambiguous. But in science, the facts speak for themselves.

- (a) I agree almost entirely with Leticia.
- (b) I agree more with Leticia, but I think Maria makes some good points.
- (c) I agree (or disagree) equally with Maria and Leticia.
- (d) I agree more with Maria, but I think Leticia makes some good points.
- (e) I agree almost entirely with Maria.

Scoring: A = 0, B = 1, C = 2, D = 3, E = 4

The Pupils' Competition in Physics

Libor Koniček, Lenka Ličmanová, Libuše Švecová

Faculty of Science, University of Ostrava, Ostrava, Czech Republic

Abstract

This paper describes results of competition in Physics for pupils of upper secondary schools (ages from 15 to 18) prepared by the Faculty of Science of University of Ostrava in the Czech Republic. The aim of this activity was to motivate pupils to study at Faculty of Science. The competition consisted of a quiz and some experiments. About 165 pupils took part in these activities. The tasks of the quiz are presented below. The first three tasks of the quiz dealt with the force of 1 N in different situations. The fourth task was focused on the boiling point of water. The fifth task was focused on the free fall. The last task was an experiment – try to lay a coin on water surface. Some pupils' misconceptions were found by analysing their answers. These misconceptions can be corrected by suitable experiments. These experiments can motivate pupils to study Science too.

Keywords: competition, misconceptions, motivation, promotion activities.

Introduction

In the last five years, a number of projects funded by the European Social Fund were implemented at the Faculty of Science of University of Ostrava. The aim of these projects was to motivate pupils of upper secondary schools to study Science at the University of Ostrava. In many countries pupils of upper secondary schools were motivated to study science and engineering like in Italy: “*The Italian government launched a policy in 2005 to promote the study of science at the university. The policy promoted extra-curricular activities for secondary school pupils in Chemistry, Physics, Maths and Materials Science*” [4].

The research shows that the support by the Italian Government has a positive impact. “*The findings indicate that the probability of enrolling in a scientific track increases by 3% for males. We find no effect for females. Participating in activities in Math increases the probability of enrolling in Physics and vice versa. The treatment had also a positive impact on enrolments in Pharmacy*” [4].

Students' selection of the field of their studies is influenced by many factors. These factors were described by studies [1] and [3]. The first cited research was carried out in Portugal. It was attended by 30 pupils. The second research was carried out in Thailand and was attended by 2638 people, 46% males and 54% females [3]. Of course, the historical development of the two countries was very different, but the results of the researches could show what influence the choice of one's profession. The propagation strategies were created for pupils at lower and upper secondary schools and their parents according to the results of various researches. All three target groups were addressed by the Faculty of Science of University of Ostrava in the last five years.

The most popular activities for pupils of upper secondary schools were organised by Department of Physics, for example:

- Open day – target group: pupils of upper secondary schools and their parents, program: propagation of Department of Physics, information about study opportunities,

- Summer school – target group: pupils interested in science, program: laboratory activities for pupils with computer aided experiments or hands on experiments,
- Seminars for pupils – target group: collectives of pupils of upper secondary schools, program: laboratory activities for pupils with computer aided experiments or hands on experiments, experiments performed by teacher,
- Pupils' competition – target group: groups of pupils of upper secondary schools, program: quiz competition which consisted of thought experiments, computer aided experiments, experiments with traditional tools and pupils' experimental tasks.

The pupils' competition is described in the following part of this paper.

The pupils' competition at the Department of Physics, Faculty of Science, University of Ostrava

Pupils' competitions were attended by 165 pupils from different upper secondary schools in May and June 2013. The pupils were motivated to solve Physics quiz on the basis of their "own experience of the game." The quiz was solved by pupils within 15 minutes. The quiz was followed by explanation and experiments. The experiments related to the same physical problems which were performed during 15 minutes. The pupils could try to do the experiments.

The pupils worked at teams of 5 members and maximum 5 teams worked parallelly. The teams were created randomly. There were two different strategies of answering – to answer individually or as a team with one collective answer. Each answer was for 1 point. Maximum was 30 points per team.

The next research [2] showed that the teachers do not have the appropriate tools to demonstrate computer aided experiments in Physics lessons in the Czech Republic. The interviews with the teachers were made during promotional events.

Therefore the tasks of the quiz were divided into several categories. The first and the third task were thought experiments. The second task was a computer aided experiment. The fourth and fifth tasks were experiments with traditional tools – vacuum pump. The sixth task was a pupils' experimental task.

Some interesting misconceptions of pupils were found after the evaluation of the quiz.

Tasks of the quiz

The quiz had 6 tasks. The tasks and pupils' answers are written below with correct answers (in bold) and with interpretations of pupils' results.

Task 1: Estimate how many sheets of office paper (80 g/m^2) size A4 have weight appropriate with 1 N?

- a) 10 pcs (**relative frequency of pupils' answers was 19 %**)
- b) **20 pcs (relative frequency of pupils' answers was 42 %)**
- c) 35 pcs (relative frequency of pupils' answers was 17 %)
- d) 50 pcs (relative frequency of pupils' answers was 14 %)
- e) 100 pcs (relative frequency of pupils' answers was 8 %)

Solution of the task:

The base A0 size of paper is defined to have an area of 1 m^2 and mass is 80 g. An A4 size paper is 1/16 part of the A0 paper and its mass is 5 g. The force 1 N is equal to the weight of 20 A4 sheets.

The correct answer was b) and that was given by majority of the pupils. Some of the pupils gave a good answer according their good estimation but majority of the pupils solved this task as described.

The results of this task point out the pupils' good ability of applications and experience with the 1 N force.

Task 2: Estimate what force is needed to tear human hair?

- a) 0.01 N (relative frequency of pupils' answers was 7 %)
- b) 0.1 N (relative frequency of pupils' answers was 8 %)
- c) **1 N (relative frequency of pupils' answers was 35 %)**
- d) 10 N (relative frequency of pupils' answers was 32 %)
- e) 100 N (relative frequency of pupils' answers was 18 %)

Solution of the task:

The real experiment was presented by Dual-Range Force Sensor and data logging Vernier system. The real data of force was from 0.8 N to 1.5 N with girls' hair sample.

The correct answer was c). The majority of pupils made good estimations. Only a few of the pupils had experience with our experiment. The graph of real data is shown in Figure 1. The hair was destroyed if force increased to more than 0.92 N. The similar results were presented in the paper [6].

The force 1 N was a destructive force in the second task and experiment.

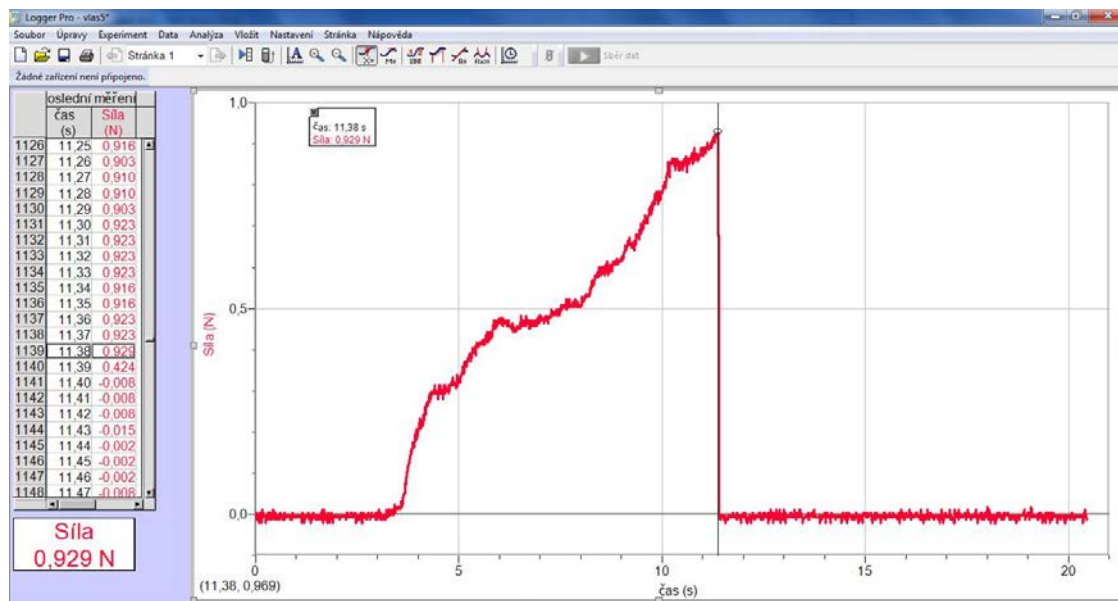

Figure 1. The graph of real data taken by Dual-Range Force Sensor of Vernier system.

Task 3: Estimate the buoyant force in the air on the Earth acts to man with 80 kg mass and 180 cm height.

- a) Buoyancy force not impacting (relative frequency answers 44 %)
- b) 0.01 N (relative frequency of pupils' answers was 15 %)
- c) 0.1 N (relative frequency of pupils' answers was 12 %)
- d) 1 N (relative frequency of pupils' answers was 14 %)**
- e) 10 N (relative frequency of pupils' answers was 15 %)

Solution of the task:

The Archimedes' principle was used to solve this task. The density of human body is approximately the same as the water density 1000 kg/m^3 and the density of the air 1.25 kg/m^3 . The buoyancy force is 800 times less than the weight of human body so in this case it is 1 N.

The correct answer was d). The majority of pupils gave answer a) and these pupils had misconception about buoyancy force in the air. The answers were surprising but this misconception is quite common. Only a few pupils connected some real experiments with hot air balloon or balloon filled by helium with the solution. These pupils' experiences are not from real everyday life. Some school real experiments can help to understand the buoyancy force in the air.

Task 4: Can we hard-boil an egg on the Earth's highest mountain *Mount Everest* (8848 meters)? Decide according to the boiling water point and the pressure in the altitude. (t_v – boiling point of water, p – atmospheric pressure)

- a) Yes, $t_v = 65^\circ\text{C}$, $p = 76 \text{ kPa}$ (relative frequency of pupils' answers was 49 %)
- b) No, $t_v = 85^\circ\text{C}$, $p = 120 \text{ kPa}$ (relative frequency of pupils' answers was 18 %)
- c) Yes, $t_v = 100^\circ\text{C}$, $p = 100 \text{ kPa}$ (relative frequency of pupils' answers was 8 %)
- d) No, $t_v = 65^\circ\text{C}$, $p = 26 \text{ kPa}$ (relative frequency of pupils' answers was 19 %)**
- e) No, $t_v = 80^\circ\text{C}$, $p = 26 \text{ kPa}$ (relative frequency of pupils' answers was 6 %)

Solution of the task:

The real experiment was performed. The vacuum pump and a beaker with water were used. The water was boiled at room temperature with very low pressure.

The correct answer was d). The majority of pupils gave answer a) and these pupils had misconception of water boiling point and the air pressure in the mountains.

This misconception is generally among people. The water boiling in low pressure and in high pressure is in everyday life. The real Physics computer supported experiments can change these misconceptions. The experiment for low pressure warming with Vernier system was performed.

Task 5: Estimate the sequence in which the given objects land when dropped from the same height:

- a) Magnet in copper tube, feather in the air, glass bullet in the air, feather and bullet in vacuum (relative frequency of pupils' answers was 3 %)
- b) Feather and bullet in vacuum, glass bullet in the air, feather in the air, magnet in copper tube, (relative frequency of pupils' answers was 50 %)

- c) Magnet in copper tube, feather and bullet in vacuum, feather in the air, glass bullet in the air, (relative frequency of pupils' answers was 21 %)
- d) Feather in the air, glass bullet in the air, magnet in copper tube, feather and bullet in vacuum (relative frequency of pupils' answers was 14 %)
- e) Feather and bullet in vacuum, magnet in copper tube, feather in the air, glass bullet in the air (relative frequency of pupils' answers was 13 %).

Solution of the task:

The real experiments with Newton's tube and copper tube with magnet were demonstrated. More examples for motivation by experiments are in [5].

The correct answer was b). The majority of pupils had good estimation of the result, although a lot of pupils did not see real experiment of falling magnet in copper tube.

Task 6: Take advantage of knowledge of surface tension of liquids and try to lay a coin on the water surface. Everyone had one attempt.

Solution of the task:

This real experiment tested pupils' skills. Different strategies were applied by pupils to lay a coin on the water surface. Some of them used two pencils as a tweezer. Some of the pupils used a filtering paper. They laid a coin on the paper and after the paper sank below the water surface and the coin stayed on the water surface.

Conclusion

The competition was organised by four departments – Physics, Chemistry, Maths and Computer science.

The conclusion of this competition was that we took pupils from secondary schools to our Department of Physics at our University of Ostrava where we made 30 minutes program for them.

The pupils were active – they solved tasks, carried out experiments, some experiments and also computer supported experiments were performed.

The results of these tasks gave some interesting conclusions. The pupils' estimations about size of force were good – results of tasks 1 and 2. The results of task 4 gave feedback of pupils' misconception of the application of the Archimedes' principle in the air.

The activities prepared by Department of Physics were highly evaluated. All approaches showed here are one of the possibilities how to enhance pupils' understanding of Physics and to make Physics more attractive.

References

- [1] DIAS, Diana. Reasons and motivations for the option of an engineering career in Portugal. *European Journal of Engineering Education*. 2011, Vol 36, No. 4, p. 367-376. DOI: 10.1080/03043797.2011.593096.
- [2] KONÍČEK, L., MECHLOVÁ, E., MALČÍK, M., ŠVECOVÁ, L. Results of Research About Exploitation ICT by Secondary School Teachers. *Results of Research About*

Exploitation ICT by Secondary School Teachers. Ostrava: Ostravská univerzita v Ostravě, 2009. p. 115-118. [2009-09-15]. ISBN 978-80-7368-459-4

- [3] LERDPORNKULRAT, Thanita, Ravinder KOUL and Chuchai SUJIVORAKUL. The influence of ability beliefs and motivational orientation on the self-efficacy of high school science pupils in Thailand. *Australian Journal of Education (ACER Press)*. 2012, Vol. 56, No. 2, p. 163-181.
- [4] MAESTRI, Virginia. Promoting scientific faculties: Does it work? Evidence from Italy. *Economics of Education Review*. 2013, Vol.. 32, s. 168-180.
DOI: 10.1016/j.econedurev.2012.10.003.
- [5] TRNA, Josef a Petr NOVÁK. Motivational effectiveness of experiments in physics education. In GIREP-ICPE-MPTL 2010. Teaching and Learning Physics Today: Challenges? Benefits? 2010.
- [6] <http://fyzweb.cz/materialy/co-muze-viset-na-vlasku/>

High Schools Students' Misconceptions in Electricity and Magnetism and How to Diagnose Them

Věra Koudelková, Leoš Dvořák

Faculty of Mathematics and Physics, Charles University in Prague, Czech Republic

Abstract

The Czech Conceptual Test from the area of Electricity and Magnetism (CCTEM) was prepared at Department of Physics Education, Faculty of Mathematics and Physics, Charles University in Prague. The test is based on American Conceptual Survey of Electricity and Magnetism (CSEM) which is used for students of introductory physics courses. Czech "CCTEM" is intended for Czech high school students. Paper presents the test and some concrete results about misconceptions from the area of Electricity and Magnetism, which students involved in the survey have.

Keywords: misconceptions, electricity and magnetism, high school

Introduction

Electricity and magnetism is one of the topics in the Czech curriculum for high school physics. It is natural to explore how Czech high school students (students of age from 15 to 19) understand Electricity and Magnetism and which misconceptions are typical for them. At first we used CSEM [1], but it is intended for students of introductory physics courses at universities. Although we left out few questions, which are not taught at Czech high schools, it was shown that the survey is too abstract and difficult for Czech high school students. The new Conceptual test from the area of Electricity and Magnetism, which is focused on high school students, was already presented at WCPE 2012 in Istanbul. Since then, the test had been slightly modified after pilot testing in 2011-2012 and we verified the modified version in the school year 2012-2013.

There were about 200 students who were involved in the pretest and post-test in pilot testing and about 100 students when we tested the modified version. Differences between both versions are relatively small in most of questions – we modified the figure concerning the question about an electric capacitor, because students indicate that the figure is confusing for some of them and we deleted one possible answer in this question to have five possible answers in all questions. We also simplified the last question concerning an electric transformer, because the original question adopted from CSEM was too difficult. Finally, we added possible answers to the question which concerns electric field, which had been open-ended in pilot testing because we had found suitable distractors.

The testing will continue in the school year 2013-2014 too, we expect to have at least another 200 students. All involved students (aged 16-18) are from general high schools, the pretest was done just before beginning of the lessons from the area of electricity and magnetism, the post-test was done just after the instruction. Students usually had lessons from the area of electricity and magnetism for about half a school year, two lessons (45 minutes each) a week. (The range partly depends on the school curriculum.)

The final test will be provided as a diagnostic tool mainly for Czech physics teachers, but the English version of this test will be provided too – we will send it by e-mail to persons interested in it.

About the test

The Czech Conceptual Test from the area of Electricity and Magnetism (CCTEM) has 18 questions divided into following topics:

- charge distribution on conductors and insulators
- Coulomb's law
- electric field
- electric capacitor
- electric current and resistance
- magnetic field and magnetic force
- electromagnetic induction
- electric transformer

The test is based on CSEM, we used nine questions from it (namely questions: 1, 2, 3, 5, 12, 17, 22, 29, 32; apart from questions 12 and 22 all were slightly modified). We chose questions which correspond with Czech high school's curriculum and were on the high school's level. The slight modifications of some of them were necessary, because it had turned out that high school students need more concrete assignment to understand the tasks.

Nine further questions correspond to Czech curriculum. We added for example questions about electric capacitor, electric resistance, magnetic field near a coil with current, and other. Some of these questions are mentioned below.

All questions are multiple-choice, each has five possible answers where only one is correct. The time we give students to complete the test is about 35 minutes, but the time limit is not strict – we give them more time, if it is needed.

Difficulty of most of questions in the test is between 20% and 80%, so it seems that the test is appropriate for Czech high schools students.

Examples of preliminary results – typical students' misconceptions

Note: results we present here are from the final version of the test.

Charge distribution on conductors and insulators

There are two questions in the test concerning charge distribution on conductors and insulators. The assignments are similar – what will happen to the small amount of charge placed on a point on a tin (in the first question) or on a PET bottle (in the second one). Students should predict what we find if we check on this charge few seconds later. Possible answers are following:

- A) All of the charge remains near the point
- B) The charge is distributed over the outside surface of the tin/bottle
- C) The charge is distributed over the outside and inside surface of the tin/bottle
- D) Most of the charge is still near the point, but part of it is distributed over the surface of the tin/bottle
- E) There will be no charge left

Students' results can be seen in fig. 1. Correct answer is B for a tin and A for a plastic bottle.

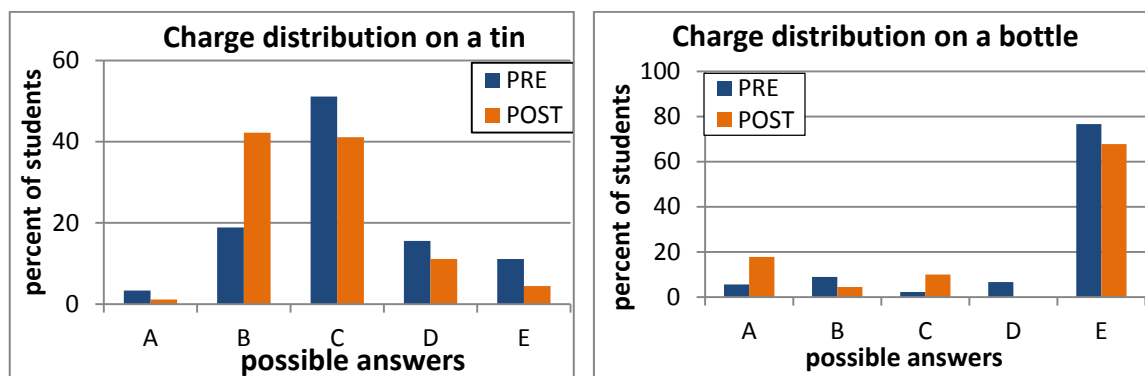

Figure 1. Charge distribution on a tin and on a bottle – students' answers. Correct answer is B for a tin and A for a bottle.

The normalized gain for the first question (about the charge on the tin) is 0.29, for the second question about the bottle 0.13.

Concerning charge on a tin most students choose either the answer that the charge will be distributed over the outside surface (answer B) or both the outside and inside surfaces (answer C). There were nearly 20% correct answers in the pretest and more than 40% correct answers in the posttest.

Concerning the charge distribution on a bottle, students seem to be convinced that the charge disappears and it seems that this misconception survives after the instruction (almost 80% of students have this idea before the instruction and still almost 70% after the instruction).

The results from the question about the charge on a bottle are similar to the results the authors of CSEM found, but their results are better: there were about 50% of correct answers in post-test and only almost 20% of students seem to have an idea about disappearing charge.

In general, as authors of CSEM wrote: *“It appears that a substantial number of students seem not to be able to distinguish between conductors and insulators or fully understand what happens to the charge at all. The data suggest that many of students may simply be recalling a statement about charge distribution without understanding the physical mechanism.”* [1, page S16]

Coulomb's law

Students usually learn Coulomb's law for quite a long time, including quantitative problems they have to solve. However, it seems that students are not able to understand it as well as one would expect after the time they spent learning it.

In the test, we include two questions concerning Coulomb's law. In the first question we ask students how the electric force will change when we put charge $3Q$ instead of the charge Q . The results of this question are good – there are about 75% of correct answers both in the pretest and post-test.

The second question is about the distance between two charges – we ask students how the electric force will change when we put both charges Q two times further. The possible answers are:

- A) $F_e/4$
- B) $F_e/2$
- C) F_e
- D) $4 F_e$
- E) another possibility

The results can be seen in figure 2 – more than 60% of students (both in the pretest and post-test) answer that the electric force will be half-size and only about 10% answers in pretest and almost 20% answers in the post-test were correct. Normalized gain for this question is 0.1.

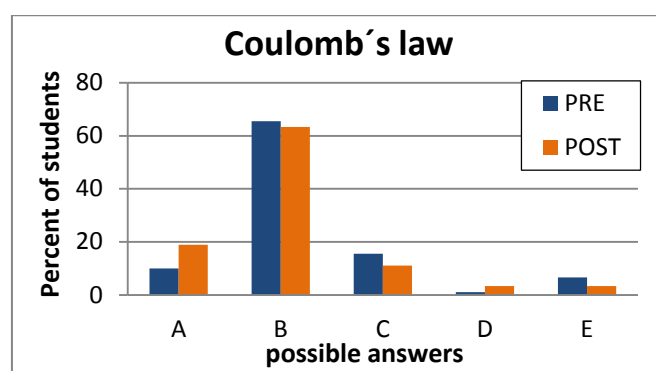

Figure 2. Coulomb's law – students' answer.

This question is based on a similar question from CSEM. There were almost 40% correct answers in the pretest and about 50% in the post-test (in calculus-based physics courses, students in algebra-based courses were worse) in CSEM corresponding question. So, results from CSEM are better, but these were results of the university students, our results come from high school students.

Orientation of the magnetic field

There is one question in the test which concerns orientation of magnetic field near a coil with current. We ask students which orientation the compass needle has at point A shown in fig. 3 near a coil with current. Direction of the current is shown in figure 3 too, dark part of the magnetic needle is oriented to the north in the earth magnetic field.

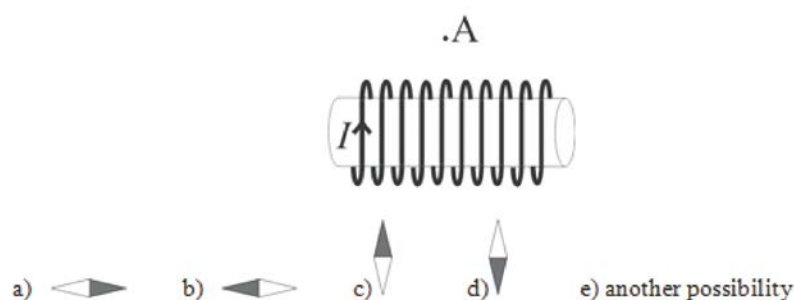

Figure 3. Assignment of the question concerning orientation of the magnetic field

The students' results can be seen in fig. 4, correct answer is A. Normalized gain for this question is 0.22.

In the pretest, there are more than 70% of students who think that the magnetic field is oriented perpendicularly to the coil (answers C or D) and only about 20% of students think that the needle is oriented parallel to the coil (perpendicularly to the current, answers A and B).

It seems that this misconception is partly reduced during instruction – in the post-test only about 30% of students have an idea that the magnetic field is oriented perpendicular to the coil and more than 60% percent of students think that the needle is oriented perpendicularly to the current. However, only about 30% of students in the post-test chose a correct answer, it seems that they have a problem with the connection between the direction of the magnetic field and the direction of current.

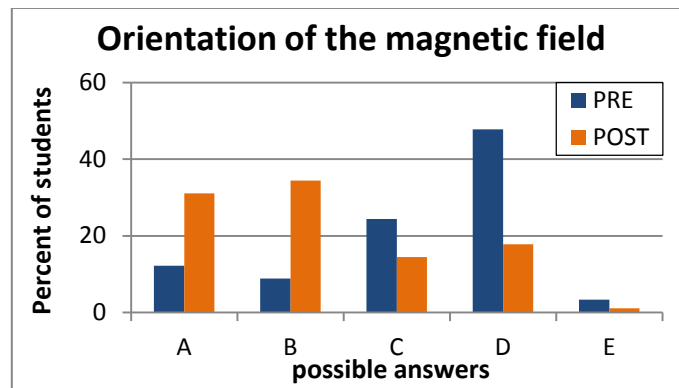

Figure 4. Students' answers to the question about orientation of magnetic field, correct answer is A.

Magnetic force

There are two questions which relate to magnetic force and moving charges in the magnetic field in the test. One of them, which were not so problematic for students, concerns direction of the magnetic force on a wire with a current between two magnetic poles. About 30% students chose correct answer in the pretest, but more than 80% students chose it in the post-test. Normalized gain for this question is 0.74.

The second question in this topic concerns an electron in the magnetic field. We ask students what the direction of magnetic field is if we know the trajectory of the electron (see figure 5).

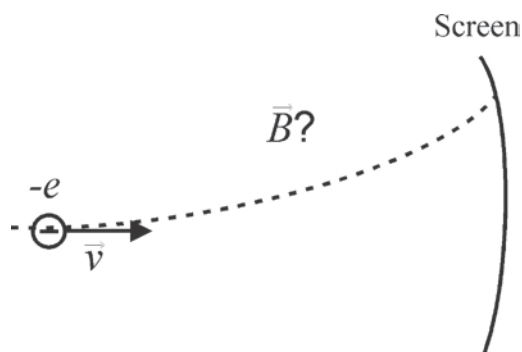

Figure 5. An electron in a magnetic field. The trajectory of the electron is marked by a dashed line.

Students have five possible answers. They can choose that the magnetic field points in one of these directions:

- 1) Toward the top of the page, perpendicularly to the direction of the velocity
- 2) Toward the bottom page, perpendicularly to the direction of the velocity
- 3) Perpendicularly to the page, into the page
- 4) Perpendicularly to the page, out of the page
- 5) Magnetic field is in the direction of the curved path

Students' results can be seen in figure 6. Correct answer D was chosen by more than 10% in the pretest and only about 15% in the post-test (normalized gain for this question is only 0.05). Answer C shows, that students seem to understand the effect of the magnetic field, but are uncertain of the direction of the current. However, both these groups together make up only nearly 40% of students in the post-test.

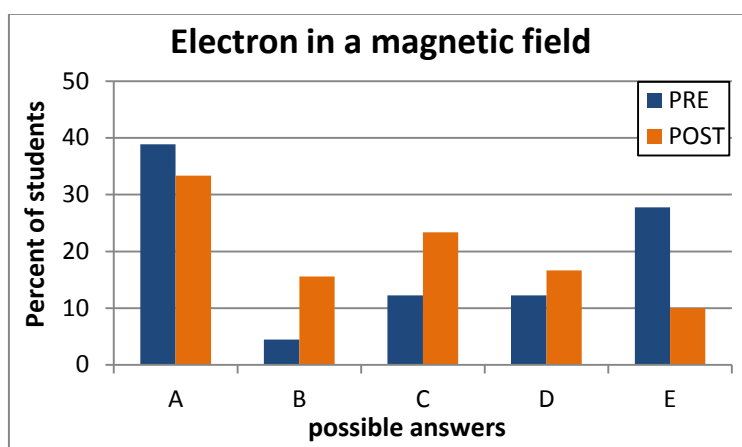

Figure 6. Students' result of the question about the direction of the magnetic field, correct answer is D.

Answer A seems to be a very strong distractor. Maybe, there is an idea behind this choice, that when the electron curves to the top of the page, the field, which causes this curve, should point to the top as well. This seems that students mix up electric and magnetic forces. Answer B seems to show the confusion between electric and magnetic forces again, but with the confusion of the direction of the current too.

This task is taken from CSEM. The authors of CSEM found this misconception as well, about 30% of students chose answers A or B in the post-test.

Change of magnetic flux

There is one question in the test which concerns electromagnetic induction and magnetic flux. The main part of the assignment can be seen in figure 6 – there is a magnet and a sensitive ammeter connected to a loop of wire in each figure. In the first case, the magnet moves to the left, in the second case the magnet is stationary and the loop is collapsing, in the third case the loop rotates counter-clockwise around its axis and in the last case the loop moves to the left.

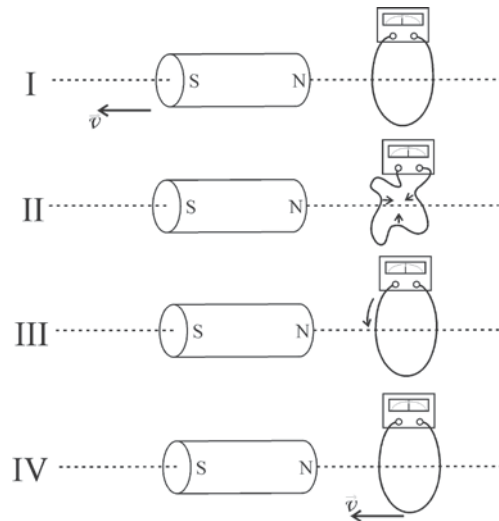

Figure 6. Part of the question concerning electromagnetic induction

Students are asked to choose, in which cases the current measured by the ammeter can be different from zero. The possible answers are that the non-zero current could be measured in cases:

- A) I, II, IV
- B) I, III, IV
- C) I, IV
- D) IV
- E) another possibility

Students' results can be seen in figure 7. Only 10% of students chose the correct answer A in the pretest and nearly 15% percent of students chose it in the post-test (normalized gain for this question is only about 0.05) – it could indicate that only these students understand what the “change of the magnetic flux” means and which movements change it. About 20% of students (in both the pretest and the post-test) may think that a loop rotating around its axis change a magnetic flux. It is interesting that more than 50% percent of students chose “safe” possibilities C or D, where are movements of the loop or the magnet they are sure with, in the pretest and even more (about 65%) in the post-test. They seem to know that the magnetic flux is changing when we move the magnet or the loop together or far apart and are not sure about collapsing and rotating the loop.

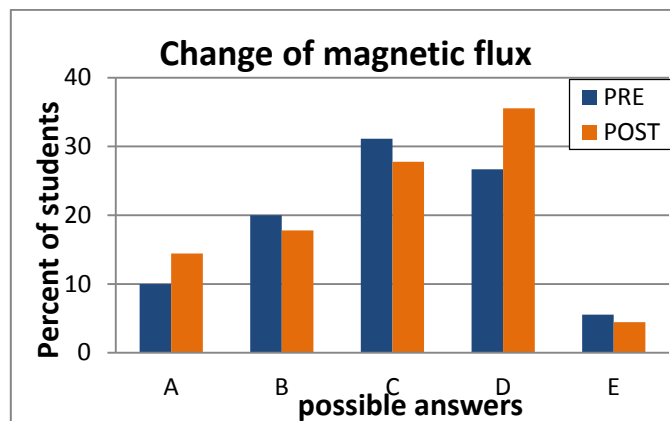

Figure 7. Changes of magnetic flux – students' answers. Correct answer is A.

This question is based on a similar question in CSEM. There were about 72% of students (both calculus and algebra-based courses) “...who choose answers that used the idea that “motion” from either the loop or the magnet is necessary to create an induced current.¹ Students may not seem the collapsing loop as changing the magnetic flux or the rotating loops as not changing the magnetic flux.” [1, page S18].

Conclusion

The CCTEM is intended primarily as a diagnostic tool for Czech high school teachers. The results show that the test is adjusted properly for high school students now. However, a larger group of involved students is needed to confirm this.

Some misconceptions students could have in the area of Electricity and Magnetism were found. Preliminary results correspond with the results from CSEM. Our results also indicate that some other misconceptions based on the topics from the Czech curriculum were identified. To identify Czech students’ misconception more precisely, the detailed interview with students will be prepared.

The test exists in the Czech version now but the English version of this test will be provided too.

However, to identify students’ misconceptions is not sufficient. Therefore, in a subsequent piece of work, we will try to find some ways how to reduce these misconceptions.

References

- [1] D. P. Maloney, T. L. O’Kuma, C. J. Hieggelke and A. Van Heuvelen: “Surveying students’ conceptual knowledge of electricity and magnetism”, Am. J. Phys. 69, 12-23 (2001)

¹ This idea corresponds with answers A, B, D in CSEM or B, C, D in the Czech test CCTEM.

The careers chosen by Physics teachers and the teachers' shortage in Brazil

Sérgio Rykio Kussuda¹, Roberto Nardi²

¹Science Education Program, Universidade Estadual Paulista "Julho de Mesquita Filho", Bauru Campus, São Paulo, Brazil

²Education Department and Science Education Program, Universidade Estadual Paulista "Julho de Mesquita Filho", Bauru Campus, São Paulo, Brazil

Abstract

Nowadays in Brazil, we are suffering with a shortage of teachers in high and secondary schools, especially on areas related to science, for example, physics. Consequently, there are a great number of schools in which this subject has been taught by teachers graduated in other subjects. The commonsense opinions has argued that this problem can be solved just graduating more physics teachers. We argue, however, that the lack of physics teachers in high schools in Brazil is not merely due to the small quantity of teachers we graduated in the universities, but to other factors. In order to prove this argument, we applied an online questionnaire to a sample of 273 of the 377 physics teachers who concluded their graduation (licenciatura) in physics in the last two decades in a public university in Brazil. Data showed that, among 52 teachers that answered the questionnaire, 12 of them have never taught, 13 stopped to teach and 27 still are teaching; among those, 11 teach at universities. These outcomes indicate that the shortage of teachers in high schools of this region studied is not only due to the small quantity of graduated in this discipline, but mainly to the refusal of teachers to choose this job and also by the desertion of those who already started this profession, motivated by the low wages and the bad quality of working conditions at public schools.

Keywords: physics education; initial education of physics teachers; shortage of physics teachers.

Introduction

Currently the Brazilian educational system is basically divided into four stages: Childhood Education (up to 5 years), elementary school (from 6 to 14 years), high school (generally between 15 and 18 years) and university education (usually after age 18), can also study through the vocational and technical education. The last three are especially focused on preparation for a profession. In this educational context, Physical discipline is taught in elementary school (taught in a subject called Science involving Physics, Chemistry and Biology), high school (taught by professors of physics at the university graduates) and depending on the chosen course can be taught at university in technical education and vocational training (we have no specification as to the teacher education). However there is great difficulty related to this subject, especially in high school, the lack of specific professionals in this area. As is possible to observe on media that have presented data demonstrating the lack of qualified teachers to work in schools in Brazil, especially in the sciences, as we can see in the title of a newspaper headline highlighted below:

“MEC [Ministry of Education, Brazil]: 70% of science teachers in Brazil do not have specific license for teaching. In physics, the shortage of teachers reaches 90% of those who teach”. (O Globo, Rio de Janeiro). [1].

This problem occurs even in schools of São Paulo, the state with the highest income and number of universities offering physics courses, which makes the amount of courses to train teachers of Physics a minor problem.

This conclusion is also possible to obtain by analyzing the data from the government on the amount of classes without permanent teachers of physics in a city where there is a course to train teachers of physics, as Bauru (São Paulo) which has 380,000 inhabitants and account with a Bachelor's Degree in Physics. According to data from the government, in this city there were, in 2012, 188 classes without permanent teachers in Physics. This university over two decades have graduated 377 graduates, showing a large discrepancy between the number of graduates in this institution and classes without teachers in this city.

Surveys conducted by other researchers as Gesqui [2] confirm the lack of effective teachers to follow a public school in Greater São Paulo, only 64% of the classes were taught by professors, by 15% and 21% no replacements were taught.

In a meeting in 2005 with physics teachers who worked in public in the region of Bauru, Camargo [3] noted that among the 46 teachers who taught this course, only 18 had undergraduate degree in Physics, two were trained in electrical engineering 20 graduates in Mathematics, one in Chemistry and five graduates in “Short Bachelor¹” of Science, major in Physics.

All these data indicate a lack of teachers to work in schools in Brazil. To solve this problem the government has adopted various measures such as the creation of distance education programs and increase enrollment in undergraduate courses. However, according to research conducted by Araújo [4] the creation of online teachers training has not been effective due to the large amount of evasion of these courses.

One possible explanation for the lack of teachers in cities that have undergraduate courses in physics, as in the case of Bauru, is the number of graduates working in other activities not related to education or has left the teaching profession. To determine their career choices we did a survey through a questionnaire online.

Methodology

In order to obtain the data used in the study, we applied a questionnaire online with graduate in Physics from a public university. The online questionnaire was divided into open and closed questions, in which the respondent was sent to another part of the questionnaire according to their characteristics, allowing us to create issues according to their characteristics. Open questions had unlimited space to answer the questions. Closed questions were analyzed statistically and presented in graphs and tables. The open questions were analyzed through Bardin's [5] content analysis.

For the questionnaire online, we initially sought the names of licensed through contact with the board of the university. In possession of the names we seek to address through a search engine. Initially we tried the Lattes Platform, a platform containing the data of all Brazilian researchers. Then we used general search engines like Google and Bing and specific search

¹ Refers to courses created from 1971 to 1996 created in a context of expansion of quantity of schools. This courses intended to graduate teachers in less years than usual courses.

engines like PILP and 123people. Then we began to see the phonebook and online social networks. This method was very efficient, since, among the 377 graduates who entered the course, 273 email addresses were found using this method, and, of these, 52 graduates responded to the questionnaire.

Data analysis

According to the data provided by the questionnaire responses we observed a high rate of dropout and retention in the physics course studied, since 645 students entered the course and only 377 had completed the course until 2011, indicating a dropout or retention of approximately 42% of students, as can be seen in the Graph 1 below. Although this value is high, it is still lower than the studies presented by Ruiz, Ramos and Hingel [6], which indicates that an average national dropout in undergraduate courses in Physics of approximately 65%.

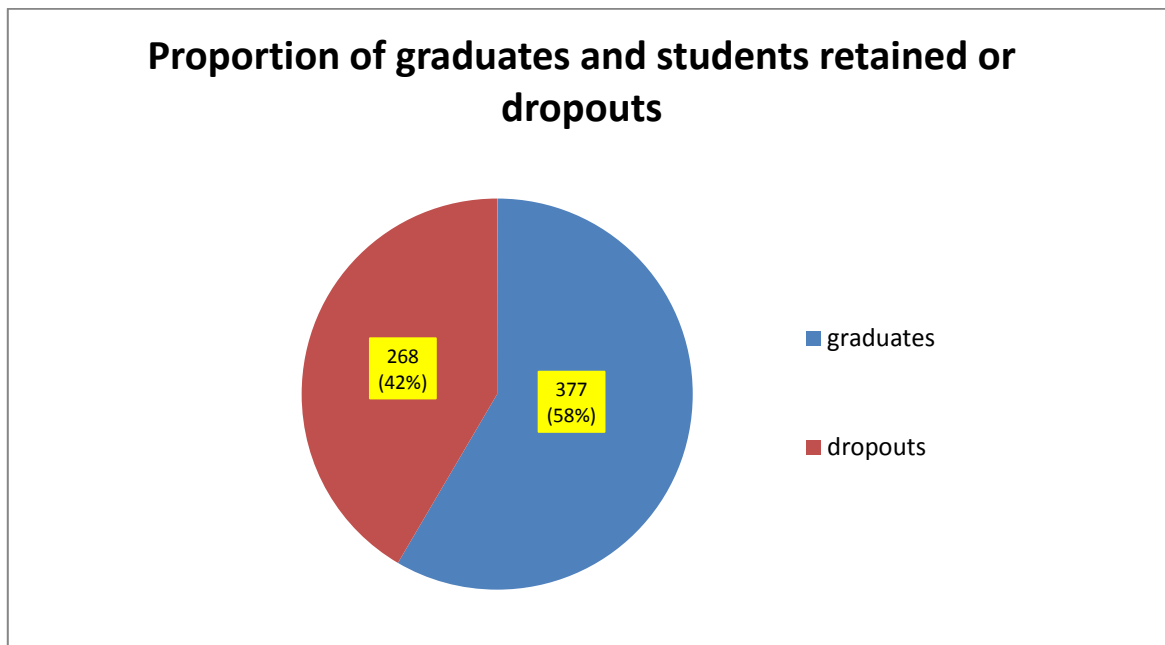

Graph 1. Proportion of graduates and students retained or dropout

These data indicate a high number of students retained or evaded from this course, indicating the need to investigate what is the motivation for the student withdraws from the course. We are now, in a new research, trying to know why there is so much evaded or retained students in this course.

Among the 377 graduates in this course, we managed to get the contact through the electronic address of 273, or approximately 72% of graduates. However, the rate of graduates who responded to the questionnaire in relation to the amount of contact was approximately 19% (See Graph 2).

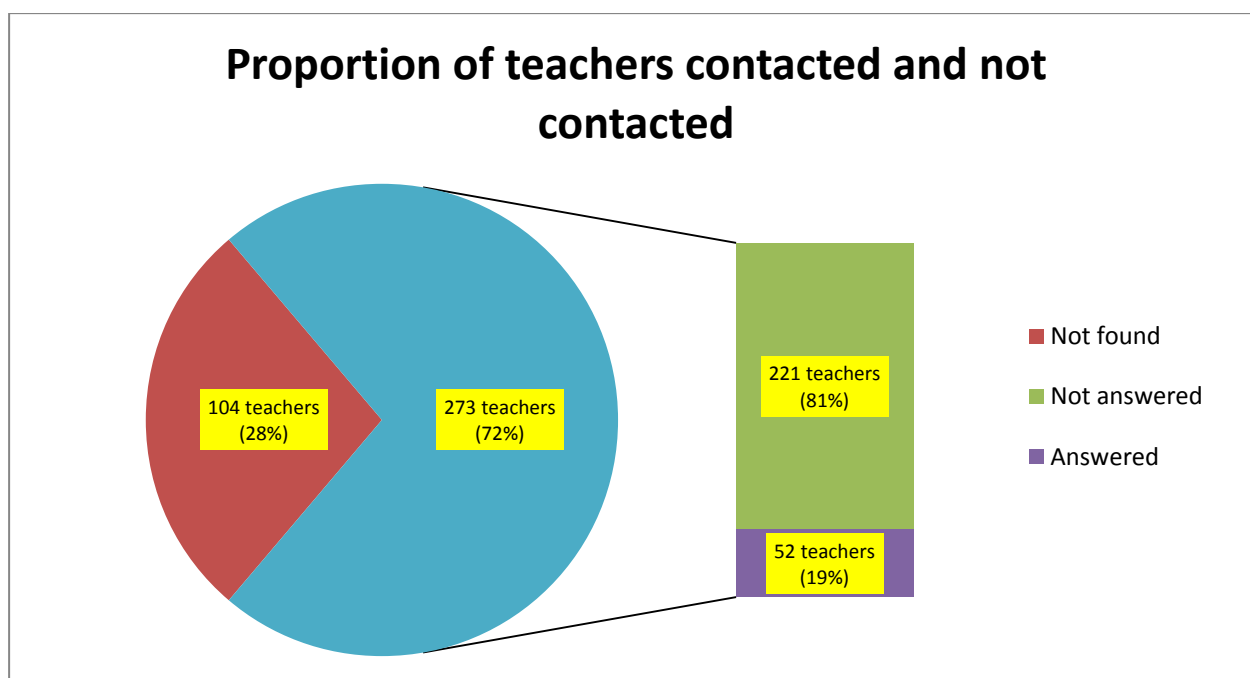

Figure 2. Proportion of teachers contacted and not contacted

The data obtained through the closed questions of the 52 questionnaires provided us with an overview of the career path traversed by the licensee after graduating. These were tabulated and analyzed and converted into graphs and tables presented below.

Table 1. Career Path traversed by the licensee after graduating

Questionnaire responses	Have worked in schools	Keep teaching	Level of education	
			Youth and Adult Education	13
(52)	(40)	(27)	Secondary School	22
			High School	16
			College	11
			Abandoned teacher profession (13)	
Never taught (12)				

Through observation of the Table 1 we can see that most of the graduates (40) worked in teaching at some point after completing graduation. However a large part (13) has abandoned the teaching profession, especially in the first five years of operation, a fact also noted by Huberman [7] to study the life cycle of the teaching career that has been a greater avoidance of this profession among the fourth and sixth year of activity.

These data indicate that two thirds of graduates who taught no longer perform in Basic Education, which is a source of great impact on the number of teachers working at this educational level. When comparing dropout rates in each grade level taught we found that only three teachers leave the teaching profession in higher education, as in basic education were 10 dropouts profession. Two graduates who left teaching in higher education have left the teaching profession because they were acting as substitute teachers and another for being awarded scholarships.

Among the graduates who worked in Basic Education and abandoned the teaching profession there are many reasons to leave the profession, but there are more applicants motivations, as motivational salary, enrollment in graduate school and the quality of work of teachers. We can summarize and categorize the responses provided by licensees in accordance with the table below:

Table 2. Quantity and Motivations for the Abandonment of the Teaching Profession

Reasons to leave the profession	Number of Teachers	Percent (%)
Salary	7	29
Quality of Work (School/Career)	6	25
Enrollment in Graduate School (as professor)	4	17
Graduation Scholarship Awarded	4	17
Enrollment as Substitute Professor	2	8
Difficulties to teach	1	4

More detailed table about the motivations for the abandonment of the teaching profession can be found in Kussuda [8].

The existence of more answers to the abandonment of teaching than graduates who have left this profession is because some licensees submit more than one reason.

In the categorization "Quality of Work (School/Career)" we considered the limitations and difficulties arising from the current legislation on the profession and the conditions of domination in which teachers are subjected due to other school workers, for example, the lack of autonomy due to attitudes of the school principal.

According to the website of the Department of Education of the State of São Paulo (SEE-SP), in July 2013 [9], Professor on his first years in the State of São Paulo (2013), received R\$ 2,257.84 (U.S. \$ 1,014.14) each month, to work 40 hours weekly. This equates to approximately 3.3 Brazilian minimum wage, and the minimum wage R\$ 678.00 (U.S. \$ 304.00). However observing the data presented by Department of Statistics and Socioeconomic Studies (DIEESE) [10] in the same period the minimum wage required to survive in Brazil was R\$ 2,750.83 (U.S. \$ 1,235.93).

Through the analysis of the above tables we can see that most of the motivations of abandonment of teaching are related to features that are independent of the teacher, but the public policies to improve the quality of work and the teacher's salary.

Conclusions

Through the analysis of the above tables it is possible to deduce that the degree course in Physics has been unable to keep making the course attractive enough for students to remain in the course or retention index appears high, since the sum of the amount students who dropped the course and retention rates are 42%. The motivation of the high dropout rate of these courses requires further study so that this knowledge can contribute to the improvement of undergraduate courses in physics.

The data obtained with the 52 graduates show that much of the lack of teachers is related to the large dropout in the teaching profession, especially in the first five years of operation and that only the increase in the number of seats in these courses will not guarantee the end of the teacher shortage to act, especially in Basic Education. So there is actually a decrease in the shortage of teachers is necessary to expand public policies to improve the quality of work and teachers' salaries, as already shown by other authors as Gatti and Baker [11], Lapo and Bueno [12] and Kussuda and Nardi [13].

Through the analysis of the data it is possible to notice that there is no specific motivation for physics teachers leave the profession, which indicates that these motivations may be related to a teaching career in general, especially teachers of Chemistry and Biology classes that have characteristics similar to that of teachers of Physics such as the amount of classes per week and need for laboratory. However to understand this is necessary a deeply research by expanding the sample to include teachers of chemistry and biology.

Observing the amount of people who leave teaching career and physics course, we started questioning what are the motivations that led the licensee to dropout or complete the course, since that seems that there is no specific motivation for the abandonment of the profession (physics teacher). To conduct this study is necessary to examine the background of graduates, noting their way to the formation or abandonment of the course. This study is being conducted by the authors.

References

- [1] Weber D.: Eles ensinam sem ter aprendido. (2007), [online]. [cit. 07. 08. 2013]. Available from: <http://oglobo.globo.com/educacao/estudo-do-mec-revela-que-70-dos-professores-de-ciencias-nao-tem-formacao-na-area-4136872>
- [2] Gesqui L. C.: Formação e condições de professores eventuais atuantes na rede pública estadual. In: 32ª Reunião Anual da ANPED, Caxambú. (2009). p. 1 – 14.
- [3] Camargo S.: Discursos presentes em um processo de reestruturação curricular de um curso de licenciatura em física: o legal, o real e o possível. (2007). Theses (PhD on Science Education Program) – Science University, Universidade Estadual Paulista, Bauru, 2007.
- [4] Araujo R. S.: Estudo sobre licenciatura em física na UAB: formação de licenciados ou professores. (2010). Tese (PhD. on Education in Biosciences and Health) – Institute Oswaldo Cruz, Universidade Federal do Rio de Janeiro, Rio de Janeiro.
- [5] Bardin L.: Análise de conteúdo. Lisboa: Edições 70 (2002) ISBN: 9789724415062.
- [6] Ruiz A. I., Ramos N. M., Hingel M.: Escassez de professores no ensino médio: soluções emergenciais e estruturais. Brasília: Ministério da Educação, (2007) p. 1-27.
- [7] Garcia C. M.: Formação de professores para uma mudança educativa. Lisboa: Porto Editora (1999) ISBN: 978-972-0-34152-5.
- [8] Kussuda S. R.: A escolha profissional de licenciados em física de uma universidade pública. (2012). Dissertação (Master's degree on Science Education Program) – Faculdade de Ciências, Universidade Estadual Paulista, Bauru, 2012.
- [9] SEE-SP. Governador aprova aumento salarial para 415 mil professores e servidores da Educação, [online]. [cit. 10. 07. 2013]. Available from: <http://www.educacao.sp.gov.br/noticias/governador-aprova-aumento-salarial-de-servidores-da-educacao>

- [10] DIEESE. Salário mínimo nominal e necessário (2013) [online]. [cit. 07.10.2013]. Available from: <http://www.dieese.org.br/analisecestabasica/salarioMinimo.html>
- [11] Gatti B. A., Barretto E. S. de S.: Professores do Brasil: impasses e desafios. (2009) Brasília: Unesco. 293p.
- [12] Lapo F. R., Bueno B. O.: O abandono do magistério: vínculos e rupturas com trabalho docente. Psicologia (2002) USP, São Paulo, v.13, n. 2.
- [13] Kussuda S. R., Nardi R.: Motivações para a permanência ou abandono do magistério segundo licenciado sem Física de uma universidade pública.(2013) In.: Simpósio Nacional de Ensino de Física, 20. 2013, São Paulo.

Influence of peer discussion on confidence in ConcepTest responses

Maykon Gonçalves Müller, Ives Solano Araujo, Eliane Angela Veit

Physics Institute, Federal University of Rio Grande do Sul, Porto Alegre, Brazil

Abstract

The main purpose of this work was to investigate the influence of peer discussion on the students' confidence level to ConcepTests during peer instruction. Briefly, we seek to answer the following research questions: i) Does discussion among peers promote an increase on the students' confidence in their own response? ii) What is the relationship between the level of confidence and the number of correct/incorrect responses before and after discussion among peers? The results show that there is a statistically significant increase in the confidence level of one's own response after discussion among peers. This increase appears to be more significant when students choose the correct answer on the second round of voting. Besides, the proportion of incorrect responses after discussion among colleagues dropped in the three (low, medium and high) confidence levels and occurred an increase in the number of correct answers.

Keywords: Peer Instruction, confidence level, high school

Introduction

In order to promote greater engagement among students during class time, some teaching methods employ classroom response systems (CRS). Students use the CRS (e.g. clickers) to answer questions and teachers use response feedback to make pedagogical decisions based on it. We highlight one instructional method where the use of CRS is prevalent: Peer Instruction (PI) [1].

Peer Instruction is an active-learning method in which students answer short, conceptually based questions during instruction. In PI [2], teachers divide the class time over short lectures on specific topics that last no more than twenty minutes. Each short presentation is followed by a ConcepTest (short conceptual question on the subject being discussed). After posing the question, students have about two minutes to formulate their answer. If the frequency of correct responses is between 35% and 70%, teachers guide students to form small groups, preferably with peers who have chosen different responses, and discuss for around three minutes. After discussion, students vote again. This process is repeated until the teacher's expectations for the class and the student's understandings are accomplished.

Several research studies have shown improvements in students' performance on conceptual tests (e.g. FCI and BEMA) and problem-solve skills [1,2,4,5,6]. Studies also have shown that after peer discussion, the class generally converges toward the correct answer [2,3]. However, it is less clear whether students are getting more (or less) convinced about the validity of their answers to these conceptual questions. Some studies have investigated the students' confidence of their answers during PI in the context of universities [2,3,7]. In general, the results show that students get more confident after the discussion among peers.

In this study, we evaluated student confidence in their ConcepTest responses, for each round of voting, in the context of a Brazilian high school. We posed the following research questions: Does discussion among peers promote an increase on the students' confidence in

their own response? What is the relationship between the level of confidence and the number of correct/incorrect responses before and after discussion among peers?

Methodology

The study was conducted in a class of 34 students at a Federal Public High School, located in Porto Alegre, RS – Brazil. The instructional sequence was related to topics of Electromagnetism, during two months over seven class meetings (90 min). The seven topics, planned to be developed one per meeting, were: magnetic field around a straight wire; magnetic field around a current carrying loop; magnetic field around a solenoid; Force between two parallel current-carrying conductors; electromagnetic induction; Faraday's Law; Lenz's Law; and the functioning of electrical transformers.

On average, three ConcepTests were used per class. In addition to the response, students should choose, for each round of voting, the confidence level of their answer. Considering that our aim is to investigate the influence of discussion among colleagues on the confidence in ConcepTests responses, we analyze only the data from the tests in which the stage of discussion occurred. In total, 12 tests resulted in peer discussion.

In order to motivate the students, the ConcepTests were adapted from universities entrance exams. Students approved the use of this specific type of questions as ConcepTests and, sometimes, they showed themselves extremely excited to settle correctly the questions. We attribute this feeling to the fact that the students would take entrance exams at the end of that year, and to get the questions right, they were earning confidence to take future exams. In the Figure 1, we show an example of ConcepTest adapted from a Brazilian university entrance exam.

A very long and straight wire, carrying a constant electric current, is placed perpendicular to the plane of the page at point P. If the Earth's magnetic field is negligible compared to that produced by this current, which number correctly indicates the alignment of magnetic needle?

(a) 1
(b) 2
(c) 3
(d) 4
(e) 5

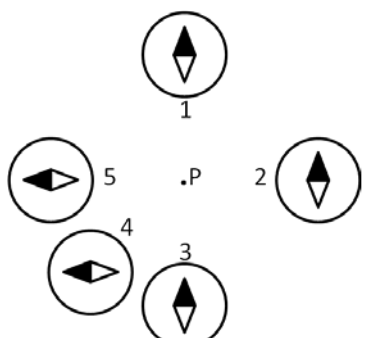

Figure 1. Example of ConcepTest

Analysis and Discussion

The Wilcoxon test was applied to the subgroups of our sample, which were divided according to the possibilities of rating to the ConcepTests before and after discussion among peers:

- Group I: Incorrect to Correct – when the student chose the incorrect answer and after discussion decided by the correct answer.
- Group II: Correct twice – when the student chose the correct response before and after the discussion.

- Group III: Incorrect twice – when the student chose the incorrect response before and after the discussion.

In order to make the analysis, to each confidence level a value was associated (low = 0; medium = 1; high = 2). Table 1 shows the average confidence level before and after the discussion, as well as the value of *p* (2-tailed) for the confidence level on the answer before and after the discussion for each group.

The results show that there is a statistically significant increase in the confidence level of one's own response after discussion among peers. This increase appears to be more significant when students choose the correct answer on the second round of voting.

Table 1. Statistical Analysis of confidence level

Group:	I (Incorrect to Correct)	II (Correct twice)	III (Incorrect twice)
N° of answers:	119	189	49
Average level before-discussion:	1.04	1.14	0.98
Average level after-discussion:	1.45	1.63	1.22
<i>p</i> (2-tailed:)	< 0.001	< 0.001	0,037

It is important to highlight that during our implementation of PI, there was none ConcepTest that had converged toward the incorrect answer. The bar-chart below (Graph 1) summarizes the results for the twelve ConcepTests that resulted in discussion among peers. Each column is identified by Qn_Cm code, where 'm' is the number of class (1, 2, 3, etc.) and 'n' represents the number of the question. As it can be observed, we found significant convergence towards the correct answer, as shown by the literature [1,2,3,7].

A descriptive analysis was conducted to examine the number of correct and incorrect responses for all three confidence levels, before and after the discussion. The results are shown in Table 2. As it can be observed, the proportion of incorrect responses after discussion among colleagues dropped in the three confidence levels (average reduction: 31%) and occurred an increase in the number of correct answers. The proportion of correct answers increased from 53% to 85% after the discussion among colleagues and the highest confidence level on the correct answers followed this tendency, emerging from approximately 12% to around 52%. As compared, the sum of the percentage of the medium and high confidence level on incorrect responses fell from 39.2% to about 13%.

At the same time, the proportion of incorrect answers decreased from 47% to 15,1% after the discussion among colleagues. As expected, the confidence levels for the incorrect answers after discussion followed this trend, reducing on the three levels. The drop on the number of incorrect answers before and after the discussion was more significant on the medium confidence level, which decreased from almost 31% of responses to 8%.

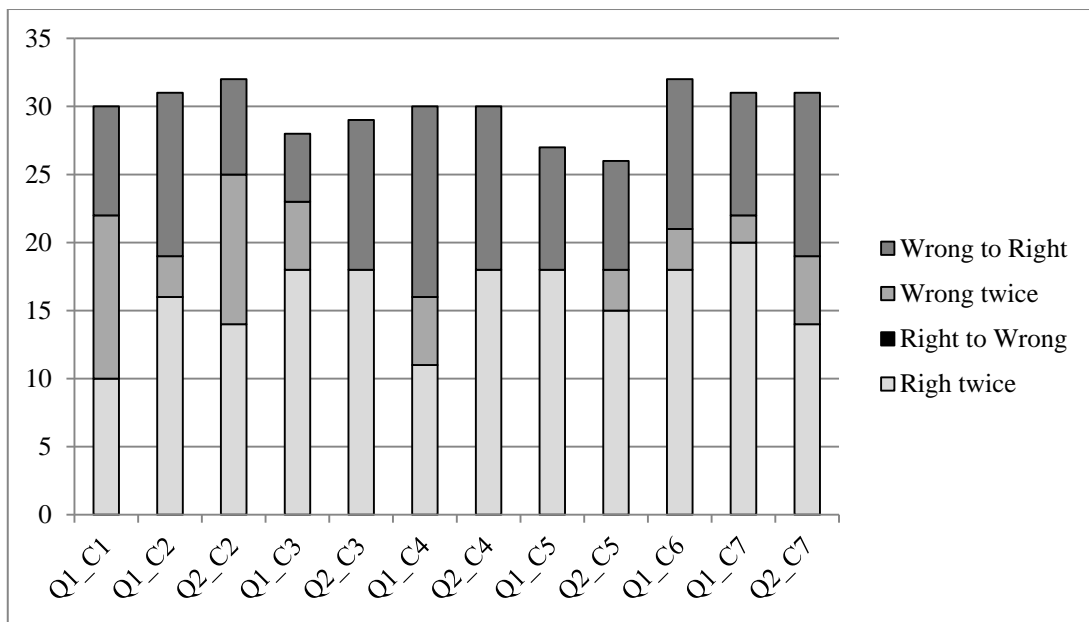

Graph 1. Distribution of ConcepTests' responses

Table 2. Descriptive analysis of correct/incorrect responses

Responses	Peer discussion	Total (N=357)	Confidence Level:		
			Low	Medium	High
Correct	Before	190	16	130	44
		53%	4.5%	36.4%	12.3%
	After	303	13	103	187
		85%	3.6%	28.9%	52.4%
Incorrect	Before	167	27	110	30
		47%	7.6%	30.8%	8.4%
	After	54	8	29	17
		15.1%	2.2%	8.1%	4.8%

Conclusions

Peer Instruction is an interactive teaching method, where students interact with each other during the lessons, teaching themselves about the concepts while trying to apply themselves in solving conceptual questions, exactly the opposite of traditional lectures where students are totally passive in the classroom. Studies have shown that after the discussion among peers, the class usually converges toward the correct answer and students get more confident about the validity of their answer [2,3,7]. In our study, we investigated if the discussion among peers promoted the increase of the correct answers and if students get more confident about their own answers, in the context of a Brazilian high school. We also investigated the relationship between the number of correct/incorrect answers and the confidence level before and after the peer discussion.

Through the results, we conclude that peer discussion, besides encouraging greater interaction in class, promotes an increase in students' confidence about their own responses and in the number of correct answers. In parallel, data suggests that peer discussion increases the number of correct answers with high confidence. These results have been shown in the literature [2,3,7] on a different context. Our study contributes to these results in the context of a Brazilian high school.

Acknowledgements

The authors would like to thank Dr. Julie Schell and Dr. Fernando Lang da Silveira for their assistance to help improve this work.

References

- [1] Crouch C. H., Mazur E. (2001): Peer Instruction: Ten years of experience and results. *American Journal of Physics*, 69(9), 970.
- [2] Mazur E. (1997): *Peer Instruction: A User's Manual* Prentice Hall, Upper Saddle River, NJ.
- [3] Butchart S., Handfield T., Restall G. (2009): Using Peer Instruction to teach Philosophy, Logic and Critical Thinking. *Teaching Philosophy*, 1 (2009), 1–40.
- [4] Cummings K., Roberts S. G., Henderson C., Sabella M., Hsu L. (2008): A Study of Peer Instruction Methods with High School Physics Students. *AIP Conference Proceedings*, 103–106.
- [5] Fagen A. P.: (2002). Peer Instruction: Results from a Range of Classrooms. *The Physics Teacher*, 40(4), 206.
- [6] Lasry N., Mazur E., Watkins J. (2008): Peer instruction : From Harvard to the two-year college, 1066–1069.
- [7] Brooks B. J., Koretsky M. D. (2011): The Influence of Group Discussion on Students' Responses and Confidence during Peer Instruction. *Journal of Chemical Education*, 88(11), 1477-1484.

Can Dynamic Concept Be Acquired by Drawing a Conceptual Diagram?

Minoru SATO

School of Science, Tokai University

Abstract

The conceptual diagrams currently used in physics are abstract and scientific figures. However, the physics beginner lacking the schema for certain physical concepts has the possibility of understanding the abstract conceptual diagrams as concrete pictures. Moreover, in visual expression using figures, measurement of comprehension of such physical concepts by beginners is difficult to measure. Therefore, investigation on how university students grasp the conceptual diagrams currently used in statics was conducted. As a result, the score on FCI by students who drew abstract figures was shown to be higher than by students who drew concrete figures. In statics, the person drawing an abstract figure has a high possibility of having a dynamics concept compared with one describing a concrete figure. Conversely, if the dynamics concept can lead to comprehension by drawing an abstract conceptual diagram, then the use of a conceptual diagram may be of benefit to comprehension in physics education. Therefore, a trial incorporating a dynamics concept acquired by the drawing of an abstract conceptual diagram was performed. It was evaluated using FCI, as to whether the students had acquired the dynamics concept by drawing an abstract conceptual diagram.

Keywords: conceptual diagram, FCI, undergraduates

Introduction

It is well known to the physics education researcher that acquisition of the dynamics concept is difficult [1]. Many education methods for conceptual acquisition are studied and the conceptual tests are used at classes.

Visualization of physical quantities that are invisible, such as power or momentum, is essential to the acquisition of a dynamics concept. Generally, some figures are used for the visualization of physical quantities. For example, it is almost certain that figures are used in dynamics textbooks for explanation. Moreover, some textbooks provide detailed explanation on the careful drawing of body free diagrams [2].

However, in order for a student to understand the meaning of a conceptual diagram, the comprehension of the concept that the diagram conveys is required. Therefore, the student of dynamics with an insufficient grasp of the dynamics concept may be unable to understand the meaning of the diagram. In all likelihood, the conceptual diagram will be interpreted as a concrete picture. Furthermore, this may inhibit comprehension of the dynamic concept.

Therefore, investigation about the relation between a dynamics concept and drawings by students was conducted. Furthermore, preliminary investigation was conducted on the ability for a dynamics concept to be grasped through the drawing a conceptual diagram.

Does the student who can draw a conceptual diagram carry the related physical concept?

Firstly, investigation about the relation between a dynamics concept and the drawings by students was conducted. Since those who have acquired the dynamics concept understood the meaning of a conceptual diagram, the hypothesis that a conceptual diagram could be drawn was built up. In order to verify this hypothesis, simultaneously with conceptual investigation of dynamics, investigation on the usage of the "translational equilibrium" figure was carried out. The investigation was conducted at the fall semester in the 2011. The subjects of the investigation were third-year university students taking a class required to obtain teacher qualification of junior high school science. The number of the subjects was 16.

The Force Concept Inventory (FCI) was used for conceptual investigation of dynamics. The rationale for using FCI is often used for conceptual investigation of dynamics and that there is less burden placed on students as the investigation time of thirty minutes is considered short.

The subject students of the investigation were instructed "to draw TSURIAI" at the time of investigation of drawing of a figure. The "TSURIAI" which is Japanese is the meaning of maintaining the balance used daily and a dynamic meaning of translational equilibrium. The subjects were directed in investigation, without distinguishing these two meanings intentionally. It was expected by this that a student who comprehends the dynamics concept would draw an abstract figure, and a student lacking the schema for this concept would draw a concrete figure. Here the abstract figure was defined as a drawing expressing invisible elements, including a dynamics concept, and the concrete figure was defined as a drawing expressing visible elements. For example, if the vector of power is drawn, it will be classified with an abstract figure, and if the balance scale is drawn, it will be classified with a concrete figure.

As the result of classifying the figures that the subject students drew as the result of the investigation, five subjects described an abstract figure, and nine subjects described a concrete figure, and two subjects described both (Figure 1). As for the subjects who described an abstract figure, all members drew some arrows of vectors. As for subjects describing a concrete figure, six drew the balance scale.

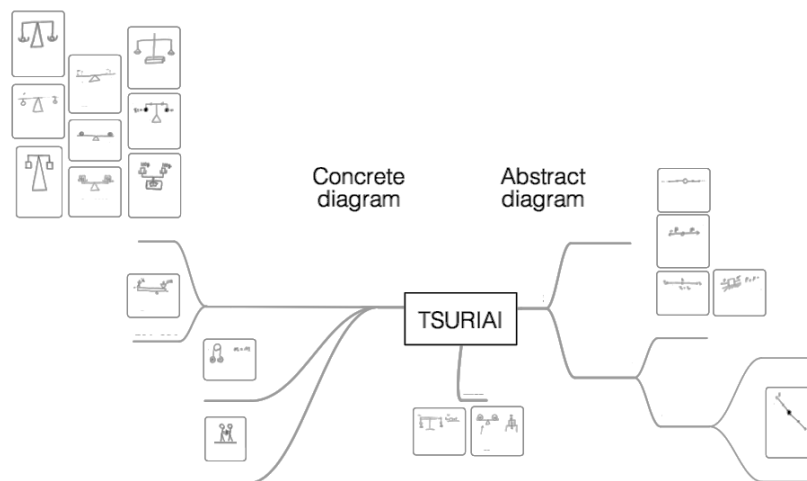

Figure 1. The figure that the subject students instructed to draw "to draw TSURIAI"

From this, the results were divided into two groups, one describing an abstract figure and the other describing a concrete figure. Then the average score of each FCI relative to each group was measured. Two subjects who described both figures were removed from the comparative subject. The average score of FCI of the group describing an abstract figure was significantly higher ($p < 0.05$) than the group describing a concrete figure (Figure 2). Therefore, it was found that the student who draws an abstract figure has a possibility of having grasped the related dynamics concept.

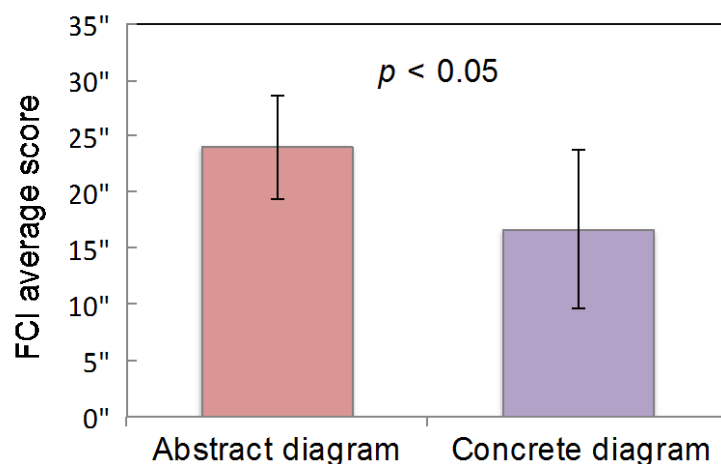

Figure 2. The average scores of FCI of the group of describing an abstract figure and a concrete figure

Can a physical concept be made to grasp by making a student draw a conceptual diagram?

Secondly, preliminary investigation was conducted on the ability of a dynamics concept to be grasped by drawing a conceptual diagram. Since it was suggested that the student who draws an abstract figure has a high possibility of having a dynamics concept by the first investigation, the hypothesis that a dynamics concept could be grasped by drawing of a conceptual diagram was created. Preliminary investigation was performed in order to evaluate the validity of this hypothesis. The investigation was conducted at the spring semester in the 2012. The subjects of the investigation were the first grade or second grade university students, studying an algebra base physics class aimed at those not studying physics at a high school. There were a total of ten subjects.

The method of investigation is as follows; the investigation was conducted after finishing kinematics and at this time, the subjects were able to draw the position-versus-time graph, the speed-versus-time graph, and the acceleration-versus-time graph. In the investigation, the subject students were shown the parabolic motion of a thrown tennis ball and the uniform accelerated motion of a cart placed on a slope first. Then, the subjects were instructed to draw each actual movement on a figure. First, after the students looked at actual motion, they were required to draw a point mass and some vectors, in which speed, acceleration and force were included. In addition, the subject students were divided into groups of two or three, and discussed each other's figure which each drew in their respective group. As a result of the discussion, the subject students were required to correct each figure if it was needed.

An example of the figures drawn by a subject is shown in Figure 3. In the figures drawn before the discussion, there were figures whose direction of acceleration and direction of force do not correspond, and whose direction of movement and direction of force correspond. The figure was corrected through a discussion on the figure and by considering movement deeply. It can be concluded by the corrected figure that the student has comprehended these concepts correctly.

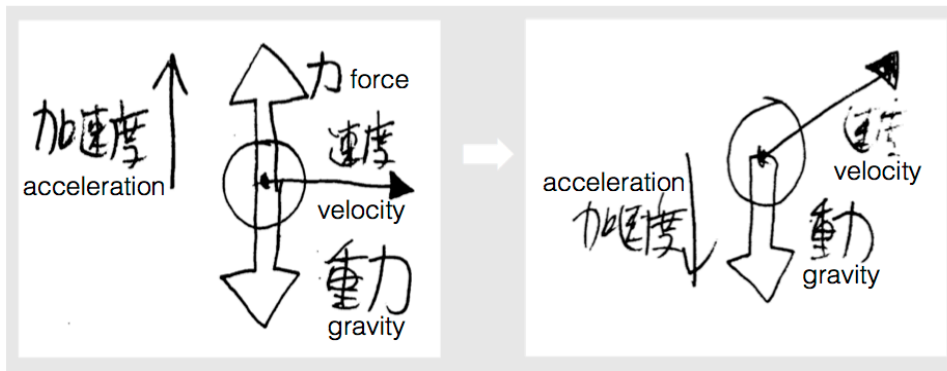

Figure 3. An example of the figures that a subject student drew

From these results, it can be said that drawing a conceptual diagram may make a student comprehend a dynamics concept.

Conclusion

When divided into two groups of describing an abstract figure and the other describing a concrete figure, the average score of FCI of the group describing an abstract figure was significantly higher than the group describing a concrete figure. Therefore, it was found that the student who draws an abstract figure had a high possibility of comprehending dynamics concept and showing an ability to convey this concept. I would like to increase the number of samples and, moreover, wish to verify this hypothesis.

When the student with the incorrect dynamics concept was made to draw conceptual diagrams and was made to convey an understanding of the figure, the right dynamics concept was shown to have been grasped. I would like to advance a full-scale investigation. Furthermore, I would like to investigate how to make a dynamics concept comprehended through the drawing of conceptual diagrams.

References

- [1] Edward F. Redish: Teaching Physics with the Physics Suite: John Wiley & Sons (2003).
- [2] James S. Walker: Physics: Prentice-Hall (2002), pp110-112.

Inquiring 5 years old pupils on MST curricula

Stefano Vercellati, Marisa Michelini, Lorenzo Santi

Research Unit in Physics Education, University of Udine, Italy

Abstract

The analysis of the official documents of a Country is not enough to have a “real” picture of the school curriculum in that Country. This analysis had to be flanked and integrated by the results of the investigation of the acted curriculum implemented by the teachers and the perception that the pupils have. With the aim to investigate 5 years old pupils’ perception of the curriculum of mathematics science and technology, two strategies for collecting data in kindergarten were implemented and experimented during the pilot phase of the SECURE European Project.

Keywords: Preschool education, kindergarten, curriculums of mathematics science and technology

Theoretical Framework

Substantial distinctions concerning the definition of “school curriculum” are present in literature [4,5]. Different meanings arise from different contexts in education research [3,4,7,8]. The analysis of the official document(s) is not enough just to have a clear vision of it. School curriculum and its modifications involve several different aspects related to institutions and subjects who are interrelated one with each other. A multilevel analysis is thus needed. Supra (international), Macro (national), Meso (school, institute), Micro (classroom, teacher), Nano (individual, pupil) levels had to be investigated to look to the whole audience for which they are addressed.

To emphasize this aspect van den Akker [1,2] propose to represent curriculum as a spider web (Figure 1) in which the main subjects and aspects of the curriculum and the curricular research take place.



Figure 1. Akker’s representation of the curricular spider web

The rational of the curriculum was placed in the centre and the components involved in the curriculum are placed around becoming the nine threads of the spider web which relevance varies on the five curriculum levels.

Contextualization of the research work

The work described in this paper was realized in the framework of the European Project Science Education CURriculum REsearch (SECURE) [6]. The SECURE project, financed by the European Union in the context of the Seventh Framework Programme, has the main goal of provide relevant and rigorous research data and translate them in recommendations useful to the debate on the curriculum of Mathematic, Science and Technology (MST) and their objectives among stakeholder and policy makers. A total of 11 partners in 10 Countries, of which 7 universities and 2 pedagogical institutes are involved in the project: Katholieke Hogeschool Kempen University College (BE), Dienst Katholiek Onderwijs vzw (BE), Universität Graz (A), University of Cyprus (CY), Technische Universität Dresden (D), Università degli Studi di Udine (I), Nationaal expertisecentrum SLO (NL), Uniwersytet Jagiellonski (PL), Univerza v Ljubljani (SI), University of Gävle (S), Nottingham Trent University (UK). The analysis and comparison between goals contents and teaching strategies proposed in the MST curricula of the involved Countries is the main research field addressed. In particular, the focus was on the identification of the shared grounds and the peculiarity existing among the MST curricula, the identification of good practices, the establishing of how the MST teachers put curricula into practice and how the current curricula affect learners' competences, motivation and perception of the relevance of the MST subjects for their life. The research work of the SECURE focus on 5, 8, 11 and 13 years old learners, their MST curricula and their teachers. These ages were chosen to investigate in depth the bridges and the gaps that there are between kindergarten, primary school and middle school in a comparable way between the involved Countries.

The implementation of the research in the SECURE project

The analysis of the elements pointed out by Akker in his spider web representation [1,2] was done on three levels: the level of the curricula in according with the official documents published by the National Ministry of Education, the level of the curricula implemented by teachers in the everyday practice and the level of the curricula perceived by pupils. The official curricula were analysed by means the use of an in-depth analysis of the official documents of each Country. The implemented and perceived curricula, instead, were analysed by means the use of questionnaires and interviews for teachers and pupils.

Two different types of questionnaires were developed for pupils: one for the 8 years old, and one for the 11 and 13 years old: the first one was constitute by 96 multiple-choice questions and one open question, while the second contained 108 multiple-choice questions and 7 open questions. As regard teachers, the subjects thought was the criteria for the differentiation in the questionnaire structures: 155 items for the teachers of mathematics and 138 for the teachers of science and technology. No questionnaire was proposed for the 5 years old pupils.

Questionnaires were filled by all of the MST teachers and the pupils in at least 15 classes per Country for the 8, 11 and 13 years old. Oral interviews were proposed to 6 classes per Country for the pupils of 8, 11 and 13 years old and all of the class of 5 years old and their MST teachers. Teachers' interviews were semi structured individual interviews, while

pupils' interviews were small group interviews done with four pupils (two girls and two boys, if the class composition allows it).

The Italian pilot study for the SECURE project

In the framework of the pilot study held in Italy a specific work was done for the development of a questionnaire and a specific strategy for its submission to the 5 years old pupils in kindergarten.

In cooperation with expert kindergarten teachers, a work of rephrasing and transduction was done to adapt the items of the questionnaire for the 8 years old to the needs of the 5 years old pupils. The main work was focused on the (re)contextualization of the questions proposed to the pupils. General and or abstract words as, “geometry”, “calculation”, “biology” etc. were changed with more contextualizing words as “work with shapes”, “work with numbers”, “work with plants and flowers” respectively.

A clear and well defined distinction was placed in the use of the verbs “to work” and “to play”: we used “to work” when we referred to activities and actions proposed by the teacher, while “to play” is referred to activities and actions that are spontaneously prosed/done by pupils. This choice retrace the usual way adopted by the teachers in Italian kindergarten to make a clear distinction between the free time activities and the class activities. It means that in pupils' perception there is a big difference in meaning between the questions “How often do you work with...?” and “How often do you play with...?”. That is important because the use of one verb or the other changes the set of the aspects investigated by the question: the first one investigates the learning activities, while the second explores the interest of the pupils with respect to the considered aspect.

In Table 1 are reported some example of rephrased questions.

Table 1. Example of rephrased questions for the 5 years old pupils

Original questions for 8 years old pupils	Rephrased version for 5 years old pupils
Do you like what you learn in Mathematics?	Do you like what you learn while you work with numbers (and shapes)?
We use various materials. For example: plants, stones, animals: Often /Sometimes/ Never	How many a time at school do you observe plants and animals?
We use exercise books Often /Sometimes/ Never	How many a time with numbers and shapes do you work with the booklets and worksheets given by your teacher?

The proposed strategies for data collection

Two classes of 5 years old pupils were involved into the pilot study. Twelve pupils composed each class: 6 boys and 6 girls in the first, and 5 boys and 7 girls in the second.

The rephrased questions of the 8 years old questionnaires, were proposed as a semi structured interview to both of the classes. Each question was thought as a multiple-choice question to which pupils had to replies choosing between three options.

Two sets of three possible answers were prepared: one for the questions which ask for an opinion and one for the question asking about “the amount of” or “how often”. The first set

was constituted by three different smiles with different expressions: sad, neutral and happy. The second set was made by squares of different size that represents (from the smaller to the bigger): little–medium–large or never–sometimes–often.

To collect data, two specific procedures were developed and experimented separately in each class.

In the first class, we provide to each pupil a wooden skewer (a long toothpick) with some plasticine at one end of it, several preprinted smiles and squares of different size (Figure 2). Fixing one end of the skewer on the table using the plasticine, it remain in a vertical position; then the researcher read a question and, depending by the type of the question, ask to pupils to put the smile (or the square) that better represents their opinion as concern the question. Each pupil has its own skewer and to answer to the questions they had to select one smile or one square and put in on the skewer. At the end of the questionnaire, looking at the papers that the pupils put on the skewers, we can collect data on each answer gave by each pupil.



Figure 2. The wooden skewer adopted for the first strategy

In the second class, we use preprinted strips of paper on which pupils, coloring the mouth of the smiles or coloring one of the squares, can answer to each question. We use one strip of paper for each group of questions and each stripe as a number that allow us to identified which pupil compiled it. A schema of the preprinted strip is reported in Figure 3. As could be noticed, smiles have already three dotted mouths that represent the possible answers; this choice was adopted to avoid possible misinterpretation due to the possible ambiguity of the free drawing of the mouth.

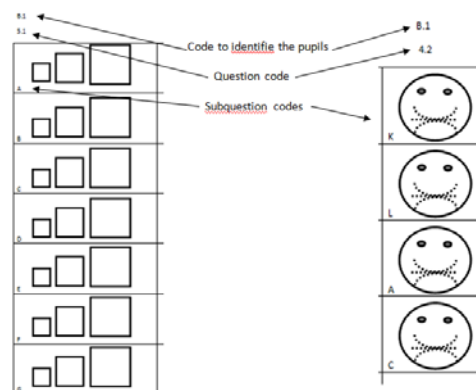

Figure 3. Example of preprint strips of paper adopted for the second strategy

Results and comments on the quality of the results for the two strategies

Table 2 and Table 3 report some example of data collected using the two strategies for what concern pupils’ opinions and the amount of the activity the do, respectively.

Table 2. Extract of the data collected as concern pupil’s opinions

	SKEWER			PAPER		
	☹	☺	☺	☹	☺	☺
Do you like working with numbers and shapes because you do them along with your friends?	1	3	8	2	1	9
Do you like working with numbers and shapes on booklets and worksheets given by the teacher?	4	3	5	0	2	10
Do you like to show others what you did?	0	1	11	0	0	12
Do you like working with experiments, plants and animals on the booklets and worksheets given by the teacher?	0	2	10	0	8	4
Do you like when you construct something and use it?	2	1	9	1	0	11

Table 3. Extract of the data collected as concern activities done by pupils

	SKEWER			PAPER		
	☐	☐	☐	☐	☐	☐
How many a time with numbers and shapes do you...						
...work with the booklets and worksheets given by your teacher	0	3	9	0	0	12
...work with the other pupils	2	5	5	1	2	9
...measure	2	2	8	1	3	8
...play with the numbers	2	3	7	2	0	10
...present your results to the other pupils of the class	6	0	6	3	3	6
...make posters on what you have studied	2	4	6	5	3	4
...memorize how to do something	3	6	3	2	5	5

Even at a first look of the data, emerge how the replies of the pupils are not simply picked, but there is a distribution that gives a first insight for the presence of not strong mutual influences by the pupils. The analysis and the comparison one by one of the single answers to each questions provided by the pupils confirm this insight proving that there are not equal (or almost) equal questionnaire between each couple of pupils inside the class.

In addition, it emerges how, even if almost all of the pupils like all of the activities, there is clear gradation in the opinion that pupils have about the different activities. For instance, in the “skewer class”, they like more to show to the class what they did, then do the experiments (rows 5 and 6 of Table 2) and pupils in the “paper class” like more to work with number and shapes using worksheets than in the “skewer class” (row 2 of Table 2).

The same independence between pupils’ answers is true also as concern the questions related to the amount and the frequency of the activities.

In particular, looking at the different sections of the questionnaire, is it possible to notice how if there is a dependency between the pupils questions, this dependencies is only small present in the early questions, when pupils are still unfamiliar with the strategies proposed. However, after few questions (about ten) this dependency disappears also for pupils seated next one to the other.

Comments and conclusions

Both of the strategies adopted gave effective and independent results from which extract the pupils' opinions even if each strategy has its pro and contra.

In pupils opinion, the skewer strategy seems like a game and pupils enjoy it, but it requires a real strict and constant control about the researcher as regards the number of smiles/square each pupils put on the skewer. If one pupil doesn't put or put twice an answer, all the following answers will be out of phase. It is therefore necessary to use control paper, put by the researcher after each group of questions to reduce the propagation of such a type of error. In addition, it is necessary to be carefully in the transport and in the transcription of data because is important to maintain the order of the papers and the original data are not easy to store because, to transcript data, the researcher need to disassemble the original skewer.

In the paper strategy, instead, it is easy to look if all pupils are in phase with the answers and do not required particular attention in the transport of the data collected, but in pupils' opinion it is boring because it is like a work for them. This problem is strictly connected with the short time of attention of the pupils of 5 years: using the paper strategy, we need to shorten the questionnaire and/or to propose it in different sessions during several days.

For both strategies, there are also a series of a general remarks that arise from the work done. To adapt effectively the questionnaire proposed to the 5 years old pupils, we had to refer to specific experienced situations that are part of the specific group of involved pupils. Even if there are no mutual influences between pupils there are several self-influence because in pupils answers there is almost no distinction between emotive and factual experience; i.e. asking them "How many...?" their reply is strongly influenced by the opinion they have about what you ask for (if they like or do not like it). Indeed, replying to the question proposed, the 5 years old pupils referred usually to their all life experience, without referring to a limited interval of time.

Those remarks represents a limitation to the nature of the data collected, but they do not confuted the validity of the data collected using the two proposed strategies that proved to be effective in the investigation of the opinions of each pupils providing an environment in which the mutual influences between pupil are negligible.

Acknowledgements

This work is based on the SECURE research project (No SIS-CT-2010-266640), which received funding from the European's Unions Seventh Framework Program for Research and Development.

References

- [1] Akker J. van den: (2003). Curriculum perspectives: An introduction. In J. van den Akker, W. Kuiper & U. Hameyer (Eds.), Curriculum landscapes and trends (pp. 1-10). Dordrecht: Kluwer Academic Publishers.
- [2] Akker J. van den, Kuiper W.: (2007). Research on models for instructional design. In J.M. Spector, M.D. Merrill, J. van Merriënboer, & M.P. Driscoll (Eds.), Handbook of research for educational communications and technology (pp.739-748). New York: Lawrence Erlbaum Associates.

- [3] Beauchamp G. A.: (1986). Curriculum theory: Meaning, development, and use. *Theory Into Practice*, 21(1), 23–27.
- [4] Clements D. H.: (2007). Curriculum research: Toward a framework for ‘research-based curricula’. *Journal for Research in Mathematics Education*, 38, 35–70.
- [5] Jackson P. W.: 1992. Conceptions on curriculum and curriculum specialist. In P. W. Jackson (Ed.) *Handbook on research on curriculum* (pp.3 40). New York: Macmillan.
- [6] Michelini M., Vercellati S.: (2012) SECURE–Science Education CUrriculum REsearch Project under the 7 th Framework Program, XV IOSTE International Symposium on Science & Technology Education for Development, Citizenship and Social Justice.
- [7] Pinar W. F., Reynolds W. M., Slattery P., Taubman P. M.: (1995). *Understanding curriculum: An introduction to the study of historical and contemporary curriculum discourse*. New York: Peter Lang Publishing.
- [8] Walker D. F.: (2003). *Fundamentals of curriculum: Passion and professionalism* (2nd edition). Mahwah, NJ: Lawrence Erlbaum Associates.

Agent Based Simulation of Group Work Performance: Diversity vs. Faultiness

Clemens Wagner and Andreas Vaterlaus

Solid State Physics and Education, ETH, Zurich, Switzerland

Abstract

There is an increased interest in science education to test students not only individually but also in teams. Thus in collaborative two-stage exams students complete a test first as individuals and then in groups. This work is a first approach to investigate the performance of a group depending on the group composition.

We have used an agent-based model in order to study group work performance. Previous models have shown that the performance of a group is higher if it is composed of randomly selected agents rather than of the best agents. This is due to the fact that the former group reveals a higher diversity than the latter and solves therefore a new problem more successfully. Although the results are used in different contexts we believe that they cannot be easily transferred to the classroom since the model uses perfect agents as problem solvers.

In this work we introduce imperfect problem solvers who are making mistakes with probability p while solving a problem. For a fixed error probability the ranking of agents changes so that the group composition of the best 10 agents depends on p . If the best 10 faulty agents work as a group they perform better than the best 10 perfect agents, despite the performance of a single agent decreases with increasing error probability. Moreover, the performance of the best 10 faulty agents rises to a similar value as the one of a randomly selected group. Two effects contribute to the performance increase. First, due to different group compositions for different error probabilities the diversity of the group slightly increases. Secondly, the erroneous agents explore a larger part of the solution space since they sometimes miss a solution. The latter seems to be the predominant effect. For high values of the error probability the performance of the best 10 and the randomly selected group decrease in parallel until at $p = 1$ the solution space isn't explored anymore.

Keywords: agent-based modelling, cooperation, group work, performance

Introduction

Due to the introduction of collaborative learning methods at universities in science teaching (e.g. peer instruction) the need for new types of assessments emerged. Thus instructors started to use collaborative exams in order to estimate student learning (1,2). In this context the problem of group composition has been pointed out by Leight et al. (3). This work shows our approach to study group work performance depending on group composition.

In recent years agent based simulations of problem solving have received increased attention in order to find a better understanding of how the interactions between group members influence the group performance. In biology group performance has been investigated in house sparrows by Liker et.al (4) and in fish shoals by Ward et.al (5). The effect of group diversity on the performance has been further investigated in economy (6), and ecology (7). Hong and Page (8) developed a model where single agents were trained to

solve an optimization problem and then sorted due to their performance. Two groups were formed: a group consisting of the 10 best performers and a group where 10 agents were randomly selected from the pool. The performance of the group of the best problem solvers is then compared to a group of randomly selected ones. The outcome of the simulation was that the 10 best problem solvers perform in the average worse on new problems than the 10 randomly selected ones. The explanation for this result is due to the diversity of problem solving strategies within a group. Since the agents were trained on a specific problem the 10 best problem solvers use similar solution strategies. In contrast, the randomly selected group shows a much higher diversity scanning a much larger solution space and therefore performs better on new problems.

In our opinion the model has a drawback when transferring it into more realistic scenario that all agents are perfect agents. They make no mistakes. If we would like to apply the model to group work in education we have to introduce imperfect agents. Thus, in this work we investigate the effect of errors on the performance of the group using the optimization problem suggested by Hong and Page (8).

Our major result is that the group of the 10 best agents with a small error probability performs better than the corresponding group of perfect agents and as well as the randomly selected group from the pool. Due to small errors the agents increase their solution space leading to an increased performance when working in a group.

The Model

The model proposed by Hong and Page (8) consists of a ring of n points. To every point i on the ring a random number between 0 and 100 is assigned. The goal of an agent is to find the maximal number on the ring always moving in clockwise direction. Each agent has its own heuristics to solve the task. A heuristic is defined by l choose k but taking the sequence of figures into account. Each agent will check utmost k numbers between 1 and l ahead of the actual position in order to find a new maximum. Since the sequence is taken into account the heuristics [2, 5, 11] is different from [5, 2, 11] for $l = 12$ and $k = 3$.

The algorithm to move around the circle is given by the following rules. For simplicity we use here $l = 4$ and $k = 2$. Overall we get 12 different agents.

$$\binom{l}{k} \cdot k! = \binom{4}{2} \cdot 2! = 12.$$

The initial point is at $i = \text{start} = 2$ with a value of 44 (see Figure 1). Let's assume that the heuristic is to check the second and the fourth position ahead (heuristic = $h[2,4]$; $h(1) = 2$ and $h(2) = 4$). Therefore we first consider point $i = \text{start} + h(1) = 2+2 = 4$ with a value of 57. Since this value is already higher than the actual of 44, we move to $i = 4$ and take it as new starting point without checking point $i = \text{start} + h(2) = 2+4 = 6$ (Figure 1A). For the next move we check first $i = \text{new start} + h(1) = 4+2 = 6$. Since the value at this point (34) is smaller than the actual maximum (57) we also take the second point into account $i = \text{new start} + h(2) = 4+4 = 8$. The value of the ring at point $i = 8$ is 65 giving the reason to move to that point (Figure 1B). Therefore the new maximum is 65 and $i = 8$ the new starting point. The algorithm stops when it cannot find a new maximum. In the present example the algorithm stops at $i = 8$ since the values at $i = 10$ (12) and at $i = 12$ (48) are smaller than the actual one (65) (Figure 1C).

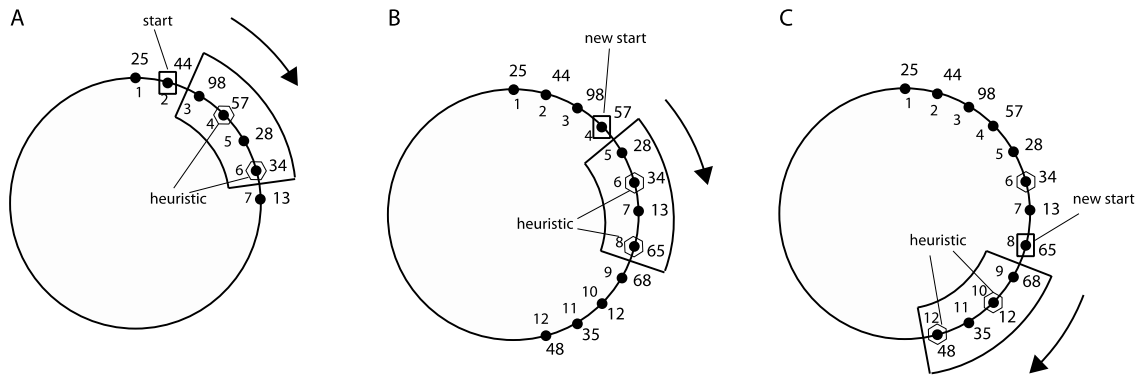

Figure 1. Illustration of the maximum search algorithm on the ring using the heuristic $h[2,4]$. Starting at $i = 2$ (maximum = 44) the agent moves to $i = 4$ during the first step (A, maximum = 57) and further to $i = 8$ during the second step (B, maximum = 65). At $i = 8$ the algorithm stops since the two values to check at $i = 10$ (12) and at $i = 12$ (48) are smaller than the actual maximum (65) (C).

Therefore we say that the agent with the heuristic $h[2, 4]$ starting at $i = 2$ finds a maximum of 65. Its trajectory is given by the numbers 44, 57, 65. The algorithm stops after three steps. The number of steps is defined by the length of the trajectory. For an agent with a given heuristic each starting point might lead to a different maximum. The performance P of an agent with heuristic h is therefore defined as the average of the maxima max_i over all starting points i of a given ring

$$P(h) = \frac{1}{n} \sum_{i=1}^n \max_i(h).$$

Simulation of single agents

For a ring consisting of $n = 1000$ points and point values between 1 and 100 we simulated the performance of agents with MATLAB. Using $l = 12$ and $k = 3$ we obtain 1320 different heuristics and therefore 1320 different agents. The values on the ring were randomly distributed. Figure 2 shows the performance of agents for three different random distributions. The sorting, running from lowest to highest, revealed an S-like shape of the performance. Interestingly the best few and the worst few agents can be well distinguished from the large set of average performers.

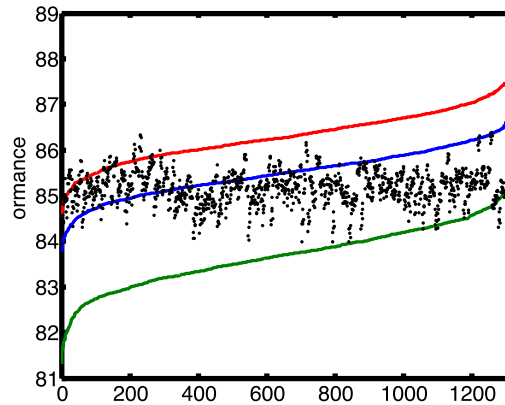

Figure 2. Performance of agents for $n = 1000, l = 12, k = 3$. The values on the ring were random number between 1 and 100. The three full lines represent the performance of agents for three different distributions of numbers on the ring. For each distribution the agents were sorted due their performance. If the agents are not sorted the performance can be averaged among the different distributions. The average performance of an agent for the three distributions is shown as a black dot.

We can also determine the average performance of an agent across the three problems. It is displayed in Figure 2 as black dot. If we let all agents solve many different problems the average performance of all agents would be the same. This underlines the fact that all agents are perfect agents. On the single problem we can find a ranking of the performance of the agents however, averaging over many problems all agents are equal and no ranking is possible.

Group work

Group work is defined in the following way. First a set of agent out of the pool is identified. The first agent starts at initial point i until it gets stuck. Then the next agent continues until it gets stock and so on. After the last agent of the group has determined its maximum, the first one starts again. This cycling continues until all agents cannot find a higher maximum. All agents of the group got stuck at the same position. The group performance is again estimated as average over all initial conditions (stating points).

The diversity of a group can be estimated by the mean of the diversity of all pairs of heuristics. The diversity of a pair of heuristics is defined as

$$D(h_1, h_2) = \frac{\sum_{j=1}^k \delta(h_1(j), h_2(j))}{k},$$

where j denotes the position in the sequence. The quantity $\delta(h_1(j), h_2(j)) = 1$ if $h_1(j) = h_2(j)$ and zero else. Thus, the diversity of the two heuristics $h_1 = [1, 12, 4]$ and $h_2 = [4, 12, 7]$ is for example

$$D(h_1, h_2) = \frac{3 - (0 + 1 + 0)}{3} = \frac{2}{3}.$$

For 1000 points on the ring ($n = 1000$), heuristic $l = 12$, $k = 3$, the results of the simulations of group performance is presented in Table 1. The data are averaged over 50 runs, where different runs have different distributions of random numbers on the ring.

Table 1. Simulation of group performance ($n = 1000$, $l = 12$, $k = 3$). The data represent the average over 50 different distributions of random numbers (50 runs). The standard deviation of the performance is given in parentheses.

Group composition	Performance	Diversity
10 best agents	92.45 (0.77)	0.8741
10 randomly selected agents	94.77 (0.61)	0.9407

The faulty agent

An agent makes a mistake when it does not recognize a maximum with a given probability. Let's assume that the agent is in the state shown in Figure 1A ($i = 2$; value = 44). The perfect agent would of course recognize the new maximum at $i = 4$ with a value of 57. In contrast, the faulty agent would identify the new maximum at $i = 4$ just with probability $1-p$, where p denotes the error probability. Figure 3 shows the performance of the best and the worst agent for a given problem depending on the error probability. The basic parameters of the simulations were the same as before ($n = 1000$, $l = 12$, $k = 3$). The performance gradually decreases from a perfect agent ($p = 0$) until it ends at 50 for an error probability $p = 1$. In the latter case the agent never recognizes a maximum and therefore remains at the initial position. Since the performance is defined as the average over all initial positions the performance of a fully faulty agent ($p = 1$) corresponds to the average over all initial values. These are $n = 1000$ random numbers between 1 and 100 providing the observed value of approximately 50. Interestingly, the profiles of the performance of the ranked faulty agents for fixed error probability look almost the same as the one for perfect agents (Figure 1). However, the performance profiles are shifted downwards with increasing error probability using the same distribution of numbers on the ring. Although the profiles are similar for different error probabilities, the best agents in Figure 3 have in general different heuristics due to the change of the ranking. The same also holds for the worst agent.

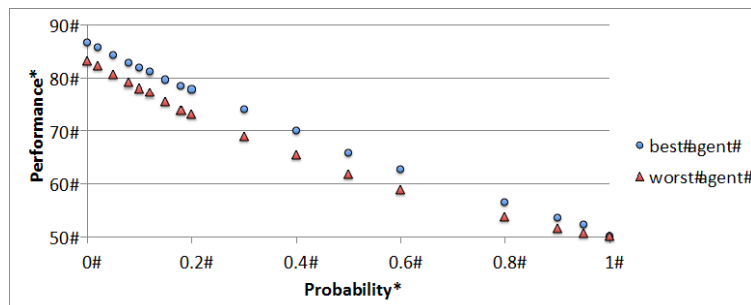

Figure 3. Performance of the best and the worst agent for $n = 1000$, $l = 12$, $k = 3$ with increasing error probability

Results

We have compared the performance of the group of the best 10 agents to the group of 10 randomly selected agents in the presence of errors. All agents were trained on the same distribution of random number on the ring. The agents were sorted due to their performance. From the sorted list the 10 best agents were singled out to form the best 10 agents group (Figure 4) and 10 agents were randomly selected constituting the randomly selected group. These groups then had to find the maximum of 50 new exercise problems (50 runs). The group performance was averaged over the 50 problems.

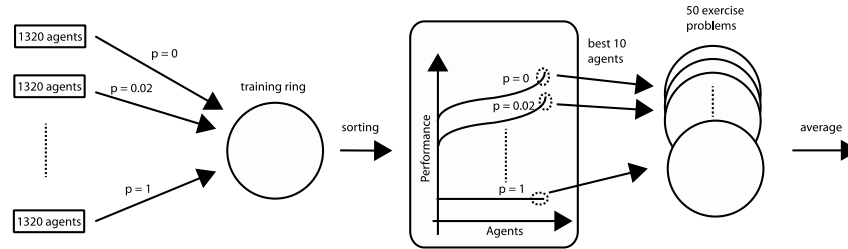

Figure 4. Procedure to determine the group performance of the best 10 agents group. For a fixed error probability p the agents were trained on a single ring and then sorted due to their performance. The best 10 agents were selected to form a group and the group performance on 50 new problems was determined. The average of this performance is presented in Figure 5. With the exception of the selection process the same procedure also holds for the randomly selected group.

The results of the simulations are presented in Figure 5. The data points are the average of 50 different distributions of numbers on the ring (50 runs). For low values of the error probability the group performance of randomly selected agents stays constantly high whereas the performance of the group of the best 10 agents increases until it reaches the level of the randomly selected group. For large error probabilities the performance of the two groups cannot be distinguished anymore and decreases down to the expected value of 50 for $p = 1$.

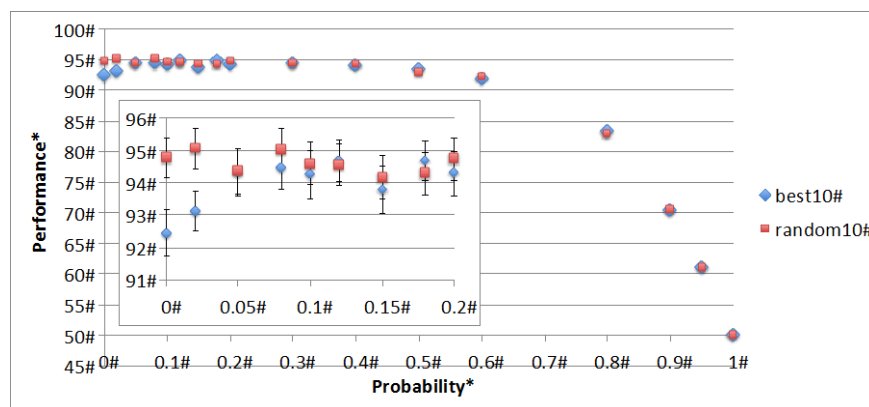

Figure 5. Comparison of group performance between the group of the best 10 (diamonds) and the randomly selected group (squares) with increasing error probability p . The inset zooms in to show the results at low error probability ($0 \leq p \leq 0.2$). The error bar refers to the standard deviation obtained from 50 different runs.

Interestingly, although the performance of single agents decreases rapidly with increasing error probability (see Figure 3) the group performance increases with increasing error probability (up to p approximately 0.4) (Figure 5).

In order to understand this counter intuitive increase of group performance of the best 10 agents group we investigated the diversity of the group. Indeed the introduction of errors changed the performance of single agents and thus its position in the ranking. Therefore the groups of the best 10 agents have different compositions for different error probabilities. This leads to a different diversity depending on the error probability (see Figure 6).

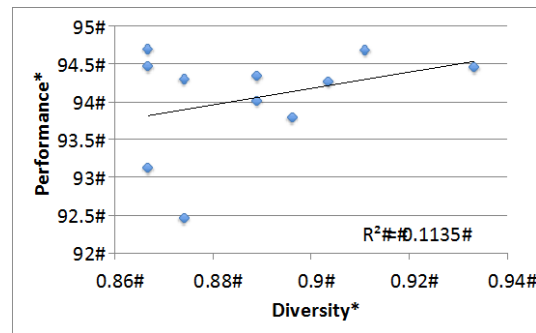

Figure 6. Group performance versus group diversity (same data as in Figure 5). The line represents a linear fit to the data (correlation coefficient $r = 0.33$).

The diversity of groups explains only about 11% of the performance increase of faulty agents as shown in Figure 6. Therefore we were looking for a parameter, which better explains the increase of group performance. Since the faulty agent ignores from time to time a possible new maximum the erroneous agent explores a larger solution space compared to the perfect agent.

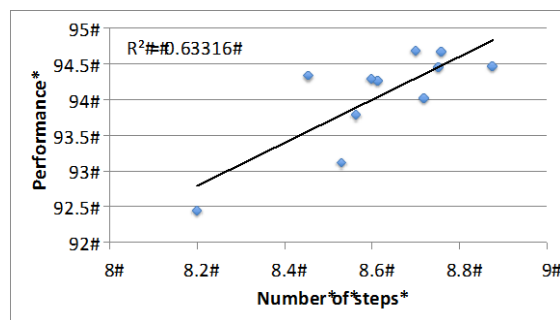

Figure 7. Group performance versus number of steps (same data as in Figure 5). The line represents a linear fit to the data (correlation coefficient $r = 0.79$).

Therefore we investigated the number of steps the agents take until they reach their maximum (length of the trajectory). As presented in Figure 7 the number of steps explains almost 65% of the performance increase of faulty agents. Thus we conclude that the increase of erroneous agents of group performance has two contributions. A small contribution originates from the small increase of the diversity, and a larger contribution from the exploration of a larger solution space.

Conclusion

We have used an agent-based model to study group work performance. The problems the agents had to work on where to find a maximum on a ring of 1000 point, where each point carries a random number between 1 and 100. Our simulations are based on a model proposed by Hong and Page (8), where each agent uses its own heuristics to find the maximum. We changed the model insofar as the agents are not perfect anymore. While going along the ring, a new maximum is only identified with probability $1-p$. Interestingly, the introduction of errors leads first to a reduction of the individual performance of all single agents however, when the best 10 faulty agents work as a group the group performance is higher than that of the best perfect agents. With increasing error probability the group of the best 10 agents approaches the performance of the group of randomly selected agents. At high error probability the performance of both groups is similar and reduces in parallel. The initial increase of the best 10 agents can be divided in two contributions. First, the diversity of the best 10 agents slightly increases and second, omitting an intermediate maximum leads to a larger exploration of the solution space. Thus, the probability to find an even higher maximum increases.

Since the performance of the best 10 students first increases with increasing error probability we can expand the conclusion of the Hong and Page paper, which was that diversity trumps ability to errors trumps perfectness.

In order to transfer the results to the classroom we would have to study the performance of groups, which consist of agents with different error probabilities. However, this is work in progress and will be presented elsewhere.

References

- [1] Gilley B. H., Clarkstone B.: (2014) Collaborative Testing: Evidence of Learning in a Controlled In-Class Study of Undergraduate Students. *Journal of College Science Teaching* 43(83 - 91).
- [2] Rieger G. W., Heiner C. E.: (2014) Examinations That Support Collaborative Learning: The Student's Perspective. *Journal of College Science Teaching* 43(41 - 47).
- [3] Leight H., Saunders C., Calkins R., Withers M.: (2012) Collaborative Testing Improves Performance but Not Content Retention in a Large-Enrollment Introductory Biology Class. *CBE-Life Sciences Education* 11:392 - 401.
- [4] Liker A., Bokony V.: (2009) Larger groups are more successful in innovative problem solving in house sparrows. *P Natl Acad Sci USA* 106(19):7893-7898.
- [5] Ward A. J. W., Herbert-Read J. E., Sumpter D. J. T., Krause J.: (2011) Fast and accurate decisions through collective vigilance in fish shoals (vol 108, pg 2312, 2011). *P Natl Acad Sci USA* 108(8):E27-E27.
- [6] Hong L., Page S. E.: (2001) Problem solving by heterogeneous agents. *J Econ Theory* 97(1):123-163.
- [7] Deadman P. J.: (1999) Modelling individual behaviour and group performance in an intelligent agent-based simulation of the tragedy of the commons. *J Environ Manage* 56(3):159-172.

- [8] Hong L., Page S. E.: (2004) Groups of diverse problem solvers can outperform groups of high-ability problem solvers. *Proceedings of the National Academy of Sciences* 101(46):16385 - 16389.

Optics Achievement Test for Research of Learning Styles in Physics

Blanka Zajacova

Charles University in Prague, Faculty of Mathematics and Physics, Czech Republic

Abstract

Nowadays learning styles are discussed especially in pedagogy or in didactics of arts. We suppose that also for physics education it would be beneficial to find out if there is some learning style preferable. For this purpose we pursue a research that will compare learning styles and strategies of students with excellent and below-average results in physics. In this contribution we present our conceptual test in optics that will be used as a part of this research. This tool was designed to assess student's understanding and interpreting of basic principles of geometric and wave optics. The test items are based on existing international conceptual tests in optics [1,2,3]. The content validity of the test and items representing the actual high school curriculum were emphasized. We also present results (item analysis, time extent of the test etc.) of a pilot study that included several tens of students from the Czech Republic.

Keywords: conceptual test, geometric optics, wave optics, secondary level education

Introduction

This paper presents the Optics Conceptual Test (OCT) and results of its preliminary pilot study. The final version of OCT will be used in a larger research project concerning learning styles in physics education, scheduled for 2014. This research is intended to help both teachers and students to recognize and respect students' learning style with benefits of higher effectiveness of teaching/learning and higher students' motivation in physics. A detailed description of the whole project is available for example in [4] or in [5].

One can find several different approaches to learning styles [6,7,8]. Many authors from psychology and also pedagogy have dealt with this topic and have developed many different definitions, interpretations and models related to this topic.

We focus especially on the terms "learning style" and "cognitive style" which are important for our own research. The two mentioned terms are really close to each other and according to Curry [6], Dunn, Dunn and Price [7] and also Mareš [8] we accept the idea that the concept of the learning style is wider and that it exceeds cognition. We understand the cognitive style as a mostly inborn and only hardly suggestible part of the learning style.

For the purpose of our research the learning style is read as a characteristic that has a number of components and is defined according to Keefe as: "the composite of characteristic cognitive, affective and physiological factors that serve as relatively stable indicators of how a learner perceives, interacts with, and responds to the learning environment"[9].

Measuring the characteristics of learning styles and learning styles diagnostics is a sophisticated process because of the complexity of this problematic (many variables that

are hardly controlled). Both qualitative and quantitative methods including observation, interview and questionnaires are used by psychologists in the learning styles research.

In our research we choose to diagnose learning styles by a learning styles questionnaire. We consider it advantageous because of the complex nature of obtained data and because there is a variety of questionnaires the validity and reliability of which was tested and studied thoroughly.

Next to a learning style questionnaire, two other tools will be administered to the participants of our research: 1. Epistemological Beliefs Assessment for Physical Science (EBAPS) that is thoroughly commented on in [10] and 2. Optics Conceptual Test developed originally for this research. The latter test and its preliminary pilot study are the main topic of this paper. The OCT was designed to test students' understanding to and interpreting of basic principles of geometric and wave optics and general characteristics of light. The main goal of the whole project is to obtain a detailed description of the learning styles used among Czech high school students in physics - optics.

Afterwards we will also compare learning styles and strategies of students with excellent and below-average results in optics. Expected diversity in students' approaches will be presented to the wide expert public and recommendations for teachers and students will be formulated. It will allow teachers to choose appropriate methodical tools to provide a good physics learning environment to different types of students.

Why have we decided to concern ourselves with optics? Czech students are taught optics in the age of 17-19 years when they probably have their own preferred learning strategies. Another reason is that this part of physics has not been explored in terms of learning styles yet (in contrast to mechanics [11]).

Particularly, when doing the preliminary pilot study we followed these goals:

- to verify comprehensibility of the Czech translation;
- to determine/ modify time extent and length of the test;
- to identify questions that are problematic in terms of test reliability;
- to access/adjust the appropriate difficulty of test items for Czech high school students.

About the Test

The OCT is aimed at high-school and college students after their optics lessons.

This test is partly based on existing conceptual test in optics [1,2,3]. We chose items with respect to the actual high school curriculum in the Czech Republic and moreover added our own 6 original items.

Thematic structure of the test is illustrated by Figure 1.

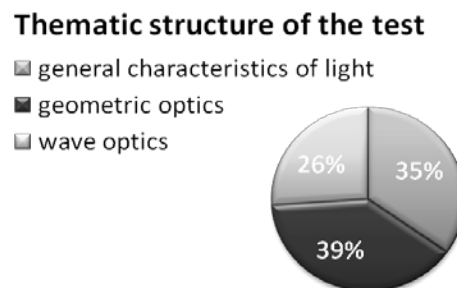

Figure 1. Thematic structure of the OCT.

The OCT consists of 31 items of 2 types:

- Multiple choice questions which are answered by choosing the best fitting option from 3 to 5 distracters;
- True/false questions.

Actual test items (both adopted from [3]) are illustrated by Figure 2 and Figure 3.

Task 9. Is the statement True or False? Shadow formation is the evidence that light travels in straight lines.

Figure 2. An example of true/false OCT item.

Task 12. The teacher and a student are sitting in front of a plane mirror as shown in the figure. A burning candle is placed outside of the front region of the mirror.

Do the teacher and student see the image of the candle formed by the plane mirror?

	Teacher	Student
a)	Sees the full image of the candle	Sees the full image of the candle.
b)	Does not see any image at all.	Does not see any image at all.
c)	Sees the full image of the candle	Does not see any image at all.
d)	Does not see any image at all.	Sees the full image of the candle.
e)	Sees the full image of the candle.	Sees only the flame part of the image.

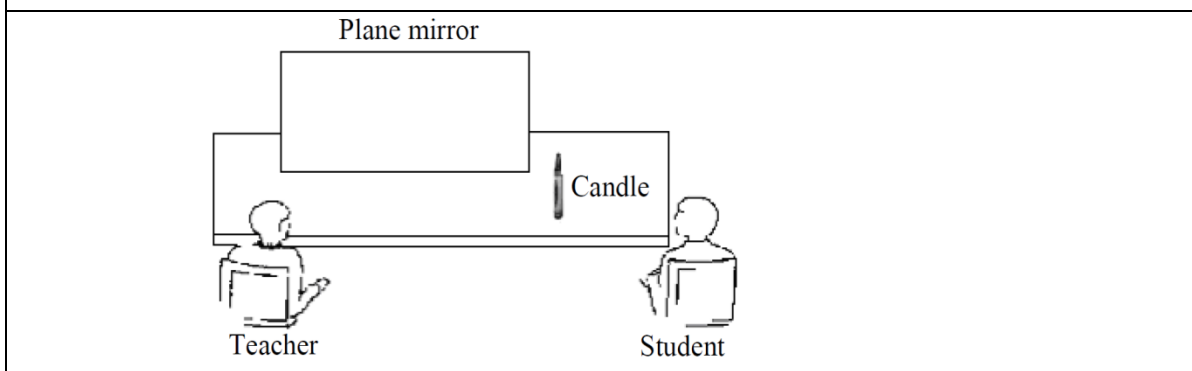

Figure 3. An example of multiple choice OCT item.

All true/false items were adapted from [3] although we are aware that their capability to provide information on students understanding of optics concepts is limited. Nevertheless we believe that carefully constructed questions such as Task 9 (Figure 2) can provide some information even in the true/false form.

Scoring of the test: Each item choice of the OCT is binary scored with 0 for wrong answers and 1 for correct answers.

Pilot Study Sample and Schedule

The data for our research were collected during May and June 2013. The participants of this study were 62 high school students from 2 high schools in Prague, Czech Republic. The students were from 17 to 19 years old and they all have their optics lessons finished not earlier than one month before the administration of OCT. The test was administered in paper&pencil form.

Goals of Quantitative Data Processing

The goals of quantitative data processing were inspired by TIMSS 1999 Technical Report [12] and they cover:

- time needed to complete the test,
- omitted items,
- consistency of results.

For statistical processing the program Statistica by Statsoft, Inc. Company was used. Primarily, we carried out descriptive statistics, item analysis and correlational analysis.

Results and Findings

Time needed to complete the test is 35 minutes or less for 90% of high school students.

Comprehensibility of the Czech translation

Before administering the test it was reviewed by 2 experienced physics teachers and 1 optics researcher. They suggested some terminology adjustments so that the test assignment was in accord with terms taught in Czech physics lessons.

To verify the comprehensibility of the Czech translation students were asked to mark tasks they did not understand with the quotation mark “?”. After completing the test individual questions and tasks were discussed with students. Students could suggest reformulations of the tasks and they could comment ambiguity of the tasks. Only one “?” was filled in the test (task no. 13) and based on discussion with students 2 tasks were rephrased.

A. Item analysis

We counted the relative frequency of particular answers for each task and we scored these answers binary. On the basis of these scores we evaluated the difficulty of each task.

Task difficulty

We evaluated task difficulty as the relative frequency of participants who did not answer the task correctly or did not answer it at all. The task difficulty was evaluated as a percentage Q :

$$Q = (1 - P) \times 100 \%, \quad (1)$$

where P stays for students who solved the task correctly. According to the tasks difficulty we mark two groups of tasks:

- very easy tasks: with difficulty < 20%,
- difficult tasks: with difficulty > 80%.

Task difficulty for all the test items is summed in the Table 1.

Table 1. Task difficulty

Task no.	1	2	3	4	5	6	7	8	9	10	11
Difficulty	16%	10%	10%	2%	32%	3%	5%	90%	15%	11%	16%
Task no.	12	13	14	15	16	17	18	19	20	21	22
Difficulty	63%	27%	63%	58%	31%	48%	48%	53%	27%	16%	31%
Task no.	23	24	25	26	27	28	29	30	31		
Difficulty	63%	34%	26%	60%	76%	69%	45%	56%	61%		

As it is obvious from the Table 1, tasks no. 1-4, 6-7, 9-11 and 21 (gray marked) were very easy for students. Most of these questions concern with general characteristics of light such as travelling of light, character of light etc.

Task no. 8 (marked in black) was difficult for respondents of our pilot study, only 10% students answered it correctly. This could be caused by students' unfamiliarity with optics terminology because this question concerns with light travelling in transparent materials.

Task omission means the ratio of participants who gave unclear or no answer to some test question, this ratio was below 3.5% for each task.

Not used and rarely used distracters

The distribution of answers was evaluated for all tasks of the test as it is illustrated by Figure 4.

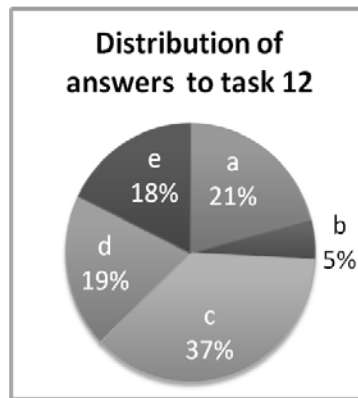

Figure 4. Distribution of answers

Distracters 11-c), 15-a) and 30-b) were not used by students at all.

Distracters 12-b), 16-a), 26-b), 28-d) and 31-c) were rarely used – by less than 5% of respondents of the pilot study. These distracters will be rephrased to a more attractive form or left out.

Test reliability was counted by Kuder-Richardson formula 20 (KR20):

$$KR_{20} = \frac{k}{k-1} \left[1 - \frac{\sum_{i=1}^k p_i(1-p_i)}{\sigma^2} \right] \quad (2)$$

where k is number of test items, p_i is relative frequency of correct answers to i -th task and σ is the variance of scores of all respondents.

Test reliability is $KR_{20} = 0.6630$.

If all of the very easy items as well as the very difficult items were eliminated then KR_{20} would yield 0.604.

B. Correlation analysis

We used correlation analysis to find out some relations between test items because we wanted to get an idea how the tool works. This data processing was made with Statistica by Statsoft, Inc. Company.

The test contains items which belong to one of three thematic areas (General characteristics of light, Geometric optics and Wave optics). When the given area would clearly measure the “same kind of optics knowledge”, we would expect high correlation between items belonging to this thematic area. Correlational analysis for questions belonging to Geometric optics area is shown in Table 2.

Table 2. Correlation coefficients between geometric optics items

Task	11	12	13	14	15	16	17	18	19
11	-	0.16	-0.1	0.16	0.4	0.18	0.19	0.1	-0
12	0.16	-	0.02	0.03	0.2	0	0.01	0.08	-0.2
13	-0.1	0.02	-	-0.1	0	-0.2	-0	-0.1	0.07
14	0.16	0.03	-0.1	-	0.3	0	0.21	0.28	0.28
15	0.37	0.16	0.01	0.29	-	0.07	0.04	0.04	0.05
16	0.18	0	-0.2	0	0.1	-	0.2	0.06	-0.2
17	0.19	0.01	-0	0.21	0	0.2	-	0.03	0
18	0.1	0.08	-0.1	0.28	0	0.06	0.03	-	0.45
19	-0	-0.2	0.07	0.28	0.1	-0.2	0	0.45	-

As we can see from the Table 2 the correlation coefficients are quite low, usually in the range of very slight correlation below the value 0.2. The results also identify that task no. 13 makes the worst contribution to the group of geometrical optics tasks. As it is obvious from the Table 3. KR20 would increase when it is omitted. We consider rephrasing this test item.

Correlation between test item and the total score is illustrated in Table 3.

Tasks marked in **white** do not correlate with total score (correlation between -0.2 and 0.2). Tasks marked in **bold italics** correlate the most with the total score. The coefficient is above 0.4. KR20 would increase if a **bold** marked item was not in the test.

Table 3. Correlation between test item and the total score.

	Correlation of item vs. total score	KR20 if item deleted
Task 1	0.31	0.6544
Task 2	0.07	0.6679
Task 3	-0.11	0.6777
Task 4	0.27	0.6586
Task 5	0.25	0.6612
Task 6	0.25	0.6582
Task 7	0.23	0.6585
Task 8	0.18	0.6616
Task 9	0.3	0.6544
Task 10	0.26	0.6568
Task 11	0.49	0.6404
Task 12	0.23	0.6639
Task 13	0.12	0.6722
Task 14	0.43	0.6443
Task 15	0.41	0.6462
Task 16	0.36	0.6508
Task 17	0.35	0.653
Task 18	0.45	0.6414
Task 19	0.22	0.6663
Task 20	0.48	0.6393
Task 21	0.41	0.6467
Task 22	0.41	0.6455
Task 23	0.14	0.6727
Task 24	0.4	0.647
Task 25	0.41	0.6461
Task 26	0.44	0.6429
Task 27	0.3	0.6561
Task 28	0.38	0.649
Task 29	0.33	0.6542
Task 30	0.26	0.6622
Task 31	0.2	0.667

For better analysis, factor analysis would be a more appropriate method. During further study we expect to collect data from much larger sample of students and that it is why we will carry out the analysis for the data.

Conclusions

Test length and time needed to complete the test is appropriate for intended age level.

The comprehensibility of the Czech translation of the OCT was checked and 2 tasks will be rephrased according to the conclusions from the discussions with students.

Several True/False tasks were very easy for the students so they did not contribute to discrimination between good and weak students. These items deal with general characteristics of light (propagation of light, sources of light and wave-particle duality). Students probably have a clear idea of these topics which was also acknowledged by experienced teachers so we consider omitting these items.

Based on correlation analysis reliability-lowering tasks were identified. Rephrasing of these items is considered.

Item analysis detected rarely used distracters that will be rephrased to a more attractive form or left out.

Acknowledgement

The author acknowledges the support of the Grant Agency of the Charles University – project no. 1124513.

References

- [1] Bardar E. M.: First Results from the Light and Spectroscopy Concept Inventory. *Astronomy education review*. 6 Issue 2 (Aug 2007 - Mar 2008). pp. 75-84.
- [2] Cox A. J., Junkin W. F. III.: Enhanced student learning in the introductory physics laboratory. *Physics education* 37. No. 1 (2002). p. 37.
- [3] Taslidere E., Eryilmaz A.: The Relative Effectiveness of Integrated Reading Study Strategy and Conceptual Physics Approach. *Research in Science Education* 42. Issue 2 (April 2012). pp. 181-199.
- [4] Zajacová B.: Learning Styles in Physics Education: Introduction of Our Research Tools and Design. Contribution within INTE conference (June 2013). Rome.
- [5] Zajacová B.: Learning Styles: An Overview of Concepts and Research Tools and Introduction of Our Research Design in Physics Education Field. Contribution within WDS conference. (June 2013). Prague.
- [6] Curry L.: An Organization of Learning Styles Theory and Constructs, ERIC document no. ED 235185, (1983).
- [7] Dunn R., Dunn K., Price G. E.: *Learning Styles Inventory*. Lawrence, KS: Price Systems, (1989).
- [8] Mareš J.: *Styly učení žáků a studentů*, Portál Praha, (1998). ISBN 80-7178-246-7.

- [9] Keefe J. W.: Assessing student learning styles. In J. W. Keefe (Ed.) Student learning styles and brain behaviour. Reston, VA: National Association of Secondary School Principals, (1982).
- [10] Kekule M., Zajacová B.: Students' Epistemological Beliefs – adapting the EBAPS instrument in the Czech Republic. Contribution within ICPE-EPEC conference. (August 2013). Prague.
- [11] Booth K. M., James B. W.: Interactive learning in a higher education Level 1 mechanics module. *International Journal of Science Education* 23. Issue 9 (July 2001). pp. 955-967.
- [12] Martin M. O., Gregory K. D., Stemler S. E. (eds.): TIMSS 1999 Technical Report. International Study Center. Lynch School of Education. Boston College. IEA. (2000). ISBN 1-889938-17-3.

Posters

mixed papers

A Cell Phone Operated Robot

Syed Rehan Ali¹, Syed Naseem Hussain Shah²

¹Department of Basic Sciences, Aligarh Institute of Technology, Karachi, Pakistan

²Department of Physics, Federal Urdu University of Arts, Science and Technology, Karachi, Pakistan

Abstract

In Technical Institutes, applied physics is introduced for understanding the concepts of physics. Since the students have very little knowledge of basic concepts of electronics, we assign them small projects to enhance their learning. The themes of the projects are selected according to their social environment and needs. Cell Phone Robots are the major research area of today and they are significant due to their frequency and working range. As in conventional RF system we have a control upto some limit however, in this case the control is very large depending upon the range of the service provider. Nowadays Cell phones are largely used by public and students and its awareness has revolutionized the whole world. Keeping in view the use of cell phone, we have introduced some projects based on the use of cell phones. One of these projects is "Cell Phone Operated Robot (CPOR)".

Keywords: physics learning, cell phone operated robot, service provider

Introduction

In Our Institute we have four technologies i.e. Electronics Technology, Electrical Technology, Computer Information Technology and Biomedical Technology. The students of each technology have Physics as their compulsory subject. This particular work is performed by the students of Electronics Technology in which we assigned them a project of physics based on electronics. The major idea is to relate the Physics with their own technology so that the interest of students remains there.

In Cell Phone Operated Robot (CPOR), the cell phone is used to get the control of a robot by just making a call to the mobile phone stacked in the robot. This project used dual tone multiple frequency (DTMF), where by pressing any button in the course of a call, a tone is heard at the other end of the call corresponding to that button[1]. The robot perceives this particular tone with the help of cell phone that attached to the robot. With the help of DTMF decoder IC CM8870 the tone received is processed through the μ controller atmega16 and finally the output from the μ controller is reached to motor driver IC L293D which is responsible to drive the two corresponding DC motors.

The Cell Phone Operated Robot is a project-based learning for the students to create project problem, to do the team work, to find availability of resources, to present their finding and to evaluate their own result. This learning method has got positive influence on the thinking of students during teaching session. This learning method takes a considerably length of time and there is a presence of variety of educational activities[2].

The aims of the project

Following are the main aims of the project:

1. To explore different uses of cell phones.

2. Involve the students into research based activity
3. To overcome the limitations of working range, frequency and control.

Block Diagram

Figure 1 shows the simple block diagram of the system in which a hand held cell phone is used as the transmitter and a cell phone attached to the robot with auto answer mode serves as receiver.

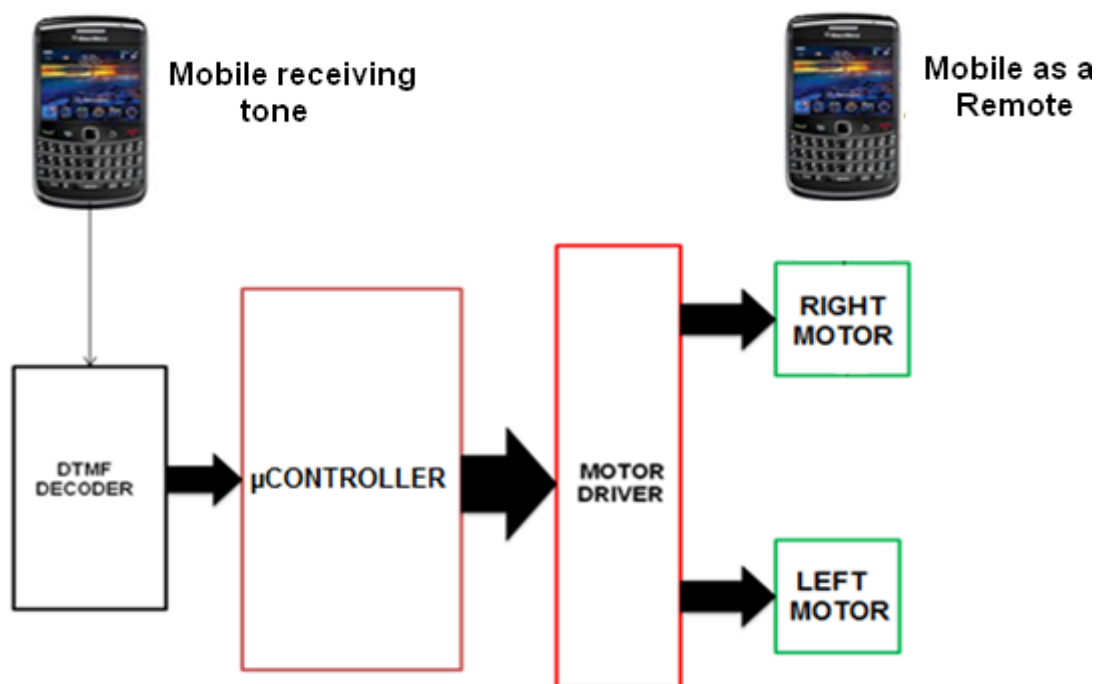

Figure 1. Block diagram

Circuit Description

In our project we used a CM8870 series DTMF decoder which works on the technique of digital counting for the detection and decoding of 16 DTMF tone pairs into an output of 4-bit code. To avoid pre-filtering there is a built-in dial tone rejection circuit. As the input signals are applied at pins 1(IN+) & 2(IN-), a differential configuration is known to be effective and an accurate 4-bit decode signal of the DTMF tone is moved to the outputs at (pin11) through (pin14). These pins (pin11 to pin14) of DTMF decoder are connected to the pins (P1.4 to P1.7) of the μ controller[3].

The atmega16 is a high performance 8-bit μ controller, it is a 40 pin μ controller which has 16 kB programmable flash memory. It has 32 I/O lines divided into four 8-bit I/O ports [4]. Outputs from port pins P0.0 through P0.3 and P0.7 of the μ -controller are connected to the IN1 through IN4 of inputs which in turn enable motor driver IC pins EN1 and EN2 to get the control of the two DC motors.

A manual reset is provided by Switch S1. Since, the output comes from the μ controller has low current therefore, requirement of current drivers are essential for proper rotation of the two motors. The L293D (quad, high-current, half-h driver) used for this purpose is designed for bidirectional drive currents 600 mA (maximum) at voltages ranging from 4.5 V to 36 V[5]. The L293D makes it convenient for the DC motors to drive. It has four

drivers in which IN1 through IN4 are the input pins of driver 1 to driver 4 and OUT1 to OUT4 represents output pins of the same. Drivers 1 and 2 are enabled by pin 1 (EN1) and driver 3 and 4 are enabled by pin 9 (EN2). Drivers 1 and 2 are enabled when input EN1 is high, and the outputs corresponding to their inputs are active. In the same manner, drivers 3 and 4 are enabled when EN2 (pin9) is high [6]. The rotation of the motors depends upon the status of IN1 to IN4 pins of motor driver IC which in turn rely on the output pins (P0.0 - P0.3) of μ controller.

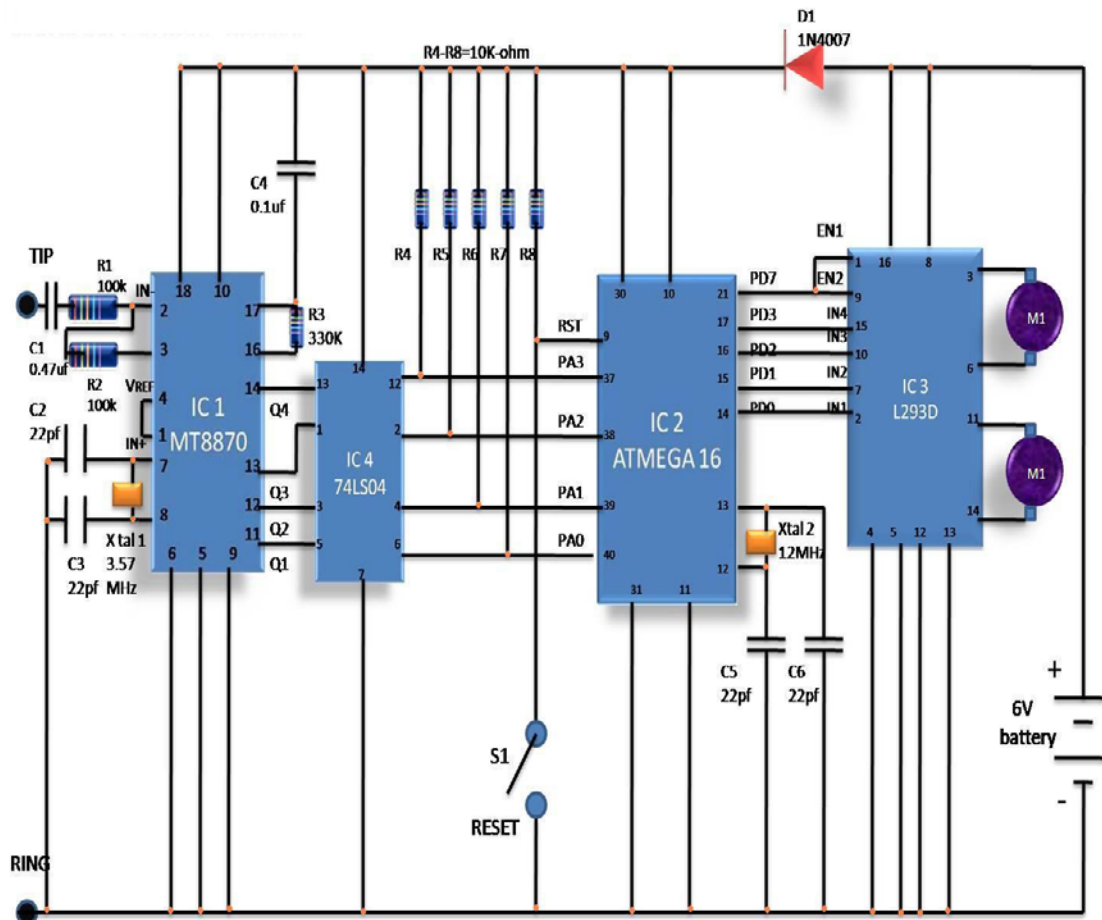

Figure 2. Circuit Diagram

Working

To control the robot by a cell phone we have to make a call to the cell phone stacked into the robot. On pressing the numeric buttons of the cell phone DTMF tones will be send. It is necessary that the cell phone at the robot end should be in 'auto answer' mode or otherwise we have to press 'OK' button to receive the call on the cell attached with the robot and then made it in hands-free mode. To perform differant functions of the robot we may press any button from our mobile phone as listed in Table 1 [7]. The cell phone in the robot received these DTMF tones. The receiving DTMF tones are transferred to the circuit with the help of cell phone's headset. The DTMF decoder IC (MT8870) decodes these tones and send it to μ controller by generating a binary equivalent number. The robot start different motions depending upon the programming of the μ controller. By pressing '2' of the keypad of cell phone (binary equivalent 00000010) at the transmitting end, the μ controller generates an outputs '10001001'. It shows that Port pins PD0, PD3 and PD7 are high. The motor driver IC will be driven by the high output of the μ controller pin PD7.

However, the two motors M1 and M2 will move in forward direction by the Port pins PD0 and PD3 (as per Table 1). Similarly, to move the motors left, right, backward or to stop them.

Table 1. Detailed Data of Every Step

Digit Pressed	O/p of MT8870 DTMFdecoder	I/p to the μ controller	O/p from the μ controller	Action performed
2	0x02 00000010	0xFD 11111101	0x09 11111001	Move Forward
4	0x04 00000100	0xFB 11111011	0x05 00000101	Left Turn Right Motor forwarded Left Motor backwarded
6	0x06 00000110	0xF9 11111001	0x0A 00001010	Right Turn Right Motor backwarded Left Motor forwarded
8	0x08 00001000	0xF7 11110111	0x06 00000110	Move Backward
5	0x05 00000101	0xFA 11111010	0x00 00000000	Brake Applied

Approach Applied

We divide the students into the groups of five students per project. One of the best among the 5 students is selected as the group leader to maintain the discipline and standard. This group is supervised by a teacher who looks after day to day matters about the project and helps the students in every aspect. Finally these students exhibit their projects and show their capabilities in front of the representatives of relevant industries and the judges of their projects. A pre and post test is conducted to evaluate their performance in which 100 questions have been asked out of which 50% from the Physics and 50% from the Basic Electronics.

Bifurcated & Consolidated Pre and Post Test Results

The Table 2 is representing the evaluated pre and post test result of the students which shows their performance in physics and electronics. However, table 3 shows a consolidated pre and post test performance of the same students. This is a groupwise performance and each group consists of 5 students.

Table 2. Pre & Post Test Bifurcated Results|

Groups	Pre Test Result		Post Test Result		Gain	
	Physics	Electronics	Physics	Electronics	Physics	Electronics
1	16	24	31	29	15	05
2	15	23	22	25	07	02
3	35	20	40	29	05	09
4	30	30	34	31	04	01
5	12	29	19	31	07	02
6	32	30	40	38	08	08
7	20	34	37	40	17	05
8	23	20	26	29	03	09
9	16	28	20	30	04	02
10	30	26	35	28	05	02
11	30	37	42	43	12	06
12	10	25	20	32	10	07
13	25	24	30	28	05	04
14	22	45	32	48	10	03
15	20	35	40	49	20	14
16	25	41	30	42	05	01
17	34	37	49	41	15	04
18	20	38	21	38	01	00
19	26	32	34	44	08	12
20	40	30	50	38	10	08

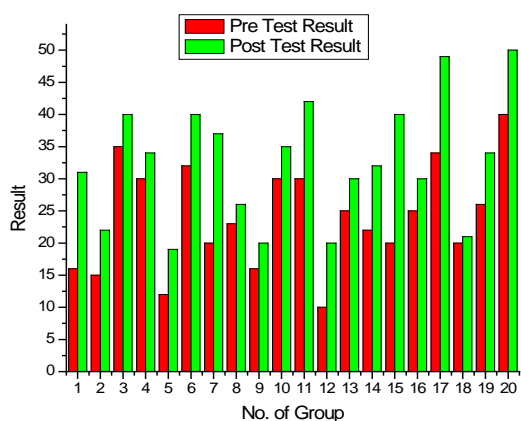

Graph 1. Pre and post Results of Physics

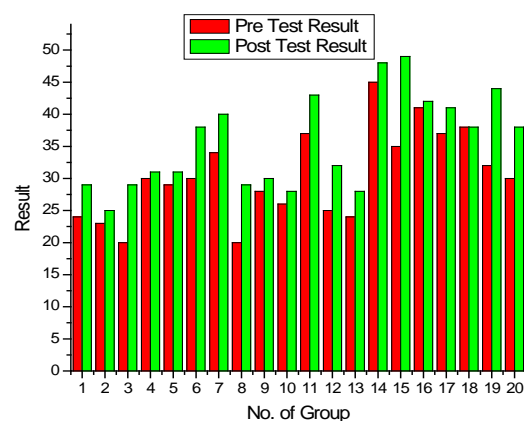

Graph 2. Pre and post Results of Electronics

Table 3. Pre & Post Test Consolidated Results

Groups	Pre Test Result	Post Test Result	Gain
1	40	60	20
2	38	47	09
3	55	69	14
4	60	65	05
5	41	50	09
6	62	78	16
7	54	77	23
8	43	49	06
9	44	50	06
10	56	63	07
11	67	85	18
12	35	52	17
13	49	58	09
14	67	80	13
15	50	84	34
16	66	72	06
17	71	90	19
18	68	69	01
19	58	78	20
20	70	88	18

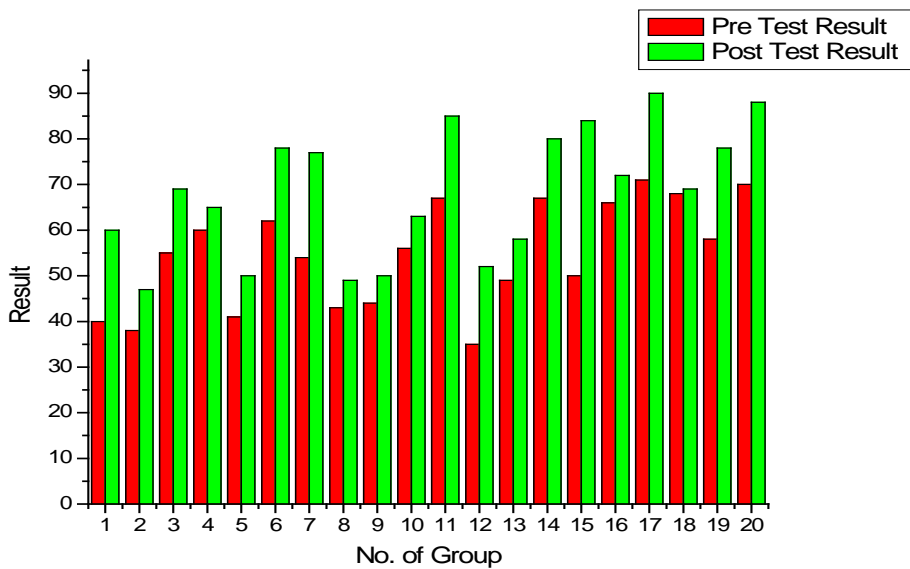

Graph 3. Consolidated Pre and Post Test Results

Conclusions

It has been observed that students learned a wide range of knowledge, for example; from the use of breadboard to the Printed Circuit Board (PCB), from tracing of circuit to the trouble shooting, from reading the values of resistors to the pin configuration of the ICs, and from hardware to software. Moreover, the post test results reflects that the students are learning in this atmosphere. The applications of such robots are very useful in our social context, especially in remote areas where the service provider exists. We can use these types of robots in these areas by placing some sensors like temperature sensor, water level sensor etc. in them to monitor these quantities without reaching there. We can also fix a camera to them to record videos and images of such places where we cannot go or where we have security problems.

References

- [1] Schenker L.: "Pushbutton Calling with a Two- Group Voice-Frequency Code", The Bell System Technical Journal, 39(1), 235–255, (1960).
- [2] Blumenfeld P. C., Soloway E., Marx R. W., Krajcik J. S., Guzdial M., Palincsar A.: Motivating project-based learning: sustaining the doing, supporting the learning. *Educ Psychol*, 26:369–398, (1991).
- [3] Edwin Wise: *Robotics Demystified* (Mc-Graw Hill, 2005).
- [4] Atmega16, 8- bit AVR μ controller with 16K Bytes In-System Programmer Flash, Atmel Corporation; <http://www.atmel.com/products/avr>
- [5] Motor driver IC-L293D, Datasheet-Atmel Corporation; <http://www.atmel.com/products/avr>
- [6] Subramanyam V.: *Electric Drives* (Mc-Graw Hill, 1996).
- [7] Nasar S. A., Boldea I.: *Electric Drives* (CRC/Taylor and Francis, 2006).

The use of smartphones in class to improve physics learning

David Méndez Coca

Centro universitario Villanueva, Spain (dmendez@villanueva.edu)

Abstract

It is difficult for physics professors to assess the students' learning every day. However, with internet and the smartphone it is possible to do it. Most of the students have a smartphone with internet. These technologies promote a motivation for the students and they are electronic devices which students use them many times, they do not need any previous training. The experiment was: the students answered with the smartphone some questions and the professor could assess the results immediately. By this way, the professor knew the learning of each student and could promote the cooperative learning joining students who have different answers. It took place with preservice elementary teachers. The contents were about mechanics and the learning was measured by a pretest and a posttest. The gain of learning was good.

Keywords: smartphones, cooperative learning, preservice elementary teachers, physics learning

Introduction

The students do not transmit their doubts neither answer the teachers' questions about doubts publicly, only a small percentage of students take part, therefore the teacher only controls the learning of these small group of students. In other moments, the teacher proposes a physics problem, gives time to think about the answer and, later, he asks one or several students about what they have thought or how they have solved it in order to assess the students' learning. Nevertheless, the teacher does not control the learning of the whole class both cases and this process takes an important part of the class' time.

These aims can be easier to achieve with the help of the new technologies. With it and the mobile devices it is possible to use it without training. Even, there are several studies which promote the use of technology to enhance the learning of the students (Méndez, 2012a, 2012b). Now, almost all the students use smartphones, the use of laptops is usual and the number of tablets is increasing. Portability makes mobile devices very useful for education because students can access them and stay connected to others the whole day (Melhuish & Falloon, 2010). The familiarity of the students with the electronic devices can be a great help in the field of education. In fact, the Smartphone is one of the devices that can change the process of instruction (Eisele-Dyrli, 2011). For instance, in United States, 98% of students between fourteen to eighteen years old own a cell phone and 70% own a laptop, tablet or netbook (Project Tomorrow, 2010).

These technologies motivate the student. Moreover, in United States, "93 percent of parents like the idea of an online textbook and 47 percent feel that online textbooks would be good investments for schools to make to improve student achievement" (Project Tomorrow, 2010: 25). For the teacher, the appearance of the new technologies in the classroom can be considered as an extra effort. However, these devices can produce a saving of time and an increase of efficiency in his profession. For example, there is no need to consume class time so as to teach students to use new instructional hardware and software (Kolb, 2011).

Today there are some web sites that facilitate these teacher's tasks, all the students can answer several questions very fast and the teacher knows the answers immediately. They are called smart student response systems. It is only necessary to use it a connection with internet and a device like laptop, tablet or smartphone. Teacher designs the activities or problems. Students simply log in with their devices and answer questions about the content. The test can be multiple choice and open questions. At the end of activity, the teacher can download the answers as a google spreadsheet or as an excel file (www.socrative.com; gosoapbox.com; www.polleverywhere.com/).

These pages have the following advantages: it is not necessary to use neither any software nor extra electronic device, only you need to use the usual resources: Internet and the Smartphone with connection to Internet. Therefore, it is easier to use and to introduce in the classroom than other devices like clickers.

These technologies can facilitate the cooperative learning, which it is promoted in science education by educational institutions (Eurydice, 2011). It is highly recommended for the education research (Méndez, 2013; Méndez & García Alonso, 2013). This kind of technologies can be useful to improve the efficiency of the cooperative learning, the teacher has students that they work at group but they have the same knowledge, nevertheless, with this technology the teacher can know what every student knows and do the groups to promote the dialogue, that is to say, the teacher can join people in the same group who have different answers.

Manuguerra & Petocz (2011) refer to mobile learning as the new concept which has followed e-learning. The use of it facilitate that the teacher knows the learning in real time, by this way he can know the doubts, it is possible to assess his own educational task and to compare the real learning with the foreseen.

On purpose, it is interesting for education to develop some instruments in order to enhance the learning, the steps can be the following with this technology:

1. The teacher can design easily some tests.
2. The students can answer just with the smartphone.
3. The teacher knows the results of this test at once.
4. The results of the test do not have to be public, they can only be known by the teacher.

Actually, it is necessary to focus in the role of the Smartphone in class. The advantages are the following (Attewell, 2005; Kolb, 2011; Duncan et al., 2012):

1. Mobile learning can be used to encourage both independent and collaborative learning experiences.
2. Mobile learning helps to remove some of the formality from the learning experience and engages reluctant learners.
3. Mobile learning helps learners to remain more focused for longer periods.
4. Mobile learning helps to raise self-esteem.
5. Mobile learning helps to combat resistance to the use of ICT and can help bridge the gap between mobile phone literacy and ICT literacy.
6. Cell phones can save money.
7. Students use them very good.
8. Cell phones are very flexible, students can use anytime, anywhere, from any source, at any pace.
9. Cell phones can empower students who are visually or hearing impaired.
10. Cell phones distract less than laptops.

About the power of mobile phone, it is said that “they are also particularly useful computers that fit in your pocket, are always with you, and are always on” (Prensky, 2004:3).

Methods

The physics professor taught 36 preservice elementary teachers some contents of mechanics, he used tutorials (McDermott & Shaffer, 1998; McDermott, Shaffer & Constantinou, 2000) and he did a pretest and a posttest, the test used was the FCI which is validated (Hestenes, Wells & Swackhammer, 1992). This test is very difficult for these students but the learning is going to be observed by the gain. These students had not studied any Physics subject for five years. The experiment took place in October 2012, it was eight 90 minute classes. The process was: the professor taught some concepts for 15 minutes. Secondly, the students answered individually with the smartphone, they had to access to www.socrative.com and answered the questions, there were usually four questions each day. The first question of all the socrative tests is the name. In this part of the class, it could take them ten minutes. Later, the professor downloaded the students' answers and he made the groups of three or four people who had different answers. Sometimes it was difficult to join four students who had different answers, nevertheless there was not a group which all the students answered the same. This process took approximately five minutes due to the fact that the answers downloaded in a spreadsheet and could be ordered according to the response. The students discussed their answers for twenty minutes in the group. After this process, the students answered again the socrative test and answered individually. Finally, the professor solved the test and the doubts of the difficult questions according to the results.

In order to illustrate the experiment, some of the questions used in the classroom were the following:

One train travels at 70 km/h and I run forward:

- A. Given the situation, I will have to make more effort than if the train is stopped.
- B. Given the situation, I will have to make same effort than if the train is stopped.
- C. Given the situation, I will have to make less effort than if the train is stopped.

Two equal cubes fall, one is made of aluminium and the second of lead, this one is heavier than the cube of aluminium. What will happen? There is no friction because of the air.

- A. The aluminium cube will arrive before to the ground.
- B. The lead cube will arrive before to the ground.
- C. Both cubes will arrive simultaneously.

Results

The general results were:

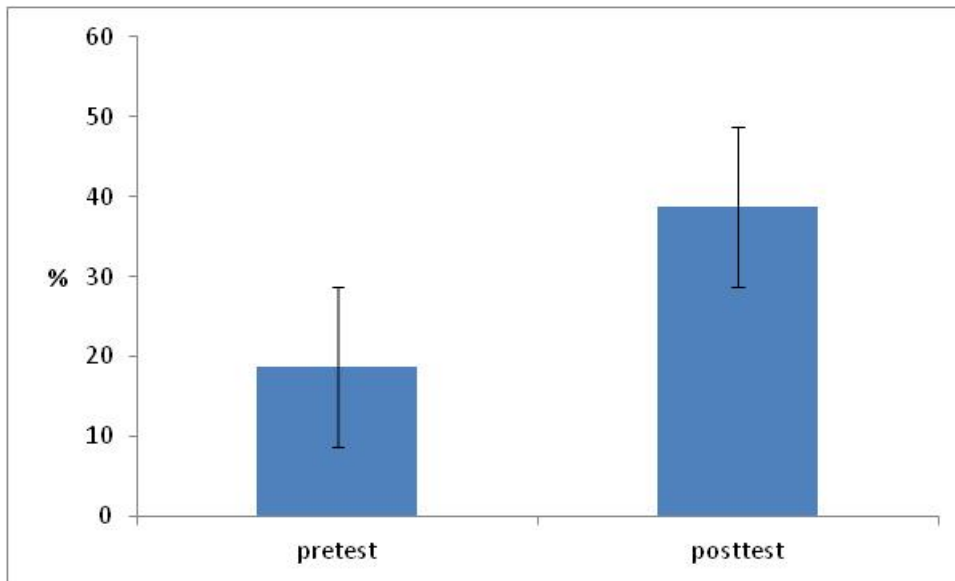

Figure 1. Results of the pretest and posttest

The results were not very high, as it is mentioned before the test is difficult for these students. If it is calculated the gaining according Hake (1998):

$$g = \frac{s_{post} - s_{pret}}{100 - s_{pret}}$$

Being g gain of learning, s_{post} the percentage of right answers in the posttest and s_{pret} the percentage of the right answers in the pretest.

In this case, it was 0.23 ± 0.16 . There was a positive effect. The learning of the students was satisfactory.

The gain of each student was:

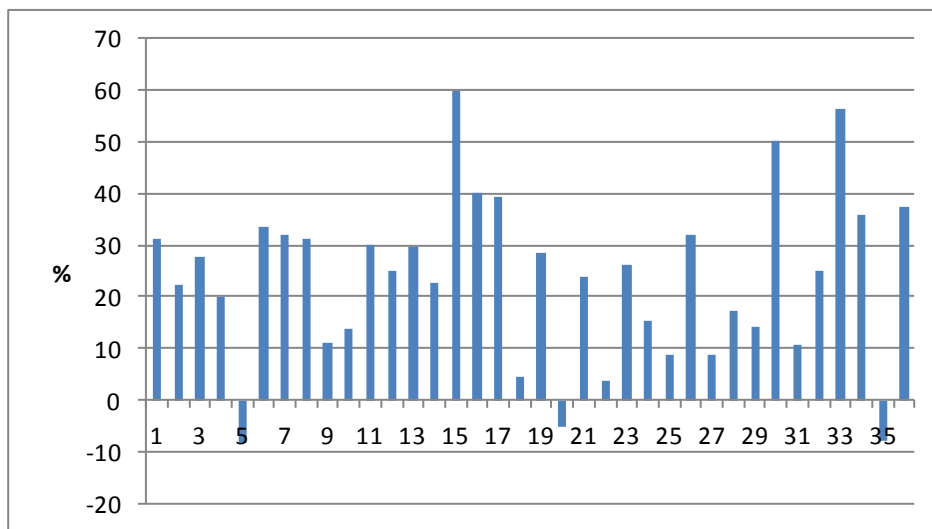

Figure 2. The gain of the 37 preservice elementary teachers

There were three students who had a negative gain but there were some students who had a very good gain too.

Discussion

Hake (1998) obtained data from mechanics tests administered 6500 students and he found that traditional classes have an average normalized gain equal to 0.23 in one semester, however interactive methods get an average gain of 0.48, even some exceed 0.70.

The gain of the cooperative learning in Physics with university students is from 0.49 to 0.82, in these cases the period of time between pretest and posttest is four months, nevertheless the traditional methodology achieves a gain from 0.23 to 0.26. When it is only an instruction for two months, the gain of cooperative learning is from 0.14 to 0.25 and the gain of traditional is 0.08 to 0.11 (Crouch & Mazur, 2001; Hänze & Berger, 2007; Desbien, 2002).

In this experiment, the gain was 0.23 in a month of class, therefore the gain was quite good because the period of time was very short. The result is the same as traditional methodology in four months. The gain in this experience has been the same as two months of cooperative learning.

Conclusions

The smartphone and internet are very useful to facilitate the learning and the motivation because the students enjoy with them, they are motivated and it enhances the learning. Another advantages are that it is very easy to use, the students do not need any previous training because they use every day, the professor can assess every class the learning of the students and these technologies can facilitate the cooperative learning. Therefore, these devices can modify some circumstances of the education, if the use is right it can promote the active learning and the motivation of the students.

In this experiment it is possible to observe the positive effect in the students' learning. The gain of learning is better than the usual gain of traditional methodology, even it is better than the gain of cooperative learning. However, it is not possible to assure that because we do not have control group. Therefore, it seems as if the technology has increased the positive effect of cooperative learning.

References

- Attewell J.: (2005). *Mobile Technologies and Learning: a technology update and m-learning project summary*. Learning and Skills Development Agency.
- Crouch C., Mazur E.: (2001) Peer instruction: ten years of experience and results. *American journal of physics*, 69 (9), 970-977.
- Desbien D.: (2002) *Modelling discourse management compared to other classroom management styles in university physics*. Dissertation presented for the requirements of the degree doctor of philosophy. Arizona State University. Available at: <http://modeling.la.asu.edu>. Accessed July 20, 2012.
- Duncan D.K., Hoekstra A.R., Wilcox B.R.: (2012) Digital devices, distraction, and student performance: Does in-class cell phone use reduce learning? *Astronomy education review*, 11, 010108-1, 10.3847.
- Eisele-Dyrli K.: (2011). Mobile Goes Mainstream. *District Administration*, 47(2), 46-55.

Eurydice: (2011). *Science Education in Europe: Common Challenges and National Policies*. EACEA: Brussels.

Hake R.: (1998). Interactive-engagement versus traditional methods: a six-thousand-student survey of mechanics test data for introductory physics courses, *American journal of physics*, 66 (1), 64-74.

Hänze M, Berger R.: (2007). Cooperative learning, motivational effects, and student characteristics: An experimental study comparing cooperative learning and direct instruction in 12th grade physics classes. *Learning and instruction*, 17, 29-41.

Hestenes D., Wells M., Swackhammer G.: (1992). Force Concept Inventory, *Phys. Teach.* 30 (3), 141–151.

Kolb L.: (2011). Adventures with cell phones. *Educational Leadership*, 68(5), 39-43.

Manuguerra M., Petocz P.: (2011) Promoting student engagement by integrating new technology into tertiary education: The role of the iPad. *Asian Social Science*, 7(11) 61-65.

McDermott L.C., Shaffer P.S.: (1998). *Tutorials in introductory physics*. Upper Saddle River, NJ.

McDermott L.C., Shaffer P.S., Constantinou C.P.: (2000) Preparing teachers to teach physics and physical science by inquiry. *Physics Education*, 35, 411–416.

Melhuish K., Falloon G.: (2010). Looking to the future: M-learning with the iPad. *Computers in New Zealand Schools: Learning, Leading, Technology*, 22(3), 1-16. Méndez, D. (2012) The experience of learning physics through the application of ICT. *Energy Education Science and Technology Part B. Social and Educational Studies*, 4(1): 674-679.

Méndez D.: (2012) Cambio motivacional realizado por las TIC en los alumnos de secundaria de Física, *Miscelánea de Comillas*, 70 (136) 199-224.

Méndez D.: (2013) The influence of teaching methodologies in the learning of thermodynamics in secondary education, *Journal of Baltic Science Education*, 12 (1), 59-72.

Méndez D., García-Alonso P.: (2013) Cambio comunicativo en las nuevas metodologías didácticas, *Estudios sobre el mensaje periodístico*, 19, núm. especial marzo, 299-308.

Prensky M.: (2004) What can you learn from a cell phone? Almost anything! Retrieved from <http://www.marcprensky.com/writing/>, accessed 13 October 2012.

Project Tomorrow.: (2010). Creating our future: Students speak up about their vision for 21st century learning. Retrieved from <http://www.tomorrow.org/speakup/pdfs/SU09NationalFindingsStudents&Parents.pdf>, accessed 13 October 2012.

<http://www.socrative.com/>

<http://gosoapbox.com/>

<http://www.polleverywhere.com/>

Teaching solar physics in a partnership between formal and informal education

Pedro Donizete Colombo Junior¹, Cibelle Celestino Silva¹

¹ Group of History, Theory and Didactics of Science of the University of São Paulo, São Carlos Institute of Physics, Brazil. pedro.colombo.jr@gmail.com; cibelle@ifsc.usp.br

Abstract

This research focuses on curriculum innovation and the introduction of modern physics in the Brazilian high school based on the partnership between formal and informal education. We established the construction and use of a Teaching Learning Sequence (TLS) that incorporates elements of the classroom with activities in a science center, taking into account the teaching knowledge and specificities of both institutions. The TLS elaborated are based into the idea of teaching with emphasis on the content, in this case on the teaching of modern physics using solar physics in different collaborative contexts. In a partnership between educators from science centers and school teachers, we investigated the process of didactic transposition of content from solar physics and modern physics in the context of formal and informal education. The science center concerned is the Dietrich Schiel Observatory in the University of Sao Paulo's Center for Scientific and Cultural Dissemination, Brazil. The methodology used in the construction and implementation of the TLS is entitled "cycles of reflection", understood as continuous research actions that provide, at every stage of investigation, didactic and pedagogical support for the teacher-researcher partnership.

Introduction

It is not rare to find little communication between schoolteachers and educators in science centers, which makes it difficult to incorporate what was experienced in these locations to what is taught in classrooms (Tran, 2007; Griffin, 2004). We need to find ways to make the relationship between school and science center more effective. Aiming at curriculum innovation, we developed a Teaching and Learning Sequence (TLS) (Méheut; Psillos, 2004) that incorporates elements of classroom teaching with activities in a science center, taking into account the teaching knowledge and the specifics of both institutions. Our goal was to train teachers to work in partnership with a science center and to teach topics of modern physics. We sought to understand the necessary conditions for a TLS, involving modern physics, so that it would resonate with the proposed curriculum and at the same time involve an informal educational space.

Solar physics is an interdisciplinary subject that allows the contextualization of modern physics topics. We discussed with students the matter constitution and energy production within stars. The observation of phenomena on the solar surface, such as sunspots, allows the discussion of the nature of the Sun as a dynamic star and concepts of electromagnetism and thermodynamics. Using a spectroscope, built by us to observe the lines of the solar spectrum, we discussed the electromagnetic spectra, the nature of the spectral lines, atomic models, and blackbody radiation. We also estimated the solar photosphere temperature using simple and low cost experiments.

Theoretical framework

We based our analysis on didactic transposition proposed by Chevallard (1991). He set out five conditions required for a particular knowledge to survive the process of didactic transposition, called the **Survival of knowledges**: knowledge has to be consensual; should strive to be up to date; has to show itself to be operational; should enable didactic creativity, and finally the knowledge should be therapeutic. We also draw on the **Rules of Didactic Transposition** proposed by Astolfi et al. (1997):

- Rule I: the modernization of school knowledge. This rule is related to the insertion of new contents and topics in the school curriculum.
- Rule II: updating school knowledge. It means that already existing contents are taught with new didactical approaches.
- Rule III: articulating new knowledge with the old.
- Rule IV: transforming knowledge into exercises and problems.
- Rule V: making the concepts more understandable.

The rules complement the original idea of the Survival of knowledges and are an operational way to better describe the dynamics of the transposition of knowledge in the context of curriculum innovation in physics teaching.

Methodology

We used a qualitative methodology for data collection. The research subjects were four physics teachers and their students. The teachers held a preparatory course of the 40 hours before the start of the activities with the students. The results presented in this study relate to the implementation of the TLS with the students (in classroom and at Observatory), occurred between the August and October 2012. The data collected include about 30 hours of audio and video recordings; ten separate, semi-structured interviews conducted with teachers and students; records and observation of lesson made, and 127 student worksheets (support materials) analyzed.

The methodology used in conducting the process of preparing the TLS was developed by us and entitled "Cycles of reflection", which are interpreted as continuous activities of research that provides, at every stage of the research, didactic and pedagogical support for the teacher-researchers partnership.

The cycles of Reflection comprise three steps: (A) *Constitution of the working group*, (B) *Updating of content, Sharing of ideas, perspectives and identifying problems and solutions, Collection of material already available and Development of the TLS*; (C) *Application of the material developed, Continuous assessment and Revision of the TLS and Provision of the material and the TLS*. This last step includes the school environment, the informal education environment, and the partnership between researchers and teachers in the continuous (re)thinking of the activities developed in the research. The "Cycles of reflection" are continuous research actions that provide (at every stage of investigation) didactic and pedagogical support for the teacher-researcher partnership.

Results

A notable feature of a TLS aimed at curriculum innovation is its inclusion in a research process based on the gradual evolutionary process, linking scientific knowledge, the student perspective and teaching activities. Following the theory of didactic transposition and the essential foundations for constructing a TLS: adoption of specific topics, a few weeks of application, development in an evolutionary cycle supported by research data (Méheut; Psillos, 2004), together with the school teachers, we devised and then applied the following TLS.

Table 1. Teaching and Learning Sequence developed in the teacher-researchers partnership

LEARNING SITUATION 01		
Theme	Teaching resources and Readings	Classes
PHASE I - The Sun and its radiations The Sun, solar activity and its radiations. General objectives	<ul style="list-style-type: none"> Videos on the Sun (YouTube) Support text “Our Star the Sun” and “α, β and γ radiations”. Audio visual resource – film Experimental Activity: "Estimating the temperature of the solar photosphere" with low cost materials. Exercises. 	06
	<ul style="list-style-type: none"> Sun, its structures and radiations. Understanding nuclear fusion and the Sun as energy source Discussion of scientific issues related to radiation from the film “2012” (Columbia Pictures, 2009, EUA). 	
LEARNING SITUATION 02		
Theme	Teaching resources and Readings	Classes
PHASE II – Spectroscopy Bohr atomic model and the Electromagnetic spectrum General objectives	<ul style="list-style-type: none"> Support text “Electromagnetic spectrum and Bohr’s atom” and “Blackbody radiation”. Support text “Spectroscopy” and Exercises. 	05
	<ul style="list-style-type: none"> Discussion of the different bands of the electromagnetic spectrum The emergence of the idea of energy quantization. Blackbody radiation Introduce Bohr atomic model and electronic transitions, and understand Kirchoff’s laws for spectroscopy. 	
LEARNING SITUATION 03		
Theme	Teaching resources and Readings	Classes
Applications of spectroscopy General objectives	<ul style="list-style-type: none"> Support text “How the lamps work” Experimental activity “Construction of an amateur spectroscope” with low cost materials. Exercises. 	03
	<ul style="list-style-type: none"> Construction and discussion an “Amateur spectroscope”. The light spectra of different everyday lamps Preparation for the visit to the Observatory. 	
LEARNING SITUATION 04		
Theme	Teaching resources and Readings	Classes
Spectroscopy in the Observatory General objectives	<ul style="list-style-type: none"> Student text “Visit to the Dietrich Schiel Observatory” Experimental activity: “The Solar Room and the solar spectrum” and Exercises 	Didactic visit (> 02)
	<ul style="list-style-type: none"> Visit to the USP Dietrich Schiel Observatory and visualization of the solar spectrum and the spectra of lamps. Working on the different types of spectrum (continuous and discrete) Introducing spectroscopy in the informal educational environment 	
LEARNING SITUATION 05		
Theme	Teaching resources and Readings	Classes
PHASE III – Systematization Feedback from the topics studied General objectives	<ul style="list-style-type: none"> Use of Applets – computer room Final evaluation activity 	02
	<ul style="list-style-type: none"> Use of multimedia resources as a means of systematizing what was dealt with during the classes. Propose a final evaluation, as one of the assessment steps of the course. 	
		Total: > 18

* Teachers and researchers in teacher training developed the support texts.

The TLS in the light of didactic transposition

Data analysis in the light of didactic transposition shows that the content of modern physics employed in the TLS developed obeys the rules of Didactic Transposition proposed by Astolfi et.al (1997).

The practical activities "Determination of the temperature of the solar photosphere" and "Building an amateur spectroscope", in addition to **making the concept more comprehensible** (Rule V) enabled the **transformation of knowledge into exercises and problems** (Rule IV) and the discussion with students of more contemporary ideas of physics, such as: quantization of energy and the emergence of quantum mechanics. This fact favored the **updating school knowledge** (Rule II) and **articulated the new knowledge with the old** (Rule III), enabling deeper discussions of the topic of the "Atom" with the students.

While discussing nuclear fusion and the proton-proton chains (solar core), the teacher expanded the students' understanding of nuclear issues, substantiating the **modernization of school knowledge** (Rule I), since it made it possible to deal with more contemporary ideas in the teaching of physics, such as solar neutrinos and α , β , and γ radiations rarely addressed in Brazilian schools. Studying Bohr atomic model (the notion of electronic transitions) and Kirchhoff's laws, the students also had the opportunity to discuss the formation of spectra: continuous, emission, and absorption.

During the visit to the Observatory, after the identification of the spectra of the lamps and the Sun, the students had the opportunity to view the practical display of the theory studied in class, a fact that contributed to **making the concepts more understandable** (Rule V) and **transforming knowledges into exercises and problems** (Rule IV). This event allowed a coherent assessment of what was taught in the classroom. The return to school, and the work of systematization performed with applets, enabled **updating school knowledge** (Rule II), since the simulations regarding spectroscopy meant that students had contact with one of the main "tools" used by astrophysicists. We understand that these activities contributed to **making the concepts more understandable** (Rule V), linking the digital universe, increasingly present in students' everyday lives, to the curiosity introduced by simulations and new items of knowledge, such as spectroscopy and stellar identification.

The content of the TLS also has all the conditions mentioned by Chevallard (1991) as necessary for the Survival of Knowledges:

The subject Sun based on activities in the classroom and in the Observatory, enabled students to understand concepts from modern physics such as spectroscopy, Bohr atomic model and blackbody radiation. The work made it possible to update the content of High School physics, indicating new horizons for the teaching of physics in the High School. The didactic creativity linked to the activities "Determination of the temperature of the solar photosphere" and "Building an amateur spectroscope" functioned very well in the role of making the knowledge of modern physics operational in activities and experiential exercises, enabling the discussion of more current topics in physics. The topics dealt within the TLS express on the one hand the consensus of its development within the teacher-researcher partnership, and on the other, obey the consensual aspect of scientific knowledge in the context of current research in physics. We infer that the good acceptance by the students, and at the end of the work the intended reapplication of the proposal by the teachers, are indicators of the therapeutic value of the topics covered in the school context, thus satisfying the requirements of the process of didactic transposition.

Conclusions

Curriculum innovation and the insertion of modern physics in the High School were made possible through the school-science center partnership and adherence to the ideas introduced by didactic transposition. With regard to the TLS structures, these may be considered satisfactory, fitting harmoniously within the existing curriculum and making viable the partnership between school and science center.

It also became evident that teacher training was essential for the smooth conduction of the research in the classroom and in the Observatory. We conclude that this is the fundamental issue when working in a partnership between schools and science center. Thus the visit to the informal space extrapolates the motivation aspect and effectively becomes part of teachers' actions in the process of teaching and learning. In general, teachers' concerns revolve around the "How to teach?" and "How to have time available for teaching?" Informal education can help overcome such difficulties, since it offers a range of educational and experimental apparatuses rarely found in classrooms.

We understand that one of the ways to confront and seek to overcome didactic-pedagogical obstacles related to teaching modern physics education through the construction of TLSs is linked precisely in the teacher-researcher partnership in compliance with the "Cycles of reflection" methodology. Finally, we conclude that it is possible to promote curricular innovation in the High School with the insertion of topics of modern physics and the observance of the assumptions and rules of didactic transposition.

References

- [1] Astolfi J. P., Darot E., Vogel Y. G., Toussaint, J.: *Mots-clés de la didactique des sciences*. Bruxelles: De Boeck & Larcier S. A, (1997). ISBN 978-280-415-716-6
- [2] Chevallard Y.: *La Transposición Didáctica: Del saber sabio al saber enseñado*. Buenos Aires: La Pensée Sauvage, (1991). ISBN 978-950-701-380-5.
- [3] Griffin J.: Research on students and museums: looking more closely at students in school groups, *Science Education*, 88, No 1, (2004), pp. 59-70.
- [4] Meheut M., Psillos D.: Teaching-learning sequences: aims and tools for science education research. *International Journal of Science Education, Special Issue*, 26, No 5, (2004), pp. 515-535.
- [5] Tran L.: Teaching science in museums: the pedagogy and goals of museum educators. *Science Education*, 91, No 2, (2007), pp. 278-297.

A hands-on to teach colour perception: The Colour Vision Tube

Claudia Haagen

Austrian Educational Competence Centre, University of Vienna, Vienna, Austria

Abstract

One basic concept for understanding colour phenomena is the concept of vision. Although vision seems to be quite a natural and simple thing, students are often not familiar with the mechanism behind perceiving objects or even “the colour of objects”. This contribution introduces a simple hands-on experiment, the Colour Vision Tube. The Colour Vision Tube facilitates the experience of seeing “coloured” objects illuminated with other than white light sources. These experiences support students in understanding the relevance of the illuminating light and the conception of selective reflection for colour vision.

Keywords: basic optics, colour, vision

Introduction

Colour phenomena are usually fascinating. However, it is frequently quite challenging for students to explain such phenomena based on adequate scientific concepts. This contribution focuses on body colour phenomena. After instruction of basic optics, students still believe the colour impression they get from an object is a fixed property of this object. [1,2,3,4]. Although they are mostly able to reproduce the laws of colour mixing, they can hardly account for colour impressions produced by objects illuminated with other than white light sources. We developed a hands-on experiment, the Colour Vision Tube, which can be easily used in class to demonstrate such colour effects.

Theoretical Background

Students’ ideas about vision have been investigated thoroughly and show students’ difficulties in explaining the visibility of objects based on light emitted by a source and reflected by the object into the observer’s visual system (cf. Figure 1, physicists’ model).

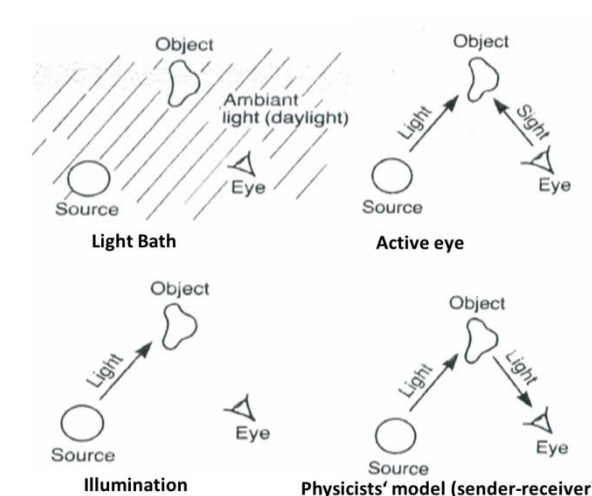

Figure 1. Students’ conceptions on vision (categories based on [6])

Without this basic concept of vision, it seems to be difficult to develop scientifically adequate ideas concerning colour and coloured objects. As a result, it is frequently believed that colour is a fixed property of an object, as mass is for example. Empirical research shows that misconceptions about colour are not only present among students but also among many adults [5].

Feher & Meyer [7] give a summary of the most frequently held conceptions about colour vision:

- (1) Coloured light mixes with the colour of the object,
- (2) coloured light is dark and makes the object darker,
- (3) coloured light gives the colour to the object and
- (4) coloured light has no effect on the object.

Conventional instruction is usually not successful in transforming these conceptions into adequate physical concepts about vision and colour [1,5]. From conceptual change theory it is known that conceptions tend to be extremely stable as they have proved to be viable in daily life in uncountable occasions [8]. Thus students do not feel the necessity to change their ideas; they frequently hold the idea that bodies have a permanent colour that can be seen when they are illuminated (cf. Figure 2, left). This theoretical background explains quite well why especially colour issues are difficult for students. In their daily lives they are predominantly in situations where their surroundings are illuminated by some kind of white light sources.

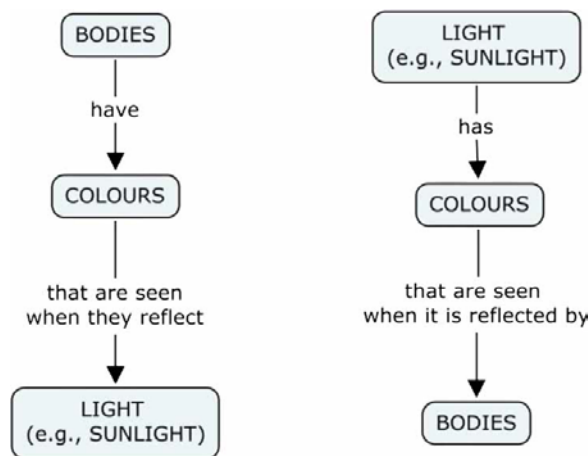

Figure 2. Concepts about colour phenomena (left: frequently held student conception; right: “new”, scientifically sound concept) [5]

One major issue of discussion within conceptual change is the question how to address students’ misconceptions in order to trigger conceptual change. Conceptual change research has not come to empirically grounded solutions on this issue, yet. Posner et.al [8], however, suggested a number of broadly accepted requirements characterising new concepts presented to students. To support conceptual change, they recommended that students do not only need to be dissatisfied with their current conceptions but the new conceptions introduced need to be intelligible, plausible, and fruitful. The Colour Vision Tube was thought to provide a variety of evidences that widen students’ ideas about colour vision. Their conceptions about colour being a fixed property of an object (cf. Figure 2, left) should be reorganised in the following way: light has colour(s), objects selectively

reflect them and the composition of the light received by our visual system creates a certain colour impression (cf. Figure 2, right).

Research Aims & Questions

The overall aim of this project was to promote students' understanding of "seeing colours". The main idea was to create a learning environment that makes students familiar with the experience of observing "differently coloured objects" illuminated by differently coloured light. Our intention was to create a hands-on that is easy to construct and also easy to handle in the classroom and above all, a hands-on that functions as learning environment which can be individually manipulated by students. The purpose of the evaluation conducted was to analyse learning effects triggered by the use of the Colour Vision Tube. Our main research questions were:

- 1) Does the use of the Colour Vision Tube promote a sender-receiver model of vision?
- 2) Does the use of the Colour Vision Tube promote students' understanding of selective absorption and reflection as basic condition for body colour phenomena?

Methods

A micro-teaching intervention based on the Colour Vision Tube was designed to be used in semi-structured student interviews. The intervention was aimed at students after their basic instruction in optics in year 8¹. The students of our sample (N=21, 9 female & 12 male) were aged 13 to 15 years. They were randomly selected: they had different school carriers and learning histories in physics, were in different types of schools in different areas of Austria. In order to avoid having a sample not representing the "typical Austrian high school student" at this age group, we also wanted to find out about their attitude towards physics and learning of physics. For this purpose we used the concept of self-efficacy in physics – following the scales of PISA 2000. The students of our sample shown a mean self-efficacy in physics $m=2.39^2$ (SD=0.73). This quite well fits the data of the Austrian PISA sample 2000 with a mean self-efficacy of $m=2.37$ (SD=0.84) [9].

In the first part of the interview the students filled in the PISA scales on self-efficacy and some other general data. Then they were given test items on colour vision [10]. After that they worked with the Colour Vision Tube following the P(redict) O(bserve) E(xplain) structure [11]. Finally, the students were asked to do some transfer tasks and fill in test items.

The data collected from the interviews were analysed concerning the lines of argumentations students used to explain colour phenomena before and after the short POE intervention with the Colour Vision Tube. The categories underlying the analysis were taken from literature. The categories about students' conceptions on colour vision were based on Feher and Meyer (cf. [7]). As we did not find any students' statements relating to the idea that coloured light is dark and makes the object darker, this category was omitted. The categories on conceptions on vision had also to be modified (cf. [6]). An additional category "reflection" was created which subsumed all student utterances that mentioned that the disc in the vision tube reflected light, but that did not contain any hints that this reflected light (partly) entered the visual system of the observer.

¹ In the Austrian educational system basic optics is part of the year 8 Physics curriculum. Colour phenomena are part of the curriculum.

² Self-efficacy runs from 1 to 4. 1 stands for high self-efficacy.

The intervention with the Colour Vision Tube

The Colour Vision Tube is a hands-on made of a tube³ which is closed at one end with a disc made of differently coloured segments (cf. Figure 3). In the middle of the tube, there is a light inlet just big enough to insert the light source. As light source we used a modified version of the colour mixer by Planinšič [12], a quite easy to build device based on RGB colour addition of LEDs. The open end of the tube serves as peephole for the observer. When students look through this peephole while the tube is illuminated with differently coloured LEDs, they can experience the effect of different illumination on the “body colour” they perceive.



Figure 3. The Colour Vision Tube (CVT)

During the intervention phase with the Colour Vision Tube, the students had to work successively on two predictions:

- 1) What will happen if we block the hole? (first POE cycle)
- 2) What will happen if we illuminate the Colour Vision Tube with red light? (second POE cycle)

The first prediction cycle was meant to initiate learning processes on a physical concept of vision based on a sender-receiver model (cf. Figure 1). The second cycle was based on the idea that the “colour of an illuminated object” depends on the illuminant. So after observing the Colour Vision Tube illuminated with red light, the students had the opportunity to explore the effects of differently coloured illuminants (cf. Figure 4).

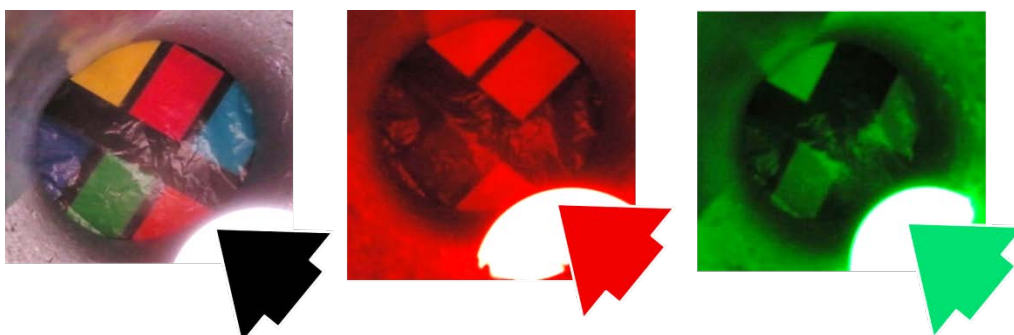

Figure 4. The inside of the Colour Vision Tube illuminated with white, red and green light

Selected results

The data collected during the first POE cycle showed that the majority of students firstly used common sense arguments to explain why they were able to see the coloured disc at

³ The tube is about 25 cm long and 8 cm in diameter. It is made of insulating material for heating pipes.

the end of the tube only as long as the light inlet was not blocked. Most students used the concept of illumination without considering the necessity of light from the disc entering the eye of the observer (cf. Figure 5). After the first POE cycle the majority of the students did not only know that light is necessary for vision, but they also identified the light source (the illuminant) – the illuminated object and the eye (receiver) as essential components for vision.

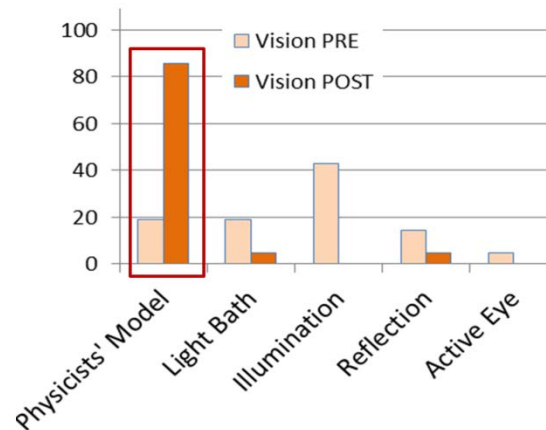

Figure 5. Students' ideas concerning vision before and after the CVT-intervention

The second POE cycle focused on colour vision, on the apparent colour of object illuminated with light sources other than white. Most students initially believed that either the colour of the illuminant or a mixture of the colour of the illuminant and the colour of the illuminated object was responsible for the colour they perceived (cf. Figure 6). Only a minority of students held the conception that selective re-emission determines the perceived colour. Similarly, the idea that the apparent colour of an object stays the same independently of the colour of the illuminant, was rarely mentioned.

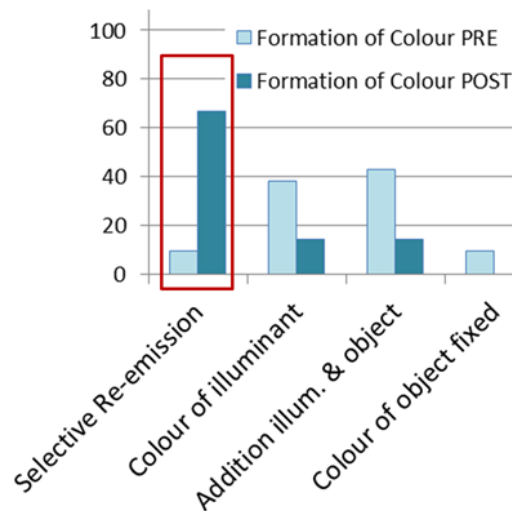

Figure 6. Students' ideas concerning colour vision before and after the CVT-intervention

After the second POE cycle, about two thirds of the students were able to apply the idea that colour impression is not a consequence of the property of objects but a consequence of the interaction between an object and the light illuminating this object (cf. Figure 6). However, a closer analysis showed that they had problems when primary colours of subtractive and additive colour mixing were used at the same time. For example it was

easy for them to use the RGB scheme to explain why the blue and green segments⁴ of the disc appeared to be black when using a red illuminant. On the other hand, most students were not able to account for the fact that yellow and magenta segments⁵ appear to be reddish when illuminated with red light, while cyan segments appear to be black.

Summary & Conclusions

The hands-on we called “Colour Vision Tube” (CVT) is easy to build. Its use in class turned out to be simple and effective. Observations with the CVT support students in experiencing colour characteristics of an illuminated object with varying illuminants (ranging from no illumination at all to white and differently coloured light).

In the prediction-stages of our intervention, most students were not able to verbalize the process of vision based on a physical correct model, nor were they able to explain the physical process of seeing colours adequately. After reinforcing a physicist model of vision in the first POE cycle, students could experience the effect of different light colours on their perception of objects in a second POE cycle.

They are used to judging the “colour of an object” when illuminated by sunlight or similar light. The lacking experience of illuminants with different colour characteristics seems to hinder students to internalize the concept that colour is not a physical property of an object, but depends on how an object reflects light that reaches it.

The use of the CVT gives students the opportunity to experience the effects of changing light colour on the reflecting behaviour of objects. This seems to support students in developing a relationship between their visual colour sensation, the colour characteristic of an illuminant and the reflection behaviour of the illuminated object.

References

- [1] Andersson B., Kärrqvist C.: How Swedish pupils, aged 12-15 years, understand light and its properties. *International Journal of Science Education* 1983;5(4):387–402.
- [2] Driver R., Guesne E., Tiberghien A. (eds): *Children's ideas in science*. 1993rd ed. Buckingham, Open University Press, 1985.
- [3] Fetherstonhaugh T., Treagust D.: Students' understanding of light and its properties: Teaching to engender conceptual change. *Science Education* 1992;76(6):653–672.
- [4] Viennot L., Hosson C. de: Beyond a Dichotomic Approach, The Case of Colour Phenomena. *International Journal of Science Education* 2012;34(9):1315–1336.
- [5] Martinez-Borreguero G., Pérez-Rodríguez Á. L., Suero-López M. I., et.al: Detection of Misconceptions about Colour and an Experimentally Tested Proposal to Combat them. *International Journal of Science Education* 2013;35(8):1299–1324.
- [6] Guesne E.: Light. In Driver R, Guesne E, Tiberghien A (eds): *Children's ideas in science*, 1993rd ed. Buckingham, Open University Press, 1985, pp 10–32.

⁴ To be more precise: the segments of the disc which appear blue and green when illuminated with white light.

⁵ To be more precise: the segments of the disc which appear yellow and magenta when illuminated with white light.

- [7] Feher E., Meyer K.: Children's conceptions of color. *Journal of research in Science Teaching* 1992;29(5):505–520.
- [8] Posner G., Strike K., Hewson P., et.al: Accommodation of a scientific conception: Toward a theory of conceptual change. *Science Education* 1982;66(2):211–227.
- [9] Kunter M., Schümer G., Artelt C., et.al: PISA 2000: Dokumentation der Erhebungsinstrumente, Max-Planck-Inst. für Bildungsforschung, 2002.
- [10] Herdt D.: Einführung in die elementare Optik. Vergleichende Untersuchung eines neuen Lehrgangs. Essen: Westarp-Wissenschaftsverlag 1990.
- [11] White R., Gunstone R.: *Probing Understanding*. 2006th ed., Routledge, 1992.
- [12] Planinšič G.: Color mixer for every student. *The Physics Teacher* 2004;42:138.

Creation of workbook in physics for pupils of technical fields at secondary vocational schools

Věra Kerlínová^{1,2}, Erika Mechlová¹, Libor Koníček¹, Lenka Ličmanová¹

¹ Faculty of Science, University of Ostrava, Ostrava, Czech Republic

² Bohumín Secondary School, Bohumín, Czech Republic

Abstract

The first version of the Workbook of Physics, Mechanics for the 1st year Secondary Vocational Schools with electro-technical focus, began forming during the school year 2007/2008. First it was focused on explaining the physical concepts and solving physical tasks. On the basis of feedback getting within pre-researches in school years 2008/2009 and 2009/2010, i.e. the results of input and output tests, questionnaires, pedagogical observing and interviews with pupils, it was gradually expanded, innovated and updated. In the school year 2010/2011, when the pedagogical research was carried out at three secondary vocational schools and one grammar school, the Workbook consisted of parts targeted on physical concepts, examples from practice and real life, physical tasks, physical terminology in English, records of pupils from viewed video projection and physical experiments.

Keywords: pedagogical research, workbook, technical fields, secondary vocational school

Introduction

Knowledge of physics are necessary for pupils of secondary vocational schools and especially because of its interconnection with most of technical subjects. The Workbook of Physics, Mechanics for the 1st year of Secondary Vocational Schools [1], was created so that it could contribute to improving the quality, streamlining and facilitating physics teaching in the initial education at secondary schools, to unification of the basic demands of the curriculum, to motivation in pupils' individual work and to support their team work, next to facilitate pupils' homework, to awareness of interdisciplinary relations, especially in the natural sciences and technical subjects, to minimize psychological burden of pupils and to support pupils with learning disabilities.

Materials & methods

For preparation and creation of Workbook was carried out analysis of physics curriculum and technical subjects at various types of schools. Within physics didactic were theoretically studied the chapters going for teaching methods, organizational forms of teaching, characteristic and function of didactic resources, information technologies in education and studies TIMSS and PISA. Long-term pedagogical experiment carried out by form of classic experiment with two groups, one experimental and one control, was realized in school year 2010/2011 in 1st years of three secondary vocational schools with technical or electro-technical focus and one grammar school. As the experimental one was marked the group, in which took place teaching physics with using the Workbook and as the control one was marked the group with traditional teaching form. The quantitative aspect was examined by testing the knowledge and skills of pupil. The qualitative aspect,

i.e. pupils' attitude to subject physics and to physics teaching with using workbook, was found out by the questionnaire survey. To evaluation was used of statistical methods.

The Workbook of Physics, Mechanics for the 1st year Secondary Vocational Schools

Structure of the Workbook

Structure of the Workbook is based on the structure of physics textbooks. The Workbook is divided into identical thematic sections, chapters and sub-chapters. Individual exercises in the Workbook are especially focused on filling in the words, drawing into the picture, calculations of physical tasks including graphic sketches, suggestions and realization of laboratory works (Figure 1–5). There are also the parts devoted to various quizzes (Figure 6), competitions, interesting things and discoveries not only of science and technology world, but also in everyday life.

e) Vyberte nesprávné odpovědi:

Hmotný bod:

- 1) je myšlený bodový objekt, který má hmotnost, ale nemá rozměry
- 2) jediný bod, který nahrazuje pohybující se těleso a má hmotnost rovnou hmotnosti tělesa
- 3) nahrazujeme jím reálné těleso, jehož rozměry i hmotnost můžeme zanedbat
- 4) nahrazujeme jím reálné těleso, pokud jsou jeho rozměry zanedbatelné vzhledem ke vzdálenostem, které těleso překonává
- 5) je myšlenkový model, u kterého uvažujeme jeho hmotnost, tvar i rozměry

3.2 Trajektorie a dráha hmotného bodu

a) Definujte pojem trajektorie:

b) Trajektorií může být: (doplňte chybějící údaje: název trajektorie nebo její tvar)



www.planimetrie.kvalita.cz

kružnice



www.milesmatia.com

parabola



www.cse.iitd.ernet.in

balistická křivka

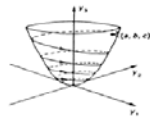

www.fsv.vutbr.cz



www.fyzika.net.pl

Vzpomenete si, ve kterém filmu jste mohli vidět spirálu jako trajektorii HB?

12

d) Spojte správné odpovědi:

- | | |
|-----------------------|--|
| 9,83 m/s ² | tižové zrychlení při povrchu Země v naší zeměpisné šířce |
| 9,78 m/s ² | tižové zrychlení na rovníku |
| 9,81 m/s ² | tižové zrychlení na zeměpisných pólích |

e) pokuste se doplnit text:

- V první polovině došlo k nevidanému rozvoji
 Galileo přizpůsobil dalekohled účelům,
 provedl další zdokonalení dalekohledu, spojil hvězdářský
 dalekohled s hodinovým strojem a vynalezen byl také (Jansen, Galileo),
 (otevřený teploměr), (Viviani, Pascal), (hustoměr)
 a další.



www.usca.edu

Galileo Galilei:

- je zakladatelem fyziky (mechanické pokusy s těles, valením koulí po studium vodorovného a pohybu)
- vyvrátil představy o tom, že těžší tělesa padají k zemi než lehčí
- vytvořil pozemských pohybů
- začátkem 17. století dospěl k principu
- se zabýval vlastnostmi a položil základy nového fyzikálního oboru -
 [Ivan Štāl Dějiny fyziky, Prometheus, 2009]

Nápopověď: J. Kepler, barometr, experimentální, kinematiku, R. Hooke, termoskop, volným pádem, 17. století, aristotelovské, kyvadla, zvuku, vrhu, astronomickým, aerometr, přístrojové a měřicí techniky, relativity, rychlosti, akustiky, mikroskop, nakloněné roviny



Dokument: Tajemný vesmír – Za velkým třeskem (History, 2009), (25. minuta – Galileo Galilei)

f) Mohl Galileo pronést památnou větu: „A přece se točí“...?

Nápopověď: např. článek Největší vědecké spory historie: „A přece se točí“ (Martin Janda, 19. 12. 2006, časopis 21. století)

28

Figure 1. Task to filling in the words in the Workbook of Physics, Mechanics for the 1st year Secondary Vocational Schools. On the left: The charter Trajectory and Path of Mass point, on the right: The chapter Free Fall [1]

h) Síla tedy musí být: skalární – vektorová fyzikální veličina (nehodící se škrtněte).



Poznámky ze sledných videí:

Video č. 1:

Video č. 2:

Video č. 3:

4.2. **Newtonovy pohybové zákony**

a) Uveďte všechny pohybové Newtonovy zákony. (obr. převzaty z: www.cartoonstock.com)

.....



b) Pokuste se přeložit a doplnit text:

For example: Newton's first law of motion = law of inertia – 1. Newtonův pohybový zákon

Newton's laws of motion =

Newton's third law of motion = law of interaction –

..... – Newtonův gravitační zákon

Newton's second law of motion =

37

48

Figure 2. Task to filling in the words in the Workbook of Physics, Mechanics for the 1st year Secondary Vocational Schools. On the left: The chapter Force and Newton's law of motion, on the right: The chapter Sliding friction [1]

4.3 **Tíhová síla a tíha tělesa**

a) Jaký je rozdíl mezi tíhovou silou a tíhou tělesa? Rozdíl vysvětlíte i zakreslete.

Tíhová síla značka: jednotka:

Tíha tělesa značka: jednotka:

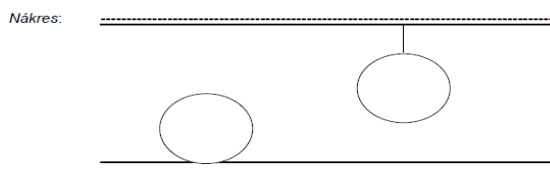

b) Máte určit, na které ze dvou těles bude působit větší síla. Jaké zařízení k tomu využijete?



c) Jaký je rozdíl mezi tíhou a hmotností tělesa?

- 1) není mezi nimi žádný rozdíl, obě veličiny měříme v newtonech
- 2) hmotnost uvádíme v newtonech, ale tíhu v kilogramech
- 3) obě veličiny měříme ve stejných jednotkách, v kilogramech, ale tíha tělesa se po přenesení tělesa na jiné místo na rozdíl od hmotnosti mění
- 4) hmotnost téhož tělesa se nemění, ale tíha téhož tělesa může být na různých místech jiná
- 5) hmotnost měříme v kilogramech, tíhu v newtonech; tíha tělesa zůstává při přenesení tělesa na jiné místo vždy konstantní, ale hmotnost tělesa kolísá

42

Figure 3. Task to drawing into the picture in the Workbook of Physics, Mechanics for the 1st year Secondary Vocational Schools: The chapter Weight of body [1]

Odpověď:

Kviz:
 1) Přifaďte názvy níže vyobrazeným rychlým vozům. Zároveň odhadněte maximální rychlost, které mohou dosáhnout. (rychlost převeďte i na m/s)

Názvy:
 a) Bugati Veyron d) Koenigsegg CCX g) Porsche 911 GT2
 b) Corvette Z06 e) Ferrari 599 GTB Fiorano
 c) Pagani Zonda F f) Lamborghini Murciélago LP640

Maximální rychlost:
 a) 320 km/h c) 340 km/h e) 345 km/h g) 407 km/h
 b) 330 km/h d) 345 km/h f) 395 km/h



1)
..... km/h, m/s



2)
..... km/h, m/s



7)
..... km/h, m/s



3)
..... km/h, m/s



4)
..... km/h, m/s

2) Rekordmani světa zvířat:
 Za nejrychlejší zvíře na světě se považuje:
 a) ve vzduchu - c) ve vodě -
 b) na souši - d) na světě -

Odhadněte maximální rychlost zvířat. U ptáků dosadte i rychlost při letu střemhlav:
 35 km/h, 50 km/h, 54 km/h, 60 km/h, 70 km/h, 100 km/h, 120 km/h, 200 km/h, až 200 km/h (střemhlav), až 300 km/h (střemhlav)



.....



.....



.....

19

20

Figure 6. Quizzes, competitions, interesting things in the Workbook of Physics, Mechanics for the 1st year Secondary Vocational Schools: The chapter Kinematics, part Velocity of Mass point [1]

The Workbook within interdisciplinary relations

The Workbook was created so that the acquired knowledge and skills of pupils were able to further develop and use in technical fields. For pupils in the field Mechanics Electrician there are subjects Basics of Electrical Engineering, Electronics, Digital Techniques, Technical Documentation, Materials and Technologies; for pupils in the field Transport Operation and Economy there are these ones Logistics, Cars, Traffic and Transport and Road Vehicles (Figure 7)

Perspective of the Workbook

The Workbook will be during the school year 2013/2014 innovated and translated into English.

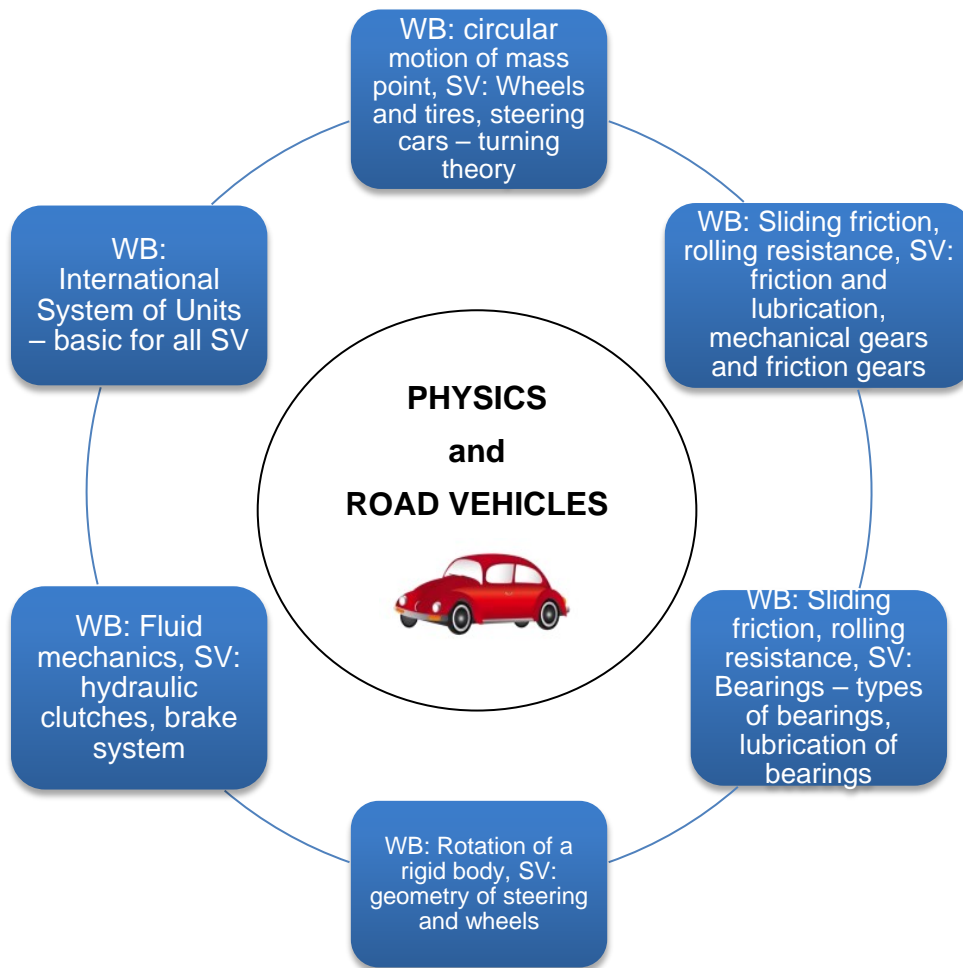

Figure 7. The Workbook within interdisciplinary relations: Physics and Road Vehicles.
WB – Workbook, SV – Vocational Subject

Conclusions

Curriculum of physics in the Workbook is applied to concrete problems that pupils will encounter in professional practice. To pupils in the experimental and control classes of 1st years of three secondary vocational schools (A, B, C) and one grammar school (D) was commissioned in the research in September 2010 Entrance test as pre-test and in January 2011 as pos-test. Selection of experimental and control classes was left to the discretion of individual teachers or school management above. However, the condition was the same substantive content of teaching physics according to educational program, the same allowance of physics lessons and teaching physics by the same teacher in both classes of identical or similar fields (Table 1). It was found out that pupils in the experimental classes of all four secondary schools (A, B, C, D) had increase knowledge and skills in unit conversion, international system of units and mechanics statistically significant. The biggest difference in the increase of correct answers was notice in the part Mechanics (see the following Graph 1).

Table 1. Specifications of secondary school participating in the teaching experiment

Designation of school	Type of secondary school	Field, form of study	Location of school	Number of pupils
A	Secondary vocational school	technical	Havířov	27
B	Secondary vocational school	technical	Ostrava	24
C	Secondary vocational school	technical	Bohumín	27
D	Grammar school	eight-year and four-year	Bohumín	26

Test task – the example of Entrance test

Kicked ball is doing:

- a) uniform linear motion b) uniform curvilinear motion
 c) non uniform linear motion d) non uniform curvilinear motion

Thrown disk, propeller or the Earth is doing the motion:

- a) only sliding b) only rotary
 c) sliding and rotary d) physically un-definable

Physical quantities Energy and Work state in units:

- a) Pascal b) Joule c) Newton
 d) Watt e) no units

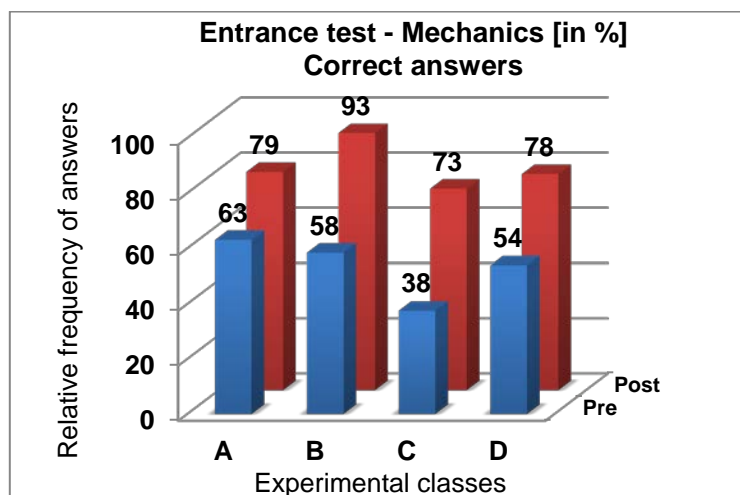

Graph 1. Number of correct answers of pupils in the experimental classes in the item Mechanics. Secondary vocational schools with technical or electro-technical focus: A – Havířov, B – Ostrava, C – Bohumín; Grammar school: D – Bohumín; Pre – Pretest, Post – Posttest.

References

- [1] KERLÍNOVÁ V.: *The Workbook - Physics: Mechanics for the 1st year Secondary vocational schools*. Ostrava, 2013. Annex dissertation. Faculty of Science, University of Ostrava. Supervisor prof. RNDr. Erika Mechlová, CSc.

SCLPX – An Alternative Approach to Experiments in Physics Lessons at School

Čeněk Kodejška, Roman Kubínek, Jan Říha

Department of Experimental Physics, Palacky University at Olomouc, Czech Republic

Abstract

Conducting experiments in physics using modern measuring techniques, and particularly those utilizing computers, is often much more attractive to students than conventionally conducted experiments. SCLPX (Sound Card Laser Pointer eXperiments) deals with physics experiments in which a computer sound card is used as a measuring device, along with other available physical devices, such as a laser pointer, a solar cell or an electret microphone. It is possible to perform very simple school experiments (both demonstration and multiple ones), whose high accuracy and clear final conclusions can be achieved at a very low cost. Further information is published on the specialized webpage www.sclpx.eu/index.php?lang=en.

Keywords: physics experiments, laboratory exercises, low cost of basic equipment, sound card, laser pointer, solar cell, PC microphone, Free Audio Editor (FAE), Visual Analyser (VA)

Introduction

Our work is based on the experience with the school kits such as Vernier, IP Coach or Pasco. It presents an alternative way of conducting physics experiments that can be used directly as demonstration experiments, multiple experiments or even as home experimentation. The most important advantage of the proposed experiments is a very low cost of the basic equipment as well as the fact that all of these experiments could be repeatedly conducted individually at home.

There is a wide range of computer controlled experiments. However, there are only several publications about simple and smart measurements that can be carried out by a sound card. For example, the photogate timer can be set by an optocoupler connected to an audio input in order to determine the acceleration due to gravity by timing the oscillations of a pendulum [2] or to specify the force constant k of a coil spring by timing the oscillations of a mass spring [3]. The computer sound card input and output can be used to measure the speed of sound or resistance and temperature [4-8].

Since 2008 we have been developing our own high school laboratory experiments by using a PC sound card. Unfortunately, these experiments have not been published yet.

Up to now, we have prepared and tested 20 experiments in the field of mechanics and sound waves. About 30 other experiments dealing with the properties of solids and liquids, electricity and magnetism or quantum physics are in the process of screening. All the experiments published at www.sclpx.eu/index.php?lang=en have been tested and evaluated at partner high schools.

How does the experiment work?

All the experiments use a simple optical gate, composed of a laser pointer and a solar cell from which the signal is transmitted through a cable to the microphone input of the sound card by a 3.5 mm jack connector. The principle of optical gate is then obvious: the interruption of the laser beam changes the output voltage of the solar cell, and the output pulse corresponds to the course during the transient process, as shown in Figure 1. A basic review of the sound card photogates is presented in [1].

In this way, we can then measure the length even for very short periods of the order of 10^{-4} to 10^{-6} seconds.

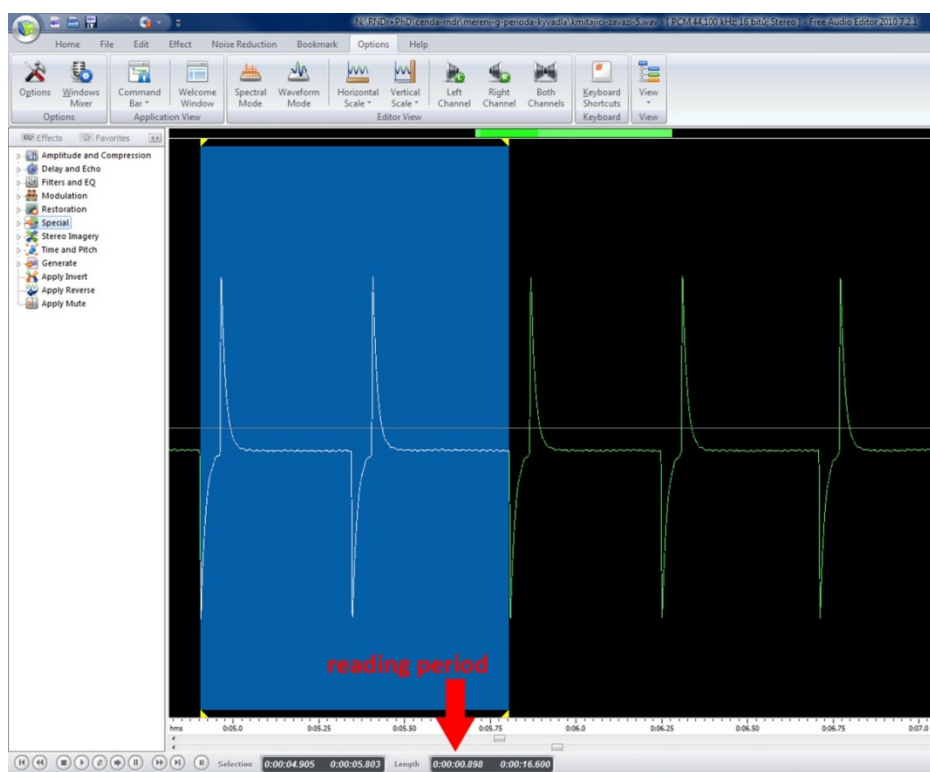

Figure 1. Output signal from solar cell with reading of the period in FAE

To record and evaluate the signal, we used a freeware program for audio editing Free Audio Editor (FAE) [9]. This program can also edit the recorded signal, so that we can make a selection of one part of the signal, after which the program calculates its length (window called Length) or we can enhance a weak signal.

Of course, the recording can also be saved in WAV format audio file, so that we can reload the experiment data at any time needed. For some experiments, especially those with sound, we used a freeware program the Visual Analyser (VA) [10].

In conclusion we would like to remind the important fact that a sound card can be used for AC voltage measurements only. The output of the solar cell is in the range of 100 mV, so there is no risk of destroying the sound card.

The advantage of using a sound card over other systems is a high sampling frequency (44.1 kHz standard, but nowadays you can go up to 384 kHz).

In the next section we will briefly describe several experiments in the field of mechanics and acoustics.

New School Physics Experiments

To carry out these experiments we always used the following tools: a notebook or PC, a photodiode or a solar cell, a laser pointer, a pendulum and a paper comb with wide teeth cut out of a cardboard. The solar cell had a larger surface than a photodiode and was therefore easier to work with. All the experiments can also be performed by using a tablet with a microphone input.

Some of our experiments, such as determination of gravity from the pendulum oscillation period, dynamic determination of a spring constant or measuring of the speed of sound, are quite known and well-documented nowadays [2-4], [8].

We therefore focused our attention on less-known experiments or those experiments which were carried out in unusual ways, as was the case of producing sound beats by using wine glasses.

Free fall – verification of time dependence of velocity of a falling paper comb

Apart from the usual tools, for this experiment we need to prepare a paper comb cut out from cardboard paper. All the teeth should be of the same width; in our case the width of the teeth d was 1 cm and the total length of the ridge was about 25 cm. The experimental arrangement can be seen in Figure 2.

We let the comb to perform a free fall from a constant height through the photogate. Since the width of the i -th tooth is known, the total time of passing of the i -th tooth through the laser beam can be determined in the Free Audio Editor. By the relation $v_i = d / t_i$ we can subsequently calculate the approximate value of the instantaneous speed of the i -th tooth. Since the movement is accelerated, the first tooth has the minimum speed, while the i -th tooth reaches the maximum speed. The graph of speed versus time is then a linear function, where the constant of proportionality is the value of gravitational acceleration ($v = g \cdot t$).

Figure 3 shows the recorded signal in the FAE, whereas Figure 4 offers a corresponding graph produced by MS Excel.



Figure 2. Free fall of a paper comb

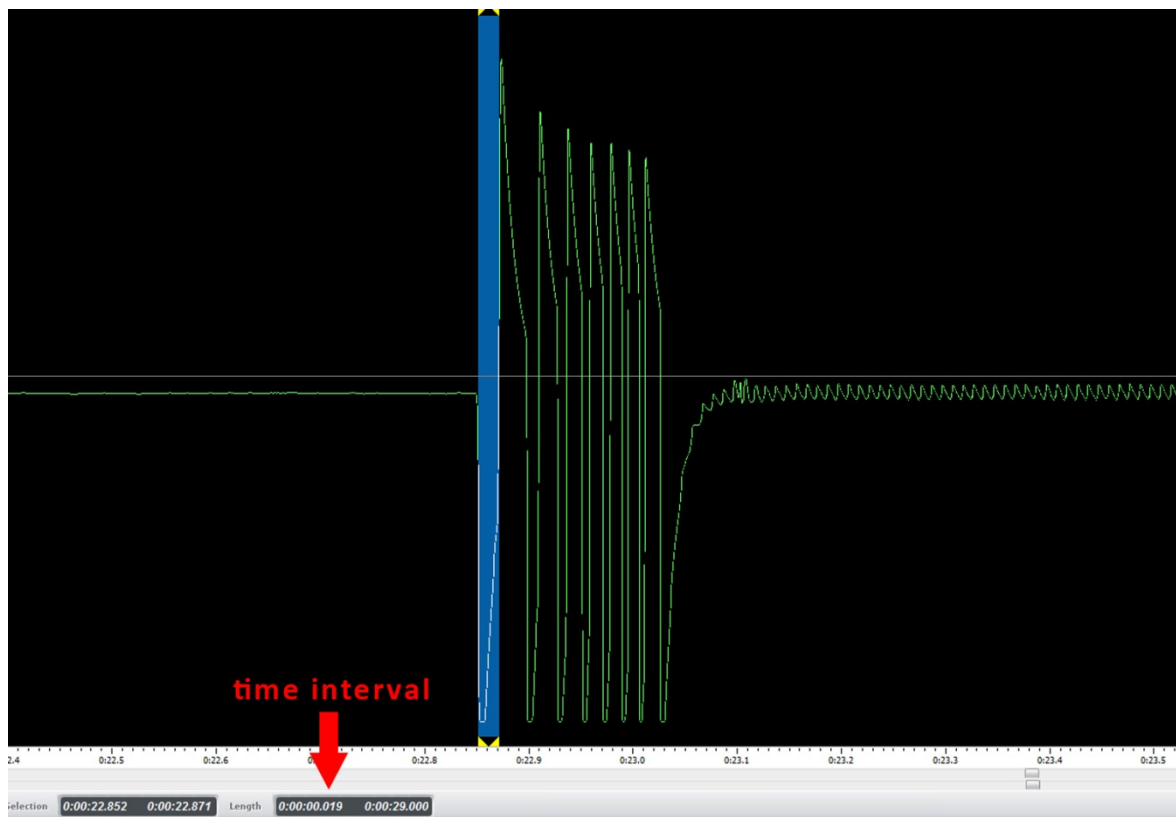

Figure 3. Free fall of a paper comb – the signal view

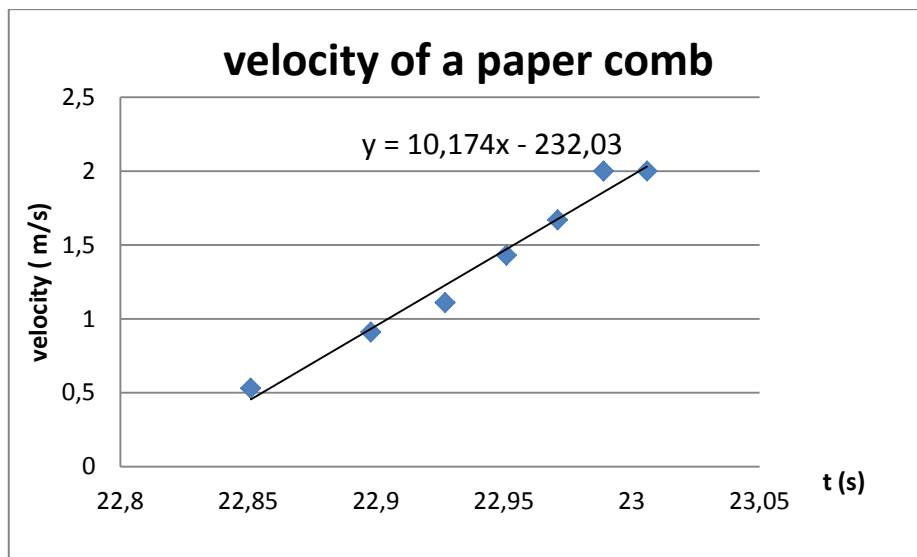

Figure 4. Free fall of a paper comb – MS Excel graph with linear regression

Determination of the coefficient of the friction from the acceleration on an inclined plane

Using plasticine (modelling clay) we affix a paper comb on a wooden block. After that we let the comb slide freely along the inclined plane. We must make sure that the laser beam

intersects with the teeth of the comb. We carry out measurements for three different inclinations of the inclined plane (30°, 35° and 40°).

Next we measure in the Free Audio Editor the transit time of the first and the last tooth. After that we calculate the instantaneous velocity by using the formula $v = \Delta s / \Delta t$, where $\Delta s = 1$ cm (comb tooth width).

The acceleration is determined by the relation $a = \Delta v / t$, where Δv the speed variation of the first and the last tooth is and t is the time between the two teeth.

Finally, we use the following formulation of the coefficient of the friction:

$$f = \operatorname{tg} \alpha - \frac{a}{g \sin \alpha}$$

The experimental arrangement can be seen in Figure 5. The recorded signal in the FAE is similar to that in Figure 3.

Average value of the coefficient of the friction $\bar{f} = 0.32$ obtained by measuring is in good agreement with the tabular value $f = 0.3$ for wood on wood surface.

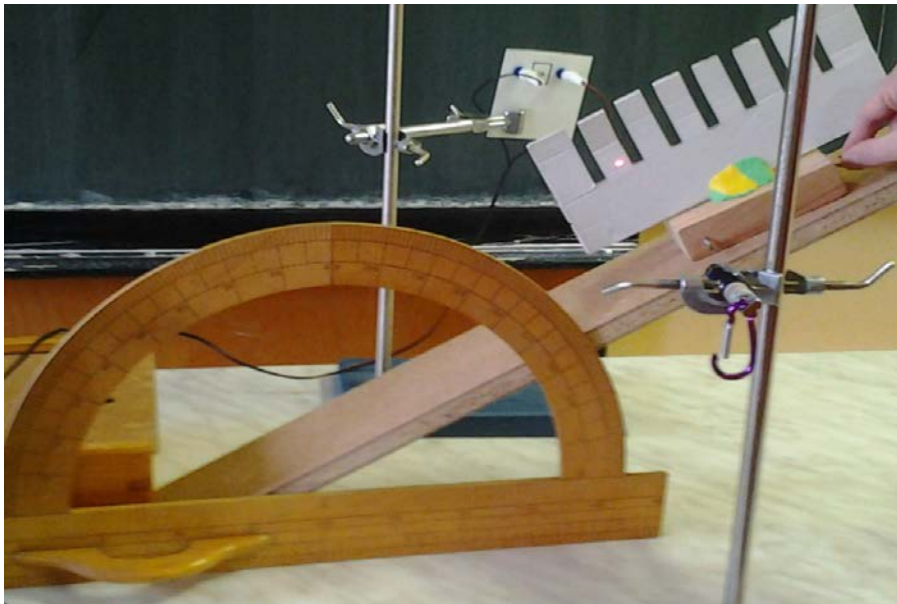

Figure 5. Measuring of the coefficient of the friction

The demonstration of sound beats by using Visual Analyser (VA)

First we connect the speakers to a sound card. The PC microphone is placed between the speakers approximately 30 cm from them.

Having started the Visual Analyser, we select the *Main* tab on the right side of the screen and click on *Wave Gen*. This opens the *Waveform Generator* window, in which we click on the *Main* tab and select *Enable* for each channel. After that we enter close frequencies for both channels.

Finally, at the bottom right of the window we set the *Main* tab on Channel (*s*) and select A + B, after which we start measuring by pressing the *On* button in the upper left corner of the screen.

To listen to the audio beats we can set the frequency at approximately 500 Hz and 505 Hz. If we want to depict it on a graph, we have to select more dissimilar frequencies in order to

make sure that the amplitude decrease of the sound beats is sufficiently evident. In our case we selected 500 Hz and 530 Hz (see Figure 6). The experiment can also be performed without a speaker and a microphone, but it will of course lack the desired sound effect.

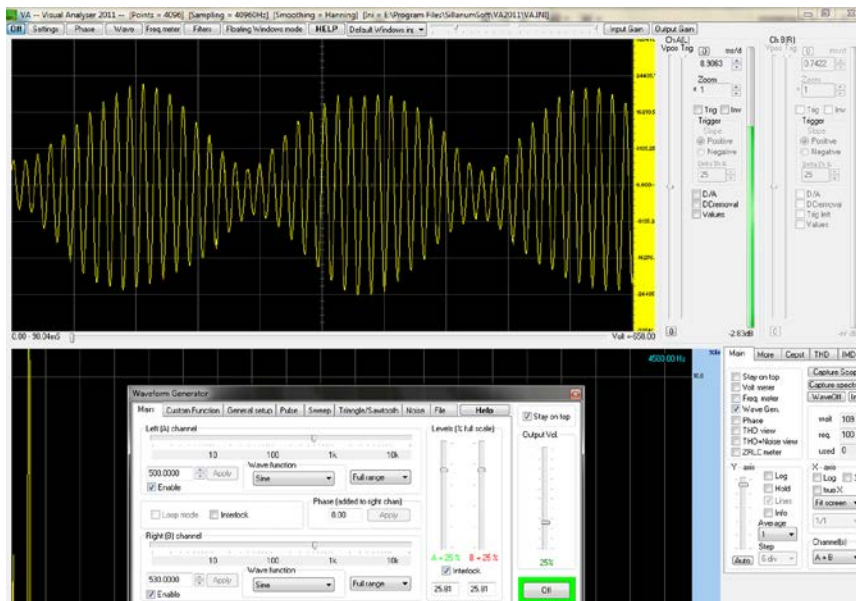

Figure 6. Sound beats by using the Visual Analyser

The demonstration of the sound beats by using wine glasses

We carry out this experiment in a similar way. As a source of sound, we can use two wine glasses filled with water. The water level in both glasses should be approximately at the same level. The microphone was positioned between the two goblets, in the middle.

The experimental arrangement can be seen in Figure 7, whereas the recording of the sound in the FAE is shown in Figure 8.



Figure 7. Sound beats produced by wine glasses

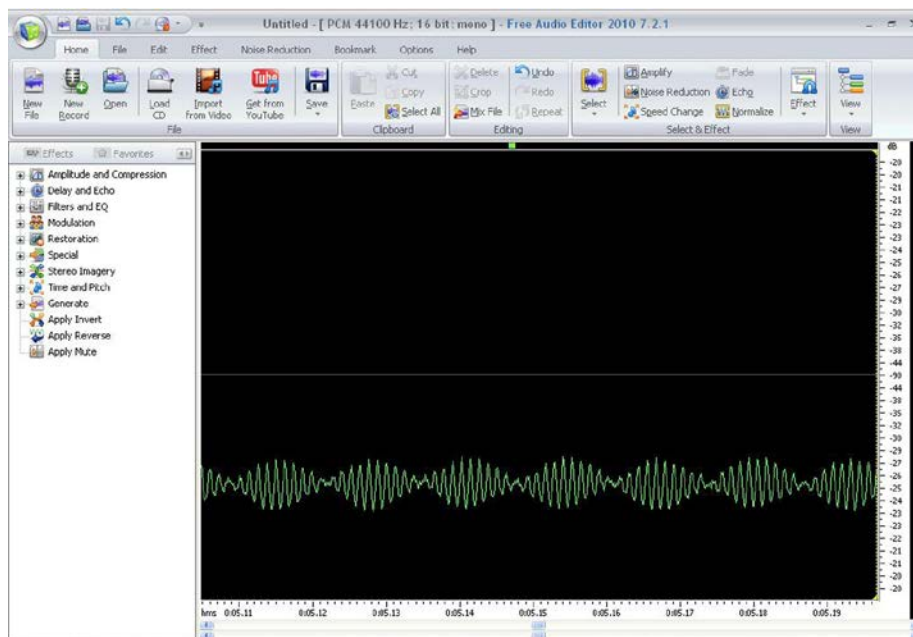

Figure 8. Preview in the Free Audio Editor

Conclusion

All computers or notebooks have a built-in sound card – the input/output interface that can directly receive or generate analogue signals. Although such sound cards have a limited potential because of the ability to process alternating signals only, it can make physics education more efficient and more interesting at a very low price. Simple sensors such as a solar cell or a PC microphone can be directly connected to the sound card input.

In this paper we have shown several experiments from the field of mechanics and acoustics. We have verified that the optical gate consisting of a solar cell and a laser pointer allows for making measurements comparable with experiments performed by using professional kits such as Vernier, IP Coach or Pasco.

The advantage of our approach is the ability to conduct experiments not only as a demonstration, but also as students' laboratory exercises. Another advantage is the affordability of the used equipment, which may offer an interesting alternative to the most expensive professional headsets for a variety of primary and secondary schools.

A very low price, ease-of-use and comprehensibility of the experiments make it possible for students to turn their computers into measurement devices, focus their attention to improve their physical skills and, last but not least, to make physics more attractive to them.

Acknowledgments

The support of the ESF project No. CZ.1.07/2.2.00/18.0018 is gratefully acknowledged. The project is co-financed by the European Social Fund and the state budget of the Czech Republic.

References

- [1] Gingel et al. 2011 Review of sound card photogates, *Eur. J. Phys.*, **32**(4), 905-924

- [2] Velasco S et al. 2011 Timing the oscillations of a pendulum, *Phys. Educ.* **46**, 133-134
- [3] White J A et al. 2011 Timing oscillations of a mass spring, *Phys. Educ.* **46**, 378-379
- [4] Khairurrijal et al. 2012 Measurement of gravitational acceleration using a computer microphone port, *Phys. Educ.* **47 (6)**, 709-714
- [5] Aguiar C E, Pereira M M 2011 Using the Sound Card as a Timer. *Phys. Teach.* **49**, 33
- [6] Gingel Z, Kocsis P 2011 Measure resistance and temperature with a sound card. *EDN (Elektronics Design, Strategy, News)*, **56(10)**, 58-59.
- [7] Litwhiler DH, Lovell TD Acoustic Measurement Using Common Computer Accessories: Do Try This at Home. Proceeding of the 2005 American Society for Engineering Education Annual Conference & Exposition. [online]. [cit. 20. 4. 2013] Available from: <http://zone.ni.com/devzone/cda/tut/p/id/3817>
- [8] Martin B E 2001 Measuring the Speed of Sound – Variation on a Familiar Theme, *Phys. Teach.*, **39**, 424-426
- [9] <http://www.free-audio-editor.com/>
- [10] <http://www.sillanumsoft.org/>

Research based discussions on optics with teachers to integrate professional development with everyday school work

Francesca Leto, Marisa Michelini, Alessandra Mossenta

Research Unit in Physics Education, University of Udine, Italy

Abstract

Within the Italian project on innovation in teaching/learning IDIFO4, research based labs for in-service teacher professional development was carried out. In the rich environment of 20 kindergarten, primary and low secondary school teachers, the discussion of content knowledge (CK) was integrated with activities on simple experiments proposed in examples of coherent paths, according to Experiential Teacher Education Model (ETEM). Activities were focused on the analysis and the discussion of tested educational paths both on conceptual change, subject matter content and educational plans. Action oriented contents and methods emerge as teaching/learning proposals based on research on children learning processes, where they melt in coherent paths as an outcome of the experienced modules of formative intervention. Optics lab offers an example of this kind of integration between educational research and teacher professional development.

Keywords: kindergarten and primary school teacher education, research based lab, optics

Introduction

The issue of the integration of content knowledge (CK) on subject matter with that producing the competence in creating an educational environment is a multidimensional problem in teacher education (TE). The lack of scientific preparation of primary and kindergarten teachers and of adequate educational tools is pivotal elements in this problem, as well as the need of a qualified in-service TE aimed at the teachers' professional development.

Although the integration of content knowledge (CK) with teaching strategies knowledge (PK) can be favoured by an Experiential Model for TE grounded on the personal involvement of teachers in carrying out the same activities planned for children, it doesn't guarantee the activation of a practice based on intellectually active children [1-7]. Among many reasons expressed by teachers, the most common is the lack of self-confidence on the conceptual discussion and on the organization of the experimental explorative activities. Several studies shown the importance of PCK in order to develop a flexible teaching competence [8-11] but in the context of primary school teacher education, PCK is often left to individual initiative, on the basis of an academic education on CK and PK. It is not easy, therefore, to determine which kind of competences are developed by these teachers and the forms in which personal development takes place. In the context of the Italian Project Innovation in teaching/learning Physics IDIFO, seven educational labs were carried out with the purpose to promote teacher's conceptual change. Each of these labs was devoted to a different topic: energy, time, fluids, interactive white board, sound, electromagnetism, optics. In this paper a case-study is discussed on primary and kindergarten school teachers attending the "Vision and Optics Lab".

Background problems

In order to guarantee an adequate education it is important to take into account some background aspects: primary school teachers tend to teach science as they were taught, they are more familiar with PK than with CK, they don't know research results on students difficulties [12] and don't reflect on this problem in school activities.

Engaging children in activities concerning hypothesis building, eliciting ideas and interpretation of phenomena requires a change in teachers' way of thinking, which is difficult to obtain in this framework [6,13,14]. Building bridges between scientific perspective on the one hand, and common sense ideas and everyday experience on the other hand, is a practice which is more evoked than acted, even when teachers say they put children learning at the center of their work. In professional development we have to take into account the lack of scientific preparation that primary/kindergarten teachers feel to have. Previous experience in this field was acquired in the framework of the IDIFO Project on the Innovation in Physics teaching/learning and School- University Cooperation, where we acknowledged that Primary School Teachers need to improve their professional formation. Teachers claim a lack of self-confidence on conceptual discussion and organization of the experimental explorative activities.

They are interested in learning methods and practical ways to apply innovative educational proposals. Beyond these aspects, they show difficulties in expressing their specific needs for an effective professional development. Several studies have shown that teachers don't really know what PCK is or, at least, it results to be a tacit knowledge and it isn't used consciously by teachers (Kind, 2009). They don't know research results on student's difficulties [12] and they don't reflect on this problem in school activities. A significant teacher's education should guarantee a change in teacher's view on scientific education and the development of awareness on his own educational practices by means of his real engagement in learning processes.

In this empirical study, the Model of Educational Reconstruction (MER) was used both as a frame for research of subject related learning and teaching [16,17], and as a basis for teacher education. According to MER, an essential step in planning educational research is subject matter clarification, meant as a reconstruction of conceptual contents for educational purposes. Within teacher education, we used subject matter clarification as a way to foster in-service teacher reflection on subject matter as well as on the relevant crucial concepts and conceptual knots. The acquisition of a structured CK is the final goal of this reflection process. For what concerns the development of PK, a reflection on pedagogical competences in action was favored. The integration of this CK and PK in action is meant to develop PCK through teaching intervention experiments (monitored for what concerns learning environment and students learning trajectories), and to produce professional development by means of reflection on learning data and the experience done (metareflection).

This project aims at addressing the following facets of PCK: teacher awareness on the role of student learning trajectories in building their scientific knowledge, and the mastery of management of scientific activities based on active learning. At the end of the labs carried out in IDIFO4 project, teachers should be able to build learning environments favouring a gradual construction of knowledge rather than transmission of information. In this context, PK represents a competence in identifying learning paths as well as strategies and

methods to promote conceptual change starting from common ideas, by means of research based materials offered during teacher education.

The interplay between researches based educational proposals and educational experiments carried out in the class aims at producing discussion and sharing of PCK elements.

Our proposal for professional development: educational labs in which is activated a co-design between researchers and teachers

In the framework of Scientific Degree Plan (PLS), University of Udine is leader partner in the IDIFO Project on Innovation in teaching/learning Physics with primary, kindergarten and secondary school teachers. In this context, seven educational labs were carried out inside a period of five months on different topics as indicated in Table 1. The labs aimed at:

- Helping teachers become aware of their educational practices in order to activate a meta-reflection on it.
- Offering examples of pupils engagement in learning processes.
- Building bridges between scientific perspective, common sense ideas and everyday experience in science (Michelini, 2006).
- Promoting transformation from skills to deep competences in order to shape the educational path.

Each lab lasted 15 hours and was organized in the following stages:

1. Design of an interview with students, including discussion of questions to be posed.
2. Interview with teachers by means of validated questions taken from research literature on conceptual knots.
3. Collective discussion on teachers answers and key-concepts of the scientific content addressed in the lab.
4. Analysis of an educational path and development of teacher knowledge on knots and on conceptual issues (Metacultural Model).
5. Experimental exploration of educational instruments used during the educational path (Experiential Model).
6. Sharing a micro-teaching project and a monitoring of learning.
7. Educational intervention of each teacher in his/her own class (Situating Model).
8. Collective analysis of data obtained during educational intervention in class and design of a new educational intervention on the same topic (learning environment, strategies, methods and contents).
9. Teachers discussion with their own students on the results of data analysis and promotion of an action research process shared between teacher and students, in which teachers acquire a new competence and students experience active-learning.
10. Collective discussion between teachers and researchers.

The activities of the IDIFO educational labs suggest a gradual change in teachers' view of scientific education. The labs furthermore offer significant examples of pupils engagement in learning processes, center the scientific education practices on children eliciting of ideas, hypothesis and interpretation of phenomena, put in action the central role of pupils learning.

Table 1. Different educational labs

LAB	CONTENTS	TEACHERS
TIME	Time measurement – Instant and time interval	-2 kindergarten
	Periodic events – Contemporary events	-3 primary
FLUIDS	Properties of fluids – Density and viscosity	-9 kindergarten
	Pressure – Weight and volume – Principles of Archimede and of Pascal	-3 primary
SOUND	Wave nature of sound – So und sources	-7 kindergarten
	Intensity-frequency – timbre – Sound propagation	-2 primary
ENERGY	Energy without work – Energy transformation	-14 primary
	Energy conservation – Types of energy vs energy sources	
ELECTRO MAGNETISM	Interaction between ferro-magnetic objects	-8 kindergarten
	Interaction between magnets	
	The electromagnetic field	
INTERACTIVE WHITE BOARD	Use of interactive white board referring to - Optics Model - Motion	-2 primary
OPTICS	- the students' models of vision - the nature of light - reflection - refraction of light - color of light - decomposition of white light	-3 primary -1 kindergarten

Methods

During the labs, the professional development of teachers was supported by different tools referred to Science Education Research:

- Research materials to activate collective discussions on stimulus questions, interactive lessons and hands-on experience of teachers.
- Step by step research discussion on active teaching: an iterative process of co-design of researchers and teachers, data analysis of classroom products and analysis of key concepts and pupils previous work (statements, drawings) according to the research practices.
- Research based educational path as experimental explorations of open hands-on tools [15].

We recorded on audio tape each collective discussion and data analysis made by teachers together with our research group, writing down CK/PK statements, questions posed, operative proposals, teachers' ideas/models/beliefs on specific topics, in order to monitor conceptual change during the labs.

We used tutorials to deepen the explanation of teacher's ideas on «optics» and then we applied the co-design between researchers and teachers in order to identify worksheets to be administered to pupils.

Qualitative data analysis of children products in the class (texts, drawings, audio recording of verbal explanations of the formers) was performed during stage 8 of each lab, identifying categories on the basis of conceptual elements introduced by student answers/drawings.

Data analysis of teachers learning was performed in two steps: the first one inside stage 10 on a collective level, and the second one by researchers. The latter included A) a phenomenographic analysis of conceptual change profiles emerging from audio-recording and transcripts of every statement made by teachers during the labs; B) analysis of teachers reports according to the following rubric: knots (on the basis of teacher statements and children's products), key-concepts, internal coherence of the path, innovative elements, teacher autonomy in planning activities, methods used during educational interventions in the class.

Features of Optics Lab

Optics lab engaged three in-service primary teachers and one kindergarten school teacher, all working in schools close to the Udine (less than thirty kilometres). All of them are female. All but one have been teachers in-service for at least 7 years. Among these teachers, only one has earned a master's degree, the others only high school diploma. The instructors are two researchers of 50 and 31 years old, respectively senior researcher and young researcher, the first one with a physics master degree and long experience in science education research, the latter with a primary school education master degree and in her first years in research.

Contents explored include student models of vision, the nature of light and the ray model, interpretation of light according to geometric and physics optics, reflection, refraction of light, color of light and decomposition of white light, spectrum of emission, perception of color as interaction between light, eye and object, sources, propagation phenomena and light-matter interaction.

Concerning content structure, the lab dealt with three different aspects of the optical processes: sources, propagation phenomena and light-matter interaction. From these perspectives physics education researchers and teachers addressed student ideas on the models of vision; they discussed pupils spontaneous statements concerning the word 'light' and light-phenomena, light sources and vision models, collected in teachers classrooms. They discussed in cooperative way children emergent ideas in classroom activities.

Teachers suggested pupils to elicit their opinion about light by means of drawings, writing answers/stories and recorded discussion sentences. During the meetings, we recorded teachers' questions and their answers to stimulus questions asked by researchers. Teachers asked for example "How could we make clear physics content hidden behind experiments? Pupils usually focus on the game and don't understand the content".

Table 2. Typical questions asked by teachers

Teachers	Typical questions
Primary	<p>What is the difference between an opaque object and one that makes shadow?</p> <p>What is the difference between reflection and the shadow?</p> <p>Is refraction similar to reflection?</p>
Kindergarten	<p>Is the color of an object a feature specifically possessed by the object?</p> <p>Does the color exist by itself?</p>

Work and data analysis methods, their results and teachers' opinions on the role of the activities in their professional development are significant for in-service teachers education in order to promote integration between research and education.

Main Results

The educational lab started with a critical discussion on what kind of questions a teacher should ask children in order to elicit their ideas about vision and optics.

The interview design activity (stage 1) elicited teachers' approach to the topic: all of them formulated extremely abstract and global questions concerning the identification of light as an entity (e.g. "what is light in your opinion?"). Three teachers on four also asked about unspecified examples and experiences of light phenomena: "tell me what light does around us", "talk about your experience with light".

After lab activities described in stages 2-6, a significant conceptual change was observed. In stage 7 teachers asked pupils specific questions on optics from a scientific point of view:

- "what do you need to see?"
- "how do you see?"
- "draw a picture in which you relate different elements necessary to see"
- "write three things that make light"
- "write three sentences with the word "light"'"
- "find pictures in which you can see things that reflect themselves"

Sixty percent of questions taken from literature were used by teachers in the original form (2) or with some changes in order to adjust them for smaller pupils with respect to their spontaneous ideas elicited in teacher's data analysis (2).

By using validated research based materials, teachers faced questionnaires, interviews, worksheets where topics aren't addressed in a generic and naive way, but with methods favouring student reasoning on scientific content. In this way, we meant to promote teacher's reflection on scientific content (light rectilinear propagation and its effects: shadow, upside down images in a camera obscura, reflection, diffusion, refraction, absorption, colour) as well as their reflection on educational paths and on the design of

new proposals grounded on reasoning coherence and on the link between phenomena and formal thinking. Different strategies for the building of formal thinking were planned (trajectory - objectification with a wool wire, tracking of the optical path of a reflected and refracted light ray; reconstruction of a refracted image; identification of the position of virtual image in a mirror).

Step by step discussions on active teaching promoted the explanation of educational practices in order to become aware of the different components needed for an effective scientific education and to address the role of the exploration of phenomena in learning processes, children's ideas and difficulties, their reasoning in relationship with phenomena and finally how to address the development of formal thinking. Teachers reports concerns at least four teaching intervention in class. Related logbooks include wider and wider information with respect to the learning processes of observed children. Already in the second teaching intervention, they include – as terms of comparison or alternative proposals - references to paths presented in the lab and discussed with colleagues during teacher formation activities. Gradually the design of the future activities became more tightly linked to the experiential exploration activity offered and to the different reasoning paths of students. However no teacher presented a complete report on each student's educational learning process: generally, teachers mentioned only those typical sentences and reasoning of students they found interesting, and reported frequencies in a semi-qualitative way (a few, some, many, etc...).

Conclusions

By unifying the contribution of each model in the framework of MER, we can promote not only PCK achievement but also a conscious process in doing it. In fact, in the final stage (stage 10) all teachers discussed by means of a grounded meta-cultural list on the basis of the results of their educational intervention in class (stage 7) and identification of knots and key-concepts. Together with researchers, they developed instruments for empirical research independently from their immediate use in the class, but as a guide for future investigations on the ideas of their student.

Physics education researchers and teachers addressed pupils' ideas on the models of vision, discussed pupils' spontaneous statements on 'light' and light-phenomena, light sources, vision models collected in teachers classrooms to make the path suitable to specific children population, discussed children's ideas in cooperative way during classroom activities for a continuous link with the real practice.

Students' ideas on light phenomena and teachers' opinions on their educational role are significant for an analysis on in-service teachers professional development and promote an integration between research and education.

It is important to identify methods to improve teacher awareness of their needs, in order to create a real co-design between researchers and primary school teachers. We suggest that by means of educational labs it is possible to elicit teacher's needs, suggesting educational paths suited to pupils.

References

- [1] Bryan A., Abell S. K.: (1999), Development of Professional Knowledge in Learning to Teach Elementary Science, *Journal of Research in Science Teaching* VOL. 36, NO. 2, PP. 121–139.

- [2] Abell S.K.: Twenty Years Later: Does pedagogical content knowledge remain a useful idea? *International Journal of Science Education*, Vol. 30, No. 10, 13 August 2008, pp. 1405–1416.
- [3] Christian O., Manfred P., Duit R.: (2011), Improving science and Mathematics Instruction the SINUS Project as an example of reform as a teacher professional development, *International journal of science education*, 32, 03 (2010).
- [4] Michelini M.: (ed.) (2004), *Quality Development in the teacher Education and Training*, Girep book of selected papers, Forum, Udine [ISBN 88-8420-225-6].
- [5] Michelini M., Stefanel A.: (2011) Prospective primary teachers and physics Pedagogical Content Knowledge's, <http://www.univ-reims.fr/site/evenement/girep-icpe-mptl-2010-reims-international>
- [6] Heron P., Michelini M., Stefanel A.: (2010) Evaluating pedagogical content knowledge of energy of prospective teachers, Rogers L. et al., *Community and Cooperation*, GIREP-EPEC & PHEC Conference 2009 Selected Paper Book.
- [7] Psillos D., Sperandeo R. M.: (2011), Pre-service science teacher education, ESERA 2011 Proceedengs.
- [8] Shulman L. S.: (1987), Knowledge and teaching: foundations of the new reform, *Harvard Educational Review* Vol. 57 No. 1 February.
- [9] Gess-Newsome J.: (1999) Pedagogical content knowledge: an introduction and orientation In: *Explaining Pedagogical Content Knowledge* Eds Gess-Newsome J. and Lederman N. Dordrecht: Kluwer.
- [10] Magnusson, Krajcik & Borko: (1999). In J. Gess-Newsome & N. G. Lederman (Eds.), (pp.95-132) Dordrecht, The Netherlands: Kluwer Academic.
- [11] Kind V.: (2009), Pedagogical content knowledge in science education: perspectives and potential for progress, *Studies in science education*, 45 (2). pp. 169-204.
- [12] McDermott L., Shaffer S. P., Constantinou C. P.: (2000), Preparing teachers to teach physics and physical science by inquiry *Phys. Educ.* 35 (6) 411.
- [13] McDermott L.C.: 1990. Millikan Lecture 1990: What we teach and what is learned — Closing the gap. *American Journal of Physics* 59: 301-315.
- [14] Michelini M.: *The Learning Challenge: A Bridge between everyday experience & scient know*, in Planinsic G. et.al (Eds.) (GIREP, Ljubljana, 2006), pp. 18-39.
- [15] Bosatta G. et.al: (1996) *Games, Experiments Ideas in Teaching the Science of Condensed Matter and New Materials*, GIREP- ICPE Book, Forum, Udine, p. 445.
- [16] Duit R., Gropengiesser H., Kattmann U.: (2004). *Towards science education research that is relevant for improving practice: the model of educational reconstruction*. Esera summer school 2004.
- [17] Duit R.: (2006) *Science Education Research – An Indispensable Prerequisite for Improving Instructional Practice*, ESERA Summer School, Braga, July 2006.

Pedagogical Content Knowledge of a Mexican secondary school Science Teacher on Kinetic Molecular Model

Esther Marín, Lina Viviana Melo Niño, Florentina Cañada

Dept. Science and Mathematics Education, Faculty of Education, University of Extremadura, Badajoz, Spain

Abstract

The overall objective of the present work was to characterize the initial Pedagogical Content Knowledge (PCK) of five (5) Mexican science teachers about the Kinetic Molecular Model [1] in the first years of a new curriculum in secondary education (Science II-Emphasis in Physics). We analyse the PCK of each teacher attending the five components of Magnusson et al. [2]: a) orientation toward science teaching, b) knowledge of the curriculum, c) knowledge of the pupils, d) knowledge of instructional strategies, and d) knowledge of evaluation.

Keywords: pedagogical content knowledge, secondary school, kinetic molecular model

Introduction

In 1983 Lee Shulman [3] develop the concept, Pedagogical Content Knowledge (PCK) to locate as knowledge develops in the minds of teachers, Shulman [3] noted that, together with general psychopedagogical knowledge and knowledge of the subject matter, teachers develop a specific body of knowledge concerning the form in which they teach their subject – their ‘pedagogical content knowledge’ (PCK). We assumed the PCK is not merely a static mixture of knowledge from different areas. Rather, it is the teacher's transformation and integration of this knowledge into an active and dynamic process [4], based on reflection-in-action [1].

The overall objective of the present work was to characterize the initial Pedagogical Content Knowledge (PCK) of five (5) Mexican science teachers about the Kinetic Molecular Model in the first years of a new curriculum in secondary education (Science II-Emphasis in Physics) [5]. We analyse the PCK of each teacher attending the five components of Magnusson et.al [2].

Currently in Mexico, the curriculum of Science II (Secondary Education) [6] have been renovate to integrate subjects together (vertically) and also their contents (horizontally). It is our interents to analyze what are the knowledge, skills, abilities, attitudes, provisions, a group of secondary teachers must have to assume this new curriculum. For this reason, we need to do a zoom into the teachers to see their PCK.

Background to the investigation

The Pedagogical Content Knowledge (PCK) "*goes beyond knowledge of subject matter per se to the dimension of subject matter knowledge for teaching*" (Shulman [3], p. 9). Pedagogical content knowledge is specific to how each particular subject is taught, and is a form of reasoning and educational action by means of which teachers transform the subject matter into representations that are comprehensible to the pupils. The understanding about relationship between each of the components of the PCK, rests on state of consciousness of each teacher, where they do introspection of their own practice.

The study on "kinetic molecular model" is crucial to be able to explain, for example, the differences between the different states of matter, its properties and changes physical or chemical [7,8,9]. We adopted Magnusson et.al [2] model. They claimed that PCK is composed of five components a) orientation toward science teaching, b) knowledge of science curriculum c) knowledge of science assessment d) knowledge of student's understanding of science and e) knowledge of science assessment. In addition, these components were our categories. We consider teachers participants of this study such as part of the investigation and not as data alone.

Research Objectives

The overall objective of the present work was to characterize the initial PCK of five (5) Mexican science teachers about the Kinetic Molecular Model in the first years of a new curriculum in secondary education (*Science II-Emphasis in Physics*), through of the content of the PCK components. This overall objective was broken down into the following five research questions:

- What are the participating teachers' orientations (i.e. visions and goals) in teaching science?
- What are your knowledge and beliefs about the science curriculum in secondary education?
- What are your knowledge and beliefs about the understanding of their students about the topic of "molecular kinetic model"?
- What are knowledge and beliefs about strategies for teaching science?
- What are your knowledge and beliefs about assessment in science?

Methodology

This research is determined by a qualitative paradigm, it is based on interpretive arguments of a case and a topic in particular. The participating teachers have different degrees: physics, veterinarian, engineer and degree in pedagogy with emphasis in physics, biology of science in general, with an age between 29 and 46 years old, and between 5 and 15 years teaching experience. The ages of their pupils ranged between 13 and 15 years old.

Data collection and analysis procedures were: (i) the curricular materials the teachers used; (ii) the lesson plans (1998); and (iii) the matrix designed by Loughran, Berry & Mulhall [10] to represent content (ReCo), to which some modifications were made in the number of questions. The data were analyzed following an iterative and systematic procedure that included both inductive and deductive processes.

Results: Initial Specifications of PCK

Data obtained with the ReCo instrument for each teacher are organized and analyzed together. Central ideas of each one are identified. A resume of those ideas are more frequents or overlapped in the majority of the teachers are selected (Figure 1).

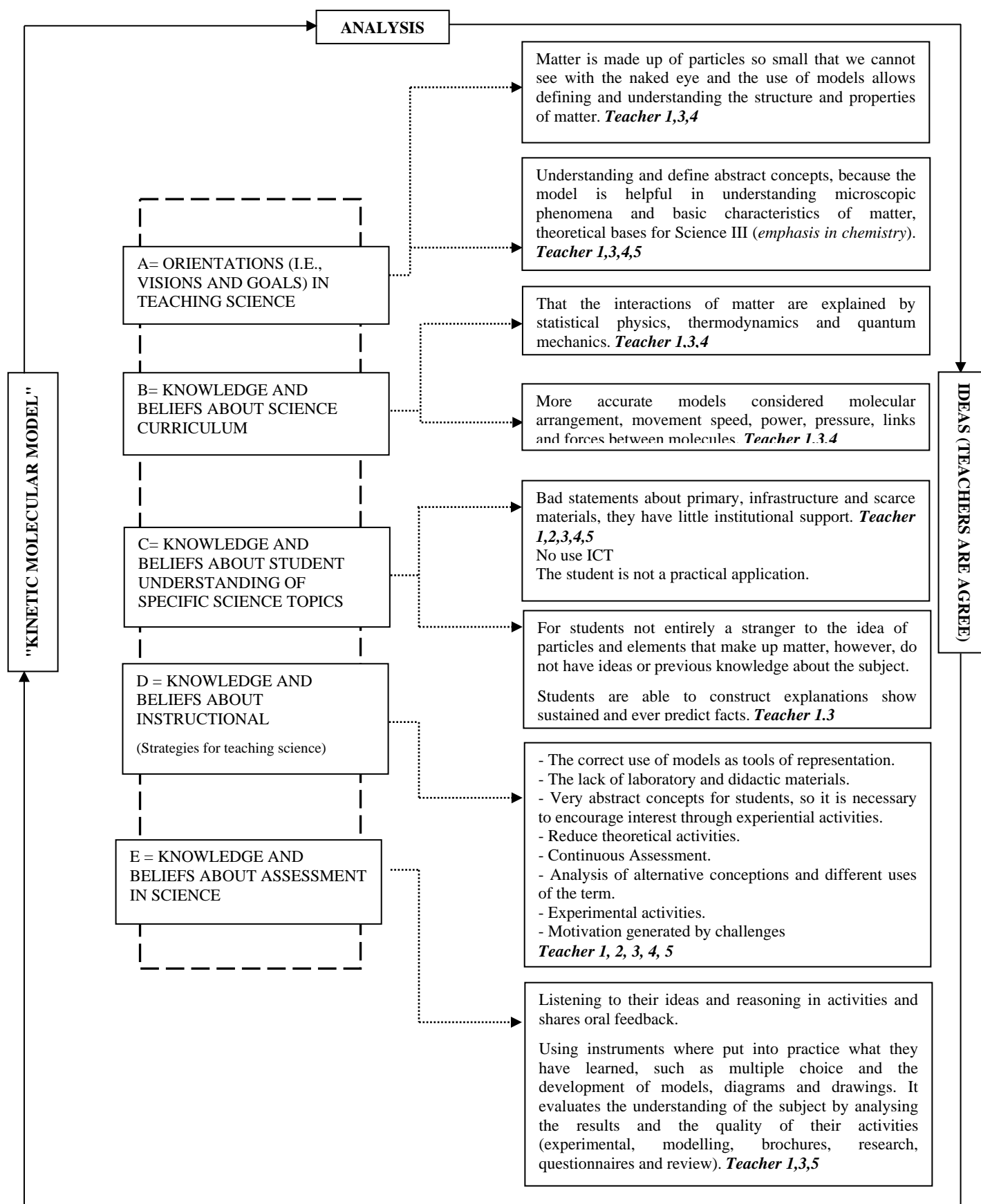

Figure 1. The main ideas that match most of the teachers

Analysis of didactic sequences (lesson plan). For the concept of "molecular kinetic model" in the didactic sequences, we can identify as teachers organize their knowledge and prepare their implementation. In the following analysis, we highlight the elements of the PCK that are embodied in the planning of each teacher. The characteristic features of each category analyzed are expressed in the Tables bellow (Table 1 to Table 5) where we are summarized the profile of each one of the 5 teachers, and we give a picture of his/her PCK.

Table 1. Teacher 1, PCK Profile

Components of PCK	Teacher 1
<i>Orientations (i.e., visions and goals) in teaching science.</i>	- Using models to explain physical phenomena.
<i>Knowledge of the Curriculum</i>	- The models most accurate consider molecular arrangement, movement speed, power, pressure, links and forces between molecules. - Teacher expressed a broad knowledge of the science (horizontal and vertical) curriculum. He establishes relationship with other subjects.
<i>Knowledge of the students face to learning the molecular kinetic model</i>	Teacher 1 does not take into account the previous ideas or preconceptions of the student. Teacher uses a metaphor "blank sheet" to define their students. ACTIVITIES FOR STUDENT: - Calculate the density of the water, oil, and of the various metal objects through the density equation. - Excursive textbook. - Written report on various hand-drawn models - Teacher takes the use of biographies, than students know since primary school.
<i>Knowledge about the teaching strategies</i>	- The activities have a didactic sequence, even so, they do not cover expected profile of the learner. - Theoretical explain of teacher
<i>Knowledge about the types of assessment</i>	Summative evaluation

Summary PCK profile: All the activities of **teacher 1 (T1)** begin with theoretical exposure. T1 consider in her teaching, science products, qualitative aspects and different contents (conceptual, procedural and attitudinal) but he does not think in the student role. However T1 does not explain what he assessment, and in what time he should evaluate. Define the type of evaluation allows for congruence with the educational aims and, purposes of the lesson plan. In general, T1 who has 5 years of experience but only 1 year he teach Science II, he is the protagonist of the process learning-teaching, and his practice has a higher theoretical load. He does not use strategies for engaging the pupil learning and, he is not using the assessment as a parameter to modify the activities.

Table 2. Teacher 2 PCK Profile

Components PCK	Teacher 2
<i>Orientations (i.e.,visions and goals) in teaching science.</i>	Teacher has to know some thinks about historical development of scientific thought. He indicates that every teacher should know how theories/models have been building, as part of the teaching process.
<i>Knowledge of the Curriculum</i>	He locate the theme and sub-topics into structure of the science curriculum in secondary.
<i>Knowledge of the students face to learning the molecular kinetic model</i>	He does not take into account the previous ideas or preconceptions of the students as a starting point, therefore the effectiveness of his activities as generators of new knowledge and a significant learning are not validated.
	<p>ACTIVITIES OF THE STUDENT: read and discuss books.</p> <ul style="list-style-type: none"> -Complement comparative tables. -Draw examples of states of matter aggregation. -Relate them to the concept of force and pressure. -In the laboratory, students will build a model to explain the molecular organization in the states of aggregation of matter. -Develop and pasted posters with the ideas and contributions of the most important item.
<i>Knowledge about the teaching strategies</i>	The activities are organized hierarchically. Students are the main generator of the teaching-learning process
<i>Knowledge about the types of assessment</i>	He evaluates each of the activities, as well as the performance in the individual work and group work.

Summary PCK profile: For **Teacher 2 (T2)**, the activities for the student are the main element in the teaching-learning process. All the activities are designed to develop skills: understanding (readings), handling and analysis of the information. The diversity of activities show us that the teacher has knowledge about the methodology and strategies of learning in science. T2 provides to students several spaces of action (laboratory, library...) where the active participation of the learner is central. The activities are characterized by a learning based on the discovery. T2 puts emphasis on the active participation of students, learning of the students and the application of the processes of science, because he thinks those are alternatives to passive methods based on the routine and memorization.

Table 3. Teacher 3 PCK Profile

Components PCK	Teacher 3
<i>Orientations (i.e.,visions and goals) in teaching science.</i>	Models are not absolute. They may be perfect including, items are discovered. -Students have control a minimum of a knowledge by general culture. - Reality can be explained using models.
<i>Knowledge of the Curriculum</i>	He locate the theme and sub-topics into structure of the science curriculum in secondary.
<i>Knowledge of the students face to learning the molecular kinetic model</i>	He takes into account the previous ideas of the student. He does a diagnosis of previous ideas. He says, he controls the evolutions of those ideas in classes. Starting activity: framing, presentation of the topic and examples of models. The student takes notes. Development: Teacher 3 establishes links between the different states of aggregation and their molecular organization. Closing activity: interpretation of the main ideas and analysis on the importance of the topic.
<i>Knowledge about the teaching strategies</i>	The activities are organized in didactic sequence. Teacher 3 emphasizes the use of ICT. During the class, Teacher 3 performs clarification and resolve doubts.
<i>Knowledge about the types of assessment</i>	-Diagnostic assessment: individual holdings. -Summative assessment: Registration in the notebook of the activity, ability to infer and describe phenomena. -Formative Evaluation: oral participation, ability to interpret the phenomena of nature

Summary PCK profile: Teacher 3 (T3) defines the expected program and locates the subject and the sub-themes according to the curriculum. He use starting activities, development and closing activities, but always in function of his theoretical exposure, although he uses several materials. T3 knows the plans and curricula. He knows the teaching suggestions that are mentioned into the plans and curricula. T3 uses three typos of assessments: diagnostic, summative and formative. He uses techniques of individual participation (brainstorm), and takes into account into account previous ideas to develop in classes.

Table 4. Teacher 4 PCK Profile

Components PCK	Teacher 4
<i>Orientations (i.e.,visions and goals) in teaching</i>	-Teacher 4 identifies changes throughout the history of the kinetic model of particles and associates it, with the unfinished nature of science. -He values the contribution from Newton to Boltzmann, to get the construction of a kinetic model. -Students have control a minimum of a knowledge by general culture.
<i>Knowledge of the Curriculum</i>	-He locate the theme and sub-topics into structure of the science curriculum in secondary. -Teacher 4 expressed a broad knowledge of the science (horizontal and vertical) curriculum. He establics relationship with other subjects.
<i>Knowledge of the students face to learning the molecular kinetic model</i>	The background of the pupils are of Natural Sciences. Each student work individually and in teams. They respond questionnaires and develop comparative tables on general and specific properties of matter. They resolve exercises and density calculations.
<i>Knowledge about the teaching strategies</i>	-The activities are organized in didactic sequence. Teacher 3 emphasizes the use of ICT. -During the class, Teacher 4 performs clarification and resolve doubts. -The class is focused on the teacher's exposition
<i>Knowledge about the types of assessment</i>	Summative evaluation: Bimonthly evaluation, type test

Summary PCK profile: Teacher 4 (T4) does experimental activities. However these activities are centred on a specific topic, (general properties of matter) they are not part of our expected learning. It is a clear example of, the teacher knows what are expected learning of the items, but he does not develop the specific activities for it.

Sometimes T4 deepens only, on topic he considers important (hidden curriculum). T4 does not understand curriculum organization fully. It is a limiting factor.

Table 5. Teacher 5 PCK Profile

Components PCK	Teacher 5
<i>Orientations (i.e.,visions and goals) in teaching</i>	Teacher compares the concept of matter consibe 200 years ago and the concept that students perceive
<i>Knowledge of the Curriculum</i>	-Teacher 5 expressed a broad knowledge of the science (horizontal and vertical) curriculum. He establics relationship with other subjects.
<i>Knowledge of the students face to learning the molecular kinetic model</i>	Each student work individually and in teams. They respond questionnaires and develop comparative tables on general and specific properties of matter. They resolve exercises and density calculations.
<i>Knowledge about the teaching strategies</i>	- <i>Teacher claims:</i> -Sometimes I don't know if my students achievement o if I was right. Always I looks for tools or resources of my around to demonstrate some peculiarities of the science, for example when you light a candle without a wick- they (students) discover what happens- - I do not have idea (I lack imagination) on how can I use the kinetic models of particles and Newton's theories. I just include videos or programs to: enhance all thinks, I say in class; show my students a proff in research
<i>Knowledge about the types of assessment</i>	The evaluation of treatment that is nuanced, trying to identify their strengths, weaknesses, skills, values, cognitive level, and emotional level whilst trying to be as impartial as possible.

Summary PCK profile: Teacher 5 (T5) raises the importance of understanding the microscopic phenomena through tools such as models, because they allow to understand and explain the behavior of matter and "enhance skills". It is directly related as generation of images and representations through of analysis of the molecular kinetic model of matter. T5 claims, the study of phenomena is as a bridge between two levels of abstraction: the macroscopic and microscopic.

Conclusion

Teachers believe the subject is important to teach the students because they can understand abstract concepts, microscopic phenomena and basic characteristics of matter, however, teachers do not have an understanding the logical structure of content this new thematic organization. The interactions on vertical and horizontal curricula do not successful because the topics of different blocks subjects remain fragmented into the teacher's mind.

For teachers, knowledge involves processes of reflection on existing theories, and they consider important to know the pupils' ideas. However about this topic, teachers consider students do not have a good idea about matter, only they recognize the particle as part constitutive of the matter after instructions. Teachers believe these problems are due to the preparation that students have at primary school, lack of institutional support in the development of new proposals and infrastructure.

They asses is a mechanical processes continue of learning and problem solving (pencil and paper) for all teachers. They do not carry out an assessment of skills, where students can take decisions, with collaborative work. Teaching sequences does not have enough activities to cover at least the learning outcomes of the subject. Teachers fail to articulate hierarchically activities for building integrated concepts: pressure, temperature, heat.

Acknowledgements

This work was financed by Research Project EDU2012-34140 of the Ministry of Economy and Competitiveness of Spain. L.M. wishes to express her gratitude to the Universidad de Extremadura for the award of a pre-doctoral studentship and to the project GR1075 of Govern of Extremadura supports of this work.

References

- [1] Mellado V., Blanco L. J., Ruiz C.: A framework for learning to teach sciences in initial teacher education. *Journal of Science Teacher Education*. 9, 195 (1998).
- [2] Magnusson S., Krajcik J., y Borko H.: (1999). Nature, Sources and Development of Pedagogical Content Knowledge for Science Teaching. En Gess-Newsome, J. y Lederman, N (Eds). *Examining Pedagogical Content Knowledge. The Construct and its Implications for Science Education*. Dordrecht, Boston, London: Kluwer Academic Publisher, p. 95-132.
- [3] Shulman L. S.: Those who understand: Knowledge growth in teaching. *Educ. Res.* 15, No. 4 (1986).
- [4] Friedrichsen P, Abell S., Pareja E., Brown: Does teaching experience matter? Examining biology teachers prior knowledge for teaching in an alternative certification program. *J. Res. Sci. Teach.* 46, 357 (2009).

- [5] SEP, Secretaría de Educación Pública, (2006). *Plan de Estudios 2006*. Educación básica. Secundaria México, D. F.
- [6] SEP, Secretaria de Educación Publica, (2006). *Reforma de la Educación Secundaria Fundamentación Curricular. Ciencias*. Primera edición, México, D.F.
- [7] Benarroch A.: (2000) Del modelo cinético-corpúscular a los modelos atómicos. Reflexiones didácticas, *Alambique. Didáctica de las Ciencias Experimentales* 23, 95-108.
- [8] Gómez-Cresp M. A. y Pozo J. I.: (2007). Relaciones entre el conocimiento cotidiano y el conocimiento científico: comprendiendo cómo cambia la materia (1)” *Rev. Eureka. Enseñ. Divul. Cien*, 4(2), 367-37.
- [9] Garritz A.: (2006). El Conocimiento Pedagógico de la estructura corpúscular de la materia. *IV Jornadas Internacionales para la enseñanza Preuniversitaria y Universitaria de la Química. Educación Química* 17[10].
- [10] Loughran J., Mulhall P., Berry A.: In Search of Pedagogical Content Knowledge in science: Developing ways of articulating and documenting professional practice, *J. Res. Sci. Teach.* 41, 370 (2004).

A pilot experience in physics laboratory for a vocational school

Vera Montalbano, Maria De Nicola, Simone Di Renzone and Serena Frati

Department of Physical Sciences, Earth and Environment, University of Siena, Siena, Italy

Abstract

The reform of the upper secondary school in Italy has recently introduced physics in the curricula of professional schools, where it was absent. Many teachers, often with a temporary position, are obliged to teaching physics in schools where the absence of the laboratory is added to the lack of interest of students who feel this matter as very far from their personal interests and from the preparation for the work which could expect from a professional school. We report a learning path for introducing students to the measurement of simple physical quantities, which continued with the study of some properties of matter (volume, mass, density) and ending with some elements of thermodynamics. Educational materials designed in order to involve students in an active learning, actions performed for improving the quality of laboratory experience and difficulties encountered are presented. Finally, we compare the active engagement of these students with a similar experience performed in a very different vocational school.

Keywords: Secondary education: lower (ages 11-15), vocational education, physics laboratory

Introduction

In few years the Italian educational system has been profoundly reformed. Secondary school reform introduced physics in the curricula of all vocational and technical schools, without any real involvement of teachers that work in these educational situations. Many teachers are facing realities in which the laboratory is absent and the students feel the matter as something useless for their professional training. This innovation may have been inspired by reflections on professional education referring to other realities [1,2] but it has not been accompanied with neither a specific training for teachers nor funds for implementing laboratories.

In the first year of the reform, one of the authors (M. D. N.) was teaching physics at a vocational school for commercial and tourist services where the new curriculum has included physics for 2 hours weekly only in the first class. The school was without laboratories but very close to the university.

Thus, she decided to use the support provided by the National Plan for Science Degree [3-5] (Piano Nazionale Lauree Scientifiche, i.e. PLS) to physics teachers without or with poor physics laboratory. The project was designed like a training activity for qualified teachers in a course of Master in Physics Educational Innovation and Orienting (IDIFO3) [6,7] and realized within the PLS.

The National Plan for Science Degree is promoted by the Ministry of Education and Scientific Research with the main purpose of contrasting the decline of students' interest in learning physics and the consequent decrease of enrolments science degree in Italy. The main actions of PLS has been to promote professional development for teachers and to orient students essentially by means of laboratory activities. The student is considered the

main character of learning, laboratory is mainly a method more than a place and joint planning by teachers and university is encouraged. In the last years, PLS have supported teachers in tackling difficulties encountered in the implementation of the various reforms which have been introduced in secondary school.

The Project

Since students were not schooled and poorly motivated, we decided in favour of designing a course of introduction to the measurement of simple physical quantities (length and area) in classroom. Then, the study of some properties of matter, such as volume, mass, density, continued in laboratory. The next step was to introduce some elements of thermodynamics (from the concepts of everyday use to the operational definition of temperature and heat). The final scheduled task was the construction and calibration of a thermometer.

The learning path was provided for two 1st classes (another class was excluded because it was considered by their teacher too undisciplined for a correct and safe participation) for a total of about 50 students (ages 14-15).

For the activities in the lab, always carried out during school hours, we scheduled 3 experiences (3 hours each one).

All the materials used in the laboratory were easily available and inexpensive (Figure 1) to encourage the school to become independent in the near future.



Figure 1. A balance, a digital thermometer, a Dewar vessel and various metal bars were utilized for investigating thermal equilibrium

A special care was paid in designing the operations to be done in order to ensure the safety of everyone even in the case of students not well accustomed to the correct behavior in laboratory.

In Laboratory

They were divided in small groups (3 or 4 students) and supported by at least 3 teachers (a university lecturer and two teachers). The first lab was dedicated to direct and indirect measurements of physical quantities, such as mass, volumes and densities. In the second lab, students started by observing the thermal equilibrium between solids (same mass and material, different mass and same material, same mass and different material) and solid/water in a Dewar flask. Then, a measure of heat capacity was realized.

The third lab should have been dedicated to construction and calibration of a thermometer but it was not realized for the reasons described in the next section.

- Management of activity outside the school, vacation and other difficulties delayed the labs, the two experiences were carried out only one month one from each other.
- Labs were carried out at the end of the school year, over a period not well suited.
- Students had not enough time for completing activities, which confirms the need to dilute the work in more parts, by planning less activities in each lab session.
- Dead times during the experimentation must be avoided, because pupils can have a decreasing of attention.
- Management of the security aspects can be more effective from educational point of view.
- Strategies are needed to reinforce the group's collaboration in the production of the common work, to avoid the tendency that the work is done by few.

The average level of the class and previous remarks led to mediocre results, for this reason the teacher gave a particular value in the assessment to participation, care and operative skills.

Students' behavior in laboratory observed through all teachers' observations, their informal comments and the examination of all other conditions that influenced the teaching/learning process were carefully analyzed and discussed in order to identify the main obstacles to the learning process. Mainly, it is possible to recognize different kinds of trouble source:

- The lack of motivation and interest is a real problem in this context, the hands-on activities are always appreciated but this is not enough if the topic is perceived as useless. Looking for examples more connected to their future professional world could favour the learning process.
- External conditions can be determinant for achieving acceptable results or an overwhelming defeat. In particular, the availability of a laboratory with a minimum of materials and a technical support that could allow to realize hands-on activity in a more effective way can make the difference in this kind of school. Thus, it could be possible to develop students skills in laboratory through less intense sessions in which they can have more time for inquiring, exploring, reflecting and consolidate their learning.
- A more effective organization in lab designing is necessary in this case, each step in the use of spaces and times must be carefully planned, tested and adapted to students reactions. In particular, the dynamics in and between groups must be investigated more in these borderline context in order to develop strategies useful in physics education.

Overall, students were involved in first steps of an active learning process, completely absent in other lectures, but the achieved results were still partial and disappointing from the point of view of physics learning. At the end, a consistent number of students used correctly the unit of measure, but not all. Almost all are able to evaluate the instrumental uncertainty for a measure in very easy cases, but few apply correctly the propagation of errors in an indirect measure. Finally, very few (not more than two or three) acquired confidence with calorimetric measurements or were able to compare correctly two measures. These results confirm that laboratory is a powerful tool for learning physics but more research in physics education is necessary for rendering effective learning processes in this difficult context.

Moreover, a first important step is to obtain the physics laboratory at school. Another important point is that physics teachers need more support in this case. The pilot

experience was performed two years ago and there was no way to continue this experience because all teachers try to stay less than possible in this school so every few months they change. Laboratory is still lacking and there is no sign of new projects for improving the learning process in physics such as in all other relevant but inadequate matters, e.g. mathematics.

The understanding of which aspects can be improved in this pilot experience has been an essential step for designing a successive learning path [9] in a different vocational school (an agricultural technical institute). In this case, the aim was to make interesting measures of physical quantities, calorimetry and state transitions connecting them to an instrument that students use in their professional career. Second classes has been involved and the main purpose of increasing students' attention on physics has been fully achieved [9].

References

- [1] Guile D., Young M.: Transfer and transition in vocational education: Some theoretical considerations, in T. Tuomi-Gröhn & Y. Engertröm (Eds.): *Between school and work. New perspectives on transfer and boundary-crossing* (pp. 63-81), Oxford. UK: Elsevier Science (2003).
- [2] *Shaping the Future 3 Physics in Vocational Courses*, Edited by Ken Gadd. Bristol: Institute of Physics Publishing (1999), ISBN 0 7503 06831.
- [3] PLS Website, (in Italian). [online]. [cit. 30. 6. 2013]. Available from: www.progettolaureescientifiche.eu
- [4] Chiefari G., Sassi E., Testa I. (2012): Improving secondary students' scientific literacy and laboratory skills: the Italian Project "Scientific Degrees", in *Proceedings of The World Conference on Physics Education 2012*, editor Mehmet Fatih Taşar, p. 53-63, Ankara: Pegem Akademi (2014). [online]. [cit. 31. 1. 2014]. Available from: <http://www.wcpe2012.org/>
- [5] Montalbano V.: Fostering Student Enrollment in Basic Sciences: the Case of Southern Tuscany, in *Proceedings of The 3rd International Multi-Conference on Complexity, Informatics and Cybernetics: IMCIC 2012*, ed. N. Callaos et al, 279, (2012), arXiv:1206.4261 [physics.ed-ph], [online]. [cit. 4. 10. 2013]. Available from: <http://arxiv.org/abs/1206.426>
- [6] Francaviglia M., Lorenzi M. G., Michelini M., Santi L., Stefanel A.: IDIFO3 - teachers formation on modern physics and mathematical foundations of quantum physics a cross sectional approach, *J. Appl. Math.* 5, No. 1(2012), p. 231- 240.
- [7] Battaglia R., Cazzaniga L., Corni F., De Ambrosis A., Fazio C., Giliberti M., Levri O., Michelini M., Mossenta A., Santi L., Sperandeo R. M., Stefanel A.: Master IDIFO (Innovazione Didattica in Fisica e Orientamento): a community of italian physics education researchers and teachers as a model for a research based in-service teacher development in modern physics, in D. Raine et al. eds., *Physics Community And Cooperation Volume 2, GIREP-EPEC & PHEC 2009 International Conference*. p. 97-136, LEICESTER: Lulu / The Centre for Interdisciplinary Science, ISBN: 978-1-4466-1139-5.
- [8] Lab worksheets (in italian) [online]. [cit. 11. 4. 2014]. Available from: https://www.researchgate.net/publication/261511275_scheda_masse_densit_volumi?ev=prf_pub .
https://www.researchgate.net/publication/261511281_Equilibrio_termico?ev=prf_pub

- [9] Benedetti R., Mariotti E., Montalbano V.: A First Steps into Physics in the Winery, in Proceedings of The World Conference on Physics Education 2012, editor Mehmet Fatih Taşar, p. 293-301, Ankara: Pegem Akademi (2014). [online]. [cit. 31. 1. 2014]. Available from: <http://www.wcpe2012.org/>

An inquiry-based laboratory on friction

Vera Montalbano

Department of Physical Sciences, Earth and Environment, University of Siena,
Siena, Italy

Abstract

Sliding friction is usually introduced in high school, but rarely through activities in laboratory. A qualitative introduction to friction is presented by proposing exploration of different kinds of materials in order to suggest which aspects can be relevant and which interaction is involved. Different quantitative experiments are proposed for studying Leonardo's laws for friction. The learning path was tested with two high school classes during an instruction trip at department. Students were engaged in the inquiry-based introductory activity and seemed to realize with care the measurements. However, the analysis of their reports shows some learning difficulties.

Keywords: Secondary education: upper (ages 15-19), friction, active learning in laboratory

Introduction

Friction is a complex phenomenon, usually missing in high school laboratory. Nevertheless, sliding friction is often introduced in the easier way in mechanics because of simple exercises which can be proposed on this subject. Another important aspect rarely explored in laboratory is the relation between static and kinetic friction.

Furthermore, a closer look in this topic allows to introduce interesting discussions on the structure of matter, the relations between macroscopic and microscopic modelling, which aspects of a phenomenon are really relevant, which others can be omitted and for which reason, and so on. Last but not least, friction can be the starting point for introducing students to the nanoscience world.

Relying on a recent study in higher education [1,2], a learning path on friction had been designed for high school students. The first activity was a qualitative explorative path on friction designed for stimulating discussions in a workshop in which physics teachers and students were involved. The unexpected reactions, especially from teachers, highlighted the necessity to realize a wider research [3] with the aim of improving the learning on this topic both in secondary school and in higher education.

The activity had been realized within the Italian National Plan for Science Degrees [4,5].

National Plan for Science Degrees

The decline of interest in studying science is a serious concern. In recent decades, a consistent decrease of graduates in science disciplines has been detected almost everywhere. In order to reverse this trend in Italy, the Ministry of Education and Scientific Research promoted since 2005 a wide national project (Progetto nazionale per le Lauree Scientifiche, i.e. PLS) [4].

The main actions of PLS were professional development for teachers and orientation for students, essentially by means of laboratory activities. In 2009, the National Plan for Science Degree (same acronym PLS) was launched and some of the most effective

methodological aspects of the previous project were emphasized in new guidelines [4,5] focused on:

- orienting to science degree by means of training
- the laboratory as a method not as a place
- the student must become the main character of learning
- favouring joint planning by teachers and university

In this context, we offered the opportunity for secondary classes of performing some learning paths in educational laboratories at university.

An introduction to friction in laboratory

The learning path on friction started with an initial inquiry-based explorative laboratory. Common materials, such as wood, were examined and their behaviour was easily predicted. Another common material with a totally different behaviour was examined in order to induce a cognitive conflict. A final activity suggested the correct interaction involved in all kinds of friction.

A quantitative laboratory followed the qualitative exploration. The same materials could be used for verifying the Leonardo's laws for sliding friction.

The laboratory on friction was tested by two 3rd classes of a scientific high school (44 students, age 16 – 17 y), during an educational trip at physics department. Sliding friction and Leonardo's laws were introduced, discussed and assessed in previous school time by their physics teacher. In the next section, the activities designed for the laboratory are presented together with some remarks on the learning process. A discussion on results, some learning difficulties and suggestions for further activities are given in the last section.

A qualitative introduction to friction

Students were invited to predict the behaviour of different sliding surfaces by using their previous knowledge and experience. Afterwards, they could realize and observe what really happened. New previsions were made and checked. Some hints were given by proposing an activity designed for selecting relevant aspects and the involved interaction. The students' description of the phenomenon changed during the qualitative path. All activities were realized with low-cost materials.

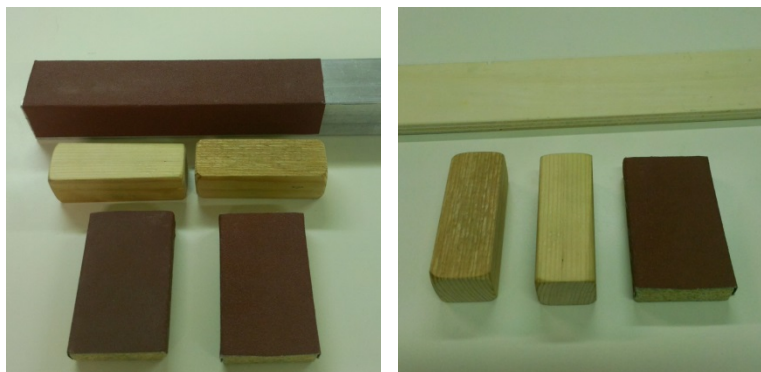

Figure 1. Different smooth and rough surfaces were explored

Students were guided by a detailed worksheet and the qualitative exploration lasted about 90 minutes, during which teachers were available to provide clarification, students were involved in animated discussions and in seeking consistent answers to the questions that were gradually raising.

Smooth and rough wooden surfaces and different types of sandpaper, like those showed in Figure 1, were examined. Sandpaper and wood were touched, predictions on sliding behaviour for surfaces with the same and different material or roughness were requested and tested soon after. A qualitative graph on how the friction force intensity varies with the roughness of the sliding surfaces had been guessed and drawn (see Figure 2).

Surface roughness is a measure of the texture of a surface. It can be quantified by the vertical deviations of a real surface from its ideal plan. Students could made roughly comparative evaluations of this texture parameter based upon tactile sense intensity. Human tactile perception can discriminate to the nanoscale, as shown in recent research [6], and questions on this part of the exploration can be the starting point for following discussions on the relevance of the nanoscale in everyday life.

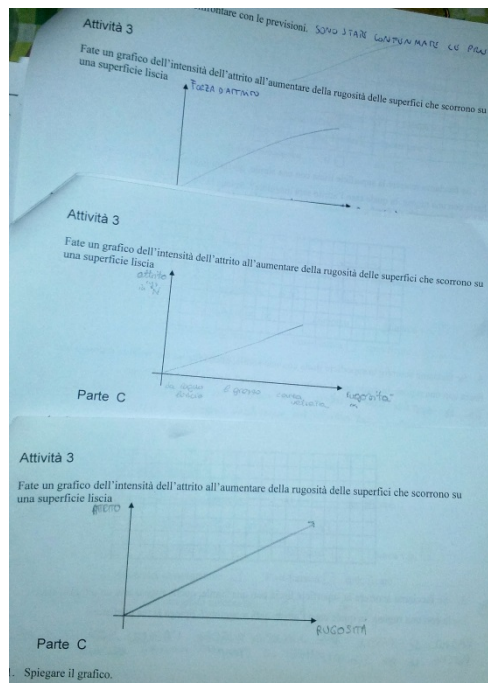

Figure 2. All students draw essentially a direct proportional behaviour for friction force intensity vs. surface roughness

Almost all students sketched a graph of friction force intensity vs. surface roughness very similar to those found in an analogous study in higher education [2].

Some remarks can be done by observing the graphs showed in Figure 2. All students seemed to identify an increasing dependence with a linear function. Moreover, recent observations with wooden surfaces and sandpapers were extended to region of roughness not observed, without any doubt that could exist a different behaviour (specific questions on this point were inserted in the worksheet and the answers were very clear).

Afterwards, metal blocks (showed in Figure 3) with rough and smooth surfaces were examined and a new prevision requested. All students were consistent with the general dependence drawn in their previous graphs, but this time the following test failed in confirming their previsions. Thus, students were engaged in a cognitive conflict.

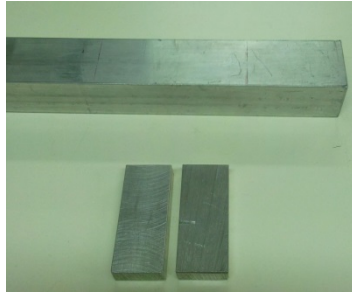

Figure 3. Metal blocks with different roughness were examined

A hint for resolving this conflict was given by the final activity. Students started from a macroscopic perspective in which friction is simply due to mechanical interactions of the atoms (interlocking or intertwining, rubbing or hitting bumps and valleys). A sheet of paper and a transparency were made sliding in different conditions (see Figure 4) suggesting that the correct interaction involved in friction is the electromagnetic one. Thus, students were introduced to the microscopic underpinnings of friction.

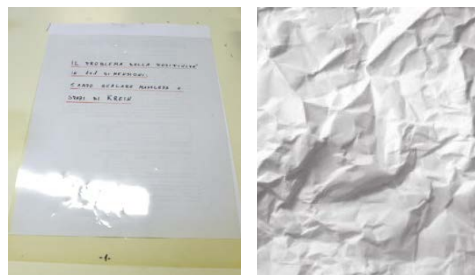

Figure 4. A transparency slides with difficulty on a sheet of paper electrostatically charged by rubbing (on the left), but it slides easier if the sheet was crumpled and flattened with hands (on the right)

Moreover, the relation between the friction force intensity and the area of contact spontaneously emerged as well as the possibility that the apparent area of contact can be different from the real one.

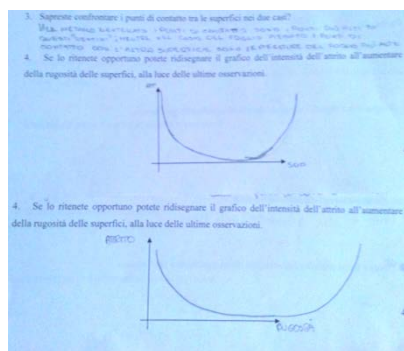

Figure 5. Revised graph of friction force versus roughness of the sliding surfaces according to observations

Finally, students could make a new graph of friction force vs. roughness, if they believed it was necessary. The most part of students (74%) revised their graph, but only few of them (4%) were able to sketch the one consistent with all previous observations (Figure 5) and according with the evidence from phenomenology [7].

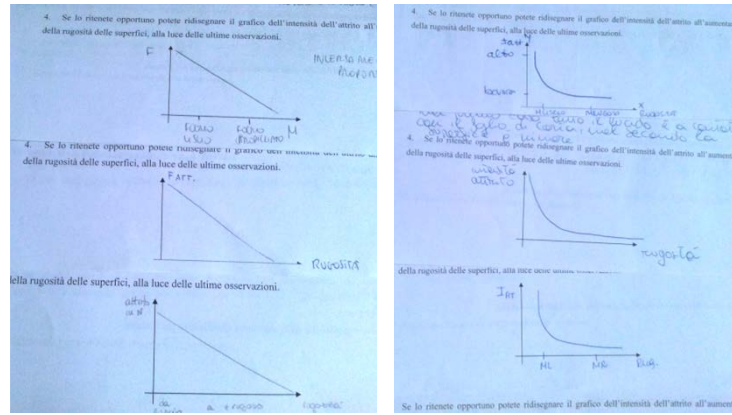

Figure 6. Other graphs can be equally divided in linear decreasing functions (on the left) and a decreasing hyperbolic function (on the right)

The most part of students gave more relevance to the last experience in laboratory and avoid connecting last and previous observations in a consistent graph. As shown in Figure 6, graphs show only a decreasing behaviour for friction force intensity.

A quantitative experience on friction

Almost all qualitative observations were tested in an experiment. The focus was on static friction and its dependence from load, sliding surface area and roughness. Students worked in small groups (3 or 4 components). Each group tested a different aspect encountered in the qualitative exploration. In particular, static friction dependence from sliding surfaces of the same material, from apparent contact area and from load were investigated both for wood and stainless steel. Each student had to produce a report on his or her experiment in which coefficients of static friction were determined.



Figure 7. Wooden blocks could slide on a wooden plane. The experiment could be repeated with a different load, apparent area of contact or surface roughness.

Experiments consisted mainly of blocks (woody or metallic) that could slide on a plane (woody or metallic) pulled by a force supplied by the weight of a hanging bottle containing water. Water was added up to determine the least amount that set in motion the body (see Figure 7). The intensity of the force was computed by using the measurement of the mass of the bottle made with a balance.

In Figure 8, the experimental set-up is showed for stainless steel blocks. In this case, it was possible to vary the position of the support wire that pulled the block so that the applied force was always parallel to the sliding plane in such a way that the force pulling the blocks had the same intensity as the weight of the hanging bottle.

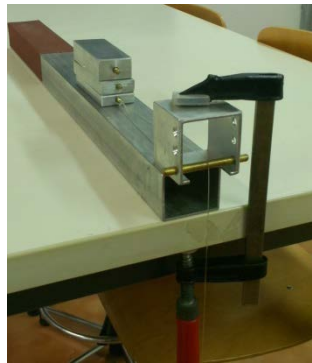

Figure 8. Experimental set-up for metal blocks

An unusual aspect of this kind of experiments was the necessity of identifying the intensity of the force and the relative uncertainty by using two "limit" measurements (maximum force without movement, minimum one with movement), like shown in Figure 9.

Descrizione dell'esperimento:

Poniamo la piastra lignea sopra un piano orizzontale, in seguito fissiamo la carrucola all'estremità della piastra per mezzo di un morsetto. Poniamo il blocchetto lungo la piastra e lo colleghiamo al recipiente d'acqua per mezzo di un filo inestensibile, facciamo scorrere quest'ultimo lungo la carrucola, in modo tale che il recipiente d'acqua (libero di cadere) applichi una forza sul blocco di legno.

Dopo un primo tentativo il blocchetto viene messo in movimento a causa dell'azione del recipiente d'acqua. Quindi ripetiamo le procedure sopracitate diminuendo progressivamente la massa d'acqua, finché la somma delle forze del sistema sia approssimativamente uguale a zero.

Ad ogni ripetizione di queste procedure il blocco viene fatto partire sempre dal medesimo punto della piastra, in modo che la superficie di contatto presenti costantemente caratteristiche omogenee.

Ogni volta che la massa del sistema recipiente-acqua viene modificata, sono effettuati tre tentativi, in ognuno dei quali cambia l'area di contatto blocchetto - piastra. Questa procedura viene eseguita per dimostrare una delle leggi fenomenologiche sull'attrito definita da Leonardo (la forza di attrito è indipendente dall'area di contatto), quindi abbiamo dimostrato la validità di questa legge.

Calcoli e tabelle:

Nello svolgimento di questo calcolo, per semplicità, consideriamo trascurabili il peso del filo, l'attrito presente tra il filo e la carrucola, le eventuali oscillazioni della carrucola.

Massa del sistema recipiente-acqua in kg	Movimento blocco di legno
0,040	Si
0,038	Si
0,035	Si
0,034	Si
0,032	Si
0,031	No

Al fine di ottenere un calcolo più attendibile possibile sulla forza di primo distacco, calcoliamo la media tra la massa del sistema recipiente acqua quando il sistema totale è in condizione di equilibrio e il valore più prossimo tra i dati rilevati durante l'esperimento.

In seguito calcoliamo l'errore assoluto.

$$M = (M_{max} + M_{min})/2 = 0,0315 \text{ Kg}$$

$$E_s = (M_{max} - M_{min})/2 = 0,0005 \text{ Kg}$$

Calcoliamo la forza di attrito statico:

Considero il sistema di riferimento come in figura

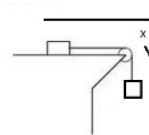

Sappiamo che $\sum F = 0$, F indica forze in N

$$F_s + Mg = 0$$

F_s indica la forza di attrito in N, M indica la massa del sistema recipiente-acqua in Kg e g indica l'accelerazione gravitazionale in m/s^2 .

$$F_s = -0,3087 \text{ N}$$

Calcolo l'errore relativo della forza di attrito:

$$E_r = (E_s/M) F_s$$

$$E_r = 0,0049 \text{ N}$$

F_s indica la forza di attrito in N, M indica la massa del sistema recipiente-acqua in Kg, E_r indica l'errore relativo della forza di attrito e E_s indica l'errore assoluto su M

$$F_s = \mu \cdot m \cdot g$$

F_s indica la forza di attrito in N, μ indica il coefficiente di attrito statico, m indica la massa del blocchetto in Kg

$$0,3087 = \mu \cdot 0,6958$$

$$\mu = 0,4437$$

Calcolo l'errore relativo del coefficiente di attrito statico:

$$E_r = (E_s/M + E_s) \mu$$

μ indica il coefficiente di attrito statico, M indica la massa del sistema recipiente-acqua in Kg, E_r indica l'errore relativo del coefficiente di attrito statico, E_s indica l'errore assoluto su M e E_r indica l'errore relativo sulla forza di attrito.

$$E_r = 0,0092$$

Figure 9. The determination of static friction coefficient in a student's report

Leonardo's laws (independence of friction from sliding surface area and linear dependence from load) were verified for steel. In the case of wooden blocks, measurements were not always in accord with Leonardo's laws and sometimes gave different results when repeated. Teachers and students agreed that the problem was in the light load and in the lack of hardness in the material of the surface. During the experiment, wooden surface roughness could show an increasing wear.

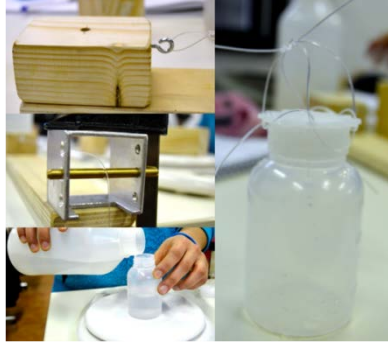

Figure 10. A collage of images presented in a report in which the student resumed the main aspects of her laboratory on friction

Despite of the general interest and involvement showed by students (see Figure 10), many discussions in the groups and teachers' clarification, which seemed effective at the moment, some severe and unexpected learning difficulties arose in the reports presented by students some weeks later. In particular, some students were unable to evaluate the friction force intensity and a larger number gave no correct force's uncertainty (results are summarized in Figure 11).

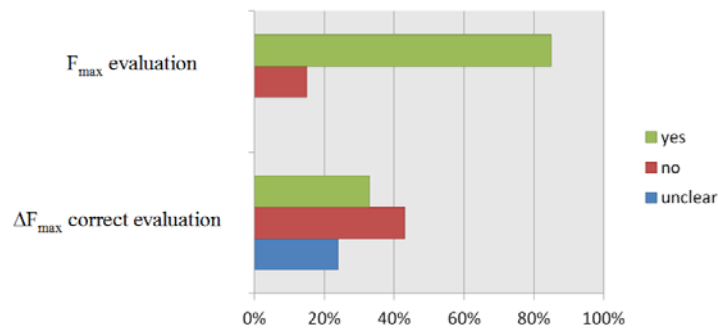

Figure 11. Percentage of correct evaluations of the maximum intensity of static friction and its uncertainty. The most common error is to evaluate uncertainty by considering only the sensibility of the measuring instrument, the balance in this case. The unclear cases consist in evaluations without explanations or explicit computations.

Moreover, a couple of students obtained inconsistent measurements respect to qualitative observations or well-established laws on friction. They seemed unaware and were not able to recognize that a problem exists.

Conclusions

- All students were very involved in the inquiry-based introductory activity and seemed to realize with care the successive measurements. This approach had improved students' understanding of friction, by discovering a rich phenomenology closely related to the structure of matter and its interactions at the nanoscale.
- However, a preliminary analysis of their reports shows some learning difficulties, based mainly on the lacking or weakness about previous basic concepts in physics laboratory or mathematics which still do not seem well assimilated:
- students had real difficulties to imagine a functional dependence different from direct and inverse proportion. Furthermore, many students confused the contrary behaviour of the direct proportion with the decreasing linear dependence, as shown in Figure 6.

- few students were able to merge different observed behaviours in a unique phenomenological graph.
- despite of their long experience in physics laboratory with their teacher (more than 20 experiments realized in small groups in two school years) and all explanations and clarifications obtained in laboratory, many students were unable to evaluate an uncertainty different from instrumental one in an unusual measure.
- These difficulties suggest that in practice some skills developed in the physics laboratory (but also fundamental topics in mathematics) are not used properly in an inquiry approach, i.e. they are not acquired correctly and completely. More research on this topic is necessary.
- A further step in the quantitative exploration of friction can be made by realizing an experience on kinetic friction. The same experimental set-up can be used in the dynamic case (hanging more mass), if the motion of the block is recorded by a camera. The coefficient of kinetic friction can be measured by elaborating images through a video analysis tool (e.g. an open source software like Tracker [8]) and Coulomb's law for friction can be verified. Also in this case, it is essential that students have a more solid training in lab as prerequisite.

References

- [1] Corpuz E. D., Rebello N. S.: Investigating students' mental models and knowledge construction of microscopic friction. I. Implications for curriculum design and development, *Phys. Rev. ST Phys. Educ. Res.* **7**, 020102 (2011).
- [2] Corpuz E. D., Rebello N. S.: Investigating students' mental models and knowledge construction of microscopic friction. II. Implications for curriculum design and development, *Phys. Rev. ST Phys. Educ. Res.* **7**, 020103 (2011).
- [3] Montalbano V.: On learning and teaching about friction, in preparation.
- [4] PLS Website, (in Italian) [online]. [cit. 30. 6. 2013]. Available from: www.progettolaureescientifiche.eu
- [5] Montalbano V.: Fostering Student Enrollment in Basic Sciences: the Case of Southern Tuscany, in *Proceedings of The 3rd International Multi-Conference on Complexity, Informatics and Cybernetics: IMCIC 2012*, ed. N. Callaos et al, 279, (2012), arXiv:1206.4261 [physics.ed-ph], [online]. [cit. 4. 10. 2013]. Available from: arxiv.org/abs/1206.426
- [6] Skedung L., Arvidsson M., Chung J. Y., Stafford C. M., Berglund B., Rutland M. W.: Feeling Small: Exploring the Tactile Perception Limits, *Scientific Reports* **3**, (2013). doi:10.1038/srep02617. [online]. [cit. 14. 4. 2014]. Available from: www.nature.com/srep/2013/130912/srep02617/full/srep02617.html
- [7] Rabinowicz E., *Friction, Wear of Materials in Fundamentals of Friction: Macroscopic and Microscopic Processes* edited by I. L. Singer and H. M. Pollock. (Kluwer Academic, Dordrecht, 1992), p. 26.
- [8] Tracker Video Analysis and Modeling Tool [online]. [cit. 14. 4. 2014]. Available from: www.opensourcephysics.org/items/detail.cfm?ID=7365

Open Inquiry based learning experiences to understand the Nature of Science

Nicola Pizzolato¹, Claudio Fazio¹, Rosa Maria Sperandeo-Mineo¹ and Dominique Persano Adorno²

Department of Physics and Chemistry, ¹Physics Education Research Group and ²Group of Interdisciplinary Physics, University of Palermo, Italy

Abstract

In this paper we address the question of the efficacy of an inquiry-based learning approach, with different levels of teacher's guidance, to introduce the students to fundamental aspects of the Nature of Science (NoS). Explicit pedagogical approaches, in which specific instruction on the topic of NoS is provided in addition to the engagement in scientific inquiry, are generally considered more effective with respect to implicit methods, where NoS conceptions are expected to develop as a natural consequence of inquiry-based learning experiences alone. In our study, we further explore the connections between scientific inquiry and implicit development of NoS conceptions, by investigating the efficacy of different kinds of inquiry approaches. Our findings confirm limited gains in developing NoS views by following a guided inquiry approach and suggest a more efficient NoS instruction by applying integrated open-inquiry-based teaching strategies.

Keywords: Open Inquiry, Integrated Teaching Strategies, Nature of Science

Introduction

Much of the interest in science and engineering education today is focused on achieving adaptive expertise (Redish & Smith, 2008), in terms of developing both specialist-discipline knowledge, abilities to solve practical problems, creativity in the design process, competences on using mathematical, scientific and technological tools to analyze and interpret data (Rocard et al., 2007; NRC, 2011). An effective science instruction should provide the students with a deeper understanding of disciplinary concepts and, at the same time, fundamental epistemological resources able to strengthen their reasoning skills and transversal abilities (NRC, 2012). In this view, an inquiry-based approach (Llewellyn, 2002) to teach science in K-12 levels of instruction is currently considered the most natural viable solution for promoting the development of all these competencies.

In inquiry-based learning environments, the students are engaged in identifying scientifically oriented questions, planning investigations, collecting data and evidences in laboratory and/or real life situations, building descriptions and explanation models, sharing their findings and eventually addressing new questions that arise. These activities are the same that real scientists carry out when perform their investigations. For this reason, these are considered the most effective way for developing scientific knowledge and stimulate the strengthening of logical and reasoning abilities. However, depending on the amount of support provided by the teachers, the students may be involved in more or less guided inquiry (GI) or open inquiry (OI) (Banchi & Bell, 2008). At this regard, the role played by the teacher is fundamental for the achievement of the desired results. In fact, it seems that a more guided instruction should provide the students with competencies more focused on conceptual knowledge, leaving the learners with a not well defined view of how scientific knowledge is produced (Chinn & Malhotra, 2002). On the other hand, a more open approach would let the students to experience a learning path with a higher level of

autonomy on deriving the inquiry questions, designing procedures and experiments, analyzing data and drawing their own conclusions. The OI-based learning, however, requires higher-order thinking skills that rarely can be found in younger students, which may develop feelings of frustration due to the lack of achieving the desired goals independently from teacher's hints (Quintana, Zhang, & Krajcik, 2005). In fact, results reported in literature are not ubiquitous for what concerns the efficacy of the IO-based method to produce an effective conceptual knowledge, while a more cohesive view supports this approach as the most suitable way to develop a deeper understanding of the NoS (Schwartz, Lederman, Crawford, 2004; Capps & Crawford, 2013).

Within this educational framework, we present in this paper the preliminary results from an extended study regarding the relationship between inquiry based instruction and the development of NoS conceptions. Here, we first introduce the theoretical framework which shaped the design and development of this work. Secondly, we report the outcomes, concerning NoS aspects, from a questionnaire that was administered to a sample of secondary school students who experienced a GI-based instruction within the context of ESTABLISH, a FP7 European Project aimed at promoting inquiry-based strategies for teaching science in European secondary schools. Then, we report the results obtained from the analysis of an OI-based learning path experienced by a sample of young engineering students at the Physics Department of the University of Palermo, Italy. A final discussion about our findings and concluding remarks are provided in the last part of the paper.

Inquiry-based instruction and Epistemology of Science

In inquiry based instruction, the amount of information and support provided by the teachers may affect the learning efficacy on specific conceptual and/or epistemological targets. Usually, in GI the teacher provides the students with the research questions, and the students design the procedures to find reasonable answers and/or test the resulting explanations. In OI-based instruction, the teacher takes the delicate role of defining the context for inquiry, stimulating the students to derive their own questions, design and carry out independent investigations, construct coherent explanations, share their findings. This teaching strategy should be helpful to develop higher skills of scientific thinking, but, at the same time, it requires the students to face great reasoning efforts. Moreover, the way the inquiry process itself is driven within the class has direct consequences upon the epistemological ideas that students might bring to bear on their work and on how the learning activity may change their perspective on scientific knowledge (Sandoval, 2005; Oliveira et al., 2012).

In the last decade, several studies have addressed the question of the efficacy of an OI methodology on teaching science concepts and/or developing NoS views, in comparison with traditional instruction or GI-based teaching approaches. Berg et al. (2003) report a better conceptual understanding in students carrying out the same experimental activity by following an OI-based laboratory with respect to those following an expository-structured learning path. An in-depth comparison between GI and OI learning approaches was presented by Sadeh & Zion (2009), who compared the mean scores achieved by two groups of 12th grade students. In their study, the OI group outperformed the GI one only in aspects concerning the perspectives of critical and reflective thinking about the process.

Recent studies suggest that a physics instruction based on GI, without providing an explicit attention to NoS aspects, seems to be more effective on repairing students' misconceptions (Nottis, Prince, & Vigeant, 2010), with respect to produce useful epistemological perceptions of science (Bell et al., 2003). On the other hand, students involved in OI

learning experiences, having the purest opportunity to act like scientists, would gain a deeper view of the nature of science and the awareness of the process of scientific inquiry (Capps & Crawford, 2013). Unfortunately, this latter approach, requiring the greatest cognitive demand from students in terms of scientific reasoning, may induce feelings of inadequacy or frustration, due, for example, to achieving of undesirable results, and could not bring about an effective understanding of the concepts (Millar, 2012). In summary, it seems that both approaches, individually considered, could not result effective enough, suggesting to take into account integrated teaching/learning strategies.

Many researchers have become increasingly interested in the interplay between science conceptual learning and other cognitive factors, such as personal learning frameworks (Hogan, 1999), learning beliefs, and science epistemologies (Hammer, 2002). It has been shown that students' epistemological beliefs about science play a significant role on their ability to solve physics problems (Bing & Redish, 2009, Kuo et al., 2013).

From an epistemological perspective: *Inquiry is the process of doing science*. There are two main reasons why an understanding of scientific epistemology needs to be included as a fundamental aspect within inquiry-based science education:

- i. The understanding of epistemological frames, characterizing the inquiry approach, will help the students to gain the awareness of their cognitive processes, causing an improvement of their learning performances.
- ii. The development of sophisticated epistemologies of science would provide powerful tools for thinking to citizens in their everyday lives.

In order to design an effective inquiry-based instruction, it is not sufficient to know what students know about a topic. One must consider the opportunity to produce a fruitful change on students' epistemologies of science, which are not globally robust beliefs that drives students' learning and problem-solving, but rather context-dependent locally-coherent views whose stability depends both on external inputs and on students' internal conceptions and emotional states (Gupta & Elby, 2011). At this regard, a very recent study support the efficacy of an *implicit* method of NoS instruction for students enrolled in classes using the *Physics by Inquiry* curriculum (Lindsey et al., 2012).

Our guiding idea is that OI-based teaching strategies, promoting an involvement in activities similar to those carried out by scientists, should provide the students with the opportunity to deepen their understanding on how scientific knowledge is produced in real research contexts. In addition, the engagement of the students within highly motivated inquiry-based learning environments should avoid the development of negative affective components.

The ESTABLISH Project and the NoS

ESTABLISH (European Science and Technology in Action: Building Links with Industry, Schools and Home) is a four year (2010-2013) project funded by the European Commission's Framework 7 Programme for Science in Society, aimed at promoting and developing the Inquiry-Based Science Education (IBSE) in European secondary schools. The ESTABLISH group consists of over 60 partners from 11 European countries, working with science teachers and educators, the scientific and industrial communities, the policy makers responsible for science curriculum and the science education research community. The project has informed the development of teaching and learning materials aimed to provide both in-service and pre-service teachers with appropriate educational supports for

a professional development, suitable designed to promote the use of IBSE in high school classrooms across Europe.

The Italian team of ESTABLISH has contributed to the project by providing many different contributions. One of these regards the preparation an articulated GI-based learning unit on thermal science, which was first experienced by a selected group of in-service teachers, in terms of a pilot validation, and then administrated to a wide sample of secondary school students.

Our sample consisted of 55 students, selected from three different high schools in Sicily, aged between 15 and 19 and with no previous experience in inquiry based learning. The feedback from our students before and after this learning unit was collected by using the pre-post activity Establish-2A questionnaire, explicitly designed to collect opinions about learning and understanding science in students from upper secondary schools. Within this questionnaire, five aspects of NoS were addressed and specifically investigated in our work (see Table 1).

Table 1. Results from the ESTABLISH project.

NoS-related concepts	Percentage of agreement	
	Before	After
Science can be learnt only by studying textbooks, avoiding to follow own experiences	73%	64%
Remembering facts is very important to understand science	86%	72%
To understand science, the formulas are really the main thing	77%	61%
In science, the facts speak for themselves and cannot support multiple theories	55%	52%
A theory explaining experimental results cannot change	88%	73%

The Establish-2A questionnaire focuses on those aspects of NoS which are the most commonly observed in students' discussions about science. The fact of considering the textbook as a sacred oracle of absolute truths (the formulas), independently from personal experiences, or a theory as an unchangeable piece of knowledge, or the importance of remembering facts, can be considered as real cognitive obstacles to the learning process. The percentages of agreement to a given NoS concept reported in Table 1 represent the percentages of students who agreed with the idea exposed in that specific statement, respectively before and after experiencing the inquiry-based learning path. Our pre-activity results show very high percentages, as expected in learners who have never been involved in the practice of science. Post-activity percentages are all lower than those recorded before the beginning of the project. However, we may argue that our students, engaged in GI-based experiences and without any specific instruction on NoS, do not significantly change their views.

The Mission to Mars project: an OI-based learning experience

Generally, physics instruction of engineering undergraduates is more oriented towards a functional approach of scientific knowledge. Students are often trained to solve physics problems automatically by simply applying mathematical tools, and it might seem that they actually do not need to hold a NoS view. However, the development of NoS conceptions in engineering students should be strongly encouraged by the benefits they may receive, in terms of strengthening of reasoning abilities and advantages on developing a scientific thinking.

We have investigated the efficacy of an OI-based learning environment to implicitly develop NoS conceptions in university students who already attended a curricular physics instruction. A sample of 30 engineering undergraduates was involved in a challenging learning environment, starting from the problem of projecting a thermodynamically efficient space base on Mars, and performed a 6-week long research-like experiences regarding the topic of thermal energy exchange by conduction, convection and radiation.

The project was developed by following the 5E model (Bybee, 1993) of sequencing learning experiences that leads students through five phases of learning:

- **Engagement:** the educators presented the project to the students, providing a brief description of the context in which their work would have been developed and the motivation for an active participation. Students were asked to work in groups and to perform scientific investigations devoted to the design, realization and testing of smart devices, having physical characteristics able to maximize the capture and storage of thermal energy from the Sun and/or systems with high insulating efficiency.
- **Exploration:** Students dedicated the second phase of the project to acquire information and plan their activities. In this phase, the students were introduced to our laboratory and stimulated to explore the measurement facilities and available materials in order to design their own experiences.
- **Explanation:** Students carried out their research investigations, designed on the base of their hypotheses pointed out during the explorative phase. They dedicated about thirty hours to complete their laboratory activities by collecting, processing and analyzing data.
- **Elaboration:** Students shared their ideas and preliminary results with the other participants and finally presented the most significant findings via oral presentations and by writing a final scientific report.
- **Evaluation:** A final phase has been devoted to a classroom discussion aimed at comparing and contrasting the results obtained by different groups of students.

Students spent a total amount of about forty hours to plan and realize a complete scientific research, concerning the design and practical realizations of smart devices, in the context of a hypothetical project about the construction of a thermodynamically efficient space base on Mars. The choice made by the educators to drive the students' inquiry within the context of a space science challenge strongly motivated the students, who, of course, were conscious that their research work was not part of a real space project, but they participated to the activities with equally high emotional involvement, being convinced of the importance of actively participate to a real research experience.

The results of this study are based on the analysis of the students' questionnaires, planning files, logbooks of experiments, final scientific reports. The data were analyzed on the basis of an in-context search for key-words or phrases and specific aspects of the students' answers that could give evidence of the cognitive process. In Table 2 we report the list of

five NoS aspects on which the literature generally agrees to consider them as the basic characteristics of the scientific knowledge. We have carefully examined both written and video recorded students' productions and reported the percentage of students mentioning NoS aspects during the project phases.

The percentages of students mentioning specific aspects of NoS show a general trend that increases through the phases of the project. This represents a global positive result, even considering the intrinsic differences between the initial explorative phase of the project, the intermediate parts, strictly devoted to practical experimentations and the search for explanations and the final one reflecting the great reasoning efforts. In particular, we find that few students considered the tentative aspect of the scientific knowledge at the beginning of the project, during the engagement phase, while almost half of them is already convinced that science is based on empirical basis.

Table 2. Results from the "Mission to Mars" project

NoS aspects	Percentage of students mentioning NoS aspects during the project phases				
	Engage	Explore	Explain	Elaborate	Evaluate
Scientific knowledge is:					
1) Tentative	17%	37%	33%	40%	53%
2) Grounded on empirical basis	47%	63%	77%	67%	73%
3) Based upon observations and inferences	40%	57%	77%	73%	80%
4) Creative	30%	47%	57%	63%	63%
5) Theories and laws are different forms of scientific knowledge	13%	27%	47%	57%	67%

Before this OI research-like experience only few students knew that theories and laws are different forms of scientific knowledge. Most students seem to believe that scientific knowledge is certain and this contrasts with its tentative nature, but our results show that during this project more than half of the students developed the understanding of the tentative aspect of the NoS. Higher percentages are found on all the other four peculiarities of the scientific knowledge. As expected, this practical experience within the context of a research project strongly reinforced the students' conception of a scientific knowledge grounded on experiments. Students usually think that scientific knowledge resides directly in experimental results, but here they learned the importance of reasoning (inferences) about the significance of their findings. Students initially believed that theories and laws were related in a linear hierarchy, but at the end 67% of them learned that theories and laws are different forms of scientific knowledge. After this experience, many students consider creativity as playing a major role in science construction.

Conclusions and future prospective

The development of scientific epistemology is an explicit goal of recent educational reforms, mainly driven by the conception that students' ideas about NoS influence their efforts to conduct (and learn) science. Of course, students need to understand disciplinary concepts and inquiry-based instruction is intended to help students' learning. Disciplinary scaffolds grounded within epistemic structures might guide students' inquiry and help them to see how to use disciplinary concepts to explain particular events. The use of integrated conceptual and epistemic guidance favors the activation of cognitive resources useful to articulate explanations.

In this work, preliminary results from questionnaire outcomes administered to secondary school students within the ESTABLISH project have shown modest benefits from a GI-based instruction in terms of an understanding about NoS aspects implicitly addressed. This result could be due to a lack of reasoning efforts in students, who are guided by the teachers step-by-step across the inquiry-based learning phases.

On the other hand, an OI-based learning environment has been experienced by a sample of engineering undergraduates who already attended university-level courses on physics concepts. Despite their previous instruction, students showed very low initial outcomes concerning the main aspects of NoS (see the percentage on the engage phase reported in Table 2). However, we have found that a highly motivating research-based environment, stimulating autonomous reasoning and problem solving abilities, may constitute an efficient teaching/learning approach both to consolidate tough physics concepts and, at the same time, to clarify important aspects of NoS. We believe that an IO-based approach could be effectively applied to implicitly teach NoS aspects to students who already have a solid background of conceptual knowledge. In these terms, the integration of curricular instruction with teaching/learning strategies based on OI approaches seems a viable solution to achieve useful NoS conceptions.

We finally point up that the two inquiry-based teaching-learning experiences here described and analyzed were deeply different for both the level of guidance provided by instructors to the learners and the different target of student population. A direct comparison between the two teaching approaches (GI and OI), although interesting and useful, is beyond the aim of this paper and it could be the subject of future investigations.

References

- [1] Redish E. F., Smith K. A.: Looking Beyond Content: Skill Development for Engineers. *J. Eng. Educ.* 97(3), 295-307 (2008).
- [2] Rocard M., Csermely P., Jorde D., Lenzen D., Walberg-Henriksson H., Hemmo V.: Science Education Now: A renewed Pedagogy for the Future of Europe, EU Research Report, ISSN 1018-5593 (2007).
- [3] National Research Council (NRC): Discipline-Based Education Research: Understanding and Improving Learning in Undergraduate Science and Engineering. The National Academies Press, Washington, DC, (2011).
- [4] National Research Council (NRC): A Framework for K-12 Science Education: Practices, Crosscutting Concepts, and Core Ideas. The National Academies Press, Washington, DC, (2012).
- [5] Llewellyn D.: *Inquiry Within: Implementing Inquiry-based Science Standards*. Corwin Press, Inc. Thousand Oaks, California, (2002).

- [6] Banchi H., Bell R.: The Many Levels of Inquiry. *Sci. Child.*, 46(2), 26 (2008).
- [7] Chinn C. A., Malhotra B. A.: Epistemologically authentic inquiry in schools: A theoretical framework for evaluating inquiry tasks. *Sci. Educ.* 86(2), 175 (2002).
- [8] Quintana C., Zhang X., and Krajcik J.: A framework for supporting meta cognitive aspects of on-line inquiry through software-based scaffolding, *Educ. Psych.* 40(4), 235 (2005).
- [9] Schwartz R. S., Lederman N. G., Crawford B. A.: Developing Views of Nature of Science in an Authentic Context: An Explicit Approach to Bridging the Gap Between Nature of Science and Scientific Inquiry. *Sci. Educ.* 88(4), 610 (2004).
- [10] Capps C. K., Crawford B. A.: Inquiry-Based Instruction and Teaching About Nature of Science: Are They Happening? *J. Sci. Teach. Educ.* 24(3), 497 (2013).
- [11] Sandoval W. A.: Understanding students' practical epistemologies and their influence on learning through inquiry, *Sci. Educ.* 89, 634 (2005).
- [12] Oliveira A. W., Akerson V. L., Colak H., Pongsanon K., Genel A.: The implicit communication of Nature of Science and Epistemology During Inquiry Discussion. *Sci. Educ.* 96(4), 652 (2012).
- [13] Berg C. A. R., Bergendahl V. C. B., Lundberg B. K. S.: Benefiting from an open-ended experiment? A comparison of attitudes to, and outcomes of, an expository versus an open-inquiry version of the same experiment. *Int. J. Sci. Educ.* 25(3), 351 (2003).
- [14] Sadeh I., Zion M.: The Development of Dynamic Inquiry Performances within an Open Inquiry Setting: A Comparison to Guided Inquiry Setting. *J. Res. Sci. Teach.* 46(10), 1137 (2009).
- [15] Nottis K., Prince M., and Vigeant M.: Building an understanding of heat transfer concepts in undergraduate chemical engineering courses. *US-China Educ. Rev.* 7(2), 1 (2010).
- [16] Bell R. L., Blair L. M., Crawford B. A., Lederman N. G.: Just do it? Impact of a science apprenticeship program on high school students' understandings of the Nature of Science and Scientific Inquiry. *J. Res. Sci. Teach.* 40(5), 487 (2003).
- [17] Millar R.: Rethinking science education: meeting the challenge of "science for all". *Sch. Sci. Rev.* 93, 345, 21 (2012).
- [18] Hogan K.: Relating students' personal frameworks for science learning to their cognition in collaborative contexts. *Sci. Educ.* 83(1), 1 (1999).
- [19] Hammer D., Elby A., in *Personal epistemology: The psychology of beliefs about knowledge and knowing*, edited by B. K. Hofer and P. R. Pintrich (Mahwah, NJ: Lawrence Erlbaum, 2002), p. 169.
- [20] Bing T. J., Redish E. F.: Analyzing problem solving using math in physics: Epistemological framing via warrants. *Phys. Rev. ST Phys. Educ. Res.* 5(2), 020108 (2009).
- [21] Kuo E., Hull M. M., Gupta A., Elby A.: How Students Blend Conceptual and Formal Mathematical Reasoning in Solving Physics Problems. *Sci. Educ.* 97(1), 32 (2013).

- [22] Gupta A., Elby A.: Beyond Epistemological Deficits: Dynamic explanations of engineering students' difficulties with mathematical sense-making. *Int. J. Sci. Educ.* 33(18), 2463 (2011).
- [23] Lindsey B. A., Hsu L., Sadaghiani H., Taylor J. W., Cummings K.: Positive attitudinal shifts with the Physics by Inquiry Curriculum across multiple implementations. *Phys. Rev. ST Phys. Educ. Res.* 8, 010102 (2012).
- [24] Bybee, R.W.: *An instructional model for science education*. In *Developing Biological Literacy*. Colorado Springs, CO: Biological Sciences Curriculum Study (1993).

Introduction of the nanoscience and nanotechnology in a Brazilian High School through a partnership with public university

Allan Victor Ribeiro¹, Moacir Pereira de Souza Filho², Sergio Rykio Kussuda³

¹ Federal Institute of Education, Science and Technology of Sao Paulo – IFSP – Birigui, SP, Brazil

² Sao Paulo State University - UNESP – Department of Physics, Chemistry and Biology - Faculty of Science and Technology - P. Prudente, SP, Brazil

³ Sao Paulo State University - UNESP – Pos-Graduate Program in Science Education – Bauru, SP, Brazil

Abstract

Relevant areas of knowledge such as Nanoscience and Nanotechnology (NS&NT) have affected the way of life of society and probably they will determine the future of the humanity. In this sense, scientific and technological knowledge is necessary at all levels of the educational system, and this task has been partially performed in several countries. Moreover, this knowledge involves interdisciplinary concepts and techniques, and therefore, new educational methodologies should be devised and tested. Regarding secondary education, the experiences with NS&NT are quite incipient, contrasting with the presence of these contents in the mainstream media. In the case of Brazil, several proposals and researches have been published, and the present work provides to the teachers of sciences some tips to effective pedagogical practices and to introduce NS&NT in their works. This investigation involves a diagnosing of the previous knowledge and interest of the students by the concepts concerning NS&NT. It was made a presentation of the main achievements and challenges. We made a proposal for the collaboration between teachers of different disciplines, and visits of the students to Unesp's research laboratories – State University of São Paulo, Brazil. A group of 80 students of an upper secondary school in the city of Bauru, São Paulo, Brazil, has participated in the dissemination in the didactical and scientific activities. They showed both a rather limited knowledge of the subjects of NS&NT and the interest to learn about them. The positive results in the development of the activities motivated the first author of this paper to elaborate a NS&NT project called Institutional Program of Teaching Initiation Scholarships (PIBID/Brazil).

Keywords: high school, nanoscience, nanotechnology, teacher training

Introduction

In the Brazil's High School, Physics contents have been taught on an interdisciplinary and contextualized science approach, and they have been presented as an integrated and articulator component in the area of Natural Science and Technology. These features of this discipline have been proposed and established by National Curriculum Parameters (PCN) to indicate its relations with other areas of knowledge, especially in the investigation and understanding of physical facts and phenomena. This includes the use of an appropriate language and the learning of how to communicate and to understand the historical and social contexts [1].

“II.5 RELATIONS AMONG SUBJECTS, INTERSUBJECT AND INTER-AREA OF THE KNOWLEDGE

**Articulate, integrate and systematize phenomena and theories related to a Science, among other sciences and knowledge areas.*

**Understand different kinds of interactions and nature of physical phenomena, to be able to use this knowledge in an articulated and integrated way.*

**Identify and comprehend different kinds of explanations of the microscopic or macroscopic physics, using the knowledge properly to comprehend each phenomenon...” [1].*

By analyzing of different topics in physics and by relating them with interdisciplinary knowledge, we can observe some relevant areas, such as Nanotechnology and Nanoscience (NS&NT), that have affected the way of lifestyle of society as well as determined the future of humanity [2]. This becomes necessary to promote scientific knowledge in different educational levels. If we consider that the interdisciplinary content is the characteristic related to NS&NT, it is necessary to create and to evaluate new teaching methodologies that involve different areas of knowledge [3,4]. In the specific case of Secondary Education or High School, the proposals to introduce concepts about NS&NT are incipient in Brazil, whereas terms related to science and technology are frequently mentioned and/or explained in the media [5].

Several applications of NS&NT have been developed in different areas of knowledge, for example, electronics, medicine, automotive and aeronautic industry [6]. In the industry of cosmetics, for example, nanoparticles of titanium dioxide are used to create solar protectors because of the capacity to absorb ultraviolet radiation. Furthermore, nanoparticles allow a better absorption by the skin and are used in anti-aging treatments, and other applications [7].

A recent Brazilian research about the communication and formation in science and technology, didn't find a systematic teaching of NS&NT in primary and secondary educational levels, although there is available articles on how to insert this topic in secondary education. Facing this reality, and the serious difficulties usually found in the Brazilian educational system (teachers training, basic infrastructure and motivation of students), the idea of teaching NS&NT seems quite utopian. However, besides the fact that having some knowledge about such topics is a cultural and economic necessity, they can serve as a way to prepare “new minds” for a “new era” [8,9].

Laherto (2010) detaches the importance of the curriculum to incorporate questions about nanoscience and nanotechnology. He also detaches the importance of education to promote a scientific and technological literacy, considering social aspects. In this perspective, training programs for Physics teachers should include strategies based on an interdisciplinary work, aiming to approximate NS&NT to high-school students [10] and making them conscious and critic about social dimension imposed by new technology [11]. In the present work, we try to contribute towards this goal, by describing our recent experience and by suggesting some specific activities.

Future training teachers: possibilities associated to the insertion of NS&NT themes in federal programs of teaching incentives

Initiatives aiming to contribute with the qualification and training teachers to work at secondary and high school level related to different areas of knowledge are been studied by the Brazilian government. In this context, it has been elaborated a project called Institutional Program of Teaching Initiation Scholarships PIBID, as one of the most relevant Brazilian teachers training program. In its first year, 2007, it has offered scholarships to undergraduates in order to allow them first contact with class, teachers and students in public schools. In this way, this project aims the formation of these students to teach after graduated.

The objective of this program is to anticipate the experience of future teachers in the classroom of the public school. This training starts in their first year as university students, where they develop didactical activities oriented by one professor from university and a teacher from the secondary or high school. With this initiative, PIBID creates a link between the university (via undergraduates and the professor), the school and the educational system. More than 41.000 scholarships have been offered in 2012, involving public and private institutions in many areas and different educational levels, including indigenous and rural education [12].

In this context, it is inevitable that universities use financial support from governmental and sponsoring organizations to develop effective actions on secondary and high schools [13]. Allows schools to be a place for teachers formation by institutional projects and attracting resources to permit insertion of NS&NT can be understand as a successful path because it involves all stakeholders in the educational context.

This work has been oriented towards developing teaching methodologies in order to bring the student's, in different educational levels, to initial contact to interesting nanoscience and nanotechnology world and make them aware and critical about social dimension imposed by recent technologies.

Methodology

This study was conducted in a private school in Bauru city / SP / Brazil. The methodology of this work was performed at three distinct moments during the year 2012. Our sample consisted of a total of eighty (80) students of the high schools, aged 14 to 17 years old, being distributed as follows: 29 students in 1st level, 24 students of 2nd level and 27 students in the 3rd level from High School.

The method used for this study was the analysis of activities and didactic sequence and two questionnaires. The first questionnaire was aimed to acquire general conceptions of students regarding topics concerning the NS&NT.

In a second moment, we sought to analyze how these themes are articulated in curricular activities in everyday life and interests of the students to deepen their knowledge in NS & NT. In this second moment, the teacher responsible by Physics and Chemistry subjects presented a lecture on the topic that lasted about an hour.

In this presentation, besides the specific concepts of NS & NT and about the order of magnitude of the nanoscale; it was highlighted information about the scientific production in Brazil in the polls about the specific courses in this area, and on partnerships between researchers with the primary education system and on the possibility of students to engage in the dissemination and development of nanotechnology.

The instrument used for data collection was a questionnaire using some multiple choice questions and survey questions. The responses of the students were classified in some categories of analysis previously established in order that we might interpret and analyze results through charts.

The third moment occurred with the interaction of students with researchers and a visit to research laboratories in NS & NT in the Faculty of Sciences – State University of São Paulo – Bauru / SP. The interaction with the expert researcher in NS & NT was through a lecture performed as part of activities of the National Week of Science and Technology, an event that traditionally brings together science fair performed by high schools students and the participation of reputed researchers from Science of Nature and Mathematics areas.

After analyzing the actions, was created a project to disseminate NS&NT based on training teachers. This project will be developed on Federal Institute of Education, Science and Technology of São Paulo – IFSP and public schools of secondary and high education in Birigui/SP and seek through an interdisciplinary approach and context of contemporary science issues introduce NS & NT in high school.

Analysis and Results

Through the analysis of the questionnaires applied in the first and second moment of the research, we selected some questions and tabulate student answers. These data show the evolution of the students' perceptions regarding the subject NS&NT. Initially we sought to analyze the perceptions of students about the relation between NS&NT and the daily world. It was found that 54% of students in first level, 29% in second level and 6% of third level from High School, they have never heard about NS&NT.

The Data indicate that despite having a expressive quantity of students that already have heard about NS&NT, a considerable quantity of students couldn't attribute meaning to terminology and therefore can not establish relationships, transpose and contextualize the reflexes of this area of knowledge to the evolution of science, society and especially the implications with your everyday life. In this regard we highlight that 79% 1st year and 56% the 2nd year could not relate NS&NT with everyday life, but 78% of 3rd year succeeded. It is possible to notice that the issues related to NS&NT fascinate students, although students don't have clear conceptual idea about the subject, more than 90% of students seems to be stimulated and willing to learn about the theme.

At the first moment we highlight that 94% students of 3rd level are able to associate NS&NT at the nanoscale and potential applications of which only 7% of 1st level succeeded.

The Data analysis of the questionnaire performed in the second time after the didactic sequence (lecture and discussion) reveals that there was a significant learning of the students about the concepts and applications discussed. When asked about applications we found that over 50% of students were able to describe examples of specific applications of NS & NT and about 30% of the students only correlated with areas of knowledge (e.g. medicine, industry, chemistry, physics etc.). In respect to ways to visualize and investigate the nanoworld was found that 78% of students specific examples microscopy showed, 18% failed to distinguish the kind of microscopy and only 4% failed to exemplify the ways of investigating nanoworld.

After the presentation we found that most students (more than 60%) were interested in learning more about NS & NT. In the analysis of the questionnaires found an interest in expressive of students participate in junior research projects (Scientific Initiation

Programs) with topics related to NS & NT, where a total of 20.7% 1st level, 16.7% of 2nd level and 18.5% of 3rd level from High School students showed interest in participating in such projects.

The interventions, analysis of results and reflection about the didactic sequence were based in the study of literature and provide subsidies to elaborate a project of teaching initiation PIBID about the theme NS&NT.

Institutional Scholarship Program for Teacher Initiation (PIBID-IFSP) – A Proposal to Improve Teacher Training

The Project elaborated provides in the integral formation of teachers, because all actions were thought and supported by theoretical references and methodological of interdisciplinary procedures, trying to establish a real significance and contextualized scientific concepts related to NS&NT to students of High School as indicated on National Curriculum Parameters (PCN).

The project of teacher initiation indicated in this study will focus on insertion of undergraduates on scholar routine on public schools using well-articulated interventions with professor (from University); teacher (High School) and undergraduates, creating opportunities to develop and participate acquiring experiences on methodological, technological and innovator and interdisciplinary teaching practice aiming to aid develop skills and competences based on well-structured knowledge of Science, and that transcends barriers imposed by fragmented views of isolated scientific area.

After finishing each step of didactic sequence and during analysis, undergraduates will be instigated to reflect about the contribution of activities created, how it was and could be improved. Undergraduates will be stimulated to present results, perceptions and discussions and new questions in written report based on observation made on classrooms and on analysis of the questionnaire applied after the activities. We highlighted a summary of main activities of the project.

- Bibliographic review of theoretical references about the Sciences and scientific publications concerning NS&NT and education.
- Diagnose the reality of school and visit the infra-structure and meetings with principal to subsidize the planning and elaborates low-cost didactic materials and organizing pedagogical places in the school.
- Find and analyze didactic material used on school and supplementary material to be used on the elaboration of interventions.
- Elaboration of didactic sequence and creation of didactic materials that subsidizes on significant learning about the theme.
- Elaboration of playful activities using daily objects and comparative projection of macro and microscopy systems.
- Adequacy of scientific language of didactic sequences for different scholar levels.
- Use of new information and communication technologies (ICTs).
- Articulation of physics concepts and applications of fundamental principles of technology associated to instruments of investigation of the nanoworld.
- Promote interaction of all involved on the project PIBID with researches, it will be articulated a visit on laboratories of NS&NT research.
- Strengthening the relation with two institutions by a collaborative work.

- Planning, confection and application of data collection to evaluate the didactic actions on school.
- Evaluate the results and reflections of didactic actions, with proposal to improve future applications and production of articles about the process.
- Socialization of innovator and interdisciplinary methods, technological and teaching practice experiences improved during the execution of the project.

There will be evaluated and reassessed all actions executed on the project with different focus on insertion of content related with NS&NT, of undergraduates (future teachers) on daily activities on public schools and the interventions articulated with the coordinator, teachers on high schools and undergraduates.

Conclusions

Many applications on NS & NT are present in the daily lives of students. The research suggests that there is need for scientific publication, it is necessary to insert these concepts from the basic education that the student has not only expertise, but an overview that would establish a critical and reflexive thought about the impact of these technologies on contemporary society.

The research results indicate a trend of students about issues related to NS & NT is evident that the students' knowledge increases with progression in school, however, it should be greater in the first level, and at the end of the activities we find meaningful learning of students about the topics related to NS & NT.

Proposals to introduce systematic NS & NT, coordinated participation of teachers and the development of activities coordinated by the university are consolidated as important actions for an effective approach of an interdisciplinary and contemporary science.

In previous work [13], we highlight some proposals which enabled the disclosure of nanotechnology. The necessity of establish concrete actions on the inclusion of contents related to NS&NT made possible to elaborate the project presented on this paper that, besides inserting and discuss ideas about NS & NT in high school, it was also structured in order to improve development skills and abilities of the future teachers, and new teaching methodologies involving the various knowledge areas, improving the conception of the importance of significant approaches, interdisciplinary and contextualized science. The project was welcome to the academic context and wait for approval on governmental organizations to release resources necessary to start the activities.

Acknowledgements

The Brazilian Institutions IFSP, Unesp, SESI/SP and the Iberian-American Network NanoDyF have partially supported this work. In particular, we should like to thank Alexys Bruno Alfonso (Unesp) who has been most helpful and generous with their advices and Maria Heloísa Saraiva Vicente by significant contributions.

References

- [1] Brasil. Ministério da Educação. Secretaria de Educação Média e Tecnológica. PCN+ Ensino médio: orientações educacionais complementares aos Parâmetros, (2002).
- [2] Domingo P. A. S.: ¿Qué sabemos de? La nanotecnología, Madrid: Catarata, (2010).

- [3] Petraglia I. C.: *Inst. de Estudos de Complexidade e Pensamento Sistêmico* Vol. 1, No 1, (2002).
- [4] Schulz P.: *Nanociência de baixo custo em casa e na escolar. Física na Escola*, Vol. 8, No.8 (2007).
- [5] Malsch I.: *Ethics and Nanotechnology; Responsible development of nanotechnology at global level in the 21st century. PhD thesis, Radboud University.* (2011).
- [6] Pereira F. D. et.al: *Nanotecnologia: Desenvolvimento de Materiais Didáticos para uma abordagem no Ensino Fundamental. Química Nova na Escola*. Vol. 32, No.2 (2010).
- [7] Silva S. L. A. et.al: *A final o que a nanociência e nanotecnologia: uma abordagem para o ensino médio. Química Nova na Escola*. Vol.31, No. 3 (2009).
- [8] Laherto A.: *An analysis of the educational significance of nanoscience and nanotechnology in scientific and technological literacy. Science Education International*. Vol. 21, No 3 (2010), p. 160-175.
- [9] Alfonso A. B.: *Situação atual da divulgação e do treinamento em nanociência e nanotecnologia no Brasil. Mundo Nano*. Vol. 4, No. 2, (2011).
- [10] Greenberg A.: *Integrating Nanoscience into the Classroom.ACSNANO*, Vol. 3, No. 4, (2009).
- [11] Laherto A.: *Nanoscience education for scientific literacy: Opportunities and challenges in secondary school and in out-of-school settings. Doctoral dissertation, University of Helsinki.* (2012).
- [12] Rossi. A. V. *O PIBID e a Licenciatura em Química, Química Nova na Escola*, Vol. 35, No. 1 (2013).
- [13] Ribeiro A. V., Souza Filho M. P., Bruno-Alfonso A.: *Propuestas para introducción de Nanociencia y Nanotecnología en escuelas preuniversitarias. Revista Digital Universitaria*, Vol. 14, (2013), p. 1-13.

Mobile Lab Classes: Scanning Tunneling Microscopy for secondary school students (ages 16-18)

Guillaume Schiltz, Andreas Vaterlaus

Department of Physics, ETH Zurich (Swiss Federal Institute of Technology), Switzerland

Abstract

The Physics Education Group at ETH Zurich offers mobile lab classes, which consist of a half-day course on scanning tunneling microscopy (STM). Our STM-lab class can be booked at no charge by middle schools (upper secondary education). By appointment a faculty member from our group, equipped with 6 mobile STMs (Nanosurf easyScan 2), visits the school. After a short presentation on electron tunneling effects, piezo motion and atomic structure, students are guided to operate the microscopes by themselves. For this active task they work in groups of 2 to 3 students, each group being equipped with a STM. In this paper we report on the feedback from teachers and students. We discuss the benefits and the drawbacks of mobile school labs and share our experiences on mobile lab classes.

Keywords: mobile labs, scanning tunneling microscopy, secondary education

Setting of the STM mobile lab class

A mobile lab consists of an experimental laboratory setting that can be transported to schools. It provides schools with educational resources they otherwise lack. Mobile labs are a major activity in university outreach programs, especially in physics, biology and chemistry [1,2,3].

In 2009 the Physics Education Group at ETH Zurich started a project on mobile lab classes, which consists of a half-day course on scanning tunneling microscopy (STM). Scanning tunneling microscopy has been invented in 1981 by Binnig and Rohrer as an imaging technique. STM is a real space, high-resolution imaging method exploiting quantum-mechanical electron tunneling between a sharp tip and the sample whose surface is imaged. The tip is raster scanned over the surface and a topographic image can be obtained. Binnig and Rohrer were awarded the Nobel Prize 1986 in physics for their discovery [4].

STMs are rather expensive devices (>10.000\$) that schools usually cannot afford. Our main motivation for this project was to provide schools with experiments addressing modern physics, and to support teachers in including it during their regular teaching schedule. The STM-lab class can be booked at no charge by middle schools (upper secondary education, ages 16-18). By appointment a faculty member from our group, equipped with 6 mobile STMs, visits the school. After a short presentation offered by the accompanying faculty member on electron tunneling effects, piezo motion and atomic structure, students are guided to operate the microscopes by themselves with different samples. Usually they work in small groups of 2 to 3 students, each group operating its own STM (Figure 1). This pedagogical setting is similar to the SCALE-UP learning environment [5] and benefits from the active learning hands-on results attested in those setups.

Other mobile lab settings, including only a single STM equipment, are mainly focusing on improving student attitudes at a broader thematic level, for instance on topics of nanoscience [6]. The main goals of our lab classes, however, are:

- to introduce students to modern physics topics that usually are not part of the standard curriculum;
- to allow students to perform hands-on experiments with high quality equipment;
- to support physics teachers;
- to engage students in experimental physics and to raise their interest in physics.



Figure 1. STM labs in a school class

Experimental equipment

The STM uses a sharpened tip of conductor material which is brought to a very close distance to the sample (1 nm or less) by piezoelectric actuators. A bias voltage, applied between tip and sample, induces a tunneling current which varies with the tip-to-sample distance. While the tip scans the sample, the tunneling current variation is recorded by a computer and compiled to a surface image by the STM-software (Figure 2).

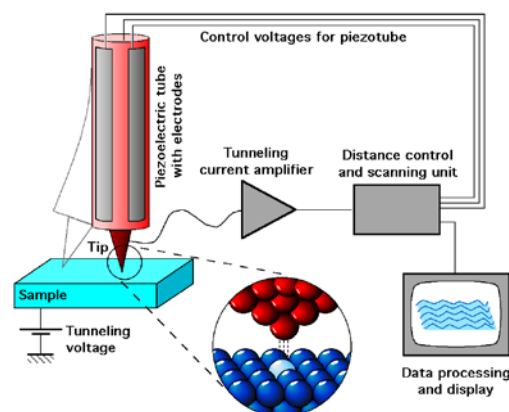

Figure 2. Schematic view of the STM (by M. Schmid, TU Wien)

Each of our experimental setups consists of a commercially available STM (Nanosurf easyScan 2) [7], the corresponding control box, and a Windows laptop hosting the STM software.

During the experiments students are guided to fabricate the tips out of Pt/Ir wire by themselves and to perform a standard measurement over a graphite surface, which should result in the representation of the atomic structure (Figure 3). Measurements of further samples (e.g. Au) and variations of the measurement process (constant height vs. constant current) can be performed and compared as well.

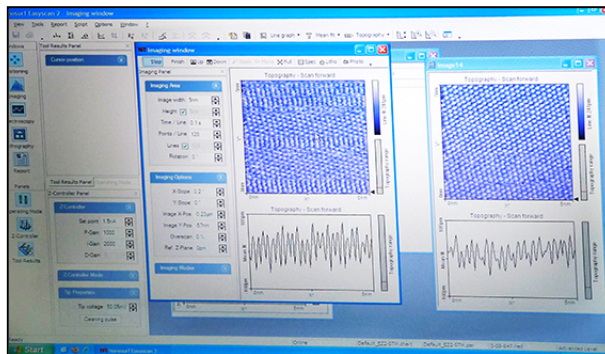

Figure 3. Screenshot of the measured atomic structure from a graphite sample

Evaluation and outcomes

About 12 teachers per year order the mobile lab class, the majority of them teaching classes with a major in science and mathematics. Each year we are thus reaching around 200 students. Early in 2013 we performed an evaluation by distributing a questionnaire to all teachers involved in 2012. The feedback was extremely positive. All respondents attested that the lab class has been enriching their teaching, 10 out of 11 teachers recommended the lab class to their colleagues and 6 teachers have reviewed the covered subjects later in class.

We also asked the teachers to report on how long the students addressed the lab class (Figure 4). 60% mentioned that students have discussed their lab experience for several days and 30% reported that students addressed the lab class even several weeks after the visit. These results show good evidence that students were strongly engaged in the lab class. Furthermore teachers and also lab instructors reported that students with a prior interest in physics did manifest the strongest engagement, whereas students with no particular interest in physics gained only marginal benefits from the lab class.

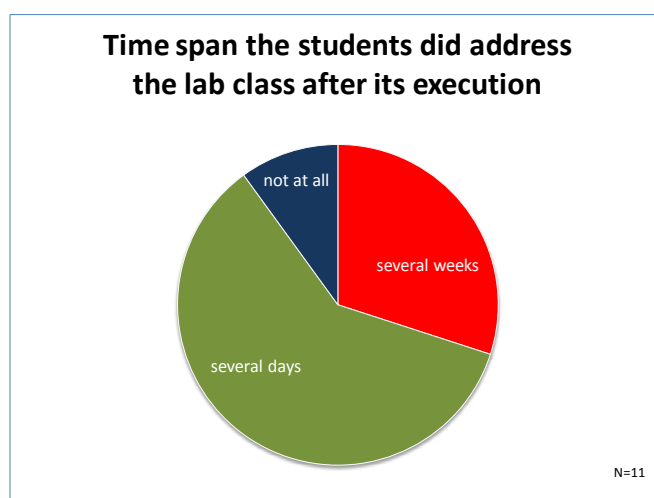

Figure 4. Teacher report on students' engagement

In order to get insights about the learning effectiveness, we carried out a study on a typical class with 13 students. First we collected input on students' perceptions right after the lab class, and then after a 4 week delay we submitted an unannounced conceptual knowledge test (5 items, [8]) to the students. Both results were extremely positive.

All students rated the practical part of the lab class highly positively and we did not get any negative feedback on the input session, neither on the comprehension level (Figure 5). For each class we try to adapt the complexity level of the input part according to the pre-knowledge and curricular orientation of the students.

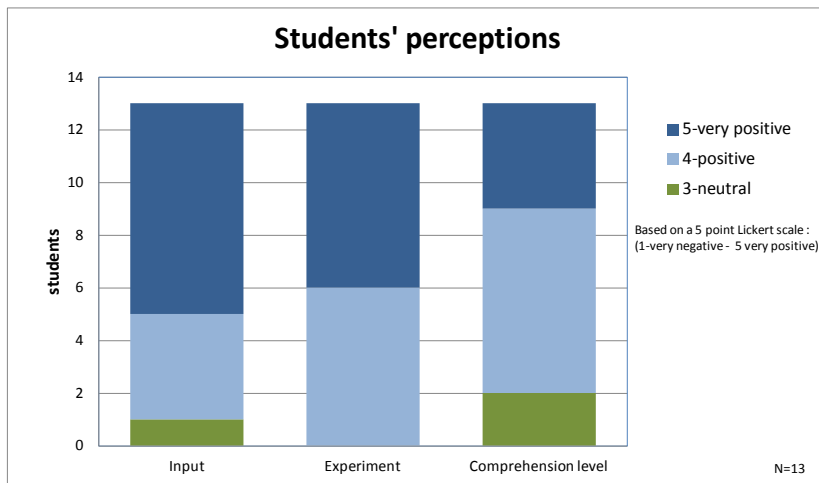

Figure 5. Students' perceptions right after the lab class

The distribution of the results from the knowledge test (almost Gaussian) is identical to the overall class performance (Figure 6), as reported by the class teacher. For the delayed and unannounced test, however, students performed much better than expected.

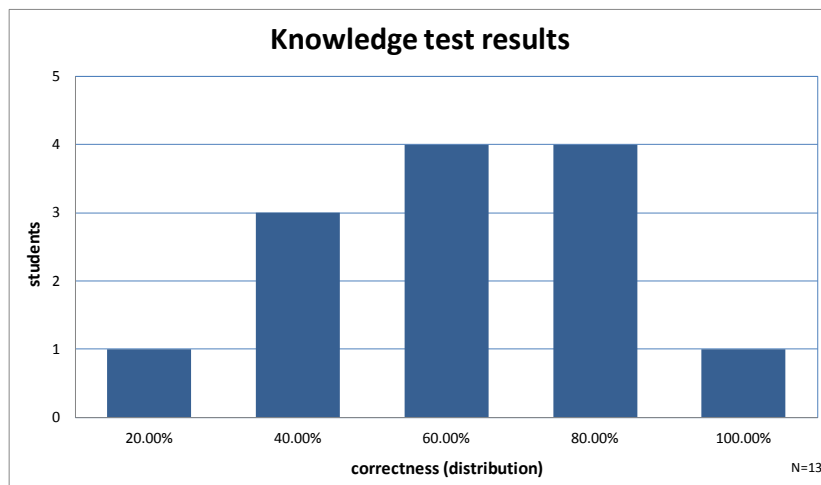

Figure 6. Knowledge test results, 4 weeks after the lab class

Conclusion

To summarize, the mobile STM-class is very much appreciated by the students and by the teachers. All of the intended goals have been achieved far beyond our expectations. Offering 6 independent STM-equipments turns out to be the major asset of our setting.

The setting of our lab class is most appropriate for students who already manifest a strong background in physics. Some mathematics and physics pre-knowledge is essential to fully understand the covered topics and with this project we did not intend to address a broader public. As it turned out, the lab class is most often booked towards the end of the school year, where teachers have time to offer supplementary topics. Nevertheless, some teachers now are fully embedding the lab class in their regular syllabus and a few teachers even take over the complete supervision of the lab class by their own.

The availability of several STMs, however, has further benefits. We regularly use our concurrent STM-settings in teacher education, for study weeks (school students) [9] and during science fairs (greater public). In future we are planning to setup additional labs in the same setting as our STMs.

References

- [1] Mobile Laboratory Coalition (MLC), [online]. [cit. 9. 9. 2013]. Available from: <http://www.mobilelabcoalition.com/wp/>
- [2] Mark H.W. et.al: Genomics Education in Practice: Evaluation of a Mobile Lab Design. *BAMBED* 38, No 4 (2010), p. 224-229.
- [3] Long G. L. et.al: Chemistry Outreach Project to High Schools Using a Mobile Chemistry Laboratory, ChemKits, and Teacher Workshops. *Chem. Educ.* 89, No 10 (2012), p. 1249–1258.
- [4] The Nobel Prize in Physics 1986, [online]. [cit. 9. 9. 2013]. Available from: http://www.nobelprize.org/nobel_prizes/physics/laureates/1986/
- [5] Beichner R. et.al: Student-Centered Activities for Large Enrollment Undergraduate Programs (SCALE-UP) project. In: E. F. Redish and P. J. Cooney (Eds.), *PER-Based Reform in University Physics*. College Park, MD: American Association of Physics Teachers (2006).
- [6] Ping Y. F.: Engaging Students in Early Exploration of Nanoscience Topics Using Hands-On Activities and Scanning Tunneling Microscopy. *J. Chem. Educ.* 86, No 6 (2009), p. 705–711.
- [7] Nanosurf AG, [online]. [cit. 9. 9. 2013]. Available from: <http://www.nanosurf.com>
- [8] Knowledge test attributed to the students 4 weeks after the mobile lab class (in German) [online]. [cit. 9. 9. 2013]. Available from: http://www.phys.ethz.ch/~schiltz/STM_knowledge_test.pdf
- [9] ETH-Studienwochen, [online]. [cit. 9. 9. 2013]. Available from: <http://www.soc.ethz.ch/orientation/studienwochen>

Project PROFILES and Development of In-service Teachers' "Stages of Concerns" Regarding IBSE in the Context of the Implementation of PROFILES Modules in Georgia

Vincent Schneider², Marika Kapanadze¹, Claus Bolte², Ekaterine Slovinsky¹

¹Ilia State University, Tbilisi, Georgia

²Freie Universität Berlin, Berlin, Germany

Abstract

The PROFILES project is a four-year European FP7-funded project in the field of "Science in Society", aiming at disseminating Inquiry-Based Science Education (IBSE) in Europe. To achieve this goal, the 22 PROFILES partners from 21 countries are conducting innovative learning environments (PROFILES type Modules) and long-term teacher training programs for the enhancement of teachers' continuous professional development (CPD). Both supportive action strategies are supposed to raise the self-efficacy of science teachers, enabling them to take "ownership" for teaching students in more effective ways, so that as many students as possible can benefit from the PROFILES approaches of teaching and learning science. To evaluate professional development processes we focus on the reconstruction of in-service teachers' professional attitudes about IBSE. For this purpose we use the Stages of Concern model. In our report, we present pre-post test results to demonstrate how professional attitudes change during a Georgian PROFILES CPD term.

Keywords: PROFILES, stages of concern, in-service teachers in Georgia

The PROFILES project

Results of the Relevance of Science Education Study [1] illustrate that students in many countries have only little interest in science and in learning science. To cause a change, different reports [2,3,4] suggest that Inquiry-Based Science Education (IBSE) might be an innovative approach to enhance learning outcomes. Educational projects such as the PROFILES (Professional Reflection-Oriented Focus on Inquiry-based Learning and Education through Science) project support this change by disseminating the IBSE approach in Europe [5].

PROFILES is one of the European FP7-funded projects in the field of "Science in Society", promoting a student motivational, everyday life related and inquiry-based approach to science teaching [5,6]. For the PROFILES project, 22 partners from 21 countries develop innovative IBSE-related lesson sequences and train in-service and pre-service teachers in long-term programs (at least 40 hours in a six to twelve month period with four or more meetings [5,6]).

The PROFILES project in Georgia

Therefore, one goal of the working group at Ilia State University (Georgia) – as one member of the PROFILES Consortium – is the development and realization of IBSE-related Continuous Professional Development (CPD) programs for Georgian in-service science teachers. In this context, in-service science teachers are invited to participate in

specific CPD training courses, working on and later implementing the PROFILES type modules [5,6]. Five PROFILES type modules have been adapted by the team of the Ilia State University in Georgia:

- “Stumbling over Biodiversity” (a PROFILES module for biology lessons) [12],
- “Preventing Holes in Teeth” (a PARSEL module for biology lessons) [13],
- “Brushing up on Chemistry” (a PARSEL module for chemistry lessons) [14],
- “Traffic Accident: Who is to blame” (a PARSEL module for physics lessons) [15], and
- “Cola and Diet Cola” (a SALiS module for science lessons) [16,17].

The aim of the CPD training and the work with PROFILES modules is to encourage in-service teachers to implement IBSE in their schools and integrate the approach into their teaching practice. In order to evaluate the impact of the provided CPD program, we analyse teachers’ attitudes about their profession because the theory of planned behaviour [7] implies that attitudes influence behaviour intentions, and these intentions in turn influence the actual behaviour. In the context of the Georgian PROFILES training, this means that the more positive and open-minded a teacher’s attitude about IBSE is, the more likely it is that this teacher will implement IBSE in his/her classes.

Evaluation of the Georgian PROFILES CPD program

To gain insights into in-service teachers’ attitudes about the implementation of IBSE, we refer to the “Stages of Concern (SoC)” theory and questionnaire [8]. The SoC model is based on seven stages (SoC scales): A – Unconcerned, B – Informational, C – Personal, D – Management, E – Consequence, F – Collaboration and G – Refocusing.

Applying the SoC theory provides information about the teachers’ attitudes towards IBSE by creating SoC-Profiles (e.g. the ‘Cooperator’, ‘Opponent’, ‘Non-User’, ‘Docile Performer’ etc.) [8,9]. For this reason we adapted a German SoC questionnaire focusing on IBSE, which was developed and tested by Schneider and Bolte in accordance with Hall and Hord [11,12,8]. The Georgian questionnaire was applied in a pre-post test in the frame of the Georgian PROFILES long-term teacher training program.

Additionally we collected written feedbacks in order to analyse the implementation of the PROFILES modules.

Results

19 science teachers from different regions of Georgia participated in the 1st PROFILES CPD program (7 biology, 6 chemistry, and 6 physics teachers). In the following we present first feedbacks about the implementation of the PROFILES modules in schools.

Georgian teachers’ impressions and feedback regarding their experiences when they started to teach inquiry based by using the PROFILES modules or approaches in the science classes after the PROFILES-based CDP courses:

A biology teacher (N1) mentioned: “Students were involved with great interest. One boy, who was never active during the lessons, was the best in all PROFILES activities”;

A physics teacher (N2) stated: “Students became very active; they did measurements in the school corridor and involved the students from other classes”;

A biology teacher (N3) fed back: “All students were very active. They did the video in the dental clinic on their own initiative, and brought their own resources in the classroom for investigations”;

A biology teacher (N4) said: “After the implementation of PROFILES modules I found my own way of teaching”; and

A chemistry teacher (N5) answered: “Students asked me to have similar lessons at least once a week, and during the lessons they considered themselves “great researchers”.

Regarding our more empirical insight, the analyzed Stages of Concern profiles for both times of collecting data (pre- and post-test) are shown in Figure 1.

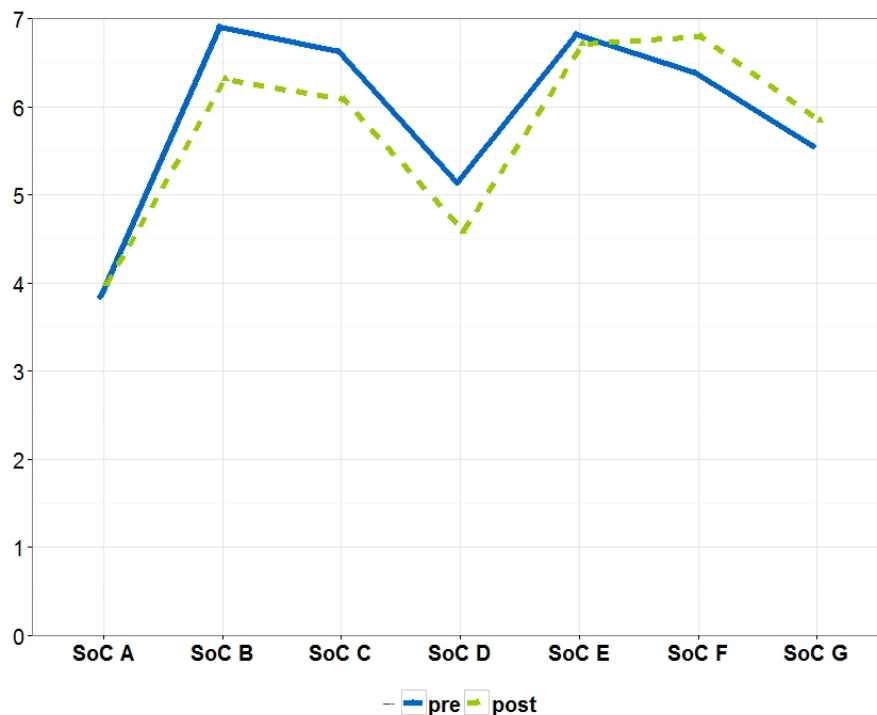

Figure 1. Stages of Concern profiles of the Georgian in-service teacher PROFILES group (N=19) in the pre and post tests; SoC A “Unconcerned”¹, SoC B “Informational”, SoC C “Personal”, SoC D “Management”, SoC E “Consequence”, SoC F “Collaboration” and SoC G “Refocusing” - Mean scores (Differences in SoC B and F are statistically significant – $p < .05$) (status: September 2013).

Discussion

From the written feedback, we draw the conclusions that the PROFILES modules were received very well and that the PROFILES approach has been implemented successfully. For example, a biology teacher (N6) said that she now found her own way of teaching. This suggests that she will continue implementing IBSE in the future.

We also observe a ‘positive’ result regarding the development of the teachers’ professional attitudes about the implementation of IBSE in school. At both times of collecting data we monitored the typical SoC profile of a ‘Cooperator’ [9]. With the theory of planned

¹ Please note: A high value on the SoC-Scale A “Unconcerned” means that the test persons’ awareness about Integrated Science is on a low level.

behaviour in mind [7], the participants of the PROFILES CPD program in Georgia will integrate IBSE-related PROFILES modules into their teaching practice with high probability.

A closer look shows that the participating teachers are more informed about IBSE (SoC B) and have a stronger focus on Collaboration (SoC F) at the end of our PROFILES treatment course. Considering the SoC scale “Refocusing” (SoC G), the participants were also more concerned about optimizing IBSE at the end of the CPD course. These results can be considered positive for the implementation of innovative educational programs [8].

However, the development of attitudes can take years and depends on the attractiveness of the educational program [8]. It can be concluded that despite the attractive offer from the Georgian PROFILES working group, there is still a long way to go. Nevertheless, the results suggest that PROFILES in Georgia is on a good course to help the participating teachers find their way to becoming better professionals and experts of IBSE.

All in all, our results show that it is possible to affect the participants’ attitudes about the implementation of IBSE in a positive manner by means of the PROFILES CPD program for science teachers in Georgia. Therefore, we will provide further IBSE-oriented and PROFILES-based CDP courses for the new generation of science teachers in Georgia to develop and consolidate their IBSE-related teacher ownership as well as to enhance scientific literacy among the pupils.

References

- [1] Schreiner C., Sjøberg S.: ROSE: The relevance of science education. Sowing the seeds of ROSE. *Acta didactica*, 4, (2004).
- [2] AAAS: *Inquiring into Inquiry Learning and Teaching in Science*. Washington, DC, (2000).
- [3] National Research Council: *Inquiry and the National Science Education Standards. A Guide for Teaching and Learning*. (8th ed.). Washington DC: National Academy Press, (2000).
- [4] Rocard M., Csermely P., Jorde D., Lenzen D., Walberg-Henriksson H., Hemmo V.: *Science Education Now: a renewed pedagogy for the future of Europe*, European Commission, (2007).
- [5] Bolte C., Holbrook J., Rauch F.: *Inquiry-based Science Education in Europe: First Examples and Reflections from the PROFILES Project*. Berlin: Freie Universität Berlin. Print: University of Klagenfurt (Austria), (2012; eds.).
- [6] PROFILES: www.profiles-project.eu, (2010).
- [7] Ajzen I.: The theory of planned behavior. *Organizational behavior and human decision processes*, 50(2), (1991), p. 179–211.
- [8] Hall G. E., Hord S. M.: *Implementing change: Patterns, principles, and potholes* (3rd ed.). Pearson Education, (2011).
- [9] Bitan-Friedlander N., Dreyfus A., Milgrom Z.: Types of “teachers in training”: the reactions of primary school science teachers when confronted with the task of implementing an innovation. *Teaching and Teacher Education* 20, No 6 (2004), p. 607–619.
- [10] Schneider V., Bolte C.: *Stages of Concern-Fragebogen*. FUB: Berlin, (2011).

- [11] Schneider V., Bolte C.: Professional Development regarding Stages of Concern towards Inquiry based Science Education. In: Bolte, C., Holbrook, J., Rauch, F.: Inquiry-based Science Education Europe: First Examples and Reflections from the PROFILES Project. Berlin: Freie Universität Berlin. Print: University of Klagenfurt (Austria), pp. 71-74, (2012).
- [12] Pany P.: Stumbling over Biodiversity – A PROFILES module for biology lessons. <https://ius.aau.at/misc/profiles/pages/materials>, 2011.
- [13] Lindh B., Nilsson B., Kennedy D.: Preventing Holes in Teeth - A PARSEL module for biology lessons. <http://www.parsel.uni-kiel.de/cms/index.php?id=76#c108>, 2009.
- [14] Tsaparlis G., Papaphotis G.: Brushing up on Chemistry. A PARSEL module for chemistry lessons. <http://www.parsel.uni-kiel.de/cms/index.php?id=57>, 2009.
- [15] Holbrook J.: Traffic Accident: who is to blame? - A PARSEL module for physics lessons. <http://www.parsel.uni-kiel.de/cms/index.php?id=56>, 2009.
- [16] Streller S., Hoffmann M., Bolte C.: “Cola and Diet Cola” – A SALiS module for science lessons. FUB: Berlin, (2011). In Georgian Language: http://www.idn.uni-bremen.de/chemiedidaktik/salis_zusatz/material_pdf/book_experiments_%20georgia.pdf, 2011.
- [17] Streller S.: Experiencing inquiry learning. Chemistry in Action! Issue 97, Summer 2012, (2012), pp 18-22.

Surprising behavior of a balloon and a foil boat in a gas denser than air: A delayed video-based far transfer test for students' understanding of buoyant force

Josip Sliško¹, Jelena Radovanović²

¹Facultad de Ciencias Fisico Matematicas, Benemerita Universidad Autonoma de Puebla, Mexico

²Elementary school "Slobodan Sekulic", Uzice, Serbia;

Abstract

The paper describes one video-based activity intended to serve as a far four-month delayed transfer test of understanding of buoyant force, floating and sinking. The aim was to check if the students were able to apply their knowledge by explaining situations shown to them in a video sequence which, at first glance, looked quite surprising and almost surreal.

Keywords: Secondary education: lower (ages about 11-15), active physics learning, predict-observe-explain, floating and sinking, delayed transfer test

Introduction

The transfer of knowledge is ability to retrieve previously learned concepts and skills from memory and apply them to new situations [1]. It is of vital importance for both application of already learned information to appropriate real-world situations and for learning new, related topics. Three ways in which the transfer occurs can be identified [2]. One mode of transfer is from prior knowledge to learning. This would, for example, include using existing everyday knowledge as a foundation when learning new scientific concepts. Another way for transfer to occur is from previous learning to new learning, as is the case when learning about new topics requires one to invoke previously learned concepts and skills. Old learning is effectively enabling new learning through transfer of knowledge. Finally, a transfer can happen between the new learning and everyday practical applications and work-related tasks.

One important aspect of knowledge transfer is the distance between the original situation being recalled from learner's long-term memory and the new learning or application. Depending on this distance, transfers can be categorized as near, in which the original is relatively close to the new experience, and far, when the distance is much greater. Different strategies have been suggested for optimizing the learning approach to better suite near or far transfers [2]. Typically, far transfers require abstract, decontextualized strategies with varied practice, while near transfers call for a more concrete, contextualized approach. In this paper, we will focus on testing far knowledge transfer in a scenario with significant temporal delay of 4 months and conceptually novel situation.

To introduce a new, conceptually challenging situation for the purpose of testing the knowledge transfer, we made use of a video recording available on the Internet. Advancements made in information technologies during the past decades have made multimedial learning environments possible, and, equally important, easily accessible to both students and teachers. Learning in such environments has been shown to increase the effectiveness of knowledge transfer, compared to traditional text-based learning [3]. Our experience shows that multimedial approach can also be used to test far knowledge transfer, by providing opportunity to easily expose students to new physical situations.

Description of activity and research sample

This assignment was designed as a final part of pilot research on efficacy of active physics learning experiences inserted in traditional lecture-based teaching on buoyant force and related topics in primary school. The research took place during the second semester of academic 2011/2012 in Uzice (Serbia). The sample consisted of 68 seventh-grade students (age 13), divided into three groups. Groups were set up in such a way that students' achievements in physics at the end of the previous school term were about the same for all the groups. Each group was asked to fill in a worksheet relating to a video sequence ("SF₆ Denser than air" at the video portal www.fizik.si) showing:

- sinking of an air-filled party balloon placed in a container filled with air, and then its floating in the same container filled with an invisible gas denser than air (Figure 1, left);
- floating of a tin foil "boat" placed in a container with the same dense gas (Figure 1, center), and then its sinking after the dense gas was poured into the "boat" itself (Figure 1, right).

Students were asked to describe what they saw and to give their explanations why it happened. They were also given the opportunity to estimate how much this activity helped them test their physics knowledge, on a scale from 1 to 5.



Figure 1. Balloon floating on gas (left), boat floating on gas (centre) and boat sinking after it is filled with gas (right); frames from educational video accessible at http://www.fizik.si/index.php/en/fizikalni-eksperimenti/mehanika?videoid=xQo-v_F1P9U#youtubegallery

We inform the reader that all three groups of students have been exposed to modified traditional teaching during the lessons on buoyant force and related phenomena – new contents was delivered using verbal teaching methods with small number of demonstrations, while the review classes included some elements of active learning. The demonstration of buoyant force was done through a predict-observe-explain activity [4, 5] and the active learning included critical evaluation of a mathematical problem related to mass and density of apples. In addition, the two groups of students have been solving the investigative homework assignment on the density of apples and their behavior in water. The homework was assigned in two different modes.

Students in the first group (A) were allowed to decide if they wanted to do the homework, and turning in the high-quality assignment would have made positive impact on their grades. Second group (B) had mandatory homework – failure to turn it in would have affected their grades negatively. Students from the third group (C) didn't solve the investigative homework problem.

By using a diagnostic test, based on the research done by Yin and associates [6], it was determined that the degree of overcoming alternative conceptions was the highest in group A, and the lowest in group C. Keeping those results in mind, the delayed far transfer test,

implemented 4 months after the teaching sequence on buoyant force and related phenomena, was organized in the following manner – different groups had different viewing experiences with the video sequence:

- 1) seeing the video with sound off (group A);
- 2) seeing the video with sound on (group B);
- 3) seeing video with sound on after a short predict-observe-explain activity which had very similar elements as the video sequence, but with water being used instead of the dense gas (group C).

Results of delayed far transfer test

1. Surprise

Most of the students from all groups (51) have described the behavior of balloon and boat as surprising or very surprising, noting the description of observed events, frequently with comments that the balloon acted “normal” in the first case, and then “weird”, “surreal” or “magical”. For example:

“I'm surprised. This is surreal! And I have no other explanation for this, except magic!”

“This physicist must have performed a magician's act!”

“I'm very surprised, because the balloon acts normally, i.e. falls to the bottom of the container, and then when something is poured in, it acts strange - it levitates!”

Several students (3 from group A and 5 from group B) have said that the behavior of balloon and boat is not surprising, while providing correct explanation for the observed events. For example:

“I was surprised at first, but as I was watching the part of the video with the boat falling to the bottom, I've realized that an invisible gas, denser than air, is used. It is poured both in the container, and in the boat.”

“As soon as the man has shown the balloon falling down in air-filled container, I assumed he was going to pour in a different, denser, gas and that the balloon will float.”

In addition, 5 students from the B group were not surprised, because they were convinced that the cause for the observed behavior was helium poured into the container and into the boat, while 4 students from the C group thought that the floating of balloon and boat was caused by draining of air from the container, i.e. by creation of vacuum. For example:

“I'm not surprised, this is easy. Helium is poured in and that is why the balloon floats.”

“I've heard a hissing sound, which means that the air was removed and that's why the balloon is floating in vacuum, so I'm not surprised.”

2. Explanations for the behavior of balloon and boat

Analysis of explanations for the behavior of balloon and boat given by the students shows several groups of typical answers:

1) The correct explanation containing the relation between the force of gravity and the buoyant force and/or the relation between average densities of objects and gas. For example:

“The gravity force acting on the air-filled balloon is equalized by the buoyant force exerted by the gas and that's why the balloon remains still at the top of the container. The balloon was falling to the bottom because the container was originally filled with just air, and now it's some gas denser than air.”

“When gas is poured into the boat, the average density of boat and gas combined becomes greater than that of the gas itself, and the boat sinks, i.e. falls to the bottom.”

2) Stating the fact that a **gas** is poured into the container and then into the boat, with an optional note that this leads to the strange behavior of balloon and boat. For example:

“A gas was poured into the container and then the boat can't fall to the bottom, just like the balloon can't. Once this gas is poured from the jar and into the boat, the boat falls to the bottom.”

3) Explanation containing just a note that **“something”** was poured into the container and the boat. For example:

“Something was poured into the container and that's why the balloon is behaving strange.”

4) The gas vessel was labeled “research gas” in Slovenian. Since the word for “gas” in Slovenian (“plin”) means specifically **cooking gas** (LPG, a mixture of propane and butane) in Serbian, some of the students have said that the cause of the observed phenomena is cooking gas. However, this was not the gas used during the demonstration. For example:

“Something was poured into the container, and the balloon can't fall. I didn't know what it could be, but I saw that the gas vessel was labeled 'cooking gas'.”

5) Some of the students explained the floating of balloon and boat by saying that **helium** was poured into the container and then into the boat. For example:

“The balloon floats because helium was added into the container. Helium prevents things from falling down.”

6) Several students thought that the „hissing sound“ heard was caused by the removal of air from the container and the **creation of vacuum** which caused the balloon and the boat to float, and that boat subsequently falls to the bottom once the air is returned into the container. For example:

“Air was sucked out of the container by the use of a tube, and then the boat could float in the airless space. Once the air was returned, it fell to the bottom.”

7) Three of the students submitted explanations that the container, and then the boat, was filled by water, “a strange air” and “invisible water”.

8) Two students offered no explanations.

Students' results by groups and over entire sample are shown in the following tables:

Table 1. Explanations in group A (23 students)

Explanation for the behavior of	Correct explanation	Invisible gas	„Something“	Cooking gas	Water	„A strange air“
Balloon	9	7	4	1	1	1
Boat	12	3	4	1	1	1

Table 2. Explanations in group B (23 students)

Explanation for the behavior of	Correct explanation	Invisible gas	„Something“	Helium	Cooking gas	No explanation
Balloon	5	3	6	5	3	1
Boat	5	5	4	5	3	1

Table 3. Explanations in group C (22 students)

Explanation for the behavior of	Correct explanation	Invisible gas	„Something“	Cooking gas	Vacuum	„An invisible water“	No explanation
Balloon	4	5	2	5	4	1	1
Boat	4	5	2	5	4	1	1

Table 4. Sample-wide explanations

Explanation for the behavior of	Correct explanation	Invisible gas	„Something“	Cooking gas	Helium	Vacuum	Other	No explanation
Balloon	18	15	12	9	5	4	3	2
Boat	21	13	10	9	5	4	3	2

3. Results of additional predict-observe-explain activity in group C

Since the C group students have had the weakest achievements during the initial investigation, a short predict-observe-explain activity was conducted immediately prior to showing them the video recording, based on the idea that students might notice the analogy between the buoyant forces acting in water and in gas.

The students were shown an air-filled balloon falling to the bottom of the glass container. The container was then filled with water, and the students were asked to predict what would happen if the inflated balloon was lowered into the container again. All of the students have given the correct prediction that the balloon will float on the surface of water, together with the following explanations for their prediction:

- 6 students stated that the balloon floats on water because its density is lower than the density of water or because the balloon is acted upon by the buoyant force equally its weight.

- A total of 13 students have given explanations that reflect presence of alternative conceptions: 10 students have said that the balloon floats on water because it has air inside, and 3 students that it floats because it is light.
- 3 students gave no explanations for their predictions.

After the experiment was conducted, all of the students have maintained their previous claims.

In the second part, students were shown a “boat” (a small ceramic bowl), floating on the surface of water. Students were asked to predict what would happen if water is poured into the “boat”. All of the students have made the proper prediction, but a lot of explanations reflected alternative conceptions, as in the previous case:

- 12 students have noted that the “boat” floated at first because it was light, and that it sank after water was added because it became heavier.
- 6 students which gave proper explanations in the first part of the activity did so in this part too, mentioning the relation between the densities of object and liquid and between the buoyant force and object’s weight.
- 4 students offered no explanations for their predictions.

After the experiment, most of the students held on to their explanations, as in the previous part. Only three students made progress from an alternative conception towards the explanation that the “boat” sinks because of the increase in gravity force acting upon it.

4. Estimate of implemented activity

Students used a scale of 1 (very little) to 5 (very much) and dedicated comment space to estimate how much this activity helped them check their physics knowledge. Most of the students provided a grade (65 students), but only about half of them elaborated on it. Average grades, by groups, were: A - 3.16; B - 3.09; and C - 2.95. We will quote some of the comments:

“The video I’ve watched is very interesting, but I’m not sure I’ve understood it correctly. Therefore, my grade is 3.”

“I, and all of my classmates, failed to study anything during the summer. However, this activity made me remember the buoyant force lesson.” (grade 5)

“I liked the experiment because it’s not the usual way of testing knowledge. I hope I have understood and explained it properly.” (grade 4)

Analysis and conclusions

Students’ scores on the delayed far transfer test of understanding phenomena related to the buoyant force, floating and sinking point towards the following:

- Slightly less than a third of tested students gave proper explanation for the behavior of balloon and aluminum foil boat when placed in gas denser than air (18 students for balloon and 21 for boat). Explanations coming from these students were clear and reflect understanding of conditions leading to floating and sinking, with good grasp of the way the buoyant force acts, not only in liquids but in gases too.
- Significant number of students (27 for balloon and 23 for boat) thought it sufficient to say that “something” was poured into the container and the boat, or that it was some

sort of gas. These students failed to provide an in-depth explanation for the observed phenomenon and look for deeper physical meaning. 9 students chose an even more simplified answer, saying that “cooking gas” was used. They simply read the text visible in the video recording, not even considering the possibility that it was in foreign language, with a different meaning. Nevertheless, this detail clearly shows how eagle-like eyes students have. Two students called the substance “strange” water or “strange” gas.

- Several students (5) were convinced that helium was poured into the container. Students are familiar with the fact that a helium-filled balloon rises in the air. However, they didn't consider the relation between the densities of helium and air as the condition for such behavior of helium balloon, and, consequently, failed to realize that the gas used to fill the container had to be of higher (instead of lower) density than air. Another 4 students came up with an *ad hoc* explanations submitting that vacuum was created in open container and that subsequent return of air caused the boat to sink. These students were encouraged by the hissing sound heard in the recording. It is clear that these students don't understand the conditions required for forming of vacuum and that they hold an alternative conception that there is no gravity in vacuum environment [7].
- Most of the students felt greatly intrigued and surprised by the video. Only 17 out of 68 students stated that they weren't surprised: 8 with correct explanations and 9 which were thoroughly convinced of their wrong explanations (with helium and vacuum).
- Comparing the achievements between the three groups, we can see that the highest number of correct explanations came from the A group, with similar numbers in B and C groups (5 from B and 4 from C, for both assignments, less than half of the A group). We should also note that the A group students made no wrong explanations such as helium or vacuum, and that they had the least number of “lazy” explanations, made by copying the text from the gas bottle seen in the video.
- Even though the B group had access to the „richer“ version of the video, including the audio, and the C group had additional POE activity with similar elements, these groups scored worse than the A group. We can ascribe these differences to the direct experiences with the floating and sinking phenomena which the A group students had while doing an investigative homework assignment on apples, and they were more motivated to submit a quality paper, than the B group, which had the mandatory homework.
- In both A and B groups, the correct explanations were given by the students that have also turned in the best-quality and most carefully done homework assignments on the density of apples and causes of their behavior when placed in water. In C group the correct explanations were given by the highest-performing students, who have noted the analogy with the experiment done with water during the POE activity immediately prior to video-based task. For example: “Air-filled balloon floats on some gas, just as it was floating on water, since both water and this gas have higher density than the balloon.”
- These differences in students' achievements correspond to a situation identified by other authors [8] in which the transfer of knowledge is successful only in learners with good general knowledge of the subject matter.

- The predict-observe-explain activity didn't help most of the C group students to successfully interpret the behavior of balloon and boat in the video. Not all of the students which provided proper explanations for the observed behavior in the experiment made the connection with the video which followed it. The POE activity has shown that alternative conceptions are deeply rooted in these students. About one half of the C group has shown the presence of some of alternative conceptions.
- Students whose education is dominated by the traditional teaching methods have little experience in self-evaluating their achievements, as is clearly demonstrated by the fact that almost half of the students failed to elaborate on the grade they gave for this activity. The grades themselves aren't too high and match the achievements of the students: the highest grades came from the A group, the lowest from group C.
- The implemented activity raises students' attention and interest in the subject. It enables the teacher to clearly see the level of understanding students have of the buoyant force, floating and sinking, and, to some extent, the presence of alternative conceptions. Therefore, this kind of activity can be a significant review element of active learning sequence on buoyant force and related phenomena.
- This segment of initial investigation has shown the need for introduction of active learning methods into regular classes, since only the direct experiences with the subject phenomena and increased learning motivation can enable students to achieve the level of knowledge which can later be applied in new situations.

Acknowledgement

This study was designed and carried out as a part of Josip Slisko's sabbatical research project "Active physics learning on line" supported by CONACyT Mexico for the period August 2012 – July 2013.

References

- [1] Chena Z., Klahrb D.: Remote transfer of scientific reasoning and problem solving strategies in children. *Advances in Child Development and Behavior*, Volume 36, (2008), p. 419-470.
- [2] Simons P. R. J.: Transfer of learning: paradoxes for learners. *International Journal of Educational Research* 31 (1999), p. 577-589.
- [3] Rosen Y.: The effects of an animation-based on-line learning environment on transfer of knowledge and on motivation for science and technology learning. *Journal of Educational Computing Research* 40, No 4 (2009) p.451-467.
- [4] White R., Gunstone R.: *Probing Understanding*, New York: The Falmer Press (1992).
- [5] Radovanovic J., Slisko J.: Applying a predict–observe–explain sequence in teaching of buoyant force. *Phys. Educ.* 48, No 1 (2013), p. 28-34.
- [6] Yin Y., Tomita K. M., Shavelson J. R.: Diagnosing and dealing with student misconceptions: floating and sinking. *Science scope* 31, No 8 (2008), p. 34 - 39.
- [7] Sequeira M., Leite L.: Alternative conceptions and history of science in physics teacher education. *Sci. Ed.* 75 (1991), p. 45–56.
- [8] Barnett S. M., Ceci S. J.: When and where do we apply what we learn? A taxonomy for far transfer. *Psychological Bulletin* 128, No. 4 (2002), p. 612–637.

Students' Perception of the Problem solving Process in Physics

Marie Snetinova, Zdenka Koupilova

Department of Physics Education, Faculty of Mathematics and Physics, Charles University in Prague, Czech Republic

Abstract

Students often struggle with many difficulties when they solve physics tasks. For this reason, we wanted to determine main points how the problem solving process runs in students' minds and where they encounter problems. This survey is only a part of a more extensive research that pursues problem solving in physics.

We focused on quantitative physics tasks only. We prepared questionnaires containing open questions for high school students. The result of the survey can be rather surprising – students are almost exclusively concerned by physics equations and the whole problem solving process is reduced to equation manipulation.

Keywords: physics, problem solving, students' perception, high school

Introduction

Students often struggle with many difficulties when solving physics tasks [1]. Understanding of these difficulties is crucial for teachers for mitigation of the students' obstacles in solving physics tasks as well as for improving students' problem solving skills.

Therefore, we decided to design a questionnaire survey focused on problem solving in physics. The main goal of the questionnaires was to look into students' perception of the problem solving process, to determine how the process runs in their minds, to find out their biggest difficulties in solving physics tasks, and how they deal with these difficulties.

Methods

The presented survey was focused on solving of quantitative physics tasks only. The conclusions of the survey were based on questionnaires containing open questions and the presented results were gained by using the grounded theory. This survey is a follow-up to previous authors' work [2] and it is only a part of a larger qualitative research aimed at solving quantitative physics tasks.

Participants

The participants of this survey were 773 high school students (students at the age of 15 to 19), who are attending physics lessons during their studies. The numbers of respondents in particular classes are presented in Table 1.

The participating schools were from Prague and other big as well as smaller cities in the Czech Republic. Besides five regular state high schools, two private high schools and one technical school were included into the selection.

Table 1: Number of respondents in particular classes

Class (students' age)	Number of respondents
1 st class (15–16)	256
2 nd class (16–17)	185
3 rd class (17–18)	183
4 th class (18–19)	149
In total	773

Description of the questionnaire survey

We used two different students' questionnaires (marked S1 and S2) to collect data. The questionnaires consisted of five open questions (see Table 2). The questionnaire S1 (408 respondents) contained additionally nine rating scales concerning use of problem solving strategies.

Both questionnaires were designed similarly on purpose. The main difference lay in the form (open questions or rating scales) of the questions that investigated students' problem solving strategies. The open questions in the questionnaire S2 offered to students an opportunity to describe strategies in their own words. So, we could easily investigate, what was the attitude of high school students to the solving of physics tasks and what obstacles, according to their opinion, they contended with. Results dealing with the students' problem solving strategies are published in [2].

Table 2. List of open questions from the questionnaires

Questionnaire S1	Questionnaire S2
1. What is your biggest problem during problem solving in physics?	1. Are there any established steps you use during problem solving in physics? What methods do you use if you don't know how to solve the problem at first sight?
2. Is there anything that helps you with solving physics tasks?	2. To what do you pay attention during solving physics tasks?
3. What is – according to you – the purpose of solving physics tasks?	3. What is – according to you – the purpose of solving physics tasks?
4. Do you think that you can use these approaches also in other situations? In which ones?	4. Do you think that you can use these approaches also in other situations? In which ones?
5. Which steps were recommended or shown to you to help you to solve physics problems?	5. Which steps were recommended or shown to you to help you to solve physics problems?

Results

Most important terms in physics problem solving process for students

The main goal of the research was to find students' perception of the problem solving process in physics. According to collected data, it seems that in solving quantitative physics tasks the most important thing for students are equations. The word "equation" or some synonym appears in answers to almost every question in the questionnaires. The most frequently mentioned terms and the connection between them are shown in the diagram in Figure 1. The structure of the key terms and relations was put together in the same order in which students meet them during solving of the physics task (see the green arrows in Figure 1). The letters in Figure 1 serve for clear arrangement of the text.

The results of the questionnaire research concerning problem solving strategies show that no significant difference is evident in using the strategies in particular classes [2]. For this reason, we did not expect any difference in students' perception of the problem solving process and we analysed the research data from all age groups together.

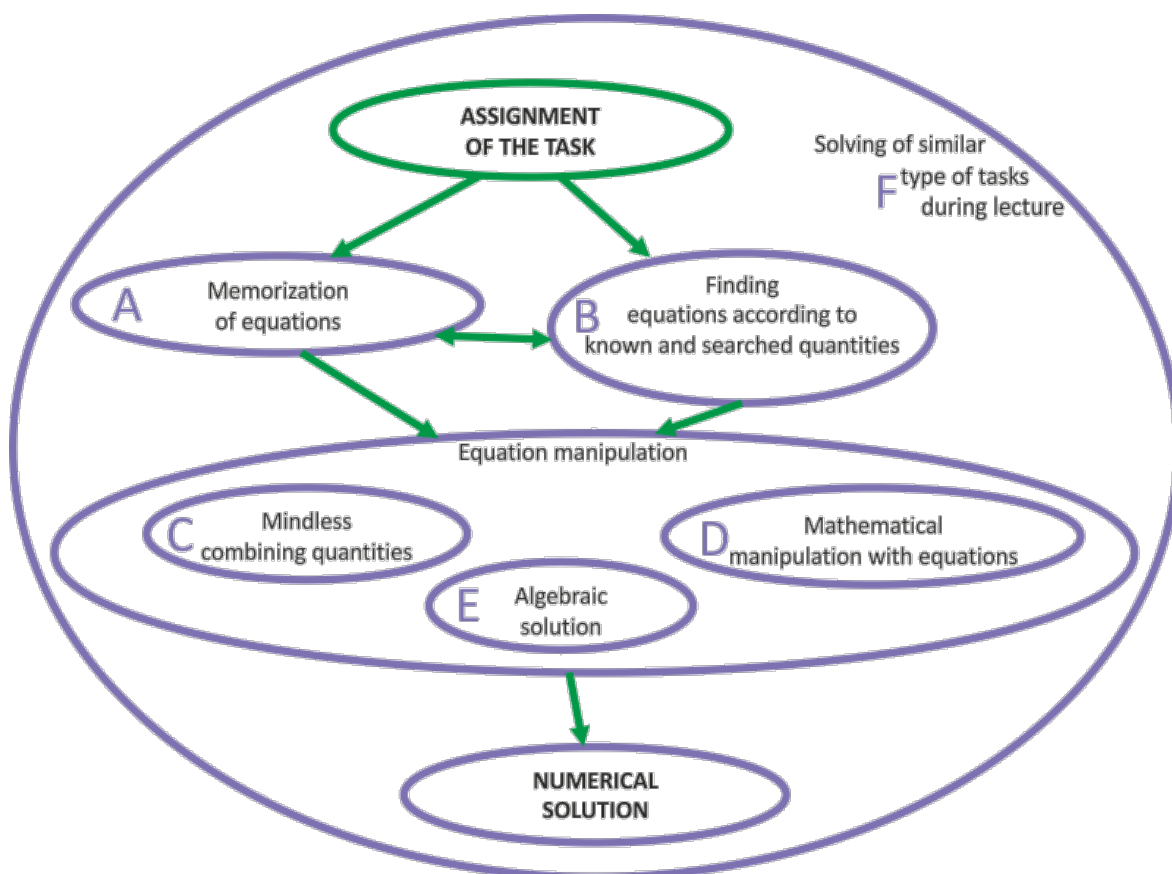

Figure 1. Students' most significant categories in problem solving process and relations between them

The categories and relations from Figure 1 are itemized and described below. Some of them are also illustrated by students' answers.

A) Memorization of equations

The students' answers in the survey indicate that students try to memorize as much physics equations as possible and then they try to fit all known and unknown quantities that appear in the assignment of the task into these memorized equations.

Question: Are there any established steps you use during problem solving in physics? What methods do you use if you don't know how to solve the problem at first sight?

Answer: "I write down a list of physics equations that I remember and then I check which one can be used for solving the task."

B) Finding equations according to known and searched quantities

Finding equations according to known and searched quantities (**B**) is closely connected to the memorization of equations (**A**). It belongs to the most often used problem solving strategies [2]. This strategy can be very effective for well-structured or end-of-chapter tasks [3], which are commonly used in physics lessons at Czech high schools – one student described it in the questionnaire by words: "In majority of tasks it is enough to put given quantities into an equation and appropriately simplify the equation to obtain the result."

From the illustrations of previous terms **A** and **B** it can be seen that the relation between them is reversible. Students memorize physics equations and try to choose the most suitable one according to the given quantities in the task, or they write down a list of all quantities from the assignment and then try to find the right equation.

Both these terms (**A** and **B**) lead to other relations connected with physics equations that seem to be very significant for students. Students try to **manipulate the equations** in various ways to gain numerical results of physics tasks. During this work, they often meet several difficulties. The following three categories are connected to the equation manipulation.

C) Mindless combining quantities

The results of the survey show that students who do not know how to solve a task sometimes approach the problem without deeper thinking. When they do not know or cannot remember proper equations, they try to combine physics equations or given quantities mindlessly to gain any number as a result of the task. This approach confirms Harper's statement that students often view the problem solving aim as "getting the right number" [4].

Question: Are there any established steps you use during problem solving in physics? What methods do you use if you don't know how to solve the problem at first sight?

Answer: "I try to recall some equations that I can use with regard to given quantities. When I really don't know, I try to combine the numbers in different ways."

D) Mathematical manipulation with equations

For students the mathematical manipulation with equations seems to be a very important process. They often wrote that they pay attention to the mathematics in solving physics tasks. Under the term "mathematics" students mean algebraic modification of physics equations as well as work with numbers. Some students also admitted that mathematics belongs to their weaknesses in problem solving process.

Question: To what do you pay attention during solving physics tasks?

Answer: "To modify the equation correctly."

Answer: "To errors during numerical calculations; to errors in expressing the unknown quantity from a more complex equation."

From the results it also follows that students consider practicing of mathematics as one of purposes why to solve physics tasks.

Question: What is – according to you – the purpose of solving physics tasks?

Answer: "By solving tasks we learn arithmetic..."

E) Algebraic solution

Finding algebraic solution is very closely connected with the mathematical manipulation with equations.

It is regarded to be other very significant part of problem solving process for students, because teachers require it as well. In addition, many students are not enough experienced in modification of physics equations and they consider obtaining the algebraic solution to be very difficult.

F) Solving of similar type of tasks during lecture

The results of the survey indicate that **solving of similar type of tasks during lecture** is very important for students. It does not relate only with physics equations but with the whole process of solving physics tasks. For this reason, it is depicted in Figure 1 as encircling the other terms.

The answers in questionnaire survey show that students are used to independent solving of tasks that are very similar to those solved during physics lecture by their teacher. When students do not see or find any similarity between the tasks, they often incline to skip the problem.

Question: Is there anything that helps you with solving physics tasks?

Answer: "In the test paper, there are such tasks that our teacher already solved on a black board in front of us and so we already know these types of tasks."

Question: Do you have any established steps you use during problem solving in physics? What methods do you use if you don't know how to solve the problem at first sight?

Answer: "I skip the task. If it is a type of task that I see for the first time, I am not coming back to it."

Summary

For students are the most important thing in solving quantitative tasks the physics equations. Students are coming to believe that they need to memorize as much physics equations as possible. One student expresses this statement in the questionnaire by words: "Physics is a very interesting science that I enjoy, because thanks to physics most of things can be explained. However, I don't like physics equations that we have to memorize although they are available everywhere."

The memorized equations serve then as a list of possibilities that can be used in solving a physics task. Students often compare symbols in the equations with the known quantities in the assignment of the task and they try to choose an equation containing the same symbols that are listed in the assignment.

When the proper equations are chosen, students try to combine them to gain numerical result of the task. Students sometimes meet some obstacles during the manipulation with the equations. They often have to pay attention to mistakes in mathematics.

Many students stated that their teacher requires writing down the algebraic solution. Because students are often not enough experienced in equation manipulation, they perceive getting the algebraic solution to be very difficult.

When students do not know how to solve a task, they often skip it or they start to combine quantities or equations mindlessly. It can be caused by the fact that students do not see problem solving as a process but they think it is a recall task and that their main aim in solving quantitative task is getting some number.

References

- [1] Byun, T., Ha, S., Lee, G.: Identifying student difficulty in problem solving process via the framework of the House Model (HM). *Proceedings of the Physics Education Research Conference*. Vol. 1064, (2008).
- [2] Snetinova, M., Koupilova, Z.: Problem Solving Strategies in High School Physics Lectures. *Scientia in Education*. Vol. 4, No. 1, (2013).
- [3] Ogilvie, C. C.: Changes in students' problem-solving strategies in a course that includes context-rich, multifaceted problems. *Physical Review Special Topics – Physics Education Research*. Vol. 5, (2009).
- [4] Harper, K. A.: Student Problem solving Behaviors. *The Physics Teacher*. Vol. 44, No. 4, (2006), p. 250-251.

Found Misunderstanding of Convection and Effective Experiment to Solve by Thermal Camera

Naoshi Takahashi¹, Katsumasa Yokokawa², Masazumi Mori³

¹ Department of Physics, Faculty of Education, Kagawa University, Japan

² Graduate School of Education, Kagawa University, Japan

³ Sakaide Elementary School, Faculty of Education, Kagawa University, Japan

Abstract

We have used conventional thermography to demonstrate heat transfer in water. From the conceptual test during the study, we realized that fifth- and sixth-grade students in Japan believed that the propagation of heat transfer should be the same as that of convection. This study shows the current situation of the misconception and its origin, together with the introduction of our idea to use thermography.

Keywords: thermography, convection, heat transfer, misconception

Introduction

In Japanese elementary schools, fourth graders learn the thermal properties of matter, including the concept of heat, and two processes of thermal energy transfer: conduction and convection. In general, teachers are always trying to demonstrate such invisible phenomena, for example, using wax to show conduction and sawdust to show convection. Despite these efforts, it is not easy to make children understand the nature of heat itself. As the first step of this study, we tested their level of understanding of this subject and realized that most of them mixed up convection and heat transfer; they thought that heat is propagated in a circular path through a water bath by warm water, i.e., that the center of the pot is the last to be warmed. Based on this finding, we concluded that a new method of teaching, which shows heat transfer directly by the color sequence of temperature, is necessary to dispel this misconception.

In this report, we will outline the children's background misconception, present a short survey of the thermography Avionics F30/F20 [1], and attempt to develop a new teaching scheme using thermography F30 in a public school.

Experiment

Researchers have believed that the use of thermography [2,3] is a potential breakthrough in thermodynamics education; however, the cost of thermographic imaging has thus far hindered its installation in schools. Recently, a conventional, digital, thermographic camera (Nippon Avionics, former NEC Avio, "Thermo Shot F30 / F20," Figure 1) has been released at a very low price. It is still relatively expensive for personal use, but it can be used in individual classrooms and schools to observe thermodynamic phenomena. It can be used for temperatures ranging from -20 to 350°C, with a temperature resolution of $\Delta T = 0.2^\circ\text{C}$. The measuring wavelength ranges from 8 to 13 μm , and 160 \times 120 pixel images can be taken with the 2.7-inch liquid crystal display at a speed of 8.5 frames/sec.

Before introducing thermography to the classroom, we examined the usage of the camera. Because of its properties, the camera is suitable for measuring surface temperatures such as the human body shown in the right panel of Figure 1 and of the metallic material shown in

Figure 2. However, it is not useful for thick-covered materials. Figure 3 shows some test cases on common materials to check whether they are suitable for the experiment: (a) glass, (b) water in a propylene bag, and (c) the polypropylene bag itself. Of these, infrared light was detected on the camera only for the last case.

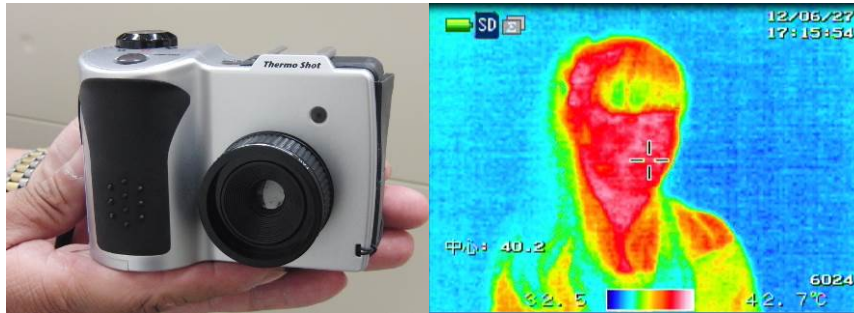

Figure 1. Thermo Shot F30 (left) and its thermal image of a human body (right)

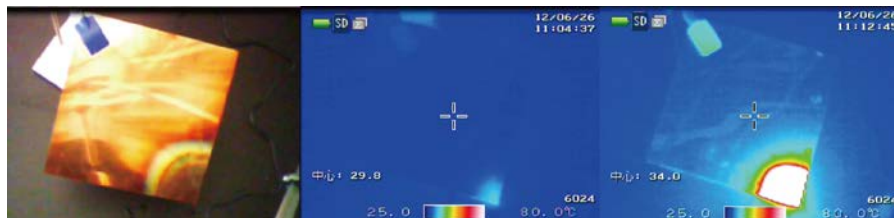

Figure 2. Example of real (left) and thermal (center and right) images (taken with a Thermo Shot F30) of a burned copper plate

(a)			Glass beaker ×
(b)			Water Δ (thicker ×)
(c)			Polypropylene ○ (4μm thickness)

Figure 3. Test pictures taken under different conditions: (a) glass, (b) water in a polypropylene bag, and (c) a polypropylene bag alone

We stuck a polypropylene bag to a styrofoam plate, as shown in Figure 4. A heater was placed at the bottom, inside the bag, to warm up the water. Experimental results are shown in Figures 5 and 6, which are a sequence of pictures cut from a movie file. These pictures clearly show that the mechanism of heat transfer in water differs from that of convection.

Initially, the heat rises from the heater and moves horizontally, and then moves down in a “layer-by-layer” manner. In both figures, the difference of temperature in the system is about 10°C. Although it shows no strong movement similar to boiling water or a plume of water, it is still regarded as semi-static; hence, it is a phenomenon of convection. The fact that the speed of the water propagating upward is much greater than that of the water propagating horizontally is also noted in this system. It means that the phenomenon was occurring not in any special space, but in general place like in the school lab. Further discussion will be made in another study.



Figure 4. Photograph of our experimental setup

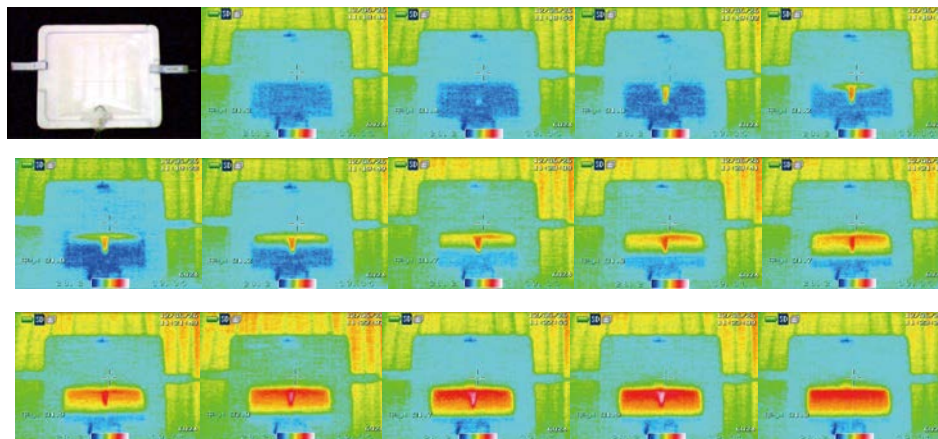

Figure 5. Experimental results using the equipment of Figure 4. These pictures clearly show that the water warms in a manner different from that of convection.

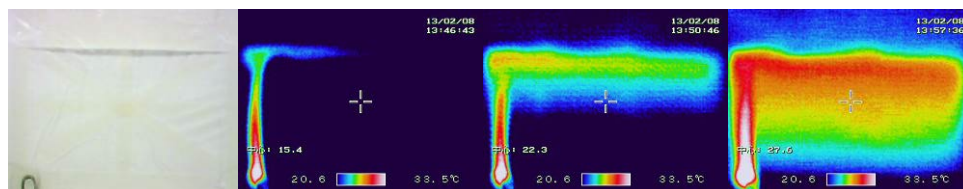

Figure 6. Another set of experimental results. In this case there is a heater at the left-bottom corner. These pictures clearly show that heat transfer in water differs from that which could be caused by convection.

Textbooks and typical teaching material

It is useful to examine the textbooks pupils use to study the thermal properties of matter before we introduce thermography to the classroom. Thermal properties are first

introduced in a fourth-grade textbook. The metal properties are used as a case study for conduction in the textbook [4]. As can be seen in the upper part of Figure 7, the metal bar and plate are warmed by conduction. Teachers usually employ a wax-coated metal bar and plate as teaching materials to show conduction, by means of observing the order in which the wax coating melts. In the diagram, there are arrows indicating the direction of heat transfer by conduction, and the text reads as “metal warms up by conduction of heat.” In addition, the textbook mentions the concept of convection. In the lower part of Figure 7, there are cases of water in a beaker and air in a room. Teachers use miso paste or sawdust in the case of water to visualize convection (see Figures 8 and 9), in which these materials move together with water. Some arrows are included in the diagram; however, it is noted that these arrows show the routes of motion of the materials themselves in convection, rather than the routes of heat transfer. One can see the description in the textbook: “water (air) warms up to the overall movement of warm water (air) by itself.”

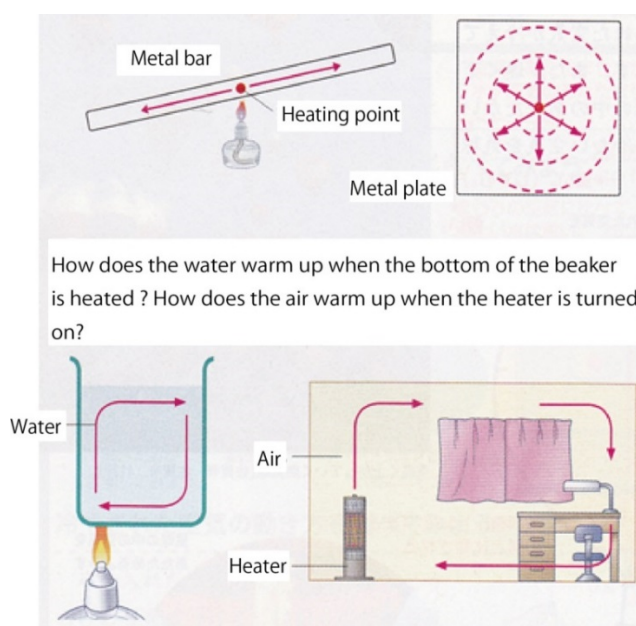

Figure 7. Image of the conduction and convection in the textbook, “New Science for 4th grade,” Tokyo Shoseki. (Hereafter, simply referred to as “the textbook”)

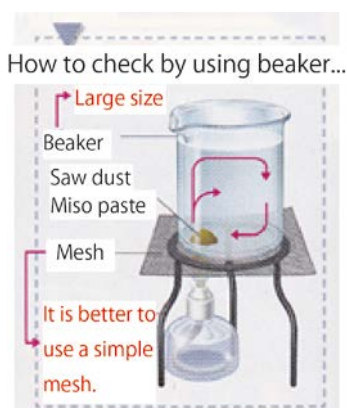

Figure 8. Saw dust/miso paste is used to visualize the motion

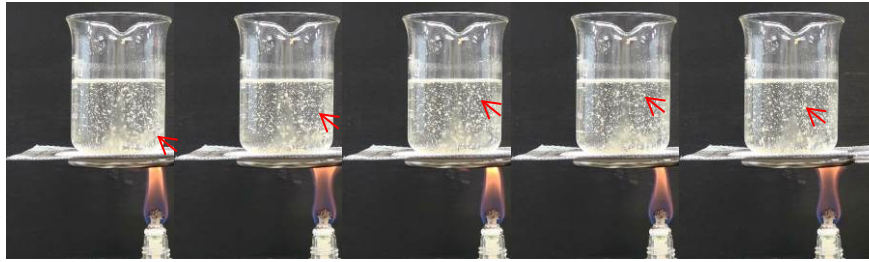

Figure 9. Sequence of photographs showing convection. We used ground sesame seeds.

Conceptual survey test

We tested children' background knowledge with a conceptual survey test. The following is an example of one of the questions asked in the investigation: "How does the water in the beaker warm up?" (see Figure 10). The test contains questions about conduction in the metal bar and plate, and about convection in water and air. The test was conducted on fifth and sixth graders of Sakaide Elementary School (attached to Kagawa University), a typical public school in Kagawa, and on some teachers and university students with additional interview questions. All of them had already learned the concepts of conduction and convection.

We show a typical result in Figure 11. We have categorized the results into five patterns of "heat arrows." First, it is surprising that one-third of Sakaide children chose No. 2, and another quarter chose Nos. 5 and 6, which contain the rotating images. In contrast, only a small number of children correctly chose No. 1. Moreover, the fact that about 23% of the students in Sakaide, 36% in the public school, six students of Kagawa University chose No. 3 is a serious problem; it shows that they clearly did not understand the difference between conduction and convection. These results show they have confused convection in water with heat transfer.

Q. How does the water warm up?

Water of the following devices, please write the number to go warm or warm up in any order. You may write the same number in places where you would have thought that the warm up at the same time.

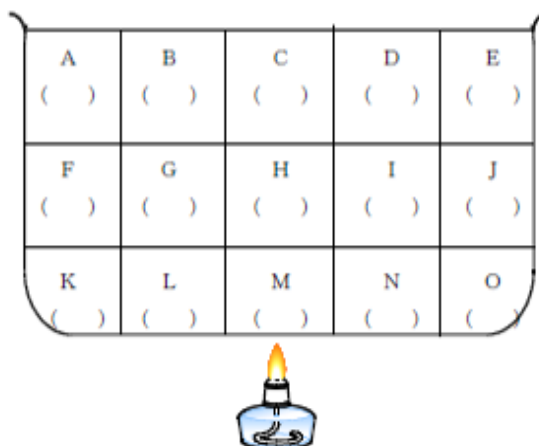

Figure 10. One question on the concept survey test concerning to convection

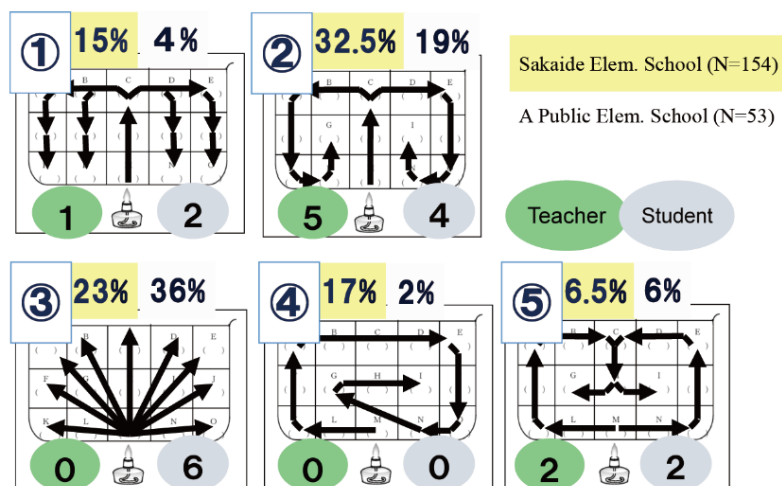

Figure 11. Results of the test

Where does the confusion between heat transfer and convection originate?

One reason for this confusion is the textbook. Diagrams in Figure 12 are from five major Japanese textbooks for the fourth grade [5]. There are arrows that show convection, but no further explanation of the heat transfer exists. These diagrams are located immediately after diagrams showing heat conduction (as seen in Figure 7), in which arrows are used to represent the direction of heat transfer. Therefore, it is misleading to children because they naturally assume that these arrows indicate heat transfer as well as the route of convection. Such misleading diagrams lead to misconceptions, and most people who do not become physicists, chemists, and meteorologists have no further chances to resolve this confusion.

There is also further historical background to this misconception. In the past, people knew that the topmost part of the bath should be hotter than the lower part through daily activities. For example, people in Japan used a deeper bath tub, called “goemon-buro,” which was directly heated from the bottom. They knew that only the top layer would be hot in the beginning, so they needed to stir the water to bring the bath to a uniform temperature. Therefore, elderly people can give the correct answer to our survey test. However, because of lifestyle changes, such experience has been lost. Therefore, it is clear that the modernization of teaching materials is necessary.

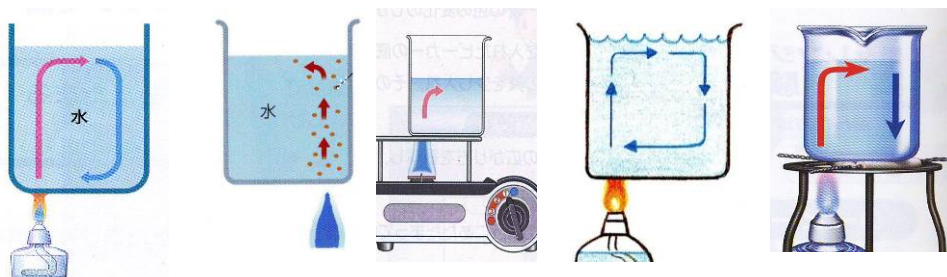

Figure 12. From the left, diagrams from textbooks produced by Tokyo Shyoseki, Dai-Nippon Tosho, Keirinkan, Shinano Kyoikukai, Gakko Tosho

Demonstration in classroom

We used the thermo shot F30 to demonstrate conduction and convection to fifth and sixth graders at Sakaide Elementary School after administering the conceptual pre-tests. In Figure 13, one of the authors, M. Mori, is seen explaining the equipment. Because of the easy connectability of the F30 to a PC, all activities were performed as real-time experiments. By using our equipment and viewing the thermography with a large PC monitor, clear images of convection and heat transfer were demonstrated to children. The right half of Figure 13 shows children's drawings after the demonstration; these show they understand heat transfer very well.

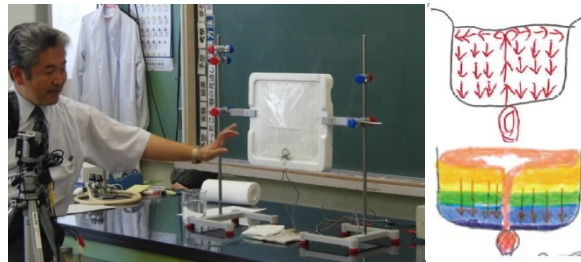

Figure 13. Photograph of the real-time demonstration by M. Mori (left), and children's drawing after the class

Summary

We examined a new, conventional thermographic camera to introduce it to the classroom. We developed teaching material suitable for thermography, and the equipment worked effectively. During our research, we administered a conceptual survey test to gauge the children's background knowledge of conduction and convection and checked textbooks that used in this study area. We found the misconceptions were caused by misleading diagrams in school textbooks and gradual lifestyle changes. Finally, we concluded that we can solve this problem using a conventional thermographic camera with an easy input/output system plus monitor.

Acknowledgment

We thank Dr. M. Sato for his great support and useful discussion. This study is supported by KAKENHI Grant-in-Aid for Scientific Research (B) Number 25282041 and Kagawa Univ. Grant for Joint Research Work between Univ. and attached school in 2012. One author, Mori, is also supported by SYOUNANKAI (Alumni Association of Kagawa University).

References

- [1] <http://www.avio.co.jp/english/>
- [2] Jen-Hong Tan *et.al*: *Infrared Physics & Technology*, 52, Issue 4, (2009) 97–108.
- [3] Naoto Kakuta *et.al*: *International Journal of Heat and Mass Transfer*, 52, (2009) 4221–4228.
- [4] “New Science for 4th grade,” Tokyo Shoseki.
- [5] “New Science for 4th grade,” Tokyo Shoseki, Dai-Nippon Tosho, Keirinkan, Shinano Kyoikukai, Gakko Tosho.

Climate Models in Physics Lessons

Anikó Tasnádi

Teacher of Karinthy Frigyes Gimnázium, Budapest, Hungary and PhD student at Eötvös Loránd University, Budapest, Hungary

Abstract

Energy crisis and climate change are both among the vital and yet unsolved problems that mankind must face in the 21st century. Though from the media we can learn about many catastrophes – floods, droughts, hurricanes – devastating different regions of the world, and continuously experience the increase of the price of electricity and gasoline, in Hungarian schools not much is taught about the different energy sources and global warming. However, the urgent need to make people more energy- and environmental-conscious leads to the world-wide demand that students must be educated on these topics. [1]

Realising the importance of these topics in the previous two years a questionnaire was given to some of the final students and some of the two-year younger ones attending our school, in order to investigate their physical background knowledge connected to power generation and global climate change, and to find out how much they know and understand from these topics.

During the discussions afterwards it was also recognized that the students are highly interested in problems connected with the atmospheric processes concerning both energetics and flows of various scales. Therefore a short syllabus was compiled for the teaching these topics at secondary schools. In this paper the questionnaire, the syllabus and the some part of the gathered teaching material are presented.

Keywords: Secondary education, questionnaire, atmospheric models

Introduction

It is a world-wide problem of teaching physics that students are getting less and less interested and motivated, and our country Hungary is not an exception unfortunately [2,3]. The increasing demand of finding new energy sources, the problem of global warming and climate change are suitable to arouse the interest of students. Also there is a lot of physics involved, and perhaps these “fashionable” topics are more challenging for the students. However, traditional physics curricula contain only very few of these topics, although they would be important in environmental point of view as well. In the media questions related to the atmosphere appear very often, mainly in connection with the climate change and the hazardous or extreme weather. The articles and comments appearing in the media often state wrong and unjustified theories, which can be the sources of students’ misconceptions. (Similarly it would be very important to explain the advantages and the disadvantages of the different types of power generation, since these very often occur in political debates. Despite the fact that power generation was asked in the questionnaire, this article is restricted only to the teaching of atmospheric models).

In order to reveal the students’ background knowledge about climate change and energy crisis and to find out how much they know and understand, a questionnaire was given to the students and a teaching material concerning climate change and atmospheric phenomena was gathered.

With the help of the collected material a deeper insight is aimed to be given, in order to clarify the beliefs and misbeliefs connected to the global warming. In the paper the questionnaire, the outline of the collected teaching material and two estimations for the average temperature of the Earth are presented in order to show the warming effect of the greenhouse gases.

The questionnaire and its discussion

In March 2012 a questionnaire was given to the final year students (18-19 year-old) and one year later some of the two years younger (16-17 year-old) students were asked. (The questions were collected without the claim of completeness, some of them asked the proper meaning of some terms used in everyday life, and some were connected to their previous studies, not necessarily in Physics).

The two percentage values at the end of each question show the ratio of correct answers given by the asked 75 students, (in case of the last question the amount of those students who answered yes to the last question). The first number is the percentage of correct answers given by the final-year students, whilst the second one shows the ratio of correct answers in the younger age group. The brief approved answers are written in italics after each open ended question; and the letter of each correct answer for the multiple choice questions is underlined.

Questions

- 1) What is the difference between the renewable and the non-renewable energy sources? List 3 for each. 54%; 57%. *Renewable energy sources are naturally replenished within a human timescale, whilst the other takes much longer time, (millions of years). Some examples for the first: wind, water, wave, sunlight; and for the latter: fossil fuels, (coal, natural gas, oil) metal ores (Uranium).*
- 2) What is the difference between a solar collector and a solar cell? 26%; 21%. *A solar collector uses the energy of the Sun to heat up water (used for central heating or for making hot water); whilst a solar cell converts the energy of solar radiation into electrical energy.*
- 3) What is the pelamis? 3%; 0%. *A special type of wave energy converter.*
- 4) What is albedo? 18%; 50%
 - A The absorbance (absorptivity) of a body.
 - B The reflexivity of a body.
 - C The emissivity of a body.
 - D The measure of whiteness of snow.
- 5) What is the average temperature of the surface of the Earth? 47%; 79%
 - A 0°C
 - B 8°C
 - C 15°C
 - D 20°C
- 6) What would be the average temperature of the surface of the Earth without the atmosphere? 13%; 35%
 - A -200°C
 - B -18°C
 - C 0°C
 - D 200°C
- 7) What is ultraviolet radiation? 14%; 7%. *UV radiation is a type of electromagnetic radiation which has shorter wavelength than that of visible light, or greater frequency*

than that of visible light. (One statement either using the wavelength or the frequency was enough).

- 8) What is infrared radiation? 11%; 7%. *IR radiation is a type of electromagnetic radiation which has longer wavelength than that of visible light, or smaller frequency than that of visible light. (One was enough).*
- 9) What is the role of the ozone layer in the atmosphere? 34%; 43%. *The Ozone absorbs the biologically harmful radiation coming from the Sun – the UV radiation.*
- 10) How does the temperature of the troposphere (an approximately 10 km high layer of the atmosphere closest to the surface of Earth) change as the height is increased? 80%; 93%. *Decreases.*
- 11) How does the troposphere warm up? 23%; 14%. *Solar radiation is absorbed by the surface of the Earth and re-radiated (at much lower frequency) and this radiation from the surface of the Earth warms up the air.*
- 12) What is the so called greenhouse effect? 3%; 7%. *(Solar radiation mostly passes the atmosphere, and is absorbed by the Earth). The lower frequency radiation emitted by the surface of the Earth is absorbed by some type of gases (the so called greenhouse gases) in the atmosphere and re-radiated into all direction, thus towards back to the Earth as well, (which means that not all the emitted power escapes to space).*
- 13) List some gases which cause the greenhouse effect. 92%; 86%. *Some examples: carbon dioxide, methane, water vapour, nitrous oxide, and ozone.*
- 14) Do you believe that there is climate change, if yes, what facts and arguments did you hear; if not, what were the arguments that you heard? 79%; 100%.

Results

Although most of the students could list renewable and non-renewable energy sources, some listed heat or electricity as some type of energy source and many had difficulty with the explanation of the terms. The importance of finding and using renewable, environmental-friendly energy sources is frequently quoted in the media, but no more details are given to explain. Only two students heard about the strange wave energy converter named after the inventor company, "pelamis" and only approximately one-quarter of the students could explain the difference between a solar cell and a solar panel. (The former question is listed because the term "pelamis" is part of the standard teaching material for the preparation to an International High School Diploma). The energy crisis is a very big problem and it would be very important to explain to everyone not only the different types of energy converters but also their advantages and disadvantages as well.

The next 10 questions were given in order to investigate the background knowledge of students concerning to the global climate change and the greenhouse effect. Altogether approximately 25% of them remembered (or guessed correctly) the term albedo, which – according to the geography books - was taught in geography. Altogether half of the students estimated the average surface temperature of the Earth correctly, but 60% of the 75 students chose - 200°C for the temperature without the atmosphere. This exaggeration may be reasoned by the fact that the warming effect of the increasing amount of greenhouse gases in the atmosphere is very frequently mentioned. In everyday life the terms infrared and ultraviolet are very often used, however, approximately 10% knew what type of radiation they are. Most of them stated that the ozone layer protects us, but did not explain correctly its role. Although the final year-students were better in these questions,

still the result is quite embarrassing since the different type of electromagnetic radiation a in the final year physics curricula in Hungary. The great majority of the students knew that the troposphere cools down as the height measured from the Earth surface increases, but could not explain how it is warmed up. Similarly they could all list some greenhouse gases, but only very few could explain how the atmosphere warms back the surface of the Earth. The great majority of the students stated (wrongly) that the Earth reflects the radiation of the Sun, and the energy is trapped by the greenhouse gases. (Similar misconceptions about the greenhouse effect and climate change were revealed in a survey at Masaryk University in the Czech Republic [4]).

Only 2 students stated that there is no climate change and a few did not answer to the last question.

The questionnaire revealed that the great majority of the students do not understand properly the terms that are used in the media or in everyday life concerning the climate and energy sources. In case of those questions, which can be related to geography the younger students showed better results, which may be reasoned with the fact that in Hungary Geography ends in the second year of the secondary school, so the final year students just forgot more. The classroom discussions after the questionnaire showed, that the students were highly interested in these topics, and that it is worth clarifying the concepts, and explaining the processes and terms connected to the energy crisis and global warming.

The syllabus

On the basis of the questionnaire and the discussions afterwards, a teaching material suitable for secondary-school students was gathered. The aim of teaching atmospheric phenomena is twofold. On one hand it contains some basic physics, which is connected to the physics of the environment; on the other hand the laws of physics were applied for the explanation of interesting atmospheric phenomena.

The outline of the syllabus:

- 1) Radiation laws (Stefan—Boltzmann law, Wien's law, black-body radiation).
- 2) The energy balance of the Earth.
- 3) Facts of climate change.

Depending on the knowledge and ability of students and the depth of the introduced material different amount of times can be spent on the different topics. For the sake of brevity, in this paper only some models and calculations connected to some of the topics in the syllabus are presented, as examples of the teaching material.

Energy balance of the Earth

In order to show the role of the atmosphere and the greenhouse gases, two simple models can be introduced. As a background, the students should have been introduced to the blackbody radiation, the Stefan—Boltzmann law, and Wien's displacement law; also the solar constant and the term albedo must be explained.

The temperature of the Earth surface without the atmosphere

In this estimation the Earth is considered a black body which absorbs some part of the incoming radiation from the Sun, while the rest is reflected – in case of the Earth the

average albedo a is considered as 30% – and also emits radiation. (In fact the 30% considered as the albedo of the Earth is estimated in the presence of atmosphere around the Earth, so with the reflective effect of clouds and the ice caps at the poles. Since we have no idea for the terrestrial albedo without the atmosphere, we consider this value. Note that the albedo of planet Mars with a much thinner atmosphere is 0.17—0.25). Because the Earth is in thermal equilibrium, the absorbed and the emitted energies are equal. At secondary school level the trickiest step of the derivation is to make the students understand that in case of the incoming radiation, the solar flux can be calculated by multiplying the Solar constant ($S = 1370 \text{ W/m}^2$) by the cross section of the Earth, whilst in case of the emitted radiation the surface area of the globe must be used. Thus the equation is:

$r^2 \pi S(1-a) = 4 \cdot r^2 \pi \sigma T_0^4$, where r is the radius of the Earth, T_0 is the surface temperature of the Earth and σ is the Stefan—Boltzmann constant.

From this the temperature of the Earth without the atmosphere T_0 can be calculated:

$$T_0 = \sqrt[4]{\frac{S(1-a)}{4\sigma}} = 255\text{K} = -18^\circ\text{C}$$

The gained temperature is surprisingly small, which means that this model was too simple and the warming effect of the so called greenhouse gases must also be considered.

The temperature of the Earth with a “grey” atmosphere

Before any calculation, the role of the atmosphere must be explained. Both the Sun and the Earth are considered as black bodies, so they emit radiation at all frequencies, but according to the Wien’s displacement law the intensity of the emitted radiation at the different frequencies are different. The surface temperature of the Sun is approximately 6000 K, so the most intense emitted radiation is in the visible light region; whilst in case of the Earth the surface temperature is much lower so the wave of maximum intensity emitted by the Earth is in the infrared region. (Applying Wien’s law and using 15°C as the average surface temperature of the Earth we gain: $\lambda_m = 0.0029/288 = 10^{-5}\text{m}$, where λ_m is the wavelength at which the intensity of the emitted radiation is maximum).

Figure 1 illustrates that the atmosphere is almost completely transparent in the visible spectrum, which is the peak of the solar spectrum. It is very opaque in the UV spectrum (mostly because of the ozone molecules), and it has variable opacity across the IR spectrum. Obviously there are other gases in the air as well, but except for oxygen which absorbs UV, the others shown in the figure are the so called greenhouse gases, since they cause the warming of the surface by absorbing the infrared radiation which is emitted by the Earth. (The surface of the Earth warms up because these greenhouse gases re-radiate the absorbed energy into all direction, so some part of the infrared radiation cannot escape to space).

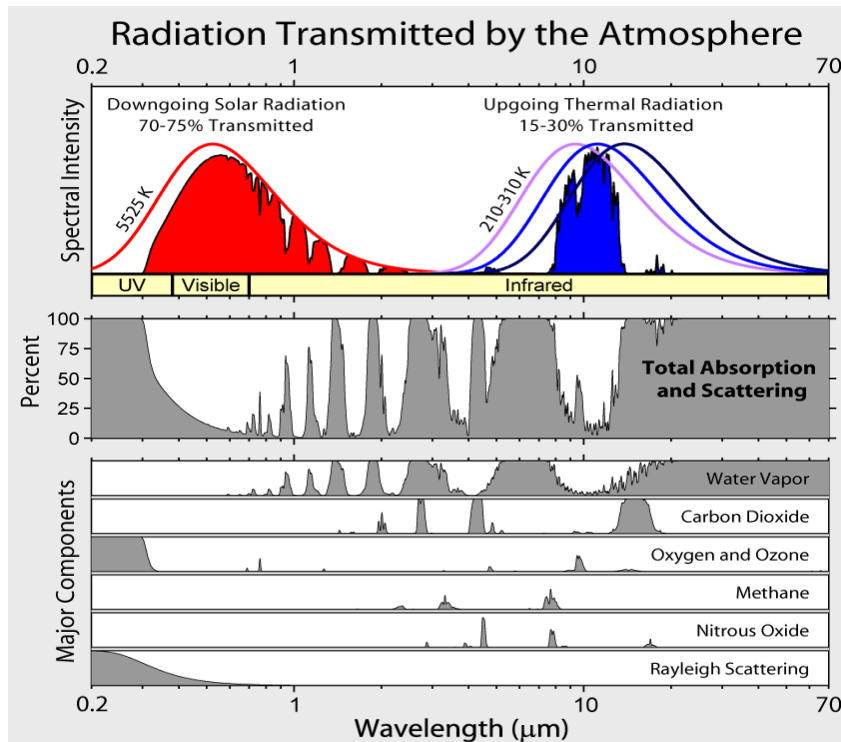

Figure 1. Absorption of the incoming solar radiation at different frequencies by different gases in the atmosphere

(http://upload.wikimedia.org/wikipedia/commons/7/7c/Atmospheric_Transmission.png)

In the second model, a “grey” atmosphere is assumed, which means that all the IR radiation is absorbed by the air. The arrows in Figure 2 show the components of a radiative balance.

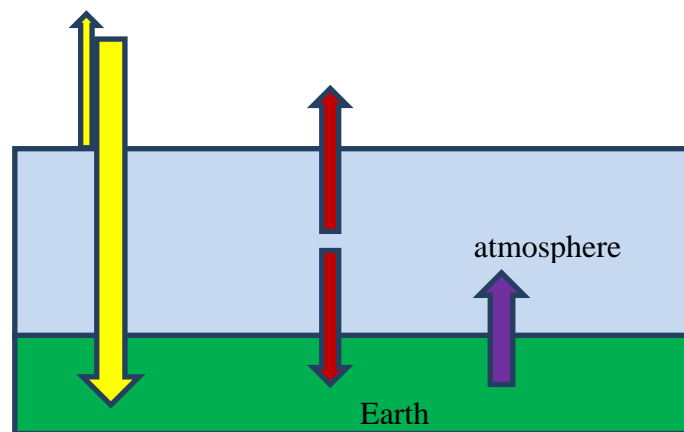

Figure 2. Main components of the radiative balance: radiation from the Sun partly reflected (yellow); radiation of the atmosphere (red); and radiation from the Earth (purple)

The radiation from the Sun, represented by the yellow arrow is partly reflected, and partly passes the atmosphere and is absorbed by the Earth. The purple arrow shows the radiation from the Earth, and it is totally absorbed by the IR opaque atmosphere. The red arrows represent the radiation by the atmosphere, both towards the Earth, and towards the space.

If the Earth and the atmosphere system is considered, energy balances can be written to both at the surface and at the top of the atmosphere of equilibrium temperatures T_e and T_a , respectively.

At the Earth surface:
$$(1-a)S\pi r^2 + \sigma T_a^4 4\pi r^2 = \sigma T_e^4 4\pi r^2$$

(The first term is the incoming power represented by the yellow arrow, the second is the incoming power emitted by the atmosphere represented by the downward red arrow. The radiation emitted by the atmosphere is assumed to be isotropic in this simple approach. The term at the right hand side of the equation is the emitted power of the Earth represented by the purple arrow).

At the top of the atmosphere:
$$(1-a)S\pi r^2 = \sigma T_a^4 4\pi r^2$$

The term on the left hand side of the equation is the power of the incoming radiation from the Sun, (represented by the yellow arrow in Figure 2). At the right hand side of the equation, the power of the radiation emitted by the atmosphere (upward red arrow) is expressed using the Stefan—Boltzmann law.

Solving the system of equations, the following results can be calculated:

$$T_a = T_0 = 255K = -18^\circ C \text{ and } T_e = \sqrt{2}T_0 = 303K = 30^\circ C$$

(Where T_0 , a , S , r and σ are the same as they were in the previous calculation, T_a is the temperature of the atmosphere and T_e is the temperature of the surface of the Earth). The gained $-18^\circ C$ for the temperature of the atmosphere is not surprisingly the same as the temperature of the Earth without the air, since the Earth and atmosphere system must behave similarly as the bare Earth in the previous model. However, the temperature of the surface of the Earth in this latter model ($30^\circ C$) is higher than the average surface temperature in reality ($15^\circ C$). So the model shows that the atmosphere makes the temperature of the surface higher, but still it is too simple to give back the true value.

Another interesting fact that is worth pointing out to the students is that although thermodynamic equilibrium exists, the temperatures are not equal. This is because the Earth and atmosphere system is not a closed system; there is a constant incoming flow of energy from the Sun and outgoing energy flow from the Earth.

Of course these two introductory models are far too simple, the behaviour of the atmosphere is very complex. Students are usually interested in the atmospheric phenomena, and the explanations involve lots of physics [5], and according to the reflections of my students, although they sometimes found the mathematical derivations difficult, they were inquiring, and found the session interesting and they stated that it was worth learning.

Conclusion

Nowadays, energy crisis, global climate change and extreme weather are hot topics, which may raise the interest in physics and motivate students. The preliminary questionnaire revealed that a lot of the students have misconceptions about these topics, and do not know and understand the physical backgrounds. To make students be able to judge individually, and form their own opinion in environmental questions, it is very important to introduce them the natural phenomena and their correct explanations using the laws of physics. The explanation for the greenhouse effect gives an opportunity to use the radiation laws, and the terms for the different types of electromagnetic radiation.

References

- [1] Pratibha J.: ICPE Chair's Corner. IUPAP International Newsletter on Physics Education No 55 (2008 April). Available from:
<http://web.phys.ksu.edu/icpe/Newsletters/n55.pdf>
- [2] Osborne J.: Attitudes towards science: a review of the literature and its implications. *Int. J. Sci. Educ.* 25, No 9 (2003), p. 1049–1079.
- [3] B. Németh, M., Korom E, Nagy L.: International and Hungarian Investigations of Scientific Knowledge. in *Hungarian Schools on Scale* ed. Csapó, B. Budapest: Nemzeti Tankönyvkiadó Rt. (2012) ISBN 978-963-19-7233-7 p. 131-191 (in Hungarian).
- [4] Milér T., Hollan J, Svobodová J.: Climate Change Education for Physics Teachers. International Conference on Physics Education (ICPE) 5.-9. August 2013, Prague (oral presentation) <http://amper.ped.muni.cz/gw/prednasky/CCeducation.pdf>
- [5] Ságodi I. Nagy, P. Tasnádi, P.: Atmospheric Physics as a Tool for Making Physics More Interesting. *Proc. MPTL14 Udine*.

Effects of studying a refutational expository text on the force-motion student models, in a curriculum integrating language and physics subjects

Carlos Julio Uribe Gartner, Alexander Bonilla Castro

Universidad del Valle, Cali, Colombia

Abstract

The purpose of this study was assessing the cognitive changes in college physics students on their force – motion mental models, which brings out a one-year intervention integrating reading and physics education. The teaching approach hinges on a research-based, conceptual “refutational text” and other cognitive conflict and metacognitive strategies, implemented both in the reading and writing one semester course and in the succeeding one semester physics course. The text was written in a former project, in which we did an educational reconstruction of Newtonian mechanics based in the momentum concept as a reconceptualization of the “motion force” that a body in motion has, according to the naïve force – motion mental model. To assess the intervention, we used Bao and Redish’s Model Analysis, finding a similar change in student mental models than the obtained by these authors in their tutorial courses, but with the further asset of a growth in communicative competences.

Keywords: integrating reading and physics education, force and motion relation, model analysis, conceptual change, refutational text

Introduction

Physics education research has turned from describing pre-instructional ideas that students bring to physics instruction, and from empirically designing and assessing teaching strategies aimed at counteracting those ideas, towards theoretically modeling the cognitive and culturally mediated development of students in relation to physics concepts and ways of reasoning [1,2,3]. This change of research focus has been fostered by an increasing realization of the limitations of the constructivist ideas of the 1980s, leading to their merging with social constructivist and social cultural orientations, in order to adequately address the complexities of the teaching and learning science processes [4]. This paper relates to one of these fresh research frameworks, the language and science education studies [5,6]. From this framework, Guzzetti et.al [7] discusses the differential effects, on science conceptual change, of using refutational and nonrefutational expository texts in instructional interventions, across a wide range of quasi-experimental studies in the traditions of both reading education and science education research. By ‘refutational expository text’ they mean instructional material intended to explicitly refute a misconception, by presenting contrasting information and counterarguments. A general finding from these studies is that this type of material supports conceptual change, when used with other strategies to induce cognitive conflict. In this work we attempt to extend and refine this finding by a recent and more stringent measure of conceptual change than those used in the papers reviewed by Guzzetti et.al, the one provided by Bao and Redish’s “Model Analysis” [1]. Another innovation of this study, closely related to the use of our refutational text, was the integration in our physics curriculum of a previous reading and writing course, in which the text was extensively used. Therefore, our research question was:

What cognitive changes in college students, as measured by Model Analysis, has a one-year intervention integrating reading and physics education which uses a research-based,

nonmathematical conceptual refutational text and other cognitive conflict strategies on the force – motion student models?

Teaching Approach

Many years of Physics Education Research has shown that the many uninstructed, implicit mental models that people use to interpret their experience on the relation between force and motion can be modelled by something like the conceptual network presented in Figure 1 (the vast body of relevant literature is well known; for an instructional oriented review, see Arons [8], and, more recently, Duit et.al [9]; however, there are many ways in which the findings are couched, from the cliché ‘motion implies force’, to more nuanced accounts; ours tries to somehow capture the complexity of the mental structure we are referring to).

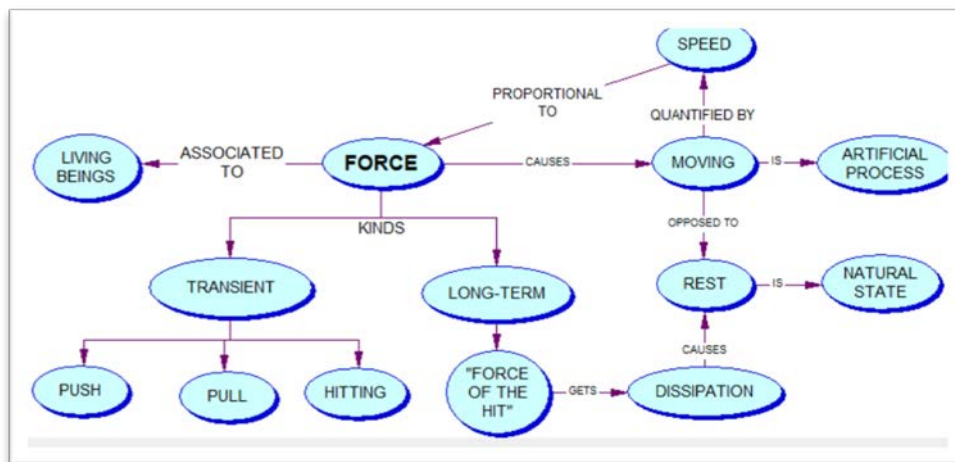

Figure 1. Implicit mental model spontaneously used to interpret motion

Although there is a long debate on the nature of the experiential knowledge on motion [2,3], it can safely be said that people conflate and at the same time distinguish the contact push or pull force applied on a heavy body in motion (or the hit force that starts projectile motion), and the long-term inner force that maintains the motion of the projectile after the agent ceases to be in contact with it. In fact, because the rest condition is felt as something fundamentally different from that of motion, what seems as free motion calls for a continuous cause that must reside in the body itself, according to the implicit, Aristotelian axiom: *quidquid movetur, ab alio movetur* (whatever is moving, it is being moved by another thing).

The main objective of the refutational text we wrote during a previous project [10], around which our teaching hinges, is to provide students with a reinterpretation of the concept of force. Students are expected to separate the two kinds of force shown in Figure 1 into two different meanings, those of **interaction** (for the transient force), and **momentum** (for the long-term “force of the hit”), the latter being conceptualized initially as something very similar to Buridan’s impetus. Of course, this reinterpretation requires the elicitation and reconstruction of these new meanings from the two-sided intuitive meaning of force they already have; it also requires the construction of the other related meanings shown in Figure 2; nevertheless, it specially requires reinterpreting also the concept of (projectile) motion, in that what causes its continuation is the momentum transferred to it by the interaction with the mover. We try to express the cognitive path from the “force of the hit” to momentum by the crossed-out box in the upper part of the diagram.

to the progress from the family of mental models represented in Figure 1 to the mental model represented in Figure 2.

Assessing the teaching approach

We completely agree with DiSessa's claim that research on learning is hampered by "our collective inability to determine and attribute knowledge to students accurately" [11, p. 117]. Therefore, we believe that the considerable effort required to apply Bao & Redish's "Model Analysis" (MA) [1] in order to assess conceptual change with a little more validity is worth doing. Although their seminal paper is widely known [12], there are only a few works that apply MA ([13,14,15,16]). In this section we present briefly MA in the context of assessing the transition from the uninstructed mental model modelled in Figure 1 (which we call M_2) to the transitional model M_1 depicted in Figure 2. Nevertheless, the reader must go to [1] to get the whole picture.

The path to expertise goes through an incoherent, "mixed knowledge state". We mean that, when the student solves a relevant problem, there is a changing probability distribution of activation (q_1, q_2, q_3) of the transitional mental model M_1 , the naive model M_2 , and a "null model" M_3 (which encompasses all faulty reasoning not attributable to M_2), respectively. M_3 is so defined to warrant that $q_1+q_2+q_3=1$. Figure 4 shows the situation in the general case in which there are more than one non-expert model. The problem posed describes a physical context, whose representation in the mind of the solver activates or triggers one of the pertinent mental models, which coexist in his or her long-term memory, with different probabilities. Successful and complete learning is conceptualized in our case (when $w = 3$) as a change from the "pure knowledge state" S_i in which $q_1 = 0, q_2 = 1, q_3 = 0$, to the pure knowledge state S_f in which $q_1 = 1, q_2 = 0, q_3 = 0$. But there are all kinds of possibilities in between. The aim of MA is measuring these probabilities at the moment, which represent the state of knowledge not for the individual student but for the whole class. The nearer they are to S_f after the course, the greater has been achieved the goal of the teaching.

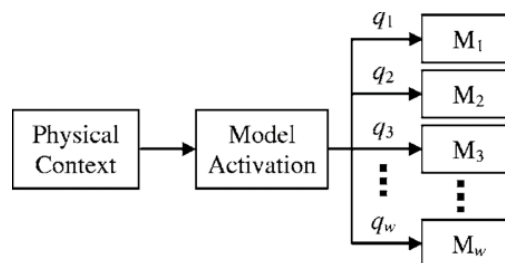

Figure 4. Basic conceptual elements of MA (reproduced from [1])

Of course, such a measurement is utterly impossible, in the sense physicists use this word. What Bao and Redish (BR) have done is to build a procedural scheme for getting a gross estimate of those probabilities when the scientific model that must be taught meets the following conditions:

- i) There is essentially an unique, common-sense mental model which interferes with the scientific target model (although for the sake of generality Bao & Redish consider the possibility of multiple common-sense models, in practice MA has been successfully applied mostly to the force - motion relation, in which there is only one such a model, encapsulated in Figure 1).
- ii) The common sense model is cultural independent because it originates in infancy from the experience with the physical world.

- iii) Qualitative psychological and educational research has conclusively demonstrated the existence of such a model in populations all over the world.
- iv) The scientific model is heavily counterintuitive, inasmuch the common sense model is so deeply entrenched that what says the scientific model is revolting to physics novices.
- v) There are a significant number of qualitatively diverse physical situations whose analyses from both models give opposing results, which at their surface and for the novice are not seen as equivalent but for the expert they are so.
- vi) Using those situations, multiple choice instruments have been constructed and validated.

It is easy to see that these conditions are fulfilled in our case. Condition vi) is fulfilled by at least two well-known instruments, FCI and FMCE [17]. So we decided to use MA as our method of assessing the results of our teaching approach.

MA estimates q_{ik} , the probability that the k-th student activates M_i , as n_{ik}/m , where $m = 8$ is the number of the questions related to the force – motion relation in the instrument (in our case the FCI, see table 1), and n_{ik} is the number of answers to those questions that correspond to mental model M_i .

Table 1. Model – options correspondence (we used the official Spanish version, 1995 edition)

Ítem	5		11		13		17		18		25		26		30						
Model 1	A	B		A	D	D			B	A	B		C			E		A	C		
Model 2	C	D	E	B	C	A	B	C	A	D	C	D	E	B	D	E	A	B	B	D	E
Model 3					E			E	C	E						A	C	D			

Instead of using the 3-tuple probability distribution (q_{1k}, q_{2k}, q_{3k}) so estimated to represent the knowledge state of student k, BR normalize it by taking the square root of q_{ik} . So, we can define a “model space” that represents all possible knowledge states of individual students by the column vectors u_k from the origin to the point over the first octant of the unitary sphere (Figure 5), whose coordinates are the non-negative numbers $\sqrt{q_{ik}}$. The natural basis vectors (eq. 1) represent the pure knowledge states, corresponding to the consistent use of either M_1, M_2 or M_3 in all expert-equivalent contexts.

$$\{e_1 = [1 \ 0 \ 0]^T, e_2 = [0 \ 1 \ 0]^T, e_3 = [0 \ 0 \ 1]^T\} \quad (1)$$

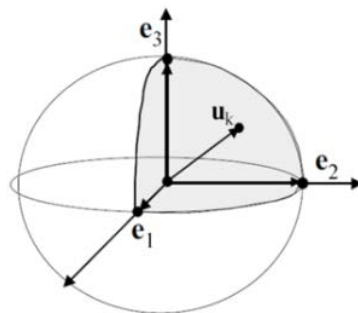

Figure 5. Model space, representing the three pure knowledge states and a typical, mixed state.

BR combine statistically the information about the knowledge state of students in the class contained in the numbers n_{ik} , considered as estimators of the q_{ik} , in the “class density matrix” \mathcal{D} (ec. 2), a kind of mean value of the student density matrices (N is the number of students in the class). We spare the reader all the mathematics needed to go from the individual 3×1 matrices \mathbf{u}_k to the 3×3 matrix \mathcal{D} , as well as the much more difficult analysis of it in terms of its eigenvalues and eigenvectors, whose result we proceed to briefly comment in the following. These analyses can be found in [1].

$$\mathcal{D} = \frac{1}{N \cdot m} \sum_{k=1}^N \begin{bmatrix} n_1^k & \sqrt{n_1^k n_2^k} & \sqrt{n_1^k n_3^k} \\ \sqrt{n_2^k n_1^k} & n_2^k & \sqrt{n_2^k n_3^k} \\ \sqrt{n_3^k n_1^k} & \sqrt{n_3^k n_2^k} & n_3^k \end{bmatrix} \quad (2)$$

This matrix contains structural information about the distribution of model activation probabilities among individual students and the heterogeneity within the group. But, most importantly, it encodes information about the distribution of coherence in the use of the different models in different contexts by single students. To disentangle such a complex information we must calculate its eigenvalues and eigenvectors. The properties of the density matrix (symmetry, positive definite, unitary trace) imply that the former are real, fall in the unitary interval, and adds up to one. The greater the first eigenvalue λ_1 , the more similar are the u_k among them and to the corresponding eigenvector $\mathbf{v}_1 = [v_{1,1} \ v_{1,2} \ v_{1,3}]^T$. Therefore, the relative values of the eigenvalues measure the homogeneity within the class. When λ_1 is sufficiently high, the class is homogeneous enough so that it makes sense to estimate the probability that the typical student uses model M_i as $P_i = \lambda_1 (v_{1,i})^2$. BR set a value around 0,65 as a minimum empirical threshold for λ_1 . In consequence, when it is above that value, the corresponding eigenvector is called the “primary class model state”, and the relative value of its elements measures the incoherence in student reasoning, the degree in which each individual uses multiple models in different contexts.

Generally the third element of the primary class model state, which indicates the null model, is much smaller than the other elements. Otherwise, the conditions for MA to apply would not hold. When those conditions hold indeed, the knowledge state of the class can be simply represented by a point in a 2-D plot, the “model plot”, whose coordinates are P_1 (as ordinate) and P_2 (as abscissa).

Results

We applied the FCI at the beginning of the sequence of the two courses, as a pretest before the reading and writing course, and at its ending, as part of the final examination of the physics course *Fundamental Physics 1* FF1 (posttest). Both class density matrices are shown in Table 2, with their greatest eigenvalue and the corresponding eigenvector. We show also the latter for one comparison group at the same University, the course for Engineering majors *Physics 1* (F1). This one was taught in 1999 also by the principal researcher, the first author, following a non-traditional, interactive method that took into account student preconceptions, but without using the teaching approach described in this paper, centred on the refutational text. The overall change in the knowledge state of these classes on the force – motion relation is shown in Figure 6. For the rationale justifying the division in different regions of the accessible triangle for the point representing the collective knowledge state, the reader should see Bao & Redish paper [1].

Table 2. Class density matrices and their eigenvalue decomposition

Instruction based on an expository refutational text (FF1 2012)						
	Pretest (N=34)			Posttest (N=32)		
Density matrix	$\begin{bmatrix} 0,268 & 0,262 & 0,064 \\ 0,262 & 0,665 & 0,117 \\ 0,064 & 0,117 & 0,066 \end{bmatrix}$			$\begin{bmatrix} 0,605 & 0,273 & 0,033 \\ 0,273 & 0,375 & 0,029 \\ 0,033 & 0,029 & 0,020 \end{bmatrix}$		
Dominant eigenvalue	0,820			0,789		
Primary Eigenvector	$\begin{pmatrix} -0,400 \\ -0,890 \\ -0,120 \end{pmatrix}$			$\begin{pmatrix} -0,830 \\ -0,550 \\ -0,055 \end{pmatrix}$		
Nontraditional instruction not based on refutational text (F1 1999)						
	Pretest (N=36)			Posttest (N=26)		
Density matrix	$\begin{bmatrix} 0,233 & 0,279 & 0,074 \\ 0,279 & 0,698 & 0,140 \\ 0,074 & 0,140 & 0,069 \end{bmatrix}$			$\begin{bmatrix} 0,466 & 0,299 & 0,032 \\ 0,299 & 0,514 & 0,032 \\ 0,032 & 0,032 & 0,019 \end{bmatrix}$		
Dominant eigenvalue	0,902			0,902		
Primary Eigenvector	$\begin{pmatrix} -0,221 \\ -0,969 \\ -0,112 \end{pmatrix}$			$\begin{pmatrix} -0,677 \\ -0,733 \\ 0,058 \end{pmatrix}$		

Discussion

Our scrutiny of Bao and Redish’s model analysis has lead us to think that it is an important theoretical and methodological advance in Physics Education Research; its diffusion as a powerful assessing tool of cognitive change should lead to consolidating consensus about the most promising ways of improving physics teaching. Through this tool and the FCI we found evidence of significant change in cognitive structure of students in our one year intervention integrating reading and writing education and physics education, which was built around a conceptual, refutational expository text of the “impetus belief”. That change is well beyond the change associated to interventions that not use such approach, in spite of being far from expository teaching. Therefore, we posit that our results confirm Guzzetti et.al’s metaanalysis (see [7]), but ours go a little beyond them because of the greater sensibility of our cognitive probe. Besides, our teaching approach has the advantage of improving students’ communicative competences, as we have ascertained through qualitative inquiry that we expect to report elsewhere.

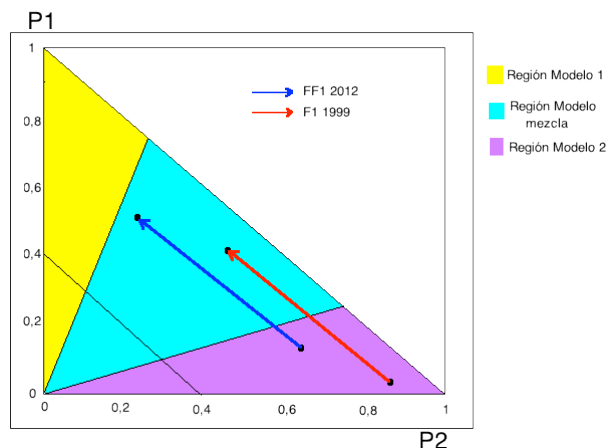

Figure 6. Model plot showing the cognitive changes of three groups (see text)

Acknowledgments

This research was financed by Universidad del Valle, grant 7894-2012. The first author acknowledges the financial support from the graduate school of the Physics Department and the “Vicerrectoría de Investigaciones” of the University for attendance to the ICPE-EPEC conference.

References

- [1] Bao L., Redish E. F.: “Model analysis: Representing and assessing the dynamics of student learning,” *Phys. Rev. Spec. Top. - Phys. Educ. Res.*, vol. 2, no. 1, pp. 010103(1–16), 2006.
- [2] DiSessa A. A., Gillespie N. M., Esterly J. B.: “Coherence versus fragmentation in the development of the concept of force,” *Cogn. Sci.*, vol. 28, pp. 843–900, 2004.
- [3] Vosniadou S.: “The framework theory approach to the Problem of Conceptual Change,” in *International Handbook of Research on Conceptual Change*, New York: Routledge, 2008, pp. 3–34.
- [4] Duit R., Treagust D. F.: “How Can Conceptual Change Contribute to Theory and Practice in Science Education?” in *Second International Handbook of Science Education*, vol. 1, Dordrecht, The Netherland: Springer, 2012, pp. 107–118.
- [5] Carlsen W.: “Language and Science Learning,” in *Handbook of Research on Science Education*, S. K. Abell and N. G. Lederman, Eds. New York: Routledge, 2007, pp. 57–74.
- [6] Kelly G. J.: “Discourse in Science Classrooms,” in *Handbook on Research on Science Education*, S. K. Abell and N. G. Lederman, Eds. Mahwah (NJ): Lawrence Erlbaum, 2007, pp. 443–469.
- [7] Guzzetti B. J., Snyder T. E., Glass G. V., Gamas W. S.: “Promoting conceptual change in science: A comparative meta-analysis of instructional interventions from reading education and science education,” *Read. Res. Q.*, no. 28, pp. 116–159, 1993.
- [8] Arons A.: *Teaching Introductory Physics*. New York: John Wiley, 1997.
- [9] Duit R., Niedderer H., Schecker H.: “Teaching Physics,” in *Handbook of Research on Science Education*, S. K. Abell and N. G. Lederman, Eds. New York: Routledge, 2007, pp. 599–629.

- [10] Uribe C.: *La transformación en la explicación y la comprensión del movimiento: Desde la concepción aristotélica hacia la newtoniana*. Cali: Programa Editorial Universidad del Valle, 2010.
- [11] DiSessa A. A.: “How should we go about attributing knowledge to students?” in *Research on Physics Education*, Amsterdam: IOS Press, 2004, pp. 117–135.
- [12] Ding L., Beichner R.: “Approaches to data analysis of multiple-choice questions,” *Phys. Rev. Spec. Top. - Phys. Educ. Res.*, vol. 5, no. 2, pp. 020103–1, Sep. 2009.
- [13] Puttisanwimon S., Rakkapao S., Pengpan T.: “Assessment of the Just-in-Time-Teaching Approach on the Newtonian Mechanics Concept by Using the Model Analysis Technique,” presented at the International Conference on Physics Education ICPE-EPEC, Prague, 2013.
- [14] Rakkapao S., Pengpan T.: “Evaluation of Tutorial and Non-Tutorial of Lecture-Based Classes of Forces and Motions by Using the Model Analysis Technique,” presented at the International Conference on Physics Education ICPE-EPEC, Prague, 2013.
- [15] Wattanakasiwich P., Ananta S.: “Model Analysis: A Quantum Approach to Analyze Student Understanding,” *Chiang Mai J Sci*, vol. 36, no. 1, pp. 24–32, 2009.
- [16] Vadnere R. V., Joshi P. P.: “On Analysis of the Perceptions of Standard 12 Students Regarding a Physics Concept Using Techniques of Quantum Mechanics,” *Phys. Educ.*, vol. 25, no. 4, pp. 279–290, 2009.
- [17] Hestenes D., Wells M., Swackhamer G.: “Force Concept Inventory,” *Phys. Teach.*, vol. 30, no. 3, pp. 141–158, 1992.

The interdisciplinary approach in teaching Physics: Electricity in the human heart

Marie Volná, Roman Kubínek

Department of Experimental Physics, Faculty of Science, Palacky University Olomouc, Czech Republic

Abstract

The Czech national curriculum offers possibilities to find some topics and create interdisciplinary examples in teaching physics and biology. The human heart is a nice and interesting example which can be used in lessons of physics at a level of secondary schools. We explored the topic of the human heart and created an interesting and exciting set of lessons for the future secondary teachers of physics. This set of lessons may inspire students in the learning process and shows future teachers how to use the interdisciplinary approach in teaching physics. This paper introduces the topic of electric phenomena in the human heart. In the first part we mention some theoretical background and then we introduce some experiments that complement practical experience with this topic. However, the topic of electric phenomena does not integrate only physics and biology but mathematics and ICT are integrated as well. The experiments are created with the help of an experimental system Vernier. This system offers modern devices to do experiments at school.

Keywords: biology, electricity, electrocardiogram, heart, ICT tools, interdisciplinary relation, physics

Introduction

The Czech schools face up to a problem with lack of popularity of physics and chemistry by secondary students. A research among 6408 Czech pupils from primary and secondary schools showed this problem [1]. A well-known problem around the world is that the students are not able to connect the knowledge across school subjects. The science subjects are taught in the Czech Republic separately and the boundaries of science subjects are getting intensified. The research found out that the students appreciate interdisciplinary teaching [2], especially about medicine and the human body [3]. The interest of students is increasing when they use new technology and new measurement system. It is known that usage of new technology in the lessons of physics motivates students in learning, improves their practical skills and consolidates acquired knowledge [4]. With the respect to these researches, we decided to explore the theme of the human heart, especially electricity in the human heart. We created an interdisciplinary module that combines knowledge from physics, biology, mathematical skills and using ICT. The added value of the module is that students observe their own body, compare the results with each other and to acquire new knowledge about technical devices used in hospitals.

Structure of the module: Electric phenomena in the heart

The interdisciplinary teaching module contains both the theoretical and practical part. The module was created for future secondary school teachers with an idea of using it in their later practice. Therefore the level of knowledge is at the level of secondary school.

Main points of the theoretical part of the module: Electric phenomena in the heart

The whole module is intertwined with an idea we can observe electric phenomena in the human organism and measure. In the module, we discuss the composition of the human body and conductivity of the human body. The module acquaints students with these processes and phenomena:

- the composition of human body (cells and an extracellular space),
- the principle of scanning the electric signal on the skin,
- the advantages for using ECG gels during scanning (gel may be applied for better electrical conduction to the leads),
- the artefacts that are caused by dirty and greasy skin (increases the resistance to the conduction of the electrical signal),
- the composition of the heart muscle: the heart is composed of two kinds of cells (the nerve cells that conducts the electric impulse and the working cells), the electric conductivity is caused by the ions in the extracellular space,
- the course after coming of an electric signal to the working cell: the cell membrane changes its properties and ions from extracellular space go inwards and the other way round, the potential of the cell membrane is increasing and after the contraction of the cell, it restores the rest state,
- every cell of the heart has its own time-independent electric current dipole and the sum of all heart time dependent dipoles shows the electrical state of the heart,
- the heart creates a small electric field which is spreading in the body in the help of conductivity of the body,
- the cardiac cycle,
- the periodical contractions are initiated by pacemaker (healthy adult approximately 72 times per minute), the peacemaker is located near the top of the atrium and spread the nerve signal through the two atria,
- the principle of measuring electrocardiograph (ECG),
- the scheme of fixing electrodes on various parts of the body (more information in next part),

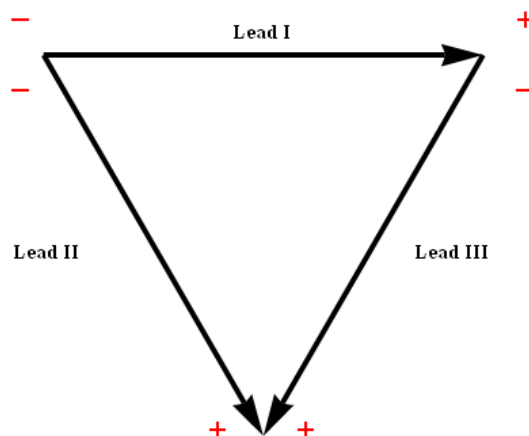

Figure 1. Einthoven's triangle

- the typical ECG signal is recorded between two electrodes and the main features are identified on the recorded signal (P, Q, R, S, T), see Figure 2:

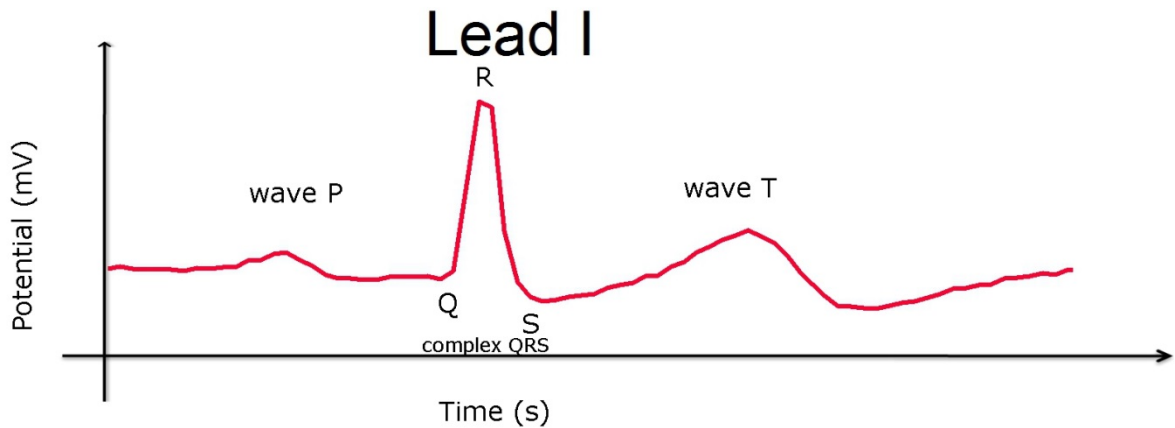

Figure 2. The main parts of the ECG curve

- the meaning of particular parts of the ECG curve: the wave P is associated with the electric activity that results in the contraction of the both atria, the QRS complex is associated with contraction of the ventricles and the wave T shows the recovery of ventricle for the next heart cycle (repolarization),
- the measured electrical potential on the body's surface is the instantaneous projection of the electric dipole in a particular direction of Einthoven's triangle.

These points of the theoretical background can be found in literature [5,6,7]. After the students acquired the theoretical background they do the practical part.

Several experiments form the practical part of the module: Electric phenomena in the heart

The experiments that are presented in this article are a portion of the practical part of the module. The described experiments are focused on the medical diagnosis and the students are investigating their heart in the electrical point of view. It is important not to make any radical decisions and inform the students that the measurements are only indicative.

The experiments are based on the recording of data by ECG probe. The measurement can be realized with the system Vernier and the ECG probe EKG-BTA or with other modern measurement systems such as Pasco. (We use the ECG sensor and Labquest from Vernier).

The ECG probe measured the electric potential between two electrodes placed on the skin. In the measurement, we use the wiring in tree lead (the stretch between two limbs) according to Einthoven (standard lead I, II and III). He placed the electrodes on three places; left and right upper limbs and left and right lower limbs. These three leads are forming a triangle where the heart is electrically constitutes the null point. The heart is approximately situated in the centre of triangle. This relationship between the standard leads is called Einthoven's triangle.

You can use just one ECG sensor for measuring but for some experiments for more accurate measurement, it is better to use two of them. The electrodes for ECG scanning are placed on four places on the body (left and right upper limbs, left and right lower limbs). At Figure 3 you can see placing electrodes of two ECG sensors. The Lead I with the symbols I, lead II with symbol II. The black clips of the sensors are placed on right lower limb.

In the next part of the paper, four basic medical descriptions of the ECG are presented.

Among the four basic medical descriptions of the ECG curve belong determination of the heart rhythm, determination of the heart frequency, determination of the heart axis and measurement and description of time intervals [8].

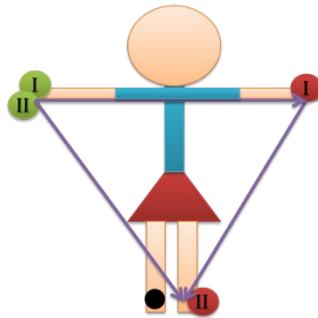

Figure 3. Placing the ECG sensor on the body.

Experiment 1: The determination of the heart rhythm

The basic heart rhythm is sinusoidal. The rhythm is sinusoidal when the depolarization spreads out in regular cycles from SA node to AV node. After the depolarization of ventricles proceeds the depolarization of the atria. We can observe these phenomena on the limb leads since the QRS complex comes after the wave P. In this part the students should be able to recognize the main parts of the ECG curve (wave P, complex QRS and wave T, see Figure 2). In Figure 3 is an example of a healthy man. We can see that everything goes in order, the wave P is followed by QRS complex and the wave T comes after QRS complex.

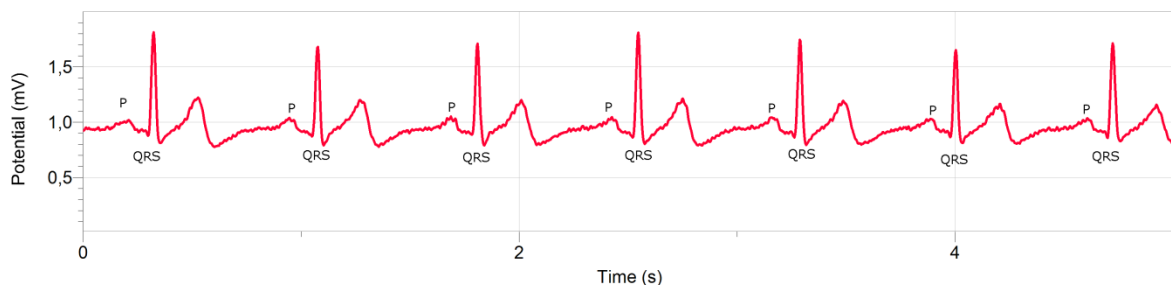

Figure 3. Study of the sinusoidal heart rhythm

Experiment 2: The determination of the heart frequency

The heart frequency of healthy people is around 72 beats per minute. There are two diseases connected with the frequency. The first disease is bradycardia. The human has bradycardia when the heart frequency is lower than 60 beats per minute. In the opposite way, the human suffers from tachycardia when his or her heart beats with the frequency higher than 100 beats per minute.

An easy way to count the heart frequency is to observe the R peak of the ECG curve. We can measure the heartbeat with the Labquest Vernier and ECG probe when we set the length of the time measurement on 60 seconds. We just count the number of R peaks and then divide the results of 60. The tested student has to be relaxed and he or she cannot move during the measurement. In this part we also discuss the heart frequency of children

and sportsmen. The children up to 12 years old have higher heartbeat compared to adults and in contrast the sportsmen have lower heartbeat because their body is well trained.

Experiment 3: The position of the electrical heart axis

The electrical heart axis is the direction of the total electric dipole in time of R peak in the frontal plane. The electric heart axis has approximately the same direction as the direction of heart apex in the ribcage when the human heart is healthy.

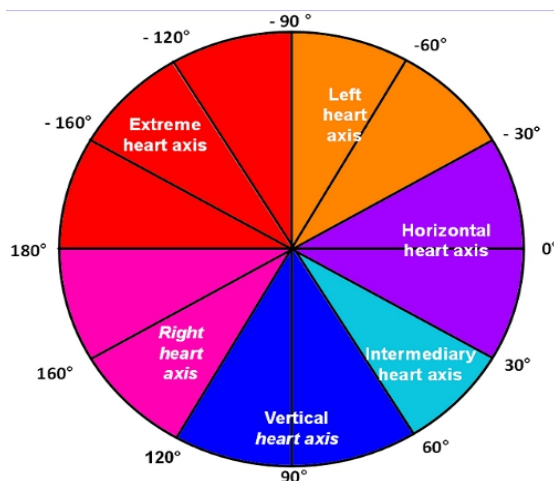

Figure 4. Types of deviation of the electric axis

The normal direction of the heart axis is from - 30 to 90 degree. When the axis is in other directions, it means some disorder that is leading to diseases. The types of deviations are showed in Figure 4. The left heart axis deviation can be found out for example with a person after heart attack and the right heart axis can be found with pregnant women or people that are obese.

There are many possibilities to compute the direction of the heart axis. The easiest one is to estimate it from limb (bipolar) leads. The simplest way to estimate the electric heart axis is to look at all three limb leads and compare it with Table 1. For example, look at Figure 5 and follow the procedure.

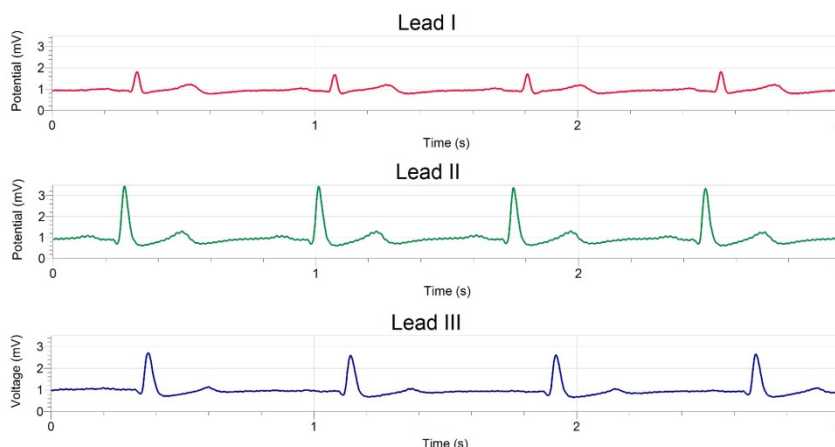

Figure 5. The ECG curve of three limb leads

In this case, we see that all leads of this ECG curves go up so the polarity is + in all leads. The human has intermediate axis.

Table 1. The polarity of maximal oscillation QRS complex in bipolar limb leads [9]

	Intermediary	Horizontal	Vertical	Left	Right	Extreme
Lead I	+	+	+ -	+	-	-
Lead II	+	+ -	+	-	+	-
Lead III	+	-	+	-	+	-

Experiment 4: The description of time intervals

The aim of the experiment is to record ECG curves of three Einthoven’s leads and to find differences between two people. In Figure 6, you can see the recorded ECG curves. The students apply knowledge from mathematics and find the coordinates of points P1, P2, Q, R, S and T (see Figure 6) and then they count the length of the particular parts of the ECG curve and compare it with standard values. The standard values are shown in the Table 2. In the Table 2, there are the calculated lengths of the measured ECG curve as well.

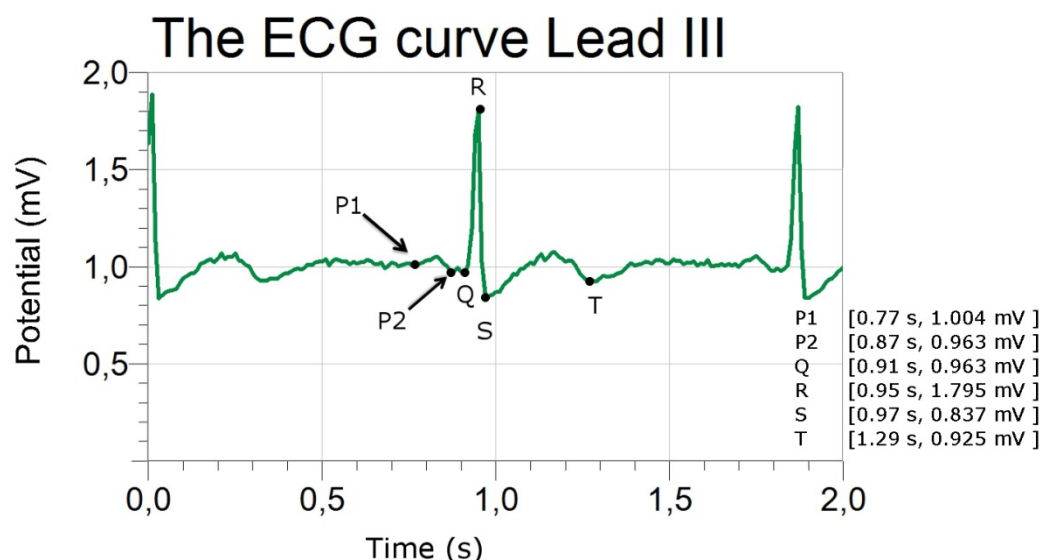

Figure 6. Investigation of the length of particular parts of ECG curve

Table 2. Comparing the real calculated lengths of particular parts of ECG curve to its standard length [8]

The part of ECG curve	Standard length	Real calculated length
Part PR [R – P1]	0.12 s – 0.20 s	0.95 s – 0.77 s = 0.18 s
Wave P [P1 – P2]	0.08 s – 0.12 s	0.87 s – 0.77 s = 0.10 s
Complex QRS [S – Q]	0.05 s – 0.10 s	0.97 s – 0.91 s = 0.06 s
Part QT [T – Q]	0.25 s – 0.45 s	1.29 s – 0.91 s = 0.38 s

Conclusions

Nowadays, it is important to connect our real world with the learning process. The demographic information in the Czech Republic shows that 51% of the people died because of illness of the circulatory system and the heart. Therefore the heart is an interesting topic how to integrate science subjects. In this topic, there is integrated knowledge from physics, biology, mathematics and ICT. The four introduced experiments demonstrate how to use experimental system Vernier and create interactive lessons. This module was verified by the first-year students of the bachelor level. The involved students were working with interest and curiosity and with questions what they can investigate about their health. They were looking forward to sharing the ascertained information about themselves with other students.

Acknowledgements

This work has been supported by the internal IGA grant of Palacký University (IGA_PrF_2014002).

References

- [1] Svoboda E., Höfer G.: *Názory a postoje žáků k výuce fyziky*. Mathematics–Physics–Informatics Vol. 16 (2006), p 212–223. (in Czech).
- [2] Hoffmann L., Hausler P., Langeheime R., Rost J., Sievers K.: A typology of students' interest in physics and the distribution of tender and age within each type. *Int. J. of Scien. Educ.* Vol 20, (1996), p. 223–238.
- [3] Jenkins E. W.: The student voice in science education: Research and issues. *J. of Balt. Educ.* Vol. 7. (2005), p. 22-30.
- [4] Millar M.: Technology in the Lab Part I: What research says about using probeware in the science classroom. *The Science Teacher* Vol. 34. (2005).
- [5] Davidovits P.: *Physics in Biology and Medicine*. Boston: Elsevier (2008), p. 82–144, 200–213. ISBN: 978-0-12-369411-9.
- [6] Cameron J. G., Skofronick R. M., Grant J.: *Physics of the body*. Wisconsin: Medical physics publishing (1999), p. 111–126, 181–212, 223–242, ISBN: 0-944838-91-X.
- [7] Russell K. H., Bradley J. R.: *Intermediate physics for medicine and biology*. New York: Springer (2007), p. 81–85, 177–201.
- [8] Sovová E. et.al: *EKG pro sestry*. Prag: Grada (2006), ISBN: 80-247-1542-2 (in Czech).
- [9] Durdil V.: *Srdeční osa, její určení a význam*. In *Practicus*. Vol. 3, 2009, p 38 -39, [online]. [cit. 10. 9. 2013]. Available from: <http://web.practicus.eu/sites/cz/Archive/practicus09-03.pdf> (in Czech).

Posters

classroom ideas papers

Science Interval Project: We Can Teach and Learn Physics During the Leisure

Francisco Adeil Gomes de Araújo^{1,2}, Meirivâni Meneses de Oliveira¹, Eloneid Felipe Nobre²

¹Secretariat of Education of the State of Ceará /EEFM Prof. Jociê Caminha de Meneses, Brazil

²Federal University of Ceará, Brazil

Abstract

The break between classes, still seen as an unproductive interval of time, in recent years, has been a cause of worry to the school community. The Science Interval Project aims to combine the science education with leisure time during the interval school, attracting the students for a time of learning and discovery. Specifically, the project aims to provoke and inspire the student to discover, build and give new meaning to knowledge and present to the school community the work developed in the classroom by the teacher and his students.

Keywords: secondary education: upper, method and strategies of teaching, low cost experiments, teaching and learning physics

Introduction

Almost every physics teacher has to face the constant challenge of teaching a subject for which students generally have little interest. The lack of students' interest in studying and learn Sciences, in general. Physics, especially, is a great problem in the secondary schools, mainly in the public schools. The teachers are constantly fighting against this lack of student's interest, lack of structure that do not provides opportunities appropriate laboratory classes and currently some Brazilian teachers have face another difficulty in the exercise of their profession: the violence in schools. The enhance of violence in the school environment has been a source of concern for the whole school community: of the 456 public schools in the city of Fortaleza, capital of Ceará, in northeastern Brazil, 35 are in hazardous areas.

With the intention to collaborate to improve this state of affairs, we decided to develop and implement The Science Interval Project at a public school in one of the poorest neighborhoods of the city of Fortaleza. The project is being conducted in a Primary/Secondary School, located in Bom Jardim, neighborhood in Fortaleza. The region is known for high rates of violence and the school has experienced the loss of students because of fights between gangs and use of drugs.

The neighborhood is known for high rates of violence and the school has experienced the loss of a few students due to fights between gangs and use of drugs. This violence came to the school environment, for example, by aggressive jokes and fights during the interval of the classes. Searching a solution to this situation, we developed this project in school seeking to involve the students in activities that awake their interest and can be performed in a cooperative way. On the last Friday or Wednesday of each month, the projects and experiments developed by teachers and students in the classroom and in the science laboratory are presented in the schoolyard. The presentation is made by the students who were chosen by their teachers, or those who have expressed an interest in participating. The

use of low cost experiments is prioritized, because the school does not have a suitable science laboratory.

Objectives

The main objective of this project is to combine the science education with leisure during the time of the interval school, attracting the students for a time of learning and new discoveries in the 20 minutes of interval between classes, without forgetting its purpose that the students can relax and have fun, before continuing their scheduled classes.

Specifically, we also intend: to provoke and inspire the student discovers, builds and gives new meaning to knowledge; to submit to the school community the work developed in the classroom by the teacher and his students; to create a culture of practical classes in school, beyond the traditional lectures using only crayon and blackboard; to awake the curiosity and taste for science among the students.

Methodology

The project began in May 2012, in a public school for basic education, located in a poor neighborhood in Fortaleza, capital of Ceará, in Northeast Brazil. Thinking of using not only the classrooms but also the gap of time between the classes, arises the project that aims to lead the science in the Interval of the classes, moments otherwise often occupied by fights, and even dangerous accidents.

The teacher is the responsible for development of ideas and practical activities in the classroom. The experiments are developed by the students, with helping of teacher, about the contents studied. To construct the experiments, the students are tasked to collect, themselves, the materials, and the use of low cost experiments is prioritized.

Once a month, all experiments are presented to school. The students are in charge of presenting the experiments in the schoolyard during the interval between classes. They have the support of their teacher and of the science lab coordinator. The presentation of the experiments in the schoolyard, is made by the students who were chosen by teachers, or by those students who have expressed an interest in participating.

When an experiment cannot be repeated during the interval, such as the dissection of a bull's eye to understand the optics of human eye, photos of experiment are available on the blog of project (<http://intervalociencia.blogspot.com.br/>).

On the day of the presentations, the students are in charge for presenting, explaining the experiments and guide the other students who visit the tables of experiments and to return to their rooms when the interval ends. This occurs both in the morning and in the afternoon. They are also responsible for the organization of experiments and materials in the yard. The teacher only accompanies the process, in order to help them, if necessary.

The use of low cost experiments is prioritized, because the school does not have a suitable science laboratory, but some materials are acquired in the science laboratory of the school.

The activities began on May 2012, during the night class, with a lecture on Astronomy, delivered by members of the Astronomy Club of Fortaleza, followed by observation by students of the Moon and Saturn through telescopes.

The project was continued with presentations of experiments on reflection and refraction of light, and exposure of photos made with dark chambers built by students in 9th grade. This material was used by the whole school community, in the morning and afternoon.

The students presented various experiments with ballons, to demonstrate many kinds of contents, such as atmospheric pressure, heat transfer, circular motion and friction.

On July the project was stopped because of school holidays. The activities returned in August, but we had little time to develop new works since the attention of teachers and students were directed to the bimonthly evaluations.

The project began again on September. The teacher, in their classrooms geometrical optics, developed, with his students, a photography project, aiming at building a machine called Pinhole Camera. The students built their own cameras using matchboxes, hair clips, among other materials. Then they chose a theme to photograph and sent to reveal. The photographs were exhibited at the school throughout the month.

During the month of September in addition to Physics, the project also included the participation of other experiments in the areas of Chemistry and Biology. The students extracted the DNA from some fruits, they performed analyzes of urine and also presented experiments on surface tension, density, condensation and sublimation. Even a student in the 6th grade of elementary school showed a robot he built using toothbrushes, and 9th grade students explained the decomposition and interference colors through huge soap bubbles.

With the development of the project, in addition to experiments on the subjects developed in the classroom, some students also presented experiments they searched at the internet, developed with the help of the coordinator of the science lab. The students presented experiments on phosphorescence and fluorescence, optical illusion, 3D technology, density of liquids. They built a periscope and some students built batteries using lemons and copper coins. As an activity linked to Biology, the students calculated the body mass index of their classmates.

During the month of November, the project was not presented at the school because the class teacher have been absent to attend the Meeting of the Physicists of the North and Northeast, a regional conference that annually gathers the community of physicists, researchers, students and teachers from the North and Northeast of Brazil.

During December, the Doppler effect was been studied, both for sound and light. Students used computer simulations and simple experiments to explain how astronomers discovered the expansion of the universe. In addition, was organized a competition of rockets, built by the students using plastic bottles. In the construction of rockets were addressed the three laws of Newton.

Analyses and Results

The experiments were performed by approximately 80 students, with the guidance of the class teacher. Among these 80 students, 16 were selected to be monitors, which were in charge of the presentation of the experiments. The total number of students participating in the project's first phase was 204, including the students who performed the experiments, the monitors and the other students of the school who participated by attending the presentations and visiting the stands with the experiments, only attending the exhibitions.

The project also included the participation of teachers from several areas: three of Physics, two of Chemistry, two of Biology, three of Mathematics and still, one of Geography, which emphasizes its multidisciplinary perspective.

We conducted a survey with the 204 students to verify if the objectives of the project were being met. The results are shown below.

First of all, we wanted to know the point of views of students on the new method of learning. Their responses are showed on the Figure 1.

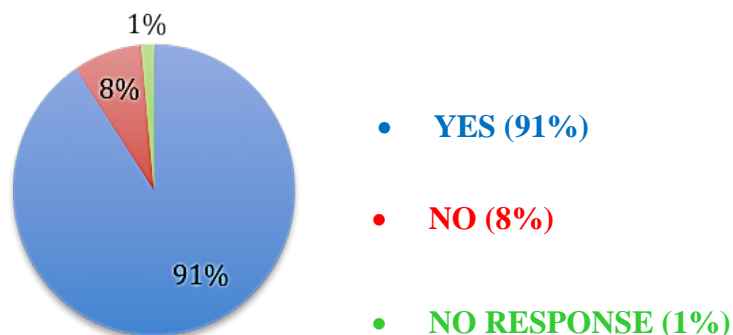

Figure 1. During the Science Interval you think you can learn science in a fun way?

186 students, about 91%; said Yes. 16 students, about 8%; said No, and 2 students about 1%, Did not answer.

With respect to the participation of students, we obtained the following results, showed on the Figure 2.

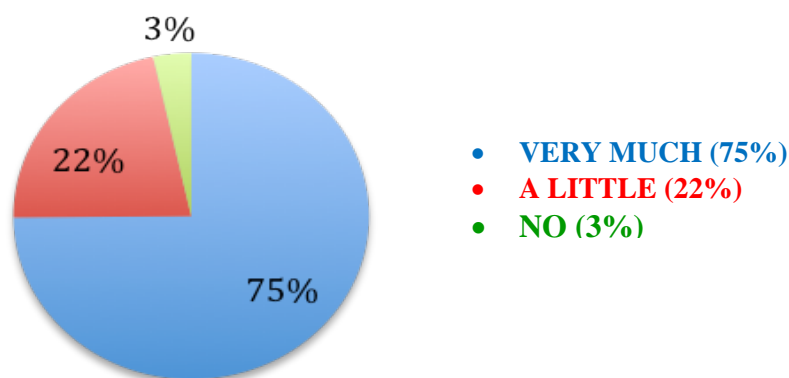

Figure 2. Do you participate in the moments of the Science Interval, visiting the tables and performing the experiments?

154 students, about 75%, have participated a lot of the presentations of the experiments. 44 students, about 22%, participated a little, and only 6 students, about 3% did not participated.

Finally, when we asked if they thought that the project has contributed to an improvement in their performance in Physics classes, we obtained the following group of responses:

154 students, about 75%, said Very much. 44 students, about 22%, said they learned somewhat. Only 6 students, about 6% thought the project did not contribute to their learning.

The schedules of classes in the Brazilian schools are divided in periods: morning, afternoon and night. This information, related with the last question, were given mainly by

the students of morning shift, composed by eleven groups. From these, two groups are formed by high school students and one of 9th grade of elementary school.

Only the high school students and those from the 9th grade participate regularly in the project, since these are the students who have Physics Chemistry and Biology in their school curriculum. This became more evident when analyzing the students' responses for the third question. When asked if the project was contributing to an improvement in their performance in science classes, where 75% of students responded very much, 22% said somewhat and 3% said it had contributed nothing.

We also monitor the student's results in the assessments of Sciences and Physics exams throughout the year 2012, when the project was implemented, compared to the results obtained in 2011, before the implementation of the Project.

The results are showed on the figures below.

To the students of the 9th grade, which were evaluated in the contents of Sciences: Physics, Chemistry and Biology, we see the following results:

The graphics in blue refer to the results of 2011 and red, the year 2012, when the project has been applied.

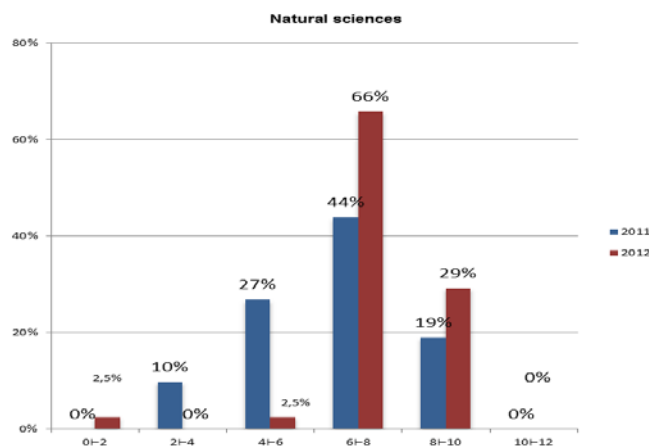

Figure 3. Results of bimonthly assessments of Sciences (March and April)

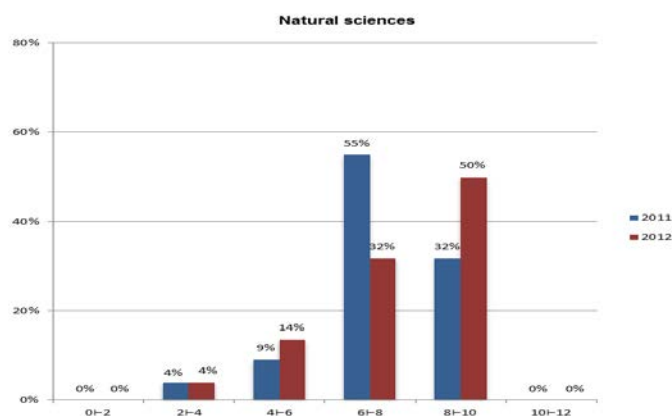

Figure 4. Results of bimonthly assessments of Sciences (May and June)

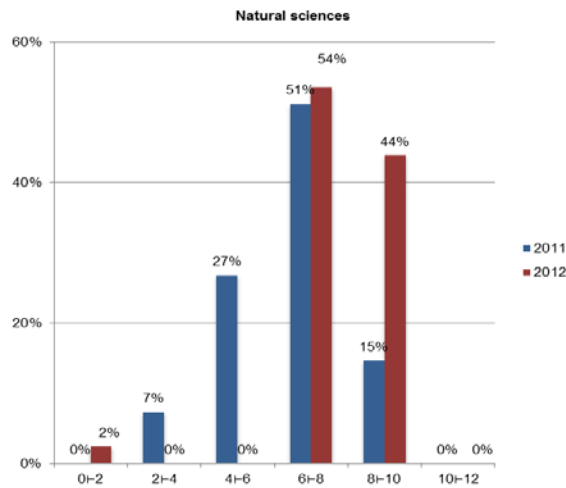

Figure 5. Results of bimonthly assessments of Sciences (August and September)

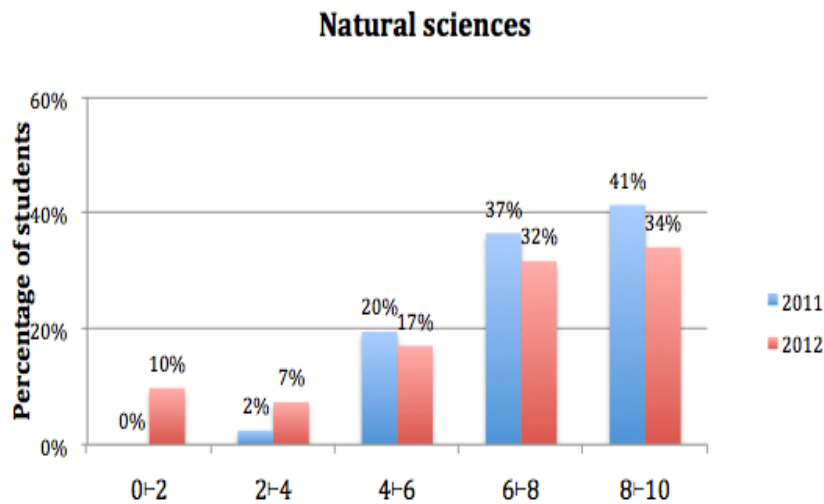

Figure 6. Results of bimonthly assessments of Sciences (October and November)

The results of assessments for the students in the high school level are showed in the graphs bellow. This group was composed by 27 students. The graphs show the results obtained in the assessments of Physics.

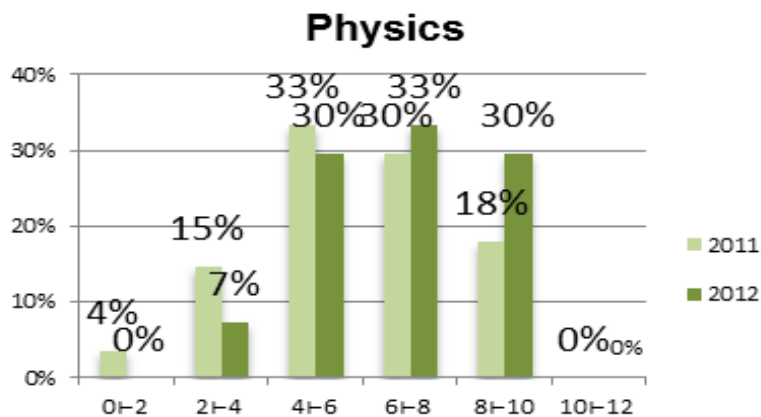

Figure 7. Results of bimonthly assessments of Physics (March and April)

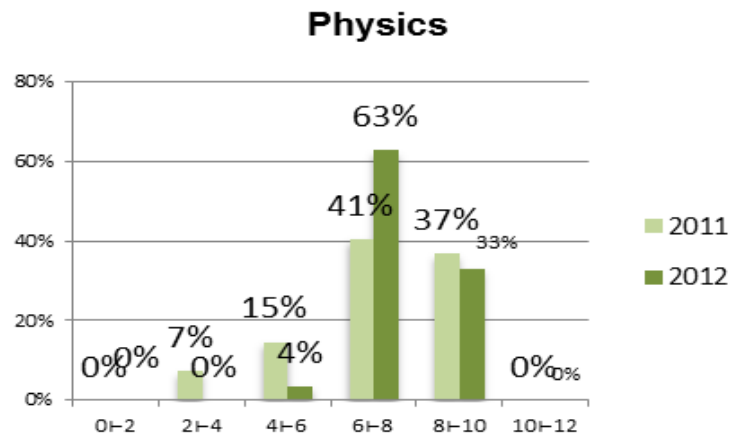

Figure 8. Results of bimonthly assessments of Physics (May and June)

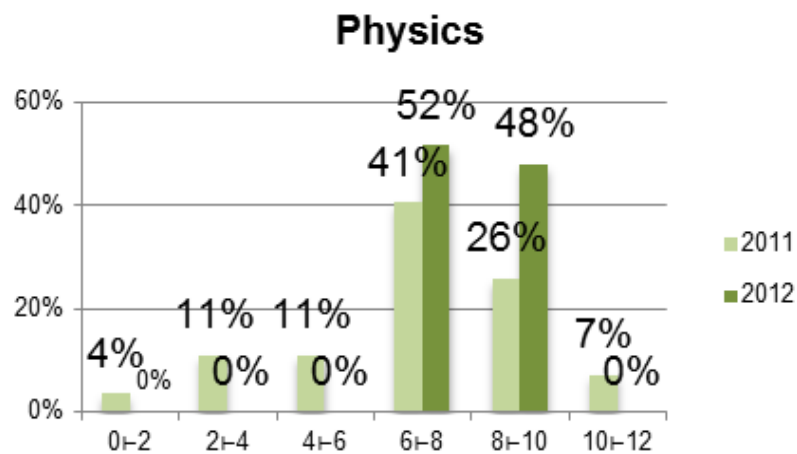

Figure 9. Results of bimonthly assessments of Physics (August and September)

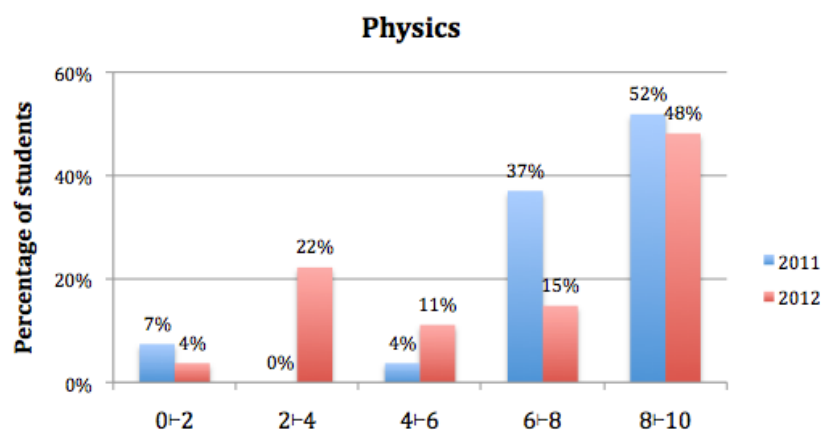

Figure 10. Results of bimonthly assessments of Physics (October and November)

The graphs show that, in general, the results obtained by the students in the assessments are better than that before the Science Interval Project was applied. The students were more involved and interested. Even the results of the fourth bimonthly assessments, which show in 2012 grades less than that of 2011, can be explained. In this period, we organized a competition with all the Physics contents, when the students had the opportunity to show

the experiments related with the contents they learned during the year. In this latest assessments, the tests were more extensive, covering the contents of the whole year and not just those seen in bimonthly periods.

We hope to get more data to analyze how the project has contributed to a more meaningful learning for the student.

Final remarks

The Science Interval Project is still a pilot project, and we intend to use the time of interval between the classes as another learning moment, but the results obtained until now suggest that the project is reaching its objectives.

Recent studies show that the method in which students perform the experiments by themselves and also themselves present them to their colleagues, results in a more meaningful learning, accumulating experiences that reach 90% of apprehension of the contents. Therefore, it is important to orientate the students to be more active in the process of teaching and learning.

The use of low cost experiments, because the school does not have an appropriate science lab, the act of teaching what they have learned, to present a project or experiment, leads the students in a remarkable improvement in their behavior, attitudes and self-esteem, and consequently in their learning.

The project has been changing the school routine. The whole school community is committed towards continuing the project, making it a routine. Teachers, students, all school community begin to understand that so important than only improving school performance, with good grades, is to make the student be able to construct their own knowledge and also changing his attitude in the society. We cannot forget of the contribution for the experimental classes. The project surely contributes to enhance the experimental classes, because the schools, in general, don't have an appropriate science lab.

Initially there was only one school and its 204 students involved in the project. Some classes 204 students, were active, performing the experiments and acting as presenters of the experiments for the school community. Others only attended the exhibition. Nowadays the project is been presented to several schools and we have more than 400 students involved.

Besides being taken to secondary schools, currently the project was adapted to be presented as workshops low cost experiments, as a complementary activity to the students of Physics of Federal University of Ceará, focused to teacher education.

References

- Moreira M. A, Masini S. F. E.: *Meaningful Learning: The Theory of David Ausubel*. São Paulo: Centauro. 2001.
- Neuenfeld Derli Juliano.: *Interval school: What happens out of sight of teachers?* Maringá, 2003. Available in: <http://periodicos.uem.br/ojs/index.php/RevEducFis/article/viewFile/3479/2512> (last accessed: 15/08/2012).
- Teixeira M. S. A.: *Vital, M.L.S; Experimental Activities in Physics Teaching: Different Approaches, Different Purposes*. *Brazilian Journal of Physics Teaching*, vol. 25, no. 2, June, 2003.

How geographically uniform is Earth's temperature rise?

Gordon J. Aubrecht, II

Ohio State University, Columbus, Ohio, USA

Abstract

One consequence of human use of energy is emission of greenhouse gases. Many nonscientists (as well as a few real scientists) do not think that climate change could be caused by human actions. Reasons range from doubt that tiny humans could affect an entire planet to belief that human life on Earth will soon end. Science is about experimental data, reasoning from those data, and theoretical perspectives supported by the data. Svante Arrhenius provided (in 1896) the first theoretical (and compelling) reasons that carbon dioxide could influence Earth's energy budget. Multiple sources of modern data underlie the belief of virtually all climate scientists that humans are changing our climate. However, many students (and even some teachers at all levels) remain steady in the belief that, though Earth's temperature might or might not be rising, humans are not involved and that any rise experienced is localized, as extreme winter weather continues to occur. Is there a real rise, and is it distributed uniformly around the world? We compare the three world temperature records (Hadley Climate Research Unit database of 162 years, and the National Oceanic and Atmospheric Administration and the Goddard Institute of Space Sciences databases of 132 years) to the US (National Climate Data Center database of 118 years) and Australian (Australian Government Bureau of Meteorology database 103 years), a small part of the US (National Climate Data Center database of 118 years), and other records to see what the temperature data show about geographic variation. The data show that the rise is real, and that while local changes exhibit greater variation than the globe, the rise is being experienced locally in parallel with the planetary rise. Because the denial of human culpability tends to discourage efforts to increase "clean" energy and encourage environmentally destructive exploitation of fossil fuels, it is important for teachers to be fully informed so that their students, who will inherit the future from us, can influence us to help preserve a world as welcoming to human habitation as we received from our forbearers.

Keywords: climate change, temperature records, anthropomorphic effects, geographic variation

Introduction

Many students and citizens misunderstand the elements of the nature of science, and think that climate science less rigorous than other science. Climate science has been less successful in seeing its consensus accepted than, for example, normal chemistry or physics research. However, climate science is simply doing physics research as usual, as reflected in scientific consensus. [1] It is clearly part of our role as teachers to assist students in building their understanding of the methods and results of that science. Many of us do, of course, present these ideas in the relevant parts of our ordinary classes, for example, when doing modeling of physical phenomena with computers. It is important that students be made aware of the theories and data supporting those theories.

Raising awareness of these facts is not enough. Elsewhere, I and others [2] have argued that filling citizens' "fact gap" is insufficient, while climate scientists as well as the rest of

us have concentrated most of their effort on addressing that aspect of the task. As *Merchants of Doubt* [3] has emphasized, much of the public's lack of understanding is due to action of political forces that could lose power if the general public recognizes the scope of the changes that are likely to occur as a result of human actions in continuing to burn fossil fuels. Much of the propaganda effort recorded in *Merchants of Doubt* is taking place in English-speaking countries (Australia, Canada, the United Kingdom, and the United States), in part because they are home to huge international fossil energy companies having the resources to fund denialist "think tanks" to preserve profits and pander to politicians in need of money to fund election campaigns. The denialists attempt to persuade the public to put off action on climate change by misleadingly suggesting scientific disagreement about the facts (data) and the outcomes, and referring to Biblical language in Genesis about humans subduing Earth and having "dominion ... over every living thing that moves" to gain support of credulous religious fundamentalists.

Many sources of data support the belief of virtually all climate scientists that humans are changing our climate. [1,4,5] Some data supporting anthropogenic climate change (ACC) I have gathered [6] include (1) Earth is not at 255 K; (2) Earth's stratosphere is cooling while the troposphere is warming; (3) Satellite measurements show that less radiation escapes to space than before; (4) Weather stations' location definitely have not caused the "apparent" warming in average temperature observed; (5) Earth's temperature is rising, particularly since 1980; (6) Most continental glaciers are receding and Arctic sea ice is declining; (7) Sea level is rising, and the oceans' pH is changing; (8) Species of animals and plants are moving toward the poles; (9) Climate change is already affecting people; and, finally, (10) Nights are warming faster than days.

In the nineteenth century, scientists first considered the effect of carbon dioxide in the atmosphere; in 1896, Svante Arrhenius provided the first compelling theoretical reasons that carbon dioxide influences Earth's energy budget. [4] Burning of fossil fuels produces greenhouse gases. As noted above, many people do not think that climate change could have been caused by human actions. Reasons expressed in letters to the editor in my small local paper range from doubt that tiny humans could affect an entire vast planet to belief that human life on Earth will soon end. [7] I continue to emphasize to students and fellow citizens (including in response letters to the editor of my local paper) that science is about experimental data, reasoning from those data, and theoretical perspectives supported by the data.

Arrhenius was correct and Earth's temperature is indeed rising. Büntgen et.al [8] show that current temperatures are unprecedented compared to European temperatures of the past 2500 years; Marcott et.al [9] show they are unprecedented globally over the past 11,300 years. This temperature rise does cause big changes, particularly in the Arctic regions. The Greenland ice sheet essentially melted (97% of the total) in July, 2012. The ice extent in 2012 was the lowest on record, though it has recovered somewhat in 2013. In a paper in the Proceedings of the National Academy, the authors warn that the Arctic could be fully open to shipping by 2050, Smith and Stephenson [10] note that their "findings have important economic, strategic, environmental, and governance implications for the region." Tingley and Huybers write, "During the past 20 years, 61% of all high northern latitude locations are more likely than not to have experienced warm temperatures that are unprecedented in the past 600 years, and 25% of northern locations are very likely ($P > 0.95$) to have experienced high temperatures that are without precedent." [11] In addition, extreme weather events such as Hurricane Sandy, unprecedented torrential rains, long-lasting droughts, etc., seem to have become more common in recent times.

To separate a “high” from a “low” exam group, teachers use the “27% rule,” which means that the highest 27% and the lowest 27% represent highs and lows, so that good questions (high students do well) and poor questions (good students do poorly) can be evaluated. [12] I selected the warmest and coldest 27% of months through 2012 (the reported temperatures, while not identical in the three, exhibit good agreement). Figure 1 shows the result; even the monthly anomaly data demonstrate good agreement among the three databases. It is clear that the rise in global temperature is reflected in the recent spate of warmest months, showing that all months from the mid-1990s onward are among the warmest in the record, found in all three datasets.

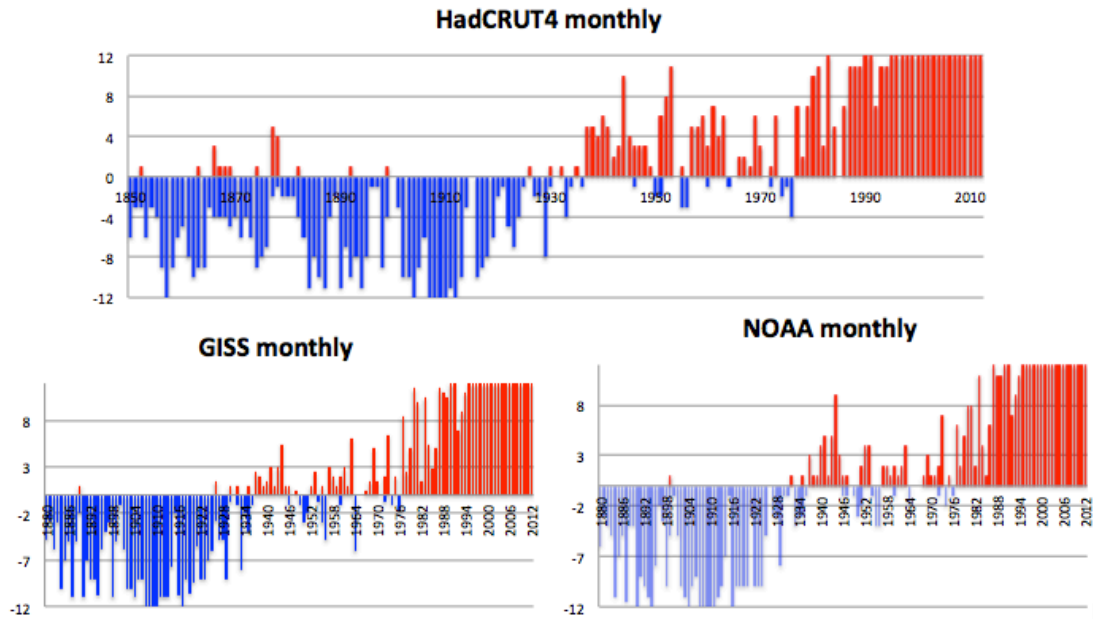

Figure 1. Monthly anomalies. Red: warmest 27%; Blue: coldest 27% of months

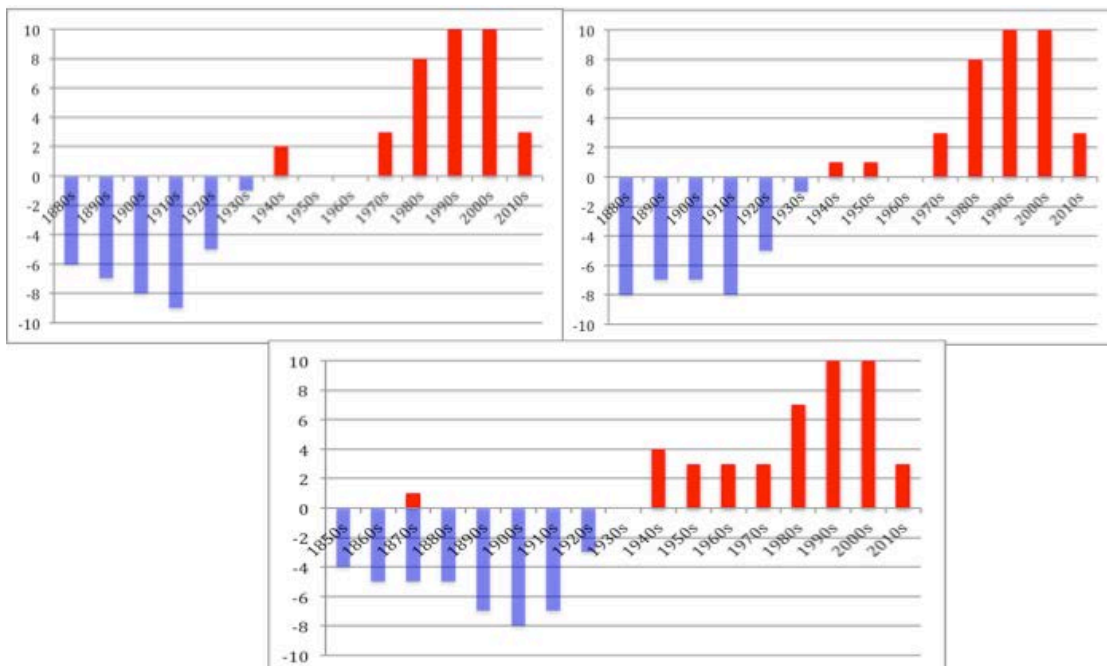

Figure 2. Decadal monthly anomalies, 27% rule. NOAA, upper left; GISS, upper right; HadCRUT4, lower middle. Red: warmest 27%; Blue: coldest 27% of years.

The three reputable global databases are the Hadley Centre-Climate Research Unit of the University of East Anglia temperature series 4 (HadCRUT4), the NASA Goddard Institute of Space Science (GISS), and the National Oceanic and Atmospheric Administration (NOAA). In Figure 1, months are designated from +12 (all months are among the warmest) to -12 (all months are among the coldest). In all subsequent figures, years are designated from +10 (all years in a decade are among the warmest) to -10 (all years in a decade are among the coldest).

Most years in the 1980s and all years in the decades of the 1990s and the 2000s, as well as three out of three years in the decade of the 2010s, are among the warmest ever. Figure 2 shows these decadal anomalies. There are 163 years in the Hadley Centre-University of East Anglia Climate Research Unit data record, more than the 133 years in the other two databases, so more recent times appear a bit warmer in that database, but the major characteristics are similar: the most recent decades are the warmest in the worldwide instrumented record (roughly 1850 to the present).

It should be noted from these two figures that the three worldwide datasets of instrumented global temperature tell essentially the same story. Temperatures have risen, and the present is clearly considerably warmer than was the case at the turn of the twentieth century.

Method

Our research question here is whether the temperature in small regions of Earth show any similarity to the global database temperatures.

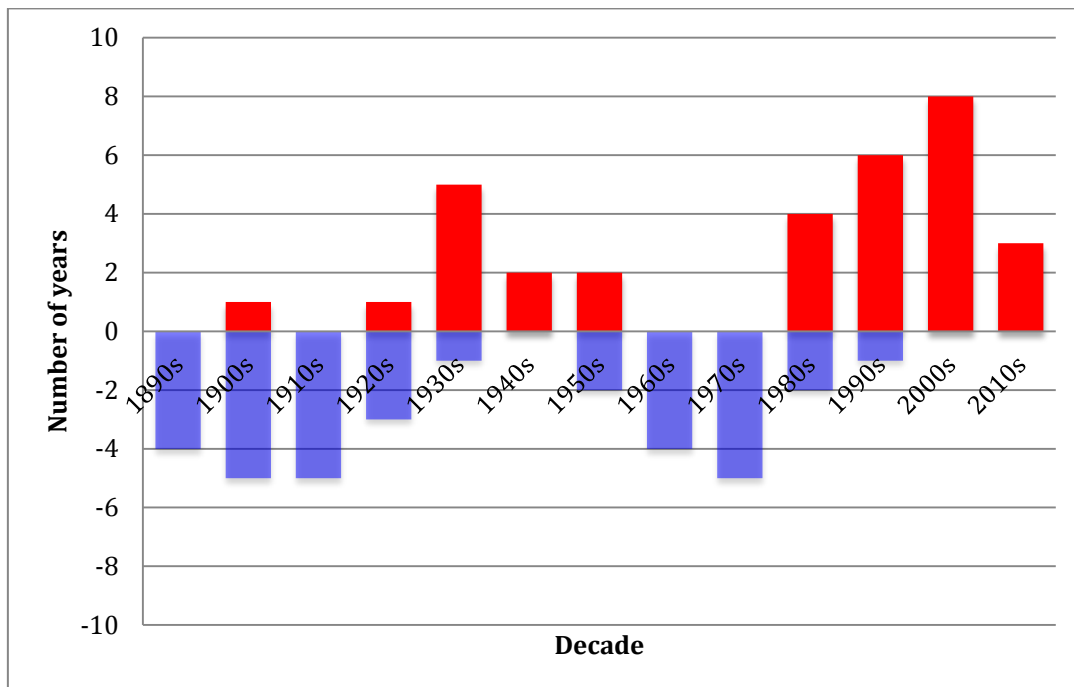

Figure 3. Decadal monthly anomalies, United States (1895-present). NCDC

In order to investigate this question, we searched the internet for national or regional temperature records. We found and examined annual temperature records from the United States (1.92% of global area, Figure 3), Australia (1.51% of global area, Figure 4), Germany (0.070% of global area, Figure 5), the U.S. state of Ohio (0.023% of global area, Figure 6), and the English Midlands (0.0056% of global area, Figure 7). The trends are

adequately represented by the decadal temperatures (red, top 27%; blue, bottom 27%), the following diagrams show the decadal results. United States (1895-present), NCDC; Australia (1910-present), Australian Bureau of Meteorology; Germany (1881-present), Deutscher Wetterdienst, Bundesministerium für Verkehr, Bau und Stadtentwicklung; Ohio (1895-present), NCDC; English Midlands (1659-present); Hadley Centre.

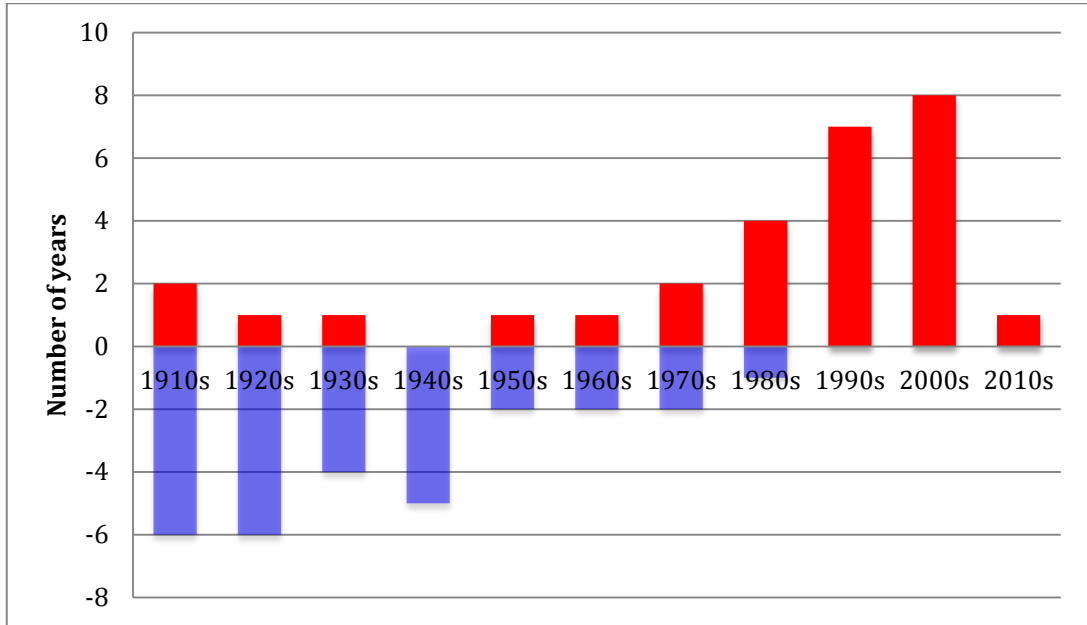

Figure 4. Decadal monthly anomalies, Australia (1910-present). Australian Bureau of Meteorology

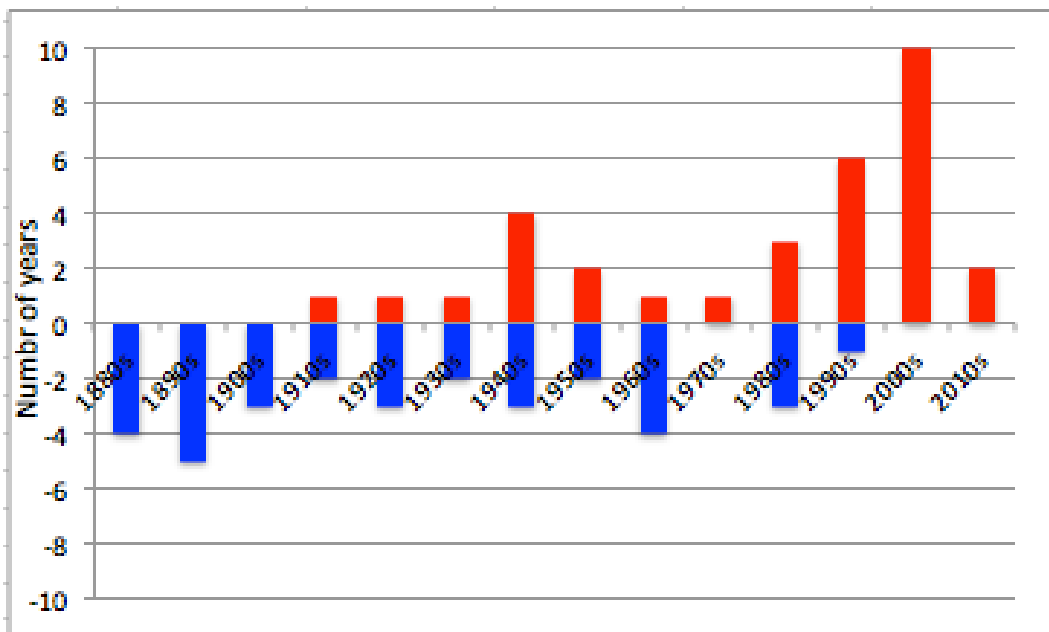

Figure 5. Decadal monthly anomalies, Germany (1881-present). Deutscher Wetterdienst, Bundesministerium für Verkehr, Bau und Stadtentwicklung

It should be clear that there is, as expected, much more variability the smaller the area involved. However, all figures 3-7 agree that the past three decades stand out as warm in all the records.

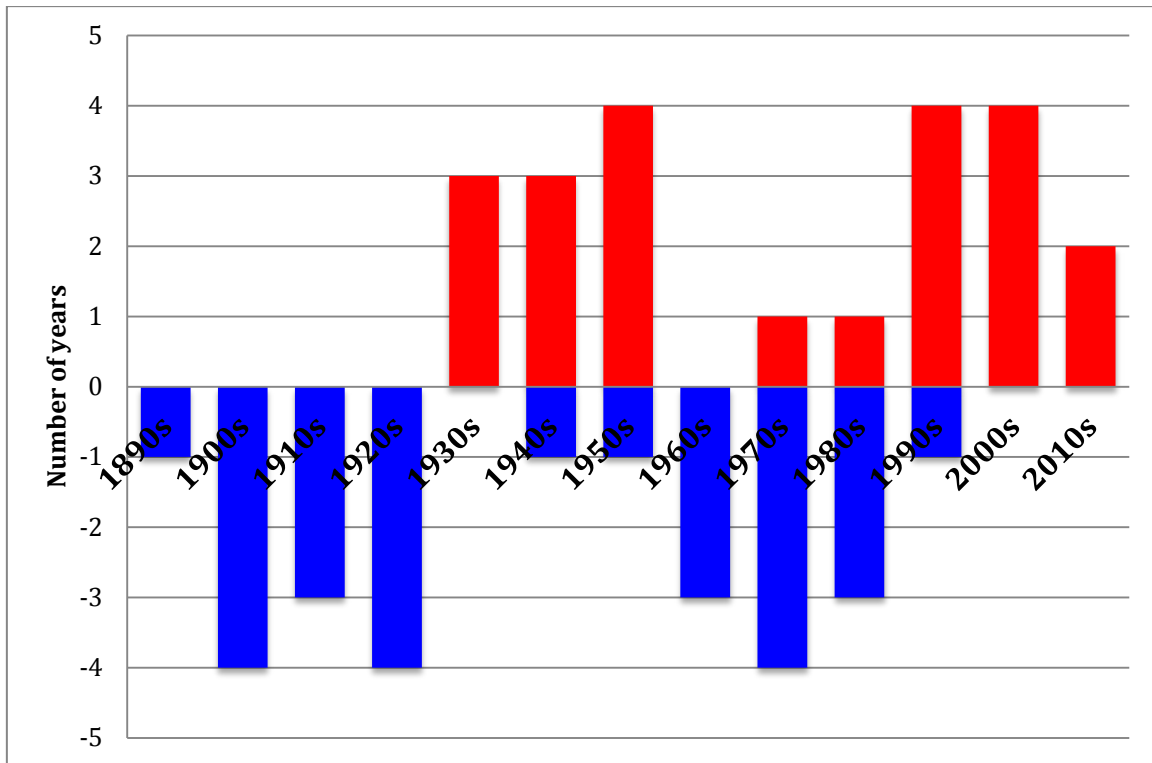

Figure 6. Decadal monthly anomalies, Ohio (1895-present). NCDC

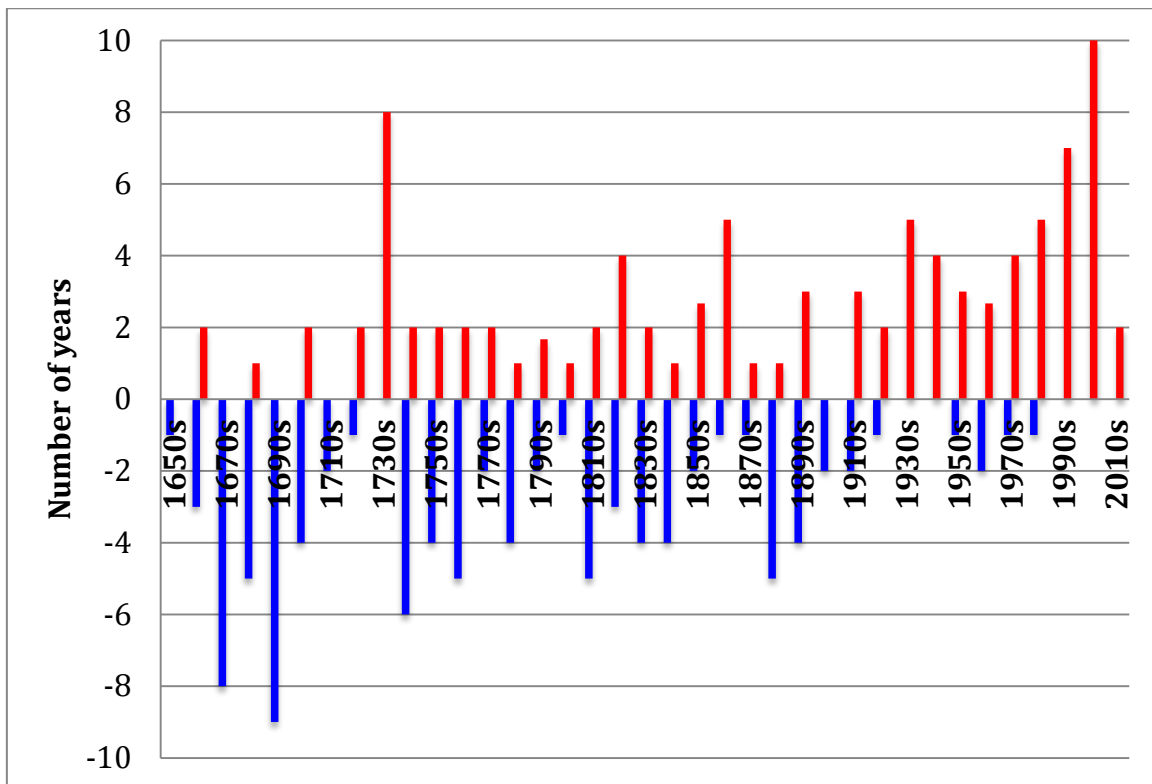

Figure 7. Decadal monthly anomalies, English Midlands. (1659-present)

Figure 8 shows how consonant the three global instrumental temperature records are as compared to local instrumental temperature records. The global records seem almost identical.

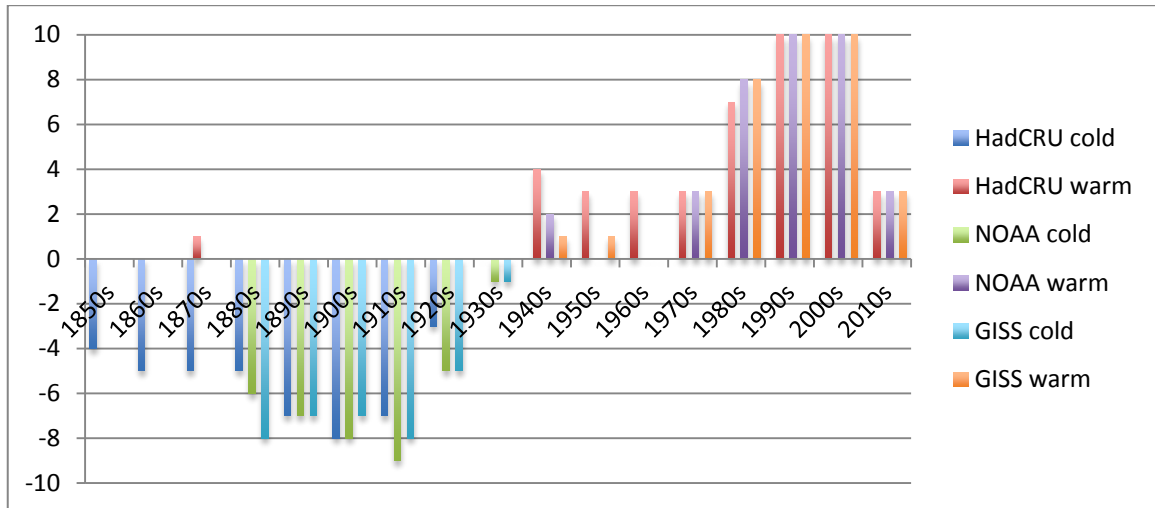

Figure 8. Comparison of consistency of the three instrumental global temperature records

The regional records (Figure 9) are much more variable up until about the 1990s, when they became much more similar to one another and to the global record. Even so, it is still not in every case that we can see all the years in a decade being among the warmest.

Globally, it is clear that the first decade of the twentieth century was cold. This is also more variable on the regional level. Some 26% of the low temperatures precede the twentieth century. The 1900s (10%), 1910s (14%), 1920s (14%), 1940s (8%), 1950s (6%), 1960s (6%), 1970s (14%), and 1990s (2%) among the 50 lowest temperatures, showing again by counterexample that the present is very warm.

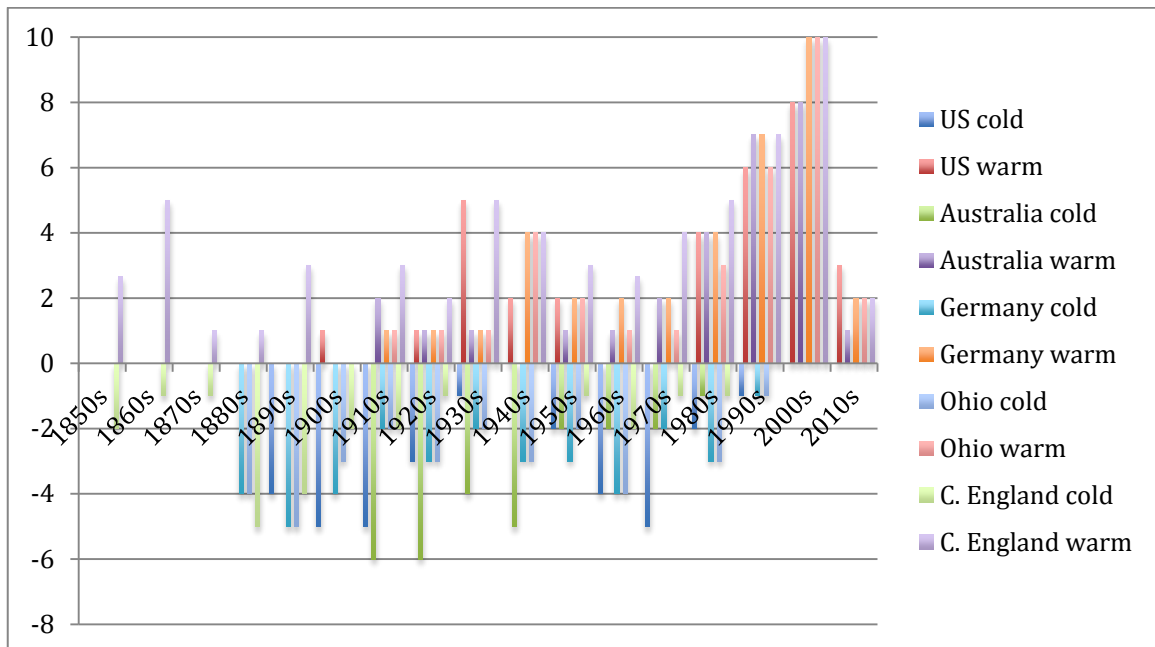

Figure 9. Comparison of consistency of instrumental regional temperature records

Results

The smaller the area, the more likely it is that other years appear among the warmest. There are individual years from the decades of the 1920s (4%), 1930s (10%), 1940s (4%),

1950s (2%), 1980s (6%), 1990s (28%), 2000s (38%), and 2010s (8%) among the 50 highest temperatures, reflecting the warmth of the last 25 years.

There is greater variation in smaller areas of Earth – the smaller the area, the greater the variation. This is the case until about the 1980s. If the 1980s – 2010s is covered, the temperatures in the various regions appear to be random, roughly as many cold as warm decades. Since 1980, these smaller areas are exhibiting warming more similar to one another and more similar to that of Earth as a whole. This is a very disturbing change, and another way to show students (and citizens) that Earth's salubrious conditions could change.

As Sterman and Sweeney [2] showed, even teaching MIT graduate students how to think clearly about climate change is fraught with difficulty. Students violate the principle of conservation of matter in thinking about increased greenhouse gases even though they should (presumably) have known that that was not possible. And, as Wagner and Zuckhauser [2] point out, “[t]he basic science is clear, and has been for decades. Putting heat-trapping gases into the atmosphere traps heat. Higher temperatures cause more extreme climatic events. Humans are mostly to blame. But large uncertainties persist around the timing and impact. These uncertainties, many about threshold effects, and our human difficulties in thinking about either, challenge the formulation of an appropriate policy response.” They also note that the climate policy “problem is made worse because of generally soft thinking about a brutal trifecta of factors: uncertainty, geography, and time. In each realm, deeply ingrained psychological biases impede rational thought. This soft thinking is harder to combat because of the significant resources at stake and the strong international incentive for nations to free-ride, reducing their economic contributions to any global approach. The need for a portfolio of responses and the recognition that complete success is unattainable make sensible climate policy less likely.”

As teachers and citizens, we scientists need not only to fill the “fact gap” but also to bring the consequences of “business as usual” to our students’ attention by showing them that these consequences are not far in the future and far from where we live. The consequences are happening around us where we ourselves live, study, and work (as we can see in the present work that the local temperatures come to more closely resemble the global results), not just at a distant corner of the globe, and that the consequences are occurring at the present moment in time, not in some indistinct future. Conservation of matter applies to the world, not just to a physics or chemistry laboratory experiment.

As teachers and citizens, we scientists need to communicate the nature of science; the meaning of theory; the effect of data; and the role of uncertainty. We need to use examples in class that connect kinematics, dynamics, thermodynamics, etc., to relate the ideas to these bases of science. It is our duty to our students, to our fellow citizens, and ultimately to our own children and grandchildren.

References

- [1] Oreskes N.: The scientific consensus on climate change, *Science* 306 (2004) 1686.
Doran P. T., Zimmerman M. K.: Examining the scientific consensus on climate change, *Eos* 90(3), 22-23 (2009). Anderegg W. R. L. et.al: Expert credibility in climate change, *Proc. Natl. Acad. Sci.* 107 (2010) 12107–12109. Rosenberg, S. et al.: Climate change: a profile of US climate scientists’ perspectives, *Clim. Change* 10 (2010) 311-329. Ding D. et.al: Support for climate policy and societal action are linked to perceptions about scientific agreement,” *Nature Clim. Change* 1, 462-466 (2011). Vautard R., Yiou P.: Robustness of warming attribution, *Nature Clim. Change* 2 (2012) 26-27.

- Lewandowsky S. et.al: The pivotal role of perceived scientific consensus in acceptance of science,” *Nature Clim. Change* **3** (2013) 399-404. Cook J. et.al: Quantifying the consensus on anthropogenic global warming in the scientific literature. *Environ. Res. Lett.* **8**(2) (2013) 024024.
- [2] Aubrecht G.: Helping scientists communicate to people, *Am. J. Phys.* **79** (2011), p. 437-439. Somerville R. C. J., Hassoll S. J.: Communicating the science of climate change, *Phys. Today* **64** (10), (2011), p. 48-53. Sherwood S.: Science controversies past and present, *Phys. Today* **64** (10), (2011), p. 39-44. Sterman J. D., Sweeney L. B.: Understanding public complacency about climate change: adults’ mental models of climate change violate conservation of matter, *Clim. Change* **80** (2007), p. 213–238. Sterman J. D.: Risk communication on climate: mental models and mass balance, *Science* **322** (2008), 532–533. Chen X.: Why do people misunderstand climate change? Heuristics, mental models and ontological assumptions, *Clim. Change* **108** (2011), p. 31–46. Sterman J. D.: Communicating climate change risks in a skeptical world, *Clim. Change* **108** (2011), p. 811–826. Wagner G., Zeckhauser R. J.: Climate policy: hard problem, soft thinking, *Clim. Change* **110** (2012), p. 507–521.
- [3] Oreskes N., Conway E. M.: Merchants of Doubt. New York: Bloomsbury Press (2010), ISBN 976-1-60619-394-3.
- [4] Arrhenius S.: On the influence of carbonic acid in the air upon the temperature of the ground, *Philosophical Magazine* **41** (1896), p. 237-276.
- [5] Aubrecht G.: Trace gases, CO₂, climate, and the greenhouse effect, *Phys. Teach.* **26** (1988), p. 145-152. Aubrecht G.: The basics of the greenhouse effect and the carbon dioxide problem, in G. Marx, ed., *Energy and Risk Veszprém*, Hungary, Eötvös University Press (1990), p. 323-356; Using the greenhouse effect to teach physics, in C. L. Ladera, ed., *Educación en Física, V. I. Caracas*, Venezuela (1993), p. 613-638; Aubrecht G.: *Energy*. Englewood Cliffs, NJ, Pearson (2006), ISBN 978-0-13-093222-8, see chapters 16 and 17. Aubrecht G.: Energy, climate, science, and sense, *Lat. Am. J. Phys. Educ.* **6**, Supp. 1 (2012), p. 78-82. Aubrecht G.: How scientists can try to change the minds of climate denialists, *Lat. Am. J. Phys. Educ.* **6**, Supp. 1 (2012), p. 83-88.
- [6] Aubrecht G.: Ten reasons to give credence to anthropogenic climate change, in M. Fatih Taşar, ed., *Proceedings of the World Conference on Physics Education 2012*, p. 297-318 Ankara, Turkey: Pegem Akademi, 2014. Aubrecht G.: “Nine reasons to have confidence in anthropogenic climate change,” talk presented at the meeting of the Ohio-region Section, American Physical Society, Ball State University, 15 October 2011, available for download on the author’s “recent presentations” webpage <http://www.physics.ohio-state.edu/~aubrecht/papers.html>
- [7] Aubrecht G.: “How can scientists best communicate science to the public?,” talk at the American Association of Physics Teachers Summer meeting, Edmonton, Alberta, 28 July 2008; “Using letters to the editor to try to bring science to the public,” talk, Joint meeting of the Ohio-Region Section, American Physical Society and the Southern Ohio Section, American Association of Physics Teachers, Ohio Wesleyan University, Delaware, Ohio, 10 October 2009; “Is writing letters to the editor effective?,” poster, AAPT-APS Winter meeting, Washington, DC, 16 February 2010; “When Scientists Should Step In. Media, Politics, and Science,” invited panelist, American Association of Physics Teachers Summer meeting, Portland, Oregon, 19 July 2010; “More letters to the editor — a scientist influencing the public,” poster presented at the American Association of Physics Teachers Summer meeting, Portland, Oregon, 20 July 2010;

“More letters to the editor — a scientist influencing the public,” poster presented at the AAPT Winter Meeting, Jacksonville, Florida, 11 January 2011; “Scientists need to write letters to the editor of their local papers,” talk presented at the AURCO Conference, Wright State University Lake Campus, 9 April 2011; “Letters to the editor of the local paper: A scientific responsibility,” talk presented at the Ohio-Region Section, American Physical Society meeting, John Carroll University, Cleveland Heights, Ohio, 16 April 2011; “A scientific duty: Letters to the editor,” poster presented at American Association of Physics Teachers Summer meeting, Creighton University, Omaha, Nebraska, 1 August 2011; “Communicating science to students and the public,” talk presented at the meeting of the Ohio-Region Section, American Physical Society, Ball State University, 15 October 2011. Many of these are available for download on the author’s “recent presentations” webpage <http://www.physics.ohio-state.edu/~aubrecht/papers.html>

- [8] Büntgen U. et.al: 2500 years of European climate variability and human susceptibility, *Science* 331 (2011), p. 578-582.
- [9] Marcott S. A. et.al: A reconstruction of regional and global temperature for the last 11,300 years, *Science* 339 (2013), p. 1198-1201.
- [10] Smith L. C., Stephenson S. R.: New trans-Arctic shipping routes navigable by midcentury, *Proc. Natl. Acad. Sci.* 110 (2013), p. E1191–E1195.
- [11] Tingley M. P., Huybers P.: Recent temperature extremes at high northern latitudes unprecedented in the past 600 years, *Nature* 496 (2013), p. 201-205.
- [12] D'Agostino R. B., Cureton E. E.: The 27 Percent Rule Revisited, *Educ. Psychol. Meas.* 35 (1975), p. 47-50.

Does an Ice Cube Melt Faster in Tap Water or in Salt Water?

Pavel Böhm

Charles University in Prague, Faculty of Mathematics and Physics, Department of Physics Education, Czech Republic

e-mail: pavel.bohm@mff.cuni.cz

Abstract

This paper presents a simple activity (melting of ice cubes in different experimental setups) that helps students to practice their observation skills.

Keywords: melting of ice cube, tap water, salt water, water temperature-density dependence, accepting/rejecting of the hypotheses

Introduction

Why does ice melt faster in tap water than in salt water? This question has been discussed many times (examples: [1,2]).

My own experience is that if you ask people (no difference if they are pupils or adults), 99% of them guess that melting should be faster in salt water. Our intuition tricks us – the experimental result says something completely different.

This surprising experiment can be utilized to practice observation skills and skills connected to formulating, accepting and rejecting of the hypotheses.

How to perform this activity with the students

1. Hypothesis

Let students put their hypotheses on the paper. They should try to find some reasons as well.

Typical answer is that an ice cube in the salt water will melt much faster, because salt is used in the winter to melt ice on the roads so salt somehow “eat” ice.

2. Experimental verification

Prepare two glasses of tap water at room temperature. Add a few teaspoons of salt to one of the glasses to make saturated solution of NaCl.

Put the ice cubes in the water. Students will be surprised that their guess was wrong.

Typical melting time in the tap water is 2–4 minutes while in the salt water it takes ice cube 10–15 minutes to disappear.

3. Revision

Let students make small groups and discuss what has happened and why. Encourage them to formulate hypotheses, conduct measurements, repeat experiment etc.

Soon or later (and with more or less intervention) they will try to measure the temperature of the water during the experiment.

They will find very interesting thing that is schematically described on the Figure 1.

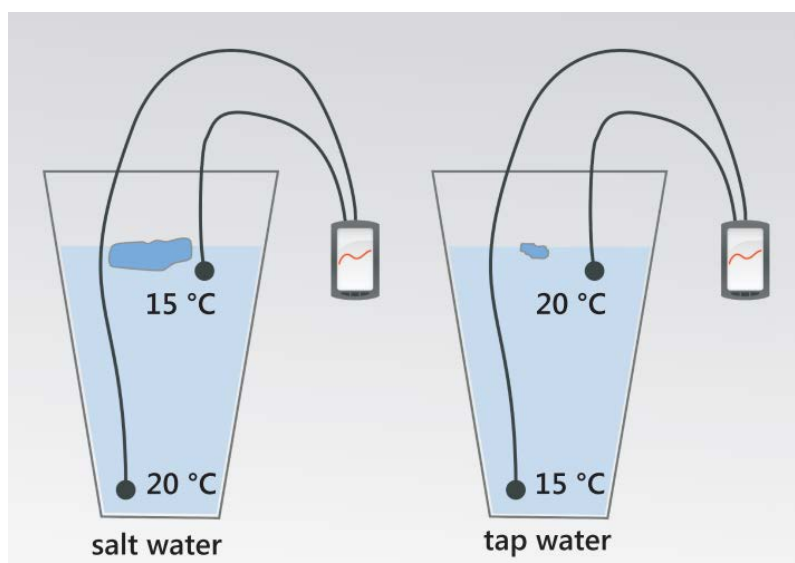

Figure 1. Different temperatures in salt water and in tap water

4. Inverted temperature

After measuring the temperature in both glasses we see that the ice cube in the salt water was surrounded by significantly colder water than the ice cube in the tap water.

Students intuitively know the Newton's law of cooling that says: *The rate of change of the temperature of an object is proportional to the difference between its own temperature and the temperature of its surroundings.*

It is easy to understand why the ice cube in the salt water melts slower – it was simply surrounded by colder water.

5. Explanation

Now it is time to find out the reason for this temperature inversion. After a while students probably come up with this new hypothesis: *The density of the water plays an important role.*

In the tap water the cold water from molten ice is slightly denser than the water at room temperature. So it falls down and forms a pool of cold water at the bottom.

On the other hand the salt water is even denser than the cold water from molten ice so in the glass with salt water the pool of cold fresh water floats at the top (see Figure 2).

6. Verification of the new hypothesis

Let students come up with experiments that will confirm or disprove the density hypothesis. Examples of what they can try:

- use sugar instead of NaCl,
- use food coloring to make colored ice cubes (Figure 2),
- add a coin to each ice cube so it falls down (Figure 3) – the ice melts faster in the salt water this time.



Figure 2. Ice cubes colored by food coloring. Left: salt water. Right: tap water.



Figure 3. Ice cubes with coins. Left: salt water. Right: tap water.

Tips for teachers

The best shape of the glass

The best glasses for this experiment are narrow ones.

How much salt we need

It is important to get saturated solution of salt. A few grains are not enough. Use a few spoons and mix it in the water.

Enthalpy of solution

Salt needs a small amount of heat to dissolve. This causes a small decrease of temperature in the salt water (approximately 1 °C). I usually don't care about this because the effect is weak. For precise experiments or with very insightful students we can allow both glasses of water to get the same room temperature first. Or we can let students to observe this effect as well.

How to accelerate the experiment

If you will use hot water (e.g. 70 °C) you will significantly accelerate this experiment.

Conclusion

During this activity students practice their observation and experimental skills and accepting/rejecting the hypotheses.

Teacher can perform this activity in short version (question – experiment – explanation) which takes approximately 15 minutes.

If we want students to be involved and really active this will take at least 1 – 2 hours.

Some parts can also be a part of students' homework or projects.

References

- [1] Department of Physics, University of Illinois at Urbana-Champaign: Ask the Van (Why does ice melt faster in tap water than in salt water?). [online]. [cit. 30. 10. 2013]. Available from: <http://van.physics.illinois.edu/qa/listing.php?id=13496>
- [2] UCSB Science Line: We did an experiment and we had an ice cube in salt water and in tap water. The ice cube in salt water needed longer to melt than the one in tap water. Why? [online]. [cit. 30. 10. 2013]. Available from: <http://scienceline.ucsb.edu/getkey.php?key=986>

Processing and visualization of measurement results in physical Laboratory

Michal Černý

Faculty of Education, Masaryk University, Brno, Czech Republic

Abstract

Processing the measurement results isn't popular activity for most students. Many of them find it very complicated and unnecessary and the same point of view shared some teachers, unfortunately. That is possible reason why this part of science teaching is underestimated and in some cases completely passed. Because students aren't enough prepared to work with special applications and drawing graphs or charts by hand is inconceivable for them, they resort to use MS Excel or LibreOffice Calc. A seemingly simple solutions however can bring about bad habits in future, because this applications, primarily intended for use in offices, don't offer the same wide range of features and functions that special science software. On the other hand, many of these applications are very expensive and unavailable for both, school and students. But it isn't necessary using only paid applications, especially in schools. In this paper we will present some free programs that can be used for quality analyzing the measurements results (for example SciDAVis, QtiPlot, LabPlot,...).

Keywords: secondary education: upper (ages about 15-19), university education, visualization, measurement, ICT, SciDAVis, QtiPlot

Introduction

The right understanding of law of physics is based on experiments. A lot of them are connected with measurement, collecting data and their evaluation. So that experiment fulfill its role, is necessary to be flawlessly performed, observed and evaluated. All these should become an integral part of the teaching of physics at all levels of school system.

Physical Laboratory is one of the an irreplaceable elements of grammar school teaching in which students can by themselves try the validity of physical laws and their application to specific situations. Little by little they are introduce to creating experiments, considering the mistakes, but also independently evaluate the measured results [1].

In spite of experiments are for many students interesting, specially processing of the measurement results is not so popular. And it is often also strongly pedagogically neglected part of lessons. Many students try to write protocols by hand, including drawn charts, but it is not so useful for students. They do not receive an overview of how the results are processed outside the school and they do not learn how to write science texts on computer.

Created the charts and analyzed data in programs such as MS Excel or LibreOffice Calc seems as solution. But this software designed primarily for business applications and if students work with them it may learn quite a bad habits especially in analysis and data visualization. These applications don't offer advanced mathematics function, which are indispensable for analyzing the results. Another limitation is the aesthetic aspect.

Graphs have little variability settings, reading of values is also problematic as well as interleaving curves. Students are pushed to interleave the curve not by using functional dependencies but simply using suitable scale to match the shape of a chart according to the theoretical assumption. It is obvious that such a conceived work in the physical laboratory doesn't provide a good quality in the field of evaluating results.

Using one of the programs, directly specified for working with charts, may be solution. Perhaps the most famous of them is Origin, but this one is expensive for a school use and despite the fact that some schools could get several licenses, students could not use it at home. Another well-known option is an open source application GnuPlot [2] which is free but not user friendly. High school students will have big problems with using this application and is more suitable for teaching computer science and programming than for measurement processing. In this paper we will focus on software for high school.

Using special applications for analysis and visualization of data offers following benefits:

1. possibility of exact reading of values;
2. identification of a parameter mistake of regression curves;
3. aesthetically more quality graphs;
4. easier creation of graphs including axes scales;
5. clearer work with data;
6. possibilities of identifying the distribution of a large number of dependent equations.

In the following part of the paper we will try to present in greater detail some free programs that can be used for analysis of measurements. As we described above, the process of analysis of results can be easier and higher quality if we use these applications than using the "normal" applications such as MS Excel or even paper.

Is the use of tools for analysis and visualization of data necessary?

Analysis and visualization of data are activities that will be essential for living in the information society. Each student should be able to work not only with these tools, but also understand their statistical and mathematical background. Important is then ability to interpret results too. These tools have wider use than just for physical education - will be valuable in sociology, mathematics, psychology, and data journalism.

Key theme for the future development includes the big data. Their processing will be associated with performed the data analysis. Physical Laboratory is a unique event - students carry out an experiment, get data, process them, compared with theory and interpret them. They have complete control over the entire process of working with data and analysis, which is important to their future lives.

Analysis and visualization of data should be a necessary part of every science education inclusive all the students, because of mentioned interdisciplinary character. The high school-educated population will have to be able to work with these tools. The advantage of the physical practices is (usually) arranged, noise-free data. In practical research students will be face the difficult situations and it is therefore advantageous if they are ready for it from school.

QtiPlot

QtiPlot [3] is a program that tries to copy the Origin, as much as possible [4]. It offers in fact identical menu structure and operation of the program is also similar. The difference is that QtiPlot can't draw some graphs (e.g. bubble ones) or miss advanced statistical functions. Final graphs are rarely aesthetically well done as the graphs used by Origin. But still in the category of free tools for analysis and visualization of function it is the strongest and best equipped instrument.

Cross platform works on Windows, Mac OS X and Linux.¹ For creating custom tools you can use Python scriptable or and muParser. OpenGL is used for 3D plotting. This makes it applicable to automate the processing.

Program offers functions for advanced statistical analysis as Student's t-Test, ANOVA, chi-square test for variance, normality test (Shapiro-Wilk). Available is linear and nonlinear curve fitting with weighting and estimation of statistical errors of the fit-parameters or multi-peak fitting.

The tools for working with graph offer the possibility of changes in the scope or scale of axes, export files, or support drawing and adding labels to the chart. The application supports both standard 2D and 3D graphs, but can work with spectrograms, histograms or vector plots too. The finished graphs can be exported to a format (PDF, SVG, BMP, JPG, PNG, TIFF, etc). Import is supported of Origin projects, Excel workbooks and ODF spreadsheets, Matlab files or SQL.

In this context we can say that QtiPlot covers completely needs that in the processing and visualization of data can occur - in physics or in any other field. The big advantage of this is the standardized environment from which students can easily change for the professional commercial applications.

Application control is relatively simple. Functional amenities in allows deployment as the primary and secondary schools, as well as the practice of university physics. Data that is entered in the chart can be interleaved functions whose parameters are stored in the log file from which they can be read. The user gets the value of variables, but also the measurement error or confidence level.

¹ QtiPlot is in the list because the free version for Linux is functionally almost identical (for students identical) to the paid. For Windows is free version unfortunately almost unusable.

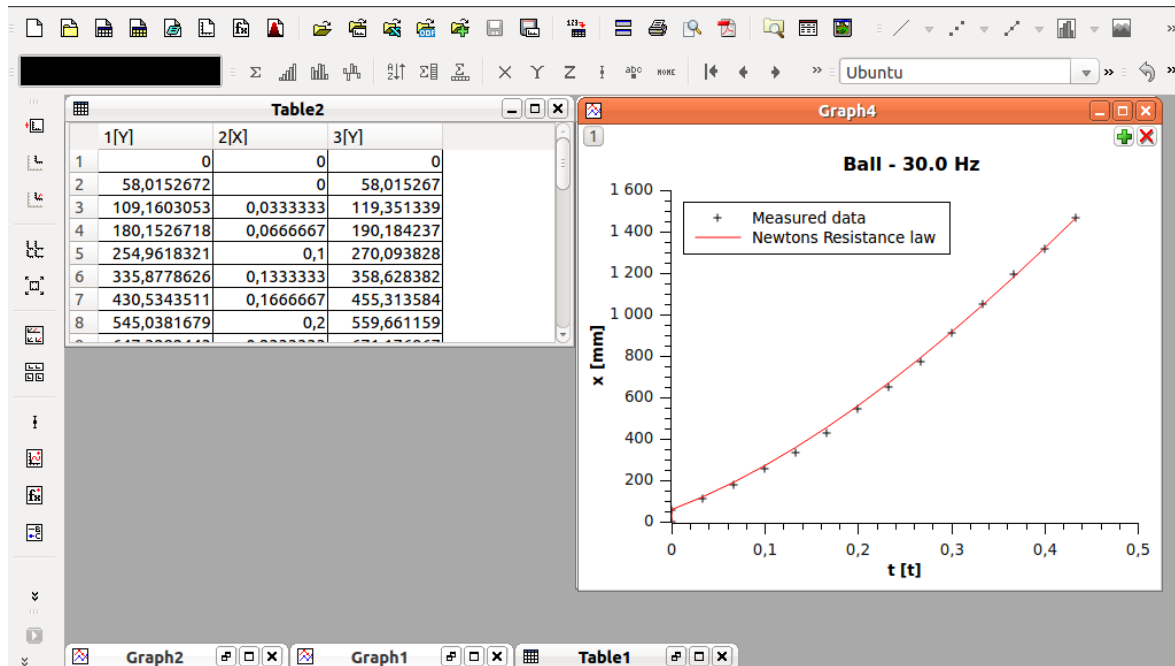

Figure 1. QtiPlot

SciDAVis

Interesting instrument for the school environment is SciDAVis [5] which is especially designed for educational purposes and not experienced users. It is available for Windows, Linux and MAC OS, so it can easily be used at school and in almost any home computer. The control is compared to Origin and QtiPlot slightly different but in my opinion it is better for students and more comfortable. It is fork QtiPlot which formed in 2007. For functional application running in Windows should install it separately Python.

Next to the window with data column is another special panel that allows insert the result of some function into the next column. For example, students will do one column with position corpus and in the second column can be inserted force of gravity by using this application. There are surely more possibilities than just addition and multiplication. This eliminates the need of constant communication with spreadsheet.

Data can be entered into tables or matrices, in which they can be insert manually or imported from ASCII files. Import data from Origin is experimentally supported, but does not work too well. Images can be exported in formats JPG, PNG, EPS, PDF, SVG etc.

There are available basic types of graph - pie, bar or scatter chart. Broader options offer the charts that are expressed by curve - it is possible to set up for example a smooth transition, stair linking, direct connection points and much more. Less common are the graphs for statistical purposes (histogram, box plot, area graph ...), 3D graphs or charts based on vector maps.

SciDAVis allows to draw more graphs into a one single frame, with the formation of enlarged cuts or working with layers. As we can see it is possible to compare the results of different measurements. Into the graphs we can also insert images, automatic shapes, arrows, labels, legends, titles, and many other elements. It is also possible to set exporting the chart, including the quality of the picture, which is for us helpful when we print or create posters.

Setting of parameters axes is done by clicking on the right button, just you click on the axis and select options. We can choose the font of labels, scale and size of display pieces, colors of axes, axes intersection or settings of grid. Of course there is also the choice of axes scales - you can choose logarithmic, linear or any other, which is also important in the range of measurements.

In analyzing data there is a tool for reading values from the graph (useful for extrapolation or interpolation) and it also allows deleting incorrect values from the graph. Application enables to zoom a part of graph for more comfortable and precise work.

The most important tools for data analysis is possibility to lead curves with measured values. There are tools for polynomial fitting 1st to 9th order, exponentials or Gauss distribution, working with multiple peak graphs or numerical integration.

There are also supported statistical functions such as on rows statistics, statistics on the column, FFT, correlation. Data can also be executed automatically by scripts in Python and muParser.

Is possible to define your own function for fitting data. Information about it can be written into the legend of the graph. At the same time it is automatically written into the log file. There is written everything needed: the parameters and their mistakes and level of data accuracy. Applications can work with the general functions and offers the possibility of statistical data analysis.

While QtiPlot is ideal for university students, SciDAVis is recommended especially for high school. It is designed to select and structure functions as well as didactically well-designed environment.

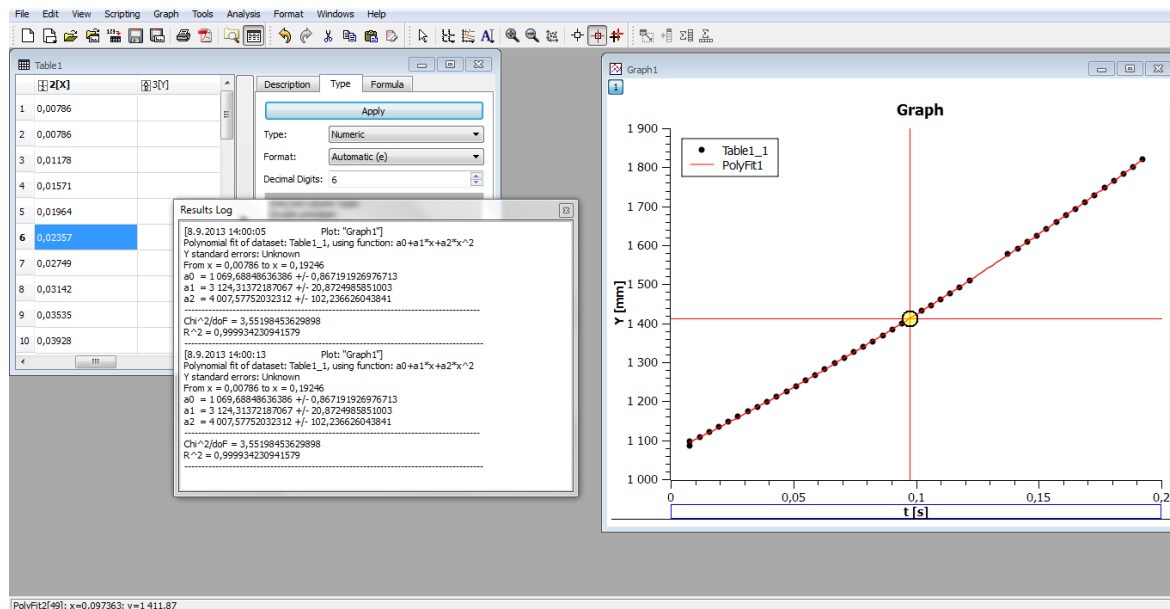

Figure 2. SciDAVis

LabPlot

The last one which will be introduced is LabPlot [6]. It was mainly intended for Linux (graphical environment KDE) but it can run in Windows as well. Except for a few differences it is similar as other programs, selected for this paper. Its main advantage is its ability to quickly create 3D graphs and do it significantly better than its competitors.

Another interesting function is the ability to read data from the database. This may be during the automated measurements (which begin to appear more at lower levels of education too) quite useful. It allows import data from Origin as well.

Important features include mainly peak find, interpolation, differences and integration, histogram, non-linear fit with also any user defined function or advanced features as Fourier, Wavelet, Laplace and Hankel transform, convolution noise, signal filter and correlation.

The application has a slightly unusual controlling but that does not diminish its functionality and usability. On the other hand, offers an interesting approach to working with data, that is - especially in Linux - effective. This is one of the best tools for working with 3D graphics.

A practical example of using

Study of free fall objects is one of the simplest phenomena that can be observed in nature and their measurement could and should be part of the physical education. One of the ways how access to measure is the use of a digital camera. Let body fall along hanging meter (e.g. metal meter) and read position in equidistant intervals [7].

If use of the camera is necessary to use either stroboscope or better pulsating ray of light that will always makes visible the falling object in the picture. Students can using this take photos or shoot of falling object and analyze its trajectory in the time.²

From elementary physics it is obvious that the trajectory should be in this shape:

$$y=0,5gt^2 + v_0t + y_0.$$

We can ensure using the help of initial conditions that the other two terms in the equation are zero. Quadratic interleaving of measured data should give to student's information about the size of 0.5 g element. So this experiment can be used to measure the acceleration of gravity.

In the analysis we focus on the study of drag forces. According to estimates Reynolds numbers to determine the dependence of the linear velocity (using Stokes' law) or quadratic (Newton's Resistance Law).

Of course there should be an analysis of interleaving mistakes and study of changes of distance measurement points from the ideal free fall. In this case thanks to these tools we can go much further and more efficiently than with a traditional office package.

² More complex variation of the problem can be found for example in Halliday, Resnick, Walker: Fundamentals of Physics. [9] Chapter 4 task 94. The role of the solution can easily be used with any of these programs.

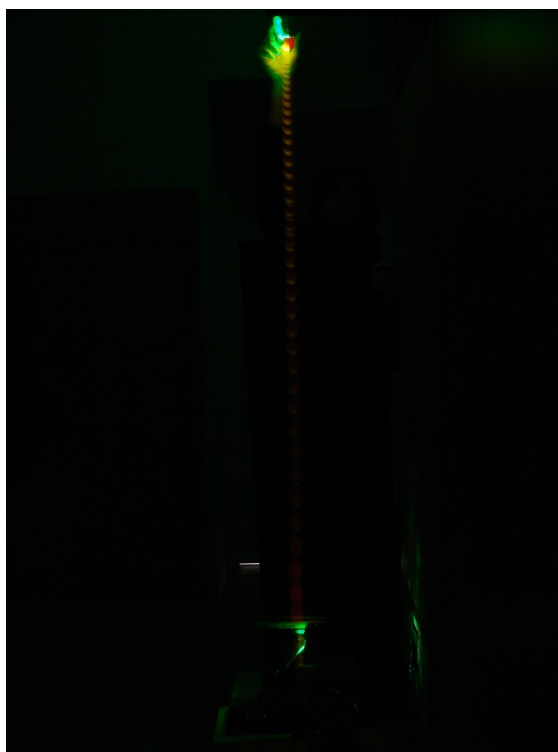

Figure 3. Free fall ball

Experience of using

Tools can be used for processing of almost any measurement. In the course (at Masaryk University in Brno) Physical Laboratory students of physics in the second semester bachelor's degree QtiPlot used for analysis. The most important task is the Cavendish experiment, which use it to implement the fitting the two curves and then identify their intersection.

In secondary practice I use SciDAVis because it is free for Windows. It handles all the normal data processing - for determining the spring constant of the harmonic oscillator, the capacity of the calorimeter, etc. This data can also be entered into a chart in MS Excel, but finding errors or data readings here is more complicated. The biggest difference is in volt-ampere characteristics of nonlinear elements such as transistors or diodes that are using this program to plot the graph (including fitting) as easily as any other curve, unlike Excel. Analogous example is the study of drag bulb glows.

Although we have no measured data, according to my experience both high school and college students preferred these programs to the office applications, after short training how to work with them.

Conclusion

Physical measurements are essential technique practice and fundamentals for building physics as a science. And that is why it is necessary to make a space for them in the schooling. The above instruments may well serve to the whole process of measurement become "more professional" in secondary and primary schools [8].

Operation of programs are in principle much easier than in the case of spreadsheet. Also possibilities for further physical discussion and interpretation of the results are better than after classical processing the results.³ Also, for students will be the measuring more fun when they will be able to deal with enough quality and competent manner. Many of them will also appreciate the aesthetic quality of the output of the measurement - described, analyzed and well-looking graph that looks exactly according to their liking.

An important role also play the fact that applications are free. This means that students can use them at home - for their measurement processing tasks or another essay or maybe even for personal entertainment. And do it without having to steal or buy expensive software.

The paper was written in the framework of the Operational Programme Education for Competitiveness: Modules innovation as a means to integrate the teaching of modern physics and chemistry, Reg.No.: CZ.1.07/2.2.00/28.0182.

References

- [1] Jerry D. Wilson, Cecilia A. Hernández: Physics Laboratory Experiments. Cengage Learning, 2009. p. 11.
- [2] Philipp K Janert: Gnuplot in action: understanding data with graphs. Manning Publications Co., 2009.
- [3] QtiPlot - Data Analysis and Scientific Visualisation. [online]. [cit. 09. 09. 2013]. Available from: <http://soft.proindependent.com/qtiplot.html>
- [4] Tim Jowers: The Business Guide to Free Information Technology Including Free/Libre Open Source Software. Lulu.com, 2006. p. 149.
- [5] SciDAVis. [online]. [cit. 09. 09. 2013]. Available from: <http://scidavis.sourceforge.net/>
- [6] LabPlot Features. [online]. [cit. 09. 09. 2013]. Available from: <http://labplot.sourceforge.net/features/>
- [7] Michal Černý: Experimentální ověření vybraných fyzikálních modelů a aproximací (2010). Available from: <http://theses.cz/id/2f8aes/>
- [8] Michal Černý: Analýza a vizualizace dat (nejen) ve fyzikálním praktiku. Matematika, fyzika, informatika: časopis pro výuku na základních a středních školách (2012). p. 560-565.
- [9] Halliday, David, Robert Resnick, and Jearl Walker: Fundamentals of physics extended. John Wiley & Sons, 2010.

³ Tasks for the computer can also be found in the famous textbook Halliday, Resnick, Walker: Fundamentals of Physics. [9] For example, Chapter 2 tasks 91-94.

Let's use our heads to play

Jana Česáková, Michaela Křížová

Faculty of Science, University of Hradec Králové, Czech Republic

Abstract

The regular activity “Let's use our heads to play” of the Faculty of Science, University of Hradec Králové is presented. The aim of the activity during its 6 volumes has been to popularize physics and other science branches. Many experiments on a variety of physics topics are presented to the public by academic staff and students. Very popular are fire experiments, liquid nitrogen, dry ice, brain teasers, optical illusions or playing with magnets and electricity. Many participants of different ages covering preschool children as well as retired persons are coming to try presented experiments by themselves. Therefore, we would like to share our experiences with the organization of the event, attended by more than 2500 people, and show some proven experiments. Approximately 100 students of our university help to prepare the happening every year. It brings them the possibility of practical testing of experiments and communication and teaching skills.

Keywords: physics, experiments, active learning, popularizing activity

Introduction

Faculty members and students from the Faculty of Education and the Faculty of Science of the University of Hradec Králové (UHK) and their colleges from the Astronomical Observatory and Planetarium in Hradec Králové together prepare science activities for pupils, students, teachers and interested persons of the public in the open air. This event is called ‘Let's use our heads to play’ and lasts two days every June. This year it is its 6th season [1].

Science competitions, festivals and events belong among important tools of science communication, popularizing science among large range of population, see [2] and the references therein. In the presented paper, we however stress also the importance of such events for students – future physics teachers – who voluntarily take part in the organization.

What is “Let's use our heads to play”

„Let's use our heads to play“ is a popularizing activity focused on physics and other science branches. The event is devoted especially for primary and secondary school pupils, however every visitor is welcomed.

There are always prepared many stands where traditional and non-traditional physics, chemistry, biological and mathematical experiments are presented. The important parts of the programme are the engaging lectures as well as the entertaining and instructive competitions.

Every presented experiment is accompanied by written description on the very understandable level. It contains basic information - tools, procedure description, task and possibly sources and alternative experiments or links to additional information. Usually the task and solution are on different sides so that the kids really had to think about it.

Children and especially their teachers can take away home these descriptions for further study and motivation. Teachers are offered methodological manuals (for example to work with GPS and geocaching) for inspiration to their lessons of physics.

We find inspirations and ideas for experiments in different sources, not only in books but also on the internet and other special activities popularizing physics (e.g. Physics Teachers' Inventions Fair [3], Physical drawer [4], Débrouillards [5]). We cite these sources in descriptions, so teachers can find there more materials for making their experiments.



Figure 1. Stands with experiments in the open air

The examples of the very popular experiments are the following: fire magic, experiments with liquid nitrogen, dry ice, brain teasers, optical illusions, observations of astronomical telescopes and facts about the universe, giant bubbles or unusual experiments with sound, optics, magnets and electricity.

Every volume have had some special topic, the topic of this year was “Physics by all the senses”.

We have introduced the special “event currency” - called “hlavounky” (from Czech word “hlava” = head) as a motivation for the children activity at the stands. Children can obtain “hlavounky” for correct answers and test tasks. Then they can buy for them various small gifts – rubber balloons, whistles, compasses, magnets, etc. In such a way the science can get into their subconscious as an interesting activity for leisure time.



Figure 2. Experiments with mirror;



Figure 3. Experiments with thermal imager



Figure 4. Giant bubbles



Figure 5. Experiments with liquid nitrogen

In the Czech Republic there are several similar events organized regularly (e. g. [6], [7], [8]). This action, however, is exceptional in several points. Above all, it is a family atmosphere in the organizing team, which consists of several UHK faculty members. They motivate more than a hundred of students of this university, especially future teachers who voluntarily participate in the preparation and implementation of the experiments. Another interesting feature is that the action is not supported by any European fund or other public source. The event is funded just by UHK sources with the contribution of the city of Hradec Králové. Tools and tutorials are made by hand from easy available materials and also waste materials, so the action takes place on a minimal budget but a huge human involvement.

As mentioned above, more than 100 UHK students work on the action every year as volunteers. Their task is to prepare and manage individual stands (you can recognize them on the photos by special t-shirts with the logo of the event - each year with a certain colour – green, yellow or blue). Students must perform a lot of activities from finding ideas, preparing the presentation to the actual implementation. The greatest benefit for future teachers is working with many children from preschool, primary and secondary school and even with adults and pensioners. Each of these groups requires a different approach. This option is not common in mostly theoretical training in university studies. The feedback from students shows that this practice is considered as a great benefit for them and their repeated voluntary participation is the evidence of it, despite the fact that the action is for them time consuming and physically quite exhaustive.

Mainly schools from Hradec Králové and its surroundings attend the event. But also schools from distant parts of Czech republic come. According to the statistical survey in 2012, 50.98% boys and 49.02% girls from registered schools participated.

Here we present one example of the task.

Task: Guess, what object is displayed in the picture?

Explanation: There is a cube in the picture whenever it does not seem like. Put the paper in same level as your eyes and look at it with one closed eye. Then you will see the cube as if it sat on the paper. It will be so called 3D. It is due a projection that helps to redraw a watching object in the suitable angle. This way of projection is used in a practise e.g. horizontal traffic marking. The driver usually looks at markings from a big distance and a small high.

Try to overdraw cubes on a pavement and take a photo of how you sit in the cube or you balance on a corner of the cube.



Figure 6., 7. “Cube” from paper on grass and template of the cube

Conclusions

We admit that the challenge to change the common children opinion, that physics is boring and completely useless subject, is still very difficult task, but we believe that our event is a good start. Mascot Albert helps us. We welcome more than 2500 attenders every year!



Figure 8.,9.,10. Mascot Albert performs experiments near the logo of “Let's use our heads to play”

References

- [1] www.hrajme-si-i-hlavou.cz
- [2] Burns T.W., O'Connor D.J., Stocklmayer S.M.: “Science communication: a contemporary definitive”, *Public Understanding of Science*, 12 (2003), 183–202.
- [3] <http://vnuf.cz/>
- [4] <http://fyzikalnisuplik.websnadno.cz/>
- [5] <http://www.debruar.cz/>
- [6] <http://www.dnyvedy.zcu.cz>
- [7] <http://www.vedeckyjarmark.cz/>
- [8] <http://fyzikalnijarmark.wikifoundry.com/>

New approach of some learning techniques in Physics

Vania Covlea, Alexandru Jipa, Marius Călin, Oana Ristea,
Cătălin Ristea, Emil Barna, Tiberiu Eșanu

Faculty of Physics, University of Bucharest, Romania

Abstract

This work discusses a few techniques applicable to the learning and teaching, including, in Physics: the interactive heuristic lecture, the collective interview, the collective experiment, the interactive software.

The general theoretical aspects of the lecture, which will be dealt with, are provided by professor to students before the course. In the lesson, professor introduces the subject, presents the main problems, with theoretical and experimental details and the possible consequences of the analyzed situation. Professor tempers the moderating discussion. In the end he makes the conclusions. Lesson is video-recorded.

Although it is a technique well-known, the experiment is continuously re-evaluated and upgraded. Professor's creativity is decisive. According to its authors, the classroom experiment built by students – under rigorous guidance of professor – has a maximum impact.

A collective interview refers to interactive assessment of the progresses in learning of the students, as well as the stabilizing their knowledge. The interview may be carried out by dedicated questionnaires, but also by spontaneous questions generated by collective interactions student-student and professor-student.

As interactive software can be used a course-lab in electronic format. For each topic, the student has at its disposal a breviary text and an application made in a friendly programming environment. The application code is shown for each topic, allowing students who are interested to develop the proposed applications in a personal manner. Illustrative examples are in the field of Physics.

Keywords: learning techniques, interactive interview, video lessons, IT applications

Introduction

The present work includes some discussions on few older or newer techniques applicable to the learning and teaching different notions in Physics. These methods are the following: **the interactive heuristic lecture, the collective interview, the collective experiment, the interactive software.**

These methods are discussed in the context of the deep and unexpected difficulties generated by the education system imposed by the Bologna and Berlin statements. The condensation of a great amount of notions in a short number of courses and in shorter number of hours per week, in conditions of shorter semesters, imposed some new ways or reconsideration of older methods for teaching basic notions and for doing easy to understand the contents.

Therefore, as a general rule applied in this context is the following: theoretical aspects of the lecture, which will be dealt with, are provided by professor to students before the debates. In the debate lesson, professor introduces the subject, presents the main problems, with theoretical and experimental details and the possible consequences of the analyzed

scientific problems. Professor moderates the debate, too, and, at the end of debate, he concludes on the major aspects and does final remarks. **Lesson could be video recorded.**

Although it is a technique well-known, **the experiment is continuously re-evaluated and upgraded**, especially in the context of lower number of practical classes per week and reduction of the period for research practice, as a consequence of the limitations imposed by the Bologna educational system. For this method the professor's creativity is decisive. According to the authors of the method, the classroom experiment built by students - under rigorous guidance of professor – has a maximum impact.

A **collective interview** refers to an interactive assessment of the progresses in students' learning of different notions introduced during the courses – in deep connection with the notions used in practical classes. This method permits a better fixation of the notions, as well as the stabilization of their knowledge. The interview may be carried out by dedicated questionnaires, but also by spontaneous questions generated by collective interactions student-student and professor-student. Small specific questionnaires, in the limit of the time allocated of the practical classes, can be proposed at the beginning of the experiments.

There are many notions and associated experiments that cannot be easy and clear presented to the students. Therefore, **interactive software** can be used in the teaching of a course, as well as at practical classes, for covering different experiments difficult to perform with usual laboratory equipment. These methods can be applied in **e-learning system**, too. According to the present status of the method, for each topic, the student has at its disposal a short and conclusive text, as well as an application performed in a friendly programming application, including different simulation codes used in scientific research, too. Some software applications are open, for different topics, allowing students which are interested to develop the proposed applications in a personal manner.

In this work we will give illustrative examples from the fields of Plasma Physics and Nuclear Physics. These fields are, probably, the systems with the most powerful impact, both visually and technically, as well as with difficulties in the teaching and learning, as well as in the performing some interesting experiments.

Interactive heuristic lecture

The interactive heuristic lecture is one of the useful methods in Physics teaching, developed during the time.

Heuristic doesn't mean: “The jam is made from fruits,
 The fruits grow in a tree,
 The tree grows near the house,
 The house is for man”

An example of interactive heuristic lesson can be a lesson on introduction of the plasma notion. Professor can begin saying that the idea of existence of a 4th state of matter was introduced by William Crookes, in 1879 [1].

The name of plasma (plassein, in Old Greek language) was done to this state of matter later, in 1928, by inspiration of Irving Langmuir [2].

Today we know that over 99,9% of the known Universe is plasma! The Sun, the stars, the interstellar space, the ionosphere of the planets and comets that have atmosphere, but also

the lighting and flame are plasmas [3,4]. Already, this notion is used in the Nuclear Physics filed for describing of a possible deconfined state of nuclear matter formed in the overlapping region of the two colliding nuclei at relativistic and ultrarelativistic nuclear collisions [5]. The quark-gluon plasma, a system consisting from free quarks and gluons at very high temperatures and baryonic densities, can be formed for a short time (around 5-10 Fm/c), at thermodynamic equilibrium. Other types of plasmas considered in this field are hadronic plasma and glasma [5].

But, what is plasma?

The classification of plasmas can be done according to the type of interaction (electromagnetic, electromagnetic plus gravitational and, as we mentioned previously, strong). There are compounds of plasmas (any system including subsystems), too.

The most important plasma parameters are: degrees of ionization, Debye length, Landau length, Langmuir frequency, as well as Coulomb parameter. These parameters can be used, doing modifications in agreement with the specific interaction, for describing nuclear plasmas, as quark-gluon plasma and hadronic plasma [6,7].

This is the structure of the first heuristic lecture about plasma. It is important to stress that we live in an “ocean” of plasmas, at macroscopic and microscopic levels, too. The manner of illustration of this fundamental statement of the Plasma Physics can be a test for the creativity of the teaching professor [8,9].

The reassessment of the experiment

Usually, the **best classical experiment** has the following steps for achieving: establishment of the theme of the experiment, documentation, design of the experimental set-up and building of the experimental set-ups by students, under professor' coordination. After these steps, follows data acquisition, obtaining of the experimental results, interpretation of the results and discussions on the fit results.

What we proposed here, as a **new way**, is the following: the students (maximum 4 students in a group) and professors build the experimental set-up in situ and in real time. The experimental aspects are analyzed, step by step. The experimental set-up is upgraded. The experimental results are collected. All these steps can be video recorded, for different purposes, including long distance teaching and long life education.

The next steps in laboratory suppose processing of the experimental data according to own laboratory software and/or to additional outside software. The students watch the recording. The best achievements are reported in different conferences or are published as laboratory book [10,11].

An example of proposed experiment is “The determination of electron temperature and plasma concentration through the Langmuir probe method”. This experiment represents an excellent scientific and practical tool. Moreover, it was used in the experiment of „Pioneer” spatial station that obtained proves on the ionosphere of Venus planet.

Students have at their disposal the theory, the experimental set-up, and the set of equipment required. The data is recorded and processed in real time, through a system called Smart Probe.

Further, important phase is the video analysis. „What was good?” „What doesn't and why?” are few of the most important questions that can complete the knowledge related to the performed experiment. This improves significantly the quality of the knowledge, as well as the possibility to do interesting connections with other fields.

The collective interview

The purpose of the **collective interview** is related to the following aspects:

- The assessment and self-assessment of the students in oral sessions.
- The determination of the students' knowledge and enhancing of the knowledge.
- The students receive thematic questionnaire, which represent the pretext of collective interview.
- The questions of the interview are established for relations at two levels: professor–student and student–student. The possible „surprise” of the method is the opportunity for students to address questions to Professor.
- The learning occurs by assessing, too.

We present here some examples:

1. In Plasma Physics Laboratory, how can be demonstrated the presence of charged and neutral parts of a plasma?
2. Are all plasmas hot?
3. What is the connection between temperature of electron and electron energy distribution function on the electron energies?
4. How do we know that the created state is plasma?
5. What non-invasive methods of plasma diagnosis know you? What local methods for plasma diagnosis know you?
6. What is the effect of magnetic field on the plasma?
7. Why plasma? [8,10-12]

Other examples are possible, too.

E–Learning

The sense of the e-learning used here is larger than what is considered usually. We tried during the time different ways for including software packages, as well as well-known simulation codes used in diverse Physics fields. We did not consider in this study different programs used in current practical classes (like ORIGIN, associated processing program for different experimental set-ups etc.).

Two major ways were taken into account. Firstly, we formed students' teams, coordinated by a professor, each team having specific tasks related to the elaboration of interactive, friendly software, usable in specialized laboratories for data processing [9-11,13]. This way was used for specific experiments in Plasma Physics Laboratory (for example, for some computational technique for plasma parameters determination using Langmuir probe data [11]) and Nuclear Physics Laboratory (for example, computer assisted tomography with X and γ rays in rotation-translation geometry [13]). This way is new and creative, but supposes students deeply involved in the specific fields.

A second way, based on the existing simulation codes used in different fields, especially in High Energy Physics, was tested with the students at the Master studies in the fields of Plasma Physics, Nuclear and Particle Physics, respectively. Based on an integrated system called YaPT [14], using all documentation offered by software packages included here, and

the basic notions acquired at the courses of Relativistic Nuclear Physics, Particle Physics and Astrophysics, the students received specific tasks (for example, rapidity distribution in Au-Au collisions at energies available at RHIC-BNL or transverse momentum spectra and identified hadron temperatures in p-Pb collisions at LHC-CERN energies) and discussed results in agreement with the specific chapters of the courses.

The performance of the distributed calculation system and GRID infrastructure helped to have simulation in enough short time, the involving of students being minimized (selection of the collisions, range of the impact parameters, beam energy, reference system used, the time step for evolution of the fireball). This method permitted better understanding of the basic notions, specific dynamical aspects of the relativistic nuclear collisions, global conditions of the different phase transitions in the dense and very hot nuclear matter formed in relativistic and ultrarelativistic nuclear collisions etc. Good results in the elaboration of the dissertation theses were observed, too.

Conclusions

We present some new forms of well-known techniques in learning and teaching, applied for Physics field. These methods could help in increasing of the interest for Sciences, generally, for Physics, especially, of different student categories. We tried to cover some lost in Physics education, both at high school levels and university level, caused by some legislative modification, in the Bologna and Berlin statements, as well as by specific economic and social condition from our country.

Some specific methods and ways can be used for long distance education, as well as for long life education, offering more knowledge in specific conditions.

The modern methods, the improving of older methods need the interest of the teaching staff for education, good collaboration with students, their interest for Physics, as well as a major ingredient: creativity, both for professors and students.

References

- [1] Crookes W.: Lecture on „Radiant matter” delivered to the British Association for the Advancement of the Science - Sheffield, August 22th, 1879 [see M. N. Hirsh, H. J. Oskam (editors) - Gaseous Electronics Academic Press, New York, San Francisco, London 1978].
- [2] Tonks L., Langmuir I.: Phys.Rev.34(1929)876, L.Tonks - Am.J.Phys 35(1967)857.
- [3] Feynman R. P., Leighton R. B., Sands M.: Lectures on Physics, Addison-Wesley, Reading, Massachusetts, 1963.
- [4] Covlea V., Andrei H. S.: Plasma: Diagnostic Techniques – Editura Universității din București University of Bucharest Publishing House), Bucharest, 2010 (in Romanian).
- [5] Jipa Al., Beșliu C.: Elemente de Fizică nucleară relativistă. Note de curs (Elements of relativistic nuclear Physics. Course notes) - Editura Universității din București University of Bucharest Publishing House), Bucharest, 2002.
- [6] Covlea V. et.al: Journal of Optoelectronics and Advanced Materials 10(8)(2008)1959-1963.
- [7] Jipa Al. et.al: Common ways in the description of the “classical” plasma and quark-gluon plasma - Indian Journal of Physics, Volume 85, Issue 1 (2011).

- [8] Sabina S., Covlea V., Jipa Al., Guster B. et.al: EDULEARN 12 Proceedings, Barcelona, 2012 (ISBN:978-84-695-3491-5), 15pag.
- [9] Covlea V. et.al: Experimental Methods in Optics, Spectroscopy, Plasma, Lasers - Editura Universității din București University of Bucharest Publishing House), Bucharest – in press.
- [10] Vladimir Manea, Cătălin Negrea, Alexandru Tudorică, Cătălin Vancea (students), Dr. Vania Covlea (Coordinating Professor) - „Plasma - Engineering interactive laboratory course” - Editura Universității din București University of Bucharest Publishing House), Bucharest, 2011 (in Romanian).
- [11] Negrea C., Manea Vl., Covlea V.: Al.Jipa – Computational technique for plasma parameters determination using Langmuir probe data – Plasma Physics Reports 37(2011)455-460.
- [12] Reece Roth J.: Plasma Engineering, volume I: Principles - Institute of Physics Publishing, Bristol, 1995.
- [13] Mihai Grososiu, Fl.Necula, M.Iovea, Al.Jipa: Annual Scientific Session of the Faculty of Physics, June 21th, 2013.
- [14] Cioranu S., Potlog M., Jipa Al.: accepted for publication in Romanian Reports in Physics 68(2015).

Interesting Facts about Tides You Might Not Have Known

Tomáš Franc

Astronomical Institute, Faculty of Mathematics and Physics, Charles University in Prague, Czech Republic

Abstract

In the paper we present several less-known phenomena caused by tidal forces – tidal acceleration and deceleration and tidal heating. We explain these phenomena in the way which is understandable to high school students. These phenomena are very interesting, enough to attract students to learn about astronomy.

Keywords: astronomy, gravity, tidal forces, tides

Introduction

One of the most difficult parts of teaching physics is to help students become motivated to understand what they study. Astronomy gives a great opportunity for this to occur, especially the topics that students do not know – or they know only a part of a more complex phenomenon, which can surprise them with something very interesting. This is the case of the *tides*. Students imagine only tidal waves (high and low tides) but that there are other tidal effects they have not known (or they just have not considered that idea). In this paper we present these less-known tidal effects such as changes in distances between satellites and planets (known as *tidal acceleration and deceleration*) and *tidal heating*, which causes volcanic and cryovolcanic activity and even the presence of subsurface oceans on several satellites in the Solar System, where life may exist.

Tidal Forces

Tidal forces per unit mass F_t (or tidal acceleration) from a planet acting on a satellite are approximately given by the formula

$$F_t = \frac{2GM_p R_s}{r^3}, \quad (1)$$

where G is the gravitational constant, M_p the mass of a planet, R_s the radius of a satellite and r the distance between the satellite and the planet; for a simple derivation of this formula see [1]. Formula (1) is valid for tidal forces at the nearest and farthest points on the Moon from the Earth (at these two points the tidal forces are the biggest). For the Moon in its mean distance from the Earth, we get the result $F_{\text{mean}} \approx 2.44 \cdot 10^{-5}$ N/kg. For tidal forces acting on some of the satellites mentioned in this paper see Table 1. For all calculations we use data obtained from [2]. In Table 1 we compare the magnitude of tidal forces with the value F_{mean} . The facts that follow from Table 1 we discuss at appropriate points in the paper. We take into account also the numerical eccentricity e of satellites' orbits, so we calculate the magnitude of tidal forces at the nearest point to a planet (periapsis) and at the farthest point from a planet (apoapsis). Let us denote by a the semi-major axis of the satellite's orbit: then the periapsis is given by $r_p = a(1 - e)$ and the apoapsis $r_a = a(1 + e)$. The ratio of tidal forces at periapsis and apoapsis depends only on the eccentricity e :

$$\frac{F_t(r_p)}{F_t(r_a)} = \frac{\frac{2GM_p R_s}{r_p^3}}{\frac{2GM_p R_s}{r_a^3}} = \left(\frac{r_a}{r_p}\right)^3 = \left(\frac{a(1+e)}{a(1-e)}\right)^3 = \left(\frac{1+e}{1-e}\right)^3$$

Table 1. Tidal forces per unit mass acting on selected satellites

Planet-Satellite	$\frac{F_t(\text{apoapsis})}{F_{\text{mean}}}$	$\frac{F_t(\text{periapsis})}{F_{\text{mean}}}$	$\frac{F_t(\text{periapsis})}{F_t(\text{apoapsis})}$
Earth-Moon	0.84	1.25	1.482
Mars-Phobos	54.59	59.77	1.095
Jupiter-Io	249.82	255.89	1.024
Jupiter-Europa	52.16	55.42	1.062
Jupiter-Ganymede	22.21	22.42	1.009
Jupiter-Callisto	3.68	3.84	1.043
Saturn-Enceladus	58.47	60.07	1.027
Saturn-Dione	32.35	32.78	1.013
Saturn-Titan	4.03	4.80	1.191
Uranus-Miranda	52.22	53.07	1.016
Uranus-Ariel	39.21	40.02	1.021
Neptune-Triton	16.92	16.92	1.000

Tidal Effect on the Satellite's Distance from Its Planet

The satellite's presence near a planet causes two tidal bulges on the planet, see [1]. These two tidal bulges are not aligned exactly along the connecting line between the planet and the satellite because of the friction between the bulges and the planet itself. This friction exists due to the different rotational period P_p of the planet and the orbital period P_s of the satellite or due to the retrograde motion of the satellite. Three cases can occur:

- 1) the satellite has prograde motion and $P_p < P_s$,
- 2) the satellite has prograde motion and $P_p > P_s$,
- 3) the satellite has retrograde motion.

The distance between a planet and its satellite changes due to the orbital eccentricity of the satellite, but we have in mind the changes in the semi-major axis. In case 1) the satellite is getting farther from the planet (also known as *tidal acceleration*) and in cases 2) and 3) it is getting closer to the planet (also known as *tidal deceleration*).

Prograde motion and $P_p < P_s$: see Figure 1. Because of different periods P_p and P_s in case 1) the friction between the tidal bulges and the planet pushes the bulges slightly ahead of the satellite. The gravitational forces (green) from the satellite acting on the two bulges are not equal and according to Newton's third law there are forces with the same magnitude acting on the satellite (orange) – their resulting force (blue) does not head to the centre of

the planet so it has a transverse component (red) in the direction of the satellite's velocity (black). The result is such that the satellite orbits away from the planet. It is the case of the Moon which gets farther from the Earth at the rate of about 3.8 cm every year. The red curve in Figure 1 denotes the direction of the planet's rotation.

Prograde motion and $P_p > P_s$: see Figure 2. In case 2) the two tidal bulges are slightly behind the satellite because of the friction between the bulges and the planet, which rotates around its axis more slowly than the satellite orbits the planet (the satellite orbits the planet under the stationary orbit, so for an observer on that satellite the planet has retrograde rotation). See Figure 1 for more details. The transverse component (red) in this case heads in a direction opposite to the satellite's velocity (black). The result is such that the satellite orbits closer to the planet. It is the case of Phobos which is getting closer to Mars by about 20 cm every year. This rate gives us the estimate that Phobos will fall onto Mars in less than 30 million years. If we take a look at the Table 1, we see that tidal forces acting on Phobos are approximately 55-times bigger than tidal forces acting on the Moon, the distance of Phobos from Mars changes not surprisingly faster than the distance of the Moon from the Earth (but the effect is not linear, so Phobos is getting closer to Mars five-times faster – and not 55-times – than the Moon gets away from the Earth). Other planets also have such satellites: Jupiter has two – Metis and Adrastea, Uranus has 11 such satellites and Neptune has 5, see [2].

Retrograde motion: see Figure 3. In case 3) the two tidal bulges are slightly behind the satellite because of the friction between the bulges and the planet which rotates around its axis in opposite direction than the satellite orbits the planet (it is independent on the relation between the satellite's orbital period and the planet's rotational period). See Figure 1 for more details. The transverse component (red) heads in the opposite direction than the satellite's velocity (black). Therefore the satellite orbits closer to the planet, as in the case of Triton, the satellite of Neptune. Other planets also have satellites with retrograde motion: Jupiter has 52, Saturn 29, Uranus 8 and Neptune has other 3 satellites, but Triton is an extraordinary one because of its big size (1,353 km radius), the other satellites with retrograde motion are very small (smaller in radius than 110 km, with most of them smaller than 10 km). The rate at which is Triton getting closer to Neptune is not known but according to Table 1 and the discussion in case 2) we can roughly estimate that rate to be between 4 cm and 20 cm per year.

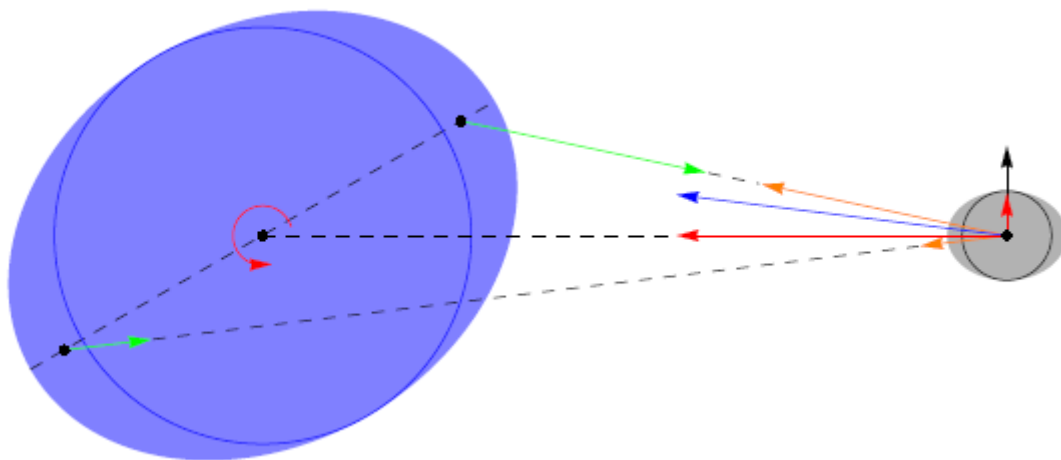

Figure 1. The satellite with prograde motion is getting farther from the planet when its orbital period is longer than the planet's rotational period (*tidal acceleration*)

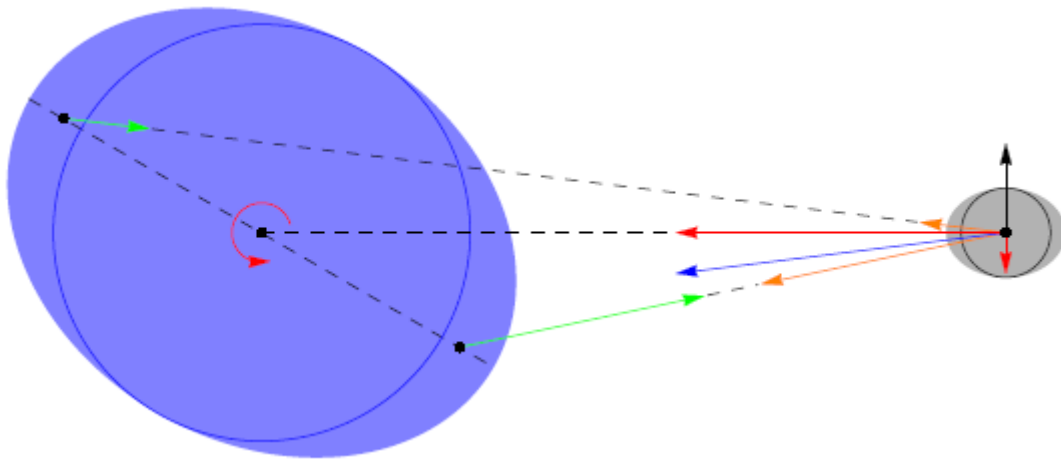

Figure 2. The satellite with prograde motion is getting closer to the planet when its orbital period is shorter than the planet's rotational period (*tidal deceleration*)

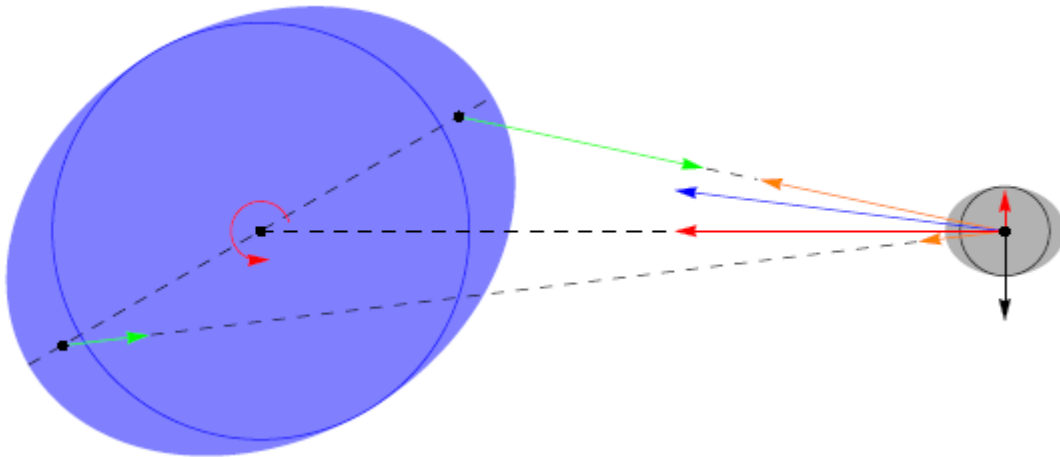

Figure 3. The satellite with retrograde motion is getting closer to the planet (*tidal deceleration*)

Tidal Heating

Because the orbits of satellites are ellipses, the distance of a satellite from its planet changes. So the magnitude of tidal forces given by formula (1) also changes. The satellite is deformed by tidal forces, which are variable. These changes in a satellite's shape generate friction inside the satellite, which results in heating of its interior. This phenomenon is known as *tidal heating*. Tidal heating causes two effects that are easily observable by a spacecraft – volcanism and cryovolcanism.

Volcanism

Volcanic activity was discovered on Jupiter's satellite Io by the Voyager 1 spacecraft in 1979, see Figure 4. The magnitude of tidal forces acting on Io from Jupiter and the eccentricity of Io's orbit ($e = 0.004$) lead to vertical differences in Io's tidal bulges of 100 metres, see Table 1. Io is the most geologically active object in the Solar System – it has more than 400 active volcanoes.

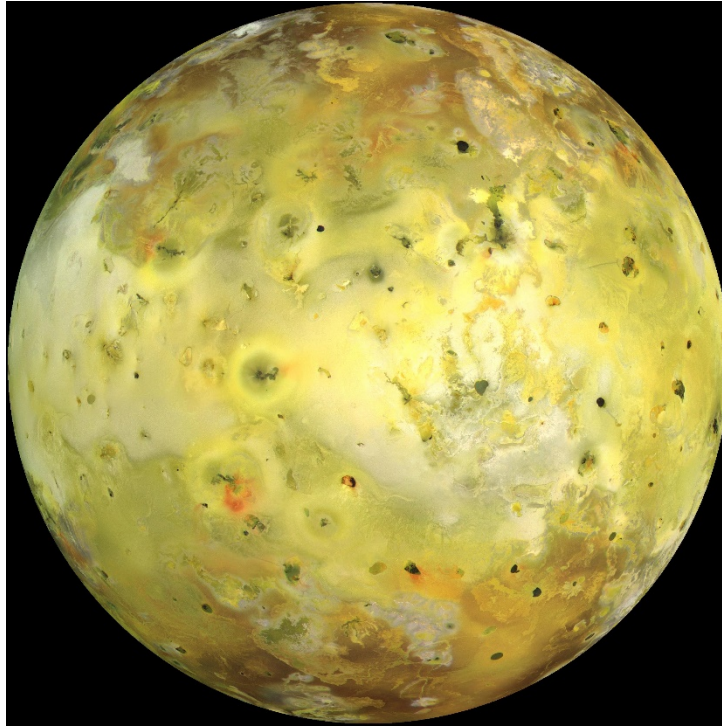

Figure 4. Global image of Io (in true colours). Io's surface is covered by sulphur in different colourful forms. The photo was taken by the Galileo spacecraft on July 03, 1999. This image was obtained from [3].

Cryovolcanism

Cryovolcanic activity was confirmed on Neptune's satellite Triton by the Voyager 2 spacecraft in 1989 and on Saturn's satellite Enceladus by the Cassini spacecraft in 2005 (see Figure 5). A cryovolcano is an icy volcano that emits plumes of cold methane, ammonia and/or water. Other satellites are also expected to have cryovolcanic activity: Europa and Ganymede (both satellites of Jupiter), Dione and Titan (Saturn), Miranda and Ariel (Uranus) – all these satellites very probably have a suitable composition of their interiors and the magnitude of tidal forces and their orbital eccentricity are relatively high enough – see Table 1.

Possible Life on Several Satellites

If the interior of a satellite has a suitable composition and is heated enough by tidal forces, it can contain a subsurface ocean where water is in liquid state. It is expected on Jupiter's satellites Europa, Ganymede and Callisto and it has already been confirmed on Titan and on Enceladus as well. On Titan very high tides (more than 10 meters) were confirmed by the Cassini spacecraft. Such high tides can be caused only by the presence of a subsurface layer of liquid water – from Table 1 we can see that the magnitude of tidal forces is relatively small (but on the other hand the changes in the magnitude are very high compared to the other satellites in the Table). If there were no subsurface layer of liquid water (solid interior), the tides would be not as high. On this satellite there exists very likely also the cryovolcanism. The Cassini spacecraft proved the presence of a subsurface ocean on Enceladus when it was flying through a geyser of icy particles on October 9, 2008 and it found traces of sodium in the form of salt, which is the evidence of a subsurface layer of liquid water. The salinity of the subsurface ocean on Enceladus is very

similar to that of water in oceans on the Earth. This makes Enceladus the most probable body in the Solar System on which extra-terrestrial life could exist.

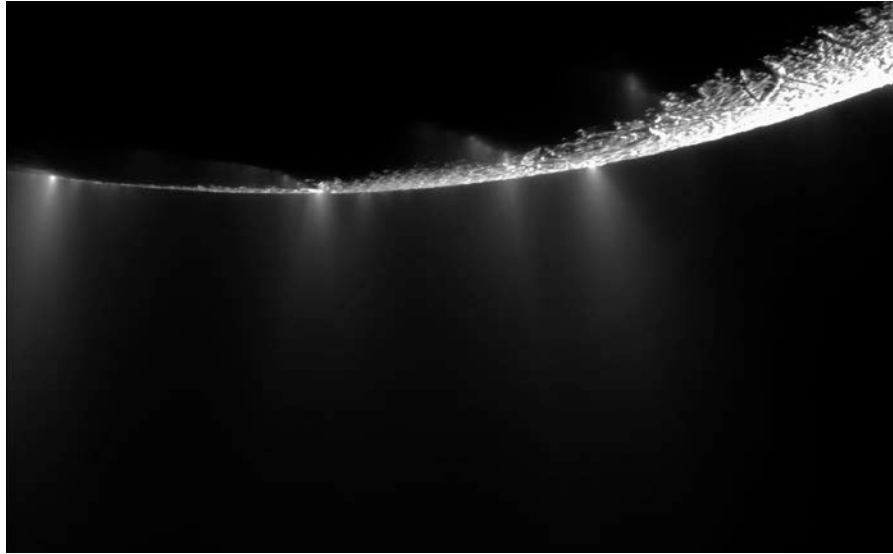

Figure 5. Cryovolcanic activity on Saturn's satellite Enceladus (near its south pole). In the picture we can see more than 30 individual jets of icy particles. On the surface there are the “tiger stripes” – the fissures that spray icy particles, water vapour and organic compounds.

The picture is a mosaic created from two images taken by the Cassini spacecraft on November 21, 2009 at a distance of approximately 14,000 km from Enceladus. This image was obtained from [3].

Conclusions

We have presented some less-known tidal effects: tidal acceleration and deceleration and tidal heating, which leads to volcanism and cryovolcanism on several satellites in the Solar System and also to the presence of subsurface oceans of water, in which life can possibly exist. These phenomena have been explained in a simple way on the level of high school physics. We have also calculated the magnitude of tidal forces on selected satellites and we have taken into account the eccentricity of satellites' orbits. All this has one purpose: to motivate students in learning physics (astronomy).

Acknowledgements

The present work was supported by the Charles University Grant Agency under Contract 341311. We also thank to NASA for providing data and pictures on websites [2] and [3].

References

- [1] Franc T.: Tides in the Earth-Moon System. In: WDS'12 Proceedings of Contributed Papers: Part III - Physics. Ed. Pavlů, J., Šafránková, J., p. 98-104. Matfyzpress, Prague, (2012). ISBN 978-80-7378-226-9.
- [2] Planetary Fact Sheets, [online]. [cit. 1. 10. 2013]. Available from: <http://nssdc.gsfc.nasa.gov/planetary/planetfact.html>
- [3] Photojournal: NASA's Image Access Home Page, [online]. [cit. 9. 10. 2013]. Available from: <http://photojournal.jpl.nasa.gov/>

Teaching Newton's law of cooling in „hands-on“ measurement approaches

Csilla Fulop

Trefort Ágoston Bilingual Vocational Secondary School, Budapest, Hungary

ELTE TTK, Physics Ph.D. School, Physics Education Programme

Abstract

Teaching methods practiced in science alter in how much focus is put on each of these means: quantities, notions, interdependence, understanding, solving problems, explanation, calculation, applications, planning or evaluating experiments, etc. Doing „hands-on measurement“ projects is a very complex method of teaching and learning. We will analyse this method in terms of these means. We also take a closer look at the activeness of this method using the „learning pyramid model“ of pedagogy.

For a specific study we will take an experimental law - the well-known Newton's law of cooling – as an example. According to Newton's Law of Cooling the rate of change in temperature of an object is proportional to the difference between its own and the ambient temperature. It means that the relation between the temperature of the object and time is exponential.

We will discuss four possibilities used in our everyday practice as students' activities in physics laboratories. So we will examine projects for three different levels. These levels can be dedicated to certain age or school system: primary school level, secondary school level, and mentor level. The academic goals of our projects are different, but the goal and means of science education are the same.

At primary school level the focus is developing the relation between sense and measured quantities. At secondary school level we disqualify the concept of steady change in cooling. The mentor level is a special course for the gifted students. In our project we highlight the numerical methods of demonstrating an exponential nexus. We present alternative solutions planned for our students.

Keywords: from primary to university education, learning pyramid, apparatus, hands-on measurement

Hand-on measurement, as an active way of learning

Teaching methods are different in terms of retention. If one can't remember what one learned the time spent learning is wasted.

The learning pyramid model of pedagogy (Figure 1.) helps to explore how different teaching methods effect retention rates. „Dale's cone of experience“ highlights the difference between passive and active ways of learning. It is a very popular model, but very often misunderstood. „...the Cone of Experience is visual model, a pictorial device that may help you to think critically about the ways in which concepts are developed.“ [1].

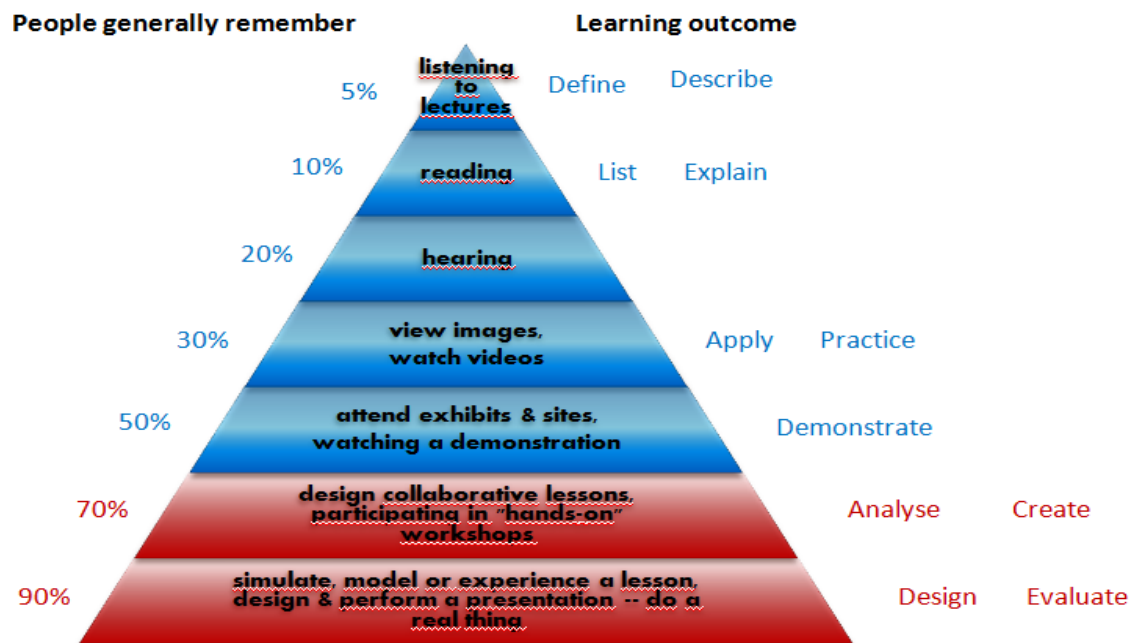

Figure 1. Dale's cone of experience making a difference between passive and active ways of learning

„Hands-on” experiments are of multi-purpose, and are worthily called active way of learning. As we can see from the model “hands-on” experiments are not used only for working with notions, introducing and measuring quantities, understanding interdependence, defining notions, practice the use of literature, finding explanation, use of graphs or formulae, being aware of applications, listing influences, apply phenomena, etc. They also include even more means, like: checking interdependence, summing up the gist in a study, discussing ideas, working in team, informing others, preparing for projects, evaluating a study, solving problems, planning an investigation, carrying out a study, verifying a law, and many more active ways of learning.

In IBL (Inquiry-based learning), research is regarded as a theme which underpins teaching. „Hands-on” measurements are widely used in IBL [2].

Newton's law of cooling

Temperature is an intensive bulk property of a system. In thermal equilibrium the temperature of any part of the system is the same. So, letting a hotter object in a cooler environment we can study the natural phenomenon of cooling. A well-known cooling law is also dedicated to one of the most famous physicists, Newton. This law is known like this: “The rate of change in temperature of an object is directly proportional to the difference between its own and the ambient temperature. Ambient temperature simply means the temperature of the surroundings; in most measurements it can be taken a constant value” [3].

We consider what this law really means, and find another mathematical form of the stated dependence [4].

We denote the temperature of the object by T , the temperature of the surroundings by T_{ambient} , time by t .

The rate of change in temperature is $\frac{dT}{dt}$ and the difference is $T - T_{\text{ambient}}$. So the law can be expressed like this, where α is a coefficient of proportionality:

$$\frac{dT}{dt} = -\alpha \cdot [T - T_{\text{ambient}}]$$

Let's solve the differential equation by separating variables method to prove that this experimental law can be written as an exponential formula.

$$\begin{aligned} \frac{dT}{[T - T_{\text{ambient}}]} &= -\alpha \cdot dt \\ \int \frac{dT}{[T - T_{\text{ambient}}]} &= \int -\alpha \cdot dt \\ \ln[T - T_{\text{ambient}}] &= -\alpha \cdot t + c \\ [T - T_{\text{ambient}}] &= e^{-\alpha t + c} \\ T &= T_{\text{ambient}} + k \cdot e^{-\alpha t} \end{aligned}$$

where c (or k) is so called integration constant which can be determined from initial conditions. This gives the final expression

$$T = T_{\text{ambient}} + (T_o - T_{\text{ambient}}) \cdot e^{-\alpha t}$$

It is generally true that if a function is directly proportional to its derivative function then the function is exponential of the variable. Therefore the law of cooling states that the temperature of the object is an exponentially decreasing function of time, where the lower limit of the function is the ambient temperature.

Teaching the cooling law...

We can learn also general lessons when we follow a series of hand-on measurements on a particular topic. We prepared a series of projects for our students of physics of different ages, or of different background competences. We highlight our intention with the activities, and also make some remarks that we gained from working with our groups, as we use these projects in our everyday practice.

So, teaching the cooling law...

...at primary school level (ages 10-14)

Motto: From perception to quantities & the concept of changing quantities

A measured quantity is combination of two elements: a measured value (given in some significant figures) plus an agreed unit. We introduce the idea of measuring temperature and time. We introduce the use of thermometers and clocks. Everyday units of the two quantities are discussed and measured: temperature in °C, and time in seconds, minutes, and hours.

It is well known that if somebody enters into a room of 20°C, it feels warm in the winter when we come from a chilly environment whereas it is very refreshing cool in the summer

when it is hot outside. We can prepare three basins for our pupils: the first one has hot, the second one mild, and last one has cold water in. The mild can feel hot if we dive our hands into it after cold water. But it feels cold after hot. They can see that sense perception is not reliable, so they understand that we need to measure quantities.

Also, we give a task to our students to do their own measurements with simple tools. We need a thermometer for each pair or small group, a watch, a cup, and some hot water. Their task is to jot down the results into a table, and then show their results in a graph. Doing this task they can understand that as time passes by temperature is changing. Thus we demonstrate the dependence of two basic quantities. It works well, if we pour about half a deciliter of 70 °C water into a measuring cylinder. We can ask them read the data every minute, about 10-12 times, since this is how long their attention-span can last. During team-work they exchange ideas, experience the phenomenon, get involved in the measurement, analyse, sum up, practice, set questions, evaluate, etc., most of which are active ways of learning.

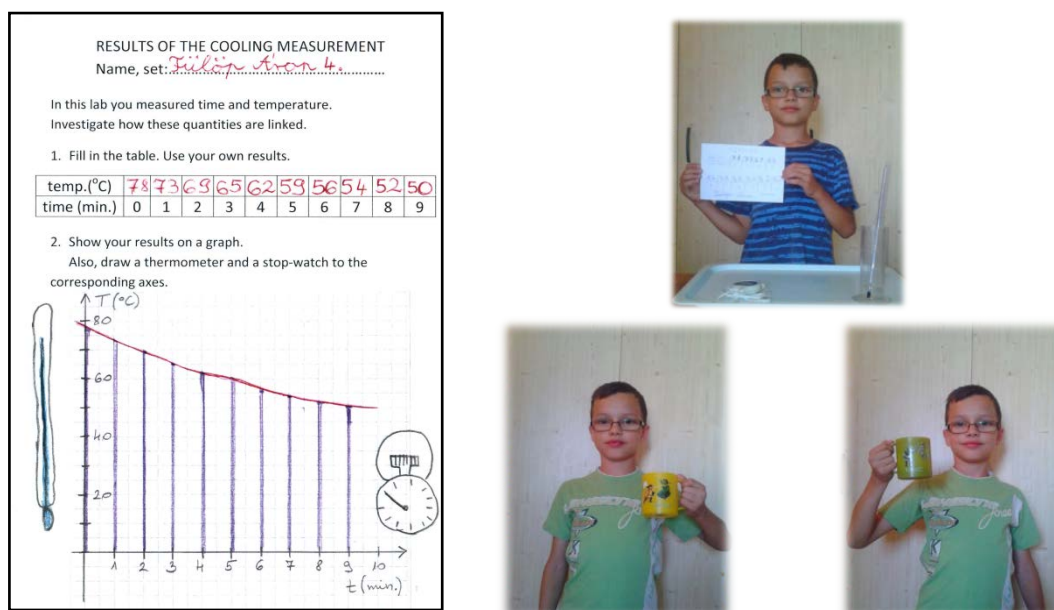

Figure 2. Boy aged 10 proudly presents his results and shows a gift mug at room temperature and filled with cold water demonstrating thermochromism

From our practice we find that pupils of this age are really fascinated to see materials (like we have mugs), that change their colour as their temperature changes. The name of the phenomenon is thermochromism, and the explanation is highly complex. But, it can enchant, hypnotize our pupils.

The time needed for demonstration and activities is one or two lessons only. We can give an insight of metrology, use of tables, and diagrams. At conceptual level we did the very important first steps by introducing quantities and the objective description of changing.

...at secondary school level (ages 14-19)

Motto: Disqualifying the concept of steady change in cooling

The way of change is not the same in natural phenomena. Steady (linear) changes are dominating in the experiments at lower level physics courses, because they are the easiest approximation.

Steady change can be checked easily in more ways. We mention three methods. The first method is most often suggested by our students. It is as follows: steady change can be checked by constituting and comparing differences. If the change is linear, the differences calculated for equal time intervals are equal. In the second method quotients are constituted and compared. If the change is linear, the quotients are equal. The third method: a linear graph denotes linear dependence between two quantities. This method is popular among our students, because it is illustrative.

Students use the data measured in class. They can figure for themselves in more ways that the temperature change is not steady. They find that the temperature differences in equal time periods are not equal: in cooling these are decreasing respectively. The temperature versus time graph is not linear.

We use a liquid thermometer, a measuring cup, some hot water, a watch, some graph paper for each group. Our investigation is designed for two lessons. Students work in teams (Figure 3) benefitting all from the advantages of this setting.

We present the results of one of our groups and the steps of their work in “normal” classes.

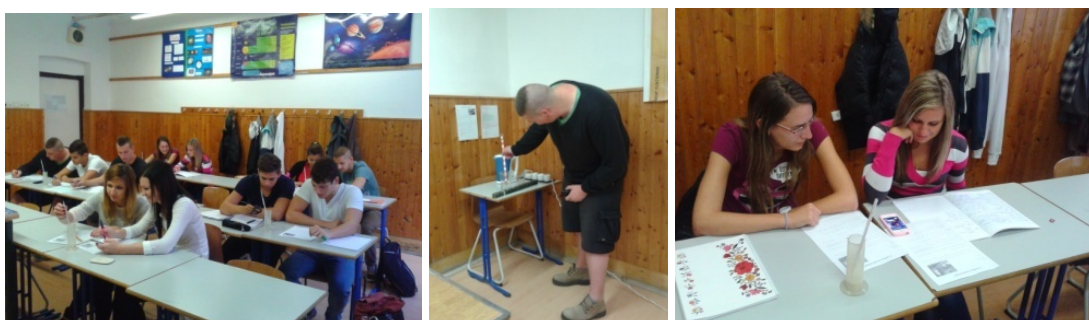

Figure 3. Set in grade 10 investigating how water is cooling

There are the results the students got in Table 1.

Table 1. Measured data: Water cooling at room temperature ($T_{\text{ambient}}=25^{\circ}\text{C}$)

$T (^{\circ}\text{C})$	75.0	66.0	59.0	53.0	48.0	44.0	41.0	38.5	36.5	34.5	33.0	32.0
$t (\text{min})$	0	3	6	9	12	15	18	21	24	27	30	33

In the task they had freedom to choose two methods to check if the dependence is linear. As usual, this team began checking the dependence with the first method. Their results are in Table 2.

Table 2. Calculated differences in every consecutive 3 minute time periods

number	1.	2.	3.	4.	5.	6.	7.	8.	9.	10.
$\Delta T (^{\circ}\text{C})$	9.0	7.0	6.0	5.0	4.0	3.0	2.5	2.0	1.5	1.0

They noticed that a decrease can be observed in ΔT respectively.

For a second study they chose to plot a graph. They showed the temperature of the water versus time.

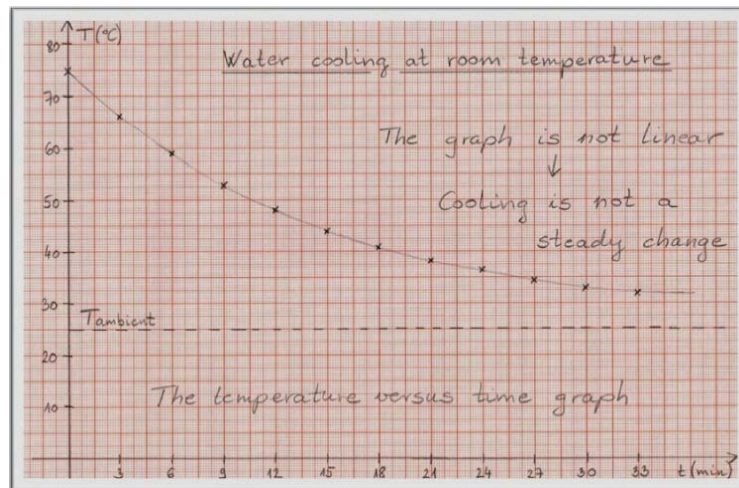

Figure 5. Water cooling at room temperature: temperature versus time graph

They also put what they figured onto the graph: “Cooling is not a steady change.”

...at mentor level (ages 15-19)

The mentor level is a special course for gifted students at secondary schools.

We present two options for a deeper study of the law in secondary education. One is dedicated more to show the theoretical, mathematical deeper issues of the exponential laws, and another more prepared for introducing the use of apparatus, and pointing towards advanced technology as well as the use of computer aided measurements. For both projects we plan three or four lessons to accomplish.

Motto: Numerical differentiation to verify exponential nexus.

The idea is based on the original wording of the law. We can verify with numerical method. The “access temperature” is defined, meaning the difference between the ambient temperature and the actual temperature. From (either the measured or the access) temperature versus time graph we constitute a few (4 or more) differential quotients. It is called the rate of change in temperature. These are the values of steepness of the tangents or of the chords: $\Delta T/\Delta t$. We can write these values into a table in pairs with the mean access temperatures. Now we plot a graph: the rate of change values versus the mean access temperature values of the studied intervals. This graph according to Newton’s law is linear furthermore it is a graph of direct proportionality (a line through the zero intercept). Thus verifying the exponential nexus is done through checking a linear nexus of two newly defined quantities.

We will show the steps of this work using the data presented in the previous chapter. These students analysed on their own data in additional classes for mentoring. We present in Figure 6 the team of some gifted and diligent students working in the physics lab.

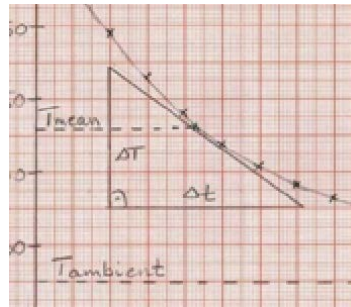
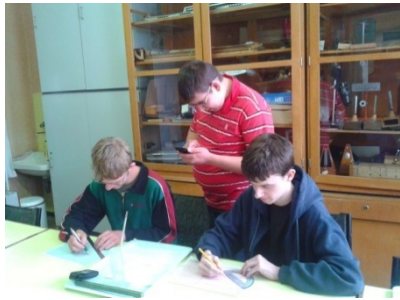

Figure 6. Tamás, Balázs and Dávid in “mentor” class in 2013 getting started with numerical methods

From the graph they calculated the values of steepness for more points, and showed their results in a table, see Table 3.

Table 3. Rate of change and mean access temperature

$\Delta T/\Delta t$ ($^{\circ}\text{C}/\text{min}$)	3.00	2.33	2.00	1.67	1.33	1.00	0.80	0.67	0.67	0.50	0.33
mean access T ($^{\circ}\text{C}$)	46	37	31	25	21	17	14	12.5	11.0	8.5	7.5

The results from the table above are used to plot a graph, as Figure 7 shows it.

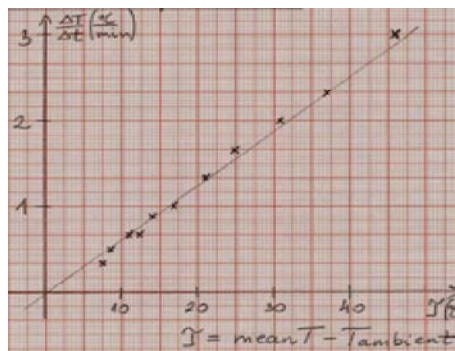

Figure 7. The rate of change versus mean access temperature graph

The direct proportional nexus seen in the graph verifies the law. The students may find it hard to understand how exponential and linear functions can be derived from each other, but can follow the steps of this guided task easily. They can get familiar with the new definitions.

Motto: Use of measuring equipment, evaluation with computer.

Introducing the use of apparatus is also an intent in teaching science. We could teach how to evaluate the results gained from a Metex M-3660D meter with the help of a computer.

The Metex M-3660D meter has got a thermal sensor in the original set. This sensor can be easily attached to the meter. The meter can be connected to computers or laptops, but a serial adaptor to the USB port is needed. The program is on a 3,5” floppy disc. A DOS based programme helps to set up the devices. The data are logged in a *.txt file, then they can be analysed in Microsoft Excel. An exponential curve can be easily adjusted.

The law is verified with computer supported evaluation.



Figure 8. A measurement setup

The use of technical devices can make a problem in the preparation of our teaching practice. Students and teacher, going through a number of technical difficulties, relying on one-another can make a group of curious scientists. They learn together in a team, where problems need to be solved also with brainstorming or other techniques, search for help, looking for tools that are essential to accomplish the purpose of the project: to create a system of instruments that are able to check the cooling law.

Conclusions

We followed attentively the steps of teaching an experimental law in “hands-on” measurement ways in public education. First we got from perception to quantities, then learned about changing quantities and characterised linear and exponential changes. We also glimpsed into mathematical methods, used simple tools and applied apparatus, finally welcomed the use of computers.

References

- [1] www2.potsdam.edu/.../dalescone_files/dalescone.html
- [2] <http://ciblearning.org/>
- [3] <http://www.ugrad.math.ubc.ca/coursedoc/math100/notes/diffeqs/cool.html>
- [4] In Hungarian: “A fizika kísérleti törvényei csoportosítása matematikai formájuk alapján” Csilla Fülöp International Conference for teachers of physics in Hungarian 2013. pp 291-296, also <http://fiztan.phd.elte.hu/letolt/konfkotet2012.pdf>
- [5] <http://www.pble.ac.uk/pble-sd/skills-attrib-qual.pdf>

Introducing Students to Experimental Research Work: Astrophysical Jet Visualization with Fluids

Andrea Muñoz Gutiérrez¹, Estela Margarita Puente Leos, Marcos Ley Koo.

Departamento de Física, Facultad de Ciencias, Universidad Nacional Autónoma de México

¹ Financial support of  COMECYT
CONSEJO NACIONAL DE CIENCIA Y TECNOLOGÍA

Abstract

In this project, jets at supersonic speeds were produced by using compressed air, syringe needles (for medical, veterinary and gastronomical purposes), a laser pointer and a common lens from a standard optics laboratory, which allowed us to observe well defined shock waves. These jets can be a visual aid for Relativity, Astrophysics and Fluids courses (depending on its approach) for undergraduate students.

Keywords: low costs tools for teaching, experimental teaching, visualization aids, astrophysical jets

Introduction

This work is an example of the type of experiments designed and carried out by undergraduate students in a one-semester elective course (Cooperative Phenomena) of the Physics Curriculum of the Facultad de Ciencias of the Universidad Nacional Autónoma de México. The main objective of this course is to introduce students to the experimental design and analysis to study phenomena present in macroscopic systems, either isolated or interacting with others, in different phase: solid, liquid, gas or combination of them; in equilibrium as well as of out of it. It is worth pointing out that, previous to this course, there is a mandatory calculus based course (Collective Phenomena), which covers the basis of Thermodynamics, Fluid Mechanics and Wave Propagation, whose purpose is to expose students to phenomena that appear by the presence of a collection of particles even if they do not interact.

Nowadays, in contemporary physics research, it is convenient to consider the phenomena under study as a manifestation of the behaviour of a collection of microscopic objects. Such objects may have different properties that will show up depending upon the environment they are in and, thus, the interest in this course are the so-called cooperative phenomena; namely, those that result from interactions among the microscopic individuals and give rise to a macro-phenomena. It is hoped that this is a way to understand how the micro-constituents act and interact as individuals, what the conditions are under which such interactions give rise to the under study phenomena. These interactions extend over distances which are enormously greater than the usual action radii of the elementary particles, so their importance in ferromagnetism, superconductivity, phase transitions, transport phenomena, astrophysics, and biology.

During the course period, students have to reproduce a phenomenon and analyze it. Starting from observation they have to provide a detailed qualitative description, pointing out the possible properties and variables, which they consider important in the observed behaviour. After this identification, they must suggest what and how to measure in order to provide a quantitative analysis of the problem and, if possible, to obtain and understand correlations between variables.

The course's design relies on and enhances the students' capabilities, since they must do a bibliography search, look for the material, equipment and facilities before writing the proposal, do the experimental work and write the final report, to realize if the original goal was accomplished and to what extent. By doing this, they will have a better idea of how research life really is and will acquire research skills. They learn to observe, to describe and to measure in an experiment.

One of the most important features of this experimental work is that students must use material and equipment available in the laboratory or easy to get; as they must propose an experiment, relying upon their knowledge and creativity. The teacher plays only a guiding role.

Our experience with this project has been that students not only work to get a final note, but they continue working after the semester has concluded. We think that this type of activities stimulate imagination and likely contribute as the starting point in the road of research. We consider that this experimental proposal would be the best way for working in all experimental courses.

In this particular case, the experiment chosen by students was a current research problem in Astrophysics: the simulation and study of plasma jets ejected by different celestial objects [1,2,3,4,5]. For this purpose, supersonic jets were obtained in order to simulate astrophysical jets.

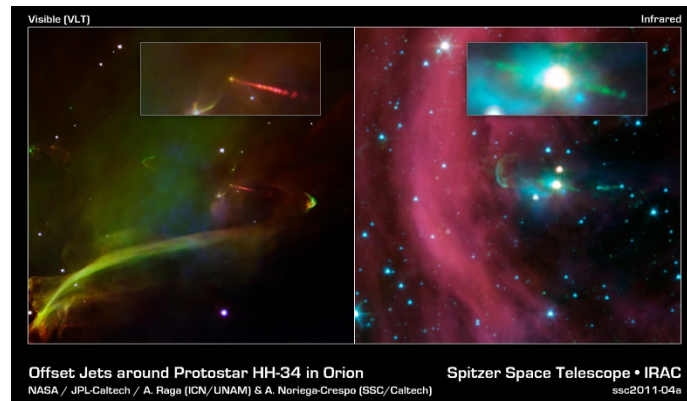

Figure 1. This image layout shows two views of the same baby star – at left is a visible-light image, and at right is an infrared image from NASA's Spitzer Space Telescope. Spitzer's view shows that this star has a second, identical jet shooting off in the opposite direction of the first. Both jets are seen in green in the Spitzer image, emanating from the fuzzy white star. Only one jet can be seen in the visible image in red.

Astrophysical jets are narrow streams of charged particles spurting from the centre of young stars and super massive black holes. Jets associated with stars are composed of ionized gas moving away from the star, with velocities of a few hundred kilometres per second. Extragalactic jets are composed of relativistic particles, magnetic field, and probably additional amounts of cooler ionized plasma either originally ejected in the jet, or by exchange with the surrounding gaseous medium. The mechanism for jet formation is currently subject of research; many of the proposed theoretical models predict that jets form as the result of magnetic forces. Laboratory experiments and simulations have been done to simulate them [3,4,5]. Researchers make plasma jets in the laboratory that closely

resemble astrophysical jets. Several studies have been performed with observations, theoretical models and numerical simulations.

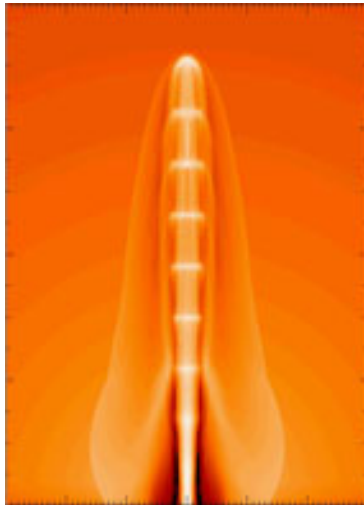

Figure 2. Simulation of a propagating Jet using the PLUTO code by Matthias Stute. Institut für Astronomy and Astrophysik. Eberhard Karls Universität Tübingen

Motivated by these experiments students were able to visualize shock waves produced by air jets. The project's originality rests on the student's ability to solve the experimental problem using syringe needles, laser pointers, common optical lenses and the University compressed air's facility, instead of high energy plasmas or electromagnetic pulses, specially made mirrors and nozzles, and high intensity lasers to understand this complex phenomenon.

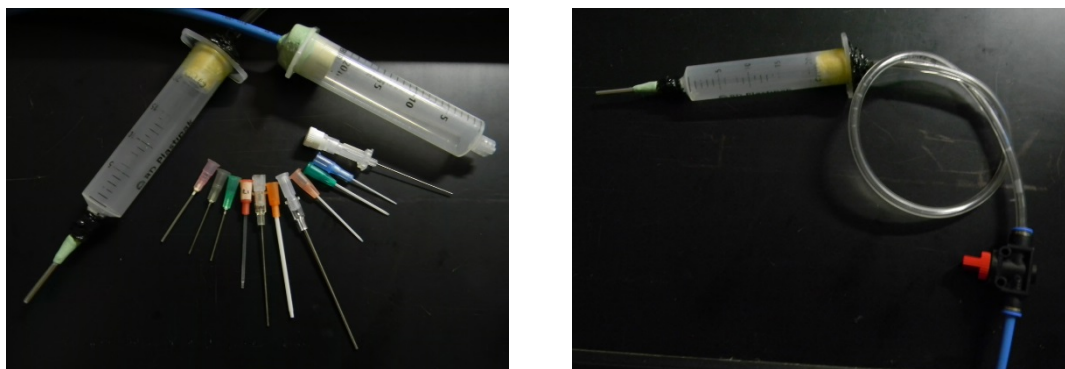

Figure 3. Syringe and needles used for obtain jets



Figure 4. Improved connection to support higher air pressures and avoid leaks

In this project, supersonic jets were obtained varying the discharge pressure, in order to change pressure several nozzles were used. The easy and cheapest way to do it is to use several syringe needles as nozzles. In Mexico City atmospheric pressure is 11.2 psi (58 cm Hg) and compressor pressures used, in this experiment were between 40 and 65 psi, so that greater discharge pressures may be achieved, as compared to sea level, as well as an increase in jet speed.

Discharge pressure is important since it determines the type of pattern that will be form within the jet boundary.

In order to visualize the flow, we use the so-called shadowgraph method; such method reveals density differences in transparent media, according to optics. These disturbances refract light rays and shadows are formed.

The optical set up included a 5 mW green laser pointer, with 532 nm wavelength, and a lens (f 8) or microscope objectives ((40x) NA 0.65 and (100x) NA 1.25). Although a 1 mW He-Ne laser was initially used, the images were blurred and since green laser give what was been looking for, no further trials with others light sources were attempted.

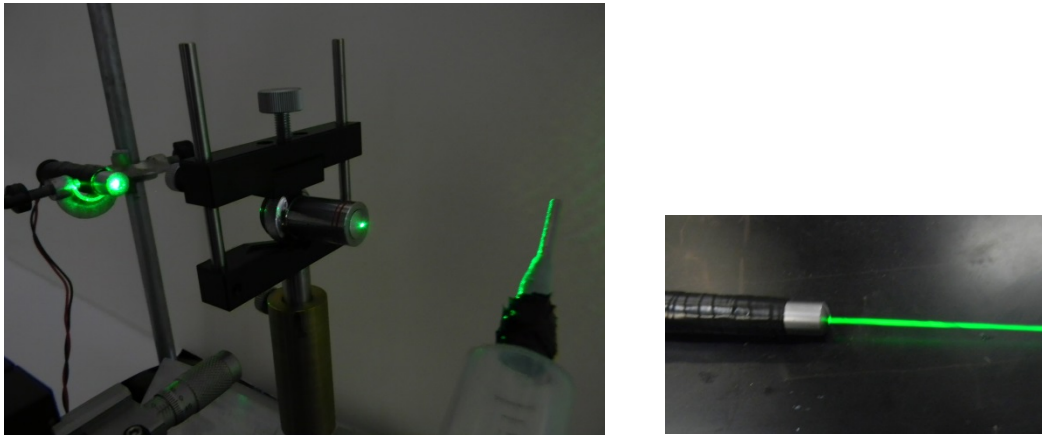

Figure 5. Optical set up

The obtained images show the presence of crossings within a jet. As pointed out in specialized literature [6,8] this indicates that supersonic speeds have been reached, and shock waves have been produced. It is argued that, there are changes in speed and pressure within the flow and the pressure difference with that of the atmosphere are responsible for the crossing. Using needles of different diameter showed that pressure jet changed, and the number of visible shock diamonds changed as well of the distance between them.

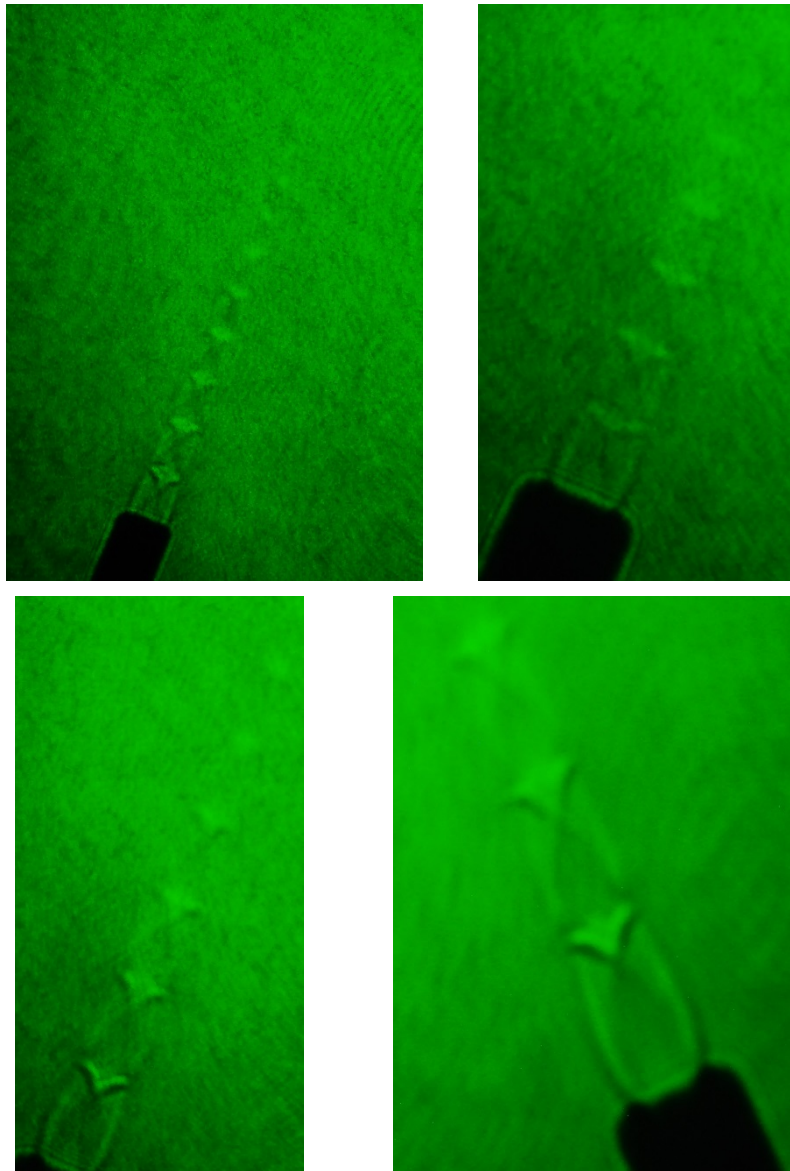

Figure 6. Flow visualization using the shadowgraph method

This kind of jets are similar to astrophysical jets in that both are very collimated, ejected with speeds greater than sound speed, and there is a pressure change within them. This experiment is used only as a simply descriptive tool but teaches students the role of analogies in a real investigation of physics.

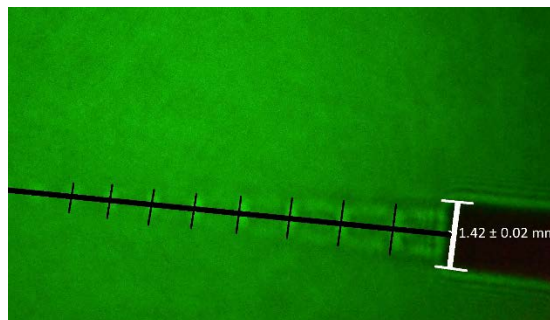

Figure 7. Knowing the dimension of nozzle, students can get quantitative results from photographs obtained from the experiment

It is expected that students will continue working in this experiment in order to get a quantitative relationship between variables, to simulate and analyse the interaction of jets with different astronomical objects (as dense clouds) and changing the pressure of the ambient atmosphere beyond the free jet.

Conclusions

A visualization of this type allows a space-time study for several hydrodynamic flows; in this particular case, a possible resemblance with astrophysical jets by means of an economical, affordable and pedagogical way.

This kind of courses students deal with experimental work in a different way as they do in traditional courses leading to a better understanding of the experimental research world not only by the work at laboratory but also by means of specialised lectures and current scientific papers.

Our experience with this kind of courses is that students improve their manual skills and their ability to observe, which are essential in experimental research work. Comparing with the traditional experimental courses with pre-designed experiments, these courses offer the students the opportunity to design their own experimental device in order to solve an experimental problem of their interest, encouraging their creativity and training their previous knowledge, basic skills of scientific professional work.

References

- [1] Noriega-Crespo A., Raga A. C.: Spitzer Observations Of The Hh 1/2 System: The Discovery Of The Counterjet, *Astrophysical Journal*, Volume 750:101. 2012.
- [2] Tordella D., Belan M., Massaglia S., De Ponte S., Mignone A., Bondenschatz E., Ferrari A.: Astrophysical jets: insights into long-term hydrodynamics. *New Journal of Physics*. Volume 13. Number 4. 2011.
- [3] Huarte-Espinosa M., Frank A., Blackman E. G.: Laboratory experiments and simulations on jets. *Proceedings of Magnetic Fields in the Universe: From Laboratory and Stars to Primordial structures*. August 21st-27th, 2011, Zakopane, Poland.
- [4] Ciardi A., Lebedev S. V., Frank A., Suzuki-Vidal F., Hall G. N., Bland Simon N., Harvey-Thompson Adam, Blackman Eric G., Camenzind Max.: Episodic magnetic bubbles and jets: astrophysical implications from laboratory experiments. *The Astrophysical Journal*, 691:L147-L150, 2009.
- [5] Suzuki-Vidal F., Lebedev S. V., Bocchi M., et.al: 2012, Experimental study of shock waves from the interaction of a supersonic plasma jet with an ambient gas, *Shock Waves*, Volume 22, , Pages: 249-251.
- [6] <http://www.aerospaceweb.org>
- [7] <http://www.spitzer.caltech.edu/images/3564-ssc2011-04a-Undercover-Jet-Exposed>
- [8] <http://www.tat.physik.uni-tuebingen.de/~stute/research.html>

A simple experiment set for demonstrating optical communication with LEDs as light transmitting and receiving components

Makoto Hasegawa

Chitose Institute of Science and Technology, Chitose, Japan

Abstract

A simplified experiment set for demonstrating optical communication by using light emitting diodes (LEDs) is provided. Intensity of light to be emitted from a LED is modulated with input audio signals, and the resultant emitted LED light is received by a light receiving component, thereby realizing optical signal communication. Use of another LED as the light receiving component, instead of a photodiode, makes this demonstration set less expensive and more advantageous. One of the advantages is better quality reception. Another is that LEDs with different colours can be used as each of the light transmitting and receiving components. In such a case, audio signals can be or can not be communicated in accordance with combination of LED colours. This aspect is useful for easily demonstrating relationship between colours of light and their energy levels.

Keywords: optical communication, LED, amplitude modulation

Introduction

A light emitting diode (LED) can also act as a light receiving component when irradiated with light. By employing this aspect, a simple experiment set for demonstrating optical communication has been provided in which LEDs are employed, not only as a light transmitting component, but also as a light receiving (antenna) component [1-3]. In this set, intensity of a light beam to be emitted from a LED as a light transmitting component is modulated in accordance with audio signals such as music from a CD. The light beam from that LED is then transmitted via air or an optical fibre to another LED which acts as a light receiving component. By sending signals from the LED as the light receiving component to a loudspeaker, the transmitted audio signals such as music can be reproduced. Thus, optical communication can be easily demonstrated. This experiment set has been effectively used in various situations of science experiment demonstration at primary schools, secondary schools, and high schools, as well as other educational facilities.

As advantages of using a LED as a light receiving component, LEDs are in general much cheaper than photodiodes. Thus, a large number of the experiment sets can be prepared at low cost and simultaneously used. Moreover, in some conditions, much clearer music can be reproduced with a LED than with a photodiode as a light receiving component. This is because output signal levels from a LED are not likely to be saturated, unlike signals from photodiodes.

Furthermore, LEDs with different colours can be employed as each of the light transmitting and receiving components. In such a case, audio signals can be or can not be communicated in accordance with combination of LED colours. This aspect is useful for demonstrating the relationship between colours of light and their energy levels.

Configuration of the experimental set

Basic concepts of the circuits

Figure 1 shows a basic circuit diagram for a light transmitting circuit and a light receiving circuit of this experiment set for optical communication.

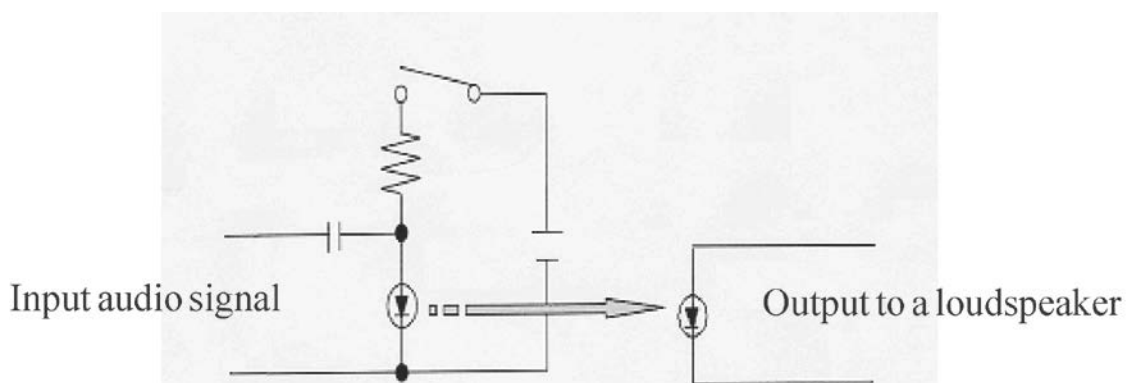

Figure 1. Basic circuit diagram
(Left: Light transmitting circuit, Right: Light receiving circuit)

In a light transmitting circuit, a LED is powered with a usual battery (for example, two 1.5V or 3V batteries). A resistor is connected for limiting a current flowing through the LED and its resistance value can be determined by well-known calculation. For example, when a LED with a forward voltage $V_F = 1.9\text{ V}$ and a nominal operating current $I_p = 20\text{ mA}$ is connected with a battery $V_S = 3\text{ V}$ (i.e. two 1.5 V batteries), a resistance value R can be determined as $R = (V_S - V_F) / I_p = \text{about } 50\ \Omega$. Without audio input signals in this circuit configuration, the LED can be operated with a DC current in a usual manner.

The light transmitting circuit is also provided with an input terminal for receiving audio signals from, for example, a CD player. This input terminal can be a monaural mini plug jack to be connected with an audio signal source such as an earphone terminal of the CD player. The audio input signal can be superimposed over a DC operating current supplied from the battery to the LED, so that amplitudes of the DC operating current for the LED can be modulated in accordance with the supplied audio input signal. This then results in intensity modulation of a light beam to be emitted from this LED, thus realizing amplitude modulation of the LED light beam with the audio signal. A capacitor (particularly, $22\ \mu\text{F}$ in this case) is intended to cut DC noises in the audio signal.

The thus modulated light beam emitted from the LED in the light transmitting circuit is then received by a light receiving or detecting component in the light receiving circuit. The detected light signals are converted into electric signals and provided to a loudspeaker for audio reproduction. No power supply is provided in the light receiving circuit, and the light receiving component is directly connected to a monaural mini plug jack as an output terminal. By employing a loudspeaker incorporating an amplifier, no amplification function is necessary in the circuit, and the output signal from the light receiving component can be directly provided to the loudspeaker.

As the light receiving component, a photodiode can be conventionally employed. However, the author often uses another LED for the purpose of receiving the modulated light beams from the light transmitting circuit. When light is incident onto a pn junction of a light emitting section of a LED, charges are generated so that a LED can act as a light receiving component, just like a conventional photodiode. Since LEDs are cheaper than

photodiodes in general, a simple and less expensive circuit can be realized by employing a LED, not only as a light transmitting component but also a light receiving component.

Figure 2 shows a picture of a light transmitting circuit (with two 3V button batteries) and a light receiving circuit provided by the author.

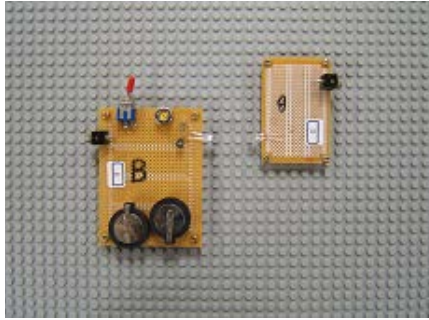

Figure 2. Actual circuits
(left: a light transmitting circuit, right: a light receiving circuit)

Selection of LEDs

As LEDs to be used in the circuits, there are no specific preferences. As an example, the author currently employs a red-colour LED with a wavelength of 644 nm, a light intensity level of 6000 mcd at an operating current of 20 mA, a forward voltage of 1.9 V, and a viewing angle of 8 degrees.

No detailed comparisons have been done in terms of influences of light intensity levels and viewing angles on optical communication performances. The author had experiences of successful experiment demonstration in which another type of LED with a lower level of light intensity such as 800 mcd was employed.

On the other hand, the author also has experiences in which satisfactory signal communication can not be established with another type of LED. It should be noted that in order to make a LED effectively act as a light receiving component, selection of appropriate LEDs seems critical to realize satisfactory transmission performance. For that purpose, light beams have to be incident onto a pn junction section of that LED. Thus, its internal structure seems to be important, although selection of LEDs based on such aspects will be difficult before purchase.

Actual demonstration with this experimental set

This experiment set for optical communication demonstration has been actually employed in various situations by the author and members of the student project team “Rika-Kobo” of the author’s university [4-5].

One of the typical situations is a science experiment demonstration event (see Figure 3). In such a case, a light transmitting circuit and a light receiving circuit are positioned on a table with a distance of about 10 – 15 cm from each other, and the LED light beams are modulated with music signal from a CD player and transmitted. The LED as the light receiving component accepts the modulated light beams and music can be reproduced from a loudspeaker. By interrupting light transmission between the two LEDs with hand or any other appropriate material, music reproduction can easily become silent, which surprises audience in various ages from children to their parents and the further to senior and retired generation.

In some situation, an optical fibre can be also employed between the light transmitting and receiving circuits so that its function in an actual communication network is explained. When an optical fibre is employed, it is preferred to use a photodiode as a light receiving component, because the intensity of light beams to be detected becomes weak after propagation through the optical fibre.



Figure 3. Demonstration at a science event

Another typical situation is science experiment classes at primary or secondary schools in local regions. In responses to requests from schools, the author and the “Rika-Kobo” project team often perform science experiment classes. One of the popular subjects in such classes is optical communication. The experiment set is used for demonstration and explanation of basic concepts of optical communication, as can be seen in Figure 4(a). Then groups of children work to prepare their own experiment circuit assembly, and they experience optical communication with their own circuit assembly. This can be easily done in about 10 to 15 minutes without soldering work by employing a breadboard, as can be seen in Figure 4(b).



(a) Demonstration and explanation (b) Circuit assembly work by children
Figure 4. Demonstration at a science experiment class for a primary school

Advantages of use of a LED as a light receiving component

Although optical communication demonstration by means of amplitude modulation (intensity modulation) of light beams to be emitted from a light source will be a known experiment, interesting aspects of the experiment set in this paper is use of a LED for a light receiving component. The advantages are as follows.

(1) LEDs are cheap

LEDs are in general much cheaper than photodiodes, and thus, a large number of the experimental sets can be prepared at low cost and can be used simultaneously. This is

advantageous for realizing a large scale demonstration. For example, in classes in a primary school, one experiment set can be provided for each group of 3-5 children. With such preparation, children can more actively participate in the optical communication experiments.

(2) Less saturation of output signals

In some conditions, much clearer music can be reproduced with a LED than with a photodiode as a light receiving component. This is because output signal levels from a LED are not likely to be saturated, unlike those from photodiodes.

Such aspects can be more clearly understood from the following experimental results [3]. Specifically, instead of audio (music) signals, a sinusoidal wave (200 Hz, $V_{P-P} = 1.2$ V) was supplied from an oscillator to a light transmitting circuit so that the LED light beam was modulated with this sinusoidal wave. The modulated light beam was then received by a light receiving circuit placed at a certain distance (which is a typical distance in actual demonstration) from the light transmitting circuit, and the output signal voltage waveform was observed with an oscilloscope. As the light receiving components, both a photodiode (PD) and a LED were employed.

Figure 5 shows examples of the observed output signal from the light receiving components. The output signal of a photodiode was likely to exhibit certain distortion (saturation) when the photodiode was placed close to the light transmitting circuit. For example, Figure 5(a) shows the exemplary output voltage waveform from the photodiode placed at 15 cm from the light transmitting circuit, and distortion or saturation in the waveform is clearly recognized. In order to avoid such distortion or saturation in output signals from a photodiode, it was necessary to place it at several tens of cm from the light transmitting circuit. On the other hand, the LED as a light receiving component produced a clear sinusoidal waveform with no distortion or saturation even at 5 cm from the light transmitting circuit, as shown in Figure 5(b). In such a case, clear music was reproduced from the loudspeaker.

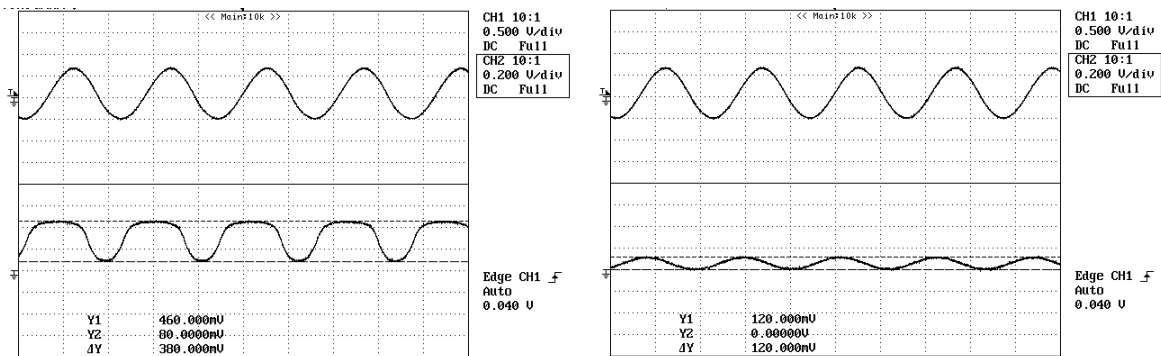

(a) With a PD at 15cm from the transmitting circuit (b) With a LED at 5cm from the transmitting circuit

Figure 5. Voltage waveforms from an oscillator (as input signals: upper) and from a light receiving component (as output signals: lower) [3]

(3) Combination of LEDs with different colours

The most advantageous aspect of the use of a LED as a light receiving component in this experimental set is that LEDs with different colours can be employed as each of the light transmitting and receiving components. In such a case, audio signals can be or can not be communicated in accordance with combination of LED colours.

As an example, success or failure status of optical communication of audio signals (music) is summarized in Table 1 for the case where a blue-colour LED (with a wavelength of 470 nm, a light intensity level of 2000 mcd at an operating current of 20 mA, a forward voltage of 3.6 V, and a viewing angle of 15 degrees) was also used in addition to a red-colour LED. In Table 1, a circle mark (○) indicates that the audio signals (music) were successfully transmitted and clearly reproduced, while a cross mark (×) indicates failed transmission. The results show that when a LED colour in a light transmitting circuit has a longer wavelength than that in a light receiving circuit (i.e. in this case, a red-colour LED in the light transmitting circuit and a blue-colour LED in the light receiving circuit), audio signals (music) were not successfully transmitted. Other combinations of LED colours exhibited similar tendencies.

This aspect can be useful for easily demonstrating relationship between colours of light (wavelengths or frequencies) and their energy levels.

Table 1. Success/failure of audio signal transmission with combination of LEDs with different colours

		<i>LED colour in a light receiving circuit</i>	
		red	blue
<i>LED colour in a light transmitting circuit</i>	red	○	×
	blue	○	○

Additional advantage of the experiment set

As a further aspect, optical wavelength division multiplex (WDM) communication can also be demonstrated with this experiment set. More specifically, two light transmitting circuits are provided in which one circuit includes a red-colour LED and the other circuit includes a blue-colour LED, and light beams of the respective LEDs are subjected to amplitude-modulation by means of different audio signals (for example, two different music songs each reproduced with a separate CD player). These two light beams are input into one optical fibre and allowed to propagate through the fibre to the other end. The output light from the optical fibre is then received and detected by a light receiving component. When both light beams of the two different colours (wavelength) are simultaneously received, both music songs can be simultaneously reproduced in mixed manner from a loudspeaker. On the other hand, when the light beams from the optical fibre are filtered by means of an appropriate colour filter so that light beams of either one colour (wavelength) can be detected by a light receiving component, only the corresponding music song can be reproduced.

Conclusions

A simple experiment set for demonstrating optical communication has been provided in which LEDs are employed, not only as a light transmitting component, but also as a light receiving component. The use of a LED as a light receiving component has several advantages compared to the conventional photodiode. This experiment set has been effectively used in various situations of science demonstrations at primary school and secondary school, as well as other educational facilities.

References

- [1] Makoto Hasegawa: “A simplified experiment set of optical communication with LEDs and demonstration of science experiments with that set”, *Japanese Journal of Applied Physics Education*, vol.32, no.2, pp.27-32 (December 2008) (in Japanese).
- [2] Makoto Hasegawa: “An experimental study on an optical communication experiment set with LEDs for transmitting light beams”, *Japanese Journal of Applied Physics Education*, vol.34, no.2, pp.53-58 (December 2010) (in Japanese).
- [3] Makoto Hasegawa: “An experimental study on performances of an experimental set for optical communication with an LED as a light receiving component”, *IEEJ Trans. on Fundamentals and Materials*, vol.131, no.8, pp.639-640 (August 2011) (in Japanese).
- [4] Makoto Hasegawa: “Physics and science education through project activities of university students and regional collaboration”, *JPS Conference. Proc. Vol.1* pp.017016-1 – 017016-4 (12th Asia Pacific Physics Conf. (APPC12), no.F-PTu-1) (July 2013).
- [5] Makoto Hasegawa: “Roles and effects of activities of a student project team in engineering education for university students in lower grades”. *Proc. of 2013 IEEE International Conference on Teaching, Assessment, and Learning for Engineering (TALE2013)*, no.140, pp.87-90 (August 2013).

Concept Cartoons as a Teaching and Learning Strategy at Basic Schools in the Czech Republic

Eva Hejnová

Faculty of Science, J. E. Purkinje University, Usti nad Labem, Czech Republic

Abstract

The contribution deals with tasks that are usually called „concept cartoons“. This type of tasks is not well known in Czech schools but their potential is large. Concept cartoons are used to diagnose misconceptions, reason with concept and evidence about common scientific phenomena and start to trigger investigation by students. A set of sixteen concept cartoons for the topic „Motion and force“ were created by the author of this contribution in the forms of slides in PDF format and it is possible to use them for interactive whiteboard too. Concept cartoons are designed for learners at the age of 13 to 15 (i.e. the pupils of lower secondary schools in the Czech Republic). Some early experiences of Czech teachers are reported.

Keywords: concept cartoons, lower secondary education, teaching and learning strategy, misconceptions

Introduction

Concept cartoons as an innovative and learning strategy were developed by Stuart Naylor and Brenda Keogh [1] in 1992 “in response to the need to find new ways of challenging the thinking of teachers” and its development took place over next eight or nine years [2], [3]. Series of books have been produced providing teachers with examples of concept cartoons which develop scientific understanding for students [1], [4], [5]. Originally the cartoons were designed for students at the age of 9 to 13, but now they are used in all phases of primary and secondary science education [6].

Cartoons have been described in the literature much early and they have been used in various ways for teaching and learning since the 80th years of the 20th century [7]. However, the use of concept cartoons as a challenge to conceptual understanding hadn't been documented in the literature before that time.

The concept cartoons consist of cartoon-style drawings showing every day or some interesting situations but they are not humorous or satiric. They have the form of a multiple-choice question, additionally concept cartoons integrate the dialogue among so-called “cartoon characters”. The cartoon characters (usually three or four children) put forward alternative viewpoints about science concepts and the format of the task invites learners to join in debate with the cartoon characters (see Figures 1 and 2).

Concept cartoons provide an appropriate stimulus for discussion, challenge and development the learners' ideas, promote thinking and reasoning, help learners to ask their own questions and provide starting points for student laboratory activities and investigations. Typically concept cartoons are used as the focus for a group discussion, which can then lead on to investigations to decide which of the viewpoints put forward is the most acceptable [8]. This approach is defended by numerous researchers as not only a better representation of the nature of science but also as challenging of critical thinking and developing of conceptual thinking. Unfortunately, no detailed guidance that sets out the implications of the research on concept cartoons is available in Czech language.

The set of concept cartoons for the topic Motion and force

The set of sixteen concept cartoons for the topic „Motion and force“ were created in the forms of slides in PDF format and it is possible to use it for interactive whiteboard too.

The tasks are designed for learners at the age of 13 to 15 (i.e. the pupils of lower secondary schools in the Czech Republic). These concept cartoons were developed according to FCI (Force Concept Inventory) test [9] and some other tasks from the book „Concept cartoons in science education“ by S. Naylor and B. Keogh [4] and they were formulated for the needs of learners at lower secondary schools.

Each of the concept cartoons contains some cartoon or a photo illustrating some situation, one or two introductory sentences and usually three or four statements written in the form of dialogues among cartoon characters. Cartoon characters have names because of the increase in effectiveness of the concept cartoons and diminishing “potential classroom management problems during whole class reflection activity” [10].

The term of concept cartoons is a standard term abroad but no established Czech term is used in the Czech Republic. Some Czech teachers call this type of tasks as “bubble tasks” or “tasks with bubbles”. The examples of the tasks presented in this paper have photographs instead of cartoons, therefore we could call them more suitable as „talking heads“.

The statements in the bubbles include widely held misconceptions and alternative conceptions. Only one scientifically acceptable explanation usually exists among the statements raised by cartoon characters. However, other statements are not implausible and are often based on students’ experiences (most frequent misconceptions [11], so that learners are likely to see many of the alternatives as credible). If learners are not confident in expressing cartoons characters’ ideas, they might express their own thoughts. That’s why blank speech bubble is also included with the text “You are wrong. I think that...” [4].

The statements are written as short as possible, minimal amounts of text are suitable for learners with limited literacy skills. Scientific ideas are often applied in everyday situations, so that learners are challenged to make connections between scientific ideas and common situations.

Figures 1 and 2 present examples of concept cartoons from the set (Ice sled and Spacewalk).

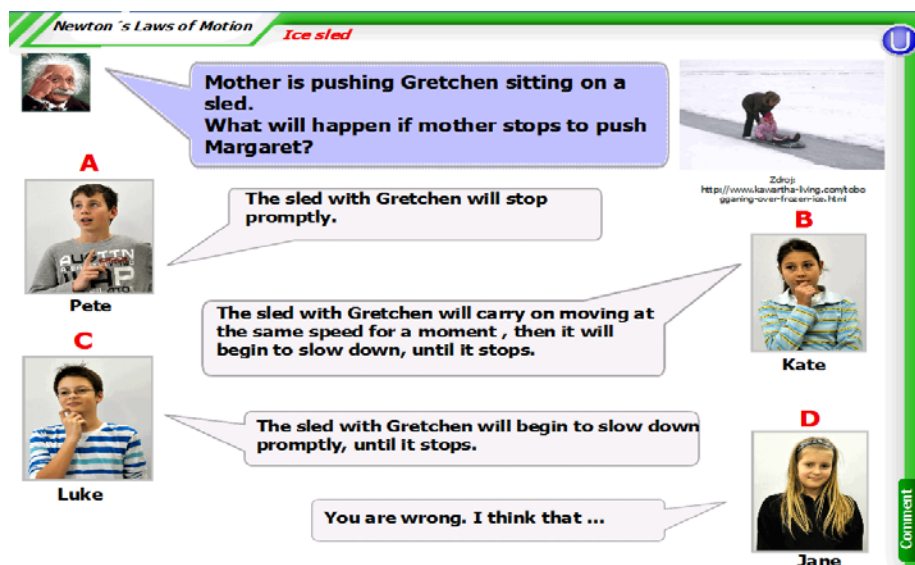

Figure 1. The example of concept cartoon “Ice sled”

Comment to the figure 1

Answer C is the most acceptable in the case the sled is moving on ice surface. But Pete may be also right; if the sled is in loose sand, it might stop immediately when not pushing. This concept cartoons can be therefore used to explore these influences of different contexts.

Pupils often find it difficult to understand that an object will keep moving with a steady speed if it has balanced forces acting on it and that when a pushing force stops acting that the object will begin slowing down promptly.

Learners often think that an object „is losing“ some force gradually if we stop acting exerting the force. However, if the stopping of the sled was caused by stopping of acting force, the sledge would stop promptly. The stopping of the sled is caused only by friction. If pupils find of friction difficult, thinking about reducing friction using a more slippery surface can help (for example it possible to carry out some experiments with a small ball sliding on variable-rough surfaces or with a hovercraft, which everyone can make from an inflatable balloon fixed to CD disc [12]).

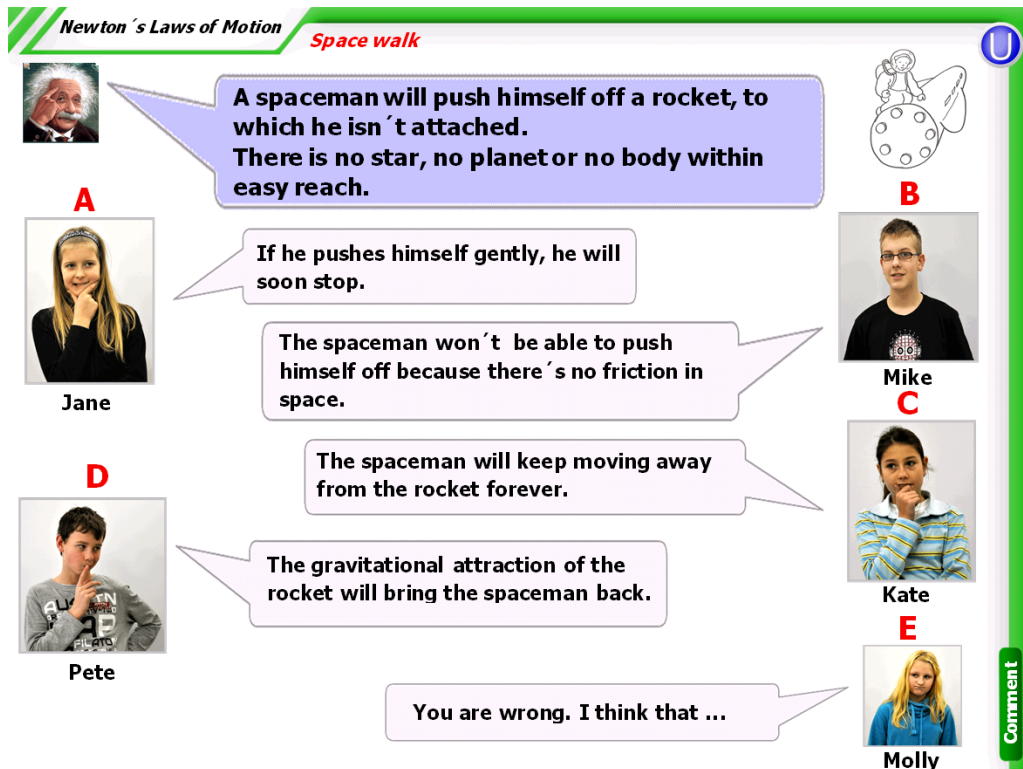

Figure 2. The example of concept cartoon “Space walk [4]”

Comment to the figure 2

Answer C is the most acceptable. In space, where there is virtually no air resistance or other friction, a moving object will keep on travelling almost indefinitely in the same direction, unless it comes under the gravitational influence of a star or a planet.

Gravity is an invisible force, and pupils often have difficulty in visualising how gravity can affect things that are far away as stars and planets, or the Earth and satellites.

Utilization of Concept Cartoons in Teaching

The concept cartoons help well in eliciting students' misconceptions, provide the participation of almost all students in class discussions and motivate learners in order to advocate and support their opinions with arguments and, what is the most important, overcome their misconceptions [13].

The concept cartoons can be used in various ways and in a wide range of settings [4]. They are often used at the start of a lesson as a stimulus for discussion, to identify areas of misconceptions and questions to be answered. However, it is possible to use them during a lesson or at the end of the topic, where the emphasis might be on reviewing or consolidating learning. When pupils use the concept cartoons there is a context and a purpose for investigating the situation, with the use of scientific ideas [8]. The investigations carried out are directly linked to the learner's existing ideas. Some of the concept cartoons from the set can be also used for asking students to think of experiments to investigate some phenomenon shown in the photo or the cartoon.

The separate tasks can be used by individual learners or in collaborative learning settings, but the social interaction involved when the concept cartoons are used collaboratively is very important. It is also valuable to the learners for clarifying what ideas they hold [4].

It is also possible to use the concept cartoons for assessment purposes. One way is to get learners to respond individually to a separate concept cartoon. In this way teachers can find out about the ideas that learner hold and the reasons that underpin his ideas. Sometimes it is useful to assess how learners respond to the same concept cartoon before and after teaching a topic (see for example the textbook [14]).

However, it is more usual that learners discuss in a small group without any systematic assessment. Learners can fill in blank speech bubbles with what they think or produce their own concept cartoons; so their teacher can take their ideas into account in developing the lesson in the most appropriate way.

It is also valuable for science teaching that the concept cartoons very often integrate concepts across different areas of science, so learners are forced to think across various topics.

Conclusions

The concept cartoons from the set presented in this paper were made public through several conferences and seminars in 2012 and 2013 and they elicited interest. This type of tasks is a new and interesting for learners from Czech schools, their motivational effect is therefore considerable.

Concept cartoons are also used by student teachers to assess their understanding of scientific concepts in our university. Some data have been collected by group discussion and interviews with student teachers and teachers from basic and high schools.

The set of the concept cartoons were given to approximately ten Czech teachers in 2012 and 2013, who used them during their teaching. Some of these teachers provided the feedback. They often stated that the concept cartoons played a useful role in development of the teacher's own subject knowledge and understanding and they appreciated that their pupils were more involved in and motivated towards science. Nevertheless, there has not been any systematic or more extensive research into those problems in the Czech Republic, the research is still in its early stages. However, many foreign studies [5] show that concept

cartoons can be utilized in science education due its success in activating and motivating learners and in identifying and eliminating students' misconceptions.

Although there is a comprehensive literature describing misconceptions and many tests (for example FCI), little detailed guidance which sets out the implications of the research for classroom practice is available in Czech language. The set of concept cartoons for the topic „Motion and force“ is therefore at disposal in the form of slides in PDF format (including comments) to Czech teachers [15]. It is possible to use them for interactive whiteboard too.

I think this method is very important in initial teacher education too, because the budding teachers can use concept cartoons for auditing and developing their own scientific understanding, for identifying likely pupils' misconceptions and planning suitable approaches to address these. That's why we also use concept cartoons in preservice science teacher education.

References

- [1] Naylor S., Keogh B.: *Concept Cartoons in Science Education*. 1st ed. Sandbach, UK: Milgate House Publishers (2000). ISBN 0-9527- 506- 2-7.
- [2] Keogh B., Naylor S.: Making sense of constructivism in the classroom. *Science Teacher Education* 20, September (1997), p. 12-14.
- [3] Naylor S., Keogh B.: Concept cartoons, teaching and learning in science: an evaluation. *Inter. J. of Scien. Ed.* 21, No 4 (April 1999), p. 431-446.
- [4] Naylor S., Keogh B.: *Concept Cartoons in Science Education*. 2nd ed. Sandbach, UK: Milgate House Publishers (2010). ISBN 9780-955626081-1.
- [5] Kabapinar F.: What Makes Concept Cartoons More Effective? Using research to Inform Practice. *Education and Science* 34, No 154 (2009), p. 104-118.
- [6] Stephenson P., Warwick P.: Using concept cartoons to support progression in students' understanding of light. *Physics Education* 37, No 2 (2002), p. 135-141.
- [7] Naylor S.: Constructivism in Classroom: Theory into practice. *Journal of Science Teacher Education* 10, No 2 (1999), p. 93-106.
- [8] Berg E. van den, Kruit P., Wu F.: Getting children to design experiment through concept cartoons. In: *Bridging the gap between education research and practice*. Leicester: EU Fibonacci conference on Inquiry Based Science & Mathematics Education, (2012), [online]. [cit. 15. 2. 2014]. Available from: <http://www.fibonacci-project.eu/resources/events/leicester-conference-2012.html>
- [9] Hestenes D., Wells M., Swackhamer G.: Force Concept Inventory 1992. *Phys. Teacher* 30, No 3 (1992), p. 141 – 158 (Czech version Burešová J., Mandíková D., 2008).
- [10] Kabapinar F.: What Makes Concept Cartoons More Effective? Using research to Inform Practice. *Education and Science* 34, No 154 (2009), p. 104-118.
- [11] Mandíková D., Trna J.: *Žákovské prekoncepce ve výuce fyziky*. Brno: Paido (2011). ISBN 978-80-7315-226-0.
- [12] Reichl J.: *Vznášedlo*, (2010), [online]. [cit. 15. 2. 2014]. Available from: <http://clanky.rvp.cz/clanek/o/g/9259/VZNASEDLO.html>

- [13] Keogh B., Naylor S., Wilson C.: Concept Cartoons: A New Perspective on Physics Education. *Physics Ed.* 33, No 4 (July 1998), p. 219-224.
- [14] Ryan. L., Sang D., Taylor J.: *Scientifica: Kids in lab Coats*. Cheltenham, UK: Nelson Thornes Ltd (2004). ISBN 0-7487-7980-9.
- [15] Hejnová E.: Úlohy pro žáky ZŠ zadané formou diskuse aneb Jak lze bojovat s prekoncepce mi žáků o síle a pohybu? [online]. [cit. 15. 2. 2014] Available from http://physics.ujep.cz/~ehejnova/Pro_ucitele/

Project Day: Technology of Metal Manufacturing

Rita Chalupnikova^{1,2}, Iva Korberova³

¹ Faculty of Science, University of Hradec Kralove, Hradec Kralove, Czech Republic

² Elementary school, Sec, Czech Republic

³ Elementary school, Slatinany, Czech Republic

Abstract

The article describes a one-day project targeting pupils of elementary schools. The aim of the project was to get pupils familiar with the characteristics and technology of metal manufacturing.

Pupils experienced mechanical manufacturing and shaping of copper. They made simple copper jewellery, like our ancestors used to do. They also observed and experienced other metal manufacturing processes – smelting of tin and tin casting in tufa stone made by students themselves. Pupils gained knowledge in the characteristics of some metals and alloys, they experienced craftwork using simple tools, and using old techniques they understood how today's blast furnaces work.

Pupils' own effort and skill practice helped them awake their interest in craftwork and respect to honest work.

Keywords: elementary school, project day, mechanical shaping of copper, smelting of tin

Introduction

The project day called *Technology of metal manufacturing* is one of ten project days carried out within the project We live in the world of technology that is focused on support of pupils' interest in technology and science subjects, on increasing pupils' manual abilities and on help with gradual implementation of effective methods into the educational process as well as on encouraging team work at schools (it was realised in The Education for competitiveness Operational Programme, registration number CZ.1.07/1.1.28/01.0010).

The targeted group of the project day called *Technology of Metal Manufacturing* were sixth-grade pupils. Primary aims of the project were to identify the topic of the day, revise pupils' knowledge of metals and experience their manufacturing.

The project day

Before the project started pupils had been given instructions to bring an old but still working screwdriver and appropriate clothing.

The project day was carried out partly in a classroom and partly outdoors. The introductory part included welcoming and a rhythmical game as a warming up exercise.

The introductory part was then followed by evocation of the topic. With covered eyes pupils were sent different objects and their task was to explore the objects by touch.

Pupils explored several metal objects – a copper vase, a lead bullet, a steel wool, a golden ring, an aluminium fork, a brass muller and a silver chain). Then the pupils were asked

how many objects they had explored, what property all explored things had in common and what material the objects were probably made of.



Figure 1. Metal things in the hands

Then the pupils gave examples of different properties of metals, for instance that under normal circumstances most of solid metal materials are good electrical current conductors, good heat conductors etc.

Only after that activity we could have introduced the topic of the project day *Technology of metal manufacturing* to pupils. Since one part of the project day included work with some tools and pupils were also going to work with fire and boiling tin, they had to be instructed about safety rules and safe behaviour during the processes. The introductory part of the project day took an hour.

The following part of the project day was carried out outside the school. Pupils were divided into two groups – group I and II. Each pupil in group I was given a file, pliers, copper, a stock anvil and a copper beating hammer. After being given instructions and after a presentation showing pupils different products they started creating their own ones by themselves.

Group II began their activity by being told a story about how marlstone came to existence by sedimentation. Speaking about this process seemed to be essential to pupils so that they could understand how to break and halve the marlstone. Then each pupil was given a small piece of marlstone, they halved it with the help of the chisel and hammer, and with the help of a screwdriver they started graving a simple ornament in the marlstone - tufa. Pupils had been informed that the work would be difficult, and that is why the ornament should be as simple as possible (triangle, square, circle, etc.). After engraving an ornament, pupils went on creating a cone (i.e. drainage for pouring molten metal), and a small drainage channel (i.e. a way for conducting air away). Pupils tied up the mould with a cord and marked his/her own one.



Figure 2. Shaping of copper

When the work was done the pupils made a swap.

The pupils who had finished their work earlier than others, assisted the teachers to make fire in a ceramic furnace that had been made from clay and fired (baked) before the project day. Two vents for bellows were made in the furnace. After heating the furnace the teachers together with pupils began to melt tin in a prepared small container. That way the pupils learnt the principles of furnaces for iron smelting. They were surprised by the speed of the tin melting down. Gradually, the teachers and pupils poured the stone mould with the tin, and then pupils worked on the final shape of their product.



Figure 3. Tin casting in tufa

During that activity the pupils' skills, creativity, and patience were important. This activity of the project was crucial and it lasted 3 hours.

When the working part of the day was finished and after the pupils tidied up, we introduced a game to revise gained knowledge about metals. The pupils were divided into seven groups. The teacher arranged 35 information cards on different spots in the garden

with information about metals, e.g. the amount of occurrence of the metal on the Earth, its value (price), colour, use, chemical symbol. Each group of pupils worked on one type of metal and they had to find all information about it. When finding an information card, the pupil was not allowed to take the information card with him/her. The task was to remember the information found and report it to a record-keeper who wasn't allowed to leave his/her standpoint. During the activity pupils were not allowed to speak loudly to each other.

The group that achieved all five pieces of information stopped the game. Then all pieces of the information were checked and corrected. The activity lasted half an hour and helped revise and summarise the learnt subject matter.



Figure 4. Pupils' own jewellery

The last part of the programme was carried out again in the pupils' classroom where they made a self- reflection and self-evaluation including the evaluation of the products made.

They also evaluated anonymously the project day for the teacher as a feedback. The evaluation included the following questions: Are you satisfied with this day? Write at least one thing you really managed to do. Write information you were surprised with today

(e.g. What was new to you? What have you never seen before?) Write a message to the teachers. (Either positive or negative: if the day was a success, if you changed anything, if you'd like to have a similar lesson again).

Pupils enjoyed and liked the day and most of them were satisfied. Every pupil found something what he/she managed to do: some pupils mentioned their products, others found the value of the project day in gaining new information, some of the pupils liked making fire in a furnace and others liked the game.

Pupils were surprised by different pieces of information provided. Here are some of their quotations:

"I was surprised by the speed of tin smelting.", "I found out that I miss patience.", "I was astonished by Monica's skills.", "I didn't know that lead is toxic.", "Actually, I haven't known that metal can be liquid.", "I was surprised that work on making a copper product can be so simple.", "The work with copper is very difficult", "The formation of mould went slowly.", "I didn't know what hard work it is to produce something."

Conclusion

The project day together with practical activities introduced properties and manufacturing of metals to pupils at an elementary school. The project day conducted various methods (community circle, brainstorming, team work, individual work, etc.). During six lessons pupils experienced mechanical shaping of copper, and like our ancestors they produced simple copper jewels. They experienced a thermal way of metal processing through smelting of tin and casting it into their own hand made marlstone (tufa) mould. They have learnt about some tools used for manufacturing and smelting of metals and through the old technology they could understand better how nowadays blast furnaces work, how the metal products are casted, what shaping of metals means, what properties metals have, what alloy is and many others. Gained practical skills and effort helped children awake their interest in craft, respect and even admiration to someone's own well-done work and to work of others.

Relevance of thought – provoking experiences for teaching physics

Jose – Luis Jiménez¹, Maria – Guadalupe Hernández², Ignacio Campos³, Gabriela del – Valle²

¹Departamento de Física, UAM-Izt., México D.F. México

²Departamento de Ciencias Básicas, UAM-Azc., México D.F. México

³Facultad de Ciencias, UNAM, México D.F.

Abstract

In the constructivist approach to teaching the students are usually confronted with thought-provoking experiences from which pertinent concepts can be developed. In the present work we propose three of such experiences which can be used with high school students. The first experience has been used to distinguish heating from rising temperature. Which in common language are taken as synonymous. Therefore the student acquires a clear concept of heat. The second can be used to develop the concept of center of mass, and how motion of a particle is indeed motion of center of mass. The third experience is the radiometer, whose functioning is explained in many physics texts as resulting from radiation pressure. This experience can be used to propose alternative explanations, and discard the explanation in terms of radiation pressure.

Keywords: constructivist approach, center of mass, heating, rising temperature, radiometer

Introduction

Constructivist strategies for teaching and learning emphasize experience as the basis on which knowledge is constructed. Thus, well-chosen experiences can be used to construct meaningful concepts. Usually these experiences have surprising aspects that stimulate the imagination and reasoning of the students. Surprise is a very good tool for teaching; surprise is greater when simple toys are used, rather than complex technological black boxes. Sometimes the explanation is simple, but sometimes it is very difficult, even challenging, as is the case with the radiometer. We present three simple experiences, two involving old simple toys, which are very useful for teaching. The story of the radiometer shows besides that scientific research also resembles the constructivist view since a contradiction between what is expected and experiences stimulates the research of alternative explanations. Our examples show this contradiction: Heating that does not rise temperature, the double cones that seem to go up against gravity, and the radiometer that turns in contrary direction to that provoked by radiation pressure. Thus surprise is an excellent way of stimulating the search for better explanation, either in learning science or in scientific research.

Boiling water: how to distinguish heating from increasing temperature

In common language it is understood that to heat an object is equivalent to increase its temperature and this understanding is so extended that even physics students sustain it. So, when a nail is rubbed against a surface, it is said that it is heated. In the constructivist view of learning it is said that this confusion constitutes a preconception, since in physics heating and increasing temperature are very different concepts and this confusion is

a conceptual obstacle to understand the important concept of heat. So, what experience can help to distinguish clearly these concepts? In teaching high school teachers to differentiate the above concepts, it has been very useful the experience of boiling water.

In our course on heat and temperature the participants put to boil about half a liter of water with a Bunsen burner. With an appropriate thermometer they were observing the temperature rise until about 96°C (the boiling temperature in Mexico City). Then the temperature did not increase any more. The participants in the course began to say “there is no more heating” or “heating stopped”. When asked what was then doing the Bunsen burner they looked perplexed. They began to discuss among them until they arrived at a conclusion: The Bunsen burner is obviously heating the water, but there is not increase of temperature, rather there is boiling and evaporation.

This simple experience permits to distinguish clearly heating from increasing temperature. In this way it is easier to understand the concept of heat as a transfer of energy due to a temperature difference. With this experience it is clear that temperature can be increased not only by heating, but also by doing work, as when we rub a nail against a hard surface, or compress a gas with a piston.

Thus, after having the experience of boiling water, the students become aware that the temperature can be increased either by heating or by doing work on the system. Also, they understand easily that heating can increase the temperature or not, as is the case in a phase transition, like water evaporation.

Another point that can be deduced from the above experience is that the boiling temperature depends on the altitude of the place where the boiling of water occurs. Usually water does not boil at 100°C , except if the experience is carried out at the sea level. Since atmospheric pressure also depends on altitude, it can also be concluded that the temperature of a phase transition also depends on pressure.

The experience of boiling water as described above is one out of thermal equilibrium. The water will continue evaporating unless the Bunsen burner is retired, or all water is consumed. Furthermore, most of experiences with thermal phenomena are in conditions without thermal equilibrium. In our view one difficulty to understand basic thermodynamics is that from experiences with phenomena out of thermal equilibrium the student must arrive at the concept of thermal equilibrium.

However, once the student has understood that heating an object is to put it in thermal contact with a system of higher temperature, it is easier to see that when two objects of different temperature are put in thermal contact under isolated conditions, that is, they are without thermal contact with other objects, they eventually reach a state where there are no more changes. This is the state of thermal equilibrium, and then temperature can be defined as the common property that systems have when they are in thermal equilibrium. From these conceptions it is easier to enunciate a formulation of the zero law of thermodynamics: two systems in thermal equilibrium with a third system are necessarily in thermal equilibrium among them.

Also, the students can observe that when two objects of different temperature are put in thermal contact under isolated conditions, always the object of higher temperature diminishes its temperature, while the object with lower temperature increases its temperature, until they attain a common temperature. These aspects of thermodynamic behaviour can be observed with experiences with mixtures, for example, mixing equal quantities of water at different temperatures in isolated conditions.

The above experiences can be used for giving one formulation of the second law: heat always flow from higher to lower temperature, until thermal equilibrium is attained. From this formulation of the second law it follows another: heat can be transferred from lower to higher temperatures only at the expense of work, as in a home refrigerator. The formulation of the second law by Sadi Carnot, that heat extracted from a hot reservoir cannot be converted totally into work by means of a cyclic process is harder to understand. Carnot used originally an analogy with hydraulic machines, arguing that in the same way that it is impossible to make function a water mill in a lake, so it is impossible to make function a heat engine extracting heat of only one heat reservoir. He argued that it was the “fall” of heat of a hot reservoir to a cold reservoir what drove the engine. So, in order to obtain work by means of a heat engine it is necessary to have a least two heat reservoirs of different temperature [1].

Now, the exchange of heat among objects occurs not only by thermal contact. It can also be produced by radiation. The experience of the sunlight or standing by a fire is enough to convince anyone that heat is also transferred by radiation. Then it is not hard to accept that two objects thermally isolated, and without thermal contact, eventually will reach the same temperature, reaching thermal equilibrium, and therefore the same temperature. Another experience with heat radiation is to put the same quantity of water at the same temperature in two different recipients, one blackened and the other reflecting. Measuring the temperature for a while will show that water in the blackened recipient gets colder quicker than water in the reflecting recipient. Thus black bodies are better heat radiators than white or reflecting bodies. This fact will be used to understand the functioning of the radiometer.

Objects rolling upward

Another surprising experience is the observation of a double cone Figure 1, that is, two cones united on their basis, that set on two long rods, for example two pencils, forming a V with the vertex lower than the open end, begins to roll upward.



Figure 1. A double cone [2]

This experience is sometimes used to introduce the concept of center of mass, or center of gravity. Usually it is not clear for the student that Newton’s laws apply only to particles under the action of external forces. The particle is physically an object whose dimensions are small compared with the distances it is going to travel. Thus, the planets can be regarded as particles in their motion around the Sun, but cannot be considered as particles if we are interested in their rotation about their axis. The particle is modelled as a mathematical point with mass.

An important theorem of classical mechanics establishes that the motion of any rigid body can be separated into the motion of the center of mass, and the motion around the center of mass. The motion of the center of mass is that of a particle. Thus the laws of Newtonian mechanics apply to the center of mass. The center of mass of symmetrical bodies coincides with the center of symmetry. The center of mass of a spherical body is its center, and the center of mass of the double cone is the center of symmetry. Then the motion of the double cone in the described incline will be such that the center of mass descends, and it is seen that though the double cone seems to go uphill, its center of mass descends, as a particle under the action of gravity does. Thus the motion of the double cone, according to the theorem quoted above, consists of the motion of the center of mass, which descends, plus the rotation around the center of mass [3-6].

The radiometer: the tortuous road of science



Figure 2. The radiometer [7]

This example illustrates through some historical remarks, how even in research there is a need to begin preconception that are changed to give rise to more pertinent concepts that permit a better understanding of nature. The radiometer Figure 2 is considered an old toy, now out of mode. It usually consists of two or more vanes, with one face blackened and the other reflective, mounted on a pivot so that it can turn easily. The vanes are in a glass bulb, similar to a light bulb, where a partial vacuum is established. When put in the sunlight, the radiometer begins to rotate according to the intensity of the light. At first it was thought that it functioned by radiation pressure. That there must be radiation pressure can be inferred from a thermodynamic argument. We can imagine a device in which by means of rotating mirrors we send heat as radiation from a cold to a hot reservoir. If this could be done without expense of work, it would be a violation of the second law. Therefore the mirrors must do work, and this work is precisely work against the radiation pressure. Besides, Maxwell's theory of electromagnetism predicts the existence of such radiation pressure, whose expression is, $p_{\text{rad}}=1/3 u$, where u is the energy density of the electromagnetic field. The functioning of the radiometer was a research theme at the end of the 19th century. The history of this research is fascinating, showing how science is done on a trial and error basis, where imagination is the main tool, rather than by following a logical line.

The radiometer attracted Crookes's interest after his experiments to determine the atomic weight of Thallium, which he had discovered by spectroscopic methods. To get more precise data he weighted his samples in a vacuum. He found that a source of heat altered the weight of the samples. If the heat source was over the sample, this seemed heavier, while if the source was below the sample this seemed lighter. These results lead him to

think that it was the heat as radiation what caused this kind of repulsion. Thus, when studying the radiometer his first hypothesis about its functioning was that the cause of the effect was radiation pressure.

However, Reynolds doubted about this explanation. He thought that the effect was rather the result of the difference in the momentum delivered by the molecules of the residual gas to the vanes of the radiometer. The molecules leaving the hotter blackened surface have a greater average speed than those leaving the colder reflective surface. Then by reaction there is a motion in the direction from the blackened to the reflective surface, as it really happens. If the effect were due to radiation reaction, the reflective surface would receive more momentum than the blackened surface, and so the motion would be from the reflective to the blackened surface, that is, in the reverse direction it really happens. So, the effect of radiation pressure is masked by certain effects that occur in rarefied gases. Indeed, Maxwell estimated that the effect of radiation pressure is 1/10 of the horizontal magnetic force in Britain. Schuster, a young colleague of Reynolds, showed experimentally that radiation pressure could not be the cause of the radiometric effect, since the rotation is in the opposite direction.

Soon it became clear that the explanation of the radiometric effect was a very difficult one. At the end of the 19th century and beginnings of the 20th century a lot of experimental and theoretical work was done by physicists like Reynolds, Maxwell, Thomson, and even Einstein. The effect of different pressures was studied, as well as the effect of different vane sizes. So, Reynolds recognized that the radiometric effect depends on the ratio of the size of the vanes to the mean free path of the molecules. In this way the radiometric effect became a problem of the kinetic theory of rarefied gases.

With this approach Reynolds, and little later Maxwell, proposed the explanation of the radiometer as a consequence of thermal transpiration, effect that he defined as the flow of a gas through a porous plate caused by a temperature difference on the two sides of the plate, the higher pressure being on the hotter side. Thus the radiometric effect is a consequence of processes out of thermal equilibrium. We can see how the explanation of the functioning of this toy becomes more and more complicated. Furthermore, different explanations are required for the cases of high and low pressures, compared through the mean free path implied by these pressures.

We have then that the explanation of the radiometric effect requires the kinetic theory of rarefied gases out of thermal equilibrium. It has been established that the difference of temperature between the hotter blackened surface and the colder reflective surface of the vanes cause thermal transpiration, that is, a flow of gas from the hotter to the colder surface on the edge of the vanes. This explanation is accepted for the case of low pressures. Indeed, Knudsen showed that for low pressures the theory is simple, but for higher pressures the theory is very complicated. In this case the calculations of Einstein give the correct order of magnitude.

This sketchy revision of the search for an explanation of the radiometer shows how a seeming simple phenomenon can lead to deep theoretical developments. In this way, the explanation of the functioning of the radiometer lead to experimental and theoretical work on the kinetic theory of rarefied gases out of thermal equilibrium [8-16].

References

- [1] Hewitt P.G.: *Conceptual Physics*. 11th ed . Addison – Wesley (2009), ISBN-13: 978-0321568090.

- [2] <http://museo.iesvegadelturia.es/>
- [3] Cortés E., Cortés-Poza D.: *Eur. J. Phys.* 32, 1559 (2011).
- [4] Gardner M.: *Phys. Teach.* 34, 461 (1996).
- [5] Balta N.: *Phys. Teach.* 40, 156 (2012).
- [6] De Luca R., Ganci S.: *Eur. J. Phys.* 32, 101 (2011).
- [7] www.thinkgeek.com
- [8] Brush S. G., Everitt W. H.: Maxwell Osborne Reynolds, and the radiometer. *Hist. Stud. Phys. Sci.* 1, 105 (1969).
- [9] Brush S. G.: *The kind of motion we call heat (Two volumes). A history of the kinetic theory of gases in the 19th century.* North Holland, Amsterdam (1976) ISBN-13: 978-0444110114.
- [10] Drapper C. W.: The Crookes radiometer revisited. A centennial celebration. *J. Chem. Educ.* 53 (6) 356 (1976).
- [11] Hull G.F.: Concerning the action of the Crookes radiometer. *Am. J. Phys.* 16 (3) 185 (1948).
- [12] Ketsdever A., Gimeshein N., Gimelshein S., Selden N.: Radiometer phenomena: From 19th to 21st century. *Vacuum* 86, 1644 (2012).
- [13] Mason E. A., Block B.: Molecular inelastic collisions cross sections from the radiometer force. *Ann. Phys. (NY)* 1, 7 (1966).
- [14] Smith J.H.: Determination of molecular diameters by the use of the Crookes radiometer. An undergraduate experiment. *J. Chem. Educ.* 47 (8) 591 (1970).
- [15] Woodruff A. E.: William Crookes and the radiometer. *Isis* 57. 188 (1966).
- [16] Woodruff A. E.: The radiometer and how it does not work. *Phys. Teacher* 6, 358 (1968).

The Summer Maths and Physics Camp

Petr Káčovský, Věra Koudelková, Marie Snětinová

Faculty of Mathematics and Physics, Charles University, Prague, Czech Republic

Abstract

In our contribution we will describe The Summer Maths and Physics Camp, a two-week event for secondary school students (aged from 14 to 19) organized every summer holiday by the Faculty of Mathematics and Physics, Charles University in Prague.

Within the scientific part of the programme, students process mathematical and physical projects and finally present their results on the closing conference. Besides projects, the programme involves courses of mathematics, physics and ICT, experts' lectures and of course rich leisure programme based on concept of experiential learning.

Keywords: summer camp, mathematics, physics, secondary school students, science projects

Introduction

Traditionally, the Maths and Physics Camp [1] held by Faculty of Mathematics and Physics (Charles University in Prague) takes place during summer holidays every year. This summer camp focuses on secondary school students interested in nature around us and its investigation through science, maths and ICT. In an informal and friendly environment we enable these students to enrich their knowledge and to gain new experience and friends.

History

More than 25 years ago, the first summer maths and physics camp took place in the village Rotava near Czech-German border. In the early years, the camp was aimed rather theoretically – for example, students processed some parts of modern physics using books, and then present their conclusions to the others. In later years, the development of leisure programme has started and since 1995, the leisure programme has been prepared by separate group of organizers. The importance of experiments was gradually growing and culminated in 1999 with establishing projects as a main part of the scientific programme. From this period dates the main characteristics of the camp, which has been preserved – of course, with many changes – until today.

Our camp today

Nowadays, the camp lasts for 2 weeks. It has not a fixed place, but every year we choose such place that is situated apart from big cities. This enables our camp to be a quiet oasis for experimentation, discovering new things and last but not least for a lot of fun.

Every year, at least 15 organizers prepare a programme for approximately 40 Czech secondary school students and final-year students of primary schools, generally students aged between 14 and 19 years. Apart from Czech students we traditionally accept Slovak students as well. The ratio between the number of participants and the number of organizers allows us to work with each participant of the camp individually according to his needs.

7:30	WAKING UP TIME,	13:00	PROJECTS	18:30	DINNER,
8:00	BREAKFAST	13:30		19:00	EVENING MEETING
8:30	COURSES	14:00		19:30	FREE TIME OR LEISURE PROGRAMME
9:00		14:30		20:00	
9:30		15:00	20:30		
10:00		15:30	21:00		
10:30	PROJECTS	16:00	LEISURE PROGRAMME	21:30	LIGHTS-OUT
11:00		16:30		22:00	
11:30		17:00		22:30	
12:00	LUNCHTIME	17:30		23:00	
12:30		18:00		23:30	

Figure 1. The schedule of typical camp day

Thanks to many years of experience and feedback from participants, the common daily schedule crystallized (the today's state is shown in Figure 1). Our goal is to combine scientific and leisure programme so as to ensure the harmonious development of participants' body and mind. For more information about individual parts of the programme see the next paragraphs.

Organizers

The programme for participants is usually prepared by approximately fifteen organizers – university students as well as experienced high school and university teachers. In addition it became a tradition that competent former participants of the camp we offer the opportunity to become organizers after their graduation. This diverse group of people creates an enriching and inspiring environment not only for the participants but also for the organizers themselves. This may be especially useful for future physics teachers on Faculty of Mathematics and Physics, who have here the unique opportunity of close contact with both active students and experienced teachers.

Organizers are divided into two groups – one of them takes care of the scientific part of the programme, the other prepares the leisure programme. In this arrangement, perfect cooperation of these two groups is necessary, but each group keeps its autonomy. Every year, the preparations for the summer camp begin during the winter when the organizers of the leisure programme start to plan a camp legend. Before summer holidays, all organizers meet for a weekend and solve the personal and material security. During the year, for impersonal communication the wiki environment and mail conference are used.

Scientific programme

An Introductory Test

Immediately after the participants arrive at the camp, an introductory test of mathematics and partly physics knowledge is prepared for them. Its goal is not to divide the participants into some groups – the results are only informative for the participants themselves and should help them to choose the courses of adequate level.

Mini-Project

In the morning, the next day after arrival, the participants usually work in groups of two or three on a simple task called “mini-project” which is the same for all. In recent years, for example, students measured the interval of one second as accurately as possible,

determined the density of an object without diving it into water, or built (from the specified material) the device that will fall as slowly as possible.

Mini-project usually takes an hour and allows the organizers to see the participants working together and to note their personal specifics which may be important for their next functioning in the collective.

Courses

Every day after breakfast, the scientific programme starts with courses which are led by organizers of the scientific programme and aim to consolidate and (often significantly) expand participants' secondary school knowledge. The participants choose courses at the beginning of the camp according to their knowledge, interest and skills. Each course consists of nine lessons.

Traditionally we offered courses of mathematics and physics, both in three levels, so every morning all participants visited one mathematical and one physical course of such level they had chosen.

The change came in 2012, when we fulfilled the participants' wishes and opened one ICT course focused on data networks. In view of success of this course, in 2013 we decide to extend our offer to three ICT courses, so that today during morning every participant attend one mathematical, one physical and one ICT course, each in duration of 40 minutes. As evident from these statements, courses typically have fewer students than typical classroom which enables individualized access.

Projects

The focus of the scientific programme lies in projects – they are responsible for the uniqueness of our summer camp. Every year the organizers of scientific programme prepare more than 40 themes of projects which they offer the participants at the beginning of the camp. The second day after their arrival participants in groups of two or three choose one project from this wide offer and they deal with this project the next ten days. Each project has its consultant - the organizer who has thought the project over and prepared it in advance.

Typical projects are e.g. construction of some device or measuring instrument (see Figure 2), looking into a certain phenomenon, software modelling of real physical or mathematical situations or studying nature with modern technology devices (USB microscope, thermo camera, high-speed camera, Vernier sensors etc.). Some students' projects are published on the web sites [2] (only Czech version).

In total, participants spend in average more than 20 hours working on the projects, but many of them continue working in their free time, e.g. after lunch or after leisure programme. Every project has to be well documented, which enables students to learn the principles of academic work including typography etc. Finally, participants present the results of their work to their colleagues at the closing conference.

Although the projects are prepared in advance, their goals and form are operationally adjusted considering students' interests and abilities and also material and time opportunities of the camp. Creative and original solutions of unexpected situations are welcome and they strengthen the research-based spirit of the camp.

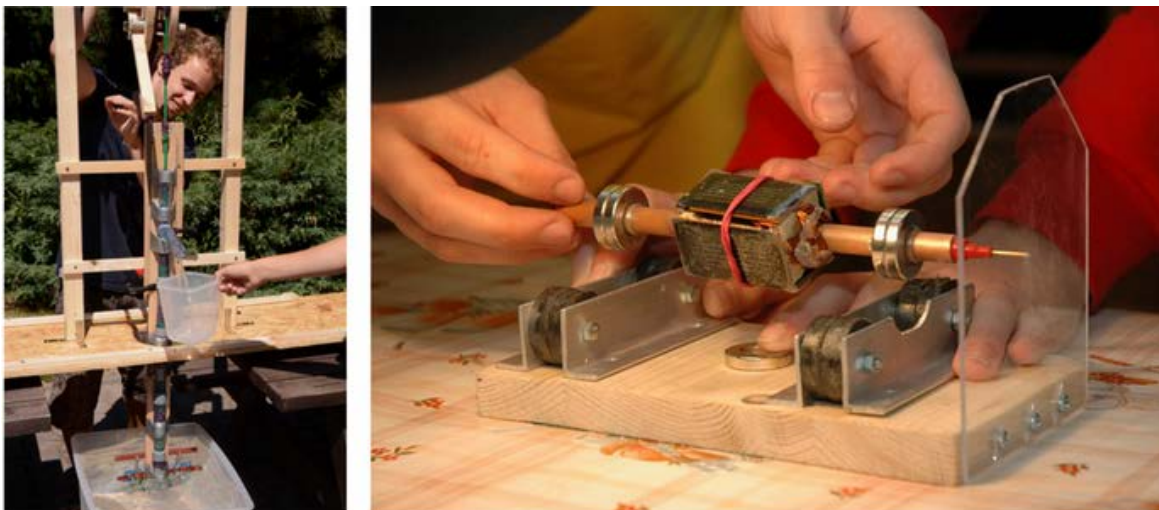

Figure 2. Examples of projects – on the left side a rope pump model, on the right side a construction of levitating engine

Lectures

Every year, four or five lecturers visit us in order to give a lecture concerning their praxis. Among the lecturers there are experts not only from our faculty, but also from other universities, experts from energy companies etc. Thanks to them we are able to offer the students the latest news of the scientific world.

Leisure programme

Although we are the maths and physics camp, the leisure programme takes an important part in our event. The leisure programme is based on the concept of experiential learning and it should lead students to cooperation and team thinking. It consists of separate afternoon and evening games connected into a coherent story, a legend, perfectly elaborated and original for each year.

Before the camp begins, the bigger part of preparations runs at non-public web sites. The organisers hold there a discussion about the topic of the leisure programme, they work on the legend, create an invitation leaflet, and prepare afternoon and evening (or night) games. It is also important for organizers to participate in several weekend meetings, where they put themselves in a proper mood for the oncoming camp.

What part of time does the leisure programme take? And how does it actually look like? As you can see on Figure 1, the main time that is given to the leisure programme lasts from 3 p.m. till the dinner. There are of course several exceptions – all-day-trip, free afternoon, or the end of the camp.

During the camp, the participants can also meet with several evening or night games. Sometimes even a morning game that runs before the breakfast is prepared for them. The organizers offer the participants also other activities for free evenings that don't have to be necessarily connected with the legend (e.g. dance evening classes, board games, guitar playing and singing, or evening reading).

Evening meetings of organizers and participants are also a very important part of both the leisure and the science programme. It is held every day after dinner and it takes approximately 30 minutes. During the meeting, the leisure programme is evaluated and

many important things that happened or that are planned for next days are also discussed. The meeting is the right opportunity for answering all occurred questions concerning the smooth running of the camp.

The end of the camp is under the direction of the leisure programme. It starts on Thursday after the closing conference and ends on Friday afternoon. During these two days, the legend of the leisure programme is closed. Usually, the participants spend this time outside (even the night, if the weather allows it), they solve various ciphers and tasks and they try to save the planet, overthrow the government or for example solve a criminal case – depending on the actual legend. The whole camp is closed on Friday evening, when a banquet is prepared and the participants can stay awake all night.

For you to get the picture of the leisure programme you can look at the video [3].

Conclusion

Our camp is an opportunity for secondary school students to do physics, mathematics and ICT by their hands and minds and to meet friends with similar interests. On the other side, students of didactics in the role of organizers have a possibility to work with young people and this way to prepare themselves for their future career.

During its 25-year existence our camp has undergone considerable transformation and, like any living organism, it certainly awaits further developments. But its role remains the same – to foster students keen on physics and science in general and in friendly informal atmosphere stimulate their personal and social development.

References

- [1] The Summer Maths and Physics Camp, (2013), [online]. [cit. 8. 10. 2013]. Available from: <http://kdf.mff.cuni.cz/tabor/english.php>
- [2] Students' projects from The Summer Maths and Physics Camp, [online]. [cit. 8. 10. 2013]. Available from: <http://www.youtube.com/mffsoustredko>
- [3] The Summer Maths and Physics Camp, leisure programme 2013, [online]. [cit. 6. 3. 2014]. Available from: <http://www.youtube.com/watch?v=RqSTJF84hBE>

Popularization of Physics by Using an Interactive Show

Petr Káčovský, Věra Koudelková, Marie Snětinová

Faculty of Mathematics and Physics, Charles University in Prague, Czech Republic

Abstract

Our contribution describes two long-term projects and activities organized by the Department of Physics Education (Faculty of Mathematics and Physics in Prague) for secondary school students. The activities are called "Physics Through All Senses" and "Magical Physics" and they have much in common – in both cases we have prepared a 90 minutes-long set of experiments performed not as a lecture with an exact theoretical background, but as an interactive show engaging students in it.

The project "Magical Physics" started in spring 2011 and it is focused on physical measurements with dataloggers. The experiments make a series of a story "The Voyage to Mars" and we emphasize here the inter-disciplinary relations mainly between biomechanics, biology and chemistry.

The project "Physics Through All Senses" started in autumn 2012 and the homonymous show contains almost thirty experiments divided into groups according to human senses.

More than 3 000 students have seen our performances till now.

Keywords: interactive show, experiments, secondary school, informal teaching

Introduction

Interactive performances “Physics Through All Senses” and “Magical Physics” were prepared by doctoral students of the Department of Physics Education (Faculty of Mathematics and Physics, Charles University in Prague) for Czech secondary school students aged from 15 to 19.

The main goals of these shows are to improve students’ perception of physics and to increase its attractiveness for students. Moreover, of course, we want to motivate them to study physics and especially physics education at the university level. Thanks to these shows, we also try to strengthen our relationship with secondary school teachers and we hope that some of our experiments can be inspiring for them.

Realization

Both shows last 90 minutes and are intended for groups of up to 90 students. All our equipment is transportable by train or by bus, and therefore we are able to present the shows at any secondary school in the Czech Republic. Each show is performed usually by two people – mostly Ph.D. students of the Department of Physics Education. The price of these shows is only symbolic – students pay no more than one euro.

Magical Physics: The Voyage to Mars

The show “Magical physics” was developed in 2011. The performance involves physics measurements with Vernier sensors and dataloggers in a story describing space colonizers’

difficulties during a hypothetical voyage to Mars. Interdisciplinary relations mainly between biomechanics, biology and chemistry are included in the show.

More than 2000 secondary school students have seen the show from April 2011 up to October 2013.

Examples of experiments and measurements

- Hand grip strength
We measure and compare students' maximal hand grip strength and their average hand grip strength during 15 seconds, both in the form of competition (see Figure 1).
- Weightlessness
Using Vernier dynamometers we try to explain the difference between gravitational force, weight and mass.
- Breathing
Using a spirometer we quantify not only vital lung capacity, but also the volume of air exchanged during quiet breathing in our lungs. Knowing this, we can calculate how much air astronauts should take with (see Figure 1).
- Energy from Sun
In this experiment we show that illumination provided by the point light sources is inversely proportional to the square of the distance, so its use e.g. for solar panels is limited.
- Ethanol rocket
Final experiment simulating jet-propelled motor using ethanol vapours ignition in a PET bottle.

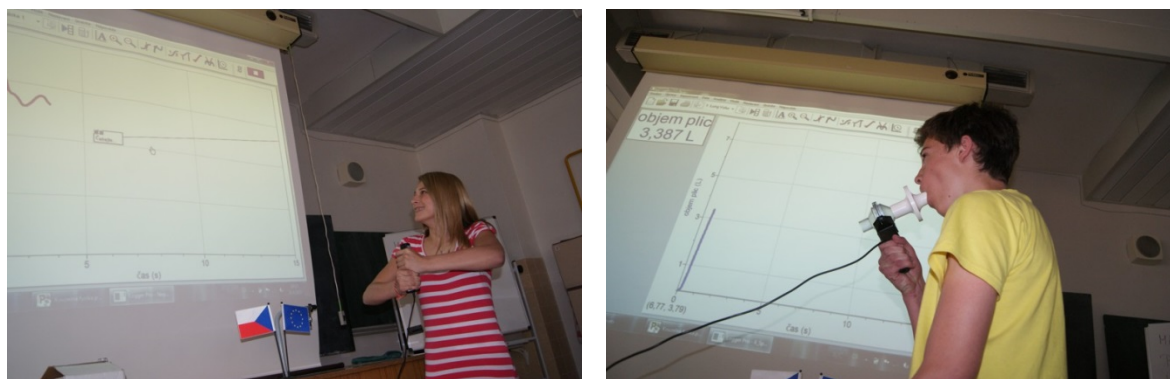

Figure 1. Hand grip strength (left) and breathing with spirometer (right)

Physics Through All Senses

The performance “Physics Through All Senses” was developed in 2012 as a part of PROGMA project which should encourage secondary school students to study at Faculty of Mathematics and Physics. The show contains almost 30 experiments divided into groups according to human senses; in addition, we have added a few “fictional” senses - like the sixth sense or the sense of technology. We use both low-cost equipment and modern technologies during the show. Students know some of our equipment from their homes (remote control, induction cooker, drill...) but usually we use it in different ways.

More than 1000 secondary school students have seen the show since October 2012 up to October 2013.

Examples of experiments (the sense, the experiment focuses on, is written in the brackets)

- RGB world (sight)
We use USB microscope to study mobile phone display or computer screen pixels. For this experiment we have prepared four different-coloured squares on the laptop screen to show the colour mixing used by LCD.
- Kitchen vacuum pump (taste)
This experiment shows the behaviour of beer foam or sweet with whipped cream during decreasing and increasing pressure in the kitchen vacuum pump (see Figure 2).
- Magdeburg suction cups (touch)
Famous experiment known as “Magdeburg hemispheres” was performed by Otto von Guericke in 1654 to confirm the existence of atmospheric pressure. In our version of this experiment, instead of hemispheres we use suction cups designed to carry glass plates.
- “Fakir’s bed” (touch)
Brave students can stand on our fakir’s bed (without shoes, of course). There are nearly a thousand pins distributed on the A4-sized plate, so the experiment is safe for its participants.
- Tube-music (hearing)
Plastic plumbing pipes with different precisely measured lengths create a musical instrument using vibrations of air columns. Students can play prepared Czech folk songs on them (see Figure 2).
- Antigravity car (sense for technology)
This car uses underpressure to move not only on the floor but also on a wall or a ceiling.



Figure 2. Beer in a kitchen vacuum pump (left) and tube music (right)

Feedback

Both students' and teachers' reactions are very positive immediately after each show. Obviously, there is a demand for similar events, teachers very often ask us for some recommendation. We perceive as a great success that in some regions schools share their experience with our shows, spreading this way the information about our activities.

Conclusion

More than 3000 high school students have seen our physics shows since 2011. The shows get a good response from teachers as well as students. We also believe that the shows help to increase attractiveness of physics for students. On that account we would like to continue presenting these interactive performances in the future. If you are interested in other experiments or want to know more information about the shows and experience with it, please do not hesitate to contact us by e-mail: vera.koudelkova@mff.cuni.cz.

Nanotechnologies: Opportunities for interdisciplinary collaboration

Lucie Kolářová, Roman Kubínek

Department of Experimental Physics, Faculty of Science, Palacky University
Olomouc, Czech Republic

Abstract

This paper suggests simple activities which can introduce nanotechnologies to high school students. Nanotechnologies are a rapidly developing field of the 21st century with large financial investment. They expand from laboratories to production and applications. We can buy various products with remarkable properties. However, the public and therefore students know little about this exceptional field. Science teachers can incorporate the knowledge about this modern and interdisciplinary field in their classes and introduce new possibilities of nanotechnologies in many fields of human activity to their students.

Keywords: nanotechnologies, science teacher, interdisciplinary collaboration, nanometer, nanoscale, surface-to-volume ratio, fullerenes

Introduction

The development of microscopy and other experimental techniques during last years had a major impact on the development of nanoscience and nanotechnologies. We understand nanotechnologies as a multidisciplinary field including chemistry, physics, biology, material science and engineering. Nanoeducation requires preparation of experts in more fields which have been taught separately till now. For science teachers nanotechnologies offer not only the possibility of incorporating the current science knowledge in their classes but also of interdisciplinary collaboration.

A short introduction to nanotechnologies

The definition says that nanoscience is the study of phenomena and manipulation of materials on atomic, molecular and macromolecular scales, where properties differ significantly from those at a larger scale. Nanotechnologies are the design, characterization, production and application of structures, devices and systems by controlling shape and size at nanometer scale. The nanometer scale is conventionally defined as 1 to 100 nm [2]. The properties of the materials (different melting point, conductivity, color, strength etc.) can differ at the nanoscale and the macroscale. For example, bulk silver is non-toxic, but silver nanoparticles are able to kill a virus upon contact. Nanotechnologies are widely used in engineering, medicine and everyday life. A further development can be expected in this area in the future.

Opportunities for interdisciplinary collaboration

Nanotechnologies represent a large amount of information from different fields. The orientation in this area may not be easy and it can be time-consuming. Teachers should not be discouraged and start with familiar things. Connections of physics and mathematics are

obvious. Thus, we can start to discover relations between nanotechnologies and mathematics.

Idea of nanometer

In nanotechnologies the size is really important. Before we start to discuss the concept of nanotechnologies with students, they should be able to imagine a nanometer. The basic SI unit of length is one meter (m). One billionth of a meter is one nanometer (10^{-9} m). Students can find it difficult to visualize how small a nanometer is. Although we offer them examples such as one nanometer is ten hydrogen atoms in one line, or sheet of paper thickness is 100,000 nanometers. For a better idea about the length we can use the following activity. Students also practice metric prefixes, proportionality and exponentiation. Teacher can use this activity in physics lessons about units and their measurement.

Activity 1

Students work in small groups. They select an object to represent a nanometer, for example a coin, a pencil or a paperclip. They should measure the length of this item and they should figure out how long a micrometer, a millimeter, a meter would be in proportion to the chosen object [1].

Possible solution:

- We select an object representing 1 nanometer. We choose a commemorative coin. We measure the diameter of the coin. The diameter is $d = 30$ mm.

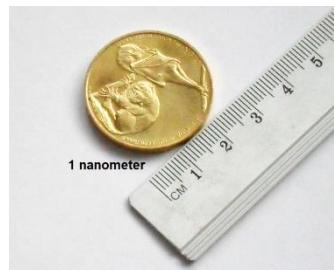

Figure 1. Setting the length of 1 nanometer

- We figure out one micrometer length with respect to the size of the coin. We use the direct proportionality to calculate it. $1 \mu\text{m} = 10^3 \text{ nm} \propto 3 \cdot 10^4 \text{ mm} = 30 \text{ m}$. For a better idea we assign an object to the calculated length, for example a blue whale.



Figure 2. Setting the length of 1 micrometer

- In the next step we calculate one millimeter length. $1 \text{ mm} = 10^3 \mu\text{m} = 10^6 \text{ nm} \approx 3 \cdot 10^7 \text{ mm} = 30 \text{ km}$. Now we assign the distance on the map to the calculated length, for example the distance between two known cities Nice and Cannes.



Figure 3. Setting the length of 1 millimeter

- In the end we calculate one meter. $1 \text{ m} = 10^9 \text{ nm} \approx 3 \cdot 10^{10} \text{ mm} = 30\,000 \text{ km}$. We assign the distance on the map of world again, for example $\frac{3}{4}$ length of the Earth equator.

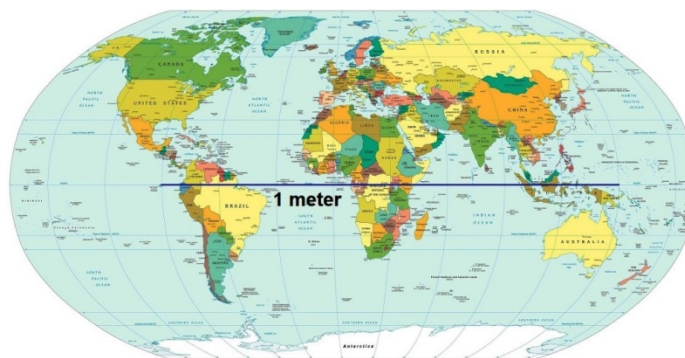

Figure 4. Setting the length of 1 meter

Surface and volume of a cutting cube

It is important that students understand in what sense nanotechnologies are so special. Nanomaterials are special for a couple of different reasons. They are small enough to get into organisms, to transport through some structures. Materials can fundamentally change their behavior: a colloid of gold nanoparticles is no longer golden but ruby red in color. Nanomaterials have an increased surface-to-volume ratio compared to bulk materials. Hence, nanomaterials have larger surface for catalysis reactions and detection reactions. The following activity helps students to understand the important properties of nanomaterials and to practice calculations of the surface area and volume of a cube [1,2]. Teacher can use this second activity in mathematics lessons.

Activity 2

Students work in small groups. They determine the size of a cube and calculate the surface area and volume of their cube. They subdivide the cube into smaller parts and calculate the surface area of all new cubes. The volume of the cube remains the same. This is repeated four times or more. Students write the results to Table 1. Then they plot the results graphically and evaluate them [1].

Possible solution:

- We determine the edge length of the cube: $a = 4$ units (u).
- We calculate the surface area and volume of our cube.

$$S = 6a^2, S = 96 \text{ u}^2,$$

$$V = a^3, V = 64 \text{ u}^3.$$

- We cut each dimension to halves and create 8 smaller cubes.

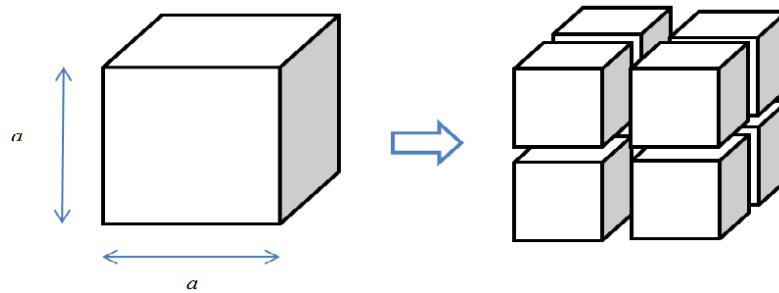

Figure 5. Cutting the cube

- The volume remains the same. We calculate the surface area of all the cubes created and write the result to the table.
- We repeat the process and write the results.

Table 1. Summary of results

Length of cube side a/u	4	2	1	0,5	0,25	0,125
Number of segments	1	8	64	512	4096	32 768
Total surface area S/u^2	96	192	384	768	1536	3072

- We depict the results graphically.

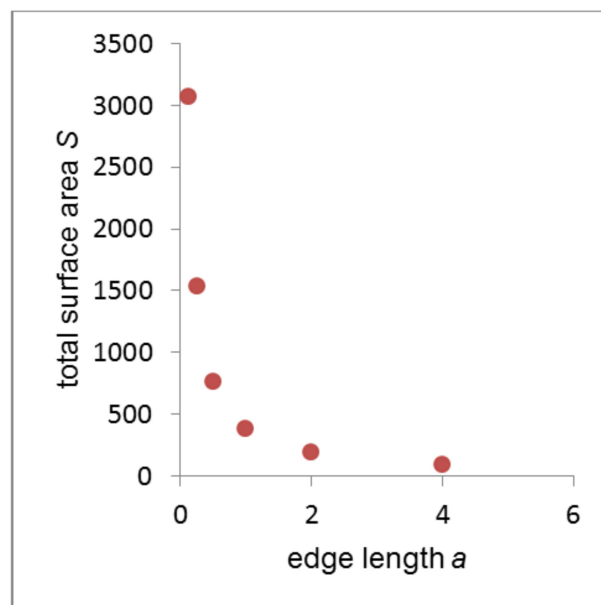

Figure 6. Total surface area S vs. edge length a

- Evaluation: Each reduction of the edge length causes a decrease of the elementary cube surface area, but on the other hand creates 2^3 of such elementary cubes. Hence, the total surface area of all the cubes forms the geometric sequence

$$S_n = S_0 \cdot 2^n,$$

where $S_0 = 96 u^2$.

Fullerenes - Platonic and Archimedean Solids

Fullerenes belong among the most perspective nanomaterials. They are molecules formed by carbon atoms with a closed structure. Fullerenes were discovered by R. F. Curl, R. E. Smalley and H. W. Kroto in 1985. The Nobel Prize in Chemistry was awarded to Curl, Smalley and Kroto for their roles in the discovery of this class of molecules in 1996. The famous fullerene is C_{60} . It looks like a soccer ball. It can be found in small quantities of soot [2]. The last activity suggested in this paper is connected with fullerenes and leads us to the geometry of Platonic and Archimedean solids. Teacher can use this activity in mathematics lessons about the stereometry.

Activity 3

Students work in groups. They choose one of the fullerenes C_{20} or C_{60} . They describe the selected fullerene – of what shapes it consists of, what type of geometrical solid it is.

Possible solution:

For easy description the students can create their model of fullerene from paper or molecular building system.

1. Fullerene C_{20} :

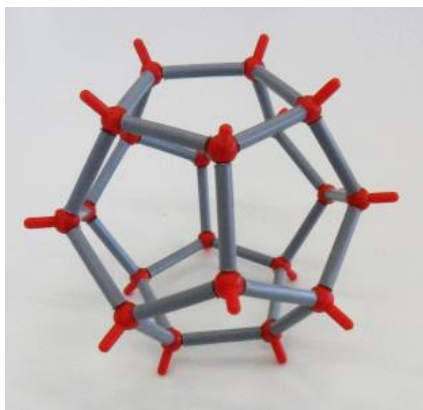

Figure 7. Model of fullerene C_{20}

- This fullerene is made of 12 pentagons.
- Fullerene C_{20} has the form of dodecahedron – regular, convex polyhedron. It has 12 faces, 20 vertices and 30 edges. All its faces are convex regular polygons. The same number of faces meets at each of its vertices. It belongs to Platonic solids. They are named after the ancient Greek philosopher Plato. He suggested that the classical elements were made of these regular solids [3].

2. Fullerene C₆₀:

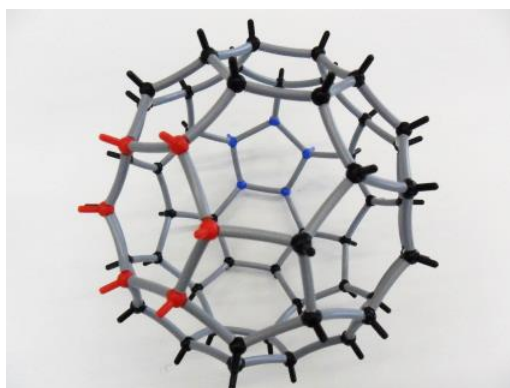

Figure 8. Model of fullerene C₆₀

- This fullerene is made of 12 pentagons and 20 hexagons.
- Fullerene C₆₀ has the form of truncated icosahedron. It has 32 faces, 60 vertices and 90 edges. It is a highly symmetric, convex polyhedron composed of two regular polygons – pentagons and hexagons. It can be made via Wythoff constructions from the Platonic solid (icosahedron). It belongs to Archimedean solids. They are named after the ancient Greek mathematician, physicist, inventor and astronomer Archimedes [4].

Conclusions

In this paper we have introduced three simple activities through which science teachers can introduce nanotechnology to students. Students use skills and knowledge gained in mathematics before this course. For many students it could be surprising that the fullerenes introduce them to ancient Greeks Plato and Archimedes. The interdisciplinary relations can help improve the quality and efficiency of education, activation and motivation of students. For a successful use of interdisciplinary relations the science teachers should cooperate, use the same conceptual apparatus, and similar education methods and curricula should be time-coordinated [5].

Acknowledgments

This article was supported by the student's project PrF_2013_009 of Palacky University Olomouc and European Community in the framework OPVK under the project No. CZ.1.07/2.2.00/28.0182.

References

- [1] Newberry D.: Fundamentals of Nanotechnology I, (2008), [online]. [29.7.2013]. Available from: <http://www.okcareertech.org/about/initiatives/oklahoma-nanotechnology-education-initiative/introduction-to-nanotechnology>
- [2] Filippini L., Sutherland D.: NANOYOU Teachers Training Kit in Nanoscience and Nanotechnologies, Module 1, Chapter 1 – Introduction to Nanoscience and Nanotechnologies, Chapter 4 – Fundamental “Nanoeffects”, Aarhus University, (2010), [online]. [6.09.2013]. Available from: <http://nanoyou.eu/nano-educators/teacher-training-kits.html?view=alphacontent>

- [3] Wikipedia, Platonic Solids, [online]. [12.09.2013]. Available from:http://en.wikipedia.org/wiki/Platonic_solid
- [4] Wikipedia, Archimedean Solids, [online]. [12.09.2013]. Available from:
http://en.wikipedia.org/wiki/Archimedean_solid
- [5] Janás J.: Mezipředmětové vztahy a jejich uplatňování ve fyzice a chemii na základní škole, Brno, UJEP (1985), ISBN 55-965-85, p. 87.

Database of selected papers of Physics Teachers' Inventions Fair

Zdeňka Koupilová, Leoš Dvořák, Jan Koupil

Department of Physics Education, Faculty of Mathematics and Physics, Charles University in Prague, Czech Republic

Abstract

The Physics Teachers' Inventions Fair [1] is an annual conference of Czech physics teachers. Papers from the conference are an appreciated source of teaching ideas. To make them more accessible we prepared a searchable database of the selected papers from all years of the conference.

Keywords: teaching ideas, simple experiments, database, conference

Conference Physics Teachers' Inventions Fair

The Physics Teachers' Inventions Fair [1] is a conference of physics teachers of all levels – from basic school teachers to university professors. It has been held annually since 1997 usually at the beginning of September and there have been about 100 - 180 participants. Because it takes place in Czech Republic, the majority of participants are Czech teachers. Several Slovak and Polish teachers and university researchers take part as well because the language barrier is not so significant for them. In September 2012 the 17th Fair took place in Prague and this year's conference will be in Hradec Králové. Even though the impact of the conference is mostly national, every year there are more than ten participants from foreign countries. [2]



Figure 1. Teacher audience observing an experiment demonstration

The conference is aimed at sharing ideas about new demonstration and laboratory experiments, long-term projects and how to make physics more interesting for pupils and students, motivating them and helping them to better physics learning and understanding. Approximately 40-60 contributions are presented each year. Exhibits of textbooks and professional teaching aids take place there as well. All papers are published in the paper proceedings.



Figure 2. Experiment presentations

Database of selected papers

Papers from the conference are a very good source of teaching ideas because they are mostly ready to be used in the classroom. However, since they were published in paper proceedings, they are badly accessible for people who didn't attend the specific conference. That is why emerged the idea of building a database of selected papers.

History of the database development

The development of the summary proceedings started in 2002 and at the occasion of the 10th conference in 2005 the first version was presented – on CD and online as well. According to the number of accesses to online version of the summary proceedings and the survey of opinions of the conference attendance done in 2008, the database was considered to be a very useful and often used source of ideas for physics teachers of all levels of schools. That's why the papers from further conferences have been gradually added.

In 2012 the implementation of the whole summary proceedings has been changed to reflect new technologies used on Internet. Instead of static web pages it is now a searchable database. To enable effective search, information about level, topic, equipment demands and keywords were added to all papers.

The database is freely accessible for public.

Selection criteria

Because not all papers were going to be stored in the database, the selection criteria had to be set. Although the selection process should be slightly biased, the criteria dealt not only with quality of the paper content, but papers have to be oriented on experiments, especially the experiments with simple stuff, easily accessible equipment or equipment usually present in schools. Besides experiment description, ideas how to make learning more attractive and active suitable for classroom usage are welcome.

Current state of the database

New database [3] contains 468 articles – original papers from the conferences. They were selected from the proceedings published during the period 1997-2012. Most of them are in Czech, several of them in Slovak or English. As mentioned above it is possible to search

the papers not only according to their titles or author names, but also according to their topics. An extensive structured index is implemented here as well.

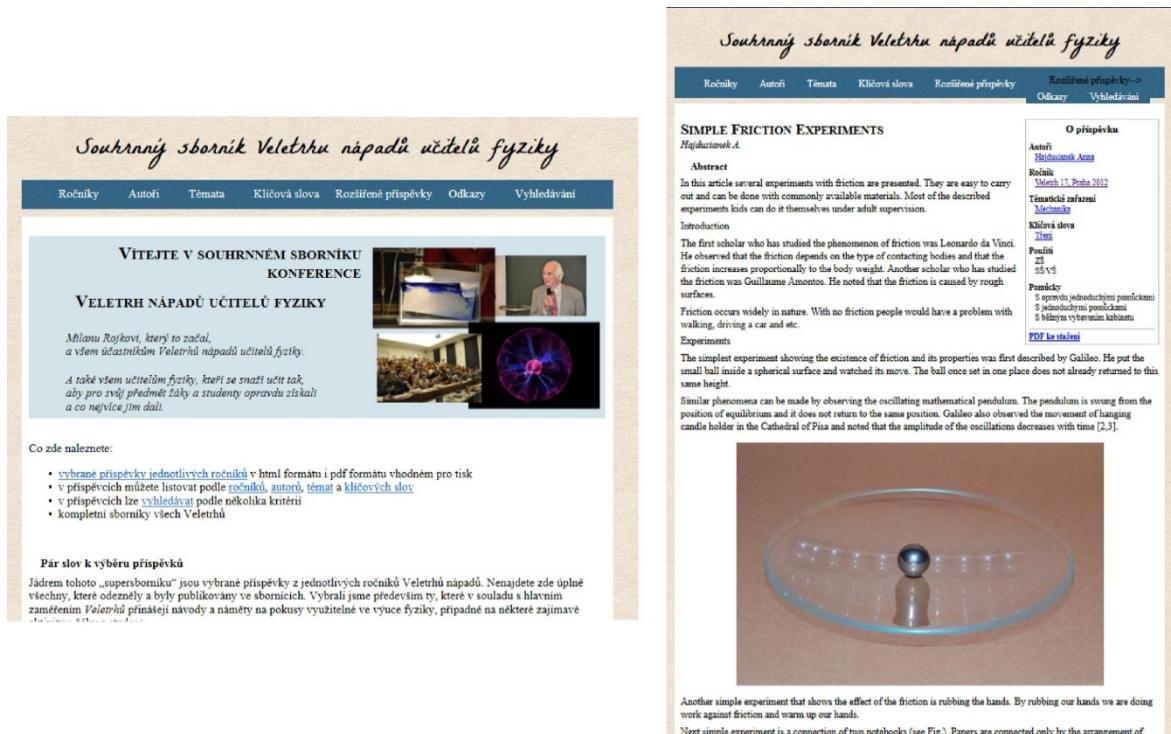

Figure 3. Browser screenshot: Title page and one selected paper

Besides the selected papers, the website contains all complete proceedings in pdf format and a list of useful links at the database webpages.

Although the entire database is in Czech, the most interesting papers are translated into English and are published at separate pages [4], making the best presented ideas internationally usable. Nowadays there are 59 papers translated.

Web visitors

At the beginning of 2013 we started to use Google Analytics to monitor web visitors. From the preliminary data we can conclude that users are mostly teachers and students because there is the lowest visit rate on Fridays and Saturdays (and Czech bank holidays) and a systematic decrease during July – but even during summer holidays there are still about 50 unique visits per day.



Figure 4. Numbers of unique visitors per day

Despite the most visitors come from public web search engines like Google, there are about 20% of returning visitors. Because of the language aspect it is not a surprising fact that 80% of visitors are Czech and 15% are Slovak.

Future plans

We would like to continue in addition of selected papers from this year and future conferences, enlarge the list of useful links and publish papers especially prepared for the summary proceedings.

The development of the database interface will continue as well. We plan to enable readers to send a question directly to paper author and to authors to put additional comments below their published articles. This should transform the database from a changeless source of ideas to a live place but without the weaknesses of open web discussions.

Because there are 59 papers in English and they are published as a simple list at a single page that starts to look quite disorganized [4], we plan to prepare an English version of the database interface. So, an English speaking reader should be able to list and search the papers according to various criteria too.

Acknowledgment

The authors would like to thank

- especially to prof. Milan Rojko, whose idea the Inventions Fair is,
- to all teachers for their contributions, that make the Fair so inspiring event,
- to all colleagues from Prague, Plzeň, Příbram, Brno, Olomouc, České Budějovice, Hradec Králové, for organizing of the Fair in last years,
- and to Zdeněk Šabatka for help with web design and permission to use his photos.

References

- [1] Home page of the conference Physics Teachers' Inventions Fair: <http://vnuf.cz/>
- [2] Teslamania 2010 Physics Teachers' Innovation Fair, [online]. [cit. 28. 8. 2013]. <http://teslamania2010.eventbrite.com/>
- [3] Database of selected contribution: Inventions Fair for Physics Education, [online]. [cit. 28. 8. 2013] Available from: <http://vnuf.cz/sbornik/>
- [4] Selected papers of Physics Teachers' Inventions Fair in English, [online]. [cit. 28. 8. 2013] Available from: <http://vnuf.cz/papers/>

Online Tutorials in Physics and Engineering

Kühn Markus, Eulenberg Katja, Grimmig Simone, Kalka Frank,
Karapanos Marios, Marquis Janina, Schneider Kim, Stach Manuel and
Lakatos Michael*

University of Applied Sciences Kaiserslautern, Kaiserslautern, Germany

*Corresponding author: michael.lakatos@fh-kl.de

Abstract

Online tutorials meanwhile have developed into a mainstream format of E-Learning. In this study examples of virtual modules for physics and engineering are presented which were developed applying professional software and multiple programming tools [1]. Embedded in the university's learning management system, student performance as well as virtual units will be evaluated effecting the further development of physics and engineering tutorials.

Keywords: university education, physics, virtual laboratories, engineering, e-learning, webcasts

Introduction

In the last decade, the increase in distance-learning and extra-occupational studies has led to an enlarged application of e-learning phases to implement location-independent learning. Also preparation before and after in-class courses are increasingly transformed into blended-learning approaches to offer time-independent opportunities connected to professional competence and didactic quality. The use of comprehension questions, self-tests, and additional teaching materials require more independent learning skills of the students (self-determination). On the other hand, e-learning offers opportunities and individualisation of lessons for students to arrange their own pace and comprehension by graded learning material and supplemental offers. Also playful elements are increasingly used, e.g. quiz, puzzle, partner work (learning by playing). They increase the diversity of media. Moreover, virtual animations and simulations – for example, simulations of experiments – are used to enlarge and to deepen students' knowledge development, because simulations can be playfully explored and repeated several times. Virtually conducted experiments offer more advantages: while the in-class situation may raise difficulties e.g. due to hazardous material, disproportionate efforts or costly equipment, in virtual experiments none of these limiting factors occur.

The challenge is to create meaningful online tutorials in terms of technique, visual appearance and didactics via a wide range of software and programming tools. Together with other universities (University of Kaiserslautern, the Universities of Applied Sciences Koblenz and Trier) and supported by several externally funded projects such as "Open competence region Western Palatinate" (Offene Kompetenzregion Westpfalz; OKW), "Open MINT labs" (OML) and tasks of the Higher Education Pact (HSP, Hochschulpakt) the University of Applied Sciences Kaiserslautern established a team of around 30 experts who support university lecturers on the subject of e-learning. The support in the area of teaching ranges from conceptual design to technically complex multimedia presentation of the contents to concrete implementation of e-learning applications and their use in different e-learning scenarios and application contexts. Particularly useful is the combination of e-learning and in-class courses – so called blended-learning concepts [2] – in the

implementation of novel ways to access university. A novel “culture of learning” has to be adapted to meet the demands of these higher education applicants, e.g. qualified professionals, business returnees, and students with professional or familial responsibility. Teaching has to be customized to offer spatial and temporal flexibility and has to allow for different learning speeds. This challenge is difficult to meet without online tutorials.

The online tutorials can be accessed at any time, as often as desired and from every place where internet connection is available. The latter aspects are of outstanding importance particularly for students of extra-occupational degree programmes. The online tutorials are embedded in a learning management system (OpenOLAT, Frentix, Zurich, Switzerland) where they are also used for computer-supported collaborative learning methods. The University of Applied Sciences Kaiserslautern provides a complete Learning Management System around the online tutorials where students can utilise various tools for learning, including additional web-resources, video-lectures, animated demonstrations and self-evaluation. Focusing mainly on the professional and technical aspects, we present examples of virtual courses and virtual laboratories in physics, chemistry and engineering embedded in blended learning environments [2] for academic teaching at the University of Applied Sciences Kaiserslautern.

Interactive webcasts in Electrical Engineering & Digital Electronics

Blended learning concepts with the focus on webcast applications are used in our courses of Electrical Engineering & Digital Electronics. The aim is to mediate theoretical knowledge as well as to motivate students to deepen and deliberate their learned knowledge independent of time and location. Moreover, students can also decide themselves when to access what specific part of the webcast. These aspects of self-determination are essential for intrinsic motivation [4].

Webcasts, videocasts or webinars are common tools to impart knowledge similar to the classical in-class lecture with front-of-class teaching concepts. For this purpose digital recordings of in-class lectures are often used to transfer contents into the digital medium efficiently in terms of time investment. In addition, it is recommended to produce more elaborate tutorials with software for screen video capture taking into account didactic aspects and interactivity.

These digital lectures can emulate the development of a blackboard synopsis step by step providing even more structure and clarity in the presentation. Multimedia-based lectures contain a variety of more or less interactive elements. Animations may be used in order to illustrate e.g. cause-and-effect chains or the chronology of events. Simulations can visualize complex mathematical equations to get an understanding for formulae (Figure 1). Live video sequences of real technical systems or hands-on experiments may also be included in the digital lectures as well as pure audio elements, graphics and photographs, apps, etc. Interactive elements like quizzes can be used as mandatory pauses as well as a means for recapitulation and monitoring of performance (Figure 2). In addition to basic video interaction features, it is possible to increase interactivity by using flash hotspot callouts that allow linking to any web page which contains, for example, interactive HTML5 and Java Script elements or java simulations [3].

The technical requirements for creating interactive webcasts are quite manageable. In addition to moderate hardware requirements like a plain personal computer with headset we also need some software. The combination of professional screen recording software such as “Camtasia Studio” (TechSmith Cooperation, Okemos, USA) and a presentation

programme like Microsoft PowerPoint (Microsoft, Redmond, USA) is sufficient in order to create the digital lectures. The tutorial can easily be recorded by a PowerPoint add-in using both features of the presentation programme as well as all post-editing features of the video software. For the extra-occupational degree programme in automation engineering we developed webcasts based on blended learning concepts in electrical engineering and digital electronics at the university. We produced around twenty exercises on electrostatics, electrical circuits and network analysis as well as exercises on Boolean algebra, combinational and sequential circuits and logic families. These fundamental topics are relevant for all students in this field and are first covered in the normal lecture. The blended-learning scenario is the combination of in-class lectures and the online exercises. Based on the PowerPoint slides the lectures are digitally recorded with Camtasia's PowerPoint add-in. The post-editing is done in Camtasia Studio. The duration of the webcasts varies between 15 and 45 minutes interspersed after around 5 minutes with quizzes for stimulation and self-monitoring.

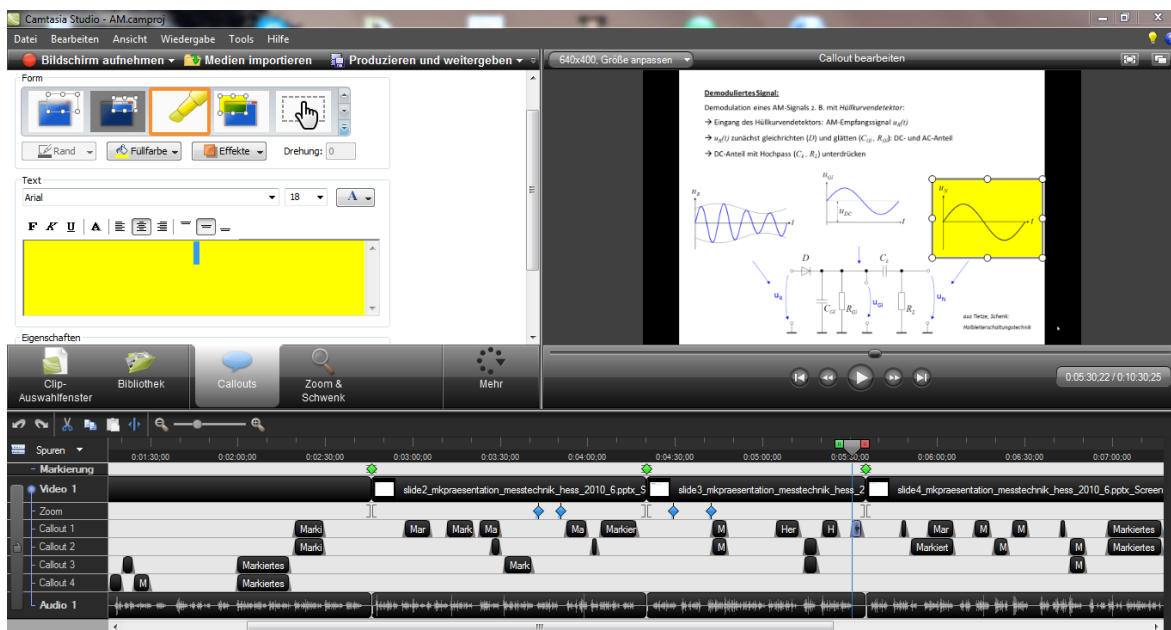

Figure 1. Post-editing of the online tutorial using the features of Camtasia Studio

Several clips can be arranged sequentially on the timeline. A variety of callouts exist and can be used with respect to didactic aspects, e.g. features like zoom and move or highlight (both for focusing), internal and external links (e.g. for self-studies), and quiz (self-monitoring).

It is possible to choose several video formats including mp4, flv, swf, wmv, mov, avi. Based on flash templates we can select a suitable player with controls, table of contents and picture-in-picture feature. By generating a SCORM module the online tutorial is embedded in a particular course of our learning management system.

This format of E-learning is well-established and famous institutions and projects like Udacity, edX, Khan academy and others have taken over the leadership in professional online lectures. The most outstanding disadvantages are the dependence on the technical requirements and the effort of developing the units.



Figure 2. Quizzes as interactive elements can be used as mandatory pauses as well as a means for recapitulation and monitoring of performance

Virtual laboratories for Physics

Besides learning theoretical basics, students also benefit from virtual tools helping to exercise and to understand practical implementations such as experiments in laboratories. The virtual laboratory is a training concept that motivates students through practical applications, it supports learning of basic and advanced concepts through repeatable experimentation and it improves their self-learning ability. Particularly in the disciplines of science and engineering remote-access to virtual labs might offer an alternative when physical distances or the lack of resources prevent students to perform experiments, particularly if sophisticated instruments or highly complex experiment designs are involved. The aim of physics and engineering courses imbedding a virtual laboratory is to introduce students to experimentation, problem solving, data gathering, and scientific interpretation.

A tool to create interactive simulations is the modelling and authoring software “Easy Java Simulations” (EJS). Its graphical drag-and-drop editor generates Java code for the creation of discrete computer simulations [5]. With EJS we use a free authoring tool for building interactive Java simulations using the actual mathematical model of the physical problem. EJS also allows developers with very few prior knowledge of programming to build a simulation with real-time user interaction. It embeds the mathematical model of a simulation by solving ordinary differential equations at real time based on the differential equations of the given physical problem. This is a great advantage for experiments with complex mechanics like Pohl’s Wheel – the topic of another blended learning unit.

With EJS virtual laboratories were created for blended-learning courses in physics e.g. the double-slit experiment. The double-slit experiment represents an important milestone for the understanding of diffraction and interference of waves (Figure 3). The task for our students is to find out the wavelength of the emitted radiation of the simulation, examining the position of the diffraction maxima. The double-slit experiment with microwaves is part of the hands-on lab in particular for our extra-occupational engineering students. In order to prepare for the hands-on lab, the virtual double-slit experiment gives the students the

freedom to choose a lot of setup parameters on their own, e.g. number, size and spacing of the slits, to experimentally learn how the diffraction patterns depend on different parameters. It is also an easy way to let students experiment with waves of different wavelengths to enhance their knowledge of the electromagnetic spectrum.

The simulation includes an experimental setup similar to the one used in our hands-on lab. Only the wavelength of the electromagnetic radiation has been changed, visible in the measurements of the size and spacing of the slits. After the “virtual experimental apparatus” is switched on (Figure 3A), a transmitter emits an unspecified radiation which is diffracted at a double-slit setup. The resulting pattern can be measured spatially with a suitable receiver. This is visualized in our simulation, both numerically and graphically.

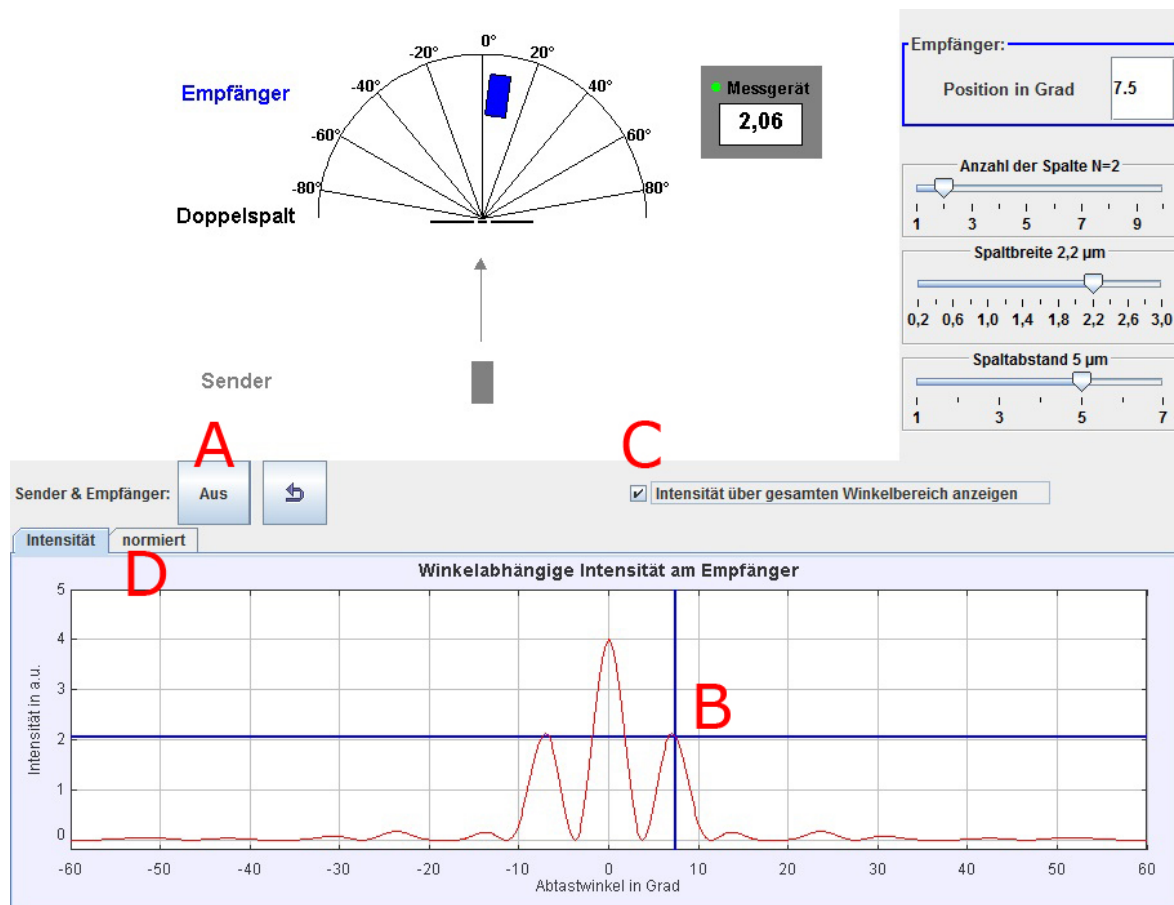

Figure 3. The double-slit simulation using the parameters: 2 slits, 5 μm spacing and 2.2 μm sizing (see text for further explanation)

One can change the following parameters in the simulation independently: Number of slits, and their space and sizing. Furthermore the position of the receiver can be changed via drag and drop or numerical input. After turning the simulation on, we can see a blue crosshair indicating the measured intensity on the ordinate and the chosen position of the receiver on the abscissa at this point (Figure 3B). Analogue to the measurement task in the hands-on lab students can get the readings piece by piece. By confirming the selection "Show intensity over the entire angular range" (Figure 3C), it is possible to speed up the measurement process. In this case the simulation shows directly the distribution of the intensity behind the slit setup. The tab "normalized" (Figure 3D) displays the intensity behind the slit setup with the maximum value normalized to one.

After logging into the university's learning management system, students can use the interactive laboratory course from every computer providing an internet connection. In addition, to run the simulation they have to install Java Runtime Environment, which is a disadvantage of using EJS. Even though we provide a FAQ troubleshoot webpage, some students still have trouble installing JRE or running Java applications in a browser on their computers. While most modern browsers such as Firefox, IE, Chrome and others support Java Applets, there is no JRE available for tablets with Android or iOS operating systems. There are also known issues with few combinations of JRE, browser versions and older operating systems.

The design of virtual laboratories for physics raises the following questions: Should the virtual experiments portray a real experimental setup with all its problems? Should we simulate measurement readings with observation errors, e.g. uncertainties, systematic and statistical errors? Or in contrast, should we favour a vivid representation of the mathematical formula which describes just the underlying physics, to make sure the students won't be overloaded by excessive demands?

In this case we decided to provide data which are calculated from the mathematical model and try to explain this problem to our students. To raise the students' awareness of measurement errors we plan to build a special virtual learning unit covering this topic.

Another aspect when designing a virtual laboratory is the complexity of the topic and the measurement setup. The more variables are needed to describe the problem the more difficult it is to build the simulation in an intuitive way. Here, feedbacks of students recommended more detailed descriptions for the handling of the virtual experiment.

Virtual Titration Lab for Chemical Engineering

Virtual laboratories are rarely stand-alone applications – rather, mostly they are imbedded in a didactical framework. Our Virtual Labs are designed as a blended learning arrangement based on an online-course that essentially consists of five chapters: i) a motivating introduction, ii) a theory chapter, iii) the experiments, which include the virtual experiment as well as real laboratory experiment, iv) an exercise and v) a conclusion. While introduction, theory, and conclusion put emphasis on knowledge transfer by presenting videos, texts and corresponding images, the virtual experiment represents a different approach being set up as a simulation using HTML5, CSS3 and the JavaScript framework jquery.

This troika provides a number of advantages other technologies like Adobe Flash or Java cannot offer. First of all, HTML5, CSS3 and JavaScript bring maximum platform independency being supported by all relevant modern browsers on desktop and more and more mobile systems without the need for installing client-side third party plugin-ins. Second and maybe even more important: unlike the mentioned alternatives the chosen technologies seem to be more future-proof being deep rooted in browser architecture. Since HTML, CSS and Javascript became web standards and because of the pure existence of billions of web pages relying on these standards, it appears to be unthinkable, that upcoming browsers will not support these standards.

One example is the development of the virtual titration lab for Chemical Engineering (Figure 4). Titration is a standard method of analytical chemistry and titration experiments are often performed in chemistry education. An unknown concentration of a solution is analysed by adding a solution of known concentration. This topic was chosen because of the wide possible educational usage, ranging from school chemistry up to variety of

undergraduate studies. The aim of the acid-base titration experiment is to identify the end point of the titration from the colour change of the solution and to determine its molarity. Students are virtually provided with a hydrochloric acid sample of unknown concentration including phenolphthalein as tracer. The graphical user interface allows for titrating self-defined amounts of sodium hydroxide. After reaching the equivalence point, which is indicated by a faint colour switch of the acid solution from transparent to light purple, the students calculate the concentration of the acid sample based on the sodium hydroxide consumption. After typing in the calculated amount, the simulation gives feedback about the correctness of the calculation and offers a new sample. Since the concentration of the provided acid sample is generated randomly, the simulation can be used for practicing multiple times. To provide better preparation for the hands-on-experiment at the laboratory, the course unit also contains a video showing how to manage the experiment focusing on basic procedures and how to avoid common mistakes. First evaluation results (guideline-based interviews with students and tutors) show positive effects especially regarding students' performance during the laboratory experiment.

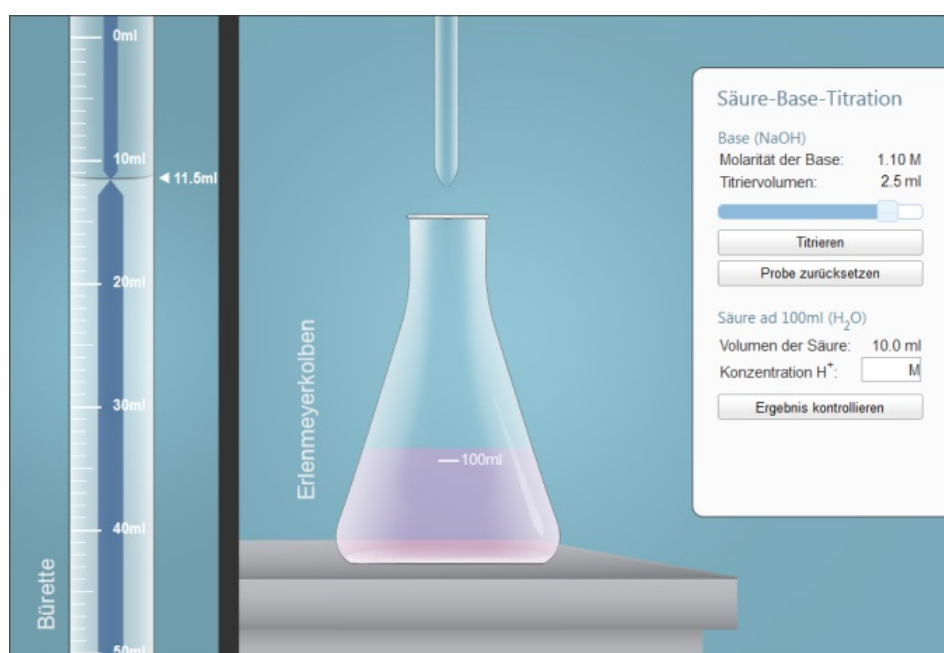

Figure 4. Interactive simulation of the titration experiment

Conclusion

The virtual units are all embedded in the university's central learning management system. At the moment, in particular students of the extra-occupational degree programmes of our university benefit from this kind of learning. A transfer to the regular courses of presence studies as add-ones has been achieved only partly so far. The first feedback of the sample group of students after working with this innovative kind of knowledge acquisition was very positive. To gather reliable data both virtual units and students' performances will be evaluated formally. The results of these evaluations will have an impact on the development of the upcoming physics and engineering tutorials.

Because of two aspects we decided to realize future tutorials by using future-proof technologies such as HTML5, CSS and JavaScript: On the one hand due to the mentioned technical problems the students were faced with, on the other hand because we would like to assure a future application and portability of the developed online tutorials (e.g. other

learning management systems or future releases of the current learning management system). Thereby, an independency from the currently used proprietary software (such as Java and Adobe Flash) is aimed. Moreover, the aim is to transfer as many lectures to these online formats as possible. This can only be achieved if a sustainable e-learning infrastructure of experts is available supporting lecturers in the production of high education tutorials. To achieve a definite dimension of unity and quality among the different learning units, the design of the learning environments will follow an agreed style guide which gives specifications and advices in didactical setup, technical issues as well as visual parameters. We hope that online tutorials following this style guide facilitate that students i) can use online tutorials more intuitively, ii) are rather more motivated and iii) and perform better in learning success.

We believe that virtual tools as presented herein will massively influence Physics and Engineering lessons both today and in the future.

Acknowledgement

We are grateful to our collaboration partners University of Kaiserslautern, the Applied Universities of Applied Sciences of Koblenz and of Trier. The study was supported by the BMBF, ESF and EU in the frame of the projects "Open competence region Western Palatinate" (16OH11064, Offene Kompetenzregion Westpfalz; OKW), "Open MINT labs" (01PL12056A, OML) and tasks of the Higher Education Pact (FHKL_Q_1, Second programme phase of the Higher Education Pact for more university entrants).

References

- [1] Kühn M., Grimmig S., Burger N., Schiwy M., Eulenberg K., Marquis J., Zapf B., Gaa J., Petry K., Lakatos M.: Physik & Elektrotechnik – virtuell und interaktiv, Proceedings of the DPG (VI) 46 (2014), DD 15.23.
- [2] Randy Garrison D., Vaughan N. D.: Blended Learning in Higher Education: Framework, Principles, and Guidelines, John Wiley & Sons, 2008.
- [3] Kühn M.: Interaktive E-Lectures zur Elektrotechnik, Proceedings of the DPG (VI) 46 (2013), DD 15.5.
- [4] Ryan R. M., Deci E. L.: Self-determination theory and the facilitation of intrinsic motivation, social development, and well-being. *American Psychologist* 55, No 1 (2000), p. 68-78.
- [5] Christian W., Esquembre F.: Modeling Physics with Easy Java Simulations. *The Physics Teacher* 45, No 8 (2007), p. 468-528.

Programming Simulations as a Way to Understand Physical Laws

Pavel Kurišćák, František Lustig

Faculty of Mathematics and Physics, Charles University in Prague

Abstract

We present an initial study of author's PhD project, which is engaged in creation of online learning environment used for teaching physics by programming numerical simulations. Our motivation is based on the belief that the calculus is the key field used in physics and its introduction using the finite difference framework may be mathematically intuitive even for secondary school students. We also present brief overview of the implementation as well as highlights from literature review.

Keywords: online learning, physics, calculus, finite differences, simulation, modelling

Calculus in physics

Mathematics is the language of many sciences – physics is probably the most notable example with calculus being its core discipline. Most fundamental physical laws are written in the form of differential equations and most of the predictive tasks in physics consist of solving these equations.

$$\begin{array}{l}
 \mathbf{F} = \frac{d\mathbf{p}}{dt} \\
 \nabla \cdot \mathbf{D} = \rho \\
 \nabla \cdot \mathbf{B} = 0 \\
 \nabla \times \mathbf{E} = -\frac{\partial \mathbf{B}}{\partial t} \\
 \nabla \times \mathbf{H} = \mathbf{J} + \frac{\partial \mathbf{D}}{\partial t}
 \end{array}
 \quad
 \begin{array}{l}
 R_{\mu\nu} - \frac{1}{2}R g_{\mu\nu} + \Lambda g_{\mu\nu} = \frac{8\pi G}{c^4} T_{\mu\nu} \\
 i\hbar \frac{\partial}{\partial t} \Psi = \hat{H} \Psi
 \end{array}$$

Figure 1. Several fundamental differential equations in physics

In this context we see that this important interconnection receives too little attention in upper-secondary or introductory college math and physics courses. Math courses are often rigorously oriented with focus on analytical exercise solving. Calculus is almost completely absent in secondary school physics. It is understandable – calculus is comparatively complicated topic with many prerequisites and it takes a considerable effort to establish the necessary theory. Our initiative however proposes following ideas:

- It may be beneficial to teach calculus and physics (and possibly its other applications) together. Immediate practical usage of the mathematical methods may help students to grasp the abstract concepts. On the other hand students may become more motivated by the ability to solve more complicated (less idealized) problems.
- We believe that it is possible to introduce the concepts of calculus to students even at upper-secondary level by using the finite difference framework.

Finite Difference Framework

Finite differences can be seen as a low-threshold introduction to calculus concepts. For completeness we shall briefly summarize the approach in somewhat informal manner thus giving a *hint how this introduction can be performed in practice*:

When describing various events around us we often come to the need of defining and measuring changes and rates of change of various quantities. To do this we use specific units most generally defined as:

$$\frac{\text{"unit of dependent quantity"}}{\text{"unit of independent quantity"}}$$

Examples are obviously m/s, km/h, rpm, but also °C/km (temperature gradient), kg/m (linear density) and many others. We often use practical ones like \$/km, \$/piece, etc., which can be seen as an extension of this concept. By looking at almost any object surrounding us we can recall several change-related units that are measurable in its context and train ourselves in recognizing the concepts of rate of change.

In case the changes in quantities of question happen uniformly, their mathematical treatment is quite intuitive, because the recipe for the computation is contained in the unit itself. Train moving uniformly with velocity of 15 meters per each second, for the duration of 5 seconds, will cover the distance of $15 \cdot 5 = 75$ meters. Performing this type of linear calculation is a basic ability gained at the elementary school level.

$$\text{"total change of dependent quantity"} = \text{"rate of change"} \times \text{"elapsed independent quantity"}$$

In many practical situations the rates of change are not constant but are also subject of change, thus the above computation method cannot be used. Nevertheless the problem is usually specified in the form:

$$\text{"rate of change"} = f(\dots)$$

meaning that the rates of change in question are at any given moment computable from other already known quantities. Those other quantities can be possibly very complicated, also subject to their own rates of change or even completely non-deterministic as for instance the quantity "user has pushed a button". Still in the end we are able to compute the rate of change of our interest.

To be able to compute the total change of our dependent quantity we can divide the elapsed independent quantity into many sufficiently small intervals, so that the rate of change is approximately constant during each interval. Inside each one we then apply our standard intuitive formula for uniform change and add all results together. We arrive at Euler's method of solving the first-order differential equation:

$$y(x + \Delta x) \approx y(x) + f(\dots) \Delta x = y(x) + \frac{\partial y}{\partial x} \Delta x$$

Numerical solution of differential equations enables us to solve very wide range of problems without increase in computational complexity, provided that we can fulfill comparatively non-restrictive conditions. Of course situation becomes very complex in case we need proper precision control, but in our case the goal is the introduction to

mathematical representation of physical principles, not the numerically precise computation. We can therefore afford sometimes only qualitatively correct results.

We should also state some disadvantages of this approach:

- Even though we can formulate the general model of a given problem, we cannot recover the general properties of its solution. Simulations always give only one result for one set of initial conditions and parameters. Retrieval of general properties of the solution is fully in the realm of analytical methods, but the range of analytically tractable problems is very limited. Nevertheless it is worthwhile to lead the student into the situation where the general results would be very helpful and point out the significance of the analytical approach.
- Solving a problem is no longer a pen and paper exercise and requires computer support. Therefore some form of programming has to be integrated into the lecture. On the other hand, resulting mix of calculus, physics (modelling) and a bit of programming is definitely valuable set of skills and in fact closer to what students are likely to encounter in their professional life.

Due to necessary computer support and the fact that this topic does not fit into the ordinary curriculum, it seems reasonable to present these ideas in an online form. Also we should recognize several other consequences:

- This approach represents a slight departure from the IBSE movement by retaining the “theory to practice” format.
- Although it is used to teach physics, due to its nature it seems to be more suitable to structure the content according to mathematical hierarchy (starting with first-order ordinary differential equations, progressing to increased order and dimensionality). Physical principles themselves do not represent the main complexity of the topic.
- It may be beneficial to include applications to other fields as well, since it can improve student’s motivation. Chemical kinetics can be one of the examples.

Project Description

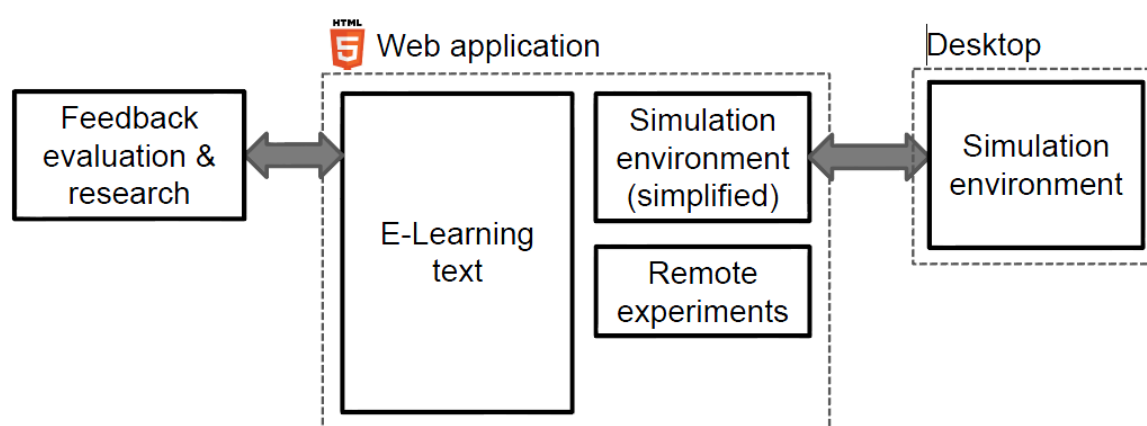

Figure 2. Project scheme

Main goal of the project is the creation of the study materials that are implementing the above mentioned approach. These materials will be available online in the newly developed learning environment. Environment must feature at least simple programming interface that will allow students to immediately test the numerical methods by

implementing their own programs. It is desirable that it also contains sufficient set of motivational and social features, so that students are able to progress through the lectures without external (or more precisely “offline”) help.

It is also possible to connect the environment to the online remote experiments since this technology is already well developed in our laboratory. This connection would allow students to compare the results of simulations with real experiment data.

Seemingly large scale of the project can be significantly reduced by utilizing existing software solutions (see section “Technical Overview”).

Second output of the PhD thesis will contain some form of quantitative evaluation of the proposed approach. The main two research questions are:

- Is current teaching practice successful at giving students competence of practically applying methods of calculus to problems in physics? (or other fields)
- How much can the competence of applying calculus, addressed in proposed teaching material, improve student’s academic results, if at all?

Precise methodology and scale of the research is yet subject of further specification and refinement.

Notable publications and projects

Idea of combining physics and finite difference calculus lectures has been explored by many. Most authors (like [1]) do not seem to provide any precise instructions of putting this idea into practice. Possibly the most notable accomplishment in this field can be seen in the textbook by Ogborn et.al [2], which is currently in use in the British curriculum and contains chapters that incorporate the idea. It is however difficult to evaluate the feedback relevant to this topic as the textbook is also quite innovative in many other areas, therefore the effects are not effectively separable. While the perception seems good overall [3], we can see indications [4] that any innovation in this field necessarily collides with the set of curriculum goals that pre-determines not only the lecture contents, but also to a very large extent the teaching methods.

In the field of computer-aided numerical computation used for teaching there are several projects allowing students to develop their own simulations. In the past the Famulus system was quite popular, today we can give an example of Modellus [5] or to some extent Easy Java Simulations [6]. While these systems encourage the idea of modelling and more or less simplified version of them will have to be developed in this project as well, they are still only computational tools. Students can use them only after they become familiar with calculus concepts and their usage.

Online physics applets such as [7] or [8] also promote concept of simulations and modelling. Although their approach is more phenomenological, they have proven to be a popular teaching aid. Student-programmed simulations will inherit many of the positive properties of applets.

Our review is concluded by relevant running online learning projects. Every year we experience growth, but more importantly *rapid evolution* of internet content as well as rising percentage of people consuming it. We see online learning projects mentioned below as the ones currently pushing the boundaries of new teaching methods and approaches and definitely worthwhile for drawing inspiration for our own efforts. Although probably not

supported by scientific research in whole depth, hundreds of thousands of users using these websites indicate validity of the implemented methods in kind of “proof by natural selection”. However we should always mind the survivorship bias.

Duolingo [9] and Codecademy [10]

These projects are examples of fully self-sufficient learning environments (Duolingo for learning languages and Codecademy for learning programming). They both contain rich user interface, guided way through lectures often in the form of a tree, motivational features such as badges/achievements, automatic testing and also social features such as support forums. All content is highly interactive and reacting to user input.

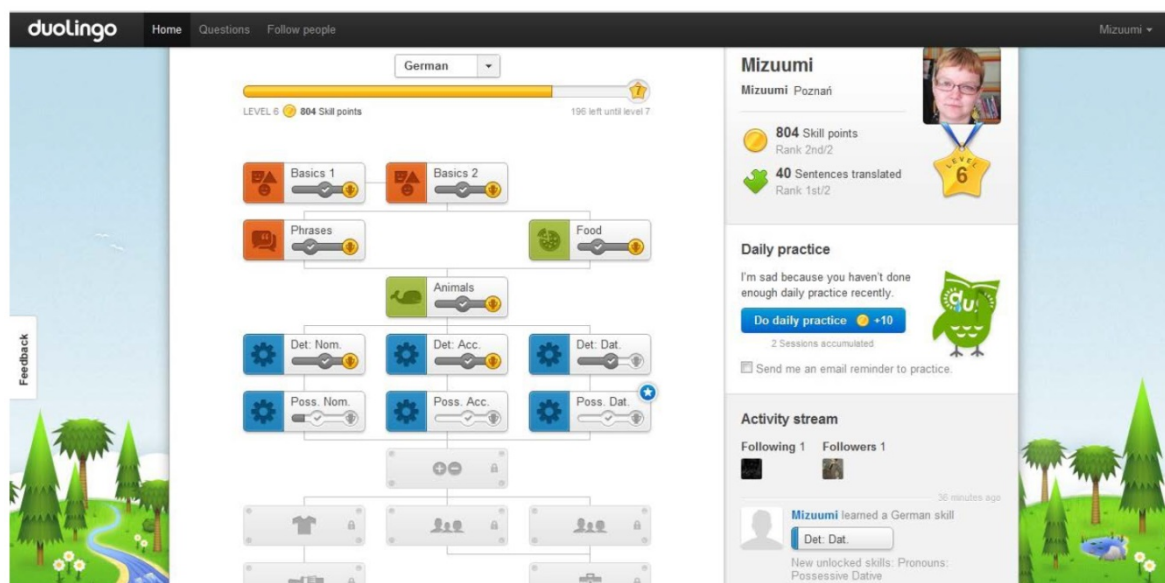

Figure 3. Duolingo user interface

We should point out that Codecademy also contains web-based programming interface allowing users to input the code directly into the web page and run it without installation of any special software. This input is directly linked to the learning text, which immediately reacts to user’s accomplishments or mistakes. Similar form of online programming will have to be incorporated to our proposed project.

Khan Academy [11] and YouTube EDU

These sites represent growing popularity of online educational videos. Khan Academy contains the content of standard school topics as commented videos and enriches them with features similar to the previously mentioned websites. It also contains section related to programming containing online programming environment with both textual and audio instructions. There are ongoing efforts of integrating Khan Academy environment into ordinary classroom [12].

YouTube educational section has hundreds of creators supplying it with the educational videos every day. Even though we can notice several unpleasant side effects of merger between education and entertainment (such as proliferation of mainstream-centred “dumbed-down” content), we can see many new and original approaches to delivering the educational message while successfully keeping the viewer’s attention and engagement. Some of these approaches are even subject of serious research [13].

Technical Overview

Completely unprecedented expansion of internet content consumption in previous 10 years was accompanied by rapid development of the related software technologies. These advances both render development of rich online applications easier and broaden their feature set.

In very recent 2-3 years we are beginning to witness the decline of the Flash and Java technology that was predominantly used for rich content delivery in previous time. Their successor – HTML 5 has already gained sufficient cross-browser/device compatibility to become their viable alternative. HTML 5 as a collection of standards enables to include advanced content directly into the website with native browser support. Technologies such as Canvas2D, WebGL (real-time graphics), Web Sockets (direct client-server communication) or CSS3 are going to be used in the proposed web application.

Apart from the low-level software, seemingly large scope of the project can be significantly reduced by using existing high-level software solutions and by utilizing modern development methods. As for website development, the Python language with the Django [14] framework will be used to significantly lower the development time needed for the core of the website. Modular extension of Markdown [15] mark-up language will be used for creating the learning text to be able to efficiently isolate the presentation from the content.

Processing

We selected the Processing [16] language as a solution to the programming environment and interface. Processing is very simple C-like language supporting OOP. It is developed specifically for the use by programming beginners and is capable to produce visual output very easily. It has gained widespread popularity amongst visual artists and DIY enthusiasts (it is incorporated into Arduino platform) and has good community support. Since it is open-source including the IDE, there are many user-submitted libraries that enhance its features.

Apart from running in desktop environment, the Processing code can be machine-translated to JavaScript Canvas2D code and inserted directly into the webpage. Only few other steps are needed to also be able to type the source code inside a web page, but these were already solved and developed by Khan Academy (open-source as well).

Available resources thus enable us to avoid “reinventing the wheel” and rather concentrate on the content and additional features.

Conclusion

When looking for best ways of teaching physics, we usually test which method is more effective in delivering the given content. However qualities of *both* content and its teaching method are multiplicative factors determining the outcome. It is therefore worthwhile to question the content itself, whether it is sufficiently contributing to the student’s academic growth.

We claim that the important ability students should receive from physics lectures is not primarily proficiency in some specific field, but rather skill of *quantitative analysis of rules governing the measurable world*. Topics discussed in this paper are the special case of

more general competence: skill of mathematical abstraction – ability to translate practical problems to the abstract language of formulas and symbols. Students struggle with this competence along all their study and we can clearly see indications of this happening (difficulties with word problems in math, formula memorizing and input-output matching in physics, etc.).

Skills of memorizing the said physical rules or calculating the results once equations are formed can be seen as inferior to the skill of abstraction. Our proposal for revisiting the finite difference approach to physics is in accordance with this message.

As for the other multiplicative factor, we cannot leave the presentation part behind. Especially in the case the learning happens online, poorly designed interfaces can lead to failure of otherwise interesting ideas. Currently running online learning environments should be one of our design inspirations and use of the most recent technological advancements is a must.

References

- [1] BELU Radian: Using Finite Difference Methods Instead of Standard Calculus in Teaching Physics. Annual ASEE Conference and Exposition (CD Proceedings) Vol. 2007.
- [2] OGBORN Jon, MARSHALL Rick, LAWRENCE Ian: Advancing Physics A2. Bristol : Institute of Physics, 2008. ISBN 0750307811.
- [3] OGBORN Jon: Advancing Physics evaluated. Physics Education. 1 July 2003. Vol. 38, no. 4, p. 330. DOI 10.1088/0031-9120/38/4/307.
- [4] Amazon.co.uk: Customer Reviews: Advancing Physics: A2 Student Book Second Edition: Student Text Book. [online]. [cit. 19.7.2013]. Available from: http://www.amazon.co.uk/product-reviews/0750307811/ref=cm_cr_dp_see_all_btm?ie=UTF8&showViewpoints=1&sortBy=bySubmissionDateDescending
- [5] Modellus. [online]. [cit. 17.4.2013]. Available from: <http://modellus.fct.unl.pt/>
- [6] Easy Java Simulations Wiki | Main / Home Page. [online]. [cit. 10.4.2013]. Available from: <http://www.um.es/fem/EjsWiki/pmwiki.php>
- [7] FENDT, WALTER: Java Applets on Physics (Java 1.4). [online]. [cit. 19.7.2013]. Available from: <http://www.walter-fendt.de/ph14e/>
- [8] PAUL FALSTAD: Math, Physics, and Engineering Applets. [online]. [cit. 19.7.2013]. Available from: <http://www.falstad.com/mathphysics.html>
- [9] Duolingo | Learn Spanish, French, German, Portuguese, Italian and English for free. [online]. [cit. 28.3.2013]. Available from: <http://duolingo.com/>
- [10] Learn to code | Codecademy. [online]. [cit. 20.3.2013]. Available from: <http://www.codecademy.com/#!/exercises/0>
- [11] Khan Academy. [online]. [cit. 20.3.2013]. Available from: <https://www.khanacademy.org/>
- [12] Salman Khan: Let's use video to reinvent education | Video on TED.com [online]. [cit. 19.7.2013]. Available from: http://www.ted.com/talks/salman_khan_let_s_use_video_to_reinvent_education.html

- [13] MULLER D.: Designing effective multimedia for physics education. 2008.
- [14] The Web framework for perfectionists with deadlines | Django. [online].
[cit. 19.7.2013]. Available from: <https://www.djangoproject.com/>
- [15] Markdown. Wikipedia, the free encyclopedia [online]. 2013. [cit. 19.7.2013].
Available from:
<http://en.wikipedia.org/w/index.php?title=Markdown&oldid=563970563>
- [16] Processing.org. [online]. [cit. 20.3.2013]. Available from: <http://processing.org/>

Experiments and Students' Individual Work

Jiri Kvapil

Gymnazium Olomouc-Hejcin, Olomouc, Czech Republic

Abstract

I introduce how my students learn Physics in an active way at our secondary school in Olomouc-Hejcin, the Czech Republic. Optional homework is a very important part of my students' learning. It is based on "Do It Yourself" (abbr. DIY), low-cost equipment and bright ideas. Students have to invent, build or discover something unusual and it is the challenge, they can involve their parents, they can show their results in front of the class, they do not have to be afraid of bad results. Each student builds a low-cost experimental Kit for Electric Circuits. They use them at school during Physics lessons but they bring them home to practice and revise or simply to play with them.

Keywords: homework, low-cost experiment, DIY, kit for electric circuits, Heureka

Experiments and my students' optional homework

I would like to introduce the way I let my students learn Physics in an active way at our secondary school in Olomouc-Hejcin, CZ. It is based on the ideas of the Heureka Project, MFF CUNI Prague, CZ. Thank you, Heureka!

I and my students focus on experiments and measurement from the 1st year (11-12 years old). It is very interesting for many of my students to prepare an experiment and to measure something in an unusual way. They love to do experiments with fire or explosion. We work with candles to learn about states of matter. Wax is the first material except for water with which we show all three states of matter – solid, liquid and gas. I also work with gas for lighters to let them learn about properties of gases. The proof of the presence of a sample of flammable gas in a beaker is one of the most favourite. I also think these experiments are priceless because of the fact that students should be able for example to use matches safely (and many of them are not).

Optional homework is a very important part of their learning. It is based on DIY, low-cost equipment and bright ideas. Students can also work on it in our club at school in the afternoon. They love this type of homework because of four things: they have to invent, build or discover something unusual and it is the challenge for them, they can involve their parents, they can show their results in front of the class and they do not have to be afraid of bad results. I and the class assess their demonstration at school. Their presentation has to explain how they made it, how it works, what is the principle of physics which it is based on. It means where and how physics is used. Then they can get the excellent mark. However, it does not work sometimes or what is worse they are not able to explain why and how it works. Then I record their activity as plus sign into my notes only. They do not get bad marks. We discuss the principle of physics or what to do better next time if it is necessary.

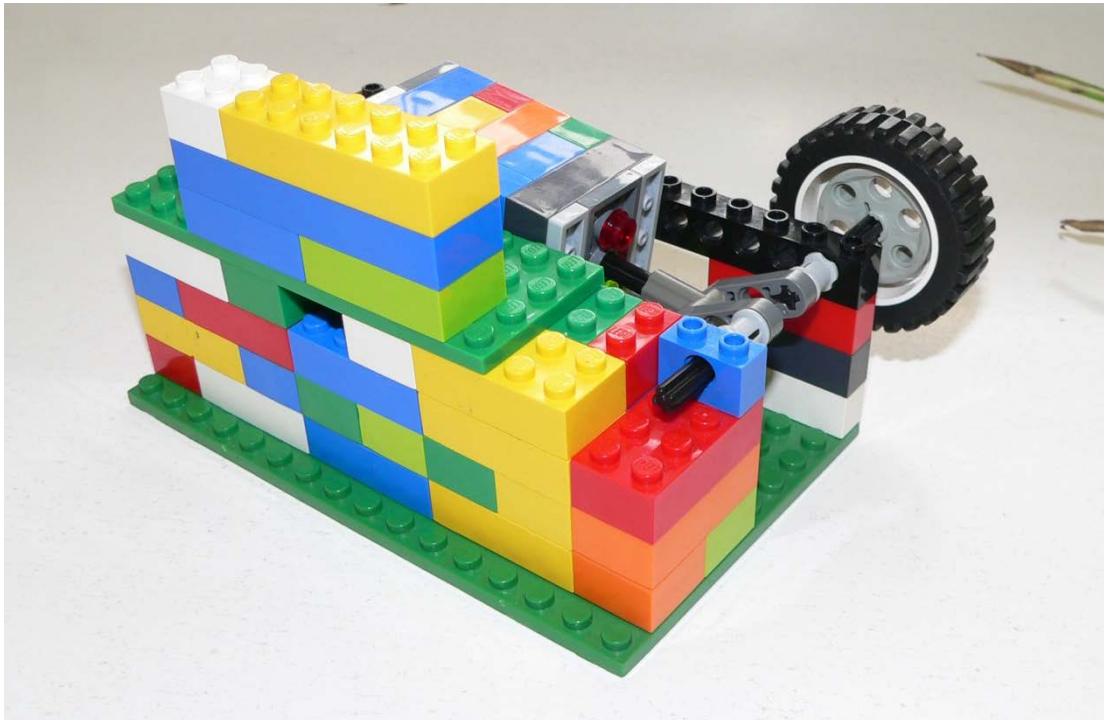

Figure 1. A model of a device which converts linear motion into rotational motion, suggested and constructed by Tomas, 11 years. The hole on the left is the inlet of air from his mouth or a hairdryer. It works 😊.

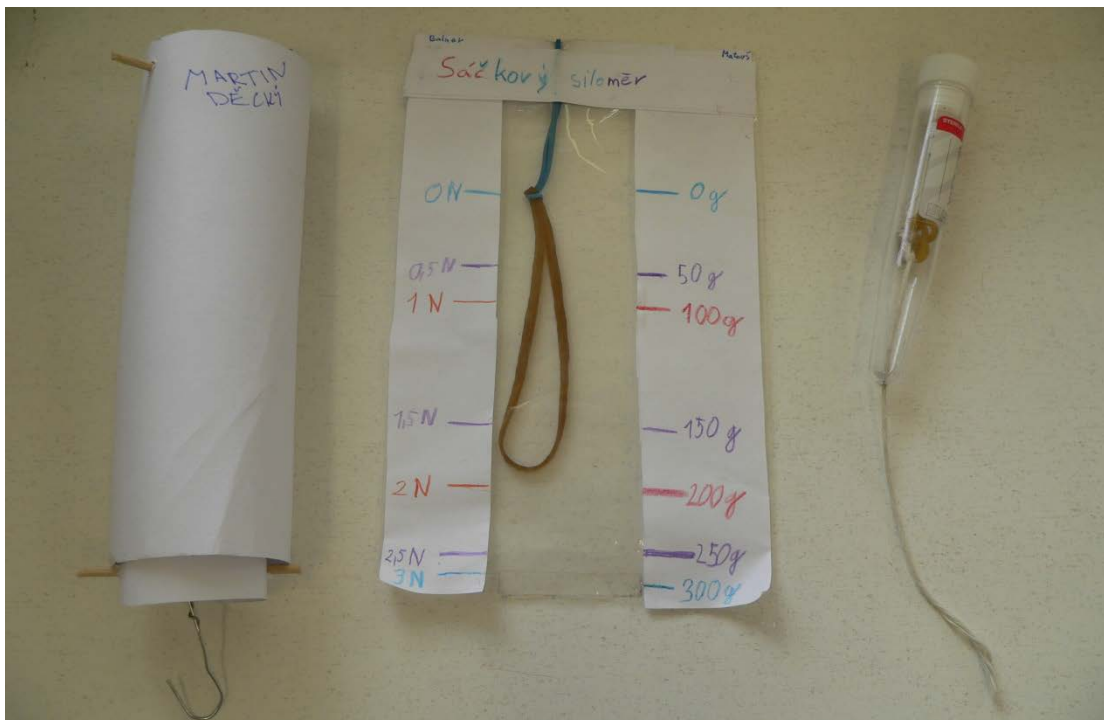

Figure 2. Three dynamometers constructed by students at home

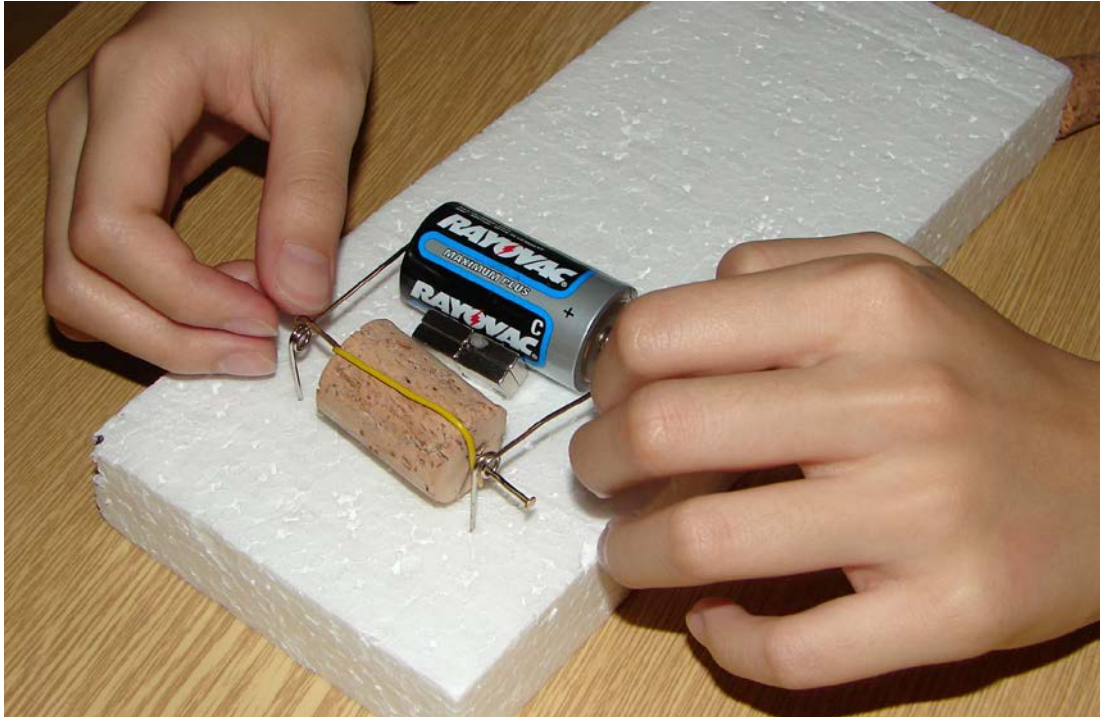

Figure 3. Simple electric motor constructed as voluntary homework

Selection of experiments and measurements to do at home:

1. Try to prove air is fluid using water and two glasses.
2. Measure the sizes of your room in your own unit (e.g. in the lengths of your favourite toy).
3. Construct watches (e.g. sandglass, water clock, candle clock etc.) and state its time interval.
4. Measure the speed of your walking, running, a mechanic toy or a pet.
5. Construct the model of a device which converts linear motion into rotational motion.
6. List all of the ways in which you can measure mass in your household.
7. Make a measuring vessel from a plastic bottle.
8. Measure the volume of your body using the bath.
9. Find in your kitchen different free flowing food and measure their density using measuring cup and scales.
10. Measure the density of an egg and different kinds of fruit and vegetables.
11. Measure the morning outside temperature for fourteen days and draw the graph.
12. Make a dynamometer using a rubber band to measure weight in your own unit.
13. Suggest the experiment to prove Archimedes' Law.
14. Make a vehicle which uses the potential elastic energy to move.
15. Try to find where the refrigerator magnets have the North and South Pole.
16. List the electric devices you use in your household. Find their specifications and order them according to their power.

17. Write a short story about a day without electricity.
18. And also many experiments using the Kit for Electric Circuits. See below.

Kit for Electric Circuit

Why?

Our school has almost no money to buy equipment for the whole class (about 30 students) to work in pairs or individually. On the other hand, students want to make something reasonable and useful. You can offer them to build their own Kit for Electric Circuit. It takes money, it takes time, it requires manual work but it will be worth the effort.

Advantages

My students aged 11 and 12 have found out how hard work it is to make something new. They practiced their fine motor skills which is very useful for their development. They take great care of their new kits because it is the result of their own work. They can keep their kits. What is the best? Girls are not afraid of physics and not even of electricity. My colleague likes this system and started to use it in her class, too. I hope others teachers can do the same.

Disadvantages

If you decide to build kits with your students be prepared it takes time. DIY could be very difficult for some students and they will need your help. I had to help them in free time as well. You should ask students to bring some equipment from home.

Price

The price of low-cost kit depends on the number of items you buy together and on the shops you choose. Panels and fibreboards were manufactured to order at a joiner. To get the best price we bought all the other items together in a few shops in Olomouc, CZ or on the Internet. The total price per kit was up to 10 € including additional panels, LEDs and a transistor. We are going to make the panels with semiconductor components two years later because of our school physics curriculum.

List of items in the complete Kit for Electric Circuits

1. Wires – set of 10 pcs with alligator ends.
2. Wires – set of 2 pcs with an alligator end and a banana pin to connect a multimeter.
3. Panel with a socket and a bulb 3.5V /0.2A – 3 pcs.
4. Panel with a pair of alligator clips.
5. Panel with a siren.
6. Panel with resistors.
7. Panel with a capacitors.
8. Panel with a switch ON-OFF-ON – 2 pcs.
9. Panel with a button switch.
10. Battery 4.5 V.



Figure 4. Some parts of the Kit in a circuit

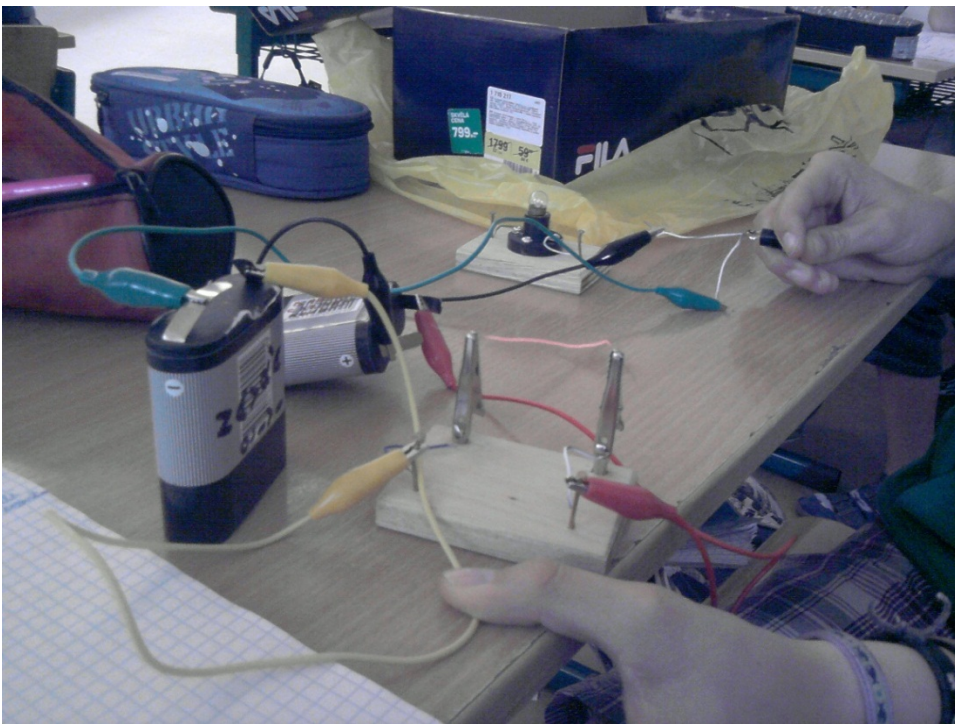

Figure 5. Panel with a pair of alligator clips and a glowing piece of wire

Shopping list

1. Set of 10 pcs of wires with alligator ends.
2. Set of 2 pcs of wires with an alligator end and a banana pin.
3. Panels about 1.2 x 5 x 7 cm – (ply)wood – 10 pcs.
4. Pieces of fibreboard 0.3 x 4 x 7 cm – 3 pcs.
5. Plastic bag for components.

6. Sockets E10 – 3 pcs.
7. Bulbs E10 3.5V /0.2A – 3 pcs.
8. Alligator clips – 2 pcs.
9. Piezosiren for direct voltage incl. 4.5 V – 1 pc.
10. Resistors 100 Ω , 200 Ω , 300 Ω – each 1 pc.
11. Capacitors 220 μF , 2200 μF – each 1 pc.
12. Switches ON-OFF-ON – 2 pcs.
13. Button switch – 1 pc.
14. Brass nails 1.8 cm – 50 pcs.
15. Iron nails about 1.2 cm – 10 pcs.
16. Woodscrews to fix sockets (depends on type of sockets) – 6 pcs.
17. Copper wire 2 m.
18. Battery 4.5 V – 1 pc.

Equipment to build the Kit for Electric Circuits

1. Hammer
2. Pliers
3. Soldering iron, solder wire
4. Glue gun
5. Electric drill
6. Paper or plastic box to store your complete kit
7. Multimeter – recommended for experiments
8. To work hard to make all the items for the kit 😊

Selection of experiments done with the Kit for Electric Circuits

1. examine the conductivity of different materials,
2. find out the conditions of electric current in the electric circuit,
3. observe different effects of electric current,
4. discover the difference between the circuit in series and the circuit in parallel,
5. connect the electric circuit given by a diagram and then we can describe its function by a table of “zeros and ones”,
6. sketch the diagram related to the real circuit given,
7. explore how the charging and discharging of a capacitor depends on its property,
8. work in pairs or groups of three or four if we need more components than we have,
9. connect a big electric circuit throughout the classroom like a Christmas lights string,

10. add another item, e. g. a compass and observe the magnetic field of the wire with electric current.

Response of my students – girls

I asked my students for a short feedback at the end of the chapter Electricity (June, 2012). They should describe if the building of the Kit and then using of the Kit during lessons and home were useful, enjoyable and if their Kit is helpful for learning about electricity in Physics. They could add an own opinion about our Physics lessons generally. It was not a real pedagogical research. It was voluntary task and about one third of the class replied. I chose few answers. All of them expressed similar ideas.

Jitka

I like not only to make the kit but also to connect circuits. It is very good we can bring the kit home to practise it and to do experiments. I have to say I like it and I enjoy it.

Karolína

The work of our Physics teacher is very interesting. The kit for electric circuits is very good idea. The building was boring but the work with electric circuits is very interesting and it helps me very much to understand Physics.

Eliška

The kits are wonderful. I think to have them is much better than to learn anything without them. It is interesting and I enjoy building them. If we only wrote down notes into our exercise books, nobody would enjoy it. I am happy you teach us because we do fantastic experiments, e. g. to burn a sample of propane – butane was wonderful.

One lesson activity – „What is it (for)?“

Several old, discarded devices or their parts are given students to estimate what they are/were used for. Students try to derive or guess it by their components, shape etc. It is the real physics adventure for them.

Preparation

Get about eight old devices and remove their cover. You can also use only inner parts of them. Number them from 1 to 8 and prepare their list for yourself. These items are the “big unknowns” for your students. Prepare a hand-out with a table for each student.

Lesson

1. Give students the prepared hand-outs.
2. Put students into pairs.
3. Distribute the “big unknowns” in the classroom. One item per desk (some desks stay free).
4. Students in pairs (not alone!) browse through the classroom looking at the devices. Each student should note his or her first idea about what it could be. Then they answer in pair. They have only about 2-3 minutes per item in average.
5. Then let them sit down and check their answers. Discuss what the clue to recognize each item was.

Homework: Choose one item and find how it works. Prepare your explanation for others.

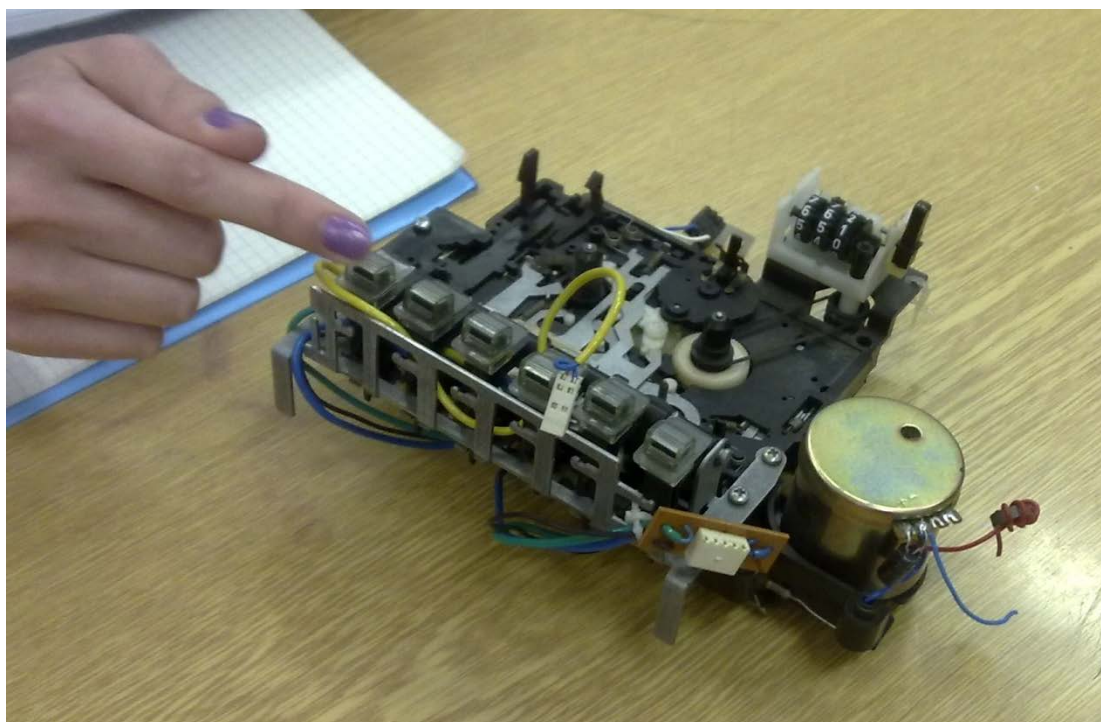

Figure 6. A cassette player inside with many interesting parts

Notes

1. It is important to involve several things which are easy to recognise. One of the most favourite pieces in my class was an uncovered electric iron. Very interesting is the inside of an electric kettle, a calculator and also of a cassette player (see Figure 6) which is for today's children almost unknown. On the other hand, include in this selection things which they have probably never seen because that happens in real life. It could be a high-pressure sodium lamp from a street lamp or an electronic circuit for a fluorescent tube.
2. You can make it easier if you give students a list of possible answers. It is useful to give one more answer than they need.
3. It is very interesting for students at the beginning of the chapter Electromagnetism. This activity helps to motivate students to understand physics principles.
4. You and your students can prepare this activity as a competition for Open Day at your school.
5. Students can spend the next lesson discussing the principles of these devices (based on their homework) more deeply.
6. This activity helps to understand the effects of electric current and the transformation of electrical energy into other types.

References

- [1] The Heuréka Project, [online]. [cit.1.9.2012]. Available from:
<http://kdf.mff.cuni.cz/heureka/en/>

A simple kit for detecting quantitative changes in energy

Yaron Lehavi^{1,2}, Oren Eckstien¹, & Guy Rosenzweig¹

¹The Weizmann Institute of Science; ²The David Yellin Academic College of Education, Israel

Abstract

Energy is often regarded as a difficult concept to teach, mainly because of its lack of a clear definition and because of its abstract nature (Millar, 2005). A possible way to address this difficulty is to refer to energy change as a fundamental concept that can be defined operationally through Joule-like experiments (Eylon & Lehavi, 2010). In this paper we present a very simple, low-cost kit that can be used to demonstrate that a change in temperature is a common result of different processes. The results of two Joule-like experiments: heating by a falling weight (Joule's original experiment) and by a change in motion are demonstrated. Possible implications for teaching the concept of energy are discussed.

Keywords: Joule experiments, energy change, operational definition

Introduction

Energy is often regarded as an abstract concept, which therefore is difficult to understand (Millar, 2005). This view is based on the fact that energy is relative and has no unique measure. In addition, the energy of a system can be described by different variables: height, speed, length (of a spring), etc. This might be one of the reasons for viewing energy as a collection of concepts ("energy types/forms"), which are often difficult to interrelate (Millar, 2005; Lehavi & Eylon, 2010). While this is true for the concept of energy, the change in energy of a system can be detected by measuring the temperature change caused by different processes (Lehavi, 2012). This is evident for such processes as chemical, electrical and light absorption, but it is less apparent in mechanical processes. Thus, performing such experiments in class has the potential to support the unification of the concept of energy and to render it more concrete.

However, although some experiments that involve temperature change are simple and can be easily performed in class, others, mainly those that aim at reproducing Joule's experiments, involve more complex devices.

In his famous series of experiments, James Prescott Joule stated that he found relations between heat and other phenomena, e.g. chemical affinity, electromotive and electromagnetic forces, and even the passage of water through narrow tubes. Joule's experiments, and especially the mechanical equivalent of heat (MEH) experiment, provided a standard measure for processes belonging to domains in nature considered to be disconnected. They laid the foundation for our understanding of the concept of energy change as a measure of such processes. Moreover, Joule's MEH experiment cannot be explained merely by the action of forces. This fact is fundamentally important for justifying the use of energy language beyond mechanics (Arons, 1999).

Surprisingly, however, it was reported that Joule's MEH experiment was omitted from the French curricula (Bécu-Robinault and Tiberghien, 1998) and the same holds for our country (Israel) as well. This, in spite of the MEH experiment's recognized importance in teaching thermodynamics (Sichau, 2000).

Therefore, owing to the great importance of Joule's conclusion with regard to the generality of his standard measure of different phenomena, it is highly desirable to reproduce his main experimental results. Previously we reported on a simple, inexpensive device that reproduces Joule's findings, and we demonstrated the heating potential of mechanical processes: falling, contraction, and braking (Lehavi, 2012). However, this device was based on a bicycle wheel, which required non-trivial mechanical skills to assemble.

Here we introduce a kit that includes, among other instruments, a very simple, small, low-cost, do-it-yourself device with which one can measure the heating caused by a falling weight, a contracting spring, and by stopping a spinning wheel. This desktop Joule device can be assembled from a thermometer and a used computer fan together with everyday objects such as a cork and soft drink bottles.

We will present here student activities for constructing this Joule-like device and the means to employ it in searching for a common feature of different processes. In addition, our kit also includes instruments other than the Joule-like device to measure energy change via the temperature change of other processes such as chemical reactions, light absorption, etc. However, the use of such instruments will not be presented here.

1. Measuring energy change in a falling process

We used the desktop Joule device to study energy change corresponding to change in height. The Joule-like device is shown in Figure 1. The picture on the left shows the whole device and the picture on the right shows only its spinning part. The spinning part is composed of a computer fan to which we attached a flywheel and a cork. We made a hole in the cork where the thermometer was inserted (see the left picture in Figure 1).



Figure 1. The desktop Joule device. The operating fully assembled device (left) and the spinning part (right)

The cork itself was inserted into the opening of a soft drink bottle around which we wrapped a string. For the falling weight in Joule's experiment we used a water bottle that was attached to the string. Thus, when the weight (the water bottle) fell, it caused the horizontal bottle and the cork within it to spin. When performing the measurement, we

held the thermometer tight against the cork to slow down its spin. This, of course, resulted in a rise in the temperature, as measured by the thermometer. We repeated the measurements for different heights and a fixed weight as well as for different weights falling from a fixed height. The results of the former experiment are shown in Figure 2.

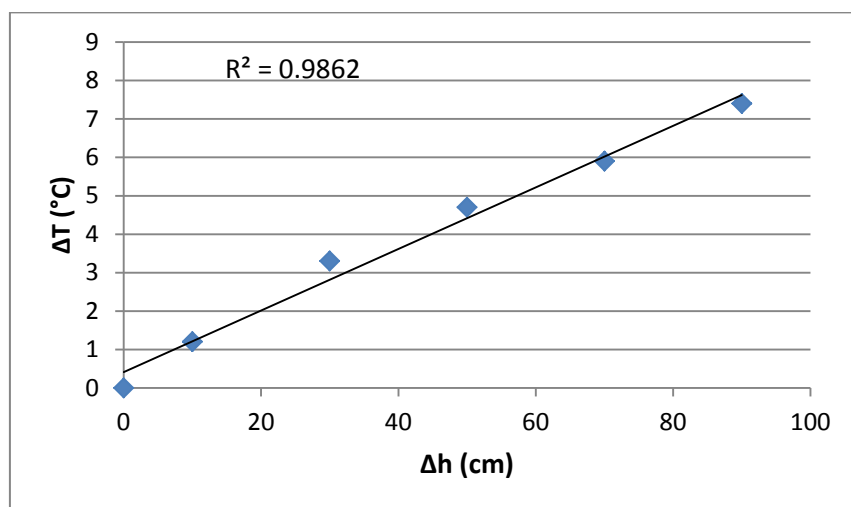

Figure 2. Energy change in the process of a falling weight

As can be seen, the results agree rather well with Joule's findings, namely, that a linear correlation exists between the change in temperature and the height from which the weight was dropped. Such a correlation was also obtained when different weights were dropped from the same height. One can use such results to demonstrate that the change in energy corresponding to the falling process is linearly dependent on both the height and the weight of the falling object.

2. Measuring the change in energy in the braking process

We used the spinning part of the same equipment to study energy change corresponding to change in speed. Here we first attached the computer fan to a power supply and when it reached a steady spin, we measured its frequency. We repeated this measurement for different voltages. After this procedure of scaling, we again attached the computer fan to the power supply and when it reached a steady spin, we disconnected it and stopped the fan's motion by holding the thermometer tightly in the cork's hole (Figure 3a).

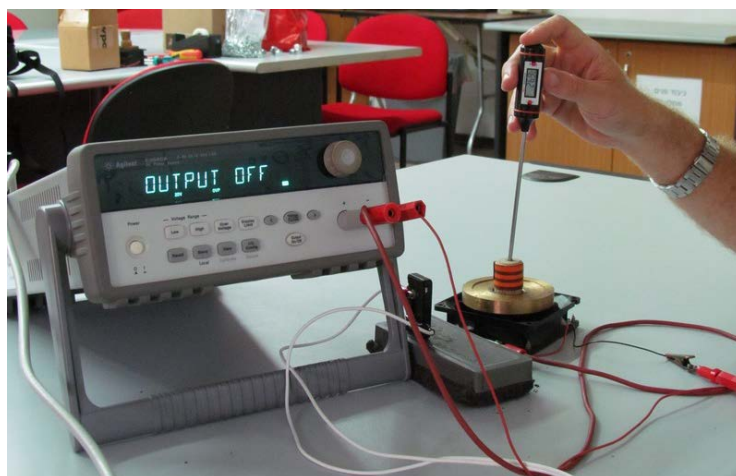

Figure 3a. Measuring energy change via the rise in temperature in the braking process

We then measured the rise in temperature caused by the braking process for different spin frequencies. The results are shown in Figure 3b.

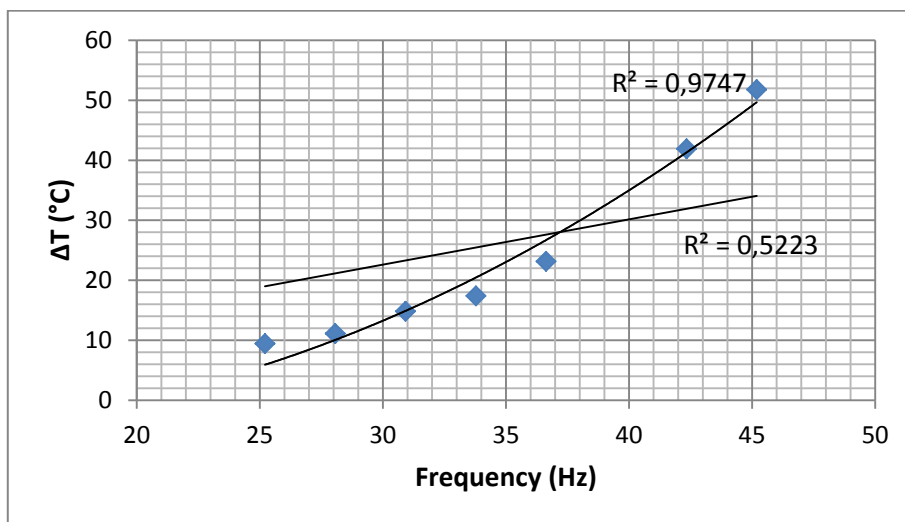

Figure 3b. Energy change in a kinetic process: a parabolic vs. linear correlation

The results clearly indicate that the rise in temperature owing to the braking process agrees much better with the quadratic correlation than with the linear one. Such results can be used to demonstrate the quadratic dependence of the change in energy corresponding to the change in speed (the change in the "kinetic energy").

3. Measuring energy change in the spring contraction process

We used the spinning part of the same equipment to study energy change corresponding to change in spring length. The experiment was similar to experiment 1 but instead of using a falling weight, we attached a spring to the end of the string (Figure 4). We then measured the change in temperature due to different lengths of the spring. The results of this experiment are not presented here — only the experimental setup.



Figure 4: Measuring energy change via the rise in temperature in a spring contraction process

Conclusions and discussion

The first experiment verifies rather well Joule's results with respect to a falling body: the change in temperature is linearly proportional to both the change in height and to the mass of the falling body:

$$1) \Delta T(\text{falling}) \propto m \cdot \Delta h$$

The second experiment, which also employs Joule's approach, confirms that the change in temperature has a quadratic dependence on the change in speed of a given body:

$$2) \Delta T(\text{braking}) \propto \Delta(v^2)$$

Previously (Lehavi, 2012) we have shown that a similar conclusion can also be drawn regarding the process of spring contraction and thus:

$$3) \Delta T(\text{contracting}) \propto \Delta(x^2)$$

If one accepts the idea that the concept of energy change can be defined (operationally) by the change in temperature of a standard body, one can attribute relations similar to those presented in eq. 1-3 also to changes in the value of energy. In other words, one can claim that relations 1-3 describe the changes in the quantity of energy in the processes of falling, speed change, and spring contraction, respectively:

$$4) \Delta E(\text{falling}) \propto m \cdot \Delta h$$

$$5) \Delta E(\text{braking}) \propto \Delta(v^2)$$

$$6) \Delta E(\text{contracting}) \propto \Delta(x^2)$$

The experiments described here support the approach whereby one focuses on energy change as a measurable quantity in teaching the concept of energy (Eylon and Lehavi, 2010). Moreover, our kit also includes means to measure (via temperature change) other heating/cooling processes: a chemical reaction (a burning candle), an electrical process (an electric current), light absorption, and heat (the contact between bodies having different temperatures).¹ Thus, one can conduct the experiments in our kit in order to demonstrate that all these processes have something in common and hence one can justify the use of a common concept – energy change – to describe them.

In addition, one of the reasons why the concept of energy is difficult to teach and understand, as previously mentioned, lies in its abstract nature (Millar, 2005). Therefore, basing the concept of energy on experiments that measure energy change may support its construction as a more concrete concept. We therefore highly recommend that such experiments be integrated into any curriculum addressing the concept of energy.

References

- [1] Arons A. B.: Development of energy concepts in introductory physics courses. *American Journal of Physics*, 67(12) (1999), p. 1063-1067.
- [2] Bécu-Robinault K., Tiberghien A.: Integrating experiments into the teaching of energy, *International Journal of Science Education*, 20(1) (1998), p. 99-114.

¹ These mechanisms, of course, require the use of devices other than our Joule-like instrument. Such devices, as mentioned earlier, are also included in our kit.

- [3] Eylon B-S., Lehavi Y.: Position paper: Energy as the language of changes. In: Heron P. R.L. Michelini, M. (Organizers): "Teaching about energy. Which concepts should be taught at which educational level?" A workshop held within: GIREP - ICPE - MPTL, University of Reims, France (2010). Retrieved from: http://www.univ-reims.fr/site/evenement/girep-icpe-mptl-2010-reims-international-conference/gallery_files/site/1/90/4401/22908/29702/30688.pdf
- [4] Joule J. P.: On the Mechanical Equivalent of Heat. *Philosophical Transactions of the Royal Society of London*, Vol. 140 (1850), 61-82. Retrieved from: <http://links.jstor.org/sici?sici=0261-0523%281850%29140%3C61%3AOTMEOH%3E2.0.CO%3B2-M>
- [5] Lehavi Y.: Reproducing Joule's Experiment(s) in Teaching the Concept of Energy. In: Michelini M. and Heron P. R.L. (Organizers): "Teaching and learning the concept of energy from early childhood school through university" A symposium held within: GIREP - WCPE, Istanbul, Turkey (2012).
- [6] Millar R.: Teaching about energy. Research Paper 2005/11. York: Department of Educational Studies, University of York. Retrieved October 30, 2012 from: www.york.ac.uk/education/research/research-paper.
- [7] Sichau C.: Practising Helps: Thermodynamics, History, and Experiment. *Science & Education*, 9(4) (2000), p. 389-398.

Optics – The spatial and spectral properties of light sources (inquiry-based learning with ICT)

Lenka Ličmanová¹, Libor Koníček¹

¹ Faculty of Science, University of Ostrava, Ostrava, Czech Republic

Abstract

Physics is a very important field necessary for the development of modern civilization. In the Czech Republic, the pupils are not interested in science today. Undoubtedly important part of today's modern education is information and communication technology. The paper describes an experiment on photometry using sensors and ICT in an inquiry-based approach for pupils of age 15-18.

Keywords: spatial properties; light source; spectrum, Vernier; light intensity

Introduction

The aim of this work is to create a set of inquiry-based learning experiments using ICT for secondary school pupils (15-18 years old) in optics. These experiments should development creativity, increase the level of knowledge and skills and teach pupils to work with ICT. In particular, pupils should be able to work with a data logging system and then to process and evaluate the measured data. Then pupils have to create a laboratory report with the following parts: name and title, tools, theory, measurement procedures, measurement data, analysis and conclusion.

Materials & methods

Inquiry-based learning [2,3] is a process where pupils are involved in their learning, formulate questions, investigate widely and then build new understandings, meanings and knowledge. That knowledge is new to the pupils and may be used to answer a question, to develop a solution or to support a position or point of view [4]. Pupils must do an experiment, they will measure with the spectrometer SpectroVis Plus, Light Sensor and Motion Detector by Vernier [5] and then evaluate the measured data using some program such as Excel and create a report. The Light Sensor approximates the human eye in spectral response. It can be used for inverse square law experiments or for studying polarizers, reflectivity, or solar energy. Motion detectors ultrasonically measure distance to the closest object and create real-time motion graphs of position, velocity, and acceleration [5]. Pupils also need light sources, e.g. classic bulb, energy saving lamp (Compact Fluorescent Lamp), LED bulb (Light Emitting Diode) [6].

Inquiry-based learning experiments

Task: 1st problem

The teacher explains to pupils the necessary concepts before measuring (light, light intensity, etc.).

In everyday life we encounter the concept of lighting. From parents and teachers we hear that it is important to read and work with adequate lighting. What is the dependence of light intensity on the distance from the light source (use a classic bulb, e.g. 12 W, 40 W, 60 W)? Suggest an experiment to verify yours hypothesis.

Pupils create a hypothesis about dependence of light intensity on the distance from the light source.

Results:

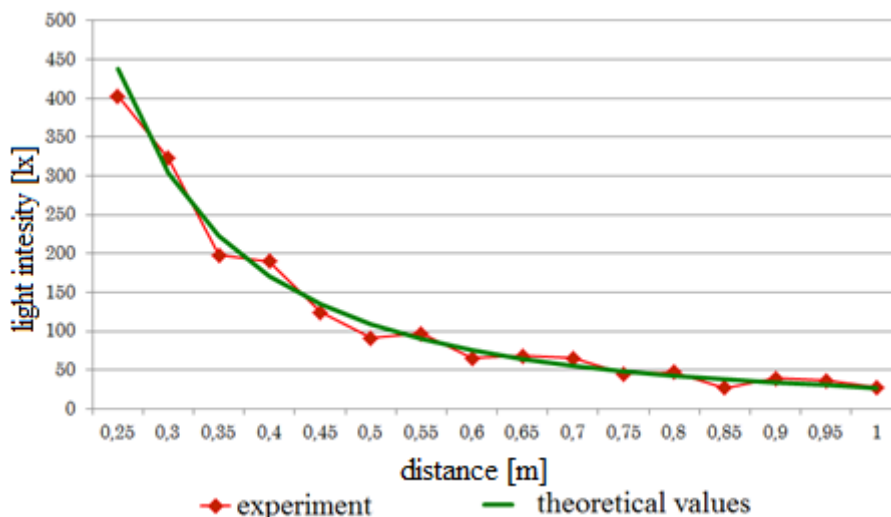

Figure 1. Dependence of light intensity on the distance from the light source (student used small classic bulb 12 W, graph was created by pupils 17 years old)

Pupils find that light intensity decreases with the square of the distance from the light source. Pupils can compare the measured values to the norm of light intensity. Pupil's assumption of dependence of light intensity on the distance from the light source you can see on the graph 2. About 70% of pupils expect that the dependence is linear.

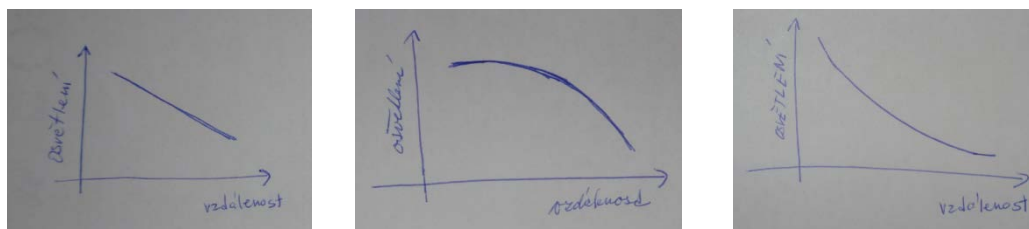

Figure 2. Pupil's assumption of dependence light intensity on the distance from the light source (16 years old)

Task: 2nd problem

The teacher explains to pupils the necessary concepts before measuring (light, spectrum, spectrum of radiation of sun, etc.).

What is light? Is the light of bulbs, of energy saving lamps (Compact Fluorescent Lamp) or of LED bulbs (Light Emitting Diode) good for the eye? Compare the spectral properties of these sources with the spectral properties of the sun.

Pupils create a hypothesis about spectrum of a bulb, energy saving lamps and LED.

Results:

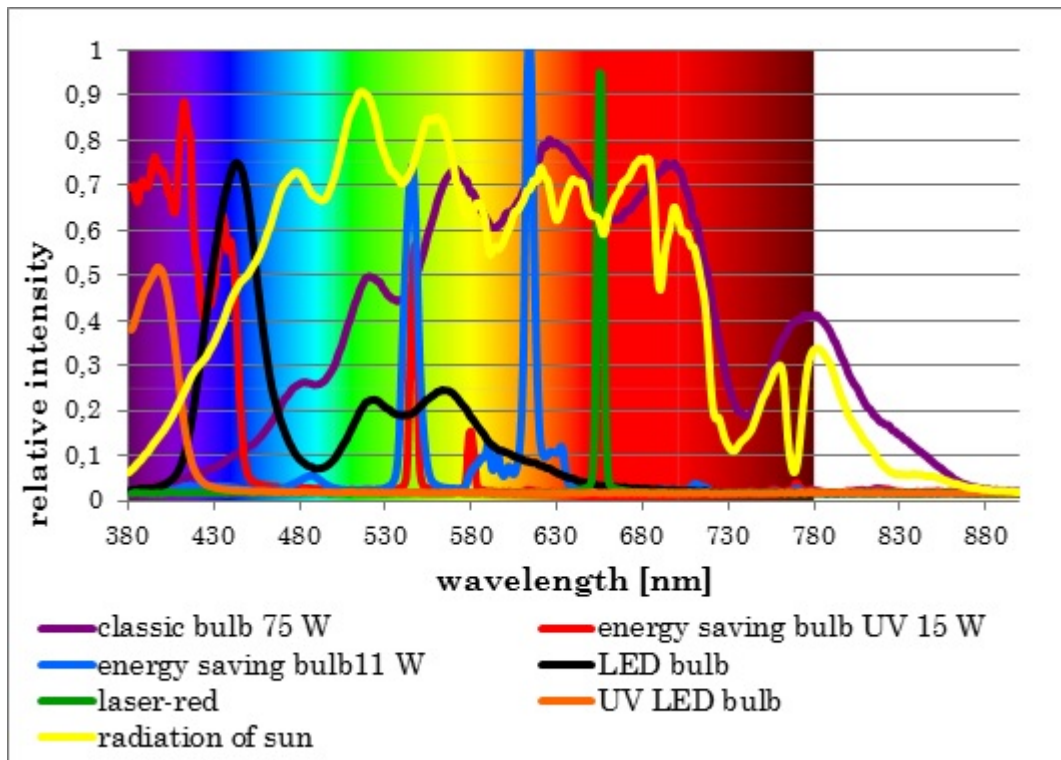

Figure 3. Spectral properties of different light sources (graph was created by pupils 17 years old)

For example, pupils deduce that a classic bulb has a continuous spectrum as well as radiation of sun, and that an energy saving lamp has a line spectrum. With regard to evolution, the human eye was adapted to sunlight and is the most natural sensor for it. A light source which has a spectrum similar to the spectrum of sunlight is also good for the human eye. Pupils are very interested in this experiment, usually they want to measure the spectrum of their screen of their mobile phone or notebook.

Task: 3rd problem

The teacher explains to pupils the necessary concepts before measuring (light, light intensity, input power, etc.).

Is the light intensity of various light sources with the “same wattage” different? How much light generates a bulb, energy saving lamp (Compact Fluorescent Lamp), LED bulb (Light Emitting Diode)? Is the light intensity the same in all directions in space? Estimate, measure and compare.

Pupils create a hypothesis about comparing the light intensity of various light sources with the “same wattage” and about light intensity of light sources in different directions.

Results:

Table 1. Values of light intensity in space, light source was positioned vertically

	0.5 m				1.0 m			
	0°	90°	180°	270°	0°	90°	180°	270°
	light Intensity (lux)							
60 W clear light bulb	196	168	263	163	40	38	61	29
60 W frosted bulb	192	148	262	153	54	30	57	34
11 W Energy Saving lamp (manufacturer claimed that the light bulb has a light as 60 W light bulb)	126	133	134	121	23	24	17	18

Table 2. Values of light intensity at different distances, values of voltage, electric current, wattage

	0.5 m	1.0 m	V	A	W
60 W clear light bulb	277 lux	75 lux	231.3	0.26	62.0
11 W Energy Saving	63 lux	17 lux	231.9	0.07	10.6
12x 1W LED	2313 lux	613 lux	232.3	0.10	12.3

Pupils deduced that light intensity in the space depends on the shape of the source and its construction. Pupils get a taste of light source's properties and which sources are suitable for table lamps and chandeliers. Pupils can compare the measured value to the norm of light intensity.

Task: 4th problem

The teacher explains to pupils the necessary concepts before measuring (light, spectrum, input power, heat, etc.).

Does classic bulb give more light or more heat during increasing input power?

Pupils create a hypothesis about lighting and heating of classic bulb.

Results:

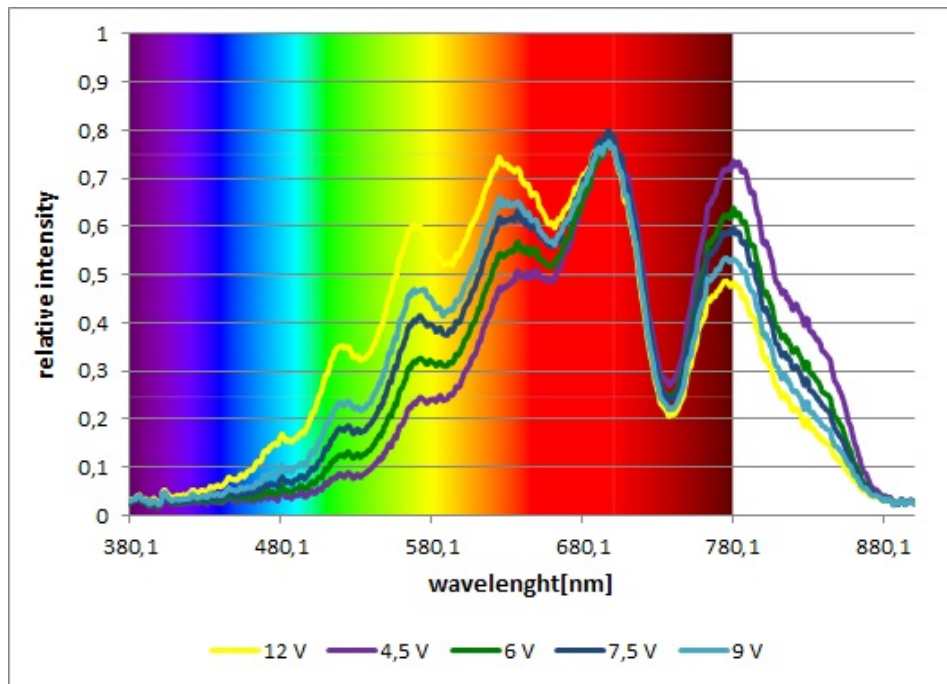

Figure 4. Spectral properties of a bulb with different input power

Pupils deduce from the graph that at higher input power bulb has a higher intensity of the visible area and a lower intensity of the infrared area.

Problem

There is a one problem with spectrometer. As you can see from this Figure 5.

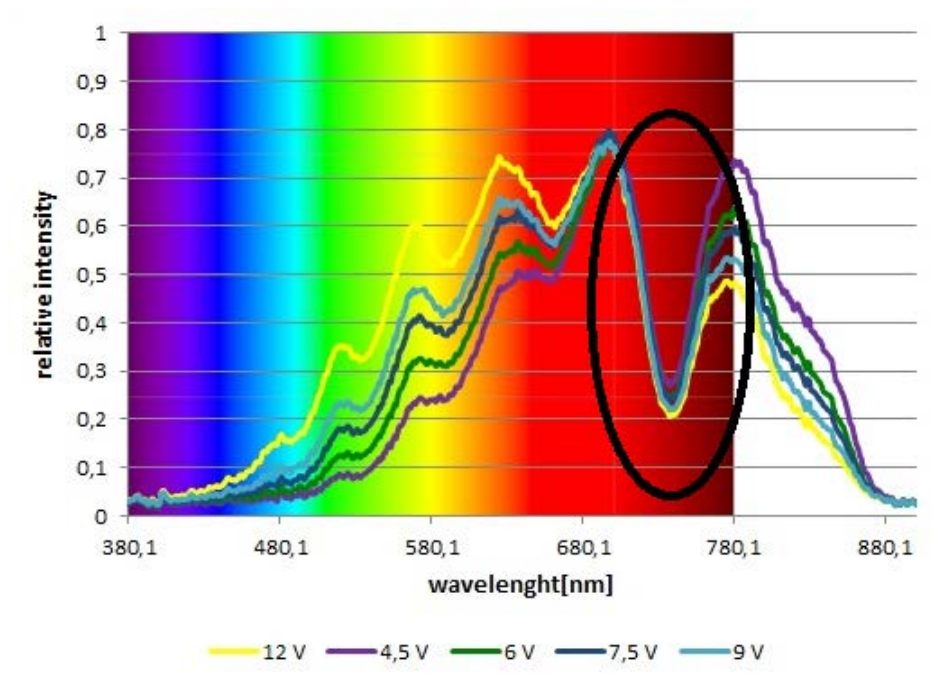

Figure 5. Problem of spectrometer

There should not be a significant minimum in the marked area and curves should be smooth also. Spectrometer consists of five sensors, responsive to a certain light wavelength ranges. The sensors are not well-sensitive in the areas of transition between the two light wavelength ranges. This error is the same for all spectrometers of this type. We will try to calibrate the spectrometer.

Conclusions

These experiments show that photometry is an interesting part of physics. Pupils appreciated the modern equipment during measurement and appreciated that the task related to their everyday life. About 30 pupils (15-19 years old) took part in the try-outs. In the autumn of 2014, the research will be done with a larger sample of pupils. In the group which will learn by methods of inquiry-based learning there will be about 100 pupils and in the group which will learn by the traditional way there will be also 100 pupils.

References

- [1] KEKULE M., PÖSCHL R., ŽÁK V.: *Jak to vidí žáci. In DVOŘÁK, I. Lze učit fyziku zajímavěji a lépe?* Praha : Matfyzpress, 2008. ISBN 978-80-7378-057-9.
- [2] Mintzes Joel, H Wandersee, James a Novak, Joseph, Donald.: *Teaching science for understanding: a human constructivist view.* San Diego, CA : Academic Pres, 1998. ISBN 01-249-8360-X.
- [3] Redish, Edward F.: *Teaching physics: with the physics suite.* Hoboken, NJ : John Wile, 2003. ISBN 04-713-9378-9.
- [4] Focus on inquiry: a teacher's guide to implementing inquiry-based learning. *Alberta.* [Online] 2004. [Citace: 25. 07 2013.] <http://education.alberta.ca/media/313361/focusoninquiry.pdf>.
- [5] Senzory. *Vernier.* [Online] 2014. [Citace: 25. 07 2013.] <http://www.vernier.cz/produkty/podrobne-informace/kod/svis-pl/>.
- [6] SEVEN. *Energeticky úsporné osvětlování v domácnostech - přehled technologií a legislativy.* Praha : Zastoupení Evropské komise v České republice, 2010.

Science toys

Kateřina Lipertov

Catholic Grammar School, Plze, The Czech Republic

Abstract

Making science toys is a real cross - border activity, it includes Physics, Mathematics and Art. Making toys is loved by kids because it's both, science and fun. Toys can be made from common household materials but they can demonstrate scientific principles very well.

Keywords: science, toys

Why to make science toys?

I work as a Physics teacher with pupils aged 11-14.

A good way how to draw kid's attention is to let them build their own „machines“. This is a playful way of exploring scientific principles. It's science, it's fun and it's work with real materials. Science toys made by pupils are a very popular part of experiment presentations and shows we do for parents and friends in our school or for passers-by at the “Science on Street” in our city.

The most favourite toys my students like to make are: dancing bugs with an eccentric motor, pencil-legged drawing robots, cardboard automata, marble machines, the Archimedean screw and water pumps, optical toys and illusions, balancing toys and a legless bench.

The activities such as the hot-air-balloon day, the water rocket competition, building a solar oven or Leonardo's self-supporting bridge are also very popular with students.

It's impossible to describe in detail all kinds of toys we make, so I chose some of them and I added links to videos from our school projects. The videos are also made by pupils.

Dancing bugs

What is a dancing bug?

A dancing bug is a robot-toy that seems to dance (Figure 1 and 2). It is made from a recycled CD, a DC motor with an eccentric load, a battery and couple of wires.



Figure 1. The dancing bug



Figure 2. The dancing bug

The pencil-legged bug (robot) even draws pictures (Figure 3). The legs can be also replaced by a brush. Our favourite one in the “school bug collection” is a bristlebot called

“The brush for a lazy housewife” (Figure 4). You can also make the body of the robot from an old tin and create a “Noisemaker” (Figure 5). The nice one is the little robot made from a toothbrush and an eccentric motor for vibration from a broken mobile phone (Figure 6).



Figure 3. The pencil-legged robot

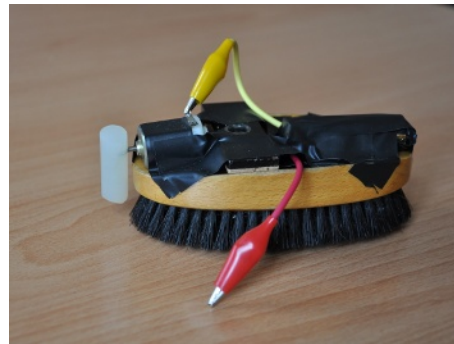

Figure 4. „The brush for a lazy housewife“



Figure 5. “The Noisemaker“



Figure 6. The dancing bugs made from toothbrushes

What do we need?

A hot glue gun, a glue stick, six pieces of thick wire, a wire cutter, pliers, scissors, a battery (AA), a recycled CD, one wire with alligator clips, duct tape, 3 volts DC motor (Figure 7), pipe cleaners, paper, beads, googly eyes and other materials for decorating.



Figure 7. Tools and materials needed for making a dancing bug

How to make a dancing bug?

1. Cut six pieces of wire.
2. Bend the wires.
3. Glue it to the CD (Figure 8).



Figure 8.

4. Cut the wire with alligator clips in two.
5. Strip off about 2 cm of plastic at the ends of the wires.
6. Tape the wires to the battery (Figure 9).



Figure 9.

7. Glue an off-center weight (a piece of glue stick, an eraser, a little pencil) to the shaft of the motor (Figure 10).



Figure 10.

8. Tape the battery and the motor to the CD (Figure 11).

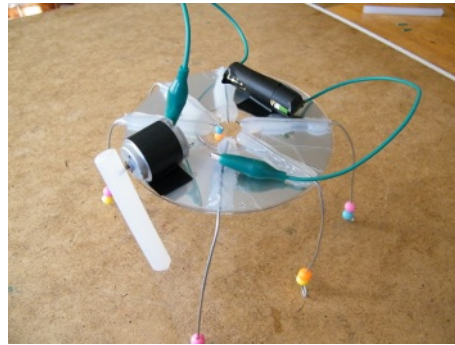

Figure 11.

9. Decorate the bug.

10. Connect the wires to the two motor leads (Figure 12).



Figure 12.

How does the bug work?

The offset weight on the shaft of the motor causes a rotational vibration and it allows the bug to “dance“. The same effect can sometimes be seen when the washing machine is “dancing” because of the unbalanced load of laundry.

In contrast, car wheels, airplane propellers or computer drives have to be well balanced to avoid a vibration.

All robots in the pictures above are made by 11-year-old kids. At the moment they make their robots-bugs they already have experience in making a simple electric circuit with a battery and light bulbs. After (or before) the kids make their bugs they discuss the question: How does the bug with a balanced load move? Then the kids build a robot using an electric circuit with a balanced load. The robot doesn't move at all. It is very useful too to compare the difference between the “more” and “less” off-set load.

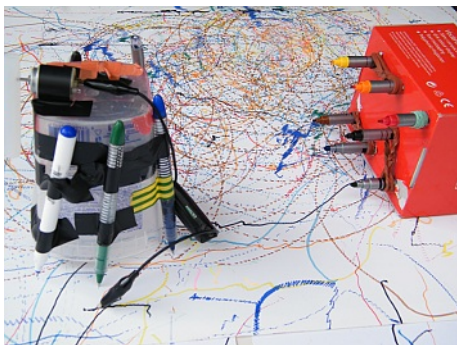

Figure 13. The pencil-legged robots (artbots)

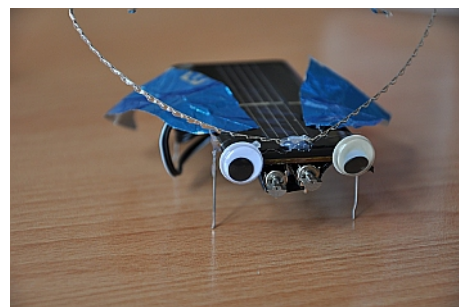

Figure 14. The solar bug

The pencil-legged robot (artbot) is also very popular with kids (Figure 13). The kids can easily change the position of the legs-pencils just by taping them on the other place or add some more pencils and create completely different pictures.

The kids can use a solar cell instead of a battery and create a solar bug (Figure 14).

The advanced task is to make a bug with blinking eyes using an astable multivibrator circuit. The figure 15 shows the blinking-eyed bug made by two 15-year-old girls.

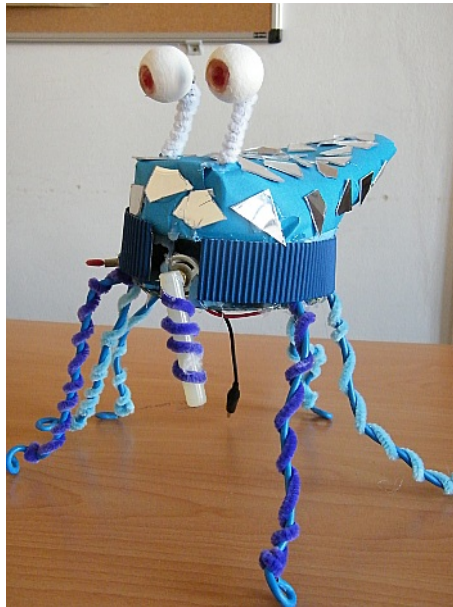

Figure 15. The blinking-eyed bug

More bugs and robots in our video on YouTube [8].

Cardboard automata

What is a cardboard automaton?

The basic principle of the automaton is to turn a circular motion into the other kinds of motion, e.g. the back and forth, up and down, side to side or round and round motion. Making cardboard automata is a nice way of exploring levers, cams, linkages and other mechanisms. These machines-automata are a good example of integrating science and art into one activity. The automata can be made very easily from cardboard, drinking straws and barbecue sticks and they can be designed any way the kids like it, e.g. a pirate ship (Figure 16 and 17), a dancing flower, a flying pancake, a butcher chasing a pig.

The 11-year-old kids are able to make a cardboard automaton by themselves. The younger kids mostly need a little help. But there is no special rule how the automaton should look like and how complicated it should be. Small kids can use only one cam for their automata. The very important part of work is designing the automaton. Even a simple automaton can look nice and “lively” when designed in an interesting way.



Figure 16. The pirate ship – an cardboard automaton made by 12-year-old girl



Figure 17. The pirate ship – an cardboard automaton made by 12-year-old girl

What do we need?

Some cardboard, a cardboard box, a glue gun, drinking straws, barbecue sticks, scissors, paper cutter, rubber bands, materials for decoration.

How does the automaton work?

Probably the most commonly used part of an automaton is the cam. The cam is simple to make and very versatile. The cam works in conjunction with a cam-follower which follows



Figure 19 a. The round and round motion



Figure 19 b. The round and round motion

the movement of the cam and transfer it to the working area. Cams turn on a shaft and need to be offset to create a mechanism that can lift. Different cam shapes give different patterns of movement.

In order to design a cam we need to know what we want it to do.

A) The round and round motion

E.g. a merry-go-round

The shaft goes through the centre of the cam (Figure 18 and 19 a, b). It is not offset.

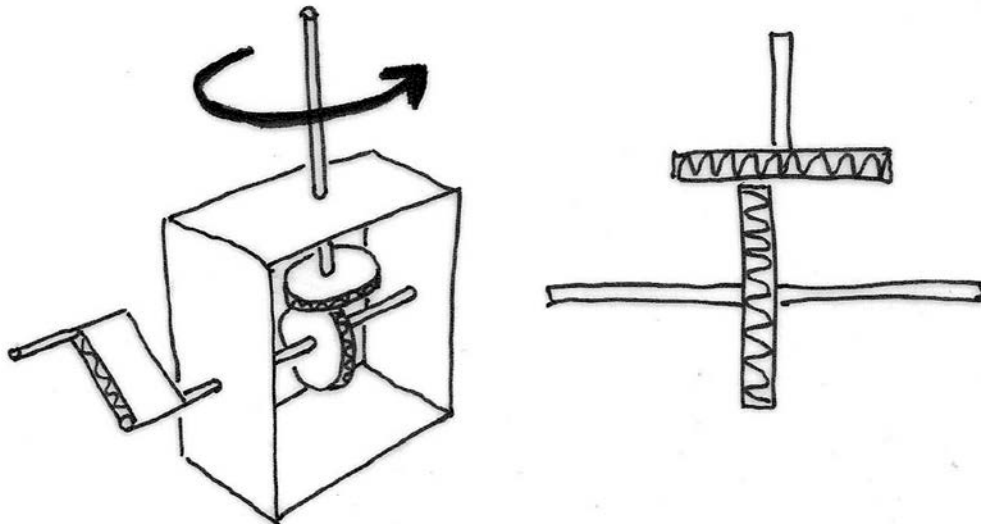

Figure 18. The round and round motion

B) The round and up and down motion

E.g. a ballet dancer

The shaft is offset (Figure 20 and 21 a, b).

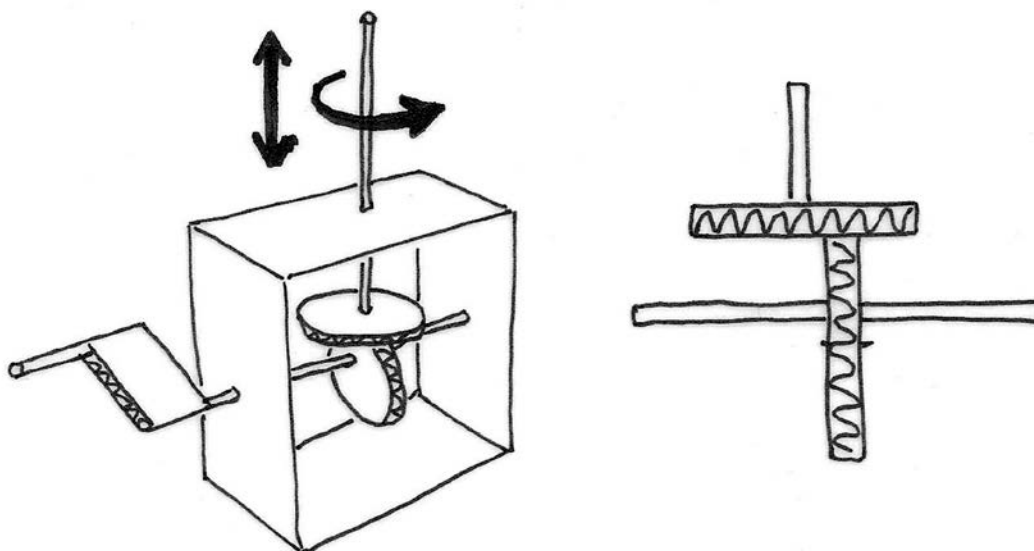

Figure 20. The round and up and down motion



Figure 21 a. The round and up and down motion



Figure 21 b. The round and up and down motion

C) The side to side motion

E.g. a rocking chair, a boat in the sea (Figure 22 and 23)

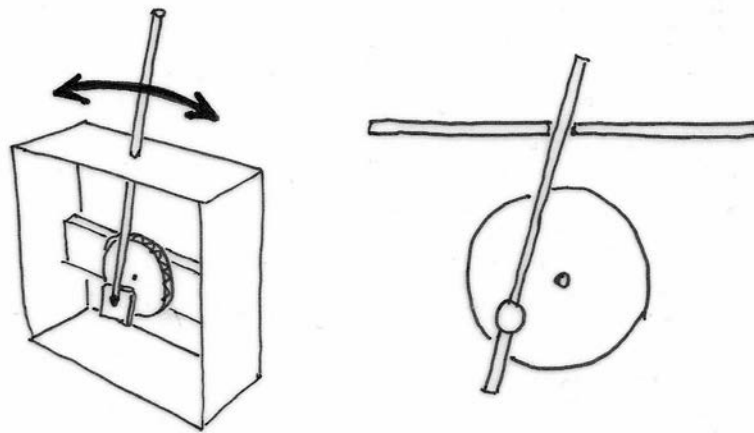

Figure 22. The side to side motion



Figure 23 a. The side to side motion



Figure 23 b. The side to side motion



Figure 23 c. The side to side motion

D) The up and down motion

E.g. a jumping frog

An egg-shaped cam makes a smooth movement pushing the cam follower up and down (Figure 24). The round cam can be used too, in that case the shaft must be offset. This cam produces a turning motion on the push-rod. This may only be very slight but can cause problems. To eliminate the turning affect you can build stops to prevent turning.

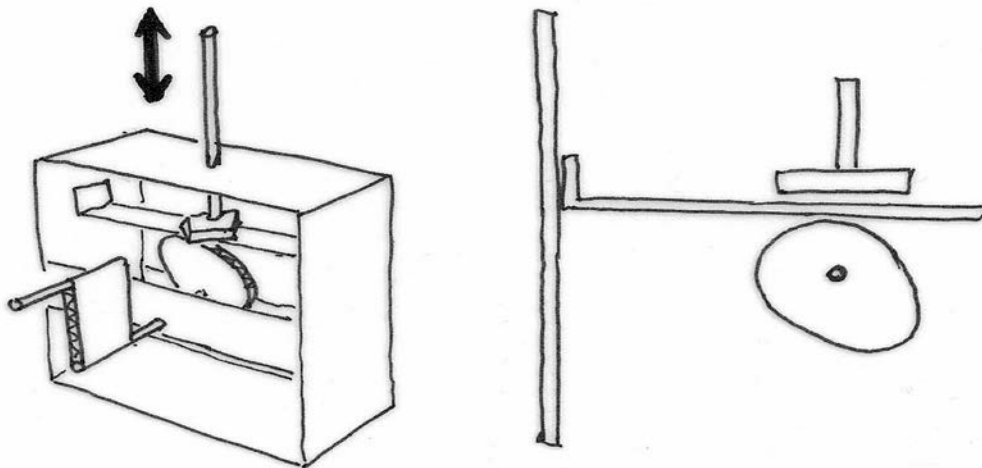

Figure 24. The up and down motion

E) The up and down, back and forth motion

E.g. a man watching tennis match (Figure 25)

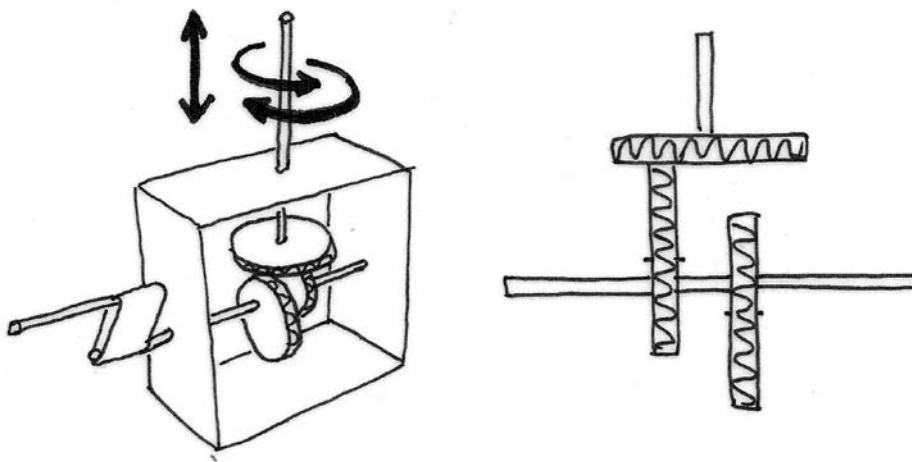

Figure 25. The up and down, back and forth motion

F) The smooth uplift which suddenly drops down

E.g. a man with a nail and a hammer

The snail (or drop) cam allows the cam-follower to rise smoothly and suddenly drop down (Figure 26). This cam can only work in one direction. If you turn it the other way the cam-follower would jam.

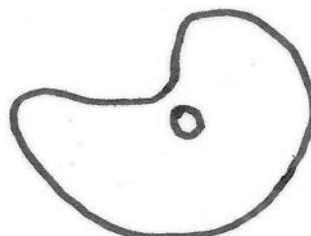

Figure 26. The snail cam

G) Several short movements from one revolution

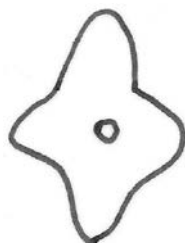

Figure 27. The irregular cam

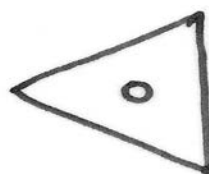

Figure 28. The triangle cam

The figure 27 shows the cam which produces four short up and down movements from one revolution. The figure 28 shows the cam which produces three very distinct movements from one revolution.

How to make a cardboard automaton?

1. Prepare a cardboard box.
2. Draw your cam and cam follower on the cardboard and cut them out.
(The cam should be about 6 cm in diameter.)
3. Put your cam on a barbecue stick inside the box.
4. Make a handle from a piece of barbecue stick and cardboard (Figure 18).
5. Glue it to the shaft (the barbecue stick with the cam).
6. Poke a hole for the cam follower in the top of the box and insert a drinking straw.
7. Glue a piece of drinking straw in place (Figure 19).
8. Glue the cam follower on the end of a barbecue stick and put it through the straw.
9. Adjust your cam under the cam follower then glue the cam into place on the shaft.

In this project the kids will learn about using mechanisms to control movement in an automaton. In the process of making automata they will develop their designing skills. They will also practice and extend their making skills through accurate cutting and gluing, measuring and prototyping.

This project is very popular with my students. It includes not only making and designing an automaton, but also sharing information and ideas in a group to develop ideas and overcome problems, presenting automata at the school exhibition and making a video from the project. For more details you can watch our video on YouTube, presenting automata made by 13- year-old kids [9].

Leonardo's bridge

Leonardo's bridge is a great activity for both, kids and adults. It can be used in Physics lessons, as a team building activity, or just for fun. The task is to build a bridge over a river. You mustn't use any nails, any ropes, any glue. There are only wooden sticks needed to realize it.

Sometime around 1485-1487, Leonardo da Vinci devised a method for building a self-supporting arched bridge that doesn't require any ropes or other fasteners. The bridge's own weight keeps it together. This bridge is a fascinating example of early bridge building architecture and the system of interlocking forms is a truly ingenious. It was originally meant to be a quick bridge for military usage - just bring along the pre-cut pieces and slot them together. It's no surprise that Leonardo DaVinci was the inventor who came up with it.

I have lots of experience with this activity with high school students (aged 12-19), I build the bridges with passers-by at Science on Street in our city (Figure 28 and 30) and I lead workshops for Science teachers. The activity is loved by everyone, because it's science, it's fun and it's work with real materials. The favourite part of the building is colapsing the bridge, of course:



Figure 28. Science on Street, Plzen 2009
Figure 29. The bridge from dowels with notches

The students build the bridge from flat wooden sticks (Figure 28, 30, 32), the bridge from boards which they can stand on (Figure 31), the bridge from coffee stirrers (Figure 33) and the bridge from dowels with notches (Figure 29). They work in teams (2-4 persons). The stability of the bridge is really surprising. The heavy bridge made from boards is the most stable, of course. Leonardo's bridge is a nice hands-on Physics activity with real-life application. The students learn a lot about forces, friction and stability.



Figure 30. Science on Street, Plzen 2009



Figure 31. Testing the bridge in our gym



Figure 32. Transporting the bridge

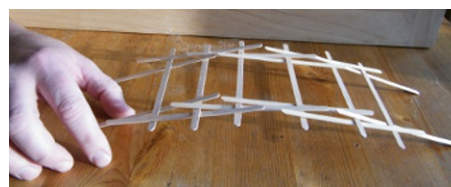
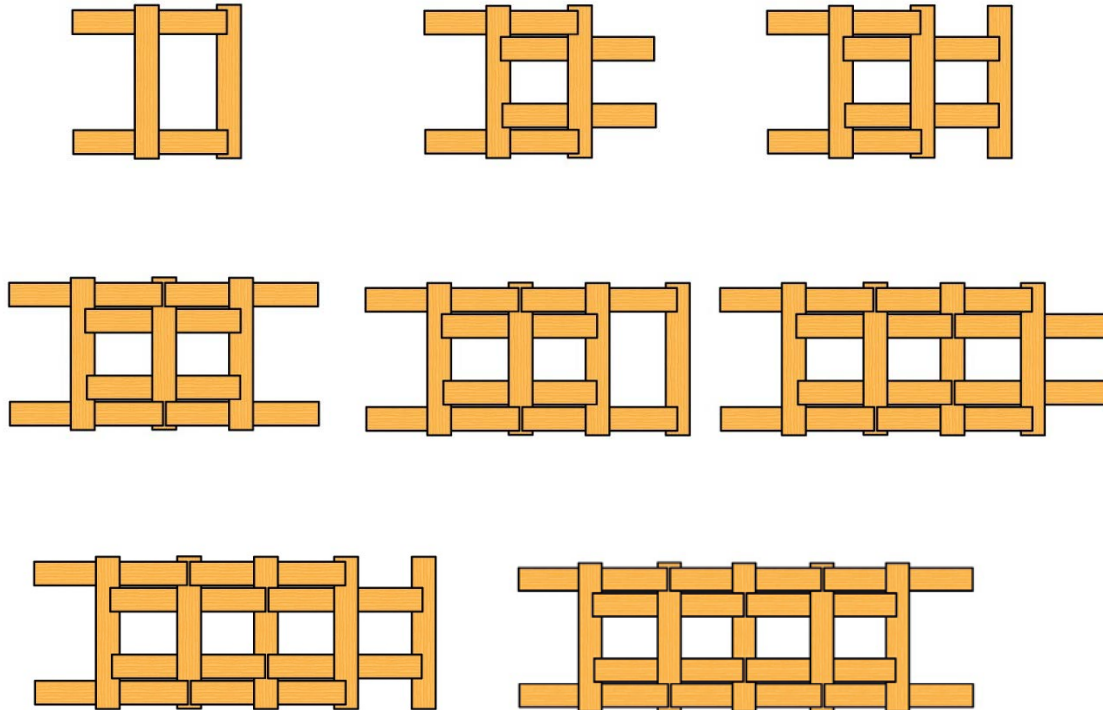

Figure 33. The bridge made from coffee stirrers

How to build the Leonardo's bridge from wooden sticks?

Work in teams (2-4 persons)!

You need: 15-30 flat wooden sticks (e.g. 5 x 45 x 365 mm)



Try also using rulers, pencils, coffee stirrers etc. Try to build the bridge you can stand on. Don't worry! It's stable enough! (I use boards 20 x 145 x 920 mm). Our video instructions [7] can be useful too.

How to build the Leonardo's bridge from dowels with notches?

You need: 15 dowels – the same length (e.g. 12 mm diameter, 250 mm length)

10 of the dowels with notches

5 of the dowels without notches

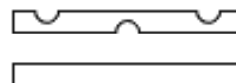

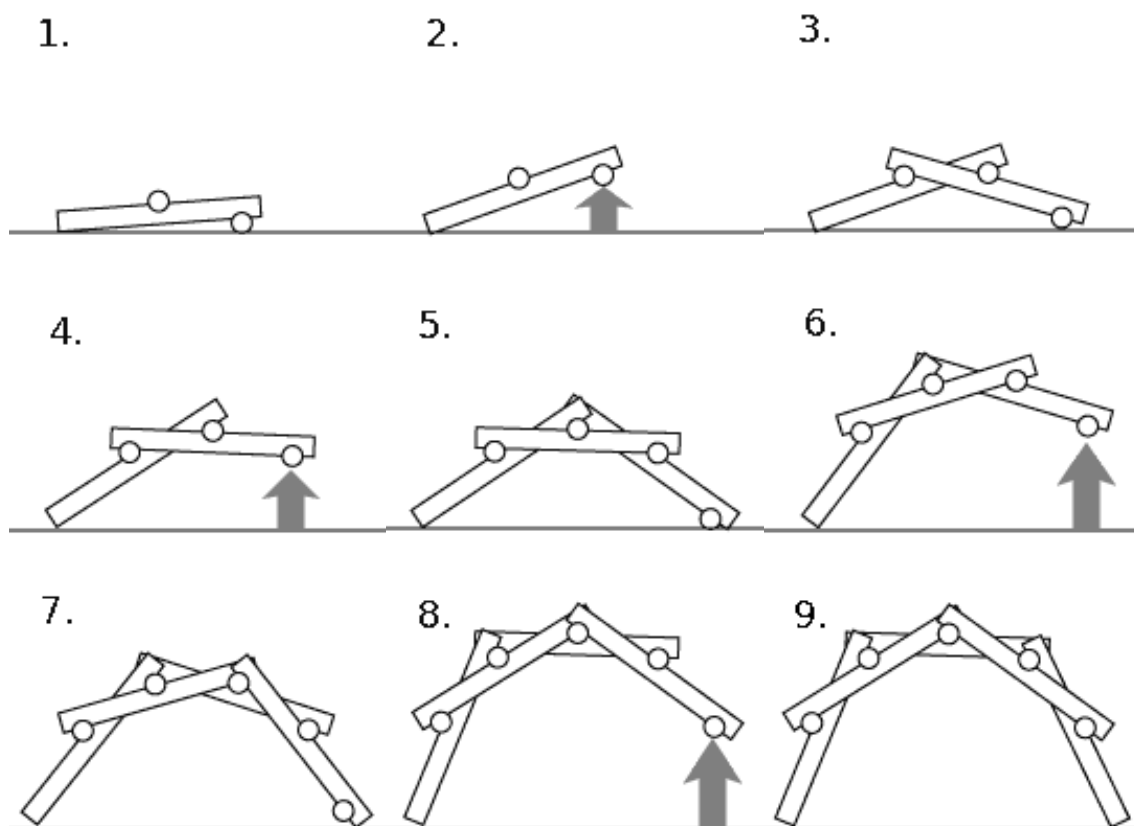

Leonardo da Vinci was not only the ingenious scientist, he is considered to be one of the greatest painters of all times and perhaps the most diversely talented person who has ever lived. The Leonardo's bridge-activity can be a starting point for a bigger school Leonardo Project. The kids can find information related to Leonardo da Vinci's life, his paintings, inventions, drawings and much more.

Conclusions

All toys described above are made from trash and common household materials but they can demonstrate scientific principles very well. No special skills and tools are required.

The today's kids have plenty of toys, of course. But making an own toy is something completely different. The kids become "real" designers and scientists. Making science toys is a real cross-border activity, it includes Physics, Mathematics and Art. It is loved by kids because it's both, science and fun.

The Science Toys Exhibition belongs to the "highlights" of the school year in our school.

References

- [1] Addams R.: How to design and make simple automata. 1st ed. Hampshire: Pardyand Son Ltd., 2003.
- [2] Ives R.: Cardboard engineering source book. Flying pig 2013
<http://www.robives.com/ebooks/cesb> (Accessed 10 .9. 2013)
- [3] Dvořák L.: Blikač, bzučák a stroboskop. Dílny Heuréky 2012, Sborník konference projektu Heuréka (Náchod, 5. – 7. 10. 2012). 1st ed. Praha: Nakladatelství P3K, 2012.

- [4] Lipertová K.: Brouci a hejblata. Dílny Heuréky 2011, Sborník konference projektu Heuréka (Náchod, 30. 9.-2. 10. 2011). 1st ed. Praha: Prometheus, 2011.
- [5] Lipertová K.: Leonardův most. Dílny Heuréky 2008, Sborník konference projektu Heuréka (Náchod, 26.-28. 9. 2008). 1st ed. Praha: Prometheus, 2008.
- [6] The Exploratorium (2014). Available at: <http://www.exploratorium.edu> (Accessed 10.3. 2014)
- [7] Lipertová K.: [Katka Lipertova]. (18.3. 2013). Leonardo's bridge-Leonardův most [Video file]. Retrieved from <http://www.youtube.com/watch?v=ivhDiIadRcg>
- [8] Lipertová K.: [Katka Lipertova]. (15.4. 2011). Brouci a jiná hejblata 1-fyzika v akci [Video file]. Retrieved from <http://www.youtube.com/watch?v=rf-QP0gfKiE>
- [9] Lipertová K.: [Katka Lipertova]. (9.4. 2011). Hejblata-fyzika v akci [Video file]. Retrieved from <http://www.youtube.com/watch?v=F-eGva4094M>

Investigation of smart fluid properties in secondary schools

Tibor Medvegy

University of Pannonia, Institute of Physics and Mechatronics, Hungary

Eötvös Loránd University, PhD School of Physics, Hungary

Abstract

The electrorheological and magnetorheological fluids are complex liquids which can rearrange their structures in the presence of an electric or magnetic field. As the result of these structural changes the viscosity of these fluids increases up to several orders of magnitude. For these fluids— due to their controllable viscosity— there are many applications emerged in the modern engineering. In my work I will show methods, how to familiarize high school students with the physical causes of the behaviour of these advanced products of physics and materials sciences. In this paper, I will present a series of laboratory demonstrations as well as experimental investigations, which can easily be performed in the classroom. I will also show how smart fluids can be prepared given the kinds of equipment school teachers have at their disposal.

Keywords: electrorheological fluid, magnetorheological fluid, smart fluid

Introduction

If we look around in the world of technology, we will notice that surrounding objects we use in everyday life are becoming smarter. The TVs, refrigerators, washing machines, telephones, watches and even the houses are getting smarter, they include more sensors and actuators and possess more PC-like functions. This change does not only concern our devices, but also the materials used in them. Modern material science refers these as smart materials. It is difficult to give a good definition to these substances, because in many cases the type of use can make a material "smart". Perhaps the simplest way, we can say that a substance may be called intelligent, if they change their properties as the result of external effects beneficial for the user. Nowadays they may be either liquids or solids and it is also very likely that we do not have to wait much longer for the appearance of smart gaseous materials.

This article aims to provide recommendation for high school physics teachers, how they can familiarize their students with a special group of intelligent materials, the electro-(ER) and magnetorheological (MR) fluids, which was discovered just a few decades ago. I will show that the ER and MR effects and materials can be for our benefit not only in the future, but even in our present they may be around us, while most of the people are still not aware of their existence. It is important that future engineers are familiarizing themselves with these special materials in their high school years, because in the future large-scale spreads of their applications are expected.

The ER and MR effects

The electrorheological and magnetorheological fluids are complex liquids which can rearrange their structures in the presence of an electric or magnetic field. From here comes the name, since the science of rheology deals with the analysis of regularities between deformations and the effects what's causes them. In both types of fluids, the active particles get induced dipole moment by the external fields, which is why the induced

positive/magnetic north poles are trying to move near to the induced negative/magnetic south pole of a second particle. In the presence of the field at first the particles rearrange themselves into pairs, than chains, and later into columns. This process results in a drastic increase in viscosity, since the chains have to be broken by perpendicular shear forces in order to create deformations in the fluids [1].

The stress-strain behaviour of the Bingham viscoplastic model is often used to describe the behaviour of MR and ER fluids [2]. In this model, the plastic viscosity is defined as the slope of the measured shear stress versus shear strain rate data. Thus, for positive values of the shear rate $\dot{\gamma}$, the total stress is given by

$$\tau = \tau_{y(\text{field})} + \eta\dot{\gamma}$$

where $\tau_{y(\text{field})}$ is the yield stress induced by the magnetic or electric field and η is the viscosity of the fluid.

Electrorheological fluids

Electrorheological fluids can be prepared if particles with a dielectric permittivity of ϵ_p are dispersed in a liquid with an $\epsilon_f < \epsilon_p$ dielectric permittivity. If a viscosity of a liquid can be controlled by external electric field, it is called an electrorheological fluid.

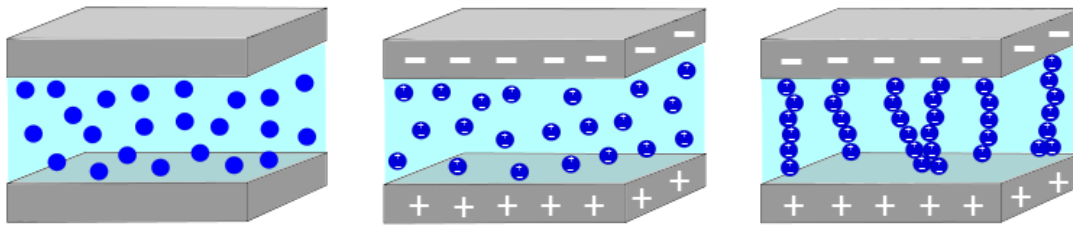

Figure 1. The chaining effect in an ER fluid in the presence of an external electric field

We can recognize a similar chaining phenomenon in a relatively frequently shown experiment in high schools, when we demonstrate the electric field lines with the help of a Van der Graaff generator by scattering ground grain into a layer of oil with the presence of high voltage (see Figure 2). The purpose of this experiment is generally to present the characteristics of the force field and field lines, therefore the explanation is sometimes omitted. Of course, the occurred chaining is also a consequence of the induced dipole moment of the particles.

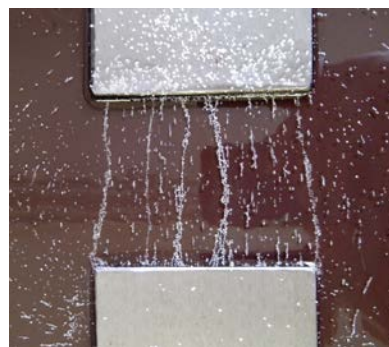

Figure 2. Scattered ground grain on a layer of oil, in the presence of high voltage

How to make ER fluid at home?

We can create electrorheological fluids for ourselves by simply add starch into silicone or vegetable oil. The ratio of the ingredients should be roughly half and half. Tentatively we pour the prepared liquid from one container to another close to a charged glass or ebonite rod and if the fluid was prepared correctly, a water jet-like deflection can be experienced (see Figure 3). If the fluid is placed close to high voltage, we can experience an increase in its viscosity up to several orders of magnitude.



Figure 3. Homemade ER fluid jet close to a charged ebonite rod

In Figure 4 we can see electrodes which was put and then removed from a homemade ER liquid. In the first case, no voltage was connected to the electrodes, therefore the liquid flows out immediately from the metal plates. In the second case, a charged Van de Graaf generator was connected to one of the electrodes (the other electrode was connected to the ground), then the mixture did not flows out from the plates for a long time.

We can easily repeat this experiment for ourselves, but we need to know that the accumulated charge is discharging quickly through the fluid, since the generator is unable to maintain notable current. Therefore, the electrodes must be well insulated from the liquid. **If you decide to use high voltage power supply for this experiment, always proceed with caution!** We can use any metal plates as electrodes. Adjust the distance between them so that the generator do not discharge trough them. In addition, we should attach a nail to both of the electrodes which are slightly closer to each other than the distance of the electrodes, so we can avoid that the generator is discharged through the insulation.

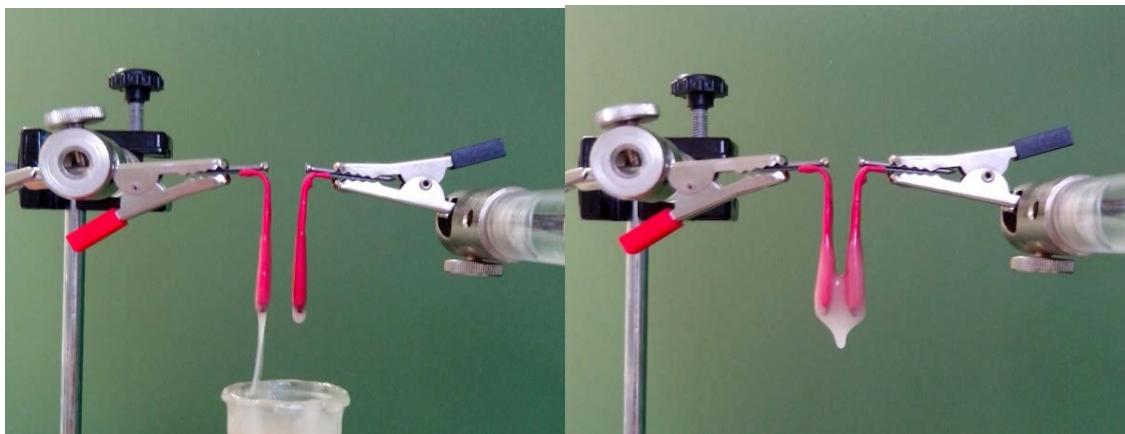

Figure 4. The behaviour of the ER fluid without and with high voltage

Measuring experiments with ER fluids

In high school, we can set up experiments to measure the field dependence of the viscosity of an ER fluid. We need to create an external electric field with a relatively controllable strength, and a homemade ER fluid. The external electric field can be simply created with a Van der Graaff generator. We can measure the time for a ball to sink in the liquid, or the time while the liquid flows out from a container with a hole in its bottom. As we change the strength of the external field, we can repeat the measurement and then we can plot the times in a graph. With this method, we can determine the critical field strength for chaining in our ER fluids.

Measuring viscosity with a falling ball

We can measure the viscosity of the fluid by using the principal of the Höppler viscosimeter by measuring the time required for a ball to fall under gravity through a sample-filled tube. The η (dynamic) viscosity is

$$\eta = \frac{2g(\rho_b - \rho_f)V}{9l} t$$

where g is the gravitational acceleration (m/s^2), ρ_b is the density of the ball (kg/m^3), ρ_f is the density of the fluid (kg/m^3), V is the volume of the ball (m^3), l is the length of the fall (m) and t is the measured time of the fall (s). At home, of course, we will be able to perform significantly less accurate measurements compared to the serial versions of the viscosimeter, but it provides a good opportunity for students to learn about the nature of viscosity. The measurement is carried out without external electric field, as well as its presence. From the maximum distance of the electrical breakdown the magnitude of the generator's voltage can be concluded ($\sim 20 \text{ kV/cm}$), then by multiplying the original distance of the electrodes, we can reduce the electric field strength (see Figure 5). Note that you can receive only highly imprecise values of the field strength with this method!

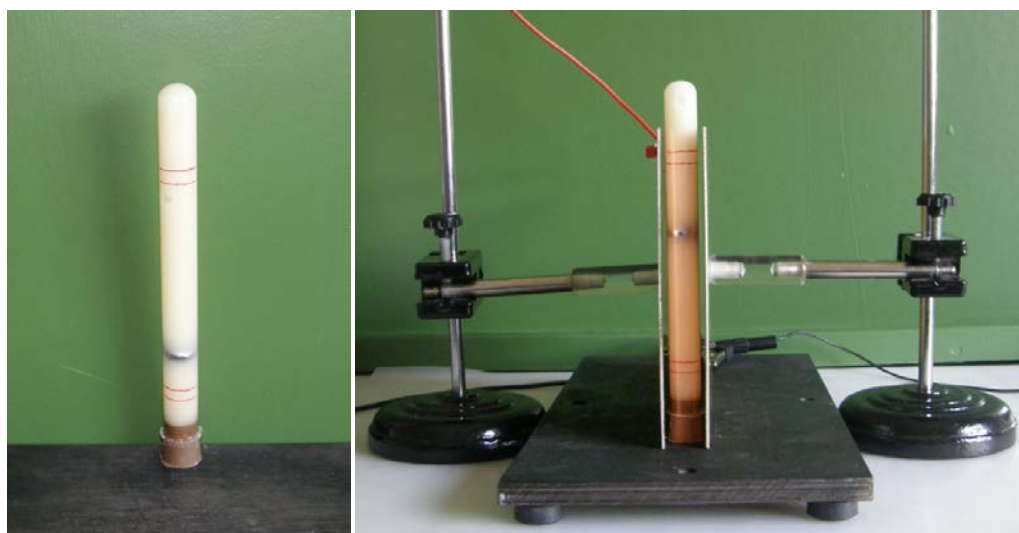

Figure 5. Measuring viscosity with a falling ball

Controlling the flow of an ER fluid with high voltage

If we let the ER fluid flow through a tube with electrodes on both sides, we can control the flow with applied high voltage to the electrodes (see Figure 6).

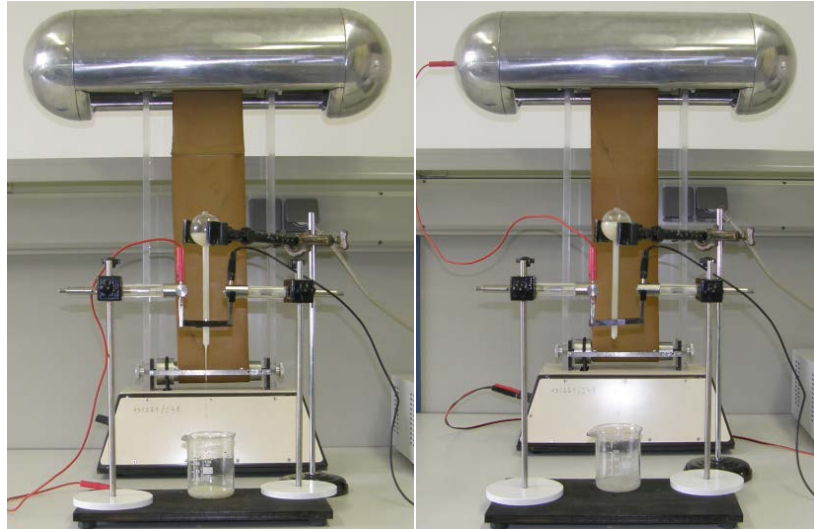

Figure 6. Controlled flow of an ER fluid by applied high voltage

Magnetorheological fluids

Magnetorheological fluids can be prepared by dispersing ferromagnetic particles with a magnetic permittivity of μ_p in a liquid with a $\mu_f < \mu_p$ magnetic permittivity. If the particles are so small, that there are only one magnetic domain in them, the magnetic fluid made from them is called a ferrofluid.

We can recognize a similar chaining phenomenon in a conventionally presented experiment, when we demonstrate the magnetic field lines by sprinkling iron filings on a sheet of paper and bringing a magnet up close to the underside of the paper, we can see that the filings line up along the lines of force (see Figure 7).

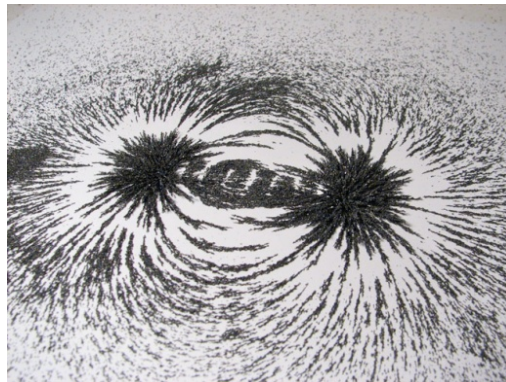

Figure 7. The iron filings line up along the lines of force

The chaining of magnetic particles can be presented by putting a layer of plastic balls and ball bearings into a magnetic field. For example, the balls can be placed between a picture frame backing, and glass, so they will not spread out and remain in the system in two dimensions (see Figure 8). When it is placed in a magnetic field, we should simulate the motion of the particles by vibrating the frame.

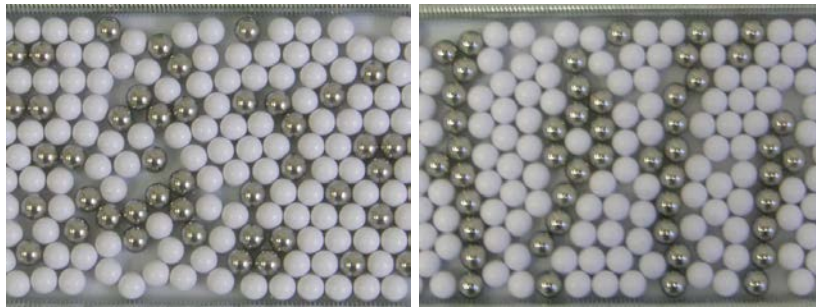

Figure 8. Bearing balls chaining in magnetic field

The MR fluids are almost solidified in the presence of an external magnetic field. In Figure 9 we can see an MR fluid placed in a strong magnetic field, if more MR fluid is dropped from above, a column-like structure can be built. When the magnetic field is turned off, the fluid does not keep shape, but almost immediately melt down (see Figure 9).

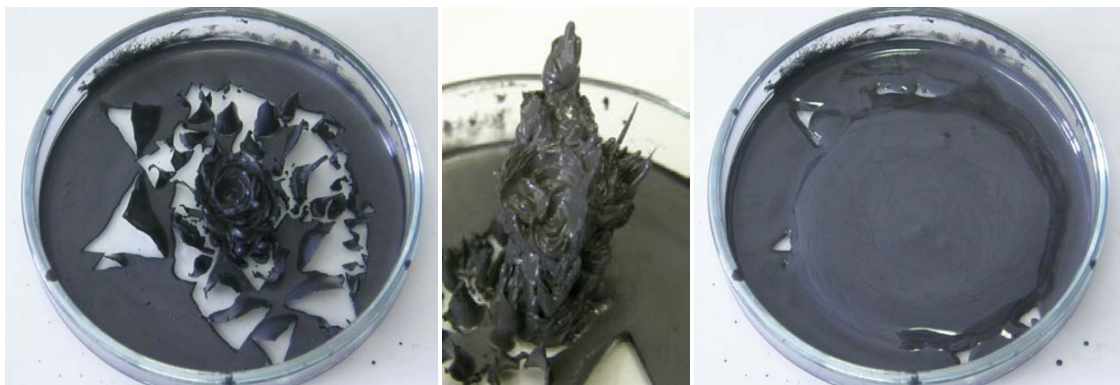

Figure 9. The behaviour on an MR fluid in an external magnetic field

If the used particle's size is so small, that it contains only one domain, we obtain so called ferrofluid. As the result of the small particle size the Brownian motion of these particles do not allows them to settle, this is why the ferrofluids are more stable than the MR fluids. The surface of the liquid draws a spiky shape in the presence of a magnetic field (see Figure 10).



Figure 10. The surface of a ferrofluid in the presence of an external magnetic field

How to make MR fluid at home?

At home, we can create only simple magnetic fluids by mixing silicone/vegetable oil, or water with fine iron or magnetite powder. To experience the MR effect, we need strong magnetic fields from neodymium- or electro magnets (see Figure 11).



Figure 11. Homemade MR fluid in increasingly powerful magnetic fields

The previously mentioned measurement experiments with ER fluids can also be performed with MR fluids, the needed magnetic field can be created by an electromagnet, therefore the field strength inside the coil can be calculated in the knowledge of the dimensions of the coil and the used current.

Magnetic elastomers

Magnetorheological elastomers (MRE) are viscoelastic solids whose mechanical properties are controllable by applied magnetic fields. They are prepared by curing a polymer containing dispersed magnetic particles in the presence or absence of a magnetic field.

How to make MRE-like materials at home?

We can create MRE-like materials at home (but not real MREs). We simply have to put fine iron or magnetite powder to commercially available gel powder before we pour hot water to it. After solidification of the gel it will show ferromagnetic properties, and its shape can be changed by an applied external magnetic fields (See Figure 12). In function of the applied field strength we can measure the occurred deformation.

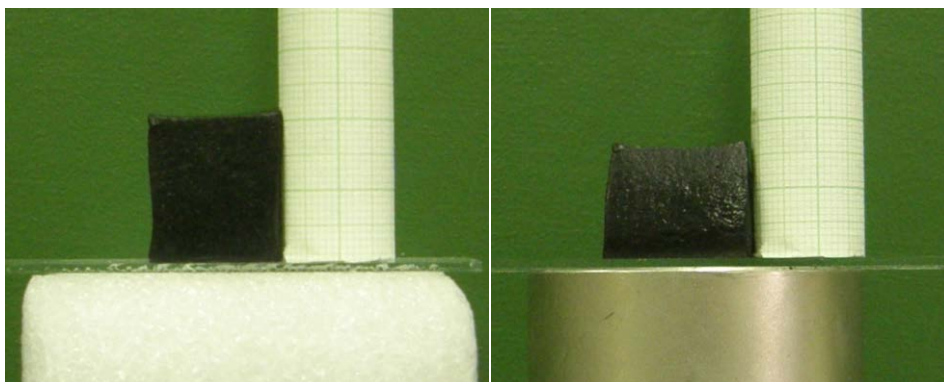

Figure 12. Homemade MRE-like material's reaction to strong (~ 300 mT) magnetic field

Applications

For these fluids – due to their controllable viscosity – there are many applications emerged in the modern engineering. The technical minded students should be familiarized with the tools based on the phenomena described so far, which can already be found in our environment.

Shock absorbers with a magnetorheological operating principle has been used in military vehicles (HMMWV) and since 2002 they are used in the civilian automotive industry too (Cadillac Seville STS, Audi TT and R8, Camaro ZL1, Ferrari 458 Italia). The hardness of these shock absorbers can be controlled within a few milliseconds.

ER and MR dampers are used in washing machines, speakers, stepping motors, air-conditioners, seats, and on a larger scale they are used in buildings and bridges in seismic systems (for example, in Japan's National Museum of Emerging Science and Innovation in Tokyo).

With the help of the controllable viscosity of the ER and MR fluids, wear-free brakes and clutches can be built, in which the rate of transmission can be controlled by changing the external field strength.

They are also used to create variable-shaped optical lenses, tactile displays, and used as printing inks as well as lubricants and sealants.

Water based, stabilized, biocompatible magnetic fluids are also used in the field of medical sciences as contrast agent for magnetic resonance imaging. In addition, for the delivery of paints and active substances with magnetic field, for separation of bio-components and for magnetic hyperthermic treatments.

Conclusions

In this paper, I have presented several laboratory demonstrations as well as experimental investigations, which can easily be performed in the classroom to familiarize students with smart materials. I have shown methods to prepare smart fluids at home, and I have shown that there is a wide range of application for these materials even in our present days.

Acknowledgments

I acknowledge the financial support of this work by the „PEREGRINATIO I.” (VVE) Foundation and the MOL Company.

References

- [1] Winslow W.M.: Induced Fibrillation of Suspensions. *Journal of Applied Physics*, Vol. 20, (1949), pp. 1137–1140.
- [2] Shames I.H., Cozzarelli F.A.: *Elastic and Inelastic Stress Analysis*. Prentice Hall, Englewood Cliffs, New Jersey, (1992), pp. 120-122.

Monitoring the level of the basic elements of students' scientific literacy developed by research-oriented activities

Mária Nováková, Marián Kireš

Faculty of Science, University of P. J. Šafárik, Šrobárova 2, Košice, Slovakia

Abstract

The term scientific literacy is defined by Arons (Held, 2011) as the effective application of scientific knowledge and skills to solving problems and making decisions in personal, social and professional life. In meeting the needs of the labor market in knowledge-based economy, the importance of scientific literacy increases. Ability to apply scientific forms of thinking in order to obtain and then use the new information requires students' developing of the components of their scientific literacy. Several experts, e.g. Colville and Pattie (2002), Beaumont and Soybo Walters (2001) agree on division of capabilities of the scientific work to basic (used to organizing and description of the subjects and phenomena) and integrated (through which we are able to solve problems and do experiments). Basic capabilities are: observing, judging, assuming, classifying and measuring.

In paper is presented the methodology of the prepared didactic experiment aimed at detecting the level of students' basic skills in scientific work. It consists of graduated system of physics observations and laboratory measurements, tools for collecting and analyzing data. Selected measurements (e.g. Gauss gun) are prepared for the different levels of research-oriented learning activities (Ibsen – Inquiry-based science education). The training Gauss cannon is specified as follows:

A sequence of identical steel balls includes a strong magnet and lies in a nonmagnetic channel. Another steel ball is rolled towards them and collides with the ball end. The ball at the opposite end of the sequence is ejected at a surprisingly high velocity. Optimize the magnet's position for the greatest effect. Activity is presented in form of instructional material for teachers using the method of interactive demonstration and a worksheet for students who carry out the method of controlled research.

Keywords: secondary education, inquiry-based science education, inquiry-based skills, scientific literacy, Gauss cannon

Introduction

The term scientific literacy is defined by Arons (Held, 2011) as the effective application of scientific knowledge and skills to solving problems and making decisions in personal, social and professional life. In meeting the needs of the labor market in knowledge-based economy, the importance of scientific literacy increases. Ability to apply scientific forms of thinking in order to obtain and then use the new information requires students' developing of the components of their scientific literacy.

Competencies: find the problem, formulate questions and hypotheses, find solutions, an objective evaluation result and defend it in front of others, are included in IBSE – Inquiry - based science education. Their integration into the educational process for students to develop their scientific literacy. They can look at the problem from different angles and

find different possible solutions, which can be useful for achieve in the labor market. Activity Gauss Cannon is processed to make interactive demonstrations, one of the forms of IBSE. Activity is suitable for the high school students as well as university students.

Interactive demonstration

The basis of this method is the introduction of so-called interactive demonstration experiments which present a series of short simple experiments about a given topic. For their conduct, it is necessary to:

- invite students constantly during the realisation of the experiment to develop prognoses, discussions and analyses of acquired results,
- computer and e.g. data projector for presenting in front of the whole class,
- tools for realisation of the experiment and equipment for measurement of various quantities using a computer (converters, sensors, software for videoanalyses).

The method of a demonstration of the experiment is based on the sequence of eight stages which are met in every conducted experiment

1. A teacher describes the experiment and conducts it in front of the whole class without the use of a computer.
2. Students note their individual prognoses.
3. Students discuss about the experiment and their prognoses with their closest classmates.
4. A teacher explores prognoses of students in class.
5. Students note final prognoses which may be modified based on discussions. Prognosis sheets are gathered without their evaluation by a teacher.
6. A teacher realises a measurement (usually using a computer, in a form of a graph), which is presented in front of the whole class using data projector (or the interactive board).
7. Students describe and discuss the results, which are written on result sheets, which they take with themselves.
8. A teacher discusses other analogous physical situations with students.

Students usually think about their prognoses (stage no.2) and the following discussion with other classmates tends to be very lively (stage no.3). A teacher must estimate when to end the discussion and proceed to the next stage.

In the stage no.4, a teacher may write the prognoses of students e.g. on the board. This stage is focused on brainstorming when a teacher explores students' prognoses without any comments about correctness of their ideas. If there is no student with an incorrect answer, which is a typically wrong student answer, a teacher may write it as well, stating that the last time one student anticipated this, so that the spectrum of answers is broader. If there is enough time, a teacher may also ask students to vote for the right prognoses.

In stages no.7 and no.8, it is up to a teacher to obtain students' arguments and explanations of experiments. A discussion must be carried out in order to deal with important moments of the experiment, avoiding an interpretative style of a teacher. A discussion must be aimed at outcomes of a real experiment which are usually presented in a graph (as the main source of information) [4].

Gauss gun

“Gauss rifle” is a type of linear magnetic accelerator. It is relatively easy to assemble and involves a rapid and dramatic increase in kinetic energy of the steel ball bearings used in the demonstration. This makes the demonstration a good attention getter, setting the stage for

a discussion of a number of physics topics, including conservation of energy, magnetic energy, and magnetic force. It also has the potential for becoming a laboratory experiment since the materials are relatively cheap, there is some challenge in the arrangement of the magnets, and the performance of the accelerator can be characterized by measuring the initial and final velocities of the bearings.

The Gauss accelerator pictured in Figure 1 consists of an 1,2-cm diameter spherical neodymium magnet and three 1,2-cm diameter steel ball bearings. When the lone ball on the left is gently brought in toward the right [Figure 1(a)], it accelerates until it collides with the magnet. The result is that the incoming ball sticks to the magnet, and the ball on the right takes off with a surprisingly large velocity [Figure 1(b)].



Figure 1(a). Before collision



Figure 1(b). After collision

The method of the interactive demonstration is based on the sequence of eight stages.

1. A teacher describes the experiment and conducts it in front of the class without the use of a computer

The Gauss gun experiment is conducted in the following stages:

1. We place a neodymium magnet on a level trajectory. We release one steel ball towards its north pole and observe its motion.
2. We place one steel ball on the south pole of a magnet, and again, we release one steel ball towards its north pole.
3. We place two steel balls on the south pole of a magnet. Again, we release one steel ball towards its north pole and observe what will happen.
4. We place several neodymium magnets on a level trajectory. We place two balls to their north poles and we release one ball towards the north pole of the first magnet.

A teacher leads a discussion using those questions:

- How does the ball move?
- How does energy increase in the crash?

- What happens when one ball is put on the south pole of the magnet? What should happen with this ball after a crash with an incoming ball?
- How many balls should be put on the south pole of a magnet to make the ball take off? Why?
- How can we measure the velocity of the ball?

Let us remind several factors

A steel ball moving towards a magnet accelerates progressively, because its movement influences the magnetic field. Kinetic energy of the moving ball increases thanks to work produced by the magnetic field of the magnet.

What happens when one ball is put on the south pole of a magnet? What should happen with this ball after a crash with an incoming ball?

Thanks to the law of conservation of energy and the law of conservation of motion, kinetic energy of the ball after the crash is transferred to the other side of the magnet. One would expect that the ball would be freed on the southern side of the magnet in the same velocity as the crash velocity of the incoming ball (as the balls have the same weight). However, the ball does not take off because of the lack of sufficient energy for breaking magnetic force of the magnetic field.

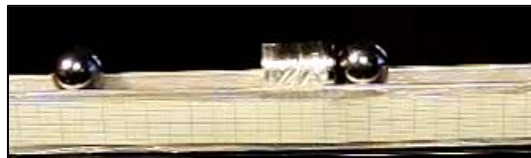

Figure 2(a). Before collision



Figure 2(b). After collision

2. Students note their own prognoses about the following questions:

- Is there a critical impact velocity which causes the separation of a ball on the south pole of the magnet?
- How does the velocity of a ball change when it approaches a magnet? Draw graphical dependence of this motion.
- Does magnetic force of the magnet influence the movement of the ball?
- What is the dependence between the amount of magnetic force and increasing distance of the magnet?
- Is the intensity of magnetic force of the magnet dependent on the magnetization of the ball?

Answers to the questions:

Acceleration of a ball approaching a magnet can be measured by, e.g. Vernier Photogates. This software can calculate velocity of a body with established length thanks to the time between blocking and unblocking of a photogate (interruption of a ray of light). By placing

photogates into different distances in front of the magnet, students may observe a gradual increase in ball velocity. Using Vernier LabPro, instantaneous velocity of a ball can be measured based on the time between blocking and unblocking of a photogate. As a result, the minimal distance where a photogate may be placed in front of a magnet is the distance d (diameter of a ball), so that the ray of infrared light is not obfuscated by the ball after the collision.

Another way of examining velocity of a ball is using video measurements in Coach 6 environment. Students should notice in the graph that its inclination is dependent on velocity. By derivation of distance and filtration we can obtain the graph of velocity dependence on time and compare impact velocity of a ball with velocity measured using photogates.

Critical impact velocity of a ball which causes a separation of a ball on the other side of a magnet, ascertained using photogates, is equal approximately to $2,3 \text{ ms}^{-1}$. Output velocity of a separated ball is very small, because it needs a lot of energy to exceed magnetic forces.

Influence of Magnetic force

Does magnetic force of the magnet influence the movement of the ball? What is the dependence between the amount of magnetic force and increasing distance of the magnet?

The activity of the magnetic field decreases with increasing distance. The dependence of magnetic induction of the strong magnet (without magnetised ball influence) on the distance can be examined using the Hall Effect sensor with manual input in Coach 6 environment. For our goals, this approximation could be suitable, enough. Analysing the results, it can be observed that the magnetic field around the magnet changes exponentially with increasing distance (Figure 3).

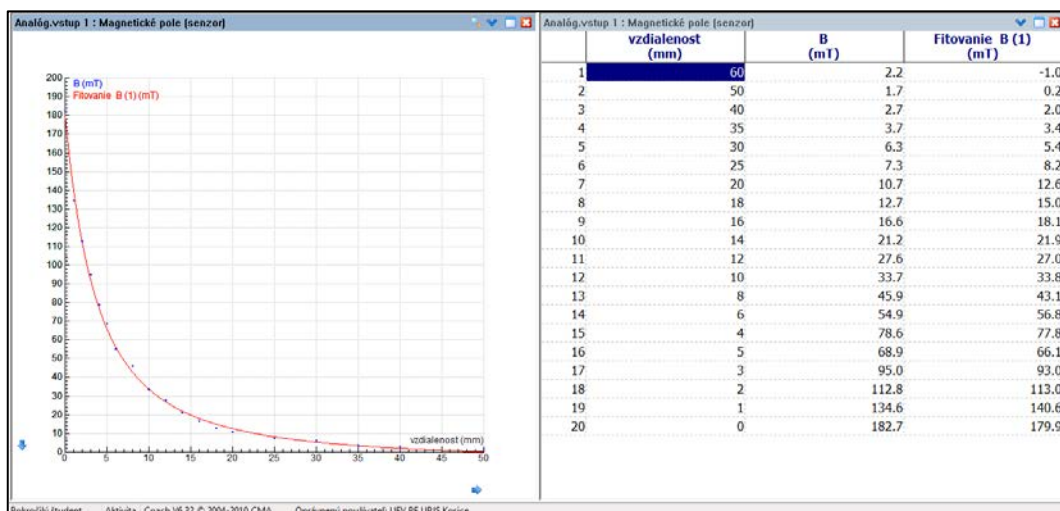

Figure 3. Dependence of the intensity of magnetic induction on the distance measured by the magnetic sensor in front of the magnet

What effect has the type of material of a ball on the intensity of magnetic force affecting the magnet? I.e. is the intensity of magnetic force of the magnet dependent on the magnetization of the ball?

The presence of a steel ball increases the magnetic field of a magnet, i.e. the more balls are there on the other side of the magnet the stronger magnetic force affects the approaching catapulted ball.

Table 1. Dependence of the intensity of magnetic force of a magnet on the amount of balls

Amount of balls on the left side of the magnet	Amount of balls on the right side of the magnet	Magnetic induction of the left side of the magnet B [mT]
0	0	182,7
0	1	184,9
0	2	188,5
0	3	189,7

Conclusion

Gauss gun is a well-known experiment with an amazing resulting effect; however, its use as a laboratory experiment for students and its introduction into teaching is not usual. Students' involvement in classes and their dealing with unnoticeable problems imitate scientific investigation which attempts to examine problems from every angle.

The activity named Gauss cannon was implemented in the 1st grade of high school. It was realized in the form of interactive demonstration. Students were amazed by the activity. They were interested in the measurement of the ball velocity using the photogates. The experiment has practiced their knowledge of the law of conservation of energy and momentum, as well as the influence of magnetic force to the ball's motion.

The students were surprised by the ball's the speed increase as well as the finding that the largest ratio of the input and output ball's speed was when the ball was released as slowly as possible. With the greater input speed the ratio decreases. Students found out that when realizing experiment with multiple magnets on the track the output speed is almost unchanged with respect to small or large input speed.

Apart from already mentioned motives for examination of the Gauss gun, this experiment may bring a lot of fun. Try studying the effect of more ball bearings on either side of the magnet. More magnets can also be added. Get a straw and try the energy experiments vertically against gravity. Only a physics person can have so much fun with such a simple device!

Acknowledgement

This work is the result of the national project Science on Stage Slovakia, under the support of the Slovak Research and Development Agency grant agreement: APVV-LPP-0223-09 and international 7FP project ESTABLISH (European Union's Seventh Framework Programme FP7/2007-2013 under grant agreement n° 244749) and VVGS project, supported by Faculty of Science, University of P.J. Šafárik, Košice, Slovakia.

References

- [1] BEAUMONT-WALTERS Y., SOYBO K.: An Analysis of High School Students' Performance on Five Integrated Science Process Skills. In *Research in Science and Technological Education*. Vol. 19, 2001, No. 2, pp. 133-145.
- [2] COLVILL M., PATTIE I.: Science Skills – The Building Blocks for Scientific Literacy. In *Investigating : Australian Primary and Junior Scientific Journal*. Vol. 18, 2002, No. 4, pp. 20-22.
- [3] HELD L.: 2011. *Inquiry-based science education (IBSE in the Slovak context)*. Bratislava: VEDA, publishers SAV, 2011. ISBN 978-80-8082-486-0.
- [4] JEŠKOVÁ Z. a kol.: 2010. *Aktívne poznávanie s prostriedkami počítačom podporovaného laboratória*. In: *Fyzika pre stredné školy, Učebný materiál – modul 3*. Košice : elfa, s.r.o., 2010. ISBN 978-80-8086-146-9. s. 27-28.

New Technologies in Teaching of Physics

Jaroslav Reichl

The Secondary School of Telecommunication and Broadcasting Technologies,
Prague, Czech Republic

Abstract

There is described the use of new technologies in teaching of physics in this article. The main aim of the use of new technologies and devices in physical lesson is to introduce physics like useful part of science and motivate students to learn it. There is described the methodology of the use of new technologies too.

Keywords: new technologies, Vernier sensors, extracts from films, Earth's magnetic field

Introduction

I have been teaching for 14 years in the technical secondary school in Prague (Czech Republic). It means the age of my students is between 15 and 20. The lessons of physics are in their timetable divided into two parts. They listen to the lectures, watch motivational and demonstrational experiments and their knowledge is tested during the common lessons of physics. Students have 45 minutes long lessons of this type twice a week. For the second type of lessons of physics students are divided into two groups. These lessons are called laboratory classes. During these lessons students can try some experiments, solve tasks and make measurement of assigned physical quantity. Students have one lesson of these lessons per week in average; there are two lessons together once per two weeks in practice. Two lessons joined together are better for laboratory class or for solving some physical tasks.

I usually try to show physics as a beautiful, logical and very practical science. Physics is for my students very important because of studying other subjects (sound and film technologies, digital technologies and others). That is why they have to understand basic physical laws and they have to be able to apply these laws in solution of school tasks and in practice. Other reason for studying physics is that students want to study at university after graduation in our school. They study in the technical secondary school and that is why they usually continue at technical universities where they study physics too. Students after graduation usually say that my lessons of physics were interesting and they liked it. The reason is they study physics very hard and they can find answer for plenty of questions about technical problems and physical phenomena in their life. They feel prepared very good for studying at technical university from my lessons of physics. My students like physics very much and therefore they also like visiting excursions which I prepare for them. They are looking forward to visiting traditional physical show before Christmas and other physical activities which I plan every year for them.

For these reasons I try to use some interesting way how to show students that physics is not boring science full of difficult formulas. I want to make my students think about problems, about methods of solving the problems and about obtained solutions - if they are real or not. Students can watch TV or read the newspaper (or on the internet) plenty of news which is very unbelievable: the description of new technical devices or some paranormal activities and lots of others. I would like to prepare my students for critical evaluation of this strange news.

That is why I use in my lessons very simple aids/tools to demonstrate basic physical principles and physical laws. I use ordinary things like small balls, bottles, cans and others. Students can repeat these experiments next lesson to consolidate their knowledge. Students also can prepare these experiments at home for their siblings or friends. This is very important for them - they improve their physics knowledge substantially.

The second type of my favourite aid is new technology. But I do not require buying any gadgets from my students! If they have them, they can use them during some type of measurements or experiments. If they do not have them, it is not any problem. They can work in groups with other students or they can do measurements or experiments with school aids. I use new gadgets (computers, mobile phones, tablets) because students usually like it. They are very good at working with these gadgets and they have a plenty of applications for measuring or display measured values. Students usually work with new measuring equipment (for example Vernier sensors). Measuring with these technologies is very easy and quick. Students have to summarize the measured values, display graph and found mistakes or data inconsistencies at the end of laboratory class. They use software Mathematica for summarizing the measured values. This software is very useful for data processing and students can study this software at workshop which I prepared for them. Some students are very good at using this software and they use it for writing their graduated thesis.

There are several reasons for writing about new measuring equipment (like Vernier sensors) as a modern way of teaching. The first reason is that these sensors are not very common in the Czech Republic. First of them appeared in the Czech Republic several years ago. The second reason is the price of these sensors. They are very good but for most of schools in our country they are very expensive. Teachers can apply for a grant for these aids for a few years. And the last reason is to use datalogger LabQuest for easy measuring. LabQuest is possible to buy in the Czech Republic but only for few years.

Using new technologies

Using new technologies can be dangerous for students! The main danger of using modern devices is that these devices “prepare” everything for students: the graph of dependence of measured physical values, the calculation of unknown physical value and others. Teachers have to be very careful and cautious when and why they allow students to use these devices. Students have to think about physics with their own head! But sometimes using modern devices is useful.

I describe some specific activities which I do with my students during laboratory classes of physics.

The Reproducing of the Characteristic of Motion

When students know the basic characteristic of rectilinear motion with constant velocity (graph of position vs. time and graph of velocity vs. time), I prepare for them task: Bring toy car for the next laboratory classes. Students are a bit confused and they do not understand why. But they bring it. I give them a paper with several graphs. There are graphs of position vs. time and graphs of velocity vs. time on this paper. The example is shown on Figure 1. Then students try to reproduce prepared graphs with using their car and Vernier sensor of motion (Figure 2). This sensor emits ultrasonic waves. After their reflection from running object (in this case running car) sensor detects them. The computer then calculates the distance of car from sensor and its velocity. During measuring students

can find out that graphs of velocity vs. time is not so nice (it means smooth) like graph position vs. time. The reason is that distance (coordinate) is directly measured whereas velocity is calculated on the basis of distance. And this calculation is not accurate; the calculation is numerical and it is divided into finite steps.

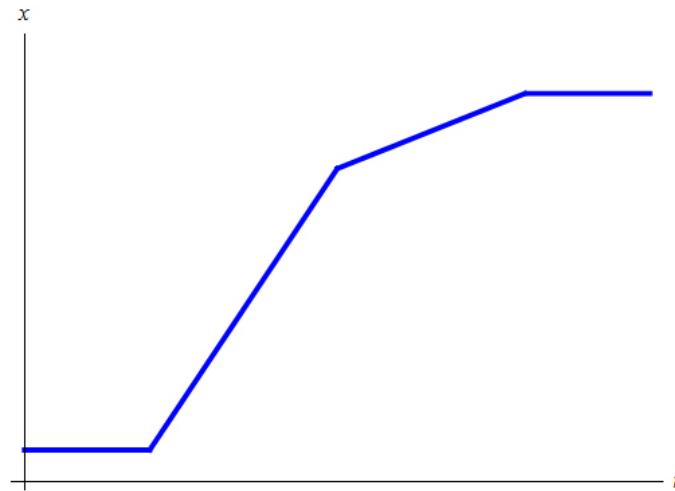

Figure 1. Prepared graph of dependence of coordinate on time

At the beginning students have a problem to reproduce graph because they do not have experiences with moving car in front of the sensor. Sometimes they destroy measurement – they put their hand between sensor and car or they move car out of going ultrasonic wave. But then they are able to move car very accurately. The measured graph is shown on Figure 3 and it is inspired by graph from Figure 1.

When we compare the graphs on Figure 1 and Figure 3, we find out that students moved car very accurately. They find out that it is not easy to realize rectilinear motion with constant velocity. The reason is that this motion does not exist in practice because there are air resistance force and friction force in practice. Both of these forces influence this motion.



Figure 2. Students try to reproduce graph

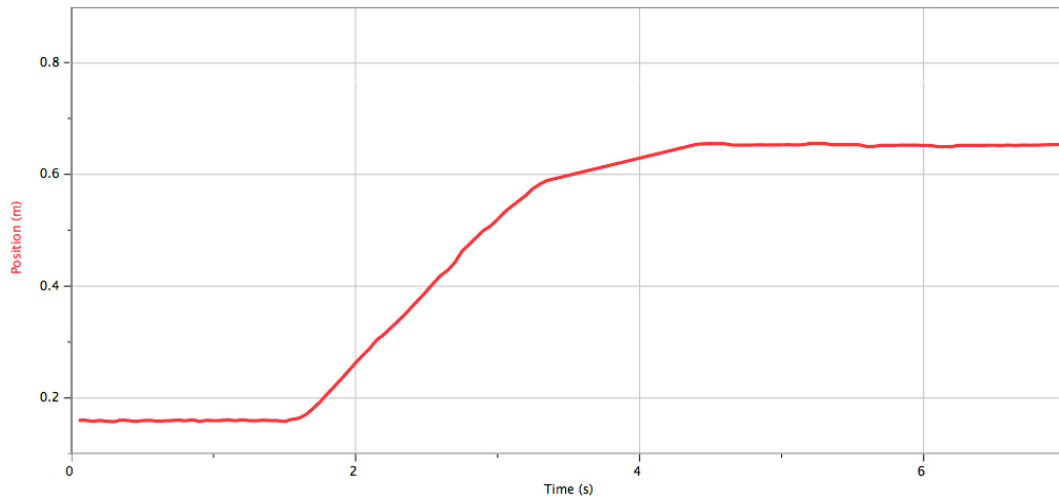

Figure 3. Measured graph

The same type of measurement students do with graphs of position vs. time and graphs of velocity vs. time for accelerated motion.

The Measuring of the Electrical Properties of Semiconductors

When students know the basic properties of semiconductors theoretically, they measure some of their parameters. It is possible to prepare experiments for students to discover properties of semiconductors alone without lecture from teacher. I prefer explain to students some basic properties before their individual measurement to discover all properties of semiconductor without teacher. I teach in the technical school and semiconductors and their properties are very important for their further study. That is why I explain basic properties and then students “discover” and measure others.

I prepare the list of tasks for students. These tasks are focused on measuring the dependence of electrical resistance on temperature, current-voltage characteristic of thermistor, diode or photodiode, the dependence of voltage drop of LED diodes on wavelength of light with maximum radiation intensity etc. These tasks are chosen to describe important properties of semiconductors used in practise. Students can use new measuring equipment (Vernier sensors: ammeter, voltmeter, light-sensor, temperature-sensor) or traditional instruments (ammeter, voltmeter or thermometer). They have to measure values, make a graph of these values and try to find theoretical equation of measured dependence. They cooperate with others in the groups of four students. They can discuss the measuring methods, aids and circuit diagram. This type of laboratory classes is a bit demanding for me (it means for teacher) because I have to prepare a plenty of semiconductor devices and other aids (candles, vessel with ice-cubes, kettle for heating water, lamps and others). This laboratory classes is prepared like that students choose only two or three tasks from my list.

Students work in group very hard (Figure 4). They have to write data down and they can use modern devices (notebook or datalogger) or they have to write data down by hand. In both possibilities they have to summarize the measured values, display graphs and found mistakes or data inconsistencies at the end of laboratory class. Students often use software Mathematica for calculate physical values or display graphs.



Figure 4. Students measure the characteristic of semiconductors

The Measuring of Magnetic Induction of Magnetic Field of Earth

The other of my prepared activities for my students is measuring of the value of the horizontal component of magnetic induction of Earth's magnetic field. Students can work with new measuring equipment or with traditional instruments. This measuring is interesting because of finding important Earth's parameter with very small value with simple aids.

When students know coil and its parameters and they are able to describe qualitatively and quantitatively its magnetic field, I ask them a question: What is the value of the horizontal component of magnetic induction of Earth's magnetic field? I prepare some hints for students to focus them to coil and its magnetic field. For this measuring I have made a model of coil from copper wire of length about five meters and plastic bottle. It is only a model but equal for magnetic field of solenoid which gives very good solutions. And this is great! It is very beneficial for students to know the correct description of some device (coil) and imperfect model which is usable for students measuring.

Students put the compass into the coil. Compass needle has to be perpendicular to coil axis of symmetry when some electrical current goes through the coil. It means compass needle is perpendicular to vector of magnetic induction of coil's magnetic field. When students connect the coil to source of voltage, the electrical current creates magnetic field in coil. This magnetic field puts together with Earth's magnetic field. The compass turns through some angle.

Students measure (Figure 5) electric current by Vernier sensors or traditional ammeter and the angle by compass scale. Then they calculate the value of magnetic induction.

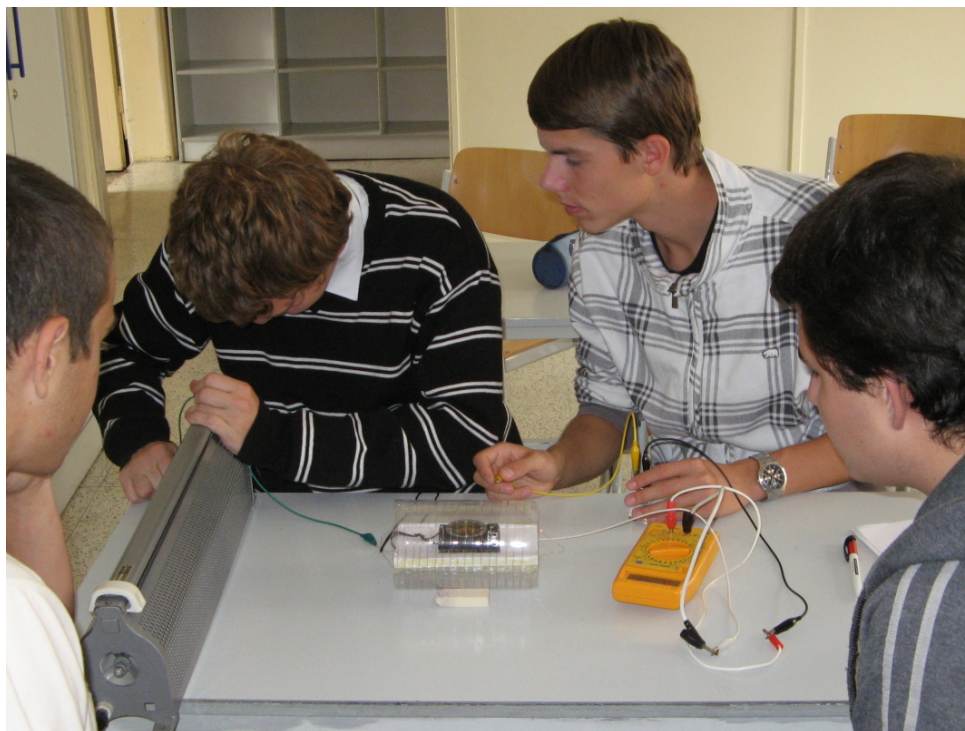

Figure 5. Students study magnetic field of Earth using a coil

The Analysis of Interesting Parts of Famous Films

Other activity of using new technologies is watching films during physics' lessons. But we do not watch the whole films! I have chosen some very famous films and prepared short extracts from them. When students have experienced this activity, they prepared extracts from their favourite films at home. I have chosen films which are very popular for students and students like them.

Students try to find in these extracts physical nonsense, they can try to explain some interesting part of films and also to calculate some parameters of devices from film or parameters of hero (velocity, power or force). Some of devices' or heroes' parameters are sometimes very strange and unreal. There are some favourite films (made in the USA) with "excellent" physical nonsense:

- *Back to the future* – traveling in time, using new devices;
- *Core* – landing space shuttle on the river, trip to the Earth's core and "repair" it;
- *Iron Man* – new technology of movement, very clever and quick computer, ...;
- *Mission Impossible* – using new devices, immortal hero, ...;
- *Star Wars* – laser's gun, ground-effect machine and sound propagation in space vacuum;
- and others.

Plenty of physical interesting extracts there are in Czech films too. But I think that films made in the USA are more famous than Czech films.

Some films are possible to use to illustrate important historical events or physical phenomena which are impossible to show in classroom. For example, the important historical event for European astronomy was meeting of Kepler and Brahe in Prague on the court of Rudolf II. (16th century). This meeting is shown in the Czech film of "*Císařův*

pekař a pekařův císař” (The *Emperor’s Baker – The Baker’s Emperor*). The event described in film probably is not like in 16th century but for students it is interesting to see the mood of that time.



Figure 6. Students study physics from extracts from famous film

The example of physical phenomenon which is impossible to show in classroom is the view of the Earth from orbit (film *Core* and others).

Students like this activity because they know these films and they enjoy it. But during this activity they can also study some more about physics. They have to discover problems without teacher or without reading text in textbooks and then they have to solve it. Student on Figure 6 tries to explain equilibrium of forces for rod with fruit and vegetables on Johnny Depp’s back in film *Pirates of the Caribbean: Dead Man’s Chest*. It is very natural to use for this activity interactive whiteboard where is possible to draw vectors of forces and other pictures squarely into frame from film.

This activity is appropriate example how to find some mistakes and inaccuracy in newspapers, in TV news or in declaration of politicians. There are inaccuracies or lies in a lot of cases.

Conclusions

I have used the new measuring equipment (it means Vernier sensors) in physics lessons approximately for four years. During that time I have listened to workshops focused on measuring with these sensors. I was surprised how quickly and exactly these sensors can measure. I liked the graphical output from datalogger too. Graphs were well arranged and it was easy to read from them the dependence of physical values. Then I borrowed one datalogger and several sensors from The Department of Physics Education on Faculty of Mathematics and Physics in Charles University in Prague. I lent these sensors to my students and I was surprised: the control of datalogger was very easy for them. That is why I asked the director of our school to buy Vernier sensors for our lessons. Nowadays I have four sets of Vernier sensors for four groups of students; they work with this measuring

equipment during laboratory classes. Sometimes it is difficult to explain students that their conclusions of measuring are very important. It is not important only for physics and laboratory classes but primarily for them. Writing conclusions by each student (or discuss in group and write only one conclusion for group) means that students understand measuring and physical principle connected with this measuring.

Using extracts from famous films in lessons of physics was actually the idea of my students. They often ask me: "Have you seen this film? There was some special situation and it was very interesting with respect to physical principles." If I have not seen that film, I borrow it from my friends or from DVD rental store and then I watch it. On the occasion of it I prepare the extracts from this film. Nowadays when I play at school some of my movie extracts, students like it. They enjoy it but they start to think about film with respect to physical laws and principles. Sometimes they actually find in film mistake or misconception which I have not found.

References

[1] <http://www.vernier.com/>

[2] <http://www.jreichl.com/fyzika/studenti/studenti.htm> (in Czech)

Peer Instruction for the age group 12-15

Jana Šestáková

Faculty of Mathematics and Physics, Charles University, Prague, Czech Republic

Abstract

Peer Instruction is an interactive teaching method developed by Eric Mazur at Harvard University in the 1990s. It was originally used to improve learning in introductory physics courses at Harvard University. Peer Instruction has been adopted across disciplines and institutions mainly for high education and universities around the world. This method improves students' understanding of physics and helps overcome their misconceptions.

Learning by the Peer Instruction method has been implemented at secondary school Lingua Universal in Litomerice (the Czech Republic) since 2010 during physics courses for 20 students at the age of 12-15 years. The ConcepTests used at this school are from Eric Mazur's book "Peer Instruction: A User's Manual" translated into Czech and multiple-choice questions newly created according to the research on misconceptions in physics. For collecting real-time feedback flash cards and audience response systems are used. Students don't practice learning with this method during every course and they don't prepare themselves at pre-class activities like Just in Time Teaching.

According to my experience as a teacher, this learning method gives students a lot of advantages. During peer discussion students improve their communication skills, they try to ask correct questions and explain their opinion which is sometimes hard for them. The most interesting moments are when some children, who were passive in the past can now after discussion understand the problem and try to explain the correct response at the end of Peer Instruction period to all classmates.

Keywords: Peer Instruction, secondary school, age group 12–15

Introduction

This article describes the first use of Peer Instruction method at secondary school in the Czech Republic. During this teaching different ConcepTests and polling tools were used. No research was carried out. The case study on implementing Peer Instruction in different types of schools in the Czech Republic will be created during the next years. More information about the case study is mentioned in the part Plans for the future.

The school and the author

The author of this article is a student of Doctoral Studies at Charles University in Prague (the Czech Republic). She has been teaching at the lower secondary school Lingua Universal in Litomerice (the Czech Republic) since 2010. She has been implementing the Peer Instruction method during physics courses in four classes for 20 students at the age from 12 to 15 years. During the courses students use a lot of different learning types (e.g. enquiry-based education) they prepare and demonstrate their own experiments, read books, write tests. Peer Instruction is used approximately once every four lessons. The ConcepTests used during these lessons are from Eric Mazur's book [1] translated into Czech and multiple-choice questions newly created according to the research on misconceptions in physics [2]. There are many others books about students'

misconceptions (e.g. [3]), for Czech students is better to use ConcepTests based on Czech research studies.

Peer Instruction

Peer Instruction is an interactive teaching method developed by Eric Mazur at Harvard University in the 1990s. It was originally used to improve learning in introductory physics courses at Harvard University. This method is based on a small group discussion and on getting real-time feedback on ConcepTests from students to teachers via a response system. A ConcepTest is a short conceptual question on the subject being discussed. This question could be multiple-choice with one (or more) correct responses and other options which are the most common misconceptions on the concept of subject. There are more than 200 ConcepTests in the book [1]. Research proves that Peer Instruction is an effective interactive method [5], [6], which can be used at different school levels [7].

During Peer Instruction students first read the ConcepTest on their own. They try to choose the correct response according to their preconceptions. Then they have time to discuss responses with peers during a small group discussion. According to the literature [1], [5] after the peer discussion students more often choose the correct response than before the peer discussion. More information about Peer Instruction can be found [1], [4].

<p>The circuit below consists of two identical light bulbs burning with equal brightness and a single 12 V battery. When the switch is closed, the brightness of bulb A</p>  <p>1. increases. 2. remains unchanged. 3. decreases.</p> <p style="text-align: right;">Pi</p>	<p>Four light bulbs are connected in series to a constant voltage source. Which bulb puts the most light?</p>  <p>A. bulb 1 B. bulb 2 C. bulb 3 D. bulb 4 E. each the same</p> <p style="text-align: right;">ŽP</p>
--	---

Figure 1. ConcepTests

Left: Used from Peer Instruction: A User's Manual [1]

Right: Own question created using results of research of students' misconceptions [2]

Findings from the class

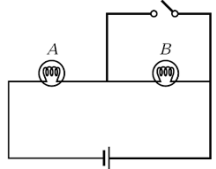
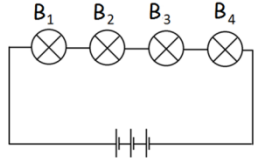
Effective students' discussion

The first goal of the lessons with the Peer Instruction method is teaching students how to create an effective discussion. Students at the age of twelve are able to think about physics topics, but mostly are not able to describe their own opinions correctly. First step for using Peer Instruction is listening to students' discussion, helping them describe what they are thinking about, helping them overcome the shame of answering.

Motivation for the discussion

Students, during their work in Peer Instruction, are appreciated according to their effort, not according to the correct responses. The conceptual questions similar to the questions used during lessons are used in students' written works in which they must not only choose

the correct response, but they must describe the reason why their response is correct. So it is useful for the children's ability to understand the responses during the lessons.

Groups of four students

Even if there are only 12 children in the class, they form usually four-student groups. According to the literature [1] there should at most 5 students in one group. In bigger groups only some students are active, mostly the best students are discussing and others are only passive listeners.

Groups of students are not random. Preferable are groups of good friends. They aren't afraid of describing their ideas. Only groups of four very physics-strong students are not suitable. They don't need to discuss at all. They agree with each other on the response so their discussion cannot be productive.

Flash cards or clickers

During the first year of using Peer Instruction at the secondary school students were using the sets of coloured flash cards with letters A – F. The letters were mainly a sign for the students, the teacher observed only the colour of the cards – the one which dominates in the class is the most common response. During the next two years students were using electronic voting systems (clickers). According to my experience students prefer clickers because they are more interesting for them. For teachers the electronic voting system brings a lot of advantages. Teachers needn't calculate the number of correct responses, results of answering can be easily preserved (for statistics purpose, not for evaluation). Elimination of copying answers during the first response is ensured using clickers.



Figure 2. Electronic voting system, Flash cards

What students think about the method

“This method is more fun than only sitting and listening.” Erika, 15 years

“I like the voting system.” Štěpán, 14 years

“I like this method and I want to use it more.” Nikola, 13 years

“The questions, when I had to think about them, were fine. But I don't like describing the answers.” Michal, 15 years

Plans for the future

Within the research project *Interactive Instructional Methods of the Peer Instruction Type and the Exploration of Their Implementation in Physics Education* supported by The Charles University Grant Agency (GAUK) a case study on implementing the method Peer Instruction into the Czech secondary and high school will be created during next school years. A group of teachers will use Peer Instruction in their physics courses. Teachers will have flash cards and electronic voting system and ready-to-use ConcepTests in Czech language in PowerPoint presentation format. The case study will be focused on the first use of the method in different schools by different teachers. The advantages and disadvantages connected with this method will be described.

Conclusion

The understanding of physics could be improved by using active teaching methods. According to the research, Peer Instruction improves students' understanding of physics significantly better than traditionally taught courses. Some ConcepTests are based on basic concepts which could be taught at high or secondary schools in the Czech Republic. This statement was verified by the author during the teaching physics courses at the Lingua Universal secondary school (Litomerice, the Czech Republic) during the last three years. Further expansion into other Czech schools is planned for the next school years during the case study *Interactive Instructional Methods of the Peer Instruction Type and the Exploration of Their Implementation in Physics Education*.

Acknowledgments

The work is supported by The Charles University Grant Agency (GAUK) under Contract1408213.

References

- [1] Mazur, E. *Peer Instruction: A User's Manual*, Prentice Hall, 253 p., ISBN: 978-0135654415, 1997.
- [2] Mandíková, D, Trna, J. *Žákovské prekoncepce ve výuce fyziky*. Brno: Paido, 245 p. ISBN 978-807-3152-260, 2011.
- [3] Driver, R. *Making sense of secondary science: research into children's ideas*. New York: Routledge, 1994, 210 p. ISBN 04-150-9765-7.
- [4] Turn to Your Neighbor, The Official Instruction Blog [online]. [cit. 8/29/2013]. Available from: < <http://blog.peerinstruction.net/> >
- [5] Crouch, C. H., Mazur, E. Peer Instruction: Ten years of experience and results. *American Journal of Physics*. Vol. 69, No. 9, pp. 970-977, ISSN: 00029505, 2001.
- [6] Fagen, A. P., Crouch, C. H., Mazur, E.. Peer Instruction: Results from a Range of Classrooms. *The Physics Teacher*. Vol. 40, pp. 206-209. ISSN: 0031-921X, 2002.
- [7] Campbell, R., Schell, J. Does Peer Instruction Work in High Schools?. In: *Turn to Your Neighbor* [online]. 2012 [cit. 2014-05-14]. Available from: <<http://blog.peerinstruction.net/2012/06/19/does-peer-instruction-work-in-high-schools-2/>>

Soap Films with Variable Frames of Prisms

Masako Tanemura¹, Masa-Aki Taniguchi², Tetsuya Iwamoto¹, Kanako Osawa¹, and Yoshinori Kitayama¹

¹Faculty of Education, Osaka Kyoiku University, Osaka, Japan,

²Comprehensive Scientific Education Center, Meijo University, Nagoya, Japan

Abstract

We experimented what kind of a soap film is made on the frame of a triangular prism using soap liquid or a kind of the resin liquid. Two kinds of surfaces can be made by changing the height of a triangular prism.

We also made a frame of the triangular prism which height can be changed freely, and we found the critical height experimentally. By changing height slowly and continuously, the phase transition from a state to another state happens. The critical height of making height low is different from one of enlarging height. Therefore there is a phenomenon like hysteresis. We also found each critical height experimentally.

Keywords: soap films, resin films, the minimum surface, triangle prism, phase transition

Introduction

In 1873, Joseph Plateau, a Belgian physicist, proved that the mathematical problem on the minimum surface is able to be solved by using a soap film. Even for a very difficult mathematical problem, the curved surface of the minimum area can be obtained with soap films physically stretched by the frame made of wire. It is because the surface area of a soap film is minimized by the surface tension [1].

We have performed the experiment lecture for children in which makes a soap film using a triangular prism, a quadratic prism, etc. in the past. A part of these experiments are introduced in the workshop of Lady Cats [2]. These experiments are not only visually appealing, but experimental results are not in agreement with anticipations. The experiments with soap film grow students' interest in surface. Even children can make a framework easily using color wires. It is also useful for raising children's spatial perception.

In this article, we discuss on the minimum surface of a triangle prism with using soap liquid or a kind of the resin liquid. We propose a new wire frame by which we can change freely the height of a triangular prism. When we change the height of the pillar, we easily show that the form of soap films changes. For example, in a triangular prism, when height is small, an approximate triangular soap film is made near the center of mass. If height is enlarged gradually, a triangular portion will become smaller and smaller. Eventually the triangle near the center of mass is lost, and the central line of a soap film is made.

In this experiment we can see the minimum curved surface by the soap films or the resin films move continuously by our eyes, and this is good teaching materials for university student which can make students to study what kind of action the surface tension is and grow mathematical concern of students.

The difference in the minimum surface by the height of a triangular prism

We make a triangular prism with wire, and if we soak it in soap liquid and pull up, a soap film will be made in a frame. At this time, the area of the soap film is minimized by the surface tension. There are two kinds of forms according to the height of triangular prisms. In the following, we set one side of a triangle to a and the height of the prism to h .

(1) State I: Form which has an inside triangle for $h \leq a/\sqrt{6}$

When height h is small, an approximate triangular soap film is made near the center of mass. The shape of the curved surfaces of the soap film is shown in Figure 1. Although each surface which constitutes these surfaces is curved actually, it is described like plane since it is easy to draw.

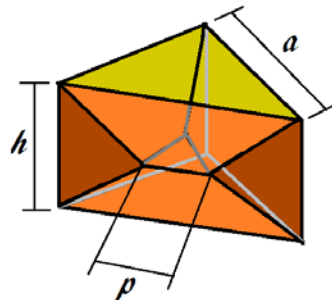

Figure 1. The shape of the soap film in State I

We set one side of an approximate triangle in the center of the soap films to p and obtain the surface area of the soap films as follows:

$$S = \frac{\sqrt{3}}{4}p^2 + \frac{3}{2}(a + p)\sqrt{\frac{1}{3}(a - p)^2 + h^2} + \frac{\sqrt{3}}{2}(a - p). \tag{1}$$

We note that this equation is approximate because a real surface is curved and the area should be larger than the real one. However it is difficult to obtain the minimum value of the surface area S analytically.

(2) State II: Form which has a line in the center for $h > a/\sqrt{6}$

If height is enlarged gradually, a triangular portion will become smaller and smaller. Eventually the triangle in the center disappears, and the central line of a soap film appears. The shape of the surfaces of the soap film is expressed in Figure 2. In this state, each surface is plane. We set the length of a central line to l . If we denote the distance between the triangle in the bottom and the edge of the central line as x , we obtain $x = (h - l)/2$.

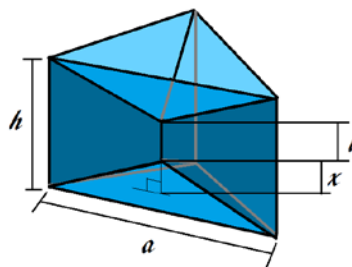

Figure 2. The shape of the soap film in State II

The area of the whole soap film is expressed as follows:

$$S = \sqrt{3} a \left\{ (h - x) + \sqrt{\frac{a^2}{4} + 3x^2} \right\}. \quad (2)$$

We differentiate S as to x and can easily obtain $x = a/(2\sqrt{6})$ which gives the local minimum of S . Therefore the length x is independent of the height of the prism h . In order to realize this result, the height of the prism is larger than $2x$, namely the condition $h > 2x = a/\sqrt{6}$ is required. If the height is satisfied with the condition $h \leq 2x = a/\sqrt{6}$, the soap film becomes another form as State I. Therefore the theoretical critical height is $h_c = a/\sqrt{6}$.

Experiments I: The minimum surface using the soap liquid and a kind of resin liquid

(1) How to build the minimum surface using an American flower

An “American flower” is an artificial flower made using synthetic resin liquid. This solution is an organic solvent which uses the main ingredients as ethyl acetate, and its volatility is high. This resin liquid can be obtained in a handicraft store or the specialty store of the production of an artificial flower. It can mix the solution of two kinds of colors, and we can also adjust a color. Figure 3 shows the resin liquid (left) and solvent liquid (right).



Figure 3. The resin liquid and solvent liquid

Since unlike a soap film this surface is not broken if it dries, it is very convenient for observation of the minimum surface. Figure 4 shows the minimum curved surface using the resin liquid.

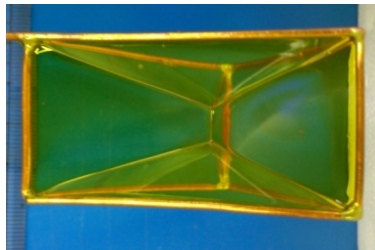

Figure 4. The minimum curved surface using the resin liquid

We explain how to produce the minimum surface in the frame of wire using this solution in the following.

- a) First, we make a solid frame with wire, such as copper wire. A knot is joined with solder etc.
- b) We adjust the concentration by adding the solvent liquid to resin liquid. At this time, if concentration is too deep, a film will not stretch, and even if too thin, a film will break

immediately. When the frame is lifted, the concentration which liquid seldom attaches to the surroundings is good.

- c) We pull up the frame after soaking the frame in the liquid. The peak is turned down and should not be moved for a while until a certain amount of liquid falls from the frame. See Figure 5.



Figure 5. We pulled up the frame out of the resin liquid

- d) If a film stretches in the form of the minimum surface, we turn the frame and we prepare a membranous form. Unevenness may be made if we turn the frame too slowly since a film becomes hard gradually.
- e) It will take about 2 hours until solidifying completely.

(2) Form of the film by the difference in height

We made the minimum surface using the resin liquid. We made six triangular prisms whose height is changed using wire. As follows, when the height of a triangular prism is changed, it turns out that the form of the minimum surface at low height (the 1st~3rd from the left) is different from one at tall height (the 4th~6th from the left) in Figure 6. Namely the form of surface is one in the state I if the height is low, and the form is one in the state II if the height is large enough.

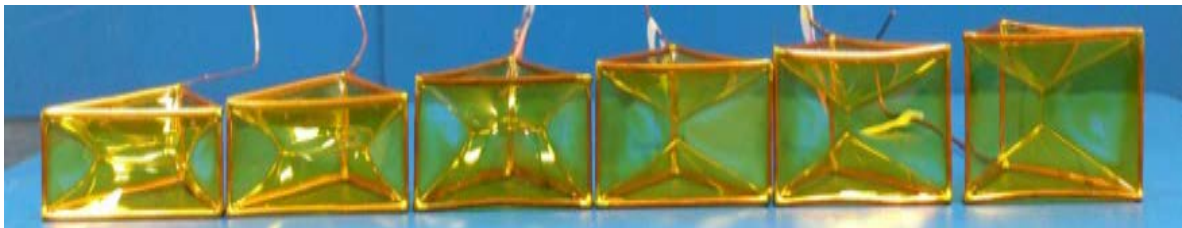





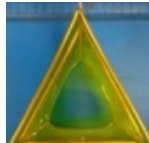
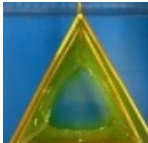

















Figure 6. Form of the film by the difference in height of Prisms

(3) The minimum curved surface by the soap film and the resin liquid

We also made six kinds of triangular prisms. One side of a triangle is 5.0 cm and height is variable from 1.5 cm to 2.5 cm which step is 0.2 cm. We compared the surface of soap films with the surface using the resin liquid. It turns out that they are almost the same.

Table 1. Comparison of soap films and resin films

	State I			State II		
Height	1. 5 cm	1. 7 cm	1. 9 cm	2. 1 cm	2. 3 cm	2. 5 cm
Soap films seen from the top						
Resin films seen from the top						
Soap films seen from a side						
Resin films seen from a side						

When height is small, an approximate triangular soap film is made near the center of mass (State I). If height is enlarged gradually, a triangular portion will become smaller and smaller. Eventually the triangle near the center of mass is lost, and the central line of a soap film is made (State II). We also found the critical height h_c is nearly equal to 2.0 cm in this static condition. This result is consistent with the critical height $h_c = a/\sqrt{6} \cong 2.04$ cm in theory in the previous section.

Experiments II: Change of a soap film when the height of a triangular prism is changed continuously

We made with wire the triangular prism which height is freely adjustable. One side of a triangle is set to 5.0 cm. We laid down the triangular prism horizontally and changed height continuously by two kinds of methods with (1) decreasing the height of the frame or (2) increasing it. We observed how the form of the soap film would change.

We expected the state of the soap film would change bordering on $h_c = a/\sqrt{6} \cong 2.04$ cm. However, the critical height in which the state changes was asymmetrical. There has a kind of hysteretic behavior.

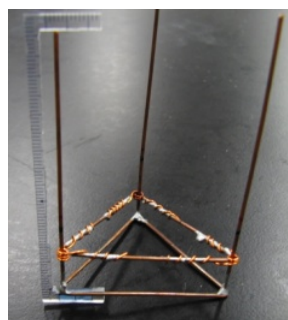

Figure 7. The triangle prism which height is freely adjustable

(1) Decreasing the height of the prism

The form of the soap film is one in State II until h becomes 2.1 cm and it turns into State I in $h = 2.0$ cm. This result is consistent with the theoretical critical value $h_c = \frac{a}{\sqrt{6}} \cong 2.04$ cm.

(2) Increasing the height of the prism

The form of the soap film is one in State I until h becomes 2.5 cm and it turns into State II in $h = 2.6$ cm. We define another critical height h'_c and the value of it is nearly equal to 2.6 cm. When h is between 2.1 cm and 2.5 cm, it is in State I although the height is above h_c and we expected it is in State II. In this range, when the slight stimulus is given from the outside, it changes from one state to another state easily.

Summary and Discussions

We studied the minimum surface of the soap films using the triangular prisms. There are two states depending on the height of the prism. When height of the prism is low, an approximate triangle is made near the center. If height is enlarged, the size of the central triangle becomes smaller and smaller. Eventually the triangle near the center is lost, and the central line of a soap film appears.

We also studied the minimum surface of the resin liquid. The surface using the resin liquid is almost the same as the surface of soap films.

We made a frame of the triangular prism which height can be changed freely. By changing height continuously, the phase transition from a state to another state happens. We found the critical height experimentally. The critical height of making height low is different from one of enlarging height. Therefore a phenomenon like hysteresis happens.

In the reference [3], they also discussed the phase transition and hysteretic behavior on the minimum surface of the soap films using the triangular prisms. They obtained the dimensionless critical heights $h_c/a = 1/\sqrt{6} \approx 0.41$ and $h'_c/a \approx 0.49$, respectively. The latter is obtained numerically with Surface Evolver algorithm [4]. They also obtained both critical heights with their experiments. The values are $h_c/a \approx 0.44$ and $h'_c/a \approx 0.52$, respectively. They explained this small difference comes from (i) non-negligible diameter of wires and (ii) the gravity. We note that they set the triangular prism on the vertical direction and changed the height of the prism vertically.

In our results, we can calculate the dimensionless critical heights as $h_c/a \approx 2.0/5.0 = 0.40$ and $h'_c/a \approx 2.6/5.0 = 0.52$, respectively. These are consistent with their theoretical results. Since we placed the triangular prism horizontally, possibly we were able to obtain such results. However, since the accuracy of our experiment is not enough, some errors may be included. We would like to do at future work about the highly precise experiment.

References

- [1] Stefan Hildebrandt, Anthony Tromba: “*Mathematics and Optimal Form (Scientific American Library)*,” W. H. Freeman & Company.
- [2] Ishii K. et.al: “Simple and Beautiful Experiments VI by LADY CATS and Science Teachers’ Group,” in the International Conference on Physics Education 2013.
- [3] Vandewalle N. et.al: Physical Review E **83**, 021403 (2011).
- [4] Brakke K. A.: Exp. Math, 141 (1992).

Computer-aided activities for inquiry-based skills development

Veronika Timková, Zuzana Ješková

Faculty of Science, University of P.J. Safarik, Kosice, Slovak Republic

Abstract

The development of scientific literacy through active students' engagement in their process of learning has become a main trend of science education today. The strong attention in the current curriculum is paid to the development of inquiry-based skills and abilities while students work as real scientists. These involve fundamental abilities that are necessary to do scientific inquiry that differ in relation to the degree of sophistication of the inquiry-oriented intellectual processes. Among the basic inquiry-based skills for upper secondary schools students there are emphasized the abilities to design and conduct scientific investigations as well as developing appropriate models enhanced by digital technologies. The contribution presents examples of activities designed for different levels of inquiry with the help of datalogging, videoanalysis and modelling computer tools (COACH6 environment). The activity on falling objects is aimed at students' simple investigation of falls of different objects (heavy and styrofoam balls, plates and cups) in order to discover the difference and the influence of the drag force. The experiments can be complemented with the modelling activity when students analyse the already existing model or create their own one eventually, depending on their intellectual level. The activity on the behaviour of balloons is based on the motivational problem of two inflated balloons and their discrepant behaviour when they are interconnected. This problem should lead students to designing and planning their own experiment to explain and reason in order to draw conclusions. The activity on the effect of Magnus force well-known and widely used by sportsmen (tennis, football, volleyball players) can be an attractive problem for students to analyse. They could design and conduct an experiment in a lab and with the help of videoanalysis tools they can collect data about the motion. The model based on dynamical modelling can be studied and analysed in detail in order to compare the results with the theory to show the correspondence.

Keywords: inquiry-based science education, inquiry-based skills, Magnus force, pressure of inflated balloon, drag force

Introduction

The development of scientific literacy through active students' engagement in their process of learning has become a main trend of science education today [1,2]. The strong attention in the current curriculum is paid to the development of inquiry-based skills and abilities while students work as real scientists. However, even if the curriculum involves the inquiry elements, there are traditional methods based on transfer of knowledge dominant in many cases. In order to change this, there are two key elements considered to be the most important: teachers must be educated in the field of inquiry-based science education (IBSE) and they have to have access to IBSE instructional materials. Teachers need to have good examples of inquiry-based activities that are aimed at different inquiry-based skills development. In this paper we focus on several examples of inquiry activities that can be used with upper secondary school students as well first grade's University students.

Inquiry-based skills

The spectrum of inquiry-based skills and abilities that are necessary to do scientific inquiry differ in relation to the degree of sophistication of the inquiry-oriented intellectual processes. Science teachers should develop inquiry skills systematically considering the level of intellectual maturity of their students. Different educators have identified different hierarchies of such skills. Rezba's hierarchy (in [3]) is based on two levels: elementary/middle school and middle/high school education [4]. The American National Research Council [5] identifies three levels based on grades: 1-4, 5-8, 9-12 while Wenning [3] suggests four groups of skills, i.e. rudimentary, basic, integrated and advanced skills based on the relative degree of sophistication of the inquiry processes. Wenning in [6] suggests a limited framework defining scientific inquiry skills presented in Table 1. Nevertheless, among the basic inquiry-based skills for upper secondary schools there are emphasized the abilities to design and conduct scientific investigations as well as to develop appropriate models enhanced by digital technologies. Digital technologies give opportunities for students to work like real scientists with possibilities to collect high-quality data from real experiments as well as from videorecordings, to construct and use computer models and to compare results from experiments with models and theory [7].

Table 1. A limited framework defining inquiry skills according to Wenning [6]

<ul style="list-style-type: none"> • Identify a problem to be investigated • Using induction, formulate a hypothesis or model incorporating logic and evidence • Using deduction, generate a prediction from the hypothesis or model • Design experimental procedures to test the prediction • Conduct a scientific experiment, observation or simulation to test the hypothesis or model <ul style="list-style-type: none"> ○ Identify the experimental system ○ Identify and define variables operationally ○ Conduct a controlled experiment or observation • Collect meaningful data, organize and analyse data accurately and precisely: <ul style="list-style-type: none"> ○ Analyse data for trends and relationships ○ Construct and interpret a graph ○ Develop a law based on evidence using graphical methods or other mathematic model, or develop a principle using induction 	<ul style="list-style-type: none"> • Apply numerical and statistical methods to numerical data to reach and support conclusions: <ul style="list-style-type: none"> ○ Use technology and math during investigations ○ Apply statistical methods to make predictions and to test the accuracy or results ○ Draw appropriate conclusions from evidence • Explain any unexpected results: <ul style="list-style-type: none"> ○ Formulate an alternative hypothesis or model if necessary ○ Identify and communicate sources of unavoidable experimental error ○ Identify possible reasons for inconsistent results such as sources of error or uncontrolled conditions • Using available technology, report, display and defend the results of an investigation to audiences that might include professional and technical experts.
---	---

We have developed several inquiry activities that are aimed at different levels of inquiry. All these activities use digital technologies, namely datalogging, videoanalysis and

modelling computer tools (COACH environment, [8]) that can enhance inquiry. The activities focus on the development of inquiry skills connected with the abilities to design and conduct investigations, create models as well as collect, organize and analyse data and draw appropriate conclusions. The skills connected to the presented activities are in bold in the table (Table 1).

Surprising behaviour of balloons

Students are assigned a problem what would happen if a well-inflated balloon is connected to a similar balloon filled with less air [9]. Carrying out the experiment for different arrangements brings a surprising result. Depending on the size of the balloons there could be all kinds of answers: smaller balloon gets smaller, bigger balloon gets smaller or even balloons can stay as they are (Figure 1). Why it is so, it is up to students to investigate.

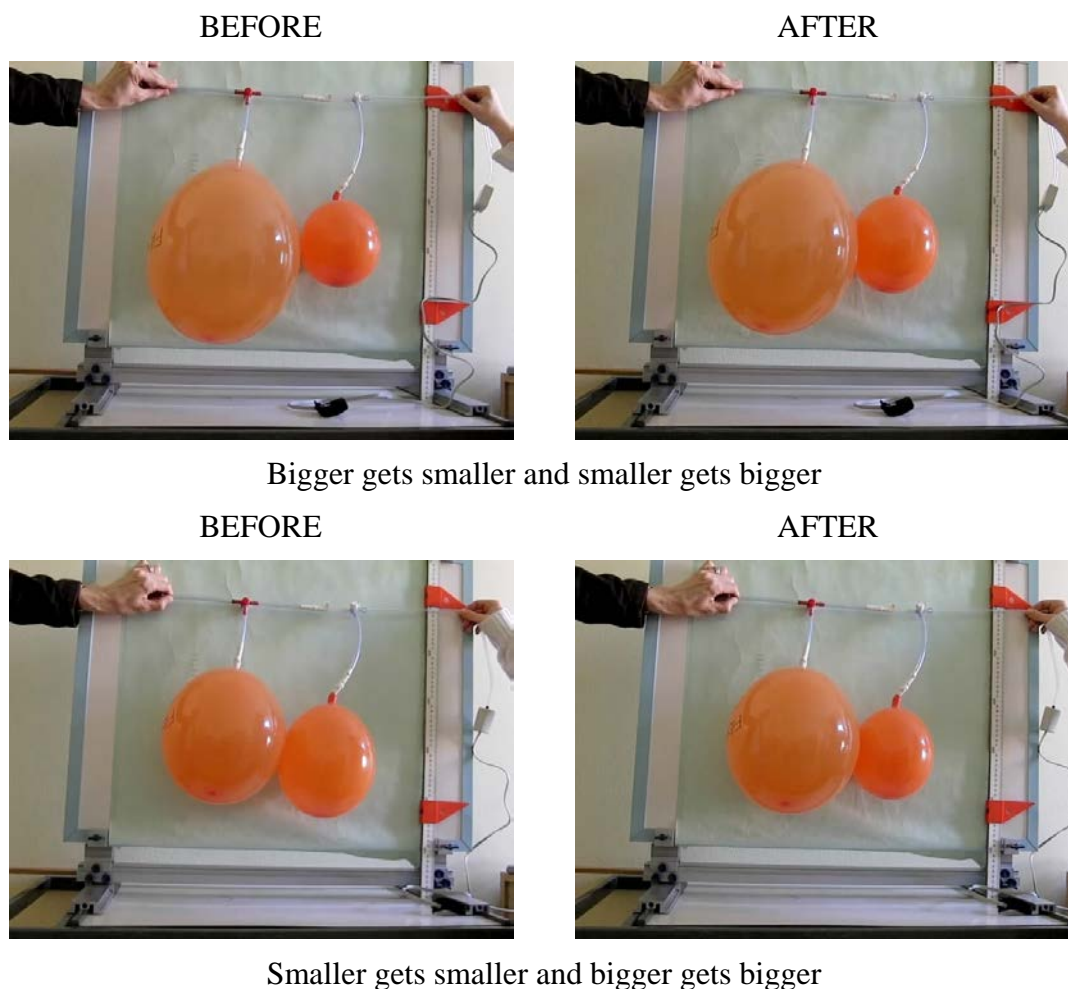

Figure 1. Surprising behaviour of connected balloons

Students can suggest an experiment and decide about the physical quantity to be measured. They should understand that it is pressure that is responsible for the connected balloons' behaviour. They measure the pressure of air inside the balloon and its corresponding radius (Figure 2). The pressure can be measured using a pressure sensor while the pressure created by the latex itself can be calculated as the difference between the pressure inside and outside the balloon $p = p_i - p_o$. The radius of balloon can be determined by measuring the circumference of the balloon. The experimental results show the N-shaped curve (Figure 3).



Figure 2. Experimental setup

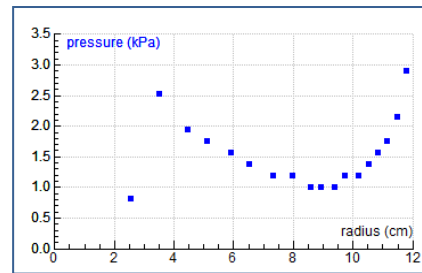

Figure 3. Pressure vs. radius during deflation

This experiment can also lead to a question about the elastic properties of latex that can be studied experimentally measuring the elastic force and the corresponding extension. Analysing both curves (Figures 3, 4) students draw conclusions about the discrepant balloons' behaviour. They are expected to explain and understand that the result of balloons' interconnection depends on the current state of each of the balloon, i.e. which part of the graph the individual balloon corresponds to.

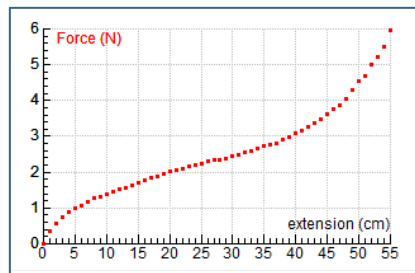

Figure 4. Force vs. extension

The soccer problem

The soccer ball kick involves an interesting and motivating problem why soccer ball kicked with a spin does not fly straight (Figure 5).

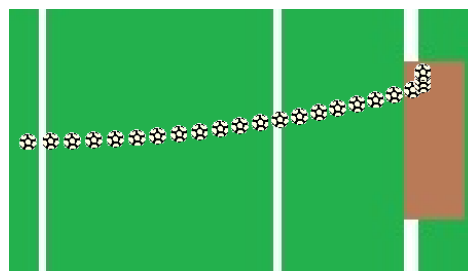

Figure 5. Animation of the soccer ball flight that is deflected from its straight trajectory as a result of anticlockwise side spin

There are several forces acting on the flying ball (Figure 6):

- gravity force $\vec{F}_g = m \cdot \vec{g}$
- drag force $\vec{F}_d = -k_{d1} v \vec{v}$ or $\vec{F}_d = -k_{d2} v^2 \frac{\vec{v}}{v}$,

- Magnus force $\vec{F}_m = k_{m1} v \frac{\vec{\omega} \times \vec{v}}{|\vec{\omega} \times \vec{v}|}$ or $\vec{F}_m = k_{m2} v^2 \frac{\vec{\omega} \times \vec{v}}{|\vec{\omega} \times \vec{v}|}$, if there is also spin imparted to the ball

where k_d and k_m are parameters determined by experiment.

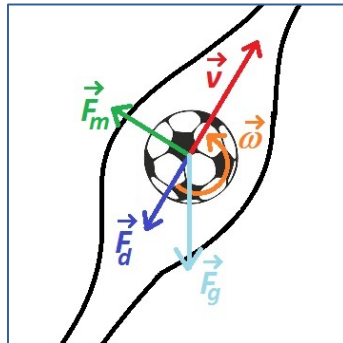

Figure 6. Forces acting on the flying ball

In order to explain and understand rather complicated motion of a soccer ball the problem can be divided into two parts to be studied by students. In the first assignment students investigate the influence of drag force only. Once they understand its effect the investigation can be extended to the analysis of the effect of Magnus force that is not commonly taught at secondary schools, however many students are aware about its existence from various sports like tennis, volleyball, soccer, etc.

How does drag force influence the motion?

Students can design their own simple investigation of falls of different objects. They can carry out real-time measurement of the position of the object using motion sensor or measurement on the videorecording of the motion with the help of videoanalyzing tools. Comparing several objects they can decide which object is influenced the most. Discussing what the drag force depends on students may be led to formulating and verifying a hypothesis assuming a simple relationship $F_d = k_{d1} \cdot v$ or $F_d = k_{d2} \cdot v^2$. To prove this they build a dynamical model (Figure 7) and compare it with the experimental results looking for the constant in each case (Figure 8).

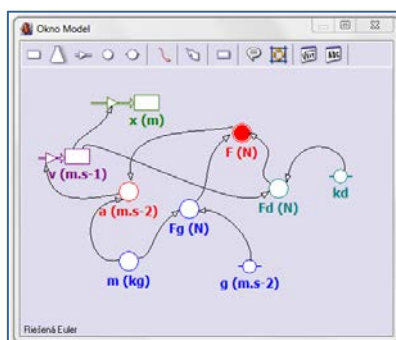

Figure 7. Dynamical model of the fall in the air

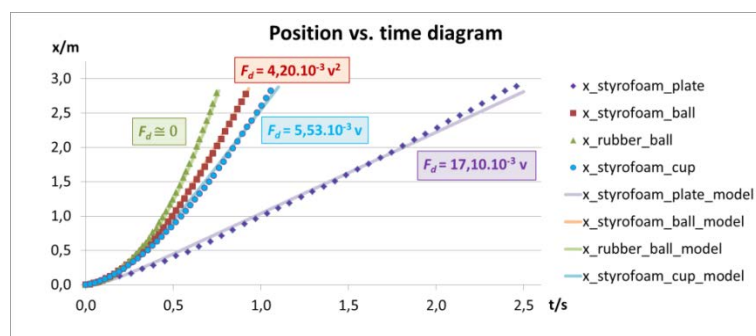

Figure 8. Model vs. experimental results

The model can be built with the help of graphical modelling tool [8] and it assumes net force acting in one direction:

$$\vec{F} = \vec{a} \cdot m = \vec{F}_g + \vec{F}_d, \text{ with its corresponding x-component:}$$

$$F = F_x = m \cdot g - k_{d1}v \text{ or } F = F_x = m \cdot g - k_{d2}v^2$$

Knowing the acceleration a at certain time and the initial values of position x , velocity v , the new values of x and v at the end of a short time interval dt can be found assuming a and v constant over dt . This method enables secondary school students to solve equation of motion in cases of more complicated motions with non-constant forces. Based on the comparison between the model and experimental results students can draw conclusions which model corresponds best (linear or quadratic drag force vs. velocity relationship) for each of the objects (e.g. rubber ball, styrofoam ball, styrofoam cup and styrofoam plate).

What does the Magnus force do?

Since to study and analyse the motion of a real soccer ball kicked in a playfield is not an easy task, students can design their own simpler experiment. The effect of the Magnus force can be investigated in a laboratory using a styrofoam ball rolling down an inclined plane. The ball rotating with topspin is then moving in the air following a curved path. The motion can be videorecorded and analysed in order to get detailed data about the motion (Figure 9a).

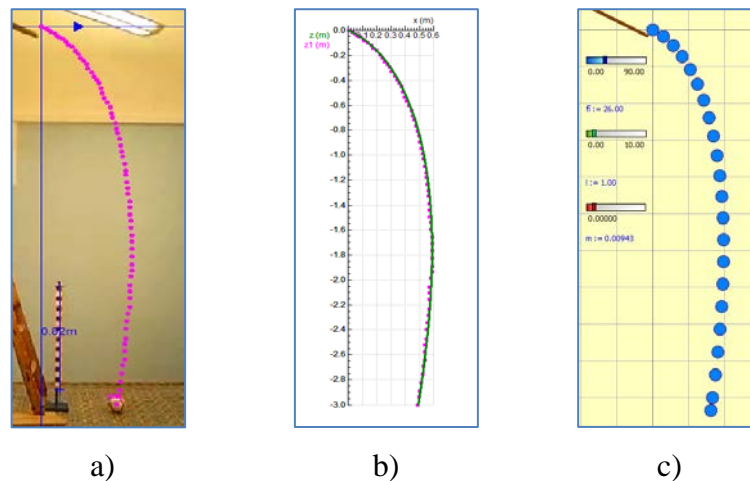

Figure 9. Fall of styrofoam ball: a – videorecording, b – model vs. experimental results, c – animation

This two-dimensional motion in xz -plane (Figure 9) can be modelled dynamically (Figure 10) calculating the total force, corresponding acceleration and velocity and position over small time intervals dt for each component. The equation of motion in vector form with three composing forces can assume linear or quadratic relationship for the drag and Magnus force. In the latter case it means:

$$\vec{F} = \vec{a} \cdot m = \vec{F}_g + \vec{F}_d + \vec{F}_m = m \cdot \vec{g} - k_d v^2 \frac{\vec{v}}{v} + k_m v^2 \frac{\vec{\omega} \times \vec{v}}{|\vec{\omega} \times \vec{v}|}$$

Considering that the ball imparts a spin with the angular velocity in a direction of y -axis, rewriting the equation of motion for x , y and z components we get:

$$F_x = -k_d v_x v + k_m v^2 \frac{(\vec{\omega} \times \vec{v})_x}{|\vec{\omega} \times \vec{v}|}$$

$$F_y = 0$$

$$F_z = -m \cdot g - k_d v_z v + k_m v^2 \frac{(\vec{\omega} \times \vec{v})_z}{|\vec{\omega} \times \vec{v}|}$$

The values of k_d and k_m are usually expressed as $k_d = 0,5 \cdot C_d A \cdot \rho$ and $k_m = 0,5 \cdot C_m A \cdot \rho$ (A – cross-sectional area of the ball, ρ – density of air). These expressions involve the drag and Magnus coefficient (C_d and C_m) that have to be determined by experiment. For the drag coefficient a simple experiment/model of the ball vertical fall can be used (Figures 7, 8). The Magnus coefficient C_m is assumed to be proportional to the angular velocity [10] and simulating the model for different values students can find the best correspondence. There can be also a model based on linear Magnus force vs. velocity relationship tested and verified. The model calculates the horizontal and vertical position of the ball that is presented in the graph together with the experimental results (line vs. dots, Figure 9b). Also the animation of the motion can be created (Figure 9c). Animation enables more realistic view of the ball's motion model with the sliders enabling simulation of the model for different parameters.

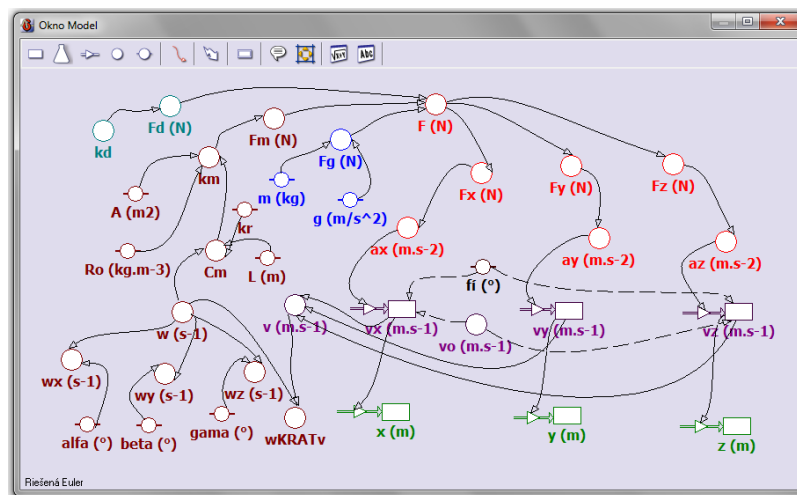

Figure 10. Dynamical model of the spinning ball motion

Possible implementation in the classroom

Not all of the presented activities have yet been tested in practice. We assume that the activity ‘Surprising behaviour of balloons’ is particularly suitable for high school students (15 - 17 years) as an interesting Hooke's law problem that can be carried out by students working in groups of 2-3 in a guided inquiry way with emphasize on students’ abilities to design and conduct of investigation. ‘The soccer problem’ activity that involves Magnus effect concept is rather demanding for high school students since Magnus effect is generally not included in a curriculum. However, it may be a challenge for gifted students motivated towards physics, such like students involving in different physics competitions (e.g. Physics Olympiad or IYPT) or in afternoon physics clubs. The activity may be also implemented within an introductory physics course at University level. Nevertheless, its part ‘How does the drag force influence the motion’ can be used within traditional physics lessons. The activity was tested with high school students (aged 15) after learning the concept of force and drag force. Students in groups of 3-4 members were working with the help of worksheets in a guided inquiry way. Each group conducted a videoexperiment on fall of different bodies (rubber ball, Styrofoam ball, Styrofoam cup and Styrofoam plate)

and created and tested a model in order to find the best correspondence. At the end of the lesson each group presented the results. The joined results can be seen in the resulting graph (Figure 8). The experience shows that students have almost no difficulties to work with digital technologies in order to collect data, however their modelling abilities and abilities to interpret data strongly depends on understanding of the concepts behind. To create a model based on equation of motion proved to be the most demanding part that required a lot of help from the teacher.

Conclusions

Both physical problems can be highly motivating for students. They can design their own investigation and they can solve rather difficult problems with the assistance of digital technologies. However, we are aware that this is not an easy task. Therefore, it is up to the teacher to choose the appropriate level of inquiry depending both on the students' skills and level of progress and on the complexity of problem [1,2,3].

Acknowledgments

This work is the result of the international 7FP projects ESTABLISH and SAILS (FP7/2007-2013, FP7/2012-2015 under grant agreement n° 244749 and n°289085) and VVGS project, supported by Faculty of Science, University of P.J. Šafárik, Košice, Slovakia.

References

- [1] ESTABLISH project, available on <www.establish-fp7.eu>
- [2] SAILS project, available on <<http://sails-project.eu/>>
- [3] Wenning C. J.: 2005. Levels of Inquiry: Hierarchies of pedagogical practices and inquiry processes. In: Journal of Physics Teacher Education On-line, 2(3), 3-11.
- [4] Rezba R. J., Sprague C., Fiel R.: 2003. Learning and Assessing science Process Skills, Debuque, IA: Kendall-Hunt Publishing Co. 4th edition.
- [5] NRC. 2000. National Science Education Standards. National Research Council. Washington, Dc: National Research Council, available on <<http://www.nap.edu/readingroom/books/nses/html>>
- [6] Wenning C. J.: 2007. Assessing inquiry skills as a component of scientific literacy, Phys.Educ.Online, 4 (2), Winter 2007, 21-24.
- [7] Ellermeijer T.: 2013. The use of ICT in the framework of Inquiry Based Science Education (IBSE), Proceedings of the international conference Hands on Science, 1-5 July, 2013, Kosice, Slovakia, 3-7.
- [8] Software COACH 6, available on <<http://cma-science.nl/>>
- [9] Ješková Z., Featonby D., Feková V.: 2012. Balloons revisited, Physics education, 2012, volume 47, 392-398.
- [10] Spathopoulos V. M.: 2009. A Spreadsheet Model for Soccer Ball Flight Mechanics Simulation, Computer Applications in Engineering Education, September 2011, Vol.19, Issue 3, 508-513.

List of reviewers

A kind help of all reviewers is appreciated very much not only by the editors of the Proceedings.

Abraham Salinas Castellanos	Tomasz Greczylo
Akizo Kobayashi	Tomaz Kranjc
Anssi Lindell	Vojta Žák
Caesar Mora	Zdeněk Bochníček
Cecile de Hosson	Zdeňka Koupilová
Claudia Haagen	Zuzana Ješková
Claudio Fazio	Ramon Lopez
Dagmara Sokolowska	James Mackay
Dana Mandíková	Ann-Marie Pendrill
David Sands	Sile Nic Chormaic
Deena Naidoo	Hiroshi Kawakatsu
Derek Raine	Scott Daniel
Ed van den Berg	Rajesh B. Khaparde
Eizo Ohno	Gordon Aubrecht
Elizabeth Swinbank	Ramanathan Subramaniam
Eugenia Etkina	Adriana Gomes Dickman
Fumiko Okiharu	Dmitry Khokhlov
Gorazd Planinšič	Michaela Křížová
Hideo Nitta	Ivan Ruddock
Irena Dvořáková	Pavel Böhm
Jerneja Pavlin	Helmut Kühnelt
Jun-ichiro Yasuda	Ingrid Krumphals
Laurence Viennot	Sandra Regina Teodoro Gatti
Leopold Mathelitsch	
Leoš Dvořák	
Marián Kireš	
Marie Snětinová	
Martin Hopf	
Masahiko Kanenaga	
Michael Vollmer	
Miloš Rotter	
Mojca Cepic	
Morag Casey	
Nada Razpet	
Peter Hockicko	
Peter Horváth	
Petr Kácovský	
Priscilla Laws	
Renata Holubová	
Sergej Faletic	
Simon Bates	

List of authors

Ageorges, Philippe
Akabane, Akira
Allevi, Alessia
Araujo, Ives Solano
Autio-Hiltunen, Marjo
Bacila, Adriana
Barbieri, Sara
Barclay, Charles
Barna, Emil
Barojas, Jorge
Barroso, Marta
Battaglia, Onofrio Rosario
Beamish, John
Beishuizen, Jos
Benedetti, Roberto
Blandin, Bernard
Böhm, Pavel
Bolte, Claus
Bondani, Maria
Bonilla, Alexander
Buaraphan, Khajornsak
Calin, Marius
Campos, Ignacio
Canada, Florentina
Castellanos, Abraham Salinas
Cavallo, Ann
Cavinato, Michela
Cifuentes, María Cristina
Coca, David Méndez
Colombo Junior, Pedro
Donizete
Cortela, Beatriz S. C.
Covlea, Vania
Černý, Michal
Česáková, Jana
Daniel, Scott
De Araújo, Francisco Adeil
Gomes
De Oliveira, Meirivâni Meneses
Del-Valle, Gabriela
Drozd, Zdeněk
Dvorakova, Irena
Dvořák, Leoš
Eckstien, Oren
Ellermeijer, Ton
Elsholz, Markus
Esanu, Tiberiu
Etkina, Eugenia
Eylon, Bat-Sheva
Favale, Fabrizio
Fawcett, Mary
Fazio, Claudio
Feldman, Gerald
Feng, Lixia
Feng, Xiumei
Filho, Moacir Pereira Souza
Franc, Tomáš
Frank, Kalka
Frati, Serena
Fulop, Csilla
Galili, Igal
Gama, Eduardo
Ganajova, Maria
Garcia-Guerrero, Miguel
Gatti, Sandra Regina Teodoro
Gedigk, Kerstin
Giliberti, Marco
Gojkošek, Mihael
Gonzales, Erin E.
Gregorcic, Bor
Grobe, Julian
Gróf, Andrea
Gutierrez, Andrea Munoz
Haagen, Claudia
Hagendorf, Susan
Hale, Gregory
Hale, Gregory R.
Hasegawa, Makoto
Hawner, Martin
Hejnová, Eva
Hernández, Maria-Guadalupe
Hollan, Jan
Holubova, Renata
Horváth, Peter
Houfkova, Jitka
Chalupnikova, Rita
Chang, Sheh Lit

Chantharanuwong, Warawun
Cheung, Kwok-Cheung
Imenda, Sitwala Namwinji
Ishii, Kyoko
Iwamoto, Tetsuya
J.Aubrecht, Gordon
Jackson, David P.
Janina, Marquis
Ješková, Zuzana
Jiménez, Jose-Luis
Jipa, Alexandru
Jolly, Pratibha
Jugueta, Eleanor Alma
Jurmanová, Jana
Kácovský, Petr
Kahkonen, Anna-Leena
Kapanadze, Marika
Katja, Eulenberg
Kawakatsu, Hiroshi
Kazachkov, Alexander
Kéhar, Ota
Kekule, Martina
Kerlínová, Věra
Khaparde, RajeshB.
Kim, Schneider
Kimakova, Katarina
Kires, Marian
Kitayama, Yoshinori
Kobel, Michael
Kodejška, Čeněk
Koenig, Kathy
Kolářová, Lucie
Koniček, Libor
Koo, Marcos Ley
Korberova, Iva
Kosionidis, Aristeidis
Koudelková, Věra
Koupil, Jan
Koupilova, Zdenka
Kozma, Cecilia
Kranjc, Tomaz
Kruit, Patricia
Křížová, Michaela
Kubínek, Roman
Kuriščák, Pavel
Kusak, Radim
Kussuda, Sérgio Rykio
Kvapil, Jiri
Lambourne, Robert
Látal, František
Laws, Priscilla W.
Lehavi, Yaron
Leitner, Rupert
Leos, Estela Margarita Puente
Leto, Francesca
Ličmanová, Lenka
Lindell, Anssi
Lipetrová, Kateřina
Lokka, Antti
Lopez, Ramon E.
Lustig, František
Macabebe, Erees Queen
Mackay, James
Mandikova, Dana
Mann, Llewellyn
Manuel, Stach
Marín, Esther
Marios, Karapanos
Marks, Joan Borg
Markus, Kühn
Martinez, Miguel Cuauhtli
Mathelitsch, Leopold
Mazzolini, Alex
Medsker, Larry
Medvegy, Tibor
Mechlová, Erika
Meldrum, Al
Mellado, Vicente
Melo-Nino, Lina Viviana
Meszéna, Tamás
Mchunu, Stephan Paraffin
Michael, Lakatos
Michelini, Marisa
Michel-Sandoval, Bertha
Milěj, Tomáš
Millar, Robin
Montalbano, Vera
Mori, Masazumi
Mossenta, Alessandra
Müller, Maykon Gonçalves
Müller, Rainer
Nardi, Roberto

Nardo, Luca
Nicola, Maria De
Nobre, Eloneid Felipe
Nováková, Mária
Novotný, Jan
Occhipinti, Susanna
Oese, Erik
Ogawa, Shinjiro
Okiharu, Fumiko
Okoronka, Augustine
Oláh, Mária Éva
Onishi, Haruka
Osawa, Kanako
Pendrill, Ann-Marie
Pengpan, Tepakorn
Pereira, Alessandro
PersanoAdorno, Dominique
Petó, Mária
Pfeffer, Jeremy I.
Pizzolato, Nicola
Planinšič, Gorazd
Pospiech, Gesche
Poutot, Géraldine
Pucholt, Zdeněk
Puttisanwimon, Supachoke
Qiu, Leiju
Radovanović, Jelena
Rakkapao, Suttida
Ramos-Rambaud, Edgar
Randa, Miroslav
Rankin, Graham
Razpet, Nada
RehanAli, Syed
Reichl, Jaroslav
Renzzone, Simone Di
Ribeiro, Allan Victor
Rigon, Enrico
Richterek, Lukáš
Ristea, Catalin
Ristea, Oana
Rosenzweig, Guy
Ruddock, Ivan S.
Říha, Jan
Sands, David
Santi, Lorenzo
Sato, Minoru
Sebestyen, Dorothy
Shah, Syed Naseem Hussain
Sharma, Nidhi
Shogenji, Takahiro
Shozawa, Jun
Schiltz, Guillaume
Schmeling, Sascha
Schneider, Vincent
Silva, Cibelle Celestino
Simone, Grimmig
Sliško, Josip
Slovinsky, Ekaterine
Snětinová, Marie
Souza De Jesus, Andréa Cristina
Sperandeo-Mineo, Rosa Maria
Stefanel, Alberto
Stellato, Marco
Strahl, Alexander
Suzuki, Shinnosuke
Svobodová, Jindřiška
Swinbank, Elizabeth
Šestáková, Jana
Švecová, Libuše
Taale, Kodjo Donkor
Takahashi, Hiroshi
Takahashi, Naoshi
Tamaki, Toyomi
Tamborini, Marina
Tanemura, Masako
Taniguchi, Masa-Aki
Tasnádi, Anikó
Taylor, John
Teese, Robert B.
Teodorescu, Raluca
Thathong, Kongsak
Theve, Andreas
Thomas, Gregory P.
Timková, Veronika
Tokuda, Kazuhiro
Tran, Trinh-Ba
Trefzger, Thomas
Tyntarev, Mikhail
Uchida, Tasuhiro
Urban, Hildegard
Uribe, Carlos Julio
van Den Berg, Ed

Vanacore, Antonio
Vaterlaus, Andreas
Veit, Eliane Angela
Vercellati, Stefano
Vinitsky-Pinsky, Lina
Volná, Marie
Wadhwa, Ajay
Wagner, Clemens
Whitehouse, Mary
Willis, MaxineC.
Yasuda, Jun-Ichiro
Yokoe, Mika
Yokokawa, Katsumasa
Yuenyong, Chokchai
Zajacova, Blanka
Zak, Vojtech
Zuccarini, Giacomo