



LUND UNIVERSITY

Resistivity investigation and monitoring for detection of internal erosion and anomalous seepage in embankment dams

Sjödahl, Pontus

2006

[Link to publication](#)

Citation for published version (APA):

Sjödahl, P. (2006). *Resistivity investigation and monitoring for detection of internal erosion and anomalous seepage in embankment dams*. [Doctoral Thesis (compilation), Division of Engineering Geology]. Engineering Geology, Lund University.

Total number of authors:

1

General rights

Unless other specific re-use rights are stated the following general rights apply:

Copyright and moral rights for the publications made accessible in the public portal are retained by the authors and/or other copyright owners and it is a condition of accessing publications that users recognise and abide by the legal requirements associated with these rights.

- Users may download and print one copy of any publication from the public portal for the purpose of private study or research.
- You may not further distribute the material or use it for any profit-making activity or commercial gain
- You may freely distribute the URL identifying the publication in the public portal

Read more about Creative commons licenses: <https://creativecommons.org/licenses/>

Take down policy

If you believe that this document breaches copyright please contact us providing details, and we will remove access to the work immediately and investigate your claim.

LUND UNIVERSITY

PO Box 117
221 00 Lund
+46 46-222 00 00

Resistivity investigation and monitoring for detection of internal erosion and anomalous seepage in embankment dams

Pontus Sjödahl

Doctoral Thesis

2006



LUND UNIVERSITY

Academic thesis which, by due permission of the Faculty of Engineering at Lund University, will be publicly defended on Friday 17th of March, 2006, at 10:15 a.m. in lecture hall C, in the V-building, John Ericssons väg 1, Lund, for the degree of Doctor of Philosophy in Engineering.

Faculty opponent: Prof. Ugur Yaramanci, Technical University of Berlin, Germany.

Engineering Geology
Lund University
Box 118
S-221 00 Lund
Sweden

© 2006 Pontus Sjö Dahl

ISBN-10: 91-973406-5-0
ISBN-13: 978-91-973406-5-6
EAN: 9789197340656
ISRN: LUTVDG/TVTG—1017-SE

Printed by KFS AB, Lund 2006

Acknowledgements

A lot of valuable contributions and support have been received through the work with this thesis. I am particularly grateful to:

Torleif Dahlin, who has been a truly great supervisor leading me in the right direction at cross-roads, and giving me strong support at difficult passages. Being a guru of data acquisition and the designer of the dam monitoring systems at Hällby and Sädva, Torleif has been a strong support for the carrying out of the work behind the thesis.

Sam Johansson, who as an assistant supervisor always encouraged me during hard times with his genuinely passionate interest for seepage monitoring in embankment dams. Sam acted as a link to the power and dam industry making the field tests at Hällby, Sädva, Enemossen and Røssvatn possible.

The financers of this work:

- Elforsk AB, who has been the major financer and a guarantor for the financing of this work during its full extension. Elforsk AB provided funding from the Swedish power companies and Svenska Kraftnät AB.
- The Swedish Association for Innovation Systems (VINNOVA), who joined as a financer and helped fund the later stage of the work through the Swedish Infrastructure Program called "Road-Bridge-Tunnel".
- The Dam Safety Interest Group (DSIG) was financing parts of the work in the initial stage.
- Eon, Statkraft and Vattenfall invested in the monitoring systems on Hällby and Sädva, thereby indirectly contributing with the field data that form a basis for this thesis.

The colleagues at Engineering Geology in Lund, for friendship and help, as well as for making the department an enjoyable place to spend days and nights.

The staff at Hällby dam and Sädva dam, for assisting with all kinds of minor and major things on the monitoring systems, such as modem communication problems, changing malfunctioning equipment, new installations, testing for errors on remote instructions and many more.

Bing Zhou, who provided invaluable help with the dam modelling studies during his time in Lund and after moving to Adelaide, Australia.

Johan Friborg, for fruitful discussions and for being a great company on field trips to Hällby, Sädva and Røssvatn.

Bob Corwin, Megan Sheffer and Ken Lum in the DSIG geophysics group for inspiring collaboration.

Family and friends for being wonderful people, and for being part of my life. Especially so, *Cilla, Milton and Flora*.

List of Papers

- PAPER 1 Sjö Dahl P, Zhou B, Dahlin T (2006) 2.5D resistivity modeling of embankment dams to assess influence from geometry and material properties. Accepted for publication in: Geophysics
- PAPER 2 Sjö Dahl P, Dahlin T, Johansson S (2005) Using resistivity measurements for dam safety evaluation at Enemossen tailings dam in southern Sweden. *Environmental Geology* 49: 267-273
- PAPER 3 Sjö Dahl P, Dahlin T, Johansson S, Loke MH (2006) Resistivity monitoring for leakage and internal erosion detection at Hällby embankment dam. Submitted for publication to: *Journal of Applied Geophysics*
- PAPER 4 Sjö Dahl P, Dahlin T, Johansson S (2006) Using the resistivity method for leakage detection in a blind test at the Rössvatn embankment dam test facility in Norway. Submitted for publication to: *Engineering Geology*
- PAPER 5 Sjö Dahl P, Dahlin T, Johansson S (2006) Estimating seepage flow from resistivity monitoring data at the Sädva embankment dam. Submitted for publication to: *Journal of Environmental and Engineering Geophysics*.

Related reports and conference papers

Sjö Dahl P, Dahlin T, Johansson S (2006) Defect detection using resistivity measurements - experiences from a field test dam and large embankment dams in Sweden. Procs. International Commission on Large Dams (ICOLD), 22th Congress, Q.86, 18-23 June 2006, Barcelona, Spain, in press

Johansson S, Nilsson Å, Garner S, Dahlin T, Friborg, J, Sjö Dahl P (2005) Internal erosion detection at the Rössvatn test site – experiences from blind test using resistivity, self potential, temperature and visual inspection. *Elforsk report 05:42*, p 138 (available at www.elforsk.se)

Johansson S, Friborg J, Dahlin T, Sjö Dahl P (2005) Long term resistivity and self potential monitoring of embankment dams – Experiences from Hällby and Sädva dams, Sweden. Canadian Electricity Association - Dam Safety Interest Group CEATI Project No T992700-0205, *Elforsk report 05:15*, p 123 (available at www.elforsk.se)

Dahlin T, Sjö Dahl P, Johansson S (2005) Resistivity monitoring for internal erosion detection at Hällby and Sädva embankment dams. Procs. International Symposium on Dam Safety and Detection of Hidden Troubles of Dams and Dikes, November 1-3 2005, Xi'an, China, p 10

Dahlin T, Sjö Dahl P, Friberg J, Johansson S (2004) Defect detection using measurements of resistivity and self potential – Experiences from a field test dam and large embankment dams in Sweden. Procs. International Seminar on Stability and Breaching of Embankment Dams, 21-22 October 2004, Oslo, Norway, p 29

Johansson S, Sjö Dahl P (2004) Downstream seepage detection using temperature measurements and visual inspection – Monitoring experiences from Røsvatn field test dam and large embankment dams in Sweden. Procs. International Seminar on Stability and Breaching of Embankment Dams, 21-22 October 2004, Oslo, Norway, p 20

Sjö Dahl P, Dahlin T, Johansson S (2004) Resistivity monitoring for internal erosion detection at Hällby embankment dam. Procs. International Conference on Environment and Engineering Geophysics, June 6-11 2004, Wuhan, China: 310-316

Sjö Dahl P, Dahlin T, Johansson S (2004) Using resistivity measurements for dam safety evaluation at Enemossen tailings dam, Procs. 10th Meeting Environmental and Engineering Geophysics, 6-9 September, Utrecht, The Netherlands, 2004, p 4

Johansson S, Dahlin T, Friberg J, Sjö Dahl P (2004) Leakage detection ability using resistivity, self potential, temperature, and induced polarization measurements – Experiences from field tests. Procs. International Commission on Large Dams (ICOLD), 72th Annual Meeting, 16-22 May 2004, Seoul, Korea: 64-83

Sjö Dahl P, Dahlin T, Johansson S (2003) Resistivity monitoring for leakage detection at Hällby embankment dam. Procs. 9th Meeting Environmental and Engineering Geophysics, 31 August-4 September 2003, Prague, Czech Republic, p 4

Sjö Dahl P, Dahlin T, Zhou B, Johansson S (2002) Monitoring of leakage in embankment dams through resistivity measurements – a 2.5D modelling study. Procs. 8th Meeting Environmental and Engineering Geophysics, 8-12 September 2002, Aveiro, Portugal: 169-172

Dahlin T, Sjö Dahl P, Friberg J, Johansson S (2001) Resistivity and SP surveying and monitoring at the Sädva embankment dam, Sweden. ISBN 90 5809 196 1, Procs. 5th European ICOLD Symposium, 25-27 June 2001, Geiranger, Norway: 107-113

Abstract

Methods for monitoring seepage and detecting internal erosion are essential for the safety evaluation of embankment dams. Internal erosion is one of the major reasons for embankment dam failures, and there are several tenths of thousands of large embankment dams in the world. Internal erosion is progressing inside the dam, and is sometimes difficult to detect by conventional methods. Therefore, there is a strong need of new or improved detection methods. The resistivity method is an established method with a variety of engineering and environmental applications, but it is only occasionally tested on embankment dams. When applied for dam safety examination, the method can principally be used in two ways. Firstly, resistivity investigations at single occasions may detect spatially anomalous zones along the dam, and can be used to investigate suspected structural weaknesses. Secondly, long-term resistivity monitoring make use of the seepage-induced seasonal variation inside the embankment to detect anomalies not only in space, but also more importantly anomalies in time, by studying deviations from the time-variation pattern.

Within this thesis the resistivity method has been used in practice on four Scandinavian locations, both in the form of investigation and monitoring. At Enemossen tailings dam a single investigation was carried out. At Hällby and Sädva dams an ongoing program with permanently installed monitoring systems has acquired daily data since 1996 and 2001 respectively. In addition, the method was tested under short-term monitoring conditions on a test embankment with built-in structural defects at Røssvatn. Apart from the field measurements, numerical modelling has been done in order to optimise measurements and support interpretation of the results.

The experience from the field measurements demonstrates that monitoring is a more powerful approach than single investigations. The seasonal resistivity variation is evident and under favourable circumstances it may be used to evaluate the seepage. A systematic methodology has been developed for efficient monitoring and evaluation of long-term resistivity data. The monitoring instrumentation has largely proved reliable. Proper electrode installations are essential. Installing the electrodes along the top of the dam core is efficient on existing dams as it creates a current channelling effect inside the conductive dam core, which is the part of the dam with highest interest.

Further development and refinement is needed to make the method more easily adaptable to the large variety of embankment dams and thereby more attractive for industrial use. Some ideas of future work are proposed. However, the efficiency of the method has been developing rapidly recently, and significant progress has been done within this thesis concerning the use of the method for dam monitoring. It is concluded that the application of the resistivity method for detection of anomalous seepage and internal erosion in embankment dams is obvious.

Keywords

embankment dam, internal erosion, leakage, seepage, detection, resistivity, modelling, monitoring, inversion, time-lapse inversion

Table of contents

1	Introduction	1
1.1	Objectives	2
1.2	Limitations.....	2
1.3	Thesis structure.....	3
2	Embankment dams.....	5
2.1	Background.....	5
2.2	Internal erosion	8
2.3	Detection methods of internal erosion.....	13
2.4	Upgrading and repair	16
3	The resistivity method	17
3.1	Background.....	17
3.2	Common application areas	19
3.3	Resistivity of geological materials	20
3.4	Data acquisition	25
3.5	Data processing.....	27
3.6	Data interpretation	34
3.7	Resistivity modelling.....	35
4	Resistivity surveying on embankment dams	39
4.1	Monitoring and investigation – two different approaches.....	39
4.2	Previous work	39
4.3	Resistivity variations in embankment dams	40
4.4	Data acquisition and measurement optimisation	47
5	Field measurements.....	55
5.1	Dam status investigation at Enemossen tailings dam.....	56
5.2	Blind test at the Rössvatn embankment dam test facility.....	58
5.3	Long-term monitoring at Hällby embankment dam	61
5.4	Seepage evaluation at Sädva embankment dam	63
5.5	Discussion on field measurements	66
6	Conclusions	69
7	Future recommendations	73
7.1	Improve usefulness and efficiency of the system.....	73
7.2	Improve resolution on large depths through new measurement concepts.....	74
7.3	Improve evaluation through new inversion techniques	74
7.4	Improve base of interpretation through advanced modelling.....	75
8	References	77

1 Introduction

Dams have been used to regulate rivers for centuries. Ancient civilizations built dams for drinking water supply, flood control and irrigation. In our days, including the motifs already mentioned, dams are constructed for a broad variety of purposes, such as hydroelectric generation, navigation, recreation, mining and many more. The benefits of dams are obvious, and in today's society dams represent a great value. However, all the achievements reached by the modern society through construction of dams, comes with a price and with a responsibility.

The price consists of the alteration of the environment and all the effects that results from that. It can be exemplified by drowned river valleys, reduced flows in rivers, impact on water quality in rivers and reduction of biodiversity due to closing out species from the upper part of the river. The list can be made much longer.

The responsibility that comes with dam construction is evident. In many cases potential dam failures may result in a catastrophe with considerable loss of life or property. In a historic perspective, dams have occasionally failed leading to terrible consequences. Working on dam safety is essential to avoid such catastrophes and must progress as long as the dam stands. Moreover, as existing dams age the importance of dam safety efforts increase even more.

Embankment dams are made of earth and rock material and represent the most common dam construction type in Sweden as well as worldwide. One of the most common failure scenarios of embankment dams starts with internal erosion. It can be described as process where soil particles from the inner parts of the dam are being carried downstream by the seepage. The process may then accelerate with increasing seepage flow, followed by further transport of fines, and so forth. Finally, a severe leakage and high water pressure in the dam body or foundation will be obtained, which may lead to the failure of the dam. The duration of the process from the start of an increased seepage to a complete failure of the dam may vary considerably, from a few hours to many years. Sometimes the process initiates but stops as the dam heals by itself. In any case, there is a strong urge to detect such a process at an early stage of its development. Conventional seepage detection methods do not always meet this requirement. As a result, these methods are being refined, but also newer unconventional methods of seepage detection are being investigated. One such method is resistivity monitoring.

The resistivity method is now well established and widely used in a variety of engineering and environmental investigations. The method is particularly attractive when monitoring on existing dams, as it is non-intrusive but still has the potential of detecting changes in the inner parts of the embankment. Recent development of the method has been astonishing, both in data acquisition and data processing. Over the last decade or two, resistivity surveying has developed from a slow procedure of manually measuring point by point to rapid multi-channel data acquisition using automatic multi-electrode systems. The development in computational power has allowed for more efficient processing of data, which has been encouraging for investigations with large amounts of data, such as three-dimensional investigations and repeated measurements.

The new improvements have therefore been advantageous for dam monitoring, where a lot of data needs to be handled as the measurements are repeated in time. To process the amount of data collected at a single time standard dam monitoring investigation would have been simply impossible just two decades ago.

Generally speaking, resistivity monitoring on embankment dams offers the possibility to measure the two basic phenomena resulting from the internal erosion process. Firstly, the resistivity is dependent of temperature, and temperature is a known indicator of seepage. Secondly, resistivity is a material parameter and might therefore detect changes in composition of the core material, which follows when internal erosion is developing.

1.1 Objectives

The main objective of this thesis has been to evaluate the potential of resistivity investigation and monitoring as tools for detection of internal erosion and anomalous seepage in embankment dams. The main questions to be answered were therefore if sensitive high-quality measurements and careful analysis of time-series from resistivity monitoring would stand a chance of detecting anomalous seepage zones, and if it was possible to evaluate seepage flow rates from such data. This hypothesis as well as a discussion on the answer of those questions is described in sections 4.3 and 5.

Development and improvement of the methodology is an inevitable part of the project. An ultimate goal is to develop a fully automatic sensitive monitoring system that can be integrated in the operational system of the dam owner.

To achieve this, field monitoring has been carried out at Hällby and Sädva embankment dams. At Hällby, a resistivity monitoring system was installed in 1996, and around the same time as the start of this thesis work in 2001, a similar system was completed for Sädva. Monitoring data from these two establishments were to constitute the foundation of the thesis work. In addition, some complementary measurements were performed at other sites and numerical modelling studies were conducted.

1.2 Limitations

This thesis is focused on the application of the resistivity method for detection of internal erosion and anomalous seepage in embankment dams. Even though other geophysical methods occasionally have been used, the thesis is limited to the use of the resistivity method.

Various numerical modelling methods have been used and constitute a central part of this work. Forward modelling, both 2.5D and 3D, and inverse modelling have been used. Existing modelling tools were employed and no theoretical development of these methods has been done, although an adaptation of standard 2.5D modelling schemes was performed. The thesis includes few theoretical descriptions in the form of mathematical formulas or equations and has no ambition of a complete coverage here, but the basic relations and references to appropriate methods are being provided.

The methodology has been developed and optimised mainly for Scandinavian conditions on zoned embankment dams. For situations with significant differences in embankment dam design or with different geo-electrical conditions of construction materials or reservoir water the evaluation techniques are useful but may need to be reworked.

1.3 Thesis structure

The thesis work is based on five scientific papers that have been sent to peer-reviewed scientific journals in the research field. The ongoing long-term field monitoring programs at Hällby and Sädva dams has been a foundation for the thesis work. The monitoring results are presented in PAPER 3 and PAPER 5. Numerical modelling has been carried out in order to support and improve the monitoring program. The modelling work is presented in PAPER 1 and as a part of PAPER 4. In PAPER 2 a case study from a dam safety investigation at Enemossen tailings dam is presented. Here a technique of using the method for single dam safety investigations is discussed. Finally, a unique possibility to test the method under real conditions appeared, as some short-term monitoring was conducted, in a blind test at the embankment dam test facility at Røssvatn in Norway. This test is described in PAPER 4.

A summary part of the thesis has been written in order to introduce and emphasize the problems investigated in the different papers and in order to try to clarify the specific contribution from each of the papers to get closer to the final objectives of the project as described above. The summary may also include some material that for various reasons was not included in the separate papers. The summary part comprises a section where embankment dams are introduced, first with a general description and later with an emphasis on the issues associated with seepage, leakage and internal erosion. In the next section the resistivity method is being described, mainly on a general basis but with a slight emphasis on issues that are important for monitoring of embankment dams. In the subsequent section selected findings regarding embankment dam resistivity monitoring in general, is brought up and discussed. After that, selected results from field measurements are presented. Finally, the summary part ends with some conclusions and some proposals for future direction of research in this area.

2 Embankment dams

This section deals with embankment dam and seepage related problems. The subject is only briefly introduced here, but other sources, such as for instance Fell et al. (1992), give a fine covering picture on embankment dams. Design and construction of embankment dams differ from one part of the world to another, depending on the available soil materials. However, in this section the centre of attention in the description of embankment dams is directed to Swedish conditions. To start with, some background information on embankment dams is presented. After that, problems associated with anomalous seepage and internal erosion are examined in more detail, as such problems have been of importance for this thesis. Subsequently, detection methods of these problems are described, and finally some common strategies of how to take measure against or solve these problems are briefly presented.

2.1 Background

In dam engineering the significance of the embankment dam is undoubted. It was the first type of dam built by man. Furthermore it is the most common dam type both among existing dams and for construction of new dams. It also forms the highest dam in the world (Penman 1986). Today 70-80% of all dams are embankment dams (ICOLD 2003; Cech 2005).

The International Commission on Large Dams, ICOLD, summarises statistics over large dams and extensive surveys over incidents and failures of large dams on a recurring basis. Customary in this context a large dam is considered a dam higher than 15 m from the lowest part of the foundation to the crest, even though the strict definition also involves a number of dams in the range of 10-15 m height with other pre-defined conditions fulfilled. Worldwide there are approximately 25000 large embankment dams (ICOLD 2003). A number that is likely to increase when China register all their dams. More than half of the dam population, and in particular most of the highest ones, were built after 1950. However, there are also many dams older than 100 years (Höeg 2001).

In Sweden, there are several thousands of smaller dams and 190 dams that meet the ICOLD definition on large dams (ICOLD 2003). These dams include both embankment dams and concrete dams. However, embankment dams are in a clear majority. Moreover, there are a number of tailings dams that are not included in the ICOLD statistics. Most of the Swedish large dams were built in the period 1950-1980.

2.1.1 Embankment dam types

An embankment dam is a dam that is constructed with earth and rock materials. A common classification is to divide embankment dams into earthfill dams and rockfill dams. Sometimes homogeneous earthfill dams are separated into a class of its own. Homogeneous dams are the oldest type of dam, constituted by one single type of low-permeable material, sometimes with coarser material on the slopes to increase stability and protect the dam from surface erosion. Due to stability problems, or more specifically due to the risk of slips, the slopes are made moderate, which extends the size of the dam. The design is unpractical and is rarely used on high dams.

Earthfill dams are embankment dams that are mainly constituted by compacted earth material, whereas rockfill dams are to the larger extent built up from crushed rock. These types of dam are built up in a number of zones, and the term zoned embankment dams are widely used to emphasize that such dams are constructed in different zones. Each zone then has different material properties and functionality. The type of zoned embankment dam with central core as shown in Figure 1 is a commonly used design for Swedish dams. The dams examined within this thesis at Hällby and Sädva, where long-term monitoring programs are in progress, are essentially of this type, with a vertical core at the Hällby dam and a slightly inclined core at the Sädva dam.

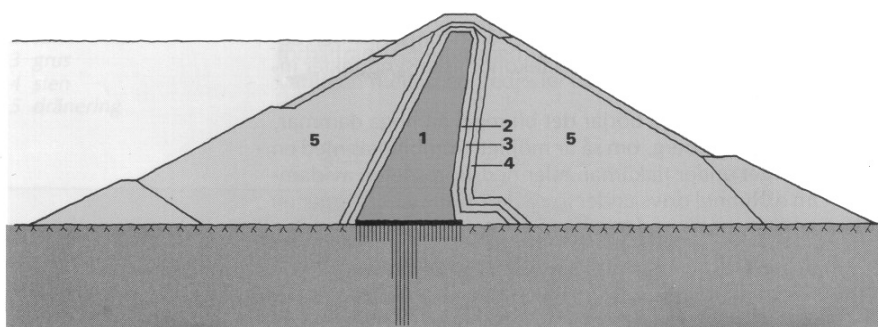

Figure 1. Cross-section of a zoned embankment dam with a central, slightly inclined core, illustrating the principle zones and some details of the dam design. Core (1), fine, medium and coarse filters (2,3,4) and support fill (5) (modified from Vattenfall 1988).

The principle zones are composed out of different materials with different properties and functionality according to the following:

- Core: This is the low-permeable zone of the dam, and its main purpose is to control the seepage flow through the dam. The core consists typically of fine-grained soils, such as clays, clayey sands and silty sands (Fell et al. 1992). For Swedish conditions glacial tills are dominating as core material. Recommended tills are of a silty or sandy character with 15-40% fines content, calculated as amount of the soil passing 0.06 mm in relation to the total material passing the 20 mm sieve, and with low content of coarser fractions. Higher percentages of fines content may cause practical difficulties during construction and lower percentages may result in too high hydraulic conductivities (Vattenfall 1988). A hydraulic conductivity in the approximate range of 10^{-7} to 10^{-9} m/s is considered satisfactory.
- Filters: The filters constitute a protection against material transport from the core. In addition, seepage water is effectively drained so that pore pressures cannot build up downstream of the core. Filter can be placed in one or more zones, with a gradual increase in grain size from the core and outwards. Between each step appropriate filter criteria should be fulfilled. Fine filters are typically sand or gravelly sand and coarse filters are normally gravelly sand or sandy gravel (Fell et al. 1992). The filter zone immediately downstream the core is considered the most important. The filter zone immediately upstream the core may help healing the core if internal erosion

occurs, in that material from the filter is transported into the eroded part of the core (Vattenfall 1988).

- Support fill: The support fill provides stability for the dam. This zone consists of coarse free draining material, commonly crushed rock. For dams with coarse rockfill several filter zones are needed to fulfil the filter requirements between filter and fill.

The classification into earthfill dams and rockfill dams as described above is used by ICOLD in their inventory of large dams. It is a general categorisation, which does not in detail describe the variety of embankment dam designs. Numerous types of embankment dams are to be seen all over the world. The selected type of design for a particular dam is depending on many factors, such as for example available construction materials and foundation condition at the site. Detailed discussions and reflections on embankment dam design and construction methods are available in the literature (e.g. Terzaghi and Peck 1948; de Mello 1977; Vattenfall 1988; Fell et al. 1992). Cooke (1984) describes the historical development of rockfill dams starting from dumped non-compacted rockfill dams around 1850-1940 to the modern rockfill dam from 1965 and onwards, which is either an earth core compacted rockfill dam or a concrete face rockfill dam. Modern dam design has paved the way for higher and higher dam constructions, and today the highest embankment dam reaches well above 300 m (Cooke 1984; Höeg 2001).

2.1.2 Embankment dam incidents and failures

According to the statistics of dam failures in large dams summarised by ICOLD, earth embankment dams stand for the majority of dam failures and historically has been nearly twice as likely to fail as concrete dams. However around 1985 and after, the probability of failure was similar to concrete dams (Fell et al. 1992). The most common reasons for embankment dam failures worldwide are overtopping and internal erosion (ICOLD 1995).

Most dam failures take place very early in the life of an embankment dam, and particularly during the first filling of the reservoir. Around two thirds of all dam failures related to internal erosion took place during the first five years of operation (Foster et al. 2000a).

Sweden has, if not counting tailings dams, experienced one single failure of a large dam. This happened when the Noppikoski dam was overtopped in 1985, due to malfunction in controlling one of the spillway gates during a high-flow situation.

Foster et al. (2000a; 2000b) perform a comprehensive statistical analysis of embankment dam failures. Internal erosion is one of the main focus areas of investigation, and the study classifies embankment dams into twelve zoning categories for a study on failures and accidents. Different types of embankment zoning have their own way of controlling embankment seepage (Fell et al. 1992), and this is also confirmed in the evaluation of the statistical analysis. Central core earth and rockfill dams, the category including the dams particularly investigated within this thesis, is categorised in the group of best performing designs against piping failures. Moreover, it

is concluded that dams with glacial till cores as well as dams with downstream rockfill zones both have reported more piping incidents but fewer dam failures due to piping than average.

The general status of tailings dams seems to be less satisfying than it is for other embankment dams, and the safety record is relatively poor (Höeg 2001). Tailings dams are constructed to manage process water from the mining and to settle and hold back tailings for an unforeseeable future. The dams are often raised repeatedly in stages or continuously as the mining activities expand and this may result in somewhat unusual dam designs. Moreover, rock and tailings from the mine is sometimes used for dam construction. All these factors may lead to constructions less well thought-out, but an increasing awareness has improved recently constructed tailings dams. Even though in Sweden, some of the tailings dams are constructed as zoned embankments with a till core, the reported incidents are relatively more frequent compared to other embankment dams. Reports from twelve tailings facilities in Sweden show a remarkable increase in incidents over the last ten years. Incidents are in this context defined as unexpected events that poses a threat to the overall safety of the dam and needs a quick response to avoid a likely dam failure. Since 1995 incidents were reported 24 times, and internal erosion was one of the most common causes. Additionally, three dam failures were registered from those twelve Swedish facilities (Bjelkevik 2005).

2.2 Internal erosion

As seen from the ICOLD statistics above, internal erosion is a major reason for embankment dam failures. The process of internal erosion in an embankment dam can be divided into three categories. One of these categories includes cases with internal erosion inside the dam body. This is the most common cause behind embankment dam failure due to internal erosion (ICOLD 1995). The other two categories involve the foundation of the dam. One is when internal erosion occurs solely through the foundation, and one category involves cases where internal erosion occurs from the embankment into the foundation. Reported piping incidents reveal that piping through the embankment is twice as common as piping through the foundation and 20 times as common as piping from embankment into the foundation (Foster et al. 2000a).

2.2.1 How internal erosion develops

Terzaghi and Peck (1948) separate between two different types of piping causing embankment dam failures. The first, called subsurface erosion, is described as a process starting with outflow of seepage water, that brings soil particles, at the downstream toe. This process then works its way back towards the upstream side of the dam constructing a pipe through the dam. The second, referred to as heave, occurs when the pore pressures become equal or greater than the total stress working on the soil. This second process is often referred to as hydraulic fracturing (Sherard 1986) when it occurs in dam cores. Some of this key terminology for internal erosion is explained in Table 1.

Table 1. Explanation of some common terms regarding development of leakage and internal erosion in embankment dams.

TERM	EXPLANATION
Piping	A form of internal erosion that, regardless of reason for initiation, results in the formation of a continuous tunnel or pipe through the embankment or foundation.
Suffusion	Also referred to as internal instability. Suffusion is a form of selective erosion, where the fine particles in the soil is removed leaving behind a soil matrix with the larger fractions. Soils susceptible to suffusion are internally instable.
Internal erosion	Soil particles within an embankment dam or its foundation are carried downstream by seepage flow.
Backward erosion	Backward erosion involves washout of soil particles to a freely drained surface. As the soils particles are carried away with the seepage flow, the free surface gradually moves towards the upstream side of the embankment and finally a pipe through the dam is shaped.
Concentrated leak	A concentrated leak may occur when there is a connection through the dam resulting from cracks, hydraulic fractures, poorly compacted weak zones or other causes.
Hydraulic fracture	Hydraulic fracturing may occur for various reasons in the low-permeable zone when the seepage pore pressure equals the total stress working on the soil. This may cause opening of fractures or creation of new fractures leading to concentrated leaks.

The description of the internal erosion process according to Terzaghi and Peck is fundamental. However, it has been slightly refined over the years. In one such refined model, the process of internal erosion and piping leading to dam failure is illustrated in the development of four stages (Wan and Fell 2004). Those four stages are:

- Stage 1. Initiation of erosion: Internal erosion inside an embankment dam initiates by a concentrated leak, suffusion or backward erosion. The concentrated leak could occur by hydraulic fracturing. Hydraulic fracturing in turn is caused by many different factors (Sherard 1986). One such factor is the occurrence of differential settlements in the dam leading to transverse or longitudinal arching of the core. This eases the total stress in certain parts of the core, and seepage pore pressures may open up existing cracks or find new paths across the core. A concentrated leak may also occur in parts of the core that have been subjected to inferior compaction. Such zones are typically located adjacent to sheet pile walls or concrete structures where compaction for practical reasons may be difficult to carry out satisfactory. However, the existence of a concentrated leak does not automatically mean that erosion will occur, even though in reality most soils will not be able to withstand the shear stresses typically occurring in cracks (Wan and Fell 2004). Suffusion is another way of internal erosion initiation. It occurs in soils that are internally unstable. Such soils typically have a gap in their grading distribution and may results in washout of some fractions of the soil by seepage flow. For backward erosion, the third initiation cause, to occur the seepage must be high enough to initiate movement of soil particles at the exit point.

- Stage 2. Continuation of erosion: Basically the question if internal erosion continues or self-heals is answered mainly by the exit conditions for the seepage flow. In central core dams, the exit point for internal erosion in the core is the filter. Appropriate filters may effectively stop the internal erosion process by catching the soil particles. Too coarse filters or free surfaces result in complete continuation of the process (Foster and Fell 2001).
- Stage 3. Progression to form a pipe: If erosion continues it does not mean that it automatically continues until a pipe is formed. Instead, this is ruled by different factors depending on the initiation process. In the case of initiation by a concentrated leak, the progression depends on for instance the geometrical shape of the leak and the erodibility of the soil. If the process, on the other hand, is initiated by backwards erosion the progression to form a pipe is governed mainly by the functionality of the filter. Even if the filter is allowing continuation of erosion it might seal after some time and thereby bring the process to a halt. If initiation was due to suffusion it is possible that, after full suffusion has taken place, the remaining soil skeleton will be eroded by backward erosion thus leading to formation of a pipe.
- Stage 4. Formation of a breach: If internal erosion progress to form a pipe as described above it may lead to structural damages in the dam and in the worst case a dam failure. There are many possible scenarios all ending in a dam failure (Figure 2). Hence, the process starting with internal erosion in the embankment may end up with overtopping of the crest, slip due to slope instability or unravelling of the toe and surface erosion. It is also worth mentioning that, if the initiation started with suffusion, the breaching mechanisms may occur without a preceding forming of a pipe.

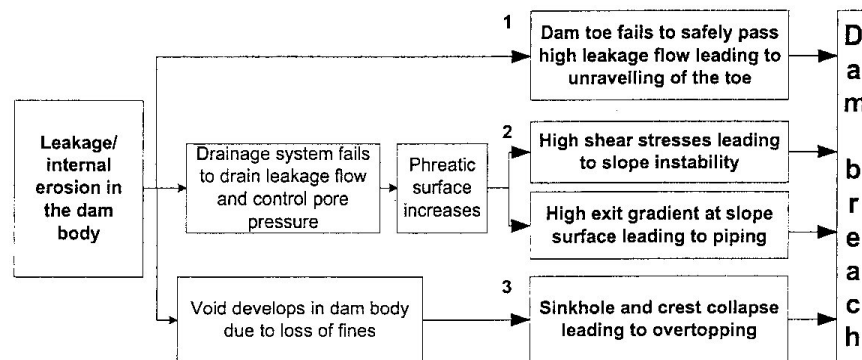

Figure 2. Failure mechanisms initiated by internal erosion in the embankment dam (from Nilsson and Bartsch 2004).

2.2.2 The importance of good filters

While the importance of good filters is undoubted in dam engineering, it is important to realise that inadequate filters are not the reason for internal erosion. They just fail to halt the process once it has commenced. The fundamental principle of filters is two-fold.

First, it should be sufficiently fine-grained to avoid erosion of the base material, i.e. the material it is protecting. Secondly, it should be sufficiently permeable to permit drainage of the seepage water.

The first task of the filter is to hinder the transport of soil particles with the seepage water on its way through the dam. Therefore the functionality of a filter can be seen as a question of geometrical relation between the pore spaces of the filter soil and the particle sizes of the base material. Many studies have been performed in this area to suggest appropriate filter criteria (e.g. Terzaghi and Peck 1948; Sherard and Dunnigan 1989). Apart from the purely geometrical relation between the particle sizes and pore spaces of the base material and the filter, the materials must also be internally stable to avoid suffusion.

In addition, the filter should also assure a certain permeability of the filter, so that sufficient drainage capacity is guaranteed. Filter criteria used in practice in Sweden focus on broadly graded soils, such as the glacial tills frequently used as core materials in Swedish dams. These criteria are based mainly on empirical relations from laboratory tests (Vattenfall 1988). Foster and Fell (2001) argued that modern filter design is essentially satisfying, but many old dams are not built according to these criteria. Thus, they proposed a method to evaluate existing filters that are not matching the current design principles.

Most effort in research on the functionality of filters is for obvious reasons put on the downstream filters. In practice, the materials selected for these filters are also used for the upstream filters. The upstream filters protect the core from wave erosion, and reversed internal erosion in case of a rapid lowering of the reservoir. However, it also serves as an important extra protection if piping occurs through the core. It may then hold back seepage flow rates and possibly partly heal the core as particles from the upstream filter follow the seepage into the damage part. Therefore, to facilitate this process it is sometimes suggested that the upstream filter should consist of less compacted single graded materials that are more easily carried away with the seepage (Vattenfall 1988).

2.2.3 Experiences from Swedish dams

The average Swedish large dam was built in the 1950s (ICOLD 2003), and ageing is more and more becoming a concern for dam safety in Sweden as well as in many other parts of the world. None of the Swedish large embankment dams have failed due to internal erosion. However, many signs of internal erosion have been reported, and sinkholes have appeared a large number of times. An inventory conducted among Swedish dam owners revealed that 84 dams experienced some kind of deterioration due to ageing, and 27 dams had reported sinkholes ranging from 0.5 m in diameter to 15-30 m³ in volume (Nilsson 1995a; Norstedt and Nilsson 1997; Nilsson et al. 1999).

Sinkholes appear on the surface of the dam and are a consequence of internal erosion. As internal erosion progress, material is transported with the seepage flow. Eventually, this results in material deficits in eroded zones inside the embankment dam. Material from higher levels may then fall down and fill up the empty space and the progress

works its way to the surface of the dam. The sinkhole most often appears at the surface in the area corresponding to the extension of the upstream filter zone (Nilsson et al. 1999). A conceptual model for development of sinkholes is presented in Figure 3.

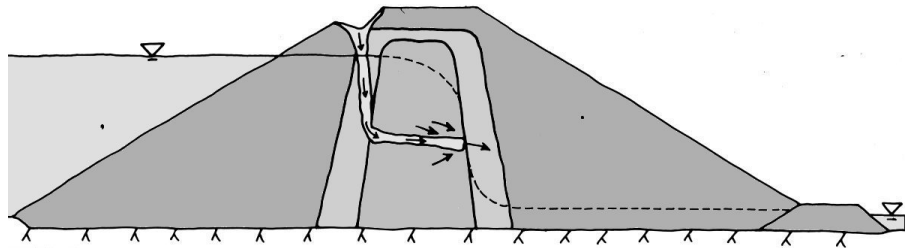

Figure 3. One principal model for development of sinkholes due to internal erosion. First, piping develops in the core for one of the reasons described in the text. Next, the upstream filter is transported into the core as seepage increases. Finally, the filter settles and the process may repeat until it reaches the dam surface. Sinkholes commonly appear at the surface in the area corresponding to the extension of the upstream filter.

Among the 27 dams that reported sinkholes, ten were put in operation in the period 1970-1975. This represents 47% of the dams built in this period and is a clear differentiation from the periods before 1970, when the proportion of dams with sinkholes is mostly 10% or less. Likewise, the dams built after 1975 continue the trend from 1970-1975 with problems in a higher percentage of the dams, even though the change is less obvious (Nilsson et al. 1999). On a closer examination of the reasons for this shift around 1970 it was revealed that for the dams from the period 1970-1975, generally a coarser filter was used, which implies that the reason for the sinkholes might be associated with insufficient filter design (Nilsson et al. 1999).



Figure 4. Two examples of effects from internal erosion in Swedish embankment dams. Left: Sinkhole, approximately 0.4 m in diameter, appearing on the upstream side of the crest. Right: Piping, approximately 1 m in diameter, through the dam core adjacent to a sheet pile. Foto: Gösta Johansson, AIB (WSP).

In Figure 4, examples of effects from internal erosion on two Swedish embankment dams are presented. In the left picture a small sinkhole is appearing on the upstream side of the crest, which is a common location for sinkholes on central core dams as has been explained above. The right picture illustrates a case of piping through the dam core,

which has developed next to a sheet pile wall. The area around sheet piles often exhibits lower compaction due to practical difficulties during construction, and additionally the core may hang on to the sheet pile while the dam settles, thereby causing hydraulic fracturing.

2.3 Detection methods of internal erosion

For embankment dams, a main safety concern is to identify internal erosion at an early stage, and methods for monitoring the seepage and for detecting internal erosion are of great use for the safety evaluation. As discussed in section 2.1.2, internal erosion through the dam or the foundation is, together with overtopping, the most frequent reason for embankment dam failures. While overtopping scenarios might be difficult to predict, they are easier to handle and design efficient monitoring systems for. A capable monitoring system for detection of internal erosion, on the other hand, is a far more complicated task to achieve.

The obvious reason to why internal erosion is difficult to detect is that it is going on inside the dam or the foundation, and the process may be progressed far before any sign is shown on the outside of the dam. The first notice from the outside may be for instance higher seepage flow rates, a visually observable concentrated leak at the downstream toe or high turbidity of seepage water. Such events may be detected by conventional monitoring methods at many dams, but in many cases the monitoring systems may also fail to identify the process. According to the inventory of Swedish dam incidents briefly presented in section 2.2.3, the by far most common method of detecting the reported incidents, of which sinkholes is one type, on Swedish embankment dams has been by direct visual observations (Nilsson 1995a).

None of the sinkhole incidents in the Swedish dams resulted in a dam failure. However, recent research demonstrates that embankment dam failure caused by internal erosion may occur quite abruptly, and the time between an early warning of a concentrated leak at the downstream toe to a full dam failure at the crest may be just a few hours (Foster et al. 2000b; Fell et al. 2003). In a majority of failures the dam breached within twelve hours from visual indication of piping developing and in many cases the time was less than six hours (Foster et al 2000b). An example is the 93 m high Teton dam, the highest embankment dam to have failed, where a breach reached the dam crest less than five hours after seepage was first seen coming from the dam (Penman 1986). This clearly indicates a need of more sensitive seepage monitoring methods.

The above examples illustrates that early detection of internal erosion is important. The fact that incidents are detected by visual inspections at many dams today in itself calls for more dam monitoring in the future. Moreover, monitoring of Swedish dams is generally scarce in an international perspective (Nilsson 1995a), even if there is an improvement in this area over the last few years.

In the next subsections some methods of detecting internal erosion is briefly presented. There are a large number of methods, frequently used for investigation of the integrity of embankment dams or used for dam repair or investigation of existing structural

damages. Those methods are not covered here. Instead, the examples given here are methods that have the possibility to detect and give early warnings of internal erosion.

2.3.1 Conventional methods

Conventional methods of detecting internal erosion can be divided into surveillance and monitoring. Surveillance includes all regularly performed scheduled investigations and visual inspections that are performed on the dam. Monitoring includes measurements of different parameters that are important for the safety of the dam. These may be fully automatic real time measurements with predefined alarm levels or more simply measurements carried out and collected on a regular basis.

Surveillance has the advantage that the whole part of the visible dam can be inspected. Recommended intervals for surveillance at Swedish dams are regulated in the Swedish guidelines for dam safety (RIDAS 2002). The intervals depend on classification of the dam. Typical for large dams are scheduled daily checks by the personnel taking care of operation and maintenance, smaller inspections once or twice a year by the same personnel, dam safety inspections every four years and a comprehensive dam safety evaluation every 15 years. The last two should be carried out by specially authorised personnel.

Conventional methods for monitoring consist of monitoring of seepage flow rates, pore pressure measurements and measurements of movements and deformation. These methods are also recommended by ICOLD as a standard instrumentation on large dams (Nilsson 1995b).

Seepage is strongly related to internal erosion, and a rapid increase in seepage flow rates is a clear signal of leakage problem, which might be associated with internal erosion. Seepage measurements are carried out on the collected drainage downstream the dam. Monitoring systems are site-specific and effects from rainfall and groundwater or surface water runoff from other sources than the reservoir must be corrected for. This might require additional monitoring of rainfall. Measurements can be done in one or more locations. If measurements are carried out in many locations, the difference between these may give information about which part of the dam the seepage originates from.

Measuring pore pressures inside the dam gives interesting information for many reasons. Pore pressures in the core may indicate leakage zones. Measurements in the downstream filter may check the integrity of the drainage capability of the filter zone. Reduced drainage capacity of the filter may be a sign of internal erosion as a washout of fines from the core could result in clogging of the downstream filter. For pore pressure measurements in the permeable filter zone, in the support fill or downstream the dam open standpipes are commonly used. A rise of the water level close to the dam toe may be an indication of increased seepage through the foundation. Pore pressure or water level readings are often measured manually at scheduled intervals.

Deformations in the dam may be associated with settlements caused by internal erosion. Deformation measurements include measurements at certain points on the crest and on

the dam slopes. Typically such measurements are repeated manually at scheduled intervals, but automatic monitoring is possible. Measuring settlements on different depths inside the dam may be relevant. Real time monitoring of deformations on different depths can be carried out using a number of inclinometers installed with one-meter intervals in a vertical pipe from the dam crest down through the downstream filter zone. This system is a special method for monitoring horizontal displacements and has been tried at a Swedish dam (Nilsson and Ekström 2004). In addition, a new concept involving strain measurements using optical fibres for detection of local displacements has been tried at the same dam (Johansson and Farhadiroushan 2005).

2.3.2 Non-conventional methods

A variety of methods have been tried for dam status investigations and leakage detection investigations on embankment dams. Johansson et al. (1995) summarises new possible methods for investigations of embankment dams in a comprehensive report. Numerous methods are considered useful for dam integrity investigations in a limited zone of the dam. For detection of anomalous seepage and internal erosion, however, it is concluded that the self-potential method, the resistivity method and temperature measurements may have the best prospects. In addition to those geophysical methods, monitoring of turbidity or hydrochemical monitoring of the seepage water were considered to be interesting methods.

It is beyond the scope of this thesis to attempt to cover all methods. Therefore, apart from the resistivity method, which is thoroughly described in section 3, only a few other methods are very briefly described in this section. These other methods, temperature and SP along with the measurements on seepage water, were selected due to the prior study were they were considered having the best potential for anomalous seepage and internal erosion detection (Johansson et al. 1995).

Temperature measurements have proven a powerful method for detection of high seepages in embankments (e.g. Kappelmeyer 1957; Merkler et al. 1985; Armbruster et al. 1989; Johansson 1991; Dornstädter 1997; Johansson 1997). The technique makes use of the fact that increased seepage affects the temperature pattern in the dam. This temperature effect can be measured and related to seepage flow rates. Traditional temperature measurements in boreholes need a period of repeated measurements for proper evaluation, and only give information about the area closest to the borehole. New improved possibilities of measuring temperature using optical fibre sensors increase the capability of the method. Such installations have been done at numerous Swedish dams during the last decade (Johansson and Farhadiroushan 2005).

Self-potential measurements have long been considered especially interesting for dam seepage investigations, where it has been frequently used (e.g. Ogilvy et al. 1969; Butler 1984; Wilt and Corwin 1988; Butler and Llopis 1990; Butler et al. 1990; Triumf and Thunehed 1996; Rozycki et al. 2005). The main reason for this particular interest is the method's natural physical coupling to subsurface water flow. A description of the phenomena causing streaming potentials, the part of the SP signal that originates from subsurface flow, is well covered in literature (e.g. Telford et al. 1990; Parasnis 1997). As with resistivity, SP can be used both in single investigations and in long-term

monitoring. The method is, like the resistivity method, non-intrusive and may cover the whole dam. On the other hand, measurements are not always straightforwardly interpreted, and like other geophysical methods it should be combined with other measurements or information to support the interpretation of the results.

Turbidity testing of seepage water can be carried out fully automatic. Internal erosion resulting in a washout of the fine particles may be detected if the drainage water is collected in a proper way. Hydrochemical monitoring of the seepage water is a method to evaluate seepage through the dam. Time-series of measurements on the composition of the water in the reservoir may be correlated to the same type of measurements on the seepage water. Removing effects from rainfall and other possible water sources drained to the downstream part of the dam may give a quantification of seepage using water balance equations (Johansson et al. 1995).

2.4 Upgrading and repair

It is extremely difficult to design reliable and efficient systems for detection of internal erosion and anomalous seepage in existing dams. Conventional methods are likely to fail in cases where the progress of the leakage is quick and unexpected. The non-conventional methods on the other hand may, even though they are promising, still be in their evaluation phase.

Another strategy for increasing dam safety is therefore to upgrade the dam by reinforcement and support as much as it becomes capable of handling a certain type of damage even without an early warning. Such upgrading on dams may include the following measures among others:

- Construction of toe-berms or reinforcements of the downstream slopes: The construction of toe-berms can be done in order for the dam to be able to handle the maximum possible leakage that can be expected to occur during the lifetime of the dam. The toe-berm is designed to keep the dam stable and withstand erosion at the dam toe even in situations with very high leakages. Extending the toe-berm to the crest, and thereby supporting the whole downstream slope also prevents against the failure mode that results in overtopping caused by the development of a sinkhole (Nilsson and Bartsch 2004).
- Construction or repair of grout curtains: This may be performed where there are indications of high seepages in the foundation.
- Repair of the core by grouting or by construction of a concrete cutoff wall: Large repair of the core is only conducted when the dam already has experienced severe damages.
- Upstream membrane: An upstream sealing layer can be used to reduce seepage.
- Construction of an upstream clay blanket: The clay blanket can be placed to make the leakage path longer and thereby reduce the seepage.

3 The resistivity method

The resistivity method is a non-intrusive method used for investigating subsurface conditions. Conrad Schlumberger conducted the first electrical resistivity field surveys in the beginning of the 20th century (Ward 1980). Ever since, the method has been developing and new application areas have come forward. During the last one or two decades this development has been particularly rapid, considering the introduction of innovative efficient instruments and the fast progress of easily available computational power. In this section, some background of the resistivity method and the basic principles behind it will be briefly described. Other publications give a more covering and detailed description (e.g. Telford et al. 1990; Parasnis 1997; Reynolds 1997; Sharma 1997). Aspects of the method that are particularly interesting for embankment dam surveys will be treated more in detail in section 4.

3.1 Background

In the resistivity method an electrical current is introduced into the ground and the resulting potential distribution is measured. The most common resistivity systems use direct current, DC, or alternating currents, AC, with very low frequency. The method is also called DC-resistivity. Complex resistivity using alternating current has not been used in this study and is not covered here. Some techniques use line electrodes or buried electrodes but the most common method involves point electrodes on the surface. Typically one pair of steel electrodes is used to inject current and another pair is used to measure the potentials (Figure 5). This type of four-electrode measurement avoids erroneous influence on measurements from contact resistance at the interface between the electrode and the ground.

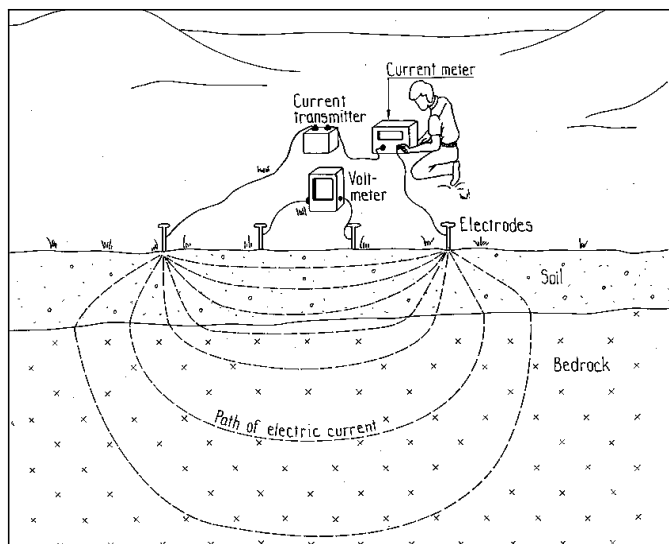

Figure 5. Sketch of the arrangement of a four-electrode surface resistivity measurement. A current is transmitted between two current electrodes and two potential electrodes are used to measure the potential field (modified from Robinson and Coruh 1988).

The measured voltage from a four-electrode arrangement can be thought of as a weighted mean value of the conductivities of all current paths between the potential electrodes. From such a measurement, information about the average electrical resistivity of certain subsurface volume is received. By altering the distances between the electrodes, different volumes of the subsurface are sensed and additional information about resistivities on different depths is obtained. This relation between electrode spacing and depth penetration is fundamental for the method. However, it is obviously impossible to tell the resistivity of a certain layer immediately from such a measurement. The current will be channelled into regions of lower resistivity and deflected from regions with higher resistivity and without information about the subsurface the true resistivities remain unknown. Therefore, a special methodology referred to as inversion or inverse modelling, is used to estimate the true resistivities. This method involves a repeated procedure of fitting a subsurface resistivity model to a set of measurements. Inversion will be discussed in detail in section 3.5.3. First, the basic theory of the resistivity method will be brought up.

The resistivity, ρ , is a material property parameter that describes the ability of a material to conduct electrical currents. It is the inverse of the electrical conductivity, σ (equation 1).

$$\rho = \frac{1}{\sigma} \quad (1)$$

Consider the geometrically ideal situation with a current flow through a homogeneous media in well-defined uniform cross-section between two potential electrodes. The resistance, R , is then described by Ohm's law (equation 2) as the measured voltage, U , divided by the current, I .

$$R = \frac{U}{I} \quad (2)$$

However, the resistance is also proportional to the cross-sectional area, A , and the distance between the electrodes, L (equation 3).

$$R = \rho \frac{L}{A} \quad (3)$$

Combining these relations, solving for the resistivity and introducing a geometrical factor, K , lead to a new expression (equation 4).

$$\rho = \frac{A}{L} R = \frac{A U}{L I} = K \frac{U}{I} \quad (4)$$

At this moment it is clear that the resistivity can be calculated for a measured voltage at a known current if the geometry is known. Applying this on the original problem of

four-electrode measurements on a plane surface over a conductive homogeneous subsurface can be done conveniently by recalculating the geometrical factor for this situation (equation 4; equation. 5; Figure 6).

$$K = 2\pi \left(\frac{1}{r_{11}} - \frac{1}{r_{21}} - \frac{1}{r_{12}} + \frac{1}{r_{22}} \right)^{-1} \quad (5)$$

The geometrical factor is specific to the way the electrodes are arranged and depends on the distances between the electrodes. The expression is valid for any general four-electrode geometry, but in practice the electrodes are almost exclusively placed on a straight line.

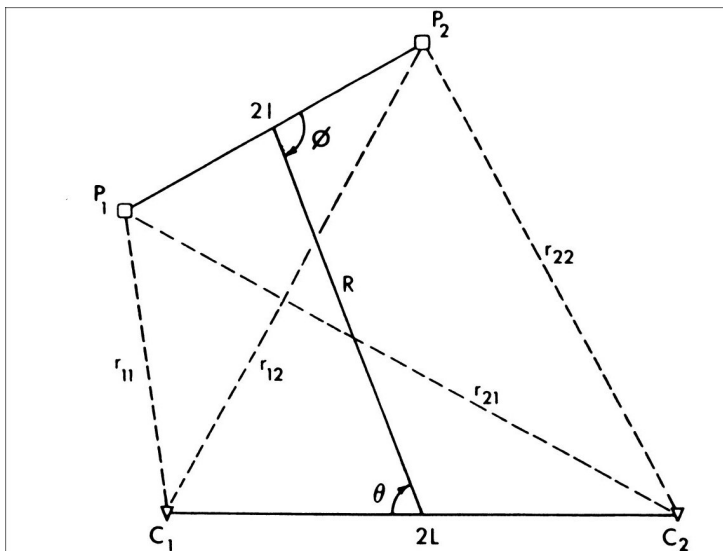

Figure 6. Sketch of the arrangement of a general four-electrode measurement with potential electrodes P1, P2 and current electrodes C1, C2 ($0 < \theta, \phi < \pi$). The distances between the electrodes are used to calculate the geometric factor, K (from O'Neill and Merrick 1984).

If the subsurface resistivity distribution is homogeneous the measured resistivity is the same as the true resistivity. However, this is never the case in practical measurements. Instead the measured resistivity should be seen as an artificial concept, which is not necessarily coinciding with the true resistivities. Therefore, the term apparent resistivity, ρ_a , is used for the raw data from measurements.

3.2 Common application areas

The resistivity method has been used for a wide range of engineering and environmental purposes (Table 2). Recent developments have led to rapid efficient data acquisition of large dense datasets. Resolution has increased and surveying cost has come down,

which has opened for a variety of applications within near-surface engineering and environmental investigations. General information, containing suggestions of how the method can be used and descriptions of how the method has been used with additional references, can be found in the literature (e.g. Ward 1990; Dahlin 1993; Pellerin 2002).

Table 2. Use of the resistivity method in environmental and engineering applications.

Area of usage	Examples of applications
Hydrogeology, groundwater	Delineation of groundwater resources for protection and contamination control. Mapping of salt-water intrusion in coastal areas. Mapping of pollution and contaminant plumes. Acid mine drainage investigations.
Landfills	Delineation of contamination plumes. Monitoring integrity of landfills.
Embankment dams, barriers	Status control of embankment dams, through leakage detection or seepage monitoring.
Landslides	Delineation of potential landslides. Monitoring moisture conditions and water content as a base of early warning systems.
Materials exploration	Detection and delineation of raw materials. For example within the mining industry or for prospecting of construction materials, such as sand and gravel.
Civil engineering	Site investigations and geotechnical applications for all kinds of civil engineering projects. Mapping of soil/bedrock interface, groundwater level, faults and cross-zones etc.
Permafrost	Mapping thickness of permafrost or temporarily frozen ground.
Others	Geothermal investigations. Delineation of walls and tombs and others in archaeological applications. Medical applications. Metal objects detection.

3.3 Resistivity of geological materials

For the resistivity method to be successful a number of conditions must fall in place. Factors like vertical and horizontal resolution, signal-to-noise ratios must be considered and they depend on the situation and specific conditions for the survey. The fundamental condition that needs to be fulfilled for motivating the use of the method is contrast in the physical property between the subsurface materials that is to be delineated. Therefore it is important to know the basics behind the electrical properties of the investigated materials.

The resistivity of natural soils and rocks vary within very wide ranges (Figure 7), and this difference in resistivity is the foundation of resistivity imaging surveying. It is, however, essential to be aware of the large overlaps in resistivity between the different types of earth materials. As a result measured resistivities should never be interpreted directly to a certain material category without additional knowledge of the specific situation.

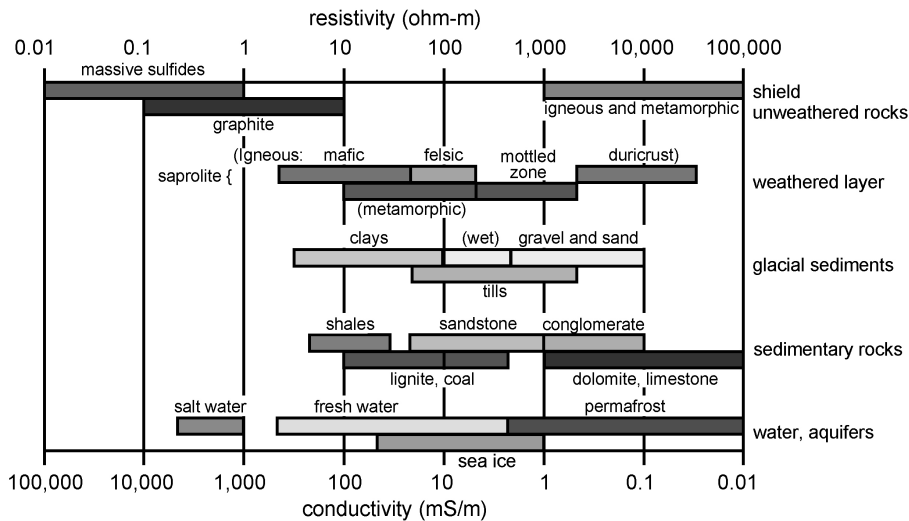

Figure 7. Resistivity of geological materials (modified from Palacky 1987).

Electrical conduction in geological materials is mainly electrolytic. The most common soil and rock forming minerals are insulators in the dry state, and thus the amount of water and the properties of the water largely determine the resistivity.

For a rock mass this means that fractures, faults and shear zones constitute the dominating current paths, whereas the solid rock normally is considered as an electric insulator. As an exception, rocks with metallic content may have significant conduction through the crystalline structure.

Soils, on the other hand, are porous media consisting of a solid skeleton of particles, or grains, and pores in between. The grains are considered electrical insulators and the conduction is concentrated to the pore space that is typically filled or partly filled with water. Therefore, resistivities of soils are strongly influenced by the amount of water, which is determined by the porosity and the degree of saturation. Also the resistivity of the water, to a great extent governed by the ion content, and the connectivity of the pore spaces are important parameters. Another important factor influencing soil resistivities is the presence of clay minerals, since these minerals bind water molecules and ions and thereby facilitate electrical conduction. Clay particles coating the surfaces of the larger mineral particles may have a dominating effect on the bulk resistivity of a predominantly coarse grained soil, creating so called surface conduction (e.g. Ward 1990; Revil and Glover 1997). Therefore, in the different models that have been used for describing resistivity of soils, there has been two categories depending on if the soil has clay content or not.

3.3.1 Soils without clay content

The assumption that the soil matrix is an insulator was used by Archie (1942) when he formulated a relation between resistivity and porosity for medium to coarse-grained soils and rocks (equation 6). More explicitly, the equation relates water saturation, S_w ,

porosity, ϕ , and pore water resistivity, ρ_w , to the bulk resistivity, ρ_b . The constants a , m and n are empirical. The exponent n reflects the properties of the water and the fact that the relationship between bulk resistivity and water saturation is not linear. When a dry porous media is wetted the first amount of water will have a larger effect on the bulk resistivity of the media than the same amount of water for an already slightly wetted media. The other exponent m is frequently called the cementation factor and reflects that the length of the current path through the formation is depending on shape, diameter and sorting of the grains and degree of cementation. As a consequence, m is larger for more compacted soils.

$$\rho_b = \frac{a \cdot \rho_w}{\phi^m \cdot S_w^n} \quad (6)$$

In practice, for unconsolidated granular material the medium dependent constant a is set equal to 1, and is thereby disregarded. Typical values for the constants m and n for soils are $m=1.4-1.5$ and $n=2$ (Frohlich and Parke 1989; Ward 1990). For water saturations lower than 30% the value of the saturation exponent may increase from around $n=2$ to a value much higher (Parasnis 1997). However, for water-saturated soils, which constitute the dominant conducting part of most embankment dams, the constant n is irrelevant, as S_w equals 1.

3.3.2 Soils with clay content

Archie's law is valid for medium and coarse-grained soils and rocks. With small grain sizes and particularly if clay minerals are present, the assumption that the soil matrix is an electrical insulator is no longer valid. The reason is that clay minerals carry mobile ions inside the grains and are therefore good conductors. Furthermore, conduction also takes place in the interface between grains and pores. This surface conduction becomes a significant factor in fine-grained soils. Hence, these phenomena must be considered in addition to the electrolytic conduction when estimating the total conductivity of a fine-grained soil. Waxman and Smits proposed a model in 1968 that became widely accepted (Ward 1990). This model was based on the consideration that the pore water and matrix were two separate resistances connected in parallel, which was later further developed by Bussian (1983) and Revil et al. (1998) among others. These models are not easily applicable. A more simple relation suggested by de Witte 1957 (Bussian 1983) is given in equation 7. In this relation, ρ_m represents the resistivity of the matrix.

$$\frac{1}{\rho_b} = \frac{\phi^m}{\rho_w} + \frac{m \cdot (1-\phi)^m}{\rho_m} \quad (7)$$

Water saturated clays have by far lower resistivity than the water it is saturated with. Thus, the matrix conduction is dominating the electrical properties of such soils. For soils with only slight clay content the relation between matrix conduction and water conduction might be more even.

For unsaturated conditions Simandoux (Ward 1990) proposed a rather complicated relation (equation 8),

$$\frac{1}{\rho_b} = \frac{V_{cl}}{\rho_{cl}} \cdot S_w + \frac{\phi^m}{a \cdot \rho_w} \cdot S_w^2 \quad (8)$$

where V_{cl} and ρ_{cl} is volume of clay fraction and resistivity of the clay fraction. It is clear that, even in soils with clay content and a conductive matrix, the largest resistivity decrease is seen in the beginning of a wetting period. Furthermore, equation 8 as well as other studies indicates that for soils with fresh high-resistive pore water the relative influence from surface conduction over electrolytic conduction becomes higher (e.g. Kwader 1985; Revil and Glover 1998).

Archie's law as well as the relations for clayey soils have been under discussion in literature for a long time (e.g. Huntley 1986; Park and Dickey 1989; Worthington 1993; Berg 1995; Glover et al. 2000; Klein and Santamarina 2003). A recent review on the resistivity of soils, describing many of the suggested models, was done by Friedman (2005). However, still today Archie's law is probably the most widely used relation for many practical applications in clay-free soils and rocks.

3.3.3 Water

As can be seen in Figure 7 water resistivity ranges widely. Palacky (1987) gives a rather narrow range around 1-100 Ωm for fresh water. However, resistivities of several hundreds of Ωm have, within this study, repeatedly been measured in Scandinavian rivers (PAPER 3; PAPER 4; PAPER 5). Furthermore, measurements carried out by the Swedish university of agricultural sciences, SLU, support these results (SLU 2005; Figure 13). The dominating factor governing the resistivity in water is the amount of total dissolved solids, TDS, that is solute in the water. TDS is a frequently used measure of water quality and is defined as the amount of solids in milligram per litre that is left if a water sample is evaporated to dryness (Fetter 1994). A high level of TDS significantly improves electrical conduction. Klein and Santamarina (2003) report on an empirical relationship between electrolytic conductivity and TDS for low ionic concentrations at 20°C made by Annan (equation 9), where TDS is measured in mg/l and σ_w in mS/m.

$$\sigma_w = 0.15 \cdot TDS \quad (9)$$

Water resistivity also varies with temperature. This is due to the fact that at higher temperatures the viscosity of the water decreases and as a result the ions in the water become more mobile. The influence from temperature effects is according to Ward (1990) worth considering for geothermal studies, but it is not a major factor in most near surface investigations. However, as the temperature influence is significant for embankment dam monitoring, it is necessary to examine it in this context. The relation between resistivity and temperature was examined by Keller and Frischknecht (1966) and a formula was proposed where the resistivities, ρ_T , at different temperatures, T , relates to the resistivity, ρ_{18} , at a temperature of 18°C (equation 10). The temperature coefficient of resistivity, α , is empirically found to be approximately 0.025°C^{-1} , and valid for temperatures above the freezing point.

$$\rho_T = \frac{\rho_{18}}{(1 + \alpha(T - 18))} \quad (10)$$

This formula (equation 10) can be used to normalize resistivities measured at different temperatures. Other studies have reached slightly different values of α . Abu-Hassanein et al. (1996) obtained a slightly higher α for tap water at 0.033°C^{-1} . Sen and Goode (1992) proposed a relation, also taking into account the solute concentration, with similar results as for $\alpha=0.025^\circ\text{C}^{-1}$ in equation 10. The relations are illustrated in Figure 8 for different values of α . It is seen that for temperatures above 0°C the relationship between resistivity and temperature is exponential. Basically, a one-degree change in temperature changes the resistivity 2-3% for temperatures around and above 18°C and as the temperature approaches 0°C the resistivity change per degree increases to 5-8% depending on α . Below freezing point the relation is not valid. At 0°C the resistivity takes a leap and may increase several orders of magnitude (Palacky 1987).

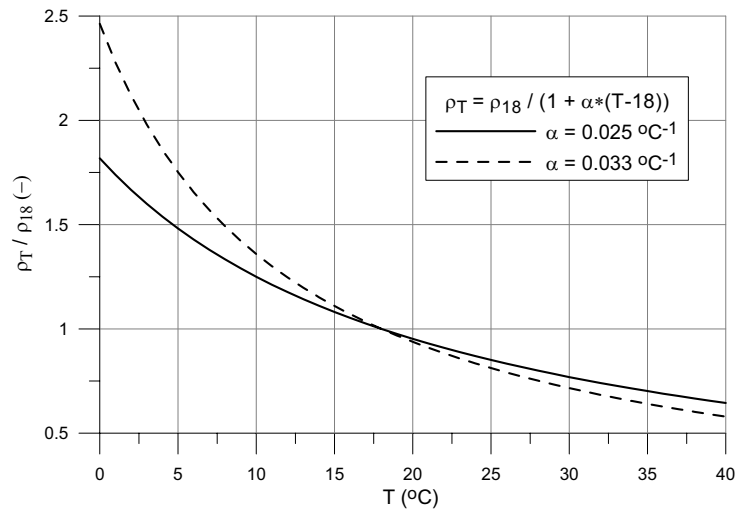

Figure 8. Influence from temperature on water resistivity, for different values of the temperature coefficient of resistivity, α .

Freezing occurs typically in the upper zone of around 1-3 m from the surface in an embankment in Scandinavia. For a medium to coarse-grained water-saturated soil where the conduction is merely electrolytic, the resistivity of the soil will be affected by temperature in a similar way as the water. Experimentally this temperature effect has been confirmed also for soils with clay content (Abu-Hassanein et al. 1996). However, for soils with significant surface conduction the temperature effect on the soil could be stronger than the temperature effect on the pore water, as the temperature dependence of surface conductivity generally is higher than the temperature dependence of the bulk electrolyte (Revil et al. 1998; Friedman 2001). Inside a Swedish zoned embankment dam, the temperature may easily range from around 5°C to 10°C over the year on 10 m depth (Johansson 1991). This corresponds to a resistivity change of approximately 20-30% depending on α .

3.4 Data acquisition

Figure 6 describes the arrangement of a general four-electrode measurement. This type of complicated configuration geometry is uncommon in practical measurements. Instead, for practical reasons most configurations are having the electrodes placed along a line. Various different approaches for design of measurement configurations have been developed and tested throughout the development history of the resistivity method. Some arrays of measurement configurations are shown in (Figure 9).

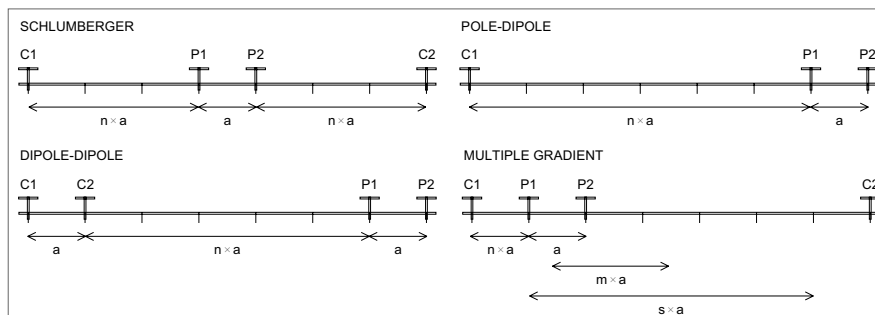

Figure 9. Common arrays used in resistivity surveys and their descriptions using a-spacing and n-factors. In general a is the distance between the potential electrodes and n·a is the closest distance between a current and a potential electrodes. Wenner array is the special case when n=1 in the Schlumberger array. The multiple gradient array is a bit more complicated to explain in these terms; n·a is the relative distance between the closest current electrode to the potential dipole being negative if the dipole is closer to the second current electrode m·a is the distance between the midpoints of the current and potential electrode pairs, and the separation factor s indicates the maximum number of potential dipoles with internal distance a that can be distributed in the array.

These arrays are commonly used in resistivity surveys. They have their strengths and their weaknesses. Arrays are typically described by their signal-to-noise ratio, their depth of investigation, their ability for lateral location of the target and their mapping abilities of horizontal layers or steeply dipping structures among other factors (Ward 1990). For example the dipole-dipole array has a good depth penetration and is considered good at mapping vertical structures but has poor depth resolution and is more sensitive to noise in practical measurements since it has a lower signal-to-noise ratio. The Wenner array is good at mapping horizontal layers and is less sensitive to noise, but has a lower depth penetration and is less efficient in mapping vertical structures. The Schlumberger array has intermediate properties both regarding sensitivity to noise and mapping abilities of different types of structures. The pole-dipole is different in its character considering the use of a remote electrode, which often makes it less practical for surveying. Even so, the pole-dipole is widely used and for permanent installations on dams it has the advantage of a higher resolution at high depths towards the end of the layouts. The multiple gradient array (Dahlin and Zhou 2006) is an approach to combine good properties from the different more established arrays and to make it suitable for modern multi-channel data acquisition. Other studies have been done to evaluate, compare and search for new and optimised arrays (e.g.

Barker 1989; Xu and Noel 1993; Beard and Tripp 1995; Olayinka and Yaramanci 2000a; Dahlin and Zhou 2004; Stummer et al. 2004). Furthermore, two or more arrays for collecting data followed by combined evaluation of the data sets with joint inversion is a concept that has been seen recently (de la Vega et al. 2003; PAPER 4). However, it should be mentioned that an increase in the number of data points does not automatically guarantee a better result. Joint inversion with bad data quality or with similar data, i.e. data from similar configurations, is not likely to be improved by an increase in the number of data points.

3.4.1 Equipment

Resistivity measuring equipment consists of a current transmitter and a voltmeter. Simple steel spikes may be used as electrodes. Cables are needed to connect the instruments to each electrode. Multi-electrode systems characteristically use multi-core cables with one take-out for each electrode. These systems also need an electrode selector, a switching unit that is controlled by the computer to select the appropriate electrodes for each measurement. There are systems with built in computers but also systems with an external PC. More details about the specific systems used for the permanent installations for dam monitoring are given in section 4.4.2 and 4.4.3.

3.4.2 Methodology

Historically, there are two basic modes of resistivity surveying, and both modes are independent of array type. Firstly, vertical electrical sounding, VES, is using the same midpoint for a specific electrode configuration. By systematically increasing the electrode separation, the current is forced deeper into the subsurface and the resistivity for different depths on a given location is the result. The other mode is electrical profiling, where the midpoint is varied and all electrode separations are fixed. The result in this case is resistivities on the same depth along a line.

Combining soundings and profiling will lead to collection of measurements on different depths along a line. This procedure is often referred to as continuous vertical electrical sounding, CVES, and has been described in detail in literature (e.g. Overmeeren and Ritsema 1988; Dahlin 1993; Dahlin 1996).

CVES involves measurements from electrodes placed along a line using a range of different electrode distances and midpoints, and is therefore advantageously performed using an automated multi-electrode system (Griffiths et al. 1990; Dahlin 1996). In such systems electrodes are inserted into the ground and separately connected to the instruments through multi-core cables. The data collection then becomes very flexible as any electrodes can be used in a pre-arranged way and easily controlled by a computer. Resulting data represents a section of the subsurface beneath the electrode line. This system is optimal for dam monitoring systems and for other types of long-term monitoring, as the electrodes are permanently installed and the measurements conveniently computer-controlled. Other systems have also been developed for efficient data acquisition in resistivity surveying. One example is a mobile system involving moving a full line of electrodes during measurements (Sørensen 1996).

CVES as described above together with subsequent 2D interpretation, i.e. 2D surveying, is the most common way to carry out resistivity surveys today. However, the combination of various separately measured 2D surveys combined in a grid with following 3D interpretation or real 3D surveys based on 3D arrays, i.e. 3D surveying, has become more common recently (e.g. Bentley and Gharibi 2004; Gharibi and Bentley 2005).

3.4.3 Monitoring

As already mentioned, the recent rapid development and automation of the method makes it possible to collect and process larger amount of data. This fact opens up for new applications in resistivity monitoring, where large amounts of data typically is involved. Examples of application areas characteristic for monitoring are systems for detecting leakages from landfills, saltwater intrusion monitoring, other types of groundwater monitoring and warning systems for landslides among others.

From a practical point of view, monitoring systems can be divided into three categories depending on degree of installation (Aaltonen 2001). The first category consists of permanent systems, which involve permanently installed electrodes and cables. These systems allow for flexible data acquisition throughout the year, but are more expensive as construction work is needed for the installations. This is the type of system that is used for dam monitoring at Hällby and Sädva dams (PAPER 3; PAPER 5). A light version of this system is when instruments are brought to the site only on measurement occasions, and not permanently positioned at the site. The second category of monitoring systems is the semi-permanent systems. These systems include fixed installed electrodes but mobile cables and instruments. They are less flexible, but still an alternative as they are cheaper than, and not as complicated as, the permanent systems. This approach has been used in pilot projects prior to the dam monitoring studies presented in this thesis (Johansson and Dahlin 1996). The third category is mobile systems, which is practically just a repetition of surveys at the same locations. These systems are flexible in the sense that no installations are needed, but they are less accurate as electrode positions are not consistent between time-steps. In the kind of surveys where monitoring systems are used, accurate measurements are often essential. A sensitive system is desired as the changes in resistivity over time that is searched for can be very small. For that reason mobile systems, using different electrode positions and electrode contact conditions between time-steps, can hardly be recommended for regular monitoring.

3.5 Data processing

As is often the case with geophysical data, data from resistivity measurements need to go through a number of steps in search for the true resistivity model of the subsurface. These steps may sometimes be rather complicated.

3.5.1 Data quality control and noise

Noise sources in resistivity investigations are plentiful. Examples of noise in urban environments include metal objects in contact with the ground, such as cables, metal pipes and fences. Moreover, other sources are active noise from the 50 Hz power grid

and telluric noise. Geometrical errors are introduced in the measurement if the electrodes are placed incorrectly as the geometrical factor will be wrong. For 2D surveying a slight error in the placement of an electrode along the line have much graver consequences on the results compared to a misplacement of an electrode off the line (Zhou and Dahlin 2003).

Measurements can be adopted to minimise the disturbances from noise. As have already been discussed, different arrays have different sensitivity to noise. In surveys where much noise can be expected measurements with less sensitive arrays could be preferred. Also, using monitoring techniques will reduce noise that is not time-dependent. The use of permanently installed electrodes eliminates electrode misplacement errors over time. In addition, assuring good grounding conditions is another way to minimise effects from noise. Bad grounding conditions lead to high electrode contact resistances, which in turn results in transmission of lower current levels. Lower current levels means smaller potential readings and lower signal-to-noise ratios.

During measurements repeated readings from the same configuration should be used to check data stability. A high variation coefficient from the same configuration is a sign of poor signal-to-noise ratio. Charge-up effects are another group of noise in resistivity measurements. In this case electrical charge is stored at the interface between the ground and the electrodes, which affect the next measurement. For this reason a measurement sequence should preferably not include an electrode measuring the potential immediately after being used as a current electrode (Dahlin 2000).

Typical noise sources that have been seen at dam sites are steel sheet walls, concrete structures, metal objects, grounding cables, other cables and metal pipes for instrumentation among others. These noise sources are in most cases not varying with time, and therefore eliminated or reduced when using long-term monitoring. However, it is important to know about them as they may significantly mislead interpretation of resistivity values.

The reciprocity principle can be used to estimate the data quality of the measurements. In a four-electrode configuration a reciprocal measurement is carried out by switching places between the two current electrodes and the two potential electrodes. According to the reciprocity principle the measured potentials from normal, R_{normal} , and from reciprocal measurements, $R_{reciprocal}$, should not be affected by switching positions of the electrodes. By carrying out measurement both ways the errors in percent, e_{obs} , can be evaluated directly (equation 11).

$$e_{obs} = 100 \cdot \frac{|R_{normal} - R_{reciprocal}|}{(R_{normal} + R_{reciprocal})/2} \quad (11)$$

For monitoring systems it is recommended to carry out such measurements on a reasonably regular basis. It gives valuable information and at the same time it is easy to carry out for automated systems. Error levels may be affected by for instance different

grounding conditions for the electrodes and noise disturbance from capacitive coupling in cables (Dahlin 1993).

3.5.2 Pseudosections

The conventional way of presenting apparent resistivity data from 2D resistivity surveys is to plot them in a section where the electrode separation or effective depth penetration is used for depth (Figure 10). On the x-axis is the distance along the surveying line and on the y-axis the pseudodepth is represented. As pseudodepth the median depth of investigation can be used or a measure that is proportional to the separation between the electrodes. The median depth is the depth at which the section of the subsurface reaches half of the contribution to the apparent resistivity value (Edwards 1977). Each dot represents a data point. Between points linear interpolation is customarily used for the plotting routine. As this section is built from apparent resistivity data it is referred to as a pseudosection and it differs largely from the true resistivity model of the subsurface. Therefore inverse modelling is needed for further interpretation.

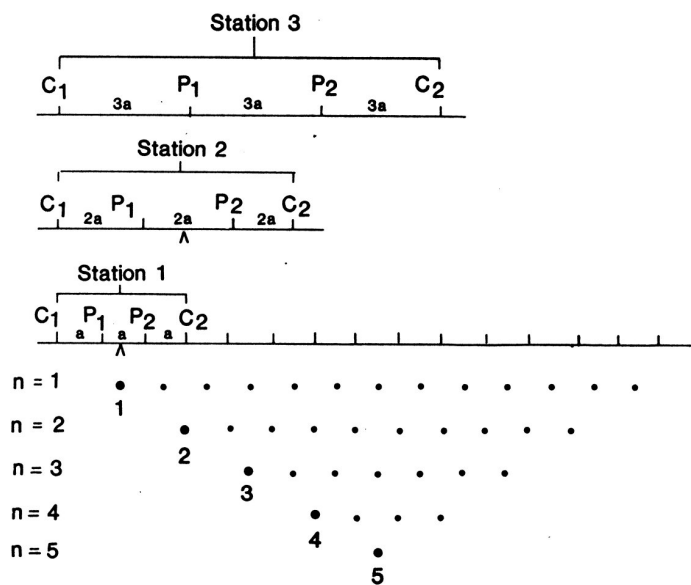

Figure 10. Principle for construction of a pseudosection for the Wenner array, with current and potential electrode locations at C1, C2 and P1, P2 respectively. On the x-axis is the distance along the surveying line for the configuration midpoint, and on the y-axis is in this case the n-factor, i.e. multiples of the minimum electrode separation, a, i.e. a measure proportional to the electrode separation. Each dot symbolizes one data point (from Barker 1992).

The pseudosection is made to present raw data, and is also a tool for rapid visual assessment of data quality. Large inconsistent changes between adjacent data points in the pseudosection, is often a sign of bad data quality in the measurements. Adjacent data point involves to a great extent the same subsurface volume for the measurement

and their respective potential readings should therefore vary in a systematic way. Slight errors in data will not be identified by checking the pseudosection, but obviously incorrect data points resulting from for instance instrumentation errors, failure of the relays in the switching unit, shorting of the cables in wet conditions, or mistakes during field surveying may be identified. It is essential to remove such obviously incorrect data points before moving on to the next step in achieving a final resistivity model, the inverse modelling.

3.5.3 Inversion

The purpose of resistivity surveying is in most cases to determine the subsurface resistivity distribution. As we have seen measurements on the ground surface results in apparent resistivities. The goal of inversion is to determine the true subsurface resistivities from a set of apparent resistivities, and it can be achieved by fitting the measured data to an assumed subsurface resistivity model. Today, inversion is performed automatically as an iterative process. This iterative process consists of an initial model guess, which is updated for every iterative step until a specific level of convergence or a maximum number of iterations is performed.

In this thesis inversion has been carried out mainly on 2D resistivity data, except for an example of 1D inversion that was performed on modelling data (PAPER 1). For all 2D inversion a widely used commercial code has been applied (Loke and Dahlin 2002; Loke 2004). This code is based on some theoretical considerations developed in the past decades, which are described briefly in this section. For more information on inversion the reader is referred to detailed sources. Important contributions in 2D inversion of apparent resistivities have been done by among others Smith and Vozoff (1984), Tripp et al. (1984), Li and Oldenburg (1992), Loke and Barker (1995), Loke and Barker (1996a) and LaBrecque et al. (1996). Recently 3D inversion (e.g. Park and Van 1991; Sasaki 1994; Zhang et al. 1995; Loke and Barker 1996b) has become more frequent in resistivity surveys and theoretical studies. However, this thesis is limited to 2D inversion of apparent resistivities from surface measurements.

As inversion is a method to fit a number of observations to a subsurface resistivity model, central for the inversion is a method of calculating the resistivities resulting from a certain measurement configuration on an assumed subsurface model. This is referred to as forward modelling. In 2D forward modelling the subsurface resistivity distribution is described by a 2D model extended in infinity in the third direction. It is important to notice, however, that the sources, the current electrodes, are modelled as 3D sources. If not, they would obviously be mistakenly described as line electrodes. Therefore, the term 2.5D is sometimes used for this kind of modelling. Coggon (1971) describes how the 3D point sources can be treated mathematically, by the means of Fourier transformation, to fit in the 2D modelling scheme. Such 2.5D modelling is further described by Dey and Morrison (1979a) and Queralt et al. (1991) among others.

More explicit, the forward modelling finds a solution to the current flow equations in inhomogeneous ground for a given resistivity distribution and current source configuration. The solution includes the potential field in the investigated 2D section,

from which calculation of the apparent resistivities from the configuration of the potential electrodes are straightforward.

The constitutive law governing the current flow in the subsurface is Ohm's law (equation 12).

$$\mathbf{J} = \sigma \mathbf{E} \quad (12)$$

where \mathbf{J} is the current density, σ is the electrical conductivity, the inverse of the resistivity, and \mathbf{E} is the electric field. The electric field is the gradient of a scalar potential V (equation 13).

$$\mathbf{E} = -\nabla V \quad (13)$$

When no sources or sinks are applied, the divergence of the current density equals zero (equation 14).

$$\nabla \cdot \mathbf{J} = 0 \quad (14)$$

Combining equation 12 and equation 13 gives equation 15.

$$\mathbf{J} = -\sigma \nabla V \quad (15)$$

Rewriting equation 14 and equation 15 gives equation 16.

$$\nabla \cdot (-\sigma \nabla V) = 0 \quad (16)$$

Equation 16 is the homogeneous version (no source term) of Poisson's equation for the electrical potential. In the presence of a point source, a current electrode, the divergence of the current density can be described by a Dirac delta function and a point current I (Coggon 1971). In equation 17, I is the amount of current injected at \mathbf{r}_s .

$$\nabla \cdot \mathbf{J} = I \delta(\mathbf{r} - \mathbf{r}_s) \quad (17)$$

Using these descriptions of sources Poisson's equation becomes (equation 18). It governs the electrical flow in inhomogeneous ground.

$$\nabla \cdot (-\sigma \nabla V) = I \delta(\mathbf{r} - \mathbf{r}_s) \quad (18)$$

For the 2.5D approximation the potential is in three-dimensions because of the 3D point source, but resistivity, the model parameter, is constant in the strike direction, or y -direction that is perpendicular to the layout direction. This allows for simplifications, and technically, the calculations are simplified into pseudo-2D by placing the source at $y=0$ and apply the Fourier cosine transform with respect to the y -coordinate (e.g. Coggon 1971; Zhou 1998; Zhou and Greenhalgh 1999).

The Poisson equation (equation 18) for full 3D or the Fourier transformed simplified equation for 2D is then typically solved numerically by dividing the subsurface in a number of finite elements and solve by matrix inversion techniques. The most common numerical methods are the finite differences or the finite element method. The commercial software used for the inversion of the embankment dam measurements in this thesis has the possibility of choosing between both these methods. The method of finite differences has been used as default except for when topography is included (PAPER 2) when the finite element method was preferred due to more flexibility in arranging the cells. For the separate modelling studies (PAPER 1; PAPER 4) the finite element method was used.

Two types of boundary conditions are used. At the surface a Neumann boundary condition is applied (the potential gradient in the normal direction is zero) due to the infinite resistivity of the air. At the other boundaries a Dirichlet boundary condition can be applied and the potential be set to zero. This is true only sufficiently far away from all possible positions of the current electrodes, which must be considered when constructing the mesh. More efficient and also more common is therefore to apply a mixed boundary condition (Dey and Morrison 1979a) along the non-air boundaries.

In the automatic inversion routine a homogeneous starting model of the subsurface resistivity distribution is used with logarithmic averages of the measured apparent resistivities (Loke and Barker 1995). The subsurface is divided into a large number of rectangular cells, and the optimisation method attempts to determine the resistivity distribution of the cells that minimises the difference between the calculated and measured apparent values subject to certain constraints (Loke et al. 2003). The inversion procedure becomes to solve the following equation (equation 19),

$$\left(\mathbf{J}_i^T \mathbf{R}_d \mathbf{J}_i + \lambda_i \mathbf{W}^T \mathbf{R}_m \mathbf{W}\right) \Delta \mathbf{r}_i = \mathbf{J}_i^T \mathbf{R}_d \mathbf{g}_i - \lambda_i \mathbf{W}^T \mathbf{R}_m \mathbf{W} \mathbf{r}_{i-1} \quad (19)$$

where \mathbf{g}_i is the data misfit vector containing the difference between the logarithms of the measured and calculated apparent resistivity values, $\Delta \mathbf{r}_i$ is the change in the model parameters for the i^{th} iteration and \mathbf{r}_{i-1} is the model parameters vector for the previous iteration, containing the logarithm of the model resistivity values. \mathbf{J} is the Jacobian matrix of partial derivatives and \mathbf{W} is a first-order roughness filter (deGroot-Hedlin and Constable 1990). The damping factor λ determines the relative importance given to minimising the model roughness and data misfit. \mathbf{R}_d and \mathbf{R}_m are weighting matrices introduced to modify the weights given to the different elements of the data misfit and model roughness vectors. By adjusting the form of these weighting matrices, the L_1 - or L_2 -norms can be used in the data misfit and model roughness minimisations. A more detailed description of the inversion method is given in Farquharson and Oldenburg (1998).

Loke et al. (2003) describes the use of the L_1 and L_2 optimisation norms. The L_1 -norm minimises the sum of the absolute values of the data misfit, whereas the L_2 -norm minimises the sum of the squares of the data misfit. The L_1 -norm optimisation has regularly been chosen for inversion of embankment dam data throughout this thesis.

Apart from being more robust to noisy data (Claerbout and Muir 1973), it tends to produce models with regions that are more blocky and separated by sharper boundaries. The latter factor is probably more consistent relating to measurements on a zoned embankment, where large resistivity contrast is expected between different materials, i.e. between the fine-grained core and the fresh igneous rock of its foundation. Another inversion scheme especially suitable for an expected subsurface with a few homogeneous regions with sharp interfaces between them was proposed by Olayinka and Yaramanci (2000b). This scheme uses a division of the subsurface into polygons, of which the boundary coordinates and layer resistivities constitute model parameters.

3.5.4 Time-lapse inversion

For monitoring data or repeated measurements the apparent resistivities from two or more different measurement occasions can be analysed jointly using time-lapse inversion. Time-lapse inversion means that two data sets from different points of time are inverted together, where the first recorded data set would normally be regarded as a reference. In time-lapse inversion a smoothness constraint is applied not only on the spatial variation but also on the temporal variation between the data sets. This approach has been shown to focus the difference between the data sets on the actual change in the model and suppress artefacts due to the resistivity structure (Loke 2001). It takes into account the fact that in many situations the changes in the resistivity occur in a limited section of the subsurface while the rest of the subsurface has much smaller changes. Thus the optimisation equation (equation 19) is modified such that it also minimises the difference in the logarithm of the model resistivity values of the later time data set and the initial time data set. The modified equation used is given by equation 20,

$$(\mathbf{J}_i^T \mathbf{R}_d \mathbf{J}_i + \lambda_i \mathbf{W}^T \mathbf{R}_m \mathbf{W}) \delta \mathbf{m}_i^k = \mathbf{J}_i^T \mathbf{R}_d \mathbf{g}_i - \lambda_i \mathbf{W}^T \mathbf{R}_m \mathbf{W} \mathbf{m}_{i-1}^k - \beta_i \lambda_i \mathbf{V}^T \mathbf{R}_t \mathbf{V} (\mathbf{m}_{i-1}^k - \mathbf{m}_{i-1}^0) \quad (20)$$

where \mathbf{m}_{i-1}^0 and \mathbf{m}_{i-1}^k are the model parameter vectors for the initial data set and the k th time data set. The additional term, $\beta_i \lambda_i \mathbf{V}^T \mathbf{R}_t \mathbf{V} (\mathbf{m}_{i-1}^k - \mathbf{m}_{i-1}^0)$, on the right-hand side of the above equation constrains the change in the model for the k th time data set such that the difference between the model resistivity values for this data set and the model for the initial time data set (which serves as a reference model) is also minimised. β is the relative weight given to this cross-model constraint and \mathbf{V} is the cross-model weighting matrix that determines the characteristic that we wish to introduce in the differences in the model resistivity values. For example, if a simple damped or Marquardt (Lines and Treitel, 1984) cross-model constraint is used, then \mathbf{V} is the identity matrix \mathbf{I} . \mathbf{R}_t is the weighting matrix that modifies the weights given to the different elements of the model difference vector such that the L_1 or L_2 norm can be used (Farquharson and Oldenburg, 1998). If it is known that the time changes in the model resistivity values vary temporally in a smooth manner (for example a chemical plume that spreads by diffusion), then the L_2 norm constraint can be used. Alternatively, if it is known that the changes are expected to change abruptly in relation to the monitoring interval, the L_1 norm constraint is more appropriate.

In dams, the resistivity varies in a cyclic manner over the year. When evaluating monitoring data from dams, the reference data set can be chosen as a median data set

over the entire selected period, e.g. one or several years. However, the variation pattern is interesting for evaluation and using the median as a reference data set involves a risk that the variations are damped out by the inversion routine. Instead, a sliding damped data set can be used when analysing the data. In this case, the reference data set follows the actual data set, but with a strong damping that suppresses noise.

3.6 Data interpretation

As have been shown many different materials may have similar resistivity (Figure 7). Therefore it is always dubious to interpret resistivity data by translating given resistivities into a certain type of material. This may be done only after having received reliable information of the material distribution in the field area, e.g. from other types of investigations to confirm the interpretations.

Calibration against field observations, borehole data and other information is of vital importance for the resistivity method and essential for a correct interpretation of a final model of true subsurface resistivities. However, the method can also be used as a tool for covering a large field area and form a basis for deciding where to invest in more detailed investigations.

For interpretation of a final 2D inverted resistivity model it is wise to always keep in mind some typical phenomena associated with the theories behind resistivity measurements that may affect the final model. A few such factors are listed below.

- Depth resolution: The resolving power of the resistivity method decreases exponentially with depth.
- Resolution at the sides of the model: At the sides of the final model there are less data points and the model may be strongly affected by boundary conditions and the weight the side blocks are assigned in the inversion. In many cases this problem can be overcome by increasing the length of the survey line so that the area of interest surely becomes entirely covered. On embankment dams, however, increasing the length is not always easy. Quite common is that the embankment dam connects in one end to a concrete structure hosting the spillway or the intake to the power station and increasing the line is then not feasible.
- The concept of non-uniqueness: The principle of equivalence can be exemplified for the case of a homogeneous earth with an embedded horizontal high-resistive layer. In that situation the high-resistive layer with a certain resistivity and a certain thickness may, within the measurement resolution, produce the same result as a layer with twice the resistivity and half the thickness (Telford 1990).
- High-resistive or high-conductive top layer: If the top layer is very resistive it might be difficult to get enough current into the ground. On the other hand, if the top layer is very conductive the current will be channelled into this layer and it might be difficult to reach the underlying structures with enough current. In both cases, the potential readings may become very small resulting in very low signal-to-noise ratios.

- 3D effects: Inversion of 2D resistivity data assumes a 2D subsurface reality and no significant variations in the direction perpendicular to the survey line. This is rarely the case, but for many surveys it is a manageable problem. A four-electrode measurement involves an earth volume with the shape of a half-sphere for the case of a homogeneous subsurface. This means in principle that structures on a certain distance to the side of the line has the same influence on the measurements as structures on a similar depth. For measurements along embankment dams, 3D effects are of great importance due to effects both from the 3D geometries from inside the dam and from the obvious topographical 3D effect from the sloping surfaces and the reservoir (PAPER 1). A 2D resistivity survey line across the embankment dam is however a valid assumption as the subsurface geometry in the direction perpendicular to the survey line, i.e. the cross-section of the dam, is reasonably invariable (PAPER 2). Severe 3D effects are best avoided by undertaking a full 3D inversion. Computational power has for long limited the use of 3D inversion but recently it is becoming more and more established, even though it is still unrealistic for handling monitoring data. Furthermore, 3D inversion would require data acquired in a pattern that may often be difficult to achieve on a dam.

3.7 Resistivity modelling

Resistivity modelling of 2D resistivity data is a useful method to increase understanding of the resolution of the method in some arranged situations. Numerical methods developed strongly in the 1970ies enabling such modelling. Since then it has been performed many times for theoretical considerations and for supporting results from case studies, and valuable contributions to the field have been seen from many studies using both the finite difference method (e.g. Mufti 1976; Dey and Morrison 1979a; Dey and Morrison 1979b; Fox et al. 1980) and finite element method (e.g. Pridmore et al. 1981; Queralt et al. 1991; Sasaki 1994; Zhou and Greenhalgh 2001), as the most common numerical methods. Basically, a synthetic model over the subsurface resistivities is constructed and then a 2D resistivity survey is simulated on this model. Sometimes artificial noise is added. The response for each measurement configuration is calculated, which results in a full set of synthetic apparent resistivities, similar to what would be received from the field survey. Comparing the modelling results with the field data may assist the interpretation. Modelling can also be used to estimate the effect from an introduced change in the subsurface. Useful in this case is the idea behind the anomaly effect, AE (equation 21).

$$AE = \frac{\rho_{a(\text{model}2)} - \rho_{a(\text{model}1)}}{\rho_{a(\text{model}1)}} \cdot 100 \quad (21)$$

Anomalies are normally differences from a constant or smoothly varying background. For modelling, the anomaly effect is the change, in percent, from comparing a reference model, (model 1) to a new model (model 2).

Evaluation of modelling results may also be done on inverted data. After inverting the synthetic data set the resistivity model can be examined, and compared to a model from

the real field data if the intention was to resemble a field situation. The whole modelling concept may give support in the interpretations of the field data.

3.7.1 Embankment dam modelling

For embankment dam, resistivity modelling can be used to estimate effects from different typical scenarios that occur on dams (PAPER 1; PAPER 4). Some examples are:

- Resistivity change due to reservoir level changes: As reservoir level fluctuates the measurements will be affected by changed conduction through the reservoir and changed resistivity of the materials inside the dam; for rapid variations mainly the upstream fill is affected.
- Resistivity change due to seasonal variation: Temperature changes over the year and resistivity of water and dam construction materials change with temperature.
- Resistivity change due to internal erosion and leakage scenarios: Internal erosion leads to material changes in certain parts of the dam. In addition, increasing seepage in those parts affect the temperature distribution inside the dam. These changes affect resistivity in the defected zone. Anomaly effects, calculated for different leakage scenarios, may give support in interpretation of field data.

Modelling can also be helpful in testing and improving the actual function of an installed monitoring system (PAPER 1). For a given situation, such as a leakage through the dam core, modelling can be used to optimise resistivity measurements on embankment dams. Some examples are:

- Comparing different arrays for a certain surveying line: Different arrays have different performance depending on dam design, type of defect and other factors. Modelling may help picking the right one.
- Comparing different locations of surveying lines: Normally, surface electrode layouts are the only possible ones on existing dams. Modelling can be used to find the optimal location on the dam surface for a given dam design.

All these different modelling investigations are site-specific, as the results will depend heavily on the resistivity model. For an embankment dam the resistivity model is constructed to resemble a cross-section drawing of the dam. Different zones consist of different materials and will have different resistivity values. All kind of documentation, such as grading curves, laboratory tests and other descriptions of the materials, is helpful when assigning resistivity values for dam construction materials.

In this thesis two different types of modelling approaches have been used using software developed by Bing Zhou. Firstly, the 2.5D modelling approach, which is a simplified 3D approach that assumes a constant cross-section of the dam extending to infinity in the strike direction. The second is the 3D modelling approach that allows for

resistivity variation in the full 3D. Both methods are briefly described below, and the results from dam modelling are discussed in section 4.4.

3.7.2 2.5D modelling

The 2.5D resistivity modelling (PAPER 1) is similar to the standard forward modelling routines incorporated in 2D inversion schemes (see section 3.5.3), with the only difference that the calculation of the potentials in this case is parallel to the strike direction instead of perpendicular to the strike direction as for the standard case. This is accomplished by performing the inverse Fourier cosine transform with non-zero y-coordinate of the potential position according to the method described by Queralt et al. (1991). The current electrodes are in this case not only modelled as 3D sources, but the model also allows placing them anywhere in the full 3D. The software uses the finite element method, as it makes it easier to deal with the dam geometry compared to the finite difference method.

The 2.5D approach turned out to be a more efficient approach than the full 3D model. The drawback is that the resistivity distribution must be constant in the strike direction, but for an elongated embankment with constant cross-section this drawback is moderate. However, for realistic modelling of important 3D features such as leakages or effects from different abutments, a full 3D modelling approach is needed.

3.7.3 3D modelling

The 3D forward modelling (PAPER 4) was used to evaluate situations where the 2.5D approach was restricted by the simplification that the cross-section must be constant in the strike direction. Such situations include for example modelling of defects limited in extension along the dam. The finite element method was used to calculate the full three-dimensional potential field for any defined geological model (Zhou and Greenhalgh 2001). Apparent resistivity values for an arbitrary electrode configuration are given as output. For such modelling of a multi-electrode layout it is most convenient to first calculate the potentials due to a single current source at all current electrode locations. Then, the potentials are combined due to the appropriate current-potential pairs in order to determine the apparent resistivity for each four-electrode configuration.

The 3D modelling is more time-consuming than the 2.5D approach. However, the rapid development of computational power recently gives advantage to this approach.

4 Resistivity surveying on embankment dams

For resistivity surveying on embankment dams the main aim is to verify the safety and integrity of the dam. This is done by detecting potential weaknesses, such as defective zones, anomalous seepages or internal erosion processes. In this section some basic principles concerning embankment dam monitoring is discussed. First comes a presentation of a short review of how the resistivity method primarily has been used in dam investigations. After that, the resistivity variations in dams, the fundamental basis for evaluation of monitoring data, is discussed. To conclude, some suggestions are brought forward relating practical aspects of data acquisition as well as improving and optimising of the use of method based on the lessons learnt within this project.

The resistivity method has been used for many purposes in connection with dams. The method has been applied for dam site investigations for proposed dams before and during construction (e.g. Aina 1996; Batayneh et al. 2000), but the main interest here is on the possibility to check the integrity of existing dams. During their operation, embankment dams are subject to a never-ending hydraulic load from the reservoir, which over the years may cause changes in the properties of the inner parts of the dam construction. Controlling such phenomena as leakages, internal erosion, anomalous seepage and structural defects are essential for dam safety.

4.1 Monitoring and investigation – two different approaches

There are two different approaches to using resistivity measurements in dam investigations. Surveys conducted at one occasion or on a limited number of occasions over a limited timeframe, and long-term monitoring with permanently installed electrodes. Single investigation is the most common approach. It is less demanding and more flexible to carry out, but it is less likely that the results from a single investigation approach will be able to give answers to crucial questions about the safety of the examined embankment dam.

In this thesis the main focus is on the monitoring approach, which is the more powerful method of the two. The basis behind evaluation of resistivity monitoring data is based on its time variation, which is described in section 4.3. This, however, requires a fairly long investigation period to be able to establish what is the normal resistivity variation in the dam. Factors, such as seasonal variation due to temperature changes and reservoir level changes among others, are to a great extent site specific and cannot be known in advance. Once established however, deviations from this normal background are taken to indicate anomalous conditions in the dam.

4.2 Previous work

The most common use of the method has traditionally been as single investigations. These investigations are performed within a limited time frame and are on the whole quite similar to resistivity surveys in many other engineering or environmental applications. The most common purpose is to check integrity of the dam or to detect anomalous seepage in the dam or the foundation. In such investigations, commonly resistivity profiling and/or resistivity soundings have been performed (e.g. Ogilvy et al.

1969; Bogoslovsky and Ogilvy 1970; Arandjelovic 1989; Butler et al. 1989; Moldoveanu and Suciu 1989; Butler and Llopis 1990; Abuzeid 1994; Okko et al. 1994; Sirls 1997; Panthulu et al. 2001; Kim et al. 2004; Lim et al. 2004; Song et al. 2005; PAPER 2; PAPER 4). The method has been applied in a similar manner on river dykes (e.g. Van Tuyen et al. 2000; Chen et al. 2004; Inazaki and Sakamoto 2005). Offshore measurements in the reservoir have also been tested (e.g. Corwin 1985). In most dam investigations the resistivity method has been used together with various other geophysical methods. Butler and Llopis (1990) emphasize on the importance of integrated multiple-method programs and also suggest the possible use of a monitoring strategy, where geophysical anomalies detected as a function of time can be correlated with the reservoir level.

Such repeated measurements in time, have also been performed. Buselli and Lu (2001) used repeated measurements on the downstream side of a tailings dam to locate contaminated seepage. Titov et al. (2000) evaluated dam integrity using measurements before and after spring flood. Similarly, Engelbert et al. (1997) conducted resistivity measurement for locating canal seepage by comparing results from empty respectively full canal. Johansson and Dahlin (1996) demonstrated seasonal resistivity variation inside an embankment dam by measuring repeatedly eight times over a period of 18 months.

The next level after repeated measurements is to perform regular monitoring. In an ongoing Swedish research program, of which this thesis is one part, resistivity monitoring of an embankment dam by daily measurements commenced in 1996 (PAPER 3) and five years later, in 2001, commenced measurements on a second dam (PAPER 5).

4.3 Resistivity variations in embankment dams

Butler and Llopis (1990) categorise geophysical methods in primary and secondary regarding their role in seepage assessment methodology. Primary methods are methods that are directly sensitive to seepage. Secondary methods, or supporting, methods are indirect, and may be sensitive either to a phenomenon that is a consequence of seepage or sensitive to a phenomenon that is a circumstance that initiates seepage. In this sense, the resistivity method is considered both primary and secondary; it is both directly sensitive to water flows and it may also indirectly detect seepage by detecting seepage paths regardless if water flow is occurring.

This way of describing the resistivity method makes sense when studying the basic principles behind evaluation of resistivity monitoring data. The direct detection method is based on the fact that the seepage water brings a seasonal resistivity variation, whereas the indirect detection method is based on the changing electrical properties of the soil that may be caused by internal erosion. In the next two subsections these two fundamental principles will be discussed in more detail.

4.3.1 Seepage-induced seasonal variations

Seasonal temperature variations in an embankment dam has since long successfully been used for seepage detection. The seasonal temperature variation inside the dam is dependent on the seepage flow rate. This temperature variation is depending mainly on the temperature of the reservoir and the time it takes for the seepage water to travel through the dam. Seepage flow rates can therefore be evaluated from temperature measurements without knowledge of hydraulic conductivity in the dam (Johansson 1997). This is a great achievement, as the true in-field hydraulic conductivity is a difficult parameter to estimate.

In a similar way resistivity can be used to evaluate seepage. Johansson and Dahlin (1996) did some initial test on this on repeated resistivity measurements from the Lövön dam. The same evaluation approach has been used within this thesis, based on the excellent data from the Sädva dam (PAPER 5). The evaluation method is based on the principle described above for the temperature variations and the assumption that the resistivity property inside the central parts of the dam can be measured with reasonable certainty and data quality.

Accordingly, the seepage will cause resistivity variations in the dam. Those variations may be recorded by repeated measurements. However, the resistivity in the dam depends also on the seasonal resistivity variation in the reservoir water (Johansson 1997). The seasonal variation of the absolute resistivity in the reservoir water is separated into two parts when the seepage water passes through the dam (Figure 11). The solutes penetrate into the dam with the pore velocity v_n , while the temperature travels with the thermal velocity v_T . The resistivity variation in the dam is therefore a combined result of these two transport processes.

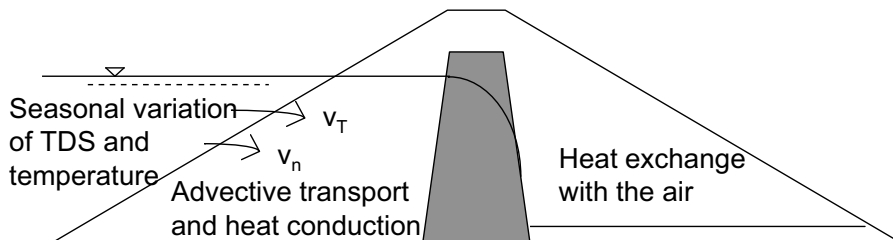

Figure 11. Cross-section of an embankment dam showing the important transport processes that affect the resistivity variation (from Johansson 1997).

The temperature method is more certain, and has a much larger precision in its measurements than the resistivity approach. The advantage of the resistivity method is that it is non-intrusive, which is important on embankment dams. Another advantage is that the method is continuous along the dam, and collects information about the core where drillings normally are avoided. The resistivity method will thus give more spatial information than conventional pressure measurements that gives information in a point, or temperature measurements in standpipes at different levels, that give information in a vertical profile.

Nevertheless, the seepage evaluation procedures of the resistivity and temperature method have a lot in common, and a basis for such evaluation is the variations in the reservoir. The temperature in the reservoirs of the two monitored embankments have been measured (Figure 7). The variations are cyclic with a period of one year. During the cold part of the year the temperatures approaches 0°C and flattens out. In summer maximum temperatures of approximately 20°C in Hällby and 15°C in Sädva are reached. The climate at Sädva is colder as it is situated farther north, and the sensor is situated on a larger depth which is the explanation to why the coldest temperatures never goes down to 0°C but stops around 2°C. The sensor at Sädva is placed on large depths to make sure it is never above the surface, taking into consideration the high operational reservoir level fluctuations at Sädva. However, just like the placing of the sensor at Hällby dam close to the main intake the sensor at Sädva is placed closed to an intake to a mini power plant, thereby assuring good mixing of the water and representative values for both reservoirs.

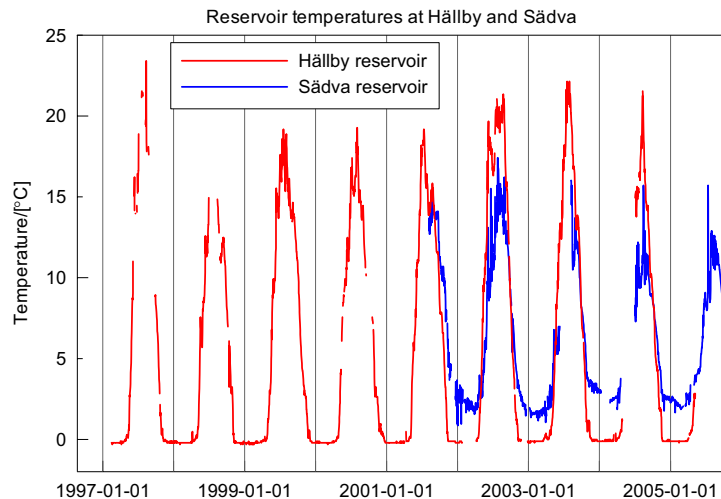

Figure 12. Temperature variations in the Hällby and Sädva reservoirs.

The resistivity in the reservoirs of the two monitored embankments has been measured (Figure 13), and just as for temperature, the seasonal variations are obvious. The measured resistivities exhibit a high variation with top levels coinciding with low temperatures in wintertime. Adjusting for temperature effects by recalculating all resistivities to 18°C values (equation 10), reduces much of the variation. However, some variation remains, and this is explained by a seasonal variation in TDS. Most noticeable are the peaks around late spring/early summer, which are caused by low TDS-levels and associated with snowmelt. Particularly at the Sädva reservoir the snowmelt is intense. The dam is located in the mountains and is the first reservoir in its river system, and therefore it receives large amounts of melting water. Consequently it is not surprising that there is a variation in the Sädva reservoir, also in the monthly measurements (Figure 13, bottom) taken by the Swedish university of agricultural sciences (SLU 2005). This variation in the monthly measurements is perceptible for the

Hällby reservoir as well, but much less evident (Figure 13, top). In general, the measured data agree well with the monthly measurements taken by SLU about 100 km downstream, although the variation of the latter is much smoother. The variation can be expected to become smoother further downstream, and moreover the monthly sampling rate might miss some of the shorter peaks. Nevertheless, for the Hällby reservoir the resistivity variation is similar to prior measurements from the reservoirs at Lövön and Moforsen, two dams situated in the same region (Johansson and Dahlin 1996).

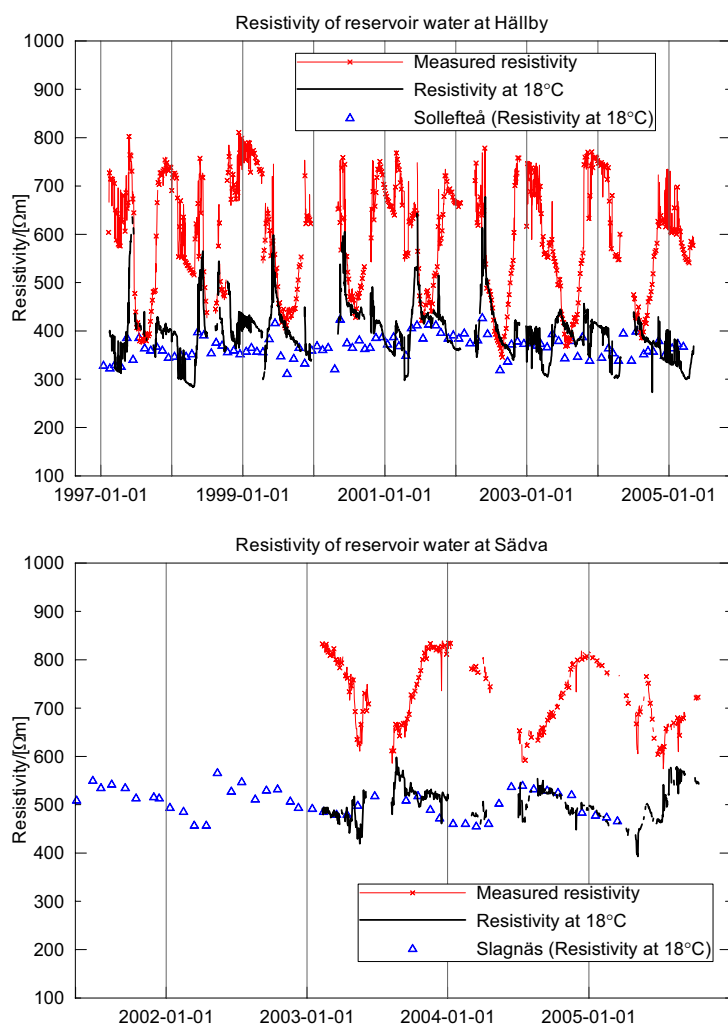

Figure 13. Resistivity variations in the Hällby reservoir (top), and the Sädva reservoir (bottom). Resistivity at 18°C has been corrected for temperature variations using a temperature coefficient of resistivity, $\alpha=0.025$ (Keller and Frischknecht 1966). Monthly measurements (triangles) taken at Sollefteå and Slagnäs (SLU 2005). These locations are approximately 100 km downstream from each of the dams.

4.3.2 Internal erosion and electrical properties of the soils

The resistivity of geological materials in general was discussed in section 3.3, along with some of the fundamental relations that govern resistivity in earth and soil materials. This section will bring up in more detail the properties of the standard construction materials for embankment dams and what to expect in terms of resistivity change of the soil in the case of internal erosion in the dam.

The materials present at embankment dams can be expected to vary significantly in resistivity. The bedrock should generally be high-resistive where fresh, 1000 Ωm or more, whereas in fractured, weathered or mineralised zones the resistivity can be dramatically lower. The core of the dam should be relatively low in resistivity due to the fine material content, possibly below 100 Ωm . The filters of the dam would be higher in resistivity than the core if unsaturated, and the saturated resistivity depends on the resistivity of the water. The total volume of filter material is relatively small, and the resistivity of the filter is somewhere in between the resistivity of the core and the fill. This reduces influence from the filter zones significantly, and it is generally not expected to have much influence on the resistivity measured in embankment dams. The downstream support fill should, if it consists of rock-fill, have a resistivity of thousands of Ωm , whereas on the upstream side saturation with reservoir water will reduce the resistivity dramatically. How much it will be reduced depends on the porosity of the rock-fill and the resistivity of the water. The resistivity of the reservoir water is rather high in Scandinavian fresh water, typically a few hundreds of Ωm as can be seen in Figure 13, resulting in formation resistivities often expected to be in the thousands.

Resistivities of some common embankment dam construction materials are given in Table 3. As can be seen, resistivities vary in wide ranges. However, the contrasts between different materials are varying less from one dam to another. The geo-electrical situation at a dam site is set mainly by the reservoir resistivity. Therefore it is likely that if one material is in the upper part of the resistivity range in Table 3, the other materials at the same site will also be in the high of their intervals, thereby keeping the relative difference on a similar level.

Table 3. Typical ranges of electrical properties of common Scandinavian embankment dam construction materials based on various published sources as referenced in the text.

Dam zone	Material	Resistivity (Ωm)
Core	Glacial till	10-500
Filter	Sand / Gravel	100-5000
Upstream fill	Rockfill (wet)	100-5000
Downstream fill	Rockfill (dry)	1000-50000
Foundation	Bedrock (non-metallic)	1000-50000
Foundation	Moraine	100-5000
Reservoir	Water	10-1000

Within this thesis only preliminary laboratory tests were performed. For proper laboratory testing a great deal of work is needed, as water content needs to be varied in a controlled way with the proper water chemistry. Quick tests were performed on core

materials and water with simple equipment (Figure 14), mostly as an aid for input to the modelling studies. Similar equipment with a tube as a sample holder, current electrodes at the ends and ring or point electrodes for potential readings is a common design for resistivity testing in laboratory.

Noticeable is the high resistivities that we see in the reservoir water of Hällby, Sädva and the test dam at Rössvatn. With water resistivities around a few hundreds of Ωm the formation resistivities of the rockfill and filter zones also become high. In dam cores constructed from glacial till, with a typical fines content of 15-40% (Vattenfall 1988), the importance of surface conduction as discussed in section 3.3.2 is significant. It is likely that the glacial till in the dam core is the best conductor of all materials including the reservoir water at these dams. In addition to the general more general studies on resistivity of soils mentioned in section 3.3, other sources point out the importance of fines content for the total resistivity of a soil (e.g. Bergström 1998; Saarenketo 1998; Yoon and Park 2001).

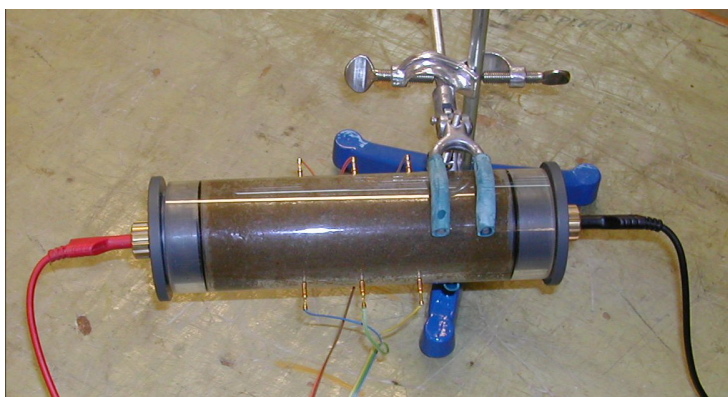

Figure 14. Basic sample holder for resistivity testing of soils. The ends of the plexiglass tube are steel plates used as current electrodes, and potentials are measured on points at known distances (3+3 cm) along the long side of the tube. Inner tube dimensions are: length 15 cm and diameter 5 cm.

Electrical material properties vary within very wide intervals and are site-specific. The variation between different sites is to a large extent governed by the properties of the reservoir water. This is fundamental when it comes to material properties considerations for resistivity investigations on embankment dams. The resistivity of the water has a large influence on the materials inside the dam construction, especially in coarse-grained soils as it governs electrical conduction in such materials. It is necessary to know about the site-specific conditions. We may compare the low-resistive reservoir water of approximately $10 \Omega\text{m}$ at Enemossen with the high-resistive water of a few hundreds of Ωm at Hällby or Sädva. What is the signature of a weak zone in the dam? It is likely that at Enemossen a leakage zone is low-resistive (PAPER 2), whereas at Hällby or Sädva it is high-resistive (PAPER 3; PAPER 5). In practice for dam investigations, both high- and low-resistive anomalies are searched for. Typically, variations in space along the dam are examined and less attention is paid to the actual

absolute resistivity values in the embankment dam. Using a monitoring approach makes it easier as in this case changes over time is analysed and actual resistivity values are even less important.

Internal erosion is the reason why weak zones can take the form of high-resistive anomalies. When internal erosion occurs, the fine particles of the soil are washed out from the core. This process affects the resistivity in two aspects, each working against the other. Firstly, the porosity of the core increases which leads to a decrease of the resistivity due to higher water content. Secondly the reduction of the fines content in itself increases the resistivity. In theory, it is difficult to predict the effect of internal erosion on the electrical properties of the dam core and this may differ from one dam to another depending on material properties and water resistivity. Laboratory test performed by Bergström (1998) on some Swedish glacial tills used for sealing layers on waste deposits indicate a significant increase in resistivity when the fine content is removed (Figure 15).

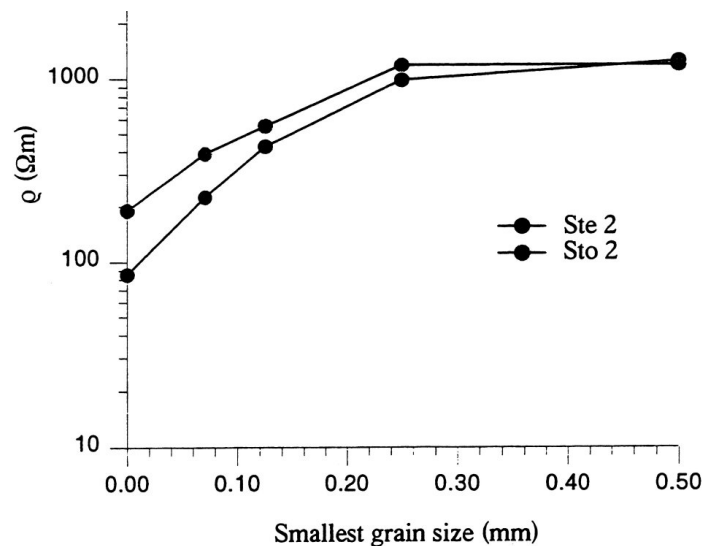

Figure 15. Importance of fines content on resistivity of soils. Results from an experiment simulating erosion in a glacial till used for sealing waste deposits, but similar to a dam core. Ste 2 and Sto 2 are named samples from two different sites (from Bergström 1998).

In the experiment conducted by Bergström resistivity was measured on the same soil with different levels of fines removed, thereby simulating washout of fines as a result of internal erosion. The glacial till sample is similar to what is used in the cores of many Swedish dams, and could be categorised as slightly coarser than average for that purpose, which then suggests that the effect may be stronger for dam core materials. In this experiment the resistivity rises up to approximately ten times on the removal of fines smaller than 0.25 mm, where it seems to flat out. Recent research based on theoretical and practical considerations, concludes that particle sizes up to 0.2 mm readily is transported to the filter face in the initial stage of a leak. If the leak increases

in size, soil fractions as large as 5 mm could be carried away by the seepage flows (Foster and Fell 2001). However, the resistivity increase is small for removal of particle sizes larger than 0.2 mm. Resistivity will thus be most sensitive in the initial phase of the internal erosion process.

Consequently, for embankment dams with typical Scandinavian conditions and unless the water is very low-resistive, it is likely that internal erosion cause an increase in the resistivity of the core, as a washout of fines occur. Burns et al. (2006) perform laboratory tests with a miniature resistivity array on a clay specimen that is exposed to piping and internal erosion. They map the growth of the developing pipe as a high-resistive eroded zone, and conclude that the method may prove useful in monitoring on large-scale embankments.

4.4 Data acquisition and measurement optimisation

A number of parameters can be studied for optimising measurements from the installed monitoring system. Numerical modelling as described in section 3.7 can be used to find out about different arrays and different layout locations on dams. It may also be useful for increasing the understanding of how water level fluctuations affect the measurements, how seasonal variations affect the measurements and what detection ability the method has for different leakage scenarios (PAPER 1). From the modelling studies the following conclusions can be drawn.

- Optimising the array: Four arrays were investigated for a layout along the crest. These were dipole-dipole, Schlumberger, gradient and the pole-dipole. The dipole-dipole array proved slightly more sensitive to a simulated damage in the dam core, but this may in practical application be counteracted by its larger noise sensitivity. Only very small differences were found between the other arrays in the same situation (PAPER 1).
- Optimising the layout location: Five different layouts were considered, and all were running along the dam. These were along the downstream toe, along the mid-downstream slope, along the crest, along the mid-upstream slope and along the upstream toe. From these locations the layout along the crest were clearly the most sensitive to a simulated damage in the dam core. It is clear that for dam designs where the core is the most conductive part a channelling effect may occur in the core increasing the current density in this region. For dams with high-resistive rockfill it is hardly possible to detect any changes in the core from measurements on the downstream or upstream slopes (PAPER 1). However, the layouts along the downstream or upstream toes may serve a purpose in monitoring the foundation or detecting inflow areas from leakages.
- Estimating effects from reservoir level changes: Reservoir level changes have significant influence on resistivity measurements. For measurements along the crest an intermediate lowering of the reservoir by 10% of the dam height from full reservoir resulted in a change of close to 14% in apparent resistivity data for large electrode distances. For a large lowering of the reservoir by close to half the dam height, the same effect was estimated to be moving towards approximately 40% for

the largest electrode distances. (PAPER 1). The results are depending on design and site-specific electrical properties, but for many dams with high reservoir level fluctuations, a change in the range of up to a few tenths of percent in apparent resistivities should be expected.

- Estimating detection ability for different leakage scenarios: The detection of zones in the core with increased resistivities from measurements along the crest was examined. Firstly in the 2.5D model this was examined in spite of the numerical limitation that the damaged zone could not be restricted in the extension along the dam. In any case, the results showed an anomaly effect of around 15% at best for a 1 m damaged layer on 20 m depth in apparent resistivities, which is enhanced to almost 25% after inversion (PAPER 1). Such anomalies are not likely to be seen using an investigation approach, but for a high-quality monitoring system there might be a possibility of detection. Secondly, full 3D modelling was performed to examine detection abilities of damages from the dam at the test site in Røssvatn (PAPER 4).

4.4.1 Handling dam geometries

For practical reasons 2D resistivity surveying are often performed along the embankment crest or along the slopes. Due to the complex geometry inversion of 2D data from such investigations is not straightforward. Two types of 3D effects lead to geometrical errors. The first is a result of the topography, from the embankment slopes and the reservoir. The second, which may turn out to be even more significant is a result of the zoning of the inner parts of the embankment dam. For an electrode layout along the dam crest the complex geometry therefore results in a violation of the 2D assumption, as apart from direct topographical effects, there is also large variation in electrical properties in the direction perpendicular to the electrode layout direction. This problem is discussed in PAPER 1.

However, 2D measurements along the embankment are performed in spite of these 3D effects. Measurements along the dam can give a good overview of the whole dam, and is used to find anomalous zones, which can subsequently be investigated more in detail using cross-sectional measurement techniques, 3D surveying or other types of investigations. In the evaluation of such anomalies, special care has to be taken due to the violation of the 2D assumption. In general, absolute resistivity values as well as depth locations are likely to be distorted.

Measurements where the surveying line is crossing the dam can be used to study a particular part of the dam in more detail. This approach is not violating the 2D assumption, as long as the dam cross-section is reasonably constant along the dam, which is true in most cases. Furthermore, it is assumed that the inversion can handle topographical variations in the electrode layout direction. Studies have been performed on how to minimise and compensate for pure topographical effect in the electrode layout direction from measurements over dams and dykes (Hennig et al. 2005), even though this is nowadays straightforwardly taken care of by available inversion techniques (e.g. Loke 2004).

Apart from measurements along the dam or crossing the dam, it is difficult to see how 2D measurements could be performed. Measurements on the downstream side may be carried out to check for seepage problems in the foundation, but is of a limited use for checking the status of the dam itself. Measurements using boreholes are an attractive approach, as it would significantly increase the resolving power on large depths. The technique could be used as a combination of layouts in one or more boreholes with surface layouts, or as measurements using layouts in two separate boreholes investigating the region between the two boreholes. However, boreholes are generally avoided in the dam core on existing dams, and in addition steel or plastic casing is needed to protect the boreholes, complicating the task to carry out of the measurements.

An approach using 3D measurements is attractive considering the problems associated with the complex geometry would be avoided. However, evaluation of 3D measurements is demanding, especially for monitoring data. Furthermore, 3D evaluation demands 3D measurements, which makes the installations substantially more demanding. It is not clear that the improvement from 3D measurements, restricted to combinations of electrodes placed on the surface of the embankment dam, will be worth the effort that such an installation demands. Quasi 3D measurements is an interesting attempt to receive a broader base of interpretation. Song et al. (2005) carried out such an attempt, by performing 3D interpretation of combined 2D resistivity measurements along the crest, at three levels along the downstream slope and at both abutments perpendicular to the dam direction. However, when combining 2D measurements along the dam with 2D measurements crossing the dam, the asymmetry of the distortions in absolute values, resulting from the violation of the 2D assumption only in the case of measuring along the dam, may lead to problems in fitting the different data into a joint 3D resistivity model.

4.4.2 Instrumentation for dam monitoring

Monitoring systems were installed at the Hällby dam in 1996 and at the Sädva dam in 2001 (Johansson et al. 2005a). Both systems were based on the ABEM Lund Imaging System, which is a mobile multi-electrode system for resistivity surveying developed at Lund University (Dahlin 1996). However, a few modifications were done to adapt the system to permanent conditions. The present instrumentation at Hällby and Sädva are briefly described in Table 4; it has been described more in detail in earlier reports at the Hällby dam (Johansson and Dahlin 1998) and at the Sädva dam (Dahlin et al. 2001). Some minor changes have been done since the first installations.

Table 4. List of components for resistivity monitoring including a brief description of present instrumentation at Hällby and Sädva dams.

Component	Hällby and Sädva installations
Computer with modem	PC based on MS-DOS, with data acquisition software ERIC and Symantec PCAnywhere for remote control and data transfer
Receiver/Control unit	Hällby: A/D Converter Lawson Labs AD201 Sädva: TerraohmRIP224
Current transmitter	ABEM Booster SAS2000
Switching unit	ABEM Electrode selector ES464
Lightning protection	Designed and built at Lund University. At Sädva also with a built in relay switch
Power supply adapters etc.	12 V adapters.
Electrode cables	Multicore cables for each layout.
Electrodes	Standard steel plate electrodes and non-polarisable SP electrodes, Farwest SP-150
Others	Probe for measuring resistivity and temperature in the reservoirs. Designed and built at Lund University.

4.4.3 Electrode installations

The electrodes serve an important function in resistivity surveying. The interface between electrodes and ground must offer good and stable conditions for electric conduction to ensure that current easily can be passed into the ground. For poor installations high contact resistances may lead to lower current levels and lower signal-to-noise ratios. At Hällby stainless steel plates were used as electrodes (Figure 16). Dimensions of 250x250x1 mm were used to ensure enough surface contact.

Self-potential (SP) measurements have also been carried out. The typically very small potential readings from such measurements make the method very vulnerable to polarisation effects in the interface between electrode and ground. Therefore special non-polarisable electrodes are normally used for SP measurements. Non-polarisable electrodes consist of a metal electrode embedded in a solution consisting of a salt of the same metal, often with a jellying agent added for stability. Commonly used are copper-copper sulphate, lead-lead chloride or silver-silver chloride electrodes (Corwin and Conti 1973; Corwin 1984; Milsom 1996; Friborg 1997). At Sädva and for the re-installation at Hällby in 2005 copper-copper sulphate electrodes were delivered pre-packaged in a cloth bag filled with a bentonite mix designed to give a good coupling to the surrounding natural soil (Figure 16). A promising design of non-polarisable copper-copper sulphate in situ-electrodes adapted for long-term monitoring was developed by Thunehed and Triumf (2001).



Figure 16. Installation of electrodes at Sädva. Both steel plate electrodes (left) and non-polarisable copper-copper sulphate electrodes pre-packaged in cloth bags with bentonite (right) have been installed.

Multicore cables have been used to connect each electrode to the instruments. This is the most convenient way for installations as special designed pre-made cables can be ordered in advance. Cable take-out intervals at the planned electrode separation and distance to the first take-out are chosen to fit the local requirements. Special care must be taken when connecting the electrodes to the cable take-outs to ensure good contact and lasting performance. At Sädva and Hällby the electrodes were connected to polyurethane (PUR) covered stainless steel wires (Figure 16), which were joined to cables splits (pig-tail splits) on a PUR covered multi core cable.

Proper installation of electrodes is important to avoid high electrode contact resistances and troublesome noise levels. Comparing the time-series of apparent resistivities from crest measurements on Hällby and Sädva dams (Figure 17; PAPER 3; PAPER 5) clearly demonstrates that the method of installing the electrodes affects data quality. In Figure 17 time series of measured apparent resistivities is presented. The thicker lines indicate the filtered data. Apart from the obvious difference in data quality, it can be observed that for the region around chainage -40 m to -45 m on Hällby left dam there is a trend indicating an increase in the apparent resistivity (Figure 17 top). For the Sädva data it can be noticed that apart from the adjustment of a few obvious data outliers the filtering routine would hardly be necessary (Figure 17 bottom).

To fully understand the reason behind the difference in data quality the difference between the installations at the two dams has to be examined. At Hällby, the electrodes were placed at 1 m depth, slightly to the upstream side of the dam crest in coarse fill material. To ensure good contact with surrounding earth material the area closest to the electrodes were backfilled with fine-grained soil. The depth was not enough to protect the electrodes from freezing during winter. If this in itself is a major problem is still unclear, but in general it will affect data quality. When used as current electrodes, it will be harder to use higher current levels during winter leading to lower signal-to-noise ratios, and the higher contact resistance will also increase the risk for noise problems caused by for example capacitive coupling when used as potential electrodes. Furthermore, on the right dam a misunderstanding led to installations of the electrodes above a thermal insulation layer protecting the upper part of the core from freezing. This led to poor measurements, and data from the right dam crest has been

considered to poor to use for evaluation. However, the installation of the electrodes above the thermal insulation layer is not the only reason as also data from the left dam is clearly inferior to what has been seen in Sädva.

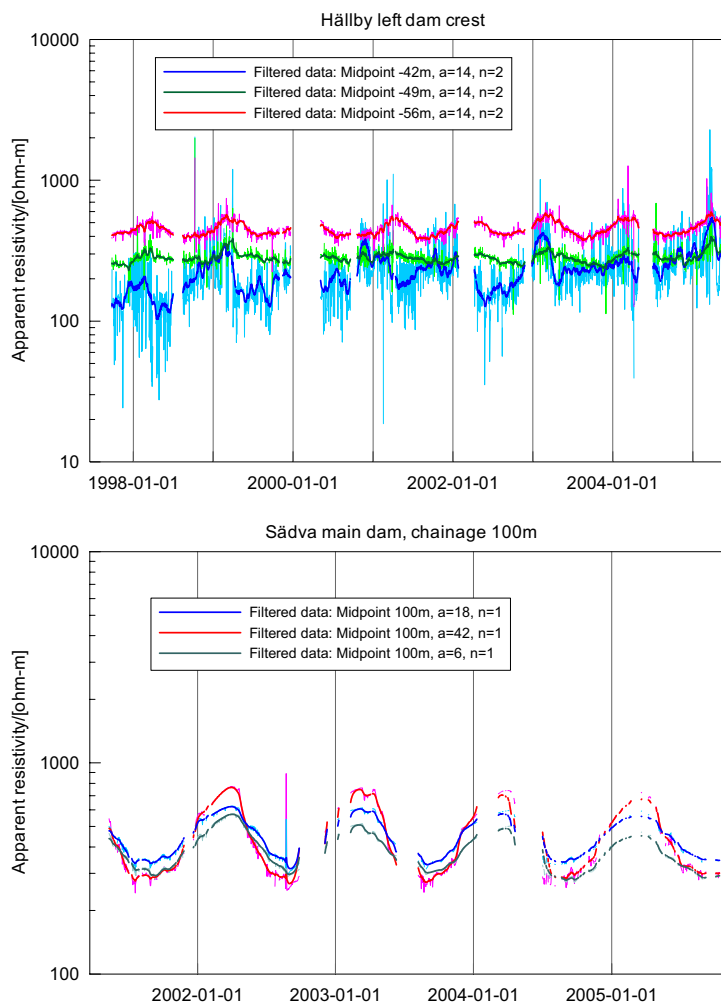

Figure 17. Example of time-series of apparent resistivities (thin lines) with filtered data from long-term measurements at the Hällby (top) and the Sädva (bottom) dams.

At Sädva the installations were performed under more favourable circumstances. Due to higher estimated extreme floods in the new guidelines for floods that were developed in Sweden (Flödeskommittén 1990), it was decided to raise the dam core. Since the crest was excavated down to the core during this work it was an excellent opportunity to install the electrodes right into the dam core. Furthermore, as the core was raised by 0.7 m and protected with thermal insulation a first-class cover was provided for the

electrodes. The electrodes were installed on the top of the original core about 3.1 m below the crest on the main dam and 2.6 m below the crest on the dyke that is 0.5 m lower (Figure 16; Figure 18).

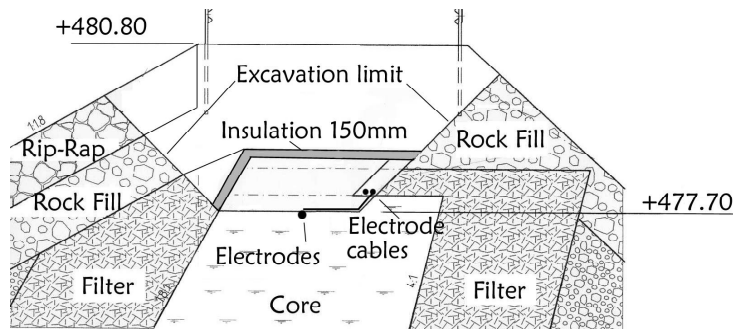

Figure 18. Installation of electrodes at Sädva main dam crest. Electrodes were placed on the top of the old core when the core was raised. After installation the electrodes were covered with new core material, thermal insulation and rockfill.

Data quality can be estimated visually by observing pseudosections or time series for a specific configuration. A more systematic approach is to examine results from reciprocal measurements (equation 11). The reciprocity principle is described in section 3.5.1. At both Hällby and Sädva reciprocal measurements have been carried out during most of the period. The results further emphasize the difference in data quality between the two dams. At Hällby dam the errors calculated from reciprocal measurements range from less than 1% for the upstream offshore layouts to 1-4% for the onshore layouts, except for the problematic layout along the right dam crest, which has errors of more than 20%. At Sädva reciprocal measurements indicate low error levels, even though over certain periods data from some of the configurations on the dyke contains large errors. However, with appropriate instrument settings this could be avoided, and occasional evaluation of the data quality through the years, show that typical measurements errors can be expected to be lower than 1%.

Another important issue for installation of permanent systems is the electrode spacing. A shorter distance between the electrodes gives more electrodes and increases resolution, as the measurements are denser. Furthermore, shorter electrode spacing resolves the upper layers better, which in turn may remove uncertainties on larger depths. The drawback is that more electrodes demand more capacity from cables and instruments, which increases the costs not only from the electrodes themselves but also for other parts of the system. At Hällby the electrode spacing was 7 m. This is probably far larger than optimal, even though no systematic analysis has been done to prove this. At Sädva the spacing is 6 m on the dyke and 3 m on the main dam. For the re-installation of the electrodes on Hällby in 2005 the electrode spacing was reduced to the half original distance, i.e. 3.5 m.

4.4.4 Routines for long-term monitoring

The long-term monitoring systems at the Hällby and the Sädva dams produce a number of 2D apparent resistivity data sets every day. The large amount of data calls for special routines to achieve a correct and efficient evaluation. The evaluation process involves a number of steps listed below, and routines have been developed to perform some of these steps automatically (Johansson et al. 2005a; PAPER 3).

- Handling data: Daily measurements are carried out. Measured resistances are stored in zip-archives on the monitoring computer, one for each day.
- Data transfer: Data is being downloaded by modem connection.
- Analysing raw data: Apparent resistivity data can be inspected by plotting pseudosections or by calculating errors using reciprocal measurements. This is not automatic and carried out on demand. Data has been checked on a relatively frequent basis for new measurements, but as long as good function is accomplished the intervals between data inspections may increase.
- Data processing: Software has been developed that automatically goes through a few steps of data processing. First, the selected data sets are extracted from the daily zip-archives. Then the data sets are filtered and averaged over longer time intervals, for instance a week. After that the reference data sets are calculated for the same period. These are used as time-constraints in the time-lapse inversion and are calculated using a stronger damping to securely avoid noise contamination. Time-lapse inversion is carried out of all the data sets, according to the method described in section 3.5.4.
- Presentation of final models: The last step involves presenting the inverted models. For each interval, normally each week, a resistivity model is produced. From these weekly data statistical parameters, such as maximum, minimum, mean, median, relative variation and variation coefficient for the models over the whole evaluation period, typically one or more years.

5 Field measurements

Field measurements have been central for the work behind this thesis. In the following section some selected results are presented. Even if only a limited part can be included in this summary, the intention is that the variety of how the measurements have been applied and the development of the method can be illustrated. For information about the methods or details in general the reader is directed to the attached papers. Instead focus in this section will be on a short description of each site and a specific part of the results from each site.

Field measurements have been performed in different ways at four dam sites, all located in Scandinavia (Figure 19). The work is to a large extent based on the monitoring of the embankment dams a Hällby and Sädva (PAPER 3; PAPER 5). Permanent monitoring systems were installed at Hällby in 1996 and in Sädva in 1999 even though regular monitoring did not start at the latter until 2001. Daily measurements have been taken at both these dams. At Enemossen a single resistivity survey was performed at one occasion using the investigation approach (PAPER 2). Finally, at Røssvatn an investigation was performed, but also with some monitoring components involved (PAPER 4).



Figure 19. Map of Scandinavia with location of the dam sites that is presented in this thesis. Hällby and Sädva are hydropower dams with permanently installed monitoring systems. Enemossen is a tailings dam where a dam status investigation was performed, and Røssvatn is an embankment dam test site where a blind test was conducted to test the method.

5.1 Dam status investigation at Enemossen tailings dam

A dam safety investigation was conducted at the Enemossen tailings dams close to the Zinkgruvan mining site in southern Sweden. (PAPER 2). The investigation comprised temperature, resistivity, induced polarisation (IP) and self-potential (SP) measurement together with standard visual inspections of the dams. The aim of the study was to examine the extent of damages around earlier reported sinkholes and to examine the overall integrity of the dams.

Large volumes of ore are involved in the mining process at the Zinkgruvan mine, and the major part of the tailings are stored at the Enemossen tailings facility. Enemossen covers an area of 0.60 km² and contains a volume of seven million m³, which is kept in place by two embankment dams with total length of 1340 m and a maximum height of 27 m. The oldest part of the dam was built in 1976, and as the mining activity expanded the dams were raised five times resulting in an unusual layout of the core (Figure 20).

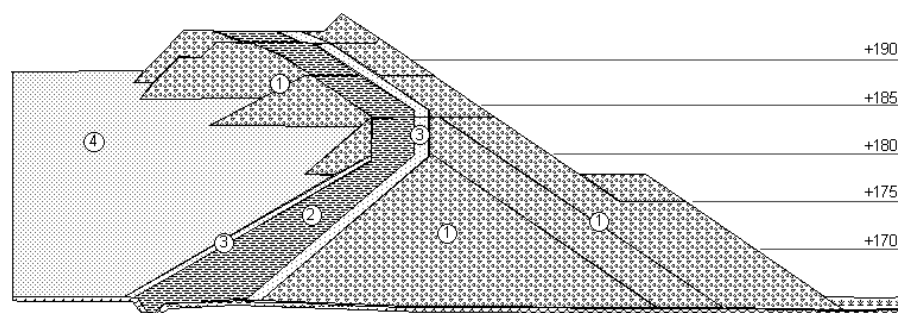

Figure 20. Cross-section of the X-Y dam at Enemossen. (1) Support fill (downstream and upstream), (2) Core, (3) Filter, (4) Tailings. Level refers to meter above sea level.

The tailings are distributed over the containment area via water through a system of pipes and the resistivity of the outflow mix of tailings and water is approximately 10 Ω m. This low resistivity for Scandinavian conditions is explained by the high amount of TDS in the tailings water. As a consequence, possible leakage areas are likely to stand out as low-resistivity areas.

Longitudinal 2D measurements along the dam crest provided an overview of the dam and based on results from those measurements and information about reported problem areas three areas on the X-Y dam were selected for detailed cross-sectional measurements (Figure 21). In general the resistivity distribution in the three cross-sections show many similarities and fit well with what could be expected in a comparison with the drawing (Figure 20) and basic knowledge of resistivities of dam construction materials.

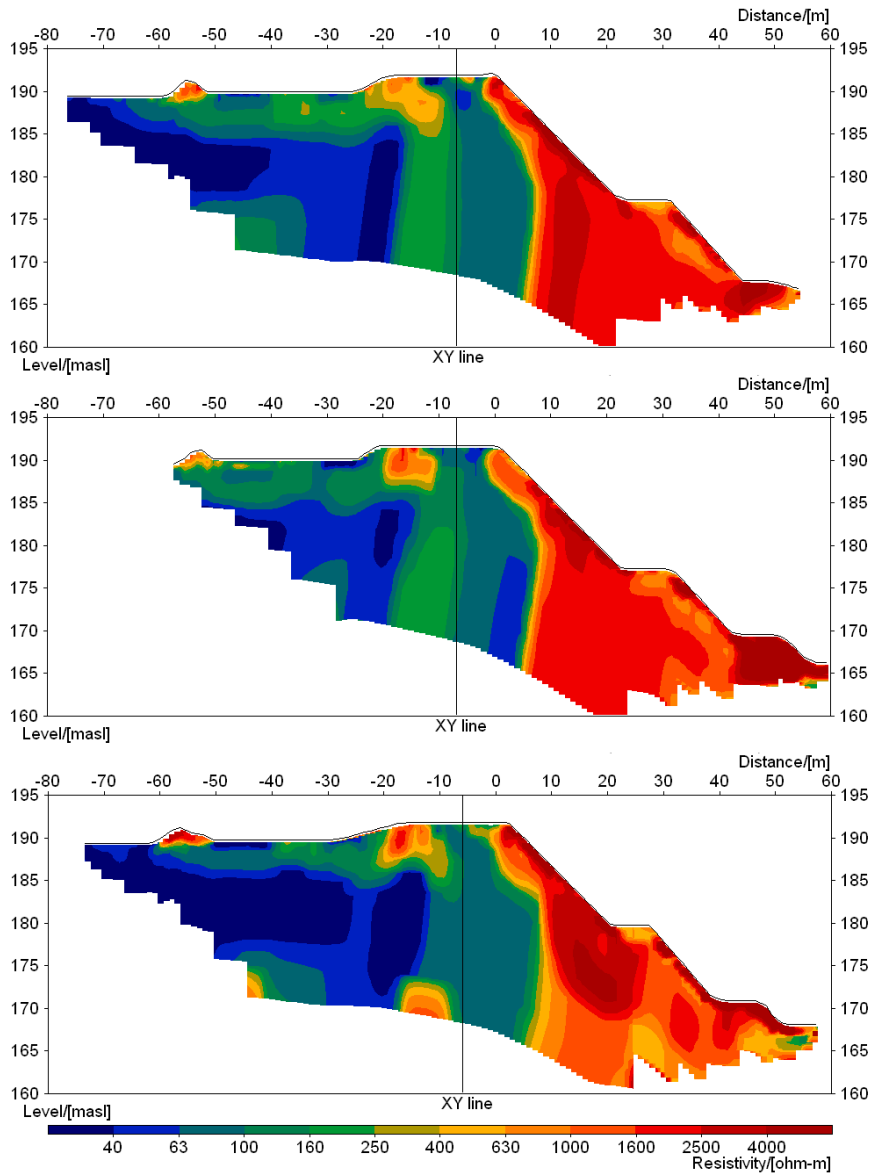

Figure 21. Inverted resistivity cross-sections from the X-Y dam. Top: chainage 0/471 m (mean residual 3.1%). Centre: chainage 0/492 m (mean residual 3.3%) Bottom: chainage 0/310 m (mean residual 1.7%). Level refers to meters above sea level and chainage to length along the dam in meters. The XY line refers to the crossing of the longitudinal measurements along the dam crest.

Some characteristic features are generally recognised. All sections illustrate the low resistivity of the tailings, where also the ground water surface can be identified thanks to the well-sorted character of the fine sand. The coarse rockfill in the constructed pier (at -55) in the tailings as well as in the upstream and downstream support fill are observed as high resistive zones. Furthermore, the inclined shape of the low-resistive dam core at the top is identified. Apart from the similarities, also a few differences were distinguished between the cross-sections. One such is the low-resistive zone beneath the upstream fill immediately upstream from the core, which is more prominent in chainage 0/310 m. This could be related to anomalous seepage and fits well with the occurrences of previous sinkholes. A lower resistivity is also seen in the downstream fill in this chainage, which may be caused by higher content of fine material.

The overall conclusion from the investigation was that none of the detected resistivity anomalies immediately needed any further investigation. The area around the latest reported sinkhole at chainage 0/500 m is similar to other parts of the dam, even though the downstream part of the core has a lower resistivity in the cross-section of 0/492 m. In general, known problem areas at Enemossen were associated with low resistivities. However, the resistivity measurements alone did not provide enough information to confidently come to a decision about the status of the dams.

5.2 Blind test at the Røssvatn embankment dam test facility

The test facility at Røssvatn has been used since 2001 for studying breaching mechanisms of embankment dams. Numerous dams with different design have been built and forced to failure by different means, whereupon the progress of the breach was documented and analysed. On one of the dams, a 6 m high and 40 m long zoned rockfill embankment dam with a central glacial till core, it was decided to test some unconventional leakage detection methods in a blind test (PAPER 4; Johansson et al. 2005b). Three defects, consisting of permeable material crossing the core at varied depths and locations, were built into the dam. Subsequently, measurements were performed and the locations of the defects were not known until after measurements, data processing and interpretation were completed.

All of the constructed defects were small (0.16 m^2), and none of them was detectable according to a pre-study that was carried out to help designing appropriate defects. However, the pre-study assumed an investigation approach using resistivity measurements only on one occasion. In the field test, it was possible to conduct repeated measurements with different reservoir levels. This short-term monitoring approach turned out to give very complicated interpretations, as the seepage regime in the dam was dynamic throughout the test. Nevertheless, the possibility of repeating the measurements was advantageous and clearly increased the detection level of the method.

Measurements were taken repeatedly during one week with permanently installed electrodes on the dam core. The reservoir was empty at the start of the measurements and during the measuring period it was filled completely and emptied again. Resistivity

measurements were taken at four different levels and SP was measured during the actual periods of filling or emptying.

In conclusion, the resistivity measurements managed to locate one of the three defects. Another one missed by 2 m but was also indicated at the same spot by the other tested methods, whereas the third one was clearly not detected. Instead, a fourth area was indicated by the method, and this turned out to be an unwanted leakage zone around the drainage pipes crossing the dam. In this section only some limited selected examples of the results are presented.

In addition to the series of measurements done on the electrode layout installed on the dam crest during the filling and emptying of the reservoir, an 80 m long line was measured that extended on each side of the dam. This was done to examine the overall geo-electric situation in the area. The extended resistivity line was measured with the reservoir empty. The corresponding inverted resistivity sections exhibit large contrasts, where the bottom of the dam stands out as a high-resistive (several thousand Ωm) bottom layer (Figure 22). These large contrasts in the outer parts of the section may be the reason for the rather high model residuals of 10.1%. The dam itself exhibits resistivities in the range a few hundred to a couple of thousand Ωm . The general shape of the bedrock agrees well with the drawings of the dam, with a steep slope to the left and a more gradual to the right.

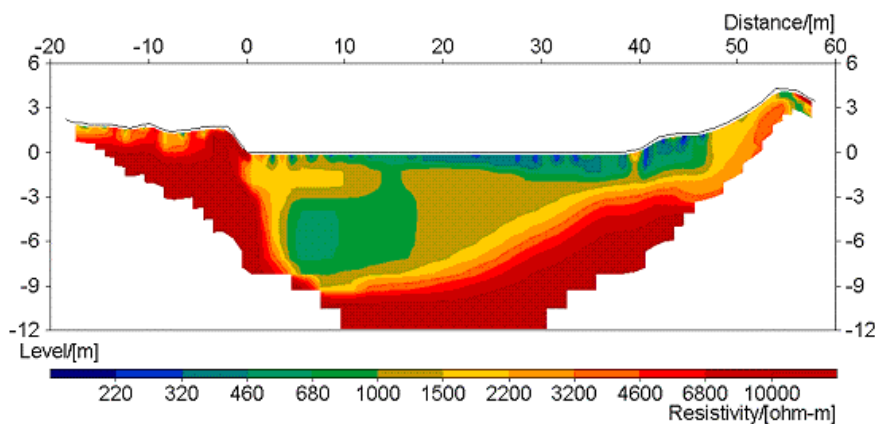

Figure 22. Inverted resistivity section based on combined gradient array and Wenner array data from the extended line measured with empty reservoir (mean residual 10.1%). The test embankment dam was built between 0 m and 40 m.

The results in Figure 23 are examples of interpretations that supported the detection of the only clearly detected defect centred at 27 m (length mark along the dam). The presented difference sections illustrate the change in resistivity from one measurement occasion to another. Negative values indicate decrease in resistivity and positive values increase in resistivity.

After increasing the reservoir water level two meters from the empty level at 5 m depth, most of the dam section beneath the level 2 m below the crest exhibits a drop in resistivity of 10-20% (Figure 23 top), but in the zone centred around 27 m the drop is over 40%. As these data sets were taken within 1-3 hours after the rise of the reservoir level it is likely that a leakage zone that respond quicker to a higher reservoir level would stand out as a zone with a larger decrease of the resistivity.

A number of measurements were made at the same water level but at different times. One example is the difference between the measurements taken at the end after returning from full reservoir to empty reservoir, and the measurements taken at empty reservoir at the start (Figure 23 bottom). A decrease in resistivity for shallow depths around 0.5-3 m is obvious, and it is probably caused by increased moisture content following from the wetting of the embankment dam when the water level increased. Below 2.5-3 m depths the resistivity has increased, except in the rightmost part starting from 24 m and to the right end where there is a decrease in resistivity. The reason for the increase in resistivity is not clear. It may be related to for example change in temperature in the upstream fill and the core, or washout of fine material and/or ions from the upstream fill, but due to lack of information only speculation is possible.

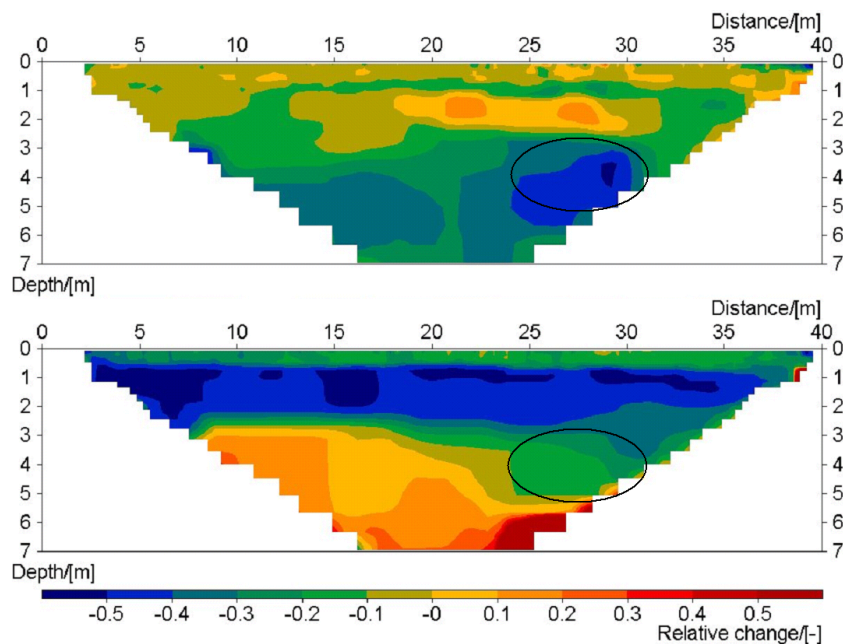

Figure 23. Difference in inverted resistivity sections based on gradient array data. Top: difference between empty reservoir (5 m depth) at the start and the first filling at 3 m depth. Bottom: difference between empty reservoir at the start (depth 5 m) and empty reservoir at the end (depth 5 m) after returning from a full reservoir. Ovals mark the detected anomalous zone at 27 m.

5.3 Long-term monitoring at Hällby embankment dam

Hällby was the first Swedish embankment to get a permanently installed monitoring system intended for resistivity measurements. Daily measurements started to take place in 1996, which make these long-term monitoring data unique (PAPER 3; Johansson et al. 2005a).

The embankment dam at Hällby is divided into a left and a right part by the centrally placed power plant and spillway structure. The left dam is 120 m and the right dam is 200 m long. Both dams have a maximum height of around 30 m and are constructed as a zoned rockfill embankment dam with a vertical central core of glacial till and filter zones. The reservoir at Hällby stores a volume of 625 million m³, and the reservoir level variations are less than 0.8 m. The monitoring installation comprises full instrumentation for resistivity measurements. Except for the resistivity system, the dams were until 2003 sparsely monitored with a few piezometers and a drainage system measuring leakage from the left dam. In 2004 the drainage system was updated and new piezometers were installed. Furthermore, starting in 2004 both the left and the right dam were reinforced as a seven-meter wide zone of coarse rockfill was placed on the full height of the downstream slope. In connection with this work the dam core was also raised and therefore all land-based electrodes at Hällby have been reinstalled.

The dam is classified into the highest consequence class in RIDAS, the Swedish guidelines for dam safety. A sinkhole was observed on the left dam in 1985, located close to where the dam connects to the intake structure. The sinkhole at Hällby was repaired by grouting. After additional drilling on the right dam it was decided to grout the area close to the spillway on the right embankment dam as well (Bronner et al. 1988).

The electrode installations were made somewhat imprudent. The electrodes on the right dam crest were placed above a thermal insulation layer, of which the existence was unknown, and the electrodes along the upstream slopes were not positioned properly. However, the measurements from the left crest and the right downstream toe have been functional, though with considerably noisy data. On reinstalling the electrodes during 2004 and 2005 (Figure 24) the same type of successful installation as in Sådva (PAPER 5; Johansson et al. 2005a) has been aimed for.

Detailed analysis of the monitoring data can be performed by examining resistivity over time in certain areas of the model section. In Figure 25 a few selected depths at two locations on the left dam, chainages -61.25 m and -43.75 m, are given in this form.

The area around chainage -61.25 m has been very stable over the full monitoring period and is considered a healthy part of the dam, whereas around chainage -43.75 m some deviation from the assumed pattern of variation has been observed. The area closest to the intake from chainage 0 m to chainage -40 m is not covered by the method on large depths.



Figure 24. Hällby dam during the reinstallations of electrodes in 2005. The top of the right dam crest is excavated and new electrodes are being placed out, every second being a non-polarisable (white bags). The downstream slope has been reinforced with additional rockfill. In the background are the spillways, the intake to the power station (high building) and the left embankment dam. Author in front.

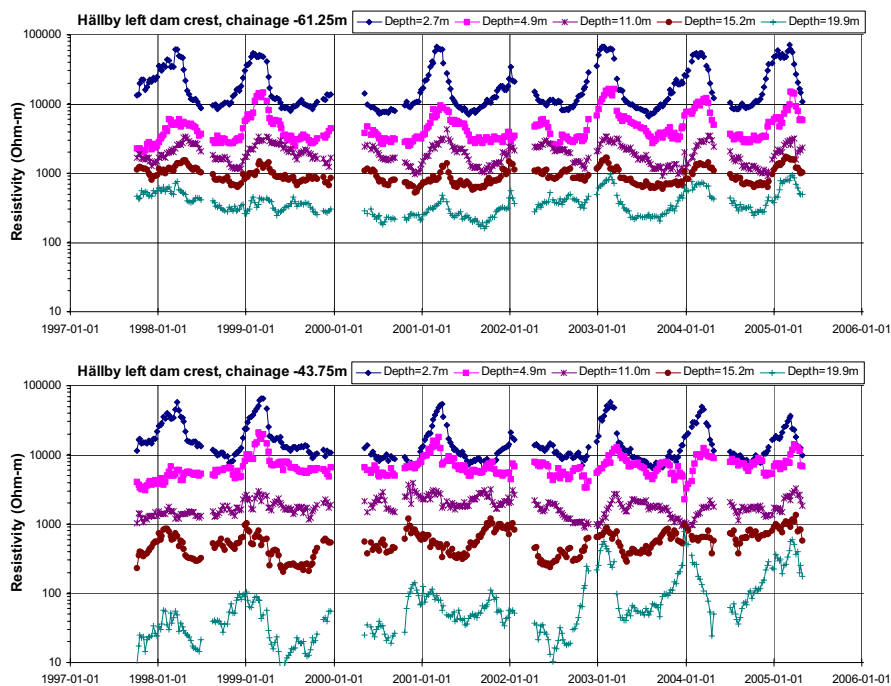

Figure 25. Time series of inverted resistivity data at five different depths from two different locations on Hällby left dam. Top: chainage -61.25 m at the healthy part of the dam. Bottom: chainage -43.75 m showing tendencies expected from internal erosion at large depths.

In general, for both locations, the variation is high close to the crest, which is explained by extremely high winter resistivities due to ground freezing. For chainage –61.25 m the amplitude of the variation becomes lower at larger depths. This is a quite typical appearance for most of the examined parts of the dam and consistent with theory as the impact from seasonal temperature variation in the reservoir or in the air decreases with distance respectively depth for a healthy dam. At chainage –43.75 m, however, there are significant variations at large depths. Furthermore, there are signs of increasing variations and increasing absolute resistivities for the largest depth.

These high variations may be a sign of higher seepage flow, and the increased resistivity may be a sign of material change due to washout of fines and internal erosion. The increased variation in combination with increased resistivity is possibly a sign of increased seepage due to the internal erosion.

Without other observations from additional investigations it is not possible to verify if internal erosion and increased seepage is the reason for the observed anomalies. However, these signs have not been observed in any other part of the dams and the area is next to a known problem area. The high variation at the bottom of the dam has spread from right to left over the last two to three years and the area at the same depth at chainage –10 m to chainage –20 m is the known problem area where sinkholes were reported in the past. Unfortunately there are so far no other measurements in this specific area. The seepage monitoring system for the left dam indicates no significant change, although a small trend may be seen. An increasing pore pressure has been observed in the pressure sensors located closer to the intake structure at chainage 0 m. None of these observations are, however, strong enough to confirm an internal erosion process.

5.4 Seepage evaluation at Sädva embankment dam

Regular daily resistivity monitoring started at the Sädva embankment dam in 2001. Installations of electrodes and cables were done in 1999 along the dam crest. With the problems experienced at Hällby in mind, a new improved installation was achieved, which has paved the way for high quality resistivity measurements (PAPER 5; Johansson et al. 2005).

The Sädva dam is located in the upper part of the Skellefteälven River just south of the Arctic Circle. It has a reservoir storage volume of 625 million m³. The dam and power plant was put into operation in 1985. The total length of the dam is 620 m, which is divided in a 210 m long main dam across the old river channel and a 410 m long dyke along the old river channel. The maximum height of the main dam is 32 m, but considerably lower for the dyke averaging around 10 m. The dam is a rock fill embankment dam with a slightly inclined central core made of fine-grained glacial till. The main dam is founded on bedrock, while the dyke is founded on moraine except where it connects to the main dam. Annual water level fluctuations are around 16 m (+460.7 - +477.0 m.a.s.l.), which is half the height of the dam. These high water level variations constitute a complication in the evaluation of the measurements, but at least

the seasonal pattern is roughly the same from one year to another. The reservoir reaches top levels in the late summer to early autumn and is lowered first rather slowly over autumn and then more rapidly over the winter to reach the lowest levels sometime in early spring. It is filled up again very rapidly during late spring to early summer with the vast snowmelt.

The high reservoir fluctuations affect the resistivity measurements at Sädva. Numerical modelling has shown that water level changes in the order of half the reservoir height may affect apparent resistivities with several tenths of percent (PAPER 1).

The same kind of evaluation of monitoring data as was done for Hällby has also been carried out for Sädva, and the difference between the two dams is obvious. Firstly, the data quality has improved significantly resulting in smoother data with less noise. This is a consequence of the improved installation. Secondly, the variations are smaller and also consistent along the length of the dam, which can be a sign of a healthier dam with generally lower seepage flow rates. The only exception is a zone, immediately next to the spillway, where both the resistivities and the resistivity variations are higher. However, no other observations indicate problems in this zone, and it has therefore been interpreted as an effect from the concrete structure of the spillway. More effort is needed to confidently come to a conclusion about the reason for the diverging measurements in this zone.

The homogeneous conditions in the main dam are evident when checking the time series for the five depths at chainage 82 m (Figure 26). The appearance is typical for most parts of the main dam with the characteristic seasonal variation. All depths inside the dam demonstrate similar conditions, with only small changes in resistivities and in size of the seasonal variations between different depths.

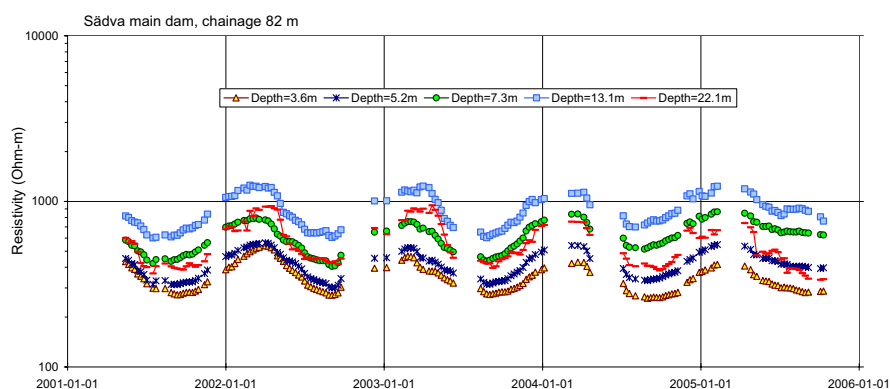

Figure 26. Time series of inverted resistivity data at five different depths at chainage 82 m from Sädva main dam over the period from 2001-05-12 to 2005-11-25.

The conditions on the dyke are not as homogeneous as for the main dam. The resistivities in the dyke are generally higher than in the main dam and also more varying along the length of the dam (Figure 27 top). The most obvious inhomogeneity is the

large difference in the foundation around chainage 450 m, which is probably due to variation in rock type or rock quality in the underlying rock. However, the clearly higher relative variation in the same area is indicating the presence of a possible seepage path in the foundation (Figure 27 bottom).

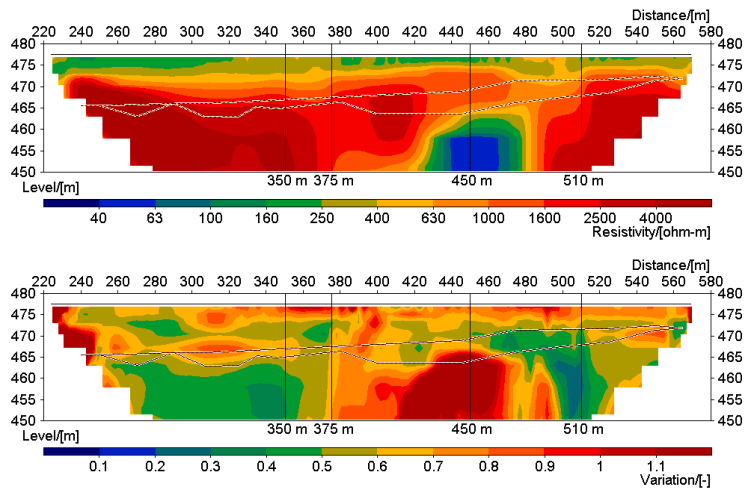

Figure 27. Sädva dyke longitudinal model sections with foundation and bedrock level indicated (solid lines). Medium inverted model of resistivity distribution (top) and relative variation of inverted resistivity models (bottom), over the period from 2001-09-20 to 2005-11-25. The four investigated areas at 350 m, 375 m, 450 m and 510 m are marked out. The investigated depth of 20 m corresponds to the level 458 meter above sea level.

Four different areas were selected for qualitative evaluation. The areas are all situated on the same depths but on different distances along the dam, chainages at 350 m, 375 m, 450 m and 510 m. They are marked out with vertical lines in Figure 27. The depth 20 m, corresponding to the level 458 meter above sea level, was selected. It is below the low retention level, meaning the soil will be saturated throughout the year. The dam geometry is also almost identical in all areas, so a similar resistivity variation should be expected at all four areas at similar seepage flow regimes.

The seasonal variation is examined in detail for each of the four areas (Figure 28). The seasonal variations in the selected areas ranges from 12% for chainage 510 m to around 75% for chainage 450 m. Comparing different areas along the embankment identifies the most sensitive areas. These may be potential leakage areas. Such areas can then be given extra attention in the further monitoring. An early detection of a trend of increasing seepage is of great value for the overall safety of embankment dams.

A quantitative evaluation method was also tested for the area around chainage 450 m. This is fully described in PAPER 5. A total seepage flow in the order of one litre per second was estimated for the whole area around chainage 450 m. This is reasonable, but at this stage, considering the amount of simplifications and assumptions in the quantitative evaluation method, the method must be seen as an initial test. More work is

needed to refine the method. However, in principle there are few or no reliable methods capable of quantifying the seepage flow along embankment dams, and a result merely in the right order of magnitude is valuable for dam safety purposes.

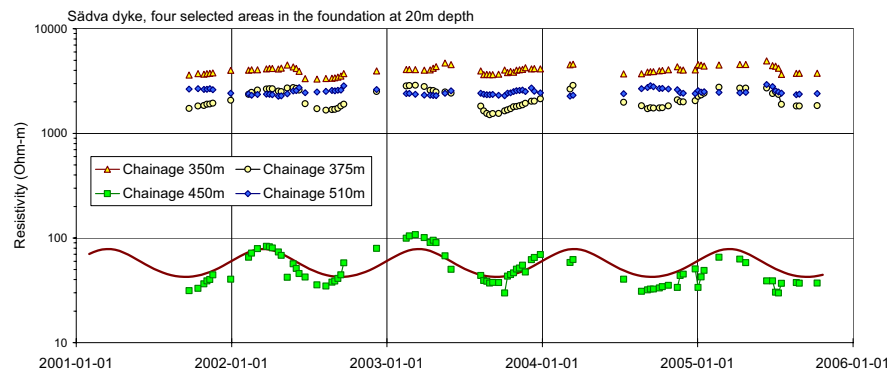

Figure 28. Seepage evaluation in the foundation of Sädva dyke. The four selected areas are located on 20 m depth, and data from the low resistive area around chainage 450 m exhibits higher variation than the other areas. The line represents an approximate method to quantify the seepage by trying to fit a calculated response from an assumed seepage flow rate of $3.0 \times 10^{-5} \text{ m}^3/(\text{s}, \text{m})$.

5.5 Discussion on field measurements

The measurements on the four dam sites all contribute, by adding valuable information from the specific site experience, to improve the use of the resistivity method on embankment dams. In the following section a few of those contributions will be brought up for discussion.

At Enemossen a dam status investigation was conducted with mobile resistivity surveying equipment and no repeated measurements in time. This is, in opposite to long-term monitoring, the standard approach today, when using the resistivity method on dams. However, the survey at Enemossen was instructive and special in a few aspects.

One aspect was the ability to measure along a line crossing the dam. Cross-sectional measurements are normally not carried out, due to practical problems of extending the line in the direction towards the reservoir and sometimes also due to problems of attaining adequate electrode contact in the high resistive downstream support fill. When carried out however, cross-sectional measurements are informative, as the 2D inversion will not be disturbed by severe 3D effects. Thus, the obtained result will reflect the true subsurface resistivities and not only be a qualitative comparison in space or in time.

Another important experience from the Enemossen survey was that it set focus on the importance of the fact that electrical properties are highly site specific. At Enemossen, the reservoir resistivity was approximately $10 \text{ } \Omega\text{m}$, whereas in the reservoirs at the other three investigated dam sites the resistivity was in the order of several hundreds of Ωm

(Figure 13). Due to this difference a leakage area might be low resistive in one situation and high resistive in the other. This tells us that information about the resistivity of the reservoir is essential for dam leakage investigations.

The test at Røssvatn brought attention to the comparison between single investigations and monitoring. Checking with the actual size and locations of the built-in defects in the modelling study conducted before the field measurements clearly stated that the defects were undetectable. Even so, using repeated measurements increased the potential of the method and lead to a better result than predicted.

However, the short-term monitoring approach at Røssvatn was far from a real monitoring situation. Complex dynamic behaviour due to complicated wetting pattern of the soil at the first filling resulted in a challenging evaluation. The possibility of rising and lowering the reservoir level, which is normally not possible to achieve more than to a lesser extent at a full-scale dam, turned out to be very efficient. On the other hand, a real monitoring situation on a full-scale dam, making use of the long-term seasonal variations would be even more efficient.

The test at Hällby demonstrates the strength of the monitoring approach. From the long-term measurements an anomalous zone was identified. The conclusion that this anomaly zone is connected to internal erosion and anomalous seepage is plausible but cannot be confirmed with only information from the resistivity monitoring data. However, it is clear that without monitoring, i.e. with only a single investigation, this anomaly would never have been discovered.

The experience from Hällby also demonstrates the importance of combining different measurements as a support for interpretation. This is a fundamental rule in all geophysical investigations and applies here also. The dilemma on embankment dams is that intrusive investigations are normally strongly avoided. Furthermore, many Swedish dams are sparsely monitored. Therefore it may be difficult to acquire proper reference data.

Finally, the experience from Sådva confirms the advantages of the monitoring approach compared to single measurements and emphasizes the importance of appropriate electrode installations. With good data quality there is a possibility that the method may advance from qualitative assessment of finding anomalies in time or space to quantitative assessment of quantifying seepage flow rates along our dams, even if today the latter involves many engineering shortcuts and simplifications.

6 Conclusions

Resistivity monitoring has been in progress at Hällby embankment dam since 1996 and at Sädva embankment dam since 2001. Parallel to the dam monitoring at Hällby and Sädva the method has been tried at other locations for shorter periods. At Enemossen, a tailings dam in southern Sweden, a dam status investigation was carried out with single resistivity measurements. In Norway, at the Røssvatn embankment dam test site formed for dam breaching tests, the method was tested for short-term measurements. Furthermore, numerical modelling studies have been performed in order to support interpretation and optimise monitoring techniques. The progress of the method during recent years is significant, and its application for dam measurements is obvious.

Resistivity is measured on embankment dams for dam safety reasons in order to detect anomalous seepages and internal erosion at an early stage of its development. The ultimate goal is still to create a fully automatic monitoring system that could be installed on any dam without too much adaptation, and the findings in this study is a step forward to reach this goal. Another general goal is to translate the measurements into seepage flow rates along the embankment dam. This goal remains to be achieved, although the simplified approach presented for data from the Sädva dam may be useful as a first approximation. The seepage quantification is highly desired for dam safety purposes, as keeping control of seepage is essential for good dam safety of embankment dams. Conventional methods of monitoring seepage do not always meet the requirements, depending on the actual field situation. Therefore, there is a need for new unconventional methods, such as resistivity monitoring.

The resistivity method, being such an unconventional method, has the obvious advantages of being non-destructive and continuous in the sense that it may measure on a large earth volume. Also, when repeating measurements, the method may detect changes taking place inside the dam, and may thus be able to give an early warning before anything is actually noticed on the surface of the dam. Among the drawbacks are the facts that the method is still used on a research basis and inadequately tested for regular industrial use. Even if the results from Hällby and Sädva seem promising it is no guarantee that it will work well on all dams. Furthermore, the method needs adjustment to site-specific conditions and some part of the evaluation from monitoring data is not possible until enough reference data has been collected for the specific dam.

The monitoring systems at Hällby and Sädva have a similar design and have performed reliably over the period. Daily data have been collected since the start in 1996 and 2001 respectively. A few shorter breaks have been experienced. At both dams data transfer with modem over the telephone wire has been partly undependable. At Hällby a current transmitter has failed, and at Sädva the power supply has been unstable for longer periods. The base of the system consists of modified ABEM Lund Imaging System, which is a set of resistivity measurement equipment originally developed for mobile investigations. Some parts of the system, such as a 2-way electrode switch and lightning protection unit, have been developed within the project at Lund University.

Conclusions

Electrode installations are important to ensure good data quality. Comparison between data quality from Sädva and Hällby demonstrates this fact. The installations in Hällby in 1996 were a pilot test, where a few misunderstandings and mistakes came along with the installation. This led to the very unsuccessful placing of electrodes above a thermal insulation layer on the right crest rendering the data from this layout as almost useless. Moreover, the documentation of the electrode positioning on the upstream layouts was unsatisfying and the electrodes had to be repositioned on a later stage. At Sädva on the contrary, the installations were planned more in detail and performed under more favourable circumstances when the full length of the dam crest was excavated in connection with a raise of the dam core. In that way good electrode contact with the dam core was achieved. The difference in data quality is evident when comparing apparent resistivity data from the two dams. Another factor that was improved at Sädva was the reduction of the electrode spacing down to 3 m, compared to 7 m at Hällby. Keeping the electrode separation small improves resolution on all depths. During the reinstallation of the electrodes along the crest at Hällby in the summer of 2005 the spacing was reduced to 3.5 m and the installation method used at Sädva was reproduced to assure good electrode contact.

Studies with numerical modelling were carried out to optimise the measurements and to serve as an aid in interpreting the results. The studies imply that an electrode layout along the top of the core is the optimal installation on existing dams, where intrusive activities are avoided. In addition, it was shown that standard 2D inversion of data from layouts along an embankment dams would lead to faulty absolute resistivity values and distorted depths in the resulting model section.

Automatic routines have been developed for analysing the resistivity monitoring data. These routines select apparent resistivity data from archives, apply a de-spiking and filtering of the data, invert data models and finally present the resulting inverted sections. Time-lapse inversion has been used to focus the results on actual variations and suppressing artefacts due to data noise. The conditions at Hällby regarding quite noisy data and relatively few electrodes have been unsatisfying as mentioned above. Even so, the monitoring results have shown that accurate processing with filtering and inversion techniques may still lead to very useful information. Due to the better quality of apparent resistivity data from Sädva no further filtering after de-spiking is necessary.

The long-term measurements at Hällby and Sädva show that seasonal resistivity variation is significant. This resistivity variation in the dam depends on the seepage flow rate, and is caused by seasonal variation of water temperature and water conductivity. Therefore, it is possible that resistivity data from monitoring can be used for leakage detection and estimation of seepage flow rates.

In a healthy dam with constant material properties over time, the measured resistivity can be considered a function of the seepage flow only. The variations in the reservoir create a variation inside the dam as the water seeps through the dam body. Temperature and TDS are the main elements governing the resistivity of the water. Temperature is the most important factor for the seasonal resistivity variation of the reservoir water, but

TDS variations are also clearly significant. High resistive peaks caused by low TDS may be identified during the snowmelt period.

In a dam where internal erosion occurs the fines in the core are being washed out. If an increased seepage follows it is likely that amplitudes of the seasonal resistivity variation also increases. Furthermore, a long-term trend might be detectable. Most Swedish dams, being constructed with a till core, are expected to show a raise in resistivity if such a scenario should occur, as resistivity in such soils largely depend on the amount of fines. This is however to some extent counteracted as internal erosion increases porosity, affecting the resistivity in the opposite direction.

In the evaluation of repeated measurements, the focus is therefore on detecting and locating zones with long-term changes of the mean value and increasing seasonal variations. Less consideration is given to absolute values.

In addition, this reasoning implies that evaluation of inverted resistivity data from single resistivity measurement may be misleading, due to the temporal resistivity variation. Single resistivity investigations may be useful for dam status investigations in special cases, but are limited to detecting anomalies in space. The monitoring approach, by adding the possibility of searching anomalies also in time, is a much more powerful method.

7 Future recommendations

In the following I have tried to outline some areas of possible improvement. The method, described in this thesis, of monitoring seepage in embankment dams with the resistivity method is relatively untested. The work behind this thesis has been done with limited resources. Thus, finding areas that will have a potential of improving the method is not difficult. I have tried to pick some areas of improvement that I think are meaningful and that are reasonably likely to contribute to a better monitoring system. I do not make priorities between the suggestions or attempt to rank them in degree of importance.

7.1 Improve usefulness and efficiency of the system

At the start of the larger project, in which this thesis work represented a smaller part, an ultimate goal was formulated. This goal described a fully automatic monitoring system that was so general and flexible that it could, without much specific modification, be installed on almost any embankment dam. This is a very ambitious goal considering the amount of factors for evaluation and interpretation that are site-specific. Even though important steps towards a general automatic system have been taken over the last few years, some parts need further development.

We know how to design a monitoring system with a good installation of electrodes and reliable instruments. Some problems have been experienced with the data transfer, which is done by modem connection at Hällby and Sädva. It has not been upgraded since the start of measurements. Today it can be improved with state of the art technology.

Next, setting alarm levels is an interesting challenge. More work can be done here. Generally speaking, the conditions for this are site-specific and not known at the start. As the monitoring continues, the amount of reference data grows and abnormal data or trends are easier to identify.

Alarm levels could be set on apparent resistivity data or on inverted data. More work can be done on optimising this. Either way, a de-spiking routine should be used to avoid unnecessary alarms from clearly faulty measurements, arising from noise of instrument malfunction. In some cases more advanced filters may be adopted. In any case, this is not generalized to fit any dam. When deciding on actual alarm levels it is recommended to study other monitoring systems. A typical approach is to set two levels, where the high level is severe and needs direct action whereas the other lower level generates a less severe alarm with less acute actions recommended.

In evaluating data fully automatically for dams with high reservoir fluctuations, it will be needed to incorporate a more sophisticated routine for compensating for these changes in reservoir level.

It looks like for the foreseeable future this type of monitoring systems will need some special site-specific adaptation during installation and regular observation and adjustments at least for the first one or two years in operation.

7.2 Improve resolution on large depths through new measurement concepts

The installations at Hällby and Sädva were carried out in the most feasible way. The most feasible way to install electrodes and cables on existing dams is undoubtedly to place them near surface, along the dam crest, along the downstream or upstream toes, or somewhere in between along the slopes, for example on berms. Placing electrodes along the dam gives optimal coverage on existing dams. The main drawback is the lack of resolution on large depths resulting from measurements from such installations. One way of solving this problem could be the installation of buried electrodes into the lower central parts of the dam. This would make it possible to step up current flow in the area of most interest, i.e. the lower part of the core, and thereby increasing measurement resolution on larger depths.

This suggestion is multifaceted as the unique non-destructiveness advantage of the concept is abandoned. A dam owner only makes intrusive investigations in a dam core if it is signalled by some sort of crisis, and rightly so. Therefore, installation of such electrodes needs to be performed without the risk of harming the dam. This might also be done in the downstream filter if such an installation is considered unsafe in the core.

However, no real guarantees can be given, and there does not seem to be enough motifs for allowing destructive installations in healthy dams at this stage of developing the method. Still, considering the huge improvement potential of the measurements by means of such installations it deserves to be mentioned here.

The next step is to extend the measurements to being fully 3D. This could be done by allowing for measurements combining electrodes on surface layouts, placed on 1-2 m depth, with buried electrodes in the central lower part of the dam as described above. However, it could also be done more simply by combining electrodes from different surface layouts, achieving some sort of cross-dam data. This latter approach is less promising, however, as the resolution of the central lower parts of the dam is kept at a low level in this case.

7.3 Improve evaluation through new inversion techniques

Evaluating 2D resistivity data from measurements along the crest is not straightforward. In this thesis, a practical approach has been chosen. Time-series of apparent resistivity and time series of inverted models are being analysed. The inverted model is processed as if they were standard 2D data sets assuming that the plane perpendicular to the layout is constant. Considering the outer geometry and the inner structure of any embankment it is easy to conclude that this assumption is severely violated. Therefore, care must be taken when analysing inverted 2D resistivity data from along-crest measurements.

Full 3D inversion can be carried out. The main problem is twofold. Firstly, there is a problem of computational power, as 3D inversion requires vast computational resources. Particularly so, considering that measurements from monitoring systems have to be evaluated repeatedly in time. These kinds of resources have not been available within this work, but considering the speed of development in this area it is not unlikely

that this can be done within a few years, or even now but then with more powerful computers than a standard PC. Secondly, to make full use of a 3D inversion, the measurements need to be in 3D, which is not always easy to carry out in practice.

Another possibility of improving evaluation might be the use of an a-priori inversion scheme. On the contrary to standard resistivity investigations, on dam monitoring the geometry of the subsurface is already known to a great extent. Making use of this in the evaluation process is logical. In the 3D case it would be possible to feed the inversion with zones taken from drawings or other investigations. In 2D evaluation, this could be done by calculating a set of geometrical parameters specific for each layout that can be used to compensate for geometrical distortions from the inversion.

7.4 Improve base of interpretation through advanced modelling

A monitoring system that generates continuous estimation of seepage flow rates along the dam would be placed on top of any dam owners wish list. Attempting to approximate seepage flow rates from resistivity monitoring data is starting to look realistic. To improve this better knowledge of the combined TDS and temperature transports through the dam is necessary. A theoretically ambitious and promising approach would be to combine hydraulic flow, heat transfer and electrical current flow. This could be done by coupled modelling of the seepage regime using equations for steady state flow, the temperature regime using equations for heat conduction, heat advection and solute transport, and the electrical regime using equations of current flow.

8 References

- Aaltonen J (2001) Ground monitoring using resistivity measurements in glaciated terrains. Doctoral Thesis, TRITA-AMI PHD 1042, ISBN -91-7283-096-4, Royal Institute of Technology, Stockholm, p 61
- Abu-Hassanein ZS, Benson CH, Blotz LR (1996) Electrical resistivity of compacted clays. *Journal of Geotechnical Engineering* 122(5): 397-406
- Abuzeid N (1994) Investigation of channel seepage areas at the existing Kaffrein dam site (Jordan) using electrical-resistivity measurements. *Journal of Applied Geophysics* 32: 163-175
- Aina A, Olurunfemi MO, Ojo JS (1996) An integration of aeromagnetic and electrical resistivity methods in dam site investigation. *Geophysics* 61: 349-356
- Arandjelovic D (1989) An attempt to determine the earth embankment conditions by resistivity investigation. In: *Lecture Notes in Earth Sciences*, vol. 27, ed. Merkler GP et al., Detection of subsurface flow phenomena, Springer-Verlag, Berlin Heidelberg: 463-471
- Archie GE (1942) Electrical-resistivity log as an aid in determining some reservoir characteristics. *Transactions of the American Institute of Mining, Metallurgical and Petroleum Engineers* 146: 54-62.
- Armbruster H, Brauns J, Mazur W, Merkler GP (1989) Effect of leaks in dams and trials to detect leakages by geophysical means. In: *Lecture Notes in Earth Sciences*, vol. 27, ed. Merkler GP et al., Detection of subsurface flow phenomena, Springer-Verlag, Berlin Heidelberg: 3-18
- Barker RD (1989) Depth of investigation of collinear symmetrical four-electrode arrays. *Geophysics* 54: 1031-1037
- Barker R (1992) A simple algorithm for electrical imaging of the subsurface. *First Break* 10(2): 53-62
- Batayneh AT, Abdallah SAZ, Abdelruhman AA (2001) Geophysical investigations for the location of a proposed dam in Al Bishriyya (Al Aritayn) area, northeast Badia of Jordan. *Environmental Geology* 40: 918-922
- Beard LP, Tripp AC (1995) Investigating the resolution of IP arrays using inverse theory. *Geophysics* 60: 1326-1341
- Bentley LR, Gharibi M (2004) Two- and three-dimensional electrical resistivity imaging at a heterogeneous remediation site. *Geophysics* 69: 674-680
- Berg CR (1995) A simple, effective-medium model for water saturation in porous rocks. *Geophysics* 60: 1070-1080
- Bergström J (1998) Geophysical methods for investigating and monitoring the integrity of sealing layers on mining waste deposits. Licentiate Thesis, ISSN 1402-1757, ISRN LTU-LIC – 98/24 – SE, Luleå University of Technology, p 77

References

- Bjelkevik A (2005) Stability of tailings dams: focus on water cover closure. Licentiate Thesis, ISSN 1402-1757 / ISRN LTU-LIC--05/85--SE / NR 2005:85, Luleå University of Technology, p 42
- Bogoslovsky VA, Ogilvy AA (1970) Application of geophysical methods for studying the technical status of earth dams. *Geophysical Prospecting* 18: 758-773
- Bronner N, Fagerström H, Stille H (1988) Bedrock cracks as a possible cause of leakage in two Swedish dams. *Procs. International Commission on Large Dams (ICOLD), 16th Congress, San Fransisco, Q.61, R.55*
- Burns B, Barker R, Ghataora GS (2006) Investigating internal erosion using a miniature resistivity array. *NDT&E International* 39: 169-174
- Buselli G, Lu K (2001) Groundwater contamination monitoring with multichannel electrical and electromagnetic methods. *Journal of Applied Geophysics* 48: 11-23
- Bussian AE (1983) Electrical conductance in a porous medium. *Geophysics* 48:1258-1268
- Butler DK (1984) Geophysical methods for seepage detection, mapping and monitoring. *SEG Expanded Abstracts* 3: 157-160
- Butler DK, Llopis JL, Deaver CM (1989) Comprehensive geophysical investigation of an existing dam foundation. (Part 1) *The Leading Edge* 1989(8): 10-18
- Butler DK, Llopis JL, Dobecki TL, Wilt MJ, Corwin RF, Olhoeft G (1990) Comprehensive geophysical investigation of an existing dam foundation. (Part 2) *The Leading Edge* 1990(9): 44-53
- Butler DK, Llopis JL (1990) Assessment of anomalous seepage conditions. In *Investigations in Geophysics no. 5: Geotechnical and Environmental Geophysics*, vol. II, ed. Ward SH, Society of Exploration Geophysicists, Tulsa: 153-173
- Cech TV (2005) *Principles of water resources: History, Development, Management, and Policy*. ISBN 0-471-48475-3, Hoboken, USA, p 468
- Chen C, Xia J, Chen J, Lin W (2004) Detection of potential leak sites in embankments using surface-wave method and electrical method. *Procs. SEG International Exposition and 74th Annual Meeting, Denver, USA, October 10-15 2004*, p 4
- Claerbout JF, Muir F (1973) Robust modeling with erratic data. *Geophysics* 38: 826-844
- Coggon JH (1971) Electromagnetic and electrical modelling by the finite element method. *Geophysics* 36: 132-155
- Cooke JB (1984) Progress in rockfill dams. *Journal of Geotechnical Engineering*, 110(10): 1383-1414
- Corwin RF, Conti U (1973) A rugged silver-silver chloride electrode for field use. *Review of Scientific Instruments* 44: 708-711
- Corwin RF (1984) The self-potential method and its engineering applications: An overview. *SEG Expanded Abstracts* 3: 152-154

-
- Corwin RF (1985) Offshore applications of the direct-current resistivity method. SEG Expanded Abstracts 4: 230- 231
- Dahlin T (1993) On the automation of 2D resistivity surveying for engineering and environmental applications. Ph.D. Thesis, ISBN 91-628-1032-4, Lund University, p 187
- Dahlin T (1996) 2D resistivity surveying for environmental and engineering applications. First Break 14(7): 275-283
- Dahlin T (2000) Short note on electrode charge-up effects in DC resistivity data acquisition using multi-electrode arrays. Geophysical Prospecting 48: 181-187
- Dahlin T, Sjö Dahl P, Friberg J, Johansson S (2001) Resistivity and SP surveying and monitoring at the Sädva embankment dam, Sweden. ISBN 90 5809 196 1, Procs. 5th European ICOLD Symposium, 25-27 June 2001, Geiranger, Norway: 107-113
- Dahlin T, Zhou B (2004) A numerical comparison of 2D resistivity imaging with ten electrode arrays. Geophysical Prospecting 52: 379-398
- Dahlin T, Zhou B (2006) Multiple gradient array measurements for multi-channel 2D resistivity imaging. Near Surface Geophysics 4: 113-123
- deGroot-Hedlin C, Constable S (1990) Occam's inversion to generate smooth, two-dimensional models from magnetotelluric data. Geophysics 55: 1613-1624
- de la Vega M, Osella A, Lascano E (2003) Joint inversion of Wenner and dipole-dipole data to study a gasoline-contaminated soil. Journal of Applied Geophysics 54: 97-109
- de Mello VFB (1977) Reflections on design decisions of practical significance to embankment dams. Géotechnique 27: 279-355
- Dey A, Morrison HF (1979a) Resistivity modelling for arbitrarily shaped two-dimensional structures. Geophysical Prospecting 27: 106-136
- Dey A, Morrison HF (1979b) Resistivity modeling for arbitrarily shaped three-dimensional structures. Geophysics 44: 753-780
- Dornstädter J (1997) Detection of internal erosion in embankment dams. Procs. International Commission on Large Dams (ICOLD), 19th Congress, Florence, Q.73, R.7
- Edwards LS (1977) A modified pseudosection for resistivity and induced-polarization. Geophysics 42: 1020-1036
- Engelbert PJ, Hotchkiss RH, Kelly WE (1997) Integrated remote sensing and geophysical techniques for locating canal seepage in Nebraska. Journal of Applied Geophysics 38:143-154
- Farquharson CG, Oldenburg DW (1998) Applied geophysical inversion. Geophysical Journal International 134: 213-227
- Fell R, MacGregor P, Stapledon D (1992) Geotechnical engineering of embankment dams. ISBN 90 5410 128 8, Balkema, Rotterdam, p 675
- Fell R, Wan CF, Cyganiewicz J, Foster M (2003) Time for Development of Internal Erosion and Piping in Embankment Dams. Journal of Geotechnical and Geoenvironmental Engineering 127(4): 307-314

References

- Fetter CW (1994) Applied hydrogeology. ISBN 0-02-336490-4, Prentice Hall, New Jersey, p 691
- Flödeskommittén (1990) Riktlinjer för bestämning av dimensionerande flöden för dammanläggningar. Slutrapport från flödeskommittén, (In Swedish), SMHI, Norrköping, Sweden
- Foster M, Fell R, Spannagle M (2000a) The statistics of embankment dam failures and accidents. *Canadian Geotechnical Journal* 37: 1000-1024
- Foster M, Fell R, Spannagle M (2000b) A method for assessing the relative likelihood of failure of embankment dams by piping. *Canadian Geotechnical Journal* 37: 1025-1061
- Foster M, Fell R (2001) Assessing embankment dam filters that do not satisfy design criteria. *Journal of Geotechnical and Geoenvironmental Engineering* 127(5): 398-407
- Fox RC, Hohmann GW, Killpack TJ, Rijo L (1980) Topographic effects in resistivity and induced-polarization surveys. *Geophysics* 45: 75-93
- Friborg J (1997) Experimental and theoretical investigations into the streaming potential phenomenon with special reference to applications in glaciated terrain. Ph.D. Thesis, ISSN 1402-1544, ISRN LTU-DT – 1997/2 – SE, Luleå University of Technology, p 166
- Friedman SP (2005) Soil properties influencing apparent electrical conductivity: a review. *Computers and electronics in agriculture* 46: 45-70
- Frolich RK, Parke CD (1989) The electrical resistivity of the vadose zone – Field survey. *Ground Water* 27: 524-530
- Gharibi M, Bentley LR (2005) Resolution of 3-D electrical resistivity images from inversions of 2-D orthogonal lines. *Journal of Environmental and Engineering Geophysics* 10: 339-349
- Glover PWJ, Hole MJ, Pous J (2000) A modified Archie's law for two conducting phases. *Earth and Planetary Science letters* 180: 369-383
- Griffiths DH, Turnbull J, Olayinka AI (1990) Two-dimensional resistivity mapping with a computer-controlled array. *First Break* 8(4): 121-129
- Hennig T, Weller A, Canh T (2005) The effect of dike geometry on different resistivity configurations. *Journal of Applied Geophysics* 57: 278-292
- Huntley D (1986) Relations between permeability and electrical resistivity in granular aquifers. *Ground Water* 24: 466-474
- Höeg K (2001) Embankment-dam engineering, safety evaluation and upgrading. *Procs. International Conference for Soil Mechanics and Geotechnical Engineering (ICSMGE)*, August 27-31 2001, Istanbul, Turkey: 2491-3504
- ICOLD (1995) Dam failures statistical analysis. *International Commission on Large Dams (ICOLD), Bulletin* 99
- ICOLD (2003) World register of dams. *International Commission on Large Dams (ICOLD)*, Paris

- Inazaki T, Sakamoto T (2005) Geotechnical characterization of levee by integrated geophysical surveying. Procs. International Symposium on Dam Safety and Detection of Hidden Troubles of Dams and Dikes, November 1-3 2005, Xi'an, China, p 11
- Johansson S (1991) Localization and quantification of water leakage in ageing embankment dams by regular temperature measurements. Procs. International Commission on Large Dams (ICOLD), 17th Congress, Vienna, Q.65, R.54
- Johansson S, Bartsch M, Landin O, Barmen G, Dahlin T, Ulriksen P (1995) Nyare metoder för tillståndskontroll av fyllningsdammar. (In Swedish with English summary) Elforsk VASO report 21, p 70, (available at www.elforsk.se)
- Johansson S, Dahlin T (1996) Seepage monitoring in an earth embankment dam by repeated resistivity measurements. European Journal of Engineering and Environmental Geophysics 1(3): 229-247
- Johansson S (1997) Seepage monitoring in embankment dams. Doctoral Thesis, TRITA-AMI PHD 1014, ISBN 91-7170-792-1, Royal Institute of Technology, Stockholm, p 49
- Johansson S, Dahlin T (1998) Seepage monitoring in Hällby embankment dam by continuous resistivity measurements. Procs. 8th Congress of the International Association of Engineering Geology and the Environment, 21-25 September 1998, Vancouver, Canada, p 8
- Johansson S, Farhadiroushan M (2005) Seepage and strain monitoring in embankment dams using distributed sensing in optical fibres – Theoretical background and experiences from some installations in Sweden. Procs. International Symposium on Dam Safety and Detection of Hidden Troubles of Dams and Dikes, November 1-3 2005, Xi'an, China, p 8
- Johansson S, Friborg J, Dahlin T, Sjö Dahl P (2005a) Long term resistivity and self potential monitoring of embankment dams – Experiences from Hällby and Sädva dams, Sweden. Canadian Electricity Association - Dam Safety Interest Group CEATI Project No T992700-0205, Elforsk report 05:15, p 123 (available at www.elforsk.se)
- Johansson S, Nilsson Å, Garner S, Dahlin T, Friborg, J, Sjö Dahl P (2005b) Internal erosion detection at the Rössvatn test site – experiences from blind test using resistivity, self potential, temperature and visual inspection. Elforsk report 05:42, p138 (available at www.elforsk.se)
- Kappelmeyer O (1957) The use of near surface temperature measurements for discovering anomalies due to causes at depths. Geophysical Prospecting 3: 239-258
- Keller GV, Frischknecht FC (1966) Electrical methods in geophysical prospecting. ISSN 0538-9992; 10, Pergamon Press, Oxford, p 519
- Kim HS, Oh SH, Park HG, Chung HJ, Shon HW, Kim KS, Lim HD (2004) Electrical resistivity imaging for comprehensive evaluation of earth-rock dam seepage and safety. Procs. International Commission on Large Dams (ICOLD), 72th Annual Meeting, 16-22 May 2004, Seoul, Korea: 123-134
- Klein KA, Santamarina JC (2003) Electrical conductivity in soils: Underlying phenomena. Journal of Environmental and Engineering Geophysics 8: 263-273

References

- Kwader T (1985) Estimating aquifer permeability from formation resistivity factors. *Ground Water* 23: 762-766
- LaBrecque D, Miletto M, Daily W, Ramirez A, Owen E (1996) The effects of noise on Occam's inversion of resistivity tomography data. *Geophysics* 61: 538-548
- Li YG, Oldenburg DW (1992) Approximate inverse mapping in DC resistivity problems. *Geophysical Journal International* 109: 343-362
- Lim HD, Kim KS, Kim JH, Kwon HS, Oh BH (2004) Leakage detection of earth dam using geophysical methods. *Procs. International Commission on Large Dams (ICOLD), 72th Annual Meeting, 16-22 May 2004, Seoul, Korea: 212-224*
- Lines LR, Treitel S (1984) Tutorial: A review of least-squares inversion and its application to geophysical problems. *Geophysical Prospecting* 32: 159-186
- Loke MH, Barker RD (1995) Least-squares deconvolution of apparent resistivity pseudosections. *Geophysics* 60: 1682-1690
- Loke MH, Barker RD (1996a) Rapid least-squares inversion of apparent resistivity pseudosections by a quasi-Newton method. *Geophysical Prospecting*, 44: 131-152
- Loke MH, Barker RD (1996b) Practical techniques for 3D resistivity surveys and data inversion. *Geophysical Prospecting*, 44: 499-523
- Loke MH (2001) Constrained time-lapse resistivity imaging inversion. *Procs. Symposium on the Application of Geophysics to Engineering and Environmental Problems, SAGEEP, Denver, Colorado, March 4-7 2001*
- Loke MH, Dahlin T (2002) A comparison of the Gauss-Newton and quasi-Newton methods in resistivity imaging inversion. *Journal of Applied Geophysics* 49: 149-162
- Loke MH, Acworth I, Dahlin T (2003) A comparison of smooth and blocky inversion methods in 2-D electrical imaging surveys. *Exploration Geophysics* 34(3): 182-187
- Loke MH (2004) Rapid 2-D resistivity & IP inversion using the least-squares method, Manual for Res2dinv, version 3.54, p 53, (available at www.goelectrical.com)
- Merkler GP, Blinde A, Armbruster H, Döscher HD (1985) Field investigations for the assessment of permeability and identification of leakage in dams and dam foundations. *Procs. International Commission on Large Dams (ICOLD), 15th Congress, Lausanne, Q.58, R.7*
- Milsom J (1996) *Field geophysics*. ISBN 0-471-96634-7, John Wiley & Sons, Chichester, p 187
- Moldoveanu T, Suci O (1989) Aspects concerning the detection by geoelectrical methods of seepage at some Romanian dams. In: *Lecture Notes in Earth Sciences*, vol. 27, ed. Merkler GP et al., *Detection of subsurface flow phenomena*, Springer-Verlag, Berlin Heidelberg: 473-487
- Mufti IR (1976) Finite difference resistivity modeling for arbitrary shaped two-dimensional structures. *Geophysics* 41: 62-78
- Nilsson Å (1995a) Åldersförändringar i fyllningsdammar. (In Swedish with English summary) *Elforsk VASO report 16*, p 9, (available at www.elforsk.se)

- Nilsson Å (1995b) Beprovade metoder för tillståndskontroll av fyllningsdammar. (In Swedish with English summary) Elforsk VASO report 20, p 27, (available at www.elforsk.se)
- Nilsson Å, Ekström I, Söder CO (1999) Inre erosion i svenska dammar. (In Swedish with English summary) Elforsk report 99:34, p 81, (available at www.elforsk.se)
- Nilsson Å, Ekström I (2004) Raising of the Ajaure embankment dam by extending the moraine core with a geomembrane. Procs. British Dam Society 13th Biennial Conference, ICOLD European Symposium 2004, 22-26 June 2004, Canterbury, UK, p 12
- Nilsson Å, Bartsch M (2004) Leakage through embankment dams: Failure modes and design of toe-berms. Procs. International Commission on Large Dams (ICOLD), 72th Annual Meeting, 16-22 May 2004, Seoul, Korea: 271-282
- Norstedt U, Nilsson Å (1997) Internal erosion and ageing in some of the Swedish earth- and rock-fill dams. Procs. International Commission on Large Dams (ICOLD), 19th Congress, Florence, Q.73, R.20
- Ogilvy AA, Ayed MA, Bogoslovsky VA (1969) Geophysical studies of water leakage from reservoirs. *Geophysical Prospecting* 17: 36-62
- Okko O, Hassinen P, Korkealaakso J (1994) Location of leakage paths below earth dams by geophysical techniques. Procs. International Conference on Soil Mechanics and Foundation Engineering (ICSMFE), 5-10 January 1994, New Delhi, India: 1349-1352
- Olayinka A, Yaramanci U (2000a) Assessment of the reliability of 2D inversion of apparent resistivity data. *Geophysical Prospecting* 48: 293-316
- Olayinka A, Yaramanci U (2000b) Use of block inversion in the 2-D interpretation of apparent resistivity data and its comparison with smooth inversion. *Journal of Applied Geophysics* 45: 63-81
- O'Neill DJ, Merrick NP (1984) A digital filter for resistivity sounding with a generalized electrode array. *Geophysical Prospecting* 32: 105-123
- Overmeeren RA van, Ritsema IL (1988) Continuous vertical electrical sounding. *First Break* 6(10): 313-324
- Palacky GJ (1987) Resistivity characteristics of geologic targets. In: *Electromagnetic methods in applied geophysics*, vol. 1, ed. Nabighian MN, Society of Exploration Geophysics, Tulsa: 53-129
- Panthulu TV, Krishnaiah C, Shirke JM (2001) Detection of seepage paths in earth dams using self-potential and electrical resistivity methods. *Engineering Geology* 59: 281-295
PAPER 1-5, see appended papers.
- Parasnis DS (1997) *Principles of applied geophysics*. ISBN 0-412-64080-5, Chapman & Hall, London, p 429
- Park SK, Dickey SK (1989) Accurate estimation of conductivity of water from geoelectric measurement – A new way to correct for clay. *Ground Water* 27: 786-792

References

- Park SK, Van GP (1991) Inversion of pole-pole data for 3-D resistivity structure beneath arrays of electrodes. *Geophysics* 56: 951-960
- Pellerin L (2002) Applications of electrical and electromagnetic methods for environmental and geotechnical investigations. *Surveys in Geophysics* 23: 101-132
- Penman ADM (1986) On the embankment dam. *Géotechnique* 36: 303-348
- Pridmore D, Hohmann GW, Ward SH, Sill WR (1981) An investigation of finite element modeling for electrical and electromagnetic data in three dimensions, *Geophysics*, 46, 1009-1024.
- Queralt P, Pous J, Marcuello A (1991) 2-D resistivity modeling: An approach to arrays parallel to the strike direction. *Geophysics* 56: 941-950
- Revil A, Glover PWJ (1997) Theory of ionic-surface electrical conduction in porous media. *Physical Review B* 55: 1757.1773
- Revil A, Glover PWJ (1998) Nature of surface electrical conductivity in natural sands, sandstones, and clays. *Geophysical Research Letters* 25: 691-694
- Revil A, Cathles LM, Losh S, Nunn JA (1998) Electrical conductivity in shaly sands with geophysical applications. *Journal of Geophysical Research* 103: 23925-23936
- Reynolds JM (1997) An introduction to applied and environmental geophysics. ISBN 0-471-95555-8, John Wiley & Sons, Chichester, p 796
- RIDAS (2002) Kraftföretagens riktlinjer för dammsäkerhet. ISBN 91-7622-174-1, (In Swedish), Svensk Energi, Stockholm p 40
- Robinson ES, Coruh C (1988) Basic exploration geophysics. ISBN 0-471-61279-0, Wiley, New York, p 562
- Rozycki A, Ruiz Fonticella JM, Cuadra A (2005) Detection and evaluation of horizontal fractures in earth dams using the self-potential method. *Engineering Geology* 82(3): 145-153
- Saarenketo T (1998) Electrical properties of water in clay and silty soils. *Journal of Applied Geophysics* 40: 73-88
- Sasaki Y (1994) 3-D resistivity inversion using the finite element method. *Geophysics* 59: 1839-1848.
- Sen PN, Goode PA (1992) Influence of temperature on electrical conductivity on shaly sands. *Geophysics* 57: 89-96
- Sharma PV (1997) Environmental and engineering geophysics. ISBN 0-521-57632-6, Cambridge University Press, Cambridge, p 499
- Sherard JL (1986) Hydraulic fracturing in embankment dams. *Journal of Geotechnical Engineering* 112(10): 905-927
- Sherard JL, Dunnigan LP (1989) Critical filters for impervious soils. *Journal of Geotechnical Engineering* 115(7): 927-947

- Sirles P (1997) Seepage investigation using geophysical techniques at Coursier lake dam, B.C., Canada. *Proc. Symposium on the Application of Geophysics to Engineering and Environmental Problems (SAGEEP)*, 23-26 March 1997, Reno, USA: 321-331
- SLU (2005) Databank för vattenkemi. Sveriges Lantbruksuniversitet, Institutionen för miljöanalys, (In Swedish), Water chemistry database, Swedish University of Agricultural Sciences, (available at www.ma.slu.se)
- Smith NC, Vozoff K (1984) Two-dimensional DC resistivity inversion for dipole-dipole data. *IEEE Transactions on Geoscience and Remote Sensing*, GE-22: 21-28
- Song SH, Song YH, Kwon BD (2005) Application of hydrogeological and geophysical methods to delineate leakage pathways in an earth fill dam. *Exploration Geophysics* 36: 92-96
- Stummer P, Maurer H, Green AG (2004) Experimental design: Electrical resistivity data sets that provide optimum subsurface information. *Geophysics* 69: 120-139
- Sørensen KI (1996) Pulled array continuous electrical profiling. *First Break* 14(3): 85-90
- Telford WM, Geldart LP, Sheriff RE (1990) *Applied geophysics*. ISBN 0-521-33938-3, Cambridge University Press, Cambridge, p 770
- Terzaghi K, Peck RB (1948) *Soil mechanics in engineering practice*, John Wiley & Sons, New York, p 566
- Thunehed H, Triumf CA (2001) Ny elektrodkonstruktion för långtidsmätning av självpotential. (In Swedish), Elforsk report 01:19, p 21, (available at www.elforsk.se)
- Titov K, Lokhmanov V, Potapov (2000) Monitoring of water seepage from a reservoir using resistivity and self polarization methods: case history of the Petergoph fountain water supply system. *First Break* 18: 431-435
- Tripp AC, Hohmann GW, Swift Jr CM (1984) Two-dimensional resistivity inversion. *Geophysics* 49: 1708-1717
- Triumf CA, Thunehed H (1996) Two years of Self-Potential measurements on a large dam in northern Sweden. *Proc. Repair and Upgrading of Dams*, KTH, Stockholm: 307-315
- Van Tuyen D, Canh T, Weller A (2000) Geophysical investigations of river dikes in Vietnam. *European Journal of Environmental and Engineering Geophysics* 4: 195-206
- Vattenfall (1988) *Jord-och stenfyllningsdammar*. ISBN 91-7186-271-4, Handbook on embankment dams (In Swedish), Stockholm, p 242
- Wan CF, Fell R (2004) Investigation of rate of erosion of soils in embankment dams. *Journal of Geotechnical and Geoenvironmental Engineering* 130(4): 373-380
- Ward SH (1980) Electrical, electromagnetic, and magnetotelluric methods. *Geophysics* 45: 1659-1666
- Ward SH (1990) Resistivity and induced polarization methods. In: *Geotechnical and environmental geophysics*, vol. 1, ed. Ward SH, Society of Exploration Geophysics, Tulsa: 147-189

References

- Wilt MJ, Corwin RF (1989) Numerical modeling of self-potential anomalies due to leaky dams: Model and field examples. In: Lecture Notes in Earth Sciences, vol. 27, ed. Merkle GP et al., Detection of subsurface flow phenomena, Springer-Verlag, Berlin Heidelberg: 73-89.
- Worthington PF (1993) The uses and abuses of the Archie equations; 1, The formation factor-porosity relationship. *Journal of Applied Geophysics* 30: 215-228
- Xu B, Noel M (1993) On the completeness of data sets with multielectrode systems for electrical resistivity survey. *Geophysical Prospecting* 41: 791-801
- Yoon GL, Park JB (2001) Sensitivity of leachate and fine contents on electrical resistivity variations of sandy soils. *Journal of Hazardous Materials B84*: 147-161
- Zhang J, Mackie R, Madden T (1995) 3-D resistivity forward modeling and inversion using conjugate gradients. *Geophysics* 60: 1313-1325
- Zhou B (1998) Crosshole resistivity and acoustic velocity imaging: 2.5-D Helmholtz equation modeling and inversion. Ph.D. thesis, The University of Adelaide, p 248
- Zhou B, Greenhalgh SA (1999) Explicit expressions and numerical calculations for the Fréchet and second derivatives in 2.5D Helmholtz equation inversion. *Geophysical Prospecting* 47: 443-468
- Zhou B, Greenhalgh SA (2001) Finite element three-dimensional direct current resistivity modeling: accuracy and efficiency considerations. *Geophysical Journal International* 145: 679-688
- Zhou B, Dahlin T (2003) Properties and effects of measurement errors on 2D resistivity imaging surveying. *Near Surface Geophysics* 1(3): 105-117