



LUND UNIVERSITY

Factors Affecting Coronary Flow in Children

Aburawi, Elhadi

2007

[Link to publication](#)

Citation for published version (APA):

Aburawi, E. (2007). *Factors Affecting Coronary Flow in Children*. [Doctoral Thesis (compilation), Paediatrics (Lund)]. Department of Paediatrics, Lund University.

Total number of authors:

1

General rights

Unless other specific re-use rights are stated the following general rights apply:

Copyright and moral rights for the publications made accessible in the public portal are retained by the authors and/or other copyright owners and it is a condition of accessing publications that users recognise and abide by the legal requirements associated with these rights.

- Users may download and print one copy of any publication from the public portal for the purpose of private study or research.
- You may not further distribute the material or use it for any profit-making activity or commercial gain
- You may freely distribute the URL identifying the publication in the public portal

Read more about Creative commons licenses: <https://creativecommons.org/licenses/>

Take down policy

If you believe that this document breaches copyright please contact us providing details, and we will remove access to the work immediately and investigate your claim.

LUND UNIVERSITY

PO Box 117
221 00 Lund
+46 46-222 00 00

Factors Affecting Coronary Flow in Children

Elhadi H. Aburawi

MD, MSc, FRCPI, FRCPCH

Division of Paediatric Cardiology

Department of Paediatrics

Lund University Hospital

Lund, Sweden



LUND UNIVERSITY
2007

The public defence of this thesis will take place,
with the assent of the Medical Faculty, Lund University,
in Old paediatric Hospital on June 12th, 2007, at 9 am.

Faculty Opponent
Professor Dag Teien
Umeå University, Sweden

Organization LUND UNIVERSITY		Document name DOCTORAL DISSERTATION
Department of Paediatrics, Division of Paediatric Cardiology, University Hospital, S-221 85 Lund, Sweden		Date of issue June 12th 2007
Author(s) Elhadi H. Aburawi, MD, FRCPI, FRCPC		Sponsoring organization -
Title and subtitle Factors Affecting Coronary Flow in Children		
Abstract Background: A number of inborn and exogenous factors influence the flow and function of the coronary arteries with possible consequences on the cardiovascular risk. The regulation of the coronary flow is partly dependent on the functional integrity of coronary endothelial cells, coronary perfusion pressure, and myocardial function. Objectives: To investigate the effects of some of the previously suggested cardiovascular risk factors on coronary flow and function in children. Methods: Blood lipid pattern and concentration of acute phase proteins and their relation to prior infections were studied. The effect of preceding airway infections on the endothelium-dependent vasomotor function of the brachial artery in healthy and type 1 diabetes mellitus children was assessed. Coronary flow was measured with transthoracic Doppler echocardiography before and after non-surgical and surgical treatment of congenital heart defects. Results: Pro-atherogenic changes consisting of decreased circulating levels of high density lipoprotein and albumin were observed in children with past infections. The brachial artery's endothelial vasomotor function was impaired in children with type 1 diabetes, being further affected by preceding mild infections in the upper airways. Compared to controls, coronary flow was increased in patients with left-to-right shunt and coarctation of aorta, and increased further after open heart surgery. In contrast, coronary flow decreased, even if not to normal, after coarctectomy and device closure of atrial septal defect. Cardiac output decreased after open heart surgery but improved after device closure. The coronary flow velocity and velocity time integral decreased with increasing CRP after open heart surgery in particular in those with prolonged aortic cross clamping. Conclusions: Residual pro-atherogenic disturbances in vascular endothelial function, lipid and albumin metabolism may be observed in children with past infections, especially in those with chronic cardiovascular risk factors such as diabetes mellitus. Cardiac malformations and open heart surgery affect negatively the coronary blood flow and cardiac output.		
Key words: • coronary flow • transthoracic Doppler echocardiography • cardiopulmonary bypass • C-reactive protein • endothelial dysfunction		
Classification system and/or index terms (if any): -		
Supplementary bibliographical information: -		Language English
ISSN and key title: 1652-8220		ISBN 978-91-85559-93-0
Recipient's notes	Number of pages 122	Price -
	Security classification -	

Distribution by (name and address)

I, the undersigned, being the copyright owner of the abstract of the above-mentioned dissertation, hereby grant to all reference sources permission to publish and disseminate the abstract of the above-mentioned dissertation.

Signature

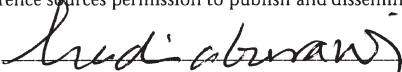

Date

June 12th 2007

Factors Affecting Coronary Flow in Children

Elhadi H. Aburawi

MD, MSc, FRCPI, FRCPCH

Division of Paediatric Cardiology

Department of Paediatrics

Lund University Hospital

Lund, Sweden



LUND UNIVERSITY

2007

Cover figure: endothelial surface of the vascular system
Copyright with permission from Endothelix Inc., Houston, Tx.

In the name of God, Most Gracious, Most Merciful

'Of knowledge is merely a little given to you'

From the Holy Quran, the parable of Alisra, verse 85.

Dedicated to:

**My wife Fatima
and
to all of my children**

TABLES OF CONTENTS	PAGE
LIST OF PUBLICATIONS	5
ABBREVIATIONS.....	6
SUMMARY	7
INTRODUCTION.....	8
1. Anatomy of coronary arteries.....	8
2. Physiology of coronary flow	8
3. Coronary flow in congenital heart disease	10
4. Methods of assessing coronary flow	11
Non-invasive methods.....	11
Invasive methods.....	12
5. Coronary reactivity.....	12
6. Atherosclerosis	13
7. Inflammation after open heart surgery	14
AIMS	15
MATERIAL AND METHODS	16
Subjects	16
Echocardiography equipment.....	16
Echocardiography settings	17
Assessment of endothelial vasomotor function.....	17
Flow measurements.....	17
Coronary Doppler data analysis and calculation.....	19
RESULTS AND DISCUSSIONS	20
Effects of diabetes mellitus and infection on endothelial function	20
Effects of cardiopulmonary bypass surgery on coronary flow	26
Effects of C-reactive protein on coronary flow.....	35
Benefits to the health care perspectives	39
CONCLUSIONS.....	40
ACKNOWLEDGEMENTS	41
REFERENCES.....	42
PAPERS 1-5.....	52

LIST OF PUBLICATIONS

This thesis is based on the following papers, which will be referred to by the Arabic numerals:

1. **Aburawi EH**, Grubb A, Raitakari O, Viikari J, Pesonen E. Lowered levels of serum albumin and HDL-cholesterol in children with a recent mild infection. *Annals of Medicine*. 2006;38:154-160.
2. **Aburawi EH**, Liuba P, Pesonen E, Yla-Herttuala S, Sjoblad S. Acute respiratory viral infections aggravate arterial endothelial dysfunction in children with type 1 diabetes. *Diabetes Care*. 2004;27:2733-5.
3. **Aburawi EH**, Berg A, Liuba P, Pesonen E. Effect of cardiopulmonary bypass surgery on coronary flow in children assessed with transthoracic Doppler echocardiography. *Am J Physiology Heart and Circulatory physiology* (in press).
4. **Aburawi EH**, Berg A, Pesonen E. Coronary blood flow in patients with atrial septal defect before and after surgical versus device closure – A transthoracic Doppler echocardiography study. Submitted to *European Heart J*.
5. **Aburawi EH**, Liuba P, Berg A, Pesonen E. C-reactive protein and coronary microcirculation in children after open heart surgery – A transtoracic Doppler echocardiography study. *Cardiology in the Young* (in press).

Papers 1 and 2 reprinted with permission of Taylor & Francis Journals (UK) and American Diabetes Association, respectively.

ABBREVIATIONS

APP	acute phase protein
ASD	atrial septal defect
AVSD	atrioventricular septal defect
CAD	coronary artery disease
CF	coronary flow
CFR	coronary flow reserve
CHD	congenital heart disease
CPB	cardiopulmonary bypass
CRP	C-reactive protein
DM	diabetes mellitus
FMD	flow mediated dilatation
HDL	high density lipoprotein
LAD	left anterior descending coronary artery
LCA	left coronary artery
LCX	left circumflex artery
LVM	left ventricular mass
NO	nitric oxide
PDA	posterior descending coronary artery
PFV	peak flow velocity
RCA	right coronary artery
TTDE	transthoracic Doppler echocardiography
VSD	ventricular septal defect
VTI	velocity time integral

Factors Affecting Coronary Flow in Children

Elhadi H. Aburawi,
MD, MSc, FRCPI, FRCPCH

Division of Paediatric Cardiology, Department of Paediatrics, Lund University, Sweden

SUMMARY

Background: A number of inborn and exogenous factors influence the flow and function of the coronary arteries with possible consequences on the cardiovascular risk. The regulation of the coronary flow is partly dependent on the functional integrity of coronary endothelial cells, coronary perfusion pressure, and myocardial function.

Objectives: To investigate the effects of some of the previously suggested cardiovascular risk factors on coronary flow and function in children.

Methods: Blood lipid pattern and concentration of acute phase proteins and their relation to prior infections were studied. The effect of preceding airway infections on the endothelium-dependent vasomotor function of the brachial artery in healthy and type 1 diabetes mellitus children was assessed. Coronary flow was measured with transthoracic Doppler echocardiography before and after non-surgical and surgical treatment of congenital heart defects.

Results: Pro-atherogenic changes consisting of decreased circulating levels of high density lipoprotein and albumin were observed in children with past infections. The brachial artery's endothelial vasomotor function was impaired in children with type 1 diabetes, being further affected by preceding mild infections in the upper airways. Compared to controls, coronary flow was increased in patients with left-to-right shunt and coarctation of aorta, and increased further after open heart surgery. In contrast, coronary flow decreased, even if not to normal, after coarctectomy and device closure of atrial septal defect. Cardiac output decreased after open heart surgery but improved after device closure. The coronary flow velocity and velocity time integral decreased with increasing CRP after open heart surgery in particular in those with prolonged aortic cross clamping.

Conclusions: Residual pro-atherogenic disturbances in vascular endothelial function, lipid and albumin metabolism may be observed in children with past infections, especially in those with chronic cardiovascular risk factors such as diabetes mellitus. Cardiac malformations and open heart surgery affect negatively the coronary blood flow and cardiac output.

Key-words: ■ coronary flow ■ transthoracic Doppler echocardiography ■ cardiopulmonary bypass ■ C-reactive protein ■ endothelial dysfunction

INTRODUICITION

1. Anatomy of the coronary arteries

Left and right coronary arteries arise from the corresponding sinuses of Valsalva. The left coronary artery (LCA) bifurcates into the left anterior descending (LAD) and the left circumflex (LCX) coronary arteries. LAD passes in the anterior interventricular groove, and it supplies anterior and septal walls and the apex of the left ventricle with its diagonal branches. LCX follows the mitral ring and divides into left obtuse marginal and left postero-lateral branches. It supplies the lateral and inferior sides of the left ventricle. Right coronary artery (RCA) gives off a conus branch, right postero-lateral branches and continues usually as a posterior descending coronary artery (PDA). RCA supplies the sinus node, right ventricle and the posterior and inferior walls of the heart. The PDA is a continuation of the RCA in up to 70%, but it branches from the left circumflex coronary artery in about 10% and combination of both in 20%.

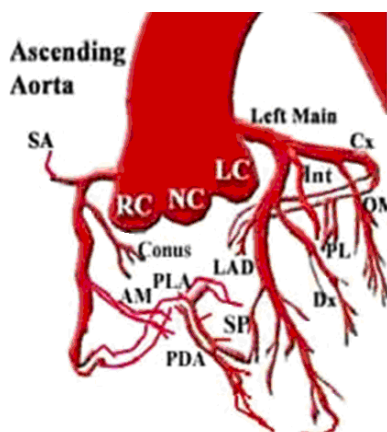

Figure 1. Coronary artery anatomy: SA=sinus artery, LC=left coronary sinus, RC=right coronary sinus, NC=noncoronary sinus, PDA=posterior descending artery, LAD=left anterior descending artery, Cx=circumflex artery, OA=obtuse artery

2. Physiology of the coronary flow

According to Ohm's law, the coronary flow is largely determined by the pressure gradient across the myocardium and inversely related to the resistance of coronary microcirculation. The driving force of the blood flow in coronary arteries is the pressure gradient. It varies throughout the cardiac cycle being greater during diastole than in systole. Resistance is influenced by blood oxygen tension and its pH and by factors affecting endothelial cells such as the inflammatory mediator C-reactive protein (CRP). The coronary arterioles form most of the resistance, being the site of the autoregulation, and metabolic and ischaemic vasodilatation (1-3).

The adaptation of coronary flow to the myocardial oxygen demand in various conditions is regulated via the following mechanisms:

- A. Myocardial oxygen consumption: The myocardium has a high demand for oxygen (8-10 ml O₂/min/100g). The rate-pressure product, the product of heart rate and mean systolic blood pressure, correlates with myocardial oxygen consumption (4). Pressure or volume overload in CHD causes an increase in the ventricular pressure and/or diameter. Accordingly, myocardial oxygen demand and wall stress increase. This in turn leads to increase of the coronary flow in order to avoid ischaemia (5). Elevated resting flow velocities may occur in several cardiac and non-cardiac conditions, including tachycardia, anaemia, hyperthyroidism, and severe left ventricular hypertrophy. Anxiety which is due to enhanced sympathetic drive may also increase baseline coronary flow velocity. B-blockers reduce myocardial metabolism and consequently baseline coronary flow velocity, mainly by decreasing heart rate and blood pressure. Coronary vasodilators such as nitrates or calcium antagonists increase the diameter of the epicardial arteries and reduce baseline flow velocity.
- B. Autoregulation: The heart has an intrinsic ability to maintain a constant blood flow despite changes in the perfusion pressure. Autoregulation of coronary blood flow is probably coordinated by metabolic factors through the ATP-sensitive K⁺ channels in vascular smooth muscle cells (6).
- C. Metabolic regulation: The heart requires ATP as a primary energy source for the function of membrane transport systems (Na⁺/K⁺-ATPase) as well as for sarcomere contraction and relaxation, which involve myosin ATPase and ATP-dependent transport of calcium by the sarcoplasmic reticulum (7, 8). The increase in the mechanical activity of the heart by increasing heart rate and contractility enhances myocardial metabolism and affect coronary flow.
- D. Myogenic control: Adenosine, prostacyclin (PGI₂) and nitric oxide (NO) have been shown to increase the coronary flow through relaxation of the smooth muscle cells, while endothelin-1 decreases the coronary flow by causing constriction. Ca²⁺ concentrations in smooth muscle cells play a major role in the myogenic regulation of the coronary flow.
- E. Endothelial regulation: Endothelium is the largest organ in the body. NO is released continuously by endothelial cells (9). Shear stress and hypoxia increase the secretion of NO (10). NO relaxes vascular smooth muscle by increasing the cyclic guanosine monophosphate (cGMP), with subsequent activation of the Ca²⁺-sensitive, K⁺ channels and K⁺_{ATP} channels. NO, PGI₂ and atrial natriuretic peptide are vasodilators and have antiproliferative effects as well (11, 12). Endothelin-1, angiotensin II, thromboxane A₂ (13),

prostaglandin H₂ (14) and superoxide (15) are known to cause constriction of coronary arteries. These mediators have proliferative effects on the vessel wall (16).

- F. Neurohumoral factors: Autonomic sympathetic and parasympathetic nerve endings in the coronary arteries regulate the coronary flow. Sympathetic stimulation increases the heart rate, contractility and cardiac output. The increase in heart rate increases the rate-pressure product which increases myocardial oxygen consumption and metabolic vasodilatation and increases coronary blood flow. Neurotransmitters and humeral factors act via α and β adrenergic and acetylcholine receptors to regulate coronary microvascular tone (17, 18).

3. Coronary flow in congenital heart disease

The determinants of coronary flow in children with congenital heart disease (CHD) are not fully understood. CHD may cause several haemodynamic and functional changes that are likely to affect coronary blood flow. CHD may be associated with reduced arterial oxygen saturation, myocardial hypertrophy, increased heart rate and volume or pressure overload, all of which may affect coronary flow by contributing to myocardial oxygen deprivation (19-22). The major determinants of the oxygen demand of the myocardium are heart rate, contractility and wall stress. Wall stress is related to ventricular pressure, chamber diameter and wall thickness (5). The rate-pressure product, the product of heart rate and mean systolic blood pressure describes myocardial oxygen demand (3). The maximal ability of coronary circulation to increase in response to increased cardiac metabolic demand is referred as coronary flow reserve (CFR). CFR is commonly expressed as the ratio of maximal coronary flow (e.g. obtained by an infusion of adenosine) to basal flow (23-25).

Cardiac surgery with the aid of cardiopulmonary bypass (CPB) in children has increased significantly during the past few decades. Ischaemia during aortic cross clamping (26), inadequate myocardial protection with hypothermia and cardioplegic solutions (27) and reperfusion injury (28, 29) may all contribute to acute myocytes dysfunction after cardiac surgery. Myocardial ischaemia/reperfusion leads to coronary endothelial dysfunction due to decreased endothelium-dependent relaxation (30). It has been shown in experimental models that endothelial dysfunction after ischaemia/reperfusion persists for at least 4-6 weeks (31, 32).

The pathogenic role of surgery on CF is nowadays attributed to combined effects of the postsurgical inflammatory response and myocardial ischemia/reperfusion (33). The systemic inflammatory response following CPB surgery is thought to result from the contact between blood components and the synthetic material of the by-pass equipment. This has been suggested to underlie in part the risk of developing arrhythmias, myocardial and pulmonary dysfunction during the first few weeks after cardiac surgery (34). Although the prevalence of major cardiovascular events during the postoperative course in children is much lower than in adults, aggressive therapy

particularly in the intensive care unit is sometimes needed to maintain cardiovascular haemodynamics at an acceptable level.

4. Methods of assessing coronary blood flow

Several methods have been developed to assess the coronary blood flow, coronary flow reserve and myocardial perfusion. Each method has its advantages and disadvantages and the results are not entirely comparable.

A. Non-invasive methods

Transthoracic Doppler echocardiography

The method is non-invasive, safe, reproducible, widely available, and relatively inexpensive. It is accurate with low intra- and inter-observer variability (35). Coronary flow velocity and coronary flow reserve assessed by this method correlate well to those obtained with intracoronary Doppler guide wire and positron emission tomography (36-38). Also stenoses of the coronary arteries can be detected even though the method is not yet standardized for clinical use (39).

Positron emission tomography

The method uses radiolabeled tracers to determine the regional myocardial blood flow related to ventricular mass. It correlates well with transthoracic and intracoronary Doppler (35, 38). It is a complex, expensive and time consuming method.

Myocardial scintigraphy

Single photon emission tomography is used for semi-quantitative evaluation of relative regional myocardial blood flow (40, 41). It is performed by injecting technetium-99 or thallium-201 isotopes.

Computed Tomography

CT angiography either as an electron beam CT or as a multislice spiral CT has achieved a reliable non-invasive detection and exclusion of coronary artery stenosis. It is useful especially when other non-invasive methods are contraindicated. It requires intravenous injection of iodinated contrast agent, which necessitates perfect timing of image acquisition to contrast injection (42, 43).

Magnetic resonance imaging

This method can be used to measure both myocardial perfusion and coronary blood flow. Gadolinium diethylenetriaminopenta acetic acid is used as contrast agent to improve the visualization in perfusion studies. Good correlation has been obtained compared with measurements with intracoronary Doppler guide wire (44).

Transoesophageal echocardiography

The coronary flow velocity measured by transoesophageal echocardiography correlates well with that assessed by intracoronary Doppler guide wire method (37). The main limitation of this method is that only visualization of the proximal one third of coronary arteries is possible and that the method overestimates the coronary flow (45).

B. Invasive methods**Coronary angiography and intracoronary Doppler guide wire**

Coronary angiography is the standard method for diagnosing CAD. The left and right coronary arteries are selectively approached and imaged using contrast media. The anatomy of the coronary arteries can be evaluated and the severity of the stenosis can be graded. It involves the risks of the radiation exposure and renal toxicity by the contrast medium. Intracoronary Doppler guide wire (IDGW) is considered the golden standard in the assessment of coronary flow velocity and coronary flow reserve. The measurement of coronary flow velocity by the IDGW has been validated both in vitro and in vivo (46, 47).

Intravascular ultrasound

This method is applied to visualize the walls of blood vessels. The ultrasound probe lies on the tip of the catheter. It is considered the golden standard for the evaluation of coronary artery diameter and wall structure in adults. It provides accurate measures of the thickness and amount of coronary plaques (48).

5. Coronary reactivity

Fatty meals cause changes in the vasculature that result in both a hypercoagulable and a provasoconstrictor state. Ingestion of saturated fat reduces the anti-inflammatory potential of HDL-cholesterol and impairs arterial endothelial function (49). Endothelial dysfunction increases platelets activation and predispose for acute coronary syndrome. Endothelial dysfunction contributes to atherosclerosis, which is more pronounced in diabetic patients (50). Infections modify the serum lipid pattern by e.g. lowering HDL-cholesterol. Decrease in HDL-cholesterol is

an independent risk factor for atherosclerosis (51). Moreover, acute infections are accompanied by oxidative modification of LDL-cholesterol (52), which is a risk factor for atherosclerosis (53). Infections decrease serum albumin concentration, which has been reported to be associated with an increased risk of CAD (54, 55).

It has been hypothesized that changes in arterial endothelial function could be one central link between inflammatory disorders and post-inflammatory vascular-related complications (56). Impairment of endothelial vasomotor function by systemic inflammation has been documented in clinical studies (57, 58).

Diabetes mellitus predisposes to arterial endothelial injury (59). Endothelial injury occurs during respiratory tract infections, which appear more frequent in patients with diabetes (60). Of note, diabetic patients have an increased risk for infection-related mortality (61, 62).

Acute disorders such as viral infections, may promote short-lasting episodes of systemic inflammation with mild elevation of inflammatory markers such as CRP, fibrinogen and pro-inflammatory cytokines. Rise in inflammatory markers precedes the onset of cardiovascular ischemic events such as myocardial infarction and stroke (63, 64). Recent findings from epidemiological studies suggest that systemic inflammation might also predispose to cardiac arrhythmias such as paroxysmal atrial fibrillation (65).

However, the precise temporal relationship between inflammation and cardiovascular diseases remains incompletely elucidated. Accumulating evidence suggests that the cardiovascular risk posed by certain conditions causing systemic inflammation (e.g. respiratory infections) may remain significant for several weeks after their onset (66 - 68). This might be one explanation for the lack of association between inflammatory markers and ischemic events in some cardiovascular patients.

6. Atherosclerosis

Atherosclerosis is a chronic inflammatory disease, being characterized at its earliest stage by increased adhesiveness of inflammatory cells to activated endothelium. Inflammation is a complex process that often develops in response to infection and surgery.

During inflammation, cytokines are released into circulation causing exacerbation of intravascular inflammation. Interleukin-6 (IL-6), for instance, stimulates the synthesis of CRP, a hallmark of systemic inflammation (69). Inflammation is now recognized as an important contributor to atherosclerosis, and is involved in the pathogenesis of acute vascular complications (70).

CRP seems to be an independent predictor of major cardiovascular events, such as heart attack and stroke. High sensitivity CRP assay is increasingly becoming a routine biochemical test in predicting the cardiovascular risk. Circulating CRP in healthy people is undetectable or very low;

elevated levels are strongly associated with inflammation. CRP appears to be an important marker of pathology in metabolic disorders such as syndrome X and diabetes mellitus, obesity, hypertension, and other cardiovascular diseases (71)

Inflammation could be the common pathway in atherosclerosis and its clinical manifestations. Children with signs of infection at their death presented intimal thickening of coronary arteries (72). Infections have been shown to initiate intimal thickening in some experimental series (73). Acute respiratory infections have been suggested to initiate an increased risk of acute myocardial infarction (74).

Ross and Glomset (75) presented in 1997 their response-to-injury theory that a single damaging hit initiates intimal thickening followed by incomplete resolution. Repeating noxious hits could cause in a cumulative manner progressive thickening of the arterial intima. This hypothesis is in keeping with previous data from serial angiographic studies indicating a stepwise rather than a linear progression of atherosclerosis (76). Studies by Liuba et al showed that endothelial dysfunction developed after an acute infection with *C pneumonia* in both mice (73) and piglets (77). Pesonen et al (78) showed that elevated viral and Chlamydia infections were associated with increased incidence of acute coronary syndromes in an additive manner. These findings are concordant with a statistical model suggesting increased risk of developing CAD after repeated short-acting damaging factors (79).

7. Inflammation after open heart surgery

CRP is an important inflammatory mediator mainly synthesized by the liver in response to pro-inflammatory cytokines such as IL-6. CRP rises rapidly after surgery reaching a peak approximately 24-48 hours after surgery (80). Data from both in vivo and in vitro studies using commercial recombinant CRP leading to a wide range of intravascular concentration suggested possible dichotomous effects of CRP on the vasomotor tone and reactivity of conduit arteries (81). Some possible explanations for such contradictory results might include contamination of the CRP extract with other substances such as endotoxin and sodium azide (82). Several studies have found an association between CRP and the risk of developing atrial fibrillation or myocardial dysfunction after CPB surgery (83). The adverse effects of CRP on the myocardium were demonstrated to occur in non-surgery patients as well (84), which lends support to the concept that CRP might be an independent mechanism in the pathogenesis of various myocardial diseases (85). The coronary microcirculation is the main determinant of myocardial perfusion, but there is no clinical proof of the effects of surgery on the coronary microcirculation.

AIMS**Study 1**

To elucidate the effects of previous infections on risk factors for CAD in children.

Study 2

To investigate the effects of type 1 diabetes and mild respiratory infection on arterial endothelial function.

Studies 3 and 4

To study the effects of CPB surgery (study 3) and device closure of an atrial septal defect (study 4) on coronary flow.

Study 5

To investigate whether CRP relates to the post-surgical changes in coronary flow.

MATERIALS AND METHODS

Subjects

Study 1

In 1983 and again 3 years later, blood samples of 2458 individuals aged 9, 12, 15, 18 and 21 years were investigated. In 1986, 106 subjects had symptoms of infection during the past 2 weeks prior to their follow-up visit. Their serum albumin and lipid concentrations were compared to those in 1983 when these individuals probably were healthy. Age- and gender-matched healthy controls from the 1986s cohort were chosen for comparison.

Study 2

Endothelial vasomotor function of the brachial artery was studied in 26 children with type 1 diabetes. Of these, 11 children had upper respiratory tract infection (body temperature $>38^{\circ}\text{C}$ and flu-like symptoms) during the past 2 months. None of the children who had infection required antibiotic treatment or hospitalization. Ten age- and weight-matched healthy children served as controls.

Studies 3, 4 and 5

Coronary flow was investigated in children with CHD by TTDE. In study 3, patients (n=18) with left-to-right shunt (ventricular and atrioventricular septal defects) were examined before and after surgery. Similarly, children (n=12) with coarctation of the aorta were investigated before and after the surgery. In study 4, children (n=27) with ASD were compared before and after the surgery via CPB or device closure of ASD by cardiac catheter intervention technique. The association of CRP with coronary flow in patients after open heart surgery was investigated in study 5.

Methods

Echocardiography equipment

Endothelial vasomotor function and coronary flow examinations were performed using a high resolution ultrasound system (Sequoia™ C512 Acuson Mountain View, CA, USA). A linear transducer of 15MHz was used for studying the endothelial function (study 2). In studies 3, 4, and 5, coronary flow of neonates and older children was visualised with 7-10 MHz and 4-5 MHz transducers, respectively. Standard M- and B-mode and Doppler echocardiographic studies were performed to determine the anatomy and function of the heart.

Echocardiography settings

Study 2: Ultrasound assessment of endothelial vasomotor function

The methodology is described in details elsewhere (86). Briefly, longitudinal scans of the brachial artery (non-dominant arm) located several centimetres above the antecubital fossa were imaged via a 15-MHz linear ultrasound transducer. The ultrasound beam frequency was set at 8 MHz. Once the image was obtained, the transducer was positioned throughout the study with aid of a transducer arm.

Studies 3, 4 and 5: Ultrasound assessment of coronary blood flow

For coronary blood flow and flow velocity measurements the following adjustments in the ultrasound machine were made (35, 87): space-time in high frame rate (T1), wall filter was set at two thirds (F2), and the colour gain was adjusted to minimize colour flow signal scatter (gate 3). Pulsed Doppler of 4.5 MHz and sweep rate of 100 mm/s were used. Velocity setting of 15-40 cm/s before and 30-60 cm/s after surgery was needed. Measurements were corrected for the angle between the Doppler beam and the coronary flow direction. True velocity was defined as the measured velocity divided by the cosine of the angle between the Doppler beam and the direction of blood.

Assessment of endothelial vasomotor function

ECG-gated end-diastolic scans of the artery were recorded at baseline, and a pressure cuff tourniquet placed around the forearm was thereafter inflated to 200 mmHg (minimum 50 mmHg over the systolic blood pressure) for 5 minutes. Frames were taken for 15 seconds before and 120 seconds after cuff deflation. Following a 10-minute recovery period, additional frames were taken before and 4 minutes after sublingual administration of 400 µg glycerol trinitrate (GTN spray). The latter was used as endothelium-independent vasodilator. All ultrasound frames were transferred to a computer via a video frame grabber for offline edge-detection measurements of the brachial artery diameter (Data Acquisition and Analysis, Information Integrity 1.51, USA). Flow-mediated and GTN-induced brachial artery dilatation were expressed as maximum percent dilatation following cuff deflation and GTN administration, respectively.

Flow measurements

The bifurcation of the left main coronary artery was imaged from the standard parasternal short-axis view of the great arteries. The internal dimension of the left anterior descending artery (LAD) was measured at the R-wave with the callipers applied on the inner borders. Measurements of

coronary artery diameter by TTDE correlate well with those obtained by quantitative coronary angiography (88, 89). The velocity scale was decreased to the minimum range and then gradually increased until colour signals were optimized within the vessel lumen. After obtaining good coronary flow signals, the pulsed Doppler sample volume was placed within the LAD artery 2-3 mm distal to the bifurcation of the left main coronary artery, and the sample volume was adjusted to 0.5-1.0 mm. A sample volume that gave the best quality envelope and pure sound throughout the cardiac cycle was chosen.

Flow in the proximal half of the PDA running in the posterior interventricular groove was registered. An apical 4-chamber view was obtained. The probe was angulated anteriorly and rotated anticlockwise until the disappearance of right ventricle from the view. The technique was otherwise similar to that used in the registration of the flow in the LAD. Because the PDA was almost parallel to the reflecting ultrasound it was impossible to measure its diameter. Therefore the internal dimension of the main right coronary artery (RCA) was instead measured.

All images were saved on a magnetic-optic disc and reviewed in a slow-motion, and single frame advance mode for analysis. The diameter of the aortic ring was measured in a long axis view by M-mode to calculate cardiac output. Left ventricular mass (LVM) was calculated from M-mode in accordance to the American Society of Echocardiography's recommendations (90). Left ventricular fractional shortening was computed from the standard formula (91). Arterial blood pressure was measured by an automatic sphygmomanometer (Dynamap, Critikon Inc, Tampa, Florida, USA). The rate-pressure product was calculated by multiplying heart rate with the mean systolic blood pressure (4). The myocardial oxygen consumption was calculated from the pressure-work index, which is calculated using an equation that incorporates RPP and left ventricular work divided by body weight (92).

Blood analyses

Plasma high-sensitivity CRP was measured by an enzyme-immunoassay using polyclonal antibodies (Dako, Copenhagen, Denmark), while an electroimmunoassay method (93) was used to assess plasma levels of fibrinogen and orosomucoid. The detection level for CRP was 0.2 mg/L. Plasma levels of von Willebrand factor antigen (vWF:Ag) was measured by enzyme-linked immunosorbent assay from sodium citrate-treated plasma (94). A modified ELISA was used to determine anti-oxLDL antibodies, which were expressed as the ratio of binding to oxLDL to binding to native LDL (oxLDL: native LDL). Plasma HDL, LDL, and total cholesterol levels were analysed by enzymatic methods using a Hitachi Modular-P system (Roche/Hitachi 912, Roche Diagnostics).

Coronary Doppler data analysis and calculation

The analysis package of the ultrasound unit was used for manual tracing of the spectral envelope. The flow velocity measurements across aortic valve were averaged over three consecutive cardiac cycles. Diastolic peak flow velocity (PFVd), systolic peak flow velocity (PFVs), diastolic velocity time integral (VTId) and systolic velocity time integral (VTIs) were measured. CF was calculated according to the following formula: $CF = VTI \times \text{heart rate} \times \pi \left[\frac{\text{diameter}}{2} \right]^2$.

Statistical analyses

Statistical analyses were performed using StatView[®] for Windows (SAS Inst. Inc. 5.0). A p value < 0.05 was considered statistically significant. Results are presented as mean \pm standard deviation unless otherwise specified. Paired student's t test was used for comparison between the data before and after surgery. Simple regression analyses were used to calculate the correlation coefficients (r).

Ethics

The study protocols were approved by the Ethics Committee for Human Research at the University of Lund.

RESULTS AND DISCUSSION

Effects of diabetes mellitus and infection on endothelial cell function –Studies 1 and 2

Study 1

On basis of the questionnaire, 106 (4.3%) of 2458 subjects had infectious symptoms during the preceding 2 weeks. All had fever, but 63 of them reported temperatures over 38°C. CRP was elevated in 22 subjects and orosomuroid in 25 subjects. The cholesterol concentrations of subjects with history of infection in 1986 were compared to the concentrations during probably infection free period in 1983, and to those of healthy controls in 1986. The study design is presented in Figure 2.

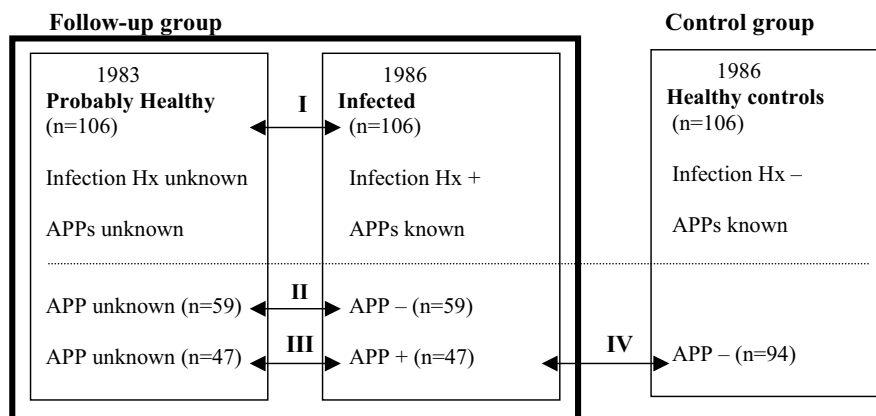

Figure 2. Study design: The cholesterol concentrations of subjects with history of infection in 1986 were compared to the concentrations during probably infection-free period in 1983, and to those of healthy controls in 1986. APPs = Acute Phase Proteins, Hx = History, + = positive/elevated, - = negative/normal. Roman numbers refer to the analysis steps.

Step 1 of analysis: Symptoms of mild infections were associated with lower levels of HDL-, LDL-, total cholesterol and the ratio of HDL/total cholesterol (table 1). These values were lower in 1986 (positive history of infection) than in 1983 (non infection group) as reported earlier using multifactorial analysis (51). When using Z-scores HDL-cholesterol proved to be significantly decreased ($p=0.01$) in subjects with a positive history of infection. BMI values were normal in both groups and their Z-scores were similar (table 1). The Z-scores of HDL-cholesterol were lower in subjects when history of infection was positive as compared to their earlier “not infection associated values” in 1983. The difference between the values increased with increasing evidence

of inflammation. The mechanism behind seems to be inflammation as evidenced by the high association of lowered HDL-cholesterol concentration to inflammation markers CRP and orosomuroid. In addition, serum albumin concentration was lower during the post infection period.

Table 1. Serum cholesterol and concentrations and BMI values in unknown history of infection (1983) and in history of infection (1986) groups, the actual values and the Z-score values adjusted for age and sex, n=106. Cholesterol values are in mmol/l.

Cholesterol parameters	Unknown History of infection (1983) n=106		Positive History of infection (1986) n=106		Difference (1986-83)	
	Mean	SD	Mean	SD	Mean	p-value
Total cholesterol	4.90	0.74	4.56	0.71	0.34	<0.0001
Z—score	-0.17		-0.24		0.07	0.34
LDL—cholesterol	2.93	0.63	2.81	0.61	0.12	0.03
Z—score	-0.16		-0.18		0.02	0.69
HDL—cholesterol	1.61	0.34	1.36	0.26	0.25	<0.0001
Z—score	-0.06		-0.27		0.19	0.01
HDL/total cholesterol	0.33	0.07	0.30	0.06	0.03	0.02
Z—score	0.08		-0.07		0.14	0.06
BMI	18.8	3.8	20.1	4.0	1.3	<0.0001
Z—Score	-0.049		-0.110		0.061	0.29

Step 2 of analysis: In 59 subjects investigated both in 1983 and 1986 and having non elevated levels of APPs (CRP and orosomuroid) but positive history of infection in 1986 the HDL-cholesterol Z-scores were significantly lower during infection in 1986 (table 2). There were no differences in BMI Z-scores.

Table 2. Cholesterol parameters in 59 subjects with positive history of infection and normal levels of APPs compared to their values during probably infection free period (1986 values compared to 1983 values). APPs were not known. Cholesterol values are in mmol/l

Cholesterol Parameters	1983 (n=59)		1986 (n=59)		Differences	
	Mean	SD	Mean	SD	Mean	p-value
Total Cholesterol	4.83	0.73	4.56	0.72	0.27	0.005
Z-score	-0.19		-0.16		0.03	0.8
LDL-Cholesterol	2.87	0.66	2.78	0.61	0.09	0.2
Z-score	-0.22		-0.14		0.08	0.6
HDL-Cholesterol	1.60	0.34	1.40	0.23	0.20	<0.0001
Z-score	-0.07		-0.09		0.02	0.9
HDL/total Cholesterol	0.33	0.07	0.31	0.06	0.02	0.002
Z-score	0.11		0.05		0.06	0.8
BMI	19.3	3.8	20.5	3.7	1.2	<0.0001
Z-score	-0.036		-0.145		0.109	0.15

Step 3 of analysis: In 47/106 subjects with elevated CRP ≥ 5 mg/l or orosomuroid ≥ 1.1 gm/l in 1986 and 47/106 subjects with probably normal (not measured) values in 1983, the difference in HDL Z-score was even higher than that based on the grouping based on the history alone (0.49 as compared to 0.19). (table 3). Elevated APPs were used as an objective evidence of a past infection, if they were elevated the change of the HDL-cholesterol was most significant even if all cholesterol values showed a trend for declining. Especially HDL-cholesterol decreased during an infection which is demonstrated the ratio of HDL/total cholesterol.

Table 3. Cholesterol parameters in 47 subjects with positive history of infection and elevated APPs compared to values during probably infection free period (1986 values compared to 1983 values) and APPs not known. CRP ≥ 5 mg/l or orosomuroid ≥ 1.1 g/l is APPs positive. Cholesterol values are in mmol/l.

Cholesterol Parameters	1983 (n=47)		1986 (n=47)		Differences	
	Mean	SD	Mean	SD	Mean	p-value
Total Cholesterol Z-score	4.90 -0.18	0.75	4.48 -0.37	0.70	0.42 0.19	0.0002 0.14
LDL-Cholesterol Z-score	2.92 -0.14	0.61	2.77 -0.25	0.63	0.13 0.11	0.12 0.40
HDL-Cholesterol Z-score	1.62 -0.04	0.35	1.29 -0.53	0.27	0.33 0.49	<0.0001 0.0007
HDL/total Cholesterol Z-score	0.33 0.09	0.07	0.29 -0.25	0.06	0.04 0.34	<0.0001 0.01
BMI Z-score	19.0 -0.066	3.9	20.4 0.065	4.5	1.4 -0.131	<0.0001 0.9

Step 4 in the analysis: In 1986 serum CRP or orosomuroid concentrations were elevated in 47/106 subjects with positive history of infection and were normal in 94/106 of age-and sex-matched healthy controls. The Z-score difference of 0.79 ($p=0.0001$) in serum HDL-cholesterol was especially high. Even total cholesterol concentration was significantly decreased (Z-score difference 0.61, $p=0.002$). BMI were normal and Z-scores similar between the groups (table 4). Mean serum albumin concentration was 46 g/l in controls and 42 g/l in infection group in 1986 ($p<0.0001$). There was no significant correlation between serum albumin concentration values and HDL-cholesterol Z-score values. Theoretically, repeated bouts of infection with temporarily increased risk factor levels could increase the risk in a cumulative manner for later CAD as suggested by Ross and Glomset (75).

Table 4. Cholesterol and albumin concentrations in 1986 in subjects: A. With positive history of infection and elevated APPs, (n=47); B. With positive history of infection, (n=106); C. With no history of infection and non elevated APPs, (n=94). Cholesterol values are in mmol/l.

Cholesterol/Albumin parameters	A. (n=47)		B. (n=106)		C. (n=94)		Difference between A and C	
	Mean	SD	Mean	SD	Mean	SD	Mean	p-value
Total cholesterol	4.48	0.70	4.56	0.71	4.88	0.76	0.40	0.02
Z-score	-0.37		-0.24		0.24		0.61	0.002
LDL-cholesterol	2.79	0.63	2.8	0.61	3.03	0.70	0.25	0.10
Z-score	-0.25		-0.18		0.18		0.43	0.03
HDL-cholesterol	1.29	0.27	1.36	0.26	1.49	0.27	0.21	0.0001
Z-score	-0.53		-0.27		0.26		0.79	0.0001
HDL/total cholesterol	0.29	0.06	0.30	0.06	0.31	0.06	0.02	0.04
Z-score	-0.25		-0.07		0.08		0.32	0.03
Albumin g/l	43.1	4.5	42.0	3.4	46.7	3.7	3.6	0.002
BMI	20.37	4.5	20.1	4.0	20.43	3.1	0.06	0.9
Z-score	-0.06		-0.11		0.05		-0.11	0.9

Physiological concentrations of albumin selectively inhibit tumour necrosis factor- α (TNF- α) induced vascular cell adhesion molecule-1 (VCAM-1) expression, monocyte adhesion and nuclear factor-KB (NF-KB) activation in human aortic endothelial cells (95). Low serum albumin is reported to be associated with an increased mortality rate among healthy subjects without evidence of inflammation (96). Djousse and colleagues found that low levels of serum albumin and serum bilirubin are associated with a greater than expected risk of myocardial infarction (97). Increasing of serum albumin levels has been suggested as an effective strategy to lower cardiovascular risk (95). Disrupted micro-vascular barrier during infection may also lead to albumin leakage (98).

The proatherogenic changes in lipoproteins may be one link between infection/inflammation and atherosclerosis. Lipid alterations may be triggered by the inflammatory response to infection. Several cytokines including TNF- α , interleukines, and interferon decrease serum HDL-cholesterol (99). The susceptibility of LDL to oxidation increases during the acute phase response initiated by infection (100). Viral infections may increase the risk for atherosclerotic clinical events by decreasing HDL-cholesterol (101). Acute infections in children have been shown to be accompanied by oxidative modification of LDL-cholesterol (52).

Study 2

No differences in the studied clinical and metabolic variables were noted between the infection and noninfection groups of diabetic children with the exception of vWF, which was higher in the

diabetic children who had infection (table 5). In the diabetic children, a direct correlation was noted between oxidized LDL and CRP ($r = 0.5$, $p = 0.03$).

Table 5: Descriptive clinical and metabolic data. NS=non-significant. Data are means \pm SD.

	Diabetics	Post-infection p &diabetic	
Number	15	11	--
Age (years)	14 \pm 4	14 \pm 3	NS
Weight (kg)	53 \pm 19	60 \pm 20	NS
Duration of diabetes (years)	5 \pm 3	6 \pm 4	NS
Systolic BP (mm Hg)	113 \pm 10	107 \pm 13	NS
Diastolic BP (mm Hg)	60 \pm 8	61 \pm 11	NS
HBA1c (%)	7.3 \pm 2	7 \pm 1.1	NS
3-month HBA1c (%)	7.1 \pm 1.9	6.9 \pm 1.5	NS
Albumin (g/l)	42 \pm 3	40 \pm 3	NS
Cholesterol (mmol/l)	4.1 \pm 0.6	4.7 \pm 1	NS
HDL-cholesterol (mmol/l)	1.7 \pm 0.5	2 \pm 0.3	NS
LDL-cholesterol (mmol/l)	2.2 \pm 0.6	2.5 \pm 1.1	NS
Oxidized LDL	1.8 \pm 1.2	1.9 \pm 1.1	NS
CRP (mg/ml)	2.2 \pm 3.7	1.1 \pm 2.5	NS
Orosomuroid (mg/ml)	0.7 \pm 0.1	0.6 \pm 0.2	NS
von Willebrand (IE/ml)	1.3 \pm 0.4	1.9 \pm 0.5	<0.05

Infection did not affect the baseline diameter and the GTN-induced dilatory response of brachial artery (figure 3, panel A and B). In contrast, diabetic children who had a recent respiratory infection had significantly lower FMD than diabetic children without infection (figure 4, panel A and B). In the infection group, FMD related inversely to orosomuroid concentration ($r = -0.8$, $p < 0.05$). Overall, diabetic children had lower FMD than healthy children (5.6 \pm 2% and 9.1 \pm 3%, respectively, $p < 0.01$). FMD was inversely correlated with vWF ($r = -0.4$, $p < 0.05$), CRP ($r = -0.6$, $p = 0.01$), and LDL cholesterol ($r = -0.6$, $p < 0.01$).

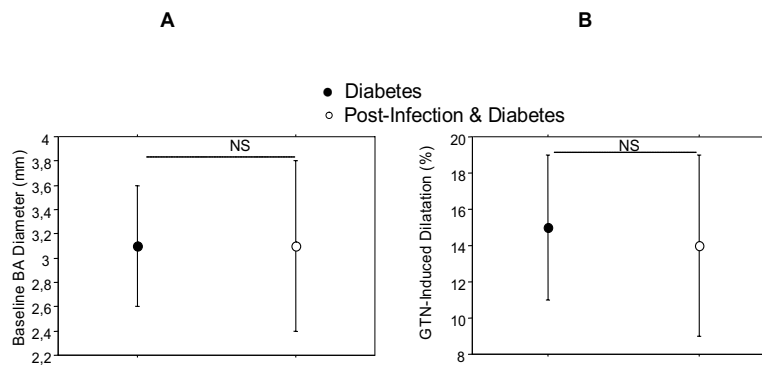

Figure 3: Baseline diameter (Panel A) and glyceryl trinitrate (GTN)-induced dilatation (Panel B) of the brachial artery in infection (n=11) and non-infection (n=15) diabetic patients. Data are mean \pm SD; NS = non-significant.

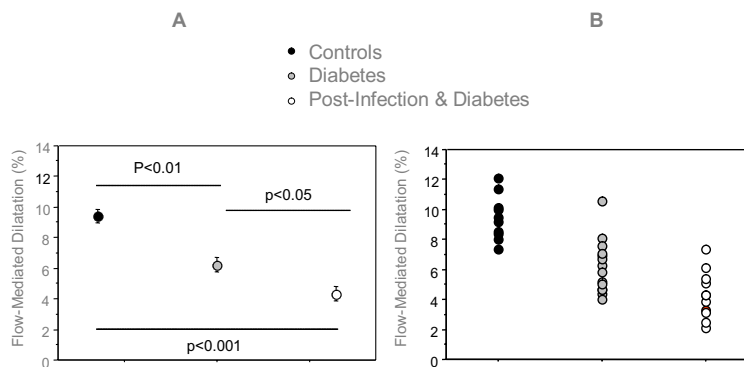

Figure 4: Flow-mediated (endothelium-dependent) dilatation of the brachial artery (Panel A: mean values; Panel B: scattergram) in the infection (n=11, white-filled circles) and non-infection (n=15, grey circles) diabetic patients, and in controls (n=10, black circles). Data are mean \pm SEM.

Diabetic children have an impaired immunity, being apparently more susceptible to recurrent acute respiratory infections (60). Acute respiratory viral infections seemed to aggravate the arterial endothelial dysfunction. The vascular dysfunction in type 1 diabetes is likely to be mediated in part by a low-grade systemic inflammatory process as suggested by the inverse correlation between FMD and CRP. Also, LDL-cholesterol was inversely correlated with FMD. Acute infections could cause short-lasting inflammatory response with subsequent endothelial damage, which, depending on the frequency of infections and presence of additional cardiovascular risk factors (e.g., diabetes), might be critical for the development of atherosclerosis (102). Liuba et al suggested that various types of acute infections could elicit proatherogenic changes in arterial structure (52).

Effects of cardiopulmonary bypass surgery on Coronary flow - Studies 3 and 4

Study 3

The study is the first to assess by means of TTDE the effect of CPB surgery on CF. The results indicate that LAD flow in children with left-to-right shunt is increased for at least 5 days after CPB surgery. Because there is a certain maximal dilatory state that can be reached, an increase in CF may lead to impaired CFR (103). Our findings are in keeping with earlier studies by PET and IDGW showing a drop in CFR after CPB surgery (104).

Infants with ventricular left-to-right shunt before surgery

The mean age of the patients was 6 months and the range was 3 to 18 months. Satisfactory coronary flow signals in LAD were obtained in 95% of cases. The mean diameter of LAD in patients was 1.7 ± 0.3 mm, and in their age-matched controls 1.5 ± 0.2 mm. VTIs+d was 9 ± 3 cm and 10 ± 3 cm in controls and PFVd 36 ± 10 cm/s and 38 ± 5 cm/s in controls. Mean CF in LAD was 27 ± 4 ml/min in patients, and, 17 ± 5 ml/minute in controls.

Neonates with coarctation of aorta before surgery

The mean age of patients was 10 days and the range was 2 to 50 days. Coronary flow in LAD was obtained in all patients with coarctation. The LAD mean diameter was 1.8 ± 0.1 mm in patients and 1.2 ± 0.1 mm in controls. VTIs+d was 11 ± 4 cm in patients and 6 ± 2 cm in controls. PFVd was 42 ± 14 cm/s in patients and 26 ± 8 cm/s in controls. The LAD flow in patients was 44 ± 20 ml/min and in age-matched neonates 8 ± 4 ml/minute.

During the first months of life, the PFVd, VTIs+d and LAD flow increase. These changes are related to the rapid normal body growth during this period. The physiological improvement in left

ventricular relaxation and compliance occurring during the first months of life could be an additional explanatory factor for the increase in coronary flow parameters (105).

Infants with ventricular left- to-right shunt after CPB surgery

The mean (range) aortic cross clamp time was 108 (90–193) minutes and CPB time 70 (47–121) min. There was no correlation between the change in CF before and after surgery and the duration of the CPB. Mean LV mass, LV fractional shortening, cardiac output, rate-pressure product and systolic and diastolic blood pressure were similar before and after surgery. Myocardial oxygen consumption increased after surgery from 65±23 to 71±27 ml O₂/minute per 100 gram, p<0.02. There was no correlation between VTId+s or CF and myocardial oxygen consumption. Heart rate was significantly greater before surgery (139 versus 129 beats/min, p=0.02; table 6).

Table 6. Haemodynamic and echocardiographic data before and 5±1 days after surgery with CPB in patients with shunt (n=18) and controls (n=19). Data are presented as mean (SD).

BP=blood pressure, RPP=rate-pressure product, HR=heart rate, CO=cardiac output, FS=fractional shortening, CPB=cardiopulmonary bypass, LAD=Left anterior descending artery, VTId+s=velocity time integral in diastole, and systole, PFV=peak flow velocity. * Pre-surgery versus after surgery.

	Controls (n=19) Mean (SD)	Patients (n=18)		p*
		Before surgery Mean (SD)	After surgery Mean (SD)	
Age months (range)	6.5 (3 - 16)	6 (3-18)	6 (3-18)	--
Systolic BP (mmHg)	89 (7)	95 (10.0)	98 (5.0)	0.46
Diastolic BP (mmHg)	50 (6)	53 (8.0)	54 (8.0)	0.9
HR (beats/min.)	132 (10)	139 (15)	129 (17)	0.02
RPP (mmHg/min)	11940 (1690)	13278 (1127)	12672 (1050)	0.25
CO (ml/min/kg)	446 (133)	422 (222)	423 (191.3)	0.9
FS (%)	36 (4)	46 (9)	42 (9)	0.5
LVM (g)	21 (5.6)	25 (10)	25 (10)	--
Aortic cross clamp time (min)	--	--	58.9 (23.5)	--
CPB duration (min)	--	--	98.8 (30.6)	--
Hb (gm%)	--	12 (1)	13 (0.9)	0.0001
LAD diameter (mm)	1.5 (0.2)	1.7 (0.3)	2.1 (0.4)	0.001
LAD VTId+s (cm)	10 (3)	9 (3.0)	14 (5.0)	0.05
LAD PFVd (cm/s)	38 (5)	36 (10)	49 (16)	0.05
LAD flow (ml/min.)	17 (5)	27 (4)	63 (18)	0.004

CF correlated to rate-pressure product after surgery ($r=0.5$, $p<0.04$) (figure 5).

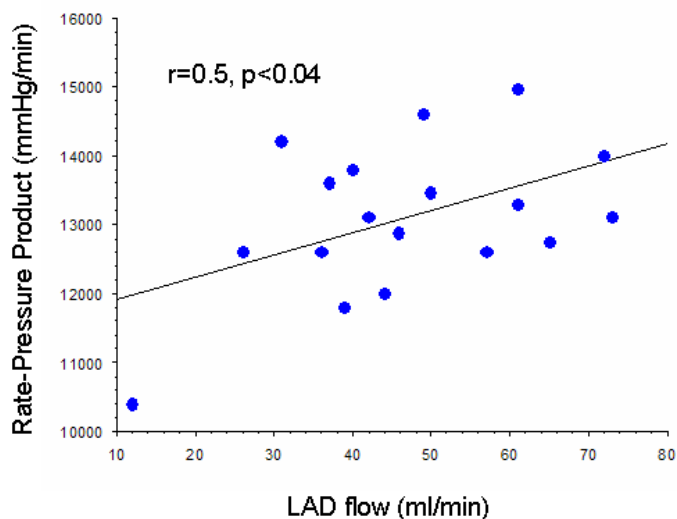

Figure 5: LAD flow correlates with the rate-pressure product after CPB surgery ($r=0.5$, $p<0.04$).

The mean LAD diameter increased from 1.7 ± 0.3 mm to 2.0 ± 0.4 mm ($p=0.001$). There was no correlation between CF and LAD diameter. LAD VTIs+d increased from 9 ± 3 to 14 ± 5 cm ($p=0.05$) and PFVd from 36 ± 10 to 49 ± 16 cm/s ($p=0.05$). An example of a flow signal taken after CPB surgery is presented in figure 6.

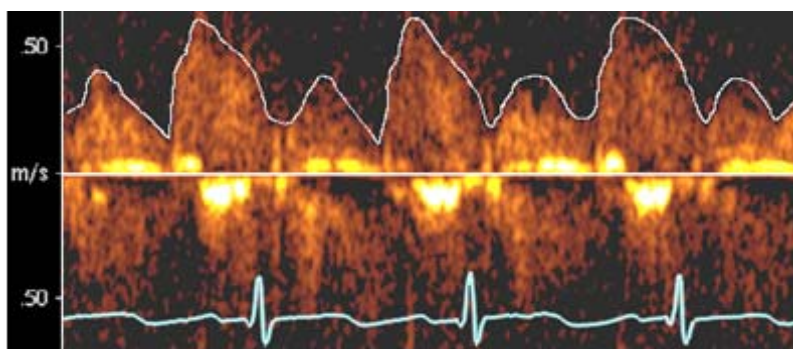

Figure 6: Pulsed-wave Doppler profile of coronary velocity signal in LAD after surgery with CPB. CF increased from 27 ± 4 to 63 ± 11 ml/minute ($p=0.0001$, figure 7). Haemoglobin concentration was higher on 5±1 days postoperatively (12 ± 1 vs. 13 ± 0.9 gm per 100 ml, $p<0.0001$).

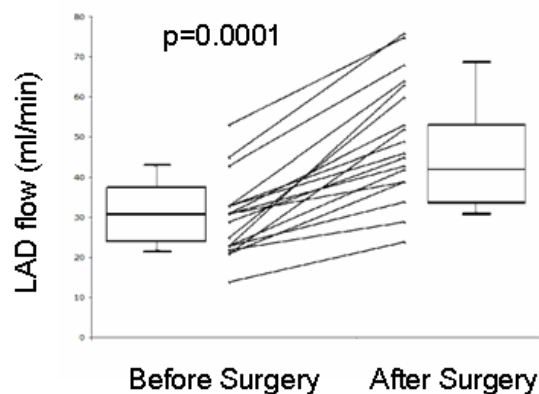

Figure 7: LAD flow before and after CPB surgery. The box plot displays the 25th percentile, median, and 75th percentile, as well as the 10th and 90th percentiles as horizontal lines outside the box.

CPB surgery is associated with several factors that may adversely influence the normal function of the arterial endothelial and smooth muscle cells. Complement system is activated, proinflammatory cytokines are released, oxidative stress and disturbances in calcium homeostasis lead to ischemia-reperfusion (106). Haemolysis has been suggested to be the main cause of early oxidative stress (107). TNF- α upregulates inducible nitric oxide synthase (iNOS) with subsequent increased release of nitric oxide (NO), which may contribute to the reduction in the intrinsic tone of coronary microcirculation (108). Prolonged ischemia-reperfusion causes an increase in oxygen-derived free radicals such as superoxide anions. Superoxide reacts with NO forming peroxynitrate, which is highly damaging for endothelial cells (109, 110). All these mechanisms may be important in the pathogenesis of coronary vasomotor dysfunction after CPB surgery (111 - 116).

Neonates with coarctation after off-pump surgery

Mean LV mass, LV fractional shortening, cardiac output and heart rate before and after surgery were similar. The systolic and diastolic blood pressures were significantly decreased after surgery (102 and 80 mmHg, $p=0.0003$, and 55 and 42 mmHg, $p=0.005$ respectively). Rate-pressure product was higher before than after surgery ($p=0.06$; table 7). Myocardial oxygen consumption decreased after surgery from 18 ± 4 to 15 ± 3 ml O₂/minute per 100gm, $p<0.001$. There was no correlation between CF and VTId+s and myocardial oxygen consumption. Before surgery, there was a weak correlation between CF and rate-pressure product ($r=0.53$, $p=0.1$).

Table 7. Haemodynamic and echocardiographic data before and 5±1 days after surgery with non-CPB in patients with coarctation of aorta (n=12) and in controls (n=55). Data are presented as mean (SD). BP=Blood pressure, RPP=rate-pressure product, HR=heart rate, CO=cardiac output, FS=fractional shortening, LAD=left anterior descending artery, VTId+s=velocity time integral in diastole and systole, PFV=peak flow velocity. * Pre-surgery versus after surgery.

	‡Controls (n=55)	Patients (n=12)		p*
	Mean (SD)	Before surgery Mean (SD)	After surgery Mean (SD)	
Age (days)	5 (0.5-30 days)	10 (2-50)	10 (2-50)	--
Systolic BP (mmHg)	79 (12)	102 (11)	80 (7.0)	0.0003
Diastolic BP (mmHg)	43 (10)	55 (8.0)	42 (4.0)	0.005
RPP (mmHg/min)	9724 (2042)	14302 (1310)	12045 (1298)	0.06
HR (beats/min)	123(17)	148 (6.5)	147 (10.6)	0.8
CO (ml/min/kg)	--	390 (121)	410 (130)	0.2
FS (%)	37 (5.1)	47 (10.2)	46 (9.5)	0.5
LVM (g)	12 (3)	14 (5.5)	14 (5.5)	--
LAD diameter (mm)	1.2 (0.19)	1.8 (0.1)	1.7 (0.1)	0.06
LAD VTId+s (cm)	6 (2.0)	11 (4)	8 (2)	0.05
LAD PFVd (cm/s)	26 (8.0)	42 (14)	30 (10)	0.008
LAD flow (ml/min)	8 (4.0)	44 (20.0)	22 (18.0)	0.001

‡From Oskarsson et al. Am J Cardiol 90:557-61, 2002.

LAD mean diameter was smaller after surgery than before surgery (1.7 ±0.1 vs. 1.8±0.1 mm, respectively; p=0.06). LAD VTIs+d decreased from 11 to 8±0.2 cm, (p=0.05), PFVd from 42±14 to 30±10 cm/s (p=0.008), and LAD flow from 44±20 to 22±14 ml/minute (p=0.001, figure 8).

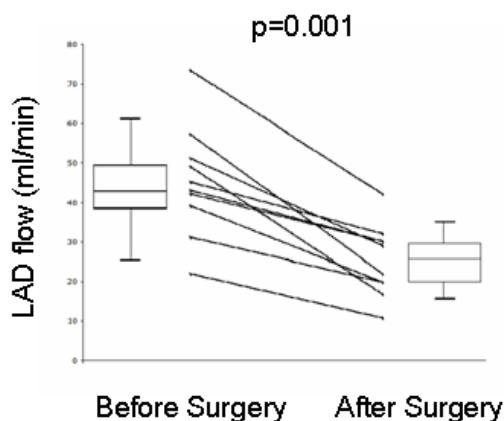

Figure 8: LAD flow before and after coarctectomy (off-pump surgery). The box plot displays the 25th percentile, median, and 75th percentile, as well as the 10th and 90th percentiles as horizontal lines outside the box.

The hypertrophic myocardium due to coarctation implies increased demand of flow. After coarctectomy, with subsequent decrease in cardiac pressure afterload, the LAD diameter, VTId+s, PFVd, CF all decreased but they were still higher on day 5 than in control neonates. This is probably due to the persistent myocardial hypertrophy, which is supported by the lack of difference in LVM between the time-points. The postoperative decrease of CF could lead to increase in CFR in these patients.

In patients with coarctation of aorta, CF before surgery was higher than in the controls. The increase in CF before surgery in coarctation patients is related to coarctation-induced elevation in blood pressure and myocardial hypertrophy, which leads to high myocardial oxygen demand and consequent increase of coronary flow. The decrease in CF after coarctectomy appears to be related to the decrease in cardiac pressure afterload, rendering thus conceivable that off-pump surgery as such has little or no impact on coronary flow.

Previous studies by PET in neonates operated with CPB have shown low CFR values (104). As suggested by the present study, a possible explanation could reside in the increased basal coronary flow after CPB surgery. Our findings suggest that the type of CHD and use of CPB during cardiac surgery are important factors affecting the postoperative resting coronary blood flow in children.

Study 4

The success rate for LAD registration was 100% and for PDA 90%. Heart rate and rate-pressure product (RPP) did not change significantly after closing atrial septal defects. Blood haemoglobin concentration was the same pre- and postoperatively (12.3 ± 0.7 vs. 11.9 ± 0.9 gm per 100 ml, $p = 0.3$). Before the device closure, simple regression analysis showed a negative correlation between CF in PDA and RVEDP (figure 9) and also Qp/Qs, measured at cardiac catheterization ($n=14$) with ($r = -0.61$, $p = 0.02$ and $r = 0.52$, $p = 0.06$, respectively).

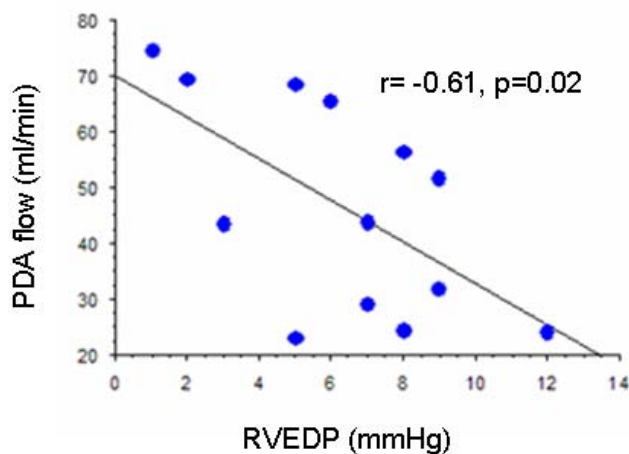

Figure 9: Blood flow in PDA correlates with right ventricular end diastolic pressure ($r = -0.61$, $p = 0.02$).

After the device closure left ventricular fractional shortening increased from $35 \pm 4\%$ to $38.5 \pm 5\%$ and cardiac output from 595 ± 210 to 702 ± 170 ml/min/kg ($p = 0.01$ and 0.001 respectively) but remained the same after the surgery (Table 8). Aorta VTI increased significantly after the device closure from 22 ± 5.5 to 26 ± 5 cm ($p = 0.001$), but was similar before and after surgery. It has been shown earlier that longitudinal contractile function of the left ventricle decreases after surgery for ASD, but not after the device closure supporting the recent findings (117). Left ventricular shortening fraction and cardiac output increased after the closure under the interventional cardiac catheterization. These features suggest that the device closure is a preferred method for closing ASD.

Table 8. Haemodynamic data 1 day before and 5 ± 1 days after surgery and 1 day after device closure of ASD. Data are presented as mean (standard deviation). BP=blood pressure, RPP=rate-pressure product, HR=heart rate, CO=cardiac output, FS=fractioning shortening, CPB=cardiopulmonary bypass.

	Surgery (n=13)		p-value	Catheter (n=14)		p
	Before	After		Before	After	
HR (beats/min.)	96 (12)	84(21)	0.18	99 (9)	97 (10)	0.5
Systolic BP (mmHg)	105 (11)	102 (11)	0.02	100 (10)	100 (8)	0.8
Diastolic BP (mmHg)	52 (7)	51 (6)	0.6	59 (7)	57 (5)	0.08
RPP (mmHg/min)	10081(1460)	8743 (2427)	0.08	9970 (1072)	9882 (1026)	0.6
CO (ml/min/kg)	460(140)	420 (160)	0.3	595 (210)	702 (170)	0.001
FS (%)	37 (8)	40 (5)	0.37	35 (4)	38.5 (5)	0.01
Aorta VTI (cm)	18 (3.8)	18 (4)	0.8	22 (5.5)	26 (5)	0.001

Our study showed that CF in ASD patients was increased before surgery and remained elevated at least one to 5 days after the closure of the defect. Compared to the pre-treatment values, CF decreased after the device closure but increased further after CPB surgery. The increased blood flow leads to decreased CFR as already suggested by Donnelly et al because arteries have a certain maximal dilatory state they can reach (104).

After CPB surgery, LAD mean diameter increased from 1.7 ± 0.6 to 2.1 ± 0.4 mm ($p=0.03$), while it remained unchanged following the device closure. Also, after CPB surgery, LAD PFVd increased from 48 ± 10 to 70 ± 12 cm/s ($p=0.0001$), CF from 62 ± 18 to 105 ± 35 ml/minute ($p=0.0001$) (figure10) and VTId+s from 18 ± 4 to 24 ± 4 cm ($p=0.0003$). RCA diameter increased from 1.5 ± 0.3 to 1.9 ± 0.2 mm, $p=0.0003$, and PDA PFVd from 42 ± 10 to 52 ± 8.8 cm/s ($p=0.03$). The estimated PDA flow (RCA diameter used instead of PDA diameter in calculations) increased from 36 ± 18 to 74 ± 41 ml/min ($p=0.0008$), and VTId+s from 13 ± 5 to 25 ± 7 cm ($p=0.005$).

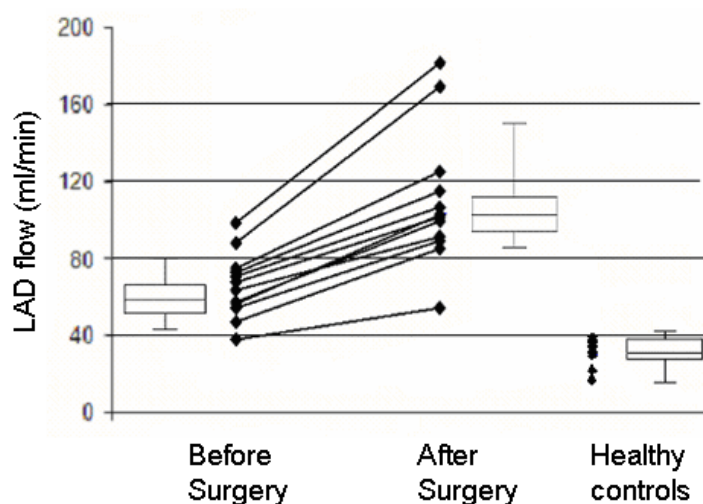

Figure 10: LAD flow before and after surgical closure of ASD and in controls. The box plot displays the 25th percentile, median, and 75th percentile, as well as the 10th and 90th percentiles as horizontal lines outside the box.

All flow measures decreased substantially after the device closure: LAD PFVd from 51 ± 9 to 40 ± 7 cm/s ($p=0.0001$), CF from 66 ± 22 to 45 ± 18 ml/minute ($p<0.0001$) (figure 11) and VTId+s from 20 ± 2 to 16 ± 4.6 cm, $p<0.04$. The RCA diameter decreased from 1.7 ± 0.24 to 1.6 ± 0.27 mm, ($p=0.2$) and for the PDA PFVd decreased from 46 ± 7 to 30 ± 8 cm/s, ($p=0.0001$), CF from 40 ± 18 to 30 ± 14 ml/min, $p=0.001$ and VTId+s from 14 ± 4 to 12 ± 2 cm, $p=0.1$.

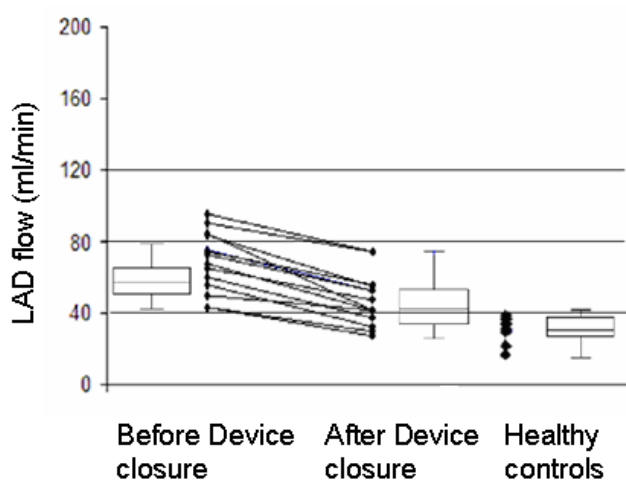

Figure 11: LAD flow before and after device closure of ASD and in controls. The box plot displays the 25th percentile, median, and 75th percentile, as well as the 10th and 90th percentiles as horizontal lines outside the box.

The coronary blood flow in LAD in the healthy controls was lower than in the patients even after the device closure of ASD: PFVd 30 ± 11 cm/s, CF 30 ± 8 ml/min and VTId+s 14 ± 5 cm, as compared to PFVd 40 ± 7 cm/s, CF 45 ± 18 ml/min and VTId+s 16 ± 5 cm ($p=0.0001$, $p=0.004$ and $p=0.0001$ respectively). In the PDA, flow parameters were also lower in controls than in the patients even after the device closure PFVd 20 ± 5 cm/s, CF 20 ± 15 ml/min and VTId+s 10 ± 3 cm ($p=0.0001$, $p=0.003$ and $p=0.0001$ respectively). The actual flow data are presented in tables 9 and 10.

Table 9. LAD flow parameters in after surgical and device closure of ASD and in controls. Data are presented as mean (standard deviation). VTId+s=velocity time integral in diastole and systole, PFV=peak flow velocity, CF=coronary flow. * Controls versus after device closure.

	Surgery (n=13)		p-value	Device closure (n=14)		p-value	Controls (n=14)	
	Before	After		Before	After		*p	
Diameter (mm)	1.7 (0.3)	2.1 (0.4)	0.03	1.7 (0.3)	1.6 (0.4)	0.1	1.7 (0.2)	0.09
PFVd (cm/s)	48 (10)	70 (12)	0.0001	51 (9)	40 (7)	0.0001	30 (11)	0.0001
CF (ml/min.)	62 (18)	105 (35)	0.0001	66 (22)	45 (18)	0.0001	30 (8)	0.004
VTId+s (cm)	18 (4)	24 (4)	0.0003	20 (2)	16 (5)	0.04	14 (5)	0.0001

Table 10: PDA flow parameters before and after surgery and device closure of ASD, and in controls. Data are presented as mean (standard deviation). VTId+s=velocity time integral in diastole and systole, PFVd=peak flow velocity in diastole. * controls versus after device closure

	Surgery (n=13)			Device closure (n=14)			Controls (n=14)	
	Before	After	p value	Before	After	p value	*p	
Diameter (mm)	1.5 (0.3)	1.9 (0.2)	0.0003	1.7 (0.2)	1.6 (0.3)	0.2	1.6 (0.15)	0.8
PFVd (cm/s)	42 (10)	52 (9)	0.03	46 (7)	30 (8)	0.0001	20 (5)	0.0001
CF (ml/min.)	36 (18)	74 (41)	0.0008	40 (18)	30 (14)	0.0001	20 (5)	0.003
VTId+s (cm)	13 (5)	25 (7)	0.005	14 (4)	12 (2)	0.1	10 (3)	0.0001

There was an increased flow in both main coronary arteries before the closure of ASD. The flow decreased after device closure but it did not decline to control values. The mechanism of increased coronary flow before intervention could be that the volume overload on the right side of the heart leads to increased secretion of atrial natriuretic peptide, which is a potent vasodilator (118). Likewise the overflow through the lungs leads to increased shear stress of the endothelial cells of the pulmonary arteries, which is a stimulus for the secretion of vasoactive substances such as prostacyclin (119).

Effects of C-reactive protein on Coronary flow - Study 5

Before surgery, all children had CRP levels under the detection limit (<0.8 mg/L). CRP increased significantly by day 2 (median: 25, range: 4 to 142 mg/L), and remained elevated on day 5 after surgery (median 11, range: 3 to 20 mg/L). Compared to the preoperative values, LAD flow, VTId+s and PFV in diastole were increased significantly on day 5 (27±8 vs 63±18 ml/minute, $p=0.0001$; 9±3 to 14±5 cm, $p=0.05$; and 36±10 to 49±16 cm/s, $p=0.05$ respectively). The post-surgery VTId+s and PFV in diastole correlated inversely with log CRP ($r=-0.6$, $p<0.01$, and $r=-0.6$, $p<0.01$, respectively; figure 12).

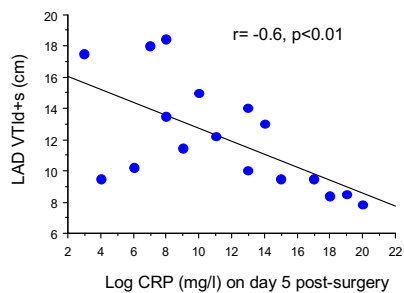

Figure 12: Left anterior descending coronary artery velocity time integral (LAD VTI) is inversely correlated with log CRP on day 5 after surgery ($r = -0.6, p < 0.01$).

When patients were divided in relation to aorta clamping time (mean: 59 min, range: 33-121 min), these associations remained significant only in those in whom clamping time exceeded 1 hour, figure 13.

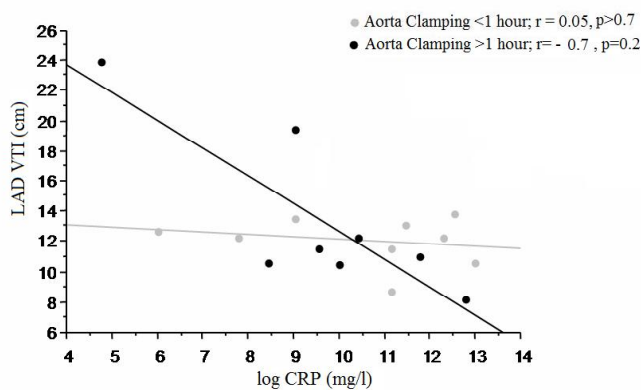

Figure 13: Effect of aorta clamping duration on the association between left anterior descending coronary artery velocity time integral in diastole and systole (LAD VTI) and log C-reactive protein on the fifth day after surgery.

Surgery and CPB are strong stimuli for systemic inflammation in both children and adults being characterized by intense and rapid rise of inflammatory cytokines, followed from day 2 by 100-200 fold increase in CRP levels (115). Importantly, the rise in CRP postoperatively, particularly in adult patients, coincides with increased risk for cardiovascular complications such as hemodynamic instability, myocardial ischemia, arrhythmias, and even multi-organ failure in severe cases (81). It has therefore been speculated that the CRP related changes in coronary circulation could be a pathophysiological substrate for the clinical outcome (116).

The significant inverse association between CRP and coronary flow velocity suggests a role of CRP in the impaired vasomotion of coronary circulation. Since the coronary flow velocity but not the diameter of the LAD correlated with CRP, we speculate that the possible inhibitory vasomotor effect of CRP is mainly confined at the microcirculatory level. The possible detrimental effects of CRP on coronary microcirculation appear to be exacerbated by prolonged aorta clamping during CPB.

The post-surgery increase in VTI corrected for LVM was significantly lower among those patients with CRP > 10 mg/L than in the remaining patients (5±2 vs. 2±1, respectively; p<0.05, figure 14).

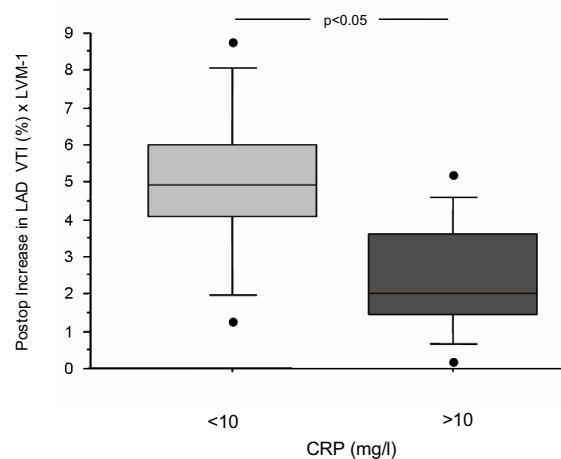

Figure 14: Effect of CRP on left anterior descending coronary artery velocity time integral (LAD VTI) corrected for left ventricular mass on day 5 after surgery (ANOVA).

On day 5 postoperatively, neither the LAD diameter nor the LAD flow correlated with CRP ($p>0.5$). Similarly, CRP showed no association with left ventricle fractional shortening, cardiac output, rate-pressure product, and mean arterial blood pressure ($p>0.5$ for all). After CPB surgery, the coronary microcirculatory phenotype is shifted to a highly disturbed state characterized by decreased myogenic tone, and impaired ability to dilate in response to physiological or pharmacological stimuli (114, 120). The mechanisms underlying the impaired coronary flow reserve appear to be manifold, and may include an unbalance between dilating and constricting compounds synthesized by the arterioles.

Importantly, CRP stimulates release from endothelial cells of endothelin-1, which is a powerful vasoconstrictor (121). CPB surgery is an important source of endothelin-1 (122). CRP also poses a downregulatory action on the constitutive form of nitric oxide synthase via decreased eNOS mRNA stability, thereby resulting in decreased amounts of nitric oxide. Although a possible link between nitric oxide and CRP has been a focus of numerous studies employing peripheral conduit arteries, artery rings or endothelial cell culture, contradictory results have been obtained. In one previous study conducted in vitro (123), exposure of coronary arterioles to human recombinant CRP at a level comparable to those attained in our study (7 vs. 11 mg/L, respectively) resulted in a significant inhibition of the endothelium-dependent nitric oxide-mediated dilatation of the arterioles by increasing superoxide production from NAD(P)H oxidase via p38 kinase activation. The inhibitory effect of CRP persisted even after inactivation of endotoxin and sodium azide, two potent vasoconstrictors known to contaminate the recombinant CRP (82).

The coronary microcirculatory phenotype associated with CRP might be a consequence of the surgery-induced disturbances in the adjacent ventricular myocytes, which closely interact with the arteriolar smooth muscle cells. Particularly during CPB surgery, the myocardial cells are highly susceptible to damage via the inflammatory response and ischemia-reperfusion, with subsequent leukocyte infiltration and oedema surrounding the arterioles and, hence, arteriolar compression (124). This hypothesis appears however less plausible since neither the myocardium-related haemodynamical parameters (heart rate, contractile function, blood pressure) nor the surgical parameters (clamping, perfusion, and overall surgery duration) correlated with CRP.

Benefits for the health care and future perspectives

The findings provide additional understanding of how various conditions affect coronary endothelial cells and flow. In children with diabetes, even a mild infection might have further detrimental effects on the arterial endothelial cells, and future studies should investigate whether anti-inflammatory strategies during clinically manifest viral infections could alleviate these effects. It is also important to investigate whether the adverse vascular effects of infection in children with diabetes may be further inhibited by a good glycaemic control. The alterations in coronary flow after CPB may contribute to the haemodynamic instability including arrhythmias and myocardial dysfunction. Serial TTDE studies of coronary flow after CPB surgery are warranted to assess prospectively the impact of the described coronary flow changes on the clinical outcome. Serial TTDE studies may be extended to other conditions associated with coronary vasculopathy, such as Kawasaki disease and cardiac transplantation.

CONCLUSIONS

1. Mild infections are associated with decreased blood levels of HDL-cholesterol and albumin; both being established risk factors for atherosclerosis and coronary artery disease.
2. Arterial endothelial function is adversely influenced by mild respiratory infection particularly in children with cardiovascular risk factors such as type 1 diabetes.
3. The basal coronary flow is increased in patients with shunt lesions (VSD, AVSD, and ASD) and with coarctation of aorta. CPB surgery leads to a further increase in coronary flow shortly after the surgery. Increase of basal flow might be a possible mechanism of the earlier reported decrease of CFR after CPB surgery.
4. After the device closure of ASD, the coronary flow decreases, in contrast to increase of flow after CPB surgery. Device closure leads to improved left ventricular function already on day one after the procedure.
5. The rise in CRP is inversely associated with coronary flow velocity as assessed by TTDE, suggesting possible constrictive effects of CRP on coronary microcirculation. This could be one mechanism of the putative adverse effects of inflammation on myocardial physiology during the first week after cardiac surgery.

ACKNOWLEDGMENTS

I wish to express my sincere gratitude to all of those who have contributed to this work and to my education through out my career. To all my co-authors, collaborators, colleagues at the Department of Paediatrics, Lund University Hospital, and especially to:

Erkki Pesonen, Professor and supervisor, for being able to inspire me to do research in the exciting field of coronary blood flow. Your continuous enthusiasm, brilliant guidance and support in various aspects of my research throughout these 5 years are very well respected.

Petru Liuba, co-supervisor, for introducing me to the field of endothelial function. I am grateful for his fantastic support and for sharing his vast knowledge in this field.

Ansgar Berg, for sharing his ideas, fruitful discussions, and a great chance to learn from his experience in professional research.

Katarina Hanseus, Sture Sjöblad, Iréne Jakobsson, Charlotta Schaedel and all my colleagues at the Department of Paediatrics and the Division of Paediatric Cardiology for their support and encouragement.

Annica Maxedius, research nurse, for her positive attitude, reliability, recruiting of patients and determination throughout these 5 years of my research.

Britt-Marie Nilsson-Brandt, for her extreme kindness and helpfulness in the administrative issues.

All the patients and their relatives for participating in the studies.

The souls of **my parents**, and to my **brothers** and **sisters** for their encouragement, love and endless support.

Last but not least, to **Fatima**, my wife, and **my children** for their love, patience, and faith in me, no matter what. This work is dedicated to all of you.

REFERENCES

1. Kanatsuka H, Lamping KG, Eastham CL, Marcus ML. Heterogeneous changes in epimyocardial microvascular size during graded coronary stenosis. Evidence of the microvascular site for autoregulation. *Circ Res* 1990;66:389-96.
2. Kanatsuka H, Lamping KG, Eastham CL, Dellsperger KC, Marcus ML. Comparison of the effects of increased myocardial oxygen consumption and adenosine on the coronary microvascular resistance. *Circ Res.* 1989;65:1296-305.
3. Chilian WM, Layne SM. Coronary microvascular responses to reductions in perfusion pressure. Evidence for persistent arteriolar vasomotor tone during coronary hypoperfusion. *Circ Res* 1990;66:1227-38.
4. Baller D, Bretschneider HJ, Hellige G. A critical look at currently used indirect indices of myocardial oxygen consumption. *Basic Res Cardiol* 1981;76:163-81.
5. Graham TP Jr, Covell JW, Sonnenblick EH, Ross J Jr, Braunwald E. Control of myocardial oxygen consumption: relative influence of contractile state and tension development. *J Clin Invest* 1968;47:375-85.
6. Narishige T, Egashira K, Akatsuka Y, Katsuda Y, Numaguchi K, Sakata M, Takeshita A. Glibenclamide, a putative ATP-sensitive K⁺ channel blocker, inhibits coronary autoregulation in anesthetized dogs. *Circ Res* 1993;73:771-6.
7. Fox AC, Reed GE, Glassman E, Kaltman AJ, Silk BB. Release of adenosine from human hearts during angina induced by rapid atrial pacing. *J Clin Invest* 1974;53:1447-57.
8. Mainwaring RD, Mentzer RM Jr, Ely SW, Rubio R, Berne RM. The role of adenosine in the regulation of coronary blood flow in newborn lambs. *Surgery* 1985;98:540-546.
9. Lefroy DC, Tousoulis D, Crake T. Inhibition of nitric oxide synthesis. *Lancet* 1993;342:1487-88.
10. Busse, R, Mulsch, A, Fleming, I, and Hecker, M. Mechanisms of Nitric-xide Release from the Vascular Endothelium. *Circulation* 1993; 87: 18-25.
11. Masakado M, Umeda F, Takei A, Hashimoto T, Sueishi K, Nawata H. Immunohistochemical localization of a novel peptide, prostacyclin-stimulating factor (PSF), in human tissues. *Thromb Haemost.* 1995 Dec;74:1407-10.
12. Shirai M, Ninomiya I, Shindo T. Selective and tone-dependent vasodilation of arterial segment in rabbit and feline pulmonary microcirculation in response to ANP. *Jpn J Physiol.* 1993;43:485-99.
13. Tesfamariam, B, Jakubowski, JA, Cohen, RA. Contraction of Diabetic Rabbit Aorta Caused by Endothelium-Derived PGH₂-Tx₂. *Am J Physiol* 1989; 257: H1327-H1333

14. Ito, T, Kato, T, Iwama, Y, Muramatsu, M, Shimizu, K, Asano, H, Okumura, K, Hashimoto, H, and Satake, T. Prostaglandin-H2 As An Endothelium-Derived Contracting Factor and Its Interaction with Endothelium-Derived Nitric-Oxide. *J Hypertens* 1991; 9: 729-36.
15. Katusic, ZS. Superoxide anion and endothelial regulation of arterial tone. *Free Radic Biol Med* 1996; 20: 443-8.
16. Dawes KE, Peacock AJ, Gray AJ, Bishop JE, Laurent GJ. Characterization of fibroblast mitogens and chemoattractants produced by endothelial cells exposed to hypoxia. *Am J Respir Cell Mol Biol*. 1994;10:552-9.
17. Woodman OL, Vatner SF. Coronary vasoconstriction mediated by alpha 1- and alpha 2-adrenoceptors in conscious dogs. *Am J Physiol*. 1987;253:H388-93.
18. Di Carli MF, Tobes MC, Mangner T, Levine AB, Muzik O, Chakroborty P, Levine TB. Effects of cardiac sympathetic innervation on coronary blood flow. *N Engl J Med*. 1997;336:1208-15.
19. Kangos JJ, Ferrer MI, Francios RA, Blanc WA, Blumenthal S. Electrocardiographic changes associated with papillary muscle infarction in congenital heart disease. *Am J Cardiol* 1969;23:801-9.
20. Fogel MA, Rychik J, Vetter J, Donofrio MT, Jacobs M. Effect of volume unloading surgery on coronary flow dynamics in patients with aortic atresia. *J Thorac Cardiovasc Surg* 1997;113:718-26.
21. Hofstetter R, Zeike B, Messmer BJ, von Bernuth G. Echocardiographic evaluation of systolic left ventricular function in infants with critical aortic stenosis before and after valvotomy. *Thorac Cardiovasc Surg* 1990;38:236-40.
22. Hongo M, Goto T, Watanab N, et al. Relation of phasic coronary flow velocity profile to clinical and hemodynamic characteristics of patients with aortic valve disease. *Circulation* 1993;88:53-60.
23. Hoffman JIE. Maximal coronary flow and the concept of coronary vascular reserve. *Circulation* 1984;70:153-9.
24. Hoffman JIE. Pediatric cardiovascular intensive care: myocardial perfusion. *Progr Ped Card* 1995;4:117-23.
25. Coffman JD, Gregg DE Reactive hyperemia characteristics of the myocardium. *Am J Physiol* 1960;11:1143-9.
26. Gold JP, Roberts AJ, Hoover EL, Blank S, Gay WA Jr, Subramanian VA. Effects of prolonged aortic cross-clamping with potassium cardioplegia on myocardial contractility in man. *Surg Forum*. 1979;30:252-4.

27. Swanson DK, Myerowitz PD. Effect of reperfusion temperature and pressure on the functional and metabolic recovery of preserved hearts. *J Thorac Cardiovasc Surg.* 1983;86:242-51.
28. Przyklenk K, Kloner RA. Reperfusion injury" by oxygen-derived free radicals? Effect of superoxide dismutase plus catalase, given at the time of reperfusion, on myocardial infarct size, contractile function, coronary microvasculature, and regional myocardial blood flow. *Circ Res.* 1989;64:86-96.
29. Opie LH. Reperfusion injury and its pharmacologic modification. *Circulation.* 1989;80:1049-62.
30. Ku DD. Coronary vascular reactivity after acute myocardial ischemia. *Science* 1982;218:576-8.
31. Kaeffer N, Richard V, Francois A, Lallemand F, Henry JP, Thuillez C. Preconditioning prevents chronic reperfusion induced coronary endothelial dysfunction in rats. *Am J Physiol* 1996;271:842-9.
32. Pearson Schaff HV, Vanhoutte PM. Long-term impairment of endothelium-dependent relaxations to aggregating platelets following reperfusion injury in canine coronary arteries. *Circulation research* 1990;8:1921-7.
33. Verrier ED, Boyle EM Jr. Endothelial cell injury in cardiovascular surgery. *Ann Thorac Surg* 1996;62:915-22.
34. Hassanabad ZF, Furman BL, Parratt JR, Aughey E. Coronary endothelial dysfunction increases the severity of ischaemia-induced ventricular arrhythmias in rat isolated perfused hearts. *Basic Res Cardiol* 1998;93:241-9.
35. Saraste, M, Koskenvuo, JW, Knuuti, J, Toikka, JO, Laine, H, Niemi, P, Sakuma, H, and Hartiala, JJ. Coronary flow reserve: measurement with transthoracic Doppler echocardiography is reproducible and comparable with positron emission tomography. *Clin Physiol* 2001; 21:114-22.
36. Hozumi T, Yoshida K, Akasaka T, Asami Y, Ogata Y, Takagi T, Kaji S, Kawamoto T, Ueda Y, Morioka S. Noninvasive assessment of coronary flow velocity and coronary flow velocity reserve in the left anterior descending coronary artery by Doppler echocardiography: comparison with invasive technique. *J Am Coll Cardiol.* 1998;32:1251-9.
37. Gadallah, S, Thaker, KB, Kawanishi, D, Mehra, A, Lau, S, Rashtian, M, and Chandraratna, PAN. Comparison of intracoronary Doppler guide wire and transesophageal echocardiography in measurement of flow velocity and coronary flow reserve in the left anterior descending coronary artery. *Am Heart J* 1998; 135: 38-42.

38. Merlet p. Merlet, P, Mazoyer, B, Hittinger, L, Valette, H, Saal, JP, Bendriem, B, Crozatier, B, Castaigne, A, Syrota, A, and Rande, JL. Assessment of coronary reserve in man: comparison between positron emission tomography intracoronary Doppler technique. *J Nucl Med* 1993; 4:1899-904.
39. Saraste, M, Vesalainen, RK, Ylitalo, A, Saraste, A, Koskenvuo, JW, Toikka, JO, Vaittinen, MA, Hartiala, JJ, and Airaksinen, KEJ. Transthoracic Doppler Echocardiography as a Noninvasive Tool to Assess Coronary Artery Stenoses-A Comparison with Quantitative Coronary Angiography. *J Am Soc Echocardiogr* 2005; 18: 679- 85.
40. Emmanoulidis GC, Riemenschneider TA, Allen HA, Gutgesell HP. Moss and Adams' heart disease in infants, children and adolescents. 5th edition 1995. Williams and Wilkins.
41. Bjorkhem G, Evander E, White T, Lundstrom NR. Myocardial scintigraphy with 201 thallium in pediatric cardiology: a review of 52 cases. *Pediatr Cardiol.* 1990;11:1-7.
42. Ropers D, Baum U, Pohle K, Anders K, Ulzheimer S, Ohnesorge B, Schlundt C, Bautz W, Daniel WG, Achenbach S. Detection of coronary artery stenoses with thin-slice multi-detector row spiral computed tomography and multiplanar reconstruction. *Circulation.* 2003 ;107:664-66.
43. Nieman K, Cademartiri F, Lemos PA, Raaijmakers R, Pattynama PM, de Feyter PJ. Reliable noninvasive coronary angiography with fast submillimeter multislice spiral computed tomography. *DGCB Circulation.* 2002;106:2036-8.
44. Langerak SE, Kunz P, Vliegen HW, Jukema JW, Zwinderman AH, Steendijk P, Lamb HJ, van der Wall EE, de Roos A. MR flow mapping in coronary artery bypass grafts: a validation study with Doppler flow measurements. *Radiology.* 2002;222:127-35.
45. Chaudhry 2001 Chaudhry, FA, Ren, JF, Ramani, K, Yacoub, AS, Kane, BJ, Greene, R, and McPherson, DD. Validation of transesophageal echocardiography to determine physiologic coronary flow. *Echocardiography* 2001; 18: 553-7.
46. Doucette, JW, Corl, PD, Payne, HM, Flynn, AE, Goto, M, Nassi, M, and Segal, J. Validation of a Doppler guide wire for intravascular measurement of coronary artery flow velocity. *Circulation* 1992;85:1899-911.
47. Vanyi J, Bowers T, Jarvis G, White CW. Can an intracoronary Doppler wire accurately measure changes in coronary blood flow velocity? *Cathet Cardiovasc Diagn.* 1993 ;29:240-6.
48. Hausmann D, Mugge A, Daniel WG. The form of atherosclerotic coronary plaques: pathoanatomic concepts and new insights using intravascular ultrasound. *Z Kardiol.* 1994;83:717-26.

49. Nicholls SJ, Lundman P, Harmer JA, Cutri B, Griffiths KA, Rye KA, Barter PJ, Celermajer DS. Consumption of saturated fat impairs the anti-inflammatory properties of high-density lipoproteins and endothelial function. *J Am Coll Cardiol.* 2006;48:715-20.
50. Anderson RA, Jones CJ, Goodfellow J. Is the fatty meal a trigger for acute coronary syndromes. *Atherosclerosis.* 2001;159:9-15.
51. Pesonen E, Rapola J, Viikari J, Turtinen J, Akerblom HK. Altered serum lipid profile after systemic infection in children: risk factor for CHD? *Eur Heart J.* 1993;14 Suppl K:7-11.
52. Liuba P, Persson J, Luoma J, Yla-Herttuala S, Pesonen E. Acute infections in children are accompanied by oxidative modification of LDL and decrease of HDL cholesterol, and are followed by thickening of carotid intima-media. *Eur Heart J.* 2003;24:515-21.
53. Yla-Herttuala S. Is oxidized low-density lipoprotein present in vivo? *Curr Opin Lipidol.* 1998;9:337-44.
54. Djousse L, Rothman KJ, Cupples LA, Levy D, Ellison RC. Serum albumin and risk of myocardial infarction and all-cause mortality in the Framingham Offspring Study. *Circulation.* 2002;106:2919-24.
55. Kuller LH, Eichner JE, Orchard TJ, Grandits GA, McCallum L, Tracy RP. The relation between serum albumin levels and risk of coronary heart disease in the Multiple Risk Factor Intervention Trial. *Am J Epidemiol.* 1991;134:1266-77.
56. Vallance P, Collier J, Bhagat K. Infection, inflammation, and infarction: does acute endothelial dysfunction provide a link? *Lancet.* 1997;349:1391-2.
57. Hingorani A, Cross J, Kharbada R, Mullen M, Bhagat K, Taylor M, et al. Acute systemic inflammation impairs endothelium-dependent dilatation in humans. *Circulation.* 2000;102:994-9.
58. Vita J, Keane J Jr, Larson M, Keyes M, Massaro J, Lipinska I, et al. Brachial artery vasodilator function and systemic inflammation in the Framingham Offspring Study. *Circulation* 2004;110:3604-9.
59. Beckman JA, Creager MA, Libby P: Diabetes and atherosclerosis: epidemiology, pathophysiology, and management. *JAMA* 2002;287:2570-81.
60. Ojetti V, Pitocco D, Bartolozzi F, Danese S, Migneco A, Lupascu A, Pola P, Ghirlanda G, Gasbarrini G, Gasbarrini A: High rate of helicobacter pylori re-infection in patients affected by type 1 diabetes (Letter). *Diabetes Care* 2002;25:1485.
61. Bertoni AG, Saydah S, Brancati FL: Diabetes and the risk of infection-related mortality in the U.S. *Diabetes Care* 2001;24:1044-49.
62. Bell DS: Inflammation, insulin resistance, infection, diabetes, and atherosclerosis. *Endocr Pract* 2000;6:272-6.

63. Pai J, Pischon T, Ma J, Manson J, Hankinson S, Joshipura K, et al. Inflammatory markers and the risk of coronary heart disease in men and women. *N Engl J Med.* 2004;351:2599-610.
64. Ridker P, Hennekens C, Buring J, Rifai N. C-reactive protein and other markers of inflammation in the prediction of cardiovascular disease in women. *N Engl J Med.*2000;342:836-43.
65. Anderson J, Allen Maycock C, Lappe D, Crandall B, Horne B, Bair T, et al; Intermountain Heart Collaborative Study group. Frequency of elevation of C-reactive protein in atrial fibrillation. *Am J Cardiol.* 2004;94:1255-9.
66. Meier C, Jick S, Derby L, Vasilakis C, Jick H. Acute respiratory-tract infections and risk of first-time acute myocardial infarction. *Lancet.* 1998;351;1467-71.
67. Mamode N, Cobbe S, Pollock J. Infarcts after surgery. *BMJ.* 1995;310:1215–16.
68. Valtonen V, Kuikka A, Syrjänen J. Thrombo-embolic complications in bacteraemic infections. *Eur Heart J.* 1993;14(Suppl. K):20-3.
69. Ikeda U, Ito T, Shimada K. Interleukin-6 and acute coronary syndrome. *Clin Cardiol.* 2001;24:701-4.
70. Libby P, Ridker PM, Maseri A. Inflammation and atherosclerosis. *Circulation.* 2002 Mar 5;105:1135-43.
71. Guven A, Cetinkaya A, Aral M, Sokmen G, Buyukbese MA, Guven A, Koksall N. High-sensitivity C-reactive protein in patients with metabolic syndrome. *Angiology.* 2006;57:295-302.
72. Pesonen E. Infection and intimal thickening: evidence from coronary arteries in Children. *Eur Heart J.* 1994;15 Suppl C:57-61.
73. Liuba P, Karnani P, Pesonen E, Paakkari I, Forslid A, Johansson L, et al. Endothelial dysfunction after repeated Chlamydia pneumoniae infection in apolipoprotein E-knockout mice. *Circulation* 2000;102:1039-44.
74. Kol A, Libby P. The mechanisms by which infectious agents may contribute to atherosclerosis and its clinical manifestations. *Trends Cardiovasc Med.* 1998;8:191-9.
75. Ross R, Glomset JA. The pathogenesis of atherosclerosis. *N Engl J Med.* 1976;19;295:420-5.
76. Bruschke AV, Kramer JR Jr, Bal ET, Haque IU, Detrano RC, Goormastic M. The dynamics of progression of coronary atherosclerosis studied in 168 medically treated patients who underwent coronary arteriography three times. *Am Heart J.* 1989;117:296-305.
77. Liuba P, Pesonen E, Paakkari I, Batra S, Forslid A, Kovanen P, Pentikainen M, Persson K, Sandstrom S. Acute Chlamydia pneumoniae infection causes coronary endothelial dysfunction in pigs. *Atherosclerosis.* 2003;167:215-22.

78. Pesonen E, Andsberg E, Ohlin H, Puolakkainen M, Rautelin H, Sarna S, Persson K. Dual role of infections as risk factors for coronary heart disease. *Atherosclerosis*. 2006 Jun 14; [Epub ahead of print].
79. Murphy E. Some difficulties in the investigation of genetic factors in coronary artery disease. *Can Med Assoc J*. 1967;97:1181-92.
80. Franke A, Lante W, Fackeldey V, Becker HP, Kurig E, Zoller LG, et al. A. Pro-inflammatory cytokines after different kinds of cardio-thoracic surgical procedures: is what we see what we know? *Eur J Cardiothorac Surg* 2005;28:569-75.
81. Sternik L, Samee S, Schaff HV, Zehr KJ, Lerman LO, Holmes DR, Herrmann J, Lerman A. C-reactive protein relaxes human vessels in vitro *Arterioscler Thromb Vasc Biol* 2002;22:1865-8.
82. Zhong Y, Li SH, Liu SM, Szmítko PE, He XQ, Fedak PW, Verma S. C-Reactive protein upregulates receptor for advanced glycation end products expression in human endothelial cells. *Hypertension* 2006;48:504-11.
83. Bruins P, te Velthuis H, Yazdanbakhsh AP, et al. Activation of the complement system during and after CPB surgery: postsurgery activation involves C-reactive protein and is associated with postoperative arrhythmia. *Circulation* 1997;96:3542-8.
84. Wiklund L, Ronquist G, Roomans GM, Rubertsson S, Waldenström A. Response of myocardial cellular energy metabolism to variation of buffer composition during open-chest experimental cardiopulmonary resuscitation in the pig. *Eur J Clin Invest* 1997;27:417-26.
85. Ridker PM. C-Reactive Protein, Inflammation, and Cardiovascular Disease Clinical Update. *Tex Heart Inst J* 2005;32:384-6.
86. Corretti, M, Anderson, T, Benjamin E, et al. Guidelines for the ultrasound assessment of endothelial-dependent flow-mediated vasodilation of the brachial artery: a report of the International Brachial Artery Reactivity Task Force. *J Am Coll Cardiol* 2002;39:257-265.
87. Hozumi T, Yoshida K, Ogata Y, Akasaka T, Asami Y, Takagi T, Morioka S. Noninvasive assessment of significant left anterior descending coronary artery stenosis by coronary flow velocity reserve with transthoracic color Doppler echocardiography. *Circulation*. 1998;97:1557-62.
88. Kiviniemi TO, Saraste M, Koskenvuo JW, Airaksinen KE, Toikka JO, Saraste A, Parkka JP, Hartiala JJ. Coronary artery diameter can be assessed reliably with transthoracic echocardiography. *Am J Physiol Heart Circ Physiol*. 2004;286:1515-20.
89. Kurotobi S, Nagai T, Kawakami N, Sano T. Coronary diameter in normal infants, children and patients with Kawasaki disease. *Pediatr Int*. 2002;44:1-4.

90. American Society of Echocardiography Committee of standards, Recommendations for quantification of the left ventricle by two-dimensional echocardiograph *J Am Soc Echocardiography*. 1989;2:358-67.
91. Lewis RP, Sandler H. Relationship between changes in the left ventricular dimension and ejection fraction in man. *Circulation*. 1971;44:548-57.
92. Rooke GA, Feigl EO. Work as a correlate of canine left ventricular oxygen concentration, and the problem of catecholamine oxygen wasting. *Circ Res* 50: 273-86, 1982.
93. Laurell CB. Electroimmuno assay. *Scand J Clin Lab Inves* 1972;124:21-37.
94. Holmberg L, Berntorp E, Donner M, Nilsson IM. Von Willebrand's disease characterized by increased ristocetin sensitivity and the presence of all von Willebrand factor multimers in plasma. *Blood* 1986;68:668-72.
95. Zhang WJ, Frei B. Albumin selectively inhibits TNF alpha-induced expression of vascular cell adhesion molecule in human aortic endothelial cells. *Cardiovasc Res* 2002; 55:820-9.
96. Reuben DB, Ferrucci L, Wallace R, Tracy RB, Corti MC, Heimovitz H, Harris. The prognostic value of serum albumin in healthy older persons with low and high serum interleukin-6 (IL-6) levels. *J Am Geriatr Soc* 2000;48:1404-7.
97. Djousse L, Rothman KJ, Cupples LA, Levy D, Ellison C. Effects of serum Albumin and Bilirubin on the Risk of Myocardial Infarction (the Framingham Offspring Study). *Am J Cardiol* 2003;91:485-8.
98. Shigematsu S, Ishida S, Gute DC, Korthuis RJ. Bradykinin prevents postischemic leukocyte adhesion and emigration and attenuates microvascular barrier disruption. *Am J Physiol* 1999;277:161-71.
99. Feingold KR, Grunfeld C. Role of cytokines in inducing hyperlipidemia. *Diabetes* 1992;41(Suppl 2):97-101.
100. Laaksonen R, Janatuinen T, Vesalainen R, Lehtimäki T, Elovaara I, Jaakkola O, Jokela H, Laakso J, Nuutila P, Punnonen K, Raitakari O, Saikku P, Salminen K, Knuuti J. High oxidized LDL and elevated plasma homocysteine contribute to the early reduction of myocardial flow reserve in healthy adults. *Eur J Clin Invest* 2002;32:795-802.
101. Van Lenten BJ, Wagner AC, Nayak DP, Hama S, Navab M, Fogelman AM. High-density lipoprotein loses its anti-inflammatory properties during acute influenza A infection. *Circulation* 2001;103:2283-8.
102. Libby P, Egan D, Skarlatos S. Roles of Infectious Agents in Atherosclerosis and Restenosis. *Circulation* 1997;96:4095-103.
103. Vassalli G, Hess OM. Measurement of coronary flow reserve and its role in patient care. *Basic Res Cardiol* 1998;93:339-53.

104. Donnelly JP, Raffel DM, Shulkin BL, Corbett JR, Bove EL, Mosca RS, Kulik TJ. Resting coronary flow and coronary flow reserve in human infants after repair or palliation of congenital heart defects as measured by positron emission tomography. *J Thorac Cardiovasc Surg* 1998;115:103-10.
105. Kozak-Barany A, Jokinen E, Rantonen T, Saraste M, Tuominen J, Jalonen J, Valimaki I. Efficiency of left ventricular diastolic function increases in healthy full-term infants during the first months of life. A prospective follow-up study. *Early Hum Dev* 2000;57:49-59.
106. Sellke FW, Boyle Jr EM, Verrier ED. Endothelial cell injury in cardiovascular surgery: the pathophysiology of vasomotor dysfunction. *Ann Thorac Surg* 1996;62:1222-8.
107. Christen S, Finckh B, Lykkesfeldt J, Gessler P, Frese-Schaper M, Nielsen P, Schmid ER, Schmitt B. Oxidative stress precedes peak systemic inflammatory response in pediatric patients undergoing cardiopulmonary bypass operation. *Free Radic Biol Med* 2005;38:1323-32.
108. Lamas S, Michel T, Brenner BM, Marsden PA. Nitric oxide synthesis in endothelial cells: evidence for a pathway inducible by TNF-alpha. *Am J Physiol* 1991;261:C63-641.
109. Rubanyi GM, Vanhoutte PM. Superoxide anions and hyperoxia inactivate endothelium-derived relaxing factor. *Am J Physiol* 1986;250:822-7.
110. Gryglewski RJ, Palmer RMJ, Moncada S. Superoxide anion is involved in the breakdown of endothelium-derived relaxing factor. *Nature* 1986;320:454-60.
111. Khan TA, Bianchi C, Ruel M, Voisine P, Li J, Liddicoat JR, Sellke FW. Mitogen-activated protein kinase inhibitor and cardioplegia-cardiopulmonary bypass reduce coronary myogenic tone. *Circulation* 2003;108:348-53.
112. Sellke FW, Friedman M, Dai HB, Shafique T, Schoen FJ, Weintraub RM, Johnson RG. Mechanism causing coronary microvascular dysfunction following crystalloid cardioplegia and reperfusion. *Cardiovasc Res* 1993;27:1925-32.
113. Sellke FW, Shafique T, Ely DL, Weintraub RM. Coronary endothelial injury after cardiopulmonary bypass and ischemic cardioplegia is mediated by oxygen-derived free radicals. *Circulation* 1993;88:395-400.
114. Wang SY, Friedman M, Franklin A, Sellke FW. Myogenic reactivity of coronary resistance arteries after cardiopulmonary bypass and hyperkalemic cardioplegia. *Circulation* 1995;92:1590-96.
115. Paparella D, Galeone A, Venneri MT, Coviello M, Visicchio G, Cappabianca G, Maselli G, Marraudino N, Quaranta M, De Luca Tuppiti Schinosa L. Blood damage related to cardiopulmonary bypass: in vivo and in vitro comparison of two different centrifugal pumps. *ASAIO J.* 2004;50:473-8.

116. Gaspardone A, Versaci F, Tomai F, et al. C-Reactive protein, clinical outcome, and restenosis rates after implantation of different drug-eluting stents. *Am J Cardiol* 2006;97:1311-16.
117. Hanseus KC, Bjorkhem G, Brodin LA, Pesonen E. Analysis of atrioventricular plane movements by Doppler tissue imaging and M-mode in children with atrial septal defects before and after surgical and device closure. *Pediatr Cardiol*. 2002;23:152-59.
118. Nagaya N, Nishikimi T, Uematsu M, Kyotani S, Satoh T, Nakanishi N, Matsuo H, Kangawa K.. Secretion patterns of brain natriuretic peptide and atrial natriuretic peptide in patients with or without pulmonary hypertension complicating atrial septal defect. *Am Heart J*. 1998;136:297-301.
119. Muta H, Ishii M, Maeno Y, Akagi T, Kato H. Quantitative evaluation of the changes in plasma concentrations of cardiac natriuretic peptide before and after transcatheter closure of atrial septal defect. *Acta Paediatr* 2002;91:649-52.
120. Hiratzka LF, Eastham CL, Carter JG, Moyers JR, Elliott DR, Doty DB, Wright CB, Marcus ML. The effects of cardiopulmonary bypass and cold cardioplegia on coronary flow velocity and the reactive hyperemic response in patients and dogs. *Ann Thorac Surg* 1988;45:474-81.
121. Verma S, Li SH, Badiwala MV, Weisel RD, Fedak PW, Li RK, Dhillon B, Mickle DA. Endothelin antagonism and interleukin-6 inhibition attenuate the proatherogenic effects of C-reactive protein. *Circulation*. 2002;105:1890-6.
122. Pernow J, Wang QD. Endothelin in myocardial ischaemia and reperfusion. *Cardiovasc Res* 1997;33:518-26.
123. Lafuente N, Azcutia V, Matesanz N, Cercas E, Rodriguez-Manas L, Sanchez-Ferrer CF, Peiro C. Evidence for sodium azide as an artefact mediating the modulation of inducible nitric oxide synthase by C-reactive protein. *J Cardiovasc Pharmacol*. 2005;45:193-196.
124. Heltné JK, Koller ME, Lund T, Bert J, Rynning SE, Stangeland L, Husby P. Dynamic evaluation of fluid shifts during normothermic and hypothermic cardiopulmonary bypass in piglets. *Acta Anaesthesiol Scand* 2000;44:1220-5.