



LUND UNIVERSITY

Capacitive Circuit Method for Fast and Efficient Design of Wideband Radar Absorbers

Kazemzadeh, Alireza; Karlsson, Anders

2008

[Link to publication](#)

Citation for published version (APA):

Kazemzadeh, A., & Karlsson, A. (2008). *Capacitive Circuit Method for Fast and Efficient Design of Wideband Radar Absorbers*. (Technical Report LUTEDX/(TEAT-7174)/1-20/(2008); Vol. TEAT-7174). [Publisher information missing].

Total number of authors:

2

General rights

Unless other specific re-use rights are stated the following general rights apply:

Copyright and moral rights for the publications made accessible in the public portal are retained by the authors and/or other copyright owners and it is a condition of accessing publications that users recognise and abide by the legal requirements associated with these rights.

- Users may download and print one copy of any publication from the public portal for the purpose of private study or research.
- You may not further distribute the material or use it for any profit-making activity or commercial gain
- You may freely distribute the URL identifying the publication in the public portal

Read more about Creative commons licenses: <https://creativecommons.org/licenses/>

Take down policy

If you believe that this document breaches copyright please contact us providing details, and we will remove access to the work immediately and investigate your claim.

LUND UNIVERSITY

PO Box 117
221 00 Lund
+46 46-222 00 00

Capacitive Circuit Method for Fast and Efficient Design of Wideband Radar Absorbers

Alireza Kazemzadeh and Anders Karlsson

Electromagnetic Theory
Department of Electrical and Information Technology
Lund University
Sweden

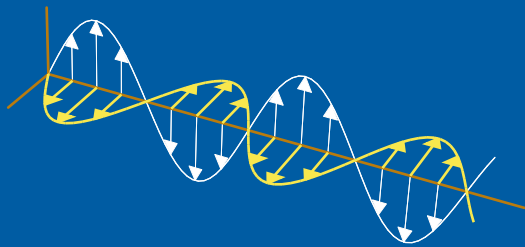

Alireza Kazemzadeh and Anders Karlsson
{Alireza.Kazemzadeh,Anders.Karlsson}@eit.lth.se

Department of Electrical and Information Technology
Electromagnetic Theory
Lund University
P.O. Box 118
SE-221 00 Lund
Sweden

Editor: Gerhard Kristensson

© Alireza Kazemzadeh and Anders Karlsson, Lund, October 30, 2008

Abstract

A simple, fast and efficient method for designing wideband radar absorbers is proposed. The idea is to modify the circuit analog absorber method without perturbing the bandwidth. This is done by utilizing the asymptotic behavior of such an absorber at low frequency and replacing the band-stop resonating frequency selective surfaces with low-pass capacitive ones, which can be synthesized by square patches. It is shown that higher frequencies are not influenced by these modifications. A thin wideband capacitive circuit absorber (CCA) is presented with 28% reduction of thickness and 57% increase of bandwidth in comparison to the Salisbury screen. It is also explained why some optimized metamaterial designs fail to compete with the CCA method. For high permittivity layers, it is shown that the CCA is a better solution than the Jaumann absorber and improvements both in thickness and bandwidth are possible. A three layered ultra wideband (4–24 GHz) CCA is presented with total thickness of 15.1 mm. Finally, a design capable of handling oblique angles of incidence for both polarizations and fulfilling different mechanical, thermal and fabrication constraints is given. The absorption band covers the entire C, X and Ku radar bands (4–18 GHz), showing significant improvement compared to the published circuit analog absorbers.

1 Introduction

The design of radar absorbers goes back to the world war II, where Salisbury [5] and Jaumann absorbers [2, 3] were introduced. In these absorbers, homogenous resistive sheets with different resistivity values are placed a quarter of a wavelength (at mid-frequency) apart to absorb power from the incident wave. Although these absorbers are simple to manufacture, they do not possess wideband response unless a large number of layers are used. This is impractical in most applications due to thickness and weight restrictions.

To achieve a wider frequency response, circuit analog absorbers were introduced [9]. Instead of plain resistive sheets, periodic patterns called frequency selective surfaces are employed. The type of frequency selective surfaces used in the design are band-stop resonating surfaces which are modeled by series RLC resonators at the operating band. The design procedure of circuit analog absorber consists of three steps:

1. Design the equivalent circuit model of the absorber by the aid of the Smith chart or a circuit simulating software.
2. Synthesize the RLC circuits of the previous step by suitable resistive frequency selective surfaces.
3. Simulate and improve the frequency response of the whole absorber structure in a full wave simulator.

The analysis of the equivalent circuit model and its adjustment to different design requirements is a straightforward task, but in the synthesizing step, parameters such

as realizability, sensitivity and simplicity of the full wave analysis and adjustment should be considered. This makes the method dependent on a rich lookup table of parametric analysis of different periodic structures. In this paper a simple design method, the capacitive circuit method, is proposed. By considering the asymptotic behavior of circuit analog absorbers, it is shown that low-pass frequency selective surfaces can replace the resonating structures at low frequency. By providing a fair approximation for the highest achievable absorption frequency for the class of circuit analog absorbers with maximum three FSS layers (including Jaumann and capacitive circuit absorber as special cases), it is explained in detail why this replacement has imperceptible effect on bandwidth (by proper design). Therefore, instead of utilizing resonating RLC circuits (Fig. 1) the absorber is formed by low-pass RC circuits, see Figs. 4 and 11(a). This has some valuable benefits:

1. Designs with thinner total thickness and still comparable bandwidths are possible in some applications (for example, see subsections 3.1, 3.2).
2. Symmetric square patches can be used to synthesize the RC circuits.
3. For large width to periodicity ratios ($w/a > 0.7$, see Fig. 4), the low-pass RC model of the square patch periodic array is valid over a very large bandwidth, see Fig. 5. This is not easy to achieve with resonating patterns because harmonics of the fundamental resonance restrict the RLC model bandwidth, see Fig. 6.

The process of FSS pattern selection and the required rich lookup tables of parametric analysis of resonating surfaces are omitted, which simplifies the design problem significantly. The method of capacitive circuit absorber is presented in the following section and many design examples are provided to demonstrate the potentials and applications of the method. Specially it is shown that in some cases the capacitive circuit absorber is the only possible or the best design when compared to the conventional Jaumann and circuit analog absorbers.

2 From circuit analog absorber to capacitive circuit absorber

The circuit model of a typical three layered circuit analog absorber is shown in Fig. 1. The procedure of finding the proper RLC values of the equivalent circuit model for matching it to free space impedance in the operating frequency band is a straightforward task. It can be done by utilizing the Smith chart [9] or a simulating software. Henceforth, it is assumed that this step is done for the circuit analog absorber. The cumbersome step is the synthesis of these RLC values by resistive frequency selective surfaces. There exists a wide range of geometries that are band-stop, equivalent to series RLC resonator over a certain frequency band, see Fig. 2. The bandwidth over which the RLC model can be applied is unit cell geometry dependent, see, *e.g.*, Fig. 6. A common misbelief is that a frequency selective surface

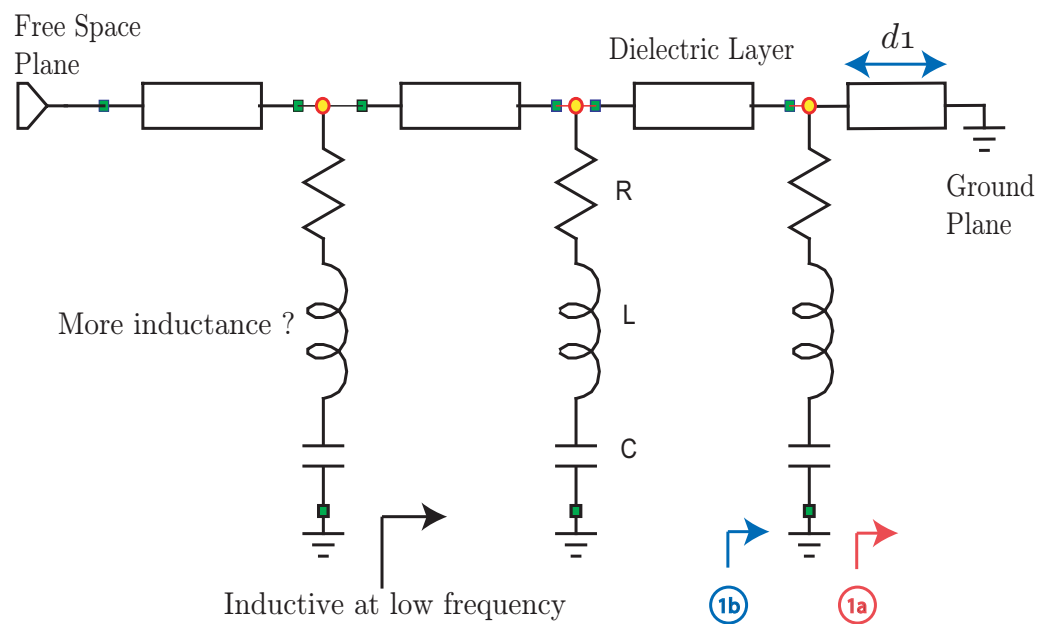

Figure 1: The circuit model of a generic three layered circuit analog absorber.

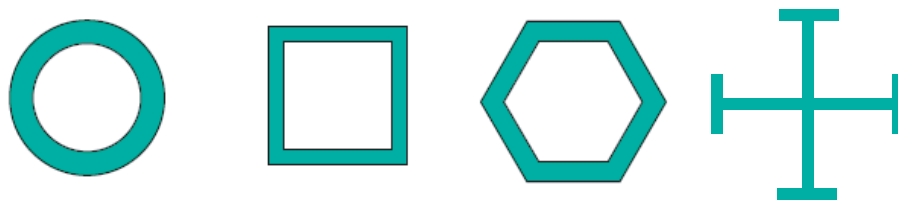

Figure 2: Some examples of band-stop resonating FSS geometries.

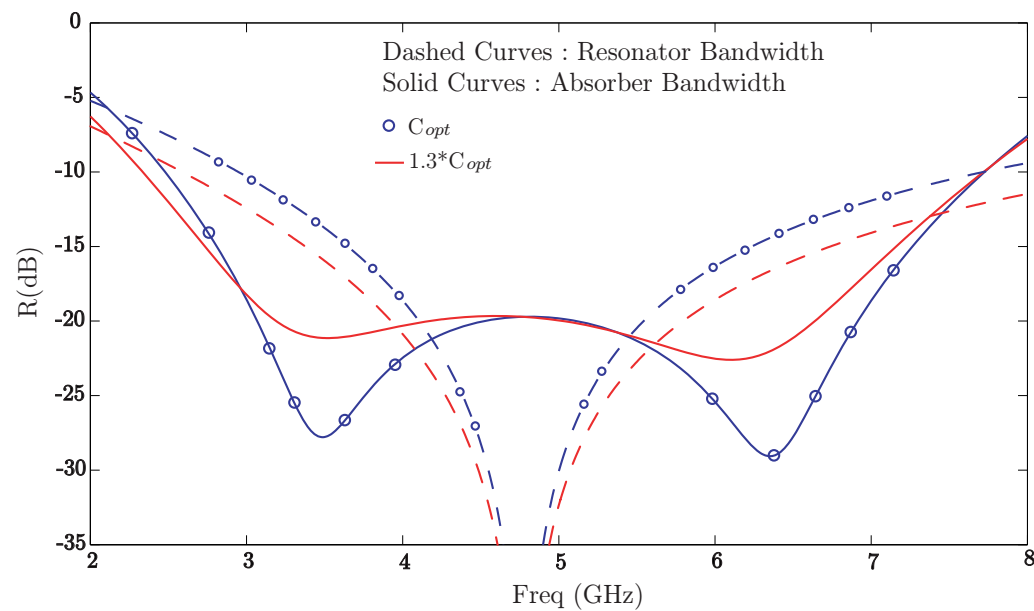

Figure 3: Comparison of the series RLC resonator bandwidth (equivalent to FSS structure it models) and the corresponding single layer circuit analog absorber.

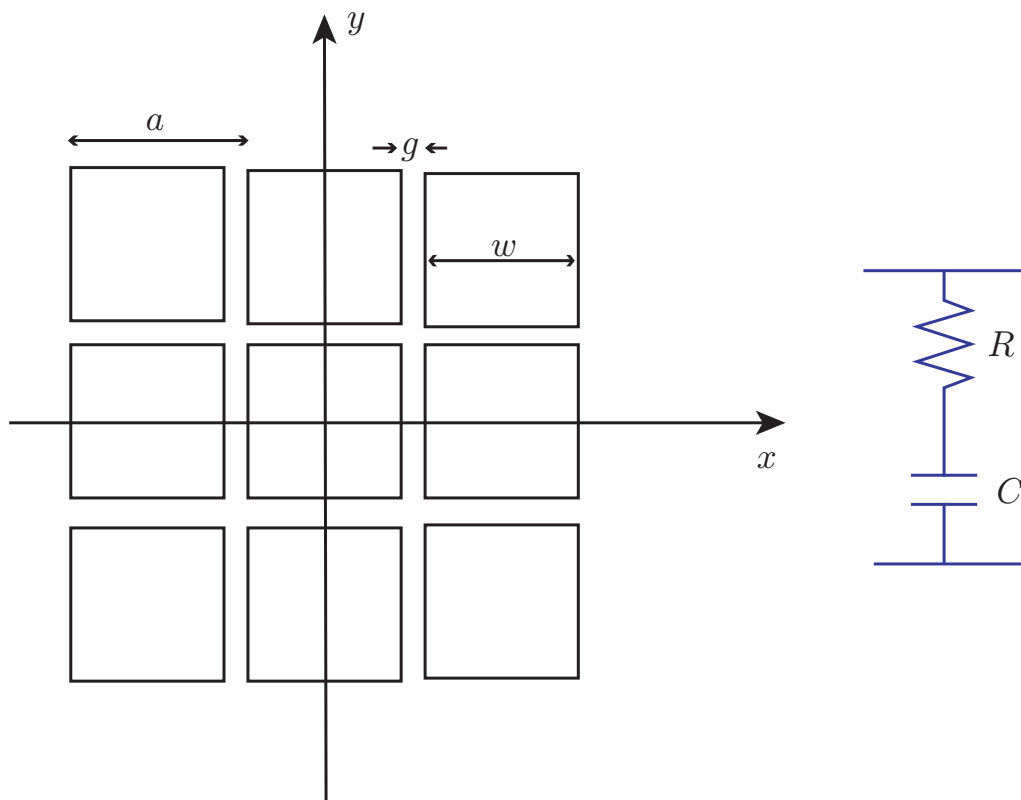

Figure 4: The geometry of the square patch and its equivalent circuit model.

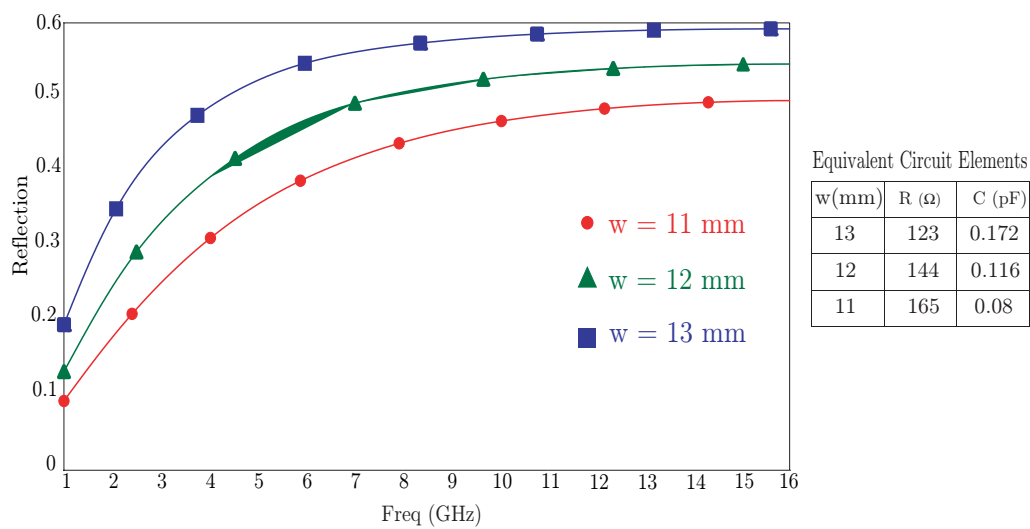

Figure 5: Frequency response (reflection coefficient) and equivalent circuit element values for a typical square patch, at normal incidence. ($a = 14$ mm, $R_s = 100 \Omega/\text{Sq}$)

with larger transmission/reflection bandwidth always results in wider absorption frequency response. Consequently it is tempting to construct the absorber by complex geometry patterns (*e.g.*, optimized unit cell elements) in hope of achieving significant bandwidth improvement. The following example shows that it is not always true. Consider a single layer circuit analog absorber with a thickness equal to $\lambda/4$ @ 5 GHz. The equivalent circuit model of the absorber consists of a series RLC circuit (modeling the resonating FSS layer) and a transmission line parallel to the RLC network and short circuited at the other end (the ground plane). The resonance frequency (F_r), the capacitance (C) and the resistance (R) of the RLC circuit are optimized to obtain the largest achievable 20 dB absorption bandwidth (3–7 GHz). The optimization results in $F_r = 4.77$ GHz, $C = 0.1616$ pF and $R = 309.6 \Omega$. It is well-known that for fixed resonance frequency increase of the capacitance enlarges the bandwidth of a series RLC circuit. But as seen from the Fig. 3, although the RLC circuit bandwidth has increased the opposite takes place for the absorption bandwidth. Therefore, it is very important to synthesize the optimal L,C values for absorption, as accurately as possible. This might be done with an FSS pattern which is not the most wideband FSS pattern when considered as a spatial filter (reflection/transmission response). Successful synthesis of these RLC values requires a rich database of parametric analysis of different types of FSS structures. Omitting these rich lookup tables of RLC values and simplifying the synthesis process is very helpful and time-saving.

The capacitive circuit method proposed in this paper aims at these goals. The idea is to replace band-stop resonating elements by low-pass resistive-capacitive (series RC) ones. The series RC circuits are synthesized by one of the simplest patterns for FSS structures, the square patch, see Fig. 4. Two degrees of freedom of the geometry, periodicity (a) and width (w), simplify the analysis and adjustment of the absorber. One important feature of the square patch is the simple relationship between RC values of the equivalent circuit and the pattern dimensions and the sheet resistivity (and the permittivity and thickness of the dielectric cover they are embedded in). This relationship can be extracted by a few number of simulations, for example the values represented in Fig. 5. Another interesting fact about the square patch array is that the RC model is valid over a very large bandwidth which can not be achieved by resonating frequency selective surfaces due to the harmonics of the fundamental resonance.

2.1 Low frequency regime

In this part it is shown that based on the low frequency behavior of the circuit analog absorber, the elimination of the inductance from the RLC circuit can be realized. The next step is to show that this does not affect higher frequencies (bandwidth of the absorber) by proper design. Rozanov [12] has shown a physical bound on the lowest achievable frequency of an absorber for a given reflectance and thickness. The bound is valid for any metal backed absorber with arbitrary dispersive relation of permittivity and permeability satisfying Kramers-Kronig relations and is derived from the analyticity of the reflection coefficient in the upper half-plane of the complex

plane ω [11]. The bound for a multilayered absorber is

$$|\ln \rho_0|(\lambda_{\max} - \lambda_{\min}) < 2\pi^2 \sum_i \mu_{s,i} d_i \quad (2.1)$$

In the above equation ρ_0 is the maximum allowable reflection coefficient, $\mu_{s,i}$ is the static permeability of layer i , and d_i is the thickness of the corresponding layer. For a broadband absorber that contains no magnetic material the above equation simplifies to

$$\lambda_{\max} \Gamma_0 \leq 172 d \quad (2.2)$$

where Γ_0 is the reflection coefficient in dB and d is the total thickness of the absorber. For a given return loss and thickness Eq. 2.2 confines the lowest absorption frequency to a theoretical limit. The most important fact for our purpose is that below and close to this frequency any metal backed absorber is inductive. It can be understood better from the asymptotic behavior of the reflection coefficient of a metal backed slab [1] which is used in the derivation of the above formulas

$$\lim_{|\lambda| \rightarrow \infty} \rho(\lambda) = -1 + j4\pi\mu d/\lambda \quad (2.3)$$

implying an inductive load. A better illustration of the idea can be seen from the low frequency behavior of the reflection coefficients in the Smith chart of Fig. 7.

Now the circuit model of the circuit analog absorber is reviewed, see Fig. 1. Consider the big arrow in the figure pointing towards the ground plane. From the above statements it is known that independent of the RLC values of equivalent impedances and permittivity and thicknesses of layers, the equivalent load seen from the ground plane side is inductive at low frequency. Therefore, additional inductance in the RLC circuit of the succeeding layer is more destructive than being effective for matching. Only a capacitive load is required to compensate the equivalent load inductance. Therefore, at low frequency band the elimination of the inductance from the resonating RLC can be performed without causing mismatch.

2.2 High frequency band

The theoretical bound of the previous section (Eq.2.2), limits the lowest possible absorption frequency for a given reflection coefficient and thickness, and gives no constraint on the highest possible absorption frequency (for wideband absorber). Generally the highest absorption frequency is limited by the design method and the structure of an absorber.

In what follows, we consider the class of circuit analog absorbers of maximum three FSS layers (the schematic is shown in Fig. 1), including Jaumann and capacitive circuit absorbers. The following factors limit the highest possible bandwidth of this class of absorbers.

1. The frequency dependant behavior of the equivalent impedance at distance d from the ground plane ($Z_{\text{eq}} = j \frac{Z_0}{\sqrt{\epsilon_r}} \tan(2\pi \sqrt{\epsilon_r} d/\lambda_0)$).

2. The grating lobes when FSS pattern are used to construct the absorber.
3. The higher harmonics of the fundamental resonance in case of resonating FSS patterns (not in case of capacitive circuit absorber, low-pass behavior in the operating bandwidth).

Consider the equivalent circuit model of the three layered circuit analog absorber of Fig. 1. The thickness of the first layer is indicated by d_1 and is usually about a quarter of wavelength at mid-frequency. At this frequency the phase difference of the reflected wave from the ground plane generates an open circuit at the point (1a) of Fig. 1, and makes no contribution to the equivalent load impedance seen at point (1b). At twice of this frequency (one octave higher), the reverse happens and the ground plane generates a short circuit at point (1a), and consequently independent of the equivalent load (FSS structure type) the impedance seen at point (1b) is short circuit. In case of a single layer absorber it results in total reflection independent of the type of FSS layer used. For two and three layered circuit analog absorber it causes the reduction of the layer numbers (the ground plane is shifted to point (1b)) which mostly results in a high reflection coefficient. The solution is to use many layers such that, reduction of one layer does not reduce the order of absorber significantly. This is impractical for circuit analog absorbers (the grating lobes and higher harmonics also limit the high frequency) and in case of Jaumann absorber it results in thicknesses which limit the applications of the absorber.

The next factor limiting the high frequency bandwidth is the excitation of grating lobes at frequencies larger than the lowest cutoff frequency (Floquet's modes). This frequency is inversely proportional to the spatial periodicity of the FSS [9]. Consequently it might seem that decreasing the spatial periodicity is a simple solution. Unfortunately, reduction of the periodicity makes the synthesizing process of RLC circuits impractical by reducing the capacitance and increasing the resonance frequency. Therefore, the minimum possible periodicity is usually dictated by the largest capacitance of the absorber circuit model which is synthesized by the FSS. To verify the statements an example is provided for a lossless (PEC) square ring pattern. The lossless case is considered to emphasize just the effect of periodicity reduction on the circuit elements (since the loss will influence the inductance value and consequently the resonance frequency). Table 2.2 represents the LC values for a typical square ring (periodicity = 14 mm, width of outer square = 12 mm and ring thickness = 1 mm) when its dimensions are all scaled by the given factor. As seen from the table the capacitance value is proportional to the scale factor.

Scale	F_r (GHz)	C (pF)	L (nH)
1	10	0.1	2.54
0.8	12.51	0.08	2.02
0.6	16.68	0.06	1.52

Table 1: Effect of scaling on LC values of the square ring.

The third limiting factor is the harmonics of the fundamental resonance, restricting the frequency band over which the RLC model can be applied to the FSS

pattern. This feature is skipped in case of square patches ($w/a \geq 0.7$), since they are low-pass structures and do not possess any resonance and harmonics over a very large bandwidth. Therefore, the square patch can be modeled more accurately over a very wideband bandwidth than resonating patterns. This is one major reason why the capacitive circuit absorbers in practice are more convenient to work with than the resonating circuit analog absorbers. Fig. 6(a) shows the frequency response of the square ring of the previous example and Fig. 6(b) the frequency response of a wideband resonating pattern, the hexagon ring. Also the LC models are compared with the actual frequency responses to show the limitation of their bandwidths. In Fig. 6(c) a slight deviation from normal incidence is considered to excite the harmonics strong enough for visualization. For a fair comparison the same periodicity as the square patches of Fig. 5 is used for the ring elements. Compare the bandwidth of the RLC models of Fig. 6 with the very accurate RC model of Fig. 5.

From the above statements on high frequency band limits and the theoretical limits of the previous subsection for the low frequency band, it is concluded that for the class of circuit analog absorber with maximum three FSS layers (Jaumann and capacitive circuits included) the absorption bandwidth hardly covers 3 octaves. If this achievable bandwidth is covered by a simple, fast and flexible method, there is no need to look for more complex designs. The design examples of the next section and their comparison to the best absorbers published verify this fact.

Before ending the section the circuit model of Fig. 1 is reconsidered. It was shown that the elimination of the inductances from the RLC circuits does not affect the low frequency absorption since the inductance is provided by the ground plane. But elimination of the inductances from the circuit model decreases the circuit order, so how can it achieve the same absorption bandwidth as the circuit analog absorbers? The answer to the question is the real potential of the capacitive circuit absorbers. In contrast to circuit analog or Jaumann absorbers, the dielectric layers are not restricted to be a quarter of a wavelength at a center frequency. Therefore, equal to the number of inductances reduced, new variable (thickness) is added to the circuit. This keeps the order of the equivalent circuit model unchanged. The flexibility of layer thickness results sometimes in designs thinner than conventional methods, which is very interesting for some applications (maybe with a tradeoff for small bandwidth reduction, case dependent). To verify that this replacement of variables is possible a design example in circuit model is shown in Fig. 7. A capacitive circuit absorber and a circuit analog absorber are designed (the equivalent circuits) and compared to verify that the reduction of inductances can be compensated by variable transmission line lengths (dielectric layer thicknesses).

3 Design examples, comparisons and explanations

In this section different design examples are provided to demonstrate the high potentials of the capacitive circuit method. Comparisons to well-known wideband designs show that improvements in both thickness and bandwidth are possible. In the first three examples all the physical and electrical details of the absorbers are presented

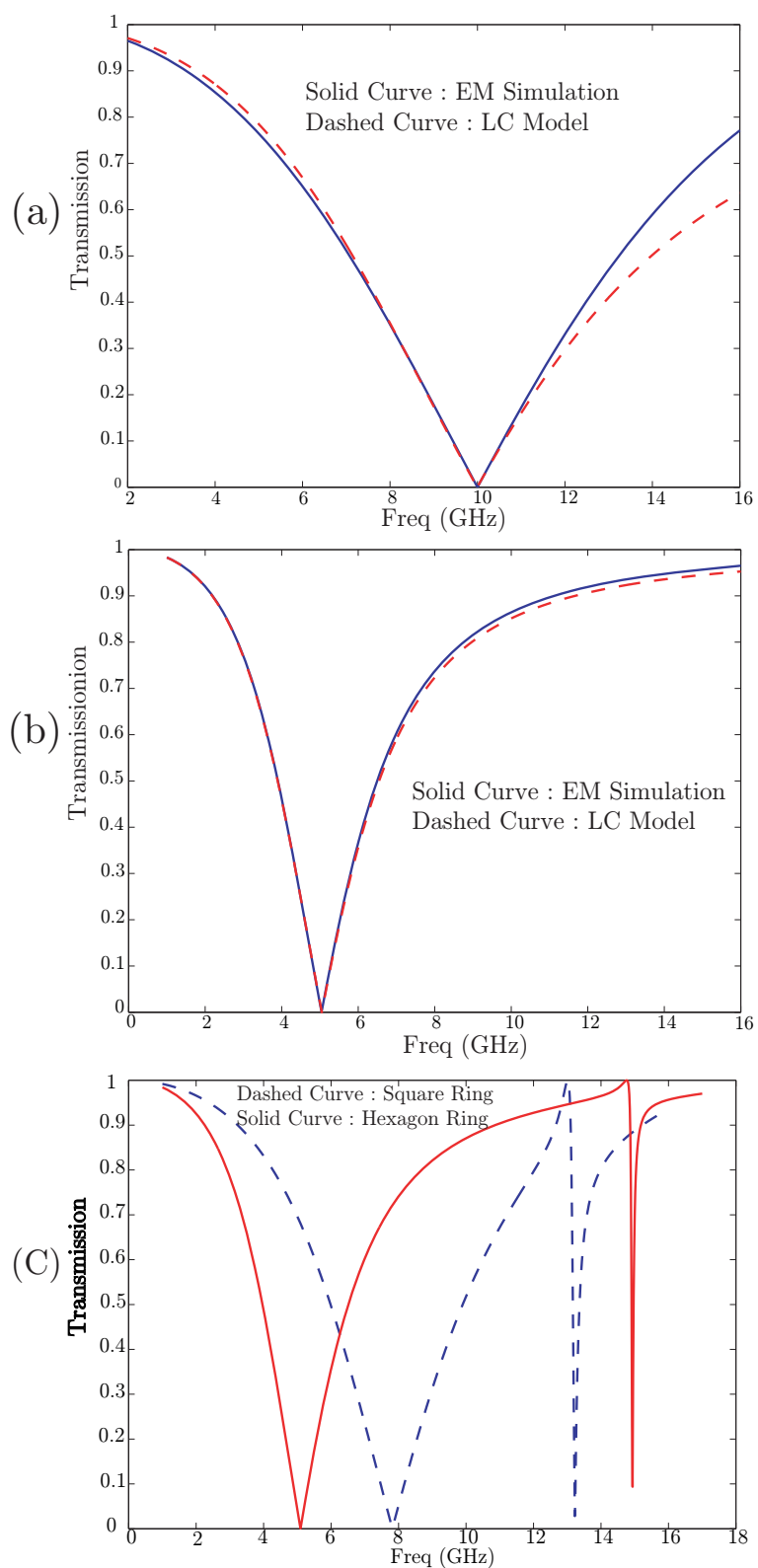

Figure 6: The frequency response (transmission coefficient) of a square and hexagon ring indicating the effect of harmonics on the RLC model bandwidth. (a) Normal incidence, Square ring (b) Normal incidence, Hexagon ring (c) Oblique angle of incidence = 15° . (periodicity in x-direction 1.4 cm)

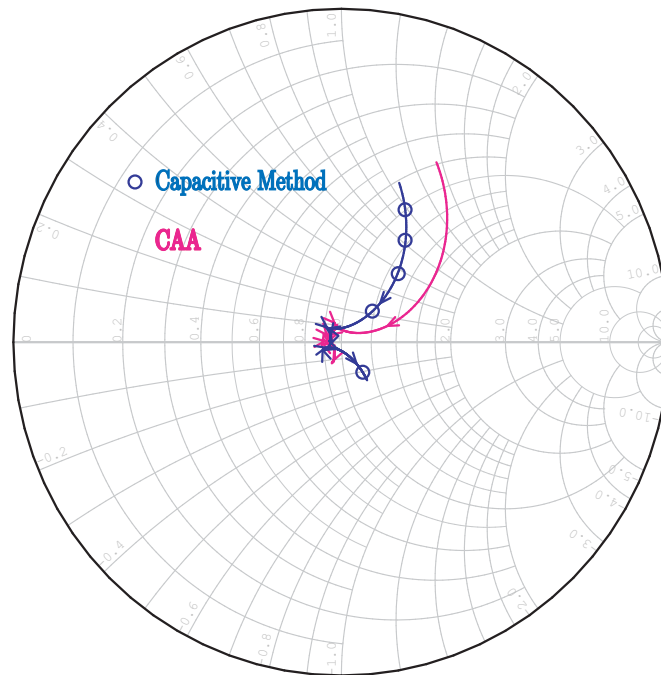
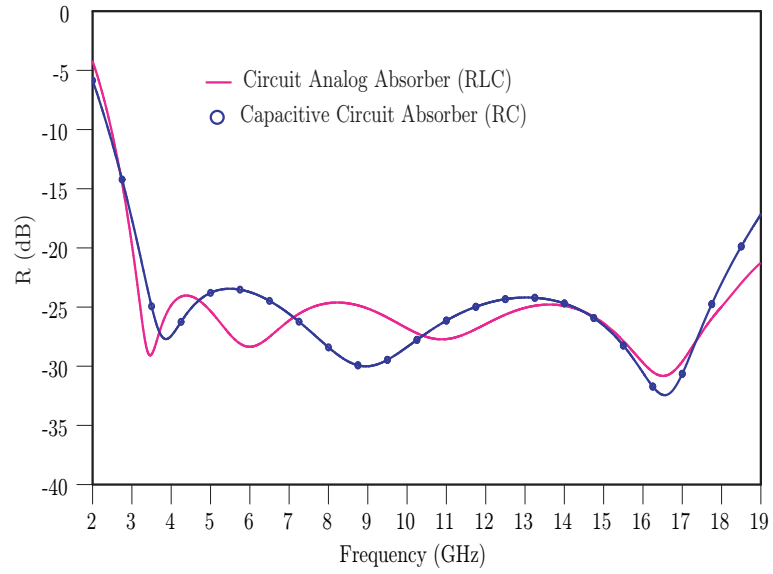

Figure 7: The frequency response of a three layered circuit analog absorber compared with a three layered capacitive circuit method. (Circuit Model, Operating band 3–18 GHz, return loss = 25 dB)

to make the reconstruction of the absorber and verification of the design method possible.

3.1 Thin wideband Absorber

Designing a thin absorber with a wideband frequency response is a challenging problem. From the theoretical bound (Eq. 2.1) it is expected that reduction of thickness reduces the bandwidth. A common approach to construct such an absorber is to use metamaterials, sometimes accompanied with genetic algorithm optimization [4, 6–8]. The designs proposed by the papers are extremely narrowband (less than 10%, *e.g.*, designs in [7]) which in most cases can be achieved easily by a Salisbury thin absorber (high permittivity for the substrate). It is shown that the capacitive circuit method is able to offer a significant improvement both in thickness and bandwidth compared to the Salisbury screen by proper design. It is explained why some of the proposed meta-surfaces fail to achieve any practical bandwidth. The schematic of a single layer capacitive circuit absorber is shown in Fig. 8(b). Since the Salisbury screen has its largest bandwidth for substrate permittivity $\epsilon_r = 1$, the CCA is also designed with this permittivity to emphasize that the reduction in the thickness is achieved by the method itself and not by high permittivity of substrate. Table 3.1 presents values of the circuit model components for achieving the best possible bandwidth for the given thickness. As seen the thickness of the CCA is reduced about 27% compared to the Salisbury screen. Comparison of frequency response of the CCA with the Salisbury screen, Fig. 9, shows remarkable bandwidth improvement about 57%. The RC values of the thin CCA, represented in Table 3.1 are synthesized by a resistive square patch with $a = 15$ mm, $w = 13$ mm and $R_s = 218 \Omega/\text{Sq}$. The details of the 20 dB absorption bandwidths are given in Table 3.1. Thinner absorbers are also possible to design in tradeoff with bandwidth. It is important to notice that although the thickness of the CCA is reduced by a factor of 0.725, it represents the same low frequency behavior as the Salisbury screen, see Fig. 9. It shows that capacitive circuit absorber uses the low frequency band dictated by the theoretical bound (Eq. 2.2) more efficiently than Salisbury. Now, two important questions are posed. The answers to them are helpful for understanding the beauty of the CCA approach.

1. Is it possible to improve bandwidth by using circuit analog (resonating RLC) approach?
2. Why do most optimized patterns (metamaterials) fail in achieving a good absorption bandwidth?

Consider the Smith chart of Fig. 8(a). The curve marked by (1a) represents the impedance seen at the point (1a) of the schematic of Fig. 8(b). As seen, in the whole absorption band this impedance is inductive for the given thickness. Therefore, additional inductances in the RLC circuit is not only helpful but also destructive for matching. This is a good example to show that there are cases in which the capacitive circuit absorber is more flexible than circuit analog absorber.

To answer the second question, a close look at a metamaterial pattern and its frequency response is needed. For this purpose the first pattern proposed by Kern

Method	Thickness(mm)	R_1 (Ω)	C_1 (pF)
Salisbury	8	367	–
Capacitive Circuit	5.8	318.8	0.135

Table 2: The electrical values of the equivalent circuits for salisbury and cca, see Fig. 8(b).

Method	F_L (GHz)	F_H (GHz)	BW (GHz)
Salisbury	8.18	10.55	2.37
Capacitive Circuit	8.14	11.87	3.73

Table 3: 20 dB absorption bandwidth comparison of the salisbury and cca. (Full wave simulation, see Fig. 9.)

and Werner [7] is considered and an extremely accurate equivalent circuit model valid over a wideband frequency range is proposed, see Fig. 10. To see the resonances of the meta-surface clearly and focus on its frequency response characteristics (reactive part of equivalent load is more important than the loss for our purpose) the lossless case (PEC) is considered. The unit cell pattern of the meta-surface is shown in Fig. 10(a) and the equivalent circuit which is valid over the whole frequency band of interest is represented in Fig. 10(b). The circuit model consists of a parallel LC network (L_2 & C_2) connected (in parallel) to a series LC network (L_1 & C_1). The parallel LC network models the effective slot area of the pattern and the series LC its ring effective area. The frequency response of the meta-surface simulated in an electromagnetic solver with high precision and the frequency response of the equivalent circuit model are shown in Fig. 10(c). The frequency response (reflection coefficient) of the meta surface has a null at 8.44 GHz (due to the mutual effect of parallel and series resonators) and a peak at 8.944 GHz (due to resonance of the series LC), also the equivalent circuit model shows that the effective slot has a resonance of 11.5 GHz. By giving this values, it is surprising that the absorber of Kern and Werner [7] is optimized at 6 GHz, where the meta-surface is inductive. Therefore, they had to use a substrate with $\epsilon_r = 6$ to lower down the resonance frequencies and increasing the capacitances of the equivalent circuit without paying attention that for this high permittivity the thickness to wavelength ratio is not 1/10 and increases to 0.245 i.e. the electrical thickness of Salisbury screen, but still their design does not have any bandwidth improvement compared to the simple Salisbury screen. To summarize, if any unit cell pattern for the FSS, independent of what is named (meta-surface or artificial magnetic conductor and so on) is going to be used for constructing a thin absorber, it must be capacitive in the whole absorption band. Therefore, forcing the optimizer to search among a set of patterns that they have redundant inductances will not result in good designs.

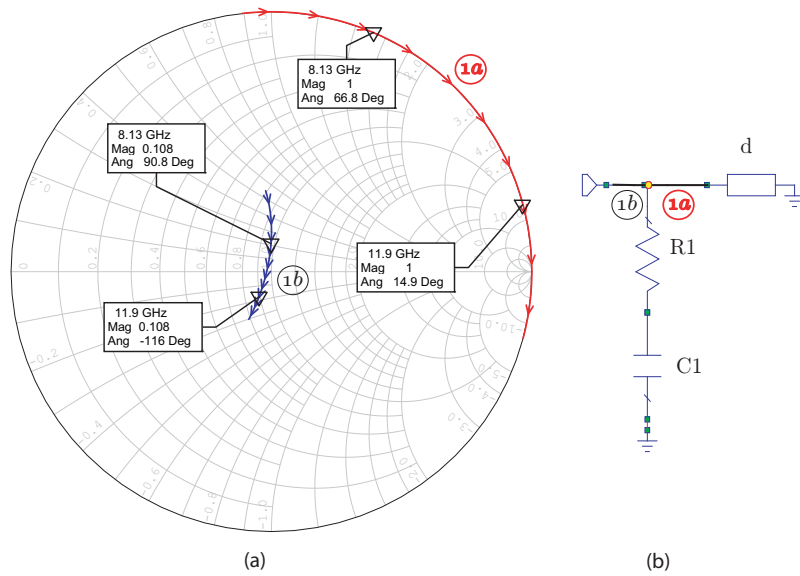

Figure 8: The equivalent circuit model of the thin wideband capacitive circuit absorber. (a) The reflection coefficient at points 1a and 1b. (b) The schematic of the single layer capacitive circuit absorber.

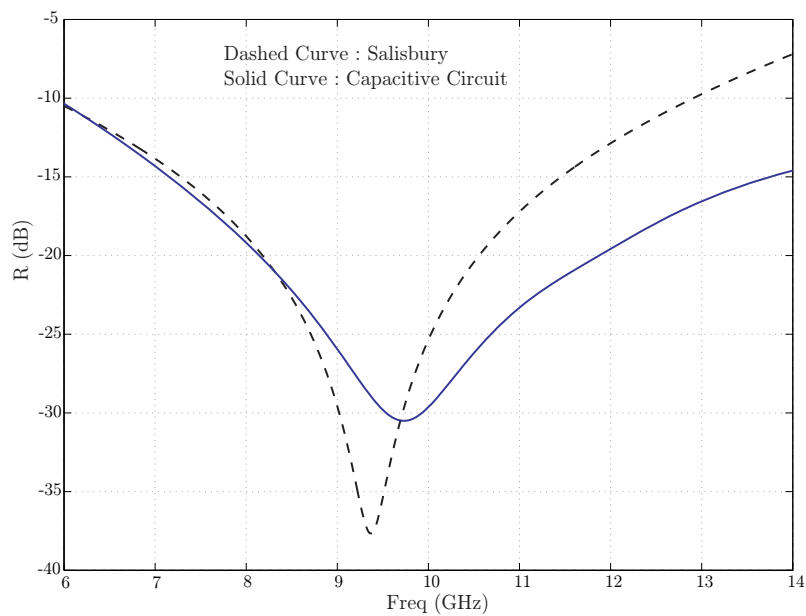

Figure 9: Comparison of the Salisbury and the thin capacitive circuit absorber bandwidths. (Full wave simulation.)

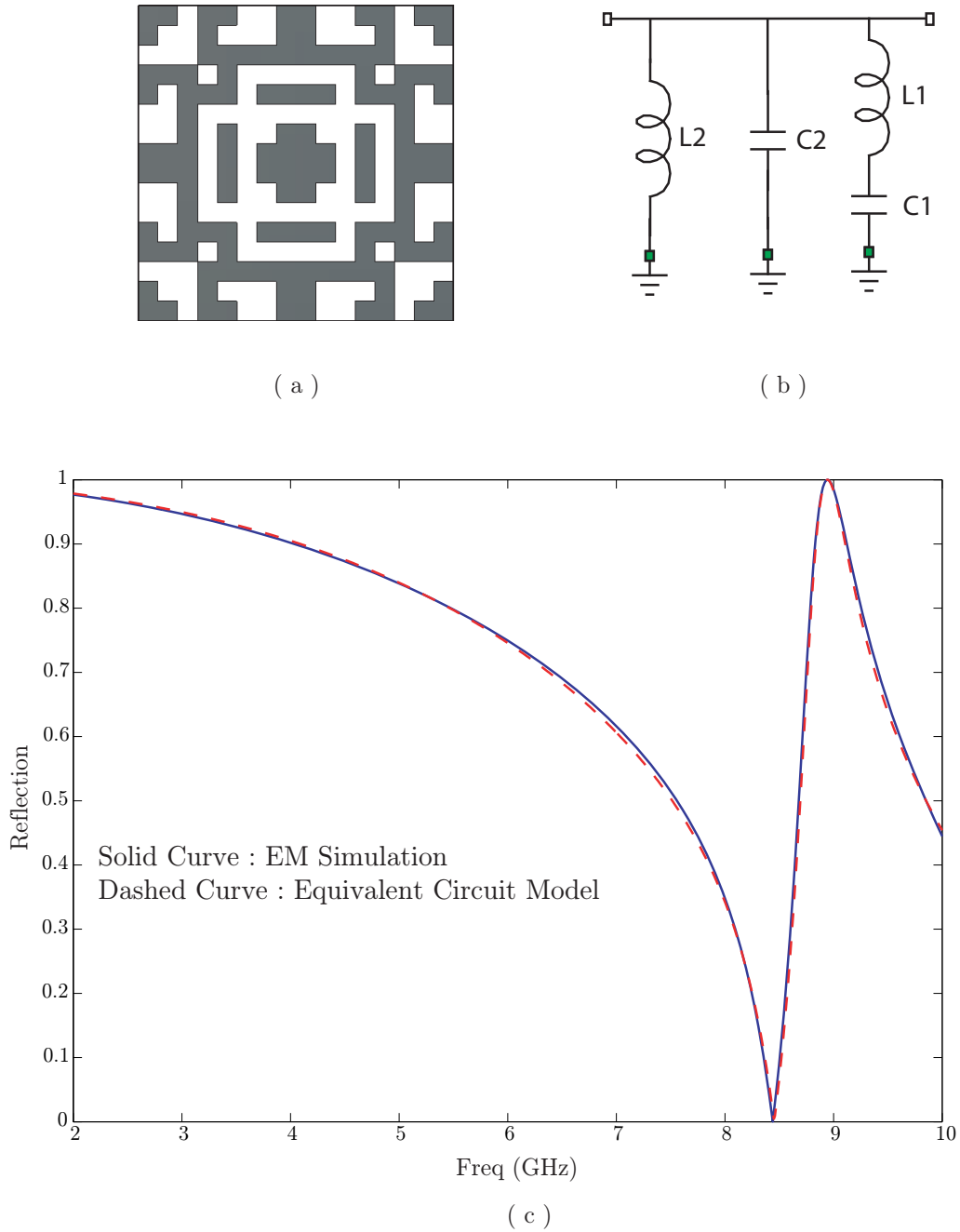

Figure 10: The accurate model of a metamaterial FSS. (a) The pattern of the unit cell (periodicity 2.73 cm). (b) The equivalent circuit model of the meta-surface ($C_1 = 0.0057$ pF, $L_1 = 55.55$ nH, $F_{r_1} = 8.944$ GHz, $C_2 = 0.0628$ pF, $L_1 = 3.05$ nH, $F_{r_2} = 11.5$ GHz). (c) The frequency response (reflection coefficient) of the meta-surface and the equivalent circuit model. (The frequency of the null = 8.44 GHz and the peak = 8.944 GHz.)

Method	$R_1(\Omega)$	$R_2(\Omega)$	$C_2(\text{pF})$
Jaumann	157.08	538.57	–
CCA	130	416.57	0.097

Table 4: Equivalent circuit values for Jaumann and CCA, see Fig. 11(a).

Method	$d_1(\text{mm})$	$d_2(\text{mm})$	$d_3(\text{mm})$	$\sum d_i(\text{mm})$
Jaumann	4.3	4.3	3.6	12.2
CCA	4.1	3.5	3.4	11

Table 5: Dielectric layer thicknesses for Jaumann and CCA, see Fig. 11(a).

3.2 High contrast dielectric layers

It is believed that for high permittivity of dielectric layers (spacers), the only practical solution is the Jaumann absorber. It is shown here that this is not true and significant improvements can be achieved by employing the capacitive circuit method. The Jaumann absorber of example 9.3 of Munk [9] is selected as the reference and our design is compared to it. To prove that the improvements are due to the method, the same dielectric profile and external skin as Munk is used for the capacitive circuit absorber. The schematic of the capacitive circuit absorber and the parameters used in the design are shown in Fig. 11(a). Table 3.2 gives the values of the RC components used in the CCA and Jaumann absorbers. Table 3.2 represents the dielectric thicknesses used in the designs. The total thickness of the absorber is reduced about 10% by using the capacitive circuit method. It should be noted that because of high permittivity of the layers, 1.2 mm thickness reduction is equivalent to a large electrical length reduction, and amazingly it is achieved just by adding a capacitance (C_2) to the Jaumann absorber, see Fig. 11(a). More interesting, in addition to the thickness reduction, 15% bandwidth improvement is also achieved. Table 3.2 gives the details of the 20 dB absorption bandwidth of the two methods and Fig. 11(b) shows the frequency response of both absorbers. It is important to note that in spite of a thickness reduction the CCA still has a slightly improved low frequency response. The RC circuit of Table 3.2 is synthesized by a square patch with the following parameters : $a = 5 \text{ mm}$, $w = 4.1 \text{ mm}$ and $R_s = 278.7 \Omega/\text{Sq}$. Comparison of this periodicity to the previous example (15 mm) shows a large reduction. This is done to avoid any extra propagating mode (higher order Floquet's modes) in dielectric layers due to high permittivity.

Method	$F_L(\text{GHz})$	$F_H(\text{GHz})$	$BW(\text{GHz})$
Jaumann	4.8	15.9	11.1
CCA	4.69	17.52	12.83

Table 6: 20 dB absorption bandwidth comparison of the jaumann and cca. (Full wave simulation, see Fig. 11(b).)

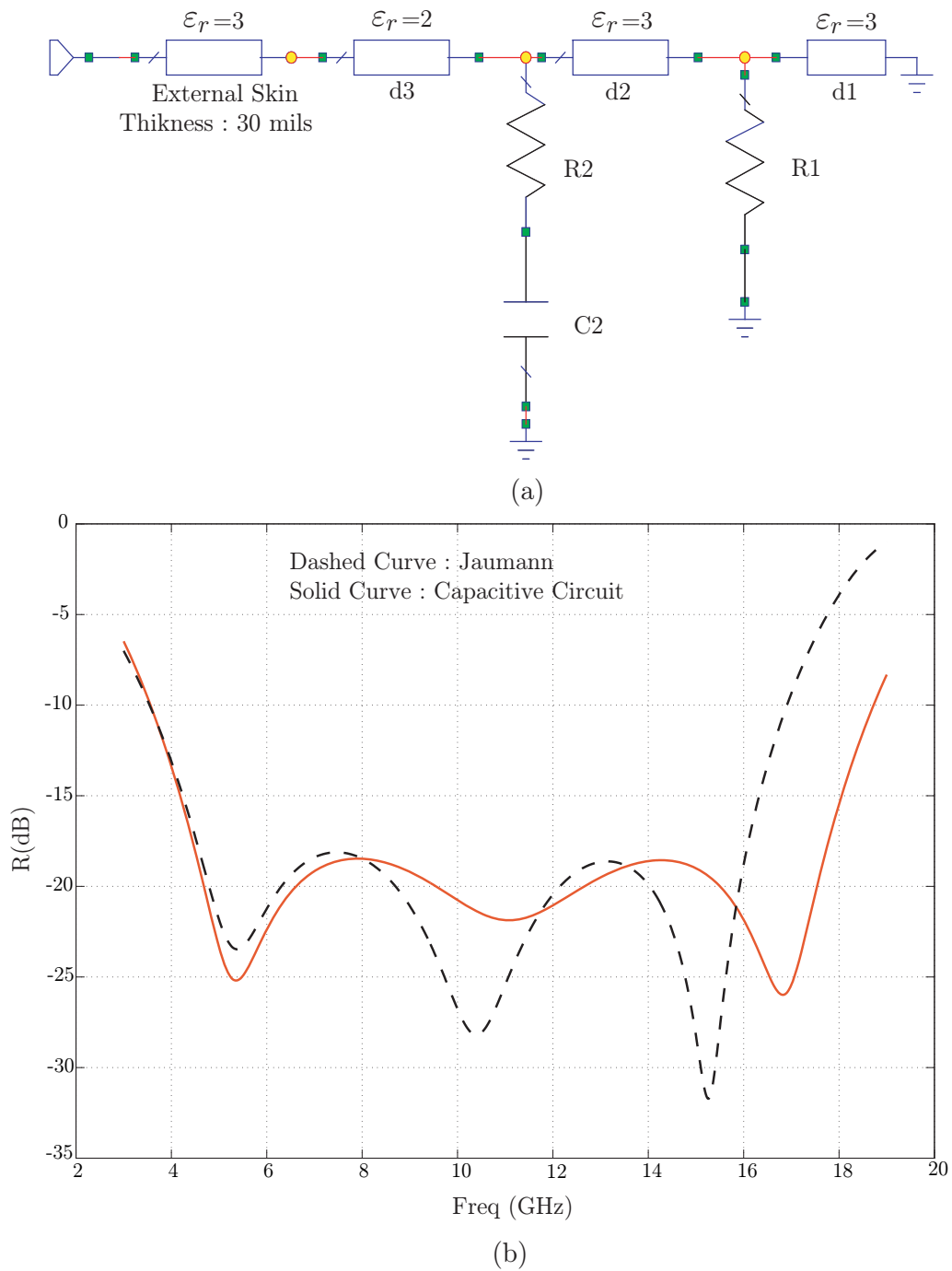

Figure 11: Comparison of the capacitive circuit absorber with the Jaumann absorber of example 9.3 of Munk [9]. (a) The schematic of the CCA. (b) Full wave simulation of the synthesized CCA absorber compared to the Jaumann.

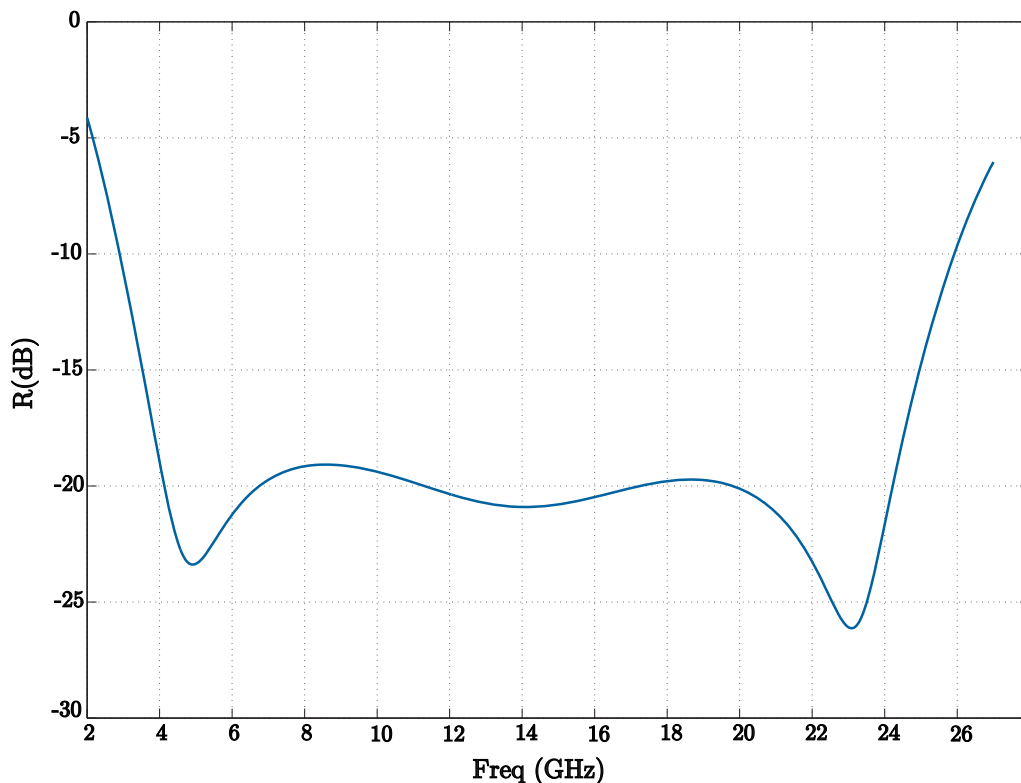

Figure 12: The frequency response of the ultra wideband capacitive circuit absorber. (Full wave simulation, 20 dB bandwidth 4–24 GHz, total thickness = 15.1 mm.)

3.3 Ultra wideband Absorber

The main application of the circuit analog absorbers (resonating RLC method) is wideband absorbers, employing low contrast spacers (foam and honey comb, $\epsilon_r \sim 1.1$) between FSS layers. The aim of this subsection is to show that capacitive circuit absorbers can compete very well with these wideband absorbers. For simplicity of the example (but not lack of generality) $\epsilon_r = 1$ is considered for all layers. A three layer capacitive circuit absorber is presented with ultra wideband frequency response covering 4–24 GHz band and a total thickness of 15.1 mm. The frequency response of the absorber is shown in Fig. 12. The RC values of the equivalent circuit are given in Table 3.3. The layer thicknesses are presented in Table 3.3. It is interesting to note that layers have different thicknesses in contrast to the quarter-wavelength approach. This leads to absorbers that use their total thickness (and therefore the absorption band dictated from theoretical and practical limits) more efficiently. The dimensions and sheet resistivity of the square patches that synthesize the RC circuits are given in Table 3.3.

$R_1(\Omega)$	$R_2(\Omega)$	$C_2(\text{pF})$	$R_3(\Omega)$	$C_3(\text{pF})$
196	424	0.12	779	0.05

Table 7: The RC values of the UWB CCA absorber.

$d_1(\text{mm})$	$d_2(\text{mm})$	$d_3(\text{mm})$	$\Sigma d_i(\text{mm})$
5.8	4.7	4.6	15.1

Table 8: Layer thicknesses of the uwb capacitive circuit absorber.

3.4 Oblique angle of incidence and other constraints

Finally, a design is presented which considers most possible constraints that an actual design might face. The goal is to have a very wideband absorber which shows good absorption both at normal and oblique angles of incidence for both polarizations. In addition it fulfills some thermal, mechanical and fabrication constraints. These constraints force the design to use a mixture of low and high contrast materials together which are not optimal for controlling oblique angles of incidence. In spite of all restrictions, it is shown that the capacitive circuit method is able to provide a brilliant solution. The details of the design are classified, but the frequency response of the absorber is presented in Fig. 13 to demonstrate the abilities of capacitive circuit method, when compared to circuit analog designs of Munk *et al.* [10], which at the best case have a 20 dB absorption bandwidth of 5-15 GHz. The capacitive circuit absorber, satisfying more constraints than oblique angle of incidence, offers the absorption bandwidth 4-18 GHz covering all the C, X and Ku radar bands.

4 Conclusion

The capacitive circuit method is presented as a simple, fast and efficient way to design wideband radar absorbers. The method is a modification of the circuit analog absorber with simpler design and fabrication process. Based on low frequency asymptotic behavior of circuit analog absorbers, replacement of the resonating RLC circuits with low-pass RC circuits is suggested. The RC circuits can be synthesized by square patches which simplifies the synthesis process. It is explained, why this modification does not affect absorption bandwidth. Design examples are given to support the ideas and present new and important applications of the capacitive circuit method. The applications include thin wideband absorber, high contrast layer absorber, ultra wideband absorber and mixed material design capable of handling oblique angle of incidence. Comparisons to well-known designs show improvements

$a(\text{mm})$	$w_2(\text{mm})$	$R_{s_2}(\Omega/\text{Sq})$	$w_3(\text{mm})$	$R_{s_3}(\Omega/\text{Sq})$
10	9.2	338	7.6	422.9

Table 9: Synthesis of the the RC values of uwb cca by resistive square patches.

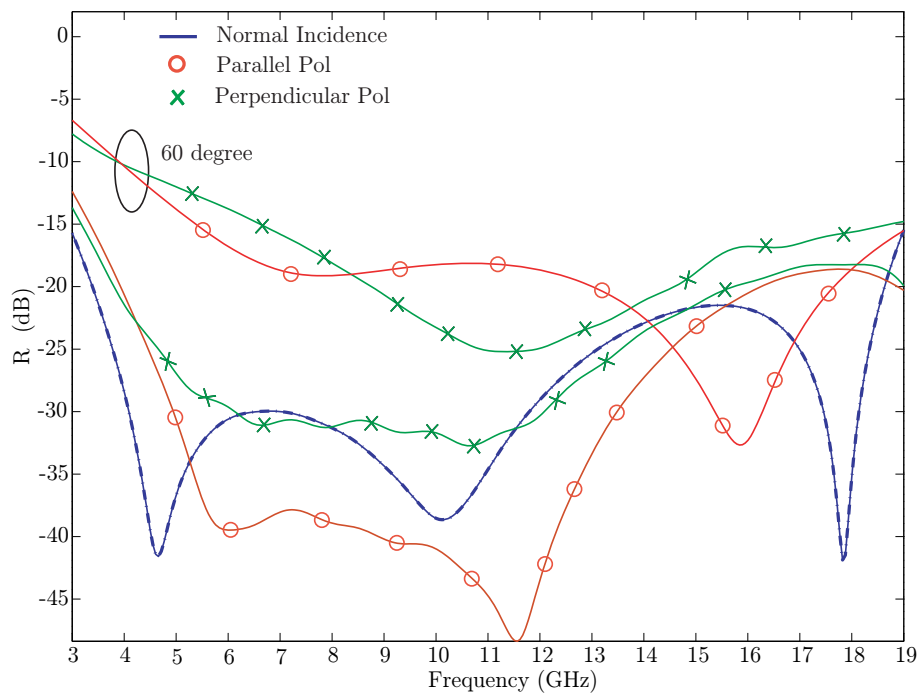

Figure 13: Frequency response of the capacitive circuit absorber at normal and oblique angles of incidence (30° and 60°) for parallel and perpendicular polarizations.

in thickness and bandwidth, verifying the potentials of capacitive circuit method.

References

- [1] L. M. Brekhovskikh. *Waves in layered media*. Academic Press, New York, second edition, 1980.
- [2] L. J. Du Toit. The design of Jauman absorbers. *IEEE Antennas and Propagation Magazine*, **36**(6), 17–25, 1994.
- [3] L. J. Du Toit and J. H. Cloete. Electric screen Jauman absorber design algorithms. *IEEE Trans. Microwave Theory Tech.*, **44**(12 Part 1), 2238–2245, 1996.
- [4] N. Engheta. Thin absorbing screens using metamaterial surfaces. In *Antennas and Propagation Society International Symposium, 2002*, volume 2, pages 392–395. IEEE, 2002.
- [5] R. L. Fante, M. T. McCormack, T. D. Syst, and M. A. Wilmington. Reflection properties of the salisbury screen. *IEEE Trans. Antennas Propagat.*, **36**(10), 1443–1454, 1988.
- [6] Q. Gao, Y. Yin, D. B. Yan, and N. C. Yuan. Application of metamaterials to ultra-thin radar-absorbing material design. *Electronics Letters*, **41**, 936, 2005.

- [7] D. J. Kern and D. H. Werner. A genetic algorithm approach to the design of ultra-thin electromagnetic bandgap absorbers. *Microwave Opt. Techn. Lett.*, **38**(1), 61–64, 2003.
- [8] H. Mosallaei and K. Sarabandi. A one-layer ultra-thin meta-surface absorber. In *Antennas and Propagation Society International Symposium, 2005 IEEE*, volume 1, pages 615–618. IEEE, 2005.
- [9] B. Munk. *Frequency Selective Surfaces: Theory and Design*. John Wiley & Sons, New York, 2000.
- [10] B. A. Munk, P. Munk, and J. Pryor. On designing Jaumann and circuit analog absorbers (CA absorbers) for oblique angle of incidence. *IEEE Trans. Antennas Propagat.*, **55**(1), 186–193, January 2007.
- [11] H. M. Nussenzveig. *Causality and dispersion relations*. Academic Press, London, 1972.
- [12] K. N. Rozanov. Ultimate thickness to bandwidth ratio of radar absorbers. *IEEE Trans. Antennas Propagat.*, **48**(8), 1230–1234, August 2000.