



LUND UNIVERSITY

Equivalent circuit based calculation of signal correlation in lossy MIMO antennas

Li, Hui; Lin, Xianqi; Lau, Buon Kiong; He, Sailing

Published in:

IEEE Transactions on Antennas and Propagation

DOI:

[10.1109/TAP.2013.2273212](https://doi.org/10.1109/TAP.2013.2273212)

2013

Document Version:

Peer reviewed version (aka post-print)

[Link to publication](#)

Citation for published version (APA):

Li, H., Lin, X., Lau, B. K., & He, S. (2013). Equivalent circuit based calculation of signal correlation in lossy MIMO antennas. *IEEE Transactions on Antennas and Propagation*, 61(10), 5214-5222. <https://doi.org/10.1109/TAP.2013.2273212>

Total number of authors:

4

General rights

Unless other specific re-use rights are stated the following general rights apply:

Copyright and moral rights for the publications made accessible in the public portal are retained by the authors and/or other copyright owners and it is a condition of accessing publications that users recognise and abide by the legal requirements associated with these rights.

- Users may download and print one copy of any publication from the public portal for the purpose of private study or research.
- You may not further distribute the material or use it for any profit-making activity or commercial gain
- You may freely distribute the URL identifying the publication in the public portal

Read more about Creative commons licenses: <https://creativecommons.org/licenses/>

Take down policy

If you believe that this document breaches copyright please contact us providing details, and we will remove access to the work immediately and investigate your claim.

LUND UNIVERSITY

PO Box 117
221 00 Lund
+46 46-222 00 00

Equivalent Circuit Based Calculation of Signal Correlation in Lossy MIMO Antennas

Hui Li, *Student Member, IEEE*, Xianqi Lin, *Member, IEEE*, Buon Kiong Lau, *Senior Member, IEEE*, and Sailing He, *Fellow, IEEE*

Abstract—Correlation coefficient of received signals across a pair of antennas is a key performance indicator for multiple-input multiple-output (MIMO) systems. For multipath environments with uniform 3D angular power spectrum, the signal correlation between two antennas can be exactly calculated from their 3D radiation patterns. When radiation patterns are unavailable, a simplified approach that only requires the antennas' scattering parameters can be used instead. However, the simpler method assumes lossless antennas and thus only works well for antennas with high radiation efficiencies. To take into account the antenna loss, the idea of equivalent circuit approximation is used in this paper to analytically separate the lossy components (resistance or conductance) from the lossy antenna arrays, using known scattering parameters and radiation efficiencies. The simplified method using S parameters can then be applied to obtain the correlation coefficient of the equivalent lossless antennas. The effectiveness of the method has been verified on antennas operating at a single mode, such as dipole or patch at its lowest resonant frequency. Good results were also obtained for the measured case of a dual-antenna mobile terminal, consisting of a monopole and a PIFA.

Index Terms— MIMO systems, antenna array, antenna correlation, antenna measurements, mutual coupling, scattering parameters

I. INTRODUCTION

Signal correlation is a critical metric in evaluating the performance of multiple antenna systems, where multiple antennas are employed at both base stations and terminals to improve the performance of wireless communications [1]. Conventionally, for the reference multipath environment of uniform 3D angular power spectrum (APS), signal correlation between two antennas can be calculated from the full spherical radiation patterns of the antennas, which are obtained with both phase and polarization information [2]. Unfortunately, it is both

time-consuming and expensive to measure antenna patterns, due to the use of specialized equipment and facilities.

Consequently, it is of significant interest to the antenna community to avoid using antenna patterns in calculating correlation. The relationship between antenna patterns and scattering (or S) parameters has been demonstrated in closed form in [3]. However, calculating correlation from S parameters only began to attract significant attention following the work of [4], which deals with the dual-antenna case. This method has been widely used in terminal antenna design (see e.g., [5]-[7]), since it is convenient to measure S parameters with a two-port vector network analyzer (VNA). However, the significant drawback of the method is that it does not take into account antenna losses, including conduction loss and dielectric loss. As a result, its accuracy becomes poor when it is applied to antennas with high losses. In [8], the author investigated an improved method to calculate correlation for the dual-antenna case and proposed an upper bound of correlation coefficient, which describes the worst possible correlation performance. The upper bound is calculated using S parameters as well as radiation efficiencies. However, the bound can be too conservative in estimating correlation coefficient in some cases. For example, when the radiation efficiency of the antenna is lower than 50%, which is possible for mobile terminal antennas, the calculated upper bound is larger than unity regardless of the antenna setup. Therefore, this approach is not intended to provide an accurate estimate of the correlation performance in general. Another upper bound of correlation was derived by treating antenna losses as fictitious additional ports that are never excited [9]. The bound is expressed in terms of the lowest antenna efficiency of the multi-antenna system. This upper bound is even more conservative than that in [8]. In addition, an antenna loss matrix was used in the modeling of lossy dual-antenna systems in [10]. The loss matrix was employed to investigate the relationship between the correlation and the increasing of the loss, but it is not intended to determine or estimate the correlation coefficient.

In this paper, we propose a method based on equivalent circuit to more accurately estimate correlation coefficients in lossy antenna arrays. Similar to the method of [8], the proposed method requires only the S parameters and the antenna efficiencies, with the latter being easier to acquire than radiation patterns. Series or parallel circuit model is employed depending on the type of the antenna. With the measured S parameters and

Manuscript received November 24, 2012. This work was supported in part by VINNOVA under grant no. 2009-04047, and in part by Vetenskapsrådet under grant no. 2010-468.

H. Li and B. K. Lau are with the Department of Electrical and Information Technology, Lund University, 221 00 Lund, Sweden (e-mail: {hui.li, bkl}@eit.lth.se). H. Li is also with the Center for Optical and Electromagnetic Research, Zhejiang University, Hangzhou, 310058, China.

X. Lin, and S. He are with the School of Electromagnetic Engineering, Royal Institute of Technology, SE-100 44 Stockholm, Sweden (e-mail: xianqilin@gmail.com; sailing@ee.kth.se). S. He is also with the Center for Optical and Electromagnetic Research, Zhejiang University, Hangzhou, 310058, China.

antenna efficiencies, loss components are separated from the original lossy antenna array and subsequently appended to the lossless antenna ports as equivalent lumped resistors. In order to accurately model the actual losses using the simple lumped resistors, the losses should be concentrated in the vicinity of the antenna ports. This implies that strong currents occur mainly near the antenna ports, such as the case of printed monopole or dipole antennas on lossy substrates operating in the fundamental mode. After extracting the loss components, the correlation coefficients for the equivalent lossless antenna array are then obtained using the simplified method in [4]. It is worth noting that although the paper only considers the case of two antennas, the proposed method can be generalized to an array with an arbitrary number of antennas. As an example, the case of four dipole antennas is derived in [11].

This paper is organized as follows. In Section II, the framework of the proposed method to calculate correlation coefficients is introduced. The calculation based on series circuit model is described in Section III, where lossy dipole arrays are taken as examples. In a similar way, Section IV illustrates the parallel circuit based calculation and uses patch antennas as examples. In Section V, practical mobile terminal antennas are fabricated and measured. The correlation coefficients calculated with different methods are compared. Section VI gives the conclusions of the paper.

II. FRAMEWORK OF THE METHOD

In lossless antenna arrays, all the power that is accepted by the transmit antennas P_{in} is released into free space as radiated power P_{rad} , i.e., $P_{in} = P_{rad}$. Assuming uniform 3D APS, the complex correlation coefficient in lossless dual-antenna arrays was derived in [4] as

$$\rho_c = \frac{-(S_{11}^* S_{12} + S_{21}^* S_{22})}{\sqrt{(1-|S_{11}|^2-|S_{21}|^2)(1-|S_{22}|^2-|S_{12}|^2)}}, \quad (1)$$

where S_{ij} 's are the S parameters of the dual-antenna system, * denotes the complex conjugate operator, $|\cdot|$ is the magnitude operator, and ρ_c is the complex correlation coefficient.

In practical lossy antenna arrays, the non-ideal materials consume parts of the accepted power in the antenna system (P_{loss}) so that the radiated power is lower than the accepted power, i.e., radiation efficiency $\eta_{rad} < 100\%$. The accepted power then becomes

$$P_{in} = P_{rad} + P_{loss}. \quad (2)$$

Due to the power loss P_{loss} , the calculation from (1), which assumes radiation efficiencies of 100%, loses its accuracy in a lossy antenna system, especially for antennas with low radiation efficiencies.

The effect of radiation efficiency has been taken into account to give an upper bound (or ‘‘guaranteed value’’) of the correlation coefficient with the method in [8]

$$|\rho_c|_{\text{guaranteed}} = \frac{|2\text{Re}(S_{11}S_{21}^*)|}{(1-|S_{11}|^2-|S_{21}|^2)\eta_{rad}} + \frac{1}{\eta_{rad}} - 1, \quad (3)$$

where the two antennas are assumed to be identical. $\text{Re}(\cdot)$ denotes the real part of (\cdot) . The upper bound of [8] gives useful insights into the impact of antenna losses on correlation, but it can give a high degree of uncertainty unless the radiation efficiencies are high. The requirement for high efficiencies hence limits its application in lossy antennas, such as small multi-antenna terminals. In particular, the upper bound of (3) largely depends on the radiation efficiencies of the antennas when the efficiencies are low; however, the true correlation coefficient does not in general vary significantly with antenna efficiencies. For example, when an antenna system is loaded with a lumped resistor at each port, the radiation efficiencies will decrease. However, the correlation coefficient is unchanged, since differences in radiation efficiencies are normalized out in the exact correlation calculation based on antenna patterns [12].

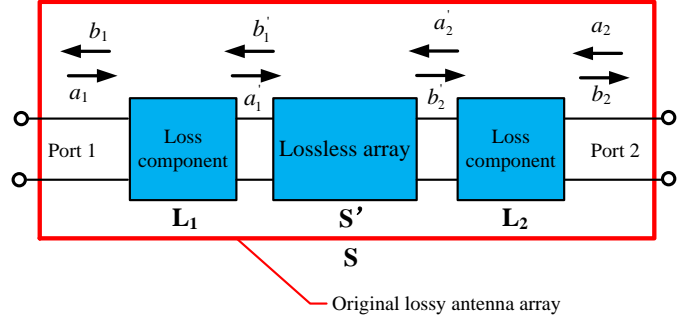

Fig. 1. Network approximation of a lossy dual-antenna array, where the antenna losses mainly occur in the vicinity of the ports. S represents the original antenna array, S' is the lossless array after extracting loss components, L₁ and L₂ are resistors in series or in parallel with S'.

Equivalent circuit is an effective way to describe a lossy antenna system, where the inductance, capacitance, radiation resistance and loss resistance are distributed along the antenna structure. Due to the limited measurable parameters (scattering matrix and antenna efficiencies), it is not easy to design an accurate equivalent circuit for the antennas and calculate the value of each distributed element. As an approximation, we use a lumped resistor (connected in series or parallel) at each antenna port to represent the antenna loss in the original antenna array. In order for this approximation to hold, it is assumed that strong currents predominately exist in the vicinity of the antenna ports. This assumption also implies that the antennas should operate in only one mode, or that all the other modes have negligible losses. Fortunately, most of the frequently used antennas are designed for the fundamental mode, corresponding to a relatively simple circuit model. After extracting the loss component from each antenna, the original lossy antenna array can be separated into lossy and lossless parts. For the dual-antenna case, these resulting parts are described by the cascade network in Fig. 1, where a_i and b_i represents an incident and a reflected wave, respectively. In this network, the loss

component is either resistance in series or conductance in parallel with the lossless array S' , depending on the antenna type. S parameters of the original lossy dual-antenna array can be measured with a two-port VNA, and the transmission (or ABCD) matrix of the loss component is obtained from the equivalent circuit. Thus, the S parameters of the lossless array can be calculated, from which correlation coefficient is obtained using (1). Assuming the separability of the lossy part from the original array, the correlation coefficient of the embedded lossless array is then equivalent to that of the original lossy antenna array. This is because as discussed earlier, introducing lumped resistors at the antenna ports will lower the radiation efficiencies without much effect on the correlation coefficient.

In summary, the proposed method of calculating correlation coefficient is described by the following procedure:

- With the measured S parameters and antenna efficiencies, the value of the loss components (resistance or conductance) is calculated based on the equivalent circuit;
- The ABCD matrix of each loss component is obtained;
- From the measured S parameters and the ABCD matrices of the loss components, the S parameters of the lossless array are extracted;
- The correlation coefficient of the lossless array as obtained from (1) is equal to that of the original lossy array.

In this procedure, the most critical step is to get the value of the loss components from the equivalent circuit. Depending on the impedance behavior of the antennas, series or parallel circuit is utilized to model the antennas, in order to achieve a better circuit model. The calculation of correlation coefficients based on series and parallel models are presented in Sections III and IV, respectively.

III. SERIES CIRCUIT BASED MODEL

A. Calculation Based on Series Circuit Model

The impedance behavior of some omnidirectional antennas, such as dipoles, can be approximately represented by a series R-L-C circuit [13]. The series circuit model for a dual-antenna array is shown in Fig. 2, where the real part of the self-impedances (Z_{11} and Z_{22}) is divided into two parts: the loss resistances ($r_{1,loss}$, $r_{2,loss}$) and the radiation resistances ($r_{1,rad}$, $r_{2,rad}$). $r_{1,rad}$ and $r_{2,rad}$ are the real parts of $Z_{11,rad}$ and $Z_{22,rad}$, respectively. Z_{12} and Z_{21} are the mutual impedances between the antennas, whose absolute values increase when the antenna spacing is reduced, indicating an increase of mutual coupling [14], [15].

Our purpose of using the equivalent circuit is to determine the value of the loss resistances. For simplicity and with no loss in generality, the two antennas and their loads are assumed to be identical, e.g., $r_{1,loss} = r_{2,loss} = r_{loss}$, $r_{1,rad} = r_{2,rad} = r_{rad}$, and $Z_{L1} = Z_{L2} = Z_L$.

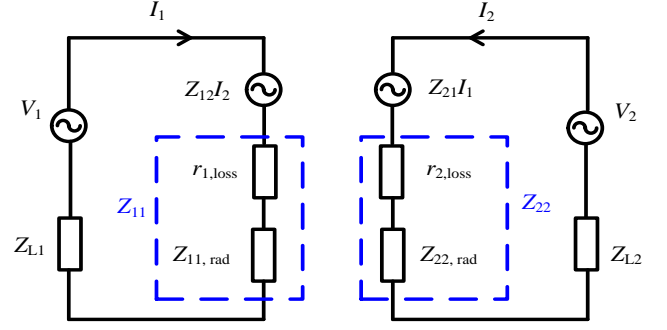

Fig. 2. Series equivalent circuit model of a lossy dual antenna array.

In measuring the efficiency of Antenna 1, Antenna 2 is not excited ($V_2 = 0$) and loaded with Z_L . Thus, the right part of the equivalent circuit model in Fig. 2 gives

$$I_2 = \frac{Z_{21}I_1}{Z_{22} + Z_L}. \quad (4)$$

For convenience of calculation, we define a new parameter k as

$$k = \left| \frac{I_1}{I_2} \right| = \left| \frac{Z_{22} + Z_L}{Z_{21}} \right|, \quad (5)$$

which can be calculated from load impedance Z_L and antenna impedances derived from the measured S parameters [16].

The dual-antenna system can be described in two different ways. On one hand, it is a two-port network, with Port 2 loaded with Z_L and not excited. On the other hand, it can be considered as a one-port network, where Z_L at Port 2 is a loss resistance which consumes the accepted power.

When the dual-antenna system is considered as a two-port network, the total efficiency of Antenna 1 is expressed as

$$\eta_{1,tot} = \eta_{1,rad} \left(1 - |S_{11}|^2 - |S_{21}|^2 \right), \quad (6)$$

where the radiation efficiency ($\eta_{1,rad}$) is calculated by:

$$\begin{aligned} \eta_{1,rad} &= \frac{P_{rad}}{P_{in}} = \frac{P_{rad}}{P_{rad} + P_{loss}} \\ &= \frac{|I_1|^2 r_{rad} + |I_2|^2 r_{rad}}{|I_1|^2 r_{rad} + |I_2|^2 r_{rad} + |I_1|^2 r_{loss} + |I_2|^2 r_{loss}} \\ &= \frac{r_{rad}}{r_{rad} + r_{loss}}. \end{aligned} \quad (7)$$

When the dual-antenna system is described as a one-port network, the total efficiency is

$$\eta_{1,tot} = \eta'_{1,rad} \left(1 - |S_{11}|^2 \right), \quad (8)$$

where the radiation efficiency ($\eta'_{1,rad}$) is different from (7) and presented as

$$\begin{aligned}\eta_{1,\text{rad}} &= \frac{P_{\text{rad}}}{P_{\text{rad}} + P_{\text{loss}}} \\ &= \frac{|I_1|^2 r_{\text{rad}} + |I_2|^2 r_{\text{rad}}}{|I_1|^2 r_{\text{rad}} + |I_2|^2 r_{\text{rad}} + |I_1|^2 r_{\text{loss}} + |I_2|^2 r_{\text{loss}} + |I_2|^2 \text{Re}(Z_L)}.\end{aligned}\quad (9)$$

Apply (5) into (9), we get

$$\eta_{1,\text{rad}} = \frac{(k^2 + 1)r_{\text{rad}}}{(k^2 + 1)r_{\text{rad}} + (k^2 + 1)r_{\text{loss}} + \text{Re}(Z_L)}.\quad (10)$$

With (7) and (10), the loss resistance is calculated as

$$r_{\text{loss}} = \frac{\eta_{1,\text{rad}}(1 - \eta_{1,\text{rad}})\text{Re}(Z_L)}{(\eta_{1,\text{rad}} - \eta_{1,\text{rad}})(k^2 + 1)},\quad (11)$$

in which $\eta_{1,\text{rad}}$ and $\eta_{1,\text{rad}}$ are calculated with the measured efficiencies and S parameters using equations (6) and (8).

For lossy antenna arrays with two different antennas, the loss resistances are obtained following a similar procedure as

$$r_{1,\text{loss}} = \frac{1}{p^2 q^2 - 1} \left[p^2 \frac{\eta_{1,\text{rad}}(1 - \eta_{1,\text{rad}})\text{Re}(Z_L)}{(\eta_{1,\text{rad}} - \eta_{1,\text{rad}})} - \frac{\eta_{2,\text{rad}}(1 - \eta_{2,\text{rad}})\text{Re}(Z_L)}{(\eta_{2,\text{rad}} - \eta_{2,\text{rad}})} \right],\quad (12)$$

$$r_{2,\text{loss}} = \frac{1}{p^2 q^2 - 1} \left[-\frac{\eta_{1,\text{rad}}(1 - \eta_{1,\text{rad}})\text{Re}(Z_L)}{(\eta_{1,\text{rad}} - \eta_{1,\text{rad}})} + q^2 \frac{\eta_{2,\text{rad}}(1 - \eta_{2,\text{rad}})\text{Re}(Z_L)}{(\eta_{2,\text{rad}} - \eta_{2,\text{rad}})} \right],\quad (13)$$

where

$$p = \left| \frac{Z_{22} + Z_L}{Z_{21}} \right|, q = \left| \frac{Z_{11} + Z_L}{Z_{12}} \right|,\quad (14)$$

$$\eta_{1,\text{rad}} = \frac{\eta_{1,\text{tot}}}{(1 - |S_{11}|^2 - |S_{21}|^2)}, \eta_{1,\text{rad}} = \frac{\eta_{1,\text{tot}}}{(1 - |S_{11}|^2)},\quad (15)$$

$$\eta_{2,\text{rad}} = \frac{\eta_{2,\text{tot}}}{(1 - |S_{22}|^2 - |S_{12}|^2)}, \eta_{2,\text{rad}} = \frac{\eta_{2,\text{tot}}}{(1 - |S_{22}|^2)},\quad (16)$$

To make the procedure clear, the flow chart to calculate the loss resistances in the dual antenna array is presented in Fig. 3, where the available parameters are highlighted in red.

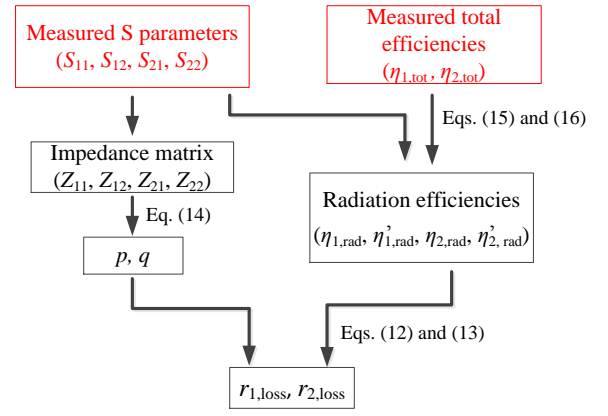

Fig. 3. Procedure for calculating loss resistances in dual-antenna array.

After obtaining the loss resistances, the cascade network in Fig. 1, with each loss component modeled by a resistor in series, can be used to obtain the scattering matrix of the embedded lossless array. For the convenience of cascade network calculation, the ABCD matrices [16] are employed

$$[\mathbf{S}]_{\text{ABCD}} = [\mathbf{L}_1]_{\text{ABCD}} \cdot [\mathbf{S}']_{\text{ABCD}} \cdot [\mathbf{L}_2]_{\text{ABCD}},\quad (17)$$

where $[\mathbf{S}]_{\text{ABCD}}$ is the ABCD matrix of the original lossy antenna array, and the ABCD matrices of loss resistors in series are defined by [16]

$$[\mathbf{L}_1]_{\text{ABCD}} = \begin{bmatrix} 1 & r_{1,\text{loss}} \\ 0 & 1 \end{bmatrix}, [\mathbf{L}_2]_{\text{ABCD}} = \begin{bmatrix} 1 & r_{2,\text{loss}} \\ 0 & 1 \end{bmatrix}.\quad (18)$$

Thus, the scattering matrix \mathbf{S}' of the embedded lossless array is obtained from the ABCD matrix-to-scattering matrix conversion [16]. Finally, correlation coefficient of the embedded lossless array, which is equivalent to that of the original lossy array, can be directly calculated with scattering matrix \mathbf{S}' using (1).

B. Dipole Antenna Array

To better illustrate the proposed method of calculating correlation, it is applied to printed dipole antenna arrays with closely spaced elements in the following example. The geometries of the dual-dipole antenna system in the simulation are shown in Fig. 4. The element separation is $\lambda/20$ (7 mm) at the center frequency of 2.15 GHz. The array is implemented on a substrate with a permittivity of 4.2 and a loss tangent ($\tan \delta$) of 0.01. The dipoles are made of copper, with an electric conductivity of 5.8×10^7 S/m. The dipole array is simulated with the frequency domain solver of CST Microwave Studio, and the magnitudes of S parameters are plotted in Fig. 5(a). An isolation of 4 dB is observed at the center frequency, indicating severe mutual coupling.

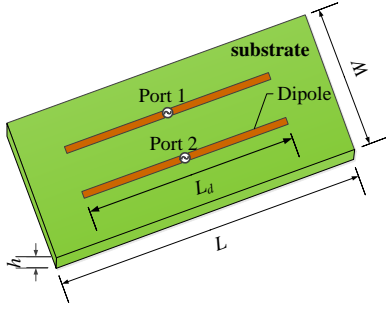

Fig. 4. Geometries of the dual-dipole array, with the dimensions: $W = 40$ mm, $L = 100$ mm, $h = 2$ mm, $L_d = 44$ mm.

The measured S parameters and efficiencies of the dipoles are: $S_{11} = S_{22} = -0.28 + j0.11$, $S_{21} = S_{12} = 0.53 - j0.34$ and $\eta_{1,\text{tot}} = \eta_{2,\text{tot}} = 46.1\%$, respectively. The efficiencies are measured in the presence of both antennas, with one antenna excited and the other antenna loaded with $Z_L = 50\Omega$, which is the characteristic impedance of the feed cable. In this way, the coupling effect of each antenna on the other is taken into account. Following the procedure in Fig. 3, the loss resistance of $r_{1,\text{loss}} = r_{2,\text{loss}} = 1.23\Omega$ is obtained. Then the ABCD matrix of the original lossy dipole antenna system and the loss matrices are calculated as:

$$[\mathbf{S}]_{\text{ABCD}} = \begin{bmatrix} 0.86 + j0.27 & 0.29 + j24.6 \\ 0.019 + j0.014 & 0.86 + j0.27 \end{bmatrix},$$

$$[\mathbf{R}_1]_{\text{ABCD}} = [\mathbf{R}_2]_{\text{ABCD}} = \begin{bmatrix} 1 & 1.23 \\ 0 & 1 \end{bmatrix},$$

respectively. Using (17) and matrix conversion, the scattering matrix of the embedded lossless array is obtained

$$\mathbf{S}' = \begin{bmatrix} -0.25 + j0.077 & 0.65 - j0.1 \\ 0.65 - j0.1 & -0.25 + j0.077 \end{bmatrix}.$$

Finally, the correlation coefficient ρ_c at the center frequency is calculated using (1) as of 0.88. As explained in Section II, since only lumped resistors are added to the ports of the derived lossless array, the correlation coefficient of the original lossy antenna system is the same as that of the lossless array.

With the same procedure, the correlation coefficient over the whole operating band is calculated. In order to verify the accuracy of the method, we also change the loss tangent of the substrate to obtain different antenna radiation efficiencies. For different radiation efficiencies, the reflection coefficients of the dipole arrays are almost unchanged, and the isolation becomes higher due to higher loss. The magnitudes of the complex correlation coefficients ρ_c with different antenna efficiencies are presented in Fig. 5. For comparison, the correlation coefficients calculated from (i) the far-field antenna patterns (“exact method”), (ii) the S-parameter method of [4] and (iii) the upper bound of [8], are also shown in Fig. 5. From Fig. 5(b), we can see that the results from both the proposed method and the upper bound are close to the exact values of correlation coefficients when the radiation efficiency is very high, whereas the S-parameter method of [4] underestimates the results. When the radiation efficiency decreases, the results from the upper bound deviate from the exact correlation coefficients and

become conservative in estimation, especially for the radiation efficiency of 60%. The estimation using only S parameters in the method of [4] also becomes worse as the efficiency drops. The proposed method always gives the best estimate of the exact value as obtained from the patterns.

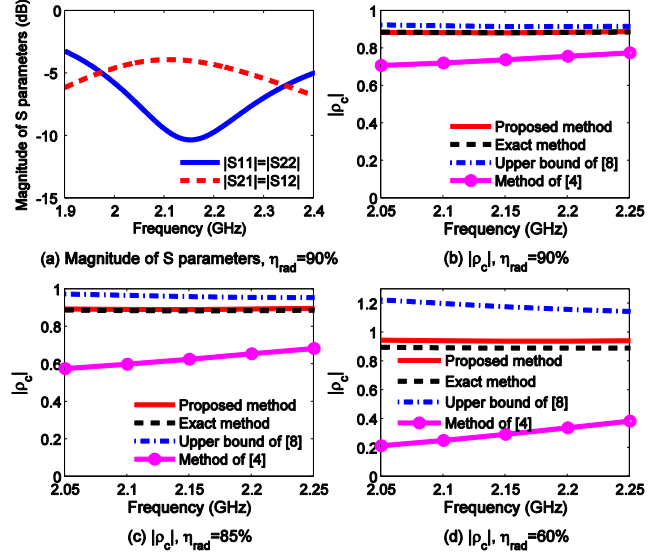

Fig. 5. S parameters and magnitude of correlation coefficients for different antenna radiation efficiencies.

The ultimate goal of estimating correlation coefficient is often to determine the MIMO performance of multiple antenna systems. In our work, we employ the multiplexing efficiency metric proposed in [17] to describe antenna’s MIMO performance. Multiplexing efficiency is the power penalty of a non-ideal antenna system in achieving a given capacity, relative to an ideal antenna system with 100% total antenna efficiencies and zero correlation. For a dual-antenna system, it is given by

$$\eta_{\text{mux}} = \frac{\sqrt{\eta_1 \eta_2}}{\eta_g} \sqrt{1 - |\rho_c|^2}, \quad (19)$$

where η_i is the total antenna efficiency of antenna i . The term η_g is the geometric mean (or arithmetic mean in decibel) of the antenna efficiencies, whereas η_r reveals the equivalent power loss due to correlation [18]. The geometric mean of the antenna efficiencies can be measured directly, and the power loss due to correlation is estimated through calculating correlation coefficients. Thus, the estimation accuracy of multiplexing efficiency (in decibel) only depends on the estimation of η_r . In Fig. 6, the estimation of η_r is presented for the dual-dipole array with antenna radiation efficiencies of 85%. It is observed that the exact correlation between the dipoles incurs around 3.5 dB of power loss (see the black dashed line) of the antenna array, which is well estimated with the proposed method. The S parameter method is too optimistic about the influence of antenna correlation (with only 1 dB power loss), whereas the upper bound is too conservative (around 6 dB power loss).

It is worth noting that the proposed method with the series circuit based model not only works well for the dipole antennas, it is also efficient for monopole and slot antennas.

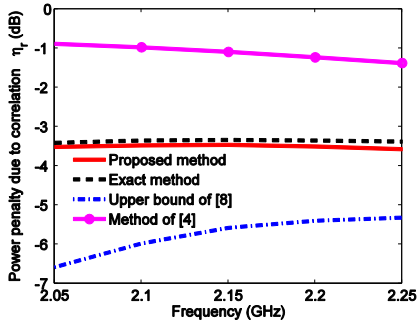

Fig. 6. Power penalty due to correlation (η_r) for the dipole antenna array with the radiation efficiencies of 85%.

We also studied the next (higher) operating mode of the same dipole antenna array at 6.2 GHz. In this case, the dipole antennas operate at one wavelength, and their currents are not strong near the ports [19], which violates our assumption. The estimated correlation coefficients are shown in Fig. 7(b). It is observed that the accuracy of the proposed method decreases, but it still has better performance than the other methods.

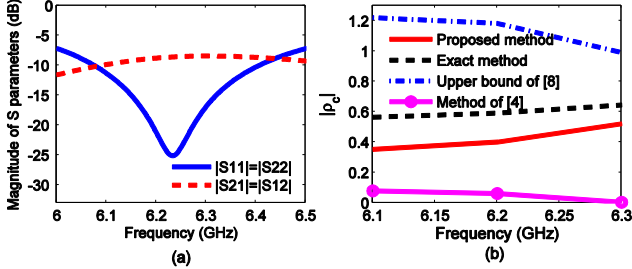

Fig. 7. (a) Magnitude of S parameters; (b) Magnitude of complex correlation coefficients for dipole arrays at a higher mode.

IV. PARALLEL CIRCUIT BASED MODEL

A. Calculation Based on Parallel Circuit Model

For some planar antenna types, such as patch antennas and PIFA antennas, the impedance behavior can be expressed in the form of a parallel R-L-C network, where R represents the radiation, conductor and dielectric losses [20]. Thus, a parallel circuit model fits the antenna impedance performance better than the series circuit model. In this section, the estimation of correlation coefficient based on the parallel circuit model is briefly described. Similar as the series circuit model, the parallel circuit model for a lossy dual-antenna array is shown in Fig. 8, where each self-admittance is divided into a loss conductance ($g_{1,loss}$ or $g_{2,loss}$) and a radiation part ($Y_{11,rad}$ or $Y_{22,rad}$).

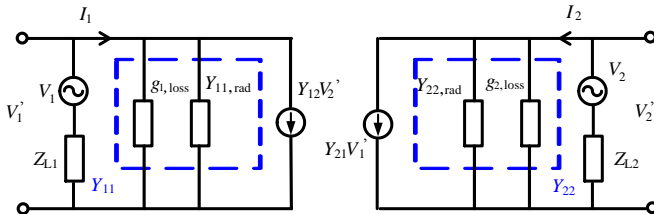

Fig. 8. Parallel equivalent circuit model of a lossy dual antenna array.

Following a similar procedure as in Section III-A and assuming that the two antennas are identical, the loss conductances of the dual antenna array are calculated as

$$g_{1,loss} = g_{2,loss} = \frac{\eta_{1,rad} (1 - \eta_{1,rad}) \text{Re}(Z_L)}{(\eta_{1,rad} - \eta_{1,rad}') (m^2 + |Z_L|^2)}. \quad (20)$$

where $\eta_{1,rad}$ and $\eta_{1,rad}'$ are the same as those in (15), and

$$m = \left| \frac{V_1}{I_2} \right| = \left| \frac{1 + Y_{22} Z_L}{Y_{21}} \right|. \quad (21)$$

For the parallel circuit, each loss component in Fig. 1 is represented by a shunt resistor, and the ABCD matrices of the loss components become

$$[\mathbf{L}_1]_{ABCD} = \begin{bmatrix} 1 & 0 \\ g_{1,loss} & 1 \end{bmatrix}, [\mathbf{L}_2]_{ABCD} = \begin{bmatrix} 1 & 0 \\ g_{2,loss} & 1 \end{bmatrix}. \quad (22)$$

With the same method as in Section III-A, the correlation coefficients can be estimated with the S parameters of the extracted lossless array.

B. Patch Antenna Array

In this subsection, closely-spaced patch antenna arrays implemented on substrates with different loss tangents are studied. The patch array is simulated with the frequency domain solver of CST Microwave Studio, and waveguide ports are employed to excite the antenna. The geometries of the patch antennas are shown in Fig. 9(a). The edge-to-edge distance between the two patches is 10 mm, equivalent to $\lambda/12$ at the center frequency. The magnitudes of S parameters of the patch antenna array on a substrate with a loss tangent of 0.001 are shown in Fig. 9(b). When the loss tangent of the substrate increases, the reflection coefficients of the array are almost unchanged, and the isolation becomes higher due to higher loss.

The correlation coefficients of the patch antenna arrays on the substrates with different loss tangents are calculated using the proposed method with parallel network model and presented in Fig. 10(a)-(d). If the material loss is very low (loss tangent $\tan \delta = 0.001$) and the radiation efficiency is high, all the methods can give a good estimate of the exact correlation coefficient. In this case, the S-parameter method of [4] is the most convenient to use since it does not require the knowledge of radiation efficiency. For the patch antenna array with a moderate loss ($\tan \delta = 0.005$), the results from the proposed method give the best estimation of correlation coefficients, whereas the other two methods start to deviate from the exact values. As the loss of the substrate increases, e.g., for FR4 substrates with $\tan \delta = 0.01$ and $\tan \delta = 0.02$, the advantage of the proposed method becomes apparent.

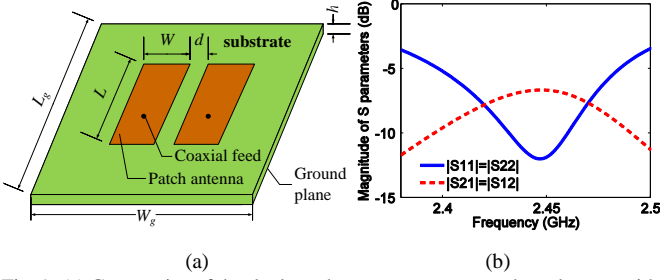

Fig. 9. (a) Geometries of the dual patch antenna system on the substrate with a permittivity of 2.3, with the dimensions: $W = 20$ mm, $L = 41.6$ mm, $h = 3$ mm, $L_g = W_g = 200$ mm, $d = 10$ mm. (b) Magnitude of S parameters of the patch antenna array with a loss tangent of 0.001.

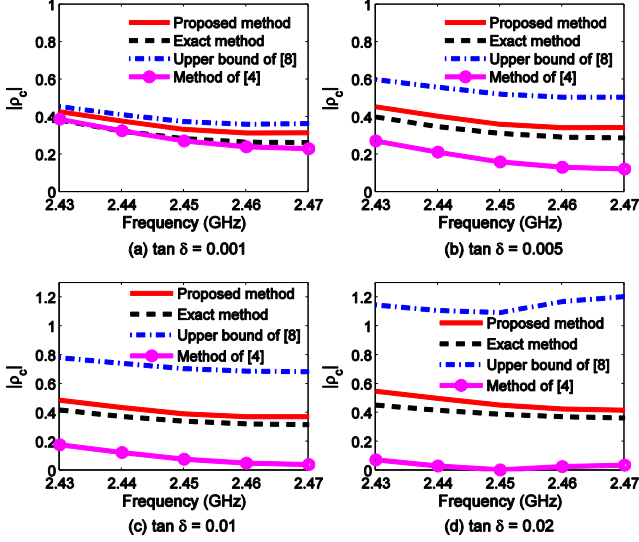

Fig. 10. Magnitude of complex correlation coefficients for patch antenna arrays on substrates with different loss tangents.

For the patch antenna array with $\tan \delta = 0.01$ (Fig. 10(c)), the power loss due to the correlation (η_r) is calculated and presented in Fig. 11. It is observed that the maximum error of the proposed method in estimating multiplexing efficiency is only 0.16 dB. The parallel circuit based model can also be applied to other planar antennas, such as planar inverted-F antennas (PIFAs) and printed UWB antennas. It is also worth noting that the correlation coefficient of the aforementioned planar antenna types can also be estimated with the proposed method based on the series network model in Section III; however, the estimation accuracy is found through simulation studies to be generally worse, which is expected due to different impedance behaviors.

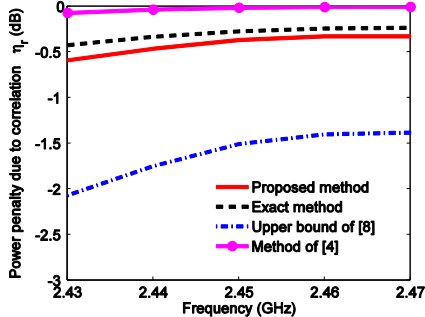

Fig. 11. Power penalty due to correlation (η_r) for the patch antenna array on the substrate with $\tan \delta = 0.01$.

V. ANTENNA MEASUREMENTS

The proposed method is well suited for measuring the correlation coefficient of terminal antenna arrays (e.g. mobile handset antennas), where the antennas are closely-spaced and radiation efficiencies are relatively low. In this section, we verify the proposed method of calculating correlation using measurement results of a mobile handset antenna array. The dual-antenna array comprises a slot monopole and a PIFA placed at the two short edges of the chassis [21]. The prototype of the dual-antenna system is shown in Fig. 12. The size of the chassis is 100 mm \times 40 mm, which is similar to those of typical candy-bar type mobile handsets. The detailed geometries of the PIFA and the slot monopole are given in [21].

The S parameters of the two antennas were measured with two-port VNA, with the magnitudes presented in Fig. 13. Since the phases of the S parameters are important for the calculation of the correlation coefficient, the reference planes of the VNA ports are calibrated to the feed points of the antennas prior to the measurement. This removes the phase shifts in the S parameters that are introduced by the feed cables.

In order to make the comparison of different methods, the exact correlation coefficients were obtained using far-field patterns (with phase and polarization information) measured in a Satimo Stargate-64 antenna measurement facility. The total efficiencies of the antennas were also measured. With the measured S parameters and efficiencies, the correlation coefficients were estimated using the proposed method based on the series circuit model, and the results are shown in Fig. 14. It is noted that the series circuit model is also used for the PIFA in this example, despite it being a planar antenna. This is because when the PIFA at the chassis edge is excited, the mobile chassis is also excited and radiates like a flat dipole [21].

Due to the low efficiencies of the mobile handset antennas (i.e., 44% and 35% for the slot-monopole and PIFA at the center frequency), the estimated correlation coefficient with the upper bound of [8] is larger than unity (see Fig. 14), so that it cannot be used to determine the MIMO performance. In comparison to the upper bound and the S-parameter method of [4], significantly better accuracy is obtained using the proposed method. As can be seen, the correlation coefficient obtained from the proposed method closely follows that of the exact method, with slightly higher deviations between 0.91 GHz and 0.93 GHz. For the multiplexing efficiency, a maximum error of 0.26 dB is obtained within the bandwidth using the proposed method. The inaccuracy of the proposed method mainly occurs when the true equivalent circuit model (involving distributed circuit elements) cannot be well approximated by a simple circuit model with losses solely represented by series resistors at the ports. The measurement procedure and equipment tolerance also lead to some inaccuracies.

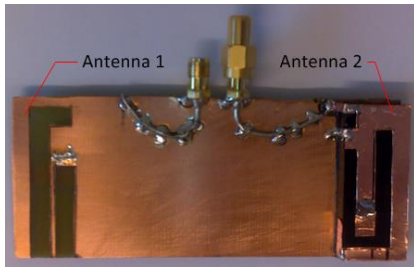

Fig. 12. Prototype of the dual-antenna array on a mobile handset chassis.

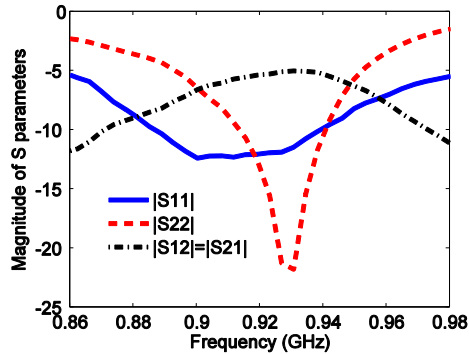

Fig. 13. Magnitude of S parameters of the dual-antenna array on the mobile handset.

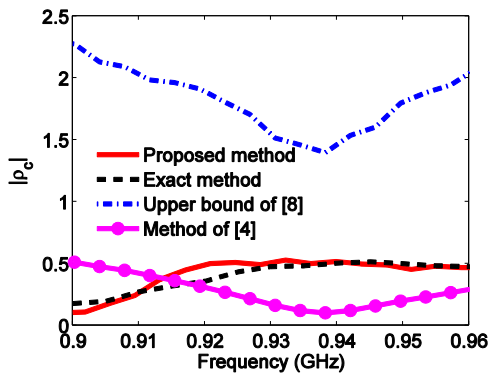

Fig. 14. Magnitude of the complex correlation coefficients of the mobile handset antennas.

VI. CONCLUSION

In this work, a method for calculating antenna correlation coefficients in lossy dual-antenna arrays is presented. The purpose of the method is to simplify measurement and reduce the measurement cost, especially for mobile handset MIMO antennas. The method is introduced based on the equivalent circuits of antenna arrays. Depending on the antenna behavior, series or parallel circuit is employed. With the information of measured efficiencies and scattering matrix, the equivalent loss resistance (or conductance) is calculated and extracted from an original lossy antenna array. Then, the correlation coefficient of the original lossy antenna array is calculated through matrix operation in the cascade connection network. The method has been applied to dipole antenna arrays and patch antenna arrays in the simulations, and significantly better accuracy has been achieved relative to conventional methods. As a practical example, a mobile handset antenna array working at the GSM900 frequency band was fabricated and measured. It is

confirmed that good accuracy is achieved using the proposed method over the entire band of interest.

ACKNOWLEDGMENT

The authors are thankful to Anders Ellgardt, Peter Fuks and Lars Jonsson of Royal Institute of Technology (KTH), Sweden for helpful discussions.

REFERENCES

- [1] M. A. Jensen and J. W. Wallace, "A review of antennas and propagation for MIMO wireless communications," *IEEE Trans. Antennas Propag.*, vol. 52, no. 11, pp. 2810-2824, Nov. 2004.
- [2] R. Clarke, "A statistical theory of mobile radio reception," *Bell System Technical Journal*, no. 2, pp. 957-1000, 1996.
- [3] S. Stein, "On cross coupling in multiple-beam antennas," *IRE Trans. Antennas Propag.*, vol. AP-10, pp. 548-557, Sep. 1962.
- [4] S. Blanch, J. Romeu, and I. Corbella, "Exact representation of antenna system diversity performance from input parameter description," *Electron. Lett.*, vol. 39, no. 9, pp. 705-707, May. 2003.
- [5] M. Sonkki, E. A. Daviu, M. C. Fabres, M. F. Bataller and E. T. Salonen, "Improved planar wideband antenna element and its usage in a mobile MIMO system," *IEEE Antennas Wireless Propag. Lett.*, vol. 11, pp. 826-829, 2012.
- [6] J. Xiong, M. Zhao, H. Li, Z. Ying and B. Wang, "Collocated electric and magnetic dipoles with extremely low correlation as a reference antenna for polarization diversity MIMO applications," *IEEE Antennas Wireless Propag. Lett.*, vol. 11, pp. 423-426, 2012.
- [7] S. W. Su, "High-gain dual-loop antennas for MIMO access points in the 2.4/5.2/5.8 GHz bands," *IEEE Trans. Antennas Propag.*, vol. 58, no. 7, pp. 2412-2419, Jul. 2010.
- [8] P. Hallbjörner, "The significance of radiation efficiencies when using S-parameters to calculate the received signal correlation from two antennas," *IEEE Antennas Wireless Propag. Lett.*, vol. 4, pp. 97-99, 2005.
- [9] A. Stjernman, "Relationship between radiation pattern correlation and scattering matrix of lossless and lossy antennas," *Electron. Lett.*, vol. 41, no. 12, pp. 678-680, Jun. 2005.
- [10] I. Salonen, C. Icheln, and P. Vainikainen, "The dependency of pattern correlation on mutual coupling and losses in antenna arrays," *Microwave Opt. Technol. Lett.*, vol. 47, no.2, pp. 145-147, 2005.
- [11] H. Li, X. Lin, B. K. Lau, and S. He, "Calculating signal correlation in lossy dipole arrays using scattering parameters and efficiencies," in *Proc. 2013 Europ. Conf. Antennas Propag. (EuCAP'2013)*, Gothenburg, Sweden, Apr. 8-12, 2013.
- [12] R. Vaughan and J. B. Andersen, *Channels, Propagation and Antennas for Mobile Communications*, ser. IEE Electromagnetic Waves Series, 50. London, U.K.: Inst. Elect. Eng., 2003, pp. 569-576.
- [13] L. J. Chu, "Physical limitation of omni-directional antennas," *J. Appl. Phys.*, vol. 19, pp. 1163-1175, Dec. 1948.
- [14] R. S. Elliott, *Antenna Theory and Design*, Revised ed. Hoboken, N.J.: John Wiley & Sons, 2003.
- [15] C. A. Balanis, *Antenna Theory: Analysis and Design*, 3rd ed. CA: Wiley, 2005, pp. 468-490.
- [16] D. M. Pozar, *Microwave Engineering*, 3rd Ed, John Wiley and Sons Ltd, 2005.
- [17] R. Tian, B. K. Lau and Z. Ying, "Multiplexing efficiency of MIMO antennas," *IEEE Antennas Wireless Propag. Lett.*, vol. 10, pp. 183-186, 2011.
- [18] H. Li, B. K. Lau, Z. Ying, and S. He, "Decoupling of multiple antennas in terminals with chassis excitation using polarization diversity, angle diversity and current control," *IEEE Trans. Antennas Propag.*, vol. 60, no. 12, pp. 5947-5957, 2012.
- [19] J. D. Kraus, *Antennas*, 2nd ed. McGraw-Hill, 1988, pp. 221-223.
- [20] R. Garg, P. Bhartia, I. Bahl and A. Ittipiboon, *Microstrip Antenna Design Handbook*. Norwood, MA: Artech House, 2001.
- [21] H. Li, Y. Tan, B. K. Lau, Z. Ying, and S. He, "Characteristic mode based tradeoff analysis of antenna-chassis interactions for multiple antenna terminals," *IEEE Trans. Antennas Propag.*, vol. 60, no. 2, Feb. 2012.