



# LUND UNIVERSITY

## Steam and Condensate System Control in Paper Making

Slätteke, Ola

2003

*Document Version:*

Publisher's PDF, also known as Version of record

[Link to publication](#)

*Citation for published version (APA):*

Slätteke, O. (2003). *Steam and Condensate System Control in Paper Making*. [Licentiate Thesis, Department of Automatic Control]. Department of Automatic Control, Lund Institute of Technology (LTH).

*Total number of authors:*

1

### General rights

Unless other specific re-use rights are stated the following general rights apply:

Copyright and moral rights for the publications made accessible in the public portal are retained by the authors and/or other copyright owners and it is a condition of accessing publications that users recognise and abide by the legal requirements associated with these rights.

- Users may download and print one copy of any publication from the public portal for the purpose of private study or research.
- You may not further distribute the material or use it for any profit-making activity or commercial gain
- You may freely distribute the URL identifying the publication in the public portal

Read more about Creative commons licenses: <https://creativecommons.org/licenses/>

### Take down policy

If you believe that this document breaches copyright please contact us providing details, and we will remove access to the work immediately and investigate your claim.

LUND UNIVERSITY

PO Box 117  
221 00 Lund  
+46 46-222 00 00

# Steam and Condensate System Control in Paper Making

Ola Slätteke

Department of Automatic Control  
Lund Institute of Technology  
Lund, October 2003

<b>Department of Automatic Control</b> <b>Lund Institute of Technology</b> <b>Box 118</b> <b>SE-221 00 Lund Sweden</b>		<i>Document name</i> LICENTIATE THESIS	
		<i>Date of issue</i> October 2003	
		<i>Document Number</i> ISRN LUTFD2/TFRT-3231-SE	
<i>Author(s)</i> Ola Slätteke		<i>Supervisors</i> Björn Wittenmark Tore Hägglund Krister Forsman	
		<i>Sponsoring organization</i> CPDC (Cent. for Chem. Proc. Design and Contr.) and ABB	
<i>Title and subtitle</i> Steam and Condensate System Control in Paper Making			
<i>Abstract</i> <p>The function of a paper machine is to form the paper sheet and remove the water from the sheet. A modern paper machine is divided into three main parts, the wire section, the press section, and the dryer section. Although the dryer section is only responsible for removing less than 1 % of the water volume in the original stock to the head box, this is the part of the paper machine that, by far, consumes most energy. Studies have shown that the dryer section uses around 3/5 of the total energy requirement in paper making. This implies that the dryer section is the most expensive part of the paper machine in terms of energy use per kg removed water. Moreover, the dryer section affects a lot of the important physical properties of the final product, such as curl and elasticity. Therefore, the dryer section plays a vital role in paper making.</p> <p>From experiments on a large number of different industrial paper machines, producing the whole range of different paper qualities, it has been found that the dynamics from the steam valve to the steam pressure can be described by a linear process model. This model has an integrator, one pole, and one zero, therefore we call it the IPZ-model. A set of simple tuning rules for PI control has been derived and is characterized by the four process parameters in the model. The method is labeled as IPZ-tuning. It has only one design parameter and is therefore easy to use. The method has been tested and evaluated on a couple of different industrial paper machines.</p> <p>The model for the steam pressure above, is a black-box model. This class of models is adequate for controller tuning but does not tell anything about the physical laws behind the dynamic behavior. A linear second-order grey-box model has also been derived, based on first principles and a few fitting parameters that have physical interpretations. The foundation of the model is simple mass and energy balances, and it has the same structure as the IPZ model. One of the goals of the grey-box model is to find the physical properties that determine the parameters in the IPZ-model.</p>			
<i>Keywords</i> Moisture control, Pressure control, Paper-making, Grey-box modeling.			
<i>Classification system and/or index terms (if any)</i>			
<i>Supplementary bibliographical information</i>			
<i>ISSN and key title</i> 0280-5316		<i>ISBN</i>	
<i>Language</i> English	<i>Number of pages</i> 84	<i>Recipient's notes</i>	
<i>Security classification</i>			

The report may be ordered from the Department of Automatic Control or borrowed through:  
 University Library 2, Box 3, SE-221 00 Lund, Sweden  
 Fax +46 46 222 44 22 E-mail ub2@ub2.se

## Contents

Preface .....	6
Acknowledgements.....	8
1. Introduction.....	11
1.1 Background and motivation.....	11
2. The paper drying process.....	15
2.1 Cylinder configurations in the dryer section.....	15
2.2 The steam and condensate system .....	17
2.3 The moisture control loop.....	19
3. Modeling of the steam pressure .....	25
3.1 A black-box model – the IPZ-transfer function.....	25
3.2 A grey-box model for the steam pressure dynamics.....	39
3.3 Summary .....	53
4. A control tuning rule for the steam pressure.....	55
4.1 Introduction.....	55
4.2 The design method.....	56
4.3 The IPZ-tuning rule.....	58
4.4 Industrial verification of the tuning rule .....	62
4.5 Summary .....	69
5. Conclusion and future work.....	71
5.1 Conclusions.....	71
5.2 Future work.....	72
6. Bibliography .....	75
A Glossary .....	81

## Preface

I first encountered process control in the summer of 1990. I was working as a summer intern at a pulp and paper mill at one of their winders (a machine that slits and winds the paper from the paper machine into the roll widths ordered by the customer). A winder does not have much process control but one night shift I was put to manage a pulper (a unit for slushing paper into pulp). I got a two minute course in control theory by one of the operators. For the first time in my life I heard words like set point and control signal. I remember that I did not understand much of it at that time. There were two important control loops to keep an eye on, the level control and the consistency control. Both were controlled by single-loop controllers, probably manufactured by Fisher & Porter. A dangerous operating point was if the consistency was too high to empty the pulper at the same time as the level was too high to dilute the pulp mix. I promised the operator to not reach that point and hoped that I was right. Luckily I managed to do fine through the night and I was placed there the following nights too.

The next summer I was working at the same site but this year at the instrument department. One day we were replacing a flow meter at the pulp dryer and I was watching a level controller, trying to understand how it worked. I noticed that the level was too low but the controller only opened the valve 40% and increased slowly. I asked the maintenance guy who was dismantling the flow meter, why the valve was not fully opened. I thought that was the appropriate thing for the controller to do if the level was low. He then explained to me the concept of dynamics and overshoot, and from that day on I was hooked on the exciting field of process control.

During my studies I continued to work at the instrument department each summer. I learned a lot, things that are still useful for me today, every thing from repairing old pneumatic controllers with solvent liquid, programming the DCS-system and understanding different control structures. After my degree I worked there for a few years more before I went back to the university to become a PhD student.

Skånetrafiken and their personnel. During these years of travel I have experienced hours of train delays, several strikes, one bomb threat, a gun shooting incident, attempted suicides and two train fires (nearly enough material for another thesis). I am still waiting for that derailment though.

A great thanks to all my friends in Bromölla: Tarja, Biffen, Bobby, Lasen, TL, Krax, Vickan, Junior, Nille, Halman, Parraj, Edit, Maz, Camilla, Kroon, Fia, kompis-Åsa, Mia, Gunnar, Karro, Blaskan, Wess, Bjäbban, Sasha and Anderrss (I sincerely hope I did not forget anyone). I have enjoyed all parties, pizzas, movies, and outdoor activities a lot. Also, thank you Jerker, for the Star Trek TNG sessions we have had, and to Jill and John for the London visits and the night-rides in Oxford Street.

Many thanks to my parents who, these days, live in the country (at Stora Slätteke). Whenever I feel I need a break from moisture control and Laplace transforms, I go there and feed their chickens instead.

Finally, my last but not least appreciation goes to my Kristin. You have only been a part of my life for a short period of time, but you have nevertheless made a great impact on me. Thank you, for everything.

*Ola*

# 1

## Introduction

### 1.1 Background and motivation

Paper is used for writing and printing, for wrapping and packaging, and for a variety of other applications ranging from kitchen towels to the manufacture of building materials. It simply comes in an enormous variety of qualities and grades. Some common types of paper qualities include the following:

- Copy paper for desk-jet printers, copying machines and writing
- Newsprint
- Cardboard
- Light-weight coated paper for magazines
- Wrapping and packaging paper
- Hygienic tissue paper
- Currency paper

affects a lot of the important physical properties of the final product, such as paper sheet strength, curl, stiffness and elasticity.

A dryer section in a paper machine can consist of up to one hundred dryer cylinders and the length of the dryer section can be more than 100 meters. For a paper mill, and even for a group of companies, erecting a new paper machine is a large investment. A high production rate and capacity is therefore essential to achieve a high return on the investment. One way to increase the production rate in a paper machine is to increase the amount of paper which has acceptable quality. This can be accomplished by both reducing the time between grade change transitions and the amount of time it takes to get the paper back on the reel after a web break [Wilhelmsson, 1995]. Another way is to ensure a stable process, and uniform and consistent product with high quality during normal operation. At the same time, as the applications of paper become more specialized and demanding, with the introduction of new products and new printing methods for example, the specifications on the end product are likely to be much stricter than today [Dumont, 1988]. The production rate can also, of course, be increased by increasing the machine speed, which most often results in the dryer section becoming a bottle-neck. In all these alternatives stated above, the dryer section plays a vital role.

These are some of the reasons why the behavior of the dryer section of the paper machine is critical. As the title reflects, this work is focused on the steam and condensate system control in the dryer section.



# 2

## The paper drying process

The most common way to evaporate the water in the paper web is to use the latent heat of vaporization in steam. The moist paper can be led around a single large steam heated cylinder, called Yankee cylinder (mainly used for the drying of tissue) or a large number of steam heated cast iron cylinders in series, called multi-cylinder drying. Here, we only give attention to the multi-cylinder dryer. A thorough textbook about paper drying is [Karlsson, 2000]. A glossary can be found in Appendix A.

### **2.1 Cylinder configurations in the dryer section**

When the steam enters the cylinder it releases its thermal energy to the cast iron shell and condenses into water. This condensate is drawn off by suction with a siphon and fed back to the boiler house. The steam is typically fed to the cylinders on the backside of the machine (called the drive side), and the condensate is evacuated on the front side (called the operator side) or the backside. At some machines the condensate is

prevent the dryer section from becoming a bottle-neck at higher machine speeds, the single-tier configuration was invented (in 1975 at Stora Enso Hylte mill [Carlberg, 1989]), see Figure 2.2. Using this technique, a single fabric is supporting the web on both the top and the bottom cylinders, as well as in the passage between them. Since the fabric is between the web and the cylinders in the bottom row, no significant drying occurs there. In modern machines, the bottom row of cylinders is therefore replaced by smaller vacuum rolls to increase the runnability even more.

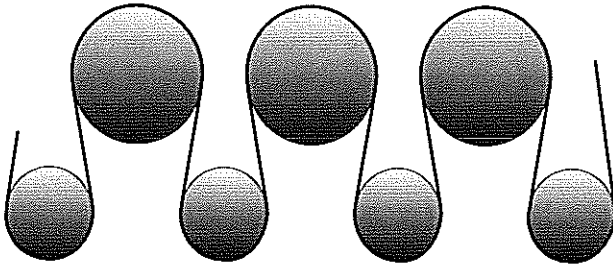

Figure 2.2 A single-tier configuration.

## 2.2 The steam and condensate system

The purpose of the steam and condensate system is to provide the sufficient amount of steam to the dryers and to deal with the produced condensate. All the cylinders in a dryer section are divided in separate dryer groups, normally between five and ten groups. The steam pressure in the different dryer groups can then be controlled individually to obtain the desired pressure profile through the dryer section, from the first group to the last one. Since the steam inside the cylinder can be regarded as saturated (because of the continuous condensation at the cylinder wall), there is a direct correlation between the steam pressure and steam temperature and you could also talk about a temperature profile. For most paper grades, dryer steam pressure is

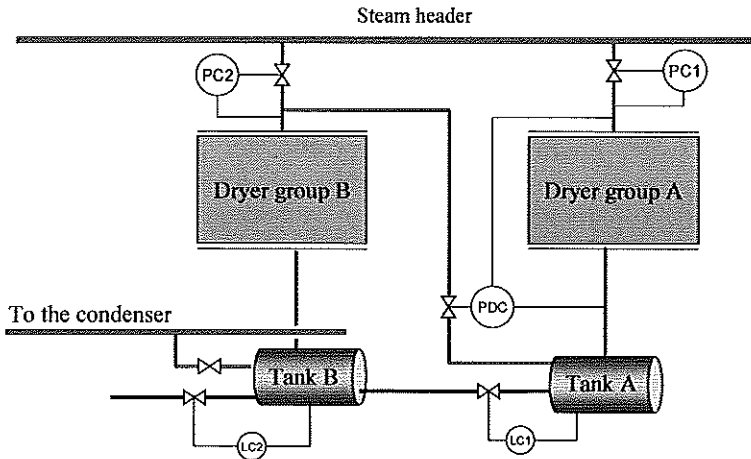

Figure 2.3 Part of a dryer section with a cascade system.

## 2.3 The moisture control loop

### The measuring principle

To control something, you must be able to measure or estimate it. Quality parameters, such as basis weight, moisture, caliper, ash content, color, and brightness are measured on-line in a paper machine. The quality control system (QCS) is divided in two separate dimensions, the machine direction control (MD) and the cross direction control (CD). The conventional technique is to measure the MD and CD signals by scanning the sheet with a single sensor. The sensor moves back and forth in the cross direction, and due to the MD movement of the paper, the measurements form a zig-zag pattern on the paper sheet, as shown in Figure 2.4. This implies that the MD and CD variations are mixed together by the measuring principle and the two signals must be separated. In [Natarajan *et al.*, 1988] an algorithm is developed, which uses least squares to estimate the CD component and Kalman-filtering

example of scanner measurements, in machine direction, during a normal run are shown in Figure 2.5, taken from a machine producing  $80 \text{ g/m}^2$  of high quality copy paper. At 1500 s, there is a short period of time when the measurements are not updated, most distinct in the basis weight. This is due to the automatic calibration of the scanner, performed at constant intervals, when the measuring head is positioned at one of the ends in the CD.

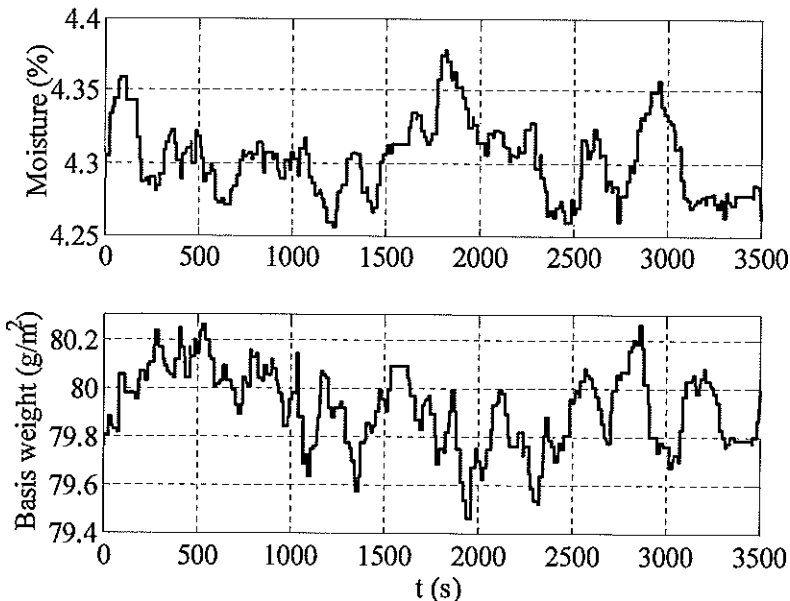

Figure 2.5 Moisture content and conditioned basis weight measurements taken from a fine paper machine. The set point for moisture in this case was 4.3 % and the basis weight set point was  $80 \text{ g/m}^2$ . The 2-sigma values were 0.056 % and  $0.3 \text{ g/m}^2$  respectively.

### The paper moisture control loop

As explained previously, the moisture in the sheet is controlled by the steam pressure in the cylinder groups. Since the dryer section is divided in separately controlled groups, one could suspect that this would lead to multivariable control of the moisture, in terms of a single-input-

is a model based dead-time compensating controller, typically of the internal model control (IMC) concept [Morari and Zafiriou, 1989] or based on the Dahlin type [Dahlin, 1968] (which is a subset of IMC). The performance of these controllers are evaluated in [Bialkowski, 1996] and [Makkonen *et al*, 1995]. More advanced control schemes, regarding the outer loop, can be found in [Isaksson *et al*, 1995], [Murphy *et al*, 1996] and [Wells, 1999]. Here we denote the controller as MBC (Model Based Controller) to keep the generalization. The MBC controls the moisture in the paper sheet, by giving set point values to the PI-controllers in the inner loop, which is the primary objective of the dryer section in the paper machine. Properties and characteristics of the MBC-controller are not dealt with in this thesis.

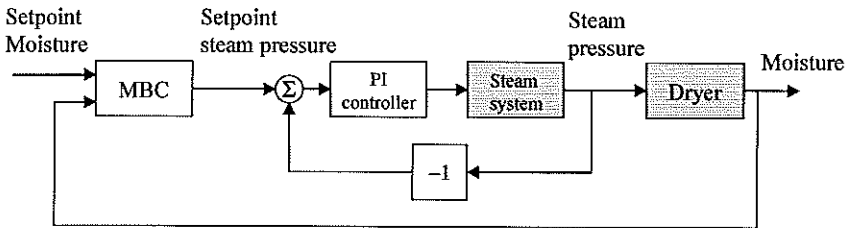

Figure 2.7 A block diagram of the moisture control loop.

As a matter of curiosity, it could be mentioned that one of the first paper companies to use digital computers to control one of their machines was Billerud AB in Sweden [Åström, 2000a]. It was in the middle of the sixties, and the system was an IBM 1710 with a CPU running at 100 kHz and 80 kB of memory. The system had a special real time operating system, written as a part of the installation project. All control was done in a supervisory mode, the digital computer provided set points to the analogue system and it was based on stochastic control theory. The history of process control in relation to the development of computers, can be read in [Balchen, 1999].

# 3

## Modeling of the steam pressure

### 3.1 A black-box model – the IPZ-transfer function

From experiments on a large number of different industrial paper machines, producing the whole range of different paper qualities, it has been found that the dynamics from the steam valve to the steam pressure can be described by a linear process model. This model has an integrator, one pole, and one zero, therefore we call it the IPZ-model. This model structure has also been suggested in [Nelson and Gardner, 1996]. The IPZ-model can be represented by the transfer function

$$G(s) = k_v \frac{(1 + sT_1)}{s(1 + sT_2)} e^{-sL} \quad T_1 > T_2 \quad (3.1)$$

Note that  $T_1$  is always larger than  $T_2$ , typically by a factor of 10 – 100. The transfer function can then be regarded as an integrator in connection with a lead-network. This gives a characteristic open loop step response, different from most processes normally encountered in

temperature of the steam and the condensation rate. But the increasing condensation rate lags behind the increasing steam inlet flow as the condensate layer heats up to the new steady state temperature. Therefore there will be a fast initial build-up in steam pressure, before the steam consumption has reached its new value.

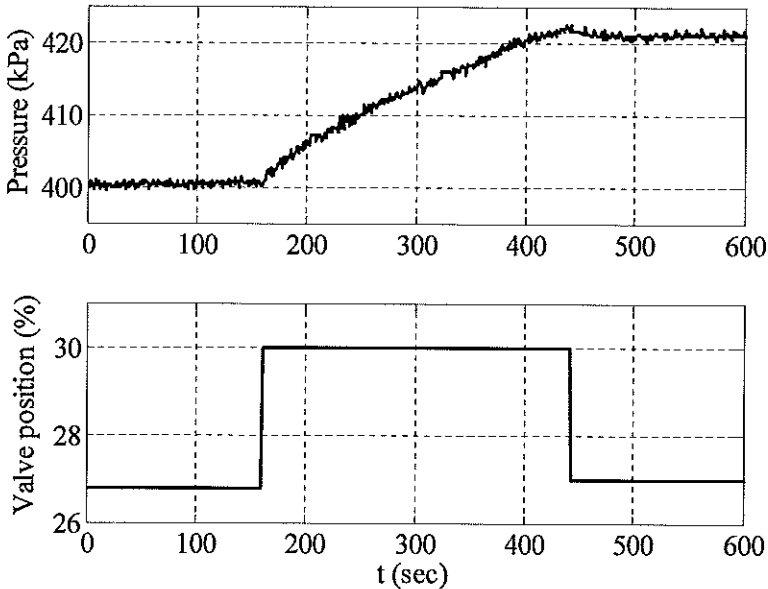

Figure 3.2 Open loop step response, taken from a board machine.

Figure 3.2 shows a good example of the cylinder pressure dynamics when the magnitude of the model parameters  $T_1$  and  $T_2$  are in the same region. The valve is first opened three percentage units and then closed by the same amount. Since the pole and the zero can almost be cancelled, the process behaves as a pure integrator. When the control signal is put back to the original position, the pressure has reached a new steady state value. A level control in a tank has the same behavior. It should be emphasized that this is an unusual example of an IPZ-model.

asymptote as time tends to infinity (called  $q_2(t)$ ), both marked in the figure. Suppose that the size of the step in the control signal is  $u_0$  and that the slope of the asymptote  $q_2(t)$  is  $k_0$ . Also suppose that the two lines intersect at the coordinates  $(t_0, y_0)$ . Then we have

$$k_v = \frac{k_0}{u_0}, \quad T_1 = \frac{y_0}{k_v u_0}, \quad T_2 = t_0 \quad (3.2)$$

The time delay  $L$  is obtained in a standard way as the time that elapses between the time when the controller output is changed and the time at which the response of the process output begins.

To derive the expression in equation (3.2), start by denoting the step response by  $y(t)$ . To get the final slope of the step response (which also is the steady state value of the impulse response), we use the final value theorem

$$\begin{aligned} k_0 &= \lim_{t \rightarrow \infty} \frac{dy(t)}{dt} = \lim_{s \rightarrow 0} s^2 G(s) \frac{u_0}{s} = \\ &= \lim_{s \rightarrow 0} \frac{k_v (1 + sT_1)}{(1 + sT_2)} u_0 = k_v u_0 \end{aligned} \quad (3.3)$$

By the initial value theorem, the initial derivative is

$$\begin{aligned} \left. \frac{dy(t)}{dt} \right|_{t=0} &= \lim_{t \rightarrow 0} \frac{dy(t)}{dt} = \lim_{s \rightarrow \infty} s^2 G(s) \frac{u_0}{s} = \\ &= \lim_{s \rightarrow \infty} \frac{k_v (1 + sT_1)}{(1 + sT_2)} u_0 = \frac{k_v T_1}{T_2} u_0 \end{aligned} \quad (3.4)$$

Thus the tangent of  $y(t)$  at  $t=0$  is, since the response starts in the origin

$$q_1(t) = \frac{k_v T_1 u_0}{T_2} t \quad (3.5)$$

By the inverse Laplace transform, the step response can also be written as



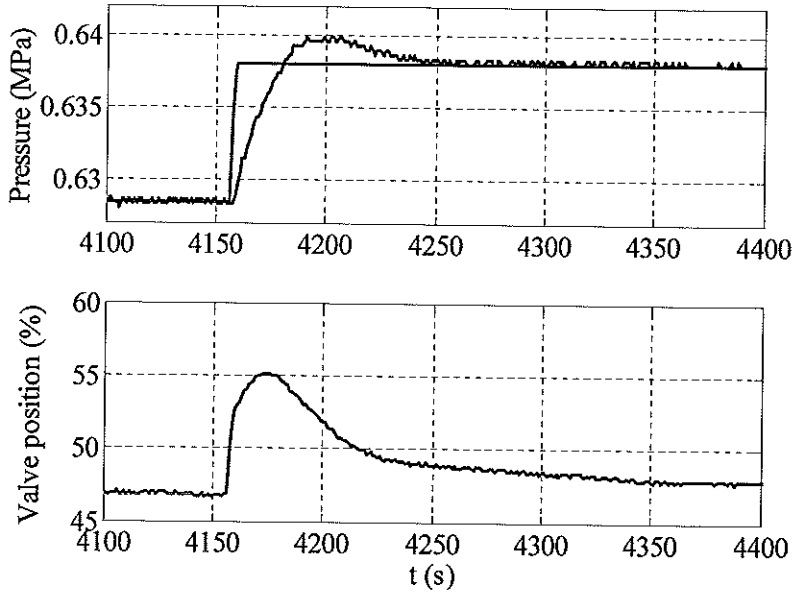

Figure 3.4 Typical closed loop step response, taken from a fluting machine.

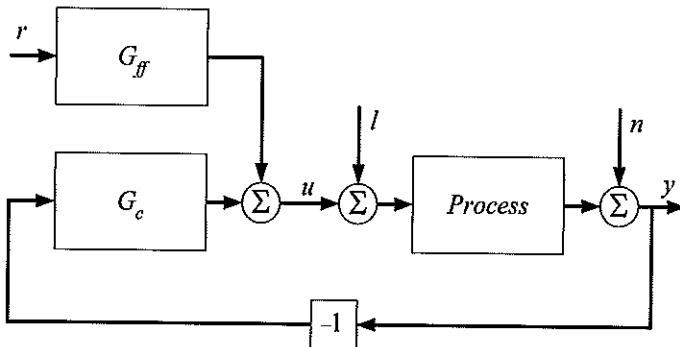

Figure 3.5 Block diagram of the PI-controller used in this thesis, together with the process.  $r$  is the set point,  $u$  the control signal,  $y$  the measurement,  $l$  a load disturbance, and  $n$  measurement noise.

$$\int_0^{\infty} e(t) dt = \lim_{s \rightarrow 0} s \cdot \frac{1}{s^2} G_{re}(s) = \quad (3.15)$$

$$= \lim_{s \rightarrow 0} \frac{T_i s + (1 - \beta) \hat{P}(s) k_c T_i}{T_i s^2 + k_c (T_i s + 1) \hat{P}(s)} = (1 - \beta) T_i$$

In the classical case, when  $\beta = 1$ , the integral of the control error is zero. This implies that there must be an overshoot in the set point step response to compensate the initial positive area in the time plot. We can also conclude that  $\beta > 1$  will give an overshoot in the step response since the integral has a negative value. The range of  $\beta$  is normally defined as

$$0 \leq \beta \leq 1 \quad (3.16)$$

and extensive simulation results have indicated that there will be an overshoot in this case too, unless  $T_i$  is exceptionally large. Also remarkable is that the integral error is independent of the controller gain,  $k_c$ , in equation (3.15). Even though it is not shown here, the result in equation (3.15) is identical if a derivative part is added to the controller structure.

### Is there a need for a two-pole model?

Since the steam pressure in a cylinder group finally must reach some steady state value, the integrator in the model is more likely to be a long time constant. This implies that the model does not capture the low frequency behavior well and this has been one of the criticisms against it. However, the purpose of the model is not simulation and the question is if its complexity is sufficient for a control design usage. Instead of the transfer function given in (3.1), with an extra pole, we would get

$$G_{PPZ}(s) = k_p \frac{(1 + sT_1)}{(1 + sT_2)(1 + sT_3)} e^{-sL} \quad T_3 > T_1 > T_2 \quad (3.17)$$

Start by defining the final value of the control signal as time goes to infinity, and assume a step in the set point with size  $\Delta r$

$$\Delta u_\infty \equiv \lim_{t \rightarrow \infty} u(t) = \lim_{s \rightarrow 0} s \cdot G_{ru}(s) \frac{\Delta r}{s} = G_{ru}(0) \Delta r \quad (3.18)$$

where  $G_{ru}(s)$  is the transfer function from the set point  $r$  to the control signal  $u$ . Assume that the process dynamics are described by the IPZ-model given in equation (3.1). Also assume that the controller is given by the definition in equation (3.10) and Figure 3.5. Then we have

$$\begin{aligned} G_{ru}(s) &= \frac{G_{ff}(s)}{1 + G_c(s)G(s)} = \frac{k_c \left( \beta + \frac{1}{T_i s} \right)}{1 + k_v k_c \left( 1 + \frac{1}{T_i s} \right) \frac{(sT_1 + 1)}{s(sT_2 + 1)} e^{-sL}} \quad (3.19) \\ &= \frac{k_c s (\beta T_i s + 1) (T_2 s + 1)}{s^2 T_i (T_2 s + 1) + k_v k_c (T_i s + 1) (T_1 s + 1) e^{-sL}} \end{aligned}$$

The steady state value of the control signal is then

$$\Delta u_\infty = G_{ru}(0) \Delta r = 0 \quad (3.20)$$

and we can see that the final value of the control signal must be equal to zero if the process is given by the IPZ-model. This means that the control signal in Figure 3.6 should have returned to its original steady state value (to the level it had before the step in the set point). If we instead let the process be of PPZ-type, equation (3.17), then the steady state value of the control signal will become,

$$\begin{aligned} & \frac{G_{ff}(0)}{1 + G_c(0)G_{PPZ}(0)} \Delta r = \\ & = \frac{k_c (1 + sT_i)(1 + sT_2)(1 + sT_3) \Delta r}{sT_i (1 + sT_2)(1 + sT_3) + k_c k_p (1 + sT_i)(1 + sT_1)} \Bigg|_{s=0} = \frac{\Delta r}{k_p} \quad (3.21) \end{aligned}$$

and it depends of the process gain and the size of the step.

$$G_1(s) = 15.5 \frac{(1 + 291s)}{(1 + 797s)(1 + 74.2s)} e^{-2.83s} \quad (3.22)$$

and the estimated IPZ model is

$$G_2(s) = 0.00421 \frac{(1 + 1896s)}{s(1 + 138s)} e^{-2.83s} \quad (3.23)$$

The difference between the two models is apparent. The IPZ-model does not capture the low frequency component of the process as well as the PPZ-model does. By manipulating the parameters in the IPZ-model, the graphical fit can be improved in the validation part of the figure, to the other part's disadvantage. In [Karlsson *et al*, 2003] it is suggested that this might be due to different amount of blow through steam at different operating points. Nevertheless the PPZ-model captures the dynamics better than the IPZ-model, in this example.

The question that we posed in the beginning of this section was if the IPZ model is sufficient for control design purposes or do we need to use a PPZ model instead? To answer that question we start by quoting [Ljung, 1999]: "Feedback control is both forgiving and demanding in the sense that we can have good control even with a mediocre model, as long as it is reliable in certain frequency ranges. Loosely speaking, the model has to be reliable around the cross-over frequency ( $\approx$  the bandwidth of the closed loop system), and it may be bad where the closed loop sensitivity function is small."

Since we have not yet designed a controller for the processes in equation (3.22) and equation (3.23), a sensitivity function does not exist but the model's cross-over frequency can be calculated. Figure 3.8 shows the open-loop Bode plot for the models in equation (3.22) and equation (3.23). Both in the magnitude- and the phase plot, there is a large discrepancy for low frequencies but the disparity between the models is negligible in the high frequency region. Around the cross-over frequency, the two different process models also have similar appearance. Even if this example does not qualify as an academic proof, we feel confident that the IPZ model is adequate and well suited

### 3.2 A grey-box model for the steam pressure dynamics

In the previous section a black-box model for the steam pressure in a dryer cylinder was presented. This class of models is adequate for controller tuning purposes but does not tell anything about the physics that generate the dynamic behavior. We will here present a first principles model proposed by [Åström, 2003]. The foundation of the model is simple mass and energy balances. The primary model is a nonlinear differential-algebraic equation set, but by algebraic manipulations and a linearization, it will have the same structure as the IPZ model. The steam pressure and the cylinder shell temperature are chosen as state variables, since both these variables are possible to measure. One of the main purposes of this grey-box model is to gain insight into which physical characteristics and mechanisms have key effect on the parameters in the IPZ model. A similar approach for a drum boiler has been presented in [Åström and Bell, 2000b]. For more on grey-box modeling, see [Allison *et al*, 1997], [Bohlin and Graebe, 1995] and [Bohlin, 1994]. A comprehensive book about physical modeling and model analysis is [Hangos and Cameron, 2001].

#### The model

Let  $q_s$  be the mass flow rate of steam into the cylinder,  $q_c$  be the condensation rate, and  $q_w$  be the siphon flow rate. Also, let  $V_s$  be the volume of steam,  $V_w$  be the volume of water (condensate),  $\rho_s$  the steam density, and  $\rho_w$  the water density. The mass balances for water and steam are then

$$\begin{aligned}\frac{d}{dt}(\rho_s V_s) &= q_s - q_c \\ \frac{d}{dt}(\rho_w V_w) &= q_c - q_w\end{aligned}\tag{3.24}$$

where we have assumed no blow-through steam. Sometimes the blow-through steam is modeled as a constant fraction of the inlet steam [Karlsson *et al*, 2002] and does then not affect the dynamics of the

Equation (3.24), (3.25), and (3.26) is a coarse model for the steam and condensate system in the cylinder cavity. It is nonlinear and of high order. To obtain a linear second-order model, we make a few simplifications.

We assume that the steam in the cylinder is saturated. This means that the state of the steam can be characterized by one variable only and that it is sufficient to use either the mass balance or energy balance. Therefore we leave out the energy balance. In addition, the thermal dynamics of the water is very fast, so we replace it by a static model. We also assume that the changes in condensate thickness are small and the second mass balance in equation (3.24) can be eliminated. The volume of steam,  $V_s$ , is then constant and is also approximated to be equal to the total cylinder volume,  $V$ .

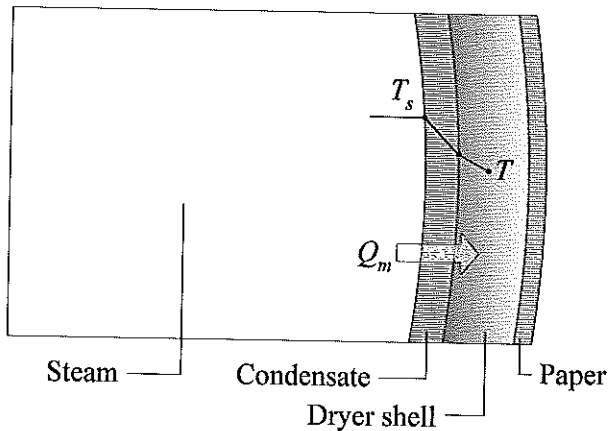

Figure 3.9 A piece of the cross-section of a drying cylinder, visualizing the assumption on the temperature profile and the energy flow to the metal, from equation (3.26). The paper web is not included in the model and consequently there is no assumption on the paper temperature. The picture has taken inspiration from [Karlsson, 2000].

Summarizing, we find that the system can be described by the equations

$$Q_p^0 = \alpha A_{cy} (T_s(p^0) - T^0) = q_s^0 h_s(p^0) - q_w^0 h_w(p^0) \quad (3.31)$$

Linearizing around the equilibrium gives

$$\begin{aligned} h_s^0 V \frac{\partial \rho_s}{\partial p} \Big|_{p=p^0} \frac{d\delta p}{dt} &= \\ &= \left( q_s^0 \frac{\partial h_s}{\partial p} - q_w^0 \frac{\partial h_w}{\partial p} - h_w(p^0) \frac{\partial q_w}{\partial p} - \alpha A_{cy} \frac{\partial T_s}{\partial p} \right) \Big|_{p=p^0} \delta p + \\ &+ \alpha A_{cy} \delta T + h_s(p^0) \delta q_s \\ m C_p \frac{d\delta T}{dt} &= \alpha A_{cy} \frac{\partial T_s}{\partial p} \Big|_{p=p^0} \delta p - \alpha A_{cy} \delta T \end{aligned} \quad (3.32)$$

where the states are expressed in terms of deviation variables. Assuming that

$$\left| q_s^0 \frac{\partial h_s}{\partial p} - q_w^0 \frac{\partial h_w}{\partial p} - h_w(p^0) \frac{\partial q_w}{\partial p} \right| \ll \alpha A_{cy} \left| \frac{\partial T_s}{\partial p} \right| \quad (3.33)$$

the model becomes

$$\begin{aligned} h_s^0 V \frac{\partial \rho_s}{\partial p} \Big|_{p=p^0} \frac{d\delta p}{dt} &= -\alpha A_{cy} \frac{\partial T_s}{\partial p} \Big|_{p=p^0} \delta p + \alpha A_{cy} \delta T + h_s(p^0) \delta q_s \\ m C_p \frac{d\delta T}{dt} &= \alpha A_{cy} \frac{\partial T_s}{\partial p} \Big|_{p=p^0} \delta p - \alpha A_{cy} \delta T \end{aligned} \quad (3.34)$$

The inequality in equation (3.33) will be commented and examined later in the simulations. Writing the system in standard state-space form, we find that

$$\begin{aligned} \dot{x} &= Ax + Bq_s \\ y &= Cx + Dq_s \end{aligned} \quad (3.35)$$

The essential properties of the model are given by the parameters

- Cylinder volume  $V$
- Cylinder mass  $m$
- Specific heat of metal  $C_p$
- Internal area of the cylinder surface  $A_{cy}$
- Steam properties  $h_s, \partial\rho_s/\partial p, \partial T_s/\partial p$
- Heat transfer coefficient  $\alpha$

All these parameters are known beforehand, either by machine specifications or from a standard chemical handbook, except the heat transfer coefficient,  $\alpha$ , which has to be estimated from calibration data. Loosely speaking, the heat transfer coefficient is used to “tweak the model to fit the measured data”. Note that it is only the last two items that depend on the operating point.

The following assumptions have been made in the development of the model

- No blow-through steam
- The steam in the cylinder is saturated
- Energy flow to paper is constant
- The thermal dynamics of the condensate is fast compared to the cylinder shell
- Changes in volume of the condensate are small
- The mathematical simplification in equation (3.33)

The heat transfer coefficient is incorporated in all terms of the system matrix,  $A$ . By varying it, the pole on the negative real axis is altered but the pole in the origin is not influenced (multiplying a matrix by a constant implies that its eigenvalues are multiplied by the same constant). From equation (3.37), we can see that the zero in the transfer



## Step response simulations

To investigate the dynamic behavior of the linearized model, given in equation (3.35), we will simulate a step response in the input signal. The machine dependent parameters are taken from a fluting machine, running at an operating point with a nominal steam pressure of 90 kPa (gauge pressure), nominal speed for this particular machine is 450 – 600 m/min and it is producing grades with a basis weight between 110 – 200 g/m<sup>2</sup>. The values used for the simulation are

- Cylinder volume:  $V = 12.6 \text{ m}^3$
- Cylinder mass:  $m = 7610 \text{ kg}$
- Cylinder area:  $A_{cy} = 37.2 \text{ m}^2$
- Heat capacity for cast iron:  $C_p = 500 \text{ J}/(\text{kg}\cdot^\circ\text{C})$
- Steam properties for the particular operating point

From a steam flow gauge, measuring the total machine steam consumption, the nominal steam mass flow rate to each cylinder is approximated to 0.25 kg/s. The size of the input step in the simulation is 0.01 kg/s and the response of the state variables are shown in Figure 3.10 for different values of the heat transfer coefficient. The steam pressure response comes out as an IPZ-model, as expected. The transfer function from mass flow rate of steam to cylinder temperature has the same poles as the steam pressure transfer function, since they have the same system matrix,  $A$ . However, the zeros may differ between them and the temperature transfer function has none. As a result, the step response appears as an integrator-lag model.

As the figures illustrate, a higher heat transfer coefficient yields a lower steam pressure, at a given time instance, since there is a larger heat transfer through the cylinder and a higher condensation rate. This has also been pointed out in [Nelson and Gardner, 1996]. A greater energy flow through the cylinder shell gives a higher cylinder temperature even though the steam has a lower temperature, at any time index. The effect of a larger  $\alpha$ , in basic terms, dominates over the effect of a lower

side. Whether the difference in magnitude between the two sides of the inequality is large enough can be discussed. Nevertheless, we will see in the next section that the model has a good fit to experimental data.

### Comparison with plant data

To evaluate the accuracy of the grey-box model it has been both calibrated and validated against measurements from a steam- and condensate system. The experiments have been carried out on the machine that has been described in the previous section. Since the input signal (steam input flow) is not manipulated directly, neither measured, a model for a steam valve has to be added. A simple approach is to let there be a linear relationship between the controller signal,  $u$ , and the steam input flow,  $q_s$ , namely

$$q_s = du \quad (3.42)$$

where  $d$  is a valve constant which will be a second calibration parameter together with the heat transfer coefficient,  $\alpha$ . Using this valve description we keep the linearity and IPZ-structure in the model, given in (3.35).

In order to calibrate the model, the functions `idgrey.m` and `pem.m` in System Identification Toolbox for Matlab, have been used to find the optimal calibration parameters. The optimization method is based on minimizing the prediction error.

In Figure 3.11 an open loop step response is plotted together with the calibrated model, where the model output is bias corrected. The obtained calibration parameters are

$$\alpha = 574.0 \text{ W/(m}^2\cdot\text{K)}; \quad d = 0.004428 \text{ kg/(s}\cdot\text{\%)}$$

To be able to compare the result with nominal values cited in literature, we need a heat transfer coefficient through only the condensate film,  $\alpha_c$ . From [Karlsson, 2000] the relationship

In [Karlsson, 2000], typical values of the heat transfer coefficient,  $\alpha_c$ , are given. They are extremely dependent of the condensate thickness and activity, and can vary between 500 and 3000 W/(m<sup>2</sup>·K). Nevertheless, the fact that our estimated value from the model is within that range, gives support for the legitimacy of the model.

The model shows a good fit to the data in the figure and it captures the dynamic behavior well. The disagreement around  $t = 1000$  seconds, is due to an unmodeled disturbance in the system. This is clear since the controller, at this point of time, is operating in closed loop and makes corrections in the control signal to be able to maintain the constant set point. Observe that the set point is not shown in the figure.

In equation (3.44) the grey-box model is validated by comparing it with the corresponding black-box model, adjusted on the same data set and given in their Laplace transforms. The black-box model is not shown in the figures but it gives a slightly better fit to the data. There is also a difference in the parameters of the transfer functions. This is further commented below.

$$\begin{aligned}
 G_{grey}(s) &= 0.00788 \frac{(251s + 1)}{s(36.6s + 1)} e^{-s} \\
 G_{black}(s) &= 0.00839 \frac{(175s + 1)}{s(16.3s + 1)} e^{-s}
 \end{aligned}
 \tag{3.44}$$

The model has also been graphically validated by using the measured control signal values to simulate an output. The model output is then compared with the measured steam pressure. Figure 3.12 shows such an evaluation.

The validation does not reveal any evident major deficiencies in the model even though there are some deviations. There is a good fit to the steady state levels but a disparity in the dynamics. This could be explained by the fact that the validation data was taken, to some extent, at a different operating point. Even though the steam pressure levels are identical for both the calibration and validation data, the basis weight and machine speed are different.

### 3.3 Summary

Two types of models, a black-box and a grey-box, have been presented in this chapter. Both possess the same dynamical structure, but have different purposes. The intention for the black-box model is purely controller tuning and some results in connection with the PI-controller have been examined. Also, the justification of the black-box model has been discussed.

The main purpose of the grey-box model is to gain insight into the physical laws behind the black-box model. How does the heat transfer coefficient, cylinder diameter, selection of materials or steam pressure affect the dynamical performance of the system? This can have effect on the mechanical design of the dryer section, such as the siphon shape and form, dryer bars, cylinder dimensions etc. This knowledge can also be a vital for the design of the differential pressure controller, since it has great impact on the condensate thickness in the cylinder and hence the pressure dynamics.

There is also a potential to make a recursive identification of the heat transfer coefficient for fault detection with respect to condensate evacuation. It would then be beneficial to have a separate pressure meter and mass flow meter installed at the drying cylinder of interest, to acquire an accurate estimate.

# 4

## A control tuning rule for the steam pressure

### 4.1 Introduction

From practical experience it has been seen that there can be significant disturbances in the dryer section which makes disturbance attenuation an important issue. Since the prevalent machine design standard is to connect all the dryer groups to the same steam header, a disturbance in one group easily affects the other groups. In this section, a simple tuning rule for PI-control is presented. The design goal is to obtain good load disturbance response. The tuning rule is based on the four process parameters in the IPZ transfer function and is therefore denoted as IPZ-tuning. To give the user the option to balance between robustness and performance, the tuning rule has a design parameter. The IPZ-tuning rule is tested and evaluated on two different industrial paper machines.

$$S(s) = \frac{1}{1+L(s)} \quad (4.1)$$

where  $L(s)$  is the loop transfer function. The maximum sensitivity,  $M_s$ , is then given by

$$M_s = \max_{\omega} |S(i\omega)| = \max_{\omega} \left| \frac{1}{1+L(i\omega)} \right| \quad (4.2)$$

Since  $|1+L(i\omega)|$  is the distance from a point on the Nyquist curve to the critical point  $-1$ , the shortest distance from the Nyquist curve to the point  $-1$  is thus  $1/M_s$ . Therefore we get

$$M_s = \frac{1}{R} \quad (4.3)$$

and we can then use  $M_s$  as our design parameter, when deriving the tuning rule. The nice thing about the maximum sensitivity function is that it connects the open loop Nyquist curve with a closed loop property.

In [Slätteke *et al*, 2002] it was shown that for a certain value of the maximum sensitivity ( $M_s = 1.2$ ), maximizing the integral gain or maximizing the bandwidth of the closed loop system (from set point to measurement) gave essentially the same controller parameters. That means that emphasis is put on both the regulator and servo problem. However, for this does not always hold even if the two criteria prove to be close.

Since both the IPZ-process and a PI-controller contains one integrator each, the Nyquist curve starts at the phase lag  $-\pi$ . At high frequencies the phase is  $-\pi/2$ , if we assume no dead time. The complete Nyquist plot then appears as in Figure 4.2.

Note that this design method does not give any suggestion about the feedforward parameter  $\beta$  in the controller since this property is connected to the complementary sensitivity function.

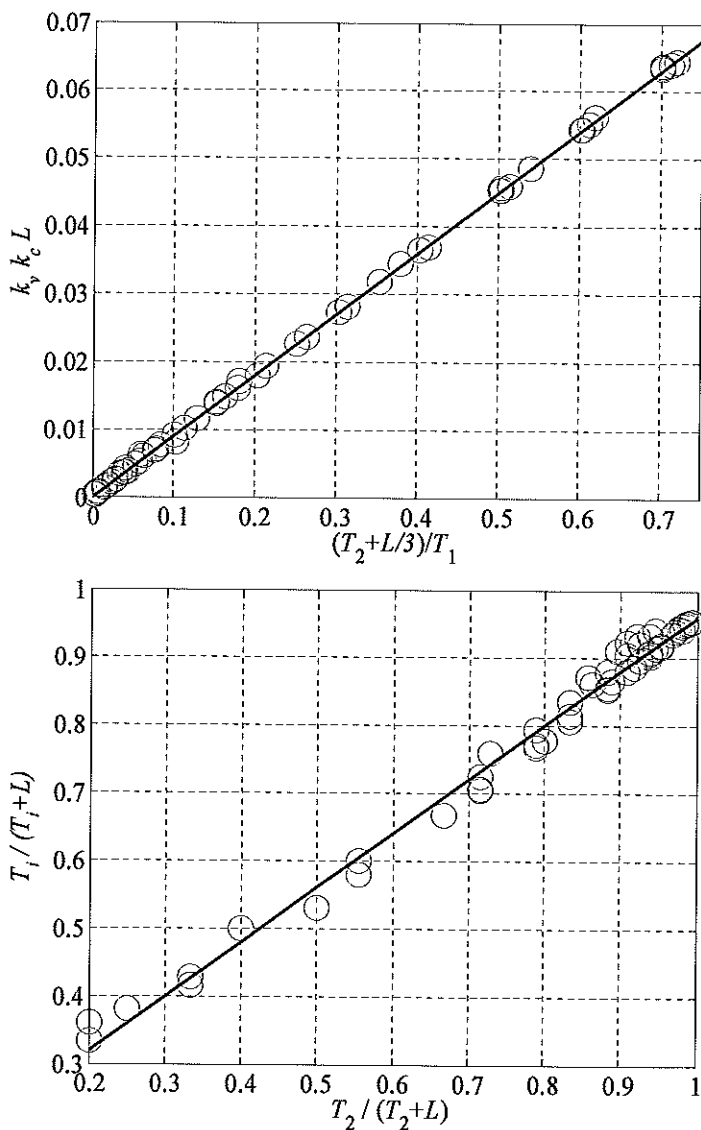

Figure 4.3 Linear relationship between the controller and process parameters for  $M_s=1.1$ .

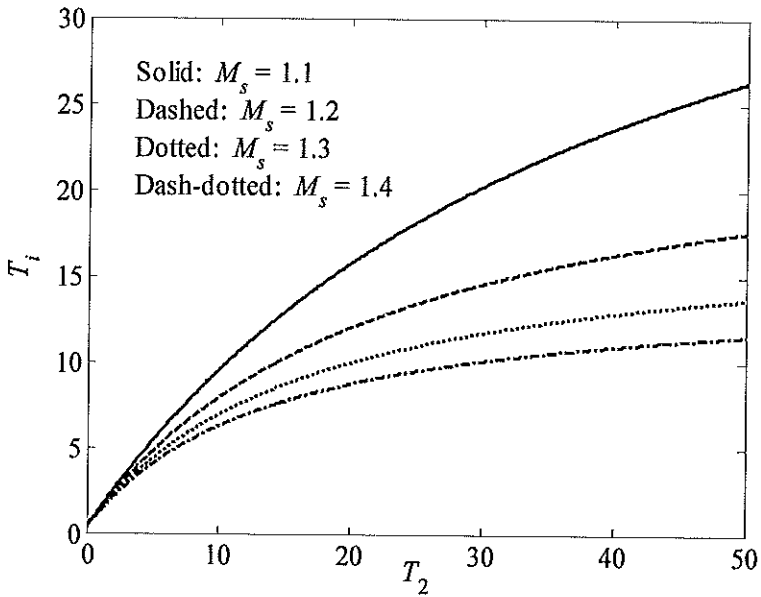

Figure 4.4 The integral time,  $T_i$ , as a function of the time constant  $T_2$ .

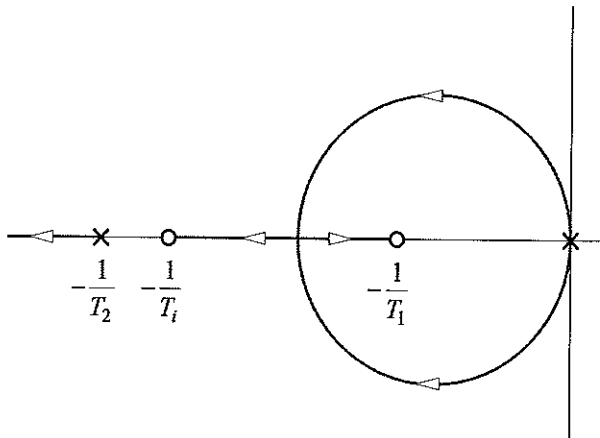
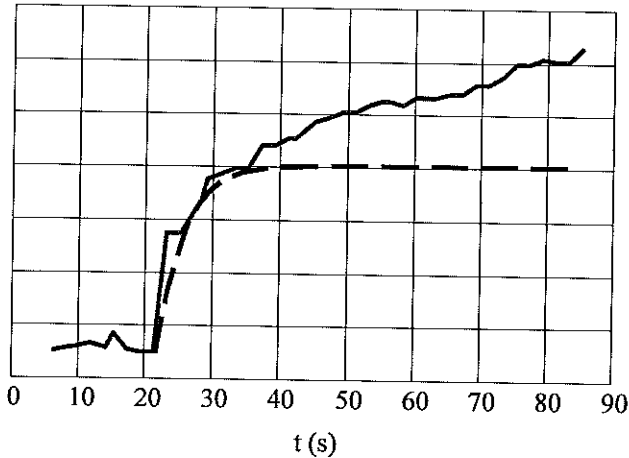

Figure 4.5 The root locus for the IPZ process in connection with a PI-controller.





**Figure 4.6** By approximating the initial dynamics as a first order process, the  $\lambda$ -tuning method can be used.

The first dryer group, in this example, consists of 21 cylinders (operating in the middle of the machine), which makes it a large group, and it only uses steam from the header (no flash or blow-through steam added to the group). From an open loop step response, the transfer function is found to be

$$0.00135 \frac{(548s + 1)}{s(26.5s + 1)} e^{-2.0s} \quad (4.5)$$

By applying lambda tuning, as described above, the controller parameters are  $k_c=2.3$ ;  $T_i=26.5$  (note that  $T_i=T_2$ ). Using the IPZ-tuning method, given in equation (4.4), and using  $M_s=1.2$ , the controller parameters are  $k_c=3.0$ ;  $T_i=13.8$ . Figure 4.7 shows an experiment with these controller parameters utilized. In this case the lambda tuning gives more damped process response than IPZ-tuning, but we will see in the next experiment that this does not always apply.

The second dryer group consists of only two cylinders, which makes it a small group, and it only uses flash steam. It is the first group in the machine and therefore it runs at a much lower pressure than in the previous case. From an open loop step response, the IPZ transfer function is found to be

$$0.0194 \frac{(141s + 1)}{s(1.81s + 1)} e^{-1.8s} \quad (4.6)$$

Using lambda tuning in this case gives the controller parameters  $k_c=0.24$ ;  $T_i=1.8$  and IPZ-tuning gives  $k_c=0.08$ ;  $T_i=2.1$ . In Figure 4.8, the experiment is shown and a vertical dashed line indicates the time when the controller parameters are changed from lambda tuning to IPZ-tuning.

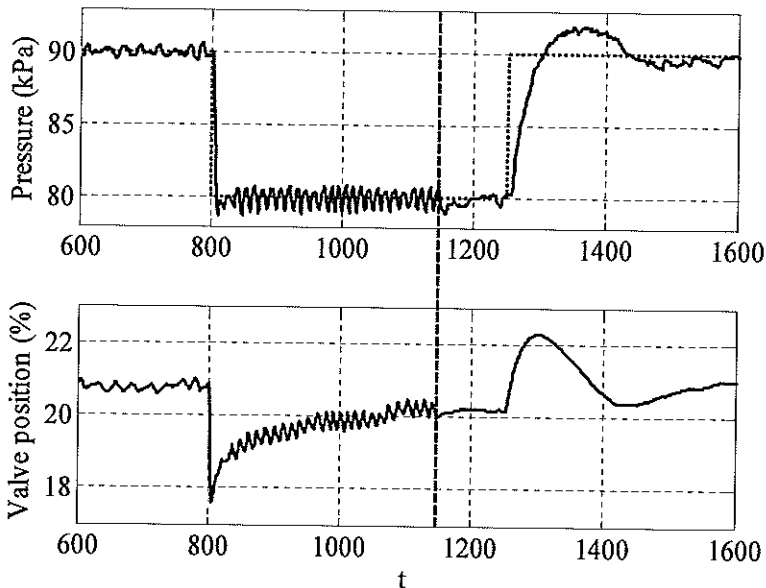

Figure 4.8 Closed loop step responses on a small group with lambda tuning (first part) and tuned by the IPZ-tuning (second part). Controller parameter  $\beta=0$ .

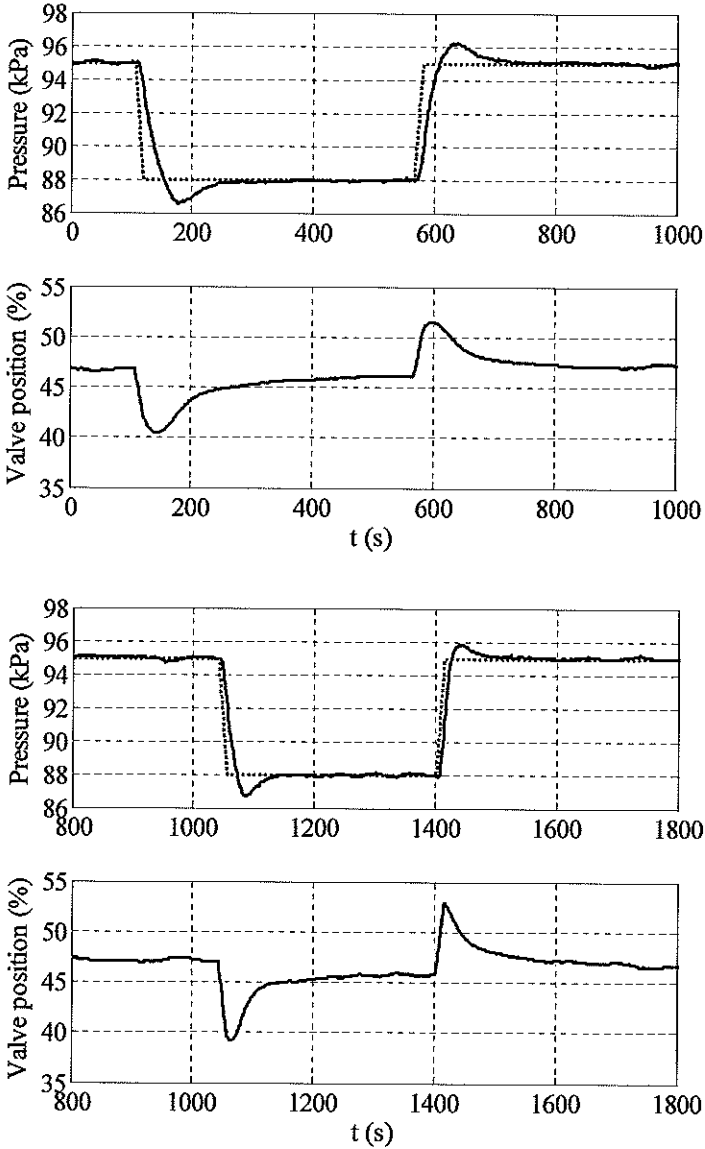

Figure 4.9 Closed loop step responses, using IPZ-tuning, for  $M_s=1.1$  (above) and  $M_s=1.2$  (below). Controller parameter  $\beta=1$ .

The step responses in the figures and the table show very well the difference between various values of the tuning parameter  $M_s$ . A higher value provides a more quick response but the valve must also work harder. This is essential to remember since an aggressive control signal can introduce disturbances in adjacent dryer groups through the steam header and must be considered when tuning a whole dryer section of a paper machine. Another important issue is the steam load to the boiler house. Large variations in the paper machines steam demand can put out the recovery boiler and this has to be considered when tuning the dryer section.

## 4.5 Summary

In this chapter a tuning method for PI-control of the steam pressure of a cylinder dryer has been presented. It is based on load disturbance rejection in connection with a robustness constraint. To calculate the controller parameters, the method requires the four process parameters of the IPZ-model and a design parameter that is set by the user. The process parameters can easily be obtained from an open loop step response. The advantage with the IPZ-tuning is that the equations are simple and it is easy to use. From tests on different cylinder groups the method has been validated and proved to perform well. However, since the dead time has a significant effect on the method, a good quality dead time estimation is essential.

# 5

## Conclusions and future work

This thesis deals with various aspects of the modeling and control of the steam pressure in a cylinder dryer. Here, a summary of the conclusions and a suggestion for future work, is given.

### 5.1 Conclusions

After a short motivation of the work in Chapter 1, a description of the paper drying process is given in Chapter 2. The different control loops and measuring principles are explained. Also, a few references are specified for further reading about subjects not treated in this text.

In Chapter 3, modeling of the steam pressure is discussed. Two types of models, a black-box and a grey-box, are presented. Both possess the same dynamical structure, but have different purposes. The intention for the black-box model is purely controller tuning. The main purpose of the grey-box model is to gain insight into the physical laws behind

- The grey-box model has two states, the steam pressure and cylinder temperature. The model can then be validated against both, if they are measured.
- Investigate couplings between different cylinder groups by modeling in Modelica and a model package called ThermoFluid [Tummescheit, 2002].

# 6

## Bibliography

Allison, B. J., A. J. Isaksson, and A. Karlström (1997): "Grey-box identification of a TMP refiner", *Pulp and Paper Canada*, 98(4), pp. 123–126.

Åström, K. J. (2003): Personal communication.

Åström, K. J. (2000a): "Control problems in paper making - revisited." *Preprints Control Systems 2000*, pp. 129–136, Canada.

Åström, K. J., and R. D. Bell (2000b): "Drum boiler dynamics." *Automatica*, 36(3), pp. 363–378.

Åström, K. J., H. Panagopoulos, and T. Hägglund (1998): "Design of PI controllers based on non-convex optimization", *Automatica*, 34(5), pp. 585–601.

Åström, K. J., and T. Hägglund (1995): *PID Controllers: theory, design, and tuning*, 2<sup>nd</sup> edition, Instrument Society of America, Research triangle Park, NC.

- Fellers, C., and B. Norman (1998): *Pappersteknik*, Institutionen för pappersteknik, KTH.
- Hangos, K., and I. Cameron (2001): *Process modelling and model analysis*, Academic Press.
- Heaven, E. M., I. M. Jonsson, T. M. Kean, M. A. Manness, and R. N. Vyse (1994): "Recent advances in cross machine profile control", *IEEE Control System Magazine*, 14(5), pp. 35–46.
- Isaksson, A. J., M. Hagberg, and L. E. Jönsson (1995): "Benchmarking for paper machine MD-control: simulation results", *Control Engineering Practice*, 3(10), pp. 1491–1498.
- Karlsson, M., O. Slätteke, B. Wittenmark, and S. Stenström (2003): "Evaluation of models for the steam supply system" In *Tappi Spring Technical Conference & Trade Fare*, Chicago, Illinois.
- Karlsson, M., S. Stenström, and E. Baggerud (2002): "Dynamic simulation of the steam supply system for a multi-cylinder dryer" *Nordic Pulp and Paper Research Journal*, 17(1), pp. 66–70.
- Karlsson, M. (ed) (2000): *Paper making part 2, drying*, Tappi Press.
- Kjaer, A. P., W. P. Heath, and P. E. Wellstead (1995): "Identification of cross-directional behaviour in web production: techniques and experience", *Control Engineering Practice*, 3(1), pp. 21–29.
- Krumenacker, R. (ed) (1997): *Paper machine steam and condensate systems*, 5<sup>th</sup> edition, Tappi Press.
- Ljung, L. (1999): *System identification - Theory for the user*, 2<sup>nd</sup> edition, Prentice Hall.
- Ljung, L. (2002): *System identification toolbox user's guide*, Release 13, Mathworks.



- Slätteke, O., and M. Karlsson (2002): "Modeling and control tuning of multi-cylinder dryers" In *Reglermöte 2002*, pp. 46–48, Linköping, Sweden.
- Stenström, S., M. Karlsson, O. Slätteke, K. Forsman, and B. Wittenmark (2002): "Productivity increase from a better understanding of dynamic processes and control of the paper dryer" In *Preprints 7<sup>th</sup> New Available Technologies*, pp. 70–73, Stockholm, Sweden.
- Stenström, S., and T. Svanquist (1991): "A general model for calculating pressure drop in siphons and siphon riser tubes – Part 2: experimental results", *Tappi Journal*, 74(12), pp. 157–162.
- Tummescheit, H. (2002): *Design and implementation of object-oriented model libraries using Modelica*, PhD-thesis, Department of Automatic Control, Lund Institute of Technology, Sweden.
- Wallén, A. (2000): *Tools for autonomous process control*, PhD-thesis, Department of Automatic Control, Lund Institute of Technology, Sweden.
- Wells, C. H. (1999): "Robust multivariable IMC control for paper machines", *Tappi Journal*, 82(7), pp. 140–144.
- Wilhelmsson, B. (1995): *An experimental and theoretical study of multi-cylinder paper drying*, PhD-thesis, Department of Chemical Engineering I, Lund Institute of Technology, Sweden.

# Appendix A

## Glossary

This glossary contains explanations taken from the following websites: [www.afandpa.org](http://www.afandpa.org), [www.internationalpaper.com](http://www.internationalpaper.com) and [www.paperonline.org](http://www.paperonline.org).

**Basis weight:** Weight in grams of one square metre of paper or board; also called grammage.

**Black liquor:** Mixture of cooking chemicals and dissolved wood material remaining after sulphate cooking; recovered during pulp washing, concentrated by evaporation and burned in the recovery boiler to regenerate the cooking chemicals and generate energy.

**Board:** Generic term for stiff paper usually made in several layers with a substance normally varying from 160 to 500 g/m<sup>2</sup>, for certain grades even higher; widely used for packaging (e.g. folding cartons) and graphic applications.

**Broke:** Papermakers own waste paper created during papermaking process it is usually repulped.

**Caliper:** The thickness of a sheet of paper or board. Also known as thickness or bulk. Usually measured in nanometers.

offset book paper cut grain long is not the same grade as the same paper cut grain short.

**Grain direction:** The direction of the fibers in paper.

**Kraft paper:** A paper made essentially from wood pulp produced by a modified sulfate pulping process. It is a comparatively coarse paper particularly noted for its strength, and in unbleached grades is primarily used as a wrapper or packaging material. It can be watermarked, striped, or calendered, and it has an acceptable surface for printing. Its natural unbleached color is brown but by the use of semibleached or fully bleached sulfate pulps it can be produced in lighter shades of brown, cream tints, and white. In addition to its use as a wrapping paper, it is converted into such products as: grocery bags, envelopes, gummed sealing tape, asphalted papers, multiwall sacks, tire wraps, butcher wraps, waxed paper, coated paper, as well as specialty bags and sacks.

**Liner:** A paper that is used as the facing material in the production of corrugated and solid fibre shipping containers.

**Mechanical pulp:** Pulp consisting of fibres separated entirely by mechanical rather than chemical means.

**Newsprint:** A lightweight paper, made mainly from mechanical wood pulp, engineered to be bright and opaque for the good print contrast needed by newspapers. Newsprint also contains special tensile strength for repeated folding. It does not include printing papers of types generally used for purposes other than newspapers such as groundwood printing papers for catalogs, directories, etc.

**Opacity:** The ability of a sheet of paper to prevent light transmission through it. Opacity prevents print that is on one side of a sheet of paper from showing through to the other side.

**Packaging papers:** These papers are used to wrap or package consumer and industrial products such as grocer's bags and sacks, shopping and merchandise bags, and multiwall shipping sacks used for shipping such products as cement, flour, sugar, chemicals and animal