



LUND UNIVERSITY

Underventilerad brand

Holmstedt, Göran; Grahn, Erik

2004

[Link to publication](#)

Citation for published version (APA):

Holmstedt, G., & Grahn, E. (2004). *Underventilerad brand*. (LUTVDG/TVBB--3131--SE; Vol. 3131). Fire Safety Engineering and Systems Safety.

Total number of authors:

2

General rights

Unless other specific re-use rights are stated the following general rights apply:

Copyright and moral rights for the publications made accessible in the public portal are retained by the authors and/or other copyright owners and it is a condition of accessing publications that users recognise and abide by the legal requirements associated with these rights.

- Users may download and print one copy of any publication from the public portal for the purpose of private study or research.
- You may not further distribute the material or use it for any profit-making activity or commercial gain
- You may freely distribute the URL identifying the publication in the public portal

Read more about Creative commons licenses: <https://creativecommons.org/licenses/>

Take down policy

If you believe that this document breaches copyright please contact us providing details, and we will remove access to the work immediately and investigate your claim.

LUND UNIVERSITY

PO Box 117
221 00 Lund
+46 46-222 00 00

Underventilerad Brand

***Göran Holmstedt
Erik Grahn***

**Department of Fire Safety Engineering
Lund University, Sweden**

**Brandteknik
Lunds tekniska högskola
Lunds universitet**

Report 3131 Lund 2004

Underventilerad brand

Göran Holmstedt
Erik Grahn

Report 3131
ISSN: 1402-3504
ISRN: LUTVDG/TVBB--3131--SE

Number of pages: 30

Keywords
Fire, underventilation, room.

Sökord
Brand, underventilerad, rum

Abstract

Combustion of hydrocarbons in under-ventilated conditions has been studied experimentally and simulated with the CFD-code SOFIE. This report covers the experimental study in a 1/3 scale model of the ISO room corner test (ISO) 9705). The CFD-simulation part of the project has been published earlier in a SP-Report 1996:41 "CFD Modelling of under-ventilated Fires" by Heimo Touvinen and presented at the Second International Seminar on Fire-and Explosion hazard of Substances and venting of Deflagrations, Moscow 1997 and is published in the proceedings of the conference.

In these experiments heptane was burnt in a 1/3 scale room model. The global equivalence ratio (GER) was changed during the experiments from a low value, (well ventilated fire) up to 1.8. At higher equivalence ratios the fire got unstable with violent fluctuations and flames now and then emerging out of the room. The following quantities were measured as a function of time in the experiments: Inside the room; Gas temperatures at eight levels (vertical array) in the corner of the room; Surface temperatures at six positions (three on the walls and three on the ceiling); Weight of the liquid fuel. In the doorway; Gas temperatures at seven levels (vertical array) in the centre of the doorway; Gas concentrations in the doorway (CO, CO₂,) Global equivalence ratio in the doorway (Phi-meter). In the exhaust duct; Gas concentration (CO, CO₂, O₂, and HC); Light attenuation due to smoke; Pressure drop from a bi-directional probe mounted in the centre of the duct; Gas temperature in the centre of the duct.

The following quantities has been derived from the measurement: Mass loss rate of fuel; Mass flow in the exhaust duct; Global equivalence ratio; Rate of heat release; Yields of CO, CO₂, HC and soot at different equivalence ratios up to 1.8.

The report includes three appendix, Appendix A (calibration procedures) Appendix B (derived variables as a function of time) and Appendix C 1-2 (raw data files of the experiments).

© Copyright: Brandteknik, Lunds tekniska högskola, Lunds universitet, Lund 2004

Brandteknik
Lunds tekniska högskola
Lunds universitet
Box 118
221 00 Lund

brand@brand.lth.se
<http://www.brand.lth.se>

Telefon: 046 - 222 73 60
Telefax: 046 - 222 46 12

Department of Fire Safety Engineering
Lund University
P.O. Box 118
SE-221 00 Lund
Sweden

brand@brand.lth.se
<http://www.brand.lth.se/english>

Telephone: +46 46 222 73 60
Fax: +46 46 222 46 12

Sammanfattning

Den toxicitet och sikttnedsättning som rökgaserna från bränder i organiska material förorsakar varierar mycket med brandbetingelserna. Bränslets sammansättning, flammornas geometri och ventilationsgrad kan medföra en ändring av produktionen av sot och giftiga gaser för samma bränsle med mer än två tiopotenser. Den kunskap vi i dag har om dessa fenomen härrör nästan uteslutande från experiment i olika skalor och den är ofta mycket fragmentarisk.

Detta projekt syftar till att undersöka olika sätt att introducera mer kemi i brandtekniska beräkningsmetoder, CFD (computational fluid dynamics), för att därigenom få en mer generell metod att förutsäga framför allt produktionen av kolmonoxid i olika brandscenarier. Kolmonoxidförgiftning är huvudorsaken till att människor omkommer vid bränder inomhus.

I detta projekt har underventilerad förbränning av heptan studerats experimentellt och simulerats med en CFD-code SOFIE. Rapporten avser en experimentell studie i en 1/3 modell av ISO room corner test (ISO 9705). CDF-simuleringarna, som testade två olika sätt att introducera kemi, den s.k. flamelet modellen och "eddy dissipation" konceptet (EDC), har tidigare publicerats i en SP-Rapport 1996:41 "CDF Modelling of under-ventilated Fires" av Heimo Tuovinen och presenterats vid Second International Seminar on Fire and Explosion Hazard of Substances and Venting of Deflagarations, Moscow 1997 och är publicerad i konferensens proceedings. I rapporten och konferensbidraget presenteras jämförelse mellan teori och experiment. I denna rapport redovisas de experimentella resultaten i detalj för att de även skall kunna användas för kommande modellutvecklings- och valideringsstudier.

Vid experimenten förbrändes heptan i ett rum som var 1/3 av ISO room corner test (ISO 9705). Ventilationsgraden, beräknad som ekvivalensförhållandet s.k. GER, varierades från låga värden (välventilerad brand) till en ventilationsgrad av GER= 1.8 (underventilerad brand). Vid högre ekvivalensförhållande än 1.8 blev rumsbranden ostabil och flammorna startade att oscillera in och ut genom dörren. Oscillationerna blev så våldsamma att branden omedelbart släcktes med en koldioxidsläckare för att undvika explosion.

Vid försöken mättes följande storheter som funktion av tiden:

Inne i rummet: gastemperaturen i åtta nivåer i ett vertikalt snitt i rummets hörn; yttemperaturen på tre väggar och i tak (tre termoelement); bränslets vikt.

I dörren: gastemperaturen i sju nivåer i ett vertikalt snitt i dörrens mitt; gaskoncentrationen i dörrens övre del (CO, CO₂); ekvivalensförhållandet i de utgående brandgaserna.

I Brandgaskanalen; gaskoncentrationen (CO, CO₂, O₂ och HC) ; ljusdämpningen förorsakad av sot; tryckfallet över ett "bi-directional" pitot rör monterad i brandgaskanalens centrum; gastemperaturen i brandgaskanalens centrum.

Från de uppmätta värdena har följande storheter beräknats: massavbrinnigen, fraktioner CO, CO₂, HC och sot för olika ekvivalensförhållande upp till 1.8.

Rapporten inkluderar tre appendix, Appendix A (kalibreringsprocedurer, Appendix B (beräknade storheter som funktion av tiden och Appendix C1-2 (rådata filer från experimenten).

Innehållsförteckning

1	INTRODUKTION.....	1
2	EXPERIMENTELL METOD.....	3
2.1	FÖRBRÄNNINGSKAMMAREN	4
2.2	KONTINUERLIGA MÄTNINGAR INNE I FÖRBRÄNNINGSKAMMAREN	4
2.3	MÄTNINGAR I ÖPPNINGEN	5
2.4	KONTINUERLIGA MÄTNINGAR I VENTILATIONSKANALEN	7
2.5	TESTVÄTSKANS EGENSKAPER.....	8
2.6	EXPERIMENTEN	9
3	BERÄKNINGAR.....	10
3.1	MASSAVBRINNING OCH MASSAVBRINNINGSHASTIGHET	10
3.2	EKVIVALENSKVOT.....	11
3.3	FÖRBRÄNNINGSGASFRAKTIONER: CO ₂ , CO OCH HC	12
3.4	EFFEKTUTVECKLING OCH TOTAL UTVECKLAD ENERGI	13
3.5	RÖKPRODUKTION	14
4	RESULTAT	15
4.1	PHI-VÄRDEN	15
4.2	TEMPERATURER I FÖRBRÄNNINGSKAMMAREN	16
4.3	EFFEKTUTVECKLING OCH TOTAL UTVECKLAD EFFEKT.	17
4.4	FRAKTIONER CO ₂ , CO, HC OCH RÖK.....	18
4.5	KVALITETSGRANSKNING AV MÄTNINGARNA	18
5	REFERENSER.....	21

APPENDIX A:Detaljerad information från försöken

APPENDIX B:Diagram över tidsberoende variabler

APPENDIX C:Rådata i diagram

Nomenklatur

A	Area på mätkanalen [m^2]
C_d	Utströmningskoefficient [-]
h	Öppningens höjd [m]
g	Gravitationskonstanten [m/s^2]
$\Delta H_{C,ox}$	Effektutveckling per massenhet förbrukat syre [kJ/gO_2]
ΔH_T	Teoretiskt förbränningsvärme [kJ/g]
I	Ljusintensitet under testet [-]
I_0	Ljusintensitet utan rök [-]
K	Utsläckningskoefficient [$1/\text{m}$]
L	Längden på en ljusstråle genom röken [m]
m	Masskoncentration av rök/aerosol [g/m^3]
m_{fuel}	Totala massan av det brända provet [g]
m_i	Total massa gas i producerad [g]
m_{soot}	Mängd sot [g]
\dot{m}_{fuel}	Avbrinningshastighet av bränslet [g/s]
\dot{m}_{O_2}	Mängd förbrukat syre [g/s]
M_C	Molekylvikt för kol [g/mole]
M_{CO}	Molekylvikt för CO [g/mole]
M_{CO_2}	Molekylvikt för CO_2 [g/mole]
M_{propan}	Molekylvikt för propan [g/mole]
Δp	Tryckskillnad i mätkanalen [Pa]
q	Effektutveckling [kW]
r	Stökiometrisk bränsle/luft masskvot [-]
T_0	Omgivningstemperatur [K]
T_e	Temperatur i mätkanalen [K]
T_u	Medeltemperatur i det varma övre lagret i förbränningskammaren [K]
\dot{V}	Volymflöde i mätkanalen [m^3/s]
w	Öppningsbredd [m]
X_0	Koncentration av syre i omgivande luft [-]
X_i	Molfraktion gas i i mätkanalen [-]
X_m	Avläst värde på syremätaren [-]
X_{O_2}	Molfraktion av syre i syremätaren med extra syre [-]
$X_{O_2}^0$	Molfraktion av O_2 i inflödande luft [-]
Y_i	Fraktion av produkt i [g/g]
α	Expansionsfaktor [-]
ϕ	Ekvivalenskvot [-]
ρ_0	Luftens densitet vid omgivande temperatur [kg/m^3]
σ_m	Utsläckningsyta [m^2/g]

Ψ_C	Fraktion C [g/g]
Ψ_{CO}	Fraktion CO [g/g]
Ψ_{CO_2}	Fraktion CO ₂ [g/g]
Ψ_{HC}	Fraktion oförbrända kolväten, HC [g/g]
Ψ_{sot}	Fraktion sot[g/g]

1 Introduktion

Den toxicitet och sikttnedsättning som rökgaserna från bränder i organiska material förorsakar varierar mycket med brandbetingelserna. Bränslets sammansättning, flammornas geometri och ventilationsgrad, som ofta anges som brandens globala ekvivalensförhållande s.k. GER, kan medföra en ändring av produktionen av sot och giftiga gaser för samma bränsle med mer än två tiopotenser. Den kunskap vi i dag har om dessa fenomen härrör nästan uteslutande från experiment i olika skalor och den är ofta mycket fragmentarisk.

Detta projekt syftar till att undersöka olika sätt att introducera mer kemi i brandtekniska beräkningsmetoder, CFD (computational fluid dynamics), för att därigenom få en mer generell metod att förutsäga framför allt produktionen av kolmonoxid i olika brandscenarier. Kolmonoxidförgiftning är huvudorsaken till att människor omkommer vid bränder inomhus.

Vid experimenten förbrändes heptan i ett rum som var 1/3 av ISO room corner test (ISO 9705). Ventilationsgraden, beräknas som ekvivalensförhållandet s.k. GER, varierades från låga värden (välventilerad brand) till en ventilationsgrad av GER= 1.8 (Underventilerad brand). Vid högre ekvivalensförhållande än 1.8 blev rumsbranden ostabil och flammorna startade att oscillera in och ut genom dörren. Oscillationerna blev så våldsamma att branden omedelbart släcktes med en koldioxidsläckare för att undvika explosion.

Vid försöken mättes följande storheter som funktion av tiden:

Inne i rummet: gastemperaturen i åtta nivåer i ett vertikalt snitt i rummets hörn; yttemperaturen på väggar (tre stycken) och tak (tre stycken); bränslets vikt.

I dörren: gastemperaturen i sju nivåer i ett vertikalt snitt i dörrens mitt; gaskoncentrationen i dörrens övre del (CO, CO₂ and CO₂); ekvivalensförhållandet i de utgående brandgaserna.

I Brandgaskanalen; gaskoncentrationen (CO, CO₂, CO₂ och HC); ljusdämpningen förorsakad av sot; tryckfallet över en "bi-directional" pitot rör monterad i brandgaskanalens centrum; gastemperaturen i brandgaskanalens centrum.

Från de uppmätta värdena har följande storheter beräknats: Massavbrinnigen, fraktioner CO, CO₂ and CO₂ och HC och sot för olika ekvivalensförhållande upp till 1.8.

Rapporten inkluderar the appendix, Appendix A (kalibreringsprocedurer, Appendix B (beräknade storheter som funktion av tiden och Appendix C1-2 (rådata filer från experimenten).

2 Experimentell metod

Förbränningsförsöken utfördes i en $0,66 \text{ m}^3$ förbränningskammare, Fig.1 Den förbrända mängden varierade mellan 0,3kg och 2,3kg. Förbränningskammaren var utrustad med en huv som samlar upp alla brandgaser. Huven var kopplad till en rörformad mätkanal där mätningar gjordes kontinuerligt. En s.k. phi-meter var kopplad till systemet för att bestämma ventilationsgraden under experimenten.

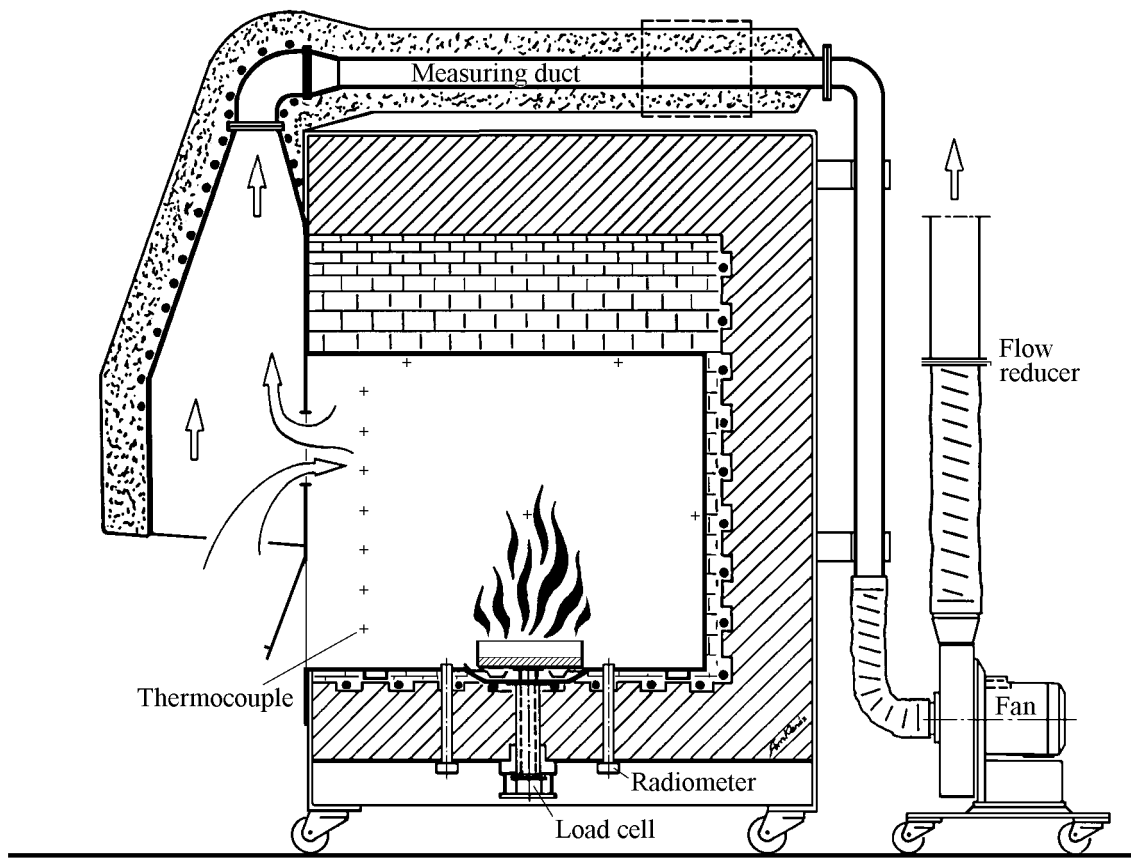

Figur 1. Översikt, konfiguration av förbränningskammaren.

2.1 Förbränningskammaren

Förbränningskammaren av rostfritt stål som användes vid experimenten placerades inne i en ugn konstruerad av keramiskt, högtemperaturtegel. Innermått på stål-kammaren var 0,75 m (bredd), 1,10 m (djup) and 0,80 m (höjd), vilket gav en volym på 0,66 m³. Detta är ungefär 1/3 av standarden, ”ISO room corner test (ISO 9705)”. Ugnens inre dimensioner var 0,80 m (bredd), 1,10 m (djup) and 1,09 m (höjd). Detta gav ett luftrum ovanför stål-kammaren och mellan sidoväggarna på kammaren och ugnen. Förbränningskammaren hade en öppning i en vägg. Öppningens bredd var 0,45 m. Höjden på öppningen var justerbar för att kunna ändra ventilationsförhållandena. En plåt i rostfritt stål användes för att täcka över den del av öppningen som skulle vara stängd. I de försök som redovisas i denna rapport användes en höjd av 0.20m i öppningen. En översikt av konfigurationen av förbränningskammaren ges i figur 1.

2.2 Kontinuerliga mätningar inne i förbränningskammaren

Ett antal mätningar gjordes inuti förbränningskammaren. En lastcell placerades i mitten av golvet under kammaren. Den exakta positionen kan ses i figur 1. Lastcellen var kopplad till en plattform inne i kammaren via en keramisk stav. Detta gjordes för att så långt som möjligt undvika termisk inverkan på lastcellen. Därför var branden placerad 0,05m ovanför botten på förbränningskammaren. En uppsättning av åtta termoelement monterades vertikalt i ett hörn av kammaren, 0,05m från närliggande väggar. Termoelementen monterades på följande avstånd från taket: 5mm, 10mm, 15mm, 20mm, 30mm, 40mm, 50mm and 60mm. Tre termoelement placerades på väggarna; alla dessa monterade i mitten på väggen och tre i taket för att mäta yttemperaturer. Termoelementen i taket monterades enligt följande specifikation: Ett termoelement placerades 0,30m från öppningsväggen och 0,15m från högerväggen och två termoelement placerades 0,30m från bakre väggen och 0,15m från höger- respektive vänsterväggen. Specifikationer av mätutrustningen presenteras i tabell 1.

Tabell 1. Mätutrustning som användes i förbränningskammaren

Uppmätt	Utrustning	Mätområde	Noggrannhet
Massa	Lastcell	0 - 10kg	± 1g
Temperatur	Termoelement Chromel Alumel, d=0.25 mm	0 - 1300°C	0.4%

2.3 Mätningar i öppningen

Öppningen på kammaren hade en bredd på 0,45m och en höjd på 0,20m i alla experiment. Öppningens design presenteras i figur 2. I mitten av öppningen monterades en uppsättning av sju termoelement för att mäta gastemperaturen på de heta förbränningsgaserna och luften som kommer in. Termoelementen var jämnt utplacerade längs den vertikala centerlinjen av öppningen. Se figur 3 för placeringen av termoelementen. Två prober monterades i öppningen för att sampla gas till phi-metern och för att mäta koncentrationer av CO, CO₂ och O₂. Proberna monterades diagonalt i övre delen av öppningen för att vara säkra på att proverna togs i de varma gaserna som lämnade kammaren. Koncentrationerna är medelvärden av koncentrationerna i det heta övre gaslagret i kammaren. Proberna är gjorda med tre hål jämt fördelade längs sträckningen i dörröppningen. Phi-proben var monterat med hålen riktade inåt kammaren för att få prover som innehöll alla typer av förbränningsprodukter, inklusive sot. Proben för gasprover däremot monterades med hålen riktade ut från rummet för att undvika sot i proverna. Probernas placering ges i figur 3.

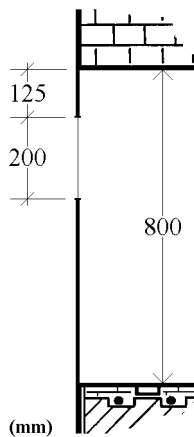

Figur 2. Öppningskonfiguration som användes i förbränningskammaren.

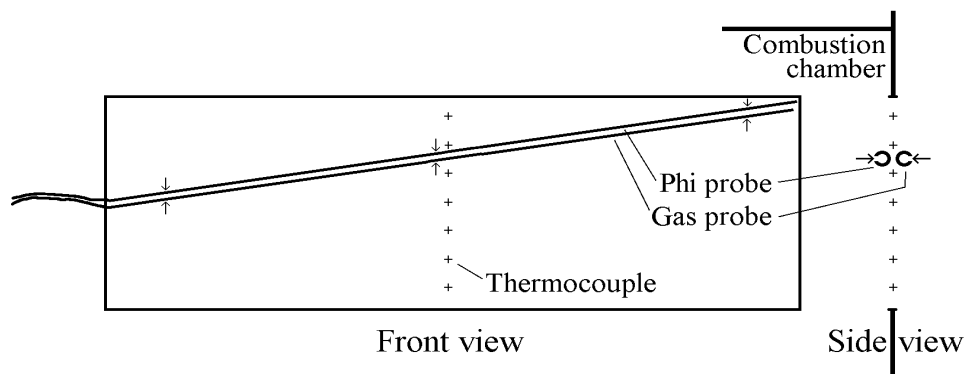

Figur 3. Placeringen av termoelement och prober för gasprovtagning i öppningen av förbränningskammaren.

När man studerar bränder med olika grad av ventilation använder man en parameter phi, förbränningens ekvivalenskvot, för att beskriva ventilationsförhållandena [7]. Utrustning med vilken den här parametern kan mätas har använts i dessa experiment. Huvudprincipen för phi-metern är att utsätta brandgaserna för en katalytisk förbränning i en reaktor med en platina tråd katalysator. I den ursprungliga layouten för phimetern, var temperaturen i reaktorn 1000°C. En ändring av katalysatorn, till en platina-katalysator i pelletform, gjorde det möjligt att reducera temperaturen till 400°C. I reaktorn transformeras alla förbränningsprodukter till CO₂ och H₂O. Efter reaktorn går gaserna igenom en serie filter där CO₂ och H₂O tas bort. Den torra kvarvarande kväve-syre blandningen analyseras sedan med avseende på syrenehållet. För att täcka in bränslerika förhållanden tillförs en känd mängd rent syre till reaktorn. En överblick av phi metern ges i figur 4. Det totala massflödet genom systemet var $0,6 \cdot 10^{-3}$ m³/min, flödet av syre var $0,13 \cdot 10^{-3}$ m³/min och temperaturen i reaktorn var 400°C.

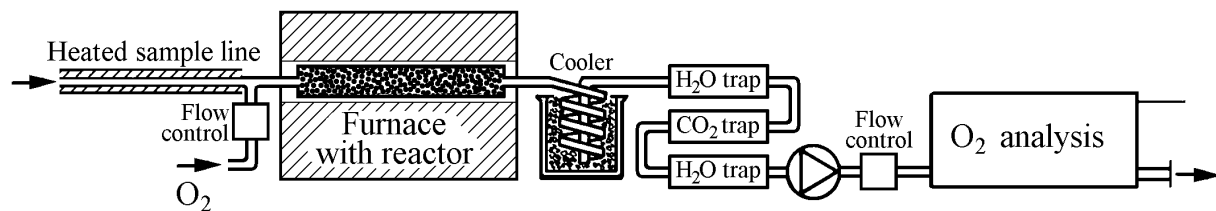

Figur 4. Överblick av phi-metern.

Mycket arbete har lagts ner för att kalibrera och verifiera phi-meterns funktion. I figur 5 presenteras ett kalibreringsdiagram för phi-metern. Kalibreringen gjordes med propan. Tidskonstanten för phi-metern uppmättes till 30s. Phi-metern är känslig för mängden syre som tillförs systemet. Det betyder att genom att ändra den tillförda mängden syre ändras även phi-meterns arbetsområde. Syrenivån skall ändras för att passa det mätintervall för phi som förväntas.

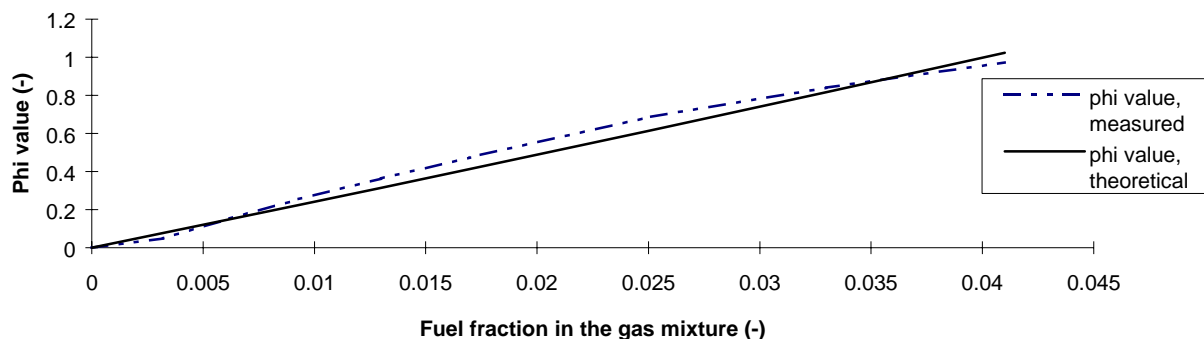

Figur 5. Kalibreringskurva för phimetern som visar en jämförelse mellan teoretiskt och uppmätt phi-värde.

2.4 Kontinuerliga mätningar i ventilationskanalen

En huv utanför förbränningskammarens öppning samlade upp alla brandgaser från förbränningskammaren. Huvven var sammankopplad med en kanal, vilken inkluderar en flödesstabiliserande sektion, där alla mätningar gjordes. Hela systemet var termiskt isolerat för att undvika kondensationsproblem. En 2,2kW radialfläkt drev röken. Flödet i kanalen kunde ändras genom att introducera flödesreducerare av varierande storlek.

Kanalen var utrustad med ett "bidirectional"-pitotrör och ett termoelement som användes för att mäta massflödet i kanalen. En ljusabsorptionsmätare registrerade ljusdämpningen förorsakad av sotinnehållet i brandgaserna och i en probe extraherades rökgaser för kontinuerlig mätning av koncentrationer av O₂, CO₂, CO och HC (oförbrända kolväten). Specificationer av mätutrustningen presenteras i tabell 2 och 3. En schematisk skiss ges i figur 6.

Tabell 2. Mätinstrument använt i mätkanalen.

Uppmätt	Utrustning	Mätområde	Noggrannhet
Rök	Lampa med färg temperatur $2900 \pm 100K$ Och fotocelldetektor	0 - 100%	Lampa: $\pm 0.2\%$ Detektor: Linjärt inom 5 %
Tryckfall	Tryckgivare kopplad till ett "bidirectional"-pitotrör	0 - 400Pa	$\pm 0.5 \%$
Temperatur	Termoelement, Chromel Alumel, d= 0.25mm	0 - 1300°C	$\pm 0.4 \%$

Tabell 3. Gasanalys utrustning för kontinuerlig analys i mätkanalen.

Uppmätt	Utrustning	Mätområde, noggrannhet	Kalibrering gas
O ₂	Siemens Oxymat 5E Paramagnetic	10-21 vol% $\pm 1\%$ av fullt utslag	21% $9.94 \pm 0.200 \%$
CO	Siemens Ultramat 22P, Icke dispersiv IR-absorption	0-1 vol% $\pm 1\%$ av fullt utslag	0.202 ± 0.0040 ppm 202 ± 4.04 ppm
CO ₂	Siemens Ultramat 22P, Icke dispersiv IR-absorption	0-20 vol% $\pm 1\%$ av fullt utslag	$4.99 \pm 0.0998 \%$ $0.502 \pm 0.010 \%$
HC	Siemens Fidamat K FID (flamjoniserande detektor)	0-100ppm $\pm 1\%$ av fullt utslag	50.9 ± 1.0 ppm propan

Massflödet i kanalen räknades ut enligt NT FIRE 025 [8] genom att använda värdet från pitotröret och termoelementet i kanalen. Ljusabsorptionen mättes också enligt NT FIRE 025. Gasproverna för kontinuerlig mätning av O₂, CO och CO₂ kylades och torkades och frigjordes från partiklar innan de kom in i mätinstrumenten. Proverna från HC mätningarna fördes genom ett samplingsrör upphettad till 200°C och ett upphettat rökfilter. Gasanalysutrustningen kalibrerades med olika gasblandningar med kända koncentrationer inom samma område som förväntades av gasproverna. Alla mätningar gjordes kontinuerligt och en Schlumberg data-logger användes för att samla mätdata och överföra dem till en PC. Mätintervallet var 4s.

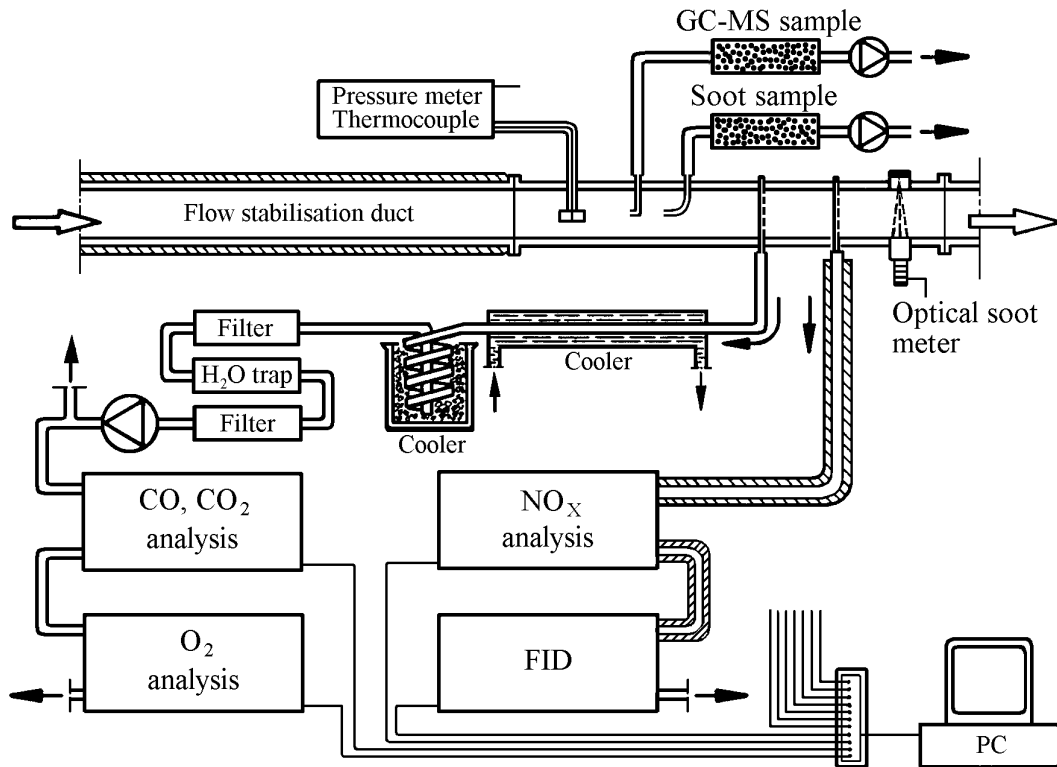

Figur 6. Schematisk skiss av mätutrustningen för mätningarna i mätkanalen.

2.5 Testvätskans egenskaper

I de två försöken användes heptan som bränsle. Tabell 4 nedan presenterar några av heptans karakteristiska egenskaper.

Tabell 4. Molekylärvikt, teoretisk förbränningsvärme och teoretiska massfraktioner för heptan.

Ämne	M_w [g/mol]	$\Delta H_{C,ox}$ [kJ/gO ₂]	ΔH_T [kJ/g]	Ψ_C [g/g]	Ψ_{CO_2} [g/g]	Ψ_{CO} [g/g]
Heptan	100.2	13.1	44.59	0.84	3.08	1.96

2.6 Experimenten

Utförandet av experimenten följde en standard procedur. Mätutrustningen kalibrerades innan experimentet startades. Efter kalibreringen startades dataloggern. Heptanet var placerat i en cylindrisk behållare på lastcellen, i mitten av förbränningskammaren. Behållarna hade diametrarna 0,20 m och 0,30 m i respektive försök. Vätskan antändes med en liten flamma. I det första försöket lämnades provet att brinna till självslockning. I det andra experimentet skedde släckning med CO₂ pga. okontrollerad förbränning med risk för explosion.

I försöken varierades endast storleken på branden, trots de möjligheter som fanns att variera ventilations- och strålningsförhållanden. Se 2.1 och 2.3.

Två försök genomfördes och de experimentella förutsättningarna ges i tabell 6 nedan.

Tabell 5. Experimentella förutsättningar för heptanförsöken.

HEPTAN				
Test Nummer	Ämne	Mängd bränsle (kg)	Diameter på branden (m)	Öppningshöjd (m)
HEP001	Heptan	1	0.2	0.2
HEP002	Heptan	2	0.3	0.2

3 Beräkningar

En stor mängd data samlades in under experimenten med hjälp av en datalogger var fjärde sekund. De olika mätvärdena erhöles i spänningssignaler, mV. Alla mätinstrument har ett linjärt beroende mellan den uppmätta signalen och utsignalen. Kalibreringsförsök kördes före och efter varje försök och med hjälp av två eller tre varelter kalibreringsfaktorn beräknades. Kalibreringsvärdena återfinns i Appendix A.

3.1 Massavbrinning och massavbrinningshastighet

Massan och massförlusten mättes med en lastcell, som beskrivet i 2.2. Provets massa registrerades var fjärde sekund och därför räknades även massförlusten ut var fjärde sekund. Denna metod ger en väldigt fluktuerande kurva. Turbulensen i rummet orsakad av flödet av luft och förbränningsgaser påverkar massmätningarna. För att göra inverkan av dessa fluktuationer så små som möjligt räknades massförlusten ut som ett medelvärde över ett antal tidsintervall. I figur 7 ges exempel från HEP002. En kurva är uträknad med ett medelvärde över 72s och den andra med ett medelvärde över 232s. Som kan ses blir kurvan mycket jämnare när tidsintervallet för medelvärdesberäkningen blir längre. I figur 8 ses att massförlusten är relativt konstant. Det är därför möjligt att ta medelvärden över långa perioder utan att göra några stora felaktigheter vid beräkningarna av massförlusten.

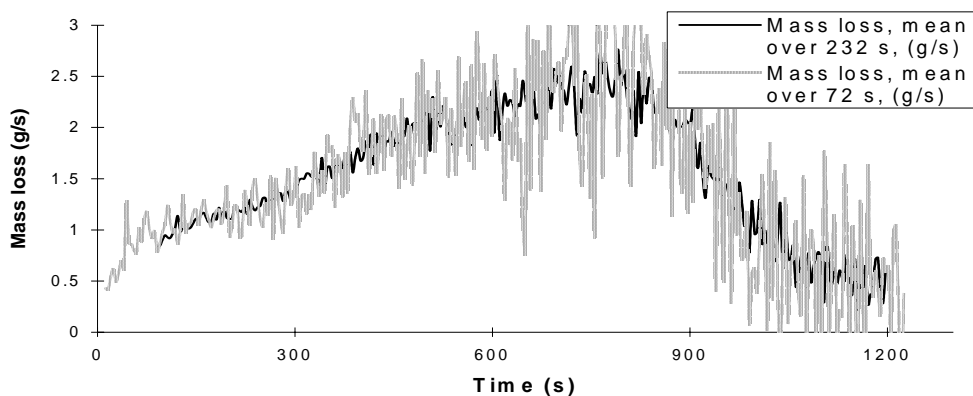

Figur 7. Massförlust som funktion av tiden för HEP002.

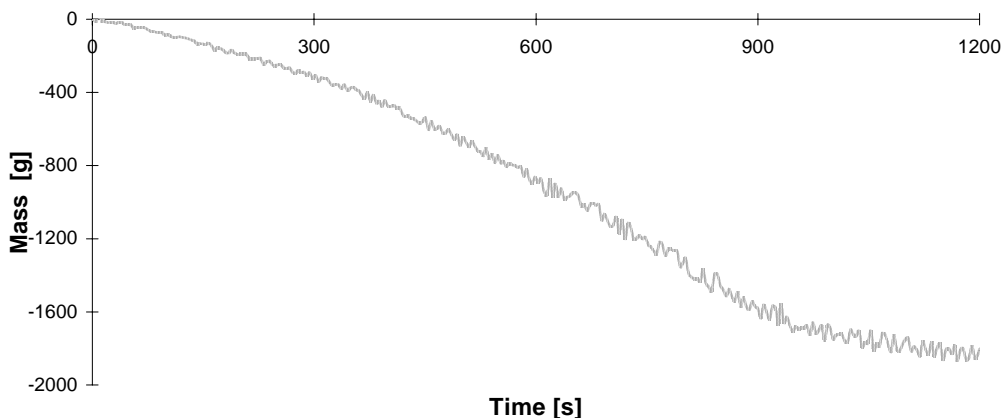

Figur 8. Provets massa som funktion av tiden för HEP002.

3.2 Ekvivalenskvot

Ventilationsförhållandet under experimenten har stort inflytande på brandens utveckling. Ett sätt att beskriva ventilationen är att använda ekvivalenskvoten eller som det ofta kallas phi-värdet. Det teoretiska phi-värdet kan skrivas som i ekvation [3.1]:

$$\phi = \left(\frac{\dot{m}_{\text{bränsle}}}{\dot{m}_{O_2}} \right) / \left(\frac{\dot{m}_{\text{bränsle}}}{\dot{m}_{O_2}} \right)_{\text{stök}} \quad [3.1]$$

Där förhållandet mellan $\dot{m}_{\text{bränsle}}$, mängden bränsle och \dot{m}_{O_2} , mängden tillgängligt syre, i det aktuella fallet jämförs med samma förhållande vid stökiometri. $\dot{m}_{\text{bränsle}}$ bestäms genom att mäta det brinnande provets massförlust. \dot{m}_{syre} bestäms genom att mäta den mängd syre som kommer in i förbränningskammaren.

Experimentellt bestämdes phi-värdet med en utrustning kallad phi-meter. Principen för utrustningen förklaras i sektion 2.3. Phi-värdet bestämdes från phi-metern och visar enligt ekvation [3.2]:

$$\begin{aligned} \phi &= (X_{O_2} - X_m) / (X_0 \cdot (1 - X_m)) \\ \phi &= 1 \text{ stökiometrisk förbränning} \\ \phi &< 1 \text{ välventilerad förbränning} \\ \phi &> 1 \text{ underventilerad förbränning} \end{aligned} \quad [3.2]$$

X_{O_2} är molfraktionen av syre i syremätaren med extra syre, X_m är det avlästa värdet på syremätaren och X_0 är koncentrationen av syre i omgivande luft, normalt 20.9 %. Detta uppmätta phi-värdet kan sedan jämföras med det teoretiska värdet.

Det stökiometriska bränsle/luft massförhållandet, vanligtvis känt som r, ges i $\text{kg}_{\text{bränsle}} / \text{kg}_{\text{luft}}$. R kan räknas ut från reaktionsformeln för fullständig förbränning av det aktuella ämnet. Reaktionsformeln för fullständig förbränning av heptan ges nedan, [3.3]:



Detta ger ett värde på r för heptan på $0.0662 \text{ kg}_{\text{bränsle}} / \text{kg}_{\text{luft}}$.

Phi-värdet kan också räknas ut från mätningar av bränslets massförlust, öppningsarea och temperaturen på den luft som strömmar in i förbränningskammaren och förbränningsgaserna som lämnar förbränningskammaren. Följande ekvation, [3.4] från referens [10] har använts i jämförelserna mellan uppmätta och uträknade phi-värden:

$$\phi = m_{fuel} \cdot 10^{-3} \cdot \left[h \cdot w \cdot \sqrt{h} \cdot \frac{2}{3} \cdot C_d \sqrt{2 \cdot g} \cdot \rho_0 \left(\frac{1 - (T_0 / T_u)}{1 + (T_u / T_0)^{1/3}} \right)^3 \cdot r \right]^{-1/2} \quad [3.4]$$

m_{fuel} är bränslets massavbrinningshastighet under experimenten givet i [g/s]. C_d , strömningskoefficienten är satt till 0.68 i uträkningarna och ρ_0 , densiteten på omgivande luft är tagen som 1.2 kg/m^3 . En omgivande temperatur på 293K används i försöken och temperaturen på det heta övre lagret T_u är taget som ett medelvärde av de fyra övre termoelementen inne i förbränningskammaren.

3.3 Förbränningsgasfraktioner: CO₂, CO och HC

Provet för CO och CO₂ mätning torkades och volymfraktionen mättes sedan. I efterhand räknades värdena om för att ta hänsyn till vattnets inverkan på volymfraktionen. Detta gjordes med antagandet att allt väte vid förbränningen omvandlats till vatten. HC mätningen gjordes direkt utan torkning av provet och behöver därför inte räknas om. Med hjälp av volymflödet i mätkanalen erhålls gasproduktionen, m_i [g/s], vilket kan räknas om till en gasfraktion med kännedom om massavbrinningen av provvämmet, m_{fuel} [g].

De uppmätta koncentrationerna av CO₂, CO och HC (oförbrända kolväten) presenteras som gasfraktioner, Y_i [g/g]. Förbrännings-gasfraktionerna räknades ut genom mätning av den totala gasproduktionen, m_i [g/s], och den totala massan, m_{fuel} [g/s], av det brända provet enligt ekvation [3.5].

$$Y_i = \frac{m_i}{m_{fuel}} \quad [3.5]$$

Bränslets kolinnehåll, Ψ_c [g/g] är känt och därför även de maximala fraktionerna, Ψ_i [g/g] av CO₂ och CO kan räknas ut. Dessa värden är givna i tabell 5. De maximala fraktionerna räknades ut enligt ekvation [3.6] and [3.7] genom att använda molekylvikterna, $M_{CO_2} = 44.01 \text{ g/mol}$, $M_{CO} = 28.01 \text{ g/mol}$ and $M_c = 12.01 \text{ g/mol}$. Antagandet att all kol omvandlas till CO₂ and CO gjordes.

$$\Psi_{CO_2} = \Psi_c \cdot \frac{M_{CO_2}}{M_c} \quad [3.6]$$

$$\Psi_{CO} = \Psi_c \cdot \frac{M_{CO}}{M_c} \quad [3.7]$$

Gasanalystrustningen mäter oförbrända kolväten med kokpunkt under 200°C. Kolvätena beräknas som propanekvivalenser. Kolväten med kokpunkt över 200°C, sotpartiklar etc., definieras som överlevnadsfraktionen och inkluderas inte bland de oförbrända kolvätena. Mängden sot som produceras räknas också ut. Beräkningsgången beskrivs i 3.5.

3.4 Effektutveckling och total utvecklad energi

Effektutvecklingen under experimentet räknades ut med standard, syreförbruknings-, metoden [7, 10]. Koncentrationer av O₂, CO₂ och CO användes för beräkningarna.

Volymflödet \dot{V} [m³/s], vid STP, i kanalen räknades ut med ekvation [3.9]. Arean på mätkanalen A [m²], tryckdifferensen i mätkanalen Δp [Pa] och gastemperaturen i kanalen T_e [K] användes för beräkningen. Kvoten mellan medelmassflödet per ytenhet och massflödet per ytenhet i mitten på kanalen är 0,9. Kalibreringskonstanten för pitotröret är 1,08.

$$\dot{V} = \frac{22.4 \cdot A \cdot 0.9}{1.08 \cdot \sqrt{\frac{\Delta p}{T_e}}} \quad [3.9]$$

Effektutvecklingen q [kW] räknades ut med följande uttryck, ekvation [3.10]:

$$q = \Delta H_{C,ox} \cdot 1.31 \cdot 1000 \cdot \frac{\Phi}{1 + \Phi(\alpha - 1)} \dot{V} \cdot X_{O_2}^0 \quad [3.10]$$

Där $\Delta H_{C,ox}$ [kJ/gO₂] är effektutvecklingen per massenhet syre som konsumeras. Värdena på de olika konstanterna återfinns i tabell 5. Densiteten på syre är 1.31kg/m³. Expansionsfaktorn α är satt till 1.1. Φ är syrgasförbrukningsfaktorn, dvs. fraktionen av inkommande luft som fullständigt förbrukat sitt syrgasinnehåll Φ kan räknas ut med hjälp av uttrycket i ekvation [3.11]:

$$\Phi = \frac{X_{O_2}^0 (1 - X_{CO_2}) - X_{O_2} (1 - X_{CO_2}^0)}{X_{O_2}^0 (1 - X_{O_2} - X_{CO_2})} \quad [3.11]$$

Där X_i^0 är molfraktionen av gas i i inkommande luft och X_i molfraktionen av gas i i mätkanalen. $X_{O_2}^0$ sattes till 0.209.

Den totala utvecklade energin tas som det integrerade värdet av effektutvecklingen under experimentet. Det ger energin i [kJ].

3.5 Rökproduktion

Rökproduktionen kan presenteras på flera olika sätt. I denna rapport definieras utsläkningskoefficienten K [1/m] som formel [3.12] från referens [11]:

$$K = \sigma_m \cdot m \quad [3.12]$$

Där σ_m är utsläkningsarean per massenhet [m^2/g] och m är masskoncentrationen av rök/aerosol [g/m^3]. Värdet på σ_m för heptan är $8,5 \text{ m}^2/\text{g}$. Från mätningarna i kanalen, räknas K ut som givet av ekvation [3.13] nedan:

$$K = \left(\frac{I}{L}\right) \cdot \ln\left(\frac{I_0}{I}\right) \quad [3.13]$$

Där L [m] är längden på ljusstrålen genom rök. I_0 [-] är ljusintensiteten utan rök och I [-] är ljusintensiteten under försöket.

Rökproduktionen ges också som en fraktion i [g/g]. Det betyder gram sot producerat per gram brunnet ämne.

Rökproduktionen given som [g/s] kan räknas ut på följande sätt, ekvation [3.15]:

$$K \cdot \dot{V} \cdot ((T_e + 273) / 273) \cdot (1 / \sigma_m) \quad [3.15]$$

Rökproduktionen i [g/s] delas med massförlusten av ämnet som också ges i [g/s]. Detta ger rökfraktionen i gram sot per gram brunnet ämne.

4 Resultat

Två försök med heptan presenteras här. Den variabel som ändras mellan försöken är kärldiametern. Resultaten ges i tabeller och diagram. De diagram som inte återfinns under ”resultat” presenteras i ett appendix till rapporten.

En viktig variabel för att karakterisera resultaten från förbränningsexperiment är graden av ventilation här givet som ekvivalenskvoten eller phi-värdet. Phi-värdet varierar mellan experimenten men också med tiden under varje enskilt försök. Detta har tagits hand om på följande sätt: Under varje experiment, har perioder med relativt konstant phi-värde valts och de andra uppmätta variablerna har utvärderats under dessa perioder.

4.1 Phi-värden

Som tidigare nämnts ger phi-värdet ett mått på ventilationsgraden under brandens fortlöpande. Ett mål med experimenten var att studera hur en variation i ventilation påverkar förbränningsförhållandena och därmed produktionen av brandgaser. Phi-värdet varierar mellan experimenten, och under varje försöks gång eftersom det är svårt att få långa perioder med konstant förbränning med försöksuppställningen som användes i dessa försök. Det uppmätta phi-värdet varierade mellan 0,1 och 1,7 i de utförda experimenten. Ett phi-värde över 1,0 indikerar underventilerade förhållanden.

Under försöken visade det sig med den använda försöksuppställningen vara svårt att nå höga phi-värden över 1.7 utan att branden började pulsera och stabila förhållanden inte kunde uppnås.

Jämförelser gjordes mellan uppmätta och teoretiska phi-värden. Metoderna för att räkna ut uppmätta och teoretiska phi-värden ges i 3.2. I figur 9 och 10 visas jämförelser mellan uppmätta och teoretiska phi-värden.

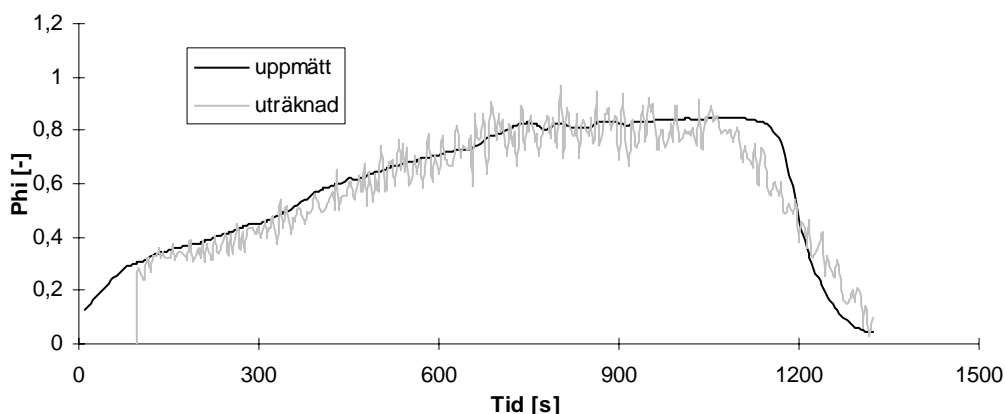

Figur 9. Jämförelse mellan uppmätt och teoretiskt phi-värde för experiment HEP001.

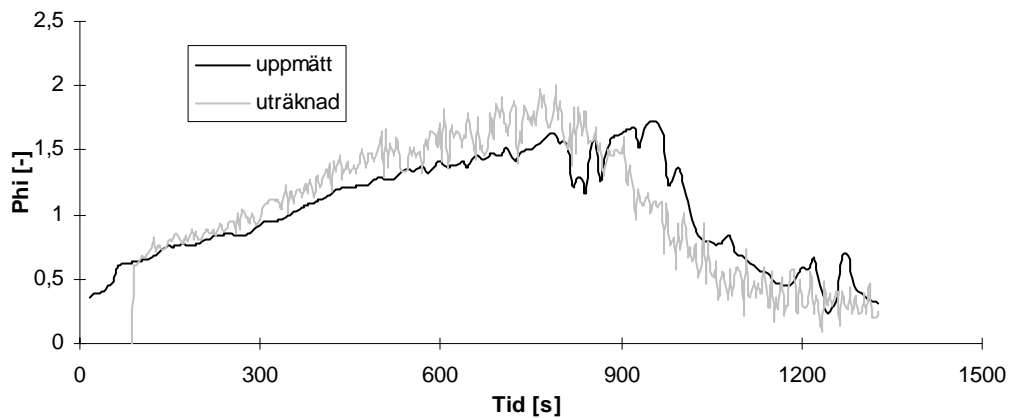

Figur 10. Jämförelse mellan uppmätt och teoretiskt phi-värde för experiment HEP002.

4.2 Temperaturer i förbränningskammaren

Temperaturen mättes på ett stort antal ställen i förbränningskammaren som beskrivet i 2.2. Yttertemperaturer på väggarna och i taket såväl som gastemperaturer mättes. I figur 11 och 12 ges exempel på yt- och gastemperaturer för de båda försöken. En fullständig redovisning av samtliga temperaturmätningar redovisas i Appendix B som diagram och i Appendix C som primärdata.

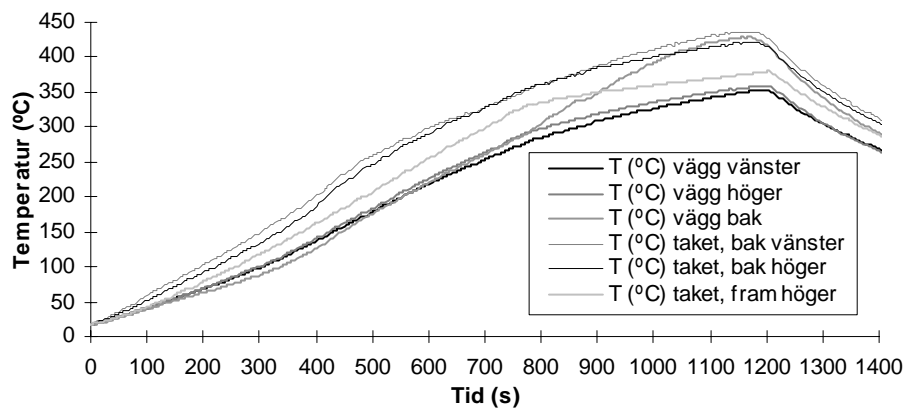

Figur 11. Yttertemperatur i förbränningskammaren för HEP001.

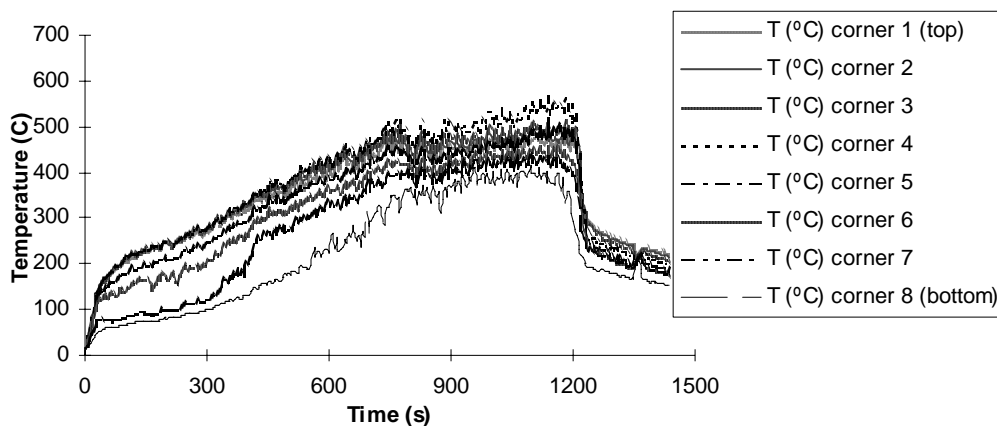

Figur 12. Gastemperaturer i förbränningskammaren för HEPT001.

4.3 Effektutveckling och total utvecklad effekt.

Den utvecklade effekten mättes med syreförbrukningsmetoden. Diagram över utvecklad effekt och total utvecklad energi som funktion av tiden finns i appendixet. Figur 13 och 14 är exempel på denna typ av kurvor. RHR står för "rate of heat release" och THR är en förkortning av "total heat release".

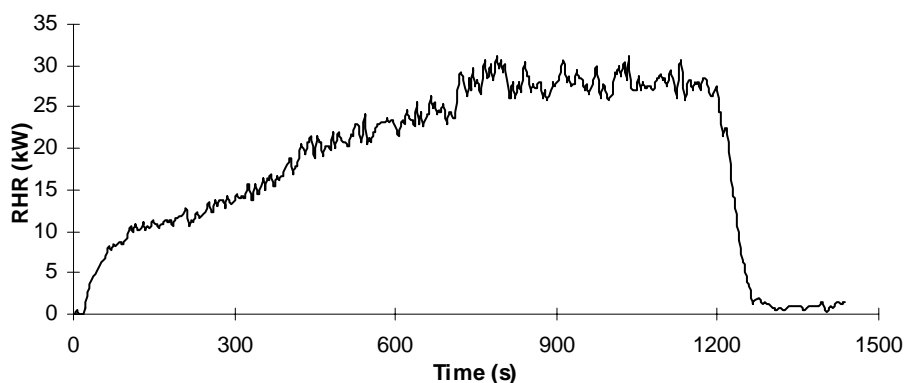

Figur 13. RHR för experiment HEPT001.

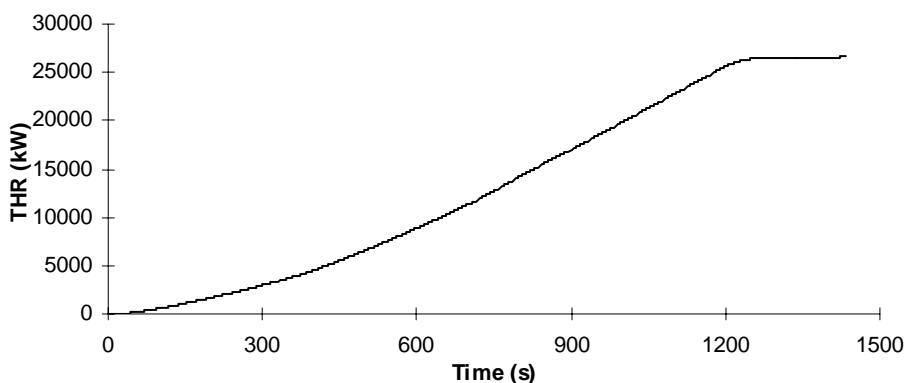

Figur 14. Total utvecklad energi under HEPT001

En fullständig redovisning av samtliga temperaturmätningar redovisas i Appendix B som diagram och i Appendix C som primärdata.

4.4 Fraktioner CO₂, CO, HC och rök

Under experimenten mättes koncentrationerna av CO₂, CO, HC och rök kontinuerligt i mätkanalen. Från dessa koncentrationer kunde fraktionerna av ämnena bestämmas genom att dela med de producerade mängderna med massavbrinningshastigheterna och därmed få fraktionen i g av det producerade ämnet per gram brunnet heptan. I Appendix B presenteras fraktionerna i diagram som funktion av tiden. Noteras bör att det endast är mätningarna i kanalen som använts och ej mätningarna i öppningen.

4.5 Kvalitetsgranskning av mätningarna

I detta avsnitt presenteras kritiska granskningar av de egna mätresultaten för att ge en bild av mätningarnas kvalitet och eventuella felkällor

4.5.1 Återfunnet kol

Ett sätt att verifiera mätningarna är att undersöka kolbalansen. Mängden kol som finns i de uppmätta produkterna skall sammanfalla med mängden kol som lämnar bränslet. Kolet i produkterna finns i CO₂, CO, oförbrända kolväten och som sot. I figur 15 och 16 visas kolbalansen för de båda försöken. De olika graferna kan vara svåra att identifiera men serieordningen följer koncentrationerna med "total carbon loss" som översta grafen och "carbon in smoke" som understa. Samma sak gäller för båda figurerna.

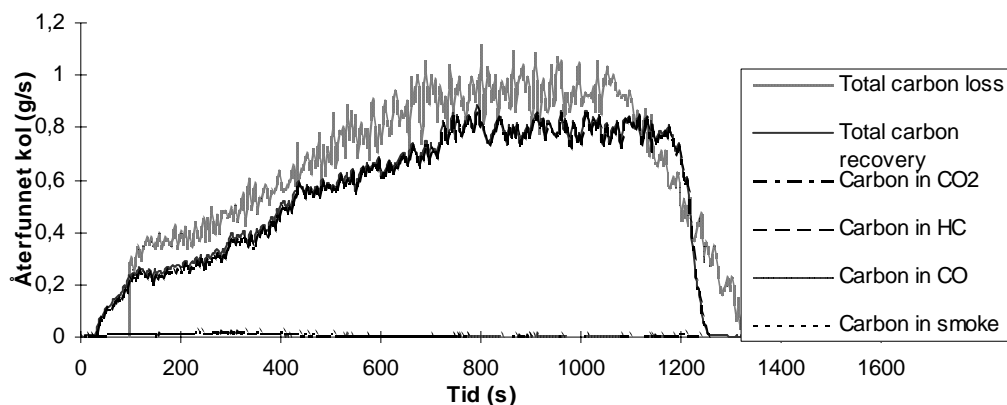

Figur 15. Kolbalans för HEPT001.

I det första försöket blev branden aldrig riktigt underventilerad och CO₂ produktionen står för i stort sett allt återfunnet kol, se fig.15. Hade mätningarna varit korrekta skulle CO₂ mätningen motsvara det kol som förloras i branden. Diskrepansen, 10-15 % kan förorsakas av mätfel i massflödesmätningarna (speciellt flödesprofilen i mätröret) eller i gaskoncentrationer.

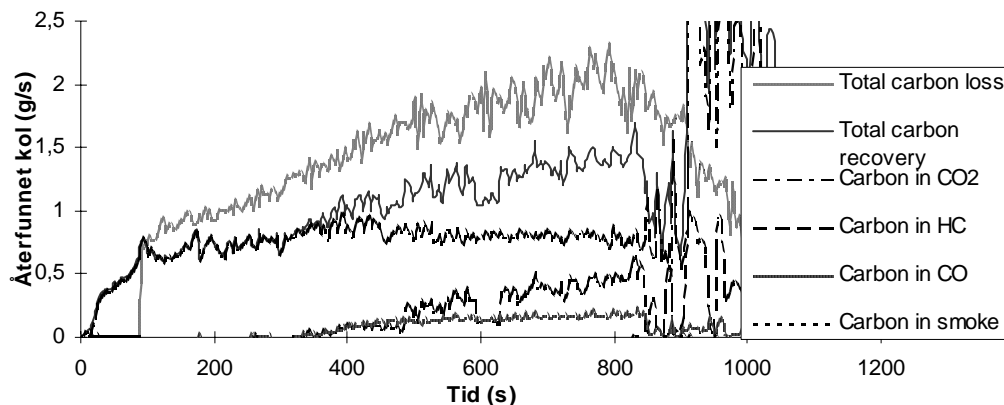

Figur 16. Kolbalans för Hept002.

Även i det andra försöket som visas i figur 16 ovan tyder kolbalansen på att en eller flera mätningar är behäftade med fel eller att inte alla kolhaltiga föreningar mäts (tyngre kolväten med kokpunkt över 200 C som kan kondensera ut). Diskrepansen, 10-15% i början av försöket och upp till 30% för då försöket blev som mest underventilerat, kan förorsakas av mätfel i massflödesmätningarna (speciellt flödesprofilen i mätroret) eller i gaskoncentrationer.

4.5.2 Teoretisk jämförelse med CO₂, CO mätningar

I litteraturen [SFPE-handboken] finns värden på hur stor mängd gaser olika bränslen bildar vid välventilerad förbränning. Dessa värden ges i g/g och med beräknad massförlust per sekund fås den teoretiska produktionen av ämnet. Noteras bör att denna jämförelse endast kan göras medan branden fortfarande är välventilerad.

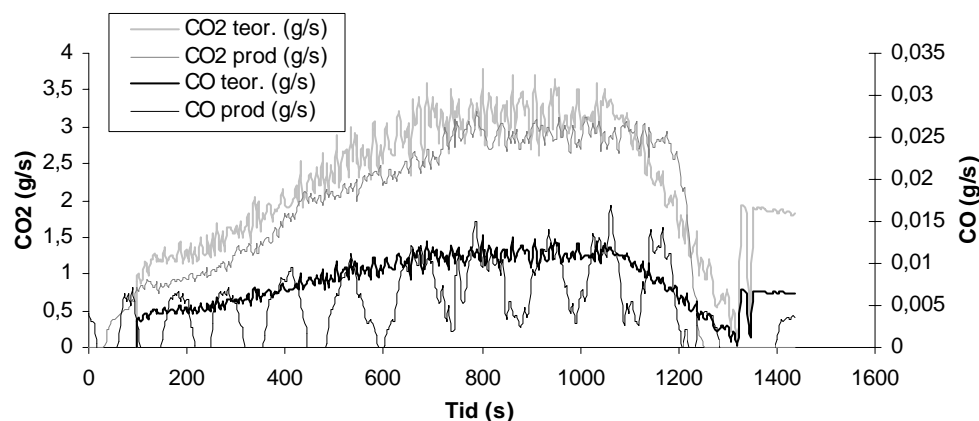

Figur 17. Jämförelse med teoretiska värden Hept001.

I det första försöket var CO koncentrationen väldigt låg pga. att ventilationen var god. Anledningen till fluktuationerna i mätningen är att utrustningen har svårt att mäta dessa låga koncentrationer. Liksom i fallet med kolbalansen tyder det på att mätningarna av någon anledning är för låga.

4.5.3 Mätningar i öppningen

Endast mätningarna i kanalen har använts för att bestämma gasfraktionerna som redovisas i appendix B. Det kan dock vara intressant att använda mätningarna i öppningen som jämförelse med de gjorda i kanalen.

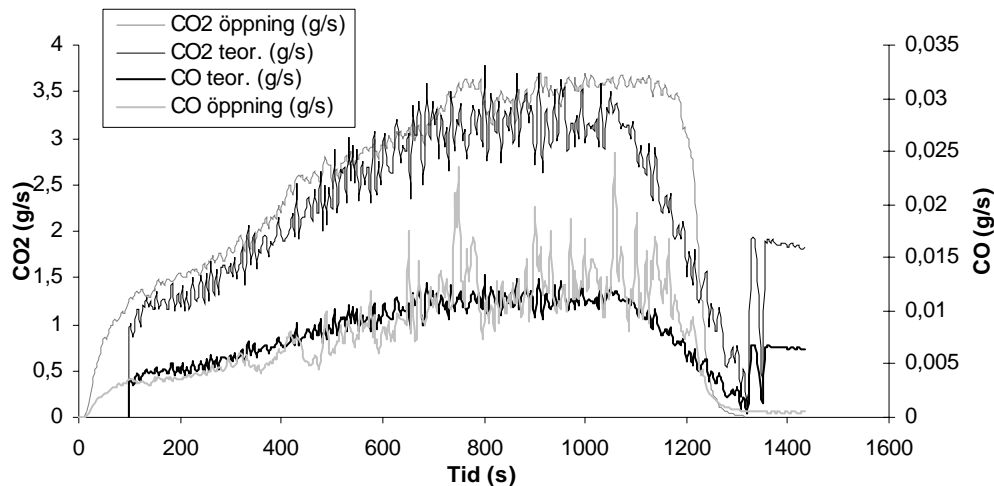

Figur 18. CO_2 och CO mätningar i dörren jämfört med teoretiska värden.

Osäkerheten med att bestämma produktionen av ett visst ämne, baserat på samplingen i öppningen, är att massflödet bestäms med en empirisk formel. Den massflödesformel som använts är en del av ekv. 3.4 där luftflödet in i rummet används för bestämning av ϕ . Massflödet tycks överskattas något då de teoretiska värdena överskrids vid denna beräkning, se figur 18 nedan. Detta innebär också att värdena på ϕ troligtvis underskattats i beräkningarna av teoretiskt ϕ -värde.

4.5.4 Teoretisk jämförelse med beräknad effektutveckling

Effektutvecklingen visar samma tendens som föregående mätningar och även här underskattas det verkliga värdet av någon anledning. Den teoretiska effektutvecklingen har räknats ut med det teoretiska värdet $\Delta H_{ch}=41.2$ kJ/g brunnet ämne. Värdet gäller för välventilerade bränder, dvs. åtminstone för de första 300 sekunderna.

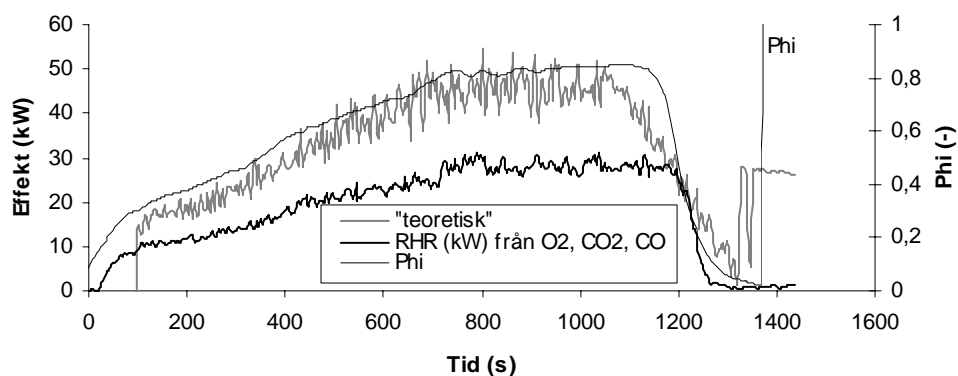

Figur 19. Teoretisk effekt jämförd med uppmätt, Hept001.

5 Referenser

- [1] Petersen, K. E., Markert, F. (Ed)., *Assessment of Fires in Chemical Warehouses. An Overview of the TOXFIRE Project.*, Risø National Laboratory, Roskilde Denmark, Risø-R-932, May 1999;
- [2] Hietaniemi, J., Mikkola, E., *Minimising fire risks at chemical storage facilities, Basis for the guidelines for fire safety engineers*, VTT Research Notes 1811, 29 p. + app. 14 p., Espoo 1997;
- [3] Särdaqvist, S., *An Engineering Approach to Fire-Fighting Tactics*, Department of Fire Safety Engineering, Lund University, ISRN LUTVDG/TVBB -- 1014 -- SE, Lund 1996;
- [4] Rasmussen, B., *Managing Fires in Chemical Warehouses*, Risø National Laboratory, Roskilde, Denmark, Risø-R-888 (EN), December 1996;
- [5] Gunners, N.E., *Methods of Measurement and Measuring Equipment for Fire Tests*, National Swedish Institute for Materials Testing, Fire Engineering Laboratory 1967:1, 1967;
- [6] Nordtest Inquiry No 1131-93, *Heat Flux Meters: Calibration*, Finland 1993;
- [7] Babrauskas, V., Parker, W. J., Mulholland, G. and Twilley, W. H., *The phi-meter: A simple, fuel-independent instrument for monitoring combustion equivalence ratio*, Re. Sci. Instrum. 65 (7), July 1994;
- [8] *Room Fire Test in Full Scale for Surface Products*, NORDTEST Fire Test Method, NT Fire 025;
- [9] Andersson, B., Davie, F., Holmstedt, G., Kenéz, A., Särdaqvist, S., *Combustion of Substances and the Impact on the Environment of the Fire Products – 1/3 Scale Room Furnace Experiments*, Department of Fire Safety Engineering, Lund University, ISRN LUTVDG/TVBB--307--SE, 1994;
- [10] Babrauskas, V., Williamson, R. B., *Post-flashover Compartment Fires*, Fire Research Group, University of California, Berkeley, USA, Report No. UCB FRG 75-1, December 1975;
- [11] Babrauskas, V., Grayson, S. J., *Heat Release in Fires*, Elsevier Applied Science, England 1992;
- [12] Mulholland, G. W., p 22-221 - 222 in *The SFPE Handbook of Fire Protection Engineering*, NFPA, 1995;
- [13] Andersson, B., Babrauskas, V., Holmstedt, G., Särdaqvist, S., Winter, G., *Scaling Effects*, Department of Fire Safety Engineering, Lund University, ISRN LUTVDG/TVBB -- 3078 -- SE, 1997;

Appendix A: Detaljerad information från försöken

HEP001

Datum 960401
Ämne Heptane
Massa 1050 g
Kärldiameter 20 cm
Öppningsarea width 45 cm, height 20 cm
Kanaldiameter 70 mm
14.33 Starttid log
14.40 Tid antändning
14.45 Start kem. sampling.
Flöde 1.0 l/min
14.55 Stop kem. sampling.
15.03 Stopp logging

KALIBRERING HEP001

Mätare i kanal

OXYMAT 5E, Syre
Gas 3:1 Före: 9700mV, Efter: 9630mV
Gas M3 Före: 10430mV, Efter: -

ULTRAMAT 22P CO₂
Gas 3:1 Före: 481mV, Efter: 480mV
Gas M3 Före: 38mV, Efter: 37mV

ULTRAMAT 22P CO
Gas 3:1 Före: 180mV, Efter: 180mV
Gas M3 Före: 14,7mV, Efter: 12,46mV

NO_x ANALYSATOR
Nollgas Före: -100mV, Efter: -102mV
Gas90ppm Före: 8993mV, Efter: 9122mV

FIDAMAT
Nollgas Före: 47,5mV, Efter: 61,0mV
Gas50,9ppm Före: 262mV, Efter: 291mV

Mätare i öppning

M&C O₂-ANALYZER (Phi-värde)
Bakgrund utan O₂
Före: 211mV, Efter: 211mV
Bakgrund med O₂
Före: 211mV, Efter: 211mV

LEYBOLD-HARAEUS CO₂-ANALYZER
Gas 3:1 Före: 492mV, Efter: 494mV
Gas M3 Före: 49,4mV, Efter: 48,8mV

LEYBOLD-HARAEUS CO-ANALYZER
Gas 3:1 Före: 229mV, Efter: 229mV
Gas M3 Före: 52mV, Efter: 54mV

OXYMAT 2
Gas 3:1 Före: 4832mV, Efter: 4778mV
Gas M3 Före: 260mV, Efter: 272mV

LASTCELL
2 kg Före: 9,88mV, Efter: 9,9mV
5 kg Före: 14,71mV, Efter: 14,72mV

HEP002

Datum 960410

Ämne Heptane

Massa 2218 g

Kärldiameter 30 cm

Öppningsarea width 45 cm, height 20 cm

Kanaldiameter 100 mm

Starttid log

Tid antändning

11.38 (435s) FID range ändrad från 500 till 1000

11.39 (474s) FID range ändrad från 1000 to 2000

11.41 (595s) FID range ändrad från 2000 to 5000

11.45 (840s) Flertalet ändringar i FIDrange

Test avbrutet på grund av explosionsrisk

Stopp logging

KALIBRERING HEP002

Mätare i kanal

OXYMAT 5E, Syre

Gas 3:1 Före: 9830mV, Efter: 9780mV

Gas M3 Före: -, Efter: - (över skalan)

ULTRAMAT 22P CO₂

Gas 3:1 Före: 500mV, Efter: 495mV

Gas M3 Före: 45,8mV, Efter: 46,2mV

ULTRAMAT 22P CO

Gas 3:1 Före: 184mV, Efter: 180mV

Gas M3 Före: 19,9mV, Efter: 18mV

NO_x ANALYSATOR

Nollgas Före: -100mV, Efter: -95mV

Gas93,6ppm Före:8520mV, Efter:8630mV

FIDAMAT

Nollgas Före: 75mV, Efter: 161mV

Gas50,9ppm Före: 396mV, Efter: 450mV

Mätare i öppning

M&C O₂-ANALYZER (Phi-värde)

Bakgrund utan O₂

Före: 213,8mV, Efter: 213mV

Bakgrund med O₂

Före: 370mV, Efter: 345mV

LEYBOLD-HARAEUS CO₂-ANALYZER

Gas 3:1 Före: 496mV, Efter: 330mV

Gas M3 Före: 49,3mV, Efter: 210mV

LEYBOLD-HARAEUS CO-ANALYZER

Gas 3:1 Före: 231mV, Efter: -288mV

Gas M3 Före: 52mV, Efter: -315mV

OXYMAT 2

Gas 3:1 Före: 4742mV, Efter: 4744mV

Gas M3 Före: 82mV, Efter: 85mV

LASTCELL

2 kg Före: 9,9mV, Efter: 9,3mV

5 kg Före: 14,7mV, Efter: 12,6mV

Gasblandning 3:1 består av 10% O₂, 4,99% CO₂, 0,202% CO, N₂

Gasblandning M3 består av 0% O₂, 0,502% CO₂, 202ppm CO, N₂

Appendix B

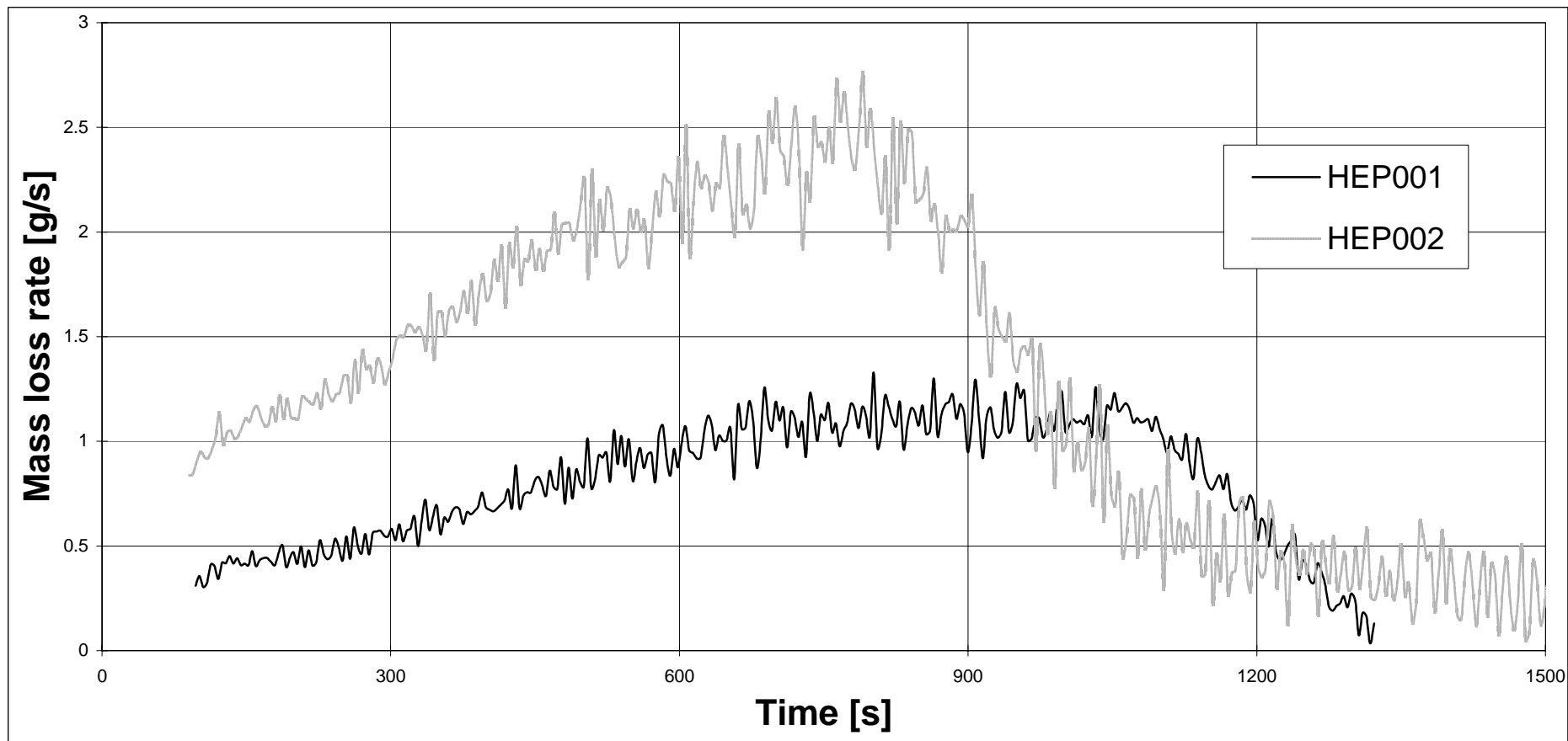

Figur B:2 Massförlusthastighet

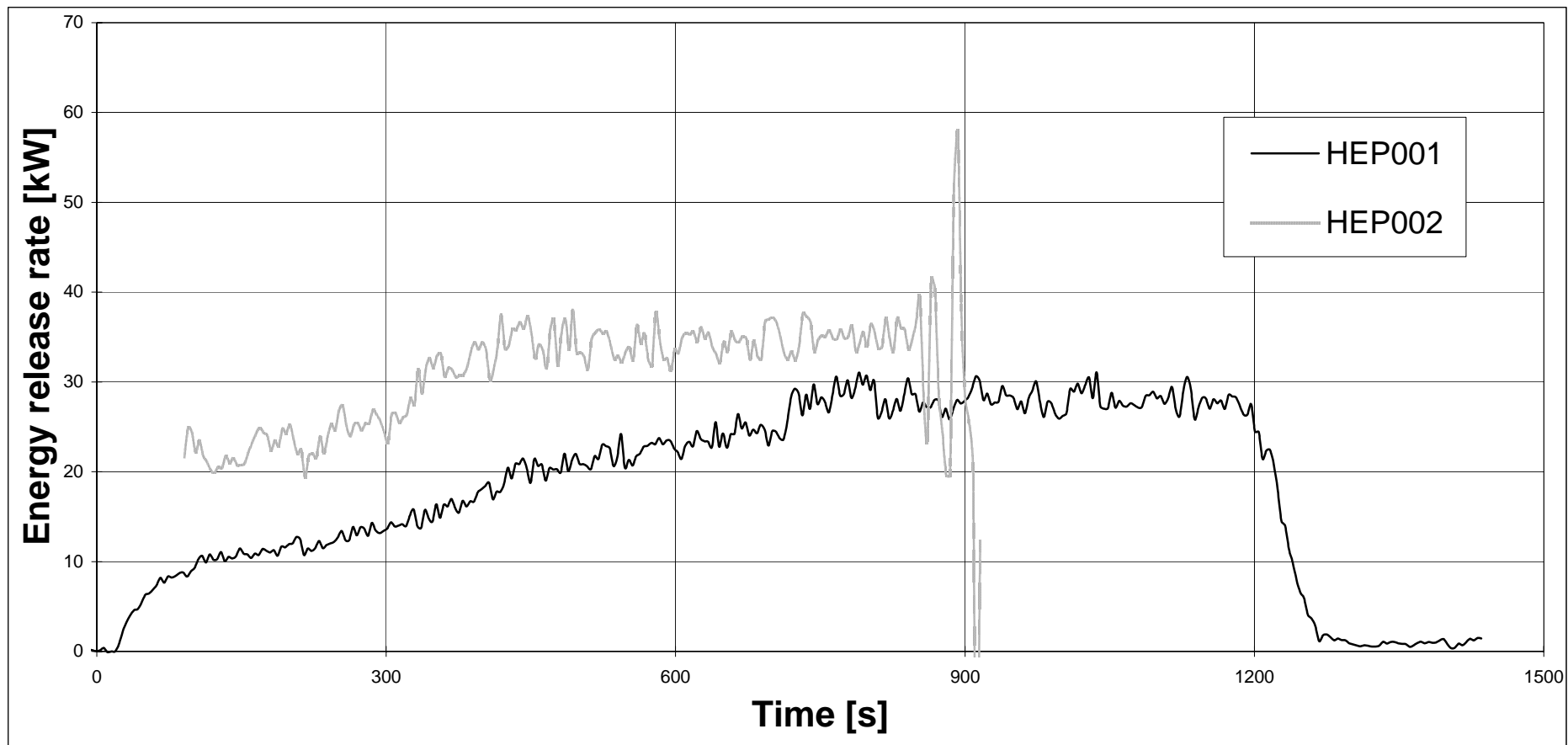

Figur B3 Beräknad effektutveckling

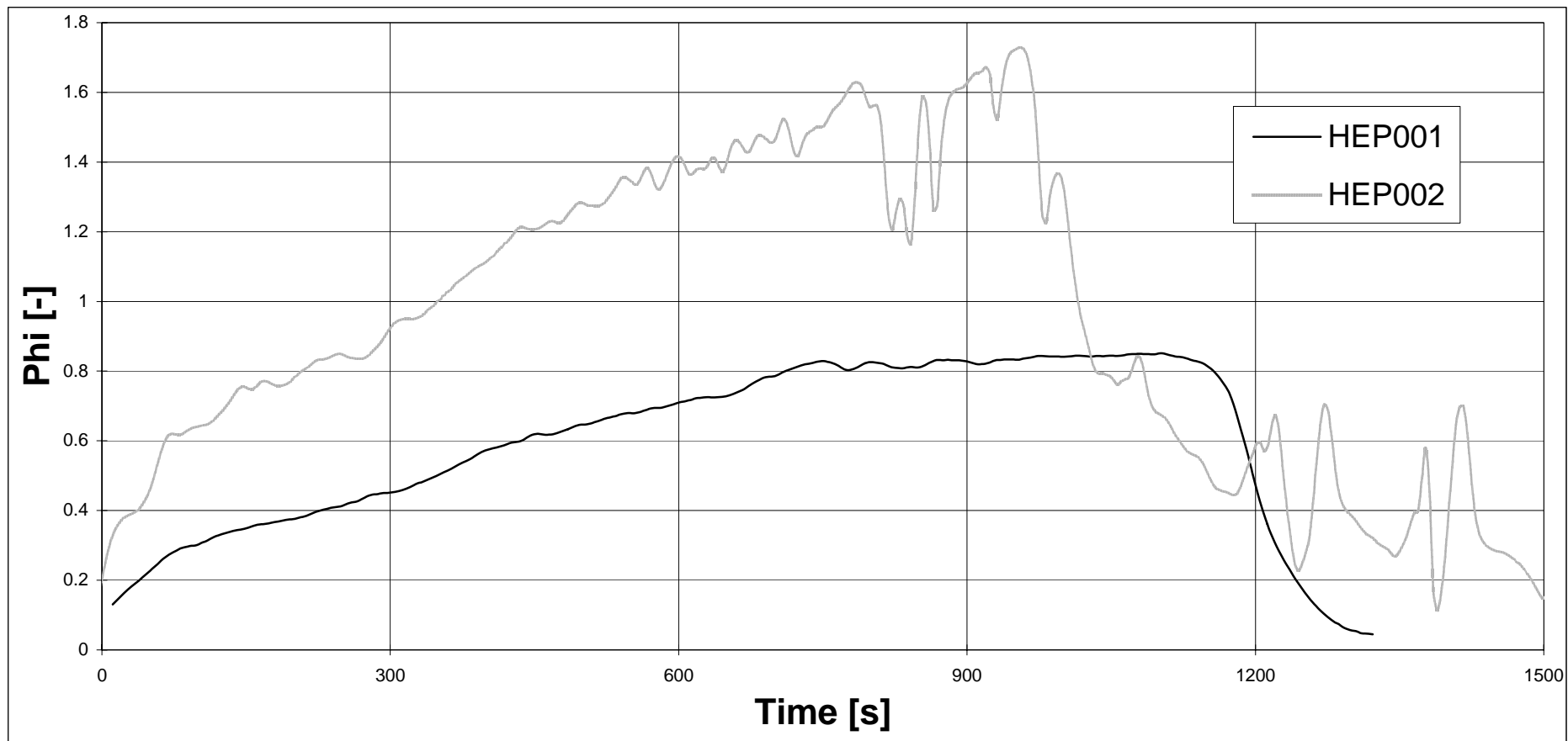

Figur B:4 Beräknat Phi-värde

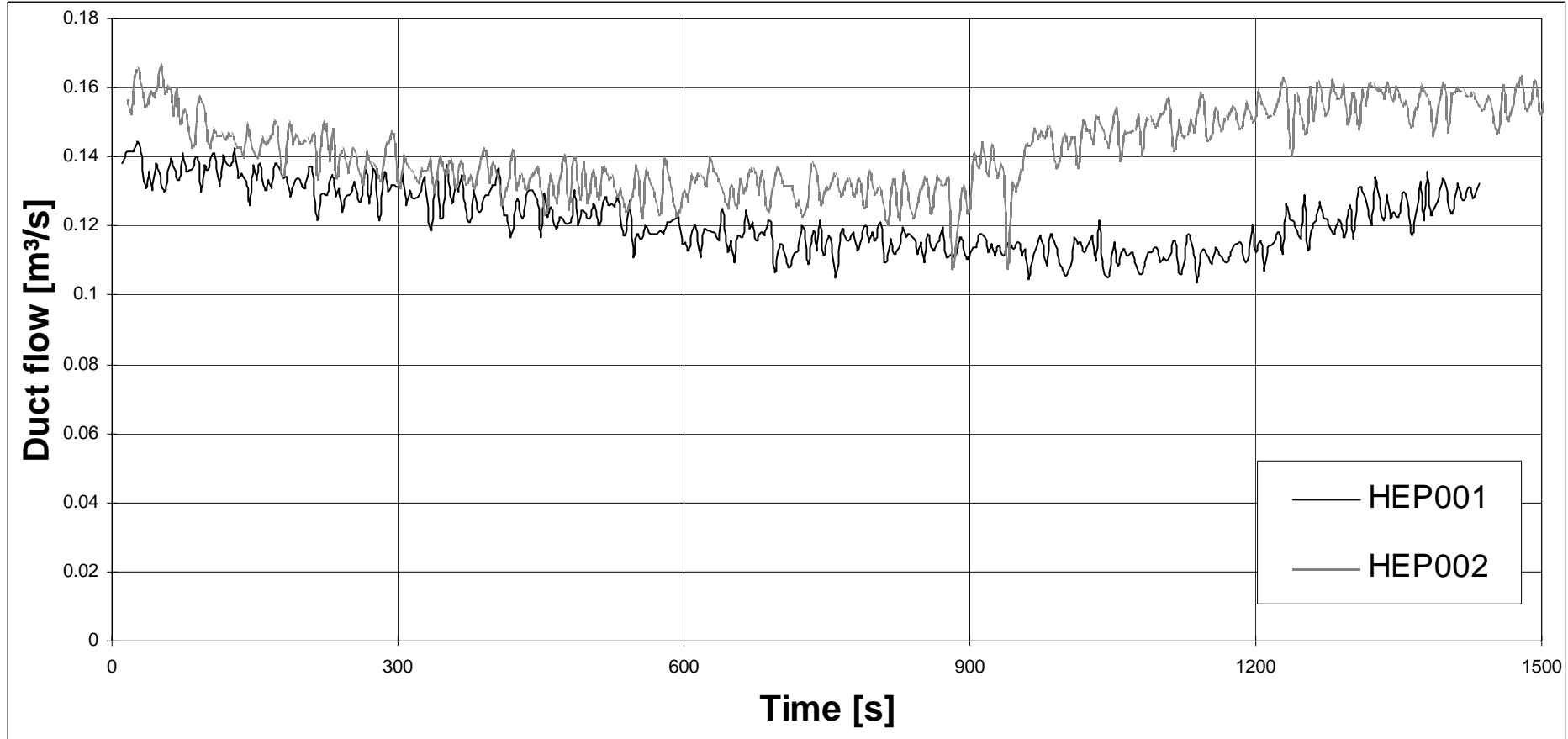

Figur B:5 Volymflöde i huven

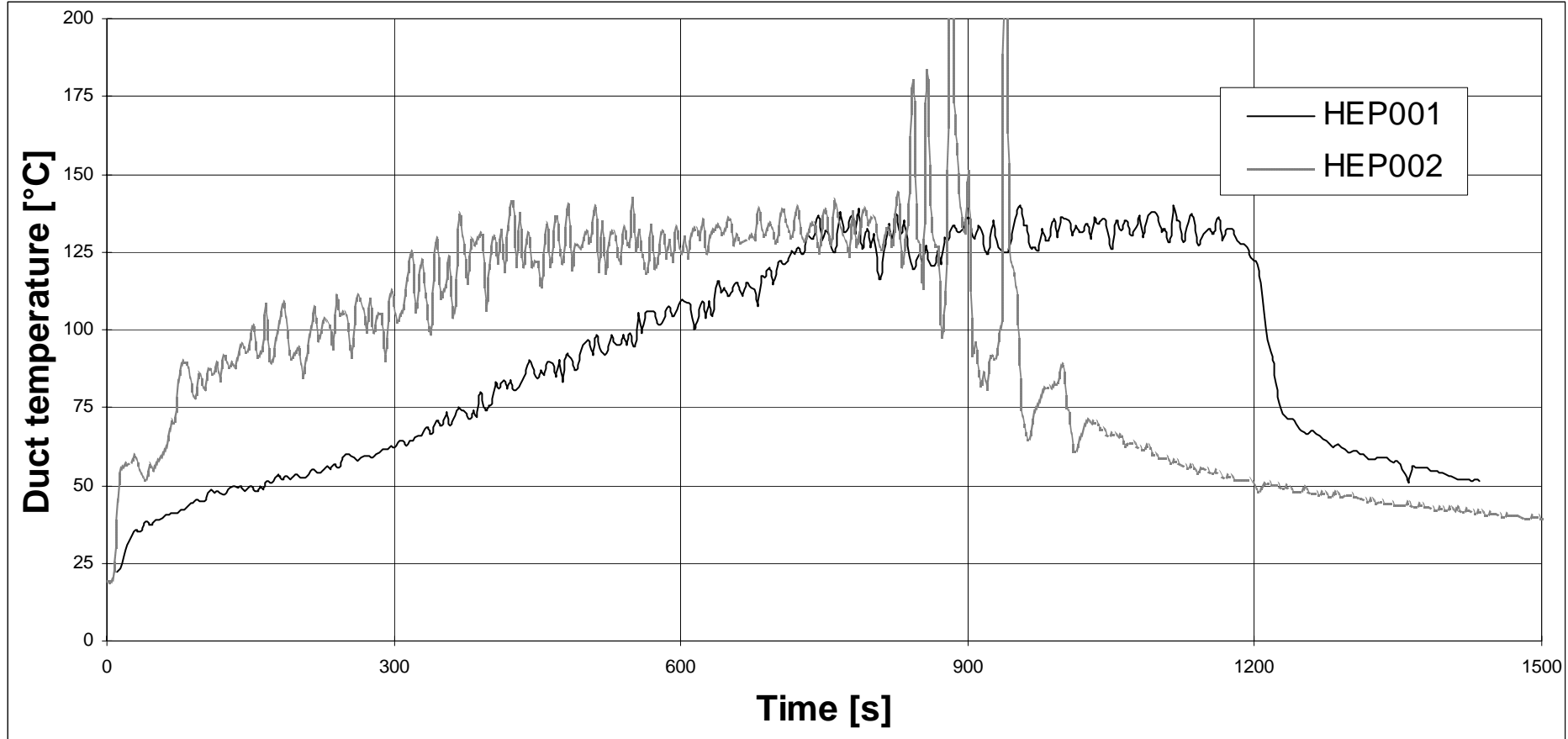

Figur B:6 Temperatur i huven

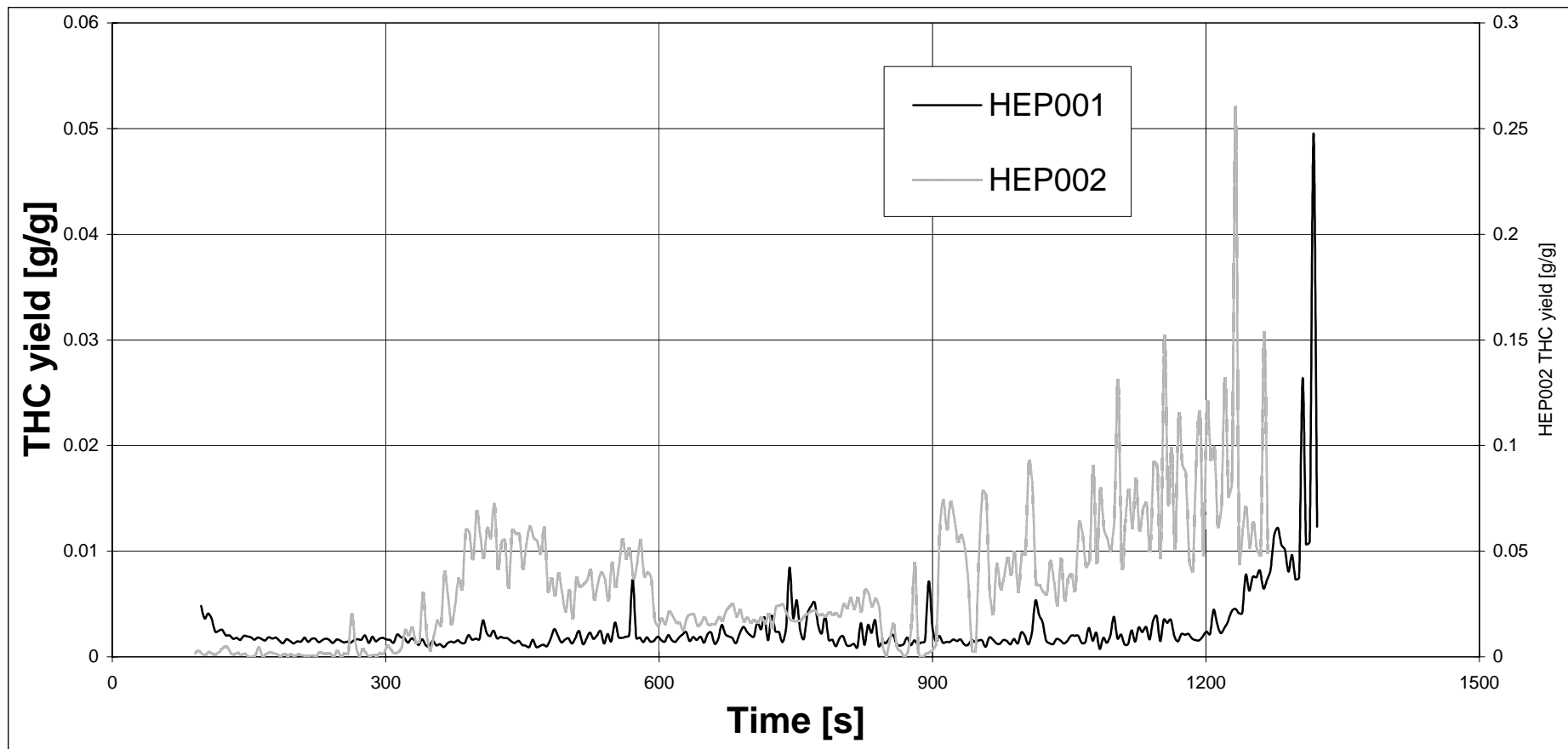

Figur B:7 Yield oförbrända kolväten

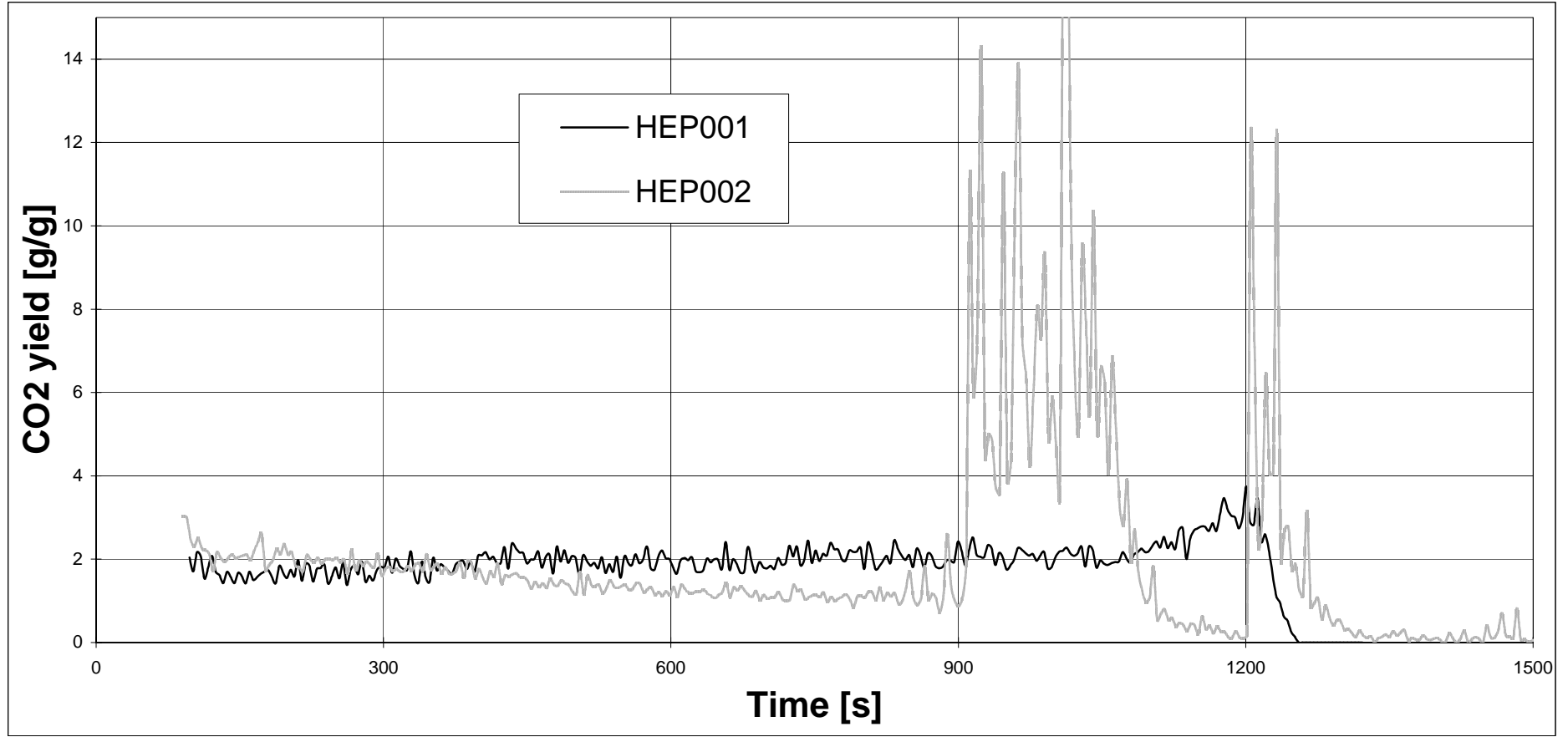

Figur B:8 Koldioxid Yield

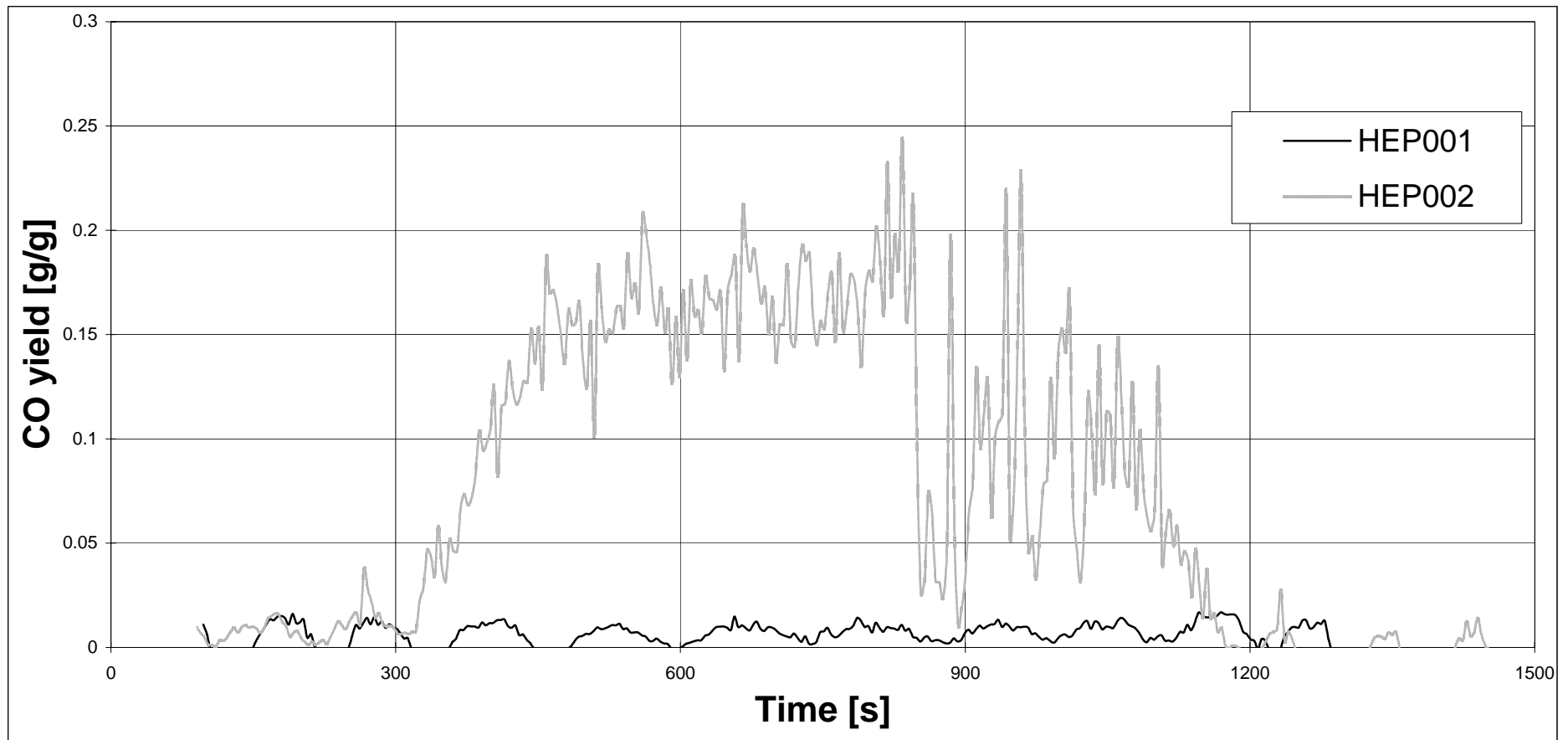

Figur B:9 Kolmonoxid yield

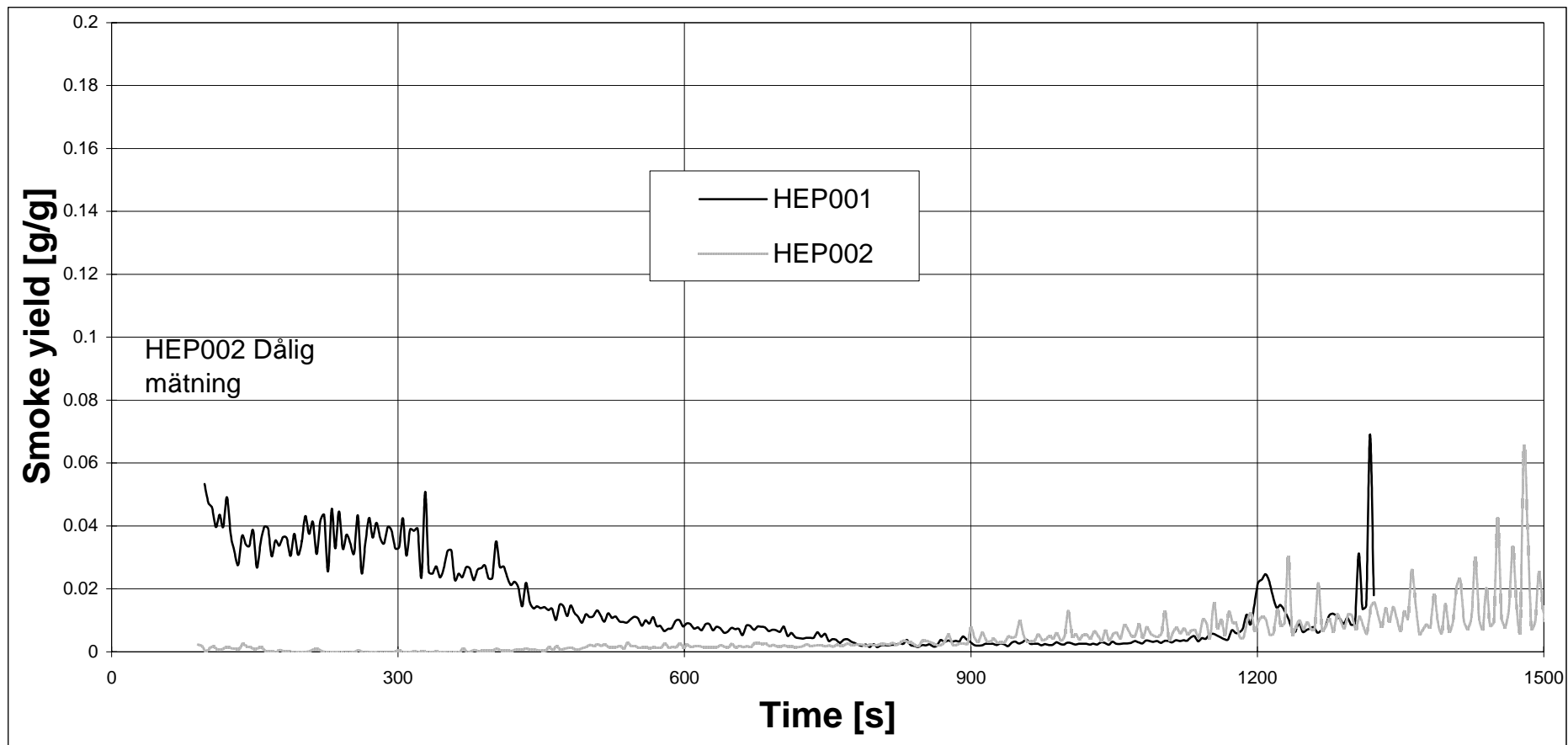

Figur B:10 Sotyield

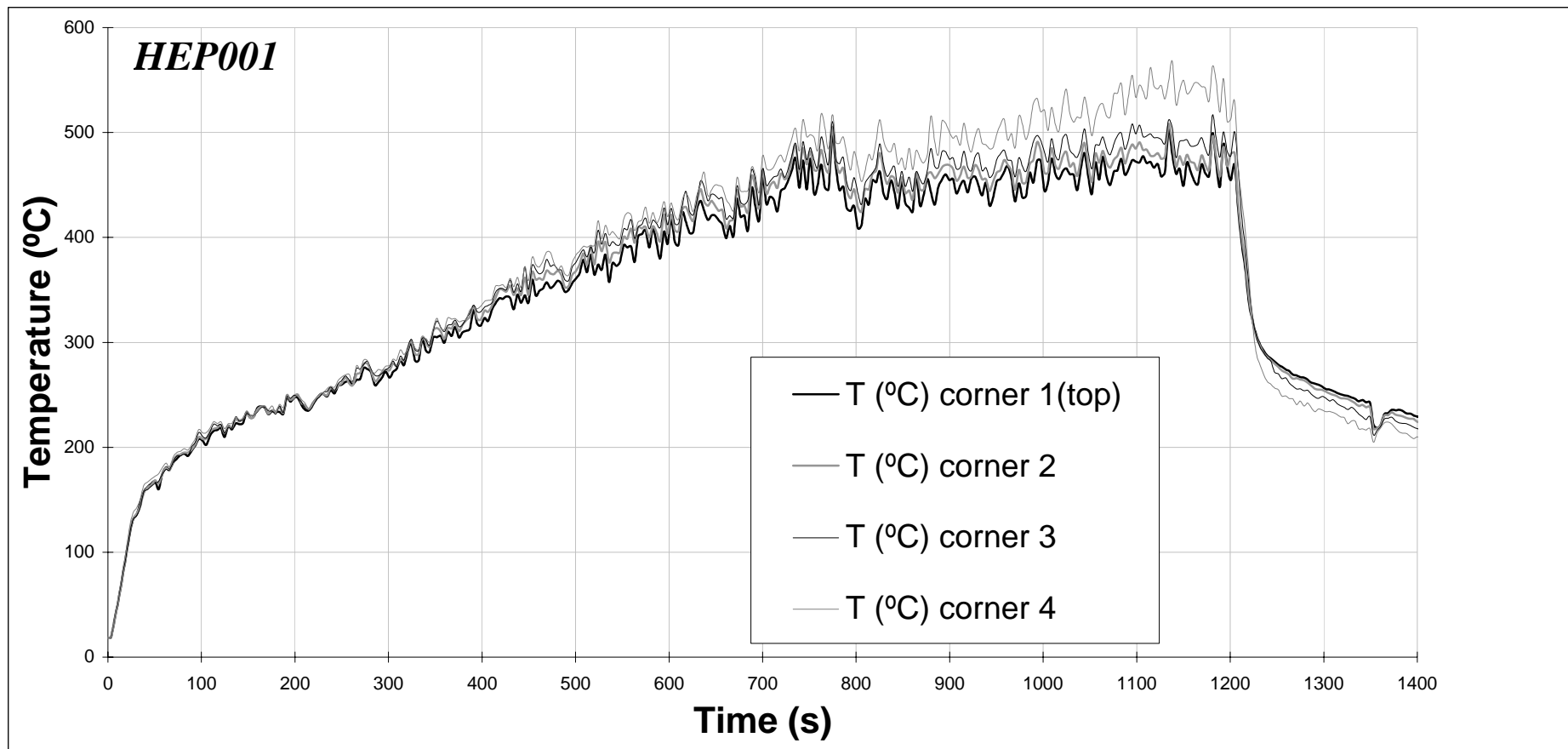

Figur B11 Försök HEP001. Temperaturen i hörnet av rummet, nr 1 högst upp.

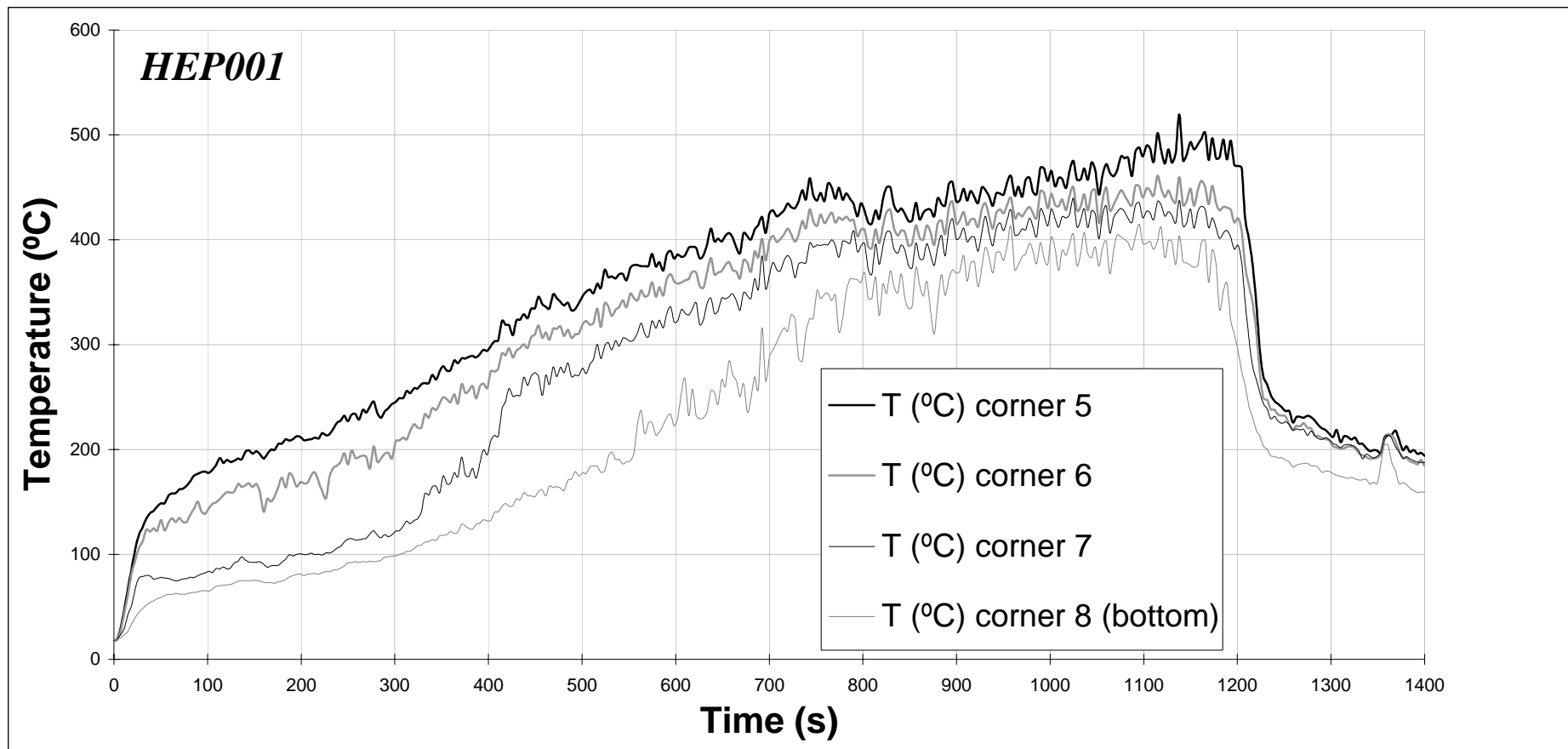

Figur B:12 Försök HEP001. Temperaturen i hörnet av rummet, nr 8 längst ned.

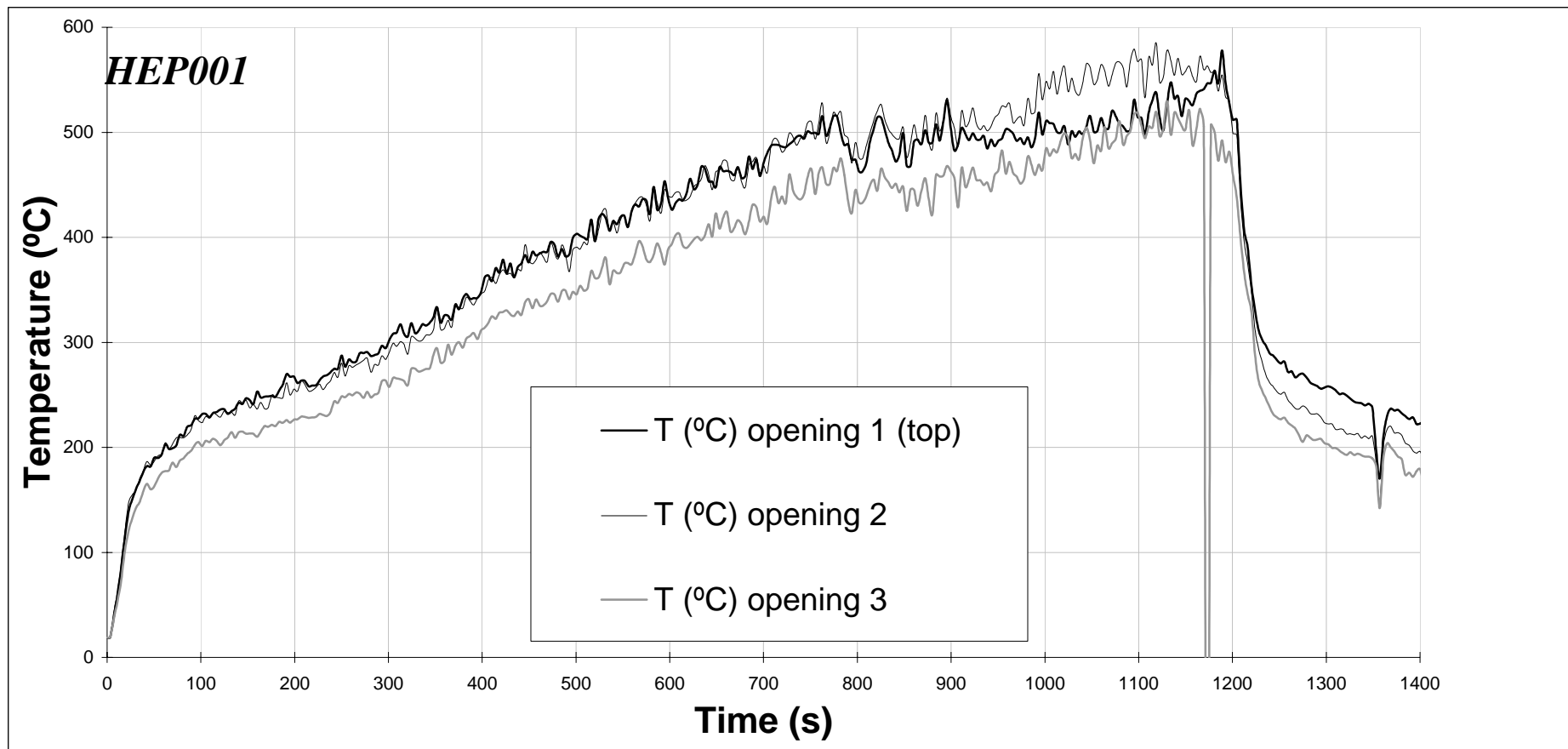

Figur B:13 Försök HEP001. Temperaturen i dörröppningen, nr 1 högst upp.

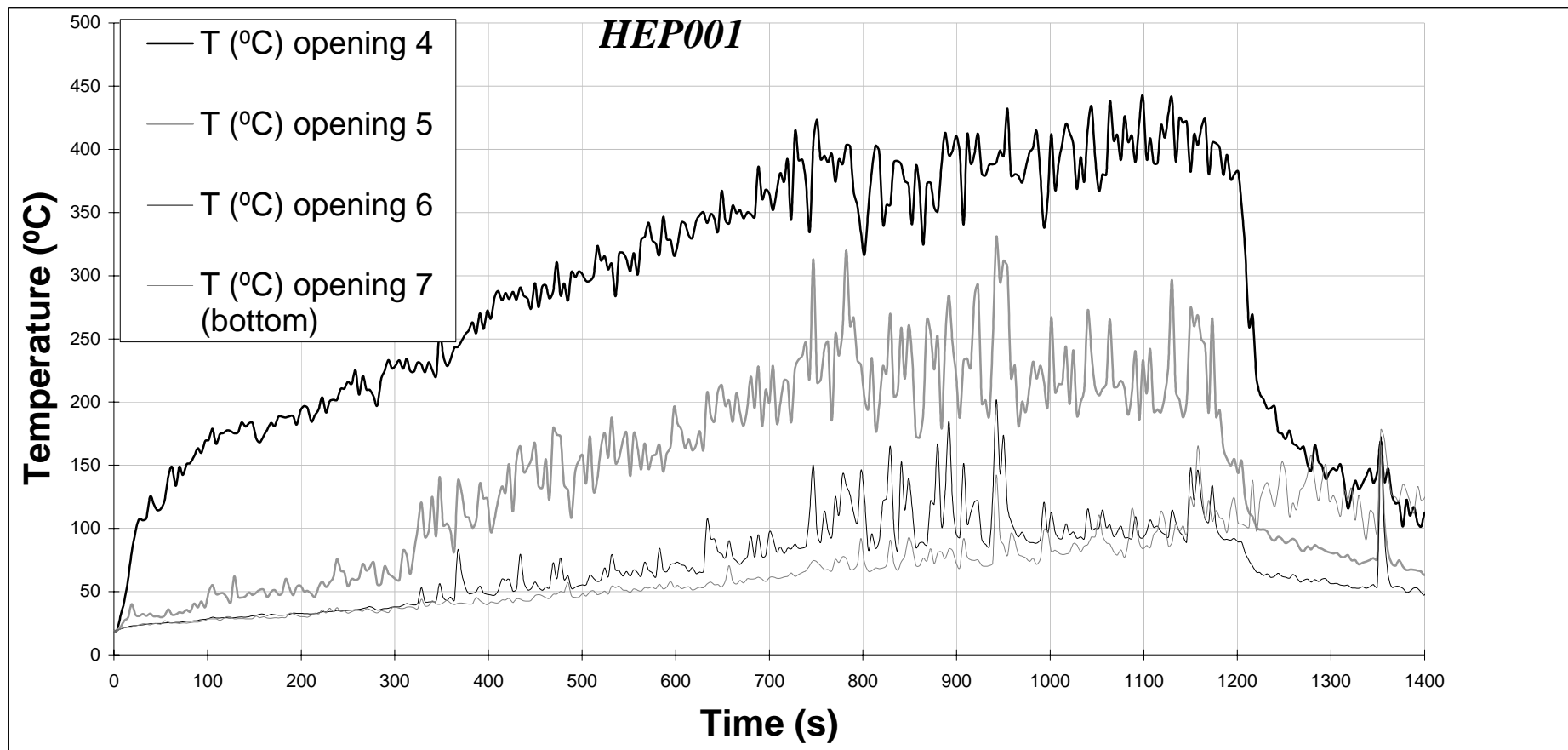

Figur B:14 Försök HEP001. Temperaturen i dörröppningen, nr 7 längst ned.

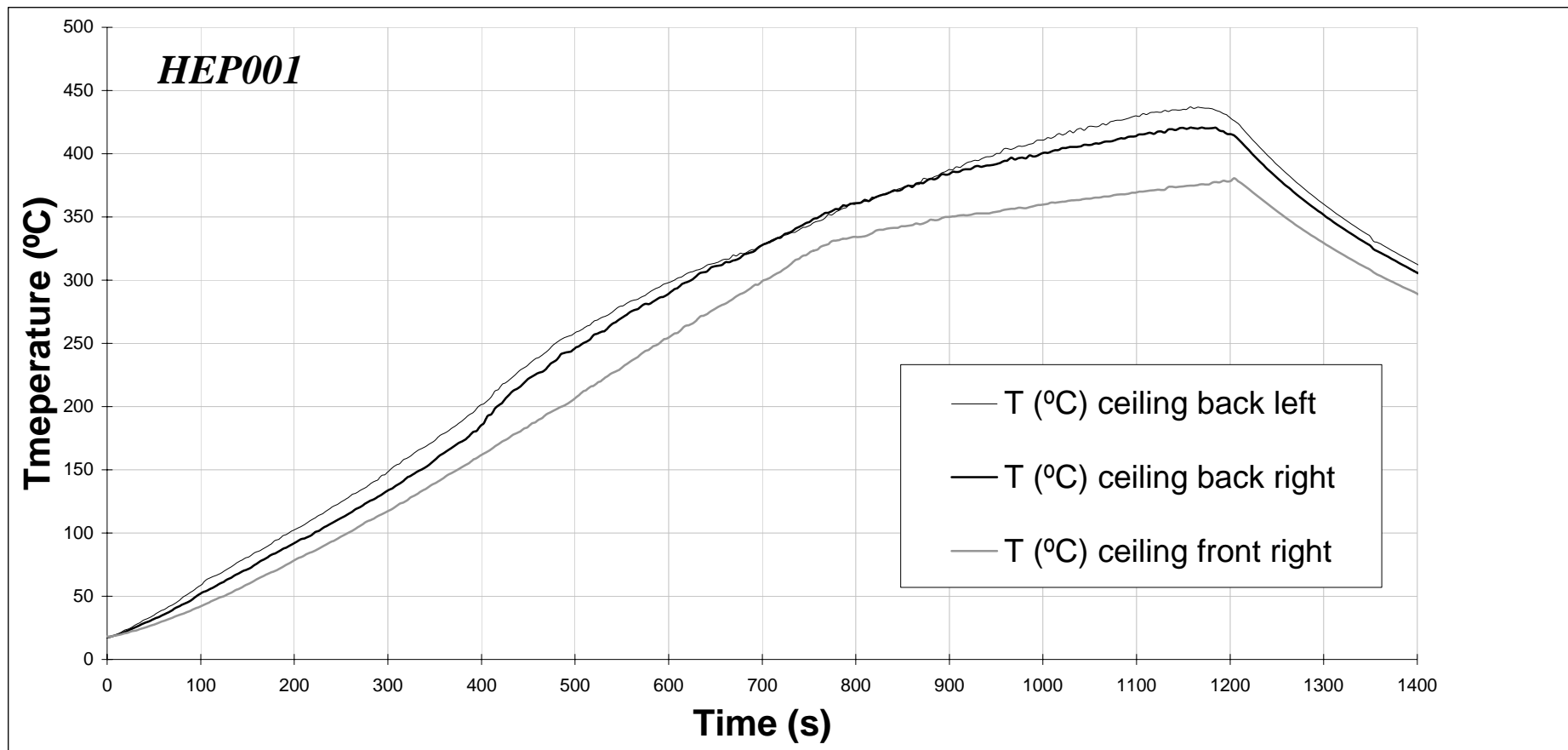

Figur B:15 Försök HEP001. Temperaturen i taket.

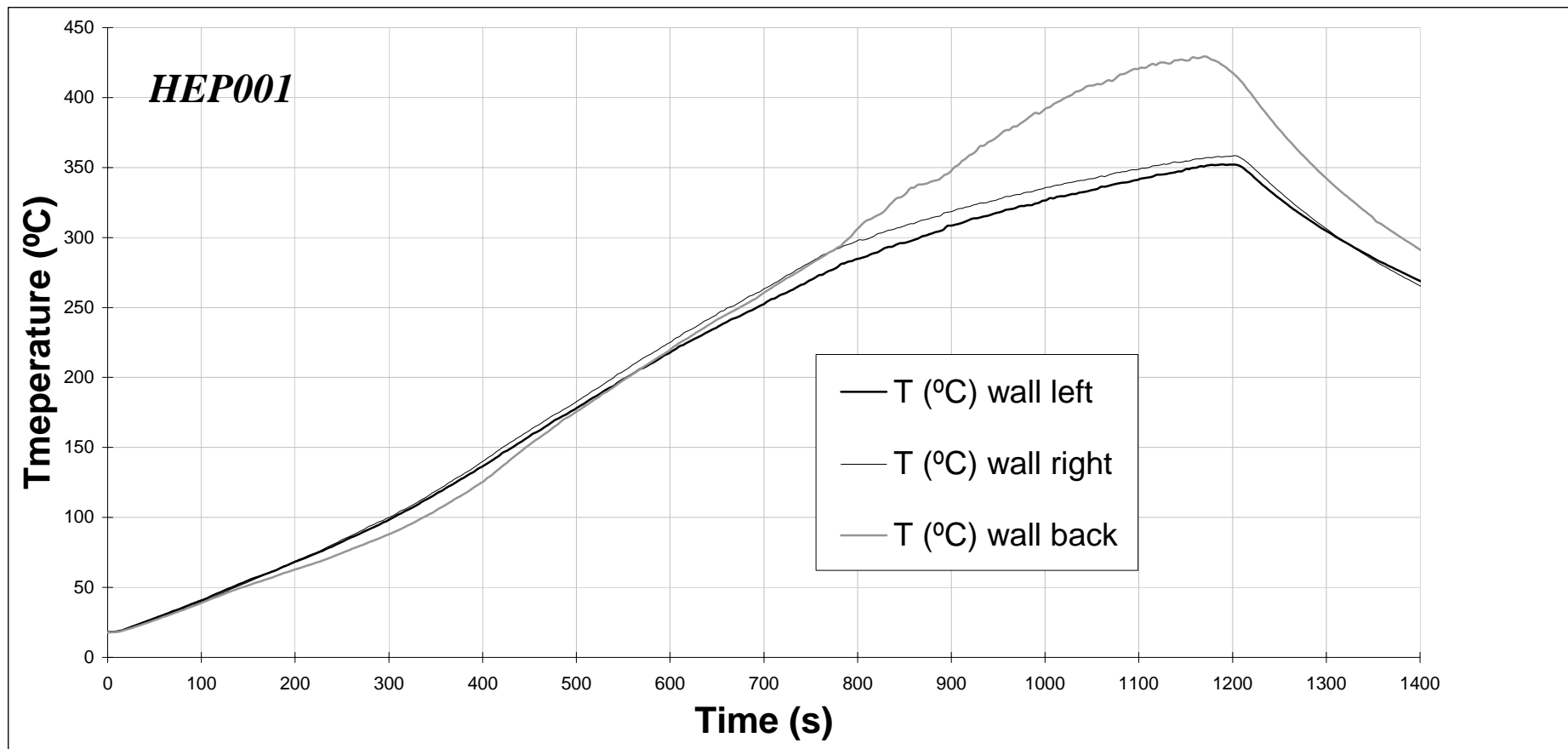

Figur B:15 Försök HEP001. Temperaturen på väggarna.

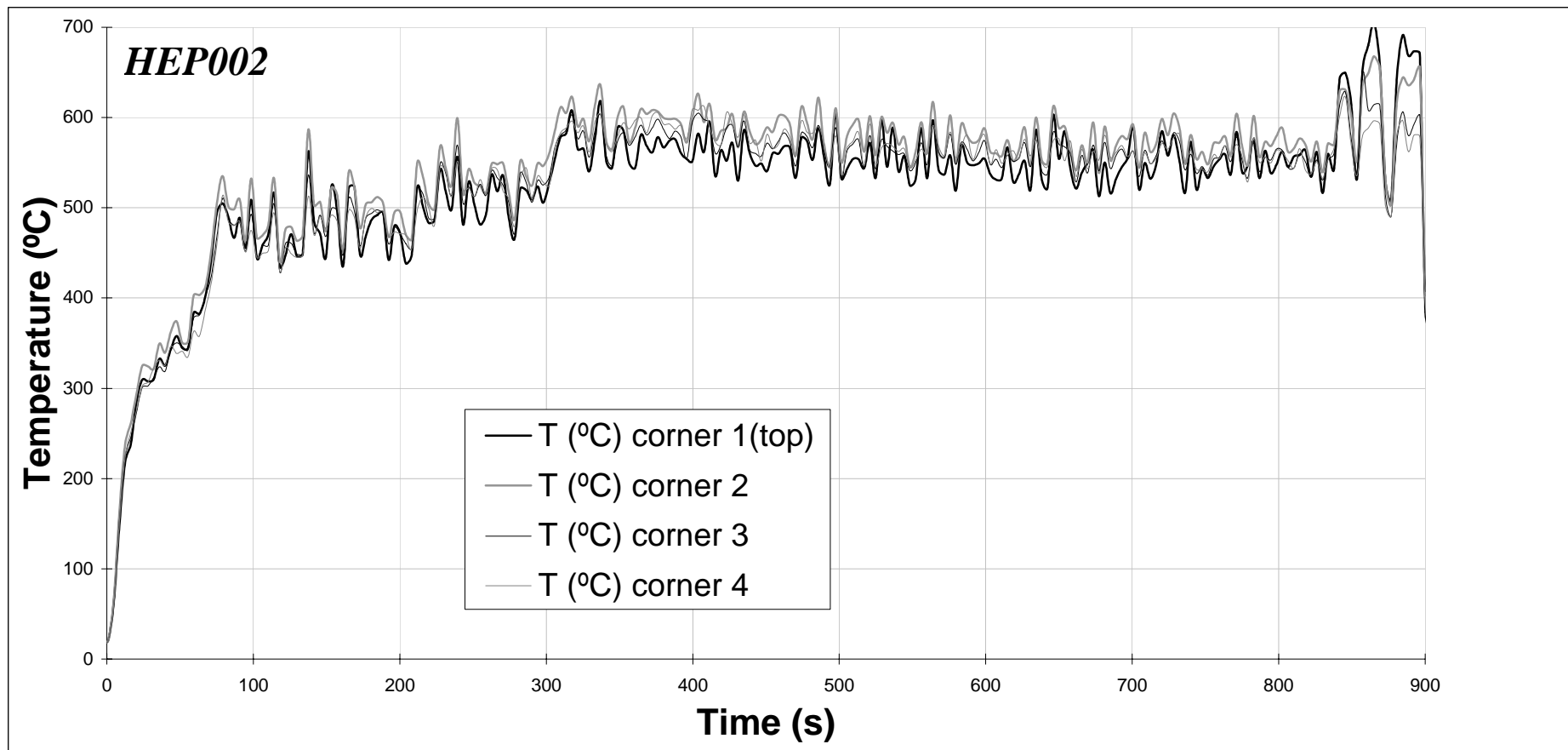

Figur B:16 Försök HEP002. Temperaturen i hörnet av rummet, nr 1 högst upp.

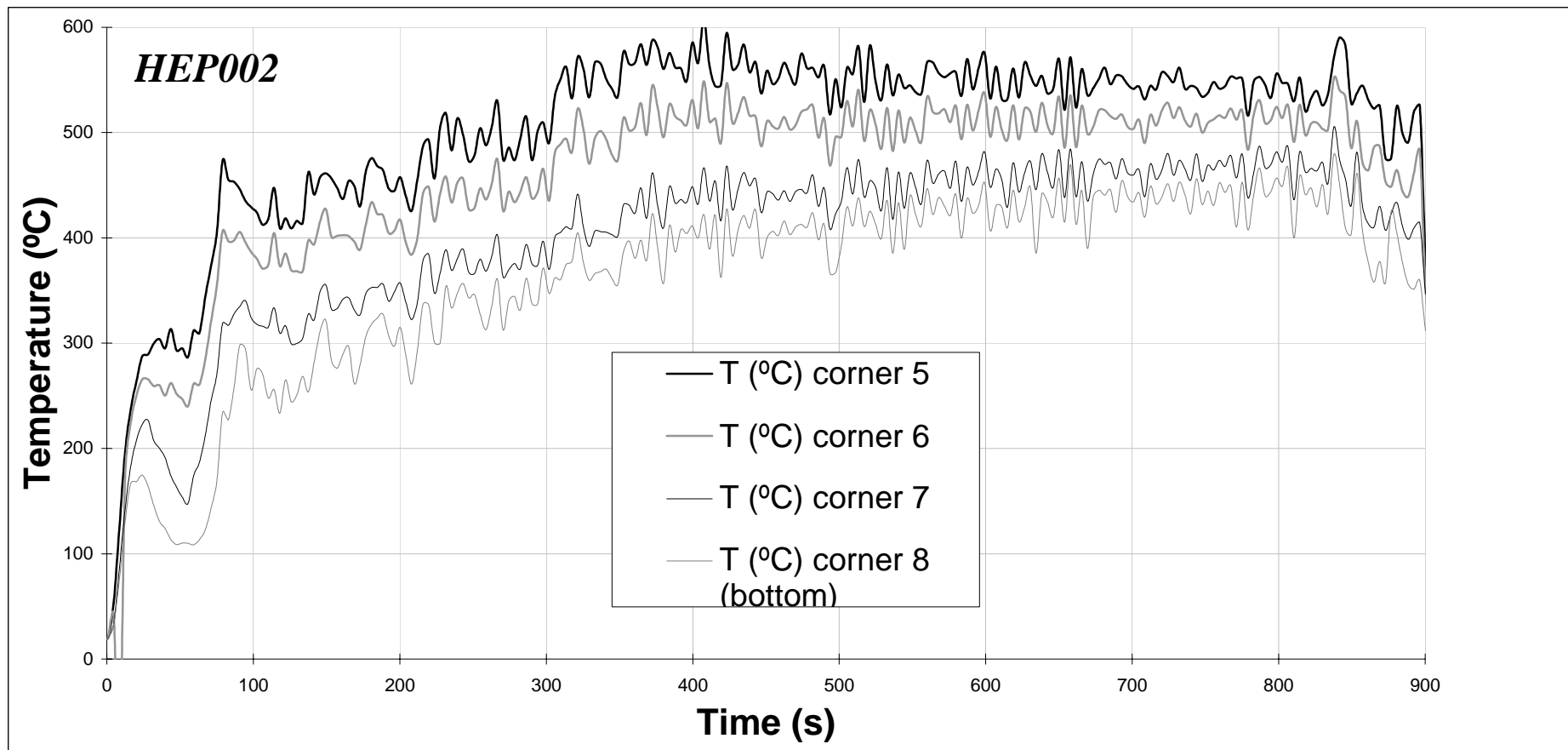

Figur B:17 Försök HEP002. Temperaturen i hörnet av rummet, nr 8 längst ned.

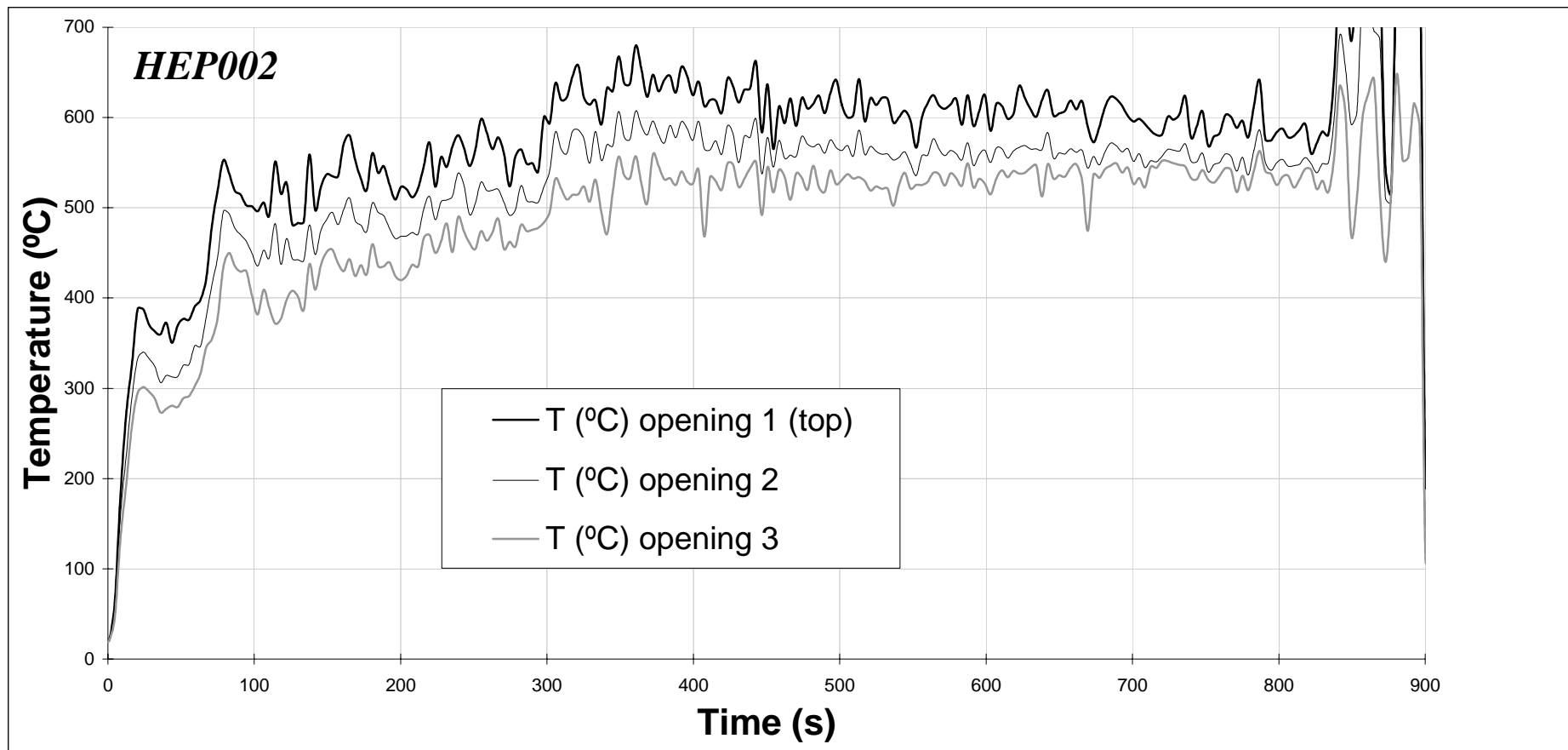

Figur B:18 Försök HEP002. Temperaturen i dörröppningen, nummer 1 längst upp.

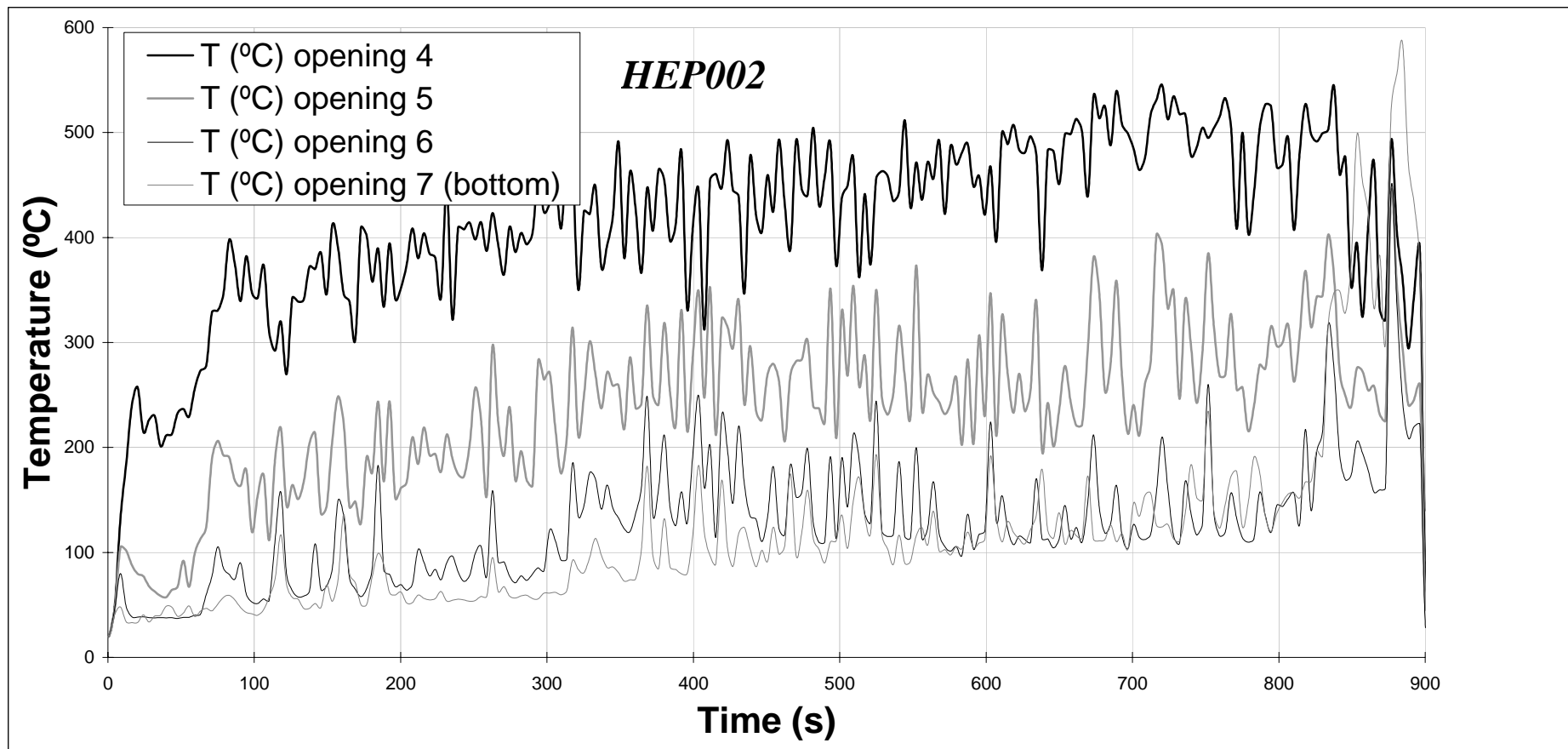

Figur B:18 Försök HEP002. Temperaturen i dörröppningen, nummer 7 längst ned.

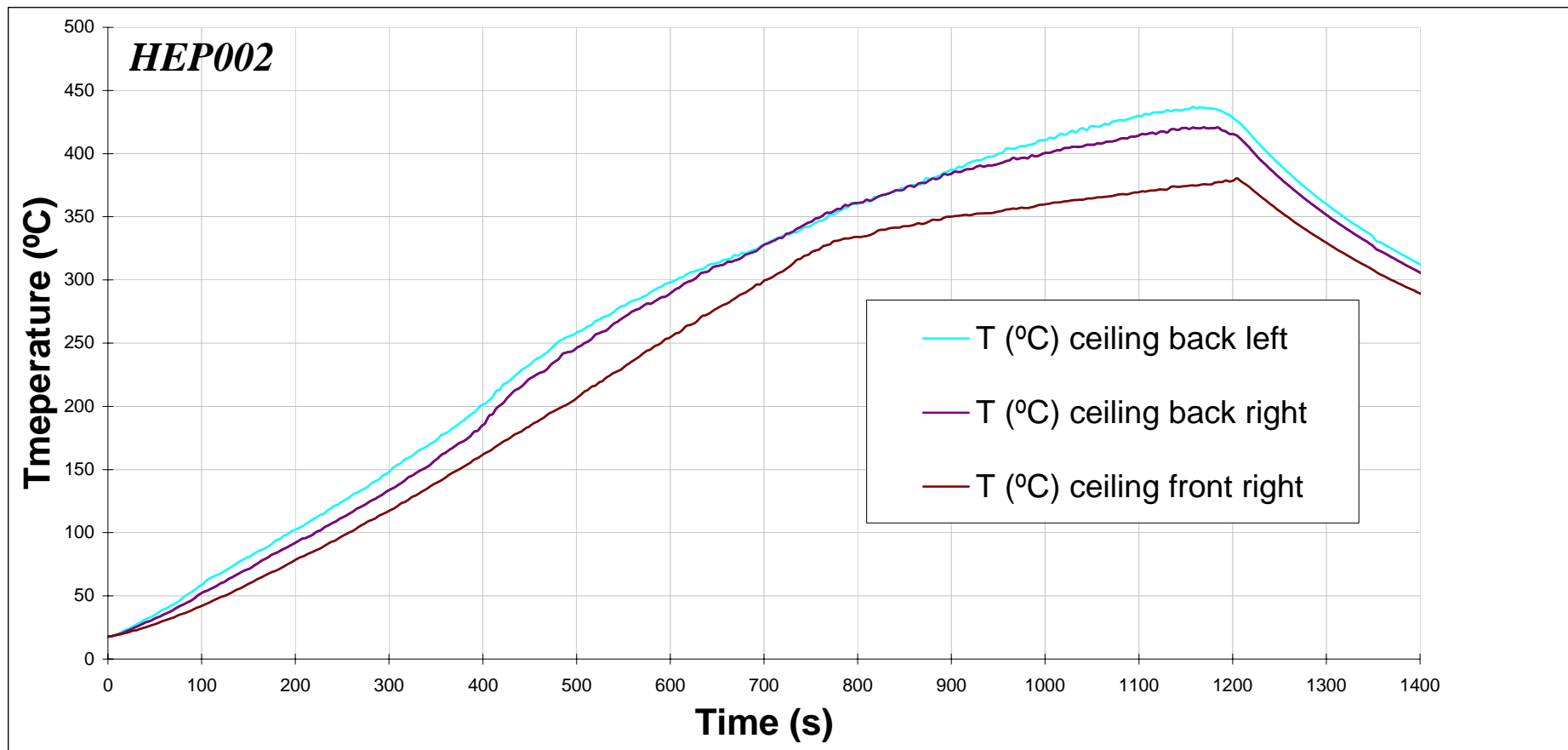

Figur B:19 Försök HEP002. Temperaturen i taket.

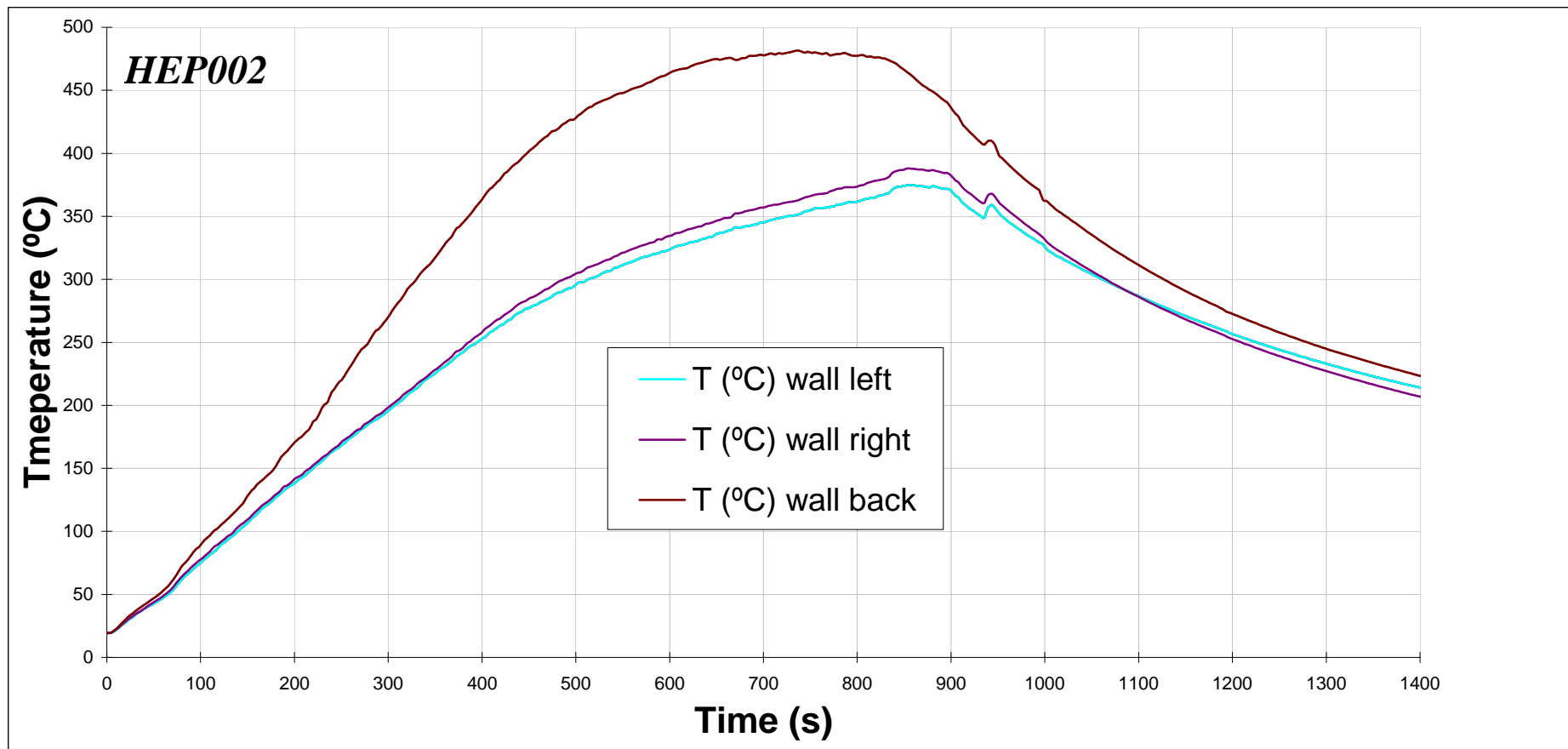

Figur B:20 Försök HEP002. Temperaturen på väggarna.

Appendix C

Time (s)	Duct temp	Duct press	Duct O2	Duct CO2	Duct CO	Duct NOx	Duct HC	Duct light i
0	26.0172	258.516	9640.75	481.518	175.404	-102.314	61.8184	168.03
3.9	26.2153	262.955	9618.53	489.706	176.41	-91.8431	61.8916	168.063
7.8	26.0732	243.225	9613.65	486.45	179.403	-101.43	61.8572	168.035
11.7	25.9181	304.388	9619.63	483.738	182.486	-101.684	61.9698	168.025
15.66	26.0383	257.036	9626.65	481.419	183.354	-101.791	62.5701	168.058
19.56	26.3818	270.107	9636.41	478.756	184.082	-101.46	61.9988	168.122
23.46	26.2267	308.582	9623.96	487.734	179.941	-101.455	62.1114	168.152
27.41	26.4189	261.524	9622.31	489.361	180.214	-102.358	62.2334	168.176
31.31	26.3611	268.036	9629.39	488.867	181.699	-100.922	62.2237	168.244
35.26	26.0476	272.772	9615.23	486.698	182.705	-101.435	62.165	168.244
39.22	26.0935	294.771	9619.08	483.492	183.897	-102.255	62.1846	168.259
43.12	26.1646	244.458	9614.75	482.899	184.097	-101.538	62.16	168.293
47.02	25.7219	265.965	9620.67	478.607	184.844	-101.645	62.1502	168.308
50.92	26.0717	259.699	9624.51	478.016	184.717	-101.591	62.077	168.244
54.82	26.0955	249.737	9617.43	478.165	183.95	-101.41	62.0625	168.118
58.72	26.2767	262.068	9633.18	480.482	181.738	-101.572	61.96	168.039
62.62	26.1493	262.264	9608.21	484.674	180.747	-101.059	62.0821	168.01
66.52	26.0726	274.498	9621.77	487.389	179.799	-101.923	62.0821	168.044
70.47	25.7273	273.314	9618.53	478.165	183.97	-102.07	62.1016	167.971
74.37	25.781	281.847	9620.12	489.855	179.028	-101.982	62.1502	167.98
78.27	25.6826	288.456	9616.88	478.016	181.489	-101.054	61.9404	167.947
82.17	25.7512	257.233	9621.77	480.482	180.473	-102.715	61.9209	167.912
86.07	25.8976	265.52	9623.41	479.496	180.678	-101.005	61.6961	167.932
89.97	25.8298	285.299	9642.39	481.371	178.114	-102.133	61.9795	168.035
93.87	25.6188	294.968	9628.85	483.343	176.4	-102.656	62.0234	168
97.77	25.6134	278.246	9623.96	486.599	175.433	-102.065	62.3994	168
101.72	25.9434	284.658	9617.98	490.051	174.71	-101.767	62.3896	167.922
105.62	25.9008	274.744	9631.53	491.285	174.647	-102.129	62.458	167.922
109.52	25.6874	273.857	9642.39	494.047	175.941	-101.836	62.531	167.908
113.42	25.5027	279.726	9650.51	491.285	175.438	-102.05	62.5458	167.927
117.32	25.2676	250.624	9654.85	491.482	177.865	-101.176	62.4921	167.971
121.22	25.5376	283.129	9652.16	487.24	177.895	-102.08	62.5701	167.908
125.12	25.8994	234.84	9634.77	482.899	178.862	-102.163	62.5215	167.912
129.02	25.7737	273.413	9614.75	477.917	178.3	-101.85	62.5753	167.864
132.98	25.9879	277.704	9128.05	423.117	100.678	-101.83	241.943	167.883
136.88	25.79	300.491	2094.83	24.907	4.81603	6222.63	257.973	167.897
140.78	25.7242	265.718	430.96	0.162437	2.08874	8040.22	259.651	167.922
144.68	25.9341	237.997	212.989	0.142436	2.83508	6889.98	261.772	167.873
148.58	25.4707	270.353	91.5308	0.13951	3.5775	8498.66	264.139	167.897
152.48	25.6576	283.573	49.8042	0.137559	3.60775	8804.14	263.548	167.883
156.37	25.674	276.619	29.5417	0.137559	3.57848	8981.02	265.816	167.878
160.27	25.5602	273.708	23.0511	0.137071	3.60335	9090.09	268.185	167.912
164.23	25.5984	279.922	20.3456	0.135607	3.2936	9161.68	270.353	167.927
168.18	25.6071	254.324	21.6545	0.13512	2.8946	9149.72	272.032	167.936
172.08	25.4213	293.736	19.9558	0.134144	3.35799	9192.08	273.857	167.952
175.98	25.4277	247.467	21.6011	0.134144	1.81363	9190.43	275.188	167.936
179.88	25.4453	261.229	14.1802	0.134632	2.40923	9187.2	276.47	167.956
183.78	25.7457	268.875	19.8187	0.134632	1.55949	9231.14	278	167.922
187.68	25.4452	283.081	25.371	0.134144	1.38583	9203.98	278.986	167.903
191.58	25.0341	286.434	12.5666	0.134144	8.34E-02	9211.61	280.022	167.932
195.48	25.3052	301.035	12.7608	0.134632	8.39E-02	9221.92	281.008	167.932
199.38	25.4298	276.865	7.84522	0.134632	8.39E-02	9202.94	281.897	167.873
203.34	25.386	269.566	-0.302434	0.134632	8.44E-02	9179.57	282.982	167.873
207.24	25.4537	257.875	7.41452	0.133656	8.34E-02	9202.39	283.623	167.83

211.19	25.3379	255.951	7.06086	0.134144	8.39E-02	9250.12	284.363	167.888
215.09	25.6691	311.789	12.3227	0.133656	8.39E-02	9224.61	284.954	167.888
219.04	25.4811	297.483	10.473	0.133656	8.29E-02	9217.04	285.595	167.869
222.94	24.9497	255.606	16.0363	0.133169	8.39E-02	9200.74	286.089	167.912
226.84	25.2428	277.605	14.2418	0.132681	8.34E-02	9217.04	286.68	167.892
230.74	25.5444	286.73	21.124	0.132193	8.34E-02	9188.29	287.075	167.869
234.7	25.3969	292.65	388.441	0.133169	8.29E-02	9212.16	287.569	167.922
238.6	25.3564	279.036	7264.89	20.0324	3.91358	9201.29	288.16	167.903
242.5	25.3105	275.335	10449.7	34.4791	8.60959	9192.63	288.506	167.927
246.4	25.3871	283.869	10448.1	36.0076	12.2447	9163.88	288.801	167.922
250.35	25.5358	265.371	10447	36.3934	14.0554	9205.08	289.099	167.912
254.25	25.5903	291.071	10445.4	37.2384	15.2974	9183.9	289.295	167.932
258.15	25.5336	285.25	10444.3	37.0576	16.5471	9166.56	289.492	167.912
262.05	25.527	244.41	10442.7	36.8526	16.6768	9170.9	289.69	167.903
265.95	25.5007	271.193	10442.1	35.5437	16.8699	9214.84	289.936	167.897
269.91	25.4264	319.138	10441	35.4998	17.1129	9173.1	290.331	167.873
273.81	25.4188	279.43	10439.9	36.6621	17.651	9163.33	290.825	167.858
277.71	25.5554	286.188	10439.4	36.6426	17.6719	9184.45	291.22	167.878
281.6	25.4723	259.996	10438.4	36.6864	17.5899	9150.27	291.515	167.966
285.56	25.4625	310.259	10437.8	36.8428	16.9559	9141.6	291.615	167.952
289.46	25.6255	260.044	10437.3	36.9844	16.3085	9133.48	291.712	167.971
293.41	25.4221	271.784	10436.2	37.1847	16.5998	9125.85	291.811	168.01
297.31	25.2341	303.797	10435.6	37.2822	16.1183	9163.33	291.91	167.922
301.21	25.6024	277.111	10435.6	37.3752	15.5666	9138.92	291.91	167.947
305.11	25.455	264.534	10434.5	37.3702	15.2603	9128.6	292.206	167.927
309.01	25.385	266.014	10434.5	37.3116	14.2583	9131.84	292.551	167.908
312.91	25.2167	292.452	10434	38.0638	13.1032	9157.35	292.747	167.873
316.81	25.2506	272.474	10432.9	38.9135	12.2188	9113.95	292.995	167.873
320.71	25.1478	274.942	10432.9	38.8744	11.8662	9167.66	292.995	167.912
324.67	25.2954	253.04	10432.4	37.3213	12.0437	9132.38	293.142	167.897
328.57	25.0942	239.526	10431.8	37.3752	11.7701	9120.42	293.291	167.878
332.47	25.1686	273.363	10431.3	38.2786	11.7047	9122.07	293.39	167.903
336.42	25.2134	263.054	10431.3	37.3409	12.2998	9118.84	293.39	167.917
340.32	24.66	259.403	10430.7	37.1504	11.8408	9128.6	293.39	167.903
344.22	25.0953	238.786	10430.2	36.9453	12.4603	9105.77	293.537	167.927
348.12	25.1686	275.78	10430.2	36.7646	12.8203	9107.42	293.242	167.932
352.02	25.1838	300.146	10430.2	36.9551	13.1598	9087.34	293.291	167.869
355.92	24.9226	255.802	10429.6	35.7196	14.0461	9129.64	293.39	167.927
359.82	24.8536	254.52	10429.1	35.2557	14.2813	9126.4	293.438	167.952
363.77	24.9862	272.427	10429.1	35.3532	15.4929	9144.29	293.636	167.873
367.67	25.1819	269.566	10428.6	36.7305	16.4065	9109.62	293.833	167.908
371.57	25.0179	282.043	10428.6	35.5389	16.5075	9100.34	293.932	167.922
375.53	25.252	276.47	10428.6	37.0576	15.7651	9132.38	293.982	167.903
379.43	24.9272	270.947	10428.6	36.921	16.4719	9128.6	294.178	167.883
383.33	25.5056	286.779	10428	37.3557	16.2783	9124.76	294.081	167.864
387.23	25.0049	234.791	10427.5	36.413	16.59	9113.95	294.277	167.878
391.13	24.9863	290.331	10427.5	37.3557	15.988	9119.38	294.327	167.878
395.03	24.9241	276.915	10426.9	36.6621	16.1188	9129.15	294.376	167.892
398.93	24.8573	279.972	10426.4	36.8867	15.2369	9092.77	294.376	167.878
402.88	24.7546	275.484	10426.4	37.0431	14.1154	9133.48	294.573	167.864
406.78	24.9592	266.211	10426.4	39.1576	12.9291	9124.27	294.474	167.869
410.73	24.8937	258.911	10426.4	37.3409	12.3008	9150.82	294.474	167.892
414.63	24.8883	279.48	10426.4	36.7599	12.3213	9109.07	294.376	167.878
418.53	24.8085	296.299	10426.4	36.6671	11.9686	9100.34	294.426	167.892
422.43	24.9705	288.456	10425.8	37.9171	12.0281	9107.97	294.523	167.897
426.33	24.78	315.29	10425.8	36.8917	11.2032	9115.54	294.474	167.892

430.23	24.6893	278.296	10425.8	37.1065	11.5823	9125.3	294.474	167.873
434.13	24.6346	278.444	10425.3	37.2286	12.0403	9157.35	294.474	167.883
438.03	25.4572	270.157	10425.8	37.3166	11.7242	9164.92	294.426	167.878
441.99	24.9872	278.986	10424.7	37.3752	12.551	9121.52	294.672	167.912
445.89	24.8232	275.288	10425.3	37.3213	12.6262	9134.03	294.722	167.869
449.79	24.9021	293.932	10425.3	37.2336	12.152	9173.1	294.819	167.892
453.69	24.9653	295.807	10424.7	36.7794	12.8832	9099.85	294.868	167.927
457.59	25.0277	291.121	10425.3	35.9197	13.8261	9095.46	294.868	168.035
461.54	24.8419	264.929	10424.2	36.159	14.1802	9099.85	294.771	167.995
465.44	24.6429	292.206	10424.2	35.5487	15.591	9086.24	294.819	168.044
469.34	24.7612	275.385	10424.2	35.2604	15.4754	9086.24	294.968	168.019
473.24	24.5153	293.488	10424.2	35.4314	16.0446	9093.32	294.868	168.03
477.14	24.5886	289.541	10423.7	36.4618	16.3543	9103.64	294.771	168.015
481.09	24.6084	245.495	10423.7	36.1395	16.3612	9101.99	294.968	168.015
484.99	24.5898	292.551	10424.2	36.35	16.6153	9138.92	294.918	167.995
488.89	24.7169	273.018	10423.7	35.5339	16.6299	940.296	294.918	167.986
492.79	24.566	287.668	10423.7	36.4571	17.0792	-3.54238	183.418	168.049
496.69	24.678	255.556	10423.2	36.3202	16.3461	-78.1298	100.561	168.058
500.59	24.7207	283.772	10423.2	21.1954	13.0559	-91.6433	96.7026	167.991
504.49	24.7744	290.232	2133.9	0.132681	6.06918	-95.6821	92.8788	167.995
508.39	24.4526	295.708	582.783	0.132681	2.69459	-97.3182	89.4895	167.966
512.35	24.6376	282.488	292.797	0.131705	2.33655	-98.2213	85.3429	168
516.25	24.3827	258.566	167.678	0.131705	2.39362	-98.876	82.1981	167.986
520.15	24.5808	283.772	105.645	0.132681	2.33801	-97.1422	79.9809	167.956
524.05	24.8069	248.898	68.4257	0.131705	2.4107	-100.59	77.0359	167.941
527.95	25.123	271.933	51.1522	0.132193	1.70046	-100.341	74.8382	167.961
531.9	24.8433	238.243	49.0961	0.132193	2.15508	-100.536	72.4206	167.966
535.86	25.1155	297.829	51.24	0.132193	1.67949	-101.913	71.0583	168.019
539.75	25.0139	234.446	53.4084	0.131218	0.974618	-101.02	69.0703	168.054
543.65	25.1309	262.314	43.9487	0.131218	1.60095	-100.111	67.4148	168.035
547.55	24.8187	294.918	31.9152	0.131705	1.62192	-102.099	65.8813	168.132
551.45	24.5585	284.954	21.7228	0.132193	8.34E-02	-101.821	64.4555	168.102
555.35	24.6483	282.242	14.8266	0.131218	8.29E-02	-101.816	63.303	168.093
559.31	24.642	277.309	13.351	0.131705	8.34E-02	-101.606	62.2284	168.054
563.21	24.5225	287.815	18.5573	0.132681	8.34E-02	-101.401	61.2712	168.025
567.11	28.2277	280.811	2.70191	0.132193	8.39E-02	-101.689	60.9198	168.01
571.01	25.5909	286.434	-6.79991	0.131705	8.29E-02	-101.85	60.231	167.995
574.96	32.6465	265.324	0.346337	0.132193	8.34E-02	-102.055	59.6988	168.044
578.86	27.676	280.811	11.5437	0.132193	8.29E-02	-102.993	59.3081	168.137
582.82	24.9878	290.726	8.76135	0.131705	8.29E-02	-102.334	58.3215	168.093
586.72	33.948	267.937	6.36479	0.132193	8.29E-02	-102.675	57.8673	168.088
590.62	31.4625	297.089	13.7559	0.131705	8.29E-02	-102.524	57.8282	168.132
594.52	31.0381	300.789	5.6726	0.131705	8.29E-02	-102.011	57.4327	168.074
598.42	29.7356	289.295	11.6359	0.131218	8.29E-02	-102.402	56.9444	168.083
602.31	30.0273	266.359	18.0548	0.131705	8.34E-02	-102.153	56.705	168.063
606.21	29.3857	303.007	16.8246	0.131705	8.29E-02	-102.592	56.6463	168.063
610.11	29.2172	278.049	31.0166	0.131218	8.24E-02	-102.338	56.793	168.049
614.07	29.1542	270.403	21.3858	0.132193	1.63558	-102.143	67.9812	168.049
617.97	28.9092	274.202	6.87745	0.131705	1.67412	-102.622	60.612	168.074
621.92	28.8754	274.399	7.79355	0.131218	1.639	-103.198	58.1505	168.054
625.82	29.0118	264.288	7.44185	0.131705	1.85704	-101.996	58.4192	168.069
629.72	28.845	265.816	5.04625	0.131218	1.79949	-102.597	56.9346	168.102
633.62	28.6306	270.847	12.9466	0.132193	2.11558	-102.402	56.3729	168.098
637.52	28.8319	239.871	16.6733	0.13073	2.17801	-102.383	55.7137	168.093
641.48	28.9095	266.754	17.4577	0.131218	2.40387	-102.319	55.2888	168.044
645.38	28.5021	306.213	10.4315	0.13073	2.29216	-102.358	55.3718	168.063

649.28	28.4259	260.044	12.152	0.132193	2.18777	-102.705	54.986	168.063
653.18	28.6058	275.633	8.04621	0.131705	2.54044	-102.973	54.8542	168.113
657.13	28.8064	255.211	9.22573	0.130242	2.39997	-102.319	54.5902	168.098
661.03	28.9766	287.47	2.47557	0.13073	2.38729	-101.836	54.3656	168.083
664.93	29.0868	283.524	1.76241	0.13073	2.17167	-103.203	54.5268	168.108
668.83	28.3682	267.197	6.38184	0.130242	2.48094	-101.967	54.3609	168.058
672.78	29.161	284.412	-2.78191	0.131705	2.41606	-102.451	53.8089	168.093
676.68	28.6802	258.961	-10.2208	0.131705	2.05216	-102.788	53.7553	168.069
680.58	28.8837	261.673	-1.07803	0.131705	1.91704	-102.309	54.0433	168.019
684.54	28.0319	267.839	-6.3321	0.13073	1.75705	-102.505	53.6819	167.991
688.44	28.033	267.591	-7.27695	0.13073	1.599	-102.207	53.8528	168.015
692.39	28.4387	227.983	-8.42375	0.132681	0.108779	-101.87	53.7748	168.019
696.29	28.1376	270.651	3.22629	0.131705	8.29E-02	-102.768	53.4182	168.108
700.19	28.3644	246.876	0.44048	0.131218	8.29E-02	-102.265	53.7405	168.093

Duct light	Phi O2 (prc	Opening C	Opening C	Opening O -	-	-	Load cell (r	
168.035	211.459	48.1095	53.8626	330.828	4.88E-04	-7.80E-03	4.88E-04	9.20767
168.069	211.411	48.0657	53.6332	308.582	-9.76E-04	-1.07E-02	-1.46E-03	9.20618
168.019	211.411	48.0754	53.9701	321.11	4.88E-04	-8.29E-03	0	9.19789
168.054	211.411	48.2316	53.6916	304.34	0	-9.27E-03	-4.88E-04	9.20278
168.054	211.459	48.2562	53.5011	319.828	0	-7.32E-03	0	9.20475
168.118	211.459	48.2609	53.5648	290.972	0	-7.80E-03	0	9.20719
168.127	211.411	48.3391	53.6819	316.868	0	-7.80E-03	-4.88E-04	9.20814
168.176	211.459	48.305	53.9212	286.335	0	-6.34E-03	0	9.19741
168.235	211.459	48.3634	53.8235	313.81	0	-8.78E-03	0	9.20522
168.23	211.459	48.4076	53.9017	286.829	0	-1.02E-02	-4.88E-04	9.22036
168.244	211.411	48.4173	53.843	282.488	0	-7.32E-03	-4.88E-04	9.20373
168.283	211.459	48.5246	53.8676	273.117	-4.88E-04	-5.37E-03	-4.88E-04	9.2057
168.293	211.459	48.5101	53.7651	276.224	-9.76E-04	-5.37E-03	-9.76E-04	9.19545
168.269	211.459	48.5101	53.9458	268.776	-4.88E-04	-3.90E-03	-9.76E-04	9.20963
168.102	211.411	48.476	53.9165	291.515	-9.76E-04	-6.83E-03	-4.88E-04	9.19348
168.035	211.459	48.4858	53.3402	270.699	4.88E-04	-3.90E-03	4.88E-04	9.19253
168.03	211.459	48.5344	53.8969	303.551	0	-5.85E-03	0	9.19741
168.044	211.411	48.5539	53.8089	284.512	-4.88E-04	-8.78E-03	0	9.20719
168	211.411	48.559	54.0092	301.922	0	-7.80E-03	4.88E-04	9.20963
167.975	211.411	48.5539	54.014	273.512	-4.88E-04	-8.78E-03	-4.88E-04	9.19694
167.941	211.459	48.4953	53.8285	271.488	-4.88E-04	-9.76E-03	-9.76E-04	9.20081
167.947	211.459	48.6908	53.9846	276.815	0	-4.39E-03	0	9.2057
167.927	211.459	48.6662	53.9114	270.651	0	-5.85E-03	0	9.19884
168.015	211.411	48.7201	53.7796	272.129	0	-5.85E-03	-4.88E-04	9.20278
167.966	211.509	48.7347	53.8821	275.78	0	-5.85E-03	-4.88E-04	9.19646
168.005	211.411	48.6908	53.8137	267.197	0	-3.41E-03	0	9.20963
167.927	211.459	48.6419	53.936	279.676	0	-6.34E-03	-4.88E-04	9.19545
167.912	211.459	48.7053	53.7307	266.014	-4.88E-04	-3.90E-03	-4.88E-04	9.19986
167.864	211.459	48.8226	53.8528	268.972	-4.88E-04	-5.37E-03	-9.76E-04	9.20325
167.932	211.459	48.6956	53.7064	290.134	0	-6.83E-03	-4.88E-04	9.20522
167.961	211.459	48.7835	53.7846	299.013	4.88E-04	-6.83E-03	0	9.19646
167.917	211.411	48.7397	53.7503	280.861	-9.76E-04	-6.83E-03	-4.88E-04	9.20421
167.912	211.459	48.769	53.8919	271.833	0	-7.80E-03	-4.88E-04	9.19205
167.864	211.459	48.6662	53.6673	270.552	0	-9.76E-03	0	9.20325
167.883	211.459	48.8031	53.726	292.601	0	-6.83E-03	0	9.18913
167.922	211.459	48.7444	54.1215	269.121	4.88E-04	-3.41E-03	0	9.20081
167.922	211.411	48.7249	53.7698	296.694	-9.76E-04	-8.29E-03	-1.46E-03	9.20767
167.883	211.459	48.7788	53.7014	290.529	-4.88E-04	-7.80E-03	-9.76E-04	9.18669
167.903	211.459	48.6662	53.6916	297.039	4.88E-04	-6.83E-03	-4.88E-04	9.20814
167.883	211.509	48.7933	54.019	287.569	4.88E-04	-9.76E-03	-9.76E-04	9.19592
167.883	211.459	48.8031	53.9651	266.605	-4.88E-04	-4.39E-03	-4.88E-04	9.19545
167.917	211.509	48.8274	53.9944	272.278	0	-6.34E-03	0	9.20373
167.917	211.411	48.9154	53.6721	270.353	-4.88E-04	-9.76E-03	-9.76E-04	9.21106
167.941	211.411	48.8567	53.936	271.687	-9.76E-04	-7.32E-03	-9.76E-04	9.19056
167.975	211.459	48.8274	53.8676	298.075	0	-6.83E-03	-9.76E-04	9.20129
167.956	211.459	48.7788	53.7553	272.327	0	-9.76E-03	0	9.19157
167.947	211.459	48.7981	53.9458	291.17	0	-7.32E-03	-4.88E-04	9.19938
167.922	211.459	48.7885	53.6184	267.395	4.88E-04	-8.29E-03	0	9.18961
167.912	211.411	48.9008	53.7992	295.904	-4.88E-04	-8.78E-03	-9.76E-04	9.19157
167.932	211.509	48.9204	53.8774	262.659	-4.88E-04	-4.39E-03	0	9.20522
167.897	211.459	48.8715	54.1215	267.492	-4.88E-04	-4.88E-03	4.88E-04	9.20767
167.883	211.509	48.8274	53.6525	259.058	9.76E-04	-2.93E-03	4.88E-04	9.20814
167.897	211.459	48.8324	54.0433	264.929	0	-3.90E-03	0	9.20182
167.844	211.459	48.8813	53.8039	276.766	-4.88E-04	-7.80E-03	-4.88E-04	9.19402

167.892	211.411	48.8958	53.9017	272.032	0	-3.41E-03	0	9.20522
167.903	211.411	5.80773	34.5864	5359.96	4.88E-04	-4.34E-02	9.76E-04	9.20814
167.873	211.509	5.49796	35.5096	9652.16	3.90E-03	-5.85E-03	4.88E-04	9.20963
167.892	211.459	4.44773	35.4655	9678.71	3.41E-03	-2.93E-03	4.88E-04	9.21011
167.869	211.459	4.35406	35.0652	9692.32	3.41E-03	-6.34E-03	0	9.20475
167.869	211.509	4.47455	35.28	9697.21	3.41E-03	-3.41E-03	-4.88E-04	9.20325
167.932	211.459	410.292	217.868	8976.13	4.88E-04	-5.85E-03	0	9.20373
167.917	211.411	483.887	228.378	4769.1	2.44E-03	-2.44E-03	4.88E-04	9.19402
167.917	211.411	484.577	228.23	4755	9.76E-04	-8.29E-03	-4.88E-04	9.193
167.903	211.411	485.514	228.971	4739.26	2.93E-03	-7.32E-03	9.76E-04	9.20421
167.912	211.411	485.958	228.871	4741.97	1.95E-03	-9.27E-03	-4.88E-04	9.19497
167.917	211.509	486.549	228.724	4734.92	1.46E-03	-2.93E-03	0	9.18961
167.888	211.459	486.599	229.019	4738.74	1.46E-03	-5.37E-03	0	9.21154
167.892	211.361	487.289	229.118	4750.12	2.44E-03	-7.32E-03	4.88E-04	9.20129
167.908	211.509	488.129	229.611	4744.69	2.44E-03	-6.34E-03	0	9.20325
167.897	211.411	489.41	230.104	4735.47	1.46E-03	-8.29E-03	0	9.19646
167.873	211.459	491.728	230.302	4749.57	2.44E-03	-6.83E-03	4.88E-04	9.19789
167.897	211.459	492.617	230.401	4741.42	1.95E-03	-6.83E-03	0	9.19741
167.936	211.411	492.666	229.907	4745.24	1.95E-03	-7.80E-03	9.76E-04	9.19741
167.947	211.509	493.111	230.401	4732.21	2.93E-03	-8.78E-03	4.88E-04	9.18913
167.98	211.509	492.863	230.302	4736.54	1.46E-03	-1.12E-02	0	9.20278
168.019	211.459	493.208	230.154	4734.38	1.95E-03	-6.34E-03	0	9.18913
167.932	211.509	493.208	229.562	4733.31	1.46E-03	-9.76E-03	0	9.19205
167.941	211.361	493.258	230.45	4732.76	1.95E-03	-3.90E-03	0	9.1911
167.927	211.411	493.504	230.006	4733.31	9.76E-04	-3.90E-03	0	9.2057
167.903	211.411	493.307	229.957	4737.09	1.46E-03	-3.90E-03	0	9.20618
167.873	211.459	493.652	230.056	4737.64	1.46E-03	-4.39E-03	0	9.193
167.873	211.509	493.801	230.549	4740.91	2.44E-03	-6.83E-03	9.76E-04	9.19545
167.883	211.459	493.406	230.154	4739.26	2.44E-03	-9.76E-03	0	9.19008
167.873	211.459	493.258	230.056	4739.26	1.46E-03	-5.85E-03	0	9.19741
167.892	211.459	493.357	230.45	4737.09	1.95E-03	-4.88E-03	-4.88E-04	9.19986
167.903	211.411	493.553	230.598	4738.19	1.95E-03	-5.85E-03	9.76E-04	9.20081
167.912	211.411	493.603	230.252	4736.54	1.95E-03	-8.78E-03	-4.88E-04	9.19348
167.897	211.459	492.962	229.907	4739.81	1.46E-03	-5.37E-03	4.88E-04	9.18669
167.917	211.411	493.553	229.661	4753.39	1.95E-03	-6.34E-03	0	9.20182
167.922	211.459	493.504	230.056	4739.26	1.95E-03	-8.78E-03	0	9.19253
167.878	211.411	493.406	230.104	4744.14	1.46E-03	-1.07E-02	-9.76E-04	9.19592
167.922	211.459	493.603	229.661	4756.62	1.46E-03	-6.34E-03	-4.88E-04	9.19449
167.947	211.459	493.652	230.056	4746.86	2.44E-03	-4.39E-03	0	9.2023
167.897	211.459	494.047	229.661	4757.72	1.95E-03	-6.83E-03	0	9.19008
167.892	211.411	494.492	229.71	4744.69	9.76E-04	-8.78E-03	0	9.19545
167.927	211.459	493.998	230.204	4746.31	1.46E-03	-4.39E-03	0	9.19592
167.912	211.459	493.998	230.204	4745.79	1.95E-03	-7.32E-03	9.76E-04	9.19741
167.888	211.459	493.998	230.056	4755	1.46E-03	-8.78E-03	-4.88E-04	9.18227
167.858	211.459	493.504	230.104	4746.31	1.95E-03	-3.90E-03	-4.88E-04	9.19592
167.912	211.459	494.097	229.957	4750.12	2.44E-03	-5.37E-03	4.88E-04	9.19205
167.888	211.459	493.603	230.351	4749.57	1.95E-03	-8.29E-03	-4.88E-04	9.20719
167.878	211.459	494.343	229.71	4752.29	1.46E-03	-5.85E-03	0	9.18913
167.888	211.411	493.652	230.154	4753.39	2.44E-03	-7.80E-03	9.76E-04	9.19789
167.873	211.509	494.047	229.71	4764.22	1.46E-03	-6.34E-03	0	9.18621
167.873	211.411	493.898	230.154	4752.29	1.95E-03	-7.80E-03	0	9.193
167.888	211.361	493.702	229.71	4755	1.95E-03	-4.88E-03	0	9.1911
167.883	211.509	493.898	230.104	4756.62	1.95E-03	-9.76E-03	0	9.19694
167.883	211.411	494.146	229.71	4772.37	1.95E-03	-7.32E-03	4.88E-04	9.18812
167.888	211.459	493.948	229.907	4763.67	1.95E-03	-5.85E-03	-4.88E-04	9.18424
167.897	211.459	493.998	230.252	4772.92	2.44E-03	-7.32E-03	4.88E-04	9.20421

167.858	211.459	493.801	230.056	4759.89	2.44E-03	-8.29E-03	-4.88E-04	9.1911
167.892	211.411	494.194	230.302	4770.72	1.95E-03	-8.29E-03	0	9.19789
167.878	211.411	493.998	229.809	4783.75	1.46E-03	-7.32E-03	-4.88E-04	9.19449
167.908	211.509	493.849	229.809	4772.37	1.46E-03	-2.93E-03	0	9.20373
167.897	211.459	494.097	229.858	4773.44	1.95E-03	-2.93E-03	4.88E-04	9.19592
167.897	211.459	493.603	229.809	4778.32	1.95E-03	-2.93E-03	4.88E-04	9.19986
167.941	211.459	494.097	229.809	4778.87	1.95E-03	-3.90E-03	0	9.17888
168.025	211.459	494.392	229.858	4781.59	1.46E-03	-3.41E-03	0	9.19986
168.01	211.459	493.652	229.957	4786.47	1.95E-03	-3.90E-03	4.88E-04	9.18519
168.039	211.411	493.702	230.351	4788.64	1.46E-03	-4.88E-03	0	9.18913
168.039	211.411	494.194	229.661	4808.17	2.44E-03	-7.32E-03	0	9.18376
168.025	211.459	493.652	229.316	4800.57	1.95E-03	-6.83E-03	0	9.19789
168.01	211.459	493.258	229.809	4797.85	1.46E-03	-3.41E-03	-4.88E-04	9.19497
168.019	211.411	491.581	226.504	4804.38	9.76E-04	-4.88E-03	-4.88E-04	9.18227
167.995	211.411	23.2172	27.4758	7821.56	9.76E-04	-8.78E-03	0	9.18961
167.98	211.509	8.33839	33.9956	9820.37	4.88E-04	-3.90E-03	0	9.19646
168.005	211.411	7.03356	33.5121	9842.04	2.44E-03	-6.83E-03	-9.76E-04	9.19789
168.044	211.411	6.29112	33.5364	9848.57	2.93E-03	-4.88E-03	0	9.19205
168.015	211.459	5.91111	33.7856	9851.81	3.41E-03	-5.85E-03	0	9.19545
167.986	211.411	5.61845	33.9515	9855.1	3.41E-03	-7.80E-03	0	9.20373
167.966	211.459	5.42188	33.7319	9858.34	3.41E-03	-7.80E-03	0	9.19157
167.986	211.459	5.42137	34.1861	9859.44	2.44E-03	-8.78E-03	0	9.19789
167.991	211.459	5.06431	34.0004	9862.67	2.93E-03	-5.85E-03	-4.88E-04	9.18424
167.986	211.459	4.96528	33.9613	9865.36	3.41E-03	-7.32E-03	9.76E-04	9.19402
167.932	211.459	4.86481	34.2155	9868.1	3.41E-03	-6.83E-03	0	9.18329
167.991	211.509	4.79406	34.0445	9867.55	3.41E-03	-4.39E-03	0	9.19253
168.015	211.459	4.78333	33.8392	9869.75	2.93E-03	-6.34E-03	0	9.193
168.025	211.411	4.63945	33.7954	9870.79	3.90E-03	-5.85E-03	4.88E-04	9.18764
168.063	211.411	3.67409	33.5071	9871.34	3.41E-03	-6.83E-03	4.88E-04	9.19497
168.069	211.411	3.62921	33.8833	9870.79	2.44E-03	-7.32E-03	-4.88E-04	9.18812
168.118	211.459	3.65897	33.771	9867.55	2.44E-03	-5.37E-03	-4.88E-04	9.18275
168.118	211.509	3.51165	33.8979	9869.2	3.90E-03	-5.37E-03	4.88E-04	9.18621
168.083	211.509	3.59312	33.644	9868.65	2.93E-03	-7.32E-03	-4.88E-04	9.18621
168.054	211.459	3.63116	33.8783	9869.2	2.44E-03	-8.29E-03	0	9.18961
168.039	211.509	3.61019	33.6392	9869.75	3.90E-03	-2.44E-03	0	9.19592
168.01	211.459	3.49019	33.7515	9870.79	3.90E-03	-2.93E-03	4.88E-04	9.18519
167.991	211.459	3.52433	33.9761	9869.75	2.44E-03	-4.39E-03	-4.88E-04	9.19789
168.025	211.459	3.46775	33.9859	9869.75	2.93E-03	-4.88E-03	0	9.1418
168.147	211.459	3.51946	33.8931	9869.2	3.41E-03	-2.93E-03	0	9.18961
168.078	211.509	3.5053	33.5805	9869.75	2.44E-03	-3.90E-03	-4.88E-04	9.20081
168.088	211.459	3.41702	34.0395	9870.24	3.90E-03	-2.93E-03	-4.88E-04	9.18764
168.113	211.459	3.38532	33.6831	9871.34	3.41E-03	-3.90E-03	0	9.19157
168.102	211.459	3.41214	33.5121	9869.75	2.93E-03	-2.93E-03	9.76E-04	9.18961
168.083	211.459	3.44823	33.854	9870.24	2.93E-03	-4.88E-03	4.88E-04	6.65745
168.063	211.459	3.39995	33.6928	9871.34	2.93E-03	-7.32E-03	0	6.66088
168.058	211.459	3.38434	33.8931	9872.99	2.93E-03	-6.83E-03	0	9.89157
168.035	211.459	3.35068	33.4241	9871.34	2.93E-03	-3.41E-03	-4.88E-04	9.8964
168.039	211.411	3.38824	33.9272	9871.34	3.41E-03	-2.93E-03	0	9.89497
168.049	211.459	3.47947	33.6781	9870.24	3.41E-03	-8.29E-03	4.88E-04	9.893
168.063	211.459	3.41849	33.8197	9869.2	2.44E-03	-8.29E-03	-1.46E-03	9.90277
168.078	211.459	3.55117	33.6196	9870.24	3.41E-03	-3.90E-03	-4.88E-04	9.89837
168.078	211.411	3.60775	33.7563	9870.24	2.93E-03	-4.88E-03	4.88E-04	9.89884
168.137	211.459	3.47702	33.7417	9869.75	4.39E-03	-1.95E-03	9.76E-04	9.89938
168.113	211.459	3.42336	33.854	9870.24	2.93E-03	-3.90E-03	-4.88E-04	9.90766
168.063	211.459	3.47312	33.7808	9869.75	2.93E-03	-5.85E-03	0	9.89449
168.074	211.411	3.43995	33.8931	9870.24	3.41E-03	-7.32E-03	0	9.89449

168.063	211.459	3.3502	33.7026	9869.75	2.93E-03	-2.93E-03	0	9.8964
168.127	211.459	3.35361	33.8686	9870.79	3.90E-03	-3.90E-03	4.88E-04	6.65942
168.078	211.459	3.32092	33.8345	9870.24	2.44E-03	-7.80E-03	-4.88E-04	14.6944
168.098	211.411	3.30044	33.9956	9871.34	2.93E-03	-7.80E-03	-4.88E-04	14.733
168.093	211.411	3.38873	33.7074	9870.79	2.93E-03	-8.78E-03	-9.76E-04	14.7164
168.03	211.411	3.34141	33.8001	9870.79	3.41E-03	-4.88E-03	0	14.7076
168.093	211.411	3.4619	33.771	9870.79	3.41E-03	-6.83E-03	0	14.712
168.049	211.411	3.41117	33.8295	9870.79	3.90E-03	-2.93E-03	4.88E-04	14.7261
168.019	211.459	3.79799	33.5805	9870.79	3.41E-03	-2.44E-03	4.88E-04	14.7169
167.986	211.411	3.49994	33.8588	9868.1	2.44E-03	-5.85E-03	-9.76E-04	14.712
168	211.411	3.49702	33.8686	9869.2	3.41E-03	-8.29E-03	-4.88E-04	14.711
168.044	211.411	3.23458	33.8051	9869.75	3.41E-03	-4.88E-03	4.88E-04	14.7251
168.098	1.76E-02	3.43896	33.9468	9870.79	3.90E-03	-6.34E-03	4.88E-04	14.7159
168.074	2.44E-02	3.68823	33.8588	9868.65	3.41E-03	-7.80E-03	0	14.7276

Radiation (Radiation (T (°C) wall T (°C) wall T (°C) wall T (°C) ceiling T (°C) ceiling T (°C) ceiling T (°C) corn

7.95E-02	6.39E-02	97.854	93.1484	98.3379	113.647	111.609	111.834	104.608
7.76E-02	6.15E-02	97.6553	92.9834	98.1382	113.457	111.383	111.62	104.173
7.80E-02	6.20E-02	97.5269	92.8779	98.021	113.326	111.277	111.478	103.399
7.80E-02	6.20E-02	97.4204	92.7725	97.8691	113.148	111.111	111.372	101.959
7.76E-02	6.20E-02	97.27	92.6431	97.6816	112.994	110.981	111.242	101.539
7.76E-02	6.15E-02	97.1777	92.5601	97.5986	112.863	110.827	111.122	101.841
7.71E-02	6.10E-02	97.0361	92.3843	97.4229	112.697	110.661	110.968	103.047
7.76E-02	6.15E-02	96.896	92.2563	97.2603	112.556	110.508	110.828	101.644
7.71E-02	6.15E-02	96.7793	92.1602	97.1294	112.399	110.376	110.707	101.7
7.71E-02	6.00E-02	96.6392	92.0674	97.0483	112.282	110.283	110.602	100.72
7.66E-02	6.10E-02	96.5083	91.9268	96.8843	112.116	110.129	110.424	99.2603
7.61E-02	6.10E-02	96.3936	91.8086	96.7314	111.985	109.962	110.293	97.2583
7.61E-02	6.00E-02	96.2759	91.7017	96.625	111.842	109.843	110.186	99.9253
7.66E-02	6.05E-02	96.1597	91.6187	96.5303	111.723	109.712	110.067	100.869
7.61E-02	6.05E-02	96.0303	91.5015	96.3896	111.592	109.583	109.949	99.4326
7.61E-02	6.00E-02	95.9146	91.3862	96.2744	111.44	109.455	109.821	101.735
7.61E-02	6.05E-02	95.7964	91.2676	96.0859	111.297	109.289	109.69	103.021
7.56E-02	6.00E-02	95.668	91.1494	95.9678	111.154	109.169	109.571	101.254
7.61E-02	6.05E-02	95.5522	91.0098	95.8164	110.99	109.005	109.407	100.263
7.51E-02	6.05E-02	95.4106	90.8931	95.7241	110.885	108.888	109.301	98.7329
7.46E-02	5.85E-02	95.3057	90.8101	95.6411	110.765	108.793	109.17	99.2114
7.56E-02	5.95E-02	95.2002	90.667	95.4512	110.574	108.614	109.027	100.926
7.46E-02	5.90E-02	95.0601	90.585	95.3457	110.479	108.52	108.932	99.7241
7.46E-02	5.95E-02	94.9546	90.502	95.2158	110.301	108.377	108.778	99.2437
7.51E-02	5.95E-02	94.8354	90.3623	95.0762	110.184	108.225	108.637	98.6362
7.46E-02	5.95E-02	94.7212	90.2437	94.9814	110.053	108.129	108.554	99.0449
7.41E-02	5.90E-02	94.5679	90.1851	94.8877	109.935	108.023	108.448	98.4126
7.37E-02	5.90E-02	94.4741	90.0322	94.7471	109.77	107.858	108.294	100.108
7.32E-02	5.85E-02	94.3457	89.9502	94.6299	109.64	107.741	-108.2	101.264
7.37E-02	5.85E-02	94.2417	89.8672	94.5117	109.521	107.622	108.081	98.5405
7.46E-02	5.90E-02	94.1353	89.7739	94.3721	109.392	107.47	107.941	99.7349
7.27E-02	5.80E-02	93.9829	89.6206	94.2305	109.237	107.362	107.833	100.235
7.37E-02	5.80E-02	93.8779	89.5137	94.1123	109.13	107.22	107.715	98.3169
7.32E-02	5.85E-02	93.7715	89.3965	94.0068	108.988	107.079	107.585	99.499
7.27E-02	5.76E-02	93.6313	89.3027	93.9014	108.847	106.961	107.479	99.3232
7.27E-02	5.85E-02	93.5386	89.1733	93.7607	108.705	106.808	107.35	97.334
7.27E-02	5.71E-02	93.3867	89.0913	93.6553	108.611	106.702	107.255	96.772
7.22E-02	5.71E-02	93.293	88.9971	93.5264	108.493	106.573	107.138	97.7085
7.27E-02	5.76E-02	93.1875	88.8555	93.396	108.338	106.419	106.984	98.4331
7.22E-02	5.71E-02	93.0698	88.7739	93.2915	108.21	106.314	106.855	96.5024
7.27E-02	5.76E-02	92.9761	88.6558	93.1616	108.079	106.195	106.736	98.2578
7.17E-02	5.76E-02	92.8472	88.5029	93.0093	107.938	106.042	106.619	97.333
7.12E-02	5.66E-02	92.7188	88.4434	92.9263	107.831	105.959	106.512	98.3501
7.12E-02	5.61E-02	92.6123	88.3608	92.7969	107.689	105.818	106.395	96.9922
7.12E-02	5.66E-02	92.4951	88.2554	92.6797	107.536	105.712	106.277	98.4321
7.22E-02	5.66E-02	92.4014	88.1025	92.5625	107.395	105.571	106.159	98.9468
7.12E-02	5.66E-02	92.2612	88.043	92.4561	107.299	105.464	106.052	97.5298
7.17E-02	5.71E-02	92.1919	87.9136	92.3506	107.182	105.335	105.935	98.127
7.07E-02	5.61E-02	92.062	87.8315	92.1978	107.029	105.194	105.805	96.7803
7.07E-02	5.71E-02	91.9438	87.7246	92.0913	106.922	105.052	105.722	95.5967
7.12E-02	5.66E-02	91.8398	87.6309	92.0093	106.792	104.947	105.616	96.7207
7.12E-02	5.61E-02	91.7578	87.5005	91.8677	106.65	104.793	105.486	97.4106
7.07E-02	5.71E-02	91.6396	87.4077	91.751	106.545	104.712	105.37	96.5688
7.02E-02	5.61E-02	91.5098	87.3125	91.6328	106.426	104.594	105.263	95.9351

7.02E-02	5.66E-02	91.4175	87.207	91.5039	106.309	104.476	105.157	98.1597
7.02E-02	5.66E-02	91.312	87.1353	91.4321	106.179	104.346	105.062	98.3931
7.02E-02	5.61E-02	91.1948	87.0073	91.2925	106.062	104.23	104.911	94.8223
7.07E-02	5.66E-02	91.0894	86.959	91.2212	105.932	104.124	104.827	96.4492
7.02E-02	5.56E-02	90.9844	86.8535	91.0688	105.779	104.006	104.687	94.7744
6.93E-02	5.51E-02	90.8662	86.7466	90.9854	105.66	103.888	104.58	96.355
7.02E-02	5.51E-02	90.7725	86.6396	90.832	105.506	103.723	104.438	97.1147
6.98E-02	5.61E-02	90.6895	86.5693	90.7495	105.413	103.652	104.368	96.3301
6.88E-02	5.51E-02	90.5381	86.4517	90.6675	105.283	103.547	104.262	97.3608
7.12E-02	5.56E-02	90.4551	86.3579	90.562	105.189	103.418	104.145	97.9111
6.93E-02	5.56E-02	90.3262	86.2393	90.4673	105.036	103.288	104.026	97.9565
6.93E-02	5.51E-02	90.2104	86.1323	90.3252	104.917	103.146	103.908	95.9302
6.83E-02	5.51E-02	90.1167	86.0278	90.2207	104.789	103.042	103.792	94.396
6.98E-02	5.46E-02	90.0322	85.9561	90.1138	104.706	102.936	103.721	95.6841
6.88E-02	5.46E-02	89.8921	85.8633	89.9976	104.601	102.819	103.604	94.7124
6.88E-02	5.51E-02	89.8101	85.7456	89.8687	104.449	102.691	103.487	95.1108
6.88E-02	5.41E-02	89.7056	85.6851	89.7842	104.353	102.56	103.38	95.7065
6.93E-02	5.46E-02	89.6201	85.5674	89.6787	104.235	102.49	103.263	96.1865
6.93E-02	5.46E-02	89.5171	85.4741	89.5269	104.119	102.362	103.158	95.6489
6.93E-02	5.51E-02	89.4233	85.3555	89.4087	103.954	102.221	103.04	96.2686
6.83E-02	5.41E-02	89.3159	85.2734	89.3379	103.872	102.139	102.958	94.687
6.88E-02	5.41E-02	89.2231	85.1782	89.208	103.766	102.021	102.852	95.8345
6.73E-02	5.32E-02	89.1167	85.0962	89.1021	103.625	101.927	102.734	92.9863
6.73E-02	5.41E-02	88.9878	85.0254	88.9966	103.531	101.81	102.641	96.1738
6.78E-02	5.37E-02	88.894	84.896	88.8911	103.378	101.682	102.5	95.8809
6.78E-02	5.41E-02	88.811	84.8013	88.7959	103.284	101.587	102.406	93.9468
6.68E-02	5.27E-02	88.6841	84.7295	88.6895	103.166	101.469	102.323	93.125
6.83E-02	5.41E-02	88.6245	84.5776	88.5493	103.003	101.33	102.16	93.4424
6.73E-02	5.37E-02	88.4956	84.5181	88.4897	102.908	101.224	102.089	93.1484
6.73E-02	5.32E-02	88.4253	84.4463	88.3828	102.813	101.129	101.994	92.9946
6.68E-02	5.37E-02	88.3198	84.2935	88.2656	102.685	100.989	101.866	93.7217
6.73E-02	5.37E-02	88.2261	84.2349	88.1597	102.603	100.907	101.807	94.249
6.63E-02	5.27E-02	88.0845	84.1523	88.0659	102.474	100.779	101.69	94.73
6.68E-02	5.37E-02	88.0142	84.082	87.96	102.357	100.674	101.573	93.6045
6.68E-02	5.32E-02	87.8979	83.9526	87.8545	102.24	100.545	101.468	93.499
6.68E-02	5.27E-02	87.7925	83.8818	87.7603	102.135	100.452	101.363	93.9443
6.59E-02	5.17E-02	87.7095	83.7988	87.6538	102.052	100.334	101.257	94.459
6.63E-02	5.27E-02	87.605	83.7397	87.5713	101.923	100.241	101.164	93.2988
6.68E-02	5.32E-02	87.5229	83.6338	87.4541	101.794	100.136	101.046	92.6655
6.59E-02	5.22E-02	87.394	83.5269	87.3589	101.7	99.9258	100.964	92.0313
6.59E-02	5.27E-02	87.311	83.4331	87.2534	101.595	99.8091	100.847	92.0781
6.59E-02	5.22E-02	87.2192	83.3389	87.124	101.466	99.7153	100.765	91.937
6.59E-02	5.27E-02	87.1372	83.2446	87.0298	101.349	99.5869	100.648	93.0044
6.49E-02	5.17E-02	87.02	83.127	86.9126	101.232	99.4814	100.52	92.8286
6.49E-02	5.17E-02	86.937	83.0918	86.854	101.151	99.4111	100.45	92.5708
6.59E-02	5.22E-02	86.8433	82.998	86.7363	101.034	99.2827	100.357	92.4297
6.44E-02	5.17E-02	86.7261	82.8789	86.606	100.893	99.1646	100.216	91.6548
6.49E-02	5.12E-02	86.6333	82.832	86.5591	100.811	99.0942	100.146	92.8979
6.54E-02	5.17E-02	86.5522	82.7495	86.4648	100.706	99.001	100.076	92.2178
6.54E-02	5.17E-02	86.4575	82.6323	86.3237	100.554	98.8604	99.8315	93.6719
6.44E-02	5.17E-02	86.3403	82.5957	86.2759	100.471	98.8125	99.7603	93.6475
6.44E-02	5.22E-02	86.2583	82.478	86.1465	100.354	98.6953	99.6665	90.8442
6.49E-02	5.12E-02	86.188	82.3721	86.041	100.227	98.5786	99.5493	90.3862
6.34E-02	5.22E-02	86.082	82.2891	85.9458	100.12	98.4722	99.4668	90.5732
6.39E-02	5.12E-02	85.9883	82.2417	85.8755	99.9463	98.3784	99.3848	89.9395
6.44E-02	5.17E-02	85.9063	82.124	85.793	99.8291	98.2612	99.2793	91.3008

6.39E-02	5.12E-02	85.7915	82.042	85.6401	99.7124	98.1445	99.1626	90.0332
6.44E-02	5.12E-02	85.6963	81.9712	85.5933	99.6538	98.0508	99.0923	89.2114
6.39E-02	4.98E-02	85.6025	81.8877	85.4863	99.5474	97.9561	99.021	90.4546
6.44E-02	5.07E-02	85.5215	81.8184	85.4053	99.4551	97.8633	98.9165	91.8286
6.34E-02	5.12E-02	85.4512	81.7124	85.311	99.3379	97.7114	98.7881	91.7114
6.34E-02	5.07E-02	85.3926	81.6406	85.2041	99.208	97.6519	98.6934	90.9004
6.39E-02	5.07E-02	85.2861	81.5464	85.1104	99.1147	97.5464	98.5996	91.7217
6.20E-02	5.02E-02	85.1699	81.4277	84.98	98.9731	97.4282	98.4585	92.8584
6.34E-02	4.98E-02	85.0879	81.3701	84.8984	98.9038	97.3354	98.4126	91.6162
6.34E-02	5.02E-02	85.0068	81.2749	84.8506	98.7861	97.2524	98.3296	90.2422
6.24E-02	5.02E-02	84.9009	81.2031	84.7437	98.6914	97.1348	98.2349	88.3979
6.24E-02	4.98E-02	84.7954	81.1099	84.6626	98.5986	97.0537	98.1426	89.2095
6.20E-02	4.93E-02	84.7134	81.0151	84.5322	98.4575	96.9121	98.0361	89.8423
6.20E-02	4.93E-02	84.6196	80.9453	84.439	98.3999	96.8428	97.9785	88.8569
6.24E-02	4.98E-02	84.5386	80.8853	84.3442	98.2935	96.7598	97.8486	90.4761
6.24E-02	5.02E-02	84.4448	80.7925	84.2275	98.1772	96.6206	97.7441	88.9395
6.20E-02	4.93E-02	84.3389	80.709	84.1792	98.1294	96.5493	97.6382	88.5742
6.20E-02	4.93E-02	84.2568	80.6382	84.0737	98.001	96.4556	97.5679	89.854
6.24E-02	4.93E-02	84.1729	80.5205	83.9678	97.8604	96.3032	97.439	89.5605
6.24E-02	4.93E-02	84.1045	80.4961	83.9077	97.7773	96.2554	97.3794	89.0547
6.15E-02	4.93E-02	84	80.4136	83.8022	97.707	96.1616	97.2856	90.0996
6.15E-02	4.83E-02	83.8945	80.3086	83.6621	97.5562	96.022	97.1465	88.1865
6.10E-02	4.83E-02	83.7886	80.2358	83.6011	97.4722	95.9614	97.0854	87.8794
6.20E-02	4.93E-02	83.7432	80.1538	83.5308	97.3667	95.8794	96.9922	87.7266
6.15E-02	4.83E-02	83.627	80.0723	83.4258	97.2739	95.7632	96.876	89.3599
6.20E-02	4.93E-02	83.5669	80.0005	83.3188	97.1909	95.6802	96.8047	89.0303
6.15E-02	4.88E-02	83.4849	79.917	83.2471	97.0728	95.562	96.71	86.7388
6.20E-02	4.98E-02	83.4155	79.8252	83.167	96.9932	95.4585	96.6299	88.4678
6.15E-02	4.93E-02	83.3076	79.7524	83.0708	96.8857	95.3628	96.5459	89.6748
6.10E-02	4.88E-02	83.2173	79.6582	82.9648	96.7803	95.269	96.4639	91.271
6.05E-02	4.83E-02	83.1221	79.564	82.8589	96.6631	95.1401	96.335	88.5947
6.15E-02	4.88E-02	83.0527	79.5039	82.7876	96.5918	95.0688	96.252	88.9927
6.10E-02	4.83E-02	82.9482	79.4463	82.7295	96.5107	94.9995	96.1714	86.668
6.15E-02	4.88E-02	82.8662	79.3276	82.564	96.3926	94.8696	96.0532	87.8535
6.05E-02	4.88E-02	82.7969	79.293	82.4946	96.335	94.7769	95.9956	87.1265
6.05E-02	4.88E-02	82.7134	79.2451	82.4229	96.2402	94.7056	95.9126	87.5835
6.00E-02	4.78E-02	82.6089	79.1626	82.3169	96.1118	94.6118	95.8188	86.479
6.00E-02	4.68E-02	82.48	79.0107	82.1416	96.0073	94.4956	95.7026	88.1016
6.00E-02	4.73E-02	82.4097	78.9497	82.0688	95.8882	94.4116	95.6187	83.8804
5.95E-02	4.73E-02	82.3052	78.833	81.9521	95.8071	94.3188	95.5376	85.2568
5.90E-02	4.73E-02	82.1768	78.7139	81.7983	95.6421	94.1772	95.4312	83.5391
5.80E-02	4.68E-02	82.0352	78.5728	81.6572	95.5132	94.0601	95.3257	74.1304
5.90E-02	4.63E-02	81.8813	78.395	81.4561	95.3247	93.8833	95.1958	71.6523
5.90E-02	4.78E-02	81.7427	78.2891	81.3149	95.2427	93.813	95.1255	69.8467
5.95E-02	4.83E-02	81.603	78.1948	81.1851	95.1724	93.731	95.0669	69.6694
5.90E-02	4.68E-02	81.4961	78.0063	81.0205	95.02	93.5903	94.938	67.9336
5.85E-02	4.68E-02	81.3091	77.9121	80.9146	94.9497	93.5313	94.8677	71.0029
5.90E-02	4.68E-02	81.1802	77.7954	80.7861	94.8218	93.415	94.7632	71.3462
5.80E-02	4.68E-02	81.0742	77.6519	80.6548	94.7144	93.3193	94.6675	70.2114
5.80E-02	4.59E-02	80.9336	77.5117	80.5024	94.5981	93.2383	94.5513	66.7642
5.80E-02	4.68E-02	80.77	77.4399	80.3838	94.4917	93.1436	94.4683	66.7866
5.71E-02	4.63E-02	80.6528	77.2866	80.2427	94.3979	93.0264	94.3862	67.1885
5.76E-02	4.73E-02	80.5469	77.1099	80.1016	94.2573	92.8975	94.2573	69.5977
5.71E-02	4.59E-02	80.4072	77.0396	79.9956	94.1753	92.8149	94.1987	68.2866
5.76E-02	4.63E-02	80.2534	76.8979	79.8779	94.0815	92.7212	94.1401	67.6846
5.76E-02	4.63E-02	80.103	76.791	79.7588	93.9868	92.6265	94.0103	69.1714

5.71E-02	4.59E-02	79.9365	76.6729	79.6411	93.8926	92.5444	93.916	69.5845
5.71E-02	4.63E-02	79.8315	76.5083	79.4644	93.7637	92.4272	93.7637	69.0771
5.61E-02	2.78E-02	79.645	76.3901	79.3706	93.6816	92.3452	93.7051	70.3989
5.56E-02	4.49E-02	79.5273	76.2832	79.2397	93.5869	92.2383	93.6221	68.6392
5.56E-02	4.44E-02	79.3853	76.1533	79.0986	93.4697	92.1328	93.5283	65.5317
5.66E-02	4.49E-02	79.2456	75.9775	78.9463	93.3652	91.9932	93.4004	66.3247
5.66E-02	4.49E-02	79.127	75.8696	78.8149	93.2578	91.9209	93.3398	66.7007
5.71E-02	4.49E-02	78.9985	75.7529	78.6865	93.1533	91.8398	93.2705	66.5127
5.56E-02	4.44E-02	78.8696	75.6104	78.5088	93.0464	91.7212	93.1641	66.8545
5.56E-02	4.39E-02	78.7168	75.5161	78.4146	92.9409	91.604	93.0347	66.3462
5.46E-02	4.44E-02	78.5981	75.3286	78.2388	92.8364	91.5229	92.9536	66.7373
5.56E-02	4.39E-02	78.4688	75.2451	78.1436	92.7769	91.4282	92.8706	66.1338
5.61E-02	4.49E-02	78.3643	75.126	78.001	92.647	91.3213	92.7524	66.3218
5.46E-02	4.39E-02	78.2241	75.0435	77.8716	92.5649	91.2393	92.6587	65.4351

T (°C) corn T (°C) corn T (°C) corn T (°C) corn T (°C) corn T (°C) corn T (°C) corn T (°C) oper T (°C) oper

97.6357	88.4077	82.9351	78.5093	77.3198	76.3535	70.1074	84.6563	71.1343
96.6045	87.291	81.7231	76.6128	76.436	76.0474	70.3442	85.3862	76.0879
95.8198	87.1147	81.7461	76.6357	76.353	76.3647	70.792	85.021	75.8276
95.3159	86.4917	81.2515	75.9873	76.6001	75.8457	69.5752	87.8047	76.5693
94.9058	86.1865	81.6865	76.1519	75.8218	74.3364	69.1606	87.0635	77.0039
95.7017	87.9243	82.769	77.9424	76.0576	73.8882	68.0044	86.5947	77.9829
96.2285	86.6084	81.9692	77.1655	71.5415	71.8364	67.4741	85.6558	77.5952
95.5151	88.1602	83.1104	77.4131	71.4473	71.5063	67.4375	86.4653	77.1582
94.9624	87.23	82.6152	76.8345	74.3125	73.5459	68.9136	84.5376	74.6953
95.2329	88.1235	81.627	75.3262	75.4912	74.772	69.314	86.582	70.6836
94.811	87.5366	82.1685	76.646	75.9272	74.3594	69.8574	86.3823	70.6602
93.7783	86.6543	81.6499	76.7988	75.6909	74.9365	69.9517	85.1953	66.8813
95.606	87.4053	81.0488	76.6328	75.1714	74.5586	68.6045	84.7354	74.1743
95.1948	87.3926	78.6118	74.0513	74.3936	73.9453	68.606	85.7827	75.3896
94.187	86.5464	81.731	77.292	74.2515	74.2397	68.3804	84.1714	76.8496
95.0327	87.8174	82.2603	78.623	72.8125	68.1978	64.7271	83.875	77.0952
95.8281	88.4624	83.7549	77.7876	72.6128	69.4614	65.2847	82.4424	71.3198
93.6592	87.4629	82.1074	76.5498	74.2158	72.1519	66.5137	82.1479	75.4355
94.1997	85.7837	81.0132	75.8545	74.2632	73.0957	67.4224	85.8745	76.7075
92.5356	85.1499	80.0952	74.6411	74.0747	74.5229	68.084	84.0762	76.2241
93.4375	85.5483	79.6006	74.2749	74.6167	73.9448	66.8672	85.8984	74.6685
94.6196	86.3223	79.3755	73.6489	73	71.1836	66.4302	85.4399	75.623
94.6548	85.9106	80.7173	72.9526	71.8555	72.1855	66.5942	84.7451	74.5728
93.8916	85.7451	81.2339	75.4038	73.3877	72.5269	67.9873	86.2485	75.0908
93.5762	85.3232	80.6108	74.1431	74.2373	74.3315	68.3062	83.8389	73.2632
94.2783	83.3818	79.1025	73.9771	74.2598	73.9531	67.1357	85.4014	71.752
93.9502	85.1577	79.8799	74.6138	73.3164	74.3779	67.6436	84.6724	74.4292
94.7119	86.0977	80.6567	73.5171	72.2666	73.2813	66.5923	84.8018	75.6553
94.9111	86.521	79.6567	70.5562	-72.1729	70.4854	65.3052	83.4038	75.8213
94.3711	86.9546	81.2563	73.6699	72.4551	70.874	66.167	81.9907	74.9365
94.6182	87.0381	81.5859	75.4263	72.9502	71.8413	65.9297	81.79	74.1455
93.8086	86.9897	81.2798	75.8862	73.7407	72.7261	68.0688	82.1323	73.6631
91.9546	85.2964	80.1372	74.9185	73.5391	73.5273	67.9023	83.7544	73.1313
92.4941	85.2612	80.7021	74.8716	72.3716	73.0791	66.8867	84.4365	74.0156
92.541	85.4023	79.5479	73.397	71.958	72.5122	66.8975	81.9653	75.2998
92.3184	84.8496	79.501	74.6353	74.0337	73.562	66.8145	81.0474	73.1538
90.5469	83.5684	78.6416	75.9673	75.0713	74.1753	65.5859	81.4946	73.9204
91.4502	85.5552	78.8999	74.6934	74.894	73.5381	66.3882	83.7876	71.9849
91.8247	84.7314	78.77	75.4829	74.7046	73.856	66.5063	83.4819	75.3105
90.4409	83.7798	78.2651	75.9912	75.3545	73.0317	65.7051	85.8823	75.7603
92.6807	85.6597	79.8179	76.1782	74.9878	72.2988	66.8252	84.9282	74.6265
92.2471	83.6963	77.5913	74.563	74.1621	72.9824	66.4819	81.3159	74.3071
92.5508	83.5542	77.2266	73.9497	74.0796	72.8174	67.3335	82.3057	74.3081
90.3804	82.2251	77.8613	75.1392	74.6914	72.9224	66.5986	81.5503	73.9878
93.1841	83.5776	76.6016	71.9204	72.0737	71.8613	65.9263	82.0103	74.4487
92.457	83.519	75.8467	70.8931	72.2622	71.4126	66.5518	82.374	74.3062
91.0718	82.9653	77.0361	72.6152	69.7949	69.1694	63.7976	80.9146	74.8013
90.5435	83.3301	79.25	74.7139	72.6855	69.6763	65.144	81.0078	74.3403
91.0366	83.1885	79.1914	74.7256	72.8506	71.5059	65.2031	81.1606	73.2085
90.5308	82.3643	78.0132	74.2891	72.3076	72.166	65.688	80.9019	69.8809
90.0967	83.1992	78.4956	73.1919	71.3398	72.3306	66.313	83.0186	71.9805
91.5391	83.7627	78.1768	74.0522	71.7993	71.4805	67.022	83.1128	73.3252
91.9507	83.0229	75.7861	72.5435	71.8945	71.8828	66.208	80.2661	72.3003
91.0229	82.6807	75.6084	72.1416	71.3389	72.0469	65.9233	80.5244	73.0425

91.6445	83.2573	75.9141	71.6216	71.9048	71.3267	64.8818	81.3354	71.4248
91.9014	83.8442	77.7163	71.3618	71.3262	70.5591	64.2671	81.2178	71.0708
89.5674	82.1865	78.0352	73.1318	72.5303	71.8223	65.2363	82.853	72.7344
91.8311	84.9375	76.939	74.5581	74.3223	73.5913	66.5718	80.688	71.7197
90.8223	82.6797	77.1855	75.4653	74.3926	73.0483	64.7036	80.1807	72.686
91.4077	84.1841	78.5518	75.3706	73.6021	72.729	64.0889	82.7227	69.4409
91.1255	83.0308	77.0786	74.4502	73.7432	71.8555	63.876	81.8755	69.0986
90.9023	82.5366	77.3491	74.1553	73.5063	72.1855	64.1348	81.6157	64.3003
91.2896	83.5127	79.3745	74.6499	73.7417	71.7246	64.7251	81.8027	65.6943
90.4092	81.6187	77.6553	73.2588	72.5864	71.1592	65.5771	80.2856	70.4199
90.021	81.1943	77.6655	72.5732	71.6885	70.2012	64.4165	79.436	72.7891
88.7402	80.7578	76.7114	74.8257	73.1748	71.0273	65.21	80.061	73.2266
89.5513	79.4165	76.3105	74.0122	72.5732	71.3818	65.0669	80.3657	73.3555
90.0317	80.5928	75.9683	72.9385	72.2778	70.5903	65.2798	79.6362	68.0327
88.2832	81.5474	75.5796	71.1807	71.1567	70.98	64.2266	78.646	69.9678
86.9326	80.8413	75.7915	72.1362	71.853	70.6021	64.4272	79.2583	71.5142
88.6572	82.6274	77.5586	72.5483	69.1499	67.6143	61.0574	77.5161	71.1377
89.6553	83.3218	79.3481	74.4937	68.606	67.1768	62.5588	80.2944	72.4697
89.3037	83.4282	78.4653	74.73	68.5	66.2319	63.115	78.3633	72.2456
89.5845	83.9917	79.6772	73.4087	67.46	66.1128	63.1375	77.6792	71.8081
88.3398	82.145	79.2544	72.2183	68.5947	67.8862	63.5654	80.8721	70.7007
88.1865	81.8853	78.6401	71.7681	69.7495	67.0454	64.0112	78.5967	71.4531
88.3037	81.3911	78.2163	72.9712	70.021	66.8564	63.7988	79.7979	71.7832
88.3271	81.6265	75.7412	73.0767	70.1387	64.752	62.2363	78.5957	71.4873
89.0786	81.9795	77.6973	73.1475	69.4302	67.2222	62.3665	77.7476	71.499
89.1245	81.0605	76.9663	72.6279	70.3506	68.1074	62.887	76.8877	70.9443
87.186	80.1299	76.6943	71.7539	69.8184	67.291	63.4536	77.0278	68.9604
87.3398	80.3779	76.0708	71.8022	69.418	67.375	64.3062	79.208	67.0479
86.9155	80.0117	75.5747	71.4473	69.2397	68.189	64.0566	80.0664	70.0698
86.856	79.0454	75.3262	71.3755	70.1831	68.6602	63.9138	79.7944	69.396
86.75	79.2104	74.8315	71.0811	69.5581	69.6763	63.1934	78.9243	69.999
86.9731	79.8462	76.3403	71.0811	69.3223	67.8223	63.4419	78.0176	69.8691
88.0068	81.3643	77.1528	71.5405	70.396	68.9082	63.7837	79.5591	69.8091
87.0088	79.8931	75.2319	69.7939	70.3369	69.7231	63.5708	76.897	70.1514
88.418	80.2466	75.6089	70.5376	70.5962	68.2471	62.7075	77.6274	69.9038
87.4434	80.1167	76.6816	71.7881	69.5693	67.125	63.157	77.7573	71.249
88.5112	80.6572	76.6812	71.7998	70.7373	67.5732	63.429	75.6479	69.5493
88.4287	79.2446	74.7007	70.4897	70.0767	68.6597	64.6465	75.5303	64.9775
88.417	79.3389	73.8516	69.6631	69.9937	69.4741	63.8772	79.5347	67.73
88.416	79.6558	74.2046	71.5625	70.7012	69.9458	63.2742	78.2036	63.1794
88.1577	80.0913	75.7607	72.353	71.4443	70.7485	62.446	77.6973	68.7573
88.416	79.75	74.5229	71.6567	70.2524	69.5327	62.9312	77.4854	69.4658
88.6978	79.8325	73.4492	70.5474	70.0161	68.918	62.303	75.4102	67.9414
88.5337	80.4678	73.7324	69.6265	69.957	69.1543	61.6169	76.9185	68.6855
87.124	79.8677	74.6401	70.4883	70.0278	68.127	62.1255	77.9082	69.5947
88.1226	80.4443	75.2061	72.4702	71.4795	69.8271	62.7764	77.0718	66.0513
88.7671	80.5142	73.979	72.1392	71.6787	70.2275	62.6333	78.6372	68.6963
88.7437	79.8311	74.5806	72.0566	70.8413	69.708	62.5032	80.0386	70.6089
88.0508	78.3828	73.2358	71.7026	69.8145	69.0352	61.7341	77.813	69.9243
87.6162	79.3955	74.957	70.77	69.5894	68.2671	62.502	77.8003	67.3843
86.981	79.3237	74.167	70.5571	68.5029	67.688	62.7751	76.4932	66.062
85.8999	79.2534	74.4253	69.0688	68.8916	68.0649	63.6482	76.562	69.2964
85.5825	78.6172	74.4492	68.5137	68.5376	68.8799	63.2107	77.3159	69.1782
84.6294	78.2041	72.6563	67.8164	68.2417	68.5249	62.572	76.7979	69.9102
83.877	77.1675	73.3403	69.2456	66.978	67.4976	61.7673	78.3057	69.5322
84.8174	78.9697	75.0859	70.084	66.9902	66.7539	61.4136	76.0684	67.6675

85.7227	79.3936	75.2495	69.7998	68.501	68.123	63.186	75.4883	65.5386
84.606	78.687	73.8818	70.3662	68.7964	68.1348	62.3462	75.6655	68.1733
84.3696	77.8853	74.3413	69.5513	67.3428	66.1733	61.3286	74.6987	63.9546
85.687	78.7695	75.2612	71.5703	69.54	66.0557	61.1985	76.3252	67.4648
85.2407	77.1675	74.6133	71.9121	70.7559	68.4419	62.2751	75.6655	68.3979
85.4629	77.4609	74.459	71.2271	70.1294	68.2993	61.8245	76.5718	69.0342
87.0845	77.4844	73.4683	70.4834	69.6216	67.9565	60.8066	77.6558	69.9673
86.0615	77.9546	73.0903	70.8252	69.3853	67.4248	60.1794	76.395	67.4165
85.1572	78.7212	73.7856	69.1128	66.7036	67.1997	61.0413	76.77	68.9023
85.6733	77.5425	73.7856	69.479	67.7314	65.8765	61.2791	76.5117	66.2104
83.1211	75.833	71.9917	68.8286	68.8638	66.9033	61.8105	76.4634	61.8933
82.8398	75.4448	71.0957	69.8091	68.4038	67.4946	62.2366	77.2646	66.918
84.7437	76.4102	72.8291	69.9854	68.0254	67.7539	62.627	77.1235	68.4185
83.9336	76.7295	71.1304	67.9072	66.7734	67.5649	62.9333	77.8765	67.791
83.1445	76.269	71.6372	67.8359	65.2012	67.5288	62.6257	75.3311	68.7124
82.4517	76.5293	72.2871	68.7583	67.4116	66.0059	60.8875	73.5283	68.5483
82.7446	77.1055	73.0059	69.7959	69.2412	67.2808	61.0994	74.9419	67.8501
83.7324	78.3779	73.4541	70.6694	69.3354	67.458	61.3835	73.3501	67.6611
84.2266	77.7183	73.1938	69.1582	67.9297	67.3745	60.7788	74.1865	68.062
84.002	76.4683	72.2969	67.2915	67.0317	66.7124	60.2935	76.0962	68.3569
84.3667	77.1514	71.2114	69.0278	67.811	67.2207	61.832	74.6699	67.5303
84.1206	76.2573	71.9077	69.7358	68.437	67.0552	61.8428	75.0107	62.2214
83.1543	75.7012	71.2705	68.5791	67.894	67.3032	62.5903	77.3105	66.0547
83.0835	74.5933	70.4795	67.3623	66.5117	66.1216	60.7207	75.4253	66.0425
83.6729	76.9629	72.8745	68.1885	67.1255	65.4951	60.1858	75.0459	67.8125
83.0718	76.5381	72.7915	63.8513	66.5342	64.5605	60.8843	75.4585	67.1157
82.106	75.1577	72.3306	68.8252	66.5928	65.2573	59.1321	75.1641	67.4468
84.1665	76.5977	73.8179	68.4248	65.0693	63.6506	58.2913	73.2065	66.4185
84.4116	77.2793	74.6543	65.2935	63.4963	63.8748	58.6711	72.7124	66.479
84.5762	77.7505	73.9697	65.4814	61.2122	63.0933	58.8469	72.9814	67.5752
83.0825	76.1479	72.4829	67.3716	64.5117	63.7786	59.3193	72.5791	63.97
82.458	75.0273	72.165	67.3721	66.2734	66.2734	60.0793	72.7349	64.019
81.9414	73.5308	71.4468	-66.2856	65.7773	66.4512	61.2156	73.9023	65.1543
83.458	74.355	70.5713	66.6626	65.7412	66.4736	61.4749	74.479	65.9688
83.1416	75.0752	70.8906	66.5571	65.9072	66.2734	60.6702	65.5552	54.0107
82.2461	75.876	71.9521	68.0449	67.7495	66.7456	62.3269	71.6367	62.0193
81.7285	74.4966	70.8657	67.8901	67.9492	67.5952	60.7983	74.3237	63.283
82.1416	74.5093	70.4995	66.1064	66.272	66.0474	59.6016	67.4307	57.1021
78.019	71.0039	67.666	65.3853	65.5864	64.7588	57.2463	61.959	47.3574
80.5166	74.5322	67.3945	64.0029	64.251	63.3052	56.085	75.1733	65.1401
77.9956	70.4023	65.6924	62.6653	63.3276	62.1448	54.3762	69.8643	61.8042
69.4814	63.0295	60.5823	57.1121	58.6995	58.593	50.0183	66.71	57.1851
66.894	60.4016	57.8816	54.5981	56.0686	56.8508	48.6396	65.7407	56.9006
65.7832	59.7742	56.0566	53.8982	55.2622	55.0015	48.0928	63.3765	54.1499
64.8022	58.9573	54.5862	51.7263	53.8982	54.4795	45.7251	63.3528	55.1106
64.6841	57.2869	54.3604	50.7637	52.4856	52.2007	45.5454	60.95	52.6062
67.5083	59.7151	53.5186	50.6099	52.676	51.7856	44.7251	62.0161	52.6309
67.9702	59.9409	54.7522	50.2773	52.3435	51.0256	45.8313	62.2754	50.9319
65.3804	57.1672	53.1145	49.5994	51.5356	51.2744	46.582	61.022	49.5313
62.6619	55.3071	51.6426	48.7556	50.9419	51.9514	45.4385	59.1978	50.3738
63.5835	57.5347	52.2119	48.0059	50.7632	51.4521	43.2705	59.5176	50.5876
64.1743	56.9539	52.0103	48.5886	50.9058	51.7964	44.6882	59.5649	51.5732
65.5576	58.7903	51.6777	48.4817	49.7891	49.397	42.1499	58.2622	49.3398
64.8838	56.6814	51.416	48.1243	50.2993	50.5608	43.9009	64.001	52.0471
63.8198	56.9775	51.3447	49.8955	51.8789	51.1785	43.1265	60.4756	50.3965
66.1948	57.9246	52.5784	50.2151	51.9849	50.8447	42.4578	63.9409	49.4092

67.3291	60.1155	54.322	51.0342	52.376	50.8799	41.8726	64.4126	48.1836
66.4194	57.5098	53.2188	49.0857	51.7705	49.8225	42.4688	62.8872	50.335
65.2373	57.6521	51.7236	48.8247	51.8899	50.2864	42.6008	61.0781	49.8606
64.8701	58.4092	51.877	49.4893	51.96	51.9006	43.3269	61.1243	50.1211
62.9426	55.7073	51.8413	48.5859	51.4614	52.6724	43.7083	58.188	50.2397
62.5652	55.1392	50.9512	47.7065	50.7612	52.3643	44.3635	59.0645	49.0515
62.3147	53.3813	50.6052	47.3838	49.8684	51.0447	43.9336	60.0342	49.1575
62.978	53.9282	50.2729	46.6587	49.4651	50.7244	44.0049	56.3501	49.1335
61.2261	54.0222	50.6169	47.5266	50.1179	50.1062	43.314	58.5896	49.1812
62.3738	54.6152	51.2698	46.8835	49.2976	50.2839	42.5022	57.6763	49.6912
62.292	55.8257	50.7119	48.4897	49.8804	49.8091	42.4785	61.8323	49.8457
61.3682	55.1606	50.6882	48.1567	49.8804	50.4744	44.4219	62.271	48.7056
63.0352	54.6023	50.26	47.5022	49.8679	50.3313	42.9563	62.8271	49.7991
61.3433	54.0803	50.2476	46.4785	49.9031	51.1624	44.2302	62.2937	49.6555

T (°C) oper T (°C) oper T (°C) oper T (°C) oper T (°C) opening 7 (bottom)

57.1338	41.2527	33.0144	28.7892	74.189
65.2061	38.6155	31.8164	30.3041	73.6123
64.8271	40.5369	33.3379	28.9814	73.3872
63.8328	43.386	32.1379	27.3688	71.2866
66.9521	39.3647	32.4727	27.5363	68.145
66.4097	41.6692	34.2712	32.5696	71.3926
67.4624	41.0261	34.7993	31.8752	70.4141
69.7876	45.9226	36.3779	32.0781	66.0435
60.2598	44.3987	36.043	36.6172	69.7051
55.7212	42.0378	34.8931	31.8131	72.3472
54.9031	39.5439	33.5635	32.6045	72.9487
52.9573	39.7349	35.3	32.9163	73.3262
60.1748	42.2395	35.8613	30.7681	67.9668
57.1318	41.2029	33.1799	27.6565	67.98
63.4287	41.166	33.083	27.7998	66.9629
66.6064	43.4292	33.9675	28.3389	61.6758
57.8298	38.217	32.5076	31.2482	67.8135
57.0359	37.2129	32.4597	31.728	69.9272
61.9016	39.9714	32.9021	30.5028	71.8145
56.2764	37.666	32.6743	30.5028	72.1328
60.2566	37.9888	33.2139	30.1666	70.3862
64.3262	38.8252	32.998	29.6021	71.0474
60.8474	37.5933	33.2366	28.7357	72.0845
62.3728	38.0583	32.3125	29.2153	71.4937
53.4634	37.6042	32.0127	31.0648	72.2368
56.7117	36.2639	31.0157	28.493	71.9409
61.4133	36.1204	31.8077	28.5171	68.813
62.135	37.5791	32.5513	27.6992	69.5332
59.7571	38.0344	34.218	32.936	70.2188
60.999	40.0996	35.0911	32.2275	69.793
65.126	36.9685	32.3342	28.2274	68.6348
64.583	35.929	31.9397	30.9318	69.2026
63.0449	38.1519	31.0146	30.9667	69.0127
60.7849	36.7532	31.4108	29.1531	67.1938
58.6289	37.864	33.0166	28.9478	67.5352
53.5669	36.4412	30.8575	27.5166	68.6929
54.7651	36.166	30.7975	27.6008	69.6372
52.5098	35.9255	31.4926	33.7944	71.0879
54.4675	34.8125	30.2922	29.6917	70.439
59.8379	39.1313	31.7587	30.4264	69.4731
62.7471	41.0391	32.0684	28.61	69.0459
60.7463	39.6177	31.4315	27.0812	69.3398
59.4805	36.1768	31.6725	33.9502	69.2231
52.5195	36.9043	32.1021	31.2983	69.811
58.2241	38.3875	32.4871	29.9548	69.1392
60.6741	37.1436	32.1021	27.9224	67.4731
65.4878	36.8325	32.4858	29.1007	67.2842
63.5481	38.8633	32.1011	27.7529	65.2739
58.3286	38.1226	30.9012	28.3542	66.6216
56.1599	36.9272	31.2853	30.325	68.9131
58.8013	36.7825	30.6841	27.1261	69.0415
62.8965	38.6233	31.2242	29.1346	69.4785
62.9094	37.501	31.8013	27.3799	69.1255
60.5774	37.9063	32.9634	32.9514	70.187

59.0725	38.4072	33.2739	30.1427	70.8115
60.5999	38.5984	32.2068	29.6863	70.3511
52.4094	35.4417	30.2988	30.1907	70.835
53.4299	32.4226	29.3499	29.2177	71.1772
63.1665	36.8044	29.9014	30.0815	67.2681
53.7849	36.637	31.8459	36.0149	67.8232
52.1353	36.1106	31.9419	29.6611	68.3545
48.0352	37.2815	32.936	30.9569	69.7822
50.114	39.6104	33.8457	30.9078	70.7139
59.781	37.5444	31.9169	28.2297	68.0229
59.7671	36.1074	31.8068	28.9969	68.8711
63.2825	36.0605	30.4877	26.881	68.3052
60.7378	35.3655	30.4026	26.603	67.7729
51.0635	35.7004	30.9548	29.754	68.5522
55.4175	35.4124	30.5216	26.8066	68.374
59.2212	35.1489	30.6056	27.5529	66.8501
61.0574	34.9226	30.7147	27.7584	67.0874
61.6833	35.9626	31.4697	28.2264	67.0156
63.3513	35.8789	31.3978	27.0112	65.9404
60.3567	36.7632	32.7759	28.8386	66.4595
60.051	37.3989	32.1067	29.3695	67.312
61.2671	38.8416	31.7915	28.0439	64.0469
62.344	35.47	30.2312	26.672	65.1938
61.5027	35.6484	30.6144	26.5144	64.2588
59.4548	35.0259	30.5063	30.3982	65.2988
57.0737	33.4929	30.038	27.5134	66.8115
57.8311	34.2585	30.6252	30.3011	66.4087
51.5222	36.4739	31.0105	27.7059	67.7212
58.6484	35.6113	30.5653	31.1654	67.6255
54.7361	35.323	31.3563	28.9064	68.0146
57.1558	34.3904	30.1329	26.7301	67.4839
57.4639	34.498	29.7726	28.3544	67.4014
53.6331	35.4668	30.132	28.9064	67.8843
49.6907	34.0898	30.0598	28.4615	67.8608
51.342	33.1672	29.303	27.1503	67.4712
60.4116	33.4907	29.4592	26.3436	65.1548
53.7397	36.376	31.0083	27.3188	65.9585
47.7649	36.5315	31.7764	34.9041	66.6206
56.0039	39.3271	31.9672	32.0271	66.9736
45.6816	32.7944	28.9174	31.7032	67.6235
48.7627	32.9504	28.689	27.0289	66.856
50.0344	32.7705	29.2778	27.4622	66.5723
53.4648	38.0835	29.421	28.9884	64.8931
51.4231	34.7583	29.3489	27.2084	61.4275
56.9038	35.4646	29.8416	29.9736	63.415
55.3508	37.6653	31.6663	34.5188	66.0039
51.1487	33.811	29.468	28.3501	66.0972
52.7754	33.6194	29.1436	27.1591	64.8325
56.5234	34.1704	29.5521	25.967	64.6792
56.937	36.635	31.1361	28.313	64.0986
52.9653	35.8345	30.2488	29.3959	64.8564
52.2747	36.1792	31.0509	27.3735	65.4453
53.4021	36.1553	30.5468	26.7235	64.606
57.7654	36.2151	30.4027	26.3262	63.6011
55.1577	37.0642	32.8621	30.8949	65.209
55.6213	36.1924	31.472	28.4092	64.6899

50.0647	35.3525	31.0259	29.657	64.936
56.4016	38.7483	30.8098	27.1678	55.6074
55.4888	38.6528	31.2659	29.657	59.3635
52.0598	39.0588	30.1014	30.1134	62.0859
55.8325	34.5386	28.924	27.6493	63.9429
53.2932	35.0164	29.2954	27.1427	65.0532
56.7444	32.5364	28.478	28.9349	64.5684
57.6924	33.8066	29.6318	28.1774	63.3977
58.3062	36.1392	29.9181	30.3503	65.1099
57.1462	34.9673	30.4596	28.1523	62.6633
50.2041	36.0913	31.1667	29.0289	64.0225
51.9736	38.7571	31.6707	30.4104	65.0508
54.0269	37.5144	32.2944	30.7346	64.9565
55.2593	36.0781	31.4896	29.4364	65.3335
57.0256	35.3843	30.1091	26.4653	64.2461
55.0232	32.9539	30.6266	31.8866	63.1001
53.646	31.9454	29.6406	30.7574	64.7896
51.0225	32.7129	29.1479	28.7994	64.5181
55.4241	34.2456	29.8077	26.9097	59.4766
50.4631	35.3711	31.2125	29.219	61.5955
53.55	37.0579	31.1765	29.0508	63.4409
46.4792	36.2915	31.1515	31.9794	64.0903
46.9573	35.9824	30.7815	27.1997	63.6667
48.6936	36.7839	31.2856	27.6689	62.3774
53.7744	36.6262	32.1592	29.5784	62.9075
51.4004	36.7578	32.6028	31.8234	62.3989
53.9287	37.2959	32.1592	29.4342	62.186
51.7329	38.3596	31.9314	30.059	61.7363
50.3325	35.5386	30.0961	28.7622	60.2581
54.3784	33.9561	28.6039	25.9683	60.907
50.2817	32.7925	29.384	29.9847	61.0005
51.0918	36.8176	29.7106	29.8907	62.0796
-51.9468	35.9207	30.5632	29.7587	62.813
46.2639	34.6746	31.3064	29.5173	61.8301
41.0449	36.1707	36.5654	37.8447	59.2495
48.7498	39.6724	36.1707	35.3809	56.9749
50.3877	46.1785	45.1548	45.0356	57.0913
52.1086	48.0095	45.8799	49.127	55.656
42.4871	40.4949	36.2773	39.8982	59.4377
57.6848	54.2351	52.9653	53.001	55.7173
57.5178	53.1187	50.8035	50.5183	52.6558
55.158	51.4082	47.5933	46.6772	46.7009
53.426	49.2222	46.2488	43.2239	44.0103
52.4412	48.8062	44.9871	42.2463	42.4253
51.9307	48.271	44.8679	42.2942	41.6143
51.2527	48.1631	44.8906	42.3049	41.2793
50.4224	46.6892	43.9387	41.7456	41.8767
48.3413	45.4146	41.9353	40.1458	41.1362
47.7002	45.0823	42.2227	40.2422	40.3137
48.0798	45.9502	42.6387	40.4321	39.8591
48.5791	46.105	42.7817	39.7637	39.2263
48.7336	45.6646	41.4583	39.4651	40.2173
47.3542	44.1165	41.3269	38.7366	39.5725
49.2556	45.104	40.8367	39.0461	39.4521
48.5186	45.5325	42.7449	39.1536	40.3953
47.5068	45.4839	41.9807	38.9016	40.5732

45.8638	44.2205	41.2046	38.4348	38.5183
46.4351	44.8042	41.0732	39.0918	39.6411
47.3521	44.7932	41.6111	39.6301	40.1196
47.6248	44.9707	42.5164	40.4766	39.9634
47.5295	44.9827	42.0991	39.5217	40.7273
46.4827	43.9585	41.5266	39.2947	38.9841
46.9456	44.8386	41.7878	38.9233	38.5889
47.8613	46.303	43.5999	39.1025	38.6846
47.3857	45.053	41.4778	38.147	39.3533
45.7424	43.6345	40.9041	38.0264	38.5042
45.9448	43.4438	40.5103	38.2654	38.1936
45.5769	42.8491	40.4517	38.7324	39.2937
45.3508	43.29	40.9409	39.425	38.8518
46.2188	43.6704	40.8086	38.0862	40.009

Time (s)	Duct temp	Duct press	Duct O2	Duct CO2	Duct CO	Duct NOx	Duct HC	Duct light ir
0	33.7048	7.22185	11.5027	0.129754	6.41209	-97.5184	140.998	175.853
3.9	33.7576	7.15697	11.8032	0.130242	6.08236	-96.1313	140.866	175.819
7.8	33.8389	7.19452	7.70622	0.129754	6.28623	-97.6844	140.924	175.795
11.75	33.7156	7.22966	8.5935	0.13073	6.31356	-98.3386	140.696	175.78
15.65	33.7371	7.20966	7.82669	0.13073	5.98577	-97.4207	140.529	175.765
19.55	33.761	7.17697	3.13117	0.130242	6.27258	-97.1909	140.344	175.819
23.45	33.7229	7.25111	0.823889	0.130242	6.06233	-97.4793	140.261	175.858
27.35	33.7109	7.18671	2.48386	0.13073	5.79748	-97.5475	140.168	175.907
31.25	33.7217	7.24524	9.64475	0.13073	6.16771	-98.3143	140.026	175.956
35.21	33.7048	7.16671	6.63406	0.130242	5.98723	-97.9285	139.709	175.985
39.11	33.7588	7.21306	4.51213	0.129754	5.63845	-98.6657	139.563	175.956
43.01	33.7061	7.21014	3.13897	0.13073	5.79357	-98.6171	139.606	175.917
46.91	33.7825	7.19795	2.79459	0.130242	5.91406	-98.1579	139.606	175.882
50.8	33.7205	7.20671	21.4635	0.129754	6.04478	-97.528	139.611	175.892
54.7	33.7563	7.20477	15.9427	0.13073	5.25603	-98.0358	139.455	175.887
58.66	33.6772	7.21404	25.2391	0.13073	5.31992	-97.6157	139.259	175.868
62.56	33.761	7.24819	16.9485	0.13073	5.85064	-98.1092	139.225	175.902
66.46	33.761	7.23207	10.61	0.130242	5.15601	-97.2838	139.22	175.941
70.36	33.7468	7.1311	8.89057	0.131218	6.2682	-97.4107	139.195	175.946
74.26	33.6763	7.26622	11.9749	0.129754	6.04087	-98.2361	139.181	175.931
78.16	33.699	7.1789	9.0369	0.130242	5.83845	-97.5037	139.294	175.907
82.11	33.7371	7.21207	7.17697	0.131218	5.49844	-97.6744	139.073	175.898
86.01	33.6846	7.20966	-7.25305	0.130242	4.88675	-98.4755	138.957	175.898
89.97	33.6104	7.18817	9.56E-02	0.131218	4.06823	-97.4741	138.888	175.898
93.87	33.626	7.24232	11.9515	0.129754	4.63456	-98.5098	138.829	175.941
97.82	33.6582	7.2194	15.1832	0.13073	3.64433	-97.4107	138.82	175.898
101.72	33.6797	7.20623	8.90279	0.131218	3.86384	-98.0554	138.673	175.863
105.62	33.6892	7.22623	2.05E-02	0.131218	3.38483	-97.1274	138.718	175.829
109.52	33.7109	7.20379	-4.74235	0.13073	2.92777	-97.7526	138.512	175.814
113.42	33.7468	7.26673	-2.84141	0.131218	2.57313	-97.826	138.507	175.78
117.32	33.7371	7.18817	3.90726	0.131218	2.3946	-98.3191	138.444	175.765
121.22	33.6858	7.23794	13.4237	0.131705	2.53557	-98.3386	138.351	175.76
125.17	33.7527	7.17306	13.1223	0.13073	2.09363	-98.1631	138.253	175.746
129.07	33.7395	7.24524	12.8934	0.131218	1.5312	-98.0263	138.156	175.736
133.03	33.7012	7.21258	13.6935	0.131705	2.13753	-97.3816	138.219	175.716
136.93	33.6619	7.21258	15.9407	0.132193	2.06289	-97.7187	138.141	175.76
140.83	33.6318	7.24232	22.6752	0.131705	2.16435	-97.6014	138.083	175.746
144.73	33.6772	7.28622	19.5055	0.131705	2.25703	-97.8065	137.995	175.746
148.63	33.6665	7.25502	16.49	0.131218	2.12386	-97.4545	138.039	175.776
152.53	33.5962	7.29209	7.95841	0.131705	2.27265	-97.5719	138.004	175.824
156.48	33.5554	7.2394	8.81934	0.13073	1.64583	-97.6844	137.94	175.858
160.38	33.6152	7.25111	8.21447	0.131705	1.99509	-98.5537	137.784	175.848
164.28	33.6057	7.24134	10.6847	0.131218	1.92485	-97.2009	137.677	175.843
168.18	33.5996	7.21842	13.4281	0.131705	1.84046	-97.24	137.623	175.795
172.08	33.6331	7.24429	10.9418	0.13073	1.61704	-97.6548	137.53	175.795
175.98	33.5864	7.28476	9.77981	0.131218	1.48778	-97.1861	137.477	175.776
179.88	33.5615	7.16281	0.122924	0.131705	1.89997	-97.7917	137.491	175.765
183.83	33.5818	7.20915	4.00969	0.13073	1.69363	-97.5475	137.565	175.78
187.79	33.5698	7.2028	14.9676	0.131218	1.61949	-97.5623	137.579	175.736
191.69	33.5686	7.19354	7.4155	0.131218	1.71119	-98.031	137.648	175.726
195.59	33.5913	7.23648	13.8963	0.13073	1.89997	-98.0263	137.701	175.746
199.54	33.522	7.23159	16.51	0.13073	1.71314	-98.0897	137.712	175.721
203.44	33.5938	7.20039	18.05	0.131218	1.71119	-98.2656	137.546	175.726
207.34	33.5566	7.20039	18.1431	0.131218	1.48681	-96.776	137.56	175.731

211.24	33.5806	7.22477	13.8749	0.131218	1.51315	-97.6548	137.399	175.692
215.14	33.6523	7.14281	34.7672	0.131218	1.62534	-97.621	137.399	175.687
219.04	33.6523	7.25305	23.3784	0.131218	1.52583	-97.7626	137.384	175.697
223	33.5579	7.27257	25.8496	0.13073	1.90338	-97.3229	137.433	175.668
226.9	33.6116	7.2194	15.707	0.131705	1.25169	-97.9824	137.462	175.682
230.8	33.6404	7.23112	14.9407	0.131705	1.12145	-97.7383	137.374	175.677
234.7	33.5757	7.25502	27.7201	0.130242	1.56778	-98.0411	137.296	175.668
238.65	33.6033	7.24575	24.4821	0.131218	1.12047	-97.6157	137.252	175.682
242.55	33.6079	7.25502	16.2963	0.132193	8.83E-02	-97.5523	137.072	175.697
246.45	33.6079	7.24721	3.79263	0.131218	0.603892	-97.8847	136.989	175.726
250.35	33.6094	7.21207	2.71118	0.132193	8.34E-02	-97.1766	137.037	175.697
254.3	33.5627	7.27892	12.0978	0.131705	0.232192	-97.7187	136.998	175.716
258.2	33.5376	7.26232	18.9929	0.132193	0.138046	-98.6905	137.062	175.76
262.1	33.5854	7.26914	23.608	0.132193	1.1434	-97.9381	137.174	175.765
266.06	33.5745	7.20868	26.2744	0.132193	1.49656	-97.8942	137.155	175.78
269.96	33.5042	7.21842	23.5542	0.131705	1.18827	-98.1727	137.306	175.77
273.91	33.4802	7.27159	24.7116	0.131705	1.38047	-97.6062	137.408	175.785
277.81	33.5149	7.23746	14.2481	0.131705	0.518039	-97.3668	137.623	175.824
281.71	33.4563	7.2155	12.5213	0.131705	8.29E-02	-97.5327	137.721	175.878
285.61	33.4597	7.21258	24.614	0.131705	0.10195	-97.2056	137.716	175.887
289.51	33.4382	7.28917	20.1746	0.131705	0.686817	-98.2461	137.751	175.868
293.41	33.4419	7.18722	18.8071	0.131705	0.709258	-96.8542	137.848	175.819
297.37	33.5232	7.26721	14.3071	0.131218	1.46241	-97.5523	137.975	175.776
301.26	33.4756	7.27159	10.6159	0.131705	1.53071	-98.6853	138.136	175.731
305.22	33.5125	7.23502	5.476	0.131705	1.43754	-97.0883	138.039	175.721
309.12	33.5088	7.28038	7.88182	0.131218	1.56437	-98.197	137.755	175.731
313.02	33.4705	7.21744	5.21407	0.131705	1.64387	-71.0778	343.159	175.726
316.92	33.4407	7.2633	1.61E-02	0.131218	1.77363	4407.78	341.383	175.726
320.82	33.4753	7.25257	-2.8663	0.131705	1.88534	6551.97	338.72	175.804
324.72	33.4526	7.2194	-2.06973	0.131705	1.70485	7663.67	335.958	175.829
328.67	33.4551	7.26673	4.53308	0.131705	1.64875	8213.26	333.738	175.785
332.57	33.5125	7.2594	11.0486	0.131705	1.759	8376.59	332.308	175.648
336.53	33.4683	7.26429	17.8334	0.131705	1.88144	8441.16	339.51	175.692
340.43	33.4336	7.26768	35.2948	1.40291	2.35558	8537.17	347.994	175.687
344.38	33.51	7.24915	61.2128	1.13949	2.18728	8541.02	355.835	175.736
348.28	33.5483	7.21404	61.1346	0.131218	2.47118	8551.27	362.841	175.776
352.18	33.4956	7.24769	61.2712	0.131705	3.3458	8544.8	369.055	175.76
356.14	33.5315	7.24524	96.7612	20.1597	4.29651	8574.1	374.777	175.814
360.04	33.4695	7.24429	148.861	3.1936	3.77409	8573	380.104	175.853
363.93	33.4097	7.24331	118.323	0.132681	3.38043	8596.86	384.937	175.882
367.83	33.4121	7.25842	88.6445	0.132193	3.79701	8563.23	389.132	175.853
371.73	33.3916	7.20429	67.1463	0.131705	3.37116	8576.78	393.175	175.863
375.69	33.387	7.19988	1849.72	196.585	126.029	8574.65	397.171	175.931
379.59	33.3284	7.20966	8183.41	483.147	177.455	8594.18	400.574	175.921
383.54	33.321	7.22185	9461.18	498.438	178.369	8581.67	403.73	175.926
387.44	33.3569	7.29892	9685.79	489.262	184.825	8595.21	407.036	175.965
391.34	33.4072	7.2794	9763.37	491.926	184.688	8609.38	410.193	175.926
395.24	33.4097	7.27841	9812.2	490.051	183.614	8632.69	412.857	175.882
399.14	33.4348	7.23258	9819.82	504.108	181.924	8665.22	415.323	175.902
403.04	33.3904	7.22039	9842.04	500.755	183.75	8676.09	417.74	175.985
406.94	33.3916	7.20134	9815.49	496.859	183.926	8679.87	419.96	175.985
410.9	33.406	7.27257	9791.08	491.777	184.307	8658.2	422.031	175.937
414.8	33.4238	7.25356	9773.68	493.258	185.21	8674.44	424.152	175.898
418.75	33.5125	7.21353	9799.19	491.482	184.673	8659.24	425.928	175.931
422.65	33.4778	7.26965	9798.1	492.912	183.559	8632.69	427.704	175.882
426.55	33.425	7.20525	9780.76	495.378	182.412	8630.49	429.234	175.965

430.45	33.425	7.16916	9793.76	498.14	181.475	8641.91	430.712	176.004
434.35	33.491	7.23648	9789.98	496.859	184.82	8631.59	432.241	176.004
438.3	33.4465	7.24134	9800.29	493.011	184.443	8677.73	433.722	176.039
442.2	33.437	7.25794	9788.33	491.926	184.542	8701.05	435.202	176.059
446.1	33.4336	7.23892	9792.11	492.813	183.75	8696.17	436.434	176.044
450.06	33.3401	7.26622	9779.66	494.047	183.218	8683.17	437.618	176.087
453.96	33.3342	7.21794	9778.02	496.365	182.481	8672.3	438.604	176.044
457.91	33.4204	7.25892	9775.88	501.347	180.654	8657.65	439.59	176.029
461.81	33.4478	7.20039	9773.68	503.319	180.361	8667.42	440.874	176.024
465.71	33.4299	7.27159	9771.54	505.932	180.761	8687.5	441.86	176.014
469.67	33.3306	7.29111	9759.58	504.65	180.864	8686.4	442.65	176.064
473.57	33.3928	7.27209	9766.66	502.876	181.592	8672.3	443.39	176.087
477.47	33.4395	7.29939	9759.58	507.66	180.796	8676.09	444.227	176.024
481.37	33.3821	7.30476	9773.68	505.44	182.099	8664.67	445.362	175.956
485.32	33.3677	7.20721	9773.68	502.43	183.281	8676.64	446.102	175.912
489.22	33.3474	7.24283	9769.9	498.98	184.219	8668.52	446.743	175.97
493.12	33.3152	7.2794	9767.7	496.218	184.683	8661.99	447.533	175.99
497.02	33.363	7.21598	9771	499.176	183.965	8693.97	448.223	176.02
500.97	33.4167	7.21258	9777.47	495.478	184.59	8678.28	448.914	176.059
504.87	33.3367	7.20575	9769.9	495.378	183.731	8671.75	449.408	176.039
508.77	33.2864	7.21842	9775.88	496.218	183.154	8692.38	449.9	176.034
512.67	33.4204	7.2194	9769.35	498.684	181.724	8679.32	450.294	176.073
516.57	33.5161	7.19696	9770.45	501.938	180.517	8699.4	450.838	176.083
520.47	33.437	7.21744	9771.54	503.517	180.195	8692.93	451.281	176.044
524.43	33.3403	7.18722	9766.66	506.229	179.863	8669.56	451.578	176.024
528.33	33.3079	7.23061	9784	507.908	179.931	8690.73	450.344	176.044
532.23	33.3403	7.27841	9786.19	507.511	180.674	8624.02	320.814	176.029
536.13	33.3008	7.24378	9772.58	506.622	181.157	459.568	330.977	176.044
540.03	33.3486	7.27111	9795.41	497.944	183.716	108.673	329.891	176.053
543.93	33.2698	7.20915	9806.21	501.049	184.957	17.0037	278.099	176.087
547.88	33.3354	7.23404	9818.73	509.731	180.658	-18.3085	274.25	176.107
551.78	33.3606	7.28136	9801.88	504.948	180.742	-37.3213	269.417	176.151
555.68	33.3928	7.19795	9781.31	498.388	182.241	-49.7651	263.25	176.156
559.63	33.3726	7.22086	9771	504.456	181.396	-60.2555	255.457	176.122
563.53	33.3643	7.22429	9781.31	505.981	179.746	-65.6714	247.024	176.151
567.43	33.3188	7.20575	9768.8	504.108	179.716	-70.3502	238.49	176.151
571.33	33.3596	7.19061	9759.03	507.858	180.181	-74.3694	230.598	176.166
575.23	33.2759	7.25648	9768.25	507.313	180.923	-75.9368	223.396	176.186
579.13	33.3418	7.20331	9753.05	504.848	180.248	-78.4082	217.033	176.186
583.09	33.3225	7.20039	9749.82	505.737	182.095	-80.5178	210.818	176.175
586.99	33.3047	7.24232	9746.58	502.728	183.564	-81.3384	205.441	176.229
590.94	33.3154	7.21696	9767.7	499.275	184.346	-84.0096	200.756	176.253
594.84	33.3394	7.16525	9771	497.204	184.566	-84.0292	196.76	176.239
598.74	33.3	7.19795	9783.45	509.388	181.005	-85.4897	193.151	176.273
602.64	33.3406	7.25159	9798.64	506.92	181.479	-87.0914	189.953	176.269
606.54	33.3394	7.2155	9797	505.146	182.383	-86.1635	186.925	176.225
610.44	33.3694	7.21014	9781.31	504.601	183.892	-87.9412	184.644	176.166
614.4	33.2834	7.20868	9805.72	501.595	184.722	-88.0098	182.129	176.2
618.29	33.2893	7.23013	9832.82	498.339	184.722	-88.244	179.79	176.136
622.25	33.3647	7.21502	9837.16	496.662	184.805	-89.0989	177.968	176.107
626.15	33.3469	7.18233	9815.98	496.809	184.517	-89.9825	176.288	176.122
630.05	33.3877	7.2633	9800.84	494.047	182.964	-89.8361	174.871	176.147
633.95	33.426	7.24331	9763.37	500.259	181.03	-90.3831	173.612	176.156
637.85	33.4067	7.25502	9773.68	502.728	180.483	-90.8375	172.444	176.166
641.75	33.3662	7.21744	9769.9	504.997	179.98	-91.5403	171.385	176.107
645.7	33.4272	7.20721	9756.35	507.511	180.063	-92.0339	170.178	176.092

649.6	33.407	7.24965	9753.6	505.146	179.399	-91.1012	169.509	176.107
653.5	33.3652	7.25257	9756.35	508.793	180.879	-90.9595	168.65	176.078
657.4	33.3127	7.24673	9788.88	506.081	183.149	-92.0339	168.069	176.117
661.3	33.3855	7.20671	9799.19	504.158	184.717	-92.2341	167.507	176.126
665.2	33.3701	7.17404	9811.1	501.74	184.878	-91.7263	166.711	176.107
669.16	33.3152	7.26184	9795.41	497.698	185.201	-92.6833	166.11	176.117
673.06	33.3533	7.1916	9805.72	496.759	186.847	-92.6833	165.647	176.087
676.96	33.302	7.25159	9788.88	496.958	186.246	-92.7858	165.334	176.112
680.86	33.345	7.20915	9786.68	496.613	186.143	-92.9322	164.928	176.117
684.75	33.3652	7.24673	9774.23	498.388	184.62	-92.7029	164.537	176.166
688.65	33.4158	7.23696	9763.92	502.335	184.19	-94.0213	164.298	176.186
692.61	33.3347	7.2155	9769.9	506.13	184.736	-93.9045	163.966	176.175
696.51	33.3633	7.2194	9784.55	507.561	185.24	-94.1143	163.653	176.17
700.41	33.3877	7.20087	9774.78	506.329	184.771	-94.1434	163.658	176.103
704.31	33.3938	7.26524	9757.93	506.92	185.352	-93.5626	163.273	176.02
708.21	33.3389	7.17306	9775.33	505.39	186.969	-93.8654	163.096	175.97
712.11	33.4167	7.2155	9794.86	503.071	187.193	-94.4805	162.999	175.917
716.01	33.3794	7.22966	9804.63	498.98	187.637	-94.5244	162.819	175.868
719.96	33.3481	7.19014	9776.43	495.182	187.247	-94.9202	162.525	175.873
723.86	33.4202	7.22086	9757.38	495.478	186.255	-94.0266	162.613	175.912
727.76	33.3228	7.23988	9752.01	496.613	186.046	-93.7529	162.364	175.961
731.66	33.291	7.25061	9759.03	501.247	185.088	-95.4719	162.292	176.044
735.56	33.3462	7.18135	9779.11	505.737	183.838	-94.5101	162.145	176.059
739.46	33.3271	7.21794	9806.21	507.957	183.564	-94.7685	161.974	176.053
743.42	33.3762	7.22477	9817.08	511.654	182.998	-95.1986	162.066	176
747.31	33.4063	7.23356	9811.65	498.783	186.437	-94.8763	162.057	175.981
751.27	33.4219	7.25305	9795.41	496.809	185.753	-94.5439	162.091	175.951
755.17	33.3682	7.17989	9776.43	496.71	184.971	-95.5548	161.94	175.898
759.07	33.3582	7.23988	9764.46	499.374	183.584	-94.7051	161.92	175.863
763.02	33.3047	7.23061	9742.25	503.368	183.384	-95.4866	161.613	175.838
766.92	33.3542	7.24623	9769.9	507.267	186.358	-95.14	161.666	175.809
770.82	33.2861	7.22671	9799.74	498.88	187.54	-95.4819	161.461	175.785
774.78	33.2671	7.19503	9804.08	498.24	187.164	-96.0875	161.447	175.751
778.68	33.3027	7.24867	9818.73	498.24	186.764	-95.4232	161.602	175.79
782.58	33.3088	7.26524	9823.06	501.495	185.836	-95.8042	161.652	175.77
786.48	33.2114	7.1916	9818.18	501.297	183.916	-95.438	161.573	175.795
790.43	33.1841	7.2594	9798.64	504.456	183.506	-95.6235	161.592	175.785
794.33	33.1975	7.23305	9820.92	508.301	183.11	-95.8481	161.691	175.804
798.23	33.3	7.22378	9811.65	509.388	183.686	-95.8285	161.7	175.824
802.19	33.2732	7.26086	9805.18	509.338	183.101	-95.2277	161.724	175.79
806.09	33.2817	7.23356	9799.19	508.793	183.575	-96.4436	161.563	175.799
809.98	33.2041	7.2194	9798.1	510.174	183.941	-95.9945	161.73	175.829
813.88	33.1611	7.22331	9809.51	508.007	185.118	-95.7847	161.832	175.77
817.78	33.2239	7.22086	9815.49	504.898	186.007	-97.1079	161.847	175.755
821.74	33.2942	7.24134	9803.53	501.396	186.598	-96.4193	161.827	175.721
825.64	33.2842	7.27794	9801.33	498.438	186.891	-95.5548	161.91	175.736
829.54	33.2632	7.26914	9788.33	496.809	187.243	-96.3411	161.94	175.78
833.49	33.304	7.28768	9781.8	495.182	186.642	-96.0774	161.963	175.776
837.39	33.3005	7.29355	9779.11	497.303	186.363	-96.2582	162.218	175.726
841.35	33.3662	7.25159	9785.1	500.359	185.816	-96.7565	162.174	175.76
845.25	33.2463	7.22477	9785.64	504.307	184.908	-96.6244	162.223	175.731
849.15	33.2209	7.32917	9781.31	500.114	187.54	-96.4341	162.174	175.736
853.05	33.2512	7.25257	9777.47	505.589	184.805	-96.5271	162.35	175.765
856.95	33.2781	7.32183	9782.35	508.549	185.787	-96.0727	162.359	175.746
860.85	33.3223	7.30866	9770.45	509.483	185.997	-97.4889	162.564	175.741
864.8	33.2554	7.23159	9779.66	507.362	186.534	-96.3607	162.633	175.751

868.7	33.2742	7.18233	9786.19	507.362	188.951	-95.7408	162.75	175.731
872.6	33.3062	7.23013	9811.65	506.969	189.293	-97.1327	162.745	175.76
876.5	33.2861	7.21452	9821.96	503.418	190.372	-96.0679	162.672	175.746
880.4	33.2432	7.26819	9794.86	499.819	191.183	-96.1657	162.891	175.726
884.3	33.3281	7.25061	9794.86	496.908	191.501	-96.0822	163.087	175.726
888.25	33.303	7.2633	9799.74	497.105	191.286	-96.4146	163.17	175.746
892.15	33.2827	7.29746	9807.31	497.944	190.28	-95.9458	163.258	175.716
896.05	33.3179	7.23404	9784	500.706	188.703	-95.9992	163.512	175.673
899.95	33.2251	7.2872	9802.98	504.356	188.415	-95.9215	163.6	175.677
903.85	33.2771	7.28574	9819.82	506.672	187.858	-97.1179	163.605	175.673
907.75	33.2737	7.2999	9812.74	507.019	186.421	-96.2629	163.775	175.643
911.71	33.3462	7.17452	9785.1	507.71	186.524	-96.6878	164.001	175.658
915.61	33.2925	7.26476	9791.08	509.09	187.506	-96.5366	163.874	175.716
919.51	33.3213	7.24185	9815.49	508.35	189.288	-96.7565	164.142	175.741
923.41	33.344	7.26429	9825.81	500.656	166.55	-96.849	164.137	175.785
927.31	33.2671	7.30574	7611.6	78.3839	24.443	-96.7221	164.201	175.765
931.21	33.2976	7.276	6410.37	26.0303	16.0197	-96.9076	164.308	175.765
935.16	33.3611	7.29549	10372.1	38.1811	17.5163	-96.6635	164.308	175.736
939.06	33.3057	7.19842	10422.1	49.5796	20.3295	-92.2976	348.091	175.712
942.96	33.2893	7.23258	10422.1	49.3355	21.6757	7917.6	349.127	175.721
946.86	33.269	7.2594	10421.5	48.6956	21.8475	8302.25	351.938	175.721
950.76	33.2827	7.28232	10421.5	48.852	21.8797	8594.18	356.823	175.721
954.66	33.3301	7.29257	10420.4	49.0229	21.6309	8637.02	361.706	175.692
958.61	33.2112	7.26673	10420.4	48.9838	21.3016	8683.17	367.279	175.682
962.51	33.2415	7.27111	10420.4	47.1084	21.4231	8702.15	372.755	175.726
966.41	33.1597	7.29305	10419.9	47.1718	21.428	8699.4	377.983	175.736
970.37	33.2004	7.2872	10419.9	47.1718	20.9811	8684.2	382.866	175.755
974.27	33.2654	7.27451	10419.3	46.874	21.5791	8715.15	387.751	175.716
978.17	33.2822	7.31158	10419.9	46.8056	21.064	8692.93	392.139	175.707
982.07	33.238	7.28038	10419.9	45.3064	21.5933	8675.54	396.282	175.716
985.97	33.2346	7.30574	10419.3	46.9425	20.8167	8690.19	400.082	175.776
989.92	33.3245	7.23842	10418.8	46.2587	20.6357	8693.97	403.78	175.804
993.82	33.2998	7.3238	10418.8	44.857	20.0748	8733.58	407.234	175.799
997.72	33.2097	7.2521	10418.8	44.9157	19.6006	8707.58	410.143	175.776
1001.62	33.3254	7.30231	10418.8	45.028	19.4304	8695.62	413.004	175.751
1005.52	33.3069	7.26476	10418.3	45.3405	18.9372	8675.54	415.718	175.746
1009.42	33.2429	7.27746	10418.8	45.5065	18.1724	8674.44	418.282	175.721
1013.37	33.2622	7.30085	10417.7	46.8299	18.3494	8699.95	420.65	175.692
1017.27	33.3054	7.27501	10418.3	47.0841	17.0065	8656.55	423.117	175.721
1021.23	33.3179	7.24378	10418.3	47.1523	16.5758	8683.65	425.138	175.677
1025.13	33.2415	7.27209	10418.3	47.1671	16.5933	8685.3	426.964	175.712
1029.03	33.291	7.29501	10418.3	47.0693	16.4729	8693.97	428.936	175.746
1032.93	33.2239	7.24232	10417.7	47.1671	16.4202	8696.72	430.367	175.721
1036.83	33.2073	7.29746	10417.7	46.9766	16.2671	8674.99	431.995	175.731
1040.73	33.1655	7.22769	10417.7	46.8447	16.0334	8719.48	433.376	175.697
1044.68	33.124	7.27013	10417.7	46.576	15.6564	8664.67	434.757	175.697
1048.58	33.0564	7.2355	10417.7	46.3417	15.4149	8644.1	435.991	175.751
1052.48	33.0193	7.24086	10417.2	46.2439	16.4441	8677.19	437.323	175.799
1056.38	33.0662	7.24086	10417.7	46.3662	16.7733	8696.17	438.408	175.79
1060.28	33.0234	7.25597	10417.2	46.2489	15.2203	8695.62	439.543	175.77
1064.18	33.0176	7.2872	10417.2	46.2978	15.8226	8681.52	440.676	175.765
1068.08	33.0942	7.26184	10417.2	46.459	15.8017	8654.91	441.614	175.809
1072.09	33.123	7.25696	10417.2	46.7226	16.3246	8670.11	442.551	175.814
1075.99	33.1182	7.25842	10417.2	46.8106	15.59	8646.79	443.439	175.79
1079.89	33.1458	7.31844	10417.2	46.4051	16.1402	8661.44	444.178	175.765
1083.79	33.115	7.30282	10417.2	46.2685	16.9778	8644.59	445.116	175.721

1087.74	33.0994	7.26038	10417.2	46.2928	18.3514	8652.77	445.608	175.721
1091.64	33.0901	7.2833	10417.2	46.3026	17.6694	8637.57	446.596	175.716
1095.54	33.0674	7.25892	10416.6	46.459	18.2207	8655.46	447.138	175.736
1099.44	33.0757	7.24575	10416.1	46.7274	18.9958	8639.71	447.878	175.746
1103.34	33.1379	7.23696	10416.1	46.9813	19.3402	8640.26	448.124	175.731
1107.24	33.0007	7.24575	10416.1	47.5285	19.7611	8635.93	448.223	175.776
1111.2	33.1199	7.29063	10416.6	47.1718	19.5339	8629.94	448.668	175.892
1115.1	33.0894	7.25746	10416.1	47.2207	20.0928	8620.18	448.767	175.946
1119	33.105	7.17649	10416.6	47.1621	19.9524	8616.39	448.963	175.981
1122.95	33.0635	7.31403	10416.1	47.5578	20.3719	8646.79	449.604	175.941
1126.85	33.0449	7.23597	10415.5	45.4578	20.6894	8627.26	449.505	175.951
1130.75	32.9822	7.26283	10416.6	46.0048	20.1743	8621.28	449.85	176.009
1134.65	33.0583	7.2633	10416.1	45.1696	20.3528	8641.36	449.999	176.029
1138.6	33.1394	7.31501	10416.1	44.8911	20.3134	8638.12	450.542	176.078
1142.5	33.1155	7.32526	10415.5	44.8473	20.1544	8619.63	450.59	176.034
1146.4	33.1311	7.28527	10416.1	44.857	20.9304	8643.55	450.888	175.97
1150.3	33.1707	7.23013	10416.1	45.0132	20.5011	8647.89	451.183	175.937
1154.2	33.1409	7.31209	10416.1	45.2576	20.5109	8652.22	451.578	175.898
1158.1	33.0366	7.29939	10416.1	45.0084	20.9392	8641.36	451.923	175.848
1162	33.0703	7.27013	10416.1	45.3992	20.663	8649.47	452.318	175.829
1165.96	33.0032	7.27209	10416.1	45.5456	21.4889	8643.01	452.959	175.937
1169.86	33.0737	7.31063	10415.5	45.702	20.5182	8659.79	453.55	175.912
1173.76	33.0974	7.24721	10415.5	45.7361	20.9719	8627.81	453.896	175.931
1177.66	33.083	7.25842	10415.5	45.7067	21.1948	8641.36	454.29	175.887
1181.56	33.0698	7.27501	10415	45.6188	21.5738	8613.71	454.536	175.892
1185.46	33.0962	7.23892	10415.5	45.3308	21.7069	8665.22	454.931	175.902
1189.41	33.1455	7.21794	10415	45.155	21.8079	8634.34	455.03	175.902
1193.31	33.0845	7.23502	10415.5	45.0037	21.7748	8622.92	455.475	175.882
1197.21	33.1267	7.27892	10415.5	44.8523	21.3602	8640.81	455.523	175.868
1201.11	33.0623	7.26378	10415	44.8425	21.6703	8597.96	455.82	175.912
1205.01	33.0417	7.27159	10415	44.8864	21.5728	8636.47	455.87	175.912
1208.96	33.0625	7.2794	10415.5	45.1159	21.6358	8604.49	456.263	175.892
1212.86	33.0002	7.24769	10415	42.9816	21.0094	8600.1	455.967	175.824
1216.76	33.0667	7.27746	10415.5	43.138	20.7001	8630.49	456.165	175.785
1220.72	33.051	7.25502	10415.5	43.2746	21.1172	8644.59	456.707	175.829
1224.62	33.0762	7.25648	10415.5	45.7411	20.9714	8614.26	457.052	175.887
1228.52	33.092	7.24524	10415	43.2453	21.0221	8603.39	457.497	175.931
1232.47	33.0837	7.29209	10415.5	43.0744	20.6606	8629.46	457.645	175.995
1236.37	33.0586	7.21744	10415	42.8302	20.864	8619.14	457.991	176.029
1240.33	33.0547	7.27695	10415	45.028	20.6133	8624.57	458.088	176.039
1244.23	33.0393	7.22671	10415.5	43.7386	20.288	8620.18	458.138	176.087
1248.18	32.9963	7.29111	10415	42.4249	20.828	8600.65	458.483	176.142
1252.08	33.103	7.24331	10415.5	42.464	20.2626	8635.93	458.729	176.17
1256.03	33.0256	7.26429	10415.5	43.2453	20.7411	8606.08	458.729	176.186
1259.93	32.9922	7.24915	10415	42.459	20.8845	8595.76	458.632	176.195
1263.89	32.9309	7.27648	10415.5	42.7034	21.1412	8577.33	458.582	176.214
1267.79	32.875	7.22477	10415	42.9671	19.787	8620.73	458.927	176.166
1271.69	33.0146	7.22232	10415	43.1576	20.306	8613.16	459.026	176.097
1275.59	33.0769	7.23892	10415	43.2649	20.0611	8586	459.074	176.029
1279.49	33.0967	7.26429	10415	43.2746	19.9572	8564.88	459.173	175.981
1283.44	33.0513	7.25013	10415	42.4299	20.9953	8584.96	459.322	175.965
1287.34	33.0273	7.26622	10415	42.5763	20.8631	8588.75	459.568	175.97
1291.24	33.0657	7.30526	10415	42.7327	20.6548	8616.39	459.667	175.965
1295.14	33.0022	7.2521	10415	42.9718	20.6602	8627.81	458.632	175.97
1299.1	32.957	7.2594	10415	43.1674	20.4869	2656.92	281.748	176
1303	33.0139	7.19306	10415	45.0914	20.8143	595.36	273.462	176.024

1306.9	32.9817	7.28622	9085.21	14.4583	15.0627	289.444	265.57	176.068
1310.8	33.0679	7.21452	1198.96	1.18779	8.74913	155.874	258.171	176.126
1314.7	33.0452	7.21842	336.994	0.227802	6.29258	88.8152	251.068	176.161
1318.59	33.0706	7.25159	192.267	0.131218	6.10867	46.581	244.31	176.17
1322.55	33.0247	7.25988	120.853	0.131218	6.08477	18.6733	238.095	176.181
1326.45	33.0254	7.23013	76.2153	0.492185	5.45797	-1.63217	231.832	176.19
1330.35	32.9775	7.19404	75.4437	0.132681	6.27941	-17.4524	226.356	176.19
1334.25	33.0132	7.22575	66.5994	1.19071	6.17599	-29.0972	221.423	176.181
1338.15	33.0554	7.24378	43.2649	0.13073	6.00722	-36.8624	216.639	176.147
1342.05	33.0925	7.22867	50.0827	0.132193	6.18625	-44.9743	212.249	176.142
1346	32.9377	7.27501	39.7143	0.264874	6.2438	-49.9752	208.402	176.151
1349.9	32.9429	7.22039	32.8918	0.131218	5.68187	-54.4145	204.948	176.126
1353.8	32.9656	7.22769	30.9482	1.14194	6.73795	-58.9075	201.841	176.112
1357.7	32.9082	7.22039	32.5403	0.13073	5.90089	-59.9625	198.899	176.087
1361.6	32.9214	7.21061	28.6723	0.139022	6.09258	-64.0697	196.126	176.059
1365.5	32.8958	7.26575	33.6049	0.131218	6.32623	-65.7105	193.649	176.048
1369.46	32.8792	7.28768	26.0693	0.131218	6.05991	-68.5039	191.476	176.073
1373.36	32.8699	7.21061	23.2221	0.883888	5.87747	-70.4675	189.523	176.009
1377.26	32.8333	7.26622	21.1905	0.227313	5.79357	-73.1044	187.736	175.995
1381.16	32.8735	7.23258	24.2233	0.13073	5.99599	-74.1935	185.992	176.048
1385.05	32.8962	7.22232	26.1866	0.130242	6.00576	-73.8125	184.321	176.044
1389.01	32.8723	7.24429	20.5654	0.15268	5.62382	-75.5854	182.744	176.053
1392.91	32.8838	7.21306	15.0017	0.13073	6.07845	-76.1423	181.22	176.073
1396.81	32.897	7.22867	13.7471	1.08876	4.86869	-78.3739	180.068	176.053
1400.71	32.8755	7.2794	15.1846	1.16632	4.74724	-79.1407	179.057	176.029
1404.66	32.8967	7.2521	9.76473	0.131218	4.60482	-80.2007	177.792	175.975
1408.56	32.9443	7.28136	16.4382	1.18974	3.75457	-81.1138	176.542	176.02
1412.52	32.8247	7.25356	18.1754	1.19071	3.3658	-81.8024	175.76	175.97
1416.42	32.8718	7.28673	32.6281	1.2034	3.28386	-81.5339	174.784	175.961
1420.32	32.8958	7.20817	46.9179	1.18583	2.70386	-83.1599	174.047	175.917
1424.27	32.8535	7.20331	37.4045	1.18779	1.71021	-83.0379	173.075	175.887
1428.17	32.8586	7.28866	37.9906	1.18729	1.65997	-83.9515	172.366	175.902
1432.07	32.8667	7.19988	31.0264	1.19071	1.819	-83.8976	171.736	175.917
1435.97	32.8416	7.21502	21.9328	1.19267	1.86924	-84.2395	171.067	175.898
1439.87	32.8242	7.23988	27.5443	1.19267	1.68339	-84.9476	170.549	175.941
1443.83	32.8523	7.22331	19.7874	1.19169	1.619	-86.0267	170.052	175.985
1447.72	32.8179	7.19696	16.387	0.171217	1.78485	-86.1344	169.753	176.029
1451.68	32.8669	7.22477	17.4924	0.136583	1.46388	-86.9546	169.202	176.048
1455.58	32.7927	7.17598	18.3958	1.02828	1.60388	-87.2674	168.532	176.122
1459.53	32.8757	7.17744	10.7067	0.13073	1.56437	-86.6032	167.903	176.181
1463.43	32.8574	7.32818	10.9091	1.18974	1.85704	-87.7705	167.658	176.214
1467.33	32.8921	7.20623	5.46917	1.19217	1.71705	-87.2283	167.463	176.117
1471.23	32.9116	7.23305	18.3417	0.131705	1.40486	-87.3013	167.004	176.103
1475.13	32.855	7.19598	7.58037	0.167802	1.53363	-89.7431	166.428	176.117
1479.03	32.8726	7.19061	5.6487	1.18876	1.65314	-88.84	166.002	176.103
1482.93	32.8447	7.21744	12.0164	1.18974	1.75802	-88.5763	165.725	176.151
1486.89	32.8835	7.21696	6.38819	0.131218	1.85558	-88.4151	165.553	176.151
1490.79	32.9038	7.30917	4.00919	1.18583	1.90875	-88.7322	165.28	176.083
1494.69	32.853	7.23794	-1.07413	1.18729	2.14972	-89.2649	164.83	176.059
1498.59	32.8147	7.24575	8.35496	1.18437	1.83412	-88.9277	164.376	176.142
1502.49	32.8418	7.2228	10.2345	1.18534	1.45071	-88.8448	164.093	176.186
1506.39	32.8135	7.2028	21.9114	1.18729	1.56827	-91.7797	163.8	176.195
1510.34	32.7437	7.19404	14.2778	0.131705	1.63998	-90.0364	163.492	176.142
1514.24	32.7056	7.19404	14.791	0.657551	1.79753	-89.499	163.224	176.039
1518.14	32.7529	7.17989	10.774	0.131218	1.86338	-91.6824	162.804	175.961
1522.04	32.7266	7.24185	5.54723	0.825353	1.68437	-89.8752	162.447	175.965

1525.94	32.675	7.17062	12.2818	0.241459	1.63998	-89.9682	162.223	175.951
1529.84	32.7017	7.17744	14.3812	1.1912	1.70875	-90.8422	162.023	175.951
1533.79	32.7124	7.24673	11.4559	1.19315	1.43851	-89.8361	161.769	175.961
1537.69	32.698	7.21648	12.3973	1.18437	1.36729	-91.5551	161.573	175.956
1541.59	32.7458	7.17306	8.23009	1.18876	1.44242	-90.764	161.251	175.995
1545.49	32.761	7.17452	11.7296	1.18876	1.71217	-89.8948	160.987	176.053
1549.39	32.8123	7.20331	9.24426	1.19022	1.61851	-92.0238	160.899	176.034
1553.29	32.7568	7.19795	5.83991	1.18145	1.48632	-91.7311	160.758	176.064
1557.25	32.731	7.24232	4.11603	0.20146	1.899	-91.98	160.685	176.059
1561.15	32.7766	7.20039	-3.22677	1.18583	1.60778	-92.8688	160.494	176
1565.05	32.7371	7.19112	5.37E-02	1.00535	1.71948	-91.6481	160.215	175.956
1568.95	32.7458	7.22232	7.09698	1.18145	2.10972	-91.8579	160.196	175.937
1572.9	32.7231	7.22915	0.542916	0.131218	1.88144	-91.3014	160.02	175.902
1576.8	32.6877	7.18671	11.653	1.03657	1.65607	-91.2571	159.844	175.868
1580.7	32.7317	7.23746	10.4598	0.26341	1.71509	-92.9666	159.595	175.785
1584.6	32.6646	7.23159	11.7725	1.18388	1.93265	-92.2098	159.405	175.77
1588.55	32.7471	7.16186	4.21309	0.206826	1.6468	-92.8545	159.253	175.741
1592.45	32.6729	7.25549	5.75894	1.08047	2.39117	-93.7724	159.112	175.751
1596.35	32.6746	7.20233	4.71944	0.760965	3.26678	-92.4931	159.009	175.726
1600.25	32.6724	7.21404	4.59164	0.131218	3.37067	-92.7959	159.024	175.776
1604.15	32.5981	7.18868	5.25942	0.160973	3.02629	-92.5856	158.985	175.858
1608.05	32.6279	7.21353	0.972182	1.10632	2.40825	-92.8984	158.921	175.921
1612.01	32.6814	7.17697	-0.418043	0.201948	2.41898	-92.4439	159.082	175.946
1615.91	32.6741	7.22623	5.20968	1.10877	2.86093	-93.3914	159.087	175.937
1619.81	32.7039	7.22086	10.3984	0.730719	2.37508	-92.9909	159.117	175.873
1623.71	32.7043	7.24623	4.32625	0.131705	1.9068	-93.8849	159.17	175.848
1627.61	32.6287	7.21744	3.38532	0.59804	2.3063	-92.3414	159.063	175.814
1631.51	32.6331	7.20721	-6.98E-02	0.131218	2.37802	-92.4149	159.117	175.785
1635.46	32.5759	7.15306	8.24034	1.19169	2.68777	-94.0361	159.283	175.77
1639.36	32.6265	7.17306	8.78817	0.139022	2.12777	-92.2828	159.366	175.765
1643.31	32.6035	7.23356	3.18581	0.132193	2.76093	-92.3657	159.424	175.755
1647.21	32.6101	7.23696	1.33022	0.131705	3.36726	-95.1643	159.366	175.804
1651.11	32.5947	7.24378	7.05403	0.131218	3.71408	-92.9618	159.615	175.863
1655.01	32.5923	7.22966	8.48037	1.19071	3.65165	-93.6356	159.942	175.917
1658.97	32.646	7.22525	8.41594	1.19022	3.85165	-93.5869	159.791	175.937
1662.92	32.5981	7.21648	6.2243	0.196095	3.84921	-93.123	159.757	175.882
1666.88	32.6145	7.22378	13.6042	0.130242	4.51994	-93.328	159.693	175.838
1670.78	32.53	7.24524	10.3003	0.131218	4.34384	-93.9531	159.688	175.795
1674.68	32.573	7.26086	14.5447	1.18388	3.82239	-93.5769	159.824	175.755
1678.63	32.6147	7.23159	14.7983	0.131218	3.76774	-94.1048	159.801	175.741
1682.53	32.6218	7.21502	15.1383	0.131218	3.66969	-93.5235	159.824	175.721
1686.43	32.5679	7.24331	9.68033	0.131218	3.97897	-92.9422	159.663	175.726
1690.39	32.6519	7.23502	12.714	0.131218	3.63652	-95.1738	159.683	175.716
1694.29	32.5835	7.28622	0.401458	0.131218	3.30141	-94.0213	159.927	175.692
1698.19	32.5559	7.24721	-0.245849	0.131705	3.61457	-92.7858	159.785	175.682
1702.08	32.5408	7.20966	3.0624	0.13073	3.42433	-94.9249	159.732	175.673
1705.98	32.6101	7.24185	10.0111	0.131705	3.35897	-92.278	159.663	175.673
1709.94	32.542	7.20233	15.6715	0.816084	2.96435	-94.4805	159.669	175.677
1713.84	32.5913	7.21404	1.69119	1.18534	2.4102	-94.2903	159.81	175.652
1717.74	32.592	7.24524	8.77982	1.19267	2.4785	-93.8506	159.849	175.652
1721.69	32.5872	7.24429	10.1755	0.193167	2.38581	-94.5683	159.893	175.668
1725.65	32.6182	7.19649	9.26471	1.19071	1.96533	-93.8458	159.815	175.652
1729.55	32.5317	7.21794	13.1534	1.06193	1.83314	-93.7529	159.781	175.643
1733.5	32.5149	7.22134	9.12374	0.314629	1.66924	-94.0509	159.718	175.687
1737.4	32.51	7.20233	12.8559	1.18583	2.60776	-94.0948	159.946	175.751
1741.3	32.4907	7.2594	14.7466	0.253167	1.92144	-94.8272	159.893	175.843

1745.26	32.5322	7.14573	4.97261	1.18632	2.07314	-94.3098	159.883	175.921
1749.16	32.4731	7.20525	9.35107	0.141461	1.87656	-94.1825	159.713	175.951
1753.06	32.4629	7.2633	8.56227	1.18876	1.71656	-93.7724	159.702	175.97
1756.96	32.4961	7.24185	0.933643	1.18974	1.66924	-94.7294	159.874	175.937
1760.91	32.4602	7.28232	4.85504	1.18632	1.49803	-94.1629	159.957	175.887
1764.81	32.5032	7.2594	6.68332	0.215607	1.65217	-94.0704	159.918	175.843
1768.76	32.5146	7.21893	4.32089	1.18632	1.86095	-94.1877	159.879	175.902
1772.66	32.5405	7.21353	4.97651	1.18632	1.46437	-94.6026	159.801	175.926
1776.56	32.4814	7.21207	4.017	1.18827	1.68388	-95.0618	159.615	175.921
1780.46	32.4753	7.17941	7.64379	1.19071	1.65802	-94.4266	159.746	175.951
1784.36	32.4824	7.25061	10.2223	0.131705	1.45071	-94.7881	159.771	175.937
1788.32	32.4065	7.28282	12.4715	0.97803	1.25267	-94.974	159.805	175.926
1792.22	32.4272	7.23207	9.02325	0.13073	1.47314	-94.6712	159.791	175.898
1796.12	32.4607	7.2282	12.7589	0.158534	1.49315	-94.4123	159.746	175.873

Duct light ir	Phi O2 (prc	Opening C	Opening C	Opening O -	-	-	Load cell (r
175.853	407.974	204.554	-318.989	9857.24	-4.88E-04	-6.83E-03	0
175.829	364.468	210.769	-319.187	9857.79	3.41E-03	-1.46E-03	4.88E-04
175.804	358.944	208.599	-318.842	9857.79	2.44E-03	-4.88E-03	4.88E-04
175.776	359.93	206.774	-318.743	9858.34	3.41E-03	-2.93E-03	0
175.765	361.855	207.069	-318.892	9857.24	2.93E-03	-5.85E-03	4.88E-04
175.819	362.988	206.675	-319.038	9856.69	2.93E-03	-5.85E-03	0
175.858	363.531	207.169	-318.447	9857.24	2.93E-03	-7.32E-03	-4.88E-04
175.912	364.122	209.388	-318.693	9857.24	3.41E-03	-6.34E-03	0
175.965	364.912	207.662	-318.398	9856.69	3.90E-03	-5.37E-03	4.88E-04
175.995	365.898	209.783	-318.693	9857.24	3.41E-03	-6.34E-03	0
175.951	366.934	207.02	-318.989	9857.24	3.90E-03	-4.39E-03	0
175.921	368.315	207.514	-318.939	9857.24	3.41E-03	-1.95E-03	0
175.887	369.598	205.836	-319.334	9856.69	3.41E-03	-1.95E-03	0
175.892	370.831	205.935	-319.088	9857.24	2.44E-03	-4.39E-03	0
175.898	371.916	209.388	-318.497	9857.79	3.41E-03	-6.34E-03	0
175.868	372.755	205.294	-318.743	9858.34	2.93E-03	-1.95E-03	0
175.907	373.346	205.738	-319.138	9858.34	2.93E-03	-5.37E-03	-4.88E-04
175.946	373.791	211.016	-318.939	9856.69	3.41E-03	-4.39E-03	4.88E-04
175.951	374.086	207.169	-318.249	9857.79	3.41E-03	-1.95E-03	4.88E-04
175.926	373.987	207.02	-319.187	9856.14	3.41E-03	-7.80E-03	-4.88E-04
175.907	373.938	209.043	-318.892	9857.79	3.41E-03	-9.76E-04	4.88E-04
175.887	373.495	209.536	-318.693	9857.79	3.90E-03	-4.88E-03	4.88E-04
175.892	373.051	208.599	-318.644	9858.34	1.95E-03	-3.90E-03	0
175.892	372.41	209.536	-318.693	9857.24	2.93E-03	-5.37E-03	4.88E-04
175.937	371.817	205.935	-319.187	9857.79	2.93E-03	-5.85E-03	0
175.902	371.126	204.85	-317.953	9857.24	3.41E-03	-4.88E-03	4.88E-04
175.858	370.485	206.477	-318.644	9856.69	3.90E-03	-2.44E-03	4.88E-04
175.834	369.844	209.683	-318.546	9857.24	3.41E-03	-1.46E-03	0
175.814	369.154	206.724	-319.038	9857.24	3.41E-03	-4.39E-03	0
175.785	368.414	204.85	-318.842	9857.24	3.41E-03	-2.44E-03	4.88E-04
175.776	367.773	208.845	-318.447	9857.79	2.44E-03	-3.41E-03	0
175.751	367.083	202.778	-318.892	9857.79	3.90E-03	-2.44E-03	4.88E-04
175.741	366.489	209.141	-318.249	9857.79	3.41E-03	-2.44E-03	-4.88E-04
175.736	365.948	208.944	-319.679	9857.79	2.44E-03	-3.41E-03	-4.88E-04
175.712	365.406	206.774	-319.433	9857.24	3.41E-03	-3.90E-03	4.88E-04
175.76	365.011	212.446	-318.398	9858.34	3.90E-03	-7.32E-03	9.76E-04
175.751	364.616	213.975	-318.644	9858.89	3.90E-03	-2.93E-03	4.88E-04
175.746	364.321	211.904	-318.398	9857.79	2.93E-03	-3.90E-03	0
175.78	364.023	210.72	-319.088	9857.79	3.41E-03	-1.46E-03	-4.88E-04
175.838	363.777	211.854	-318.644	9856.69	3.41E-03	-1.95E-03	9.76E-04
175.858	363.432	206.527	-319.187	9857.79	3.90E-03	-7.80E-03	0
175.843	363.087	204.356	-319.286	9856.69	3.41E-03	-5.85E-03	0
175.843	362.89	206.576	-318.447	9857.79	3.41E-03	-5.85E-03	0
175.79	362.495	207.76	-319.384	9856.69	2.93E-03	-7.32E-03	0
175.79	362.297	203.518	-318.989	9858.34	3.90E-03	-4.88E-03	0
175.765	362.051	202.729	-318.989	9858.34	3.90E-03	-3.41E-03	0
175.76	361.902	202.778	-318.743	9857.24	3.41E-03	-5.85E-03	4.88E-04
175.776	361.656	204.603	-318.792	9857.24	2.93E-03	-5.85E-03	4.88E-04
175.736	361.507	207.069	-318.594	9856.69	3.90E-03	-2.93E-03	9.76E-04
175.721	361.311	207.859	-319.237	9858.34	3.41E-03	-1.95E-03	-4.88E-04
175.751	361.115	206.724	-318.939	9857.79	2.93E-03	-1.95E-03	0
175.721	361.115	202.729	-318.693	9857.24	2.44E-03	-2.93E-03	-4.88E-04
175.731	361.015	204.061	-319.038	9857.24	2.93E-03	-6.34E-03	0
175.726	360.817	203.715	-318.892	9857.79	2.44E-03	-5.37E-03	-9.76E-04

175.697	360.72	203.123	-318.447	9856.69	3.41E-03	-9.76E-04	0	6.46916
175.677	360.62	206.576	-318.693	9856.69	2.93E-03	-2.44E-03	0	6.46967
175.697	360.62	208.105	-318.546	9856.69	2.93E-03	-2.44E-03	0	6.46722
175.668	360.769	210.523	-319.038	9858.34	3.41E-03	-4.88E-03	4.88E-04	6.46967
175.682	360.72	202.235	-318.546	9857.79	3.41E-03	-2.93E-03	9.76E-04	6.47452
175.682	360.72	201.496	-319.187	9857.24	3.90E-03	-3.41E-03	0	6.46818
175.687	360.521	203.765	-319.632	9858.89	3.41E-03	-5.37E-03	9.76E-04	6.47208
175.682	360.521	207.217	-318.298	9857.24	2.93E-03	-3.90E-03	-4.88E-04	6.47306
175.707	360.424	209.93	-319.088	9858.89	3.41E-03	-4.39E-03	4.88E-04	6.46868
175.721	360.325	206.281	-318.892	9858.34	3.41E-03	-6.83E-03	0	6.46818
175.697	360.424	206.576	-319.237	9856.69	2.44E-03	-5.37E-03	0	6.46967
175.726	360.374	209.388	-318.594	9857.79	3.41E-03	-5.37E-03	4.88E-04	6.46916
175.755	360.325	205.541	-319.088	9858.34	2.93E-03	-4.39E-03	4.88E-04	6.47306
175.755	360.126	202.532	-318.842	9858.34	2.93E-03	-3.90E-03	0	6.47208
175.776	360.029	204.801	-319.237	9857.79	3.41E-03	-1.46E-03	4.88E-04	6.46868
175.776	359.93	202.187	-318.348	9857.24	3.41E-03	-6.83E-03	4.88E-04	6.46818
175.776	359.98	202.137	-319.038	9857.24	3.41E-03	-7.80E-03	4.88E-04	6.47259
175.824	359.98	206.872	-318.743	9857.24	3.41E-03	-7.32E-03	4.88E-04	6.4716
175.882	360.029	200.114	-318.546	9855.59	3.41E-03	-7.32E-03	0	6.46818
175.887	359.98	166.623	-318.842	9857.24	4.88E-04	-4.88E-03	4.88E-04	6.47062
175.873	359.93	179.37	-319.138	9857.24	2.44E-03	-6.83E-03	-9.76E-04	6.47062
175.819	359.732	192.321	-319.237	9855.1	2.44E-03	-7.32E-03	-4.88E-04	6.47062
175.78	359.732	197.625	-319.286	9856.14	2.44E-03	-6.83E-03	-4.88E-04	6.46967
175.731	359.585	201.527	-318.693	9855.59	3.41E-03	-5.37E-03	0	6.46672
175.731	359.585	206.923	-318.842	9855.1	3.41E-03	-2.44E-03	0	6.46967
175.731	359.634	204.897	-319.286	9856.14	3.41E-03	-4.88E-03	4.88E-04	6.47062
175.726	359.535	202.323	-318.546	9856.14	2.93E-03	-3.90E-03	0	6.47259
175.741	359.486	209.893	-318.939	9857.24	2.93E-03	-8.29E-03	0	6.47306
175.809	359.386	207.334	-318.546	9857.24	2.44E-03	-7.32E-03	-4.88E-04	6.46916
175.829	359.386	206.557	-319.138	9857.24	4.39E-03	-1.46E-03	4.88E-04	6.46868
175.785	359.289	209.971	-318.497	9857.24	2.93E-03	-2.93E-03	0	6.47062
175.673	359.19	208.305	-318.447	9858.34	3.90E-03	-3.90E-03	4.88E-04	6.47014
175.702	359.19	205.488	-318.447	9857.24	3.90E-03	-2.44E-03	4.88E-04	6.47306
175.692	359.19	203.72	-319.582	9857.24	3.90E-03	-2.44E-03	4.88E-04	6.47357
175.736	359.24	207.637	-319.384	9857.24	3.41E-03	-2.44E-03	0	6.47357
175.78	359.19	208.257	-318.644	9857.79	3.41E-03	-1.46E-03	4.88E-04	6.47259
175.765	359.24	210.205	-318.939	9856.69	3.41E-03	-4.39E-03	0	6.46818
175.804	359.289	207.954	-319.088	9856.69	3.41E-03	-5.37E-03	0	6.47357
175.853	359.289	210.152	-318.594	9858.34	2.44E-03	-1.95E-03	0	6.47014
175.878	359.24	208.027	-319.679	9858.34	3.41E-03	-1.95E-03	0	6.46916
175.843	358.994	205.933	-319.286	9857.24	3.41E-03	-4.88E-04	4.88E-04	6.47306
175.858	358.845	203.939	-318.497	9858.34	3.90E-03	-4.88E-03	9.76E-04	6.46818
175.941	358.648	205.708	-319.187	9856.69	2.93E-03	-4.39E-03	-4.88E-04	6.47014
175.917	358.648	208.252	-318.497	9858.34	3.90E-03	-4.88E-03	4.88E-04	6.46818
175.926	358.599	210.02	-318.594	9857.79	2.93E-03	-2.44E-03	-4.88E-04	6.46868
175.961	358.549	210.723	-319.138	9857.79	3.90E-03	-3.41E-03	9.76E-04	6.46967
175.926	358.549	214.068	-318.497	9857.79	3.90E-03	-1.46E-03	4.88E-04	6.4677
175.878	358.5	211.475	-318.892	9857.79	3.90E-03	-1.46E-03	9.76E-04	6.47014
175.902	358.5	210.274	-319.138	9857.24	2.93E-03	-3.41E-03	4.88E-04	6.46967
175.985	358.351	209.599	-318.644	9857.79	3.41E-03	-7.32E-03	4.88E-04	6.47014
175.981	358.253	207.197	-319.138	9856.14	3.90E-03	-4.88E-03	0	6.47405
175.931	358.204	207.598	-318.939	9856.69	3.41E-03	-5.85E-03	0	6.46916
175.907	358.154	206.694	-319.187	9857.24	2.93E-03	-7.32E-03	0	6.47062
175.931	358.055	207.847	-319.532	9857.24	3.90E-03	4.88E-04	4.88E-04	6.46818
175.887	358.105	210.46	-318.594	9858.34	2.44E-03	-5.85E-03	0	6.46868
175.97	358.006	214.02	-319.138	9857.24	2.93E-03	-6.34E-03	0	6.47306

175.99	357.908	212.134	-318.989	9857.24	3.90E-03	-6.34E-03	4.88E-04	6.46868
176.009	357.809	208.027	-318.892	9856.69	2.93E-03	-8.29E-03	4.88E-04	6.47062
176.024	357.759	205.795	-318.842	9858.89	3.90E-03	-2.93E-03	4.88E-04	6.46818
176.059	357.611	205.791	-318.989	9857.24	3.41E-03	-6.34E-03	0	6.47259
176.048	357.513	204.78	-318.892	9857.24	3.90E-03	-6.34E-03	4.88E-04	6.46868
176.083	357.464	207.827	-318.792	9857.24	3.41E-03	-6.83E-03	4.88E-04	6.47014
176.039	357.464	212.486	-318.693	9857.24	2.93E-03	-6.83E-03	-4.88E-04	6.46722
176.024	357.265	212.682	-318.792	9857.79	3.90E-03	-1.46E-03	0	6.47113
176.024	357.119	209.673	-318.546	9857.79	3.90E-03	-4.39E-03	9.76E-04	6.47306
176.014	356.92	210.889	-318.693	9857.79	3.41E-03	-6.34E-03	0	6.46916
176.064	356.773	214.015	-318.842	9857.79	3.41E-03	-6.34E-03	4.88E-04	6.47113
176.092	356.625	214.181	-319.138	9857.24	3.90E-03	-1.46E-03	4.88E-04	6.46868
176.014	356.527	211.573	-319.237	9857.24	2.93E-03	-2.44E-03	4.88E-04	6.46967
175.956	356.428	209.62	-318.693	9856.69	3.41E-03	-8.78E-03	4.88E-04	6.47259
175.912	356.428	211.876	-318.594	9856.14	3.90E-03	-4.88E-03	9.76E-04	6.47306
175.975	356.279	210.918	-319.088	9856.69	2.93E-03	-2.93E-03	0	6.47014
175.995	356.182	211.641	-318.842	9858.34	3.41E-03	-5.37E-03	0	6.47208
176.014	356.133	211.573	-318.892	9856.69	2.93E-03	-3.90E-03	4.88E-04	6.47113
176.053	356.083	211.778	-319.334	9857.24	3.41E-03	-2.93E-03	0	6.47259
176.039	355.934	213.912	-318.743	9857.79	3.41E-03	-5.37E-03	4.88E-04	6.46967
176.029	355.984	212.53	-318.693	9857.24	3.41E-03	-4.39E-03	4.88E-04	6.46672
176.073	355.984	214.782	-319.088	9857.79	3.90E-03	-5.37E-03	4.88E-04	6.47306
176.083	355.984	211.788	-318.939	9856.14	3.41E-03	-7.80E-03	4.88E-04	6.46868
176.039	355.885	213.121	-318.792	9856.14	3.41E-03	-7.80E-03	0	6.46967
176.014	355.638	213.702	-319.138	9857.79	3.41E-03	-5.85E-03	4.88E-04	6.47014
176.034	355.392	211.466	-318.989	9857.79	3.41E-03	-1.95E-03	4.88E-04	6.46624
176.024	355.145	209.765	-318.892	9856.69	3.41E-03	-2.93E-03	0	6.47113
176.059	355.244	210.796	-319.334	9857.24	3.90E-03	-8.29E-03	-4.88E-04	6.46916
176.059	355.293	210.259	-318.497	9856.69	2.93E-03	-4.39E-03	-4.88E-04	6.46916
176.078	355.343	213.746	-318.792	9857.79	3.41E-03	-6.34E-03	0	6.47113
176.112	355.293	211.416	-318.693	9858.34	3.41E-03	-3.90E-03	4.88E-04	6.46818
176.142	355.343	211.04	-318.939	9858.34	3.90E-03	-5.85E-03	4.88E-04	6.4716
176.166	355.293	209.751	-318.842	9856.69	3.41E-03	-3.41E-03	4.88E-04	6.47062
176.136	355.244	205.082	-319.187	9857.24	2.93E-03	-7.80E-03	4.88E-04	6.46967
176.151	355.194	206.489	-319.038	9856.14	3.41E-03	-6.83E-03	4.88E-04	6.4716
176.151	355.047	207.465	-319.187	9857.24	3.41E-03	-3.90E-03	4.88E-04	6.4716
176.161	354.849	206.382	-319.286	9856.69	3.41E-03	-4.39E-03	4.88E-04	6.46722
176.195	354.752	207.314	-318.792	9856.69	2.93E-03	-7.32E-03	0	6.46967
176.195	354.603	205.737	-318.594	9856.69	2.93E-03	-3.90E-03	-4.88E-04	6.46967
176.175	354.603	210.977	-318.743	9856.69	3.41E-03	-4.39E-03	0	6.47259
176.234	354.553	208.203	-318.792	9857.79	2.93E-03	-2.93E-03	0	6.47208
176.249	354.454	212.355	-319.187	9857.79	3.41E-03	-4.88E-03	0	6.47014
176.234	354.406	209.17	-318.693	9857.79	3.90E-03	-2.93E-03	4.88E-04	6.4677
176.273	354.307	207.969	-318.348	9858.89	3.41E-03	-4.39E-03	4.88E-04	6.47259
176.264	354.208	208.379	-318.892	9857.24	2.93E-03	-7.32E-03	-4.88E-04	6.47113
176.214	354.208	209.654	-318.546	9857.79	3.41E-03	-4.39E-03	4.88E-04	6.46818
176.166	354.109	206.249	-318.546	9857.79	2.93E-03	-5.85E-03	-4.88E-04	6.47062
176.2	354.012	205.668	-318.842	9856.69	3.90E-03	-4.88E-03	4.88E-04	6.47062
176.136	354.059	207.066	-319.038	9857.24	3.41E-03	-5.85E-03	4.88E-04	6.46672
176.107	353.912	206.108	-319.138	9856.14	3.90E-03	-2.44E-03	9.76E-04	6.4716
176.112	353.863	205.913	-319.582	9856.69	2.44E-03	-3.90E-03	-4.88E-04	6.47062
176.142	353.714	206.87	-319.038	9857.79	3.41E-03	-4.88E-03	4.88E-04	6.47259
176.161	353.518	208.135	-318.939	9857.79	3.41E-03	-6.83E-03	4.88E-04	6.47208
176.156	353.321	207.886	-318.743	9857.79	3.90E-03	-7.32E-03	4.88E-04	6.47208
176.107	353.271	206.493	-318.792	9856.69	2.93E-03	-6.34E-03	-4.88E-04	6.47062
176.097	353.222	208.105	-318.989	9857.79	3.41E-03	-1.95E-03	4.88E-04	6.4716

176.103	353.222	208.344	-318.792	9856.14	3.90E-03	-2.93E-03	9.76E-04	6.47259
176.073	353.172	211.588	-318.892	9857.24	2.93E-03	-5.37E-03	0	6.46868
176.107	353.073	207.266	-318.939	9857.24	3.41E-03	-6.83E-03	4.88E-04	6.4716
176.126	352.877	206.596	-318.447	9857.24	3.41E-03	-7.32E-03	0	6.46868
176.107	352.877	211.699	-319.237	9857.79	3.41E-03	-5.85E-03	-4.88E-04	6.46818
176.112	352.728	210.357	-318.497	9857.24	2.93E-03	-3.41E-03	4.88E-04	6.4677
176.092	352.777	213.433	-318.693	9857.24	2.93E-03	-9.76E-04	4.88E-04	6.47208
176.112	352.631	210.748	-318.842	9857.24	2.44E-03	-9.76E-04	0	6.47014
176.117	352.482	209.111	-319.237	9857.24	3.41E-03	-1.46E-03	0	6.4716
176.175	352.283	214.151	-318.447	9856.69	3.90E-03	-5.85E-03	4.88E-04	6.47062
176.186	352.137	210.865	-319.384	9857.24	3.90E-03	-4.39E-03	1.46E-03	6.47208
176.17	351.938	212.623	-318.348	9857.79	3.41E-03	-6.83E-03	0	6.47014
176.186	351.891	213.062	-318.693	9856.69	3.41E-03	-3.41E-03	0	6.47259
176.103	351.692	207.651	-319.384	9857.24	3.41E-03	-3.41E-03	4.88E-04	6.46967
176.02	351.545	210.704	-318.842	9856.69	3.41E-03	-5.37E-03	0	6.47259
175.97	351.347	210.147	-319.483	9858.34	3.90E-03	-4.88E-03	0	6.46967
175.917	351.101	203.939	-318.989	9857.79	3.41E-03	-3.41E-03	4.88E-04	6.46868
175.868	350.805	207.637	-319.138	9856.69	2.93E-03	-3.90E-03	0	6.47113
175.868	350.557	209.981	-318.348	9857.24	3.41E-03	-8.78E-03	0	6.47208
175.902	350.311	208.364	-318.842	9856.69	3.41E-03	-4.39E-03	0	6.47062
175.965	350.212	210.088	-318.792	9856.69	3.41E-03	-6.34E-03	0	6.46967
176.044	350.115	210.011	-319.187	9857.24	2.93E-03	-7.80E-03	-4.88E-04	6.47062
176.053	350.016	210.987	-318.792	9856.69	3.90E-03	0	9.76E-04	6.47014
176.053	349.867	210.049	-318.743	9858.34	3.41E-03	-9.76E-04	0	6.47014
176.009	349.77	208.174	-318.644	9856.69	3.41E-03	-1.46E-03	0	6.4716
175.975	349.72	201.683	-318.989	9856.69	3.41E-03	-2.93E-03	0	9.27299
175.956	349.522	204.579	-319.038	9856.14	3.41E-03	-4.39E-03	0	9.26572
175.898	349.472	205.043	-319.483	9857.24	2.93E-03	-2.93E-03	-4.88E-04	9.26131
175.863	349.375	207.72	-318.546	9857.24	3.41E-03	-5.37E-03	9.76E-04	9.25934
175.829	349.276	206.518	-319.138	9857.79	3.90E-03	-4.88E-03	0	9.26083
175.814	349.03	210.499	-318.892	9857.24	2.93E-03	-1.46E-03	-4.88E-04	9.26083
175.776	348.831	208.188	-319.384	9856.69	3.41E-03	-4.39E-03	-4.88E-04	9.26518
175.76	348.635	207.768	-318.842	9857.24	2.93E-03	-2.93E-03	0	9.26518
175.785	348.585	208.286	-318.743	9858.34	2.93E-03	-6.83E-03	0	9.25791
175.776	348.339	209.682	-319.286	9856.69	3.41E-03	-8.29E-03	0	9.26518
175.799	348.141	207.954	-319.286	9856.14	3.41E-03	-5.85E-03	0	9.26423
175.78	347.994	205.088	-319.187	9856.14	3.41E-03	-6.83E-03	4.88E-04	9.26131
175.804	347.895	206.308	-318.743	9857.24	3.41E-03	-3.41E-03	0	9.2628
175.829	347.649	209.56	-319.433	9857.79	3.41E-03	-9.76E-04	4.88E-04	9.2569
175.79	347.5	204.077	-318.546	9858.89	2.93E-03	-1.46E-03	0	9.26518
175.799	347.254	205.849	-318.989	9857.79	2.44E-03	-6.83E-03	-9.76E-04	9.26083
175.834	346.958	205.443	-318.939	9857.79	3.41E-03	-4.39E-03	4.88E-04	9.26036
175.77	346.76	206.025	-318.348	9857.24	3.41E-03	-2.44E-03	-4.88E-04	9.26226
175.751	346.71	209.937	-319.138	9858.34	2.93E-03	-4.88E-03	-4.88E-04	9.2569
175.726	346.464	209.233	-318.892	9857.24	2.93E-03	-7.32E-03	0	9.26471
175.736	346.266	209.199	-319.088	9857.24	3.41E-03	-4.39E-03	4.88E-04	9.26328
175.77	346.02	208.003	-318.989	9857.24	3.41E-03	-1.46E-03	0	9.25744
175.776	345.774	209.995	-318.989	9856.69	3.41E-03	-2.44E-03	0	9.26083
175.731	345.575	214.865	-318.792	9856.69	2.44E-03	-3.41E-03	0	9.26179
175.76	345.379	210.987	-319.088	9857.24	3.90E-03	-6.34E-03	9.76E-04	9.26864
175.736	345.28	211.329	-318.447	9856.14	2.93E-03	-8.29E-03	0	9.25791
175.741	345.182	212.008	-318.842	9857.24	2.93E-03	-7.80E-03	0	9.25446
175.765	345.133	215.807	-318.398	9857.24	2.93E-03	-6.83E-03	0	9.26131
175.751	344.984	216.359	-318.644	9857.24	3.90E-03	-5.85E-03	4.88E-04	9.26328
175.746	344.738	217.711	-318.693	9856.69	3.90E-03	-6.83E-03	4.88E-04	9.25982
175.755	344.49	212.867	-318.447	9857.24	3.90E-03	-3.41E-03	0	9.26328

175.731	344.244	214.186	-318.644	9857.24	2.93E-03	-2.44E-03	0	9.25934
175.751	343.948	210.444	-319.334	9857.79	3.41E-03	-2.44E-03	4.88E-04	9.26083
175.751	343.752	209.722	-318.497	9857.24	2.44E-03	-2.44E-03	-4.88E-04	9.25791
175.731	343.702	208.379	-318.693	9857.24	3.41E-03	-7.80E-03	0	9.26572
175.731	343.752	215.353	-318.743	9857.24	4.39E-03	-5.37E-03	9.76E-04	9.26226
175.746	343.702	213.414	-319.187	9857.24	2.93E-03	-4.88E-03	4.88E-04	9.25744
175.716	343.702	209.883	-319.237	9856.69	3.41E-03	-2.44E-03	4.88E-04	9.26375
175.673	343.752	212.632	-318.546	9857.79	2.93E-03	-1.46E-03	0	9.26131
175.677	343.653	211.988	-319.532	9856.69	2.93E-03	-1.95E-03	4.88E-04	9.25791
175.673	343.702	211.061	-318.594	9856.69	2.93E-03	-1.95E-03	-9.76E-04	9.2628
175.648	343.554	211.021	-319.334	9856.69	3.41E-03	-7.80E-03	0	9.2628
175.658	343.454	202.293	-318.892	9857.79	3.41E-03	-6.34E-03	4.88E-04	9.26375
175.721	343.407	203.202	-318.939	9858.34	3.41E-03	-6.34E-03	0	9.25595
175.731	343.159	210.425	-318.102	9856.69	3.41E-03	-4.39E-03	9.76E-04	9.26328
175.785	342.764	210.967	-319.828	9856.14	3.41E-03	-5.37E-03	9.76E-04	9.26131
175.77	336.401	208.061	-318.939	9856.14	3.41E-03	-6.83E-03	-4.88E-04	9.26375
175.76	313.267	206.484	-318.939	9856.69	3.90E-03	-2.93E-03	4.88E-04	9.26375
175.731	281.353	210.587	-319.286	9857.79	3.41E-03	-6.34E-03	0	9.2628
175.712	257.185	211.66	-318.497	9856.14	2.93E-03	-5.85E-03	-4.88E-04	9.25887
175.726	243.127	215.094	-319.334	9856.69	2.44E-03	-6.34E-03	-4.88E-04	9.26083
175.721	237.355	218.727	-318.842	9856.69	2.93E-03	-8.29E-03	-9.76E-04	9.26036
175.712	235.136	211.231	-318.989	9857.24	3.90E-03	-2.93E-03	4.88E-04	9.26131
175.697	234.199	211.549	-318.497	9857.24	2.93E-03	-5.85E-03	4.88E-04	9.25839
175.677	233.706	211.289	-318.348	9857.24	2.93E-03	-5.85E-03	4.88E-04	9.2569
175.716	233.41	214.044	-318.249	9855.59	3.90E-03	-8.78E-03	4.88E-04	9.26083
175.736	233.212	217.321	-319.582	9855.1	3.90E-03	-6.83E-03	9.76E-04	9.25982
175.751	233.065	211.768	-318.497	9857.24	3.41E-03	-5.85E-03	4.88E-04	9.26083
175.721	232.916	209.912	-319.187	9856.69	2.93E-03	-2.44E-03	0	9.25595
175.707	232.719	207.041	-318.693	9857.24	3.90E-03	-3.90E-03	4.88E-04	9.25982
175.716	232.325	209.595	-318.892	9856.69	3.41E-03	-4.88E-03	4.88E-04	9.26083
175.77	231.832	210.591	-317.558	9856.14	2.44E-03	-1.46E-03	4.88E-04	9.25982
175.804	231.239	210.073	-319.038	9855.1	3.90E-03	-6.83E-03	4.88E-04	9.25499
175.804	230.549	211.671	-319.237	9855.59	3.41E-03	-2.44E-03	9.76E-04	9.2628
175.78	229.71	206.562	-318.743	9855.59	2.93E-03	-3.90E-03	-4.88E-04	9.26226
175.746	228.724	207.543	-319.237	9855.59	3.41E-03	-5.85E-03	0	9.26083
175.751	227.638	208.652	-319.088	9856.69	3.41E-03	-4.88E-03	4.88E-04	9.25839
175.721	226.652	209.434	-318.644	9854.55	2.44E-03	-5.37E-03	0	6.47843
175.697	225.567	211.617	-318.792	9855.1	2.93E-03	-8.29E-03	-4.88E-04	12.6354
175.726	224.432	206.274	-319.038	9856.14	3.41E-03	-7.32E-03	4.88E-04	12.6266
175.692	223.298	208.994	-318.151	9856.69	3.90E-03	-6.34E-03	4.88E-04	12.6315
175.716	222.261	212.15	-318.842	9855.59	3.41E-03	-7.80E-03	0	12.6115
175.736	221.275	213.165	-318.644	9854.55	4.39E-03	-4.39E-03	4.88E-04	12.5949
175.721	220.437	219.934	-318.546	9856.14	3.90E-03	-2.93E-03	0	12.6042
175.731	219.5	210.821	-319.038	9856.14	3.41E-03	-6.34E-03	4.88E-04	12.6364
175.697	218.711	210.982	-318.892	9856.69	3.90E-03	-2.44E-03	-4.88E-04	12.6393
175.702	218.019	211.505	-319.433	9856.14	2.93E-03	-3.41E-03	4.88E-04	12.6027
175.751	217.379	211.734	-319.187	9856.14	3.41E-03	-1.95E-03	0	12.6023
175.809	216.886	208.335	-318.693	9856.69	2.93E-03	-6.34E-03	0	12.6178
175.795	216.343	211.011	-318.743	9856.14	2.93E-03	-7.32E-03	0	12.6276
175.765	215.85	211.353	-318.939	9857.24	3.41E-03	-4.88E-03	0	12.6291
175.765	215.455	209.571	-318.989	9856.69	3.41E-03	-2.93E-03	4.88E-04	12.61
175.804	215.11	208.033	-319.187	9855.59	3.41E-03	-5.85E-03	4.88E-04	12.591
175.819	214.813	210.826	-318.989	9855.59	3.41E-03	-5.85E-03	0	12.6315
175.795	214.617	212.399	-318.989	9857.24	2.93E-03	-7.80E-03	4.88E-04	12.5988
175.755	214.37	206.596	-318.989	9856.69	3.41E-03	-7.32E-03	4.88E-04	12.63
175.736	214.172	208.76	-318.546	9855.59	2.93E-03	-8.29E-03	0	12.6188

175.707	213.975	211.407	-319.088	9856.14	4.39E-03	-2.44E-03	9.76E-04	12.5998
175.721	213.925	209.571	-318.644	9856.14	3.90E-03	-3.90E-03	4.88E-04	12.6188
175.741	213.679	209.712	-319.237	9856.14	3.41E-03	-1.95E-03	4.88E-04	12.6256
175.746	213.58	209.668	-319.433	9856.69	3.41E-03	-3.41E-03	9.76E-04	12.6173
175.736	213.482	209.56	-318.892	9856.69	3.41E-03	-9.76E-04	4.88E-04	12.6057
175.785	213.432	208.632	-318.989	9855.59	2.93E-03	-1.46E-03	-4.88E-04	12.6184
175.907	213.432	207.603	-318.792	9856.14	3.41E-03	-6.83E-03	4.88E-04	12.6276
175.946	213.432	209.585	-318.693	9855.59	3.41E-03	-7.80E-03	0	12.5974
175.975	213.284	207.515	-318.842	9855.59	3.41E-03	-2.93E-03	0	12.6061
175.941	213.334	210.923	-319.632	9855.59	3.41E-03	-4.88E-03	4.88E-04	12.6403
175.951	213.235	210.826	-318.348	9855.59	3.90E-03	-9.76E-04	4.88E-04	12.5969
176.009	213.235	212.682	-318.497	9855.59	3.90E-03	-2.44E-03	1.46E-03	12.6076
176.039	213.186	216.613	-318.989	9856.14	3.90E-03	-1.46E-03	4.88E-04	12.6222
176.078	213.186	210.728	-318.594	9856.69	3.41E-03	-5.85E-03	4.88E-04	12.6057
176.029	213.186	208.662	-319.384	9857.79	2.93E-03	-5.37E-03	4.88E-04	12.6106
175.97	213.186	208.867	-318.743	9856.69	2.93E-03	-4.39E-03	0	12.6091
175.946	213.137	211.084	-317.904	9856.14	3.41E-03	-6.34E-03	4.88E-04	12.6383
175.898	213.087	213.287	-319.187	9856.14	3.41E-03	-2.93E-03	0	12.6017
175.848	213.137	211.949	-318.003	9856.69	2.44E-03	-3.41E-03	-9.76E-04	12.5852
175.838	213.087	209.698	-318.939	9856.69	3.41E-03	-4.88E-03	4.88E-04	12.6271
175.937	213.087	212.173	-318.743	9855.1	3.90E-03	-7.80E-03	0	12.6091
175.912	213.087	209.599	-318.892	9857.24	3.41E-03	-2.44E-03	9.76E-04	12.6013
175.931	213.087	213.82	-318.546	9856.14	4.39E-03	-2.44E-03	0	12.6061
175.878	213.137	208.521	-318.939	9856.14	3.41E-03	-1.46E-03	0	12.6266
175.887	213.087	212.15	-318.892	9856.14	2.44E-03	-1.46E-03	-4.88E-04	12.6213
175.902	213.037	210.826	-319.138	9856.69	3.90E-03	-6.34E-03	4.88E-04	12.6027
175.898	213.087	208.047	-318.892	9856.14	3.41E-03	-5.37E-03	4.88E-04	12.6149
175.887	213.087	208.54	-318.939	9857.24	2.93E-03	-6.34E-03	0	12.6359
175.873	213.037	209.175	-318.693	9856.69	3.41E-03	-9.76E-04	4.88E-04	12.6042
175.912	213.087	209.307	-318.497	9857.24	3.41E-03	-2.93E-03	4.88E-04	12.5988
175.912	213.037	210.616	-318.348	9856.14	2.44E-03	-3.90E-03	4.88E-04	12.6154
175.898	213.137	208.105	-318.743	9857.79	3.90E-03	-6.34E-03	4.88E-04	12.6339
175.814	212.989	208.125	-319.138	9856.14	2.93E-03	-7.80E-03	0	12.614
175.79	213.037	210.122	-318.594	9857.24	3.90E-03	-3.90E-03	4.88E-04	12.5847
175.829	213.037	211.529	-318.249	9856.69	3.41E-03	-5.85E-03	4.88E-04	12.6178
175.892	213.037	205.282	-319.038	9857.79	3.90E-03	-5.37E-03	0	12.6252
175.926	213.087	205.546	-318.743	9856.69	3.41E-03	-2.44E-03	4.88E-04	12.6008
175.99	212.989	205.629	-318.693	9856.69	3.41E-03	-4.88E-03	4.88E-04	12.5979
176.029	212.989	209.615	-318.546	9856.14	3.90E-03	-5.85E-03	9.76E-04	12.6135
176.034	213.087	208.526	-319.187	9856.14	4.39E-03	-1.46E-03	4.88E-04	12.632
176.083	213.037	209.419	-319.088	9857.24	3.41E-03	-1.95E-03	1.46E-03	12.5945
176.142	213.037	207.788	-318.892	9857.24	3.41E-03	-4.88E-03	4.88E-04	12.612
176.181	213.087	209.981	-319.088	9858.34	3.41E-03	-5.37E-03	0	12.6393
176.17	212.989	208.037	-318.249	9856.69	2.93E-03	-7.32E-03	-9.76E-04	12.6091
176.2	212.989	208.349	-318.939	9856.69	2.44E-03	-7.32E-03	-4.88E-04	12.6023
176.214	212.989	209.288	-318.743	9857.24	3.41E-03	-5.37E-03	4.88E-04	12.6115
176.166	212.989	209.629	-318.939	9856.69	4.39E-03	-7.80E-03	0	12.6403
176.097	212.939	207.9	-318.842	9856.69	3.41E-03	-6.34E-03	0	12.6013
176.034	212.989	208.643	-318.792	9856.69	3.90E-03	-3.41E-03	0	12.6149
175.981	212.89	209.136	-318.447	9857.79	3.41E-03	-3.90E-03	0	12.6169
175.97	212.89	207.656	-318.497	9856.14	2.44E-03	-7.32E-03	-4.88E-04	12.6334
175.965	212.989	208.037	-318.743	9856.69	2.93E-03	-3.90E-03	-4.88E-04	12.6027
175.965	212.939	202.528	-318.298	9857.24	3.41E-03	-6.34E-03	9.76E-04	12.6198
175.961	212.989	204.428	-319.038	9856.69	3.41E-03	-2.93E-03	0	12.6281
176	212.939	211.959	-318.792	9858.34	2.93E-03	-1.95E-03	0	12.6159
176.014	212.89	211.441	-318.743	9857.79	2.44E-03	-6.83E-03	-9.76E-04	12.5979

176.068	212.989	205.302	-318.497	9857.24	3.41E-03	-1.95E-03	4.88E-04	12.5949
176.126	212.89	203.969	-319.088	9856.69	3.41E-03	-4.39E-03	0	12.6345
176.161	212.89	206.518	-319.088	9856.69	3.41E-03	-6.34E-03	4.88E-04	12.5979
176.175	212.989	205.83	-318.989	9857.24	3.41E-03	-5.37E-03	0	12.5979
176.186	212.89	206.391	-319.237	9856.69	2.93E-03	-6.83E-03	-4.88E-04	12.6154
176.195	212.841	207.554	-318.398	9856.69	2.93E-03	-1.46E-03	4.88E-04	12.5998
176.19	212.841	207.632	-319.138	9856.14	3.41E-03	-2.93E-03	4.88E-04	12.6149
176.186	212.791	211.372	-318.497	9856.14	2.93E-03	-7.32E-03	0	12.5901
176.147	212.841	209.454	-318.743	9856.14	3.41E-03	-4.39E-03	4.88E-04	12.6359
176.142	212.791	211.084	-319.088	9856.69	4.39E-03	-2.44E-03	9.76E-04	12.6266
176.147	212.692	213.497	-319.237	9855.1	3.41E-03	-3.41E-03	-4.88E-04	12.6027
176.126	212.692	207.417	-319.384	9856.69	2.93E-03	-7.80E-03	-4.88E-04	12.6091
176.107	212.594	207.368	-318.743	9861.02	3.90E-03	-6.83E-03	9.76E-04	12.6256
176.083	212.544	248.849	-318.644	9844.79	9.76E-04	-1.46E-03	0	12.6115
176.059	212.446	215.998	-318.644	9773.13	2.93E-03	-1.95E-03	4.88E-04	12.5979
176.053	212.298	201.151	-319.483	9803.53	3.41E-03	-5.37E-03	4.88E-04	12.6237
176.064	212.199	246.579	-308.977	9773.68	3.41E-03	-6.34E-03	4.88E-04	12.613
176.009	212.101	211.756	-319.187	9603.33	4.39E-03	-6.34E-03	1.46E-03	12.6032
176	211.953	210.177	-319.286	9846.38	3.41E-03	-7.32E-03	0	12.6125
176.053	212.002	210.375	-318.348	9849.67	3.90E-03	-2.44E-03	9.76E-04	12.6213
176.044	212.002	214.813	-318.102	9852.36	3.41E-03	-4.39E-03	0	12.6042
176.059	212.002	338.572	-287.125	6514.53	1.46E-03	-5.37E-03	-9.76E-04	12.6008
176.073	212.002	242.634	-310.949	4822.81	1.95E-03	-3.90E-03	0	12.61
176.044	212.002	261.328	-319.138	9805.72	2.93E-03	-6.83E-03	0	12.6256
176.034	211.953	253.386	-319.038	9856.14	4.39E-03	-5.37E-03	1.46E-03	12.6076
175.975	212.051	321.159	-287.716	7446.66	2.44E-03	-4.88E-03	0	12.6081
176.014	211.953	318.102	-288.063	4762.6	2.44E-03	-8.29E-03	0	12.6169
175.965	211.904	318.693	-287.569	4751.19	1.95E-03	-9.27E-03	0	12.6037
175.951	212.002	327.276	-288.309	4749.57	1.95E-03	-3.90E-03	4.88E-04	12.5979
175.921	211.904	328.115	-288.16	4762.05	1.46E-03	-7.32E-03	0	12.6242
175.892	211.953	327.326	-288.111	4746.31	2.44E-03	-3.41E-03	-4.88E-04	12.61
175.902	212.002	329.447	-288.013	4748.5	9.76E-04	-3.41E-03	-4.88E-04	12.5901
175.921	211.953	331.814	-288.359	4747.41	1.46E-03	-5.85E-03	0	12.6218
175.892	212.051	329.348	-288.16	4746.31	1.95E-03	-3.90E-03	0	12.6184
175.946	212.002	328.806	-287.964	4749.02	2.44E-03	-4.88E-03	0	12.5979
175.975	212.051	329.348	-288.95	4749.02	2.44E-03	-2.93E-03	4.88E-04	12.6149
176.029	211.953	339.016	-287.619	4748.5	1.46E-03	-3.90E-03	4.88E-04	12.5871
176.044	212.051	331.469	-287.716	4746.31	2.44E-03	-6.83E-03	0	12.6383
176.122	212.101	325.5	-288.013	4746.86	1.46E-03	-1.46E-03	0	12.5998
176.186	217.576	328.953	-287.964	4744.69	1.46E-03	-3.90E-03	-4.88E-04	12.5969
176.209	243.965	326.042	-287.964	4762.05	1.95E-03	-5.85E-03	0	12.6086
176.126	274.103	323.874	-288.013	4758.79	1.46E-03	-5.37E-03	4.88E-04	12.6334
176.097	291.071	324.07	-287.914	4753.39	1.46E-03	-8.29E-03	0	12.5993
176.122	296.103	326.487	-288.111	4747.41	1.95E-03	-6.83E-03	9.76E-04	12.6159
176.112	296.989	323.528	-288.555	4745.79	2.44E-03	-2.93E-03	4.88E-04	12.6281
176.161	297.138	327.473	-287.766	4747.41	1.95E-03	-3.90E-03	0	12.6135
176.156	297.384	319.088	-288.359	4744.14	1.46E-03	-2.93E-03	0	12.6125
176.083	297.729	331.764	-287.964	4742.52	1.46E-03	-2.44E-03	0	12.5945
176.059	298.224	330.482	-287.914	4745.79	1.46E-03	-3.90E-03	4.88E-04	12.6208
176.142	298.864	326.241	-288.359	4747.41	1.95E-03	-3.90E-03	0	12.6247
176.181	299.654	330.532	-287.619	4744.69	1.95E-03	-3.41E-03	0	12.5905
176.2	300.69	323.576	-288.309	4761.5	1.95E-03	-4.88E-03	4.88E-04	12.5974
176.136	301.874	329.102	-288.16	4756.62	1.95E-03	-6.83E-03	-4.88E-04	12.6252
176.044	303.255	329.939	-287.964	4762.05	4.88E-04	-6.34E-03	-4.88E-04	12.63
175.965	304.686	330.631	-288.359	4762.05	1.46E-03	-5.37E-03	-4.88E-04	12.5959
175.961	306.164	330.236	-288.456	4747.41	1.46E-03	-2.93E-03	0	12.6042

175.961	307.594	328.115	-287.964	4748.5	1.95E-03	-3.90E-03	0	12.6017
175.941	308.977	325.945	-288.456	4744.69	1.46E-03	-2.44E-03	0	12.6154
175.965	310.259	332.998	-288.111	4747.96	1.46E-03	-6.83E-03	0	12.6213
175.956	311.443	322.935	-287.865	4750.67	1.46E-03	-3.90E-03	0	12.5861
175.99	312.33	329.988	-287.964	4745.79	1.95E-03	-2.44E-03	0	12.6252
176.059	313.267	319.729	-287.914	4747.41	1.95E-03	-3.41E-03	0	12.6291
176.034	313.959	323.675	-287.865	4756.62	1.95E-03	-5.37E-03	4.88E-04	12.5949
176.059	314.697	325.451	-288.359	4746.86	1.46E-03	-4.88E-03	0	12.5954
176.064	315.34	324.514	-287.766	4742.52	2.44E-03	-1.95E-03	0	12.6218
176	315.783	331.617	-288.26	4758.27	1.95E-03	-5.85E-03	4.88E-04	12.6281
175.956	315.882	326.387	-288.013	4751.19	1.95E-03	-9.27E-03	0	12.6095
175.941	315.981	325.846	-287.716	4758.79	1.46E-03	-8.29E-03	-4.88E-04	12.593
175.902	316.08	329.643	-288.654	4763.15	1.46E-03	-7.80E-03	-4.88E-04	12.6242
175.868	316.326	326.685	-288.309	4748.5	1.95E-03	-5.37E-03	0	12.631
175.79	316.473	330.137	-288.309	4744.69	1.95E-03	-3.41E-03	4.88E-04	12.592
175.77	316.376	326.635	-287.716	4747.41	1.95E-03	-3.41E-03	0	12.5979
175.746	316.08	329.348	-288.309	4744.14	9.76E-04	-2.93E-03	4.88E-04	12.6237
175.755	315.832	327.08	-288.063	4752.29	1.46E-03	-7.32E-03	-4.88E-04	12.6081
175.716	315.882	329.447	-288.21	4746.86	1.46E-03	-5.85E-03	4.88E-04	12.5915
175.776	316.08	320.864	-288.408	4747.96	1.95E-03	-6.34E-03	4.88E-04	12.611
175.853	316.128	331.123	-288.013	4751.19	1.46E-03	-8.29E-03	-9.76E-04	12.6383
175.926	316.128	333.935	-287.766	4745.79	2.44E-03	-9.76E-04	0	12.5934
175.956	316.128	327.967	-288.309	4746.31	9.76E-04	-2.93E-03	-4.88E-04	12.591
175.931	316.128	327.967	-287.964	4748.5	9.76E-04	-2.93E-03	-4.88E-04	12.6213
175.868	316.08	328.163	-288.26	4749.57	1.95E-03	-2.44E-03	9.76E-04	12.6135
175.848	316.08	335.218	-288.309	4746.31	1.95E-03	-2.44E-03	4.88E-04	12.6144
175.819	316.031	336.351	-288.408	4759.89	1.95E-03	-4.88E-03	9.76E-04	12.5969
175.785	315.981	231.93	-319.778	7293.64	2.44E-03	-3.41E-03	4.88E-04	12.6222
175.765	315.832	226.898	-319.483	9888.73	3.41E-03	-1.95E-03	4.88E-04	12.6262
175.76	315.586	219.5	-318.693	9893.62	4.39E-03	-6.34E-03	1.46E-03	12.5939
175.751	315.437	213.58	-319.038	9888.73	3.41E-03	-4.39E-03	-4.88E-04	12.6076
175.809	315.34	210.769	-319.187	9893.07	3.41E-03	-1.95E-03	4.88E-04	12.6296
175.863	315.191	231.832	-317.362	9877.87	3.41E-03	-2.93E-03	0	12.6193
175.921	315.142	222.656	-315.636	2582.05	1.46E-03	-6.34E-03	-4.88E-04	12.61
175.937	315.241	222.608	-315.388	709.648	4.88E-04	-4.88E-03	4.88E-04	12.6262
175.892	315.241	214.222	-315.536	329.546	0	-4.39E-03	0	12.6125
175.834	315.29	208.697	-315.142	135.142	-4.88E-04	-3.90E-03	-4.88E-04	12.6144
175.795	315.34	209.98	-315.437	104.717	0	-3.41E-03	0	12.5861
175.751	315.437	214.123	-315.34	99.174	-4.88E-04	-4.88E-03	-4.88E-04	12.6032
175.736	315.34	205.244	-315.685	102.163	-4.88E-04	-6.83E-03	-4.88E-04	12.5988
175.716	315.29	209.832	-315.735	90.6811	0	-3.90E-03	0	12.6266
175.726	315.241	207.514	-316.128	107.242	0	-5.85E-03	0	12.6144
175.712	315.29	215.505	-315.685	88.625	-4.88E-04	-2.93E-03	-4.88E-04	12.5964
175.687	315.29	214.863	-315.191	120.486	0	-6.83E-03	0	12.6193
175.682	315.34	211.706	-315.241	91.3014	0	-7.32E-03	0	12.632
175.673	315.29	215.208	-315.29	95.7112	0	-4.39E-03	-4.88E-04	12.5983
175.668	315.241	209.29	-315.142	87.9068	0	-2.44E-03	4.88E-04	12.6057
175.673	315.142	216.293	-315.191	93.0352	-9.76E-04	-3.41E-03	-4.88E-04	12.6247
175.643	315.092	215.751	-315.29	87.326	-4.88E-04	-4.88E-03	-9.76E-04	12.6276
175.658	315.191	213.432	-315.586	83.199	-4.88E-04	-3.41E-03	-4.88E-04	12.6042
175.668	315.042	211.361	-315.882	88.5906	-4.88E-04	-4.39E-03	-4.88E-04	12.6135
175.658	314.945	215.159	-315.092	83.0283	-4.88E-04	-2.93E-03	0	12.6115
175.643	314.846	214.074	-315.487	115.217	-4.88E-04	-7.32E-03	-9.76E-04	12.593
175.687	314.846	211.657	-315.092	87.194	0	-8.78E-03	-9.76E-04	12.6364
175.746	314.945	213.729	-315.882	99.7062	4.88E-04	-8.78E-03	0	12.613
175.843	314.896	216.589	-315.735	83.0379	0	-4.88E-03	-4.88E-04	12.5945

175.926	314.796	208.5	-314.896	102.651	0	-5.85E-03	4.88E-04	12.6354
175.951	314.747	211.361	-315.29	85.187	4.88E-04	-4.39E-03	4.88E-04	12.6003
175.975	314.846	215.701	-315.34	116.921	0	-8.29E-03	-4.88E-04	12.6057
175.931	314.846	213.778	-315.34	85.0258	-9.76E-04	-3.41E-03	-9.76E-04	12.6115
175.887	314.945	205.541	-315.092	79.7658	0	-2.93E-03	0	12.5925
175.853	314.846	212.15	-315.536	90.7297	4.88E-04	-4.88E-03	4.88E-04	12.6276
175.902	314.896	207.908	-305.622	108.731	4.88E-04	-7.80E-03	0	12.6188
175.931	314.945	213.63	-316.128	86.0415	4.88E-04	-8.78E-03	0	12.5969
175.926	314.896	213.037	-315.241	94.3193	4.88E-04	-9.76E-03	0	12.6315
175.951	314.846	215.652	-315.636	91.6824	0	-6.34E-03	-4.88E-04	12.6281
175.931	314.846	213.729	-315.388	86.1244	0	-2.44E-03	0	12.5847
175.926	314.846	220.289	-316.572	105.371	-9.76E-04	-4.88E-03	0	12.6286
175.898	314.846	205.048	-318.989	8033.14	1.46E-03	-4.39E-03	1.95E-03	12.6286
175.868	314.747	204.751	-319.334	9844.79	3.41E-03	-5.85E-03	4.88E-04	12.6256

Radiation (Radiation (T (°C) wall T (°C) wall T (°C) wall T (°C) ceiling T (°C) ceiling T (°C) ceiling T (°C) corn

1.41E-02	9.76E-03	38.6897	37.3105	36.7007	43.3381	43.3738	44.0649	42.6946
1.46E-02	1.02E-02	38.699	37.3225	36.7246	43.3381	43.3857	44.053	42.6707
1.41E-02	9.76E-03	38.6738	37.2747	36.6887	43.3142	43.3501	44.041	42.623
1.46E-02	1.02E-02	38.6726	37.3081	36.6985	43.3237	43.3833	44.0745	42.6802
1.37E-02	9.76E-03	38.6726	37.2974	36.7114	43.325	43.3726	44.0757	42.6934
1.46E-02	9.76E-03	38.6702	37.2844	36.6626	43.3	43.3357	44.0388	42.6563
1.41E-02	9.76E-03	38.6357	37.3201	36.6985	43.3357	43.3596	44.0269	42.6563
1.41E-02	9.76E-03	38.6462	37.3059	36.6841	43.3215	43.3452	44.0244	42.6658
1.46E-02	1.02E-02	38.6582	37.2725	36.6746	43.312	43.3357	44.0149	42.6086
1.41E-02	9.76E-03	38.6438	37.3059	36.696	43.2976	43.3452	44.0364	42.6421
1.37E-02	1.02E-02	38.6558	37.2832	36.6853	43.2988	43.3464	44.0017	42.6433
1.37E-02	9.76E-03	38.6306	37.2927	36.6709	43.2727	43.344	43.9995	42.6409
1.46E-02	9.76E-03	38.6426	37.2939	36.6602	43.2737	43.3333	44.0005	42.6421
1.37E-02	9.27E-03	38.6174	37.282	36.6841	43.2737	43.3215	44.0005	42.6421
1.46E-02	1.02E-02	38.6401	37.2556	36.6577	43.2595	43.3428	43.9624	42.6396
1.37E-02	9.27E-03	38.6162	37.2568	36.6589	43.2488	43.3083	43.9756	42.5933
1.41E-02	9.27E-03	38.615	37.2544	36.6685	43.2463	43.3059	43.9851	42.6028
1.46E-02	9.76E-03	38.627	37.2305	36.6445	43.2344	43.2822	43.9375	42.5549
1.46E-02	1.07E-02	38.6138	37.2317	36.6458	43.2119	43.2595	43.9624	42.5325
1.37E-02	9.76E-03	38.5767	37.2544	36.6565	43.2224	43.2939	43.9731	42.5669
1.46E-02	1.02E-02	38.5754	37.2424	36.6326	43.2107	43.2822	43.9612	42.5669
1.46E-02	1.02E-02	38.6006	37.2305	36.5967	43.1987	43.2463	43.9375	42.4954
1.32E-02	8.29E-03	38.5742	37.2532	36.6433	43.2451	43.293	43.9006	42.6135
1.32E-02	1.02E-02	38.5742	37.2412	36.6074	43.2571	43.281	43.9243	42.5657
1.37E-02	9.27E-03	38.561	37.24	36.6184	43.2202	43.2678	43.9231	42.5527
1.51E-02	1.02E-02	38.573	37.2292	36.5955	43.1855	43.2214	43.9006	42.554
1.41E-02	9.76E-03	38.6089	37.2412	36.6194	43.2095	43.2451	43.9363	42.542
1.41E-02	1.02E-02	38.5718	37.2163	36.5945	43.1843	43.2439	43.8755	42.5288
1.37E-02	9.76E-03	38.5586	37.1804	36.5825	43.1726	43.2202	43.8755	42.4932
1.41E-02	1.02E-02	38.5586	37.2163	36.6064	43.1606	43.2202	43.8994	42.5049
1.41E-02	9.76E-03	38.5454	37.2378	36.616	43.1821	43.2537	43.9089	42.5027
1.41E-02	1.02E-02	38.5574	37.166	36.5801	43.1582	43.2178	43.8494	42.5146
1.37E-02	9.27E-03	38.5454	37.1912	36.5933	43.1714	43.207	43.8625	42.5156
1.37E-02	9.27E-03	38.5334	37.178	36.604	43.1343	43.1941	43.8733	42.4907
1.41E-02	9.27E-03	38.531	37.178	36.592	43.1582	43.1821	43.9089	42.4788
1.41E-02	1.02E-02	38.5298	37.1516	36.5776	43.1558	43.1797	43.835	42.4524
1.41E-02	9.76E-03	38.531	37.1541	36.5562	43.1106	43.1343	43.8494	42.4431
1.37E-02	1.02E-02	38.5178	37.1743	36.5764	43.095	43.1545	43.8337	42.4634
1.41E-02	9.76E-03	38.5178	37.1516	36.5657	43.1201	43.1797	43.835	42.4644
1.41E-02	9.76E-03	38.5178	37.178	36.5801	43.1226	43.1941	43.8254	42.4431
1.37E-02	9.27E-03	38.5046	37.1768	36.5549	43.1094	43.157	43.8242	42.406
1.46E-02	1.02E-02	38.5166	37.1624	36.5525	43.1189	43.1428	43.8337	42.4036
1.37E-02	9.76E-03	38.4927	37.1636	36.5417	43.1201	43.1558	43.7874	42.4407
1.37E-02	9.76E-03	38.4795	37.1516	36.5298	43.1082	43.1558	43.7874	42.4167
1.41E-02	9.76E-03	38.481	37.1289	36.5071	43.0854	43.1331	43.7529	42.406
1.46E-02	9.76E-03	38.4902	37.1504	36.5405	43.083	43.1665	43.7625	42.4514
1.37E-02	9.27E-03	38.457	37.1504	36.5166	43.0713	43.1428	43.7505	42.4275
1.41E-02	1.02E-02	38.4915	37.1289	36.519	43.0618	43.1213	43.741	42.394
1.46E-02	9.76E-03	38.4678	37.1255	36.5393	43.0461	43.1057	43.7612	42.3428
1.37E-02	9.27E-03	38.4546	37.1265	36.5046	43.0474	43.1069	43.7625	42.3679
1.46E-02	1.02E-02	38.4666	37.1016	36.5034	43.0701	43.1057	43.7136	42.3906
1.32E-02	9.27E-03	38.4546	37.1255	36.5154	43.0701	43.1057	43.7612	42.3667
1.41E-02	9.76E-03	38.4546	37.1016	36.4915	43.0461	43.094	43.7136	42.3428
1.41E-02	9.27E-03	38.4426	37.1255	36.5154	43.0701	43.1177	43.6897	42.4026

1.41E-02	1.02E-02	38.4426	37.1135	36.4915	43.0225	43.0701	43.7373	42.3547
1.37E-02	9.27E-03	38.4307	37.1135	36.4915	43.0461	43.1057	43.7136	42.3547
1.46E-02	1.02E-02	38.4534	37.1016	36.4915	43.0225	43.1057	43.6897	42.3787
1.41E-02	9.76E-03	38.4282	37.1111	36.5012	43.0557	43.1152	43.6873	42.3643
1.41E-02	9.27E-03	38.4414	37.0752	36.4653	42.9724	43.0676	43.6755	42.269
1.41E-02	1.02E-02	38.4187	37.0884	36.4905	43.0212	43.0808	43.7004	42.3298
1.41E-02	9.76E-03	38.4307	37.0764	36.4666	43.0332	43.0688	43.7124	42.2703
1.37E-02	9.76E-03	38.4055	37.0417	36.4675	42.9866	43.0581	43.6421	42.3071
1.41E-02	1.07E-02	38.4187	37.0645	36.4905	42.9854	43.0449	43.6528	42.3179
1.37E-02	1.02E-02	38.4175	37.0513	36.4534	42.9724	43.0081	43.6992	42.2808
1.37E-02	9.27E-03	38.3818	37.0525	36.4666	42.9734	43.0332	43.6765	42.3059
1.46E-02	1.07E-02	38.4055	37.0525	36.4666	42.9734	43.0212	43.6765	42.2583
1.41E-02	1.02E-02	38.395	37.0178	36.4436	42.9629	42.9985	43.6421	42.2476
1.37E-02	9.76E-03	38.3831	37.0405	36.4426	42.9617	42.9973	43.6289	42.2939
1.41E-02	1.07E-02	38.3936	37.0405	36.4307	42.9854	43.0093	43.6409	42.282
1.41E-02	1.02E-02	38.395	37.0142	36.4521	42.9592	43.0188	43.6743	42.2439
1.37E-02	1.02E-02	38.3962	37.0166	36.3948	42.9258	42.9734	43.6169	42.2104
1.41E-02	1.07E-02	38.3831	37.0405	36.4307	42.9258	43.0093	43.6052	42.2224
1.37E-02	9.76E-03	38.3711	37.0405	36.4307	42.9497	43.0332	43.5933	42.2104
1.41E-02	1.02E-02	38.3699	37.0142	36.4402	42.9353	43.0068	43.6147	42.1963
1.37E-02	9.27E-03	38.3223	37.0273	36.4294	42.9126	42.9841	43.604	42.2212
1.37E-02	9.27E-03	38.3579	36.9795	36.3936	42.9009	42.9724	43.5444	42.1855
1.27E-02	9.27E-03	38.3352	37.0022	36.4163	42.8997	42.9353	43.5908	42.2083
1.37E-02	9.76E-03	38.3472	37.0034	36.4414	42.9126	42.9604	43.592	42.2571
1.41E-02	9.76E-03	38.3591	36.9675	36.4055	42.9126	42.9604	43.5681	42.2092
1.37E-02	1.02E-02	38.3496	37.0129	36.4031	42.9104	42.97	43.554	42.1711
1.37E-02	9.76E-03	38.3235	36.9436	36.3696	42.877	42.9126	43.5444	42.1616
1.37E-02	9.27E-03	38.3259	37.001	36.3911	42.9224	42.946	43.542	42.207
1.32E-02	9.27E-03	38.3247	36.9915	36.3816	42.877	42.9246	43.5562	42.1616
1.46E-02	1.02E-02	38.3367	36.9556	36.3696	42.853	42.9126	43.5325	42.1377
1.37E-02	9.76E-03	38.3247	37.0022	36.3804	42.8877	42.9353	43.5432	42.22
1.37E-02	1.02E-02	38.3247	36.9807	36.3948	42.8662	42.9138	43.5457	42.2224
1.32E-02	1.02E-02	38.3127	36.9915	36.3816	42.853	42.9604	43.5085	42.1616
1.46E-02	1.02E-02	38.314	36.9902	36.3684	42.8281	42.9233	43.5073	42.1484
1.41E-02	9.27E-03	38.314	36.9807	36.3948	42.8662	42.9377	43.5217	42.1868
1.41E-02	9.76E-03	38.3032	36.9292	36.3193	42.803	42.8984	43.4824	42.1116
1.37E-02	1.02E-02	38.29	36.9424	36.3923	42.8281	42.8877	43.5313	42.1248
1.41E-02	9.76E-03	38.3032	36.928	36.366	42.8496	42.8972	43.4692	42.158
1.37E-02	9.76E-03	38.29	36.9412	36.3672	42.8149	42.8865	43.4944	42.1592
1.37E-02	1.02E-02	38.29	36.9543	36.3804	42.8518	42.8997	43.4956	42.1128
1.41E-02	1.02E-02	38.3032	36.9185	36.3445	42.8162	42.8638	43.4597	42.0769
1.41E-02	1.07E-02	38.3032	36.9292	36.3193	42.8269	42.8508	43.4824	42.1355
1.41E-02	9.76E-03	38.2795	36.9436	36.3457	42.8054	42.8411	43.4729	42.0901
1.37E-02	9.76E-03	38.2676	36.9172	36.3313	42.8149	42.8508	43.4824	42.1116
1.37E-02	9.76E-03	38.2556	36.9424	36.3445	42.8162	42.8518	43.4597	42.1248
1.46E-02	1.02E-02	38.2927	36.9065	36.3086	42.8042	42.8518	43.4241	42.1128
1.41E-02	1.02E-02	38.2808	36.9053	36.3313	42.803	42.8269	43.4585	42.0757
1.46E-02	1.07E-02	38.2927	36.916	36.3062	42.79	42.8257	43.4336	42.0388
1.32E-02	9.27E-03	38.2568	36.9053	36.2954	42.7793	42.8269	43.4229	42.0996
1.37E-02	9.27E-03	38.2329	36.9412	36.3193	42.803	42.8389	43.4585	42.0757
1.37E-02	9.76E-03	38.2344	36.8826	36.2847	42.7446	42.8042	43.3882	42.0532
1.46E-02	9.76E-03	38.2344	36.8945	36.2966	42.7686	42.8401	43.4001	42.0889
1.32E-02	8.78E-03	38.2356	36.9304	36.3206	42.7686	42.8281	43.4121	42.0769
1.41E-02	1.07E-02	38.2461	36.8826	36.2966	42.7327	42.8162	43.3762	41.9934
1.32E-02	9.76E-03	38.2344	36.8945	36.3086	42.7327	42.8281	43.4001	42.0532
1.32E-02	1.02E-02	38.2104	36.8696	36.2954	42.7197	42.8149	43.3633	42.052

1.37E-02	1.02E-02	38.2236	36.8804	36.3062	42.7302	42.8018	43.3621	42.0269
1.32E-02	9.76E-03	38.1997	36.8706	36.2966	42.7446	42.7803	43.4001	42.0173
1.46E-02	1.07E-02	38.2368	36.8479	36.2739	42.6982	42.7458	43.3655	41.9827
1.32E-02	9.76E-03	38.2129	36.8467	36.2488	42.709	42.7686	43.3645	41.9578
1.46E-02	9.76E-03	38.2236	36.8586	36.2727	42.709	42.7803	43.3762	41.9817
1.41E-02	9.76E-03	38.2009	36.8586	36.2488	42.7446	42.7686	43.3525	42.0173
1.27E-02	9.27E-03	38.1758	36.8313	36.2451	42.7173	42.741	43.3252	41.9661
1.41E-02	9.76E-03	38.1758	36.8457	36.2356	42.7078	42.7554	43.3274	41.9924
1.37E-02	1.02E-02	38.1877	36.8457	36.2356	42.7078	42.7434	43.3394	41.9924
1.37E-02	9.76E-03	38.1877	36.8457	36.2476	42.7078	42.7554	43.3037	41.9924
1.37E-02	9.76E-03	38.1758	36.8108	36.2249	42.6611	42.709	43.293	41.9219
1.46E-02	9.27E-03	38.189	36.8086	36.2344	42.6707	42.7065	43.3262	41.9077
1.32E-02	9.76E-03	38.1521	36.8433	36.2451	42.6694	42.7292	43.3369	41.9661
1.37E-02	9.76E-03	38.1772	36.8193	36.2212	42.6338	42.7173	43.3013	41.9541
1.46E-02	1.02E-02	38.1877	36.7979	36.2236	42.6719	42.6958	43.3037	41.9326
1.27E-02	9.27E-03	38.1521	36.8228	36.2249	42.6731	42.697	43.281	41.9458
1.37E-02	9.27E-03	38.1628	36.8098	36.2236	42.6599	42.7314	43.2678	41.9326
1.41E-02	9.76E-03	38.1509	36.8086	36.2224	42.6589	42.6946	43.2549	41.9314
1.32E-02	9.76E-03	38.1521	36.7739	36.2117	42.6362	42.6958	43.2678	41.9446
1.37E-02	1.02E-02	38.1389	36.7966	36.2104	42.623	42.6826	43.2666	41.9197
1.41E-02	9.76E-03	38.1377	36.8206	36.2224	42.635	42.7185	43.2429	41.9434
1.37E-02	1.02E-02	38.1509	36.7966	36.1985	42.6111	42.7065	43.231	41.9077
1.32E-02	9.76E-03	38.1257	36.7607	36.1985	42.5991	42.6589	43.2429	41.8838
1.37E-02	9.76E-03	38.1377	36.7727	36.1985	42.623	42.6589	43.2666	41.8718
1.37E-02	9.76E-03	38.127	36.7703	36.196	42.6206	42.6802	43.2166	41.9053
1.46E-02	1.02E-02	38.1377	36.7834	36.1614	42.6338	42.6577	43.2178	41.8706
1.37E-02	9.76E-03	38.1138	36.7847	36.1746	42.5991	42.6946	43.207	41.9077
1.32E-02	8.78E-03	38.1006	36.7476	36.1614	42.5979	42.6458	43.1941	41.835
1.32E-02	8.78E-03	38.0898	36.7607	36.1985	42.5874	42.6589	43.219	41.8362
1.37E-02	1.02E-02	38.0994	36.7488	36.1865	42.5754	42.635	43.1833	41.8599
1.41E-02	1.02E-02	38.1006	36.7332	36.1709	42.5598	42.6313	43.1797	41.8325
1.37E-02	9.76E-03	38.0874	36.7451	36.1589	42.5598	42.5957	43.2273	41.7849
1.32E-02	9.76E-03	38.0635	36.7356	36.1733	42.5623	42.6218	43.1821	41.8706
1.37E-02	9.76E-03	38.0874	36.7117	36.1375	42.5383	42.5862	43.1941	41.7991
1.41E-02	9.76E-03	38.0754	36.7356	36.1494	42.5503	42.6218	43.1702	41.835
1.37E-02	9.76E-03	38.0874	36.7344	36.1482	42.561	42.5969	43.1689	41.8218
1.41E-02	9.27E-03	38.073	36.7463	36.1482	42.561	42.6086	43.1453	41.8577
1.27E-02	9.27E-03	38.0491	36.6997	36.1135	42.5503	42.5623	43.1345	41.7871
1.32E-02	9.27E-03	38.0491	36.6973	36.1111	42.5122	42.5598	43.1321	41.8086
1.32E-02	9.27E-03	38.061	36.7319	36.1221	42.5229	42.5945	43.1428	41.8074
1.37E-02	8.78E-03	38.0466	36.7344	36.1243	42.5015	42.585	43.1333	41.8337
1.37E-02	9.27E-03	38.0361	36.7212	36.1111	42.5002	42.5957	43.1321	41.7251
1.41E-02	1.02E-02	38.0466	36.72	36.134	42.499	42.6064	43.1309	41.8074
1.37E-02	9.76E-03	38.0454	36.708	36.1101	42.499	42.5469	43.1069	41.7717
1.37E-02	9.76E-03	38.0334	36.696	36.1101	42.511	42.5469	43.1189	41.7598
1.46E-02	1.07E-02	38.0454	36.696	36.1101	42.511	42.5469	43.1189	41.7717
1.27E-02	8.78E-03	38.0203	36.72	36.1101	42.5229	42.5586	43.1069	41.7957
1.41E-02	9.76E-03	38.043	36.6482	36.0623	42.4634	42.511	43.0474	41.7241
1.41E-02	1.02E-02	38.0178	36.6829	36.1089	42.4861	42.5217	43.106	41.7585
1.46E-02	1.02E-02	38.0178	36.6948	36.073	42.4622	42.5217	43.0701	41.7825
1.22E-02	8.78E-03	37.9702	36.6819	36.0837	42.449	42.5205	43.0928	41.7336
1.41E-02	9.76E-03	38.0059	36.658	36.0598	42.4133	42.5085	43.0212	41.6858
1.37E-02	9.27E-03	37.9927	36.6687	36.1064	42.4597	42.5432	43.0559	41.7563
1.41E-02	1.02E-02	38.0166	36.6699	36.0837	42.437	42.5205	43.0569	41.7336
1.32E-02	8.29E-03	37.9795	36.6699	36.0957	42.4609	42.5085	43.0452	41.6858
1.41E-02	9.27E-03	37.9795	36.634	36.0718	42.4133	42.4729	43.0093	41.7097

1.37E-02	1.02E-02	37.989	36.6448	36.0586	42.436	42.4597	43.0676	41.6965
1.32E-02	8.78E-03	37.9534	36.6448	36.0706	42.4478	42.4597	43.0676	41.7085
1.37E-02	9.76E-03	37.9639	36.6077	36.0334	42.4229	42.4348	43.0427	41.6238
1.37E-02	9.27E-03	37.9878	36.6208	36.0706	42.436	42.4836	43.0559	41.6729
1.32E-02	9.27E-03	37.9387	36.6448	36.0586	42.4001	42.4597	43.032	41.6846
1.37E-02	9.76E-03	37.9507	36.5945	36.0203	42.4097	42.4456	43.0059	41.6824
1.37E-02	9.76E-03	37.9602	36.6316	36.0454	42.4229	42.4468	43.0188	41.7192
1.32E-02	9.27E-03	37.9375	36.6316	36.0215	42.4229	42.4705	43.0068	41.6477
1.37E-02	8.78E-03	37.9351	36.6292	36.043	42.3728	42.4563	42.9807	41.6812
1.41E-02	1.02E-02	37.947	36.5837	35.9976	42.3394	42.4229	42.9832	41.6357
1.46E-02	1.07E-02	37.9458	36.6436	36.0334	42.4109	42.4348	42.9951	41.6357
1.37E-02	1.02E-02	37.9219	36.6064	36.0203	42.3621	42.4575	42.946	41.6345
1.41E-02	9.76E-03	37.9326	36.6052	36.0071	42.3369	42.4324	42.9568	41.6096
1.41E-02	9.27E-03	37.9314	36.592	36.0178	42.3716	42.4312	42.9795	41.6204
1.37E-02	9.27E-03	37.905	36.604	36.0537	42.3835	42.4551	42.9795	41.668
1.37E-02	9.76E-03	37.9182	36.5801	36.0298	42.3477	42.4072	42.9558	41.6323
1.46E-02	1.02E-02	37.905	36.6028	36.0288	42.3823	42.4063	42.9902	41.5952
1.32E-02	9.27E-03	37.9038	36.5801	35.9939	42.3477	42.3955	42.9558	41.5964
1.41E-02	9.27E-03	37.8906	36.5693	36.0071	42.3132	42.3848	42.9211	41.5977
1.37E-02	9.27E-03	37.9014	36.5789	35.9929	42.3347	42.4063	42.9426	41.6431
1.37E-02	9.27E-03	37.8774	36.5669	36.0049	42.3347	42.3943	42.9307	41.6311
1.32E-02	9.27E-03	37.8762	36.5549	35.9929	42.3464	42.3823	42.895	41.5596
1.46E-02	9.76E-03	37.887	36.5181	35.9678	42.3096	42.3811	42.8938	41.5583
1.46E-02	8.78E-03	37.8618	36.5898	35.9917	42.3335	42.3691	42.9294	41.6179
1.37E-02	9.76E-03	37.8606	36.5767	35.9785	42.3203	42.3918	42.9165	41.6167
1.37E-02	8.78E-03	37.8486	36.5647	35.9546	42.3083	42.3679	42.8926	41.6763
1.41E-02	8.78E-03	37.8474	36.53	35.9438	42.2856	42.3691	42.8818	41.4985
1.37E-02	9.27E-03	37.8354	36.5396	35.9414	42.2952	42.3669	42.8674	41.1384
1.46E-02	1.02E-02	37.8582	36.5396	35.9653	42.2715	42.343	42.8914	41.3413
1.37E-02	1.02E-02	37.845	36.5491	35.9868	42.281	42.3765	42.8652	41.4343
1.37E-02	9.27E-03	37.821	36.5383	35.9521	42.2703	42.3418	42.8662	41.5547
1.32E-02	9.27E-03	37.8318	36.4785	35.9402	42.2583	42.2942	42.8662	41.2803
1.32E-02	9.27E-03	37.8186	36.5132	35.927	42.2571	42.3286	42.8533	41.3984
1.37E-02	9.76E-03	37.8291	36.5144	35.9521	42.2703	42.3298	42.8545	41.3638
1.37E-02	1.02E-02	37.8267	36.5132	35.939	42.269	42.281	42.8413	41.4224
1.37E-02	9.76E-03	37.8267	36.5132	35.939	42.2571	42.3049	42.8413	41.4343
1.51E-02	9.76E-03	37.8015	36.5024	35.9282	42.2703	42.2822	42.8186	41.4116
1.37E-02	9.76E-03	37.8015	36.512	35.9377	42.2798	42.3274	42.8281	41.4331
1.46E-02	1.02E-02	37.7991	36.5359	35.9497	42.3037	42.2917	42.8521	41.3853
1.41E-02	9.76E-03	37.7979	36.5107	35.9126	42.2429	42.2666	42.8389	41.3723
1.27E-02	9.76E-03	37.7871	36.5239	35.9258	42.2559	42.2917	42.8281	41.3972
1.41E-02	9.76E-03	37.7859	36.4988	35.9126	42.231	42.2666	42.7913	41.3484
1.41E-02	1.02E-02	37.7847	36.4988	35.9365	42.231	42.2905	42.8032	41.4319
1.41E-02	9.76E-03	37.7822	36.4978	35.9236	42.2058	42.3013	42.7781	41.4546
1.41E-02	1.02E-02	37.7942	36.4727	35.9224	42.1929	42.2881	42.7888	41.4294
1.37E-02	1.02E-02	37.7942	36.4727	35.9463	42.2166	42.2405	42.8008	41.4294
1.37E-02	9.76E-03	37.793	36.4858	35.9236	42.2297	42.2537	42.7781	41.4067
1.32E-02	9.27E-03	37.7798	36.4966	35.9463	42.2048	42.2524	42.8008	41.4175
1.37E-02	9.27E-03	37.7905	36.4846	35.9104	42.1929	42.2166	42.7888	41.4294
1.46E-02	1.02E-02	37.8142	36.5073	35.9331	42.2156	42.2751	42.7639	41.4521
1.37E-02	9.27E-03	37.7893	36.4834	35.9092	42.1677	42.2393	42.74	41.4402
1.37E-02	9.76E-03	37.7761	36.4966	35.8984	42.2048	42.2405	42.7651	41.4294
1.41E-02	9.27E-03	37.7761	36.5073	35.8972	42.1917	42.2512	42.752	41.4402
1.37E-02	1.02E-02	37.7866	36.4583	35.896	42.1545	42.2261	42.7268	41.4153
1.46E-02	1.07E-02	37.7974	36.4834	35.9092	42.1797	42.2273	42.728	41.4761
1.37E-02	9.27E-03	37.7734	36.4941	35.896	42.1785	42.2261	42.7507	41.4629

1.41E-02	1.02E-02	37.783	36.4917	35.8936	42.1643	42.2	42.7366	41.4248
1.37E-02	9.76E-03	37.7722	36.4463	35.884	42.1309	42.1904	42.6912	41.3914
1.37E-02	8.78E-03	37.7473	36.4929	35.9067	42.1536	42.2488	42.7139	41.4497
1.37E-02	9.76E-03	37.7578	36.4941	35.908	42.1428	42.238	42.6912	41.439
1.51E-02	1.07E-02	37.7686	36.4319	35.8696	42.1045	42.1643	42.6531	41.377
1.37E-02	9.27E-03	37.7566	36.4785	35.8804	42.1035	42.1987	42.6758	41.4355
1.37E-02	1.02E-02	37.7566	36.469	35.8948	42.1416	42.2131	42.7019	41.4141
1.37E-02	9.76E-03	37.7554	36.4438	35.8816	42.1284	42.1643	42.7007	41.4248
1.37E-02	9.27E-03	37.7554	36.4546	35.9043	42.1272	42.1511	42.6995	41.4236
1.37E-02	9.27E-03	37.7434	36.4678	35.8816	42.1045	42.1643	42.7007	41.4368
1.41E-02	9.76E-03	37.7542	36.5037	35.9055	42.1284	42.188	42.7126	41.4128
1.41E-02	1.07E-02	37.7649	36.4187	35.8564	42.0916	42.175	42.6875	41.364
1.32E-02	9.27E-03	37.729	36.4773	35.8911	42.0903	42.1858	42.6506	41.3984
1.37E-02	9.76E-03	37.741	36.4653	35.8911	42.1023	42.114	42.6267	41.3984
1.37E-02	1.02E-02	37.7649	36.4534	35.8672	42.0664	42.1619	42.6506	41.4104
1.32E-02	8.78E-03	37.741	36.5012	35.9031	42.0784	42.1738	42.615	41.4104
1.37E-02	9.76E-03	37.7397	36.4666	35.8804	42.0796	42.175	42.6279	41.376
1.37E-02	9.27E-03	37.7385	36.4534	35.8792	42.0784	42.1619	42.615	41.3984
1.32E-02	9.76E-03	37.7158	36.4534	35.8792	42.0544	42.1619	42.615	41.4104
1.37E-02	9.27E-03	37.7397	36.4644	35.9021	42.0652	42.1487	42.6377	41.3975
1.27E-02	8.78E-03	37.7278	36.4285	35.8901	42.0535	42.0891	42.6138	41.3616
1.37E-02	1.02E-02	37.7637	36.4414	35.8792	42.0664	42.1023	42.6387	41.3269
1.32E-02	9.76E-03	37.7373	36.4524	35.9021	42.0652	42.125	42.6257	41.3616
1.37E-02	9.76E-03	37.7385	36.4294	35.8792	42.0544	42.114	42.6387	41.3508
1.32E-02	9.76E-03	37.7493	36.4524	35.8662	42.0415	42.0891	42.6138	41.3376
1.32E-02	1.02E-02	37.7505	36.4524	35.8901	42.0652	42.113	42.5898	41.3616
1.32E-02	9.76E-03	37.7385	36.4763	35.8782	42.0535	42.1367	42.5779	41.3855
1.32E-02	8.78E-03	37.7134	36.4751	35.8889	42.0759	42.1118	42.5767	41.3962
1.41E-02	9.27E-03	37.7266	36.4285	35.8542	42.0295	42.1011	42.5542	41.3975
1.37E-02	9.27E-03	37.7373	36.4512	35.8411	41.9924	42.1118	42.541	41.4082
1.32E-02	9.76E-03	37.7134	36.4524	35.8423	41.9937	42.0771	42.5542	41.2661
1.32E-02	9.76E-03	37.7134	36.426	35.8279	41.9795	42.0747	42.5398	41.1565
1.37E-02	9.76E-03	37.7493	36.4285	35.8423	41.9937	42.1011	42.5542	41.314
1.27E-02	9.76E-03	37.6777	36.4141	35.8279	41.9675	42.0747	42.5398	41.3711
1.37E-02	8.78E-03	37.7026	36.426	35.8398	42.0032	42.063	42.5637	41.252
1.41E-02	9.27E-03	37.679	36.3782	35.792	41.9675	42.0032	42.5159	41.1921
1.32E-02	9.27E-03	37.6895	36.4021	35.8159	41.9675	42.0151	42.5518	40.9417
1.27E-02	8.78E-03	37.667	36.3914	35.7932	41.9329	42.0044	42.5291	40.9785
1.27E-02	9.76E-03	37.6777	36.4021	35.804	41.9795	42.0391	42.5518	41.073
1.32E-02	9.27E-03	37.6538	36.3782	35.804	41.9436	42.0032	42.5398	40.9656
1.37E-02	8.78E-03	37.679	36.3794	35.7813	41.9448	41.9688	42.4814	40.8831
1.37E-02	1.02E-02	37.6563	36.3674	35.7813	41.9329	42.0164	42.4934	40.895
1.37E-02	9.76E-03	37.6443	36.3674	35.7813	41.9089	42.0164	42.4934	41.074
1.32E-02	9.27E-03	37.6443	36.3555	35.7813	41.9089	42.0044	42.4934	41.1338
1.37E-02	9.27E-03	37.6563	36.3542	35.78	41.9197	42.0151	42.4683	41.1445
1.41E-02	8.78E-03	37.6563	36.3411	35.8027	41.9424	41.9783	42.491	41.1433
1.37E-02	9.27E-03	37.6335	36.3555	35.8052	41.9209	41.9807	42.4695	41.0623
1.37E-02	9.76E-03	37.6335	36.3184	35.78	41.908	41.9795	42.4563	41.073
1.37E-02	8.78E-03	37.6335	36.3435	35.7813	41.9329	41.9924	42.4814	41.0979
1.32E-02	9.76E-03	37.6335	36.3555	35.7813	41.9089	42.0044	42.4934	41.0144
1.46E-02	1.02E-02	37.635	36.3171	35.7549	41.9304	41.9424	42.479	41.0359
1.41E-02	9.76E-03	37.623	36.3423	35.7441	41.9436	41.9675	42.4802	41.073
1.41E-02	9.76E-03	37.6111	36.3435	35.7693	41.9209	41.9329	42.4695	41.0503
1.41E-02	9.76E-03	37.6362	36.3423	35.78	41.9316	42.0032	42.4563	41.061
1.32E-02	9.27E-03	37.6255	36.353	35.7668	41.8828	41.9663	42.4075	41.1433
1.32E-02	8.78E-03	37.6123	36.3184	35.7561	41.884	41.9675	42.4207	41.0967

1.41E-02	1.02E-02	37.6362	36.3184	35.7322	41.8721	41.9556	42.4087	41.0967
1.37E-02	9.27E-03	37.6135	36.3279	35.7417	41.8696	41.9294	42.4063	41.0825
1.41E-02	9.76E-03	37.6135	36.3171	35.7429	41.8708	41.9543	42.4075	41.0718
1.41E-02	9.76E-03	37.6255	36.3291	35.7668	41.8828	41.9187	42.4075	41.0837
1.41E-02	9.27E-03	37.6135	36.3303	35.7561	41.8721	41.908	42.3848	41.1326
1.22E-02	8.78E-03	37.5908	36.3159	35.7417	41.8936	41.9294	42.4182	41.0945
1.32E-02	9.27E-03	37.5803	36.3184	35.7561	41.8721	41.9436	42.3967	41.1206
1.37E-02	9.76E-03	37.604	36.3184	35.7441	41.8481	41.9197	42.3967	41.0847
1.41E-02	9.27E-03	37.604	36.3303	35.7681	41.8601	41.9556	42.3848	41.0847
1.32E-02	9.76E-03	37.616	36.3291	35.7668	41.8352	41.9304	42.3599	41.1074
1.41E-02	1.02E-02	37.6292	36.3159	35.7776	41.8577	41.9055	42.3943	41.0825
1.46E-02	9.76E-03	37.6172	36.304	35.7537	41.834	41.9055	42.3943	41.1062
1.37E-02	1.02E-02	37.6172	36.3052	35.7549	41.8352	41.8708	42.3718	41.0837
1.37E-02	1.02E-02	37.6052	36.292	35.7656	41.8459	41.9294	42.3706	41.1062
1.27E-02	8.78E-03	37.5947	36.2693	35.731	41.8232	41.8472	42.3599	41.0239
1.27E-02	8.78E-03	37.5935	36.3064	35.7441	41.8481	41.8721	42.3611	41.073
1.37E-02	9.76E-03	37.5947	36.3291	35.7668	41.8352	41.8948	42.3599	41.1074
1.37E-02	9.76E-03	37.6052	36.2825	35.7202	41.8125	41.8601	42.3013	41.0491
1.27E-02	8.29E-03	37.5828	36.3052	35.731	41.8232	41.8828	42.324	41.0718
1.37E-02	9.76E-03	37.6064	36.3159	35.7537	41.8577	41.9055	42.3228	41.1182
1.37E-02	9.76E-03	37.6184	36.2813	35.707	41.7874	41.8589	42.3003	41.0359
1.37E-02	9.76E-03	37.5959	36.3171	35.731	41.7874	41.8708	42.312	41.0718
1.41E-02	9.76E-03	37.6064	36.304	35.7178	41.7744	41.8696	42.2991	41.0945
1.32E-02	9.27E-03	37.5947	36.304	35.7297	41.7861	41.8577	42.3108	41.0706
1.37E-02	8.78E-03	37.5828	36.2825	35.7083	41.7529	41.8481	42.2537	41.0251
1.37E-02	1.02E-02	37.5828	36.28	35.7178	41.7744	41.834	42.2991	41.0347
1.41E-02	9.27E-03	37.5828	36.2681	35.7297	41.7744	41.834	42.2871	41.0466
1.27E-02	9.27E-03	37.5708	36.2429	35.7285	41.7612	41.8088	42.2739	41.0215
1.32E-02	9.27E-03	37.6079	36.28	35.7537	41.7505	41.8101	42.2751	41.0347
1.37E-02	9.76E-03	37.584	36.2813	35.7549	41.7754	41.8113	42.2883	41.0598
1.27E-02	8.29E-03	37.5708	36.2825	35.7322	41.741	41.8245	42.2656	41.0251
1.37E-02	1.02E-02	37.6064	36.28	35.7297	41.7625	41.8459	42.2751	41.0706
1.37E-02	9.76E-03	37.5828	36.2813	35.719	41.7637	41.8352	42.2524	41.0479
1.37E-02	9.76E-03	37.5828	36.2908	35.7166	41.7732	41.8208	42.25	41.0215
1.37E-02	1.02E-02	37.5828	36.292	35.7178	41.7385	41.7861	42.2393	41.0466
1.37E-02	1.02E-02	37.5828	36.28	35.7417	41.7744	41.834	42.2512	41.0466
1.37E-02	9.27E-03	37.5684	36.2561	35.7058	41.7026	41.7861	42.2036	41.0107
1.37E-02	1.02E-02	37.5815	36.2681	35.7297	41.7146	41.8101	42.2156	41.0466
1.41E-02	1.07E-02	37.5815	36.28	35.7058	41.6909	41.7505	42.2036	40.999
1.32E-02	9.76E-03	37.5815	36.28	35.7178	41.7266	41.7505	42.2512	40.9631
1.37E-02	1.02E-02	37.592	36.2573	35.731	41.7397	41.7874	42.2168	40.9883
1.37E-02	9.76E-03	37.5803	36.2681	35.7178	41.7026	41.7505	42.2156	41.0107
1.32E-02	9.27E-03	37.5684	36.292	35.7297	41.7266	41.7981	42.2036	41.0227
1.27E-02	8.78E-03	37.5552	36.2681	35.7178	41.7505	41.7625	42.2036	40.9751
1.27E-02	8.29E-03	37.5432	36.2681	35.7297	41.7146	41.7385	42.1917	40.9871
1.37E-02	9.27E-03	37.5564	36.2681	35.7178	41.7026	41.7625	42.1917	41.0107
1.37E-02	9.76E-03	37.5671	36.2813	35.707	41.6563	41.7397	42.1929	41
1.27E-02	9.27E-03	37.5552	36.2668	35.7046	41.6777	41.7253	42.1785	40.9858
1.41E-02	9.27E-03	37.554	36.3018	35.7153	41.6765	41.772	42.1775	40.9727
1.37E-02	9.27E-03	37.5776	36.2549	35.7046	41.6538	41.7493	42.1428	40.926
1.32E-02	8.78E-03	37.5408	36.2668	35.7285	41.6777	41.7253	42.1667	40.9619
1.32E-02	9.27E-03	37.542	36.2549	35.7285	41.6658	41.7373	42.1785	40.9143
1.37E-02	9.76E-03	37.5527	36.2659	35.7273	41.6526	41.748	42.1536	40.949
1.32E-02	9.27E-03	37.554	36.2668	35.7046	41.6299	41.7253	42.1667	40.95
1.37E-02	9.27E-03	37.5408	36.219	35.6807	41.6182	41.6777	42.1309	40.926
1.27E-02	8.78E-03	37.5276	36.2668	35.7046	41.6658	41.7134	42.1548	40.9619

1.32E-02	9.27E-03	37.5515	36.2788	35.7166	41.6538	41.7014	42.1428	40.95
1.37E-02	9.76E-03	37.5276	36.219	35.6807	41.6062	41.6658	42.0833	40.8784
1.32E-02	9.27E-03	37.5608	36.2527	35.6902	41.6396	41.6873	42.1047	40.9358
1.32E-02	8.78E-03	37.5251	36.2527	35.7021	41.6516	41.7112	42.1284	40.9714
1.37E-02	9.27E-03	37.5371	36.2778	35.7393	41.6765	41.7004	42.1775	40.925
1.37E-02	8.78E-03	37.5371	36.23	35.6794	41.6169	41.6765	42.0701	40.9011
1.37E-02	9.27E-03	37.5239	36.2549	35.7046	41.6182	41.6897	42.1189	40.8904
1.32E-02	8.78E-03	37.5239	36.2754	35.7009	41.6025	41.71	42.1035	40.9226
1.32E-02	9.76E-03	37.5344	36.2539	35.7034	41.6169	41.6765	42.082	40.9011
1.41E-02	9.76E-03	37.5571	36.2288	35.6902	41.5798	41.6753	42.0808	40.9119
1.32E-02	9.27E-03	37.5227	36.2419	35.6914	41.5811	41.6646	42.0701	40.8652
1.32E-02	9.76E-03	37.5212	36.2275	35.689	41.5906	41.6621	42.0676	40.8511
1.41E-02	1.07E-02	37.5188	36.2515	35.7249	41.6145	41.6384	42.1035	40.8511
1.37E-02	9.27E-03	37.532	36.2754	35.7371	41.6145	41.6741	42.1035	40.8987
1.27E-02	8.78E-03	37.5081	36.23	35.6914	41.5811	41.6646	42.0581	40.8535
1.37E-02	9.27E-03	37.5188	36.2515	35.689	41.5906	41.6384	42.0916	40.8391
1.46E-02	9.76E-03	37.5295	36.2263	35.688	41.5776	41.6372	42.0547	40.8738
1.41E-02	9.76E-03	37.5415	36.2502	35.688	41.5776	41.6372	42.0427	40.8857
1.37E-02	9.27E-03	37.4912	36.2156	35.677	41.5789	41.6025	42.0081	40.8391
1.37E-02	9.76E-03	37.5271	36.2288	35.6902	41.5918	41.6396	42.0332	40.8523
1.37E-02	8.78E-03	37.5164	36.2515	35.7009	41.5906	41.6265	42.0439	40.8987
1.27E-02	8.78E-03	37.49	36.1904	35.6401	41.5417	41.5657	41.9949	40.814
1.37E-02	9.76E-03	37.5151	36.2383	35.688	41.5537	41.6492	42.0308	40.8618
1.37E-02	9.76E-03	37.4888	36.249	35.6509	41.5166	41.624	42.0176	40.8247
1.37E-02	9.76E-03	37.5115	36.2251	35.6987	41.5525	41.6001	42.0415	40.8127
1.37E-02	8.78E-03	37.5103	36.2478	35.6975	41.5393	41.6467	42.0164	40.8474
1.41E-02	8.78E-03	-37.4983	36.2131	35.6868	41.5049	41.5764	41.9819	40.8247
1.32E-02	9.27E-03	37.4983	36.2	35.6855	41.5513	41.5872	42.0164	40.7998
1.37E-02	9.27E-03	37.4851	36.2251	35.6868	41.5286	41.6001	42.0295	40.7891
1.32E-02	8.78E-03	37.4839	36.2119	35.6855	41.5513	41.5991	42.0283	40.7998
1.32E-02	8.78E-03	37.4839	36.1748	35.6484	41.5024	41.5264	42.0034	40.7627
1.27E-02	8.29E-03	37.46	36.2119	35.6616	41.5156	41.5632	41.9807	40.7759
1.37E-02	8.78E-03	37.4827	36.2107	35.6604	41.5264	41.562	42.0034	40.7627
1.37E-02	8.78E-03	37.4695	36.2227	35.6843	41.5383	41.5859	41.9675	40.7986
1.32E-02	8.78E-03	37.4668	36.2346	35.6604	41.5264	41.562	41.9675	40.8105
1.37E-02	9.27E-03	37.4788	36.1628	35.6365	41.5024	41.5383	41.9438	40.7507
1.37E-02	9.76E-03	37.4788	36.2095	35.6711	41.4653	41.5371	41.9783	40.7615
1.41E-02	9.27E-03	37.4656	36.2214	35.6831	41.5012	41.5728	41.9426	40.8213
1.37E-02	9.27E-03	37.4775	36.2334	35.6711	41.4653	41.5608	41.9663	40.7734
1.32E-02	9.27E-03	37.4619	36.2214	35.6592	41.4773	41.5728	41.9307	40.7615
1.41E-02	1.02E-02	37.4871	36.2205	35.658	41.4644	41.5479	41.9294	40.7485
1.32E-02	9.27E-03	37.4619	36.2454	35.6472	41.4773	41.5371	41.9307	40.7378
1.32E-02	9.27E-03	37.4739	36.2085	35.658	41.4761	41.5239	41.9294	40.7366
1.37E-02	1.02E-02	37.4607	36.1833	35.6328	41.4631	41.5466	41.9282	40.7712
1.37E-02	9.27E-03	37.4595	36.2095	35.6831	41.4773	41.5371	41.9307	40.7378
1.41E-02	9.27E-03	37.4607	36.2085	35.658	41.4285	41.5	41.9055	40.7126
1.27E-02	8.78E-03	37.4343	36.1714	35.6567	41.4751	41.4871	41.9282	40.6995
1.32E-02	9.27E-03	37.4331	36.1833	35.6687	41.4631	41.4871	41.9402	40.7114
1.37E-02	9.27E-03	37.469	36.1953	35.6328	41.4392	41.4751	41.9402	40.6995
1.37E-02	9.27E-03	37.4558	36.1821	35.6316	41.438	41.4619	41.915	40.6982
1.37E-02	9.76E-03	37.4558	36.1594	35.6448	41.4392	41.4631	41.8926	40.6875
1.41E-02	9.76E-03	37.4414	36.1929	35.6426	41.437	41.4966	41.8901	40.6973
1.37E-02	9.27E-03	37.4414	36.1941	35.6436	41.4143	41.4619	41.8555	40.6982
1.32E-02	8.78E-03	37.4175	36.1689	35.6306	41.4011	41.4607	41.9141	40.6853
1.32E-02	9.76E-03	37.4414	36.1809	35.6426	41.425	41.4846	41.9021	40.6973
1.32E-02	9.27E-03	37.439	36.1941	35.6436	41.438	41.45	41.8914	40.6387

1.41E-02	9.76E-03	37.4507	36.1797	35.6414	41.4358	41.4714	41.865	40.6841
1.27E-02	9.27E-03	37.4258	36.2036	35.6533	41.4358	41.4834	41.8533	40.708
1.37E-02	8.78E-03	37.4375	36.145	35.6187	41.3772	41.425	41.8186	40.6853
1.32E-02	9.27E-03	37.4363	36.1904	35.6401	41.3987	41.4702	41.8401	40.7188
1.32E-02	9.76E-03	37.4351	36.1917	35.6533	41.4238	41.4595	41.865	40.6482
1.37E-02	9.27E-03	37.4351	36.1809	35.6306	41.3892	41.4487	41.8306	40.6733
1.32E-02	9.76E-03	37.4219	36.2024	35.6282	41.3748	41.4465	41.8401	40.6589
1.32E-02	9.76E-03	37.4207	36.1785	35.6282	41.3511	41.4465	41.8042	40.6589
1.37E-02	9.76E-03	37.4326	36.1785	35.6401	41.363	41.4465	41.8162	40.6353
1.37E-02	9.27E-03	37.4182	36.1306	35.6042	41.3391	41.4106	41.8162	40.6113
1.32E-02	8.78E-03	37.4182	36.1772	35.6509	41.3738	41.4214	41.8508	40.6577
1.27E-02	9.76E-03	37.4194	36.1785	35.6521	41.363	41.4346	41.8162	40.6709
1.32E-02	9.27E-03	37.405	36.1284	35.6138	41.3367	41.3962	41.802	40.585
1.27E-02	8.78E-03	37.405	36.1653	35.6389	41.3499	41.4333	41.803	40.646
1.41E-02	9.76E-03	37.4277	36.1533	35.603	41.3499	41.4094	41.8149	40.6101
1.37E-02	9.27E-03	37.4158	36.1772	35.5911	41.3499	41.3857	41.803	40.6221
1.32E-02	9.27E-03	37.4026	36.1653	35.615	41.3499	41.3975	41.803	40.6101
1.37E-02	9.27E-03	37.4014	36.1294	35.615	41.3499	41.3857	41.7434	40.5862
1.37E-02	9.27E-03	37.3906	36.1631	35.6125	41.3713	41.3713	41.8008	40.5837
1.41E-02	9.27E-03	37.4121	36.187	35.6125	41.3713	41.4072	41.7888	40.6077
1.27E-02	8.78E-03	37.387	36.1284	35.5898	41.301	41.3486	41.7302	40.5969
1.37E-02	9.76E-03	37.3989	36.1738	35.6113	41.2986	41.394	41.752	40.5947
1.27E-02	8.78E-03	37.363	36.1631	35.6006	41.3118	41.3713	41.7292	40.5601
1.32E-02	9.27E-03	37.3977	36.1392	35.5886	41.2759	41.3713	41.7292	40.5837
1.41E-02	9.27E-03	37.3977	36.1379	35.6353	41.3225	41.394	41.7637	40.5588
1.37E-02	9.76E-03	37.3965	36.1272	35.6125	41.3118	41.3354	41.7649	40.5242
1.32E-02	9.76E-03	37.3845	36.1379	35.6233	41.2866	41.3701	41.7637	40.5708
1.41E-02	9.27E-03	37.3726	36.1379	35.5994	41.2747	41.3345	41.7161	40.5469
1.32E-02	9.27E-03	37.3953	36.1499	35.6113	41.2986	41.3701	41.74	40.5349
1.37E-02	1.02E-02	37.3845	36.1379	35.6113	41.2747	41.3462	41.74	40.5349
1.27E-02	9.27E-03	37.3701	36.126	35.5754	41.2747	41.3225	41.74	40.5349
1.32E-02	9.76E-03	37.3953	36.1008	35.5864	41.2615	41.3333	41.7148	40.5098
1.32E-02	9.27E-03	37.394	36.114	35.5994	41.2747	41.3462	41.7041	40.5469
1.27E-02	8.78E-03	37.3821	36.1379	35.5874	41.3105	41.3105	41.7041	40.5229
1.27E-02	9.76E-03	37.3701	36.1248	35.5864	41.2854	41.3333	41.6909	40.5217
1.27E-02	9.27E-03	37.3833	36.126	35.5874	41.2986	41.3225	41.728	40.5229
1.32E-02	8.78E-03	37.3701	36.1248	35.5984	41.2498	41.3213	41.7029	40.5337
1.27E-02	9.76E-03	37.3689	36.1475	35.5852	41.2605	41.3201	41.7017	40.5205
1.22E-02	8.78E-03	37.3582	36.1355	35.5613	41.2366	41.332	41.678	40.5088
1.27E-02	9.27E-03	37.3701	36.1248	35.5745	41.2378	41.3213	41.6672	40.4861
1.32E-02	9.27E-03	37.3582	36.1008	35.5745	41.2258	41.3093	41.6553	40.4861
1.32E-02	9.76E-03	37.3821	36.1116	35.5852	41.2246	41.2961	41.678	40.5088
1.32E-02	9.27E-03	37.3689	36.1128	35.5984	41.2378	41.2734	41.6792	40.4622
1.41E-02	9.27E-03	37.3689	36.1008	35.5984	41.2378	41.2615	41.7029	40.4622
1.32E-02	8.78E-03	37.345	36.126	35.6113	41.2507	41.2866	41.7041	40.4514
1.32E-02	9.27E-03	37.3557	36.1128	35.5745	41.2019	41.2615	41.6553	40.4741
1.37E-02	9.76E-03	37.3809	36.114	35.5635	41.239	41.2986	41.6565	40.499
1.32E-02	8.29E-03	37.3462	36.1379	35.5635	41.2271	41.2747	41.6445	40.4753
1.27E-02	8.29E-03	37.3569	36.0769	35.5383	41.1899	41.2734	41.6194	40.4502
1.27E-02	9.27E-03	37.3582	36.1128	35.5503	41.2139	41.2615	41.6433	40.4502
1.27E-02	8.78E-03	37.3223	36.1104	35.5601	41.1997	41.2593	41.6172	40.4717
1.27E-02	9.27E-03	37.345	36.114	35.5515	41.2151	41.2507	41.6326	40.4155
1.27E-02	8.78E-03	37.3582	36.1128	35.5623	41.2019	41.2615	41.6194	40.4382
1.27E-02	8.78E-03	37.3462	36.0876	35.5732	41.2007	41.2842	41.6182	40.449
1.37E-02	9.27E-03	37.3462	36.0889	35.5623	41.1899	41.2498	41.6074	40.3906
1.22E-02	9.27E-03	37.3474	36.1008	35.5623	41.178	41.2378	41.6074	40.4143

1.37E-02	9.27E-03	37.3582	36.1008	35.5864	41.2019	41.2378	41.6313	40.4502
1.37E-02	8.78E-03	37.3594	36.053	35.5623	41.1663	41.2258	41.5718	40.3787
1.32E-02	7.80E-03	37.3486	36.0769	35.5623	41.1663	41.2258	41.6074	40.4143
1.22E-02	8.29E-03	37.3118	36.0889	35.5745	41.178	41.2139	41.6074	40.4143
1.27E-02	9.76E-03	37.3486	36.1008	35.5623	41.178	41.2139	41.5957	40.4026
1.37E-02	9.76E-03	37.3379	36.0889	35.5623	41.178	41.2139	41.5718	40.4143
1.22E-02	9.27E-03	37.3262	36.1008	35.5864	41.2139	41.2498	41.5957	40.4263
1.37E-02	9.76E-03	37.3379	36.0422	35.5276	41.1436	41.2151	41.5371	40.3799
1.37E-02	9.76E-03	37.3286	36.0781	35.5515	41.1555	41.1792	41.5967	40.4155
1.37E-02	9.27E-03	37.3379	36.0901	35.5515	41.1555	41.2151	41.585	40.3918
1.32E-02	9.27E-03	37.3394	36.0889	35.5623	41.1543	41.1899	41.5718	40.4026
1.37E-02	9.76E-03	37.3394	36.041	35.5144	41.0945	41.178	41.5002	40.3547
1.66E-02	1.02E-02	37.3394	36.0793	35.5647	41.1565	41.2043	41.5623	40.3691
1.27E-02	8.78E-03	37.3298	36.0901	35.5635	41.1555	41.2271	41.561	40.4036

T (°C) corn T (°C) corn T (°C) corn T (°C) corn T (°C) corn T (°C) corn T (°C) corn T (°C) oper T (°C) oper

40.989	38.6731	37.2642	34.3445	32.9666	32.2234	30.6049	39.106	37.0625
40.8696	38.6611	37.2043	34.4045	32.9788	32.4031	30.6169	39.0103	37.0505
40.834	38.7087	37.073	34.3564	32.7869	32.4392	30.4248	39.0342	37.0745
40.8555	38.6826	37.144	34.4038	32.7502	32.4626	30.4501	39.0833	37.0876
40.9043	38.7075	37.168	34.0925	32.7861	32.5344	30.677	39.2969	37.2297
40.915	38.7661	37.2869	34.1038	32.7498	32.438	30.833	39.1655	37.1699
40.8435	38.7065	37.1907	34.4026	32.7729	32.4133	30.7719	39.1763	37.145
40.8411	38.6204	37.2739	34.4141	32.7366	32.3169	30.797	39.0581	37.1343
40.8435	38.6228	36.9868	34.4739	32.8564	32.2927	30.8066	39.0198	37.084
40.8171	38.6682	37.082	34.593	32.9517	32.3042	30.7958	39.1047	37.1331
40.8184	38.6335	37.2009	34.4846	32.9031	32.2317	30.9855	39.1143	37.0708
40.8638	38.667	37.2122	34.52	32.9385	32.1353	30.7706	39.2827	37.2512
40.8291	38.6204	37.104	34.4236	32.9019	32.1826	30.6481	39.1011	37.1653
40.853	38.6323	37.0442	34.4116	32.9258	32.3384	30.8282	39.0652	37.1772
40.8865	38.6179	37.1147	34.3984	32.7808	32.3252	30.8522	39.0891	37.1772
40.8518	38.5715	37.2349	34.3152	32.7214	32.3018	30.8762	38.9219	37.0576
40.8733	38.5452	37.2336	34.2302	32.6365	32.1687	30.8402	39.0056	37.0815
40.8018	38.5571	37.2576	34.2183	32.5884	32.1567	30.6841	39.1729	37.1772
40.7791	38.5344	37.2217	34.2661	32.7202	32.1807	30.6829	39.0999	37.0564
40.8018	38.6406	37.1733	34.4331	32.8635	32.1201	30.8149	39.0879	37.0085
40.7898	38.4614	37.1143	34.2781	32.8762	32.1807	30.7322	39.0771	36.9978
40.7302	38.4973	37.1733	34.3374	32.8037	32.2761	30.6829	39.1836	37.1162
40.8245	38.6396	37.1602	34.3601	32.9343	32.2148	30.8137	39.0627	37.127
40.8005	38.5918	37.1489	34.3486	32.887	32.2036	30.947	39.1597	37.1162
40.7874	38.4951	37.0764	34.3362	32.8743	32.1909	30.8989	39.0283	37.0205
40.8364	38.5918	37.1721	34.1206	32.8145	32.1428	30.9218	39.0867	37.0193
40.8604	38.6516	37.3269	34.3716	32.8137	32.1782	30.8845	39.3125	37.1018
40.7517	38.4951	37.2905	34.1792	32.8013	31.9739	30.8365	39.1572	37.042
40.6919	38.4473	37.2307	34.2632	32.7292	31.9979	30.7526	39.0378	36.9941
40.7039	38.5906	37.0867	34.2864	32.8845	31.9613	30.6553	39.0366	36.969
40.7373	38.636	37.2649	34.3572	32.8474	32.2358	30.6793	39.144	37.0408
40.7493	38.5286	37.1333	34.1296	32.6917	32.104	30.5472	39.1919	37.0886
40.7026	38.6013	37.0974	34.1895	32.6914	32.1399	30.3899	39.0593	37.0515
40.6538	38.5166	36.9294	34.0212	32.7029	32.1514	30.3779	39.0713	37.0994
40.7373	38.5405	36.9766	34.2122	32.7622	32.1267	30.4847	39.0461	37.0264
40.5559	38.4902	36.9526	34.2122	32.7983	32.0908	30.5833	39.144	36.957
40.6179	38.5645	36.8333	34.0205	32.6663	32.0789	30.845	39.1536	37.0027
40.7456	38.4651	36.9397	34.1033	32.6411	31.9697	30.702	39.1189	37.0156
40.6753	38.5381	36.9402	33.948	32.3181	31.9343	30.7861	39.0115	36.9797
40.5942	38.5286	36.7734	34.0325	32.2827	31.9949	30.8329	38.9744	36.9548
40.6526	38.5154	37.0957	34.1636	32.3181	31.9343	30.7729	38.9863	36.9429
40.6025	38.3936	36.9636	34.1392	32.1855	31.9218	30.8341	39.0713	36.9441
40.6873	38.3708	36.8911	34.1504	32.5686	31.873	30.8318	38.7939	36.7144
40.6514	38.4663	36.9749	33.8989	32.6167	31.8851	30.6156	39.033	36.8101
40.5811	38.3601	37.1543	33.9348	32.6406	31.957	30.4944	38.9719	36.8088
40.6145	38.2859	36.9509	34.1025	32.5925	31.9451	30.7249	38.9983	36.8591
40.6265	38.4651	37.0215	34.1494	32.4834	31.9199	30.5544	39.0676	36.9045
40.6406	38.4436	36.9629	34.0427	32.5566	31.969	30.6384	39.0796	36.9883
40.5654	38.3206	36.9851	33.9451	32.2791	31.9313	30.6024	39.0198	36.8806
40.5547	38.3696	36.9146	33.9702	32.1362	31.9445	30.7357	38.9375	36.9177
40.5894	38.4521	36.7458	33.9331	32.363	31.8713	30.6265	38.8525	36.9524
40.5178	38.5596	36.7949	33.9104	32.52	31.8005	30.7249	38.9268	36.8711
40.5774	38.4043	36.8181	34.0295	32.5554	31.7999	30.6036	38.9136	36.834
40.6372	38.3086	36.7817	34.1128	32.5669	31.7874	30.5544	38.96	36.8328

40.6133	38.261	36.8169	34.208	32.698	31.9067	30.5292	38.947	36.9512
40.5894	38.3325	36.9246	34.1841	32.686	31.9547	30.3971	38.8035	36.9153
40.6013	38.4163	36.9365	34.196	32.6143	32.0386	30.5292	38.8035	36.8914
40.5869	38.4736	36.8643	34.1235	32.6497	32.0859	30.5664	38.781	36.7849
40.5154	38.3899	37.031	34.075	32.457	31.8815	30.6732	38.8872	36.8196
40.624	38.3911	36.9233	34.123	32.4331	31.8455	30.66	38.8979	36.8303
40.5405	38.2957	36.8518	34.0991	32.5291	31.9294	30.624	38.9338	36.8542
40.5178	38.3923	37.0078	34.1355	32.4097	31.8341	30.672	38.9219	36.9858
40.5286	38.3792	36.7566	34.0996	32.2659	31.7742	30.6252	39.0066	37.0469
40.4795	38.2825	36.7202	33.9673	32.3132	31.8815	30.6492	38.7917	36.8555
40.5286	38.2598	36.7554	33.9785	32.3367	31.9049	30.6829	38.7773	36.8171
40.457	38.3193	36.7681	34.0151	32.3733	31.8215	30.636	38.7307	36.7705
40.4939	38.3445	36.7446	34.1116	32.2898	31.7861	30.624	38.8621	36.8542
40.469	38.3792	36.78	34.147	32.3013	31.8455	30.636	38.8381	36.8184
40.4927	38.427	36.9104	34.1099	32.4678	31.7963	30.5375	38.7642	36.7322
40.5142	38.3052	36.7913	34.0505	32.3486	31.809	30.6252	38.8154	36.7358
40.4927	38.2837	36.7793	34.0864	32.4326	31.8209	30.5387	38.646	36.6855
40.4807	38.2957	37.0066	34.0745	32.4924	31.8329	30.6708	38.7773	36.8171
40.457	38.2957	37.0537	34.002	32.2881	31.8083	30.5736	38.8955	36.8398
40.5142	38.3171	37.0413	33.9773	32.4434	31.8197	30.4907	38.8728	36.8291
40.5154	38.2346	36.8989	33.8108	32.3005	31.8569	30.5399	38.8381	36.95
40.4319	38.1509	36.8984	33.8582	32.1802	31.8083	30.6348	38.7175	36.865
40.4426	38.1975	36.7542	34.1211	32.3953	31.7837	30.6348	38.7654	36.8171
40.4915	38.3181	36.6951	34.1458	32.3359	31.7483	30.4788	38.7534	36.7932
40.408	38.2825	36.6716	34.1821	32.5525	31.725	30.4438	38.6353	36.6628
40.3818	38.3279	36.4194	33.9414	32.5032	32.0356	30.4919	38.7188	36.7466
40.384	38.2107	36.8147	33.9541	32.3721	31.9883	30.4667	38.646	36.7214
40.5012	38.2441	36.7908	34.0859	32.1682	31.9163	30.4811	38.8274	36.7717
40.4319	38.3181	36.6943	34.0732	32.2034	31.9276	30.5496	38.7642	36.792
40.408	38.2825	36.9456	34.1091	32.1316	31.8796	30.6096	38.7283	36.78
40.4666	38.2334	36.8135	34.0366	32.071	31.879	30.6456	38.812	36.8279
40.469	38.1162	36.6711	34.1338	32.1921	31.7723	30.4535	38.7642	36.7681
40.4199	38.1987	36.5388	34.0852	32.2993	31.7717	30.3094	38.7043	36.7441
40.3948	38.2813	36.6931	34.1438	32.478	31.7585	30.4523	38.6792	36.7668
40.457	38.2239	36.8499	34.0374	32.5032	31.7957	30.1881	38.751	36.731
40.4294	38.1963	36.7529	33.7844	32.4182	31.8306	30.2134	38.7043	36.7322
40.4187	38.2334	36.79	33.9414	32.5393	31.9996	30.4547	38.7534	36.7693
40.4402	38.1714	36.6807	34.0596	32.3215	31.782	30.2494	38.8	36.8757
40.4414	38.1963	36.7661	34.0015	32.3115	31.6997	30.528	38.7068	36.7825
40.3831	38.2693	36.7417	34.0247	32.3948	31.7471	30.5856	38.8	36.7561
40.2993	38.1257	36.7529	33.8325	32.5142	31.6865	30.5963	38.6555	36.7549
40.4175	38.0649	36.717	33.9043	32.3103	31.6986	30.6696	38.7043	36.7322
40.408	38.0554	36.6584	34.0493	32.4792	31.8077	30.6576	38.824	36.7561
40.3938	38.292	36.8845	34.0361	32.55	31.9025	30.7656	38.7881	36.7322
40.4067	38.2813	36.8486	34.072	32.55	31.9385	30.6683	38.8108	36.7668
40.3472	38.1736	36.7058	34.0007	32.5146	31.8911	30.5255	38.7642	36.7202
40.3699	38.2681	36.8242	34.0115	32.5615	31.8658	30.5363	38.739	36.7908
40.3208	38.1355	36.6335	33.9644	32.5142	31.9385	30.4667	38.6697	36.6497
40.3818	38.2083	36.7764	33.9158	32.5374	31.9978	30.6204	38.6792	36.6472
40.3459	38.1724	36.7649	33.9282	32.478	32.0583	30.5615	38.8477	36.8279
40.2993	38.1855	36.7166	33.9517	32.4055	31.9619	30.5592	38.6782	36.6941
40.3831	38.1975	36.8374	34.0366	32.4067	31.915	30.7177	38.7522	36.792
40.3232	38.1855	36.3225	34.0242	32.3342	31.9025	30.6924	38.739	36.731
40.2397	38.1021	36.4421	33.8564	32.1663	31.7825	30.7284	38.5239	36.6592
40.2874	38.1975	36.5623	33.9409	32.2629	31.7351	30.5736	38.6328	36.7441
40.3579	38.1606	36.5378	33.8923	32.2742	31.7705	30.5255	38.6804	36.7083

40.3447	38.2549	36.7046	33.7839	32.3335	31.7699	30.4415	38.5969	36.6724
40.3113	38.2214	36.6926	34.0234	32.4656	31.8179	30.4271	38.5945	36.6941
40.3484	38.1987	36.5498	33.9763	32.4541	31.7345	30.3311	38.511	36.6104
40.2756	38.1616	36.585	33.9995	32.4775	31.8779	30.415	38.499	36.5984
40.2637	38.1497	36.7996	33.9509	32.4409	31.8293	30.4019	38.7366	36.7046
40.3232	38.1616	36.8362	33.7839	32.4895	31.7819	30.5471	38.8096	36.7417
40.3079	38.1462	36.823	33.8306	32.3323	31.8767	30.4763	38.6436	36.6353
40.2505	38.0291	36.7996	33.8792	32.3091	31.8893	30.3671	38.6782	36.6941
40.2864	38.1248	36.7764	33.9277	32.3096	31.782	30.3562	38.6436	36.6711
40.2266	38.053	36.752	33.7473	31.9852	31.7334	30.283	38.5706	36.6223
40.2278	37.9465	36.646	33.8928	32.2148	31.7351	30.3574	38.6328	36.6724
40.2852	37.9919	36.6436	33.9983	32.2244	31.7448	30.1869	38.5347	36.5984
40.2959	38.0027	36.679	33.938	32.188	31.8281	30.379	38.7019	36.6702
40.26	38.0027	36.7034	33.8787	32.3203	31.7207	30.2721	38.5957	36.6113
40.2983	38.1843	36.7034	34.0222	32.3804	31.6007	30.3298	38.677	36.5852
40.1682	38.0662	36.7046	33.9038	32.2976	31.6859	30.2229	38.5706	36.6462
40.2026	38.0171	36.7034	33.5911	32.4404	31.7808	30.0896	38.5693	36.5852
40.2493	38.1831	36.5952	33.6265	32.4158	31.6361	30.2217	38.665	36.5972
40.179	38.1963	36.512	33.7109	32.4282	31.7328	30.2817	38.7246	36.6689
40.1538	38.1235	36.5718	33.7827	32.4043	31.8168	30.2229	38.6782	36.7537
40.2014	38.0039	36.5957	33.6748	32.3083	31.7087	30.355	38.4512	36.5505
40.2134	37.9084	36.427	33.6855	32.0913	31.6235	30.5087	38.5442	36.5122
40.0583	37.9561	36.4509	33.8174	32.1152	31.6235	30.3885	38.5801	36.6079
40.1538	37.968	36.5474	33.866	32.2478	31.5642	30.3778	38.5334	36.5852
40.1633	38.0613	36.5813	33.9001	32.366	31.5743	30.1604	38.4846	36.4883
40.1526	38.0864	36.4636	33.8899	32.4517	31.7682	30.1869	38.5347	36.5505
40.2014	38.0518	36.4504	33.8528	32.3787	31.7549	30.1112	38.3757	36.499
40.1526	38.0984	36.4976	33.7922	32.186	31.7543	29.9551	38.4355	36.511
40.1299	38.0757	36.6064	33.7097	32.1753	31.7435	29.9683	38.5322	36.6438
40.2014	37.98	36.606	33.7209	32.1868	31.7189	30.0752	38.5073	36.6545
40.1145	38.072	36.5688	33.8396	32.1016	31.5858	30.3165	38.4128	36.5959
40.0547	37.9885	36.509	34.0073	32.1614	31.5618	30.3646	38.353	36.4644
40.1646	38.1104	36.616	33.8271	32.2688	31.6692	30.2889	38.5527	36.6521
40.1287	38.1343	36.3303	33.7803	32.27	31.6703	30.2073	38.5073	36.4871
40.1047	38.0745	36.4736	33.8281	32.342	31.5984	30.3274	38.5193	36.6067
40.1038	38.0374	36.3416	33.7559	32.4133	31.5498	30.3033	38.4834	36.5708
40.1038	38.0374	36.4607	33.7671	32.3887	31.6692	30.3502	38.4583	36.5935
40.0691	37.9907	36.4373	33.8037	32.2214	31.6937	30.2781	38.5657	36.5935
40.1265	38.0364	36.5198	33.8264	32.2441	31.7166	30.2661	38.554	36.5337
40.0774	37.9993	36.5193	33.8738	32.3396	31.704	30.3502	38.6016	36.5576
40.1394	37.906	36.46	33.6108	32.3401	31.5966	30.397	38.457	36.4966
40.0547	37.8809	36.2566	33.7905	32.3882	31.6686	30.4103	38.3984	36.5337
40.1372	37.9993	36.4348	33.7415	32.3389	31.7153	30.493	38.5408	36.5684
40.0894	37.9395	36.4229	33.7654	32.219	31.6674	30.385	38.469	36.5205
40.1133	37.9634	36.5425	33.8853	32.1831	31.5953	30.385	38.4451	36.3889
40.1252	37.9993	36.5186	33.8013	32.303	31.5953	30.2529	38.5168	36.4846
40.0774	38.0591	36.554	33.7168	32.1345	31.6188	30.4198	38.4438	36.4954
40.0415	37.9036	36.5898	33.8127	32.3025	31.7147	30.4078	38.3364	36.3997
40.0642	37.8904	36.613	33.8601	32.3379	31.7861	30.5039	38.5635	36.5073
40.1121	37.9143	36.4929	33.7036	32.0613	31.6416	30.4426	38.5144	36.4941
40.0632	37.9131	36.5647	33.5837	32.1213	31.6776	30.4438	38.5515	36.615
39.9795	37.937	36.469	33.8594	32.1094	31.6176	30.5278	38.4199	36.5313
40.074	37.9717	36.5388	33.6299	31.9996	31.5198	30.5975	38.3818	36.5527
40.0273	37.9729	36.5396	33.5586	32.0842	31.5684	30.4534	38.4773	36.6006
40.0154	37.9729	36.4199	33.5227	32.3	31.5323	30.3934	38.4294	36.5647
40.0034	38.0686	36.6353	33.7383	32.3359	31.6643	30.4414	38.322	36.457

40.0142	38.1272	36.6221	33.7131	32.1069	31.6991	30.4042	38.4521	36.4917
40.074	37.9836	36.634	33.821	32.2148	31.6991	30.3081	38.5479	36.5515
39.9294	37.8032	36.4792	33.8096	32.1555	31.6758	30.4066	38.395	36.4822
39.9426	37.8882	36.4187	33.833	32.2869	31.7592	30.2721	38.3567	36.5276
39.9902	37.9358	36.4187	33.7971	32.3708	31.6991	30.2361	38.4761	36.5156
39.9641	37.8738	36.2866	33.7844	32.3462	31.6746	30.2252	38.4414	36.457
40.0728	37.8989	36.3464	33.7964	32.3701	31.7705	30.4642	38.3926	36.5037
40.0129	37.875	36.4653	33.7839	32.3696	31.7939	30.3188	38.4629	36.4905
39.939	37.8726	36.5	33.7708	32.2485	31.8527	30.463	38.4153	36.4666
39.9055	37.7793	36.4402	33.8306	32.2004	31.7567	30.1844	38.365	36.4521
39.9653	37.8152	36.4768	33.8552	32.249	31.8173	30.3538	38.3423	36.4414
39.9521	37.814	36.5	33.8186	32.2964	31.9006	30.5098	38.3303	36.5012
39.9749	37.8965	36.4641	33.7947	32.1765	31.9247	30.1748	38.1523	36.3948
39.9736	37.8354	36.6179	33.781	32.2346	31.9109	30.3885	38.3171	36.3687
40.0215	37.8115	36.6064	33.6978	32.1992	31.9115	30.2217	38.45	36.4414
40.0332	37.8713	36.3547	33.5173	32.2585	31.8989	30.2565	38.4724	36.5837
39.9009	37.894	36.5454	33.7563	32.2461	31.8263	30.3165	38.3889	36.4761
39.8662	37.7759	36.4026	33.6252	32.0188	31.719	30.2565	38.2576	36.3926
39.8911	37.8845	36.4983	33.4814	32.2107	31.611	30.2552	38.2205	36.3435
39.9604	37.8701	36.3547	33.6731	32.2827	31.551	30.2817	38.4141	36.4653
39.9485	37.8821	36.4133	33.6958	32.2573	31.6698	30.2552	38.4116	36.5229
39.877	37.7268	36.4607	33.7312	32.3047	31.6091	30.1099	38.2432	36.426
39.8757	37.7256	36.4368	33.7073	32.3289	31.4292	30.0872	37.8738	36.1282
39.8877	37.6777	36.2334	33.7073	32.3047	31.5852	30.1232	38.9373	36.7021
39.8745	37.7961	36.0049	33.3586	32.0996	31.4399	30.0259	39.4019	37.1077
40.0178	37.9873	36.1604	33.2388	31.8239	31.224	29.6775	39.3062	36.8325
39.625	37.4507	36.0647	33.2388	31.7399	31.212	29.472	37.2856	35.3
38.8464	36.8027	35.2737	32.95	31.5708	31.1268	29.7003	37.3455	35.4795
39.3599	37.5081	36.0156	33.0576	31.4628	31.0427	29.3639	37.7041	35.8027
39.4771	37.3862	36.1221	33.3562	31.3776	30.9095	29.3519	37.8596	35.8027
39.8005	37.6025	36.1213	33.5833	31.377	30.7048	29.3254	38.2874	36.0276
39.4543	37.4111	35.9307	33.6917	31.5696	30.8135	29.3987	37.5356	35.562
39.4771	37.5295	36.134	33.428	31.4376	31.0295	29.7003	37.5129	35.6829
39.3586	37.4231	36.2297	33.7996	32.0974	31.3055	29.7711	37.894	35.9211
39.6204	37.8403	36.4072	34.0374	32.4434	31.5918	29.949	38.1545	36.0862
39.668	37.7805	36.3953	33.9175	32.3833	31.7477	30.1051	38.2024	36.1101
39.6096	37.7698	36.4802	33.9785	32.6243	31.9529	30.4666	38.2036	36.219
39.6787	37.7078	36.3477	34.1091	32.7791	32.1436	30.5986	38.0125	36.231
39.6191	37.6121	36.3708	34.2043	32.8623	32.2388	30.7534	37.9275	36.0862
39.6538	37.6707	36.4302	34.3235	32.9097	32.2861	30.8735	38.2144	36.3374
39.7146	37.7556	36.478	34.4075	32.9817	32.394	31.0283	37.9741	36.2166
39.582	37.563	36.3691	34.3342	32.9685	32.3689	31.0392	38.2119	36.311
39.7969	37.8259	36.5491	34.4067	33.0769	32.4895	31.1483	38.1536	36.2166
39.8196	37.7771	36.3923	34.3936	33.1716	32.5242	31.2432	38.2358	36.2751
39.8423	37.8237	36.4282	34.4775	33.2195	32.5962	31.2924	38.1536	36.2883
39.8066	37.7759	36.4995	34.5366	33.2429	32.6316	31.2911	38.3076	36.3589
39.7839	37.7651	36.5239	34.5134	33.2434	32.6921	31.2911	38.2478	36.3828
39.8303	37.7998	36.5479	34.5732	33.2915	32.728	31.2684	38.2131	36.384
39.8901	37.8118	36.5234	34.5366	33.3027	32.7395	31.3392	38.2717	36.4307
39.9009	37.8704	36.5461	34.6074	33.3376	32.7861	31.3979	38.3782	36.5251
39.877	37.9063	36.5713	34.5967	33.3269	32.8235	31.3884	38.3328	36.5276
39.8423	37.9072	36.6423	34.5959	33.3381	32.8586	31.4939	38.2346	36.4534
39.853	37.9063	36.677	34.6187	33.3608	32.8816	31.5048	38.2932	36.4761
39.8518	37.8213	36.606	34.5955	33.3855	32.8582	31.3632	38.2957	36.4426
39.8889	37.918	36.6658	34.6433	33.3975	32.918	31.3979	38.3901	36.5251
39.8877	37.8691	36.6172	34.6667	33.385	32.9294	31.23	38.3064	36.5251

39.8616	37.9146	36.6638	34.6775	33.4197	32.9163	31.3259	38.2705	36.4653
39.8162	37.905	36.6877	34.6536	33.3958	32.8564	31.4196	38.3997	36.5466
39.8984	37.9397	36.6758	34.7014	33.3838	32.8923	31.4688	38.2573	36.512
39.8877	37.8931	36.6877	34.7134	33.3958	32.8923	31.4916	38.3279	36.5347
39.8735	37.8667	36.5796	34.7246	33.407	32.8916	31.4327	38.3052	36.5239
39.8843	37.9731	36.759	34.7488	33.4431	32.9038	31.554	38.4019	36.585
39.8865	37.9397	36.6865	34.76	33.4543	32.927	31.6343	38.3386	36.5095
39.8972	37.9504	36.6621	34.7236	33.4539	32.8784	31.6104	38.3386	36.4976
39.8843	37.9253	36.6501	34.7595	33.5137	32.9385	31.6475	38.4233	36.5945
39.9331	37.9504	36.6628	34.76	33.5503	32.939	31.6116	38.4353	36.6184
39.8972	37.9026	36.6741	34.7834	33.5857	32.9624	31.6104	38.3386	36.5215
39.8484	37.8774	36.6621	34.7476	33.5256	32.9744	31.6235	38.3638	36.5107
39.8591	37.9001	36.7214	34.7468	33.5251	32.9978	31.6835	38.3757	36.5466
39.8472	37.8762	36.6377	34.699	33.4893	32.9258	31.6116	38.3997	36.5347
39.907	37.948	36.6963	34.7456	33.488	32.9246	31.6091	38.3853	36.616
39.907	37.936	36.6956	34.793	33.5474	32.96	31.5599	38.3481	36.5669
39.8723	37.9014	36.637	34.7822	33.5486	32.9971	31.4291	38.4568	36.616
39.907	37.9241	36.6843	34.7695	33.5479	32.9607	31.4531	38.4451	36.6399
39.895	37.9121	36.6724	34.7695	33.512	32.9607	31.4531	38.4451	36.6519
39.9058	37.9348	36.707	34.7925	33.5466	32.9595	31.4879	38.3721	36.6267
39.834	37.887	36.6472	34.7805	33.5227	32.9834	31.4879	38.3003	36.5549
39.8232	37.8523	36.6604	34.7935	33.5359	32.9607	31.4891	38.3733	36.5442
39.8459	37.9468	36.707	34.7805	33.5586	32.9475	31.5239	38.4319	36.5789
39.8591	37.96	36.7075	34.7332	33.4873	32.936	31.5359	38.408	36.6028
39.8579	37.9229	36.707	34.7686	33.5107	32.9595	31.476	38.4199	36.5789
39.8459	37.887	36.6704	34.8037	33.594	32.9829	31.3907	38.4187	36.5896
39.8699	37.8989	36.6597	34.793	33.5952	32.9719	31.4171	38.3494	36.5562
39.8447	37.886	36.6943	34.7798	33.5103	32.9587	31.4399	38.408	36.531
39.834	37.875	36.5623	34.5398	33.2339	32.7424	30.7294	39.2656	37.3298
39.9285	38.0054	36.7302	34.4326	33.1626	32.2515	29.663	39.8291	37.679
39.5356	37.4329	36.0969	34.2776	33.1152	32.408	30.0834	39.053	36.9138
39.1152	36.7969	35.4131	33.8445	32.562	32.2024	30.0461	37.6897	35.4771
39.4043	37.5286	35.4255	33.3418	32.0349	31.9031	29.5885	37.8796	35.8228
39.6646	37.7891	36.3225	33.0295	31.4226	31.3625	29.0609	39.3264	37.5461
39.5571	37.4663	36.0586	32.957	31.158	31.1219	28.8314	38.4175	36.8276
39.5093	37.3228	35.6404	33.1733	31.1826	30.9425	28.6643	37.8928	36.3625
39.187	37.1316	35.6284	33.1733	31.1106	30.8705	28.7244	37.5344	35.7402
39.2119	37.2524	35.8325	32.8862	30.7391	30.631	28.3036	37.8213	35.9319
39.2227	36.9761	35.6165	32.7539	30.7745	30.3663	28.5079	38.4187	36.3865
39.0437	36.9163	35.2939	32.9224	30.9431	30.439	28.9299	37.0693	35.6816
38.9612	36.8337	35.1384	32.6826	30.631	30.3669	29.037	36.6016	35.1897
39.0925	37.1208	35.6404	32.8137	30.7264	30.4503	28.8795	37.043	35.2605
39.4031	37.4556	35.9521	33.2698	30.9552	30.403	29.109	38.0723	35.5728
39.415	37.2166	35.8433	33.3167	31.146	30.7139	29.1787	37.8904	35.5464
39.3779	37.1914	35.7954	33.1609	31.506	30.8699	29.3481	37.7722	35.6433
39.4246	37.3098	36.0227	33.7	31.8179	30.8939	29.5776	37.9646	36.1353
39.3433	37.1807	35.856	33.7007	31.8905	31.0505	29.7927	37.4016	35.8828
39.3303	37.2512	35.8911	33.5564	32.1538	31.2059	29.7927	37.5928	35.7749
39.4509	37.4556	36.2148	33.8564	32.4063	31.3265	29.9489	37.9275	36.1221
39.415	37.5154	36.3225	33.9282	32.5381	31.6865	30.105	37.6406	35.9905
39.3411	37.3457	36.2615	33.9751	32.6448	31.8533	30.093	37.5928	35.7629
39.4617	37.3945	36.2273	34.0608	32.7065	32.0469	30.2756	37.9299	35.969
39.4509	37.4795	36.2998	34.1812	32.8149	32.2395	30.4197	37.8225	35.9329
39.4138	37.4304	36.311	34.1804	32.8384	32.3108	30.5037	37.918	35.981
39.4961	37.4531	36.2966	34.2261	32.8718	32.3564	30.5361	37.9741	36.1089
39.4973	37.5381	36.3105	34.2517	32.9578	32.478	30.7065	37.9885	36.1233

39.4854	37.562	36.3816	34.239	33.041	32.5134	30.8975	37.8916	36.0862
39.4712	37.4998	36.3577	34.323	33.1008	32.5374	30.9719	37.9539	36.1365
39.52	37.5129	36.3577	34.3708	33.137	32.6213	31.1027	37.9048	36.1233
39.4961	37.5249	36.3337	34.3708	33.1489	32.6934	31.1267	38.0244	36.1711
39.5691	37.6458	36.4175	34.3708	33.2087	32.7173	31.2335	38.1067	36.2776
39.5427	37.6074	36.4653	34.4067	33.2688	32.7893	31.2599	38.0732	36.292
39.5452	37.6694	36.5139	34.4314	33.2693	32.7419	31.2587	38.084	36.2549
39.5332	37.562	36.4426	34.48	33.2939	32.8264	31.308	38.0496	36.2202
39.5571	37.6099	36.4307	34.4678	33.2939	32.8623	31.464	38.2048	36.3877
39.5798	37.6206	36.5132	34.4788	33.2927	32.885	31.4867	38.0483	36.3147
39.5786	37.5596	36.4414	34.5146	33.3406	32.9211	31.512	38.0732	36.292
39.5667	37.6313	36.5012	34.5386	33.3406	32.9331	31.584	38.1929	36.3997
39.6038	37.6445	36.4055	34.5864	33.3525	32.957	31.4387	38.1558	36.3865
39.5906	37.6553	36.4768	34.6099	33.3879	32.9924	31.1987	38.1079	36.3386
39.5439	37.6326	36.4893	34.5625	33.3645	32.957	31.1987	38.1199	36.2908
39.5332	37.5859	36.4541	34.5391	33.437	32.9937	31.4628	38.1199	36.3625
39.6038	37.728	36.5378	34.563	33.4131	32.9937	31.548	38.1929	36.4595
39.5811	37.6934	36.4546	34.5637	33.3657	32.9224	31.4999	38.157	36.3757
39.5798	37.6921	36.5503	34.5876	33.4258	32.9104	31.5371	38.1941	36.4485
39.6621	37.7031	36.5737	34.647	33.521	32.9817	31.6451	38.2061	36.4006
39.52	37.6326	36.5251	34.6223	33.5083	32.957	31.5947	38.2036	36.4463
39.5679	37.6326	36.585	34.6104	33.4963	33.0049	31.6787	38.1079	36.4224
39.5547	37.5955	36.5371	34.6223	33.4844	33.0171	31.7159	38.0852	36.3279
39.6025	37.6912	36.5491	34.6582	33.5083	33.0171	31.7279	38.2168	36.3997
39.5571	37.6814	36.5857	34.6111	33.4971	33.0295	31.7026	38.2634	36.4583
39.5786	37.7031	36.6323	34.6099	33.4597	33.0403	31.6547	38.2036	36.4822
39.5786	37.6553	36.5725	34.6577	33.4839	33.0164	31.7147	38.1797	36.4463
39.5774	37.6899	36.5845	34.6697	33.5078	33.0403	31.7279	38.145	36.4714
39.5667	37.6672	36.5132	34.6821	33.4844	33.0291	31.4999	38.145	36.3997
39.5798	37.6921	36.5491	34.6941	33.5322	33.053	31.1147	38.2156	36.4583
39.5571	37.6814	36.5383	34.6475	33.5334	33.0662	31.308	38.145	36.3757
39.6145	37.7031	36.5132	34.6702	33.5322	33.053	31.476	38.1809	36.4714
39.6274	37.728	36.5498	34.647	33.5688	33.0776	31.308	38.2288	36.4475
39.5415	37.6899	36.585	34.6821	33.5684	33.053	31.3331	38.218	36.4126
39.5786	37.6792	36.5366	34.6816	33.5557	33.0164	31.4027	38.2156	36.4463
39.5906	37.6912	36.5247	34.6936	33.5676	33.0522	31.4628	38.1677	36.4224
39.5188	37.6792	36.5725	34.6577	33.5317	32.9924	31.5947	38.2156	36.4104
39.5906	37.7031	36.5605	34.6697	33.5198	32.9805	31.6307	38.1917	36.4702
39.5786	37.7031	36.5491	34.6462	33.4844	32.9331	31.6439	38.2048	36.4475
39.5068	37.6553	36.5366	34.6697	33.5437	32.9924	31.6907	38.2036	36.4104
39.5081	37.6804	36.5605	34.6697	33.5437	32.9324	31.7374	38.1545	36.4211
39.5547	37.7151	36.5251	34.6343	33.5322	32.9211	31.7159	38.1809	36.4355
39.5547	37.6672	36.5486	34.6936	33.5557	32.9565	31.7386	38.1797	36.4702
39.5188	37.6433	36.5132	34.7063	33.5803	32.957	31.7639	38.1809	36.4236
39.5188	37.6433	36.5012	34.7063	33.5684	33.0171	31.7279	38.157	36.4475
39.5786	37.7031	36.5486	34.6697	33.5317	33.0044	31.6667	38.1558	36.4104
39.5439	37.6685	36.5737	34.623	33.521	33.0176	31.7878	38.1929	36.3757
39.5535	37.6301	36.5239	34.657	33.4951	33.0039	31.7627	38.1558	36.4224
39.5046	37.6768	36.5479	34.6812	33.5671	33.0398	31.7518	38.2168	36.4714
39.5059	37.6421	36.5466	34.6199	33.53	33.0027	31.6163	38.1533	36.4199
39.5535	37.6899	36.5474	34.6685	33.5305	33.051	31.6895	38.2024	36.4929
39.4939	37.6301	36.5234	34.7163	33.5305	33.0151	31.7135	38.1426	36.4331
39.5046	37.6528	36.5359	34.717	33.5193	32.9797	31.7159	38.1091	36.4236
39.5176	37.666	36.5359	34.7051	33.531	32.9917	31.7386	38.1558	36.4224
39.4939	37.6541	36.5234	34.6804	33.5305	32.9434	31.7495	38.1785	36.4211
39.5295	37.6541	36.5234	34.6685	33.5425	32.9673	31.8094	-38.1187	36.3853

39.5176	37.678	36.5239	34.6812	33.5552	33.0039	31.8226	38.1199	36.4104
39.446	37.5823	36.5239	34.645	33.5071	32.908	31.7627	38.1677	36.4104
39.5034	37.6516	36.4871	34.656	33.5659	32.9546	31.7627	38.1558	36.4702
39.5273	37.6755	36.5466	34.656	33.5898	33.0146	31.7506	38.1438	36.4343
39.4927	37.6768	36.5957	34.7051	33.5911	33.0757	31.6919	38.1211	36.4116
39.4448	37.6169	36.5227	34.668	33.53	33.0146	31.3895	38.1187	36.3254
39.4341	37.5942	36.5107	34.668	33.5059	33.0386	31.4003	38.1414	36.4199
39.5022	37.6265	36.5217	34.6548	33.5288	33.0613	31.6295	38.1545	36.4331
39.4807	37.6289	36.5103	34.6553	33.4336	33.0259	31.7123	38.1414	36.384
39.4915	37.6396	36.5098	34.6548	33.4329	32.9775	31.6882	38.0938	36.408
39.4927	37.6409	36.4744	34.6672	33.4575	32.978	31.6403	38.0579	36.396
39.4424	37.5908	36.4851	34.666	33.4802	32.9648	31.5443	38.0698	36.396
39.4307	37.6384	36.509	34.678	33.5042	32.9768	31.5563	38.1533	36.4438
39.4663	37.6384	36.5205	34.6895	33.5156	33.0122	31.5431	38.1521	36.4546
39.4807	37.6169	36.5098	34.6667	33.4927	32.9294	31.6271	38.0208	36.323
39.4187	37.6145	36.4492	34.6899	33.54	32.9648	31.7123	38.1533	36.4199
39.4534	37.6492	36.4607	34.6296	33.5276	32.9402	31.7603	38.022	36.3481
39.4771	37.6492	36.5198	34.605	33.5149	32.9517	31.7471	38.1165	36.3828
39.4187	37.5908	36.4851	34.6301	33.5281	32.917	31.7242	38.1057	36.3481
39.4436	37.5918	36.4851	34.6541	33.54	32.9888	31.7471	38.1282	36.4067
39.4543	37.6504	36.5205	34.6057	33.5156	32.9883	31.807	38.1401	36.4187
39.3696	37.5537	36.448	34.605	33.4312	32.9397	31.7471	38.1401	36.4067
39.4414	37.5657	36.5085	34.6536	33.4797	33.0002	31.7843	38.0938	36.3721
39.4043	37.5645	36.4707	34.6157	33.4658	32.9624	31.7458	38.0315	36.3577
39.4282	37.5645	36.4595	34.6165	33.5024	32.999	31.7471	38.0447	36.3469
39.439	37.5752	36.4468	34.6516	33.5017	32.9985	31.7831	38.0447	36.3589
39.3923	37.5645	36.4468	34.6038	33.4658	32.9624	31.7698	38.0315	36.3696
39.4031	37.5393	36.4109	34.6877	33.4778	32.9985	31.723	38.1521	36.4546
39.4043	37.5764	36.4229	34.6755	33.4419	32.9385	31.7218	38.0435	36.3577
39.4509	37.6589	36.4946	34.6396	33.4419	32.9385	31.7351	38.0806	36.3708
39.3662	37.5381	36.4338	34.6025	33.4407	32.9133	31.7098	38.0435	36.3457
39.3555	37.5393	36.4575	34.6384	33.5125	32.9731	31.7566	38.0303	36.3325
39.3184	37.5142	36.4575	34.6145	33.4766	32.9854	31.7218	38.0435	36.3457
39.3782	37.562	36.4814	34.6387	33.4646	32.9612	31.6619	38.1033	36.3696
39.4138	37.574	36.5049	34.6499	33.5359	32.9846	31.6487	38.126	36.3564
39.3184	37.4902	36.4092	34.614	33.488	32.9846	31.5886	38.0781	36.3325
39.365	37.5129	36.4685	34.6133	33.4993	32.948	31.6127	38.126	36.3804
39.365	37.489	36.4087	34.6255	33.5234	32.96	31.7206	38.0303	36.3564
39.3889	37.5728	36.4565	34.6255	33.4873	32.9841	31.7206	38.0303	36.2847
39.353	37.501	36.457	34.6021	33.4641	32.9607	31.7938	38.0913	36.3457
39.3757	37.5237	36.4666	34.6235	33.5334	32.9822	31.8262	38.1475	36.4019
39.3411	37.5249	36.4438	34.6008	33.4749	32.9595	31.5995	38.1248	36.415
39.3398	37.5356	36.4182	34.6111	33.449	32.9817	31.6331	37.9907	36.3408
39.3865	37.5586	36.4546	34.5876	33.4497	32.9583	31.6835	38.0291	36.4031
39.353	37.5249	36.4314	34.6243	33.4741	32.9468	31.6942	37.9919	36.354
39.304	37.488	36.3704	34.5872	33.4609	32.9697	31.6331	37.9788	36.3049
39.3147	37.4988	36.4055	34.6223	33.4246	32.9211	31.6691	38.0027	36.3049
39.3147	37.5347	36.4294	34.6343	33.4485	32.9211	31.609	38.0625	36.3528
39.3506	37.5227	36.417	34.6099	33.4358	32.9084	31.6438	38.0254	36.3157
39.3018	37.4976	36.3691	34.5979	33.4839	32.9204	31.657	38.0625	36.3049
39.2551	37.4629	36.3816	34.5625	33.5083	32.8853	31.705	37.9431	36.269
39.2886	37.4485	36.405	34.574	33.5078	32.9326	31.7183	38.0159	36.354
39.3254	37.4617	36.3679	34.5608	33.4226	32.8953	31.7146	38.0005	36.3264
39.3245	37.5203	36.3931	34.55	33.4358	32.9207	31.6703	38.0039	36.3301
39.3364	37.5442	36.4404	34.5852	33.4592	32.9199	31.729	38.0146	36.269
39.2659	37.4976	36.4517	34.5608	33.4468	32.8833	31.7386	38.084	36.3743

39.2754	37.4712	36.4045	34.5732	33.4832	32.9199	31.6942	38.0039	36.366
39.2874	37.4712	36.4038	34.5728	33.5066	32.9072	31.645	38.0505	36.3767
39.2886	37.4485	36.3674	34.5122	33.446	32.8347	31.6187	37.9766	36.2666
39.334	37.458	36.3662	34.5708	33.481	32.8696	31.6306	38.0244	36.2905
39.2634	37.4951	36.4026	34.5715	33.4336	32.9063	31.6427	37.9526	36.2905
39.2527	37.4485	36.3555	34.5242	33.4102	32.8708	31.6187	37.9646	36.2786
39.2861	37.4819	36.3542	34.583	33.4209	32.8936	31.6547	38.0125	36.2546
39.2981	37.47	36.3655	34.5464	33.4204	32.8569	31.6294	37.9753	36.3132
39.2622	37.458	36.3542	34.5588	33.4568	32.8816	31.6547	37.9766	36.3025
39.2266	37.4104	36.3411	34.5217	33.4077	32.8445	31.6522	37.9622	36.312
39.3208	37.457	36.3403	34.5571	33.4192	32.9038	31.7002	37.9741	36.3
39.322	37.4224	36.3296	34.5464	33.4204	32.917	31.6895	37.9155	36.2773
39.2002	37.408	36.3171	34.5459	33.3838	32.8564	31.6786	37.8569	36.2307
39.2612	37.4092	36.3774	34.5344	33.4324	32.8569	31.7266	37.9646	36.2905
39.2253	37.4092	36.2805	34.5571	33.4312	32.8557	31.7002	37.998	36.3
39.2373	37.4929	36.4009	34.5457	33.3599	32.8445	31.6174	38.0112	36.2893
39.2493	37.469	36.3882	34.5452	33.3953	32.8318	31.6282	37.9502	36.2761
39.2253	37.457	36.3403	34.5212	33.3953	32.76	31.5563	37.9143	36.2043
39.187	37.4067	36.3398	34.5566	33.4424	32.8193	31.5575	38.0232	36.2654
39.2229	37.4067	36.3027	34.5435	33.4172	32.7942	31.579	37.9609	36.311
39.2122	37.396	36.3164	34.4734	33.3591	32.7478	31.5934	37.9036	36.2056
39.2217	37.3696	36.3513	34.4961	33.4299	32.8066	31.6174	37.9634	36.2534
39.2229	37.4307	36.3381	34.5068	33.3928	32.8293	31.6018	37.9358	36.238
39.2109	37.4067	36.2908	34.4834	33.3694	32.8062	31.603	37.9011	36.2273
39.2456	37.4175	36.2656	34.5183	33.416	32.8408	31.5538	37.8999	36.238
39.187	37.3828	36.3022	34.4949	33.3689	32.8413	31.6138	37.9358	36.262
39.2217	37.4294	36.3733	34.4702	33.3682	32.8289	31.5059	37.8999	36.2739
39.2217	37.3936	36.3489	34.4458	33.3315	32.7922	31.3126	37.9465	36.2727
39.1858	37.3816	36.3135	34.5183	33.3682	32.8169	31.2058	37.9597	36.262
39.1382	37.4055	36.2896	34.4824	33.3801	32.8289	31.3738	37.9119	36.2261
39.1741	37.3816	36.2656	34.4824	33.3323	32.8528	31.4818	37.8281	36.1782
39.1848	37.3564	36.2537	34.4343	33.2844	32.781	31.603	37.8413	36.1914
39.2097	37.4294	36.2908	34.4714	33.2734	32.77	31.5442	37.9023	36.1924
39.1382	37.3936	36.3262	34.4949	33.3328	32.7935	31.447	37.9729	36.2034
39.137	37.3804	36.2651	34.4937	33.3557	32.8162	31.5178	37.9597	36.2739
39.1501	37.3936	36.2532	34.4458	33.3557	32.7683	31.5166	37.8628	36.189
39.1609	37.3564	36.2651	34.4099	33.3315	32.7922	31.5417	37.9358	36.2261
39.1477	37.3435	36.2644	34.4573	33.355	32.8157	31.6138	37.9478	36.25
39.1956	37.3792	36.2891	34.4338	33.3196	32.7803	31.603	37.8892	36.2273
39.137	37.3564	36.301	34.4219	33.3076	32.7683	31.6257	37.876	36.25
39.125	37.261	36.2173	34.4099	33.3076	32.7563	31.6257	37.8164	36.1902
39.1716	37.3315	36.2524	34.4812	33.3071	32.7798	31.5538	37.876	36.238
39.125	37.3328	36.2651	34.4578	33.2957	32.8162	31.5538	37.8044	36.1902
39.125	37.3564	36.2405	34.4812	33.3071	32.8157	31.5526	37.8032	36.1052
39.0784	37.2622	36.1926	34.4692	33.355	32.7917	31.5634	37.9453	36.2117
39.1011	37.3208	36.2053	34.4219	33.3438	32.8042	31.5417	37.9238	36.2979
39.1858	37.3816	36.2776	34.4224	33.3442	32.8049	31.5778	37.8401	36.2141
39.1741	37.3936	36.2532	34.4219	33.3557	32.8281	31.4927	37.8628	36.189
39.0891	37.2969	36.1814	34.4338	33.3557	32.7683	31.4698	37.8521	36.1782
39.1011	37.2969	36.2166	34.4451	33.3669	32.8276	31.5406	37.8628	36.177
39.1106	37.3542	36.2878	34.4326	33.3306	32.803	31.5059	37.8999	36.1423
39.0544	37.3218	36.2883	34.4092	33.3071	32.8037	31.5154	37.8499	36.1758
39.0891	37.2969	36.2891	34.4219	33.2837	32.7563	31.5658	37.8999	36.2739
39.1238	37.3196	36.2161	34.4685	33.3064	32.7671	31.5886	37.8628	36.2129
39.0891	37.3328	36.2053	34.4697	33.3315	32.7803	31.5658	37.7686	36.1543
39.113	37.3328	36.1926	34.4211	33.343	32.7917	31.5046	37.8867	36.2249

39.137	37.3328	36.2405	34.4211	33.3311	32.7676	31.4446	37.8511	36.2009
39.0652	37.2729	36.2292	34.3621	33.3076	32.7444	31.4219	37.7686	36.1184
39.0771	37.3445	36.2644	34.3972	33.3191	32.7556	31.4927	37.8628	36.2368
39.0771	37.2849	36.2292	34.4099	33.2598	32.7324	31.5178	37.8281	36.1782
39.0532	37.2849	36.1807	34.4451	33.2952	32.7317	31.5886	37.8628	36.1411
39.0652	37.2969	36.2405	34.4331	33.3191	32.7556	31.5526	37.8511	36.2129
39.0415	37.2729	36.2178	34.4224	33.3323	32.7688	31.519	37.8413	36.2034
39.0188	37.2383	36.1455	34.374	33.3076	32.6963	31.4927	37.6956	36.0574
39.0544	37.2622	36.1699	34.4104	33.3323	32.793	31.5059	37.876	36.1423
39.0664	37.3218	36.1934	34.386	33.2837	32.7803	31.4326	37.9226	36.2488
39.0771	37.3088	36.2297	34.3984	33.2844	32.793	31.495	37.8057	36.2034
38.9937	37.2251	36.1807	34.3613	33.1753	32.6958	31.4446	37.7075	36.0693
39.0437	37.2632	36.1938	34.3984	33.2603	32.7329	31.4927	37.7913	36.1292
39.0544	37.2622	36.1934	34.374	33.2598	32.7205	31.4207	37.8152	36.2129

T (°C) oper T (°C) oper T (°C) oper T (°C) oper T (°C) opening 7 (bottom)

35.603	34.6335	33.5435	32.8723	32.6084
35.5073	34.5496	33.6152	32.9321	32.6445
35.5432	34.5376	33.5674	32.9441	32.6804
35.6042	34.6226	33.5447	32.8735	32.7056
35.6628	34.6335	33.5554	32.8723	32.6565
35.603	34.6213	33.5315	32.8843	32.6084
35.5779	34.6563	33.6021	32.9429	32.6553
35.5552	34.6455	33.6392	32.9922	32.6204
35.5647	34.655	33.6609	33.0017	32.6541
35.6138	34.7041	33.686	32.991	32.6672
35.5037	34.594	33.5398	32.8806	32.6648
35.6245	34.571	33.457	32.75	32.594
35.6221	34.6526	33.5505	32.8074	32.5916
35.6221	34.6167	33.5745	32.8674	32.5796
35.6221	34.5928	33.5864	32.8674	32.5676
35.6101	34.6047	33.6104	32.8674	32.5198
35.5862	34.6646	33.6345	32.9514	32.5676
35.6221	34.5928	33.5386	32.8074	32.4836
35.573	34.6035	33.5732	32.8542	32.4824
35.5491	34.5676	33.5613	32.9141	32.4946
35.5742	34.6167	33.6226	32.9153	32.4717
35.561	34.5195	33.5015	32.8901	32.4585
35.6438	34.6501	33.584	32.9009	32.4573
35.5371	34.5557	33.5613	32.9021	32.4824
35.5132	34.5557	33.5134	32.8542	32.4585
35.488	34.5784	33.5242	32.8171	32.4214
35.4868	34.5413	33.5349	32.7917	32.4441
35.415	34.4333	33.4631	32.8159	32.4321
35.4749	34.5173	33.4751	32.804	32.4441
35.4736	34.564	33.4978	32.8027	32.491
35.4258	34.5039	33.4138	32.7307	32.4668
35.4138	34.4321	33.4258	32.6707	32.395
35.4485	34.4309	33.4487	32.6936	32.3457
35.5564	34.5269	33.4607	32.7534	32.3818
35.4595	34.5017	33.4114	32.7043	32.3806
35.3062	34.3005	33.27	32.5989	32.323
35.3037	34.2622	33.2917	32.5483	32.2007
35.4126	34.3472	33.3169	32.5857	32.1538
35.3887	34.395	33.293	32.6216	32.2019
35.4714	34.3938	33.2917	32.6204	32.2366
35.4475	34.4297	33.3276	32.6323	32.1648
35.4966	34.4429	33.3169	32.6335	32.1899
35.3745	34.4404	33.3384	32.6553	32.2234
35.3384	34.4165	33.3503	32.6553	32.2715
35.3013	34.3914	33.2773	32.582	32.2463
35.3635	34.4536	33.3635	32.6804	32.3206
35.3013	34.3674	33.2893	32.606	32.2942
35.3853	34.4153	33.2654	32.51	32.2222
35.3853	34.3794	33.2893	32.5701	32.2222
35.3623	34.3567	33.2905	32.6553	32.2595
35.3972	34.3435	33.2773	32.6299	32.3181
35.3755	34.3459	33.2317	32.5725	32.2966
35.3503	34.3687	33.3145	32.5833	32.2715
35.2773	34.3435	33.2893	32.6299	32.3062

35.408	34.3901	33.252	32.6047	32.353
35.324	34.3303	33.324	32.6768	32.3889
35.324	34.3423	33.3	32.6887	32.4009
35.2415	34.3435	33.3372	32.7139	32.4021
35.2881	34.3303	33.3599	32.6648	32.377
35.2749	34.3411	33.3228	32.6274	32.3757
35.2151	34.2693	33.3706	32.6155	32.3276
35.3708	34.2932	33.251	32.5676	32.2559
35.4199	34.3423	33.252	32.5928	32.1731
35.384	34.4141	33.2642	32.6047	32.209
35.3218	34.3757	33.3096	32.5425	32.1826
35.2869	34.2932	33.2749	32.5076	32.1838
35.335	34.365	33.2749	32.5195	32.136
35.335	34.425	33.3826	32.6394	32.1958
35.2366	34.3267	33.3804	32.5891	32.1694
35.2043	34.2944	33.312	32.5928	32.1731
35.2139	34.2322	33.2256	32.5063	32.1226
35.2979	34.3398	33.2498	32.5183	32.1348
35.2725	34.3267	33.2844	32.4812	32.1094
35.2378	34.28	33.2976	32.5305	32.1348
35.3228	34.2813	33.2629	32.5437	32.0999
35.3098	34.2441	33.1658	32.4824	32.0986
35.3098	34.3398	33.2498	32.5425	32.1467
35.3098	34.3997	33.3574	32.6143	32.1826
35.239	34.353	33.3948	32.6516	32.1958
35.2749	34.3411	33.3347	32.6155	32.2678
35.2856	34.3279	33.3096	32.6143	32.2185
35.324	34.3303	33.2761	32.6287	32.269
35.2966	34.3147	33.2485	32.6372	32.2534
35.2847	34.3147	33.2244	32.6011	32.2534
35.3086	34.3625	33.2725	32.6011	32.2415
35.2847	34.3506	33.2725	32.6011	32.2534
35.2246	34.3147	33.2844	32.5891	32.2053
35.3193	34.3975	33.3792	32.6599	32.2522
35.2593	34.3374	33.3191	32.636	32.2402
35.2126	34.219	33.2244	32.5413	32.2415
35.2019	34.2322	33.1777	32.5183	32.2065
35.2966	34.3147	33.2485	32.5532	32.2053
35.2749	34.3291	33.3467	32.6394	32.3037
35.1409	34.219	33.2964	32.6011	32.2773
35.2834	34.3015	33.3071	32.5759	32.2642
35.2605	34.3386	33.3562	32.625	32.2773
35.2126	34.2429	33.2964	32.5771	32.2415
35.1887	34.1951	33.1765	32.5293	32.2415
35.2954	34.2896	33.2112	32.5159	32.1802
35.2605	34.3267	33.2605	32.5532	32.2053
35.2954	34.3015	33.2231	32.48	32.2041
35.1899	34.28	33.2737	32.5544	32.1826
35.1396	34.2297	33.2354	32.5999	32.2402
35.2485	34.2429	33.2124	32.5051	32.2534
35.1863	34.2405	33.1741	32.4907	32.167
35.1887	34.2668	33.2725	32.5891	32.2053
35.1636	34.2537	33.3071	32.5999	32.2161
35.1277	34.1218	33.2231	32.5759	32.2761
35.2366	34.2668	33.2485	32.5771	32.2534
35.2126	34.2429	33.2605	32.4932	32.1934

35.1648	34.219	33.2605	32.5652	32.1934
35.2224	34.2883	33.282	32.5388	32.1909
35.1025	34.1807	33.27	32.5149	32.155
35.1504	34.1807	33.2461	32.5269	32.1311
35.281	34.2512	33.1968	32.5017	32.1538
35.2703	34.2883	33.1621	32.4788	32.1311
35.1995	34.2537	33.2231	32.4561	32.0723
35.1145	34.1926	33.198	32.5149	32.095
35.1157	34.1697	33.2112	32.552	32.1323
35.0906	34.1445	33.186	32.5388	32.1191
35.1289	34.135	33.0806	32.4092	32.0496
35.1504	34.2046	33.1262	32.407	32.071
35.1025	34.1445	33.0903	32.4668	32.1191
35.1157	34.1577	33.1633	32.4321	32.0962
35.0894	34.1555	33.1489	32.4417	32.0818
35.1743	34.1687	33.1501	32.4548	32.0591
35.0535	34.1433	33.125	32.5256	32.106
35.0654	34.0955	33.125	32.4656	32.1179
35.0774	34.0476	33.041	32.3816	32.1179
35.2104	34.2046	33.1023	32.407	32.083
35.0786	34.1926	33.1382	32.4309	32.083
34.9805	34.0105	32.9919	32.3564	32.0208
35.0881	34.0942	33.0039	32.3086	31.9728
35.1492	34.1675	33.1011	32.3457	31.986
35.0881	34.1663	33.0879	32.3804	32.0686
35.0308	34.0249	33.0662	32.3948	32.0471
35.0391	34.0571	33.1465	32.4272	32.0195
35.0391	34.0452	33.0747	32.4153	32.0554
35.1121	34.0823	32.9919	32.3564	32.0208
35.1709	34.2009	33.0627	32.3552	32.0435
35.196	34.238	33.1118	32.3804	32.0088
35.0642	34.1782	33.1238	32.4404	32.0447
35.1326	34.1865	33.156	32.4009	32.041
34.9792	34.0571	33.0867	32.3792	31.9956
35.1108	34.1292	33.0747	32.4392	32.0674
35.075	34.0691	33.1106	32.4512	32.0554
35.0857	34.0798	33.0735	32.4021	32.0781
35.0498	34.0918	33.0374	32.3901	32.0422
35.0498	34.1038	33.0735	32.3901	32.0422
35.0857	34.1758	33.1094	32.4141	32.0303
35.0366	34.1506	33.144	32.4368	32.0891
35.0259	34.116	33.0854	32.4021	32.0781
35.0847	34.1746	33.1082	32.4487	32.0891
35.1206	34.1626	33.0603	32.4607	32.041
34.9768	34.0667	33.0483	32.4729	32.0891
35.0486	34.1267	33.1321	32.4729	32.1011
35.1194	34.2212	33.167	32.4956	32.1238
34.9875	34.1016	33.1069	32.4236	32.0759
35.0234	34.0896	33.071	32.3997	32.0759
35.0823	34.1602	33.1057	32.4583	32.0146
35.0715	34.1016	33.0591	32.4355	32.0879
35.0234	34.0654	33.0591	32.3757	32.0039
35.0571	34.1111	33.1284	32.4812	32.0493
35.0452	34.0632	33.0686	32.4451	32.1094
34.9612	34.0271	33.0806	32.4573	32.1213
34.9851	34.0752	33.0925	32.4451	32.0854

35.0559	34.0979	33.0674	32.408	32.0483
35.02	34.0859	33.0913	32.408	32.0842
34.9863	34.0642	33.0698	32.4104	32.0505
35.032	34.0979	33.1274	32.4199	32.0842
34.9722	34.0259	33.0913	32.408	32.1082
34.9612	34.0391	33.0327	32.4211	32.0854
35.02	34.0859	33.0793	32.396	32.0603
34.9829	34.0967	33.0542	32.3828	32.0471
35.0308	34.0847	33.0542	32.3708	32.0349
34.9685	34.0823	33.0159	32.3445	31.9727
34.9697	34.0835	33.0649	32.3577	32.0459
34.9937	34.0715	33.0649	32.3816	32.0337
34.9587	34.0728	33.0542	32.3828	32.0591
34.9326	34.0344	33.0996	32.3923	32.0447
34.9578	34.0476	33.0171	32.4055	32.0698
35.0762	34.0942	33.0159	32.3206	32.0085
35.0403	34.1182	33.1118	32.3804	31.9967
34.9685	34.0823	33.1238	32.4043	31.9847
34.9194	33.9854	33.0386	32.4392	32.0073
34.9578	33.9756	32.957	32.3577	31.9979
35.0151	34.0212	32.9546	32.3433	31.9955
34.99	34.0559	33.0732	32.4141	32.0542
34.7996	33.9373	33.0146	32.4512	32.0913
34.9194	33.8535	32.751	32.0674	31.4316
35.2292	33.948	32.5098	31.6704	30.9624
34.8823	33.4329	32.0061	31.1425	30.5663
33.7432	32.9883	32.0649	31.5251	30.9492
34.0667	33.3237	32.3887	31.7771	31.1532
34.3062	33.5874	32.8445	32.1011	31.4412
34.2344	33.5874	33.0122	32.4966	32.1729
34.2678	33.3813	32.9858	32.4463	32.5422
34.1614	33.4185	32.927	32.5315	32.7112
34.3542	33.6355	33.144	32.7844	32.8203
34.377	33.5623	33.1309	32.7712	32.8191
34.6499	33.7515	33.1284	32.7927	32.9126
34.6379	33.8354	33.1885	32.8167	33.0325
34.6392	33.8367	33.2495	32.8059	32.9019
34.8787	34.0403	33.3574	32.9138	32.842
34.6021	33.9673	33.416	32.9487	32.9006
34.8655	34.0032	33.4519	32.9846	32.9006
34.7683	33.978	33.4509	32.9355	32.9595
34.9109	34.1086	33.4617	32.9822	32.9702
34.8643	34.1099	33.4988	33.0793	32.9475
34.8391	34.0725	33.5574	33.114	32.9583
34.9121	34.1577	33.5347	33.1152	32.9355
34.9348	34.1804	33.6055	33.1379	33.0181
34.9468	34.2402	33.6414	33.21	33.0181
34.9958	34.3015	33.6545	33.2351	33.0313
34.9827	34.2642	33.6892	33.21	33.0181
35.0774	34.2871	33.7361	33.2686	32.9929
35.1157	34.3254	33.7024	33.271	32.9834
35.0774	34.323	33.748	33.3406	33.041
35.0881	34.3577	33.7588	33.3872	33.0398
35.1025	34.3481	33.7373	33.3657	33.0061
35.1611	34.3828	33.8198	33.4124	33.053
35.1851	34.4426	33.8198	33.4243	33.1008

35.1013	34.4307	33.8079	33.3884	33.0168
35.1348	34.4043	33.8174	33.446	33.0745
35.1479	34.4294	33.8665	33.4951	33.1477
35.1587	34.4043	33.8774	33.446	33.1465
35.1838	34.4294	33.8306	33.4592	33.0278
35.209	34.5146	33.9277	33.4963	33.1128
35.1575	34.4751	33.96	33.5166	33.1091
35.1455	34.427	33.9121	33.5046	33.0613
35.2185	34.4763	33.9014	33.5298	33.0505
35.2424	34.5002	33.9133	33.5298	33.0745
35.2412	34.5229	33.9001	33.5767	33.1331
35.1826	34.5122	33.8894	33.5298	33.0984
35.2185	34.5361	33.9373	33.5779	33.1343
35.1348	34.4883	33.9492	33.5298	33.0745
35.2041	34.4978	33.9587	33.5874	33.2278
35.2029	34.4607	33.9216	33.6101	33.2146
35.24	34.5457	33.9348	33.5754	33.168
35.24	34.4978	33.9707	33.5874	33.1799
35.252	34.5457	33.9707	33.5874	33.144
35.2627	34.5564	34.0056	33.658	33.0828
35.2148	34.5085	33.9934	33.6221	33.0828
35.24	34.5337	33.9587	33.5994	33.0361
35.2507	34.4966	33.9575	33.5981	33.0708
35.2749	34.5205	33.9814	33.6101	33.1548
35.2148	34.5205	33.9814	33.5981	33.1189
35.2617	34.5552	33.9683	33.6448	33.0815
35.24	34.5576	33.9946	33.6472	33.1321
35.2029	34.5325	33.9814	33.6221	33.1189
35.6433	34.626	33.6797	33.1404	32.5649
35.6697	34.4248	33.3345	32.6394	32.1357
35.0833	33.9695	33.0469	32.5193	31.9678
34.0522	33.0576	32.1704	31.6307	31.4268
34.2068	33.1523	32.0012	31.2936	31.3175
35.4771	33.6328	32.1465	31.2467	31.0067
35.3203	33.9912	32.373	31.4495	31.1135
35.0701	33.9443	32.5542	31.3667	31.0306
34.5432	33.6929	32.7339	31.9186	30.8746
34.4236	33.4531	32.2544	31.4507	30.6586
34.4595	32.9858	31.5107	30.7666	30.5985
34.4368	33.4902	32.6633	31.7279	30.9719
34.1719	33.3933	32.3862	31.6667	30.9827
34.1348	33.5359	32.7808	32.0493	31.4135
34.0881	33.5371	32.866	32.2305	32.0745
33.7144	33.0913	32.5518	32.1082	32.228
34.0151	33.2603	32.5889	32.2412	32.1572
34.5073	33.5969	32.8779	32.3743	31.9546
34.4822	33.5598	32.8767	32.3372	32.0613
34.3865	33.5	32.9246	32.385	32.0613
34.6379	33.7275	33.0684	32.5889	31.9414
34.7217	33.8833	33.2002	32.7688	31.8334
34.5779	33.8235	33.2363	32.7808	32.0012
34.6042	33.8738	33.2866	32.8792	32.1116
34.5923	33.9216	33.2986	32.8911	32.0757
34.6643	33.9456	33.3945	32.927	32.1116
34.7085	33.9299	33.4268	32.9233	32.1201
34.7827	34.0403	33.4771	32.9736	32.1584

34.7217	34.0151	33.5	32.9365	32.0852
34.772	34.0535	33.5144	33.011	32.0996
34.7349	34.0403	33.5251	33.0935	32.1704
34.7708	34.0522	33.5491	33.0576	32.0144
34.8533	34.075	33.5957	33.1284	32.0972
34.9158	34.1611	33.5862	33.1428	32.1357
34.9265	34.1841	33.6328	33.1655	32.2305
34.8916	34.1731	33.5981	33.011	32.0518
34.9756	34.2451	33.6702	33.1069	32.2197
34.9983	34.2439	33.6809	33.2014	32.2424
34.9636	34.2451	33.6941	33.1667	32.2075
34.9517	34.2332	33.73	33.1428	32.1836
35.0701	34.3037	33.7048	33.1775	32.1584
35.0581	34.3516	33.7527	33.2615	32.1824
34.9863	34.3037	33.7527	33.1895	32.0864
35.0103	34.3157	33.7886	33.2615	32.3145
35.0952	34.3528	33.8018	33.2507	32.2676
35.0234	34.281	33.7539	33.2507	32.2676
35.0725	34.3301	33.7671	33.2759	32.3286
35.0605	34.3301	33.8149	33.2759	32.3047
35.094	34.3516	33.7527	33.2134	32.2424
35.1299	34.3997	33.8005	33.2854	32.2544
35.0474	34.3767	33.8018	33.3105	32.2915
35.0833	34.4009	33.8379	33.2866	32.3396
35.0581	34.3635	33.8125	33.2615	32.3503
35.106	34.4116	33.8005	33.2134	32.2424
35.082	34.4116	33.8367	33.2615	32.2783
35.0833	34.4009	33.8499	33.2026	32.2075
35.0833	34.4128	33.9097	33.2866	32.2437
35.106	34.4236	33.9204	33.3213	32.2664
35.0234	34.3289	33.8857	33.3105	32.2915
35.167	34.3887	33.8738	33.2266	32.1956
35.167	34.4248	33.8738	33.3225	32.2915
35.1084	34.426	33.863	33.3477	32.3167
35.094	34.4116	33.8726	33.3694	32.3743
35.1299	34.4236	33.8726	33.2974	32.2544
35.082	34.4116	33.8486	33.3213	32.3022
35.1538	34.4236	33.8965	33.3452	32.3743
35.1311	34.3887	33.8499	33.3105	32.3035
35.1179	34.4116	33.8486	33.3213	32.3022
35.1287	34.3984	33.8713	33.3801	32.3132
35.1311	34.4128	33.8857	33.3706	32.3154
35.106	34.4355	33.8965	33.3093	32.3022
35.1072	34.3767	33.8738	33.3345	32.3276
35.1191	34.4009	33.8857	33.3945	32.3396
35.082	34.4116	33.8965	33.3213	32.2903
35.0713	34.4128	33.8738	33.3105	32.2676
35.082	34.3997	33.8845	33.3213	32.2783
35.1072	34.4248	33.9336	33.3345	32.2915
35.0916	34.3972	33.8342	33.2949	32.2161
35.1047	34.3984	33.8953	33.332	32.301
35.1047	34.3984	33.8833	33.344	32.2891
35.1311	34.4009	33.8738	33.3105	32.2317
35.1179	34.3997	33.8606	33.3333	32.2063
35.0569	34.3503	33.8474	33.3201	32.2292
35.1406	34.4104	33.8594	33.3201	-32.1931

35.1179	34.4355	33.8845	33.4053	32.3145
35.0342	34.3396	33.8367	33.2734	32.2185
35.094	34.3755	33.8367	33.2495	32.1584
35.1658	34.4236	33.8845	33.3813	32.2903
35.155	34.4487	33.8977	33.3706	32.2317
35.0688	34.4224	33.8833	33.3201	32.2051
35.0557	34.3853	33.8582	33.343	32.324
35.1047	34.4104	33.8833	33.3081	32.1812
35.0796	34.4092	33.8462	33.271	32.1321
35.0676	34.3853	33.894	33.4268	32.2878
35.0557	34.3372	33.8701	33.355	32.2759
35.0916	34.3613	33.8103	33.2231	32.228
35.1514	34.4331	33.8701	33.3308	32.168
35.1621	34.4199	33.8689	33.3538	32.2507
35.0784	34.384	33.845	33.2937	32.1787
35.1155	34.4092	33.906	33.3909	32.2759
35.0676	34.3494	33.8582	33.355	32.3
35.0784	34.3481	33.8569	33.2937	32.2148
35.0796	34.3733	33.8342	33.3308	32.2041
35.0903	34.408	33.8809	33.3657	32.1787
35.0784	34.396	33.8809	33.3176	32.2148
35.0186	34.324	33.8091	33.1858	32.0947
35.0916	34.4211	33.8821	33.343	32.312
35.0891	34.4067	33.8438	33.2805	32.1057
35.0425	34.384	33.8689	33.3296	32.2268
35.0305	34.384	33.8569	33.2937	32.2627
35.0173	34.3108	33.8198	33.1965	32.1895
35.1262	34.3601	33.8689	33.3176	32.1667
35.113	34.3828	33.8198	33.2446	32.1057
35.0903	34.408	33.8569	33.2698	32.0708
35.0413	34.3469	33.8318	33.3164	32.1655
35.04	34.3577	33.8306	33.2195	32.1404
35.125	34.4187	33.8318	33.2805	32.1536
35.1011	34.4187	33.8557	33.2686	32.1416
35.0759	34.4055	33.8545	33.3274	32.1523
35.0042	34.3577	33.8306	33.2913	32.1763
35.0161	34.3577	33.8665	33.2554	32.1885
35.064	34.3936	33.8545	33.3152	32.2722
35.04	34.3696	33.8425	33.2793	32.1165
35.0532	34.3708	33.8557	33.2805	32.2017
35.0137	34.3313	33.8401	33.2529	32.2339
35.0747	34.3923	33.8174	33.2781	32.1631
35.0483	34.366	33.8389	33.2756	32.1968
35.0989	34.3923	33.8174	33.3142	32.2471
35.0857	34.415	33.8401	33.313	32.198
34.9885	34.354	33.8628	33.2998	32.1606
35.0005	34.3181	33.8628	33.2756	32.1248
35.0605	34.354	33.8149	33.2278	32.1128
35.0115	34.3169	33.8257	33.2146	32.0876
35.0005	34.3301	33.8149	33.2756	32.1968
34.9646	34.2942	33.7671	33.2278	32.2207
35.0498	34.3193	33.7922	33.2649	32.186
35.0103	34.2798	33.8005	33.2373	32.1104
35.0737	34.3672	33.8162	33.2649	32.126
35.0364	34.342	33.791	33.3237	32.2327
35.0222	34.3396	33.8245	33.2493	32.1465

35.0618	34.3433	33.8162	33.2888	32.198
35.0605	34.342	33.803	33.2756	32.1968
34.9863	34.2798	33.7886	33.2615	32.1704
35.0222	34.3396	33.7646	33.2373	32.1465
35.0103	34.3635	33.8005	33.2734	32.2183
34.9502	34.3037	33.7766	33.2615	32.1704
34.9744	34.3157	33.7766	33.2134	32.1223
34.9971	34.3145	33.7993	33.2122	32.1091
35.0103	34.3276	33.7886	33.2253	32.1343
34.96	34.2773	33.7742	33.175	32.072
34.9958	34.2893	33.7742	33.187	32.0481
35.021	34.3384	33.7874	33.2361	32.0732
34.9863	34.2917	33.8125	33.1655	32.0383
35.0103	34.3157	33.8005	33.2134	32.1824
34.9719	34.2654	33.7622	33.1272	32.0481
35.009	34.2666	33.7515	33.248	32.1572
35.0198	34.3252	33.7622	33.2949	32.144
34.9238	34.2415	33.7144	33.2229	32.072
34.925	34.2427	33.7275	33.2241	32.1331
35.0186	34.3	33.761	33.1978	32.0469
34.925	34.2185	33.7156	33.1284	32.0012
34.9609	34.2786	33.7754	33.2361	32.1091
34.9336	34.2869	33.7358	33.2327	32.1174
34.9348	34.2283	33.7012	33.2217	32.1189
34.9097	34.2031	33.7358	33.2085	32.0815
34.9216	34.2271	33.7239	33.1726	32.0337
34.9934	34.2869	33.7478	33.2446	32.1416
34.9443	34.2617	33.7825	33.1953	32.1165
34.9575	34.2271	33.7358	33.2327	32.2014
34.9097	34.239	33.7119	33.1846	32.0696
34.9216	34.2629	33.7358	33.2085	32.1174
34.9229	34.2402	33.7251	33.2458	32.0469
34.9358	34.2295	33.7622	33.2349	32.1079
34.8989	34.2522	33.7729	33.1738	32.1067
34.9216	34.239	33.7358	33.2566	32.0935
34.9324	34.2019	33.7107	33.2195	32.0684
34.8855	34.239	33.7	33.1726	32.1655
34.9097	34.2271	33.7239	33.1965	32.2014
34.9468	34.2283	33.6892	33.1379	32.1067
34.9216	34.2151	33.7	33.1367	32.1055
34.8975	34.2031	33.7119	33.1726	32.0337
34.9336	34.2271	33.7	33.2446	31.9977
34.9216	34.2151	33.7239	33.2925	32.1655
34.8845	34.2139	33.7107	33.1953	32.0325
34.8833	34.2007	33.6855	33.0864	32.0313
34.9695	34.2271	33.676	33.1367	32.1296
34.9456	34.2271	33.7239	33.1606	32.0337
34.9084	34.1899	33.6868	33.1953	32.1165
34.8855	34.167	33.6519	33.1008	31.9257
34.9204	34.2378	33.7107	33.1953	32.0564
34.8616	34.239	33.688	33.2085	32.1174
34.8713	34.2007	33.6736	33.1462	32.0911
34.9575	34.2271	33.7	33.0767	31.9736
34.9084	34.2378	33.6868	33.1475	32.0444
34.8257	34.155	33.688	33.1487	32.1174
34.8845	34.1418	33.6868	33.1714	32.0684

34.9324	34.1899	33.6628	33.1594	32.1042
34.8376	34.1431	33.676	33.1606	32.0935
34.9802	34.2258	33.6748	33.1714	31.9965
34.9097	34.2031	33.6519	33.1726	32.1174
34.8604	34.166	33.6267	33.0996	32.0083
34.9324	34.2139	33.6748	33.1355	31.9725
34.9587	34.2402	33.6892	33.2339	32.0588
34.8364	34.1418	33.6509	33.1833	31.9965
34.8018	34.179	33.6399	33.1248	32.0457
34.8604	34.178	33.6028	33.1116	32.0205
34.9348	34.2402	33.6531	33.1619	32.0469
34.8005	34.166	33.6267	33.1116	32.0564
34.8245	34.1538	33.6628	33.1475	32.1165
34.8965	34.178	33.6748	33.1355	32.0564