



LUND UNIVERSITY

Församlingsfilter för Biotekniskt lab

Axelsson, Jan Peter; Hedlund, Krister

1986

Document Version:
Förlagets slutgiltiga version

[Link to publication](#)

Citation for published version (APA):
Axelsson, J. P., & Hedlund, K. (1986). *Församlingsfilter för Biotekniskt lab*. (Technical Reports TFRT-7311). Department of Automatic Control, Lund Institute of Technology (LTH).

Total number of authors:
2

General rights

Unless other specific re-use rights are stated the following general rights apply:
Copyright and moral rights for the publications made accessible in the public portal are retained by the authors and/or other copyright owners and it is a condition of accessing publications that users recognise and abide by the legal requirements associated with these rights.

- Users may download and print one copy of any publication from the public portal for the purpose of private study or research.
- You may not further distribute the material or use it for any profit-making activity or commercial gain
- You may freely distribute the URL identifying the publication in the public portal

Read more about Creative commons licenses: <https://creativecommons.org/licenses/>

Take down policy

If you believe that this document breaches copyright please contact us providing details, and we will remove access to the work immediately and investigate your claim.

LUND UNIVERSITY

PO Box 117
221 00 Lund
+46 46-222 00 00

Församlingsfilter för Biotekniskt Lab

Jan Peter Axelsson

Krister Hedlund

DEPARTMENT OF AUTOMATIC CONTROL
LUND INSTITUTE OF TECHNOLOGY

JULY 1986

Department of Automatic Control Lund Institute of Technology P.O. Box 118 S-221 00 Lund Sweden	Document name INTERNAL REPORT	
	Date of issue July 1986	
	Document Number CODEN: LUTFD2/(TFRT-7311)/1-18/(1986)	
Author(s) Jan Peter Axelsson, Krister Hedlund	Supervisor Rolf Braun	
	Sponsoring organisation STU	
Title and subtitle Församlingsfilter för Biotekniskt Lab. (Pre sampling filter for a Biotechnical Lab).		
Abstract <p>In this report a pre sampling filter is described. The filter is of second order and the filter constant is easily changed up to about 100 sec. The input is galvanically isolated using AD 284 J. There is also an amplifier with variable gain (0-10 times) and variable zero.</p> <p>The layout is given for two channels on a board for 19" rack and 31 pin jack DIN 41 617.</p>		
Key words		
Classification system and/or index terms (if any)		
Supplementary bibliographical information		
ISSN and key title		ISBN
Language Swedish	Number of pages 18	Recipient's notes
Security classification		

FÖRSAMPLINGSFILTER FÖR BIOTEKNISKT LAB

Här beskrivs ett filter att placeras mellan givares signal och ingång på dator. Filtret är anpassat för de krav som vi mött under ett par års arbete i ett biotekniskt lab.

Brusnivån på signalerna är i regel betydligt större än vad man ser på ett skrivarpapper. I skrivaren filtreras i regel signalen. Då givaren anslutes utan filter till dator, kan högfrekventa störningar (relativt samplingsintervallet) uppträda som lågfrekventa svävningar s. k. vikningseffekt (aliasing)*. Då biotekniska processer ofta är långsamma, samplingsintervall flera minuter, och analoga filter är svåra att göra med tidskonstant större än ca 20 sek, är det lämpligt att kombinera ett analogt församlingsfilter med ett digitalt filter i datorn.

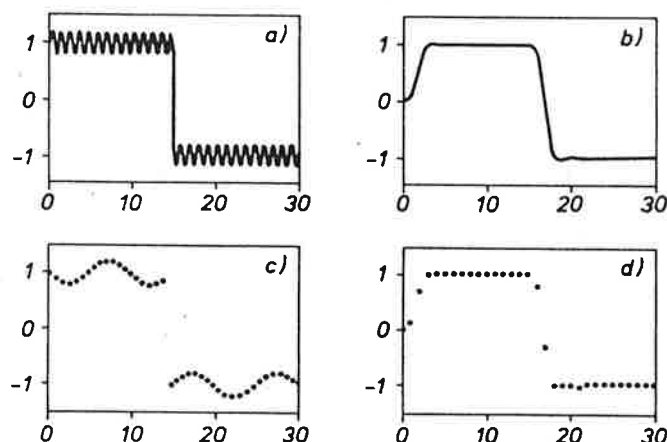

Fig. 1. I figuren illustreras värdet av ett församlingsfilter. a) Mätssignal med sinusformad störning; b) Mätssignalen filtrerad genom ett fjärde ordningens filter; c) Sampling av signalen i (a); d) Sampling av signalen i (b).

Beskrivning

Filtret är av andra ordningen. Tidskonstanter upp till 100 sek har testats. Komponenterna för filtrets tidskonstanter sitter på en lätt utbytbar sockel.

Differentiellt ingångssteg är ett måste, för att undvika jordningsproblem. Här har ingångssteget galvaniskt skilts från filtret för att helt eliminera dessa problem. En standard krets används, AD 284 J från Analog Devices.

Variabel förstärkning (0-10) och variabel nollnivå är värdefullt. Vidare har enheten försetts med två utgångar, en ofiltrerad och en filtrerad. Dessutom kan man byta tecken på den ofiltrerade signalen. En ofiltrerad signal med ombytt tecken är praktiskt att ha vid parallell anslutning till skrivare. Operationsförstärkare 3140 används.

Kretskort och frontpanel är avsett för 19" rack och anslutning med 31-polig jack, DIN 41 617. På varje kort finns två kanaler.

*Se, till exempel kapitel 2.5. i 'Computer Controlled Systems', Prentice Hall, 1984 av K.J. Åström och B. Wittenmark.

Förfarande vid trimning

Grundläggande trimning görs på kortet, på följande sätt:

- 1) Kortslut ingången (brygga mellan Hi och Lo).
- 2) Häng mätproben på testpunkt 1 och anslut jord till mätdonet.
- 3) Skruva på potentiometern närmast busskontakten tills mätspänningen blir så nära 0 V som möjligt.
- 4) Anslut en referensspänning mellan Hi och Lo.
- 5) Skruva på potentiometern i mitten av kretskortet till dess spänningen ligger så nära referensspänningen som möjligt.

Trimning från panelen:

- 1) Kortslut ingången (brygga mellan Hi och Lo).
- 2) Anslut mätproben till utgången.
- 3) Vänta tills utsignalen är i jämvikt (3 ggr aktuell tidskonstant).
- 4) Skruva på panelpotentiometern märkt Z (nolläge) tills utspänningen är 0 V.
- 5) Anslut referensspänningen till ingången.
- 6) Vänta tills utsignalen är i jämvikt (3 ggr aktuell tidskonstant).
- 7) Skruva på panelpotentiometrarna för förstärkning märkt F och C (fine och course) tills utspänning erhålles med önskad förstärkning.

Komponenter för filterkonstanten

Ett andra ordningens filter användes med uppbyggnad enligt nedanstående schema.

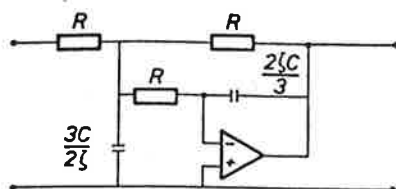

Figure 2.9 An operational amplifier realization of a second-order filter. The transfer function of the filter is given by (2.13) with $\omega = 1/RC$.

TABLE 2.1 Damping ζ and natural frequency ω for Butterworth, ITAE (Integral Time Absolute Error), and Bessel filters. The higher-order filters are obtained by cascading filters of the form of (2.13). Here, ω_0 is the desired natural frequency of the filter.

Order	Butterworth		ITAE		Bessel	
	ω/ω_0	ζ	ω/ω_0	ζ	ω/ω_0	ζ
2	1	0.71	1.00	0.71	1.00	0.87
4	1	0.38	1.33	0.32	3.39	0.62
	1	0.92	0.75	0.83	3.02	0.96
6	1	0.26	1.30	0.32	5.14	0.49
	1	0.71	0.98	0.60	5.57	0.82
	1	0.97	0.79	0.93	4.34	0.98

Frekvensanalys av filtret

En frekvensanalysator (Solartron 1250) har använts för analys av filtrets dynamiska egenskaper. Mätdata presenteras i Bode diagram. Mätdata har sedan använts för passning till parametrisk modell enligt minsta kvadratmetoden. Filtrets egenskaper stämmer väl med teorin.

Mätdata

Två olika filter testades med tidskonstant 10 resp 100 sek. Ifall det är viktigt att filtret ej ger översläng då insignalen är ett steg, skall filterpolerna ha något större dämpning än vad vi nu har. Polerna placeras enligt Bessel, se tabell på föregående sida.

I fig. 1. och fig. 2. visas Bode diagram för resp filter. I samma diagram visas uppmätta punkter vid frekvensanalys samt anpassad modell. Vidare visas stegsvaret för den skattade modellen. En knappt märkbar översläng kan iakttagas.

Tidskonstant	[s]	10	100
R	[MΩ]	1.03	10.1
C1	[μF]	0.89	0.85
C2	[μF]	3.45	3.26
ω°	[rad/s]	0.55	0.059
ζ	[1]	0.76	0.77
<hr/>			
Uppmätt			
ω°	[rad/s]	0.65	0.057
ζ	[1]	0.74	0.78

Där

$$\omega^{\circ} = \frac{1}{R \cdot \sqrt{C1 \cdot C2}} , \quad \zeta = 1.5 \cdot \sqrt{C1/C2}$$

Referenser

- 1) "Computer Controlled Systems", K.J. Åström, B. Wittenmark, Prentice Hall 1984. Kapitel 2.5 diskuterar församlingsfilter.
- 2) "Digital Signal Analysis", S. Stearns, Hayden, New Jersey 1975. Ett helt kapitel ägnas åt sampling.
- 3) "Analog and Digital Filters: Design and Realization", H. Lam, Prentice Hall 1979. Den här boken tar upp både analoga och digitala filter.
- 4) "Digital Signal Processing", A. Oppenheim, R. Schafer, Prentice Hall 1975. Detta är en standard bok i digital filterteknik.

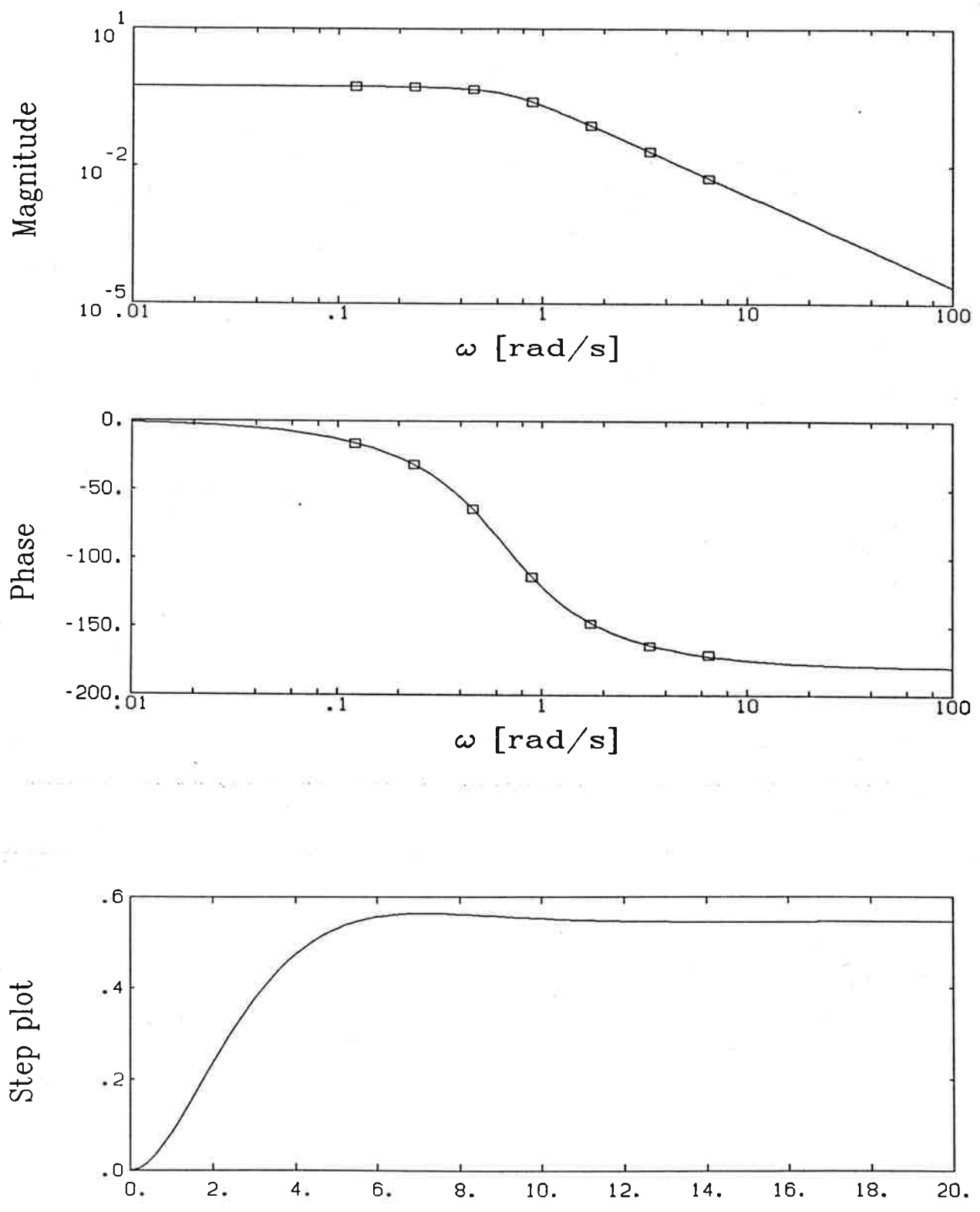

Fig. 1. I de båda övre figurerna visas Bodediagrammet för filter med tidskonstant 10 s. Mätpunkter är markerade med (□) och heldragen kurva är det skattade filtrets Bodediagram. Viktad mista kvadrat metod har använts vid skattning av överföringsfunktion från frekvensanalysdata. Den nedre kurvan visar stegsvaret för det skattade filtret. En lätt översläng kan märkas.

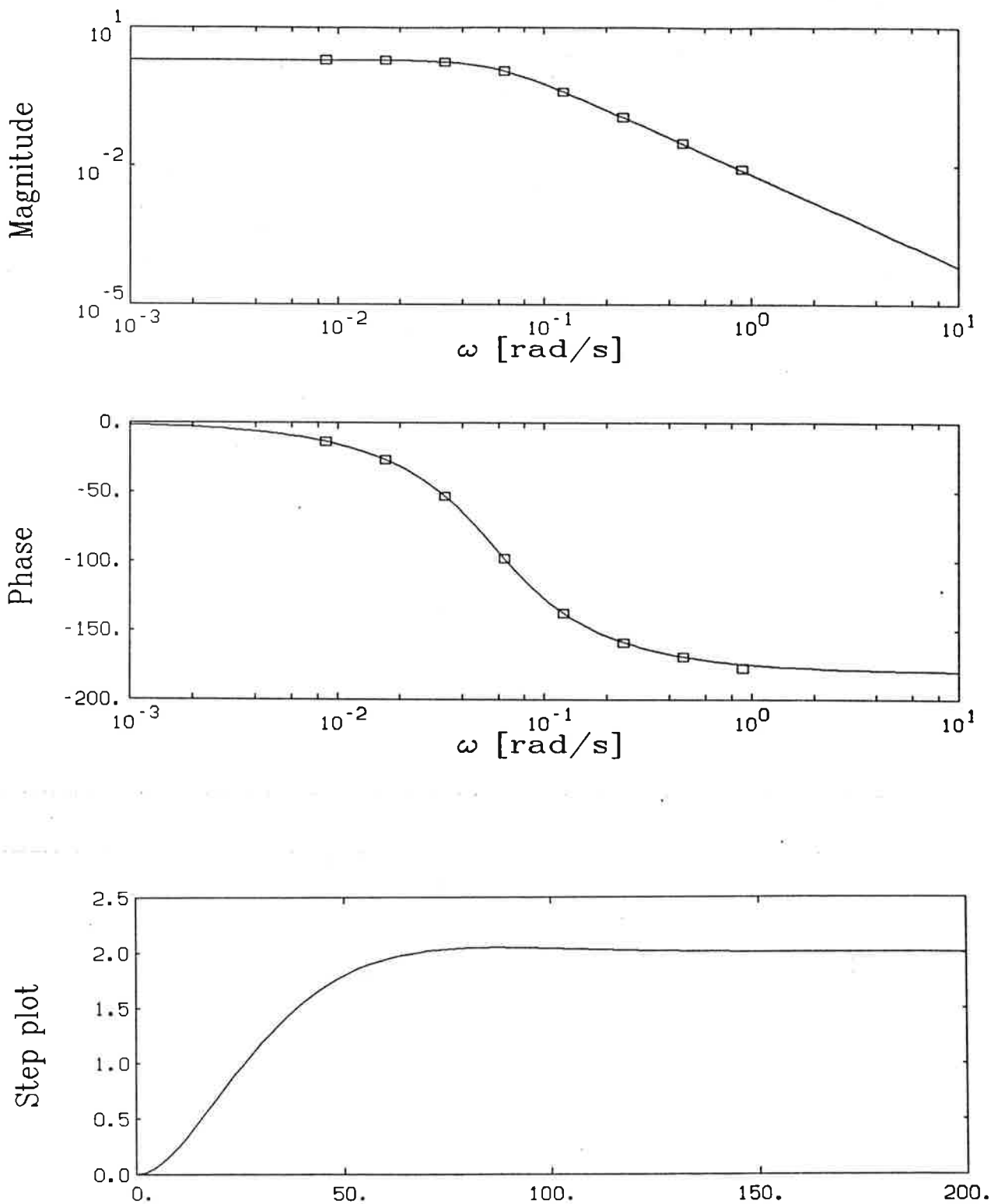
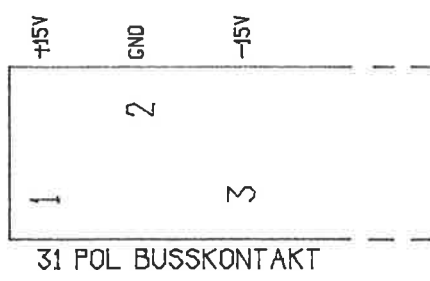
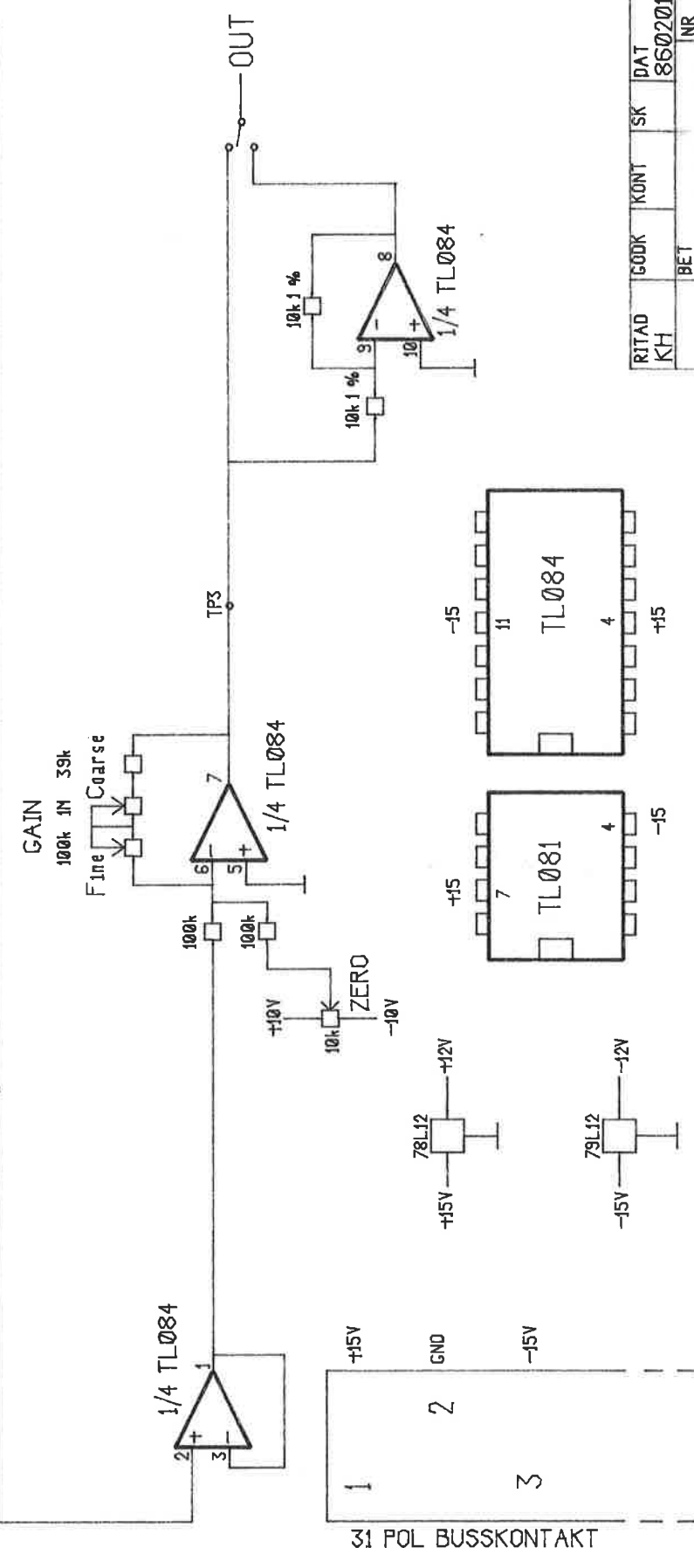
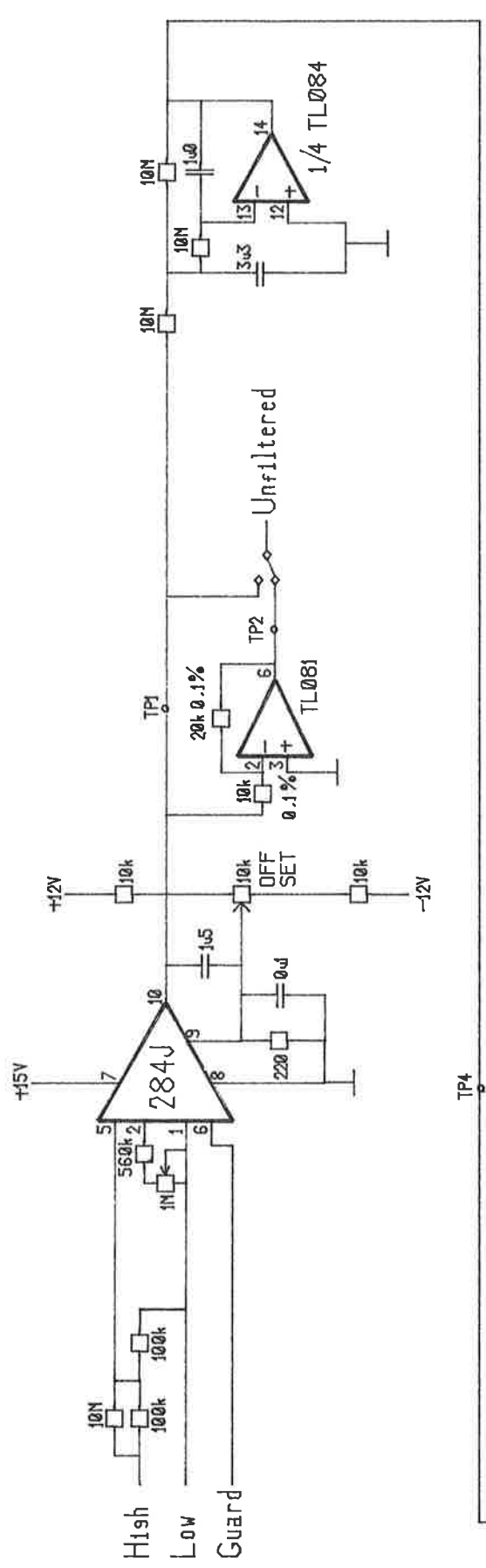

Fig. 2. I de båda övre figurerna visas Bodediagrammet för filter med tidskonstant 100s. Mätpunkter är markerade med (□) och heldragen kurva är det skattade filtrets Bodediagram. Viktad mista kvadrat metod har använts vid skattning av överföringsfunktion från frekvensanalysdata. Den nedre kurvan visar stegsvaret för det skattade filtret. En lätt översläng kan märkas.

Appendix

- 1) Kretsschema.
- 2) Komponentlista.
- 3) Datablad för isolationsförstärkare AD 284J.
- 4) Kretskort för 19" rack och plugg DIN 41 617.
- 5) Komponentplacering.
- 6) Ritning till frontpanel för 19" rack och frontbredd 40 mm.



RITAD KH	GODK BET	KONT ISOLATIONSFORST	SK	DAT 850201	NR
-------------	-------------	-------------------------	----	---------------	----

KOMPONENTLISTA

Här följer en fullständig lista på de komponenter och kretskortsdetaljer som behövs. Beställningsnummer till ELFA anges.

PER KORT:

Kretskortlaminat, 19" rack	1	49-5727-0
Frontpanel	1	52-6706-7
Kortkontakt, 31-pol DIN 41 617	1	43-7221-5
78L12	1	73-0913-1
79L12	1	73-0918-0
Laboratoriehylsa, svart	4	40-2850-2
Laboratoriehylsa, röd	4	40-2852-8
Laboratoriehylsa, vit	6	40-2859-3
Komponentadapter, 20-pol	2	48-1524-7
Sockel, 20-pol	2	48-1215-2
Löddöron	8	48-9360-8
Lödstift	8	48-9260-0
Kontakthylsor	4	48-9270-9

PER KANAL (dubbla antalet komponenter per kort om två kanaler önskas):

IC-kretsar

284J	1	NAXAB
TL084CN	1	73-1185-5
TL081CP	1	73-1180-6

Kondensatorer

C1	1.5 μF	1	65-2314-6
C2, C4, C7	0.1 μF	3	65-7268-9
C3	0.47 μF	1	65-7276-2
C5	3.3 μF	1	65-2318-7
C6	1.0 μF	1	65-7281-2

Motstånd

R1, R2	100k 0.1%	2	60-4027-3
R8	10k 0.1%	1	60-4021-6
R9	20k 0.1%	1	60-0897-3
R6, R7, R17, R18	10k 1%	4	60-0879-3
R5	220k 5%	1	60-1041-7
R4	560k 5%	1	60-1082-1
R16	39k 5%	1	60-1068-0
R14, R15	100k 5%	2	60-1073-0
R11, R12, R13	1M 5%	3	60-1085-4 ???
R3	10M 5%	1	60-1297-5 ???
R10 utgår			

Trimpotentiometrar

Offset	10k	1	64-7432-4
Zero	10k	1	64-7232-8
Fine	100k	1	64-7240-1
Coarse	1M	1	64-7247-6
Först	1M	1	64-7447-2

MODELS 284J, 286J, 281

FEATURES

- High CMV Isolation:** $\pm 5000V$ pk, 10ms Pulse; $\pm 2500V$ dc Continuous
- High CMR:** 110dB min with $5k\Omega$ imbalance
- Low Nonlinearity:** 0.05% @ 10V pk-pk Output
- High Gain Stability:** $\pm 0.0075\%/^{\circ}C$, $\pm 0.001\%/1000$ hours
- Low Input Offset Voltage Drift:** $10\mu V/^{\circ}C$, $G = 100V/V$ (Model 286J)
- Resistor Programmed Gain:** 1 to 10V/V (284J)
1 to 100V/V (286J)
- Isolated Power Supply:** $\pm 8.5V$ dc @ $\pm 5mA$ (284J)
 $\pm 15V$ dc @ $\pm 15mA$ (286J)
- Meets IEEE Std 472:** Transient Protection (SWC)
- Meets UL Std 544 Leakage @ 115V ac, 60Hz:**
2.0 μA max (284J)
2.5 μA max (286J)

APPLICATIONS

- Fetal Heartbeat Monitoring
- Multi-Channel ECG Recording
- Ground Loop Elimination in Industrial and Process Control
- High Voltage Protection in Data Acquisition Systems
- 4-20mA Isolated Current Loop Receiver

GENERAL DESCRIPTION

The models 284J, 286J are low cost, high performance isolation amplifiers designed for high CMV isolation and low leakage in biomedical, industrial and data acquisition systems. Using modulation techniques with reliable transformer isolation, the models 284J, 286J protect both patients and ultra-sensitive equipment from high CMV transients up to $\pm 5000V$ pk (10ms pulse) or 2500V dc continuous, high CMR of 110dB ($5k\Omega$ imbalance) and feature maximum leakage current of less than $3\mu A$ rms, @ 115V ac, 60Hz (inputs to power common).

The model 284J is a self-contained isolation amplifier for single channel applications. For multi-channel applications, the model 286J combined with an external synchronizing oscillator such as the model 281 may be used; up to 16 model 286J amplifiers can be driven from 1 model 281 oscillator. Additional channels may be obtained by configuring an unlimited number of 284Js with several ganged 281 oscillators.

Both models also provide resistor-programmable gain of 1 to 10V/V (284J) or 1 to 100V/V (286J), high gain stability of $0.0075\%/^{\circ}C$, low nonlinearity of 0.05% @ 10V pk-pk output and isolated power supply outputs of $\pm 15V$ dc @ $\pm 15mA$ (286J) or $\pm 8.5V$ dc @ $\pm 5mA$ (284J).

WHERE TO USE MODELS 284J, 286J

Industrial Applications: In data acquisition systems, computer interface systems, process signal isolators and high CMV instrumentation, models 284J, 286J offer complete galvanic isolation and protection against damage from transients and fault voltages. High level transducer interface capability is afforded

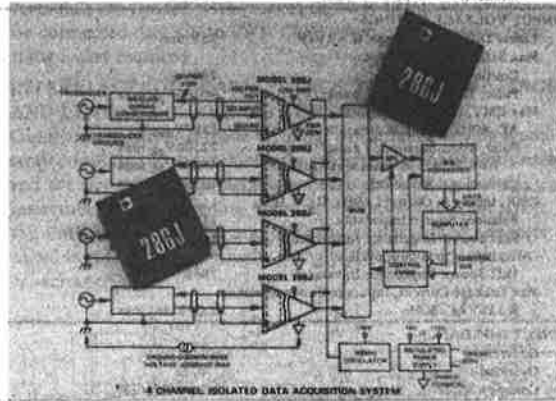

with model 286J's 20V pk-pk or model 284J's 10V pk-pk input signal range at a gain of 1V/V operation. In portable field designs, single supply, wide range operation (+8V to +16V) offers simple battery operation.

Medical Applications: In biomedical and patient monitoring equipment such as multi-channel VCG, ECG, and polygraph recorders, models 284J, 286J offer protection from lethal ground fault currents as well as 5kV defibrillator pulse inputs. Low level bioelectric signal recording is achieved with low input noise ($8\mu V$ pk-pk @ $G = \text{max gain}$) and high CMR (110dB, min @ 60Hz).

DESIGN FEATURES AND USER BENEFITS

High Reliability: Models 284J, 286J are conservatively designed, compact modules, capable of reliable operation in harsh environments. Models 284J, 286J have calculated MTBF of over 390,000 hours and are designed to meet MIL-STD-202E environmental testing as well as the IEEE Standard for Transient Voltage Protection (472-1974: Surge Withstand Capability). As an additional assurance of reliability, every model 284J and 286J is factory tested for CMV and input ratings by application of 5kV pk, 10ms pulses, between input terminals as well as input/output terminals.

Isolated Power Supply: Dual regulated supplies, completely isolated from the input power terminals ($\pm 2500V$ dc isolation), provides the capability to excite floating signal conditioners, front end buffer amplifiers as well as remote transducers such as thermistors or bridges.

Adjustable Gain: A single external resistor enables gain adjustment from 1V/V to 100V/V (286J) or 1V/V to 10V/V (284J) providing the flexibility of applying models 284J, 286J in both high-level transducer interfacing as well as low-level sensor measurements.

For detailed information, contact factory.

SPECIFICATIONS

(typical @ +25°C and $V_S = +15V$ dc unless otherwise noted)

MODEL	284J	286J ¹
GAIN (NON-INVERTING)		
Range (50kΩ Load)	1 to 10V/V	1 to 100V/V
Formula	$Gain = \left[1 + \frac{100k\Omega}{10.7k\Omega + R_1(k\Omega)} \right]$	$Gain = \left[1 + \frac{100k\Omega}{1k\Omega + R_1(k\Omega)} \right]$
Deviation from Formula vs. Time	±3%	±4%
vs. Temperature (0 to +70°C) ²	±0.001%/1000 Hours	•
Nonlinearity, 10V pk-pk Output ³	±0.0075%/°C	•
	±0.05%	•
INPUT VOLTAGE RATINGS		
Linear Differential Range, $G = 1V/V$	±5V min	±10V min
Max Safe Differential Input		
Continuous	240V _{rms}	•
Pulse, 10ms duration, 1 pulse/10 sec	±6500V _{pk} max	•
Max CMV, Inputs to Outputs		
AC, 60Hz, 1 minute duration	2500V _{rms}	•
Pulse, 10ms duration, 1 pulse/10 sec	±2500V _{pk} max	•
With 510kΩ in series with Guard	±5000V _{pk} max	•
Continuous, AC or DC	±2500V _{pk} max	•
CMR, Inputs to Outputs, 60Hz, $R_S \leq 5k\Omega$		
Balanced Source Impedance	114dB	•
5kΩ Source Impedance Imbalance	110dB min	•
CMR, Inputs to Guard, 60Hz		
1kΩ Source Impedance Imbalance	78dB	•
Max Leakage Current, Inputs to Power Common @ 115VAC, 60Hz	2.0μA rms max	2.5μA rms max
INPUT IMPEDANCE		
Differential	10 ⁸ Ω 70pF	10 ⁸ Ω 150pF
Overload	>0.2Ω	•
Common Mode	5x10 ¹⁰ Ω 20pF	•
INPUT DIFFERENCE CURRENT		
Initial, @ +25°C	±7nA max	•
vs. Temperature (0 to +70°C)	±0.1nA/°C	•
INPUT NOISE		
Voltage ³		
0.05Hz to 100Hz	8μV pk-pk	•
10Hz to 1kHz	10μV rms	3μV rms
Current		
0.05Hz to 100Hz	5pA pk-pk	•
FREQUENCY RESPONSE		
Small Signal, -3dB	1kHz	•
Slew Rate	25mV/μs	•
Full Power, 10V p-p Output	200Hz	900Hz
Full Power, 20V p-p Output	N/A	400Hz
Recovery Time, to ±100μV after Application of ±6500V _{pk} Differential Input Pulse	200ms	•
OFFSET VOLTAGE REFERRED TO INPUT		
Initial, @ +25°C, Adjustable to Zero	±(5 + 20/G)mV	±(5 + 45/G)mV
vs. Temperature (0 to +70°C)	±(1 + 150/G)μV/°C	±(7 + 250/G)μV/°C
vs. Supply Voltage	±1mV/%	•
RATED OUTPUT		
Voltage, 50kΩ Load	±5V min	±10V min
Output Impedance	1kΩ	•
Output Ripple, 1MHz Bandwidth	5mV pk-pk	20mV pk-pk
ISOLATED POWER OUTPUTS		
Voltage, ±5mA Load	±8.5V dc	±15V dc
Accuracy	±5%	0, -6%
Current	±5mA min	±15mA min
Regulation, No Load to Full Load	+0, -15%	+0, -10%
Ripple, 100kHz Bandwidth	100mV pk-pk	200mV pk-pk
POWER SUPPLY, SINGLE POLARITY⁴		
Voltage, Rated Performance	+15V dc	•
Voltage Operating	+(8 to 15.5)V dc	•
Current, Quiescent	+10mA	+13mA
TEMPERATURE RANGE		
Rated Performance	0 to +70°C	•
Operating	-25°C to +85°C	•
Storage	-55°C to +85°C	•
CASE DIMENSIONS⁵	1.5" x 1.5" x 0.62"	•

NOTES
¹ Specifications same as model 284J.
² Specifications for model 286J apply when driven by ADI model 281 oscillator.
³ Gain temperature drift and gain nonlinearity are specified as a percentage of output signal level.
⁴ Model 284J: Gain = 10V/V; Model 286J: Gain = 100V/V.
⁵ Recommended power supply, ADI model 904, ±15V @ 50mA.
⁶ Recommended mounting sockets - model 284J: ADI Part Number AC1049; model 286J: ADI Part Number AC1054.
 Specifications subject to change without notice.

OUTLINE DIMENSIONS

Dimensions shown in inches and (mm).

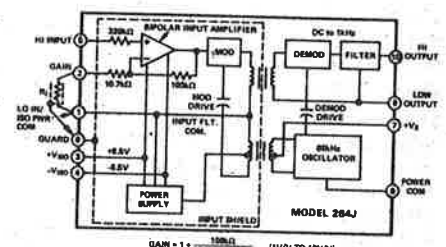
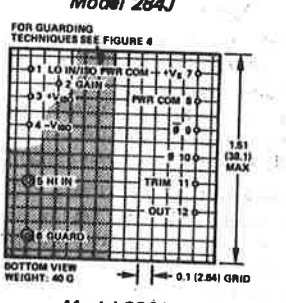
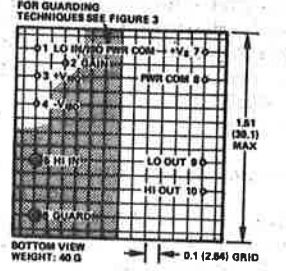
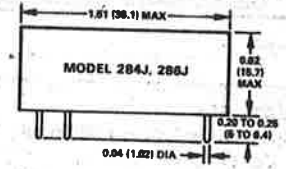

Figure 1. Block Diagram - Model 284J

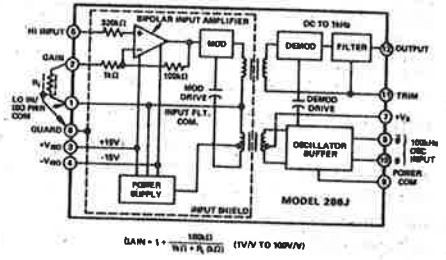
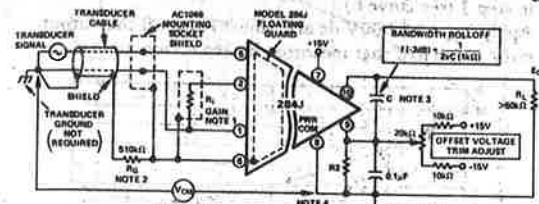

Figure 2. Block Diagram - Model 286J

Understanding the Isolation Amplifier Performance

INTERCONNECTION AND GUARDING TECHNIQUES

Models 284J, 286J can be applied directly to achieve rated performance as shown in Figures 3 and 4. To preserve the high



- NOTE 1. GAIN RESISTOR, R_1 , 1%, 50ppm/°C METAL FILM TYPE IS RECOMMENDED. FOR GAIN = 1V/V, LEAVE TERMINAL 2 OPEN. FOR GAIN = 10V/V, SHORT TERMINAL 2 TO TERMINAL 1
 $GAIN = 1 + \frac{10k\Omega}{R_1 + R_2}$
- NOTE 2. GUARD RESISTOR, R_0 , REQUIRED ONLY FOR CMV > ±2500V_{PK} (15kV_{PK} MAX). R_0 MAY BE MOUNTED ON AC1048 MOUNTING SOCKET USING STANDOFF PROVIDED. USE 1/4 WATT, 5%, CARBON COMPOSITION TYPE; ALLEN BRADLEY RECOMMENDED.
- NOTE 3. OUTPUT FILTER CAPACITOR, C, SELECT TO ROLLOFF NOISE AND OUTPUT RIPPLE. (e.g. SELECT C = 1.5μF FOR dc TO 100Hz BANDWIDTH).
- NOTE 4. $R_2 \sim 200\Omega$, G = 1; $R_2 \sim 2k\Omega$, G > 1

Figure 3. Model 284J Basic Isolator Interconnection

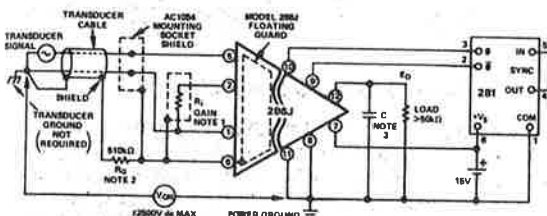

- NOTE 1. GAIN RESISTOR, R_1 , USE 50ppm/°C METAL FILM TYPE. FOR GAIN = 1V/V, LEAVE TERMINAL 2 OPEN. FOR GAIN = 10V/V, SHORT TERMINAL 2 TO TERMINAL 1 FOR GAINS FROM 1V/V TO 100V/V.
 $GAIN = 1 + \frac{10k\Omega}{R_1 + R_2}$
- NOTE 2. OPTIONAL GUARD RESISTOR, R_0 , REQUIRED ONLY FOR CMV > ±2500V_{PK}. R_0 MAY BE CONVENIENTLY MOUNTED ON AC1048 MOUNTING SOCKET USING THE STANDOFF PROVIDED (R₀). USE 1/4 WATT, 5% CARBON COMPOSITION TYPE; ALLEN BRADLEY RECOMMENDED.
- NOTE 3. OUTPUT FILTER CAPACITOR C, SELECT TO ROLL OFF NOISE AND OUTPUT RIPPLE. (e.g. SELECT C = 1.5μF FOR dc TO 100Hz BANDWIDTH)
 $f(-3dB) = \frac{1}{2\pi C(R_1||R_2)}$

Figure 4. Model 286J Basic Isolator Interconnection

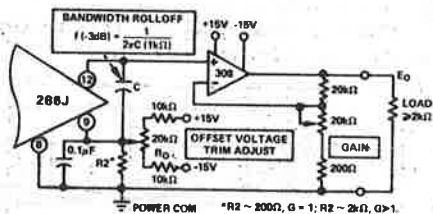

Figure 5. Model 286J Optional Connection: Offset Voltage Trim Adjust, Bandwidth (-3dB) Rolloff and Gain Adjust (G > 100V/V)

CMR performance, care must be taken to keep the capacitance balanced about the input terminals. A shield should be provided on the printed circuit board under model 284J or 286J. The GUARD (Pin 6) should be connected to this shield. The guard-shield is provided with the mounting socket. To reduce effective cable capacitance, cable shield should be connected to the common mode signal source by connecting the shield as close as possible to the signal low.

Offset Voltage Trim Adjust: The trim adjust circuits shown in Figures 3 and 5 can be used to zero the output offset voltage over the specified gain range. The output terminals, HI OUT and LO OUT, can be floated with respect to PWR COM up to ±50V_{PK} max, offering three-port isolation. A 0.1μF capacitor is required from LO OUT to PWR COM whenever the output terminals are floated with respect to PWR COM. LO OUT can be connected directly to PWR COM when output offset trimming is not required.

INTERELECTRODE CAPACITANCE, TERMINAL RATINGS AND LEAKAGE CURRENTS LIMITS

Capacitance: Interelectrode terminal capacitance arising from stray coupling capacitance effects between the input terminals and the signal output terminals are each shunted by leakage resistance values exceeding 50kMΩ. Figures 6 and 8 illustrate the CMR ratings at 60Hz and 5kΩ source imbalance between signal input/output terminals, along with their respective capacitance.

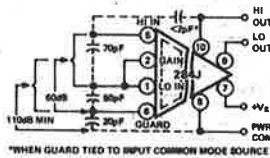

Figure 6. Model 284J Terminal Capacitance and CMR Ratings

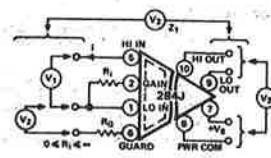

Figure 7. Model 284J Terminal Ratings

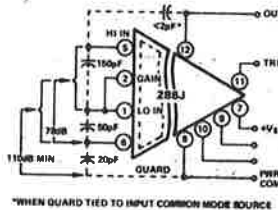

Figure 8. Model 286J Terminal Capacitance and CMR Ratings

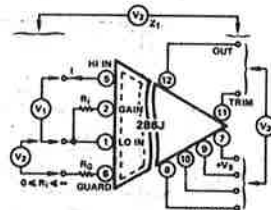

Figure 9. Model 286J Terminal Ratings

Terminal Ratings: CMV performance is given in both peak pulse and continuous ac or dc peak ratings. Pulse ratings are intended to support defibrillator and other transient voltages. Continuous peak ratings apply from dc up to the normal full power response frequencies. Figures 7 and 9 and Table 1 illustrate models 284J, 286J ratings between terminals.

SYMBOL	RATING	REMARKS
V1 (pulse)	±6500V _{PK} (10ms)	Withstand Voltage, Defibrillator
V1 (cont.)	±240V _{RMS}	Withstand Voltage, Steady State
V2 (pulse)	±2500V _{PK} (10ms) R _C = 0	Transient
V2 (cont.)	±5000V _{PK} (10ms) R _C = 510kΩ	Isolation, Defibrillator
V3 (cont.)	±2500V _{PK}	Isolation, Steady State
Z1	±50V _{PK}	Isolation, dc
I (286J)	50μA rms	Input Fault Limit, dc to 200kHz
I (284J)	35μA rms	Input Fault Limit, dc to 60kHz

Table 1. Isolation Ratings Between Terminals

Leakage Current Limits: The low coupling capacitance between inputs and output yields a ground leakage current of less than $2.0\mu\text{A rms}$ (284J) and $2.5\mu\text{A rms}$ (286J) at 115V ac, 60Hz (or $0.02\mu\text{A/V ac}$). As shown in Figures 10 and 11, the transformer coupled modulator signal, through stray coupling, also creates an internally generated leakage current. Line frequency leakage current levels are unaffected by the power on or off condition of models 284J, 286J.

For medical applications, models 284J and 286J are designed to improve on patient safety current limits proposed by F.D.A., U.L., A.A.M.I. and other regulatory agencies (e.g., model 286J complies with leakage requirements for the Underwriters Laboratory STANDARD FOR SAFETY, MEDICAL AND DENTAL EQUIPMENT as established under UL544 for type A and B patient connected equipment - reference *Leakage Current*, paragraph 27.5).

In patient monitoring equipment, such as ECG recorders, models 284J, 286J will provide adequate isolation without exposing the patient to potentially lethal microshock hazards. Using passive components for input protection, this design limits input fault currents even under amplifier failure conditions.

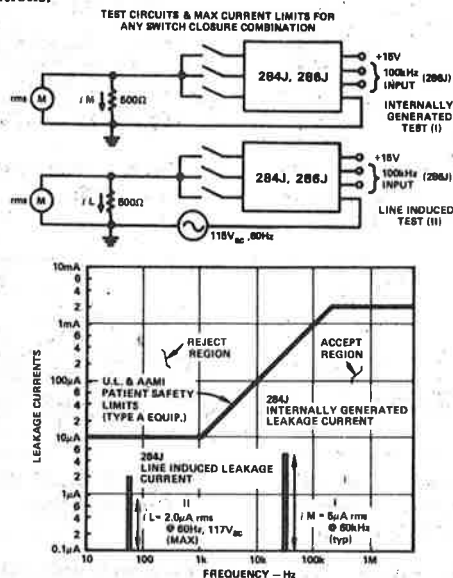

Figure 10. Model 284J Leakage Current Performance from Line Induced and Internally Generated (Modulator) Operating Conditions

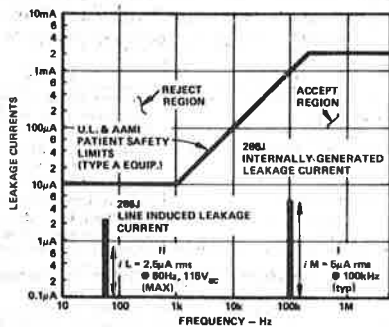

Figure 11. Model 286J Leakage Current Performance from Line Induced and Internally Generated (Modulator) Operating Conditions

GAIN AND OFFSET TRIM PROCEDURE, MODEL 284J

1. Apply $e_{IN} = 0$ volts and adjust R_O for $e_O = 0$ volts.
2. Apply $e_{IN} = +1.000\text{V dc}$ and adjust R_G for $e_O = +5.000\text{V dc}$.
3. Apply $e_{IN} = -1.000\text{V dc}$ and measure the output error (see curve a).
4. Adjust R_G until the output error is one half that measured in step 3 (see curve b).
5. Apply $e_{IN} = +1.000\text{V dc}$ and adjust R_O until the output error is one half that measured in step 4 (see curve c).

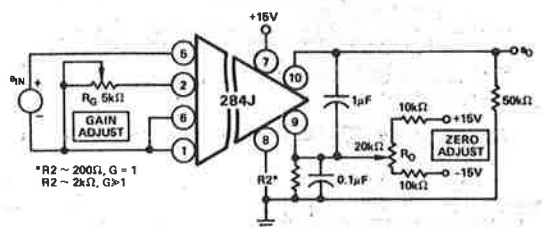
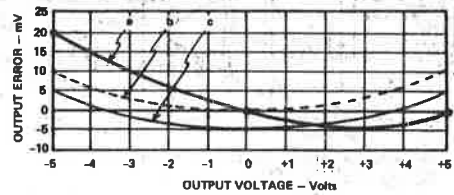

Figure 12. Gain and Offset Adjustment

GAIN AND OFFSET TRIM PROCEDURE, MODEL 286J

In applying the isolation amplifier, highest accuracy is achieved by adjustment of gain and offset voltage to minimize the peak error encountered over the selected output voltage span. The following procedure illustrates a calibration technique which can be used to minimize output error. In this example, the output span is +5V to -5V and operation at Gain = 10V/V is desired.

1. Apply $e_{IN} = 0$ volts and adjust R_O for $e_O = 0$ volts.
2. Apply $e_{IN} = +0.500\text{V dc}$ and adjust R_G for $e_O = +5.000\text{V dc}$.
3. Apply $e_{IN} = -0.500\text{V dc}$ and measure the output error (see curve a).
4. Adjust R_G until the output error is one half that measured in step 3 (see curve b).
5. Apply $+0.500\text{V dc}$ and adjust R_O until the output error is one half that measured in step 4 (see curve c).

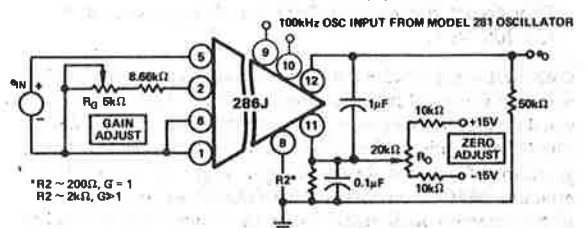
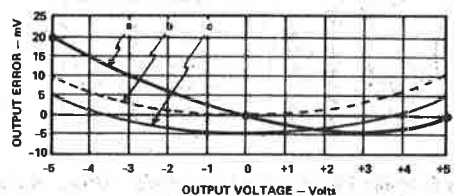

Figure 13. Gain and Offset Adjustment

EL 284J
 volts.
 = +5,000V dc.
 ut error (see

it measured

ie output
 rive c).



-4 -5

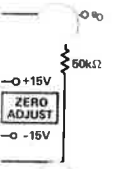

L 286J
 is achieved
 the peak
 span. The
 ue which
 ble, the
 10V/V

ts.
 5,000V dc.
 error

measured

t error is



ATOR

15V
 RO
 UST
 15V

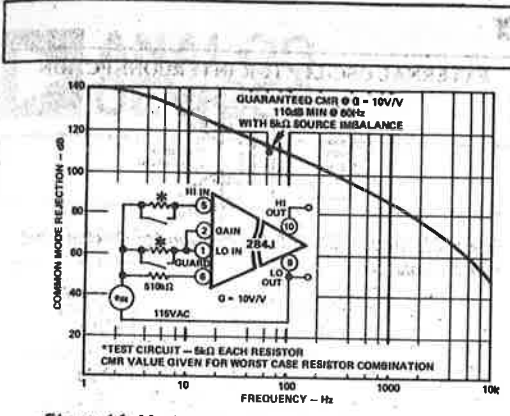

Figure 14. Model 284J Common Mode Rejection vs. Frequency

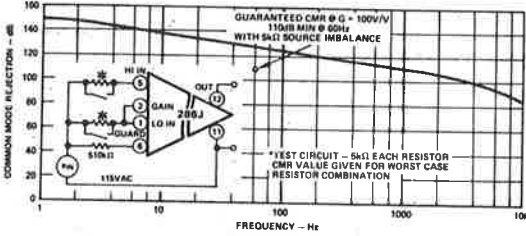

Figure 15. Model 286J Common Mode Rejection vs. Frequency

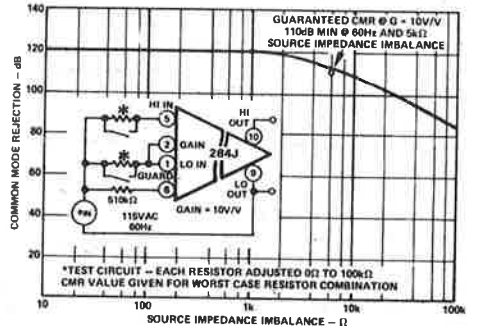

Figure 16. Model 284J Common Mode Rejection vs. Source Impedance Imbalance

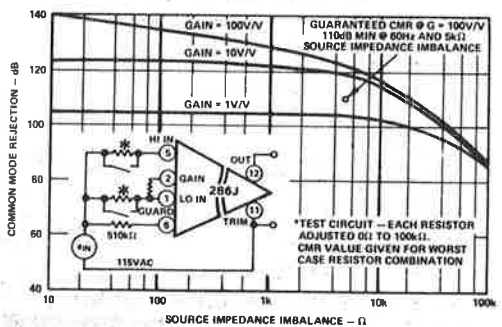

Figure 17. Model 286J Common Mode Rejection vs. Source Impedance Imbalance

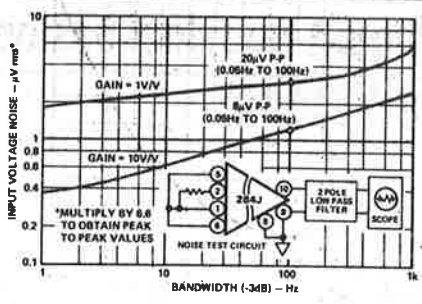

Figure 18. Model 284J Input Voltage Noise vs. Bandwidth

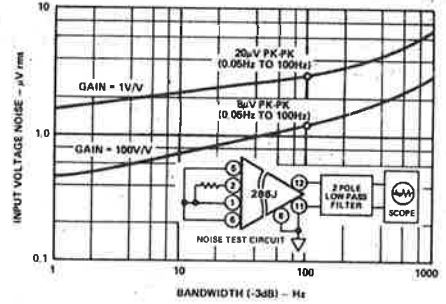

Figure 19. Model 286J Input Voltage Noise vs. Bandwidth

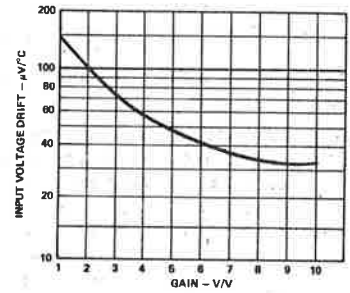

Figure 20. Model 284J Input Offset Voltage Drift vs. Gain

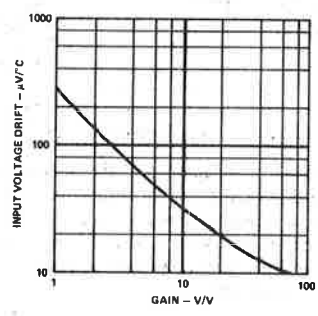

Figure 21. Model 286J Input Offset Voltage Drift vs. Gain

Applying the Multi-Channel Isolation Amplifier

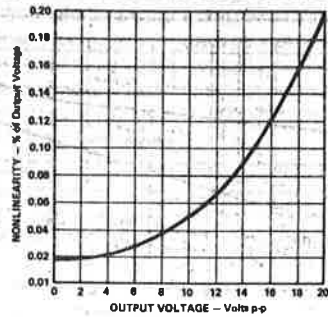
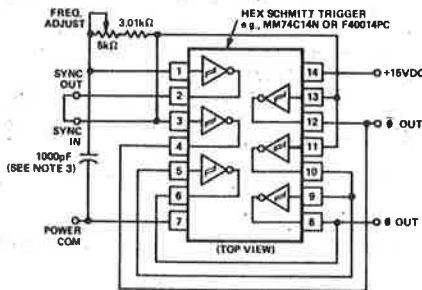

Figure 22. Model 286J Gain Nonlinearity vs. Output Voltage.

REFERENCE EXCITATION OSCILLATOR*

When applying model 286j, the user has the option of building a low cost 100kHz excitation oscillator, as shown in Figure 23, or purchasing a module from Analog Devices — model 281.



NOTES:
 1. FREQ. ADJUST. ADJUST TRIM POT FOR OUTPUT FREQUENCY OF 100kHz ±5%.
 2. FOR SLAVE OPERATION, REMOVE JUMPER FROM SYNC OUT AND SYNC IN PINS.
 3. USE CERAMIC CAPACITOR, "C0G" OR "NPO" CHARACTERISTIC.

Figure 23. Model 281 100kHz Oscillator - Logic and Interconnection Diagram

The block diagram of model 281 is shown in Figure 24. An internal +12V dc regulator is provided to permit the user the option of operating over two, pin selectable, power input ranges; terminal 6 offers a range of +14V dc to +28V dc; terminal 7 offers an input range of +8V dc to +14V dc.

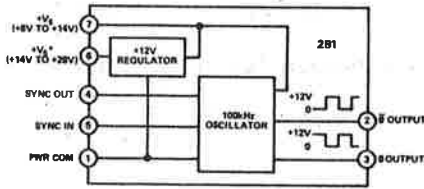

*LEAVE TERMINAL 6 OPEN, WHEN POWER IS APPLIED TO TERMINAL 7.

Figure 24. Model 281 Block Diagram

Model 281 oscillator is capable of driving up to 16 model 286j's as shown in Figure 25. An additional model 281 may be driven in a slave-mode, as shown in Figure 26 to expand the total system channels from 16 to 32. By adding additional model 281's in this manner, systems of over 1000 channels may be easily configured.

*CAUTION:

ESD(Electro-static-discharge) sensitive device. Permanent damage may occur on unconnected devices subjected to high-energy electrostatic fields. Unused devices must be stored in conductive foam or shunts. The protective foam should be discharged to the destination socket before devices are removed.

EXTERNAL OSCILLATOR INTERCONNECTION

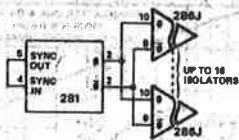

Figure 25. Model 281/286 Connection for Driving from 1 to 16 Isolators

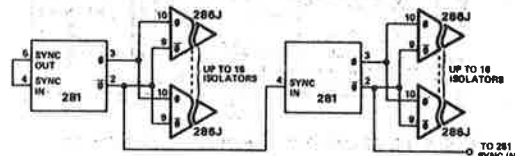

Figure 26. Model 281/286 Connection for Driving > 16 Isolators

SPECIFICATIONS

(typical @ +25°C and V_S = +15V dc unless otherwise noted)

MODEL	281*
OUTPUT	
Frequency	100kHz ±5%
Waveform	Squarewave
Voltage (φ and φ̄ terminals)	0 to +12V pk
Fan-Out ^{1,2}	16 max
POWER SUPPLY RANGE³	
High Input, Pin 6	+ (14 to 28)V dc
Quiescent Current, N.L.	+5mA
F.L.	+16mA
Low Input, Pin 7	+ (8 to 14)V dc
Quiescent Current, N.L.	+12mA
F.L.	+33mA
TEMPERATURE	
Rated Performance	0 to +70°C
Storage	-55°C to +85°C
MECHANICAL	
Case Size	1.4" x 0.6" x 0.49"
Weight	10 grams

¹ Model 286j oscillator drive input represents unity oscillator load.
² For applications requiring more than 16 286j's, additional 281's may be used in a master/slave mode. Refer to Figure 26.
³ Full load consists of 16 model 286j's and 281 oscillator slave.
 Specifications subject to change without notice.

OUTLINE DIMENSIONS

Dimensions shown in inches and (mm).

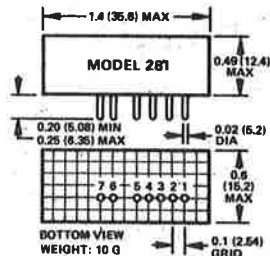

PIN TERMINAL IDENTIFICATION

- 1 POWER COMMON
- 2 φ OUTPUT
- 3 φ̄ OUTPUT
- 4 SYNC INPUT
- 5 SYNC OUTPUT
- 6 +V_S: HIGH RANGE (+14 to 28)V_{dc}
- 7 +V_S: LOW RANGE (+8 to 14)V_{dc}

MATING SOCKET: Cinch #16 DIP or Equivalent



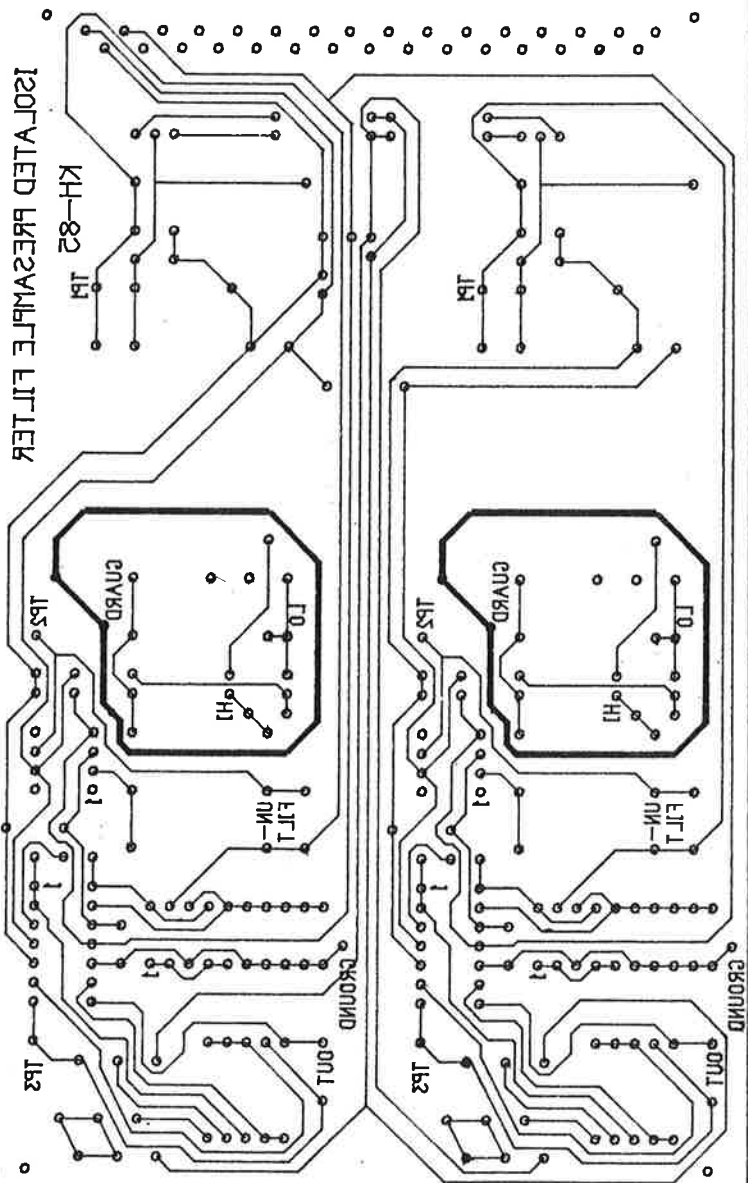

ISOLATED PRESAMPLE FILTER

KH-82 JM

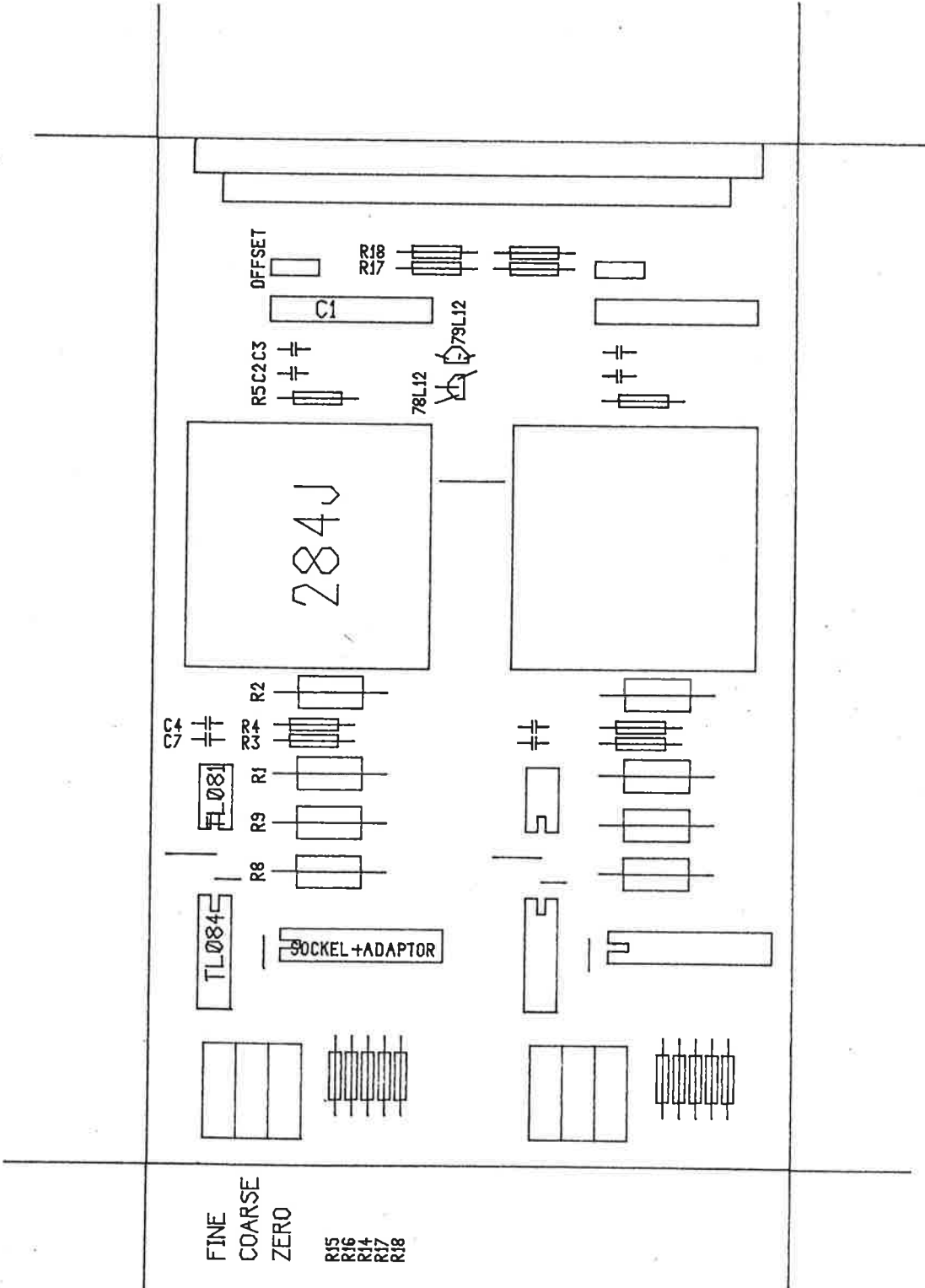

Frontpanel

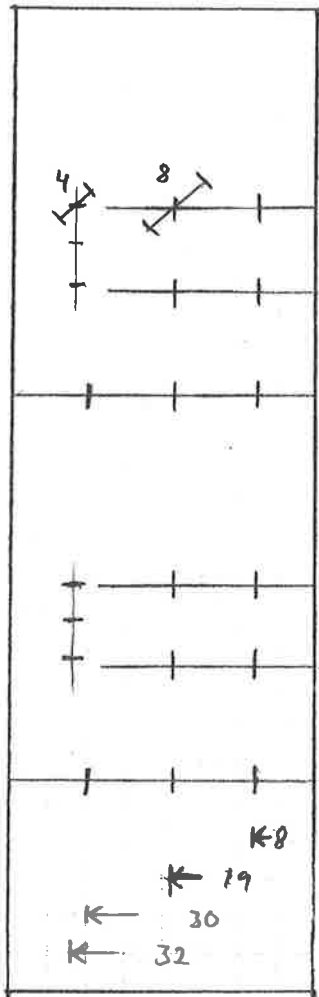

71 pol jack DIN 41 617

