



LUND UNIVERSITY

Lean Burn Natural Gas Operation vs. Stoichiometric Operation with EGR and a Three Way Catalyst

Einewall, Patrik; Tunestål, Per; Johansson, Bengt

Published in:
SAE Special Publications

DOI:
[10.4271/2005-01-0250](https://doi.org/10.4271/2005-01-0250)

2005

[Link to publication](#)

Citation for published version (APA):
Einewall, P., Tunestål, P., & Johansson, B. (2005). Lean Burn Natural Gas Operation vs. Stoichiometric Operation with EGR and a Three Way Catalyst. In *SAE Special Publications* (Vol. 2005, pp. 343-362). Article 2005-01-0250 Society of Automotive Engineers. <https://doi.org/10.4271/2005-01-0250>

Total number of authors:
3

General rights

Unless other specific re-use rights are stated the following general rights apply:
Copyright and moral rights for the publications made accessible in the public portal are retained by the authors and/or other copyright owners and it is a condition of accessing publications that users recognise and abide by the legal requirements associated with these rights.

- Users may download and print one copy of any publication from the public portal for the purpose of private study or research.
- You may not further distribute the material or use it for any profit-making activity or commercial gain
- You may freely distribute the URL identifying the publication in the public portal

Read more about Creative commons licenses: <https://creativecommons.org/licenses/>

Take down policy

If you believe that this document breaches copyright please contact us providing details, and we will remove access to the work immediately and investigate your claim.

LUND UNIVERSITY

PO Box 117
221 00 Lund
+46 46-222 00 00

Lean Burn Natural Gas Operation vs. Stoichiometric Operation with EGR and a Three Way Catalyst

Patrik Einewall, Per Tunestål and Bengt Johansson
Lund Institute of Technology

Reprinted From: **SI Combustion and Direct Injection SI Engine Technology**
(SP-1972)

ISBN 0-7680-1636-3



9 780768 016369

SAE *International*[™]

2005 SAE World Congress
Detroit, Michigan
April 11-14, 2005

The Engineering Meetings Board has approved this paper for publication. It has successfully completed SAE's peer review process under the supervision of the session organizer. This process requires a minimum of three (3) reviews by industry experts.

All rights reserved. No part of this publication may be reproduced, stored in a retrieval system, or transmitted, in any form or by any means, electronic, mechanical, photocopying, recording, or otherwise, without the prior written permission of SAE.

For permission and licensing requests contact:

SAE Permissions
400 Commonwealth Drive
Warrendale, PA 15096-0001-USA
Email: permissions@sae.org
Tel: 724-772-4028
Fax: 724-772-4891



For multiple print copies contact:

SAE Customer Service
Tel: 877-606-7323 (inside USA and Canada)
Tel: 724-776-4970 (outside USA)
Fax: 724-776-1615
Email: CustomerService@sae.org

ISSN 0148-7191
Copyright © 2005 SAE International

Positions and opinions advanced in this paper are those of the author(s) and not necessarily those of SAE. The author is solely responsible for the content of the paper. A process is available by which discussions will be printed with the paper if it is published in SAE Transactions.

Persons wishing to submit papers to be considered for presentation or publication by SAE should send the manuscript or a 300 word abstract to Secretary, Engineering Meetings Board, SAE.

Printed in USA

Lean Burn Natural Gas Operation vs. Stoichiometric Operation with EGR and a Three Way Catalyst

Patrik Einewall, Per Tunestål and Bengt Johansson
Lund Institute of Technology

Copyright © 2005 SAE International

ABSTRACT

Exhaust Emissions from lean burn natural gas engines may not always be as low as the potential permits, especially engines with open loop lambda control. These engines can produce much higher emissions than a comparable diesel engine without exhaust gas after treatment. Even if the engine has closed loop lambda control, emissions are often unacceptably high for future emission regulations. A three way catalyst is, today, the best way to reduce hazardous emissions. The drawback is that the engine has to operate with a stoichiometric mixture and this leads to; higher heat losses, higher pumping work at low to medium loads, higher thermal stress on the engine and higher knock tendency (requiring lower compression ratio, and thus lower brake efficiency). One way to reduce these drawbacks is to dilute the stoichiometric mixture with EGR. This paper compares lean burn operation with operation at stoichiometric conditions diluted with EGR, and using a three way catalyst. The results show that nitric oxides (NO_x) and hydrocarbon (HC) emissions are several orders of magnitude lower than at lean operation. Higher loads can be achieved, and brake efficiency is higher than lean operation optimized for low NO_x production. A fast burning (high turbulence) combustion chamber is used to allow high amounts of dilution.

INTRODUCTION

Hazardous emissions and greenhouse gases from internal combustion engines have been a "hot" topic for many years. A modern spark ignition (SI) engine with a three way catalyst emits very low amounts of hazardous emissions, mostly water and carbon dioxide (CO_2), if driven according to the certifying cycle. CO_2 , which is a greenhouse gas, can be reduced in various ways; e.g. by improving fuel economy, using a fuel with a higher hydrogen to carbon ratio (H/C) or using a renewable fuel.

The fuel economy can be improved by operating the engine with diluted mixtures (extra air or EGR). This will lower the combustion temperature and thus the heat

losses. As a bonus, the raw NO_x emissions are reduced with highly diluted mixtures. Pumping losses at part load are also reduced with these strategies. Diesel engines and HCCI engines (Homogenous Charge Compression Ignition) operate lean and have the above advantages. SI combustion with direct fuel injection also reduces pumping and heat losses and reduces fuel consumption.

The H/C ratio is increased when changing the fuel from diesel to e.g. natural gas or bio gas (methane), the change is approximately from 1.8 to 3.7 to 4.0. The engine is often modified from diesel to SI operation when changing the fuel from diesel to natural gas. The engine efficiency is however, in most cases, reduced when changing to SI combustion. Combustion of methane-rich fuels such as bio gas and natural gas produces relatively low amounts of CO_2 but emission of methane takes place and methane is a much stronger greenhouse gas than CO_2 , by more than 20 times. Even if natural gas cannot prove itself as an intrinsically better fuel than gasoline and Diesel fuel in terms of emissions or efficiency, there is still a very good reason to study natural gas as engine fuel: the sources of natural gas are far bigger than the sources of oil and natural gas will be available at a competitive cost for a long time.

The best way to operate an engine is often a tradeoff between good fuel economy and low emissions. Very good fuel economy can be achieved with lean burn operation. Lean burn engines can use an oxidizing catalyst to reduce HC and carbon monoxide (CO) emissions, but NO_x emissions are still a problem. Stoichiometric SI-operation with a three way catalyst results in very low hazardous emissions, overall. One way to get better fuel economy than pure stoichiometric SI-operation, and lower emissions than lean burn operation, is by addition of EGR to a stoichiometric mixture, and use a three way catalyst.

The aim of this paper is to compare lean burn operation with EGR (stoichiometric) operation and study emissions before and after a three way catalyst. The ignition-angle window between misfire and knock is larger with EGR than at lean operation. There are therefore more

combinations of dilution and ignition angles, using EGR. This can be used for a strategy to maximize inlet manifold pressure (MAP) without exceeding any of the design parameters, thus maximizing the brake mean effective pressure (BMEP).

EXPERIMENTAL APPARATUS

THE ENGINE

The Engine (TG103/G10A) was originally developed for diesel operation and redesigned by Volvo for natural gas operation, see Table 1 for specifications. The fuel is in these tests port-injected and the engine is equipped with a cooled EGR system, Figure 2.

Table 1

Displaced volume/cyl.	1600 cm ³
Compression ratio	11.8:1
Rated power	184 kW (at 2000 rpm)
Maximum brake torque	1150 Nm (at 1150 rpm)
Bore	120.65 mm
Stroke	140 mm
Ignition sequence	1-5-3-6-2-4

NATURAL-GAS PORT-INJECTION SYSTEM

The street version of this engine has single point injection, with four injectors at the fuel injector assembly. The gas pressure is approximately 10 bar (a). The test bench engine is supplied with natural gas at 4.6 bar (a), so the port injection system is equipped with 12 injectors (2 per cylinder) to be able to cover the whole load range, Figure 1. An extension of the intake ports prevents cross breathing of natural gas between cylinders at high loads. The total volume of each inlet port is slightly larger than half the displacement volume per cylinder.

Fuel injection timing

Mixing of air and natural gas may be a problem when using port injection [1]. Injection timing is selected to be centered around top dead center (TDC) gas-exchange at low to medium injection durations, and early enough to finish injection 30 degrees before inlet valve closing (IVC at 230 degrees after top dead center, ATDC) for long injection durations. This strategy ensures sufficient air-flow past the inlet valve for mixing of air and natural gas. If the fuel is injected after IVC the next cycle will receive a stratified charge due to poor mixing.

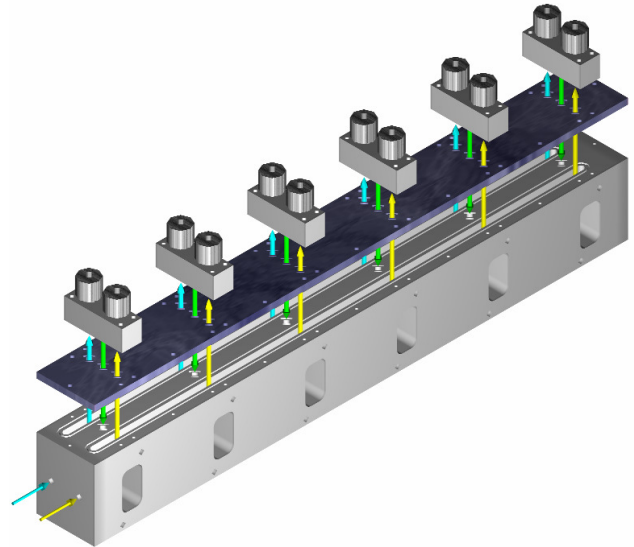

Figure 1. The port injection system.

ENGINE CONTROL SYSTEM

A PC controls each cylinder individually via six cylinder control modules (CCM) from MECCEL. A crank angle encoder (1800 pulses per revolution) is connected to the CCMs, and provides engine speed and crank angle information. The following parameters can be set from the PC:

- Fuel injection (timing and duration)
- Ignition timing for
- Lambda value
- Engine dynamometer speed
- Amount of EGR

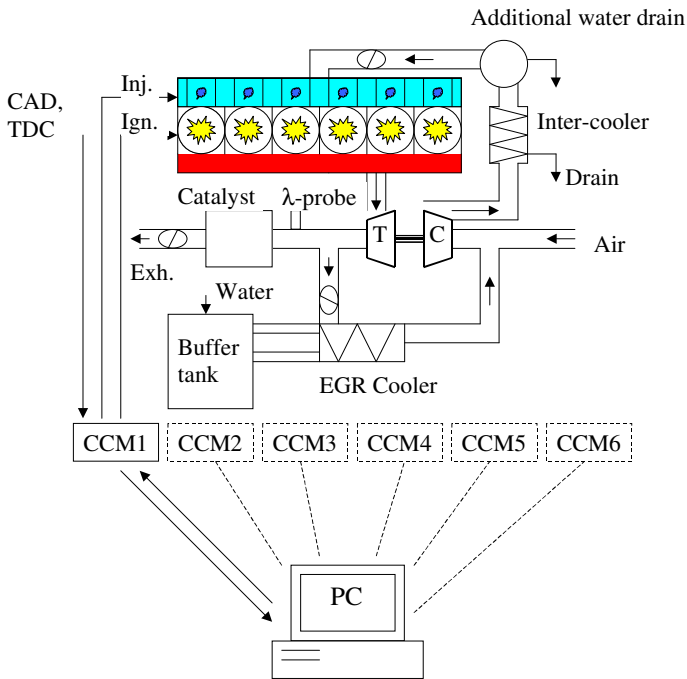

Figure 2. The Engine.

EGR SYSTEM

A long-route EGR system is used, i.e. exhaust gas is extracted downstream the exhaust turbine and reintroduced upstream the compressor. An exhaust-gas heat exchanger is used to cool the EGR. Water from a buffer tank, with water maintained at a constant temperature, is circulated through the heat exchanger to control the EGR temperature (approximately 60 °C). Both hot and cold water are connected to the buffer tank. A throttle on the inlet of the exhaust-gas side of the EGR cooler controls the amount of EGR delivered to the engine. A throttle at the end of the exhaust pipe is used to further increase the amount of EGR (if the EGR-throttle is fully open and not enough EGR is delivered). The amount of EGR is computed according to:

$$\%EGR = \frac{CO_{2inlet}}{CO_{2exhaust}} * 100 \quad \%-vol$$

Where CO_{2inlet} is compensated for the injected fuel.

THE THREE WAY CATALYST

The ceramic monolith catalyst, from Johnson Matthey, is designed to have good oxidation capacity for methane. *"...it is a multi-layered technology with different components for the oxidation of methane under lean and rich conditions contained in each layer."*

MEASUREMENT SYSTEMS

Pressure

Each cylinder head is equipped with a piezo electric pressure transducer, Kistler 7061B. The signal from the charge amplifier, Kistler 5017A, is processed by two parallel Dattel PCI-416 boards in a PC for on-line pressure measurements. The cylinder pressures are measured 5 times per crank angle degree using an external clock from a Leine & Linde crank-angle encoder. The pressures are used for heat-release calculations. The program is described in [2]. Pressures are also measured in the inlet manifold (before and after the throttle) and in the exhaust pipe, before the exhaust throttle.

Emissions

Emissions are measured before and after the catalyst. The emissions are measured by a Pierburg AMA 2000 emission system consisting of; a Heated Flame Ionization Detector (HFID/FID) for hydrocarbons, a Heated Chemiluminescence Detector (HCLD/CLD) for nitric oxides and a Paramagnetic Detector (PMD) for oxygen (O_2). The HC emissions are presented as methane equivalent (C1) in the figures. Four Non Dispersive Infra-red Detectors (NDIR) measure carbon monoxide (CO high and low) and carbon dioxide (in the exhaust and in the air/EGR mixture).

In addition to lambda calculations, a lean lambda probe (ETAS) is installed in the exhaust pipe, before the catalyst.

Temperatures

Probes for temperature measurements are located between the exhaust valves and exhaust manifold on all six cylinder heads, for cylinder individual measurements. Temperatures on the EGR system are measured on the hot and the cold side, both for exhaust gas and cooling water. Exhaust gas temperatures are also measured before and after the catalyst. The temperature probes (Pentronic) on the hot side are shielded. Supervising temperatures are measured in the inlet manifold, cooling water and engine oil.

Flows

The mass flow of natural gas is measured with a Bronkhorst F106A-HC.

Torque

The engine is connected to a Schenk U2-30G water brake, controlled by the engine control system. The torque is measured with a load cell, Nobel Elektronik KRG-4.

All data, except in-cylinder pressures, are collected by a HP 34970A Data Acquisition/Switch unit.

COMBUSTION CHAMBER

A fast burning combustion chamber, with high turbulence, is used to enable operation with highly diluted mixtures, see Figure 3. The Quartette

combustion chamber breaks down the swirl into turbulence and promotes rapid combustion. The Turbine combustion chamber is the standard combustion chamber for this engine type with low turbulence and slow combustion as a consequence. In [4] these and other combustion chambers are compared and it turns out that the Quartette combustion chamber has much faster and more stable combustion particularly under highly diluted conditions. For both combustion chambers the spark plug is centrally located in the cylinder head. One drawback with a fast burning combustion chamber is that the exhaust gases are colder due to the increase in effective expansion ratio. The turbocharger is optimized for the original slow burning combustion chamber called Turbine, see Figure 3. Even if a fast combustion chamber is more tolerant to diluted mixtures, the cold exhaust gases result in too low boost pressure at highly diluted conditions.

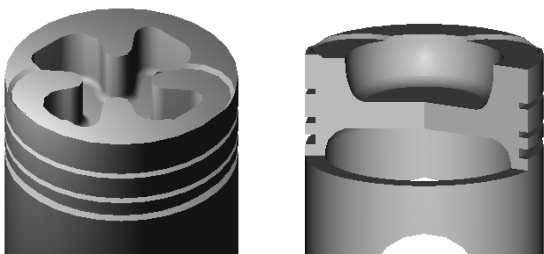

Figure 3. Quartette (left) and Turbine (right) combustion chambers.

GAS DATA

Natural gas from the North Sea is used in this study. The composition varies slightly over time since it is a mix from several North Sea locations. The lower heating value of the gas is 40.10 MJ/kg.

Table 2: Typical natural gas composition during the test

Substance	Percentage (vol)
CH ₄	87.7
C ₂ H ₆	6.71
C ₃ H ₈	2.94
C ₄ H ₁₀ and heavier	1.29
CO ₂	1.06
N ₂	0.31

EXPERIMENT

The first tests are conducted at 1200 rpm and ignition timing set so the position of maximum cylinder pressure, $P_{MAX\alpha}$, is located at 12 crank angle degrees (CAD)

ATDC. The ignition timing resulting in maximum efficiency is called MBT ignition (maximum brake torque ignition). A common rule says that 50% of the fuel is burned at about 10 CAD ATDC, resulting in $P_{MAX\alpha} \approx 16$ CAD ATDC [3], at MBT ignition. Earlier tests with this fast burning combustion chamber show that MBT ignition is when 50% of the fuel is burned at 8-10 CAD ATDC, resulting in $P_{MAX\alpha} \approx 12-14$ CAD ATDC.

Figure 4 shows the limitations on load and dilution. The engine stability limits the dilution at low to medium loads due to high amount of residual gases from the previous combustion cycle. High loads and high amount of additional air or EGR results in too low exhaust energy for sufficient boost pressure. Knock limits the load when the amount of dilution decreases. Three sets of dilutions and ignition strategies are tested:

- Stoichiometric operation with EGR, and $P_{MAX\alpha} = 12$ CAD ATDC ignition timing. Lambda is not at exactly stoichiometric in all modes, but is chosen so NO_x emissions are lower than 10 ppm after the catalyst.
- Lean burn operation with $P_{MAX\alpha} = 12$ CAD ATDC ignition timing
- Lean burn operation with ignition timing set so NO_x emissions are minimized (ignition angles after TDC are not used). The goal is to get less than 2 g/kWh NO_x. Loads above 12 bar BMEP are not possible to operate at any lambda with this goal, due to misfire.

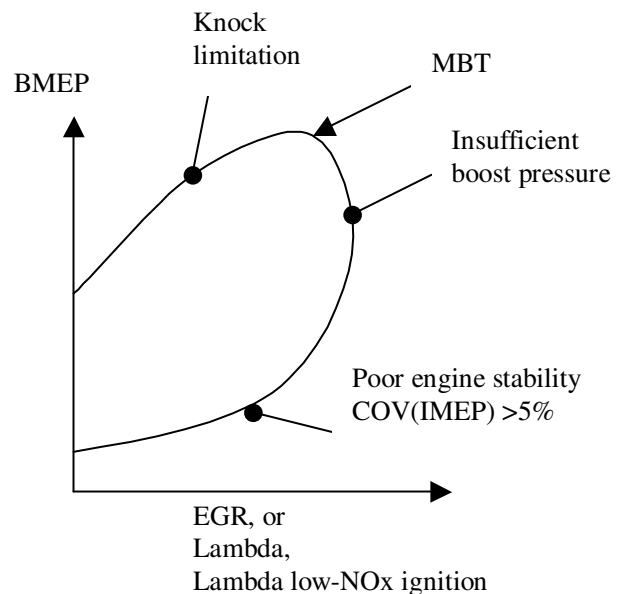

Figure 4. Limitations in load and dilution for the engine mapping.

Lambda is in the next test swept from slightly lean to slightly rich and then back to lean again. The first tests with EGR showed that the tradeoff between NO_x and CO

emissions after the catalyst is very sensitive with respect to lambda. A slight increase in lambda from the optimum point results in increased NO_x emissions, and vice versa for the CO emissions. The HC emissions are more tolerant with respect to lambda. The lambda control does not work like in a conventional SI stoichiometric engine, where lambda oscillates between lean and rich a few times per second. In this system the lambda value is constant, so any oxygen storage features in the catalyst are not utilized. This makes the lambda window, where the catalyst works for all three emissions, much narrower than with a binary lambda probe and an oscillating system [6].

Finally, two strategies for maximizing boost pressure are tested:

- The parameter held constant is $P_{MAX\alpha} = 12$ CAD ATDC, this is done with the ignition angle. Maximum load is then achieved by decreasing the dilution level until the engine starts to knock.
- Both dilution and ignition are optimized for maximum load. More energy is left in the exhaust gases (higher temperature) if ignition is retarded from the point where $P_{MAX\alpha} = 12$ CAD ATDC. This is used to increase boost pressure from the turbo charger. The combination of dilution (decreased until knock) and ignition angle (retarded until COV_{IMEP} reaches 5%) results in maximum load. The ignition angles are presented in appendix B.

RESULTS

The operating points are first evaluated in terms of emissions, combustion and efficiency in order to find out whether stoichiometric operation with EGR is a viable alternative to lean operation. The catalyst behavior, when lambda varies slightly from stoichiometric, is then evaluated, and finally the strategies for getting maximum boost pressure are evaluated.

EMISSIONS

Emissions measured before and after the catalyst, are presented in terms of brake specific emissions (g/kWh), HC emissions are presented as methane equivalent (C1). HC and NO_x emissions are presented below, CO emissions can be seen in appendix A. Ignition timing is set so $P_{MAX\alpha} = 12$ CAD ATDC for EGR and lean operation, and set to minimize NO_x emissions for the lean low-NO_x case. Ignition angles are shown in appendix B. The mass flow through the engine is lower for high dilutions with EGR compared to excess air, so specific emissions are lower using EGR, even if concentrations may be higher.

Figure 5 to Figure 7 show HC emissions before the catalyst for the three dilution and ignition strategies. HC

increases as the amount of EGR increases, and decreases as the load increases. The modes with the highest amounts of EGR have slower and colder combustion, resulting in increased HC emissions, Figure 5. The lean cases, Figure 6 and Figure 7, have minimum HC emissions at λ 1.1 to 1.2. HC increases due to less oxygen on the richer side, and due to colder and slower combustion on the leaner side. The low-NO_x ignition strategy has slightly lower HC emissions in the mid range of lambda values, as the expansion and exhaust temperatures are a bit higher, see Figure 8 to Figure 10. This leads to more post oxidation of HC in the expansion stroke and exhaust manifold [3].

Figure 11 to Figure 13 show the HC emissions after the catalyst. HC emissions after the catalyst are almost constant when operating stoichiometric and increasing the amount of EGR, Figure 11. Low loads and high amounts of EGR result in increased HC after the catalyst. Figure 12 and Figure 13 show emissions for the lean cases. The emissions increase rapidly as lambda increase, but some oxidation in the catalyst can be seen. The high amounts of HC after the catalyst for the leanest cases in Figure 12 are probably due to the fact that emissions before and after the catalyst are not measured simultaneously. The engine is running at modes where partial burn or even misfire can happen.

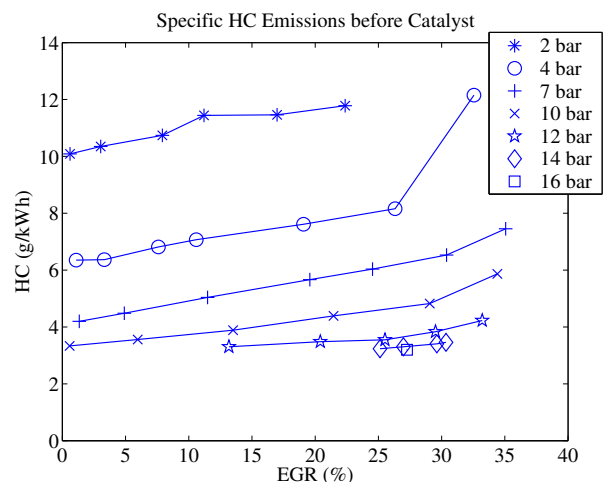

Figure 5. Specific HC emissions before the catalyst, with EGR dilution, for various load cases.

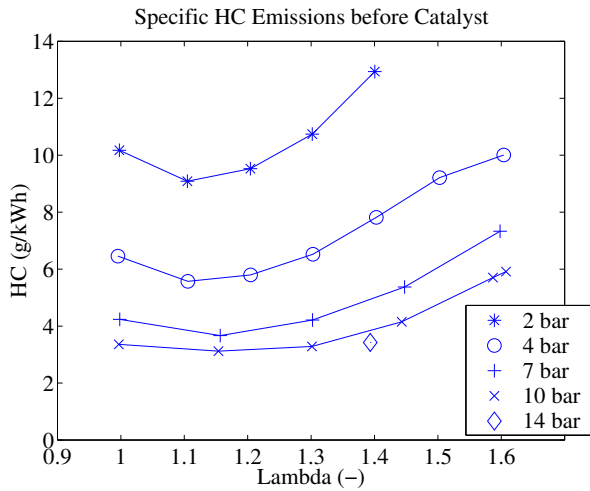

Figure 6. Specific HC emissions before the catalyst, at lean operation, for various load cases.

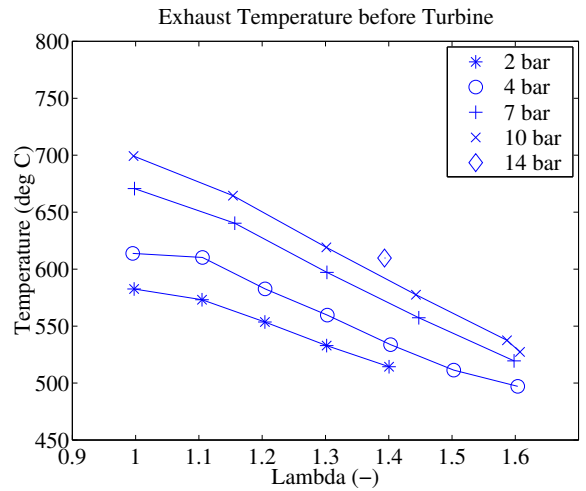

Figure 9. Exhaust temperature before turbine, at lean operation, for various load cases.

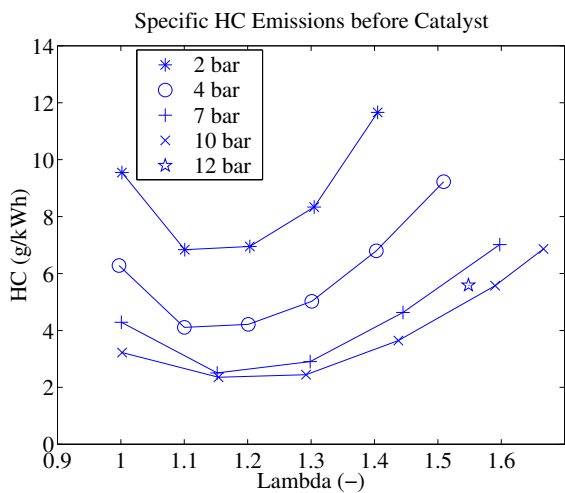

Figure 7. Specific HC emissions before the catalyst, at lean operation with ignition set to minimize NOx emissions, for various load cases.

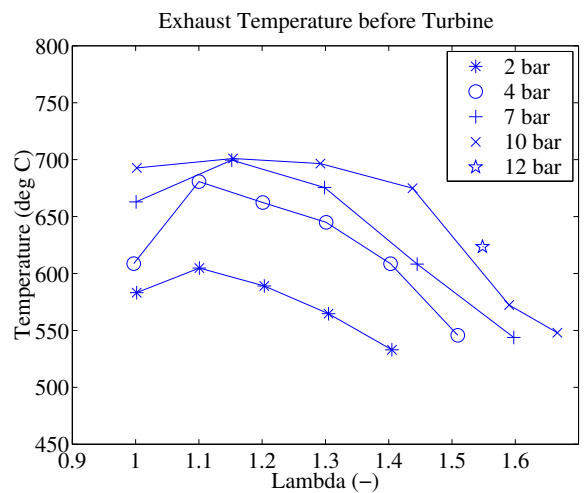

Figure 10. Exhaust temperature before turbine, at lean operation with ignition set to minimize NOx emissions, for various load cases.

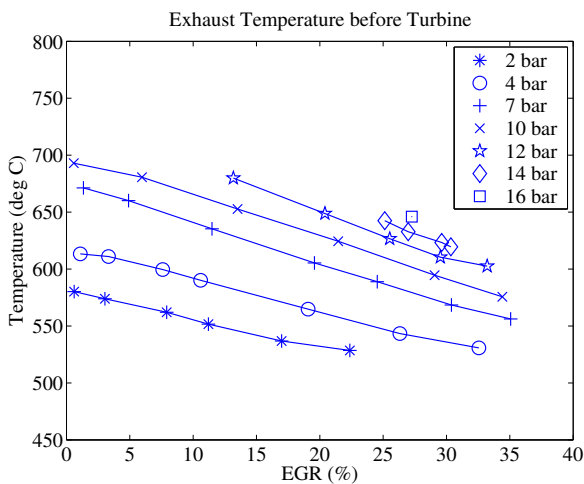

Figure 8. Exhaust temperature before turbine, with EGR dilution, for various load cases.

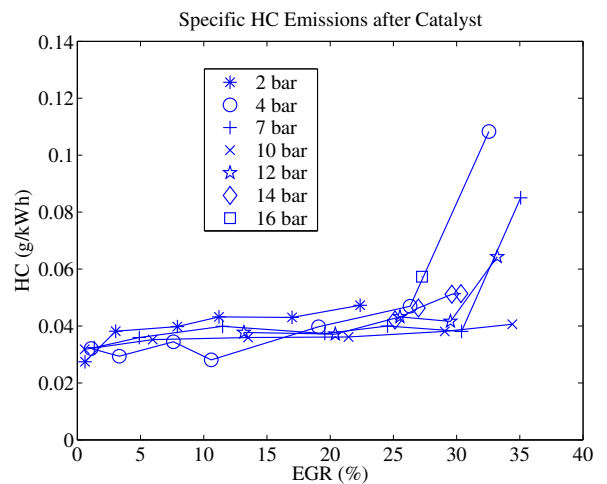

Figure 11. Specific HC emissions after the catalyst, with EGR dilution, for various load cases.

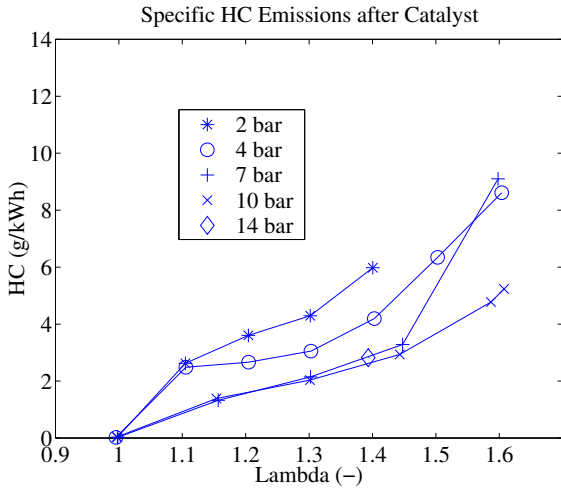

Figure 12. Specific HC emissions after the catalyst, at lean operation, for various load cases.

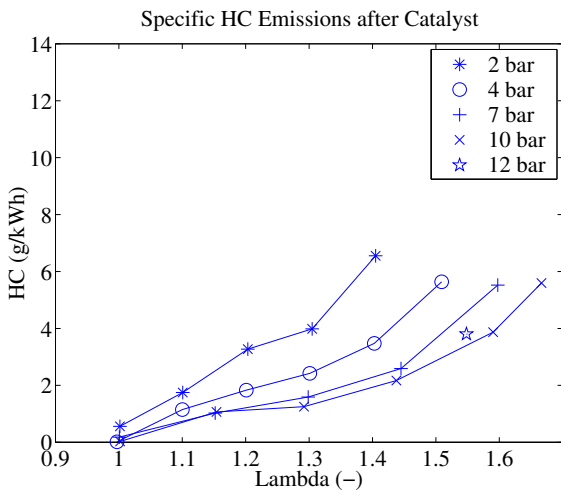

Figure 13. Specific HC emissions after the catalyst, at lean operation with ignition set to minimize NO_x emissions, for various load cases.

The NO_x emissions before the catalyst for the three strategies are shown in Figure 14 to Figure 16. EGR is a very effective way to reduce the amount of raw NO_x emissions, Figure 14. There is an almost linear relationship between reduced NO_x and increased amount of EGR. The NO_x emissions are reduced by more than 90% with high EGR dilution. The emissions increase as the load increases for a constant amount of EGR. Figure 15 and Figure 16 show NO_x emissions before the catalyst for the two lean cases. Ignition timing at $\lambda=1$ is the same for both cases, set for $P_{MAX\alpha} = 12$ CAD ATDC. The trends are as expected, with a peak in NO_x around $\lambda=1.1$ and increasing with increased load. The relatively high emissions at $\lambda=1$ for the low-NO_x case can be explained by the ignition angle.

NO_x emissions after the catalyst with stoichiometric operation are reduced by 98-99%, depending on the amount of EGR, compared to before the catalyst, Figure

17. The unexpected peak at 8% EGR and 2 bar is probably due to a slight increase in lambda at that operating point. The catalyst does not work for NO_x reduction at lean operation, as expected, see Figure 18 and Figure 19.

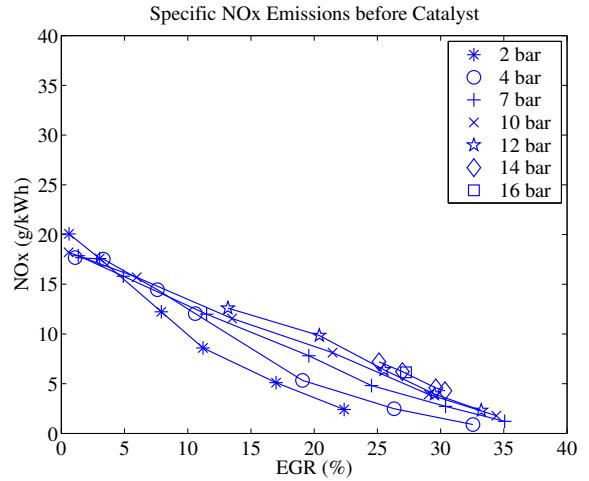

Figure 14. Specific NO_x emissions before the catalyst, with EGR dilution, for various load cases.

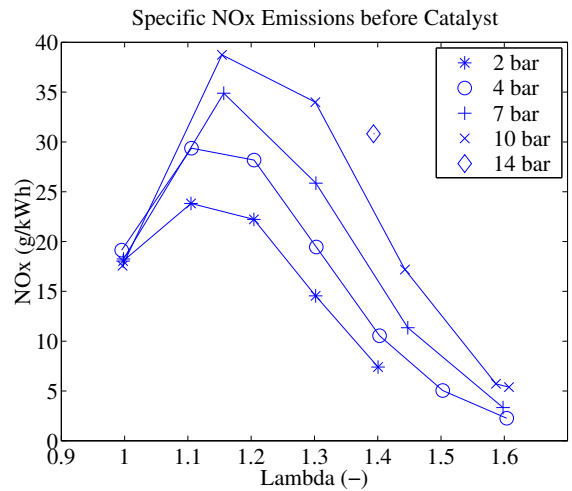

Figure 15. . Specific NO_x emissions before the catalyst, at lean operation, for various load cases.

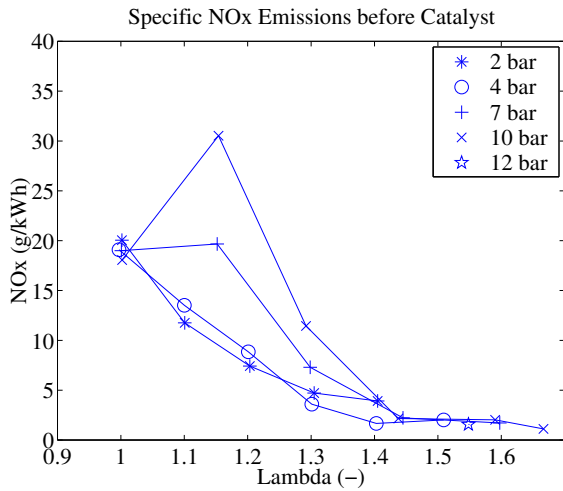

Figure 16. Specific NOx emissions before the catalyst, at lean operation with ignition set to minimize NOx emissions, for various load cases.

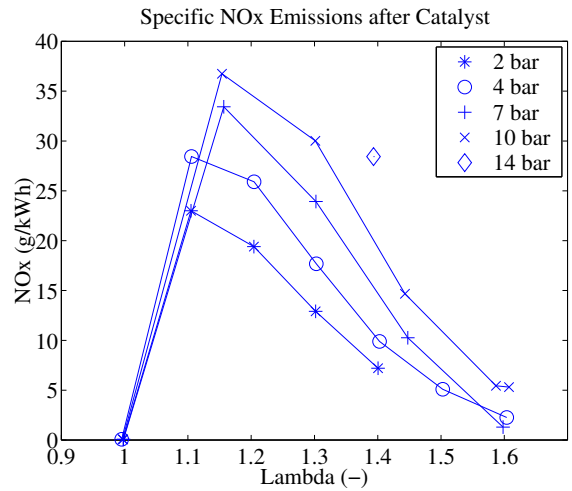

Figure 18. Specific NOx emissions after the catalyst, at lean operation, for various load cases.

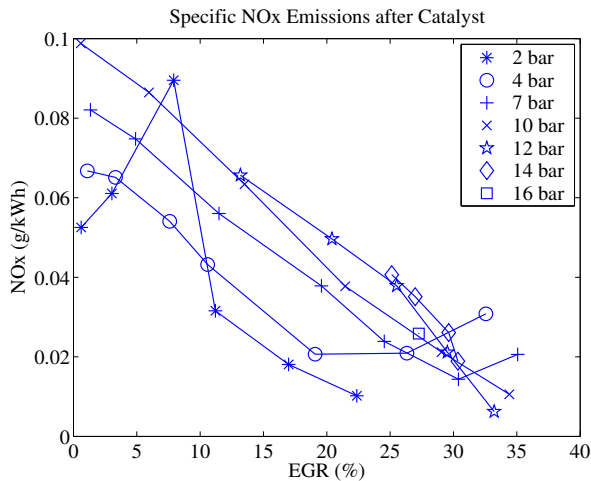

Figure 17. Specific NOx emissions after the catalyst, with EGR dilution, for various load cases.

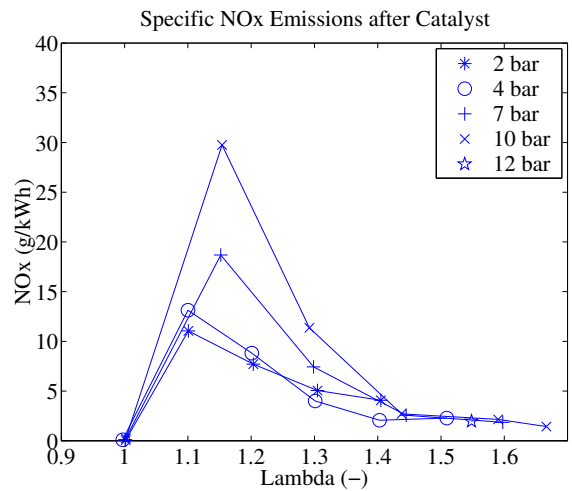

Figure 19. Specific NOx emissions after the catalyst, at lean operation with ignition set to minimize NOx emissions, for various load cases.

The catalyst efficiency for stoichiometric (EGR) operation and lean operation, at 10 bar BMEP, can be seen in Figure 20 and Figure 21. The efficiency for HC and NO_x is approximately constant at 99% and 99.5%, respectively, for all EGR amounts, Figure 20. The tradeoff between NO_x and CO is very narrow with respect to lambda. Lambda is set for NO_x emissions less than 10 ppm after the catalyst. This explains why the CO efficiency varies. The tradeoff can also be seen for the lean case, Figure 21, where CO efficiency is above 97% except at $\lambda=1$. The catalyst efficiency for HC, and especially for NO_x, decreases as lambda increases.

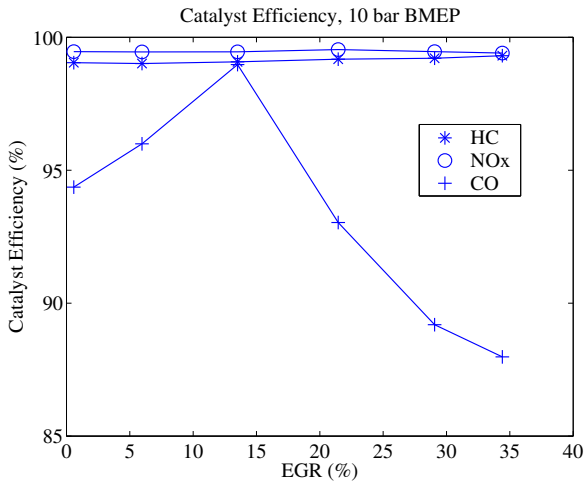

Figure 20. The catalyst efficiency for various amounts of EGR, at stoichiometric conditions and 10 bar BMEP.

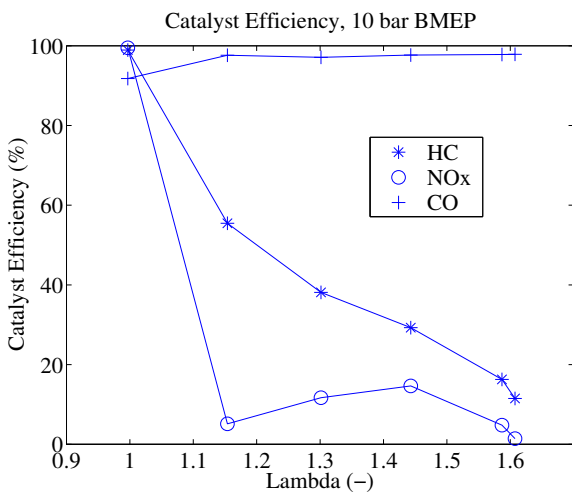

Figure 21. The catalyst efficiency at lean operation and 10 bar BMEP.

COMBUSTION

The Quartette combustion chamber was designed to be tolerant to highly diluted mixtures, and thus have a fast combustion. Previous tests at the department have shown that this is the case [4], [5]. The main combustion duration, CAD duration between 10% and 90% burned, can be seen in Figure 22 to Figure 24. The combustion duration increases when the amount of EGR increases, as expected, Figure 22. Low loads already have residual gases from the previous cycle, so combustion is slower in those cases than for high load operation. Similar combustion duration trends can be seen for the lean cases, Figure 23 and Figure 24. Dilution with EGR or air has practically the same influence on the main combustion duration with this combustion chamber.

The flame development period (0% to 5% burned, where 0% is the crank angle of ignition) is shown in Figure 25 to Figure 27. EGR has a strong influence on the early

combustion since the laminar flame speed is more reduced compared to lean operation, due to lower oxygen concentration. The flame conditions during the early flame development are nearly laminar since the size of the flame is small compared to the integral length of the turbulence. The lean cases in Figure 26 and Figure 27 have much shorter duration for the early combustion, comparing high dilutions. Ignition angles differ as much as 15 CAD between the two lean cases, but no significant difference can be seen in the early combustion duration.

The cycle-to-cycle variations, presented as COV for IMEP, can be seen in Appendix C.

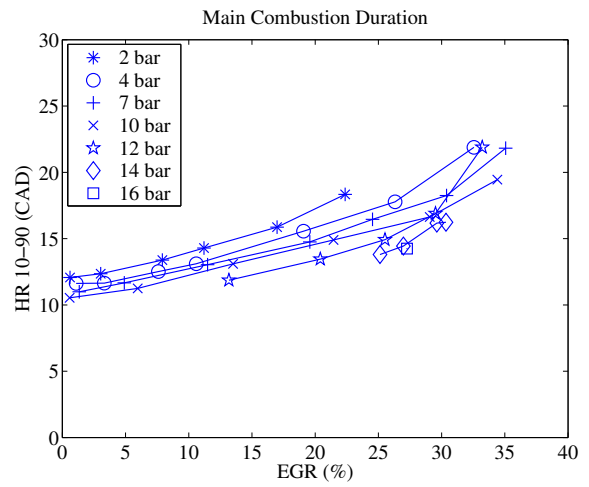

Figure 22. The main combustion duration for the EGR case, presented as the CAD duration between 10% and 90% burned.

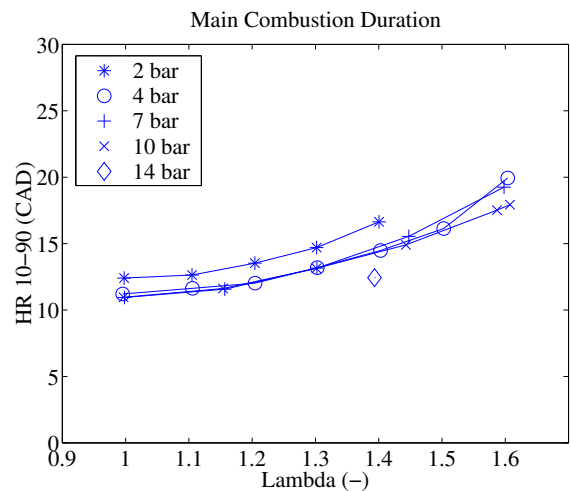

Figure 23. The main combustion duration for the lean case, presented as the CAD duration between 10% and 90% burned.

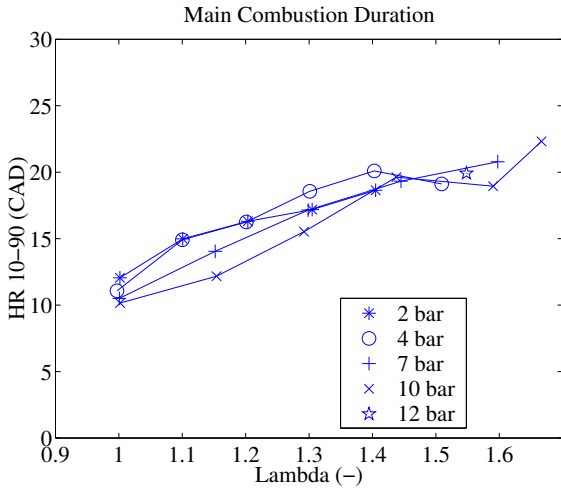

Figure 24. The main combustion duration for the lean case with ignition set to minimize NO_x.

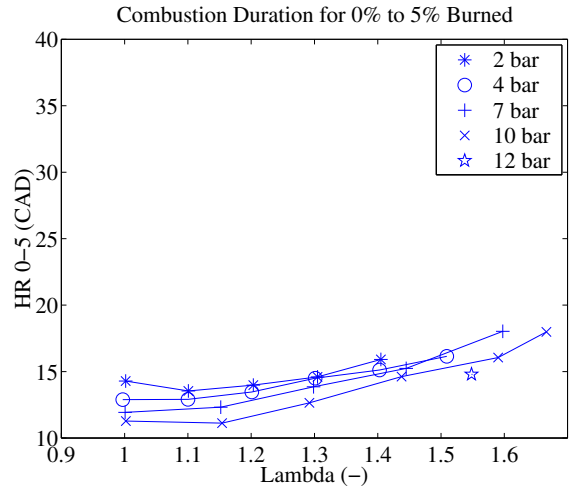

Figure 27. The flame development period for the lean low-NO_x case, presented as the CAD duration for 0% to 5% burned.

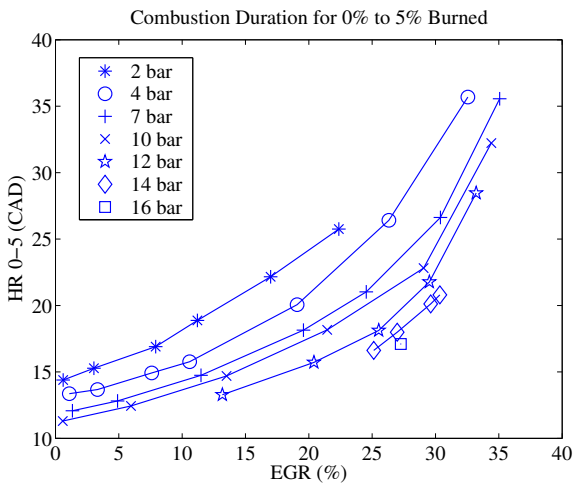

Figure 25. The flame development period for the EGR case, presented as the CAD duration for 0% to 5% burned.

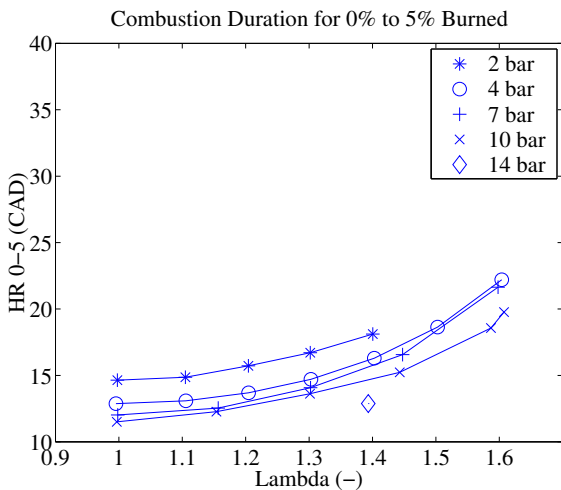

Figure 26. The flame development period for the lean case, presented as the CAD duration for 0% to 5% burned.

EFFICIENCY

Figure 28 to Figure 30 show brake efficiency for the three cases. Dilution with both air and EGR increase the efficiency, until combustion stability deteriorates. The highest efficiency can be found at lean operation and maximum load, Figure 29. The main reason for the lower efficiency with EGR, Figure 28, compared to lean operation is lower combustion efficiency (mainly due to higher CO emissions). For the lean low-NO_x case, the ignition angle is chosen to minimize NO_x emissions, Figure 30, and this does not favor high efficiency. Efficiency is therefore somewhat lower at the lean low-NO_x case at higher loads.

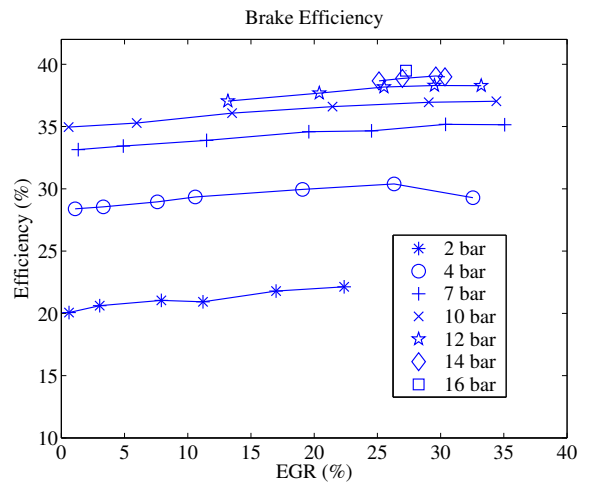

Figure 28. Brake efficiency for the EGR case.

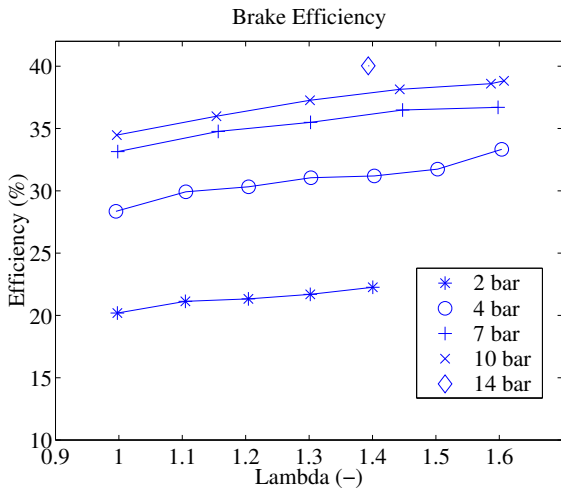

Figure 29. Brake efficiency for lean operation.

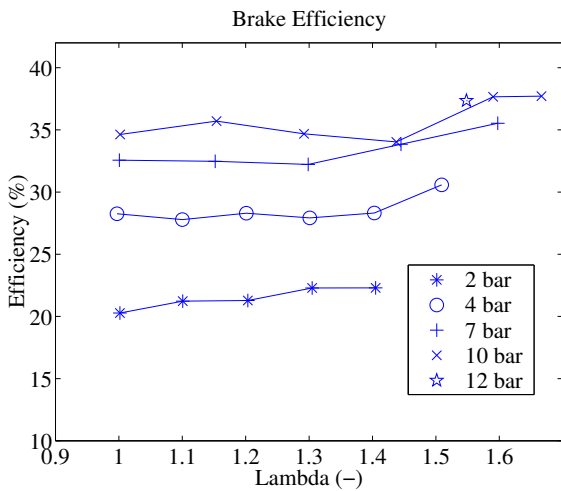

Figure 30. Brake efficiency for the lean case with ignition set to minimize NOx.

LAMBDA SWEEP

The engine is operated at 1200 rpm, 30% EGR and 14 bar BMEP in this test. Lambda is swept from slightly lean to slightly rich and then back to lean again, in order to find the tradeoff between NO_x reduction and CO (HC) oxidation.

The raw emissions are shown in Figure 31. HC and NO_x emissions are similar on the rich side. NO_x starts to rise and HC becomes lower as the mixture becomes leaner. The CO emissions decrease steadily with increased lambda, and are 2 to 5 times higher than the HC and NO_x. Figure 32 shows the emissions after the catalyst. Very low HC and NO_x emissions can be seen on the rich side. They both start to increase close to λ=0.995 and NO_x increases more rapidly than HC. The trend is opposite for the CO emissions. The catalyst efficiency can be seen in Figure 33. A deviation of less than 1%

from the optimum lambda value will cause increased NO_x and HC emissions, or increased CO emissions.

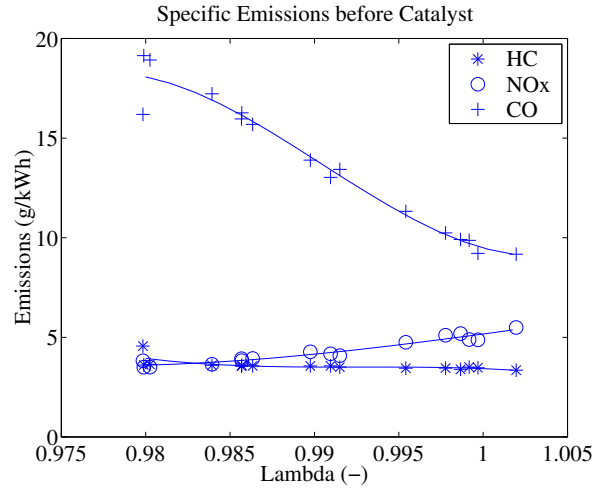

Figure 31. Specific HC, NOx and CO emissions before the catalyst, 30% EGR 14 bar BMEP.

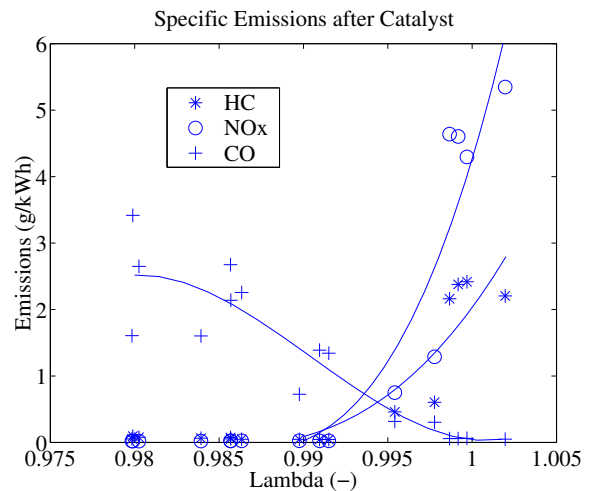

Figure 32. Specific HC, NOx and CO emissions after the catalyst, 30% EGR 14 bar BMEP.

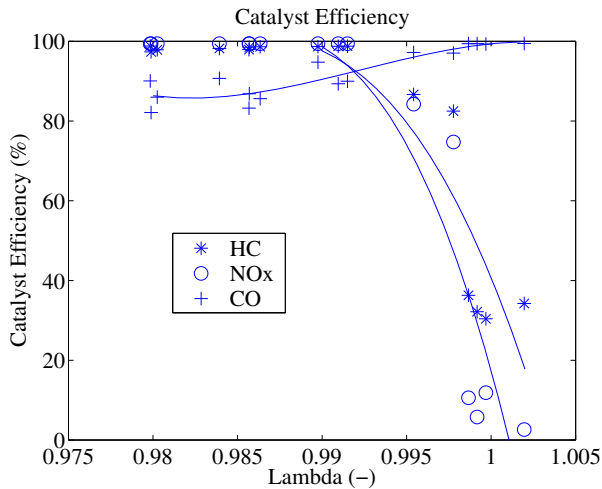

Figure 33. The catalyst efficiency for HC, NOx and CO, 30% EGR 14 bar BMEP.

STRATEGIES TO ACHIEVE MAXIMUM LOAD

The three cases are in this test investigated with the two strategies for achieving maximum load, at various engine speeds (1000, 1100 and 1200 rpm, lean low-NO_x case only 1200 rpm).

Load

The obtained loads are shown in Figure 34. The highest loads are achieved at stoichiometric operation with EGR, with retarded ignition angle. Loads are similar between EGR (ignition set so $P_{MAX}\alpha = 12$ CAD ATDC) and lean operation with retarded ignition. Slightly lower loads can be seen at lean operation with ignition set so $P_{MAX}\alpha = 12$ CAD ATDC. NO_x emissions can not be kept under 2 g/kWh (due to misfire) in the low-NO_x case, for loads above 12 bar BMEP.

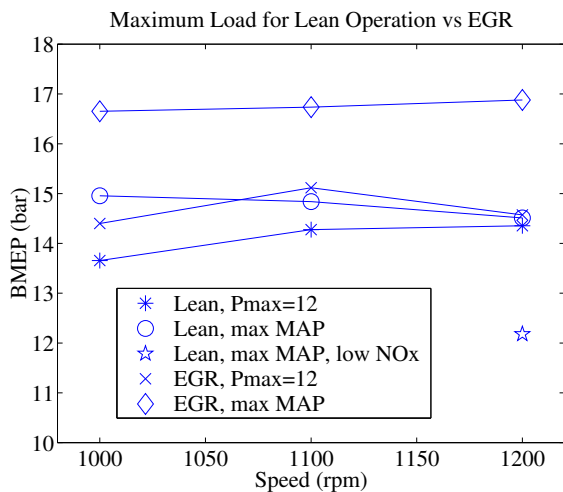

Figure 34. Maximum achieved loads for lean versus EGR operation. The operating strategies are outlined in the "Experiments" section above.

Efficiency

Brake efficiencies are shown in Figure 35. Lean operation with no restriction in NO_x emissions has the highest efficiency, mainly due to the higher specific heat ratio. Early ignition increases the heat losses in the cylinder, since the maximum cylinder temperature increases. Retarded ignition increases the heat remaining in the exhaust gases. The differences in efficiency for each case may be explained by these facts. In some cases heat losses in the cylinder dominate and in other cases losses to the exhaust gases dominate.

One way to present the various losses is by showing each step from fuel energy to engine output energy by the means of mean effective pressures (MEP). Figure 36 show these MEPs at 1200 rpm, where:

- FuelMEP is the energy put into the engine (for each cycle) normalized by the displacement volume of the engine.

$$FuelMEP = \frac{m_f Q_{LHV}}{V_D} \text{ where}$$

m_f = fuel mass per cycle

Q_{LHV} = lower heating value of the fuel

V_D = displaced volume

- QMEP is the heat released during combustion normalized by V_D . The difference between FuelMEP and QMEP is therefore determined by the combustion efficiency, computed here from the emissions.
- The difference between QMEP and $IMEP_{gross}$ is heat losses, in the cylinder and to the exhaust gases.
- The difference between $IMEP_{gross}$ and $IMEP_{net}$ is pumping losses.
- The difference between $IMEP_{net}$ and BMEP is friction losses.

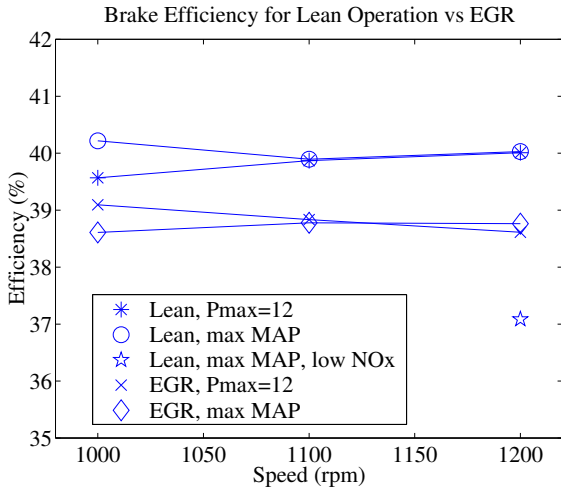

Figure 35. Brake efficiency for lean versus EGR operation.

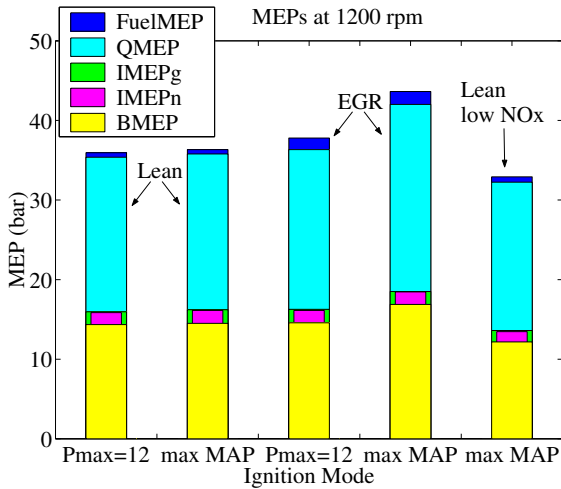

Figure 36. Mean effective pressures at 1200 rpm.

Losses to the different processes are presented in Table 3 as % lost energy. The EGR case has the highest losses to the exhaust in the form of remaining chemical energy (combustion inefficiency). The lean low-NO_x case has the highest heat- and pumping losses.

Table 3. Energy "losses" (% of fuel energy) at 1200 rpm

	1	2	3	4	5
Lean P _{MAX} α=12	1.57	54.03	0.30	4.16	39.94
Lean max MAP	1.52	53.84	0.27	4.44	39.93
EGR P _{MAX} α=12	3.87	53.10	0.36	4.12	38.56
EGR max MAP	3.71	53.88	0.10	3.61	38.68
Lean low-NO _x max MAP	2.07	56.60	0.44	3.90	37.0

1. Percentage of chemical energy remaining in the exhaust gases (1 – combustion efficiency)
2. Percentage of heat lost in the cylinder and to the exhaust gases
3. Percentage of gross indicated work expended as pumping losses
4. Percentage of net indicated work expended as friction losses
5. Useful work from the engine as a percentage of supplied chemical energy (overall efficiency)

Emissions

Specific HC emissions before and after the catalyst are shown in Figure 37 for the different strategies of achieving maximum load. The EGR case has slightly higher raw emissions than lean operation at low speeds. At 1200 rpm, the HC emissions are similar for EGR and lean operation. The lean low-NO_x case has higher specific emissions since the efficiency is lower. The lean cases have some oxidation of HC in the catalyst, but far away from the levels in the EGR case.

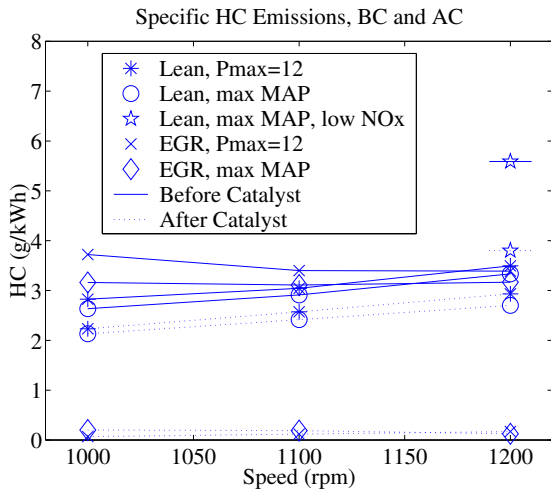

Figure 37. Specific HC emissions before and after the catalyst, for lean versus EGR operation.

Even more interesting are the NO_x emissions, see Figure 38 (note that the Y-axis is logarithmic). The raw emissions are more than 4 times higher at lean operation compared to stoichiometric (EGR). The goal of less than 2 g/kWh NO_x can be achieved for the low- NO_x case at 12 bar BMEP. Practically no reduction of NO_x in the catalyst can be seen at lean operation, the low- NO_x case has higher emissions after the catalyst than before. NO_x emissions are very low after the catalyst for the EGR case. The emissions are 700 times higher at lean operation (with ignition set so $P_{\text{MAX}\alpha} = 12$ CAD ATDC) compared to stoichiometric operation with EGR.

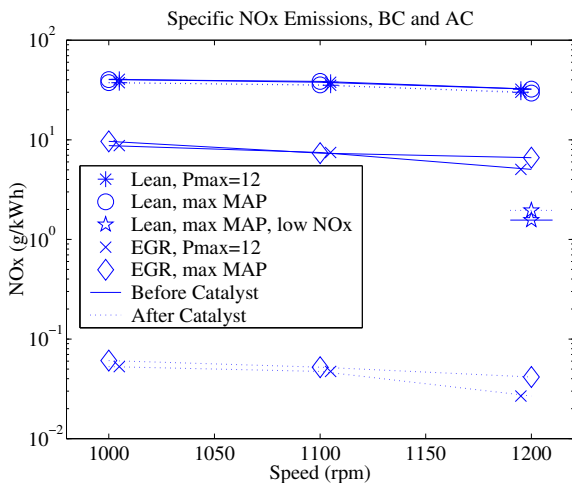

Figure 38. Specific NO_x emissions before and after the catalyst, for lean versus EGR operation (logarithmic Y-axis).

The above figures (and also specific CO emissions) are summarized in Table 4, for the 1200 rpm cases. The table shows the change in percentage when changing from stoichiometric EGR operation to lean operation.

Table 4. Change (increase) when changing from EGR to lean operation (%).

	Load	HC	NO_x	CO	η_{Brake}
Lean	-14	2060	70000	-92	3.2
Lean low- NO_x case	-28	2940	3614	-92	-4

DISCUSSION

The much slower early-combustion with EGR compared to lean operation can be explained by the lower reaction rates with EGR, resulting in decreased laminar flame speed. This explains the need for earlier ignition timing, see Appendix B, when EGR is used compared to lean operation. Ignition timing differs by as much as 15 CAD between the two lean cases, but no significant differences can be seen in the early combustion duration. The Quartette combustion chamber has a high and fairly wide turbulence peak located close to TDC [4], making the turbulent flame speed higher. This may be the reason for the similar early combustion duration for the two lean cases. The flame kernel has to be big enough when the turbulence kicks in, so it can be wrinkled and increase combustion speed. This may also explain the fact that the main combustion duration is very similar in all three cases. Even if the laminar flame speed is slower with EGR, the high turbulence at TDC increases the main combustion speed.

The pollutant emission levels obtained in this study depend highly on the type of catalyst used. A catalyst optimized for lean operation would reduce emissions of HC and CO under lean operating conditions but NO_x emissions would still be at an unacceptable level without any kind of additional NO_x reduction system.

CONCLUSIONS

NO_x emissions can be reduced by 99.9% and HC emissions by 90-97% by operating the engine stoichiometric with EGR and using a three-way catalyst compared to the lean high-efficiency strategy. Due to the increased window of usable ignition angles between misfire and knock the boost can be maximized without exceeding any design parameters which allows an increase in maximum BMEP by 10-15%. Compared to the lean low- NO_x strategy, there is also a slight increase in overall efficiency due to more favorable combustion phasing.

The penalties associated with stoichiometric operation with EGR include significantly higher CO emissions (1-2 g/kWh) as well as a slight drop in efficiency compared to the lean high-efficiency strategy. The air/fuel ratio window with an acceptable trade-off between NO_x reduction and CO oxidation in the catalyst is very narrow

(± 0.01 in terms of λ). This means that very accurate air/fuel ratio control is essential. Operation with high EGR rates also requires a fast combustion chamber which increases the heat losses.

In light of the above observations, the authors suggest stoichiometric operation with EGR and three-way catalyst as the preferred strategy.

ACKNOWLEDGMENTS

We would like to thank Swedish Gas Center, Volvo Truck Company, Scania, MECEL, Caterpillar, Johnson Matthey and Swedish National Energy Administration for their support of the presented work.

REFERENCES

1. P.V. Puzinauskas, B. D. Willson, K. H. Evans:
"Optimization of Natural Gas Combustion in Spark-Ignited Engines Through Manipulation of Intake-Flow Configuration", SAE paper 2000-01-1948
2. B. Johansson:
"On Cycle to Cycle Variations in Spark Ignition Engines", Doctoral Thesis, Lund Institute of Technology, 1995.
3. J. B. Heywood:
"Internal Combustion Engine Fundamentals"
ISBN 0-07 100499-8.
4. P. Einewall, B. Johansson:
"Combustion Chambers for Supercharged Natural Gas Engines", SAE paper 970221
5. P. Tunestal, M. Christensen, P. Einewall, T. Andersson, B. Johansson:
"Hydrogen Addition for Improved Lean Burn Capability of Slow and Fast Burning Natural Gas Combustion Chambers", SAE paper 2002-01-2686
6. R. M. Heck, R. J. Farrauto:
"Catalytic Air Pollution Control – Commercial Technology", ISBN 0-442-01782-0

APPENDIX A

The CO emissions from the different tests are shown below.

Figure A 1 to Figure A 6 show emissions before and after the catalyst for EGR versus lean operation at 1200 rpm and various loads. The raw emissions are high for all EGR amounts, Figure A 1. This was expected since the engine operates with a stoichiometric mixture. The emissions are much lower after the catalyst, see Figure A 2. Lambda is chosen so the NO_x emissions after the catalyst are less than 10 ppm. CO emissions can be further reduced after the catalyst, but with the constant lambda operation (no oscillation) this will lead to increased NO_x emissions after the catalyst. Figure A 3 shows the raw CO emissions for the lean case with P_{MAX}α=12 CAD ATDC. CO decreases significantly as the mixture is leaned out, as expected. Emissions after the catalyst, Figure A 4, are very low for lean operation, since CO is rather easy to oxidize in a catalyst if additional air is present. Similar trends can be seen for the lean low-NO_x case as in the lean case with P_{MAX}α=12 CAD ATDC, Figure A 5 and Figure A 6.

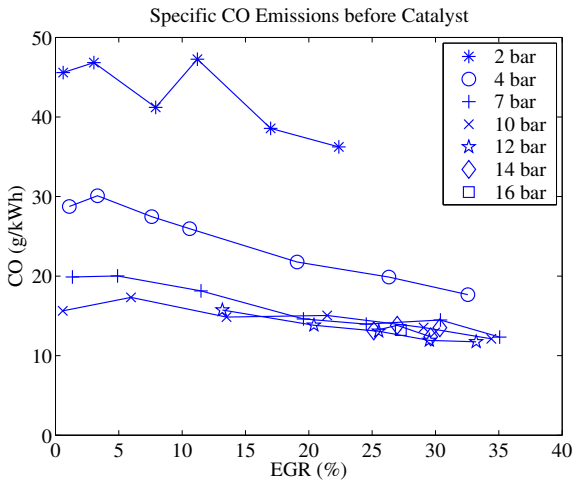

Figure A 1. Specific CO emissions before the catalyst for the EGR case, at various loads and P_{MAX}α=12 CAD ATDC.

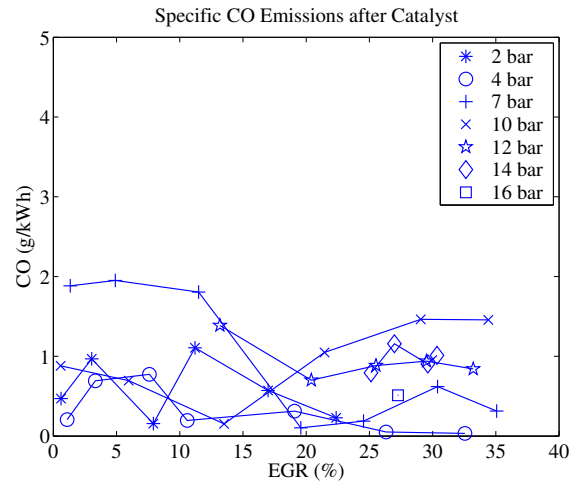

Figure A 2. Specific CO emissions after the catalyst for the EGR case, at various loads and P_{MAX}α=12 CAD ATDC.

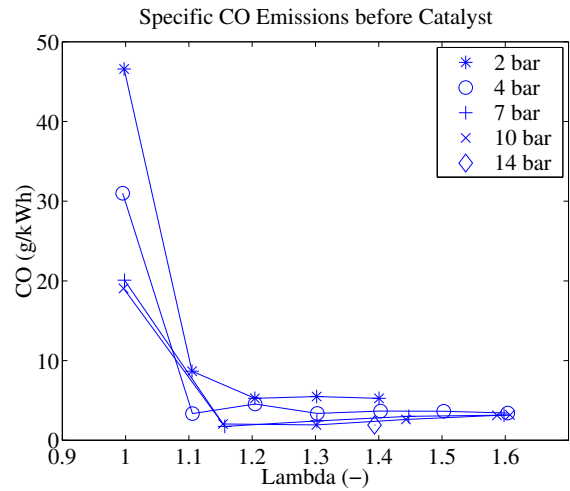

Figure A 3. Specific CO emissions before the catalyst for the lean case, at various loads and P_{MAX}α=12 CAD ATDC.

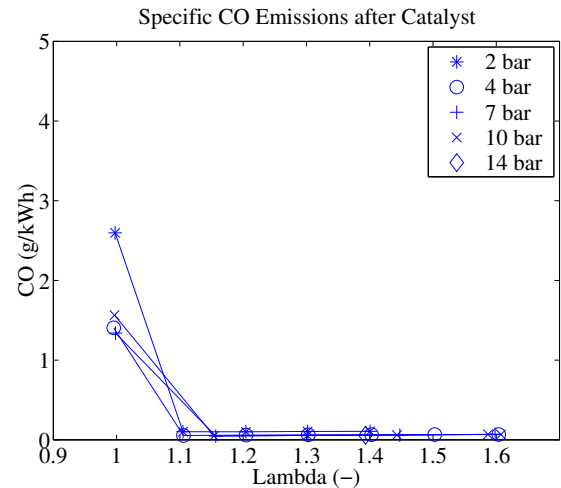

Figure A 4. Specific CO emissions after the catalyst for the lean case, at various loads and P_{MAX}α=12 CAD ATDC.

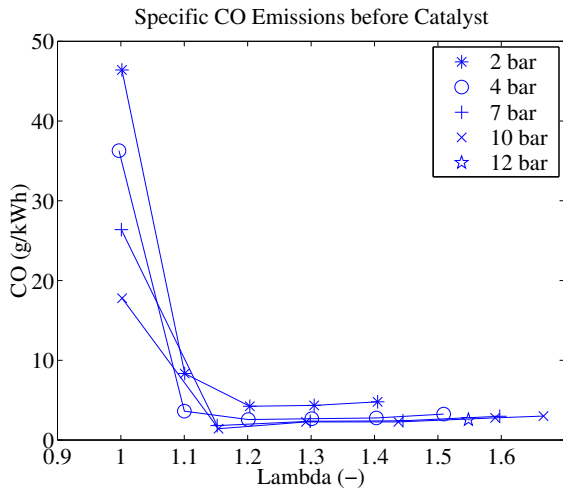

Figure A 5. Specific CO emissions before the catalyst for the lean low-NOx case, at various loads.

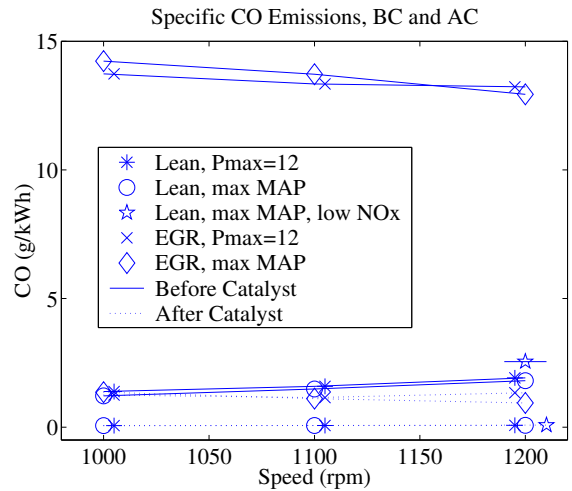

Figure A 7. Specific CO emissions before and after the catalyst for lean versus EGR operation, at maximum achieved loads for various engine speeds.

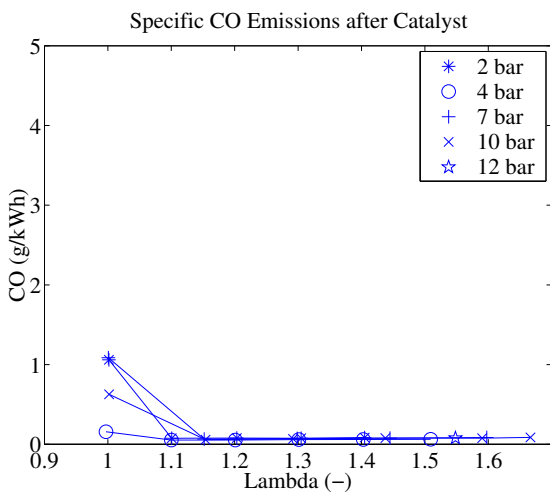

Figure A 6. Specific CO emissions after the catalyst for the lean low-NOx case, at various loads.

CO emissions for the two strategies of achieving maximum load are shown in Figure A 7, before and after the catalyst. Even if the catalyst oxidizes CO, the raw emissions at lean operation is approximately the same as the emissions after the catalyst for the EGR case. Addition of extra air after the three way catalyst and then an oxidizing two way catalyst, could reduce the CO emissions for the EGR case to very low levels.

APPENDIX B

The following figures show ignition angles for the different tests, as CAD BTDC.

EGR has a stronger influence on the laminar flame speed than excess air, [3]. Much earlier ignition angles must therefore be used for the EGR case compared to lean operation so $P_{MAX\alpha}=12$ CAD ATDC, see Figure B 1 and Figure B 2. Ignition angles are set so $P_{MAX\alpha}=12$ CAD ATDC for the lean low- NO_x case at stoichiometric operation since a three way catalyst can be used, Figure B 3. Ignition angles for the other operating points are limited by either:

- Achieving the goal of less than 2 g/kWh NO_x
- Poor engine stability, $COV_{IMEP} \geq 5\%$
- Exhaust temperature exceeding 700 °C
- No ignition angles ATDC

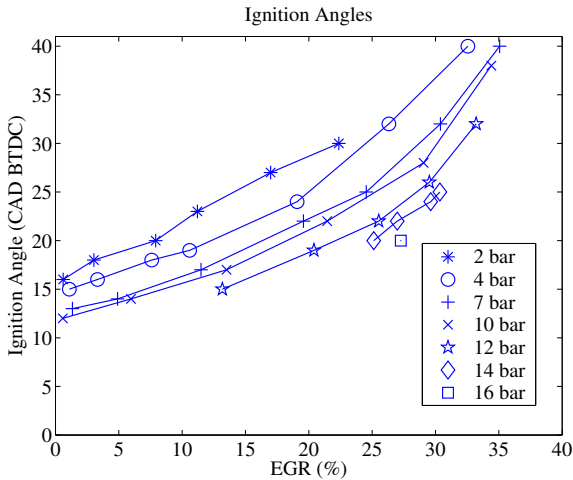

Figure B 1. Ignition angles for the EGR case at various loads, set so $P_{MAX\alpha}=12$ CAD ATDC.

Ignition angles for the two strategies for achieving maximum load are shown in Figure B 4. Ignition angles for maximum MAP are similar for EGR and lean operation. Ignition angles for achieving $P_{MAX\alpha}=12$ CAD ATDC are earlier for the EGR case.

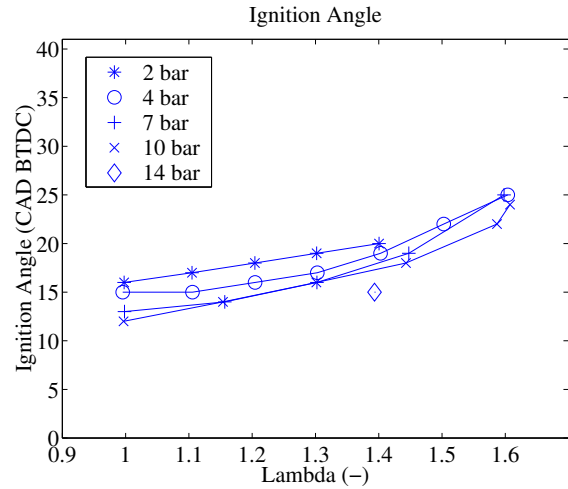

Figure B 2. Ignition angles for the lean case at various loads, set so $P_{MAX\alpha}=12$ CAD ATDC.

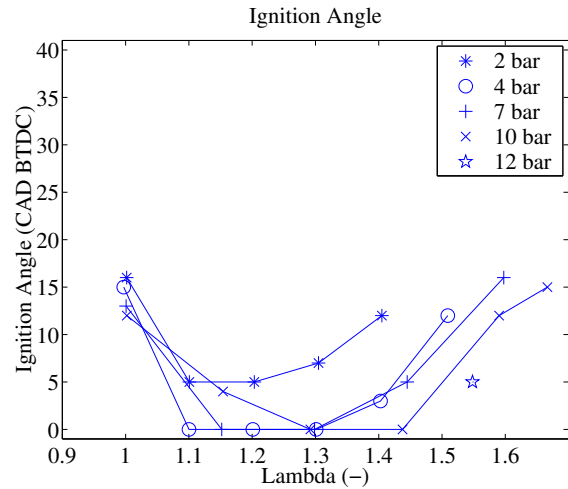

Figure B 3. Ignition angles for the lean case at various loads, set to minimize NO_x emissions.

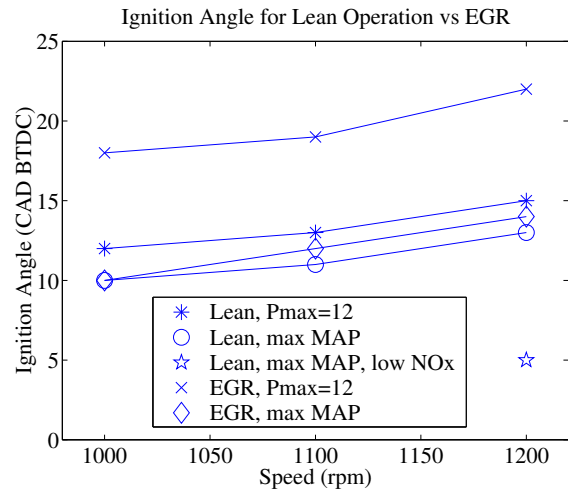

Figure B 4. Ignition angles for lean versus EGR operation, at maximum achieved loads for various engine speeds.

APPENDIX C

The cycle-to-cycle variations, COV for IMEP, are shown below for the different cases.

Figure 39 shows COV for the EGR case. Low loads have higher COV due to higher amount of residual gases. Engine stability starts to deteriorate rapidly for EGR ratios above 30%. Also the lean case, Figure 40, has the highest COV at low loads. The cycle-to-cycle variations are generally higher than for the EGR case. The much retarded ignition timing for the lean low-NO_x case results in the highest overall COV, Figure 41. Engine stability for the three strategies for achieving maximum load are shown in Figure 42. No clear trend can be seen between EGR and lean operation, optimized for efficiency. The lean low-NO_x case has higher COV however, because of the ignition strategy.

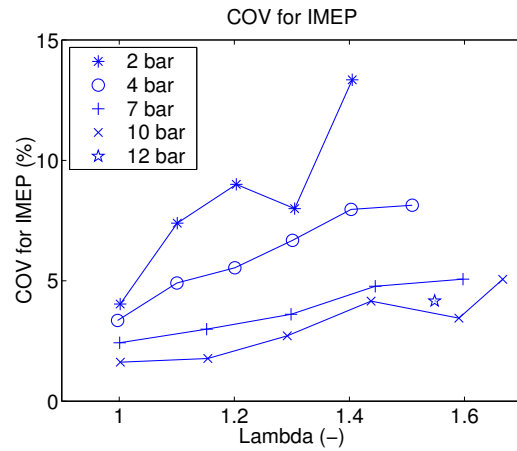

Figure 41. Cycle-to-cycle variations presented as COV for IMEP, for the lean low-NO_x case.

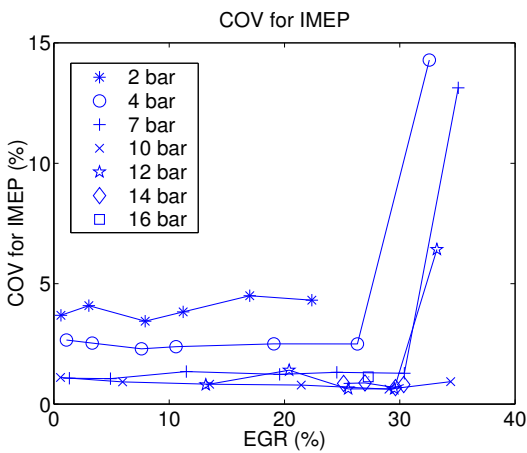

Figure 39. Cycle-to-cycle variations presented as COV for IMEP, for the EGR case.

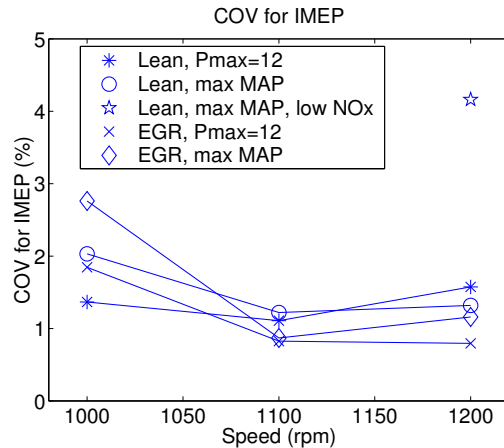

Figure 42. Cycle-to-cycle variations presented as COV for IMEP, for max BMEP operation.

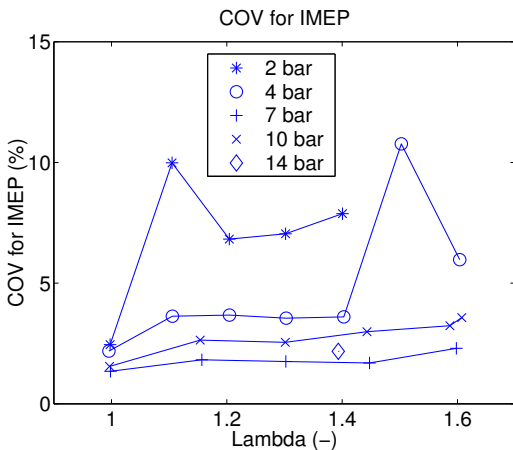

Figure 40. Cycle-to-cycle variations presented as COV for IMEP, for the lean case.