



LUND UNIVERSITY

Theoretical Evaluation of Fire Resistance Tests of Floor and Roof Assemblies with Suspended Ceiling

Sandberg, Bertil; Pettersson, Ove

1978

[Link to publication](#)

Citation for published version (APA):

Sandberg, B., & Pettersson, O. (1978). *Theoretical Evaluation of Fire Resistance Tests of Floor and Roof Assemblies with Suspended Ceiling*. (Bulletin of Division of Structural Mechanics and Concrete Construction, Bulletin 58; Vol. Bulletin 58). Lund Institute of Technology.

Total number of authors:

2

General rights

Unless other specific re-use rights are stated the following general rights apply:

Copyright and moral rights for the publications made accessible in the public portal are retained by the authors and/or other copyright owners and it is a condition of accessing publications that users recognise and abide by the legal requirements associated with these rights.

- Users may download and print one copy of any publication from the public portal for the purpose of private study or research.
- You may not further distribute the material or use it for any profit-making activity or commercial gain
- You may freely distribute the URL identifying the publication in the public portal

Read more about Creative commons licenses: <https://creativecommons.org/licenses/>

Take down policy

If you believe that this document breaches copyright please contact us providing details, and we will remove access to the work immediately and investigate your claim.

LUND UNIVERSITY

PO Box 117
221 00 Lund
+46 46-222 00 00

95

BERTIL SANDBERG – OVE PETTERSSON

THEORETICAL EVALUATION OF FIRE
RESISTANCE TESTS OF FLOOR AND ROOF
ASSEMBLIES WITH SUSPENDED CEILING

Brandteknik
Lunds Tekniska Högskola
Biblioteket

BIBLIOTEKET
EU

LUND INSTITUTE OF TECHNOLOGY · LUND · SWEDEN · 1978

DIVISION OF STRUCTURAL MECHANICS AND CONCRETE CONSTRUCTION · BULLETIN 58

BERTIL SANDBERG - OVE PETERSSON

THEORETICAL EVALUATION OF FIRE RESISTANCE TESTS OF FLOOR AND ROOF
ASSEMBLIES WITH SUSPENDED CEILING

Document No.:

ISO/TC 92 N 504 E

LUND INSTITUTE OF TECHNOLOGY · LUND · SWEDEN · 1978

DIVISION OF STRUCTURAL MECHANICS AND CONCRETE CONSTRUCTION · BULLETIN 58

Brandteknik
Lunds Tekniska Högskola
Biblioteket

BERTIL SANDBERG - OVE PETTERSSON

THEORETICAL EVALUATION OF FIRE RESISTANCE TESTS OF FLOOR AND ROOF
ASSEMBLIES WITH SUSPENDED CEILING

TABLE OF CONTENTS	PAGE
PREFACE	
1. INTRODUCTION. GENERAL BACKGROUND	6
2. MAIN CHARACTERISTICS OF A THEORETICAL EVALUATION OF FIRE RESISTANCE TESTS ACCORDING TO DP 6167	10
3. BASIC EQUATIONS OF HEAT TRANSFER IN A FIRE EXPOSED FLOOR OR ROOF ASSEMBLY WITH A SUSPENDED CEILING	16
3.1. The heat balance equations	16
3.1.1. Calculation of the surface temperature of the slab and suspended ceiling, considering only the heat capacity of the slab	17
3.1.2. Calculation of the surface temperature of the slab and suspended ceiling, considering the heat capacity of the slab as well as the suspended ceiling	21
3.1.3. Calculation of the temperature of the steel beams, protected by a suspended ceiling	24
3.1.4. Calculation of the temperature of the steel beams after a failure of the suspended ceiling	27
3.2. Computer program for calculating the transient temperature state in a fire exposed floor or roof assembly with a suspended ceiling	32
4. THERMAL MATERIAL PROPERTIES AND SOME OTHER BASIC QUANTITIES, RELEVANT TO A HEAT TRANSFER ANALYSIS OF FIRE EXPOSED FLOOR OR ROOF ASSEMBLIES WITH A SUSPENDED CEILING	33

4.1. Properties of the supporting steel beams	33
4.1.1. Density γ_s	33
4.1.2. Specific heat capacity c_{ps}	33
4.1.3. U_s/F_s ratio	34
4.2. Thermal properties of normal concrete with density 2300 kg m^{-3}	36
4.2.1. Thermal conductivity λ	36
4.2.2. Specific heat capacity c_p or enthalpy	38
4.3. Thermal properties of aerated concrete with density 600 kg m^{-3}	41
4.3.1. Thermal conductivity λ	41
4.3.2. Specific heat capacity c_p or enthalpy	43
4.4. Thermal properties of gypsum slab material with density 800 kg m^{-3}	45
4.4.1. Thermal conductivity λ	45
4.4.2. Enthalpy	46
4.4.3. Critical temperature for material disintegration	48
4.5. Thermal properties of mineral wool	48
4.5.1. Thermal conductivity λ	48
4.5.2. Enthalpy	49

5.	COMPARISONS OF CALCULATED TEMPERATURE-TIME FIELDS WITH THOSE MEASURED IN TESTS	52
6.	DESIGN BASIS FOR A THEORETICAL EXTRAPOLATION OF RESULTS FROM FIRE RESISTANCE TESTS. EXAMPLES	60
6.1.	Design basis for determination of $(d_i/\lambda_i)_{der}$ and critical temperature $T_{i,crit}$ of suspended ceiling - step 2	62
6.2.	Design basis for step 3	70
6.3.	Examples	80
7.	SUMMARY	93
	BIBLIOGRAPHY	95
	APPENDIX A. Computer program for heat transfer calculations of fire exposed floor or roof assemblies with a suspended ceiling	97

PREFACE

This publication has arisen in direct connection with the work within ISO/TC92/WG11 on the draft proposal ISO DP 6167 "Fire Resistance Test - Suspended Ceilings". This standard specifies a method of test for assessing the contribution of suspended ceilings to the fire resistance of unventilated load bearing floor or roof assemblies composed of a supporting structure of steel beams and a slab of normal concrete or aerated concrete. In the test, a fire attack on the underside of the suspended ceiling is simulated by a thermal exposure according to the standard fire resistance test ISO 834 [1]. The fire resistance is obtained being the time of the specified heating process, at which the supporting structure no longer performs its load bearing function under the applied loading.

The fire resistance, determined in the test, can be applied directly for a classification of an assembly with the same structural design as the one tested. The test result can also be used directly for a classification on the safe side of the investigated assembly, structurally modified in such a way that the heating of the load bearing steel beams will be slower at a fire resistance test than for the assembly tested.

For a floor or roof assembly, structurally modified in relation to the assembly tested, alternatively, a more precise classification can be performed by theoretical calculations which take into account the real behaviour at fire exposure of the suspended ceiling as determined in the test. The present publication deals with this problem and includes a design basis in the form of diagrams and tables, which can facilitate such a classification in practice.

The main characteristics of a theoretical evaluation of a fire resistance test, performed according to DP 6167, is presented in chapter 2. Chapter 3 deals with the basic equations of heat transfer in a fire exposed floor or roof assembly with a suspended ceiling. A survey of relevant thermal properties of steel, ordinary concrete, aerated concrete and some materials for suspended ceilings is given in chapter 4.

In chapter 5, the theory according to chapter 3 is examined by some comparisons with results obtained in standard fire resistance tests. Chapter 6 comprises the design diagrams and tables for the theoretical evaluation of a DP 6167 test, determined from the heat transfer equations in chapter 3 by way of the computer program, described and listed in Appendix A. The evaluation procedure is illustrated by some examples.

For how the results of a fire resistance test according to DP 6167 of an assembly with a suspended ceiling can be used as an input information in an analytical fire engineering design based on real fire exposure characteristics, reference is given to [2].

1. INTRODUCTION. GENERAL BACKGROUND

In DP 6167 "Fire Resistance Test - Suspended Ceilings", drawn up by ISO/TC92/WG 11, a standard test procedure is specified for a determination of the contribution of suspended ceilings to the fire resistance of an unventilated, load bearing floor or roof assembly - figure 1a. The test specification refers to ISO 834 [1] for heating, pressure and loading conditions which implies that

(1) the temperature rise within the test furnace shall be controlled so as to vary with time, within specified limits, according to the relationship

$$T - T_0 = 345 \log_{10} (8t + 1) \quad (1a)$$

where

t is the time, expressed in minutes

T is the furnace temperature at time t, expressed in °C

T₀ is the initial furnace temperature, expressed in °C,

(2) an overpressure of 10 ± 2 Pa shall exist in the furnace during the whole heating period of the fire resistance test - the condition not mandatory for the first 5 minutes,

(3) the assembly shall be subjected to a loading which, in the critical regions of the supporting construction, produces stresses of the same magnitude as would be produced normally in the full size element when subjected to the design load.

By means of the test, the fire resistance of the floor or roof assembly is obtained as that time of the prescribed heating process at which the supporting construction no longer performs its load bearing function under the applied loading. Strictly, this corresponds to a rate of deflection of the supporting construction approaching an infinite value [3]. In practice, such a collapse criterion however must be replaced by some limiting deflection criterion, for instance, the criterion for maximum deflection or maximum rate of deflection according to RYAN and ROBERTSON [4] or some other equivalent deflection criterion, specified in national standards.

DP 6167 also permits the contribution of a suspended ceiling to the fire resistance of a floor or roof assembly to be determined with the test assembly unloaded. Instead of a limiting deflection criterion, then a temperature criterion must be applied to the supporting construction, fixed in a conservative way to give test results which generally are on the safe side in comparison with the corresponding fire resistance given by a limiting deflection criterion in a test with the test assembly loaded. In the commentary to the standard, a temperature criterion of a maximum temperature of 400°C in any point of the steel beams of the supporting construction is recommended in evaluating tests carried out with the assembly unloaded.

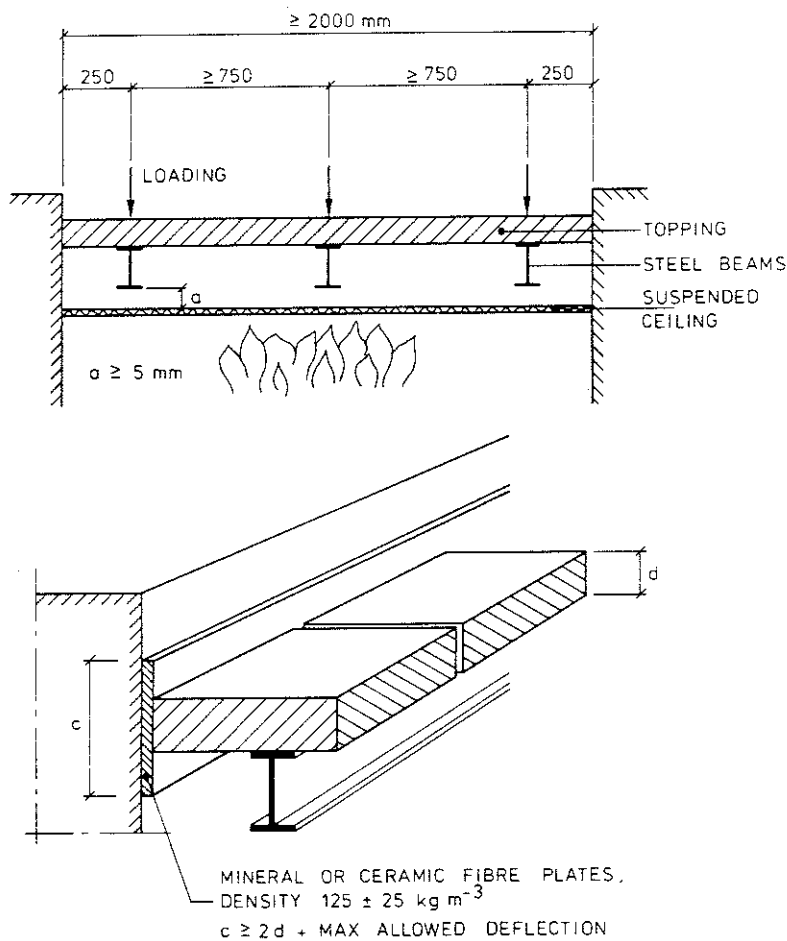

Figure 1a. Test assembly for a determination according to DP 6167 of the contribution of a suspended ceiling to the fire resistance of an unventilated load bearing floor or roof structure

The standard specifies the test assembly to comprise the suspended

ceiling under test (the test specimen) and a supporting construction of alternatively - figure 1a

(1) simply supported steel beams, topped with reinforced aerated concrete slabs of density $600 \pm 50 \text{ kg m}^{-3}$ and of thickness not less than 100 mm, or

(2) simply supported steel beams, topped with reinforced normal concrete slabs of density not less than 2200 kg m^{-3} and of thickness not less than 50 mm.

The slabs or slab elements, forming the topping of the test assembly, are to be arranged in a way not to give any contribution to the load bearing function and capacity of the supporting steel beams. The test assembly shall be unventilated, i.e. the cavity between the floor or roof soffit and the suspended ceiling shall entirely be surrounded by barriers for the purpose of preventing the transfer of air.

A main principle of the test according to DP 6167 is to give such information on the contribution of the suspended ceiling to the fire resistance of an unventilated load bearing floor or roof assembly, that the test results can be used for a direct classification with an application in practise, which is as general as possible. In order to increase these possibilities, the standard specifies the test to be carried out with supporting steel beams of a comparatively high value of U/F , if the test results are intended to be used for a direct classification - viz. steel beams with $U/F \geq 290 \text{ m}^{-1}$, e.g. IPE 140. U is the heat exposed surface of the steel beam per unit length (m^2/m), i.e. the total surface of the beam except the part covered by the slabs, and F the volume of the steel beam per unit length (m^3/m).

As concerns a direct application of the test results for a classification with the tested suspended ceiling as a part of a floor or roof assembly, the commentary of the standard gives the following guidance.

The fire resistance time determined in the test can be applied directly for a classification of a floor or roof assembly with the same structural design as the one tested. The fire resistance time

obtained can also be supplied for a direct classification on the safe side of a floor or roof assembly with the same suspended ceiling but with the rest of the assembly structurally modified in comparison to the tested assembly in such a way that the rate of heating of the load bearing steel beams will be decreased. Alterations which each by itself gives an effect in this direction are:

- (1) An increase of the volume of the unventilated cavity,
- (2) an increase of the density and the specific heat of the topping material, e.g. an exchange of an aerated concrete slab to a light weight concrete slab with a higher density, to a slab of normal concrete, or to a slab with hollow brick or concrete blocks,
- (3) a decrease of the U/F value of the steel beams.

An increase of the thickness of the slab gives a practically negligible influence on the heating of the steel beams, if the thickness is larger than about 50 mm.

Furthermore, a replacement of the steel beams by beams of reinforced or prestressed concrete gives a modified floor or roof assembly which can be classified on the safe side by a direct application of the results of a fire resistance test in accordance with the standard DP 6167.

2. MAIN CHARACTERISTICS OF A THEORETICAL EVALUATION OF FIRE RESISTANCE TESTS ACCORDING TO DP 6167

As an alternative to a direct classification, as described in chapter 1, the commentary to DP 6167 indicates the possibilities of a more differentiated classification of a floor or roof assembly by theoretical calculations, taking into account the real behaviour at fire exposure of the suspended ceiling, investigated in the test. Such a theoretical, differentiated evaluation of the results, obtained in a fire resistance test for a determination of the contribution of a suspended ceiling to the fire behaviour of an unventilated, load bearing floor or roof assembly according to figure 1a, comprises the main steps summarized below. In order to make the procedure safe, the test assembly should be so designed that as much information as possible is given in the test concerning the behaviour of the suspended ceiling. Of that reason, the standard specifies that supporting steel beams with a comparatively low value of $U/F - U/F \leq 160 \text{ m}^{-1}$, e.g. HE 140B - shall be used in the test if the test results are to be applied to a subsequent differentiated evaluation by calculation. As to slab material, the theoretical evaluation should go from a material with a higher heat capacity to a material with a lower heat capacity, which implies, for instance, that an extrapolation from a floor or roof assembly with a slab of aerated concrete to an assembly with a slab of normal concrete should be avoided.

Step 1: The fire resistance test according to DP 6167 gives the time curve of the steel temperature T_s of the bottom flange at mid-span of the centre supporting beam (figure 2a), the time $t_{s,crit}$ for collapse of the supporting construction and the corresponding steel temperature $T_{s,crit}$ for the floor or roof assembly tested, specified by

the material, thickness and density of the slab,
the U/F value of the supporting steel beams,
the material and structural characteristics of the suspended ceiling, its fastening devices included, and
the ratio between the applied test load, ordinarily the design load Q , and the ultimate load at ambient temperature Q_u .

If the suspended ceiling is damaged in the test, the time of this damage $t_{i,crit}$ is noted.

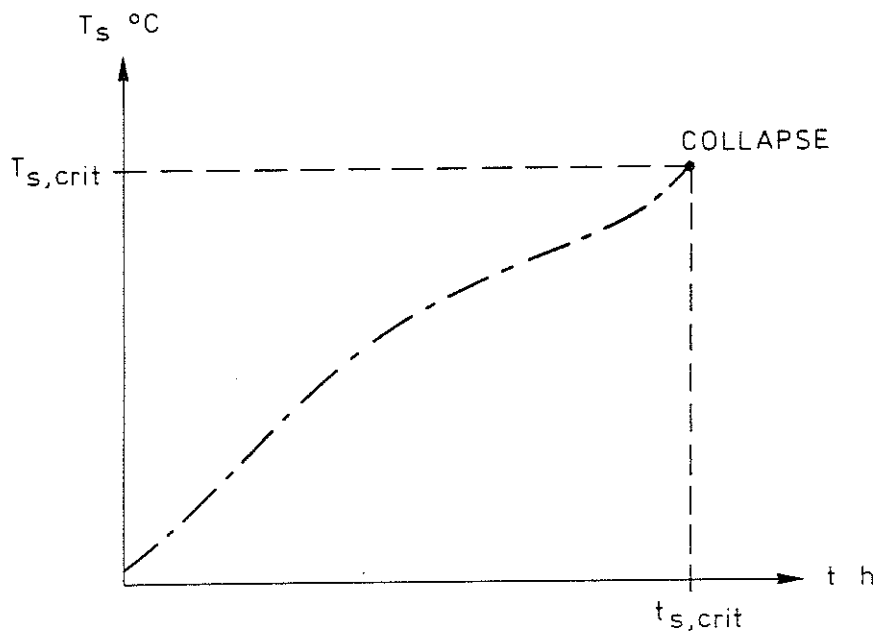

Figure 2a. Time curve of steel temperature T_s of bottom flange at midspan of centre supporting beam, time $t_{s,crit}^s$ for collapse of supporting construction and corresponding steel temperature $T_{s,crit}$, determined in a fire resistance test according to DP 6167

Step 2: This step comprises a determination of a derived value $(d_i/\lambda_i)_{der}$ of the suspended ceiling tested - d_i is a thickness measure and λ_i a thermal conductivity measure for the ceiling. The determination is based on the requirement that the agreement between the time curve of the steel temperature of the bottom flange at midspan of the centre supporting beam, measured in the test - the T_s - t curve according to figure 2a - and the corresponding calculated time curve shall be as close as possible. This determination is rendered easily feasible by a set of diagrams of the type shown by the full lines in figure 2b, presented in chapter 6 for unventilated floor or roof assemblies with a slab of alternatively normal concrete of density 2300 kg m^{-3} or aerated concrete of density 600 kg m^{-3} and supporting steel beams with an U/F value of alternatively 299 m^{-1} (IPE 140) or 160 m^{-1} (HE 140 B). By this procedure, the suspended ceiling tested is characterized in an integrated way with regard taken to real structural design and behaviour at a fire exposure, including the influence of initial moisture content, crack formations, disintegration of materials, and partial failure of the ceiling and its fastening devices.

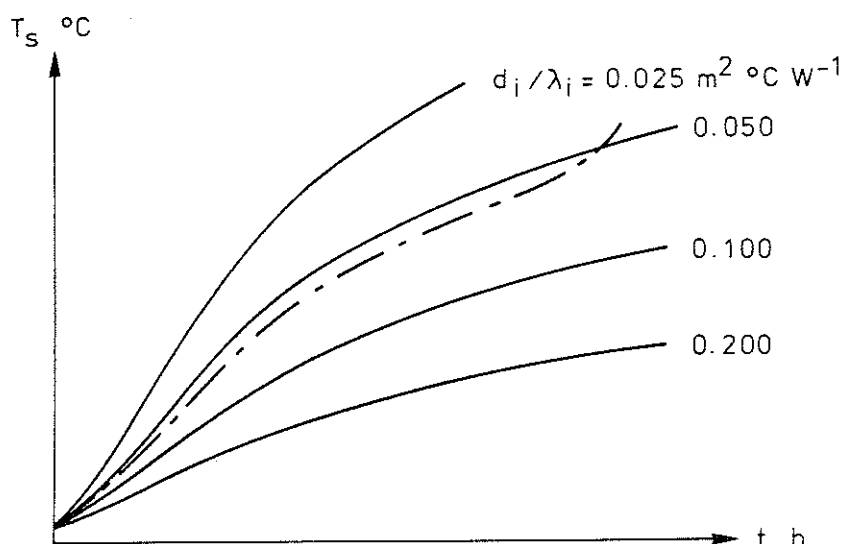

Figure 2b. Calculated time curves of the steel temperature T_s of the supporting beams of a floor or roof assembly, according to figure 1a, with a suspended ceiling, having different values of d_i/λ_i (full line curves), and a measured time curve of the steel temperature of bottom flange at midspan of centre supporting beam, determined in a fire resistance test according to DP 6167 (dashed and dotted line curve)

The reference diagrams in chapter 6 are based on heat transfer equations which neglect the influence of the heat stored in the suspended ceiling. If these diagrams are used for the determination of the derived value $(d_i/\lambda_i)_{\text{der}}$ of the suspended ceiling tested, the influence of this stored heat will be included in a way which has to be described more as a trick of calculation than as a functionally based procedure. For ordinary types of suspended ceilings, the approximation is reasonable. For suspended ceilings with a large thickness and made of materials of high density, it is recommended to use the computer program in the appendix for a direct and more accurate characterization of the suspended ceiling.

For some types of suspended ceilings, the measured time curve of the steel beam temperature can have a form which deviates considerably from the calculated time curves of the steel beam temperature - figure 2c. The criterion for the determination of the value $(d_i/\lambda_i)_{\text{der}}$ of the suspended ceiling then should be that the calculated curve and the curve measured in the test give the same steel temperature $T_{s,\text{crit}}$ at the time $t_{s,\text{crit}}$. For the example, shown in figure 2c, this leads to a $(d_i/\lambda_i)_{\text{der}} = 0.05 \text{ m}^2 \text{ }^\circ\text{C W}^{-1}$. By applying such a criterion, a $(d_i/\lambda_i)_{\text{der}}$ is obtained, from which test results can be

extrapolated without giving values of the fire resistance on the unsafe side. Already, such a minor deviation as indicated in figure 2b may give reasons for the use of this criterion.

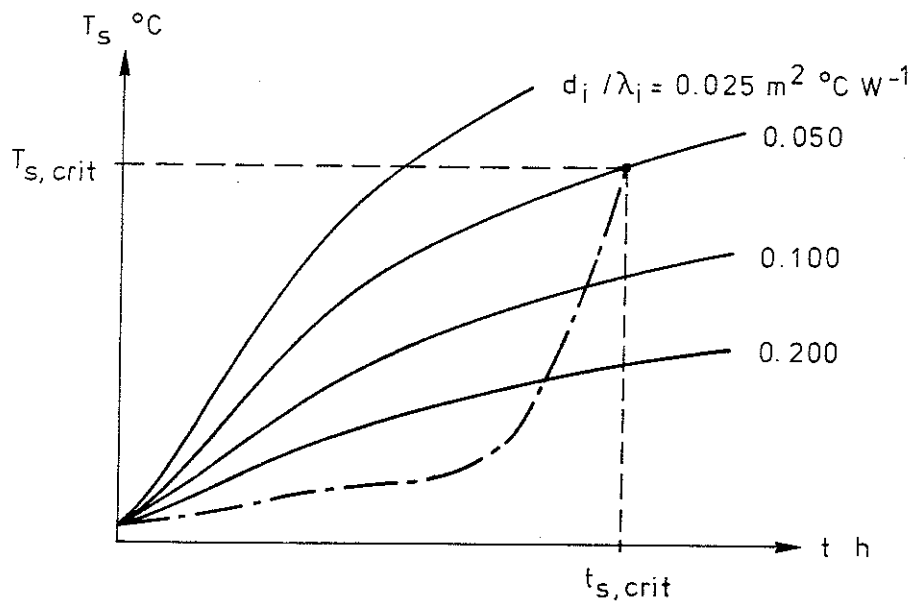

Figure 2c. Criterion for the determination of $(d_i/\lambda_i)_{der}$ of a suspended ceiling, if the forms of the measured and calculated time curves of the steel beam temperature deviate. Notation according to figure 2a and 2b

If the suspended ceiling is damaged in the test, the time for this damage $t_{i,crit}$ can be transferred to a critical temperature at the centre level of the ceiling $T_{i,crit}$ by using design diagrams, presented in chapter 6 and exemplified in figure 2d.

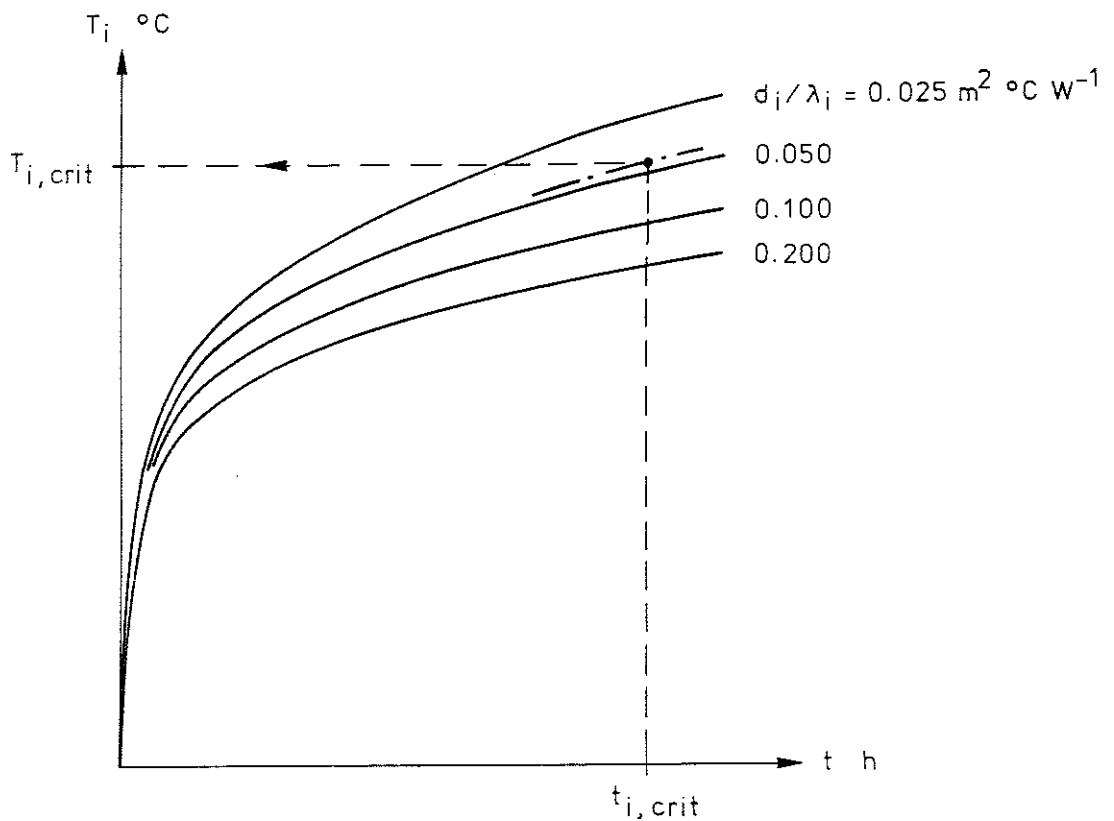

Figure 2d. Calculated time curves of the temperature at the centre level of the suspended ceiling T_i in an unventilated floor or roof assembly, according to figure 1a, for different values of d_i/λ_i of the ceiling. The dashed and dotted line curve applies to a derived value $(d_i/\lambda_i)_{der}$ of an assembly tested and used for transferring a time for damage of the suspended ceiling $t_{i,crit}$ to a corresponding critical temperature of the ceiling $T_{i,crit}$.

Step_3: This step comprises a determination of the fire resistance time of the floor or roof assembly in question, structurally modified in relation to the assembly tested. This time can be obtained directly by using the design tables in chapter 6 with applicable values of $(d_i/\lambda_i)_{der}$ for the suspended ceiling and of U/F for the steel beams, and the type of slab as entrance variables. The limiting design criteria are the steel beam temperature $T_{s,crit}$ corresponding to collapse of the supporting construction of the assembly (figure 2a) and the critical temperature at the centre level of the suspended ceiling $T_{i,crit}$ corresponding to damage of the suspended ceiling, if any (figure 2d).

If the floor or roof assembly in question is to be classified for the same ratio between the design load Q and the ultimate load at

ambient temperature Q_u as applied in the test, the steel temperature $T_{s,crit}$, determined in the test on the basis of a failure criterion, is chosen as the limiting value. If the classification is connected to another ratio Q/Q_u than used in the test, the limiting steel beam temperature of the supporting construction $T_{s,crit}$ can be taken from figure 2e [5].

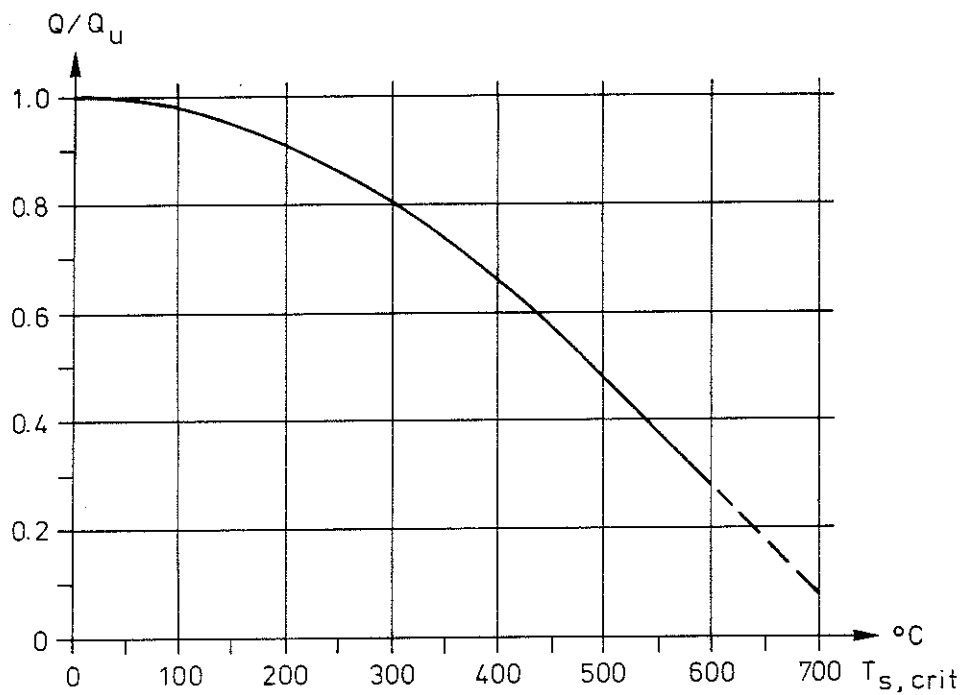

Figure 2e. Limiting steel temperature $T_{s,crit}$ as function of ratio between design load Q and ultimate load at ambient temperature Q_u [5]

The described procedure for a theoretical evaluation of the results of fire resistance tests according to DP 6167 is further developed in the following chapters. The basic equations of heat transfer in a fire exposed floor or roof assembly with a suspended ceiling are dealt with in chapter 3. Chapter 4 is mainly devoted to a survey of relevant thermal properties of steel, ordinary concrete, aerated concrete and some materials for suspended ceilings. Some comparisons of calculated steel temperature-time curves with those measured in fire resistance tests are presented in chapter 5. Finally, chapter 6 comprises design diagrams and tables, facilitating the steps 2 and 3 of the theoretical evaluation. Some examples of the practical application of the procedure are given in this chapter, too.

3. BASIC EQUATIONS OF HEAT TRANSFER IN A FIRE EXPOSED FLOOR OR ROOF ASSEMBLY WITH A SUSPENDED CEILING

3.1. The heat balance equations

In a floor or roof assembly of the type shown in figure 1a, the flanges of the supporting steel beams normally cover only a small part of the suspended ceiling. This gives reasons for a simplified heat transfer analysis in two steps according to figure 3.1a for the assembly, fire exposed from below.

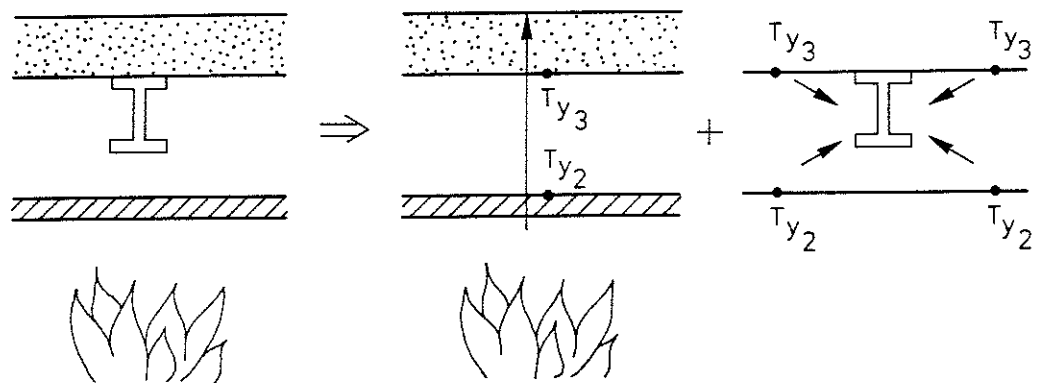

Figure 3.1a. Two steps model for a heat transfer analysis at fire exposure of a floor or roof assembly with a suspended ceiling

The first step comprises a determination of the surface temperature at the top of the suspended ceiling T_{y2} and at the bottom of the slab T_{y3} by a one dimensional heat transfer analysis for the suspended ceiling, the air gap and the slab without considering the presence of the steel beams. In the second step, then the temperature T_s is calculated for the steel supporting beams, as exposed to heat radiation from the top of the suspended ceiling and the soffit of the slab, and to heat transfer by convection.

If the suspended ceiling fails at a time $t_{i,crit}$ - cf. figure 2d - the supporting steel beams will be directly exposed to a radiation from flames penetrating between the beams from that point of time - see figure 3.1b.

A calculation of the surface temperature of the suspended ceiling T_{y2} and the slab T_{y3} can generally be carried out - as an approximation on the safe side - without considering the heat capacities of

the steel beams, the air gap and the suspended ceiling. The approximation is reasonable for floor or roof assemblies with ordinary types of suspended ceilings, for which usually the heat capacity of the slab predominates. For assemblies with suspended ceilings of large thickness and made of materials with high density, the approximation can give calculated temperatures too much on the safe side. A more accurate analysis, taking the heat stored in the suspended ceiling into account, then is suitable.

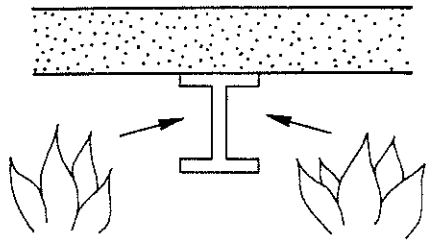

Figure 3.1b. Flames penetrating between the supporting steel beams after a failure of the suspended ceiling

In the following, both alternatives are dealt with.

3.1.1. Calculation of the surface temperature of the slab and suspended ceiling, considering only the heat capacity of the slab

The theory of a transient heat transfer analysis for this case is given in [2]. This theory is recapitulated below.

In the calculation the slab is divided into a number of elements as shown in figure 3.1.1a.

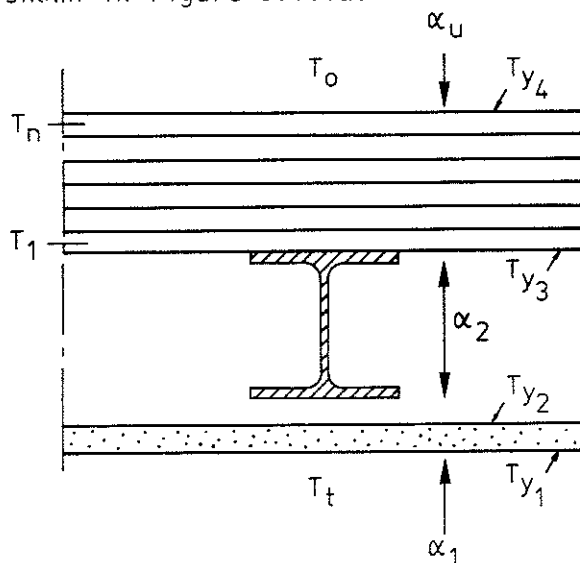

Figure 3.1.1a. Division of slab into elements

If the heat capacities of the steel beams, the air gap and the suspended ceiling are ignored, the temperature drops in the various surfaces and layers from the fire compartment to the slab are proportional to the thermal resistance of the surface or layer concerned. Using the symbols set out in figure 3.1.1a, the following expressions therefore hold for the surface temperatures

$$T_{y_1} = T_t - K \frac{1}{\alpha_1} (T_t - T_1) \quad (^\circ\text{C})$$

$$T_{y_2} = T_t - K \left(\frac{1}{\alpha_1} + \frac{d_i}{\lambda_i} \right) (T_t - T_1) \quad (^\circ\text{C}) \quad (3.1.1a)$$

$$T_{y_3} = T_t - K \left(\frac{1}{\alpha_1} + \frac{d_i}{\lambda_i} + \frac{1}{\alpha_2} \right) (T_t - T_1) \quad (^\circ\text{C})$$

The coefficient K follows the formula

$$K = \frac{1}{\frac{1}{\alpha_1} + \frac{d_i}{\lambda_i} + \frac{1}{\alpha_2} + \frac{\Delta x}{2\lambda_{bj}}} \quad (\text{W m}^{-2} \text{ } ^\circ\text{C}^{-1}) \quad (3.1.1b)$$

In Equations (3.1.1a) and (3.1.1b)

T_t = gas temperature in the fire compartment at time t ($^\circ\text{C}$)

T_1 = temperature in the middle of the lowest strip of slab at time t ($^\circ\text{C}$)

d_i = thickness of suspended ceiling (m)

λ_i = thermal conductivity of suspended ceiling ($\text{W m}^{-1} \text{ } ^\circ\text{C}^{-1}$)

α_1 = surface coefficient of heat transfer in the boundary layer between the combustion gases and the suspended ceiling ($\text{W m}^{-2} \text{ } ^\circ\text{C}^{-1}$)

α_2 = surface coefficient of heat transfer for radiation and convection between the suspended ceiling and the slab ($\text{W m}^{-2} \text{ } ^\circ\text{C}^{-1}$)

Δx = thickness of the lowest slab strip (m)

λ_{bj} = thermal conductivity of slab ($\text{W m}^{-1} \text{ } ^\circ\text{C}^{-1}$).

The surface coefficient of heat transfer α_1 at the fire exposed surface of the suspended ceiling may be assumed to be made up of a radiation component which is dominant at the high temperatures which occur during a fire, and of a convection component which, with satisfactory accuracy, can be put constant and equal to $23 \text{ W m}^{-2} \text{ } ^\circ\text{C}^{-1}$ [2], [6].

By applying the Stefan-Boltzman law, this gives for α_1

$$\alpha_1 = 23 + \frac{5.77\epsilon_r}{T_t - T_{y1}} \left[\left(\frac{T_t + 273}{100} \right)^4 - \left(\frac{T_{y1} + 273}{100} \right)^4 \right] \quad (\text{W m}^{-2} \text{ } ^\circ\text{C}^{-1}) \quad (3.1.1c)$$

The resultant emissivity ϵ_r can be calculated from the formula

$$\epsilon_r = \frac{1}{1/\epsilon_t + 1/\epsilon_i - 1} \quad (3.1.1d)$$

where

ϵ_t = emissivity of the flames

ϵ_i = emissivity of the surface of the suspended ceiling.

With the emissivity of the flames $\epsilon_t = 0.85$ and the suspended ceiling emissivity $\epsilon_i = 0.80$, Equation (3.1.1d) gives a resultant emissivity $\epsilon_r = 0.70$.

As regards the surface coefficient of heat transfer α_2 , the convection portion can be assumed to be smaller than in the case of α_1 . A reasonable value for the convection portion of the surface coefficient of heat transfer in this instance is $8.7 \text{ W m}^{-2} \text{ } ^\circ\text{C}^{-1}$ [2], [7]. The surface coefficient of heat transfer α_2 can therefore be written

$$\alpha_2 = 8.7 + \frac{5.77\epsilon_r}{T_{y2} - T_{y3}} \left[\left(\frac{T_{y2} + 273}{100} \right)^4 - \left(\frac{T_{y3} + 273}{100} \right)^4 \right] \quad (\text{W m}^{-2} \text{ } ^\circ\text{C}^{-1}) \quad (3.1.1e)$$

The resultant emissivity can be calculated on the assumption that the emissivity of both the suspended ceiling and the slab is 0.80 [2], [8]. According to Equation (3.1.1d), this gives the value $\epsilon_r = 0.67$.

In order to calculate the surface temperatures according to Equation (3.1.1a), we must know the temperature T_1 in the lowest strip of the slab according to figure 3.1.1a, in addition to the combustion gas temperature T_t in the fire compartment. The quantity of heat which dissipate per unit time to and through the floor or roof assembly can be determined by solving the general thermal conduction equation for one dimensional nonsteady thermal conduction, consideration being given to the temperature dependence of the thermal material properties.

The thermal conduction equation reads as follows

$$c\gamma \frac{\delta T}{\delta t} = \frac{\delta}{\delta x} \left(\lambda \frac{\delta T}{\delta x} \right) \quad (3.1.1f)$$

where

c = specific heat capacity ($\text{J kg}^{-1} \text{ } ^\circ\text{C}^{-1}$)

γ = density (kg m^{-3})

λ = thermal conductivity ($\text{W m}^{-1} \text{ } ^\circ\text{C}^{-1}$)

x = positional coordinate (m)

t = time (s).

The temperature T_1 is calculated from the thermal conduction equation of the slab elements by division of the fire into a number of short time intervals Δt . This gives a system of equations

$$\begin{aligned} \Delta x_1 c(x,T) \gamma(x) \frac{\Delta T_1}{\Delta t} &= \frac{1}{\Delta x_1} (T_{y_3} - T_1) - \frac{1}{\frac{\Delta x_1}{2\lambda(x,T)} + \frac{\Delta x_2}{2\lambda(x,T)}} (T_1 - T_2) \\ \cdot \\ \cdot \\ \Delta x_k c(x,T) \gamma(x) \frac{\Delta T_k}{\Delta t} &= \frac{1}{\frac{\Delta x_{k-1}}{2\lambda(x,T)} + \frac{\Delta x_k}{2\lambda(x,T)}} (T_{k-1} - T_k) - \\ &\frac{1}{\frac{\Delta x_k}{2\lambda(x,T)} + \frac{\Delta x_{k+1}}{2\lambda(x,T)}} (T_k - T_{k+1}) \quad (3.1.1g) \\ \cdot \\ \cdot \\ \Delta x_n c(x,T) \gamma(x) \frac{\Delta T_n}{\Delta t} &= \frac{1}{\frac{\Delta x_{n-1}}{2\lambda(x,T)} + \frac{\Delta x_n}{2\lambda(x,T)}} (T_{n-1} - T_n) - \frac{1}{\frac{\Delta x_n}{2\lambda(x,T)} + \frac{1}{\alpha_u(T)}} (T_n - T_0) \end{aligned}$$

where

$c(x,T)$ = specific heat capacity at section x at temperature T
($\text{J kg}^{-1} \text{ } ^\circ\text{C}^{-1}$)

$\gamma(x)$ = density at section x (kg m^{-3})

$\lambda(x,T)$ = thermal conductivity at section x at temperature T
($\text{W m}^{-1} \text{ } ^\circ\text{C}^{-1}$)

T_k = temperature at the centre of layer k ($^\circ\text{C}$)

Δx_k = thickness of layer k (m)

$\alpha_u(T)$ = surface coefficient of heat transfer at the top of the slab
($\text{W m}^{-2} \text{ } ^\circ\text{C}^{-1}$).

For α_u , the approximate expression can be used [7]

$$\alpha_u = 8.7 + 0.033 T_{y_4} \quad (\text{W m}^{-2} \text{ } ^\circ\text{C}^{-1}) \quad (3.1.1h)$$

When the expression for T_{y_3} according to Equation (3.1.1a) is substituted into the system of equations (3.1.1g), this can be solved by numerical integration. The surface temperatures T_{y_1} , T_{y_2} , T_{y_3} are then obtained from Equation (3.1.1a).

3.1.2. Calculation of the surface temperature of the slab and suspended ceiling, considering the heat capacity of the slab as well as the suspended ceiling

For floor or roof assemblies with suspended ceilings of large thickness and made of materials with high density, an analysis according to section 3.1.1 can give calculated temperatures which are too much on the safe side. For such applications, a further developed analysis taking into account also the heat capacity of the suspended ceiling is preferable. This implies a supplementary splitting up of the suspended ceiling into a number of elements, as shown in figure 3.1.2a, and an extension of the system of equations (3.1.1g) by thermal conduction equations for these elements.

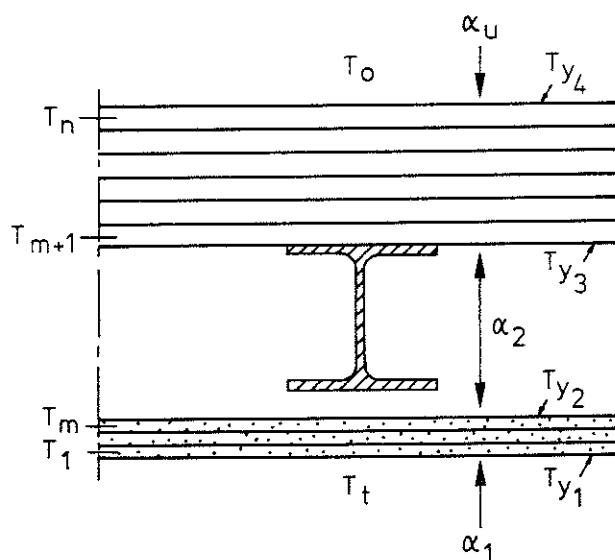

Figure 3.1.2a. Division of slab and suspended ceiling into elements

Using the symbols set out in figure 3.1.2a, the following expressions are obtained for the surface temperatures T_{y_1} , T_{y_2} , and T_{y_3} - cf. the

analogous formulas in Equation (3.1.1a)

$$T_{y_1} = T_t - \frac{1}{\left(\frac{1}{\alpha_1} + \frac{\Delta x_1}{2\lambda_i}\right)} \cdot \frac{1}{\alpha_1} (T_t - T_1) \quad (^\circ\text{C})$$

$$T_{y_2} = T_m - \frac{1}{\left(\frac{\Delta x_m}{2\lambda_i} + \frac{1}{\alpha_2} + \frac{\Delta x_{m+1}}{2\lambda_{bj}}\right)} \cdot \frac{\Delta x_m}{2\lambda_i} (T_m - T_{m+1}) \quad (^\circ\text{C}) \quad (3.1.2a)$$

$$T_{y_3} = T_m - \frac{1}{\left(\frac{\Delta x_m}{2\lambda_i} + \frac{1}{\alpha_2} + \frac{\Delta x_{m+1}}{2\lambda_{bj}}\right)} \cdot \left(\frac{\Delta x_m}{2\lambda_i} + \frac{1}{\alpha_2}\right) (T_m - T_{m+1}) \quad (^\circ\text{C})$$

where

T_t = gas temperature in the fire compartment at time t ($^\circ\text{C}$)

T_1 = temperature in the middle of the lowest strip of suspended ceiling at time t ($^\circ\text{C}$)

T_m = temperature in the middle of the highest strip of suspended ceiling at time t ($^\circ\text{C}$)

T_{m+1} = temperature in the middle of the lowest strip of slab at time t ($^\circ\text{C}$)

Δx_k = thickness of strip number k (m)

λ_i = thermal conductivity of suspended ceiling ($\text{W m}^{-1} \text{ }^\circ\text{C}^{-1}$)

λ_{bj} = thermal conductivity of slab ($\text{W m}^{-1} \text{ }^\circ\text{C}^{-1}$)

α_1 = surface coefficient of heat transfer in the boundary layer between the combustion gases and the suspended ceiling ($\text{W m}^{-2} \text{ }^\circ\text{C}^{-1}$)

α_2 = surface coefficient of heat transfer for radiation and convection between the suspended ceiling and the slab ($\text{W m}^{-2} \text{ }^\circ\text{C}^{-1}$).

The surface coefficients of heat transfer α_1 and α_2 follow Equations (3.1.1c) and (3.1.1e), respectively.

For a calculation of the surface temperatures according to Equation (3.1.2a), we have to know the temperatures T_1 in the lowest strip of the suspended ceiling, T_m in the highest strip of the suspended ceiling and T_{m+1} in the lowest strip of the slab, in addition to the combustion gas temperature T_t in the fire compartment. The strip temperatures are calculated from the general thermal conduction equation for one dimensional non steady thermal conduction, Equation (3.1.1f), applied to the suspended ceiling and the slab, considering the temperature dependence of the thermal material properties. Regarding the strips according to figure 3.1.2a and dividing

the fire into a number of short time intervals Δt , this procedure gives the following system of equations

$$\Delta x_1 c_i(x, T) \gamma_i(x) \frac{\Delta T_1}{\Delta t} = \frac{1}{\frac{1}{\alpha_1(T)} + \frac{\Delta x_1}{2\lambda_i(x, T)}} (T_t - T_1) -$$

$$\frac{1}{\frac{\Delta x_1}{2\lambda_i(x, T)} + \frac{\Delta x_2}{2\lambda_i(x, T)}} (T_1 - T_2)$$

·
·
·

$$\Delta x_m c_i(x, T) \gamma_i(x) \frac{\Delta T_m}{\Delta t} = \frac{1}{\frac{\Delta x_{m-1}}{2\lambda_i(x, T)} + \frac{\Delta x_m}{2\lambda_i(x, T)}} (T_{m-1} - T_m) -$$

$$\frac{1}{\frac{\Delta x_m}{2\lambda_i(x, T)} + \frac{1}{\alpha_2(T)} + \frac{\Delta x_{m+1}}{2\lambda_{bj}(x, T)}} (T_m - T_{m+1})$$

$$\Delta x_{m+1} c_{bj}(x, T) \gamma_{bj}(x) \frac{\Delta T_{m+1}}{\Delta t} = \frac{1}{\frac{\Delta x_m}{2\lambda_i(x, T)} + \frac{1}{\alpha_2(T)} + \frac{\Delta x_{m+1}}{2\lambda_{bj}(x, T)}} (T_m - T_{m+1}) -$$

$$\frac{1}{\frac{\Delta x_{m+1}}{2\lambda_{bj}(x, T)} + \frac{\Delta x_{m+2}}{2\lambda_{bj}(x, T)}} (T_{m+1} - T_{m+2}) \tag{3.1.2b}$$

·
·
·

$$\Delta x_k c_{bj}(x, T) \gamma_{bj}(x) \frac{\Delta T_k}{\Delta t} = \frac{1}{\frac{\Delta x_{k-1}}{2\lambda_{bj}(x, T)} + \frac{\Delta x_k}{2\lambda_{bj}(x, T)}} (T_{k-1} - T_k) -$$

$$\frac{1}{\frac{\Delta x_k}{2\lambda_{bj}(x, T)} + \frac{\Delta x_{k+1}}{2\lambda_{bj}(x, T)}} (T_k - T_{k+1})$$

·
·
·

$$\Delta x_n c_{bj}(x, T) \gamma_{bj}(x) \frac{\Delta T_n}{\Delta t} = \frac{1}{\frac{\Delta x_{n-1}}{2\lambda_{bj}(x, T)} + \frac{\Delta x_n}{2\lambda_{bj}(x, T)}} (T_{n-1} - T_n) -$$

$$\frac{1}{\frac{\Delta x_n}{2\lambda_{bj}(x, T)} + \frac{1}{\alpha_u(T)}} (T_n - T_0)$$

where

- $c_i(x,T)$ = specific heat capacity of the suspended ceiling at section x at temperature T ($\text{J kg}^{-1} \text{ } ^\circ\text{C}^{-1}$)
- $c_{bj}(x,T)$ = specific heat capacity of the slab at section x at temperature T ($\text{J kg}^{-1} \text{ } ^\circ\text{C}^{-1}$)
- $\gamma_i(x)$ = density of the suspended ceiling at section x (kg m^{-3})
- $\gamma_{bj}(x)$ = density of the slab at section x (kg m^{-3})
- $\lambda_i(x,T)$ = thermal conductivity of the suspended ceiling at section x at temperature T ($\text{W m}^{-1} \text{ } ^\circ\text{C}^{-1}$)
- $\lambda_{bj}(x,T)$ = thermal conductivity of the slab at section x at temperature T ($\text{W m}^{-1} \text{ } ^\circ\text{C}^{-1}$)
- T_t = gas temperature in the fire compartment at time t ($^\circ\text{C}$)
- T_o = outside air temperature at time t ($^\circ\text{C}$)
- T_k = temperature at the centre of strip k ($^\circ\text{C}$)
- Δx_k = thickness of strip k (m)
- $\alpha_u(T)$ = surface coefficient of heat transfer at the top of the slab ($\text{W m}^{-2} \text{ } ^\circ\text{C}^{-1}$).

The surface coefficient of heat transfer α_u is given by Equation (3.1.1h).

The system of equations (3.1.2b) can be solved by numerical integration. The surface temperatures T_{y_1} , T_{y_2} and T_{y_3} are then obtained from Equation (3.1.2a).

3.1.3 Calculation of the temperature of the steel beams, protected by a suspended ceiling

The quantity of heat Q per unit length of steel beam, required to raise the steel temperature by ΔT_s $^\circ\text{C}$, is

$$Q = c_{ps} \Delta T_s F_s \gamma_s \quad (\text{J m}^{-1}) \quad (3.1.3a)$$

where

- c_{ps} = specific heat capacity of the steel ($\text{J kg}^{-1} \text{ } ^\circ\text{C}^{-1}$)
- ΔT_s = temperature rise in steel beam ($^\circ\text{C}$)
- F_s = volume of the steel section per unit length ($\text{m}^3 \text{ m}^{-1}$)
- γ_s = density of the steel (kg m^{-3}).

It is assumed that the steel section is exposed to heat radiation from the top surface of the suspended ceiling and the bottom surface of the slab, and to heat transfer by convection. The air temperature in the space between the suspended ceiling and the slab is assumed to be the same as the mean of the surface temperatures T_{y_2} and T_{y_3} . This is a consequence of the assumptions, that the temperature drops in the various surfaces and layers are proportional to the thermal resistance of the surface and layer concerned, which led to Equations (3.1.1a) and (3.1.2a). The assumption is valid if the space is unventilated. If there is no conduction between the top flange of the steel beam and the slab, then the quantity of heat Q , which is supplied to the steel beam per unit length over the time interval Δt , can be written [2]

$$Q = \alpha_{s_2} U_s (T_{y_2} - T_s) \Delta t + \alpha_{s_3} U_s (T_{y_3} - T_s) \Delta t + \alpha_k U_s \left(\frac{T_{y_2} + T_{y_3}}{2} - T_s \right) \Delta t \quad (\text{J m}^{-1}) \quad (3.1.3b)$$

where

- U_s = surface area of the steel section per unit length, with the exception of the part carrying the slab ($\text{m}^2 \text{m}^{-1}$)
- T_s = temperature of steel section at time t ($^{\circ}\text{C}$)
- T_{y_2} = temperature of the top surface of the suspended ceiling at time t ($^{\circ}\text{C}$)
- T_{y_3} = temperature of the bottom surface of the slab at time t ($^{\circ}\text{C}$)
- $\alpha_{s_2}, \alpha_{s_3}$ = surface coefficients of heat transfer due to radiation ($\text{W m}^{-2} \text{ }^{\circ}\text{C}^{-1}$)
- α_k = surface coefficient of heat transfer due to convection ($\text{W m}^{-2} \text{ }^{\circ}\text{C}^{-1}$).

The radiation portions α_{s_2} and α_{s_3} of the surface coefficients of heat transfer are obtained from the expressions

$$\alpha_{s_2} = \frac{5.77 \epsilon_r}{T_{y_2} - T_s} \left[\left(\frac{T_{y_2} + 273}{100} \right)^4 - \left(\frac{T_s + 273}{100} \right)^4 \right] (\text{W m}^{-2} \text{ }^{\circ}\text{C}^{-1}) \quad (3.1.3c)$$

$$\alpha_{s_3} = \frac{5.77 \epsilon_{r_3}}{T_{y_3} - T_s} \left[\left(\frac{T_{y_3} + 273}{100} \right)^4 - \left(\frac{T_s + 273}{100} \right)^4 \right] \quad (\text{W m}^{-2} \text{ } ^\circ\text{C}^{-1})$$

The calculation of the resultant emissivity ϵ_r between two radiating surfaces, in accordance with Equation (3.1.1d), presupposes that all radiation from one of the surfaces strikes the other surface, and vice versa. This does not occur in the case of steel beams in a construction as shown in figure 3.1.1a and 3.1.2a. For this reason, apart from the emissivity of the surfaces, the value of ϵ_r will also depend on the shapes and spacing of the beams. The value of ϵ_{r_2} can be found from figure 3.1.3a and the value of ϵ_{r_3} , with satisfactory accuracy, from figure 3.1.3b [8], a convenient assumption being that all surfaces on the suspended ceiling, the slab and the beams have an emissivity of 0.8. The difference between the resultant emissivity for the suspended ceiling and the beams ϵ_{r_2} and the resultant emissivity for the slab and the beams ϵ_{r_3} is due to the fact that in the latter case one of the flanges of the beams does not participate in the radiation exchange.

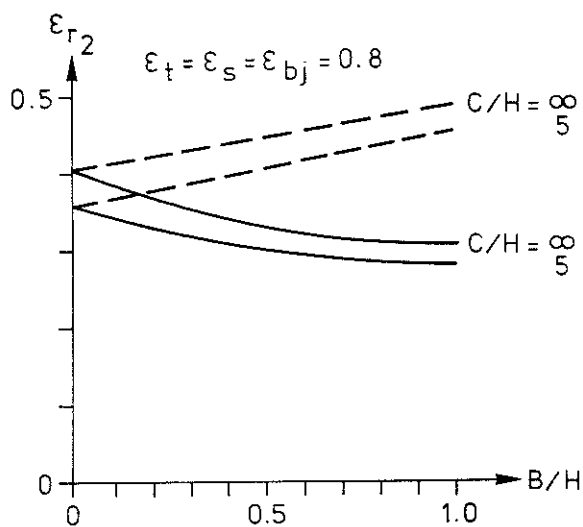

Figure 3.1.3a. The resultant emissivity ϵ_{r_2} between the suspended ceiling and the steel beams. ϵ_s = emissivity of the beams, ϵ_t = emissivity of the suspended ceiling, ϵ_{bj} = emissivity of the slab, B/H = width-depth ratio of beams, C/H = spacing-depth ratio of beams, ————— = I sections, - - - - = box sections

The convection portion α_k of the surface coefficient of heat transfer can, with sufficient accuracy, be put at a constant value of $8.7 \text{ W m}^{-2} \text{ } ^\circ\text{C}^{-1}$ (see subsection 3.1.1).

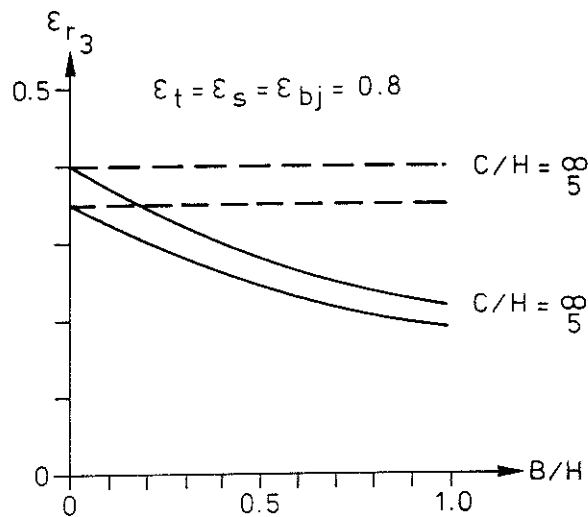

Figure 3.1.3b. The resultant emissivity ϵ_{r3} between the slab and the steel beams. Notations according to figure 3.1.3a

From Equations (3.1.3a) and (3.1.3b), the rise in temperature ΔT_s in the steel beams over the time interval Δt is obtained as

$$\Delta T_s = \frac{U_s \Delta t}{F_s \gamma_s c_{ps}} \left[\left(\frac{\alpha_k}{2} + \alpha_{s2} \right) (T_{y2} - T_s) + \left(\frac{\alpha_k}{2} + \alpha_{s3} \right) (T_{y3} - T_s) \right] \quad (3.1.3d)$$

3.1.4. Calculation of the temperature of the steel beams after a failure of the suspended ceiling

After a complete failure of the suspended ceiling, the steel beams will be directly exposed - without any protection - to the flames and combustion gases in the fire compartment.

Equation (3.1.3a) still holds for the quantity of heat Q per unit length of the steel beams, required to increase the steel temperature by ΔT_s °C.

The quantity of heat Q which passes through the boundary layer between the combustion gases and the steel beams per unit length over a short interval of time Δt can be written

$$Q = \alpha U_s (T_t - T_s) \Delta t \quad (\text{J m}^{-1}) \quad (3.1.4a)$$

where

α = surface coefficient of heat transfer in the boundary layer between the combustion gases and the steel beam ($\text{W m}^{-2} \text{ } ^\circ\text{C}^{-1}$)

U_s = the surface of the steel section per unit length which is exposed to fire ($m^2 m^{-1}$)

T_t = the gas temperature in the fire compartment at time t ($^{\circ}C$)

T_s = the temperature of the steel section at time t ($^{\circ}C$)

Δt = the length of time interval (s).

The surface coefficient of heat transfer α of the boundary layer is made up of a convection portion and a radiation portion. With an accuracy that is sufficient in a normal fire engineering context, the convection portion α_k can be put equal to $23 W m^{-2} ^{\circ}C^{-1}$ [2],[6]. The temperature dependent radiation portion α_s is determined from Stefan-Boltzman equation. The total surface coefficient of heat transfer $\alpha = \alpha_s + \alpha_k$ is thus

$$\alpha = 23 + \frac{5.77 \epsilon_r}{T_t - T_s} \left[\left(\frac{T_t + 273}{100} \right)^4 - \left(\frac{T_s + 273}{100} \right)^4 \right] \quad (W m^{-2} ^{\circ}C^{-1}) \quad (3.1.4b)$$

where

ϵ_r = resultant emissivity

T_t = gas temperature in the fire compartment at time t ($^{\circ}C$)

T_s = temperature of the steel section at time t ($^{\circ}C$).

The resultant emissivity ϵ_r is dependent on the emissivities ϵ_t and ϵ_s of the flames and the steel beams and on their individual sizes and relative positions.

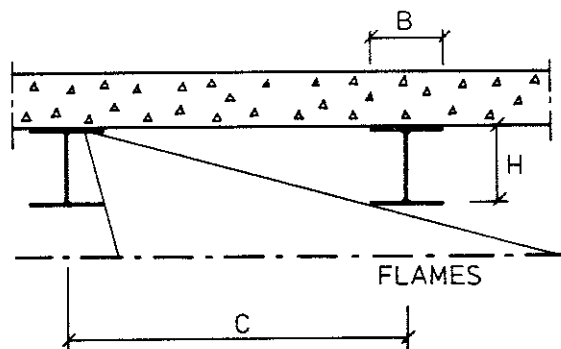

Figure 3.1.4a. Floor assembly where the flames are in their entirety below the beams

In the case of beams situated in rooms of sufficient height, the whole of the heat emitting surface, i.e. the flames, is below the beams. Some parts of the beam surfaces will not be subjected to full radiation in such a case, since they are partly shielded from the flames

by other parts of the beams (see figure 3.1.4a). The radiation to which the beams are subjected, is dependent on the width-height ratio B/H and on the spacing-height ratio C/H of the beams. The resultant emissivity ϵ_r as a function of these geometrical conditions is shown in figure 3.1.4b [2], [8]. The emissivities ϵ_s and ϵ_{bj} of the steel beams and the slab have been taken as 0.8 throughout. Unless some other value is shown to be more correct, it is recommended that a value of 0.85 should be taken as the emissivity ϵ_t of the flames.

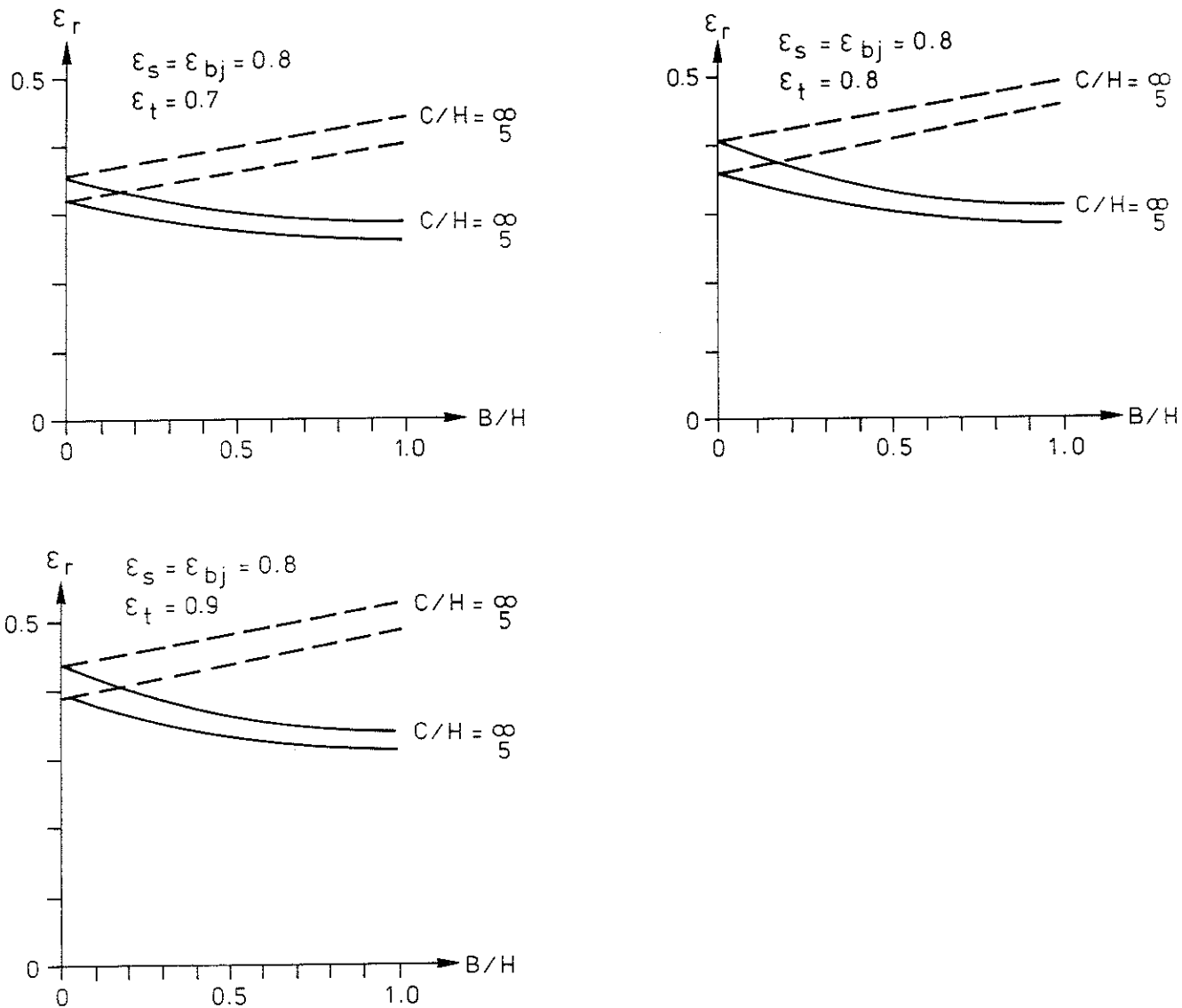

Figure 3.1.4b. Resultant emissivity ϵ_r for steel beams under fire exposure conditions, with the flames r situated below the beams. ϵ_s = emissivity of the beams, ϵ_{bj} = emissivity of the slab, ϵ_t = emissivity of the flames, B/H = width-depth ratio of the beams, C/H = spacing-depth ratio of the beams. ————— = I section, ----- = box section

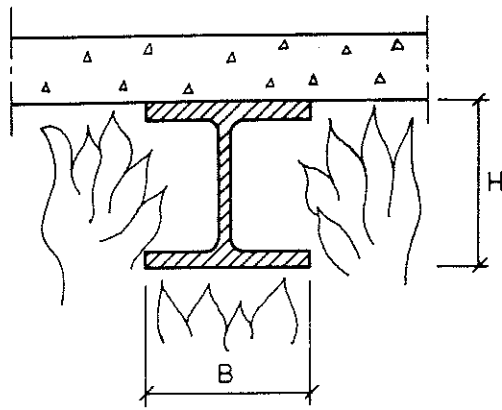

Figure 3.1.4c. Floor assembly where the flames penetrate between the steel beams

Where the flames penetrate between the beams (see figure 3.1.4c), the beams are exposed to greater radiation than beams which are situated completely above the flames. The resultant emissivity ϵ_r for I section beams carrying a slab on their top flanges, is given in figure 3.1.4d as a function of the width-height ratio B/H of the beams, for different values of the flame emissivity ϵ_t . The emissivity of the beams was assumed to be 0.8. Unless some other value can be shown to be more correct, it is recommended that the value of the flame emissivity is taken to be 0.85.

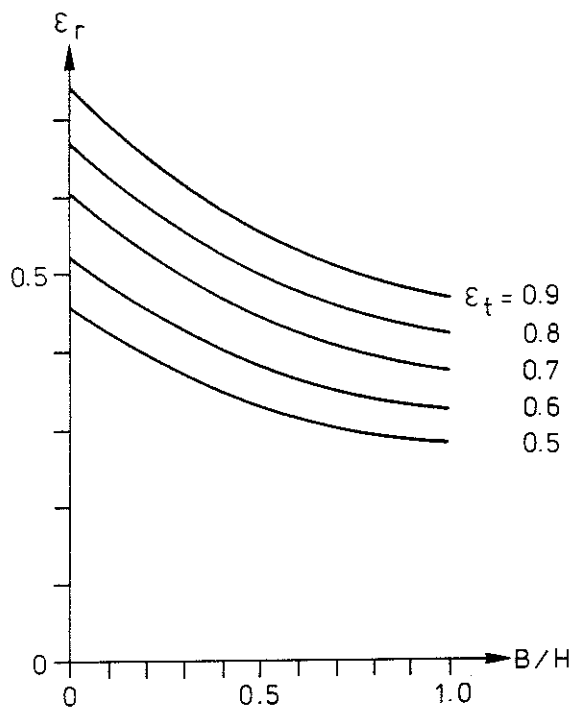

Figure 3.1.4d. Resultant emissivity ϵ_r for I section beams where the flames penetrate up to the slab. ϵ_t = emissivity of the flames, B/H = width-depth ratio of the beams. The emissivity of the beams is assumed to be 0.8

For beams of box section, the resultant emissivity ϵ_r is to be calculated in the same way as for a column placed inside a fire compartment if it is assumed that the flames reach the bottom surface of the slab [2]. Equation (3.1.1d) can be used for a calculation of ϵ_r , since it is assumed that the flames completely surround the beams, all radiation from these will impinge, and vice versa

$$\epsilon_r = \frac{1}{1/\epsilon_t + 1/\epsilon_s - 1} \quad (3.1.4c)$$

where

ϵ_t = emissivity of the flames
 ϵ_s = emissivity of the steel beams.

If the emissivities of the flames and the beams are taken as 0.85 and 0.80 respectively, Equation (3.1.4c) gives a resultant emissivity of $\epsilon_r = 0.7$.

The quantity of heat supplied according to Equation (3.1.4a) is equal to the quantity of heat required according to Equation (3.1.3a) to increase the steel temperature by ΔT_s °C; then it is assumed that there is no heat conduction between the slab and the top flange of the beam. This gives the following expression for the rise in temperature ΔT_s in the beam over the time interval Δt during the fire

$$\Delta T_s = \frac{\alpha}{\gamma_s c_{ps}} \cdot \frac{U_s}{F_s} (T_t - T_s) \Delta t \quad (^\circ\text{C}) \quad (3.1.4d)$$

Derivation of Equation (3.1.4d) is based on the assumptions, that the heat flow is unidimensional and that the steel temperature is uniformly distributed over the cross section of the steel beam. Owing to the high thermal conductivity of steel, these assumptions give satisfactory accuracy in ordinary cases. Sections of extremely thick walls constitute exceptions to this.

If the gas temperature-time curve and thus T_t is known for a fire compartment, the steel temperature can be determined by calculating the rise in steel temperature for each time interval by means of Equation (3.1.4d).

3.2. Computer program for calculating the transient temperature state in a fire exposed floor or roof assembly with a suspended ceiling

For a determination of the transient temperature state in a fire exposed, unventilated floor or roof assembly with a suspended ceiling, structurally designed as shown in figure 1a, 3.1.1a and 3.1.2a, a computer program, written in Standard FORTRAN, has been developed. The computer program is directly based on the theory for a heat transfer analysis according to above. The computer program is described in Appendix A.

4. THERMAL MATERIAL PROPERTIES AND SOME OTHER BASIC QUANTITIES, RELEVANT TO A HEAT TRANSFER ANALYSIS OF FIRE EXPOSED FLOOR OR ROOF ASSEMBLIES WITH A SUSPENDED CEILING

In this chapter, a survey is given of those thermal material properties which are basic quantities in a heat transfer analysis of fire exposed floor or roof assemblies with a suspended ceiling. The survey comprises ordinary structural steel, normal concrete with density 2300 kg m^{-3} , aerated concrete with density 600 kg m^{-3} and some other materials, exemplifying frequent materials in suspended ceilings. Furthermore, section 4.1.3 presents a summary design basis, facilitating the determination of the structural parameter U_s/F_s of the supporting steel beams of the assembly.

4.1. Properties of the supporting steel beams

4.1.1. Density γ_s

The density of steel $\gamma_s = 7850 \text{ kg m}^{-3}$.

4.1.2. Specific heat capacity c_{ps}

The specific heat capacity of steel c_{ps} varies with the temperature and the type of steel. Representative values for ordinary structural steels at different temperatures are given in table 4.1.2a and figure 4.1.2a [2].

Temp ($^{\circ}\text{C}$)	c_{ps} ($\text{J kg}^{-1} \text{ }^{\circ}\text{C}^{-1}$)
0	482
100	482
200	522
300	560
400	600
500	640
600	682
700	695
900	687 (estimated value)

Table 4.1.2a. Representative values of the specific heat capacity c_{ps} for ordinary structural steels at different temperatures

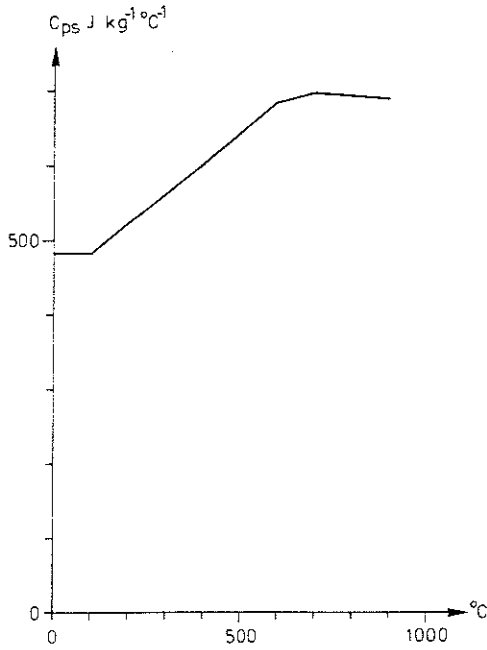
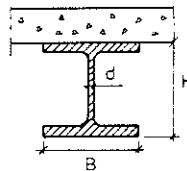

Figure 4.1.2a. The specific heat capacity c_{ps} for ordinary structural steels at different temperatures (table 4.1.2a)

4.1.3. U_s/F_s ratio

The ratio U_s/F_s between the fire exposed surface of a supporting steel beam and its volume per unit length varies as a function of the section dimensions and the structural design.

Beams with a floor or roof slab, supported on the upper flange of the beams



$$\frac{U_s}{V_s} = \frac{2H + 4B - d}{\text{cross section area}}$$

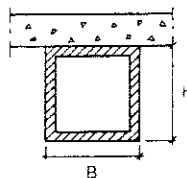

$$\frac{U_s}{V_s} = \frac{2H + B}{\text{cross section area}}$$

Floor or roof slab beams of truss type (U_s/F_s is determined for each part of the truss)

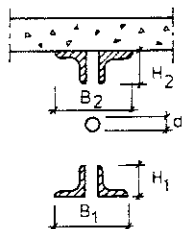

$$\frac{U_s}{V_s} \text{ (lower flange)} = \frac{2B_2 + 2H_2}{\text{cross section area of lower flange}}$$

$$\frac{U_s}{V_s} \text{ (upper flange)} = \frac{B_1 + 2H_1}{\text{cross section area of upper flange}}$$

$$\frac{U_s}{V_s} \text{ (diagonal)} = \frac{1}{\sqrt{2}}$$

Figure 4.1.3a. Formulas for a determination of U_s/F_s for different types of steel beams with a floor or roof slab at the upper flange

For a beam, where the slab is carried on the top of the upper flange, the fire exposed surface U_s is equal to the total surface area of the beam per unit length, less the surface area of the top of the upper flange, and the volume F_s is equal to the total volume of the beam per unit length.

In figure 4.1.3a, some formulas are given for a calculation of U_s/F_s for different types of steel supporting beams with a floor or roof slab at the upper flange [2].

Table 4.1.3a directly gives values of the U_s/F_s ratio (m^{-1}) for rolled standard I girders, carrying a floor or roof slab on the top of the upper flange according to figure 4.1.3a [2].

Steel section	U_s/F_s (m^{-1})
HEA	
100	227
120	229
140	215
160	199
180	192
200	180
220	166
240	152
260	146
280	140
300	130
320	121
340	115
360	110
400	104
HEB	
100	188
120	173
140	160
160	144
180	135
200	126
220	119
240	111
260	108
280	105
300	99
320	94
340	91
360	88
400	85

Steel section	U_s/F_s (m^{-1})
IPE	
80	380
100	346
120	321
140	299
160	277
180	260
200	242
220	227
240	212
270	203
300	193
330	180
360	167
400	157

Table 4.1.3a. U_s/F_s for rolled standard I girders with a slab at the upper flange

4.2. Thermal properties of normal concrete with density 2300 kg m^{-3}

4.2.1. Thermal conductivity λ

For such a material as concrete, an experimental determination of reliable thermal data entails considerable difficulties. Test results of measurements, made in different laboratories on "identical" specimens, may often vary not insignificantly, depending on the method used in the test.

The influence of moisture on the thermal properties of concrete presents special difficulties. This is relevant for temperatures within the range up to about $200 \text{ }^\circ\text{C}$. Well-defined measurements of the thermal properties for moist material are very difficult to undertake in this temperature range due to the complicated interaction between moisture and heat flow.

For normal weight concrete, the thermal conductivity λ decreases with increasing temperature. This is illustrated in figure 4.2.1a for a granite aggregate concrete [9]. The figure also shows the λ variation under cooling from different maximum temperature levels.

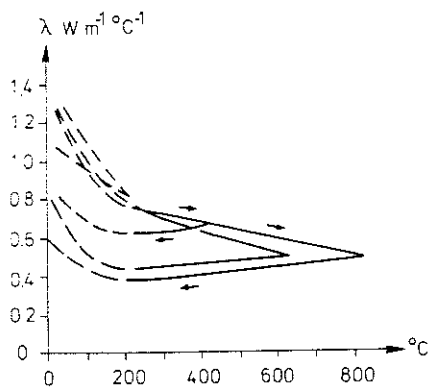

Figure 4.2.1a. Thermal conductivity λ for granite aggregate concrete as a function of temperature under heating and subsequent cooling. Cement: aggregate 1:6, w/c = 0.7

For the determination of the design basis, presented in chapter 6, the thermal conductivity λ has been assumed to vary with the temperature according to table 4.2.1a and the full-line curve in figure 4.2.1b. This λ variation is based on test results from a determination by Stålhane-Pyks method, made at the Central Laboratory of Högans AB for a normal concrete with quartz aggregate and an initial

moisture content of 1.5% by weight [10]. This corresponds to a moisture state, representative to the equilibrium moisture content at a conditioning of the concrete in an atmosphere of ordinary room temperature and a relative humidity of about 60%.

Figure 4.2.1b also includes a dashed curve, which shows the temperature dependence for the thermal conductivity of normal concrete, dried by a series of repeated heating. The curve is roughly estimated from tests according to Stålhane-Pyks method, made only at ordinary room temperature and at 1000 °C. The λ curve for dried concrete is used in chapter 5 in connection with a theoretical analysis of some standard fire resistance tests.

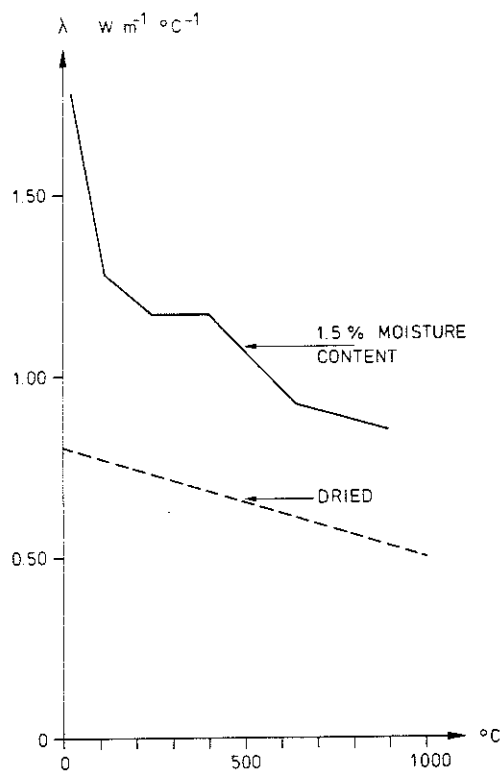

Figure 4.2.1b. Thermal conductivity λ as a function of temperature for quartz aggregate concrete with an initial moisture content of 1.5% by weight (full-line curve) and dried by repeated heating (dashed curve), respectively. Density $\gamma = 2300 \text{ kg m}^{-3}$, $w/c = 0.63$

Temp ($^{\circ}\text{C}$)	λ ($\text{W m}^{-1} \text{ }^{\circ}\text{C}^{-1}$)
25	1.78
115	1.28
243	1.17
401	1.17
643	0.92
895	0.85

Table 4.2.1a. Thermal conductivity λ as a function of temperature for quartz aggregate concrete with an initial moisture content of 1.5% by weight (corresponding to full-line curve in figure 4.2.1b). Density $\gamma = 2300 \text{ kg m}^{-3}$, $w/c = 0.63$

4.2.2. Specific heat capacity c_p or enthalpy

A practical calculation of the temperature-time fields in a fire exposed structural member of concrete gives less difficulties if the specific heat capacity c_p is replaced by its temperature integral, i.e. the enthalpy per unit mass I or the enthalpy per unit volume I_v , defined by the formulas

$$I = \int c_p \, dT \quad (4.2.2a)$$

$$I_v = \gamma \int c_p \, dT \quad (4.2.2b)$$

Available methods of measurement enable a determination of the specific heat capacity or the enthalpy versus temperature for a material of the type concrete only under cooling from different temperature levels. The latent heat of various exothermic and endothermic reactions taking place under the initial heating then is not included.

Table 4.2.2a gives the temperature variation of the specific heat capacity c_p , determined in this way by a Dynatech apparatus for normal concrete with granite aggregate [11]. The test values refer to concrete with a ratio cement: aggregate 1:4.5 and $w/c = 0.55$. Published results verify, however, that the influence on the specific heat capacity of varying w/c and proportion cement: aggregate is tolerably negligible.

Temp ($^{\circ}\text{C}$)	c_p ($\text{J kg}^{-1} \text{ }^{\circ}\text{C}^{-1}$)
200	852
400	953
600	967
800	992
1000	1049

Table 4.2.2a. Specific heat capacity c_p of granite aggregate concrete, determined as an average value under cooling from various temperature. Cement: aggregate 1:4.5, w/c = 0.55

As a consequence of the testing technique, the c_p values in table 4.2.2a are valid for dry concrete. A transfer of the c_p values to the volumetric enthalpy I_v results in curve (1) in figure 4.2.2a. Curve (2) gives that variation of the enthalpy I_v which can be expected during heating of concrete without free moisture. The curve has been determined theoretically on the basis of stoichiometric calculations and simplified assumptions on the chemical reactions [12]. A significant difference between the two curves exists for temperatures above about $500 \text{ }^{\circ}\text{C}$.

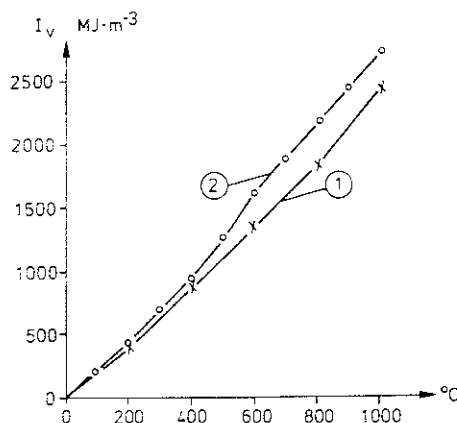

Figure 4.2.2a. Volumetric enthalpy I_v as a function of temperature for concrete with granite aggregate. (1) Measured curve under cooling (corresponding to the c_p values in table 4.2.2a), (2) theoretical curve

The most important modification of the enthalpy-temperature curve measured under cooling, however, is due to the presence of evaporable water. During a fire exposure of a concrete structure, the moisture distribution changes continuously. A consideration of this in a calculation of the transient temperature state requires a very complicated analysis of the connected heat and moisture transfer mechanisms.

In the simplified approach, usually applied in a structural fire engineering design, this difficulty is avoided by including the effect of free moisture into the thermal properties - which is principally not correct - and by assuming that all free moisture evaporates at its initial place in the structure within a temperature range between 100 °C and T_1 °C according to figure 4.2.2b. T_1 then depends on the dimensions of the structure and the size and distribution of the pores of the material. For the determination of the design basis in chapter 6, T_1 is put equal to 105 °C.

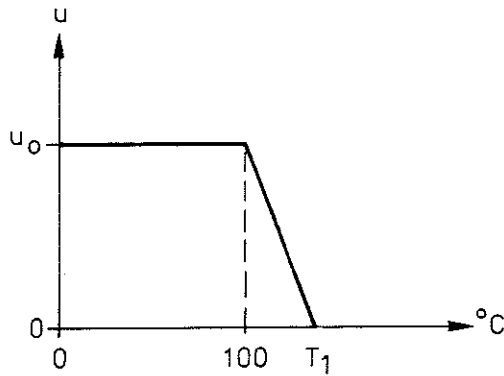

Figure 4.2.2b. Assumed variation of moisture content u versus temperature in arbitrarily selected point of fire exposed concrete structural member. u_0 is the initial moisture content

The above discussion can be summarized in a simplified form according to figure 4.2.2c and table 4.2.2b, giving the volumetric enthalpy I_V as a function of the temperature for on one hand dried concrete on the other concrete with an initial moisture content $u_0 = 1.5\%$ by weight. The simplification implies that the different parts of the enthalpy-temperature curves have been linearized. The steep branch of the curve, valid for concrete with an initial moisture content, corresponds to the evaporation of the moisture within the temperature range 100 to 105 °C.

Temp (°C)	I_V (MJ m ⁻³)	
	Dried concrete	Concrete with $u_0 = 1.5\%$
0	0	0
100	168	183
105		273
1000	2340	2430

Table 4.2.2b. Volumetric enthalpy I_V versus temperature for dried concrete and concrete with an initial moisture content $u_0 = 1.5\%$ by weight, respectively. Concrete with granite aggregate, density $\gamma = 2300$ kg m⁻³

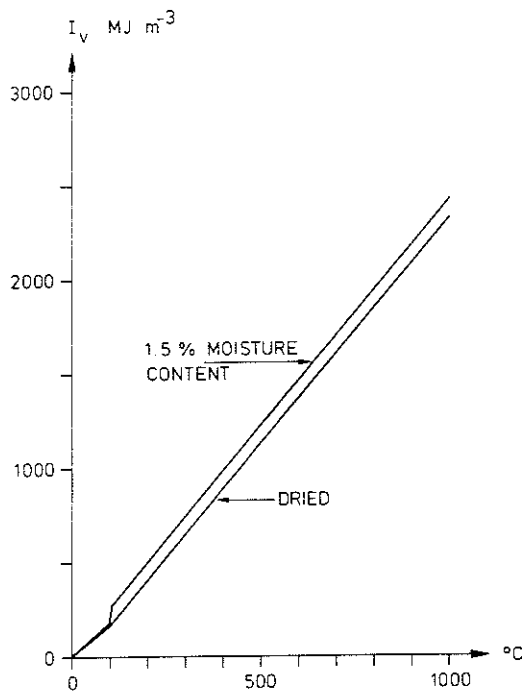

Figure 4.2.2c. Volumetric enthalpy I_v as a function of temperature according to table 4.2.2b for granite aggregate concrete with density $\gamma = 2300 \text{ kg m}^{-3}$

4.3. Thermal properties of aerated concrete with density 600 kg m^{-3}

4.3.1. Thermal conductivity λ

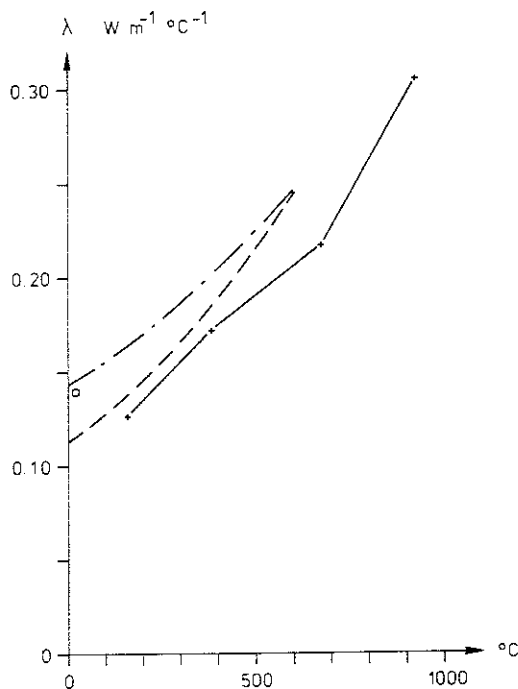

Figure 4.3.1a. Thermal conductivity λ for dry aerated concrete with a density $\gamma = 600 \text{ kg m}^{-3}$ as a function of temperature. - - - - according to D'Ana and Lax, - · - · - according to Forschungsheim für Wärmeschutz, München, -x-x- according to National Swedish Institute for Materials Testing and Meteorology, \square according to Saare and Jansson

In figure 4.3.1a, some published experimental results are put together for the thermal conductivity λ of dry aerated concrete with a density $\gamma = 600 \text{ kg m}^{-3}$ as a function of the temperature. The results are valid for the first heating of the material.

A linear regression on the test values in figure 4.3.1a gives the thermal conductivity-temperature curve, denoted by "dried" in figure 4.3.1b and determined by $\lambda = 0.122 \text{ W m}^{-1} \text{ }^\circ\text{C}^{-1}$ at $0 \text{ }^\circ\text{C}$ and $\lambda = 0.303 \text{ W m}^{-1} \text{ }^\circ\text{C}^{-1}$ at $1000 \text{ }^\circ\text{C}$.

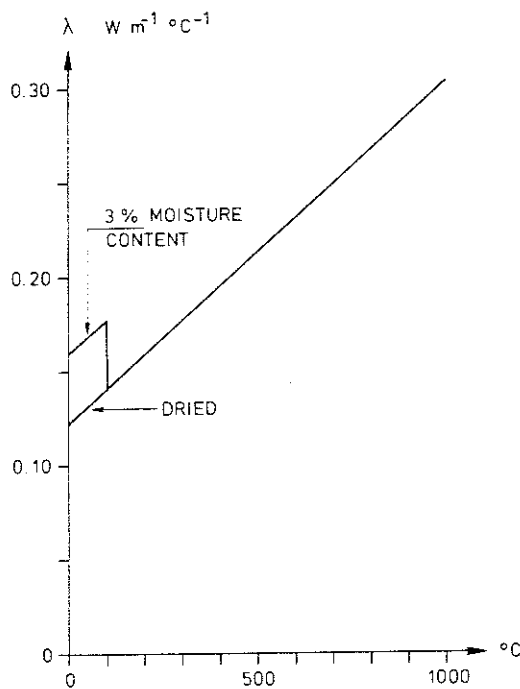

Figure 4.3.1b. Thermal conductivity λ as a function of temperature for aerated concrete with a density $\gamma = 600 \text{ kg m}^{-3}$, dried, respectively with an initial moisture content of 3% by weight (table 4.3.1a)

No test results are available, showing the temperature dependence for the thermal conductivity of aerated concrete with an initial moisture content. Consequently, this information must be found by a reasonable estimation. [13], [14] give $\lambda = 0.163 \text{ W m}^{-1} \text{ }^\circ\text{C}^{-1}$ as a mean value at ordinary room temperature for aerated concrete with a density $\gamma = 600 \text{ kg m}^{-3}$, having a moisture content of 3% by weight, which corresponds to the equilibrium moisture content at a conditioning in an atmosphere of ordinary room temperature and a relative humidity of about 60%. Hypothetically, it may be assumed that the initial moisture content is kept unchanged up to the temperature $100 \text{ }^\circ\text{C}$ and then is evaporated linearly between $100 \text{ }^\circ\text{C}$ and $T_1 = 105 \text{ }^\circ\text{C}$; cf. section 4.2.2.

This leads to a thermal conductivity-temperature curve, consisting of three linear parts according to figure 4.3.1b and table 4.3.1a.

Temp ($^{\circ}\text{C}$)	λ ($\text{W m}^{-1} \text{ }^{\circ}\text{C}^{-1}$)
0	0.159
100	0.177
105	0.141
1000	0.303

Table 4.3.1a. Thermal conductivity λ as a function of temperature for aerated concrete with a density $\gamma = 600 \text{ kg m}^{-3}$ and an initial moisture content of 3% by weight

4.3.2. Specific heat capacity c_p or enthalpy

Table 4.3.2a gives the temperature variation of the specific heat capacity c_p of aerated concrete, determined by a Dynatech apparatus as the average value under cooling from various temperature. The determination was made on crushed material at the National Swedish Institute for Materials Testing and Meteorology. The applied testing technique makes the c_p values best representative to dry aerated concrete.

Temp ($^{\circ}\text{C}$)	c_p ($\text{J kg}^{-1} \text{ }^{\circ}\text{C}^{-1}$)
198	938
299	917
397	976
498	984
600	980
697	1047
801	997
901	1030

Table 4.3.2a. Specific heat capacity c_p of aerated concrete, determined as an average value under cooling from various temperature

The c_p values in table 4.3.2a can be transferred to the corresponding volumetric enthalpy I_v by applying Equation (4.2.2b). After linear regression, this gives the curve, denoted by "dried" in figure 4.3.2a

and determined by $I_v = 0$ at 0°C , $I_v = 48.7 \text{ MJ m}^{-3}$ at 100°C and $I_v = 608 \text{ MJ m}^{-3}$ at 1000°C .

An approximate modification of the enthalpy-temperature curve with respect to the influence of an initial moisture content can be done by the use of the simplified technique according to section 4.2.2. This leads to the enthalpy variation, shown in figure 4.3.2a and table 4.3.2b for aerated concrete with a density $\gamma = 600 \text{ kg m}^{-3}$ and with an initial moisture content of 3% by weight, i.e. a moisture state representative to the equilibrium moisture content at a conditioning of the material in an atmosphere of ordinary room temperature and a relative humidity of about 60%.

The λ and I_v curves, given in figure 4.3.1b and figure 4.3.2a, respectively, for aerated concrete with the initial moisture content 3% by weight, are used as input material characteristics for the determination of the design basis, presented in chapter 6.

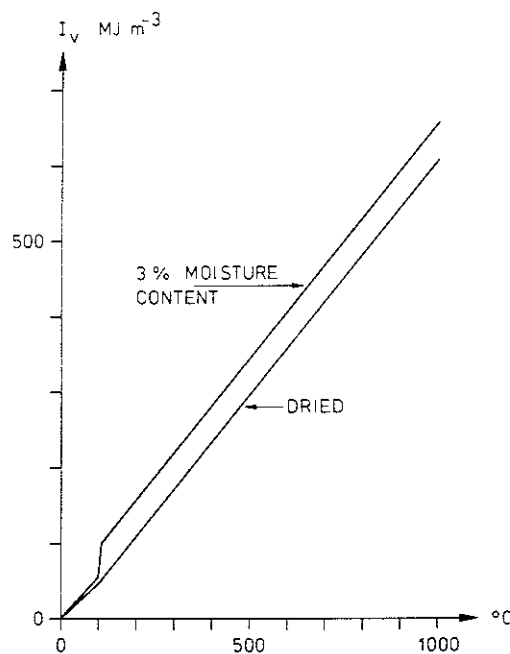

Figure 4.3.2a. Volumetric enthalpy I_v as a function of temperature according to table 4.3.2b for aerated concrete with density $\gamma = 600 \text{ kg m}^{-3}$

Temp (°C)	I_V (MJ m ⁻³)	
	Dried material	Material with $u_0 = 3\%$
0	0	0
100	48.7	56.2
105		99.9
1000	608	656

Table 4.3.2b. Volumetric enthalpy I_V versus temperature for dried aerated concrete and aerated concrete with an initial moisture content $u_0 = 3\%$ by weight, respectively. Density $\gamma = 600 \text{ kg m}^{-3}$

4.4. Thermal properties of gypsum slab material with density 800 kg m^{-3}

4.4.1. Thermal conductivity λ

Gypsum plaster with a density of about 800 kg m^{-3} is frequently used for fire insulation of structures and structural members of steel. It is also a frequent material for suspended ceilings or components of them.

Gypsum plaster contains relatively large quantities of water in both free and chemically bound forms. At heating by a fire exposure, this water evaporates under the storage of large quantities of energy. Together with the direct thermal insulation effect, this storage of energy retards the temperature rise in the insulated structure or structural member efficiently. When all water has evaporated, the gypsum plaster material disintegrates. By adding small quantities of glass fibres as reinforcement to the material, the critical temperature for disintegration can be increased and by that improving the fire resistance.

Table 4.4.1a and figure 4.4.1a are giving the thermal conductivity λ as a function of the temperature for gypsum plaster slabs, type Gyproc, with a density $\gamma = 790 \text{ kg m}^{-3}$ [15]. The λ values are based on test results determined by Stålhane-Pyks method at the Central Laboratory of Höganäs AB and at the National Swedish Institute for Materials Testing and Meteorology.

Temp ($^{\circ}\text{C}$)	λ ($\text{W m}^{-1} \text{ }^{\circ}\text{C}^{-1}$)
0	0.209
99	0.209
101	0.116
1000	0.326

Table 4.4.1a. Thermal conductivity λ as a function of temperature for gypsum plaster slabs, type Gyproc, with density $\gamma = 790 \text{ kg m}^{-3}$

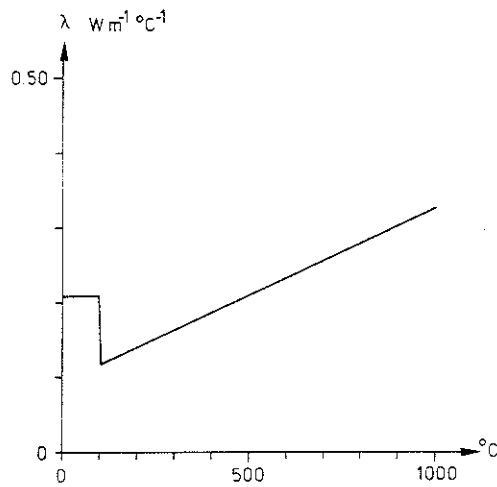

Figure 4.4.1a. Thermal conductivity λ as a function of temperature according to table 4.4.1a for gypsum plaster slabs, type Gyproc, with density $\gamma = 790 \text{ kg m}^{-3}$

4.4.2. Enthalpy

The volumetric enthalpy I_v of gypsum plaster slabs, type Gyproc, with density $\gamma = 790 \text{ kg m}^{-3}$ is shown in table 4.4.2a, table 4.4.2b and figure 4.4.2a as a function of temperature. These I_v variations have been constructed on the basis of results from small scale and full scale tests and of information in the literature [16]. The enthalpy-temperature variation is differentiated with respect to the rate of heating. The alternative of a rapid rate of heating then is representative to a gypsum plaster slab which is directly fire exposed, and the alternative of a slow rate of heating to a gypsum plaster slab which is protected from a direct fire exposure.

Temp ($^{\circ}\text{C}$)	I_V (MJ m^{-3})
0	0
99	92.4
101	107
185	211
225	588
400	628
1000	1047

Table 4.4.2a. Volumetric enthalpy I_V versus temperature for gypsum plaster slabs, type Gyproc, with density $\gamma = 790 \text{ kg m}^{-3}$. Rapid rate of heating

Temp ($^{\circ}\text{C}$)	I_V (MJ m^{-3})
0	0
90	84.0
110	469
150	574
225	588
400	628
1000	1047

Table 4.4.2b. Volumetric enthalpy I_V versus temperature for gypsum plaster slabs, type Gyproc, with density $\gamma = 790 \text{ kg m}^{-3}$. Slow rate of heating

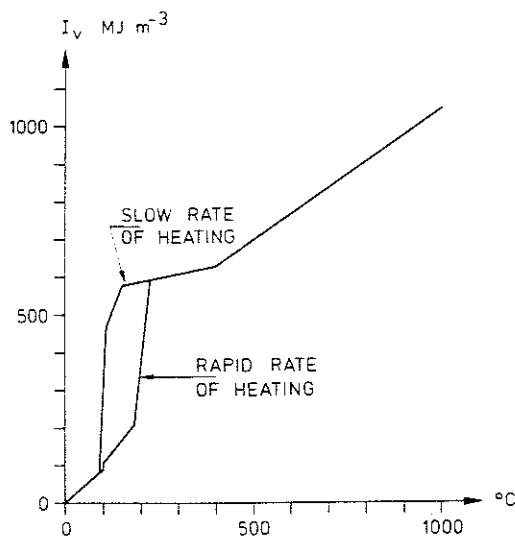

Figure 4.4.2a. Volumetric enthalpy I_V as a function of temperature according to table 4.4.2a and 4.4.2b for gypsum plaster slabs, type Gyproc, with density $\gamma = 790 \text{ kg m}^{-3}$

4.4.3. Critical temperature for material disintegration

As mentioned in section 4.4.1, gypsum plaster slabs are characterized by a critical temperature state with respect to disintegration. From standard fire resistance tests, it then appears that this critical state can be specified by a temperature of about 500 °C at the unexposed side of the unilaterally fire exposed gypsum plaster slab without any glass fibre reinforcement, if the slab is placed horizontally [15]. For a glass fibre reinforced gypsum plaster slab, the corresponding critical temperature is about 550 °C on the unexposed side. In [2], the critical temperature on the unexposed side of the horizontal slab is replaced with a critical temperature at the centre level of the slab, amounting to about 625 °C for a non-fibre reinforced and to about 650 °C for a glass fibre reinforced gypsum plaster slab.

4.5. Thermal properties of mineral wool

4.5.1. Thermal conductivity λ

In the table 4.5.1a, table 4.5.1b and figure 4.5.1a, the thermal conductivity λ at elevated temperatures is shown for two types of mineral wool slabs with the densities $\gamma = 75$ and 150 kg m^{-3} , respectively. The presented λ values have been determined according to Stålhane-Pyks method at the National Swedish Institute for Materials Testing and Meteorology.

Temp (°C)	$\lambda (\text{W m}^{-1} \text{ °C}^{-1})$
0	0.052
200	0.116
600	0.314
1000	0.547

Table 4.5.1a. Thermal conductivity λ as a function of temperature for slabs of mineral wool, type Textur 887, with a density $\gamma = 75 \text{ kg m}^{-3}$

Temp ($^{\circ}\text{C}$)	λ ($\text{W m}^{-1} \text{ }^{\circ}\text{C}^{-1}$)
0	0.037
100	0.054
200	0.071
300	0.096
400	0.129
500	0.167
600	0.205
700	0.250
800	0.303
900	0.366
1000	0.450

Table 4.5.1b. Thermal conductivity λ as a function of temperature for slabs of mineral wool, type Minwool 3060 or Rockwool 337, with a density $\gamma = 150 \text{ kg m}^{-3}$. The λ values for 900 and 1000 $^{\circ}\text{C}$ are extrapolated values

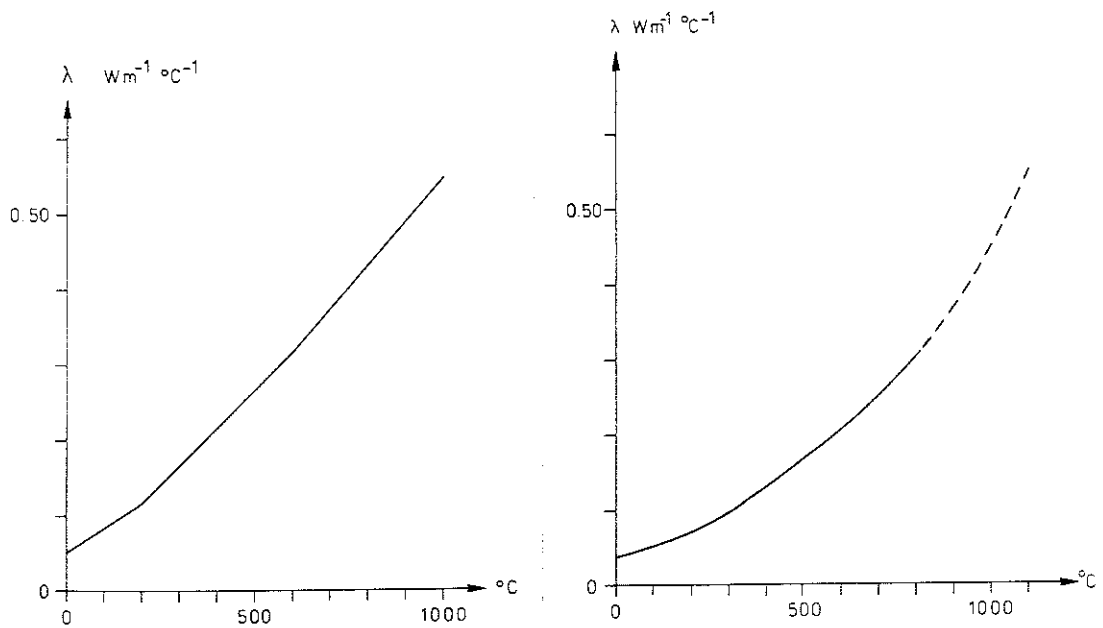

Figure 4.5.1a. Thermal conductivity λ as a function of temperature according to table 4.5.1a and b for slabs of mineral wool. Left: Density $\gamma = 75 \text{ kg m}^{-3}$, type Textur 887. Right: Density $\gamma = 150 \text{ kg m}^{-3}$, type Minwool 3060 or Rockwool 337

4.5.2. Enthalpy

The volumetric enthalpy I_V for mineral wool slabs with the densities $\gamma = 75$ and 150 kg m^{-3} is given as a function of the temperature in

table 4.5.2a, table 4.5.2b and figure 4.5.2a. The I_V values are based on the results of tests, carried out at the National Swedish Institute for Materials Testing and Meteorology.

Temp ($^{\circ}\text{C}$)	I_V (MJ m^{-3})
0	0
100	6.4
200	13,9
300	22.7
400	32.7
500	44.0
600	56.6
700	70.9
800	86.3
900	103.2
1000	121.2

Table 4.5.2a. Volumetric enthalpy I_V versus temperature for slabs of mineral wool, type Textur 887, with a density $\gamma = 75 \text{ kg m}^{-3}$. The I_V values for 900 and 1000 $^{\circ}\text{C}$ are extrapolated values

Temp ($^{\circ}\text{C}$)	I_V (MJ m^{-3})
0	0
100	12.8
200	27.8
300	45.3
400	65.3
500	87.9
600	113.3
700	141.7
800	172.5
900	206.4
1000	242.4

Table 4.5.2b. Volumetric enthalpy I_V versus temperature for slabs of mineral wool, type Minwool 3060 or Rockwool 337, with a density $\gamma = 150 \text{ kg m}^{-3}$. The I_V values for 900 and 1000 $^{\circ}\text{C}$ are extrapolated values

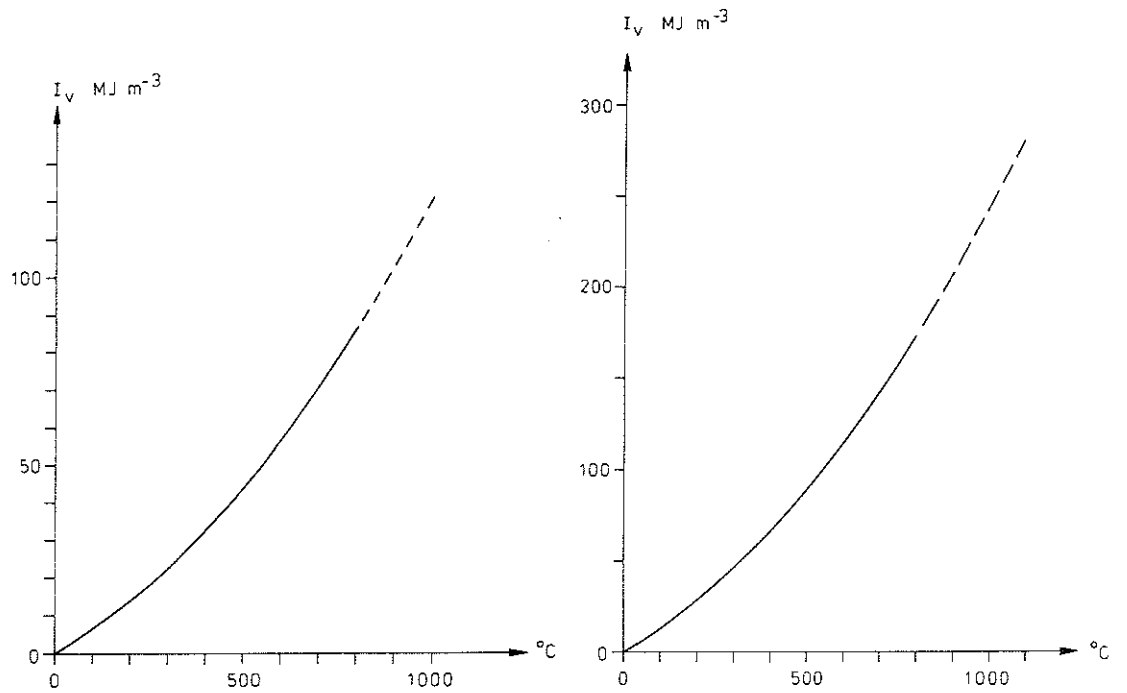

Figure 4.5.2a. Volumetric enthalpy I_v versus temperature according to table 4.5.2a and b for slabs of mineral wool. Left: Density $\gamma = 75 \text{ kg m}^{-3}$, type Textur 887. Right: Density $\gamma = 150 \text{ kg m}^{-3}$, type Minwool 3060 or Rockwool 337

5. COMPARISONS OF CALCULATED TEMPERATURE-TIME FIELDS WITH THOSE MEASURED IN TESTS

In this chapter, some comparisons are presented between temperature-time fields, calculated according to the theory developed in chapter 3, and the corresponding temperature-time fields, measured in standard fire resistance tests. The comparisons include four types of suspended ceilings, forming part of unventilated floor assemblies with following geometrical characteristics, specified from top to bottom.

Type_1 - figure 5a

Slab of normal concrete - thickness 160 mm, density 2300 kg m^{-3} ,

steel beams of section IPE 270 - centre distance 1200 mm,

suspended ceiling of one gypsum plaster slab without fibre reinforcement - thickness 13 mm, density 790 kg m^{-3} , free vertical distance from bottom of steel beams to top of ceiling 200 mm.

Type_2 - figure 5b

Slab of normal concrete - thickness 160 mm, density 2300 kg m^{-3} ,

steel beams of section IPE 270 - centre distance 1200 mm,

suspended ceiling of two glass fibre reinforced gypsum plaster slabs - thickness $2 \times 13 \text{ mm}$, density 790 kg m^{-3} , free vertical distance from bottom of steel beams to top of ceiling 200 mm.

Type_3 - figure 5c

Slab of normal concrete - thickness 160 mm, density 2300 kg m^{-3} ,

steel beams of section IPE 270 - centre distance 1200 mm,

suspended ceiling of three glass fibre reinforced gypsum plaster slabs - thickness $3 \times 13 \text{ mm}$, density 790 kg m^{-3} , free vertical distance from bottom of steel beams to top of ceiling 200 mm.

Type_4 - figure 5d

Slab of normal concrete - thickness 50 mm, density 2300 kg m^{-3} ,

steel beams of section IPE 140 - centre distance 750 mm,

suspended ceiling of slabs of mineral wool, type Textur 887 - slab dimensions $1200 \times 600 \times 40 \text{ mm}^3$, density 75 kg m^{-3} , free vertical distance from bottom of steel beams to top of ceiling 160 mm.

The reason for choosing suspended ceilings of gypsum plaster slabs in a dominant extent for the comparison between calculated and measured temperature-time fields is, that such a type of suspended ceiling gives a very decisive control of the theory due to its fire behaviour with a critical temperature state for slab disintegration. For type 2 and 3 of the floor assemblies chosen, this implies that the theory must simulate also a successive collapse of the ceiling slabs.

In figure 5a, b, c and d, the full-line curves are showing the time variation of the temperature, measured in specified points of the respective floor assemblies, when tested according to the international standard ISO 834. For the floor assemblies, type 1, 2 and 3, these tests have been performed at the National Swedish Institute for Materials Testing and Meteorology [17]. The fire resistance test of the floor assembly, type 4, has been carried out at the Research and Development department, A/S ROCKWOOL, Hedehusene, Denmark. Figure 5a, b and c include the measured time curves for the average furnace temperature, the temperature in four measuring points (1, 2, 3, 4) in the steel beams, and the temperature in two measuring points (5, 6) at the top surface of the suspended ceiling. A dashed and dotted curve in the respective figure gives the mean value for the steel beam temperature in the measuring points 1 - 4. The full-line curves in figure 5d are reporting the time variation of the temperature in the lower flange of the steel beams (measuring point 4) and at the top surface of the concrete slab (measuring point 8). Both curves then represent the mean value of 6 measuring points with equivalent location.

The corresponding temperature-time variations, calculated according to the theory developed in chapter 3, are shown in the figures as dashed curves. The calculation then is based on the following assumptions:

- (1) The initial temperature of the floor assembly is 20 °C,
- (2) the fire exposure is specified according to the ideal ISO 834 furnace temperature-time curve, Equation (1a),
- (3) the heat capacity of the suspended ceiling is taken into account,
- (4) the influence of the quotients B/H and C/H is considered in specifying the radiation characteristics within the floor assembly - figure 3.1.3a and b,
- (5) the thermal properties of the concrete slab are described by the temperature curves for dried material in figure 4.2.1b and 4.2.2c,
- (6) the thermal properties of the material of the suspended ceiling are determined according to the data in section 4.4 for gypsum plaster slabs and in section 4.5 for mineral wool slabs,
- (7) a gypsum plaster slab disintegrates and falls down when the critical temperature state according to section 4.4.3 is reached.

The comparison between calculated and experimentally determined temperature-time curves, presented in figure 5a - d, verifies the theory developed in chapter 3 as sufficiently accurate for a fire engineering design in practice. This conclusion then should be seen in the light of that uncertainty which is inherent in the choice of representative data for the thermal properties of the slab and suspended ceiling materials.

For the floor assembly, type 1, the collapse of the gypsum plaster slab occurred after 48 minutes in the fire resistance test. Theoretically, the collapse time was found to 54 minutes. For the floor assembly, type 2, including two 13 mm gypsum plaster slabs, the theory gives a collapse for the first slab after 40 minutes and for the second slab after 78 minutes fire exposure. In the fire resistance test, the fire behaviour of the suspended ceiling was not that absolute. The final collapse of the suspended ceiling occurred after about 60 minutes. For the floor assembly, type 3, including three 13 mm gypsum plaster slabs, finally, the calculated collapse time is 41 minutes for the first slab, 58 minutes for the second slab and 87 minutes for the third slab. Experimentally, the ultimate collapse of the suspended ceiling took place after 75 to 80 minutes fire exposure. Accordingly, the theory developed in chapter 3

describes the detailed fire behaviour reasonably correct also for such a complicated suspended ceiling which has disintegration included in its behaviour.

For the floor assembly, type 4, which has a less complicated fire behaviour, the calculated and experimentally determined temperature-time curves are in close agreement.

Figure 5a. Calculated (---) and experimentally determined (—) temperature-time curves in specified points 1 - 6 of a floor assembly, consisting of a 160 mm slab of normal concrete, steel beams IPE 270 and a suspended ceiling of one 13 mm, non-reinforced, gypsum plaster slab with density 790 kg m⁻³. Fire exposure according to ISO 834. The dashed and dotted curve (---) gives the average temperature for measuring points 1 - 4

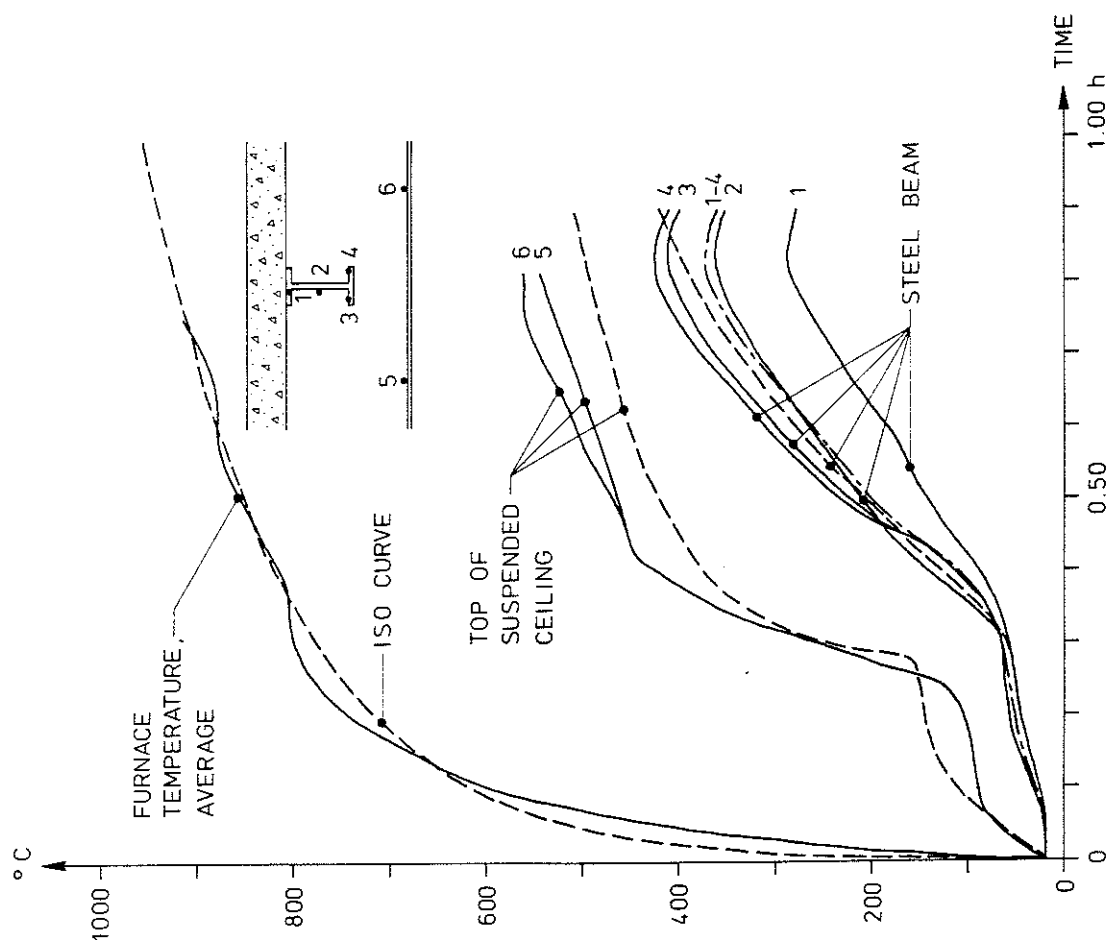

Figure 5b. Calculated (---) and experimentally determined (—) temperature-time curves in specified points 1 - 6 of a floor assembly, consisting of a 160 mm slab of normal concrete, steel beams IPE 270 and a suspended ceiling of two 13 mm, glass fibre reinforced, gypsum plaster slabs with density 790 kg m⁻³. Fire exposure according to ISO 834. The dashed and dotted curve (---) gives the average temperature for measuring points 1 - 4

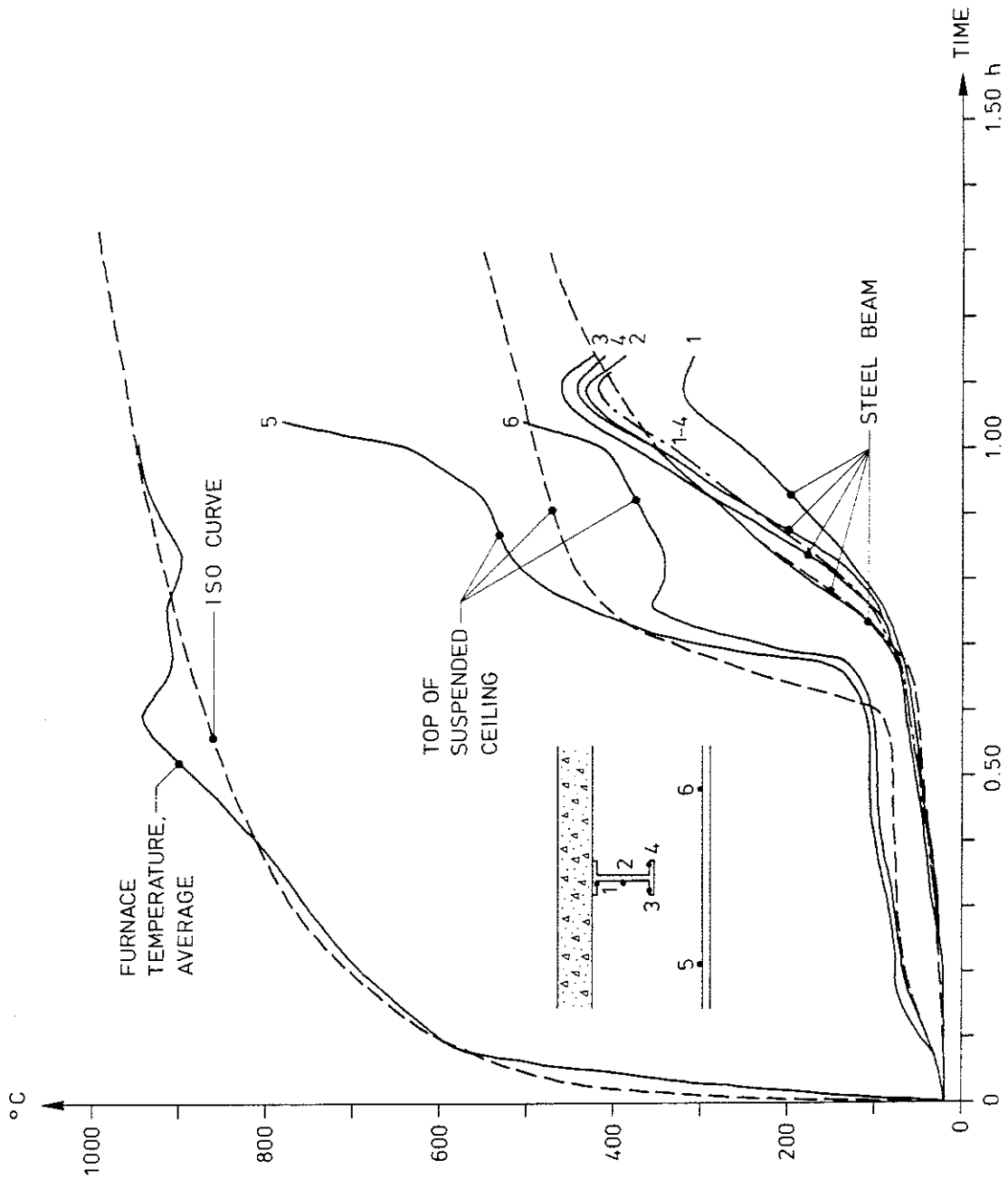
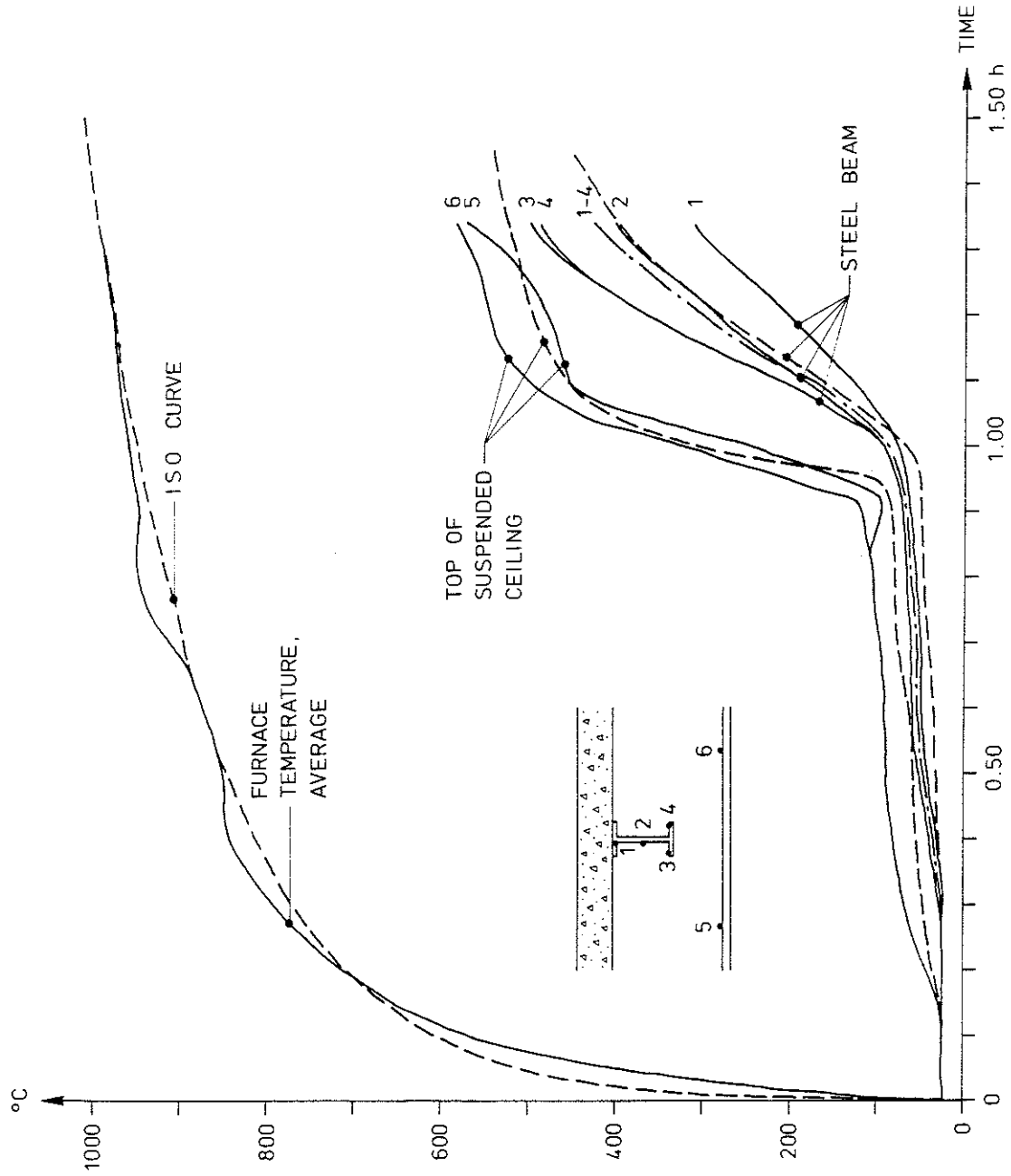

Figure 5c. Calculated (---) and experimentally determined (—) temperature-time curves in specified points 1 - 6 of a floor assembly, consisting of a 160 mm slab of normal concrete, steel beams IPE 270 and a suspended ceiling of three 13 mm, glass fibre reinforced, gypsum plaster slabs with density 790 kg m⁻³. Fire exposure according to ISO 834. The dashed and dotted curve (---) gives the average temperature for measuring points 1 - 4



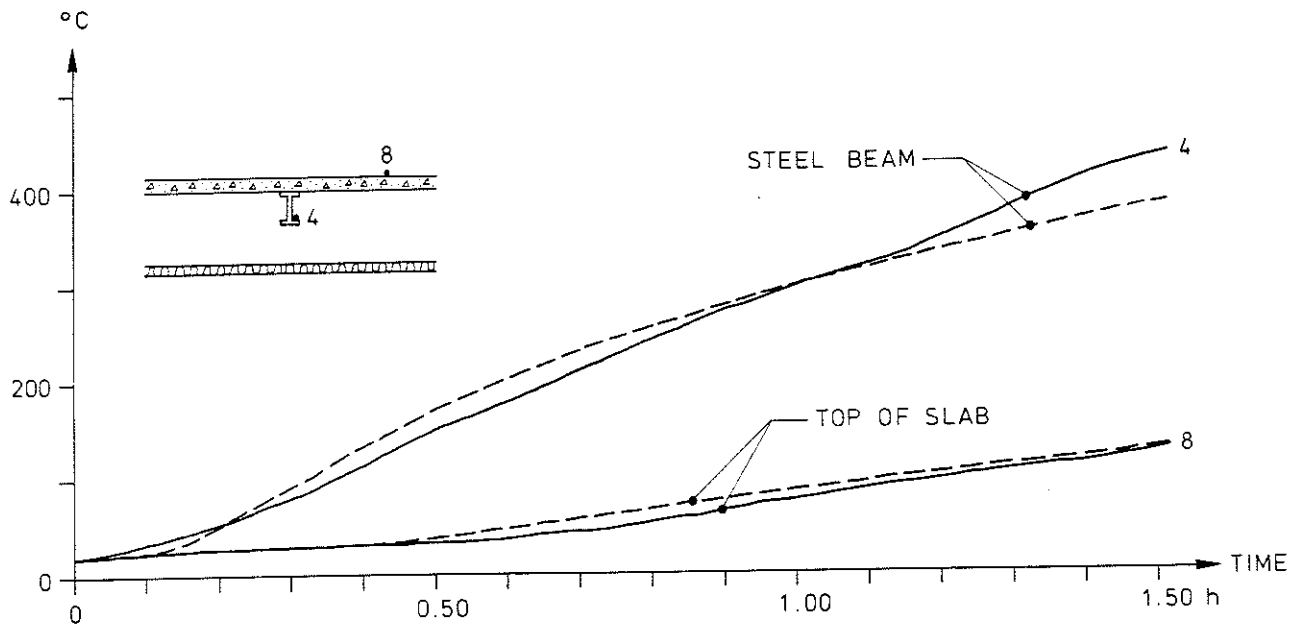

Figure 5d. Calculated (- - -) and experimentally determined (—) temperature-time curves in specified points 4 and 8 of a floor assembly, consisting of a 50 mm slab of normal concrete, steel beams IPE 140 and a suspended ceiling of 40 mm mineral wool with density 75 kg m^{-3} , type Textur 887. Fire exposure according to ISO 834

6. DESIGN BASIS FOR A THEORETICAL EXTRAPOLATION OF RESULTS FROM FIRE RESISTANCE TESTS. EXAMPLES

The procedure for a theoretical extrapolation of the results from a fire resistance test of a suspended ceiling, forming part of an un-ventilated, load-bearing floor or roof assembly, is described in chapter 2. The procedure includes three steps.

Step 1 consists of an evaluation, from the fire resistance test, of the time curve of the steel temperature T_s in the bottom flange at midspan of the centre supporting beam, the time $t_{s,crit}$ for a collapse of the supporting construction, the corresponding steel temperature $T_{s,crit}$, and the time $t_{i,crit}$ for a failure of the suspended ceiling, if any - figure 2a.

In step 2, a derived value $(d_i/\lambda_i)_{der}$ is determined for the suspended ceiling tested. The determination, which is illustrated in figure 2b and 2c, is to be based on time curves of the steel beam temperature T_s , calculated for different values of d_i/λ_i of a suspended ceiling, entering into a floor or roof assembly with the same slab and the same steel beams as in the tested assembly. The criterion for the derived value $(d_i/\lambda_i)_{der}$ is that the calculated T_s -t curve of the steel beams and the corresponding curve measured in the test are giving the same steel temperature $T_{s,crit}$ at time $t_{s,crit}$. By this technique, the tested suspended ceiling is characterized in an integrated way with regard taken to the real structural design and fire behaviour including the influence of initial moisture content, crack formations, disintegration of materials, and partial failure of the ceiling and its fastening devices.

If the suspended ceiling has failed in the fire resistance test and if then the failure temperature $T_{i,crit}$ of the suspended ceiling has not been measured, this temperature has to be determined theoretically in step 2. This can be done according to figure 2d by way of the calculated time curve of the temperature T_i at the centre level of the suspended ceiling with $d_i/\lambda_i = (d_i/\lambda_i)_{der}$. The time $t_{i,crit}$ for the failure of the suspended ceiling, obtained in the fire resistance test, then directly gives the failure temperature $T_{i,crit}$.

Step 3, finally, consists of the theoretical extrapolation of the results from the fire resistance test. By this extrapolation, the time

of fire resistance can be determined for a structural modification of the tested floor or roof assembly, having a suspended ceiling which is identical with the one tested. The modification relates to the slab and/or the supporting steel beams. As to slab material, the extrapolation then should go from a material with a higher heat capacity to a material with a lower heat capacity. This implies, for instance, that an extrapolation from an assembly with a slab of aerated concrete to an assembly with a slab of normal concrete should be avoided.

A quick carrying through of step 3 requires that a design basis is available, which directly gives the steel beam temperature T_s and the temperature T_i at the centre level of the suspended ceiling for varying slab material, steel beam characteristics and $(d_i/\lambda_i)_{der}$ for the suspended ceiling at a fire exposure according to ISO 834. The limiting criteria for the fire resistance of the assembly are the steel beam temperature $T_{s,crit}$, corresponding to collapse of the supporting construction, and the critical temperature $T_{i,crit}$ at the centre level of the suspended ceiling, corresponding to failure of the suspended ceiling, if any.

A design basis, facilitating the practical carrying through of the steps 2 and 3, is presented in sections 6.1 and 6.2. The design basis has been determined by applying the theory developed in chapter 3 and the connected computer program presented in Appendix A. Generally, the influence of the heat stored in the suspended ceiling during the fire exposure has been neglected in the determination of the design diagrams and tables. This leads to computed temperatures which are on the safe side. For ordinary types of suspended ceilings, the approximation is reasonable. For suspended ceilings with large thickness and of materials with high density, the approximation may give a design which is too much on the safe side. For getting an accurate description of the fire behaviour for such suspended ceilings, the extrapolation has to be done by using the computer program in the appendix. It is, however, important to point out in this connection that the procedure of extrapolation in itself has such a structure, that the influence of the heat stored in the suspended ceiling will be included indirectly in an approximate way in deriving the quantity $(d_i/\lambda_i)_{der}$ from the real fire behaviour of the assembly in a standard fire resistance test.

If the extrapolation of the test results is done for the same ratio between the design load Q and the ultimate load at ambient temperature

Q_u as applied in the fire resistance test, the steel beam temperature $T_{s,crit}$ obtained in the test is chosen as the limiting criterion for collapse of the supporting construction. If the extrapolation is connected to another ratio Q/Q_u than used in the test, the limiting steel beam temperature $T_{s,crit}$ can be determined on the basis of figure 2e.

The extrapolation procedure is further illustrated in section 6.3 by some examples with detailed solutions.

6.1. Design basis for determination of $(d_i/\lambda_i)_{der}$ and critical temperature $T_{i,crit}$ of suspended ceiling - step 2

For facilitating the practical carrying out of step 2 of the theoretical extrapolation of the results from standard fire resistance tests of suspended ceilings, the design diagrams in figure 6.1a - f have been computed. The diagrams in figure 6.1a, b, d and e then are giving the steel beam temperature T_s versus time and the diagrams in figure 6.1c and f the temperature at the centre level of the suspended ceiling T_i versus time at varying d_i/λ_i of the suspended ceiling for an unventilated floor or roof assembly, consisting of a slab, load-bearing steel beams and a suspended ceiling and fire exposed according to ISO 834. Figure 6.1a, b and c refer to a slab of normal concrete of density 2300 kg m^{-3} and of thickness not less than 50 mm, figure 6.1d, e and f to a slab of aerated concrete of density 600 kg m^{-3} and of thickness not less than 100 mm. Figure 6.1a and d are applicable to steel beams of section HE 140 B ($U_s/F_s = 160 \text{ m}^{-1}$) and figure 6.1b and e to steel beams of section IPE 140 ($U_s/F_s = 299 \text{ m}^{-1}$). For the time variation of the temperature T_i at the centre level of the suspended ceiling (figure 6.1c and f), the influence of varying steel beam section is practically negligible.

The design diagrams have been calculated by applying the theory according to chapter 3 and the connected computer program in Appendix A. The calculation then is based on the following assumptions:

- (1) The initial temperature of the floor or roof assembly is 20°C ,
- (2) the fire exposure follows the ideal ISO 834 furnace temperature-time curve, Equation (1a),

(3) the heat capacity of the suspended ceiling is neglected,

(4) the steel beams have a centre distance of 750 mm,

(5) the thermal properties of the slab material - normal concrete and aerated concrete - at elevated temperature are described by figure 4.2.1b, 4.2.2c, 4.3.1b and 4.3.2a with regard taken to an initial moisture content, which corresponds to the equilibrium moisture content at a conditioning of the material in an atmosphere of ordinary room temperature and a relative humidity of about 60%.

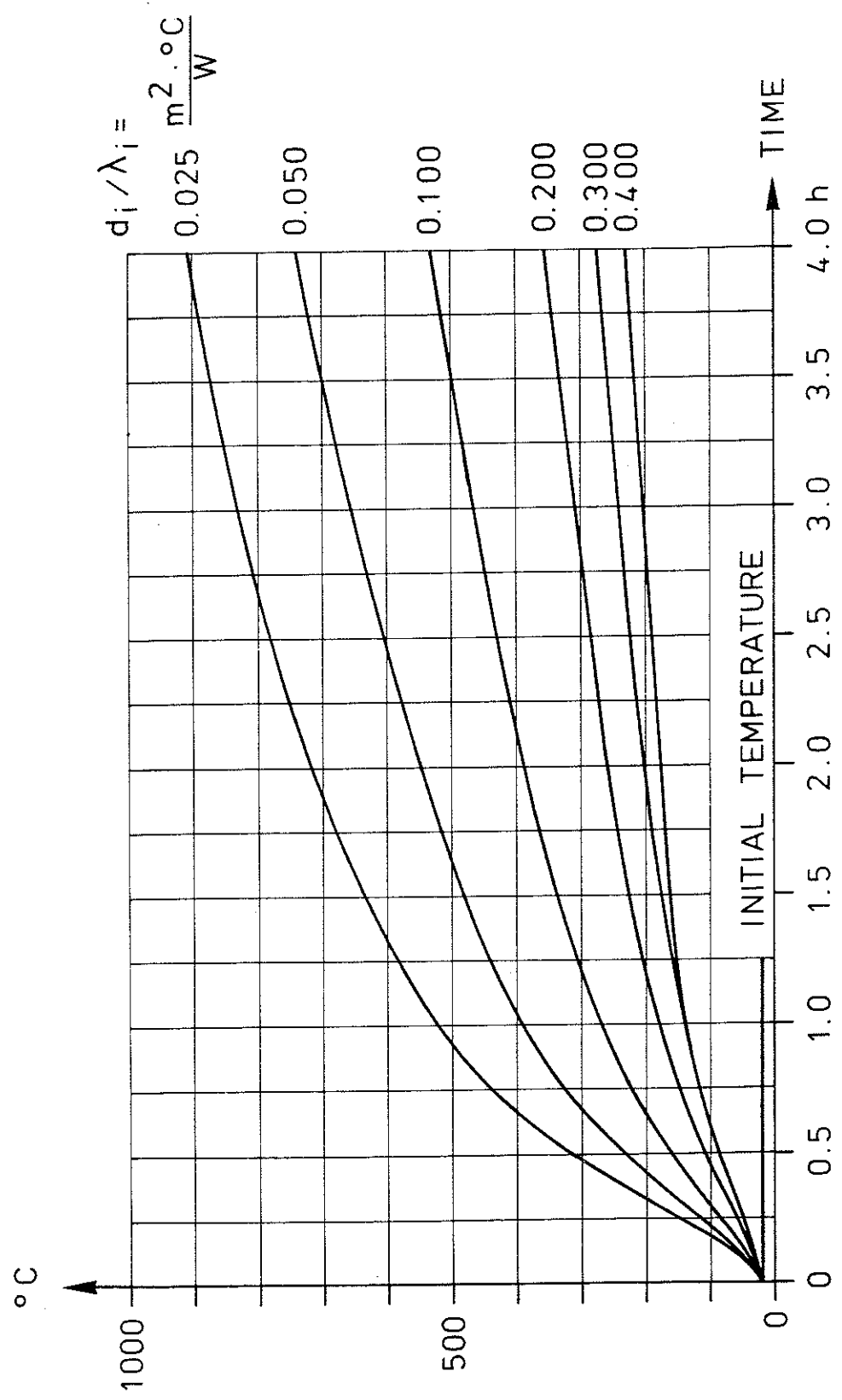

Figure 6.1a. Unventilated floor or roof assembly, consisting of a slab of normal concrete with density 2300 kg m^{-3} and thickness not less than 50 mm, steel beams HE 140 B, and a suspended ceiling. Steel beam temperature versus time for varying d_i/λ_i of the suspended ceiling at a fire exposure according to ISO 834

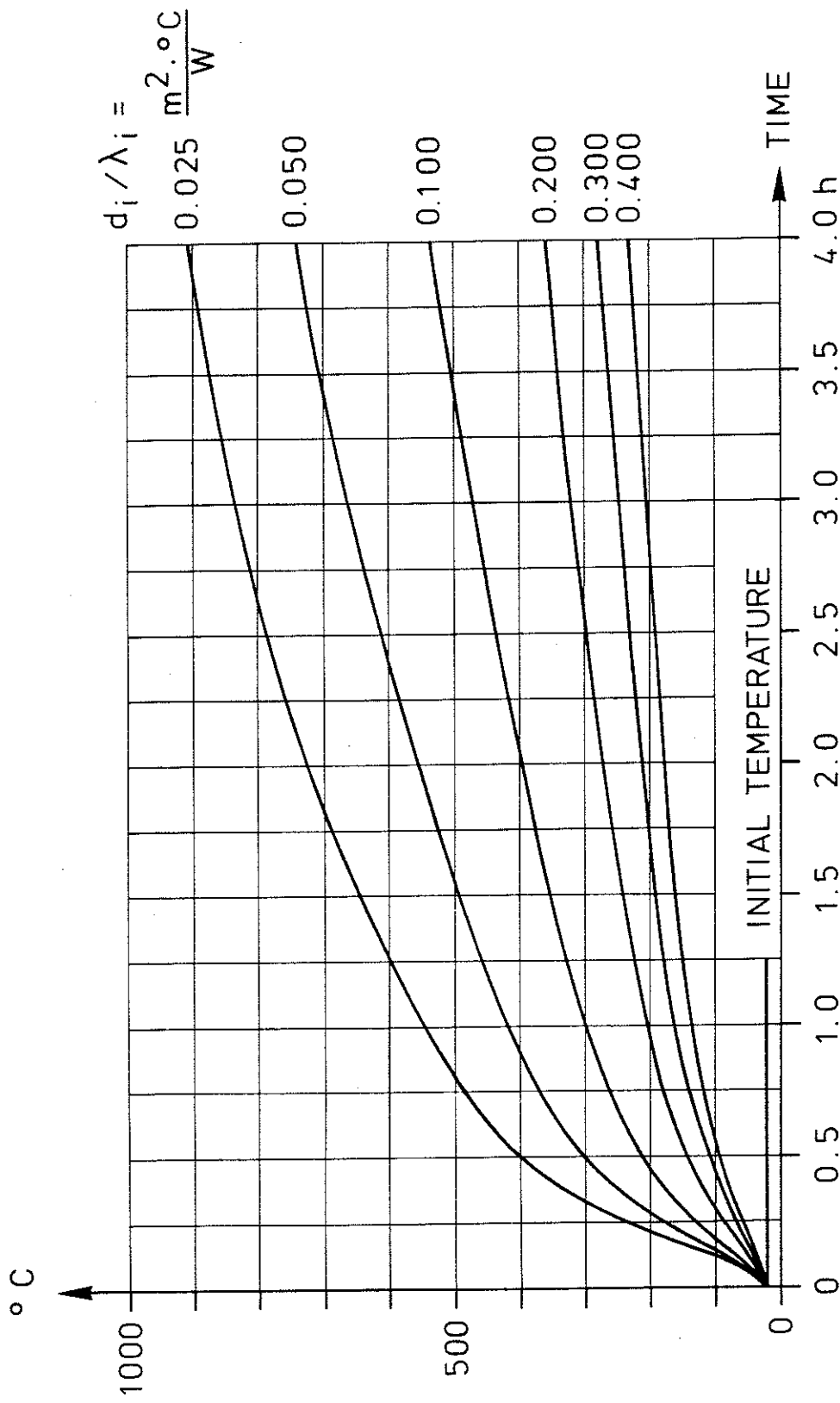

Figure 6.1b. Unventilated floor or roof assembly, consisting of a slab of normal concrete with density 2300 kg m^{-3} and thickness not less than 50 mm, steel beams IPE 140, and a suspended ceiling. Steel beam temperature versus time for varying d_i/λ_i of the suspended ceiling at a fire exposure according to ISO 834

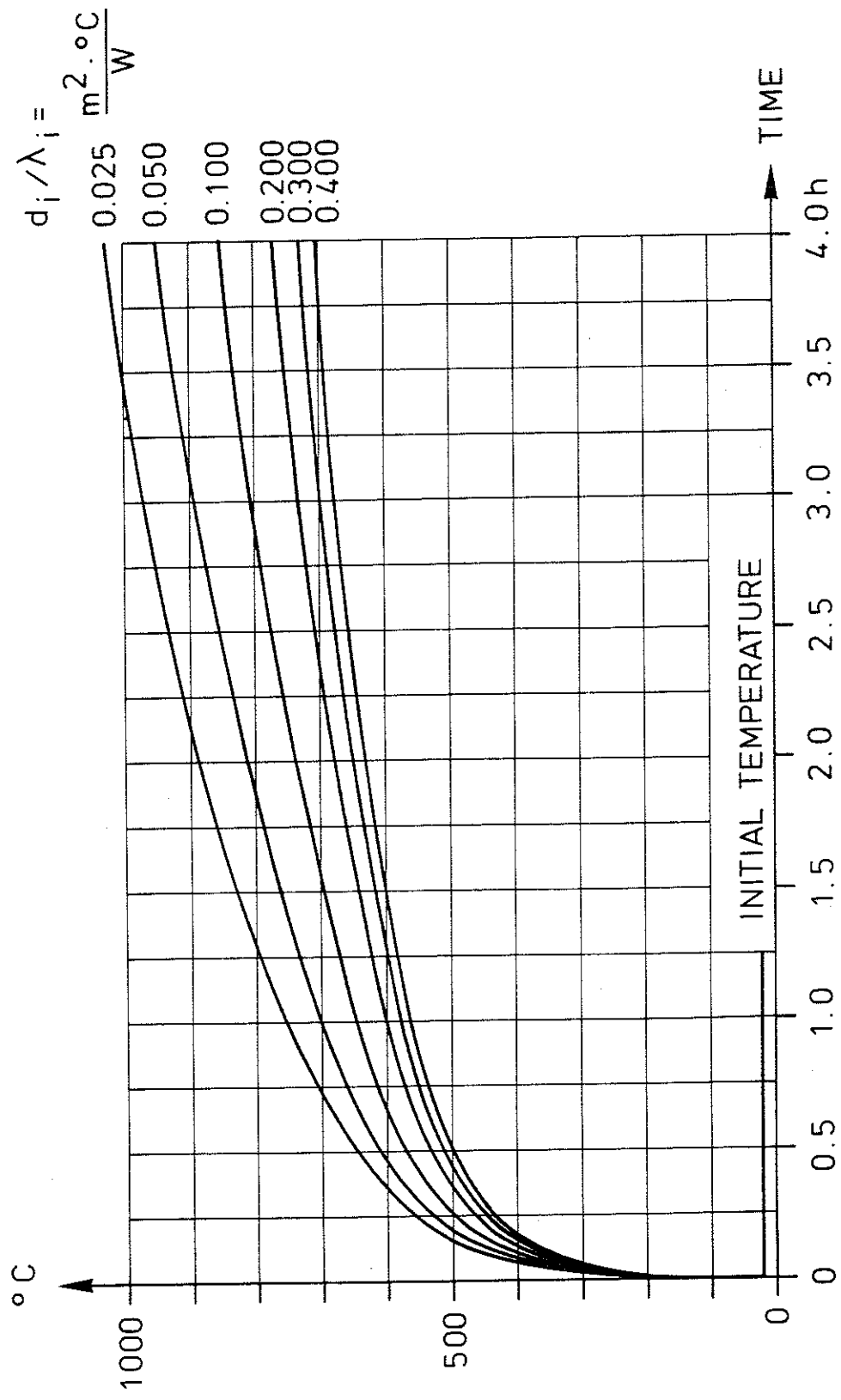

Figure 6.1c. Unventilated floor or roof assembly, consisting of a slab of normal concrete with density 2300 kg m^{-3} and thickness not less than 50 mm, steel beams HE 140 B or IPE 140, and a suspended ceiling. Temperature at centre level of suspended ceiling versus time for varying d_i/λ_i of the suspended ceiling at a fire exposure according to ISO 834

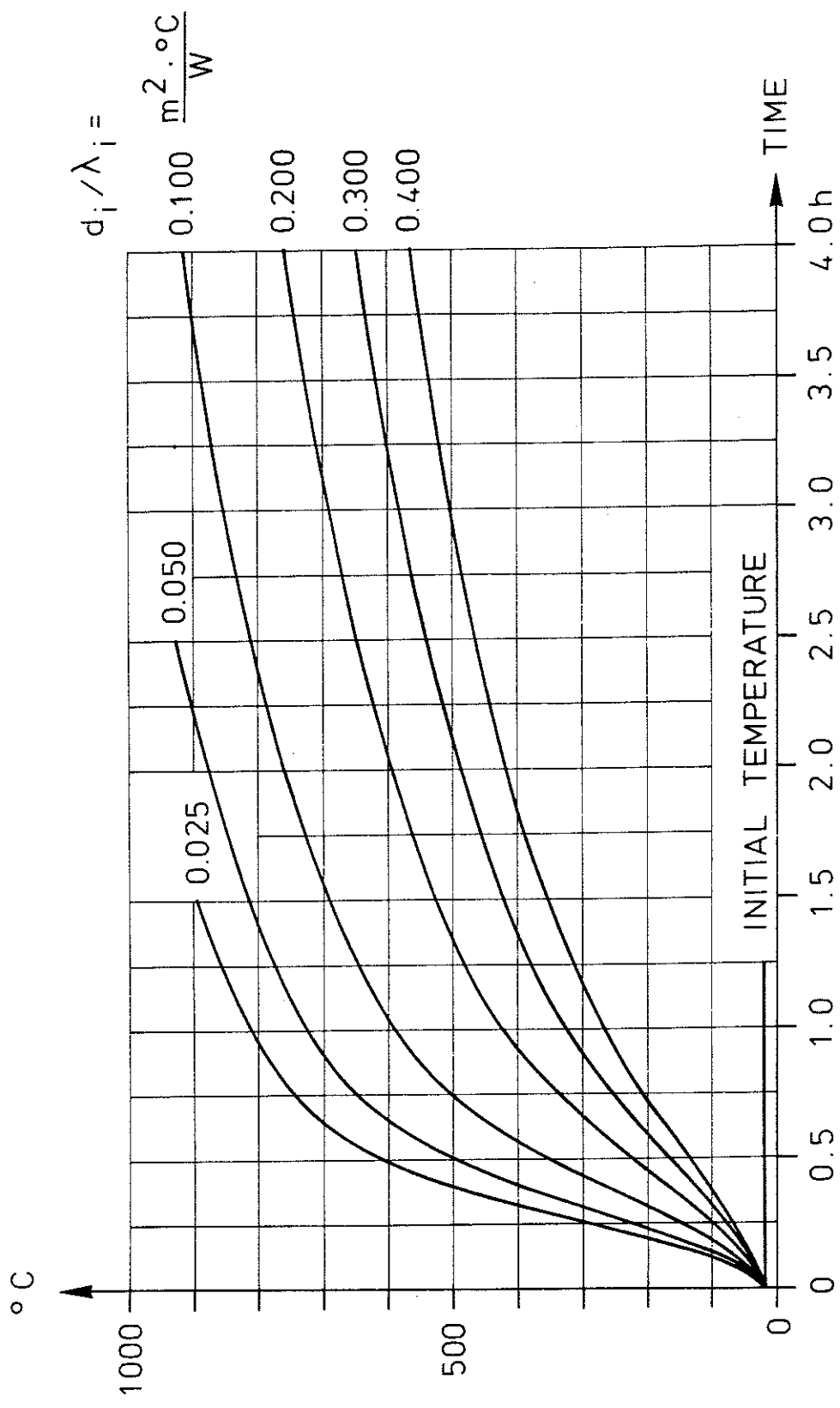

Figure 6.1d. Unventilated floor or roof assembly, consisting of a slab of aerated concrete with density 600 kg m^{-3} and thickness not less than 100 mm, steel beams HE 140 B, and a suspended ceiling. Steel beam temperature versus time for varying d_i/λ_i of the suspended ceiling at a fire exposure according to ISO 834

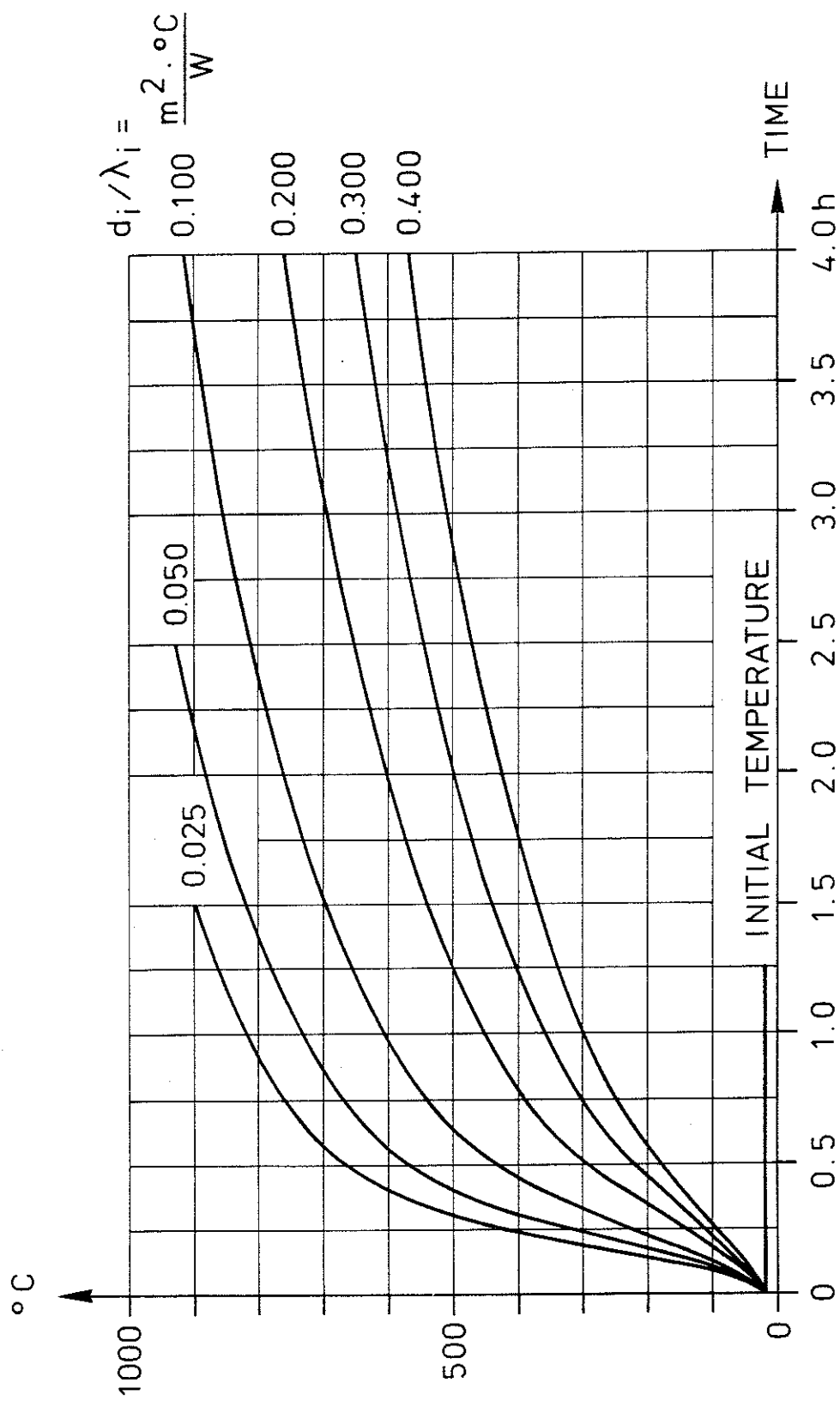

Figure 6.1e. Unventilated floor or roof assembly, consisting of a slab of aerated concrete with density 600 kg m^{-3} and thickness not less than 100 mm, steel beams IPE 140, and a suspended ceiling. Steel beam temperature versus time for varying d_i/λ_i of the suspended ceiling at a fire exposure according to ISO 834

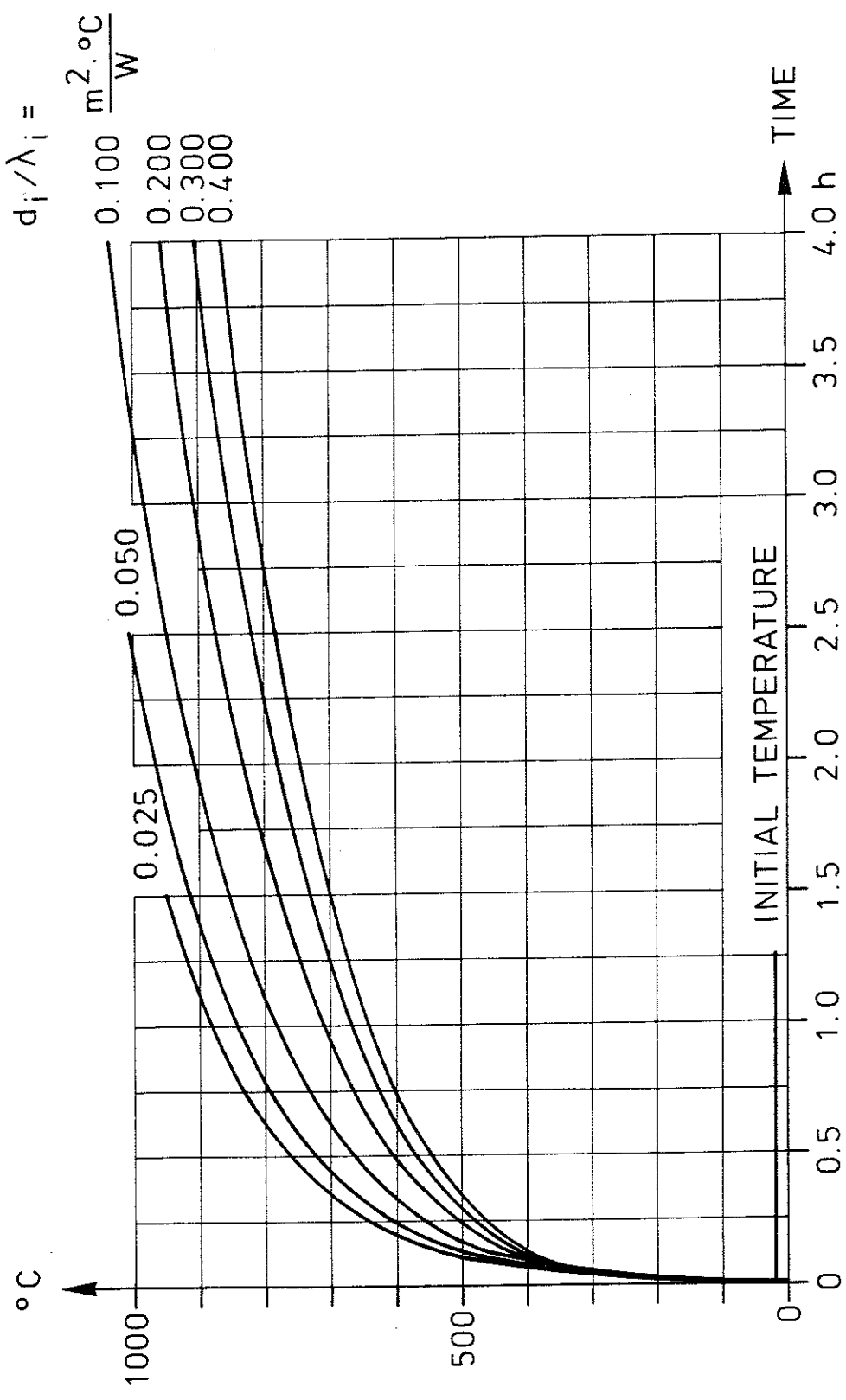

Figure 6.1f. Unventilated floor or roof assembly, consisting of a slab of aerated concrete with density 600 kg m^{-3} and thickness not less than 100 mm, steel beams HE 140 B or IPE 140, and a suspended ceiling. Temperature at centre level of suspended ceiling versus time for varying d_i/λ_i of the suspended ceiling at a fire exposure according to ISO 834

6.2. Design basis for step 3

After having passed step 1 and 2 of the theoretical evaluation of a fire resistance test according to DP 6167, the following basic quantities of the tested floor or roof assembly are known:

- (1) The critical steel beam temperature $T_{s,crit}$, corresponding to collapse of the supporting construction of the assembly - figure 2a,
- (2) the critical temperature $T_{i,crit}$ at the centre level of the suspended ceiling, corresponding to failure of the suspended ceiling, if any - figure 2d,
- (3) the derived value $(d_i/\lambda_i)_{der}$ of the suspended ceiling, characterizing the real structural design and fire behaviour of the suspended ceiling in an integrated way - figure 2b and c.

For a comparatively quick calculation of the fire resistance of structurally modified versions of the tested floor or roof assembly, a design basis must be available for a direct determination of the time curves for the steel beam temperature T_s and the temperature at the centre level of the suspended ceiling T_i for varying material and thickness of the slab, ratio U_s/F_s for the steel beams and derived insulation parameter $(d_i/\lambda_i)_{der}$ for the tested suspended ceiling. Table 6.2.a - d constitute such a design basis, computed by applying the theory developed in chapter 3 and the connected computer program in Appendix A under the same assumptions as specified in section 6.1, excluding assumption (4).

Table 6.2a and b then apply to a floor or roof assembly with a top slab of normal concrete of density 2300 kg m^{-3} . Table 6.2a is valid for a slab thickness of 50 mm and table 6.2b for a slab thickness ≥ 100 mm. For a slab thickness within the interval 50 to 100 mm, the temperature values can be calculated with acceptable accuracy by linear interpolation between the two tables. The temperature values have been computed for the width-depth ratio of beams $B/H = 0.5$ and the spacing-depth ratio of the beams $C/H = 5$, but the values can be used also for other ratios B/H and C/H with an accuracy which is sufficient for ordinary practical applications.

Table 6.2c and d apply to a floor or roof assembly with a top slab of aerated concrete of density 600 kg m^{-3} , having a thickness $\geq 100 \text{ mm}$. The tables are differentiated with respect to the spacing-depth ratio C/H . Table 6.2c then is valid for $C/H \leq 5$ and table 6.2d for $C/H > 5$.

In addition to the steel beam temperature T_s and the temperature T_i at the centre level of the suspended ceiling, table 6.2a and b are giving also the maximum temperature at the upper surface of the concrete slab. The values of this surface temperature, given in table 6.2b, then apply only to the slab thickness 100 mm . For a larger slab thickness, the surface temperature decreases with increasing thickness. For slab thicknesses between 50 and 100 mm , the surface temperature can be determined by linear interpolation between table 6.2a and table 6.2b. For a floor or roof assembly with a top slab of aerated concrete - table 6.2c and d - the maximum temperature at the upper surface of the slab lies generally below $65 \text{ }^\circ\text{C}$ within the area of application, covered by the tables.

Table 6.2a

t_d [min]	U_s/F_s [m ⁻¹]	NORMAL CONCRETE SLAB: Density $\gamma = 2300 \text{ kg m}^{-3}$, thickness 50 mm Maximum steel temperature $T_{s,max}$, maximum temperature at centre level of suspended ceiling $T_{i,max}$ (), and maximum temperature at top surface of floor or roof slab []											
		$(d_i/\lambda_i)_{der}$, [m ² · °C W ⁻¹]											
		0.025		0.050		0.100		0.200		0.300		0.400	
15	50	70		55		45		35		30		30	
	100	115 (560)		90 (525)		65 (495)		50 (465)		40 (445)		35 (435)	
	200	185		140		100		70		55		50	
	300	235 [45]		180 [40]		130 [35]		85 [30]		70 [25]		60 [25]	
	400	270		210		150		100		80		65	
30	50	160		115		80		55		45		40	
	100	260 (650)		185 (610)		125 (570)		85 (535)		65 (510)		55 (500)	
	200	360		265		185		125		95		80	
	300	400 [90]		305 [75]		215 [65]		145 [50]		115 [40]		95 [35]	
	400	415		320		230		160		125		100	
45	50	265		180		120		80		65		55	
	100	390 (715)		280 (665)		185 (615)		120 (570)		95 (550)		80 (535)	
	200	470		355		245		165		130		105	
	300	490 [130]		375 [95]		270 [85]		180 [70]		145 [55]		120 [50]	
	400	495		380		275		190		150		125	
60	50	370		255		165		105		85		70	
	100	495 (760)		355 (705)		240 (650)		155 (605)		120 (580)		100 (565)	
	200	540		410		290		195		155		130	
	300	550 [185]		425 [135]		305 [95]		210 [80]		165 [70]		140 [60]	
	400	555		430		310		215		170		145	
75	50	475		325		210		130		100		85	
	100	570 (800)		420 (740)		285 (680)		185 (630)		145 (605)		120 (585)	
	200	600		460		325		220		175		145	
	300	610 [235]		470 [175]		335 [115]		230 [90]		180 [80]		155 [70]	
	400	615		470		335		235		185		160	
90	50	560		390		250		155		120		100	
	100	635 (835)		475 (770)		325 (705)		210 (650)		165 (620)		135 (605)	
	200	655		500		355		240		190		160	
	300	660 [275]		510 [210]		365 [145]		245 [95]		195 [85]		165 [80]	
	400	660		510		365		250		200		165	
120	50	690		505		330		205		155		125	
	100	730 (895)		555 (820)		390 (745)		250 (685)		195 (655)		165 (635)	
	200	740		570		410		270		215		180	
	300	740 [330]		575 [260]		415 [185]		280 [120]		220 [95]		185 [85]	
	400	740		575		415		280		220		185	

Table 6.2a cont.

t_d [min]	U_s/F_s [m^{-1}]	NORMAL CONCRETE SLAB: Density $\gamma = 2300 \text{ kg m}^{-3}$, thickness 50 mm Maximum steel temperature $T_{s,max}$, maximum temperature at centre level of suspended ceiling $T_{i,max}$ (), and maximum temperature at top surface of floor or roof slab []											
		$(d_i/\lambda_i)_{der}$, [$m^2 \cdot ^\circ C W^{-1}$]											
		0.025		0.050		0.100		0.200		0.300		0.400	
150	50	770		585		395		245		210		175	
	100		(940)	615	(860)	440	(780)	290	(715)	240	(680)	200	(660)
	200			625		435		305		250		210	
	300		[360]	630	[300]	460	[220]	310	[145]	255	[110]	215	[95]
	400			630		460		310		255		215	
180	50			645		450		285		210		175	
	100			665	(895)	475	(810)	320	(740)	240	(700)	200	(680)
	200			670		485		330		250		210	
	300			675	[325]	490	[245]	335	[165]	255	[125]	215	[100]
	400			675		490		335		255		215	
210	50			685		485		315		235		190	
	100			695	(920)	510	(830)	345	(760)	260	(720)	215	(695)
	200			700		515		355		270		220	
	300			700	[340]	520	[265]	355	[180]	275	[140]	225	[115]
	400			700		520		355		275		225	
240	50			715		520		345		260		210	
	100			720	(940)	535	(855)	365	(775)	280	(735)	230	(710)
	200			725		535		370		285		235	
	300			725	[350]	540	[275]	370	[195]	290	[150]	240	[125]
	400			725		540		370		290		240	

Table 6.2b

t_d [min]	U_s/F_s [m^{-1}]	NORMAL CONCRETE SLAB: Density $\gamma = 2300 \text{ kg m}^{-3}$, thickness $\geq 100 \text{ mm}$ Maximum steel temperature $T_{s,max}$, maximum temperature at centre level of suspended ceiling $T_{i,max}$ (), and maximum temperature at top surface of floor or roof slab []											
		$(d_i/\lambda_i)_{der}$, [$m^2 \cdot ^\circ C W^{-1}$]											
		0.025		0.050		0.100		0.200		0.300		0.400	
15	50	70		55		45		35		30		30	
	100	115	(560)	90	(525)	65	(495)	50	(465)	40	(445)	35	(435)
	200	185		140		100		70		55		50	
	300	235	[20]	180	[20]	130	[20]	85	[20]	70	[20]	60	[20]
	400	270		210		150		100		80		65	
30	50	160		115		80		55		45		40	
	100	260	(650)	185	(610)	125	(570)	85	(535)	65	(510)	55	(500)
	200	360		265		185		125		95		80	
	300	400	[35]	305	[30]	215	[30]	145	[25]	115	[25]	95	[25]
	400	415		320		230		160		125		100	
45	50	260		180		120		80		65		55	
	100	385	(710)	275	(660)	185	(615)	120	(570)	95	(550)	80	(535)
	200	465		350		245		165		130		105	
	300	485	[50]	370	[45]	265	[40]	180	[35]	145	[30]	120	[30]
	400	490		375		270		190		150		125	
60	50	365		250		160		105		85		70	
	100	485	(755)	350	(700)	235	(645)	150	(600)	120	(580)	100	(565)
	200	530		405		285		190		150		125	
	300	540	[70]	415	[60]	295	[50]	205	[40]	160	[35]	135	[35]
	400	545		420		300		210		165		140	
75	50	460		315		205		130		100		80	
	100	555	(795)	410	(735)	280	(675)	180	(625)	140	(600)	115	(585)
	200	585		445		315		215		170		140	
	300	595	[85]	455	[70]	325	[60]	225	[50]	175	[45]	150	[40]
	400	595		455		330		230		180		155	
90	50	540		375		240		150		115		95	
	100	615	(825)	460	(760)	315	(700)	200	(645)	155	(620)	130	(605)
	200	635		485		345		230		180		155	
	300	640	[95]	490	[85]	350	[70]	235	[55]	185	[50]	160	[45]
	400	640		490		350		240		190		160	
120	50	665		480		315		195		145		120	
	100	705	(885)	530	(810)	370	(740)	240	(680)	185	(650)	155	(630)
	200	715		545		390		260		205		170	
	300	715	[140]	550	[100]	395	[85]	270	[70]	210	[60]	175	[55]
	400	715		550		395		270		210		175	

Table 6.2b cont.

t_d [min]	U_s/F_s [m^{-1}]	NORMAL CONCRETE SLAB: Density $\gamma = 2300 \text{ kg m}^{-3}$, thickness $\geq 100 \text{ mm}$ Maximum steel temperature $T_{s,max}$, maximum temperature at centre level of suspended ceiling $T_{i,max}$ (), and maximum temperature at top surface of floor or roof slab []											
		$(d_i/\lambda_i)_{der}$, [$m^2 \cdot ^\circ C W^{-1}$]											
		0.025		0.050		0.100		0.200		0.300		0.400	
150	50	750		560		375		235		200		165	
	100		(930)	590	(850)	415	(770)	275	(705)	230	(675)	190	(655)
	200			600		430		290		240		200	
	300		[185]	605	[140]	435	[95]	295	[80]	245	[70]	205	[65]
	400			605		435		295		245		205	
180	50			620		425		270		200		165	
	100			645	(885)	450	(800)	300	(730)	230	(695)	190	(675)
	200			650		460		310		240		200	
	300			655	[175]	465	[120]	315	[90]	245	[75]	205	[70]
	400			655		465		315		245		205	
210	50			675		465		295		225		185	
	100			690	(915)	490	(825)	325	(750)	250	(715)	205	(690)
	200			695		495		335		260		215	
	300			700	[200]	500	[145]	335	[95]	260	[80]	215	[75]
	400			700		500		335		260		215	
240	50			720		500		325		245		200	
	100			730	(945)	520	(850)	345	(770)	265	(730)	220	(705)
	200			735		525		355		270		225	
	300			735	[220]	530	[165]	355	[105]	275	[90]	230	[80]
	400			735		530		355		275		230	

t_d [min]	U_s/F_s [m^{-1}]	AERATED CONCRETE SLAB: Density $\gamma = 600 \text{ kg m}^{-3}$, thickness $\geq 100 \text{ mm}$, $C/H \leq 5$ Maximum steel temperature $T_{s,max}$ and maximum temperature at centre level of suspended ceiling ()										
		$(d_i/\lambda_i)_{der}$, [$m^2 \cdot ^\circ C W^{-1}$]										
		0.025		0.050		0.100		0.200		0.300		0.400
15	50	130		100		70		50		45		40
	100	220		165		115		75		60		55
	200	355 (645)		270 (610)		185 (560)		120 (510)		95 (480)		80 (465)
	300	430		340		235		150		120		100
	400	480		380		270		175		135		115
30	50	350		265		175		110		80		70
	100	525		415		285		175		130		105
	200	645 (765)		540 (725)		400 (665)		260 (605)		195 (575)		155 (550)
	300	670		575		440		300		230		180
	400	680		585		460		320		245		200
45	50	555		445		305		185		135		110
	100			600		445		285		210		170
	200		(835)	660 (795)		525 (735)		365 (665)		280 (625)		230 (600)
	300			670		545		395		310		255
	400			675		550		400		320		270
60	50			595		430		285		195		155
	100			705		555		380		280		225
	200			730 (845)		600 (785)		440 (710)		345 (670)		285 (640)
	300			735		610		455		360		300
	400			740		615		460		365		305
75	50			700		540		350		255		200
	100					630		450		345		280
	200				(880)	655 (825)		495 (750)		395 (705)		330 (670)
	300					660		500		405		340
	400					660		505		410		345
90	50					620		425		315		250
	100					680		510		400		330
	200					695 (855)		535 (780)		435 (730)		365 (700)
	300					700		540		440		375
	400					700		545		445		380
120	50					730		540		415		335
	100					755		590		475		400
	200						(910)	600 (830)		495 (780)		420 (745)
	300							605		500		425
	400							605		500		430

Table 6.2c cont.

t_d [min]	U_s/F_s [m ⁻¹]	AERATED CONCRETE SLAB: Density $\gamma = 600 \text{ kg m}^{-3}$, thickness $\geq 100 \text{ mm}$, $C/H \leq 5$ Maximum steel temperature $T_{s,max}$ and maximum temperature at centre level of suspended ceiling ()											
		$(d_i/\lambda_i)_{der}$, [m ² · °C W ⁻¹]											
		0.025		0.050		0.100		0.200		0.300		0.400	
150	50							615		495		410	
	100							645		535		455	
	200							650 (870)		545 (820)		465 (785)	
	300							655		550		470	
	400							655		550		475	
180	50							670		550		465	
	100							685		575		495	
	200							690 (905)		585 (850)		505 (815)	
	300							695		585		510	
	400							695		585		510	
210	50									595		510	
	100									615		530	
	200									620 (880)		535 (840)	
	300									620		540	
	400									620		540	
240	50									635		545	
	100									645		560	
	200									650 (905)		565	
	300									650		570	
	400									650		570	

Table 6.2d

t_d [min]	U_s/F_s [m^{-1}]	AERATED CONCRETE SLAB: Density $\gamma = 600 \text{ kg m}^{-3}$, thickness $\geq 100 \text{ mm}$, $C/H > 5$ Maximum steel temperature $T_{s,max}$ and maximum temperature at centre level of suspended ceiling ()											
		$(d_i/\lambda_i)_{der}$, [$m^2 \cdot ^\circ C W^{-1}$]											
		0.025		0.050		0.100		0.200		0.300		0.400	
15	50	140		105		70		50		45		40	
	100	230		175		120		80		60		55	
	200	370	(645)	280	(610)	195	(560)	125	(510)	95	(480)	80	(465)
	300	445		350		235		155		125		105	
	400	490		390		275		180		140		120	
30	50	370		280		185		115		85		70	
	100	545		430		295		185		135		110	
	200	655	(765)	550	(725)	410	(665)	265	(605)	200	(575)	160	(550)
	300	675		580		445		305		235		185	
	400	680		585		460		325		250		200	
45	50	580		465		320		195		140		115	
	100			610		460		295		215		175	
	200		(835)	665	(795)	530	(735)	370	(665)	285	(625)	235	(600)
	300			675		545		395		310		260	
	400			680		550		405		320		270	
60	50			615		450		280		200		160	
	100			710		565		390		290		235	
	200			730	(845)	605	(785)	445	(710)	350	(670)	290	(640)
	300			735		610		455		360		300	
	400			740		615		460		365		305	
75	50			715		555		365		265		210	
	100					635		460		355		285	
	200				(880)	655	(825)	495	(750)	400	(705)	330	(670)
	300					660		500		405		340	
	400					660		505		410		345	
90	50					630		435		325		260	
	100					685		515		405		335	
	200					695	(855)	535	(780)	435	(730)	365	(700)
	300					700		540		440		375	
	400					700		545		445		380	
120	50					735		550		425		345	
	100					755		590		480		405	
	200						(910)	600	(830)	495	(780)	420	(745)
	300							605		500		425	
	400							605		500		430	

Table 6.2d cont.

t_d [min]	U_s/F_s [m^{-1}]	AERATED CONCRETE SLAB: Density $\gamma = 600 \text{ kg m}^{-3}$, thickness $\geq 100 \text{ mm}$, $C/H > 5$ Maximum steel temperature $T_{s,max}$ and maximum temperature at centre level of suspended ceiling ()										
		$(d_i/\lambda_i)_{der}$, [$m^2 \cdot ^\circ C W^{-1}$]										
		0.025		0.050		0.100		0.200		0.300		0.400
150	50							620		500		415
	100							645		535		455
	200							650 (870)		545 (820)		465 (785)
	300							655		550		470
	400							655		550		475
180	50							675		555		470
	100							685		575		495
	200							690 (905)		585 (850)		505 (815)
	300							695		585		510
	400							695		585		510
210	50									600		515
	100									615		530
	200									620 (880)		535 (840)
	300									620		540
	400									620		540
240	50									635		550
	100									645		560
	200									650 (905)		565 (865)
	300									650		570
	400									650		570

6.3. Examples

Example 1

A test roof assembly according to figure 1a is composed of a top slab of normal concrete with thickness 50 mm, simply supported steel beams HE 140 B and a suspended ceiling of mineral wool type. At a fire resistance test, performed in conformity with DP 6167, the following values were recorded for the steel temperature T_s of the bottom flange at midspan of the centre supporting beam:

t min	15	30	45	60	75	90	105	120
T_s °C	100	190	280	330	375	410	440	470

The assembly was subjected to a test load producing the maximum permissible stress in the supporting steel beams.

The supporting steel beams collapsed at the time $t_{s,crit} = 122$ min - the collapse defined by a limiting deflection criterion. The corresponding steel beam temperature $T_{s,crit}$ was measured to 475°C. At the collapse of the steel beams, the suspended ceiling was intact.

The time curve of the measured steel beam temperature T_s is plotted as the dashed and dotted line curve in figure 6.3a together with the corresponding calculated time curves, applicable to the same material and thickness of the slab and the same steel beam section as for the test assembly - the time curves according to figure 6.1a. The measured time curve and the calculated time curves are obviously very similar in shape in this case, which is to be expected for a suspended ceiling keeping completely intact during the fire exposure. By linear interpolation, figure 6.3a gives a derived value

$$(d_i/\lambda_i)_{der} = 0.075 \text{ m}^2 \text{ } ^\circ\text{C W}^{-1} \quad (\text{a})$$

for the tested suspended ceiling.

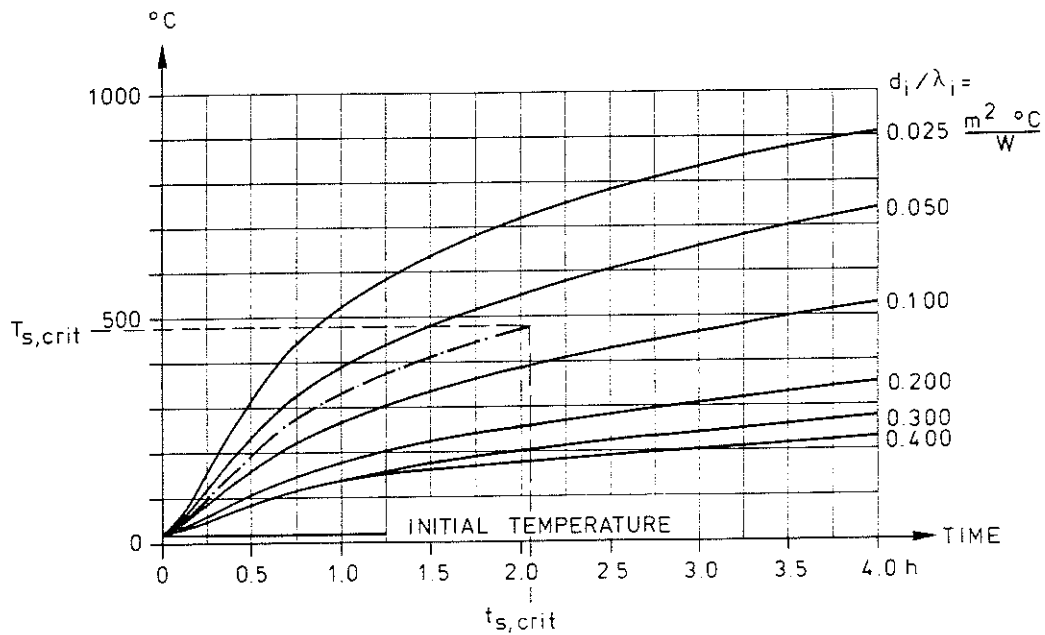

Figure 6.3a. Measured time curve of the steel temperature T_s of bottom flange at midspan of centre supporting beam, obtained in the fire resistance test according to DP 6167 (dashed and dotted line curve), and corresponding time curves for varying d_i/λ_i , applicable to the same material and thickness of the slab and the same steel beam section as for the test assembly - time curves according to figure 6.1a

For $d_i/\lambda_i = 0.075 \text{ m}^2 \text{ }^\circ\text{C W}^{-1}$, figure 6.1c gives a temperature at centre level of the suspended ceiling T_i which amounts to

$$T_i = 780^\circ\text{C} \quad (\text{b})$$

at the time $t_{s,crit} = 122 \text{ min}$ for the collapse of the supporting steel beams. Since the suspended ceiling was intact at the collapse of the steel beams, this T_i value is not a critical temperature for the suspended ceiling.

Using the derived value $(d_i/\lambda_i)_{der} = 0.075 \text{ m}^2 \text{ }^\circ\text{C W}^{-1}$ of the tested suspended ceiling as basic information, determine theoretically the fire resistance time t_{fr} for a floor assembly with the same suspended ceiling as in the test and having

- (a) a slab of normal concrete with a thickness 120 mm and simply supported steel beams IPE 160,

(b) a slab of normal concrete with a thickness 120 mm and simply supported steel beams HE 300 B,

(c) a slab of aerated concrete of density 600 kg m^{-3} and of thickness 150 mm and simply supported steel beams HE 300 B with a spacing-depth ratio $C/H = 4$.

In all three cases, the ratio between the design load Q and the ultimate load at ordinary room temperature Q_u is assumed to be the same as for the tested assembly, which means a critical steel beam temperature $T_{s,crit} = 475^\circ\text{C}$ all through.

(a) A floor assembly with a normal concrete slab of thickness 120 mm corresponds with the design table 6.2b. For supporting steel beams IPE 160 $U_s/F_s = 277 \text{ m}^{-1}$ - cf. table 4.1.3a.

With linear interpolation, table 6.2b gives for a floor assembly with $(d_i/\lambda_i)_{der} = 0.075 \text{ m}^2 \text{ }^\circ\text{C W}^{-1}$ and $U_s/F_s = 277 \text{ m}^{-1}$

at a standard fire duration $t_d = 90 \text{ min}$

$$T_s = 415^\circ\text{C} \text{ for } U_s/F_s = 200 \text{ m}^{-1}$$

$$T_s = 420^\circ\text{C} \text{ for } U_s/F_s = 300 \text{ m}^{-1}$$

$$T_s \approx 420^\circ\text{C} \text{ for } U_s/F_s = 277 \text{ m}^{-1}$$

and at a standard fire duration $t_d = 120 \text{ min}$

$$T_s = 470^\circ\text{C} \text{ for } U_s/F_s = 200 \text{ m}^{-1}$$

$$T_s = 475^\circ\text{C} \text{ for } U_s/F_s = 300 \text{ m}^{-1}$$

$$T_s \approx 475^\circ\text{C} \text{ for } U_s/F_s = 277 \text{ m}^{-1}$$

Accordingly, the critical steel beam temperature $T_{s,crit} = 475^\circ\text{C}$ is reached after a 120 min standard fire exposure, i.e. the fire resistance time

$$t_{fr} = 120 \text{ min}$$

(c)

The tested and the structurally modified floor assemblies have obviously about the same fire resistance. Consequently, the favourable influence of a larger slab thickness for the modified assembly (120 against 50 mm) is approximately balanced by the unfavourable influence of a larger value of U_s/F_s (277 m^{-1} for IPE 160 against 160 m^{-1} for HE 140 B). For the modified floor assembly, table 6.2b gives a temperature at the centre level of the suspended ceiling $T_i = 775^\circ\text{C}$ at the fire resistance time $t_{fr} = 120 \text{ min}$, i.e. an insignificantly smaller value than for the tested floor assembly.

(b) As for the problem (a), design table 6.2b is applicable. For supporting steel beams HE 300 B $U_s/F_s = 99 \text{ m}^{-1}$ - cf. table 4.1.3a.

For a floor assembly with $(d_i/\lambda_i)_{der} = 0.075 \text{ m}^2 \text{ }^\circ\text{C W}^{-1}$ and $U_s/F_s = 99 \text{ m}^{-1}$, table 6.2b gives

at a standard fire duration $t_d = 120 \text{ min}$

$$T_s = 450^\circ\text{C}, \quad T_i = 775^\circ\text{C}$$

and at a standard fire duration $t_d = 150 \text{ min}$

$$T_s = 505^\circ\text{C}, \quad T_i = 810^\circ\text{C}$$

By linear interpolation, the critical steel beam temperature $T_{s,crit} = 475^\circ\text{C}$ is calculated to be reached after a standard fire exposure of about 135 min, i.e. the fire resistance time

$$t_{fr} = 135 \text{ min} \tag{d}$$

The corresponding temperature at the centre level of the suspended ceiling $T_i = 795^\circ\text{C}$, i.e. a somewhat higher value than achieved in the fire resistance test from which the theoretical extrapolation starts. Consequently, a practical application of the calculated fire resistance according to Equation (d) requires a verification that the temperature $T_i = 795^\circ\text{C}$ does not give rise to any failure of the suspended ceiling, which can be examined by a small scale test.

(c) A floor assembly with a slab of aerated concrete of density 600 kg m^{-3} and with steel beams having a spacing-depth ratio $C/H = 4$ corresponds with the design table 6.2c. For supporting steel beams HE 300 B $U_s/F_s = 99 \text{ m}^{-1}$ - cf. table 4.1.3a.

For a floor assembly with $(d_i/\lambda_i)_{\text{der}} = 0.075 \text{ m}^2 \text{ }^\circ\text{C W}^{-1}$ and $U_s/F_s = 99 \text{ m}^{-1}$, table 6.2c gives

at a standard fire duration $t_d = 30 \text{ min}$

$$T_s = 350^\circ\text{C}, \quad T_i = 695^\circ\text{C}$$

and at a standard fire duration $t_d = 45 \text{ min}$

$$T_s = 525^\circ\text{C}, \quad T_i = 765^\circ\text{C}$$

By linear interpolation, the critical steel beam temperature $T_{s,\text{crit}} = 475^\circ\text{C}$ is found to be reached after a standard fire exposure of about 40 min, i.e. the fire resistance time

$$t_{\text{fr}} = 40 \text{ min} \tag{e}$$

The simultaneous temperature at the centre level of the suspended ceiling $T_i = 740^\circ\text{C}$, for which the suspended ceiling is verified to be intact by the fire resistance test.

A comparison between problems (b) and (c) demonstrates the very large influence on the fire resistance of a replacement of a slab of normal concrete by a slab of aerated concrete in a floor or roof assembly with load-bearing steel beams, protected by a suspended ceiling - a decrease of the fire resistance t_{fr} from 135 to 40 min. Compared to this, the influence on the fire resistance of an altered U_s/F_s ratio of the load-bearing steel beams is modest. This is illustrated by problems (a) and (b) showing an increase of the fire resistance t_{fr} from 120 to 135 min at a decrease of the U_s/F_s ratio from 277 to 99 m^{-1} .

Example 2

Starting from the results of the fire resistance test, described in Example 1, determine theoretically the fire resistance time t_{fr} for a floor assembly with the same suspended ceiling as in the test and having for the rest a slab of normal concrete with a thickness 120 mm and supporting steel beams HE 300 B which are built in at both ends - case ② in figure 6.3b.

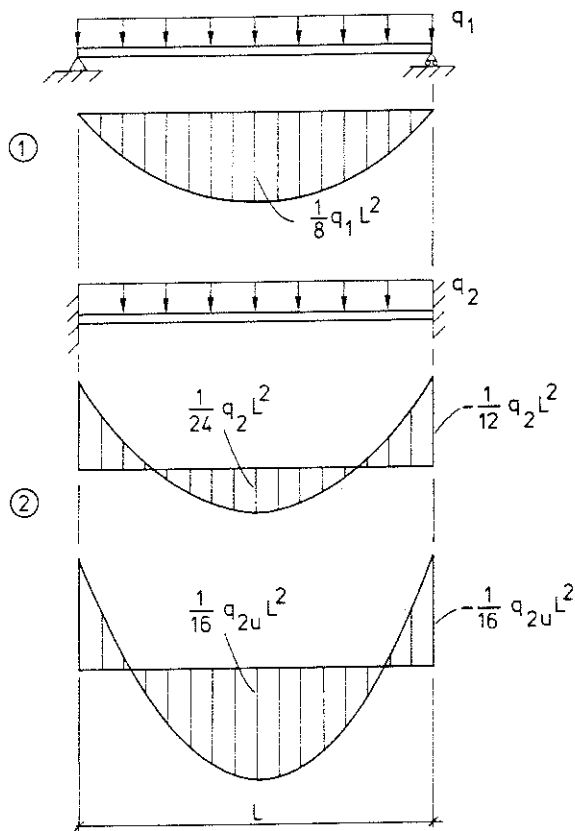

Figure 6.3b. Simply supported floor assembly, subjected to a fire resistance test according to Example 1 - case ① - and a floor assembly with supporting steel beams, built in at both ends, theoretically analysed in Example 2 - case ②

As stated in Example 1, the fire resistance test was performed with the load-bearing steel beams simply supported and subjected to a test load producing the maximum permissible stress σ_{perm} in the beams - cf.

case ① in figure 6.3b. With the test load applied as a uniformly distributed load q_1 , the maximum bending moment during the test is determined by the relationship

$$M_{\max} = \sigma_{\text{perm}} W = \frac{1}{8} q_1 L^2 \quad (\text{a})$$

where

W = elastic modulus of steel beam section (m^3).

The ultimate bending moment M_u and the corresponding ultimate load q_{1u} at ordinary room temperature are given by the formula

$$M_u = \sigma_y \alpha_p W = \frac{1}{8} q_{1u} L^2 \quad (\text{b})$$

where

σ_y = yield point of steel material at ordinary room temperature (MPa)
 α_p = plastification factor of the cross section.

From Equations (a) and (b), the ratio between the design load Q_1 and the ultimate load Q_{1u} is obtained as

$$\frac{Q_1}{Q_{1u}} = \frac{q_1 L}{q_{1u} L} = \frac{\sigma_{\text{perm}}}{\sigma_y \alpha_p} \quad (\text{c})$$

At the fire resistance test, the load-bearing steel beams collapsed at a temperature $T_{s,\text{crit}} = 475^\circ\text{C}$, measured in the bottom flange at midspan of the centre beam. By way of figure 2e, this temperature corresponds to

$$\frac{Q_1}{Q_{1u}} = 0.53 \quad (\text{d})$$

For the floor assembly with the load-bearing steel beams built in at both ends, the bending moment distribution is shown in figure 6.3b - case ② - for elastic conditions and for the ultimate state. At elastic conditions, the following relationship applies between the uniformly distributed load q_2 and the maximum permissible stress σ_{perm} in the beams

$$M_{\max} = \sigma_{\text{perm}} W = \frac{1}{12} q_2 L^2 \quad (e)$$

At the ultimate state, the connection between the ultimate bending moment M_u and the ultimate load q_{2u} is given by the equation

$$M_u = \sigma_y \alpha_p W = \frac{1}{16} q_{2u} L^2 \quad (f)$$

From Equation (e) and (f), the ratio between the design load Q_2 and the ultimate load Q_{2u}

$$\frac{Q_2}{Q_{2u}} = \frac{q_2 L}{q_{2u} L} = \frac{3\sigma_{\text{perm}}}{4\sigma_y \alpha_p} \quad (g)$$

follows. Combined with Equations (c) and (d), this value is transformed to

$$\frac{Q_2}{Q_{2u}} = \frac{3Q_1}{4Q_{1u}} = \frac{3}{4} \cdot 0.53 = 0.40 \quad (h)$$

which according to figure 2e corresponds to the critical steel beam temperature

$$T_{s,\text{crit}} = 540^\circ\text{C} \quad (i)$$

for the floor assembly with the load-bearing steel beams built in at their ends.

Knowing the design characteristics of the floor assembly - slab of normal concrete with a thickness 120 mm, load-bearing steel beams HE 300 B ($U_s/F_s = 99 \text{ m}^{-1}$) with $T_{s,\text{crit}} = 540^\circ\text{C}$, suspended ceiling with $(d_i/\lambda_i)_{\text{der}} = 0.075 \text{ m}^2 \text{ }^\circ\text{C W}^{-1}$ (Example 1) - the fire resistance t_{fr} , asked for, can be directly determined from table 6.2b. With linear interpolation, this gives

at a standard fire duration $t_d = 150 \text{ min}$

$$T_s = 505^\circ\text{C}, \quad T_i = 810^\circ\text{C}$$

and at a standard fire duration $t_d = 180 \text{ min}$

$$T_s = 550^{\circ}\text{C}, \quad T_i = 845^{\circ}\text{C}$$

The critical steel beam temperature $T_{s,crit} = 540^{\circ}\text{C}$ will be reached after a standard fire exposure of about 175 min, i.e. the fire resistance

$$t_{fr} = 175 \text{ min} \quad (\text{j})$$

The corresponding temperature at the centre level of the suspended ceiling T_i amounts to 840°C , i.e. about 60°C more than achieved in the fire resistance test on which the theoretical extrapolation is based. As a consequence, the calculated value of the fire resistance t_{fr} can not be used in practice until additional test - suitably a small scale test - has verified that the temperature $T_i = 840^{\circ}\text{C}$ does not cause any failure of the suspended ceiling.

Under this reservation, a comparison between problem (b) in Example 1 and the problem dealt with in the present example illustrates an increase of the fire resistance t_{fr} of about 30 % - from 135 to 175 min - when the support conditions of the load-bearing steel beams in the floor assembly are changed from simply supported to built in at both ends of the beams. In reality, a supplementary fire resistance test for the load-bearing steel beams having their ends built in can be expected to give a higher percentage increase of the fire resistance due to a favourable influence of a lower temperature within the support regions than at the centre of the span in ordinary fire resistance tests. A theoretical estimation of this influence, assuming a temperature difference of 100°C between the centre and the supports of the load-bearing steel beams at the time of collapse, gives an increase of about 50 instead of 30 % in the fire resistance by replacing the simply supported end conditions of the beams by built in end conditions in the actual case.

Example 3

A test roof assembly according to figure 1a is composed of a top slab of normal concrete with thickness 160 mm, simply supported steel beams

IPE 270 and a suspended ceiling of gypsum plaster slab type. At a fire resistance test, performed in conformity with DP 6167, the following values were recorded for the steel temperature T_s of the bottom flange at midspan of the centre supporting beam:

t min	7.5	15	22.5	30	37.5	45	52.5	60
T_s °C	25	30	40	50	95	150	225	300

The assembly was subjected to a test load producing the maximum permissible stress in the supporting steel beams.

After about 30 min fire exposure, the first cracks were observed in the suspended ceiling. The extent of the crack pattern then increased successively and a total failure of the suspended ceiling occurred after 60 min fire exposure. After this failure, the load-bearing steel beams were directly exposed to the hot gases in the test furnace, having a temperature of about 950°C at that time. The load-bearing steel beams collapsed about 4 min later by reaching a limit deflection. At the collapse, the steel temperature $T_{s,crit}$ of the bottom flange at midspan of the centre supporting beam was 490°C.

Since the test assembly had load-bearing steel beams of other section than HE 140 B or IPE 140, the diagrams in figure 6.1 can not be used as a basis for a direct derivation of $(d_i/\lambda_i)_{der}$ of the suspended ceiling. Consequently, the theoretical evaluation of the test must begin with a determination of the corresponding design basis applicable to a floor or roof assembly with the same steel beam section - IPE 270 with $U_s/F_s = 203 \text{ m}^{-1}$; cf. table 4.1.3a - and the same slab - normal concrete, thickness 160 mm - as for the test assembly. This determination can be done directly from table 6.2b, giving the time curves of the steel beam temperature for varying d_i/λ_i of the suspended ceiling in figure 6.3c.

The time curve of the steel temperature, measured at the fire resistance test of the floor assembly in the bottom flange at midspan of the centre supporting beam, is plotted in figure 6.3c as the dashed

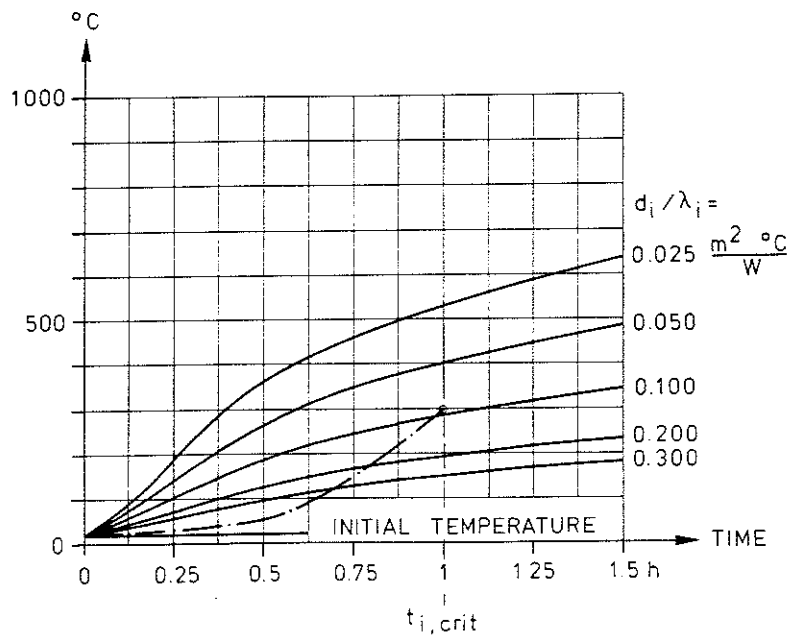

Figure 6.3c. Steel beam temperature versus time for varying d_i/λ_i of the suspended ceiling, applicable to a floor or roof assembly with a slab of normal concrete of thickness ≥ 100 mm and load-bearing steel beams IPE 270 - full line curves. Time curve of the steel temperature of the bottom flange at midspan of the centre supporting beam, measured at the fire resistance test of the assembly - dashed and dotted line curve

and dotted line curve. The tested type of suspended ceiling is apparently characterized by a time curve of the steel beam temperature with a form, which deviates considerably from the corresponding time curves, calculated for varying d_i/λ_i under the assumption of a completely intact suspended ceiling during the fire exposure. In such a case, the value $(d_i/\lambda_i)_{der}$ of the suspended ceiling should be determined for a criterion which requires, that the calculated time curve and the time curve measured in the test are giving the same steel beam temperature at the time of damage of the suspended ceiling $t_{i,crit}$ or at the time of collapse of the load-bearing steel beams $t_{s,crit}$ - cf. chapter 2. For the floor assembly tested, the time $t_{i,crit} = 60$ min decides. By applying this criterion, a linear interpolation between the time curves for $d_i/\lambda_i = 0.050$ and $0.100 \text{ m}^2 \text{ } ^\circ C \text{ W}^{-1}$ gives the value

$$(d_i/\lambda_i)_{\text{der}} = 0.095 \text{ m}^2 \text{ }^\circ\text{C W}^{-1} \quad (\text{a})$$

for the suspended ceiling. As appears from figure 6.3c, this value brings about a calculated steel beam temperature T_s which is generally higher than the measured temperature for $t < t_{i,\text{crit}}$.

The temperature at centre level of the suspended ceiling $T_{i,\text{crit}}$ at the time of damage $t_{i,\text{crit}} = 60 \text{ min}$ can be obtained directly from figure 6.1c which is approximately applicable irrespective of the steel beam section. For $d_i/\lambda_i = 0.095 \text{ m}^2 \text{ }^\circ\text{C W}^{-1}$, this gives

$$T_{i,\text{crit}} = 650^\circ\text{C} \quad (\text{b})$$

After having found $(d_i/\lambda_i)_{\text{der}}$ and $T_{i,\text{crit}}$ of the tested suspended ceiling, determine theoretically the fire resistance t_{fr} for a floor assembly, composed of a top slab of aerated concrete of density 600 kg m^{-3} and thickness 150 mm, load-bearing steel beams with (a) $U_s/F_s = 50$, (b) $U_s/F_s = 400 \text{ m}^{-1}$ and a spacing-depth ratio $C/H = 7$, and a suspended ceiling of the same type as the one tested.

The ratio between the design load Q and the ultimate load Q_u at ordinary room temperature is assumed to be the same as in the fire resistance test, i.e. the critical steel beam temperature $T_{s,\text{crit}} = 490^\circ\text{C}$.

The roof assembly in question connects to the design table 6.2d. By linear interpolation, this gives for $(d_i/\lambda_i)_{\text{der}} = 0.095 \text{ m}^2 \text{ }^\circ\text{C W}^{-1}$ at

$$\begin{aligned} t_d = 15 \text{ min: } T_s &= 75^\circ\text{C} \quad \text{for } U_s/F_s = 50 \text{ m}^{-1} \\ T_s &= 285^\circ\text{C} \quad \text{for } U_s/F_s = 400 \text{ m}^{-1} \\ T_i &= 565^\circ\text{C} \end{aligned}$$

$$\begin{aligned} t_d = 30 \text{ min: } T_s &= 195^\circ\text{C} \quad \text{for } U_s/F_s = 50 \text{ m}^{-1} \\ T_s &= 470^\circ\text{C} \quad \text{for } U_s/F_s = 400 \text{ m}^{-1} \\ T_i &= 670^\circ\text{C} \end{aligned}$$

Accordingly, the critical temperature of the suspended ceiling $T_{i,crit} = 650^{\circ}\text{C}$ is found to be attained after 27 min standard fire exposure. At this time, the steel beam temperature T_s is lower than the critical value $T_{s,crit} = 490^{\circ}\text{C}$ for both values of U_s/F_s . After the damage of the suspended ceiling, the steel beam temperature increases very rapidly and can be estimated to have reached the critical value about 6 min later for the alternative $U_s/F_s = 50 \text{ m}^{-1}$ and within less than 1 min for the alternative $U_s/F_s = 400 \text{ m}^{-1}$.

The fire resistance of the roof assembly in question, consequently, is $t_{fr} = 33 \text{ min}$, if the assembly has steel beams with $U_s/F_s = 50 \text{ m}^{-1}$, and $t_{fr} = 27 \text{ min}$, if the assembly has steel beams with $U_s/F_s = 400 \text{ m}^{-1}$.

7. SUMMARY

The draft proposal to ISO standard DP 6167 "Fire Resistance Test - Suspended Ceilings" specifies a test method for a determination of the contribution of a suspended ceiling to the fire resistance of an unventilated, load-bearing floor or roof assembly of the type shown in figure 1a. A primary aim of the test method is to give such information on the thermal and mechanical behaviour of the suspended ceiling at a fire exposure, that the test results can be used for a direct classification with an application in practise, which is as general as possible.

The fire resistance determined in the test then can be applied directly for a classification of a floor or roof assembly with the same structural design as the one tested. The fire resistance obtained can also be used for a direct classification on the safe side of a floor or roof assembly with the same suspended ceiling but with the rest of the assembly structurally modified in comparison to the tested assembly in such a way that the rate of heating of the load-bearing steel beams will be decreased.

Alternatively, the test results can serve as an input information for a theoretical extrapolation in order to get a more accurate determination of the fire resistance of structurally modified designs of the tested floor or roof assembly. This possibility is indicated in the commentary to DP 6167. The present paper is devoted to such a theoretical extrapolation of the test results.

Chapter 2 describes the main steps of the extrapolation procedure.

In a first step, the results of the fire resistance test are characterized summarily by the time curve of the maximum steel temperature in the load-bearing beams, the critical steel temperature $T_{s,crit}$ and the corresponding time $t_{s,crit}$ for a collapse of the load-bearing beams, and time $t_{i,crit}$ for a damage of the suspended ceiling, if any.

The second step comprises a determination of a derived value $(d_i/\lambda_i)_{der}$ of the tested suspended ceiling - d_i is a thickness measure and λ_i a thermal conductivity measure for the ceiling. The criterion for this determination is defined by figure 2b and c. The derived value

$(d_i/\lambda_i)_{\text{der}}$ characterizes the suspended ceiling in an integrated way with regard taken to the real design and behaviour at a fire exposure, including the influence of initial moisture content, crack formations, disintegration of materials, and partial failure of the ceiling and its fastening devices. If the suspended ceiling is damaged in the test, the time for this damage $t_{i,\text{crit}}$ is transferred in step 2 to a critical temperature at the centre level of the ceiling $T_{i,\text{crit}}$ according to figure 2d.

The third step comprises the calculation of the fire resistance of the floor or roof assembly in question, structurally modified in relation to the assembly tested. Entrance variables then are the type and thickness of slab, the derived value $(d_i/\lambda_i)_{\text{der}}$ of the suspended ceiling, and U_s/F_s for the steel beams - U_s is the heat exposed surface of the steel beams per unit length and F_s the volume of the steel beams per unit length. The limiting design criteria are the steel beam temperature $T_{s,\text{crit}}$ corresponding to a collapse of the load-bearing beams, and the critical temperature at the centre level of the suspended ceiling $T_{i,\text{crit}}$ at damage of the ceiling, if any.

In chapter 6, a design basis is presented in the form of tables and diagrams which facilitate the practical carrying through of the second and third steps of the theoretical evaluation. The chapter also includes some examples of the practical application of the evaluation procedure.

The design basis has been computed from the equations of heat transfer in a fire exposed floor or roof assembly, derived in chapter 3. A connected computer program is presented in Appendix A. Chapter 4 gives a survey of relevant thermal properties of steel, normal concrete, aerated concrete and some materials for suspended ceilings. Chapter 5 shows some comparisons of calculated time curves for the steel beam temperature with those measured in fire resistance tests. The comparisons validate the derived heat transfer equations, the computer program and the design basis, presented in chapter 6.

BIBLIOGRAPHY

- [1] ISO, Fire Resistance Tests - Elements of Building Construction. International Standard 834, 1975-11-01.
- [2] PETERSSON, O. - MAGNUSSON, S.E. - THOR, J., Fire Engineering Design of Steel Structures. Manual, Publication 50 from Swedish Institute of Steel Construction, Stockholm, and Bulletin 52 from Division of Structural Mechanics and Concrete Construction, Lund Institute of Technology, 1976 (Swedish edition 1974).
- [3] EHM, H. - WITTEVEEN, J., Die kritische Temperatur bei hochtemperaturbeanspruchten Bau - und Betonstählen. Der Stahlbau, 11/1970, p 339.
- [4] RYAN, J.V. - ROBERTSON, A.F., Proposed Criteria for Defining Load Failure of Beams, Floors, and Roof Construction During Fire Tests. Journal of Research of the National Bureau of Standards, Washington, Vol. 63 C, No. 2, 1959.
- [5] WITTEVEEN, J., Brandveiligheid Staalconstructies (Fire Resistance of Steel Structures). Centrum Bouwen in Staal, Rotterdam 1966.
- [6] ØDEEN, K., Theoretical Study of Fire Characteristics in Enclosed Spaces. Bulletin 10, Division of Building Construction, Royal Institute of Technology, Stockholm 1963.
- [7] MAGNUSSON, S.E. - THELANDERSSON, S., Temperature - Time Curves for the Complete Process of Fire Development. A Theoretical Study of Wood Fuel Fires in Enclosed Spaces. Acta Polytechnica Scandinavica, Ci 65, Stockholm 1970.
- [8] THOR, J., Strålningspåverkan på oisolerade eller undertaksisolerade stålkonstruktioner vid brand (Effect of Radiation during a Fire on Steel Structures with No Insulation or Insulation in the Form of a Suspended Ceiling). Bulletin 29, Division of Structural Mechanics and Concrete Construction, Lund Institute of Technology, Lund 1972.

- [9] ÖDEEN, K. - NORDSTRÖM, Å., Termiska egenskaper hos betong vid höga temperaturer (Thermal Properties of Concrete at High Temperatures). Cement och Betong 1972:1, Stockholm.

- [10] ANDERBERG, Y., Fire-Exposed Hyperstatic Concrete Structures - An Experimental and Theoretical Study. Bulletin 55, Division of Structural Mechanics and Concrete Construction, Lund Institute of Technology, Lund 1976.

- [11] ÖDEEN, K., Fire Resistance of Concrete Double T Units. Acta Polytechnica Scandinavica, Ci 48, Stockholm 1968.

- [12] HARMATHY, T.Z., Thermal Properties of Concrete at High Temperatures. Journal of Materials, ASTM, Vol. 5, No. 1, March 1970.

- [13] SAARE, E. - JANSSON, I., Measurement of Thermal Conductivity of Moist Porous Building Materials. Proceedings, Rilem Symposium on Light Weight Concrete, held in Gothenburg 1960, p 353.

- [14] KÜNZEL, H., Gasbeton. Wärme- und Feuchtigkeitsverhalten. Wiesbaden und Berlin 1971.

- [15] MAGNUSSON, S.E. - PETTERSSON, O., Brandteknisk dimensionering av isolerad stålkonstruktion i bärande eller avskiljande funktion (Fire Engineering Design of Insulated Load-Bearing or Separating Steel Structures). Väg- och vattenbyggaren No. 4, Stockholm 1969.

- [16] HARMATHY, T.Z., A Treatise on Theoretical Fire Endurance Rating. Research Paper No. 153, Division of Building Research, National Research Council, Canada, Ottawa 1962.

- [17] ÖDEEN, K. - ANAS, B., Brandskyddande undertak för stålkonstruktioner (Fire Protection for Steel Structures in the Form of a Suspended Ceiling). Byggmästaren No. 12, Stockholm 1969.

APPENDIX A. Computer Program for Heat Transfer Calculations of Fire Exposed Floor or Roof Assemblies with a Suspended Ceiling.

In chapter 3, an analytical model is presented for a simulation of the heat transfer within a fire exposed, unventilated floor or roof assembly of the type shown in figure 1a. The model gives the complete transient temperature field for the top slab, the supporting steel beams and the suspended ceiling.

The model is given in two alternative versions, corresponding to different degree of accuracy. In the less accurate version, the influence of the heat capacity of the suspended ceiling is neglected. In the more accurate version, this influence is considered. In both versions, the influence of the heat capacity of the slab is taken into account. Neglecting the heat capacity of the suspended ceiling is a reasonable approximation for floor or roof assemblies with ordinary types of suspended ceilings. For assemblies with suspended ceilings of large thickness and made of materials with high density, this approximation can give calculated temperatures which are too much on the safe side. The more accurate analysis, taking the heat stored in the suspended ceiling into consideration, then is suitable.

In what follows, a computer program is described for a determination of the transient temperature state in a fire exposed, unventilated floor or roof assembly with a suspended ceiling. The program is written in Standard FORTRAN and is directly based on the heat transfer equations derived in chapter 3.

Input data in the computer program are

- (1) the fire exposure characteristics, specified by the ISO time curve of the temperature rise within the test furnace according to Equation (1a)
- (2) the geometrical data of the floor or roof assembly
- (3) the emissivities of the combustion gases in the test furnace and of the surfaces of the suspended ceiling and the slab as well as the resultant emissivities between the suspended ceiling and the steel beams and between the slab and the steel beams

(4) the thermal properties of the different materials of the floor or roof assembly - the thermal conductivity and the volumetric enthalpy of the slab and suspended ceiling materials, the specific heat capacity and the density of the steel beam material

(5) a critical temperature state for damage, if any, of components of the suspended ceiling, e.g. a gypsum plaster slab.

A.1. Description of FUNCTIONS and SUBROUTINES in the program

A.1.1. INPUT

This SUBROUTINE contains reading of datacards. Following cards are included.

ESTIM-card. A logical which is true, when the heat capacity of the suspended ceiling is not considered, otherwise it is false.

NUMBER-card. Contains two integers. The first is telling how many strips the suspended ceiling is divided into and the second how many strips the suspended ceiling together with the floor slab are divided into, i.e. the total number of strips. If the heat capacity of the suspended ceiling is not considered, the suspended ceiling should not be divided into strips and consequently the first integer should be 0 (zero). If the heat capacity of the suspended ceiling is considered and the suspended ceiling is built up by slabs, which have a critical temperature state for damage and hence may fall down, the strips should coincide with the slabs, i.e. the first integer should be the same as the number of slabs. See also DX-card. Due to the width of the paper used when the result is printed, the number of strips of the suspended ceiling is limited to 8 and of the top slab to 7. However, this is possible to change by some adjustments in SUBROUTINE OUTPUT.

THICK-card. Contains two reals. The first value is the thickness of the suspended ceiling and the second the thickness of the top slab.

DX-card. One or two cards, containing reals. The values on the cards give the thickness of each strip, in order from the bottom to the top of the assembly. Naturally, the number of values are the same as the number of strips. If the heat capacity of the suspended ceiling is built up by slabs, which may fall down at a critical temperature state, the strips should coincide with the slabs, i.e. the thickness of the strips in the suspended ceiling should be the same as the thickness of the slabs.

TETI-card. Contains two reals. The first value shows the initial temperature in the whole assembly. The second value gives the chosen length

of the thermal exposure in hours.

TEXT-card. At least three cards. The first contains an integer, telling how many cards with text following. In this version of the program, the number of cards with text is limited to 14. This can easily be changed.

BEAM-card. Contains two reals. The first value gives the ratio U_S/F_S of the steel beams. The second value gives the density of the steel beam material.

EPS-card. Contains four resultant emissivities, viz. between the combustion gases and the suspended ceiling, between the suspended ceiling and the top slab, between the suspended ceiling and the beams and between the top slab and the beams. The order is as indicated above. The resultant emissivities should be reals with values according to sections 3.1.1 and 3.1.2.

DELTA 1-card. In the integrating SUBROUTINE KUTMER, the length of the time increment is adjusted by the SUBROUTINE so that the maximum relative error of the dependent variables is less than the value prescribed on this card. The card applies to the case of an intact suspended ceiling. In the calculations, presented in chapters 5 and 6 and in the following examples, a prescribed value of $1.0 \cdot 10^{-3}$ has been used.

SPECH-card. At least 3 cards and, in this version of the program, not more than 31 cards. The SPECH-card builds up a tabular of the temperature dependence of the specific heat capacity of the steel beams. The first card contains an integer, telling how many cards that follows. Each of these following cards has two reals, first a temperature and after that the corresponding specific heat capacity ($\text{J kg}^{-1} \text{C}^{-1}$).

CONFL-card. Between 3 and 31 cards, building up a tabular of the temperature dependence of the thermal conductivity of the top slab ($\text{Wm}^{-1} \text{C}^{-1}$), principally in the same way as the SPECH-card.

ENTFL-card. Between 3 and 31 cards, building up a tabular of the temperature dependence of the volumetric enthalpy (Jm^{-3}) of the top slab, principally in the same way as the SPECH-card.

CONIS-card. Between 3 and 31 cards, building up a tabular of the temperature dependence of the thermal conductivity of suspended ceiling ($\text{Wm}^{-1}\text{C}^{-1}$), principally in the same way as the SPECH-card.

GYPSUM-card. A logical, which is true, when the suspended ceiling is built up by slabs, which are damaged and fall down at certain critical temperatures. The card also applies to suspended ceilings of other materials, being damaged at certain critical temperatures and by that causing the ceiling to fall down. A postulate is that the heat capacity of the suspended ceiling is considered in the calculation, i.e. if the GYPSUM-card is true, the ESTIM-card must be false. For suspended ceilings, which are intact during the fire exposure, the logical has the value false.

If the ESTIM-card has the value true, no more input data are required.

ENTIS-card. Between 3 and 31 cards, building up a tabular of the temperature dependence of the volumetric enthalpy (Jm^{-3}) of the suspended ceiling, principally in the same way as the SPECH-card.

FALL-card. Contains three reals. The first one is giving the critical temperature between the lowest and the second lowest slab, when the lowest one falls down. The second tells the critical temperature in the middle of the last slab, when this falls down. The last value gives the resultant emissivity between the flames - combustion gases in the furnace - and the unprotected steel beams. See section 3.1.4.

DELTA 2-card. This card, which contains a real, fills the same demand as the DELTA 1-card but for the case, that the suspended ceiling has fallen down. In the calculations for the following Example 3, the value $0.5 \cdot 10^{-3}$ has been prescribed.

FENIS-card. Between 3 and 31 cards, building up a tabular of the temperature dependence of the volumetric enthalpy (Jm^{-3}) of the lowest slab, i.e. the lowest strip, of the suspended ceiling, principally in the same way as the SPECH-card. Although the FENIS-card is the same as the ENTIS-card, the values must be red again.

That completes the list of input data.

A.1.2. Other FUNCTIONS and SUBROUTINES

CALCUL

This SUBROUTINE calculates the net inflow of heat per m^2 and s to each of the strips at a certain temperature condition.

ECHO

At a call to this SUBROUTINE, the input data will be written out in a suitable form.

ENTTEM

This SUBROUTINE transfers the enthalpy of all the strips into temperature.

FATEST

This SUBROUTINE investigates, if the critical falldown temperature of the suspended ceiling is reached. An accepted deviation of $\pm 5^{\circ}C$ from the critical falldown temperature is prescribed. Everything is OK, if the temperature is less, but if it is higher the calculation in the integrating SUBROUTINE KUTMER is repeated with a shorter length of the time increment. Prescribed, accepted deviation can easily be changed.

INTVUE

At a call to this SUBROUTINE, a number of variables are given their initial values.

KUTMER

This SUBROUTINE integrates a system of ordinary first order differential equations from one point of time to another, by the Kutta-Mersons method. The length of the time increment is adjusted by the SUBROUTINE so that the maximum relative error of the dependent variables is less than a prescribed value, see DELTA 1-card and DELTA 2-card. The evaluation of the temperature in the assembly is done in two steps. First an integration is done to determine the temperature of the strips. When this step is finalized, a determination of the temperature of the steel beams is done. If the steel beams are unprotected - after a damage of the suspended ceiling - their temperature is determined directly without any calculation of the temperature in the strips. The SUBROUTINE is not written in a general way but directly adapted to the program. This SUBROUTINE can be seen as a main program.

OUTPUT

This SUBROUTINE gives outprint of the evaluated temperatures of the assembly with a time interval not less than 0.025 h. The interval can be adjusted in SUBROUTINE KUTMER. The form of the outprint is adapted to the number of strips in the suspended ceiling and the top slab, and further more to the consideration of the heat capacity of the suspended ceiling and to a falling down of ceiling slabs, if any.

REDUCE

This SUBROUTINE adjusts the values of some variables after a falling down of a ceiling slab.

STETEM

This SUBROUTINE calculates the derivative of the temperature of the steel beam at a certain temperature condition.

SURTEM

A SUBROUTINE, which determines the surface temperatures at the bottom and the top surfaces of both the suspended ceiling and the top slab at a certain temperature condition.

TEMENT

This SUBROUTINE transfers the temperature of all the strips into enthalpy.

THCOND

This SUBROUTINE determines the surface coefficient of heat transfer in the boundary layer between the combustion gases and the suspended ceiling and the surface coefficient of heat transfer between the suspended ceiling and the top slab. If the heat capacity of the suspended ceiling is not considered, the SUBROUTINE also determines the thermal conductivity of the suspended ceiling. If the whole suspended ceiling has fallen down, only the surface coefficient of heat transfer in the boundary layer between the combustion gases and the steel beams is determined.

UNPRCT

This SUBROUTINE calculates the derivative of the temperature of steel beam, when the whole suspended ceiling has fallen down. The derivative

depends on the temperatures of the steel beam and the combustion gases.

XINTPO

This FUNCTION works as a table look up function in an array with two colons. For a certain value in the second colon, the function looks up the corresponding value in the first colon.

YINTPO

This FUNCTION works as a table look up function in an array with two colons. For a certain value in the first colon, the function looks up the corresponding value in the second colon.

WRONG

If the input value in the functions XINTPO and YINTPO is outside the values of the table, this SUBROUTINE prints out the input value and the table.

A.2. Main program

The main program starts with some preparatory measures. After the reading of the input data, an input receipt is printed as a control and some checking measures are made. Finally, the head of the table is printed and some variables are given their initial values.

Then the calculation procedure is called upon and at the end the result is printed. The calculation procedure must be followed only if the heat capacity of the suspended ceiling is considered and the suspended ceiling is built up by slabs, which are damaged and fall down at certain temperature conditions. After a falling down of a ceiling slab, some adjusting measures must be done and then the integration procedure is called upon again. The time of the falling down is printed after the table.

A3. Listing of computer program

```

MAIN PROGRAM
1* COMMON /A/ESTIM,N,DX(15),THICIS,THICFL
2* COMMON /B/TIME,Y(16),TIMEFL,FIRST
3* COMMON /E/EPS1,EPS2,TEXT(14,14),NTEXT,TIMEAT
4* COMMON /F/IPHASE,GYPSUM,FALL,NISOL,ROOMT
5* COMMON /J/NFALL,TIFALL(8),X(16)
6* EXTERNAL CALCUL,UNPRCT
7* LOGICAL ESTIM,GYPSUM,FALL,FIRST
8* 100 FORMAT(1H1,49H TIME TFL TS1 -TEMPERATURE IN THE SUSPENDED,
9* *62H CEILING STRIPS- TS2 TST TS3 -TEMPERATURE IN THE FLOOR,
10* *20H SLAB STRIPS- TS4/)
11* 101 FORMAT(1H1,48H TIME TFL TS1 TIS TS2 TST TS3 -TEM,
12* *41HPERATURE IN THE FLOOR SLAB STRIPS- TS4/)
13* 102 FORMAT(54H IT IS NOT POSSIBLE TO HAVE BOTH GYPSUM AND ESTIM TRUE)
14* 103 FORMAT(1X,29HTIME FOR FALL OF GYPSUM SLAB:,8(F6.0,11H MINUTES ))
15* 104 FORMAT(51H IF ESTIM ARE TRUE,THEN NISOL MUST BE EQUAL TO ZERO)
16* 105 FORMAT(51H IF ESTIM ARE FALSE,THEN NISOL MUST NOT BE EQUAL TO,
17* *5H ZERO)
18* CALL INPUT
19* CALL ECHO
20* IF(ESTIM) GO TO 14
21* IF(NISOL.NE.0) GO TO 13
22* WRITE(6,105)
23* STOP
24* 14 IF(GYPSUM) WRITE(6,102)
25* IF(NISOL.NE.0) WRITE(6,104)
26* IF((NISOL.NE.0).OR.GYPSUM) STOP
27* 13 IF(.NOT.ESTIM) WRITE(6,100)
28* IF(ESTIM) WRITE(6,101)
29* CALL INTVUE
30* 12 CALL KUTMER(N,TIME,Y,EPS1,TIMEFL,CALCUL,FIRST,X)
31* IF(.NOT.GYPSUM) STOP
32* IF(.NOT.FALL) GO TO 10
33* CALL REDUCE(TIME)
34* TIMEFL=TIMEAT-TIME
35* IF(TIMEFL.LT.0.05) GO TO 10
36* NN=N+1
37* DO 11 I=1,NN
38* 11 Y(I)=X(I)
39* IF(NISOL.NE.0) GO TO 12
40* IPHASE=2
41* Y(1)=X(N+1)
42* N=1
43* CALL KUTMER(N,TIME,Y,EPS2,TIMEFL,UNPRCT,FIRST,X)
44* 10 IF(NFALL.NE.0) WRITE(6,103) (TIFALL(I),I=1,NFALL)
45* STOP
46* END

```

```

1* SUBROUTINE CALCUL(TIME,ENT,RES)
2* COMMON /A/ESTIM,N,DX(15),THICIS,THICFL
3* COMMON /F/IPHASE,GYPSUM,FALL,NISOL,ROOMT
4* COMMON /G/CONIS(30,2),NCONIS,CONFL(30,2),NCONFL,ECONIS,TFALL1,
5* *TFALL2
6* COMMON /I/ALFIN,ALFAIR,ALFOUT,EPSIN1,EPSIN2,EPSAIR
7* LOGICAL ESTIM,GYPSUM,FALL
8* DIMENSION ENT(1),RES(1),TEMP(16),DENOM(16),PSI(16)
9* CALL ENTTEM(ENT,TEMP)
10* TEMP(N+1)=ROOMT
11* TFL=345.*ALOG10(480.*TIME+1.)+ROOMT
12* DENOM0=1./ALFIN
13* IF(ESTIM) DENOM0=DENOM0+THICIS/ECONIS+1./ALFAIR
14* IF(NISOL.EQ.0) GO TO 11
15* DO 10 I=1,NISOL
16* 10 DENOM(I)=DX(I)/(2.*YINTPO(TEMP(I),CONIS,NCONIS))
17* 11 NNISOL=NISOL+1
18* DO 12 I=NNISOL,N
19* 12 DENOM(I)=DX(I)/(2.*YINTPO(TEMP(I),CONFL,NCONFL))
20* DENOM(N+1)=1./ALFOUT
21* PSI(1)=1./(DENOM0+DENOM(1))
22* NN=N+1
23* DO 13 I=2,NN
24* 13 PSI(I)=1./(DENOM(I-1)+DENOM(I))
25* IF(NISOL.NE.0) PSI(NISOL+1)=1./(DENOM(NISOL)+1./ALFAIR+

```

```

26*      *DENOM(NISOL+1))
27*      RES(1)=(PSI(1)*(TFL-TEMP(1))-PSI(2)*(TEMP(1)-TEMP(2)))*3600.
28*      DO 14 I=2,N
29*      14 RES(I)=(PSI(I)*(TEMP(I-1)-TEMP(I))-PSI(I+1)*(TEMP(I)-TEMP(I+1)))*
30*      *3600.
31*      RETURN
32*      END

```

```

1*      SUBROUTINE ECHO
2*      COMMON /A/ESTIM,N,DX(15),THICIS,THICFL
3*      COMMON /D/ADIVV,DENS,SPECH(30,2),NSPECH,EPST2,EPST3
4*      COMMON /E/EPS1,EPS2,TEXT(14,14),NTEXT,TIMEAT
5*      COMMON /F/IPHASE,GYPSUM,FALL,NISOL,ROOMT
6*      COMMON /G/CONIS(30,2),NCONIS,CONFL(30,2),NCONFL,ECONIS,TFALL1,
7*      *TFALL2
8*      COMMON /H/ENTIS(30,2),NENTIS,ENTFL(30,2),NENTFL,FENIS(30,2),NFENIS
9*      COMMON /I/ALFIN,ALFAIR,ALFOUT,EPSIN1,EPSIN2,EPSAIR
10*     LOGICAL ESTIM,GYPSUM,FALL
11*     100 FORMAT(1H,13A6,A2)
12*     101 FORMAT(1X,13A6,A2)
13*     102 FORMAT(/41H GAS TEMPERATURE IN THE FIRE COMPARTMENT:)
14*     103 FORMAT(1X,F10.3,2H H,18X,F10.0,12H DEG CELSIUS)
15*     104 FORMAT(/42H ORIGINAL TEMPERATURE OF THE CONSTRUCTION=F4.0,4H DEG,
16*     *8H CELSIUS)
17*     127 FORMAT(33H THE LENGTH OF THE HEATING PHASE=F6.3,2H H)
18*     130 FORMAT(/50H NO CONSIDERATION IS TAKEN TO THE HEAT CAPACITY OF,
19*     *43H THE SUSPENDED CEILING,THAT WILL SAY ESTIM=L2)
20*     131 FORMAT(/51H CONSIDERATION IS TAKEN TO THE HEAT CAPACITY OF THE,
21*     *39H SUSPENDED CEILING,THAT WILL SAY ESTIM=L2)
22*     128 FORMAT(/45H THE MATERIAL IN THE SUSPENDED CEILING IS NOT,
23*     *34H GYPSUMLIKE,THAT WILL SAY: GYPSUM=L2)
24*     129 FORMAT(/52H THE MATERIAL IN THE SUSPENDED CEILING IS GYPSUMLIKE,
25*     *25H,THAT WILL SAY: GYPSUM=L2)
26*     105 FORMAT(36H THICKNESS OF THE SUSPENDED CEILING=F6.3,2H M/
27*     *18H NJMREK OF STRIPS=L3)
28*     106 FORMAT(25H THICKNESS OF THE STRIPS=L8(F8.3,2H M))
29*     107 FORMAT(/47H THERMAL CONDUCTIVITY OF THE SUSPENDED CEILING:)
30*     108 FORMAT(1X,F10.0,12H DEG CELSIUS,8X,F10.5,16H W/M DEG CELSIUS)
31*     109 FORMAT(/35H ENTHALPY OF THE SUSPENDED CEILING:)
32*     110 FORMAT(1X,F10.0,12H DEG CELSIUS,4X,F14.0,7H J/CU M)
33*     112 FORMAT(/36H ENTHALPY OF THE LOWEST GYPSUM SLAB:)
34*     113 FORMAT(/53H TEMPERATURE BETWEEN THE LOWEST AND THE SECOND LOWEST,
35*     *38H GYPSUM SLAB,THEN THE LOWEST ONE FALLS/6H DOWN=F5.0,4H DEG,
36*     *8H CELSIUS/ 50H TEMPERATURE IN THE MIDDLE OF THE LAST GYPSUM SLAB
37*     *20H,THEN IT FALLS DOWN=F5.0,12H DEG CELSIUS)
38*     114 FORMAT(/30H DENSITY OF THE STEEL GIRDERS=F6.0,8H KG/CU M/
39*     *60H SURFACE AREA OF THE STEEL SECTION,WITH THE EXCEPTION OF THE,
40*     *40H PART CARRYING THE FLOOR SLAB PER VOLUME/13H OF THE STEEL,
41*     *15H SECTION,ADIVV=F7.2,10H SQ M/CU M)
42*     115 FORMAT(/45H SPECIFIC HEAT CAPACITY OF THE STEEL GIRDERS:)
43*     116 FORMAT(1X,F10.0,12H DEG CELSIUS,8X,F10.3,17H J/KG DEG CELSIUS)
44*     117 FORMAT(/29H THICKNESS OF THE FLOOR SLAB=F6.3,2H M/ 7H NUMBER,
45*     *11H OF STRIPS=L3)
46*     118 FORMAT(/40H THERMAL CONDUCTIVITY OF THE FLOOR SLAB:)
47*     119 FORMAT(/26H ENTHALPY OF THE FLOOR SLAB:)
48*     120 FORMAT(/52H THE RESULTANT EMISSIVITY BETWEEN THE FLAMES AND THE,
49*     *19H SUSPENDED CEILING=F5.3)
50*     121 FORMAT(52H THE RESULTANT EMISSIVITY BETWEEN THE FLAMES AND THE,
51*     *26H UNPROTECTED STEEL GIRDER=F5.3)
52*     122 FORMAT(47H THE RESULTANT EMISSIVITY BETWEEN THE SUSPENDED,
53*     *28H CEILING AND THE FLOOR SLAB=F5.3)
54*     123 FORMAT(52H THE RESULTANT EMISSIVITY BETWEEN THE GIRDER AND THE,
55*     *12H FLOOR SLAB=F5.3)
56*     124 FORMAT(52H THE RESULTANT EMISSIVITY BETWEEN THE GIRDER AND THE,
57*     *19H SUSPENDED CEILING=F5.3)
58*     125 FORMAT(/38H THE ALLOWABLE ERROR IN THE ITERATION=E9.2)
59*     126 FORMAT(51H THE ALLOWABLE ERROR IN THE ITERATION,IF ALL GYPSUM,
60*     *18H SLABS HAS FALLEN=E9.2)
61*     WRITE(6,100) (TEXT(I,1),I=1,14)
62*     DO 10 J=2,NTEXT
63*     10 WRITE(6,101) (TEXT(I,J),I=1,14)
64*     WRITE(6,102)
65*     T=0.
66*     11 TFL=345.*ALOG10(480.*T+1.)+ROOMT
67*     WRITE(6,103) T,TFL
68*     DELTAT=0.05
69*     IF(T.GT.1.299) DELTAT=0.10
70*     IF(T.GT.0.999) DELTAT=0.25
71*     IF(T.GT.1.499) DELTAT=0.50
72*     T=T+DELTAT
73*     IF(T.LE.(TIMEAT+DELTAT-0.001)) GO TO 11

```

```

74*      WRITE(6,104) ROOMT
75*      WRITE(6,127) TIMEAT
76*      IF(ESTIM) WRITE(6,130) ESTIM
77*      IF(.NOT.ESTIM) WRITE(6,131) ESTIM
78*      IF(.NOT.GYPSUM) WRITE(6,128) GYPSUM
79*      IF(GYPSUM) WRITE(6,129) GYPSUM
80*      WRITE(6,105) THICIS,NISOL
81*      IF(NISOL.NE.0) *WRITE(6,106) (DX(I),I=1,NISOL)
82*      WRITE(6,107)
83*      DO 13 I=1,NCONIS
84*      13  WRITE(6,108) CONIS(I,1),CONIS(I,2)
85*      IF(ESTIM) GO TO 16
86*      WRITE(6,109)
87*      DO 14 I=1,NENTIS
88*      14  WRITE(6,110) ENTIS(I,1),ENTIS(I,2)
89*      IF(.NOT.GYPSUM) GO TO 16
90*      WRITE(6,112)
91*      DO 17 I=1,NFENIS
92*      17  WRITE(6,110) FENIS(I,1),FENIS(I,2)
93*      WRITE(6,113) TFALL2,TFALL1
94*      16  WRITE(6,114) DENS,ADIVV
95*      WRITE(6,115)
96*      DO 18 I=1,NSPECH
97*      18  WRITE(6,116) SPECH(I,1),SPECH(I,2)
98*      NFL=N-NISOL
99*      WRITE(6,117) THICFL,NFL
100*     NNISOL=NISOL+1
101*     WRITE(6,106) (DX(I),I=NNISOL,N)
102*     WRITE(6,118)
103*     DO 20 I=1,NCONFL
104*     20  WRITE(6,108) CONFL(I,1),CONFL(I,2)
105*     WRITE(6,119)
106*     DO 21 I=1,NENTFL
107*     21  WRITE(6,110) ENTFL(I,1),ENTFL(I,2)
108*     WRITE(6,120) EPSIN1
109*     IF(GYPSUM) WRITE(6,121) EPSIN2
110*     WRITE(6,122) EPSAIR
111*     WRITE(6,123) EPSST3
112*     WRITE(6,124) EPSST2
113*     WRITE(6,125) EPS1
114*     IF(GYPSUM) WRITE(6,126) EPS2
115*     RETURN
116*     END

```

```

1*      SUBROUTINE ENTTEM(ENT,TEM)
2*      COMMON /A/ESTIM,N,DX(15),THICIS,THICFL
3*      COMMON /F/IPHASE,GYPSUM,FALL,NISOL,ROOMT
4*      COMMON /H/ENTIS(30,2),NENTIS,ENTFL(30,2),NENTFL,FENIS(30,2),NFENIS
5*      LOGICAL GYPSUM,ESTIM,FALL
6*      DIMENSION ENT(1),TEM(1)
7*      IF(.NOT.GYPSUM) GO TO 11
8*      TEM(1)=XINTPO(ENT(1)/DX(1),FENIS,NFENIS)
9*      IF(NISOL.EQ.1) GO TO 13
10*     DO 10 I=2,NISOL
11*     10  TEM(I)=XINTPO(ENT(I)/DX(I),ENTIS,NENTIS)
12*     GO TO 13
13*     11  IF(NISOL.EQ.0) GO TO 13
14*     DO 12 I=1,NISOL
15*     12  TEM(I)=XINTPO(ENT(I)/DX(I),ENTIS,NENTIS)
16*     13  NNISOL=NISOL+1
17*     DO 14 I=NNISOL,N
18*     14  TEM(I)=XINTPO(ENT(I)/DX(I),ENTFL,NENTFL)
19*     RETURN
20*     END

```

```

1*      SUBROUTINE FATEST(Y,NISOL,FALL,PASS)
2*      COMMON /A/ESTIM,N,DX(15),THICIS,THICFL
3*      COMMON /G/CONIS(30,2),NCONIS,CONFL(30,2),NCONFL,FCONIS,TFALL1,
4*      *TFALL2
5*      DIMENSION Y(1)
6*      LOGICAL FALL,PASS
7*      FALL=.FALSE.
8*      PASS=.FALSE.
9*      IF(NISOL.LQ.1) GO TO 10
10*     HCON1=YINTPO(Y(1),CONIS,NCONIS)
11*     HCON2=YINTPO(Y(2),CONIS,NCONIS)
12*     TCRIT=(Y(1)*HCON1*DX(2)+Y(2)*HCON2*DX(1))/(HCON1*DX(2)+HCON2*

```



```

13*      *DX(1)
14*      IF(TCRIT.GT.(TFALL2-5.)) FALL=.TRUE.
15*      IF(TCRIT.GT.(TFALL2+5.)) PASS=.TRUE.
16*      RETURN
17* 10    TCRIT=Y(1)
18*      IF(TCRIT.GT.(TFALL1-5.)) FALL=.TRUE.
19*      IF(TCRIT.GT.(TFALL1+5.)) PASS=.TRUE.
20*      RETURN
21*      END

1*      SUBROUTINE INPUT
2*      COMMON /A/ESTIM,N,DX(15),THICIS,THICFL
3*      COMMON /D/ADIVV,DENS,SPECH(30,2),NSPECH,EPSST2,EPSST3
4*      COMMON /E/EPS1,EPS2,TEXT(14,14),NTEXT,TIHEAT
5*      COMMON /F/IPHASE,GYPSUM,FALL,NISOL,ROOMT
6*      COMMON /G/CONIS(30,2),NCONIS,CONFL(30,2),NCONFL,FCONIS,TFALL1,
7*      *TFALL2
8*      COMMON /H/ENTIS(30,2),NENTIS,ENTFL(30,2),NENTFL,FENIS(30,2),NFENIS
9*      COMMON /I/ALF1,ALFAIR,ALFOUT,EPSIN1,EPSIN2,EPSAIR
10*     LOGICAL GYPSUM,ESTIM,FALL
11* 101   FORMAT(8F10.3)
12* 102   FORMAT(8E10.3)
13* 103   FORMAT(I10/(2F10.3))
14* 104   FORMAT(8L10)
15* 105   FORMAT(8I10)
16* 106   FORMAT(13A6,A2)
17*      READ(5,104) ESTIM
18*      READ(5,105) NISOL,N
19*      READ(5,101) THICIS,THICFL
20*      READ(5,101) (DX(I),I=1,N)
21*      READ(5,101) ROOMT,TIHEAT
22*      READ(5,105) NTEXT
23*      DO 11 J=1,NTEXT
24* 11    READ(5,106) (TEXT(I,J),I=1,14)
25*      READ(5,101) ADIVV,DENS
26*      READ(5,101) EPSIN1,EPSAIR,EPSST2,EPSST3
27*      READ(5,102) EPS1
28*      READ(5,103) NSPECH,(SPECH(I,1),SPECH(I,2),I=1,NSPECH)
29*      READ(5,103) NCONFL,(CONFL(I,1),CONFL(I,2),I=1,NCONFL)
30*      READ(5,103) NENTFL,(ENTFL(I,1),ENTFL(I,2),I=1,NENTFL)
31*      READ(5,103) NCONIS,(CONIS(I,1),CONIS(I,2),I=1,NCONIS)
32*      READ(5,104) GYPSUM
33*      IF((.NOT.ESTIM).OR.GYPSUM) READ(5,103) NENTIS,(ENTIS(I,1),
34*      *ENTIS(I,2),I=1,NENTIS)
35*      IF(.NOT.GYPSUM) RETURN
36* 10    READ(5,101) TFALL1,TFALL2,EPSIN2
37*      READ(5,102) EPS2
38*      READ(5,103) NFENIS,(FENIS(I,1),FENIS(I,2),I=1,NFENIS)
39*      RETURN
40*      END

1*      SUBROUTINE INTVUE
2*      COMMON /A/ESTIM,N,DX(15),THICIS,THICFL
3*      COMMON /B/TIME,Y(16),TIMEFL,FIRST
4*      COMMON /C/TSURF(4),HC,IPLOC,ILOC,TIMOUT
5*      COMMON /E/EPS1,EPS2,TEXT(14,14),NTEXT,TIHEAT
6*      COMMON /F/IPHASE,GYPSUM,FALL,NISOL,ROOMT
7*      COMMON /J/NFALL,TIFALL(8),X(16)
8*      LOGICAL FIRST,FALL,ESTIM,GYPSUM
9*      FIRST=.TRUE.
10*     IPHASE=1
11*     DO 10 I=1,4
12* 10    TSURF(I)=ROOMT
13*     TSTEEL=ROOMT
14*     DO 11 I=1,N
15* 11    Y(I)=ROOMT
16*     Y(N+1)=TSTEEL
17*     TIME=0.
18*     TIMEFL=TIHEAT
19*     IF(.NOT.GYPSUM) RETURN
20*     NFALL=0
21*     DO 14 I=1,NISOL
22* 14    TIFALL(I)=0.
23*     RETURN
24*     END

```

```
1*      SUBROUTINE KUTMER(N,TIME,Y,EPS,H,FCT,FIRST,X)
2*      COMMON /C/TSURF(4),HC,IPLOC,ILOC,TIMOUT
3*      COMMON /F/IPHASE,GYPSUM,FALL,NISOL,ROOMT
4*      DIMENSION Y(1),X(1),Y0(15),YENT0(15),YENT1(15),YENT2(15),
5*      *FENT0(15),FENT1(15),FENT2(15),TS(4)
6*      LOGICAL GYPSUM,FALL,FIRST,DOUBLE,PASS
7*      DO 10 I=1,N
8*      10  Y0(I)=Y(I)
9*          IF(IPHASE.EQ.1) TSTEEL=Y(N+1)
10*         IF(.NOT.FIRST) GO TO 11
11*         INDEX=INT(ALOG10(H/0.010)/ALOG10(2.))+0.5)
12*         IF(INDEX.LT.0) INDEX=0
13*         IPLOC=2**INDEX
14*         HC=H/FLOAT(IPLOC)
15*         ILOC=0
16*         TIMOUT=-0.00001
17*         FIRST=.FALSE.
18*      11  IF(IPHASE.EQ.2) YENT0(1)=Y0(1)
19*          IF(IPHASE.EQ.2) TSURF(1)=Y0(1)
20*          IF(IPHASE.EQ.1) CALL TEMENT(Y0,YENT0)
21*      23  CALL THCOND(TIME,TSURF)
22*      18  CALL FCT(TIME,YENT0,FENT0)
23*          DO 12 I=1,N
24*          12  YENT1(I)=YENT0(I)+HC/3.*FENT0(I)
25*              CALL FCT(TIME+HC/3.,YENT1,FENT1)
26*              DO 13 I=1,N
27*              13  YENT1(I)=YENT0(I)+HC/6.*FENT0(I)+HC/6.*FENT1(I)
28*                  CALL FCT(TIME+HC/3.,YENT1,FENT1)
29*                  DO 14 I=1,N
30*                  14  YENT1(I)=YENT0(I)+HC/8.*FENT0(I)+3.*HC/8.*FENT1(I)
31*                      CALL FCT(TIME+HC/2.,YENT1,FENT2)
32*                      DO 15 I=1,N
33*                      15  YENT1(I)=YENT0(I)+HC/2.*FENT0(I)-3.*HC/2.*FENT1(I)+2.*HC*FENT2(I)
34*                          CALL FCT(TIME+HC,YENT1,FENT1)
35*                          DO 16 I=1,N
36*                          16  YENT2(I)=YENT0(I)+HC/6.*FENT0(I)+2.*HC/3.*FENT2(I)+HC/6.*FENT1(I)
37*                              DOUBLE=.TRUE.
38*                              DO 17 J=1,N
39*                              ERROR=ABS(0.2-0.2*YENT2(J)/YENT1(J))
40*                              IF(ERROR.LE.EPS) GO TO 17
41*                              HC=HC/2.
42*                              IPLOC=IPLOC*2
43*                              ILOC=ILOC*2
44*                              GO TO 18
45*      17  IF(ERROR*64..GT.EPS) DOUBLE=.FALSE.
46*          IF(IPHASE.EQ.1) GO TO 19
47*          Y0(1)=YENT2(1)
48*          TSURF(1)=YENT2(1)
49*          TSTEEL=YENT2(1)
50*          GO TO 20
51*      19  CALL ENTTEM(YENT2,Y0)
52*          IF(.NOT.GYPSUM) GO TO 27
53*          CALL FATEST(Y0,NISOL,FALL,PASS)
54*          IF(.NOT.PASS) GO TO 27
55*          HC=HC/2.
56*          IPLOC=IPLOC*2
57*          ILOC=ILOC*2
58*          GO TO 18
59*      27  CALL SURTEM(TIME+HC,Y0,TS)
60*          CALL STETEM(TSURF(2),TSURF(3),TSTEEL,ADD0)
61*          TST=TSTEEL+HC/3.*ADD0
62*          CALL STETEM((2.*TSURF(2)+TS(2))/3.,(2.*TSURF(3)+TS(3))/3.,TST,
63*          *ADD1)
64*          TST=TSTEEL+HC/6.*ADD0+HC/6.*ADD1
65*          CALL STETEM((2.*TSURF(2)+TS(2))/3.,(2.*TSURF(3)+TS(3))/3.,TST,
66*          *ADD1)
67*          TST=TSTEEL+HC/8.*ADD0+3.*HC/8.*ADD1
68*          CALL STETEM((TSURF(2)+TS(2))/2.,(TSURF(3)+TS(3))/2.,TST,ADD2)
69*          TST=TSTEEL+HC/2.*ADD0-3.*HC/2.*ADD1+2.*HC*ADD2
70*          CALL STETEM(TS(2),TS(3),TST,ADD1)
71*          TIT=TSTEEL+HC/6.*ADD0+2.*HC/3.*ADD2+HC/6.*ADD1
72*          ERROR=ABS(0.2-0.2*TIT/TST)
73*          IF(ERROR.LE.EPS) GO TO 28
74*          HC=HC/2.
75*          IPLOC=IPLOC*2
76*          ILOC=ILOC*2
77*          GO TO 18
78*      28  IF(ERROR*64..GT.EPS) DOUBLE=.FALSE.
79*          TSTEEL=TIT
80*          DO 29 I=1,4
81*          29  TSURF(I)=TS(I)
82*          20  ILOC=ILOC+1
83*          TIME=TIME+HC
84*          DO 21 I=1,N
85*          21  YENT0(I)=YENT2(I)
```

```

86*      IF(TIMOUT.GT.TIME) GO TO 26
87*      CALL OUTPUT(TIME,Y0,TSURF,TSTEEL)
88*      TIMOUT=TIME+0.02499
89*      26  IF(ILOC.GE.IPLOC) GO TO 24
90*      IF((.NOT.GYPSUM).OR.(IPHASE.EQ.2)) GO TO 22
91*      IF(FALL) GO TO 24
92*      22  IF((MOD(ILOC,2).NE.0).OR.(IPLOC.LE.1).OR.(.NOT.DOUBLE)) GO TO 23
93*      HC=HC*2.
94*      ILOC=ILOC/2
95*      IPLOC=IPLOC/2
96*      GO TO 23
97*      24  DO 25 I=1,N
98*      25  X(I)=Y0(I)
99*      IF(IPHASE.EQ.1) X(N+1)=TSTEEL
100*     RETURN
101*     END

```

```

1*      SUBROUTINE OUTPUT(TIME,Y0,TSURF,TSTEEL)
2*      COMMON /A/ESTIM,N,DX(15),THICIS,THICFL
3*      COMMON /F/IPHASE,GYPSUM,FALL,NISOL,ROOMT
4*      LOGICAL ESTIM,GYPSUM,FALL
5*      DIMENSION Y0(1),TSURF(1),OUT(3),SEC(8)
6*      100  FORMAT(1X,F5.3,13F6.0)
7*      101  FORMAT(1H+,83X,F6.0)
8*      102  FORMAT(1X,F5.3,2F6.0)
9*      103  FORMAT(1H+,125X,F6.0)
10*     104  FORMAT(1X,F5.3,F6.0,60X,F6.0)
11*     DATA OUT(1),OUT(3)/5H(1H+,5HF6.0)/
12*     DATA SEC/6H59X,11,6H53X,12,6H47X,13,6H41X,14,6H35X,15,6H29X,16,
13*     *6H23X,17,6H17X,18/
14*     TFL=345.*ALOG10(480.*TIME+1.)+ROOMT
15*     IF(.NOT.ESTIM) GO TO 10
16*     TISOL=(TSURF(1)+TSURF(2))*0.5
17*     WRITE(6,100) TIME,TFL,TSURF(1),TISOL,TSURF(2),TSTEEL,TSURF(3),
18*     *(Y0(I),I=1,N)
19*     WRITE(6,101) TSURF(4)
20*     RETURN
21*     10  IF(IPHASE.EQ.2) GO TO 11
22*     WRITE(6,102) TIME,TFL,TSURF(1)
23*     OUT(2)=SEC(NISOL)
24*     NNISOL=NISOL+1
25*     WRITE(6,OUT) (Y0(I),I=1,NISOL),TSURF(2),TSTEEL,TSURF(3),
26*     *(Y0(I),I=NNISOL,N)
27*     WRITE(6,103) TSURF(4)
28*     RETURN
29*     11  WRITE(6,104) TIME,TFL,TSTEEL
30*     RETURN
31*     END

```

```

1*      SUBROUTINE REDUCE(TIME)
2*      COMMON /A/ESTIM,N,DX(15),THICIS,THICFL
3*      COMMON /F/IPHASE,GYPSUM,FALL,NISOL,ROOMT
4*      COMMON /J/NFALL,TIFALL(6),X(16)
5*      LOGICAL FALL,ESTIM,GYPSUM
6*      NFALL=NFALL+1
7*      TIFALL(NFALL)=TIME*60.
8*      N=N-1
9*      NISOL=NISOL-1
10*     DO 10 I=1,N
11*     10  DX(I)=DX(I+1)
12*     10  X(I)=X(I+1)
13*     X(N+1)=X(N+2)
14*     RETURN
15*     END

```

```

1*      SUBROUTINE STETEM(TS2,TS3,TSTEEL,RES)
2*      COMMON /D/ADIVV,DENS,SPECH(30,2),NSPECH,FPSST2,EPSST3
3*      TS24=((TS2+273.)/100.)**4
4*      TS34=((TS3+273.)/100.)**4
5*      TST4=((TSTEEL+273.)/100.)**4
6*      CP=YINTPO(TSTEEL,SPECH,NSPECH)
7*      RES=3600.*ADIVV/(DENS*CP)*(8.7*((TS2+TS3)*0.5-TSTEEL)+

```

```

8*      *S.77*(EPSST2*(TS24-TST4)+EPSST3*(TS34-TST4)))
9*      RETURN
10*     END

```

```

1*      SUBROUTINE SURTEM(TIME,TEM,TSURF)
2*      COMMON /A/ESTIM,N,DX(15),THICIS,THICFL
3*      COMMON /F/IPHASE,GYPSUM,FALL,NISOL,ROOMT
4*      COMMON /G/CONIS(30,2),NCONIS,CONFL(30,2),NCONFL,FCONIS,TFALL1,
5*      *TFALL2
6*      COMMON /I/ALFIN,ALFAIR,ALFOUT,EPSIN1,EPSIN2,EPSAIR
7*      LOGICAL ESTIM,GYPSUM,FALL
8*      DIMENSION TEM(1),TSURF(1)
9*      TFL=345.*ALOG10(480.*TIME+1.)+ROOMT
10*     R1=1./ALFIN
11*     IF(ESTIM) GO TO 10
12*     R2=DX(1)/(2*YINTPO(TEM(1),CONIS,NCONIS))
13*     R3=DX(NISOL)/(2*YINTPO(TEM(NISOL),CONIS,NCONIS))
14*     GO TO 11
15*     10  R2=THICIS/ECONIS/2.
16*     R3=R2
17*     11  R4=1./ALFAIR
18*     R5=DX(NISOL+1)/(2*YINTPO(TEM(NISOL+1),CONFL,NCONFL))
19*     R6=DX(N)/(2*YINTPO(TEM(N),CONFL,NCONFL))
20*     R7=1./ALFOUT
21*     IF(ESTIM) GO TO 12
22*     TSURF(1)=TFL-R1/(R1+R2)*(TFL-TEM(1))
23*     TSURF(2)=TEM(NISOL)-R3/(R3+R4+R5)*(TEM(NISOL)-TEM(NISOL+1))
24*     TSURF(3)=TEM(NISOL)-(R3+R4)/(R3+R4+R5)*(TEM(NISOL)-TEM(NISOL+1))
25*     GO TO 13
26*     12  TSURF(1)=TFL-R1/(R1+R2+R3+R4+R5)*(TFL-TEM(1))
27*     TSURF(2)=TFL-(R1+R2+R3)/(R1+R2+R3+R4+R5)*(TFL-TEM(1))
28*     TSURF(3)=TFL-(R1+R2+R3+R4)/(R1+R2+R3+R4+R5)*(TFL-TEM(1))
29*     13  TSURF(4)=TEM(N)-R6/(R6+R7)*(TEM(N)-ROOMT)
30*     RETURN
31*     END

```

```

1*      SUBROUTINE TEMENT(TEMP,ENT)
2*      COMMON /A/ESTIM,N,DX(15),THICIS,THICFL
3*      COMMON /F/IPHASE,GYPSUM,FALL,NISOL,ROOMT
4*      COMMON /H/ENTIS(30,2),NENTIS,ENTFL(30,2),NENTFL,FENIS(30,2),NFENIS
5*      LOGICAL ESTIM,GYPSUM,FALL
6*      DIMENSION TEMP(1),ENT(1)
7*      IF(NISOL.EQ.0) GO TO 11
8*      DO 10 I=1,NISOL
9*      10  ENT(I)=YINTPO(TEMP(I),ENTIS,NENTIS)*DX(I)
10*     NNISOL=NISOL+1
11*     DO 12 I=NNISOL,N
12*     12  ENT(I)=YINTPO(TEMP(I),ENTFL,NENTFL)*DX(I)
13*     RETURN
14*     END

```

```

1*      SUBROUTINE THCOND(TIME,TSURF)
2*      COMMON /A/ESTIM,N,DX(15),THICIS,THICFL
3*      COMMON /F/IPHASE,GYPSUM,FALL,NISOL,ROOMT
4*      COMMON /G/CONIS(30,2),NCONIS,CONFL(30,2),NCONFL,FCONIS,TFALL1,
5*      *TFALL2
6*      COMMON /I/ALFIN,ALFAIR,ALFOUT,EPSIN1,EPSIN2,EPSAIR
7*      LOGICAL GYPSUM,ESTIM,FALL
8*      DIMENSION TSURF(1)
9*      IF(ESTIM) ECONIS=YINTPO((TSURF(1)+TSURF(2))/2.,CONIS,NCONIS)
10*     TFL=345.*ALOG10(480.*TIME+1.)+ROOMT
11*     TFL4=((TFL+273.)/100.)**4
12*     TS14=((TSURF(1)+273.)/100.)**4
13*     ALFIN=35.
14*     EPSIN=EPSIN1
15*     IF(IPHASE.EQ.2) EPSIN=EPSIN2
16*     IF(TIME.GE.0.05) ALFAIR=23.+5.77*EPSIN*(TFL4-TS14)/(TFL-TSURF(1))
17*     IF(IPHASE.EQ.2) RETURN
18*     TS24=((TSURF(2)+273.)/100.)**4
19*     TS34=((TSURF(3)+273.)/100.)**4
20*     ALFAIR=8.7
21*     IF(ABS(TSURF(2)-TSURF(3)).GT.1.E-6) ALFAIR=ALFAIR+5.77*EPSAIR*

```

```
22*      *(TS24-TS34)/(TSURF(2)-TSURF(3))
23*      ALFOUT=8.7+0.033*TSURF(4)
24*      RETURN
25*      END
```

```
1*      SUBROUTINE UNPRCT(TIME,TEMP,RES)
2*      COMMON /D/ADIVV,DENS,SPECH(30,2),NSPECH,EPSST2,EPSST3
3*      COMMON /F/IPHASE,GYPSUM,FALL,NISOL,ROOMT
4*      COMMON /I/ALFIN,ALFAIR,ALFOUT,EPSIN1,EPSIN2,EPSAIR
5*      DIMENSION TEMP(1),RES(1)
6*      LOGICAL GYPSUM,FALL
7*      TFL=345.*ALOG10(480.*TIME+1.)+ROOMT
8*      CP=YIN(TPO(TEMP(1),SPECH,NSPECH))
9*      RES(1)=3600.*ADIVV*ALFIN*(TFL-TEMP(1))/(DENS*CP)
10*     RETURN
11*     END
```

```
1*      FUNCTION XINTPO(Y,AR,N)
2*      DIMENSION AR(30,1)
3*      IF(Y.GT.AMAX1(AR(1,2),AR(N,2)).OR.Y.LT.AMIN1(AR(1,2),AR(N,2)))
4*      *GO TO 14
5*      NN=N-1
6*      IF(AR(1,2).LT.AR(N,2)) GO TO 11
7*      DO 10 I=1,NN
8*      IF(Y.GT.AR(I+1,2)) GO TO 13
9*      CONTINUE
10*     11 DO 12 I=1,NN
11*     IF(Y.LT.AR(I+1,2)) GO TO 13
12*     CONTINUE
13*     13 XINTPO=AR(I,1)+(Y-AR(I,2))/(AR(I+1,2)-AR(I,2))*(AR(I+1,1)-AR(I,1))
14*     RETURN
15*     14 CALL WRONG(Y,AR,N)
16*     STOP
17*     END
```

```
1*      FUNCTION YINTPO(X,AR,N)
2*      DIMENSION AR(30,1)
3*      IF(X.GT.AMAX1(AR(1,1),AR(N,1)).OR.X.LT.AMIN1(AR(1,1),AR(N,1)))
4*      *GO TO 14
5*      NN=N-1
6*      IF(AR(1,1).LT.AR(N,1)) GO TO 11
7*      DO 10 I=1,NN
8*      IF(X.GT.AR(I+1,1)) GO TO 13
9*      CONTINUE
10*     11 DO 12 I=1,NN
11*     IF(X.LT.AR(I+1,1)) GO TO 13
12*     CONTINUE
13*     13 YINTPO=AR(I,2)+(X-AR(I,1))/(AR(I+1,1)-AR(I,1))*(AR(I+1,2)-AR(I,2))
14*     RETURN
15*     14 CALL WRONG(X,AR,N)
16*     STOP
17*     END
```

```
1*      SUBROUTINE WRONG(Z,AR,N)
2*      DIMENSION AR(30,1)
3*      100 FORMAT(///1X,F15.3,35H IS OUTSIDE THE LIMITS OF THE ARRAY)
4*      101 FORMAT(/1X,F15.3,F20.3)
5*      102 FORMAT( 1X,F15.3,F20.3)
6*      WRITE(6,100) Z
7*      WRITE(6,101) AR(1,1),AR(1,2)
8*      DO 10 I=2,N
9*      10 WRITE(6,102) AR(I,1),AR(I,2)
10*     RETURN
11*     END
```