



# LUND UNIVERSITY

## Secondary Metabolites from Bolivian Plants- Isolation and Characterization

Davila, Marcelo

2014

[Link to publication](#)

*Citation for published version (APA):*

Davila, M. (2014). *Secondary Metabolites from Bolivian Plants- Isolation and Characterization*. [Doctoral Thesis (compilation), Centre for Analysis and Synthesis]. Lund University.

*Total number of authors:*

1

### General rights

Unless other specific re-use rights are stated the following general rights apply:

Copyright and moral rights for the publications made accessible in the public portal are retained by the authors and/or other copyright owners and it is a condition of accessing publications that users recognise and abide by the legal requirements associated with these rights.

- Users may download and print one copy of any publication from the public portal for the purpose of private study or research.
- You may not further distribute the material or use it for any profit-making activity or commercial gain
- You may freely distribute the URL identifying the publication in the public portal

Read more about Creative commons licenses: <https://creativecommons.org/licenses/>

### Take down policy

If you believe that this document breaches copyright please contact us providing details, and we will remove access to the work immediately and investigate your claim.

LUND UNIVERSITY

PO Box 117  
221 00 Lund  
+46 46-222 00 00

# Secondary Metabolites from Bolivian Plants

Isolation and characterization



**LUNDS**  
UNIVERSITET

Marcelo A. Dávila Cabrera

Academic thesis which, by due permission of the Faculty of Engineering at Lund University, will be publicly defended on Thursday 2nd October, 2014, at 09.00 a.m. in lecture hall C, at Center of Chemistry and Chemical Engineering, Getingevägen 60, Lund, for the degree of Doctor of Philosophy.  
Faculty opponent: Prof. Luis M. Peña Rodríguez

A doctoral thesis at a university in Sweden is produced as a monograph or as a collection of papers. In the latter case, the introductory part constitutes the formal thesis, which summarizes the accompanying papers. These have either already been published or are manuscripts at various stages (*in press*, *submitted* or *manuscript*).



Copyright © Marcelo A. Dávila Cabrera

Lund University  
Centre of Analysis and Synthesis  
Department of Chemistry  
P.O. Box 124  
SE-221 00 Lund  
Sweden

ISBN-number 978-91-7422-363-7

Printed in Sweden by Media-Tryck, Lund University  
Lund 2014

*Dedicated to my mother*

*Mary*



# Abstract

Nature has been recognized as a rich source of potentially useful chemicals. Throughout the years, phytochemical studies have led to the discovery of an enormous number of natural products, their chemical diversity is unique and many of them possess various biological activities. As a contribution, this thesis presents the results obtained from the phytochemical study of four Bolivian plants. *Senecio clivicolus*, *Prumnopitys exigua*, *Baccharis polycephala* and *Podocarpus parlatoresi*, which all are species that grow naturally in Bolivia. The study is based on the isolation, purification and spectroscopic characterization of secondary metabolites. To achieve this, various chromatographic methods have been applied to the crude plant extracts in order to fractionate them to the point that pure compounds are obtained. Once a natural product is isolated, it was subjected to high-resolution mass spectrometry to determine its elemental composition and NMR spectroscopy to elucidate the molecular structure.

# Popular Summary

Plants produce an array of organic chemicals with an enormous diversity of structural types. Many of these phytochemicals are biologically active compounds necessary for the well-being, survival, and evolution of the plants, but also have been used by humans, who have used them in traditional medicine and for pharmaceutical industry.

During the course of this research, the natural products isolated from four endemic or medicinal plant species of Bolivia are presented, as well as the techniques and processes through which have been isolated and identified. It also contains the biological activities reported in the literature.

# List of Papers

1. Davila, M., Sterner, O. & Hinojosa, N. 2013. Furanoeremophilanes from *Senecio clivicolus* Weddell. *Bolivian Journal of Chemistry*, 30, 80-83. My contribution: I did all laboratory work and wrote the paper.
2. Davila, M., Sterner, O. & Hinojosa, N. 2013. Metabolites from *Prumnopitys exigua* De Laubenf. *Bolivian Journal of Chemistry*, 30, 142-145. My contribution: I did all laboratory work and wrote the paper.
3. Davila, M., Sterner, O. & Hinojosa, N. 2013. Flavonoids from *Baccharis polycephala* Weddell. *Bolivian Journal of Chemistry*, 30, 137-141. My contribution: I did all laboratory work and wrote the paper.
4. Davila, M., Sterner, O. & Hinojosa, N. Secondary Metabolites from *Podocarpus parlatorei* Pilger. *Bolivian Journal of Chemistry*, 31, 21-27. My contribution: I did all laboratory work and wrote the paper.



# Abbreviations

ATR-IR	Attenuated total reflectance-infrared
<sup>13</sup> C NMR	Carbon nuclear magnetic spectroscopy
COSY	Correlation spectroscopy
CTLC	Centrifugal preparative TLC
DEPT	Distortionless enhancement by polarization transfer
HMBC	Heteronuclear multiple-bond correlation spectroscopy
HMQC	Heteronuclear multiple-quantum correlation spectroscopy
<sup>1</sup> H NMR	Proton nuclear magnetic spectroscopy
HR-ESI-MS	High resolution-electro spray ionization-mass spectroscopy
IMS	Isotropic magnetic shielding
CC	Column chromatography
L-L	Liquid-liquid extraction
m.a.s.l	Meters above sea level
MS	Mass spectroscopy
NMR	Nuclear magnetic spectroscopy
NOESY	Nuclear Overhauser effect spectroscopy
ppm	Parts per million
TLC	Thin layer chromatography
VLC	Vacuum liquid chromatography

# Table of Content

Abstract	v
List of Papers	vii
Abbreviations	viii
Table of Content	ix
Introduction	1
1 Plants investigated during this study	7
1.1. <i>Senecio clivicolus</i> Weddell (I)	7
1.1.1. Chemical constituents isolated	8
1.2. <i>Prumnopitys exigua</i> de Laubenf (II)	14
1.2.1. Chemical constituents isolated	15
1.2.2. Computational calculations	22
1.3. <i>Baccharis polycephala</i> Weddell (III)	26
1.3.1. Chemical constituents isolated	26
1.4. <i>Podocarpus parlatoresi</i> Pilger (IV)	34
2 Conclusions and Future Perspectives	49
3 References	51
4 Acknowledgements	67



# Introduction

“Human-plant” is a relationship as old as mankind, since prehistoric times man has relied on plants for their basic needs, not only for food and clothing, but also to alleviate diseases.

A characteristic feature of plants, as well as other organisms, is their capacity to handle a variety of organic compounds that are categorized as primary or secondary metabolites, which are synthesized using a battery of enzymatic systems in well-defined sequences called metabolic pathways. Primary metabolites are directly involved with functions that are essential to growth and development, and are therefore present in all plants (Buchanan et al., 2000). In contrast to the primary metabolites, there also is a secondary metabolism that produces secondary metabolites or natural products. These have a limited distribution in nature, and they are found in only specific organisms. They do not appear to participate directly in growth and development, but their production plays an important role in the adaptation of plants to their environment, e.g. by protecting it against parasites and predators or as attractants towards the same or other species (Bourgaud et al., 2001).

Natural product chemistry is an old science which deals with the isolation, identification, structure elucidation and study of the chemical characteristics of secondary metabolites. Its growth is closely associated with the biological investigations, in studies where the structure and the biological activity are closely linked. Furthermore, the advances and development of new and highly specific chromatographic methods (LC, MPLC, HPLC, GC), and spectroscopic techniques (UV, IR, MS, NMR, CD, ORD, X-ray diffraction), have made it much easier to screen, isolate, and identify natural products (Borris, 1996, Phillipson, 2007).

Interest in plant natural products is due to their chemical diversity and biological activities; they are one of the major sources of new drugs developed by the pharmaceutical industry. Of the approximately 250 000 - 500 000 species of higher plants classified (McChesney et al., 2007), around 20-30 % have been investigated in a phytochemical sense (Wink, 2010), and about 200 000 secondary metabolites have been reported until 2003 (Dixon and Strack, 2003). In 1985 it was estimated that over 80 % of the worlds' population uses plant materials as their source of primary health care (Cordell, 2002). Moreover, approximately 10

000 plants world-wide have been documented as medicinal (McChesney et al., 2007).

Bolivia is located in the central zone of South America and occupies 6 % of the continent. Its geographical position combined with many different environments and landscapes has given to Bolivia an extremely rich biodiversity. Bolivia is considered to be one of the most forest-rich countries of the world (Ibisch, 1998), and to have more than 20 000 species of plants (Ibisch and Beck, 2003). It is estimated that between 20 and 25 % of the plants from Bolivia are endemic (Araujo et al., 2005). In addition to this, Bolivia is endowed with a diverse range of plants used in traditional medicine by indigenous communities. The knowledge about medicinal plants comes from ancient cultures from Andean and Amazonian regions, which have endured throughout time. Traditionally, this knowledge is passed on through generations. Several authors have documented medicinal plants used by various indigenous communities in Bolivia (Bourdy et al., 2004, Deharo et al., 2001, Hajdu and Hohmann, 2012, Macía et al., 2005, Muñoz et al., 2000, Thomas et al., 2011).

Based upon the rich biodiversity and cultural characteristics in Bolivia, there is an urgent need to conduct studies in the field of natural products chemistry, in order to discover useful secondary metabolites. In this respect, a great potential is expected from Bolivian plants as a source for new drug candidates.

As part of our interest in the secondary metabolites from Bolivian plants, the investigation presented in this thesis has been based on the isolation, purification and structural elucidation of natural products from Bolivian plants. Our plant selection has been based on the traditional medicine or by its endemic condition.

The study of natural products can be considered to have begun over 200 years ago when Friedrich Wilhelm Sertürner isolated the first biologically active pure compound from a plant (*Papaver somniferum*), morphine (Hartmann, 2007). This discovery showed that the active principle of a plant can be isolated, studied and attributed to a single chemical compound, and administered in precise dosages not considering the source or age of the material (Li and Vederas, 2009). The isolated compound can be transformed into other and equally useful compounds, and one example is apomorphine, a potent dopamine receptor agonist used to treat Parkinson's disease, which is a derivative of morphine (Balunas and Kinghorn, 2005).

Aspirin was first produced about 100 years ago, but the natural form, salicylic acid, found in the bark and leaves of the willow trees, has been used for thousands of years. The bark's active ingredient was isolated in 1828 and named salicin for the Greek word salix, meaning willow (Mahdi et al., 2006). Salicylic acid, first produced from salicin, was an effective analgesic and antipyretic drug, but it was found to be an irritant of the stomach causing bleeding at large doses. In 1897, F.

Hoffmann, synthesized acetylsalicylic acid in a successful attempt to eliminate the side effects of salicylic acid (Mahdi et al., 2006). Soon the acetylsalicylic acid, commonly known as aspirin, became the most popular therapeutic drug in the world. It is used as an analgesic (pain-killing), antipyretic (fever-reducing), and anti-inflammatory drug. Aspirin has also been used to prevent the myocardial infarction and strokes (Wu, 2000).

In 1928, penicillin was discovered by Alexander Flemings when he observed that colonies of the bacterium *Staphylococcus aureus* could be destroyed by the mold *Penicillium notatum* (Schmidt et al., 2008). However, the use of penicillin as an antibiotic did not begin until the 1940s when Howard Florey and Ernst Chain isolated the active ingredient and developed the commercial medicine (Butler, 2004). With this, microorganisms were recognized as important sources of new natural products, and penicillin is one of the earliest discovered and most widely used antibiotic agents.

Quinine is a potent antimalarial drug isolated by Caventou and Pelletier in 1820 from the bark of *Cinchona* species (e. g., *C. officinalis*). The bark had been used by indigenous groups in the Amazon region for the treatment of fever. Quinine was the lead compound for the development of the drugs commonly used today against malaria, chloroquine and mefloquine, which largely has replaced quinine. However, the appearance of strains resistant to these two drugs, led to the investigation of other plant widely used in the treatment of fever in the traditional Chinese Medicine, especially *Artemisia annua* (Cragg and Newman, 2013). In 1972, the active constituent was isolated from the aerial parts of this plant and was called artemisinin (Klayman et al., 1984).

Other significant drugs developed from traditional medicinal plants include: ephedrine, from *Ephedra sinica*, which later was the model for the synthesis of the anti-asthma agents salbutamol and salmetrol. The muscle relaxant tubocurarine was isolated from *Chondrodendron* and *Curarea* species used by indigenous groups in the Amazon as the source for the arrow poison curare (Cragg and Newman, 2013).

Natural products from plants have a long history of use in the treatment of cancer (Graham et al., 2000). Anticancer drugs discovered from plants can be categorized in four main classes of compounds (Balunas and Kinghorn, 2005):

- 1) The vinca alkaloids, of which the best known are vinblastine and vincristine, were isolated from the Madagascar periwinkle, *Catharanthus roseus* (Cragg and Newman, 2013). The vinca alkaloids and several of their semi-synthetic derivatives block cell growth by inhibiting mitosis. Vinblastine is often used in combinations to treat bladder and breast cancers, and is an integral part of the curative treatment for Hodgkin's disease. Vincristine is mainly used to treat acute

leukemia and lymphomas and constitutes an important component of the regime that has been so successful in treating childhood leukemias (Ishikawa et al., 2009).

2) The second class are the epipodophyllotoxins, which has generated the very potent clinical antitumor drugs etoposide and teniposide that are used for the treatment of small cell lung cancer and Kaposi's sarcoma (Engelhardt et al., 2003). The two clinically-active derivatives act as anti-cancer drugs by inhibiting the enzyme topoisomerase II, involved in DNA replication (Cragg and Newman, 2013).

3) Paclitaxel, a plant-derived diterpenoid anticancer drug discovered in 1966 (Oberlies and Kroll, 2004), occurs in the bark of various *Taxus* species and was originally isolated from *Taxus brevifolia* Nutt. (Oberlies and Kroll, 2004). The taxanes, including paclitaxel and derivatives such as docetaxel and cabazitaxel, act by binding to a protein, tubulin, thus inhibiting cell division. Paclitaxel has shown particular efficacy against ovarian cancer, and is today also used against breast and non-small cell lung, prostate cancer and in Kaposi's sarcoma (Wall and Wani, 1995).

4) The camptothecins are the last class of anticancer agents, of which camptothecin was isolated from the wood bark of *Camptotheca acuminata* Decne. in 1966 (Wall and Wani, 1995). Camptothecin showed remarkable anticancer activity but also showed unacceptable adverse drug reaction. It inhibits the DNA enzyme topoisomerase I (Balunas and Kinghorn, 2005). Numerous derivatives of camptothecin compound class have been synthesized, some of which are currently in clinical use such as topotecan and irinotecan (Wall and Wani, 1996).

The preceding sections have provided a very brief impression of the importance of natural products, both as pharmaceutical agents and/or as leads to biologically active molecules.

Selected natural products and derivatives with biological activities:

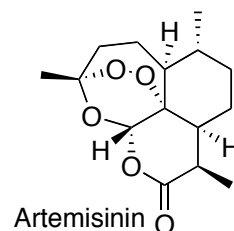
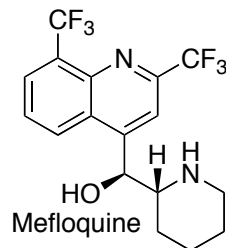
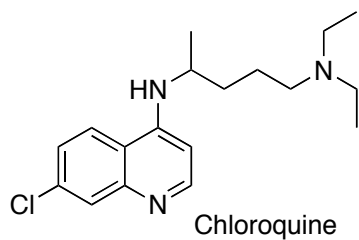
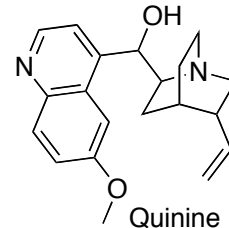
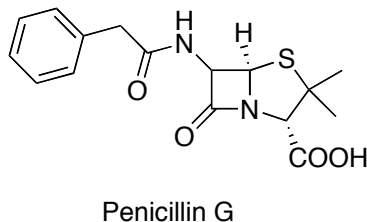
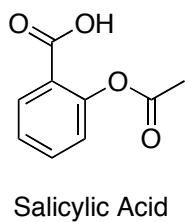
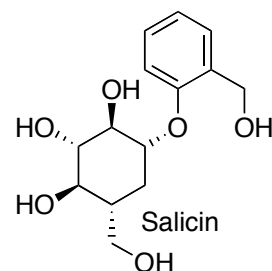
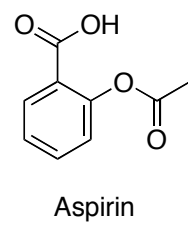
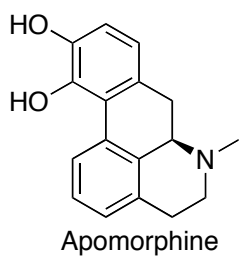
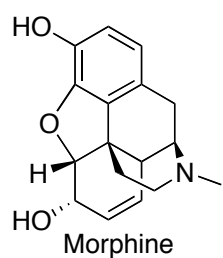



Selected natural products and derivatives with biological activities (Continued):

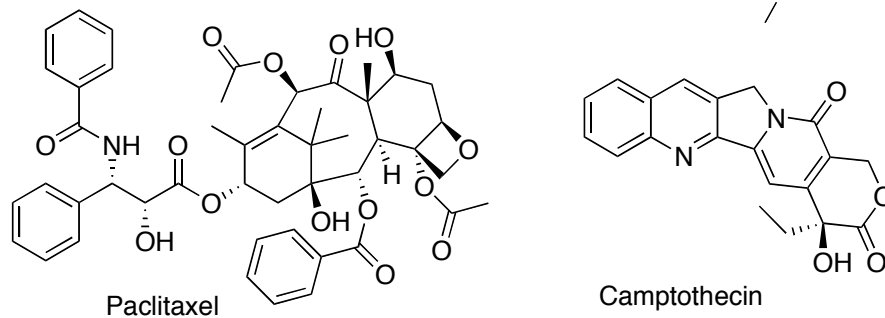
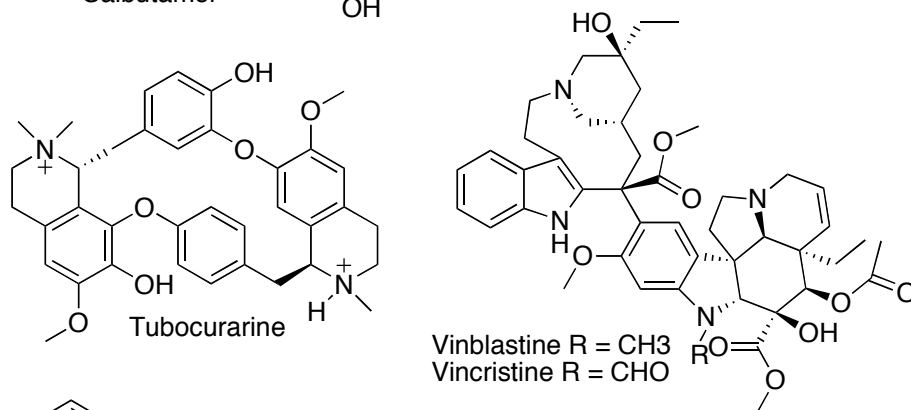
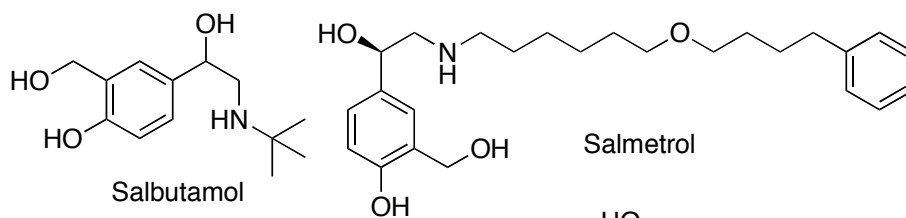

# 1 Plants investigated during this study

The plants studied grow naturally in the region of Monte Punco, which belongs to the Carrasco province, located 180 km south of the city of Cochabamba. Monte Punco has two different geographic and climatic zones: one is mountainous while the other is dominated by sub-Andean Amazonian forest. The region is characterized by extreme temperature variations, high temperatures during the day with a sharp drop at nights. Freezing periods are common, particularly during the arrival of the polar winds from the south. The plants growing in this region are exposed to severe environmental stresses, and they have presumably adapted to these conditions by synthesizing suitable secondary metabolites.

Fresh aerial parts of the plants were collected in 2008 and 2010. The collection and identification of the plants was made by Lic. Modesto Zárate, a research scientist at the National Herbarium “Herbario Nacional Martin Cardenas” in Cochabamba. Voucher specimens are stored at the “Herbario Nacional Martin Cardenas”. The fresh plant materials were thoroughly cleaned and dried in the shade for ten days, whereafter they were homogenized to a powder and stored in bottles for further studies.

## 1.1. *Senecio clivicolus* Weddell (I)

The genus *Senecio*, with over 1500 species is one of the largest genus of flowering plants, and occurs in all the continents. The species are herbs, shrubs, vines, and trees (Mohamed and Ahmed, 2005). Previous phytochemical studies carried out on plants belonging to this genus have reported the presence of eremophilane, furanoeremophilane sesquiterpene and pyrrolizidine alkaloids (Pelser et al., 2007). *Senecio* species are used in the traditional medicine for many purposes, such as a remedy for gastric-ulcer and stomach pain (Hariprasath et al., 2012), as well as chest pain, cough, fever and running nose (Gu et al., 2004, York et al., 2011). In the north region of Argentina, *S. graveolens* is used to counteract mountain sickness, digestive problems and to treat coughs (Pérez et al., 1999).

*Senecio clivicolus* is a perennial shrub that grows in areas of western Bolivia, particularly in the mountainous region, where it is commonly known as “chiñi

waycha” or “waycha negra”. It is a medicinal plant used by the natives to relieve stomach pain (Vandebroek et al., 2003), as well as an anti-diarrhea remedy (Fournet et al., 1994). Moreover, the use of an extract of this plant against skin fungal infections (Bustamante et al., 2001) has been reported. A previous phytochemical study of *S. clivicolus* have resulted in the isolation of (*E,E*)-alpha-farnesene (**1**), (*S*)-(-)-germacrene D (**2**) and 1-pentadecene (**3**) (Bohlmann and Zdero, 1979) (Figure 1).

**Figure 1** Compound reported from *Senecio clivicolus*

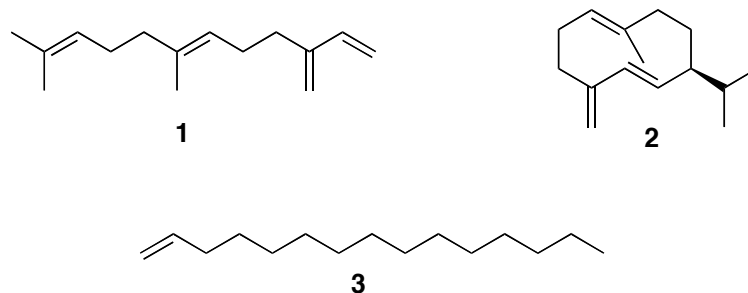

### 1.1.1. Chemical constituents isolated

The air-dried powdered plant material of *S. clivicolus* was extracted with 95 % ethanol for three days at room temperature. The resulting extract was filtered through a glass frit and evaporated to dryness on a rotary evaporator under vacuum. The resulting extract was suspended in ethanol-water (80:20) and successively partitioned with hexane and chloroform. The chloroform fraction was precipitated with ethyl acetate to yield a dark brown precipitate and a dark liquid, which was subjected to VLC to give several fractions, which were further purified by CTLC and CC to provide the four furanoeremophilanes **4-7** (Figure 2), by the procedure depicted in Scheme 1.

The isolated compounds were identified by NMR and HR-ESI-MS analysis, and by comparison with NMR data reported in the literature. Decompostin (**4**) (Rodríguez-Hahn et al., 1968, Pérez-Castorena et al., 2004), 6 $\beta$ -acetoxy-9-oxo-10 $\alpha$ H furanoeremophilane (**5**) (Villaruel et al., 1991), 1 $\alpha$ -acetoxy-6 $\beta$ -acetoxy-9-oxo-10 $\alpha$ H furanoeremophilane (**6**) and 1 $\alpha$ -hydroxy-6 $\beta$ -acetoxy-9-oxo-10 $\alpha$ H furanoeremophilane (**7**) (Arias Cassara et al., 2010).

**Figure 2** Compounds isolated from *Senecio clivicolus*.

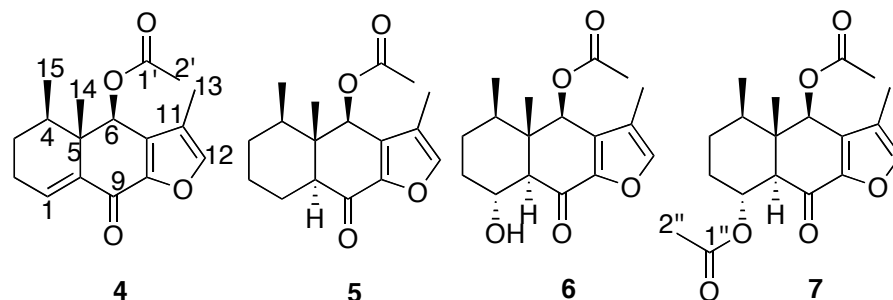

**Scheme 1** Sequential fractionation of the ethanol extract from *S. clivicolus*.

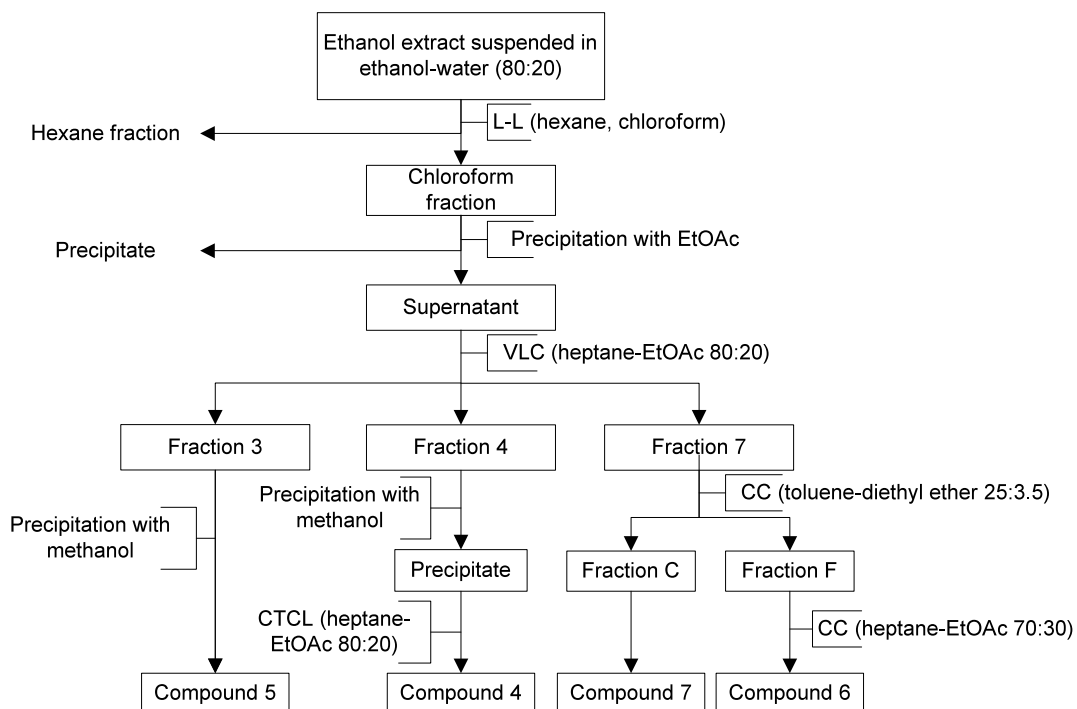

Decompostin (**4**) was obtained as a white amorphous solid. The molecular formula of compound **4** was determined to be  $C_{17}H_{20}O_4$ , based on the 1D NMR spectra as well as HR-ESI-MS data. Consequently, **4** has eight degrees of unsaturation, and as the NMR data show the presence of three carbon-carbon double bonds and two carbonyl groups **4** is tricyclic. In the  $^1H$  NMR spectrum a signal corresponding to a

furan ring proton was observed at  $\delta$  7.41 (1H, q,  $J= 1.0$ ; 12-H), which in the COSY spectrum correlates with the methyl signal at  $\delta$  1.93 (3H, d,  $J= 1.0$ ; 13-H<sub>3</sub>). In addition to this, and besides a methyl group obviously belonging to an acetyl group ( $\delta$  2.20, 3H, s), the proton spectrum indicated the presence of another two methyls by the signals at  $\delta$  1.09 (3H, s; 14-H<sub>3</sub>) and  $\delta$  1.93 (3H, d,  $J= 6.8$ ; 15-H<sub>3</sub>). COSY and HMBC correlations from these as well as 1-H ( $\delta$  6.93, 1H, ddd,  $J= 4.9, 3.2, 0.8$ ) close the left ring, and show that the acetoxy substituted C-6 is next to C-5 and that the carbonyl group C-9 is adjacent to C-10. HMBC correlations from 6-H, 12-H and 13-H<sub>3</sub> reveal all components of the furan ring, and the final bond between C-8 and C-9 is inevitable. The relative configuration of **4** was elucidated based on the NOESY correlations observed between H-6 and H-4 as well as between 14-H<sub>3</sub> and 15-H<sub>3</sub>. The structure of compound **4** has previously been isolated from *Cacalia decomposita* (Rodríguez-Hahn et al., 1968) and *Psacalium beamanii* (Pérez-Castorena et al., 2004).

Compound **5** was obtained as a white amorphous solid. The HR-ESI-MS of **5** indicated that its elemental composition is C<sub>17</sub>H<sub>22</sub>O<sub>4</sub> with one unsaturation less than **4**. Comparison of the spectroscopic data of **4** and **5** revealed that the C-1/C-10 double bond in **4** is a single bond in **5**, and COSY as well as HMBC correlations established the structure. The relative configuration of **5** was determined based on NOESY correlations between the three protons 4-H, 6-H and 10-H, and **5** was found to be identical to 6 $\beta$ -acetoxy-9-oxo-10 $\alpha$ H-furanoeremophilane, previously reported from *S. chilensis* and *S. patagonicus* (Villarroel et al., 1991). However, the <sup>13</sup>C NMR data reported (Villarroel et al., 1991) are significantly different from those recorded here even if the same NMR solvent was used, indicating that it is necessary to correct the chemical shifts for C-1, C-2, C-3, C-14 and C-15 in the literature (Figure 3).

**Figure 3** Comparison of experimental <sup>13</sup>C chemical shift of **5** with literature data.

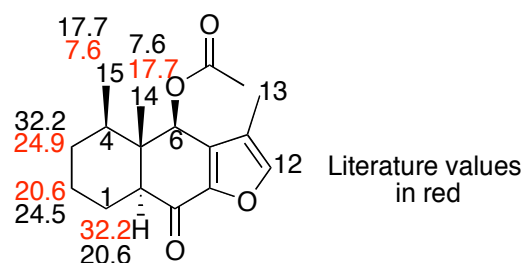

The NMR data of compound **6** (C<sub>17</sub>H<sub>22</sub>O<sub>5</sub> according to HR-ESI-MS) and **7** (C<sub>19</sub>H<sub>24</sub>O<sub>6</sub> according to HR-ESI-MS) are similar to those of compounds **4** and **5**, with the exception for the signals assigned to C-1 and C-10. In both **6** and **7** C-1 is oxygenated while C-10 is protonated, and extensive 2D NMR experiments show that, compared to **4**, the C-1/C-10 double bond had added water in **6** and acetic

acid in **7**. NOESY correlations were observed between 1-H and 14-H<sub>3</sub>, as well as between 4-H, 6-H and 10-H in both compounds, establishing their relative configuration. Based on these data the structures were established as 1 $\alpha$ -hydroxy-6 $\beta$ -acetoxy-9-oxo-10 $\alpha$ H-furanoeremophilane (**6**) and 1 $\alpha$ -acetoxy-6 $\beta$ -acetoxy-9-oxo-10 $\alpha$ H-furanoeremophilane (**7**). Compounds **6** and **7** have previously been reported from *S. santelisis* (Arias Cassara et al., 2010).

Furanoeremophilanes is one of the large and most important classes of compounds of the *Senecio* species. Some furanoeremophilanes (Figure 4 shows compounds with similar structure to those isolated) have been described as insect antifeedants, antifungal, cytotoxic, antioxidant, anti-inflammatory, and antimicrobial agents. Compound **8**, known as cacalone, was shown to possess potent anti-inflammatory activity in rat paw and mouse ear edema assays (Jimenez-Estrada et al., 2006). Additionally, **8** was demonstrated to be a radical scavenger and possess antioxidant activity (Krasovskaya et al., 1989). Compound **9** has been isolated from *Senecio filaginoides* var. *filaginoides*; it was described as antifungal against some *Candida* spp, and reduced the fungal growth of *Botrytis cinerea* (Arancibia et al., 2013). Furanoeremophilanes **6**, **7** and **10** showed toxic activity against the freshwater snail *Biomphalaria peregrine*, while compound **6** exhibited remarkable growth inhibitory activity against *B. cinerea* (Arias Cassara et al., 2010). Compounds **11** and **12** show mild anti-tubercular activity against *Mycobacterium tuberculosis*, and this is the first evidence that furanoeremophilanes may be considered as potential anti-tubercular leads (Gu et al., 2004). Compound **5** was found to be an antifeedant against the *Spodoptera littoralis* larvae as well as the aphids *Myzus persicae* and *Rhopalosiphum padi* (Reina et al., 2012). Similarly, Dominguez et al. described the antifeedant effect of compounds **13-15** against *S. littoralis*, *M. persicae* and *R. padi*. In addition, compounds **13** and **15** have been shown to be cytotoxic towards mammalian CHO cells (Dominguez et al., 2008). Also compound **4** showed an anti-inflammatory effect in the mouse ear edema assay (Arciniegas et al., 2009), and the antimicrobial activity of compound **4** against five microorganisms, *Staphylococcus aureus*, *Escherichia coli*, *Pseudomonas aeruginosa*, *Proteus mirabilis*, and *Candida albicans*, has been established (Garduno-Ramirez et al., 2001).

**Figure 4** Sesquiterpenoids isolated from *Senecio* species.

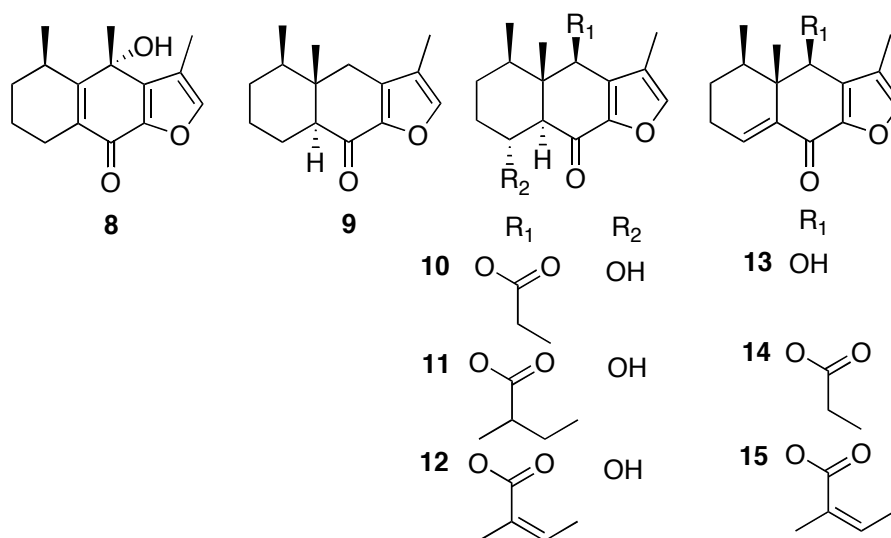

**Decompostin (4).**

White amorphous solid. mp 195-198 °C.  $[\alpha]_D^{20}$  -60° (*c* 0.60, CHCl<sub>3</sub>). HR-ESI-MS calculated for C<sub>17</sub>H<sub>20</sub>O<sub>4</sub> [M+H]<sup>+</sup> 289.1440. Found: 289.1445. <sup>1</sup>H NMR (Dichloromethane-*d*<sub>2</sub> 400 MHz): δ 6.94 (ddd, *J*= 4.9, 3.2, 0.8; 1-H), 2.24/2.24 (m/m; 2-H<sub>2</sub>), 1.45/1.55 (m/m; 3-H<sub>2</sub>), 1.95 (m; 4-H), 6.29 (s; 6-H), 7.41 (q, *J*= 1.0; 12-H), 1.93 (d, *J*= 1.0; 13-H<sub>3</sub>), 1.09 (s; 14-H<sub>3</sub>), 0.99 (d, *J*= 6.8; 15-H<sub>3</sub>), 2.20 (s; 2'-H<sub>3</sub>). <sup>13</sup>C NMR (Dichloromethane-*d*<sub>2</sub> 100 MHz): δ 138.3 (C-1), 25.5 (C-2), 28.2 (C-3), 38.1 (C-4), 46.8 (C-5), 74.9 (C-6), 136.0 (C-7), 147.2 (C-8), 176.5 (C-9), 141.7 (C-10), 121.5 (C-11), 146.2 (C-12), 8.6 (C-13), 15.5 (C-14), 17.7 (C-15), 171.0 (C-1'), 21.6 (C-2').

**6β-acetoxy-9-oxo-10αH-furanoeremophilane (5).**

White amorphous solid. mp 147-150 °C.  $[\alpha]_D^{20}$  -72° (*c* 0.70, CHCl<sub>3</sub>). HR-ESI-MS calculated for C<sub>17</sub>H<sub>22</sub>O<sub>4</sub> [M+H]<sup>+</sup> 291.1596. Found: 291.1586. <sup>1</sup>H NMR (Chloroform-*d* 400 MHz): δ 2.18/1.41 (m/m; 1-H<sub>2</sub>), 1.82/1.29 (m/m; 2-H<sub>2</sub>), 1.41/1.29 (m/m; 3-H<sub>2</sub>), 1.82 (m; 4-H), 6.33 (s; 6-H), 2.37 (dd, *J*= 12.0, 3.5; 10-H), 7.33 (br; 12-H), 1.91 (br; 13-H<sub>3</sub>), 0.91 (s; 14-H<sub>3</sub>), 0.89 (d, *J*= 6.6; 15-H<sub>3</sub>), 2.18 (s; 2'-H<sub>3</sub>). <sup>13</sup>C NMR (Chloroform-*d* 100 MHz): δ 20.6 (C-1), 24.5 (C-2), 32.2 (C-3), 42.1 (C-4), 49.8 (C-5), 75.7 (C-6), 134.6 (C-7), 146.7 (C-8), 186.7 (C-9), 55.1 (C-10), 120.7 (C-11), 145.1 (C-12), 8.5 (C-13), 7.6 (C-14), 17.7 (C-15), 170.3 (C-1'), 21.6 (C-2').

1 $\alpha$ -hydroxy-6 $\beta$ -acetoxy-9-oxo-10 $\alpha$ H-furanoeremophilane (6).

Pale yellowish oil.  $[\alpha]_D^{20}$   $-12^\circ$  ( $c$  0.20, CHCl<sub>3</sub>). HR-ESI-MS calculated for C<sub>17</sub>H<sub>22</sub>O<sub>5</sub> [M+H]<sup>+</sup> 307.1545. Found: 307.1555. <sup>1</sup>H NMR (Chloroform-*d* 400 MHz):  $\delta$  4.14 (m; 1-H), 2.04/1.40 (m/m; 2-H<sub>2</sub>), 1.49/1.40 (m/m; 3-H<sub>2</sub>), 1.87 (m; 4-H), 6.34 (s; 6-H), 2.37 (d,  $J$  = 9.5; 10-H), 7.39 (q,  $J$  = 1.0; 12-H), 1.91 (d;  $J$  = 1.0; 13-H<sub>3</sub>), 0.95 (s; 14-H<sub>3</sub>), 0.90 (d,  $J$  = 6.6; 15-H<sub>3</sub>), 2.17 (s; 2'-H<sub>3</sub>), 4.52 (d,  $J$  = 1.7; 1-OH). <sup>13</sup>C NMR (Chloroform-*d* 100 MHz):  $\delta$  66.4 (C-1), 32.9 (C-2), 30.3 (C-3), 41.7 (C-4), 51.0 (C-5), 75.2 (C-6), 136.2 (C-7), 146.5 (C-8), 189.3 (C-9), 60.8 (C-10), 121.2 (C-11), 146.2 (C-12), 8.6 (C-13), 8.9 (C-14), 17.6 (C-15), 170.9 (C-1'), 21.6 (C-2').

1 $\alpha$ -acetoxy-6 $\beta$ -acetoxy-9-oxo-10 $\alpha$ H-furanoeremophilane (7).

White amorphous solid. mp 149-151 °C;  $[\alpha]_D^{20}$   $-84^\circ$ , ( $c$  0.37, CHCl<sub>3</sub>). HR-ESI-MS calculated for C<sub>19</sub>H<sub>24</sub>O<sub>6</sub> [M+H]<sup>+</sup> 349.1651. Found: 349.1654. <sup>1</sup>H NMR (Chloroform-*d* 400 MHz):  $\delta$  5.28 (m; 1-H), 2.11/1.40 (m/m; 2-H<sub>2</sub>), 1.40/1.40 (m/m; 3-H<sub>2</sub>), 1.86 (m; 4-H), 6.36 (s; 6-H), 2.65 (d,  $J$  = 10.5; 10-H), 7.32 (q,  $J$  = 1.0; 12-H), 1.88 (d;  $J$  = 1.0; 13-H<sub>3</sub>), 0.95 (s; 14-H<sub>3</sub>), 0.91 (d,  $J$  = 6.6; 15-H<sub>3</sub>), 2.16 (s; 2'-H<sub>3</sub>), 2.02 (s; 2''-H<sub>3</sub>). <sup>13</sup>C NMR (Chloroform-*d* 100 MHz):  $\delta$  67.3 (C-1), 31.3 (C-2), 29.9 (C-3), 41.5 (C-4), 51.4 (C-5), 75.3 (C-6), 133.8 (C-7), 147.1 (C-8), 184.7 (C-9), 58.0 (C-10), 120.7 (C-11), 145.1 (C-12), 8.67 (C-13), 8.69 (C-14), 17.5 (C-15), 171.0 (C-1'), 21.6 (C-2'), 170.6 (C-1''), 21.4 (C-2'').



## 1.2. *Prumnopitys exigua* de Laubenf (II)

*Prumnopitys* is a genus of conifers belonging to the Podocarp family Podocarpaceae, this genus contains small to large trees up to 60 meters tall, which are predominantly found in the wet forest of the Southern Hemisphere (Farjon and Page, 1999). The *Prumnopitys* genus has only ten extant species, of which one, *Prumnopitys exigua*, is a conifer evergreen tree that is endemic tree to the Sub-Andean Amazonian Forest region of Bolivia (Silba, 1984, Stockey and Frevel, 1997). It is known as “pino colorado” by the natives of the region (Mercado, 1998, Zárate et al., 1999). The only current known use is as energy source and timber (Cárdenas, 1968, Vargas et al., 2000). A literature survey indicated that no phytochemical study of *P. exigua* was ever conducted.

However, previous studies carried out on plants belonging to this genus have yielded bioactive natural products. Some are diterpenes with an abietane skeleton, e.g. abietatriene (**16**), ferruginol (**17**), acetyl ferruginol (**18**), isopimarol (**19**) (Flores et al., 2001) and 2- $\beta$ -acetoxy-ferruginol (**20**) (Smith et al., 2008), which were isolated from *P. andina*. Flavonoids such as flavonol 3-*O*-mono- and diglycosides have been reported from *P. ferruginea*, *P. taxifolia* and *P. andina* (Markham et al., 1985). Lorimer and co-workers reported the isolation of picein (**21**) and  $\beta$ -miroside (**22**) from *P. ferruginea* (Lorimer et al., 1995) (Figure 5). Moreover, the essential oils of *P. ladei* and *P. ferruginea* contain a number of mono-, sesqui- and diterpenes (Clarke et al., 1994, Brophy et al., 2006).

**Figure 5** Compounds isolated from *Prumnopitys* species.

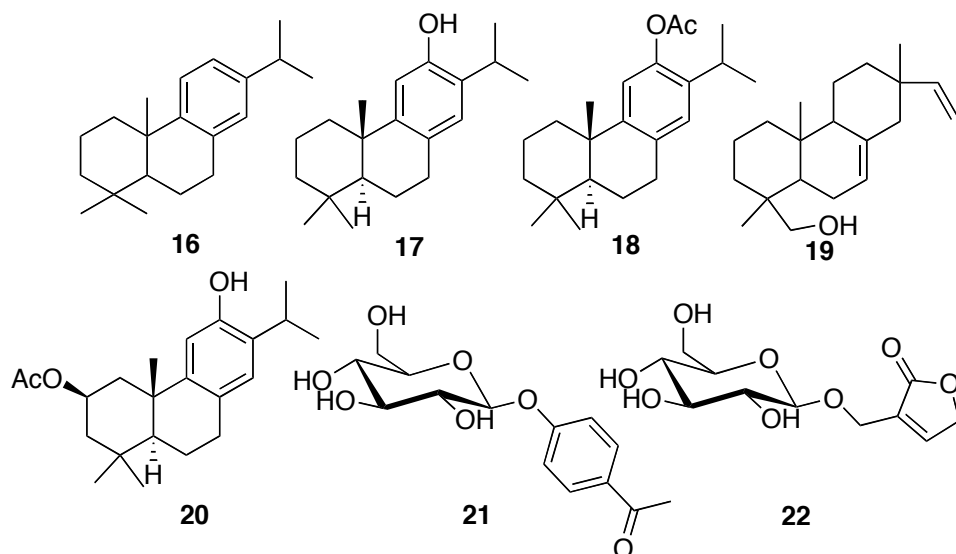

### 1.2.1. Chemical constituents isolated

The plant material of *Prumnopitys exigua*, which consisted of the green part of the branches, was collected from a tree of 10 meters located at the south province of Cochabamba-Bolivia during April 2010 at 2930 m.a.s.l.; the dried and powdered plant material was successively extracted with hexane (12 h) and chloroform (12 h) at room temperature. The chloroform extract was subjected to VLC on silica gel eluted with a stepwise gradient of heptane-ethyl acetate (90:10, 80:20 and 70:30) affording six main fractions (1-6). The fraction 6 was subjected to VLC eluted with toluene-ethyl acetate (30:1 and 90:10) to give ten sub-fractions (A-J). Sub-fraction D was precipitated with methanol to give a pure yellow compound **23**. Sub-fraction A was subjected to VLC using mixtures of heptane-ethyl acetate (30:1, 90:10 and 80:20) to give three fractions. The third of these was filtered through a mixture of silica gel and activated charcoal (100:3), and eluted with toluene-ethyl acetate (80:20) to give two fractions. The first fraction was subjected to CC eluted with heptane-ethyl acetate (80:20) to give five fractions. Fraction 5 consisted of pure compound **24**.

The structures of compounds **23** and **24** (Figure 6) were elucidated by NMR spectroscopy,  $^1\text{H}$  NMR and  $^{13}\text{C}$  NMR as well as 2D COSY, NOESY, HMQC and HMBC experiments, and by HR-ESI-MS experiments.

**Figure 6** Compounds isolated from *Prumnopitys exigua*.

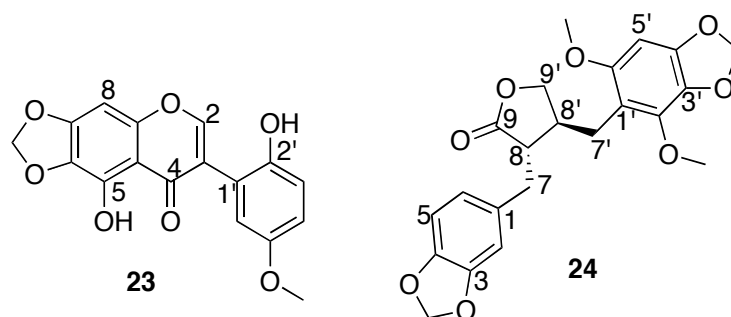

Compound **23** was isolated as a yellowish powder. The HR-ESI-MS and 1D NMR data (Table 1) established that the elemental composition of **23** is  $C_{17}H_{12}O_7$ , and that it consequently has twelve degrees of unsaturation. The  $^1H$  NMR spectrum revealed two sharp signals at  $\delta$  12.89 and 9.03. The first was assigned to the hydroxy group at C-5 due to the hydrogen bond to the carbonyl oxygen, a common proton signal of 5-hydroxy-flavonoids (Umehara et al., 2009). The signal at  $\delta$  9.03 must belong to a second hydroxy group, as it does not give rise to a cross-peak in the HMQC spectrum. A methoxy group is easily identified at  $\delta$  3.68 (3H, s). The remaining seven proton signals appear between  $\delta$  6.00 and 8.50 ppm. Among these protons, a signal at  $\delta$  8.36 (1H, s; C-2) is characteristic of 2-H in isoflavones (Singh et al., 2011, Nazir et al., 2008); three aromatic protons form a spin system, where the signals are overlapped at  $\delta$  6.82; a sharp singlet at  $\delta$  6.19 integrating for two protons attached to the carbon at  $\delta$  102.9, was attributed to a methylenedioxy group (Ibrahim et al., 2012, Wollenweber et al., 2003). Finally, a singlet signal at  $\delta$  6.92 was assigned to the carbon at  $\delta$  89.6.

In the DEPT  $^{13}C$  NMR spectrum, a carbonyl group and the methoxy group could be identified; the identification of the only one negative signal at  $\delta$  102.9 established the presence of the methylene group assigned as a methylenedioxy group. The region from  $\delta$  85 to 160 ppm showed five positive signals, which must belong to the four H-bearing aromatic carbons and the strongly deshielded C-2 carbon.

The hydroxy protons ( $\delta$  12.89) attached to C-5 displayed HMBC correlations to C-5, C-6 and C-10 (HMBC correlations are shown in Figure 6). The HMBC correlations from the methylene protons at  $\delta$  6.19 (2H, s) to  $\delta$  129.6 and  $\delta$  154.0 established the position of the methylenedioxy group at C-6 and C-7. The singlet at  $\delta$  6.92 represents consequently the only aromatic proton in ring A, its position at C-8 was demonstrated by the HMBC couplings from 8-H to C-6, C-7, C-9 and C-10. Finally, correlations from 2-H to C-4, C-9 and C-1' were observed.

Correlations from the hydroxy proton at  $\delta$  9.03 to C-1', C-2' and C-3', confirm the position of the second hydroxy group at C-2'. The methoxy group was assigned to C-5', from the HMBC correlations between  $\delta$  3.68 (3H, s) and  $\delta$  151.8 (C-5'). The overlapping signals at  $\delta$  6.82 must consequently be part of the B-ring.

Additional information was obtained from the  $^1\text{H}$  NMR spectrum recorded in chloroform-*d* with 10 % methanol-*d*<sub>4</sub> (Table 1). The three proton signals of the B-ring are now resolved at  $\delta$  6.86 (1H, dd,  $J$ = 8.8, 2.9),  $\delta$  6.94 (1H, d,  $J$ = 8.8), and  $\delta$  6.70 (1H, d,  $J$ = 2.9). The B-ring is consequently 1,2,5-tri-substituted, and a NOESY correlation between 2-H and  $\delta$  6.70 (6'-H) determines the B-ring as shown in Figure 7. In addition, NOESY correlations between the methoxy protons and 4'-H as well as 6'-H confirm the suggested structure of compound **23**. It is the isoflavone 5,2'-dihydroxy-5'-methoxy-6,7-methylenedioxy isoflavone (tetranin B), that recently was reported from *Salsola tetrandra* (Beyaoui et al., 2011).

**Figure 7** Selected HMBC (a) and NOESY (b) correlations of **23**

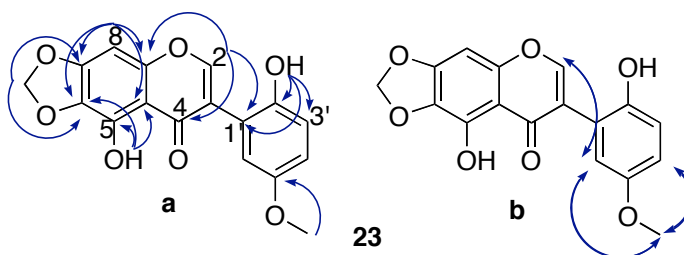

Compound **24** was isolated as yellowish oil. The HR-ESI-MS suggested that the elemental composition is  $\text{C}_{22}\text{H}_{22}\text{O}_8$ , which was confirmed by  $^1\text{H}$  NMR and  $^{13}\text{C}$  NMR data (Table 2) displaying signals for 22 protons and 22 carbons, and **24** consequently has twelve degrees of unsaturation. The ATR-IR spectrum suggested the presence of a  $\gamma$ -lactone ( $1767\text{ cm}^{-1}$ ) and a methylenedioxybenzene group ( $932\text{ cm}^{-1}$ ). The  $^1\text{H}$  NMR spectra showed four signals in the aromatic region, three protons revealed a spin system, characteristic for a 1,3,4-tri-substituted aromatic ring, the fourth aromatic proton appeared as a singlet at  $\delta$  6.04. Moreover, four protons at  $\delta$  5.28 and 5.31 were observed. Two singlet signals at  $\delta$  3.72 and 3.16 revealed the presence of two methoxy groups. The remaining eight protons appeared between  $\delta$  2.0 and 4.0 ppm, and are coupled to each other in the COSY spectrum.

In the  $^{13}\text{C}$  NMR and HMQC spectra, a carbonyl group was observed at  $\delta$  178.0. Two methoxy groups at  $\delta$  55.4 and 59.0 were recognized. Five methylene groups were identified at  $\delta$  25.7, 34.3, 70.9, 100.6 and 100.8, the last two signals ( $\delta$  100.6 and 100.8) were attributed to the two methylenedioxy groups correlated with the proton signals at  $\delta$  5.28 and 5.31, respectively. Four H-bearing aromatic carbons

were identified at  $\delta$  123.2, 110.6 and 108.3, which belong to the 1,3,4-tri-substituted aromatic ring, and the last H-bearing aromatic carbon at  $\delta$  88.6, which is an unusual signal probably shielded by its position between the oxygens (the same pattern was observed in compound **23**). The above data allowed the identification of the remaining aromatic carbons, which suggested the presence of twelve aromatic carbons, or two aromatic rings, which makes this compound a pentacyclic natural product. Finally, two carbon signals were observed at  $\delta$  39.4 and 47.0.

**Table 1**  $^1\text{H}$  NMR and  $^{13}\text{C}$  spectral data.  $^1\text{H}$ - $^{13}\text{C}$  correlations of **23**

Position	Compound <b>23</b> <sup>a</sup>				Compound <b>23</b> <sup>b</sup>
	$^{13}\text{C}$	$^1\text{H}$	$^2J$	$^3J$	$^1\text{H}$
1					
2	156.2	8.36 s	C-3	C-4, C-9, C-1'	8.02 s
3	120.2				
4	180.7				
5	141.3				
6	129.6				
7	154.0				
8	89.6	6.92 s	C-7, C-9	C-6, C-10	6.55 s
9	153.0				
10	107.5				
1'	118.1				
2'	149.3				
3'	116.3	6.82*			6.94 d (8.8)
4'	115.1	6.82*			6.86 d (2.9, 8.8)
5'	151.8				
6'	116.9	6.82*			6.70 d (2.9)
CH <sub>3</sub> O (5')	55.5	3.68 s		C-5'	3.75 s
OCH <sub>2</sub> O (6, 7)	102.9	6.19 s		C-6, C-7	6.09 s
2'-OH		9.03 s	C-2'	C-1', C-3'	
5-OH		12.89 s	C-5	C-6, C-10	

\*Overlapping. Spectra recorded in <sup>a</sup>DMSO-*d*<sub>6</sub> and <sup>b</sup>10% MeOH-*d*<sub>4</sub> in CHCl<sub>3</sub>-*d*.

**Table 2**  $^1\text{H}$  NMR and  $^{13}\text{C}$  spectral data.  $^1\text{H}$ - $^{13}\text{C}$  correlations of 24

Position	$^{13}\text{C}$	$^1\text{H}$	$^2J$	$^3J$
1	132.4			
2	110.6	6.70 d (1.1)	C-3	C-4, C-6, C-7
3	148.0			
4	146.7			
5	108.3	6.59 d (8.1)*	C-4	C-1, C-3
6	123.2	6.61 dd (1.1, 8.1)*		C-2, C-4, C-7
7	34.3	2.88 dd (6.1, 14.0)	C-1, C-8	C-2, C-6, C-9, C-8'
		2.77 dd (5.1, 14.0)		
8 $\beta$	47.0	2.28 m	C-7, C-9, C-8'	C-1, C-7'
9	178.0			
1'	110.7			
2'	142.4			
3'	130.3			
4'	148.5			
5'	88.6	6.04 s	C-4', C-6'	C-1', C-3'
6'	153.3			
7'	25.7	2.61 dd (6.4, 13.0)	C-1', C-8'	C-8, C-2', C-6', C-9'
		2.47 dd (7.7, 13.0)		
8' $\alpha$	39.4	2.36 m	C-7', C-9'	C-7, C-1'
9' $\alpha$	70.9	3.71 dd (8.7, 7.8)*	C-8'	C-7', C-8, C-9
9' $\beta$		3.59 dd (8.7, 8.7)		
CH <sub>3</sub> O (2')	59.0	3.72 s*		C-2'
CH <sub>3</sub> O (6')	55.4	3.16 s		C-6'
OCH <sub>2</sub> O (3, 4)	100.8	5.31 d (1.4)		C-3, C-4
		5.28 d (1.4)*		
OCH <sub>2</sub> O (3', 4')	100.6	5.28 d (1.4)*		C-3', C-4'
		5.27 d (1.4)		

\*Overlapping. The spectra recorded in Benzene- $d_6$ .

The HMBC spectrum displayed correlations from methylenedioxy protons at  $\delta$  5.31 (2H, s;  $\delta_c$  100.8) to  $\delta$  148.0 and 146.7, which demonstrated the presence of the methylenedioxy group attached to an aromatic ring, specifically to C-3 and C-4 (HMBC correlations are shown in Figure 7). Moreover, HMBC correlations from 6-H to C-2 and C-4, from 2-H to C-3, C-4 and C-6, and from 5-H to C-1, C-3 and C-4 determined the structure of the first methylenedioxybenzene system. Both 2-H and 6-H gave HMBC correlations to the benzylic carbon C-7, while 7-H<sub>2</sub> gave HMBC correlations to C-1, C-2 and C-6. The spin system 7-H<sub>2</sub> – 8-H – 8'-H – 7'-H<sub>2</sub> and 9'-H<sub>2</sub> is demonstrated by the COSY correlations. C-9' ( $\delta_c$  70.9) is oxygenated and the HMBC correlations from 9'-H<sub>2</sub> and the carbonyl group C-9 as well as from 7-H<sub>2</sub> and 8-H to C-9 settled this part of the molecule as a lactone. 7'-H<sub>2</sub> gave HMBC correlations to C-1', C-2' and C-6' while the protons of the two methoxy groups gave HMBC correlations to C-2' and C-6'. 5'-H gave HMBC correlations to C-1', C-3', C-4' and C-6', consequently the second methylenedioxybenzene group is attached to C-3' and C-4'.

The relative configuration at the lactone ring was assigned by the analysis of the NOESY correlations (Figure 8). Strong correlations were observed from 7'-H<sub>2</sub> to 9'-H<sub>β</sub> and 8-H<sub>β</sub> protons, favoring the *trans* configuration. Additionally, correlations between 7-H<sub>2</sub> and 8'-H<sub>α</sub> and from H-2/H-6 to the methoxy groups, suggesting again the *trans* configuration. The absence of an NOESY correlations between 7-H<sub>2</sub> and 7'-H<sub>2</sub> (as expected in a *cis* configuration) confirmed the *trans* configuration. Consequently, the structure of compound 24 was shown to be (8 $\beta$ ,8' $\alpha$ )-3,4:3',4'-bis-methylenedioxy-2',6' dimethoxy lignano-9,9'-lactone, a new dibenzylbutyrolactone.

**Figure 8** Selected HMBC (a) and NOESY (b) correlations of **24**.

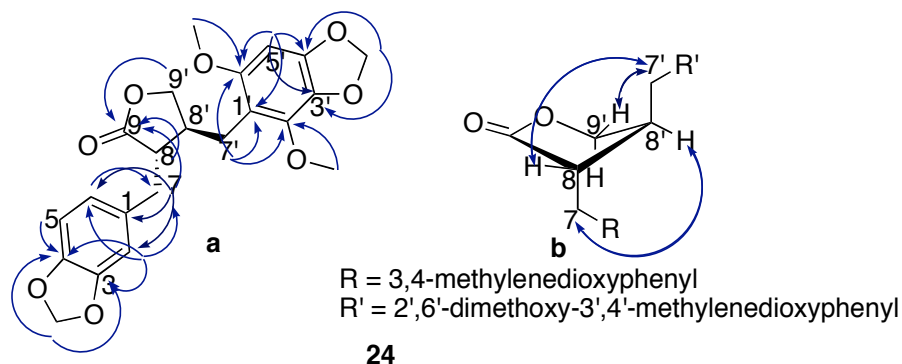

Numerous reviews dealing with the structures and biological activities of lignans have provided a comprehensive view of these natural products. Bioassays of lignans have revealed significant biological activities (MacRae and Towers, 1984, Ríos et al., 2002, Lee and Xiao, 2003). Antitumor and antiviral activities undoubtedly are the most relevant property of the lignans, where podophyllotoxin (**25**) and its analogs (e.g. etoposide, etopophos and teniposide) are the best-known compounds (Figure 9) (Canel et al., 2000, Ríos et al., 2002, Cos et al., 2008). They also exhibit anti-inflammatory effect modifying the activity of enzymes and mediators implicated in inflammation process (Ríos et al., 2002, Saleem et al., 2005, Lee et al., 2012). Lignans are also good antioxidants scavenging free radicals that may play a role in some diseases like cardiovascular disease. They also have been shown to possess antibacterial, antifungal and antiparasitic activities (Ríos et al., 2002, Saleem et al., 2005).

**Figure 9** Examples of biologically active lignans.

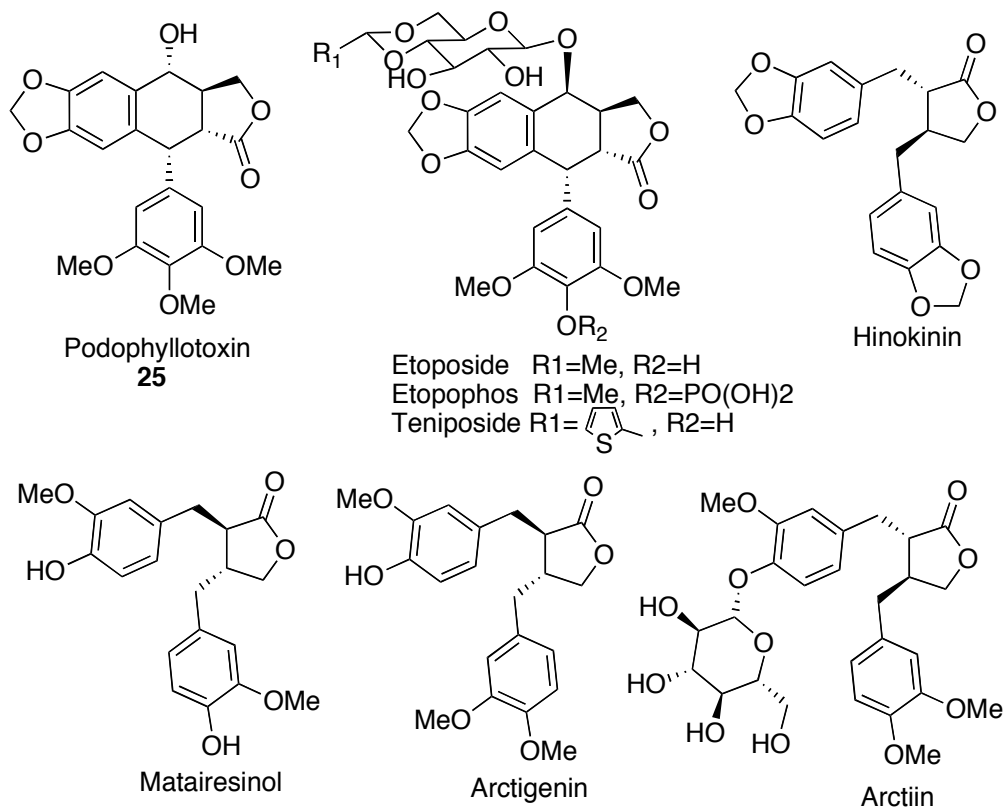

5,2'-dihydroxy-5'-methoxy-6,7-methylenedioxy isoflavone (**23**).

Yellowish powder. mp 218-220 °C. HR-ESI-MS calculated for C<sub>17</sub>H<sub>12</sub>O<sub>7</sub> [M+H]<sup>+</sup>: 329.0661. Found: 329.0659. <sup>1</sup>H (at 500 MHz) and <sup>13</sup>C NMR (at 125 MHz) was recorded in dimethyl sulfoxide-*d*<sub>6</sub> or in chloroform-*d* with 10% methanol-*d*<sub>4</sub> (Table 1).

(8β,8'α)-3,4:3',4'-bis-methylenedioxy-2',6' dimethoxy lignano-9,9'-lactone (**24**).

Yellowish oil. [α]<sub>D</sub><sup>20</sup> -29 (*c* 0.22, CHCl<sub>3</sub>). ATR-IR ν<sub>max</sub> (cm<sup>-1</sup>): 932, 1039, 1075, 1124, 1192, 1247, 1445, 1482, 1629, 1767, 2778, 2909. HR-ESI-MS calculated for C<sub>22</sub>H<sub>22</sub>O<sub>8</sub> [M+H]<sup>+</sup>: 415.1393. Found: 415.1373. <sup>1</sup>H (at 500 MHz) and <sup>13</sup>C NMR (at 125 MHz) was recorded in benzene-*d*<sub>6</sub>, data are shown in Table 2.



## 1.2.2. Computational calculations

### Conformational analysis and $^{13}\text{C}$ chemical shifts calculations

Theoretical methods were employed to study the structure characteristics of (8 $\beta$ ,8' $\alpha$ )-3,4:3',4'-bis-methylenedioxy-2',6' dimethoxy lignano-9,9'-lactone (**24**). The conformational properties have been investigated in chloroform using the MacroModel conformational search. Chemical shifts for  $^{13}\text{C}$  nuclei have been calculated using the mPW1PW91/6-31G\*\* level of theory. Theoretical values are compared with the corresponding experimental data.

### Computational methods

Compound coordinates were built using the Maestro 9.2 interface of Schrödinger Suite. After initial geometry cleanup, the compound was subjected to MacroModel 9.9 conformational search, using the OPLS-2005 force field and chloroform as solvent. A maximum of 500 steps with a convergent threshold of 0.05 was applied for the Polak-Ribier conjugate gradient algorithm (PRCG). The lowest energy conformer of the Boltzmann distribution was selected for the calculation of the isotropic magnetic shielding (IMS) ( $\sigma$ ). Jaguar 7.9 software was used to optimize the molecular geometry and calculate the NMR shielding constants at the Density Functional Theory (DFT), mPW1PW91 level of theory and 6-31G\*\* basis set. To explore the conformational preference of the isomers, selected rotation angles have been considered, as denoted in Figure 10.

**Figure 10** Molecular structure of **24** and the studied rotational angles

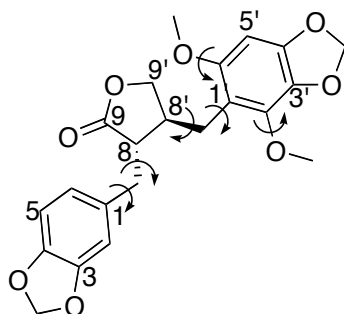

The calculated chemical shifts for  $^{13}\text{C}$  nuclei were obtained from subtracting the IMS ( $\sigma$ ) for the conformer from those of the reference (benzene), calculated at the same level of theory, and adding the chemical shift of the reference ( $\delta_{\text{calc}} = \sigma_{(\text{IMS ref})} - \sigma_{(\text{IMS})} + \delta_{(\text{ref})}$ ) (Cimino et al., 2004). The scaled  $^{13}\text{C}$  chemical shifts were obtained by linear fit of the calculated chemical shift versus the experimental chemical shifts (Lodewyk et al., 2011). The obtained scaled chemical shifts were compared with the experimental data. Three criteria were proposed to evaluate the quality in

the reproduction of experimental chemical shift values: (a) the linear regression analysis of the correlation between  $\delta_{\text{calc}}$  and  $\delta_{\text{exp}}$ ; (b) the absolute error ( $|\Delta\delta|$ ), which gives a measure of the dispersion between the theoretical and experimental values; and (c) the mean absolute error (MAE) is a quantity used to measure how close the theoretical values are to the experimental outcomes.

## Results and discussion

The dibenzylbutyrolactone lignan was analyzed according to the protocol described above. Considering the Boltzmann distribution, Table 3 shows the more relevant conformational structures and their relative energies for each conformer. The conformer energy differences range from 0.591 to 1.444 kJ mol<sup>-1</sup>.

**Table 3** Low energy conformers of 24

Conformer	Relative Energy (KJ/mol)	Boltzman distribution (%)
16.1	0.000	28.93
16.2	0.591	22.80
16.3	0.803	20.92
16.4	1.444	16.16

Conformational characteristics are presented in Table 4. The four structures share a common conformational feature, the  $\gamma$ -butyrolactone ring adopts the envelope-shape on C-8', which is turned "up" from the plane of the other four ring atoms. The bent shape is clearly observed by the dihedral angle C9-C8-C8'-C9' (Figure 11).

**Table 4** Conformational characteristics

Properties	Conformer			
	24.1	24.2	24.3	24.4
Lactone conformation	"up"	"up"	"up"	"up"
Dihedral angle C9-C8-C8'-C9'	-17.8	-19.7	-20.5	-16.0
Molecular conformation	-g -g	-g -g	-g -g	-g -g
Dihedral angle H8-C8-C7-C1	-51.3	-54.6	-57.3	-45.7
Dihedral angle H8'-C8'-C7'-C1'	-52.7	-58.0	-56.7	-45.1

The molecular conformation is defined by the position of the methylenedioxybenzyl units relative to the  $\gamma$ -butyrolactone ring and it is expressed as the rotation dihedral angle H8-C8-C7-C1 and H8'-C8'-C7'-C1', representing a conformer type *gauche-gauche* (g-g), these conformers can be characterized as

stacked conformer, where the methylenedioxybenzyl units are in nearly parallel and stacked relative position (Figure 11).

**Figure 11** Bent shape at the lactone ring. Stacked conformer where the methylenedioxybenzyl units are in parallel

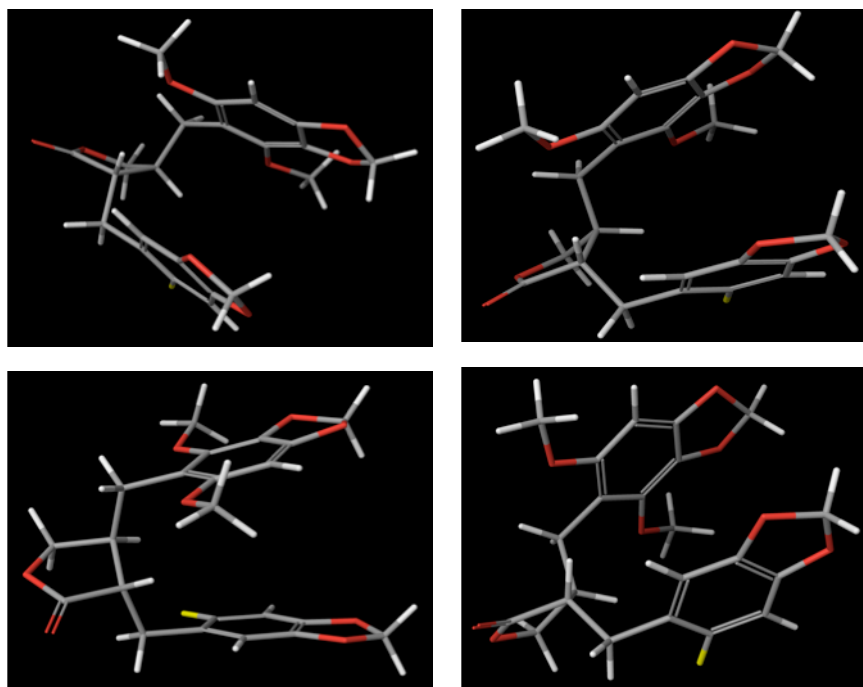

The linear correlation between the calculated  $^{13}\text{C}$  chemical shifts and the corresponding experimental values provide a good fit, as denoted by the coefficient of determination ( $R^2=0.9946$ ) (Figure 12), which reinforces the proposed structure.

**Figure 12** Linear regression between calculated vs. experimental chemical shifts ( $\delta_{\text{calc}} = a + b \delta_{\text{exp}}$ ) and coefficient of determination ( $R^2$ )

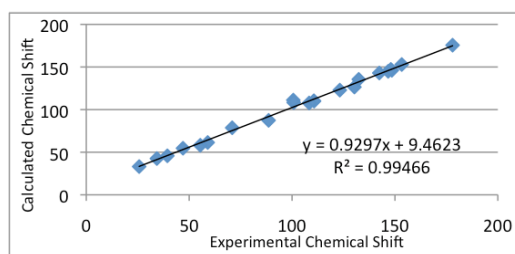

Table 5 compares the theoretical and experimental  $^{13}\text{C}$  chemical shifts. Analysis of the  $|\Delta\delta|$  values shows that the theoretical chemical shift values are close to the experimental ones, the maximum absolute error between theoretical and experimental chemical shifts is 8.78 ppm, and the mean absolute error is 2.45 ppm. From these results, it is understood that the theoretical  $^{13}\text{C}$  chemical shifts provide good correlation with the experimental values. The study of the conformational preferences and calculation of chemical shifts by computational methods was a convenient aid to confirm the proposed structure.

**Table 5** Comparison of experimental  $^{13}\text{C}$  chemical shift and theoretical data

Position	Conformer 24.1				
	IMS ( $\sigma$ )	$\delta_{\text{exp}}$	$\delta_{\text{calc}}^{\text{a}}$	$\delta_{\text{calc}}^{\text{b}}$	$ \Delta\delta ^{\text{c}}$
1	64.56	132.40	135.49	135.56	3.16
2	89.65	110.60	110.40	108.57	2.03
3	52.87	148.00	147.18	148.13	0.13
4	55.14	146.70	144.91	145.69	1.01
5	92.28	108.30	107.77	105.74	2.56
6	77.19	123.20	122.86	121.97	1.23
7	157.49	34.30	42.56	35.60	1.30
8	145.39	47.00	54.66	48.62	1.62
9	24.47	178.00	175.58	178.68	0.68
1'	90.13	110.70	109.92	108.05	2.65
2'	57.09	142.40	142.96	143.59	1.19
3'	73.57	130.30	126.48	125.87	4.43
4'	53.94	148.50	146.11	146.98	1.52
5'	112.68	88.60	87.37	83.80	4.80
6'	47.16	153.30	152.89	154.27	0.97
7'	166.90	25.70	33.15	25.48	0.22
8'	154.28	39.40	45.77	39.05	0.35
9'	121.37	70.90	78.68	74.45	3.55
CH <sub>3</sub> O (2')	138.64	59.00	61.41	55.88	3.12
CH <sub>3</sub> O (6')	141.88	55.40	58.17	52.39	3.01
OCH <sub>2</sub> O (3, 4)	91.76	100.80	108.29	106.30	5.50
OCH <sub>2</sub> O (3', 4')	88.90	100.60	111.15	109.38	8.78
MAE					2.45 <sup>d</sup>

<sup>a</sup> Calculated chemical shifts for the most stable conformer. <sup>b</sup> Obtained by linear fit of  $\delta_{\text{calc}}$  vs  $\delta_{\text{exp}}$ . <sup>c</sup>  $|\Delta\delta| = |\delta_{\text{exp}} - \delta_{\text{scaled}}|$ . <sup>d</sup> Mean absolute error  $\Sigma|\Delta\delta|/n$ , where  $n=22$ .

### 1.3. *Baccharis polycephala* Weddell (III)

The genus *Baccharis* L. (Asteraceae) comprises over 500 species, its distribution is exclusively American (Abad and Bermejo, 2007). *Baccharis* species are widely used in traditional medicine, all over America, where a large number are used in folk medicine to control or treat various diseases, and the list of the reported traditional uses is long (Abad et al., 2006, Abad and Bermejo, 2007, Morales et al., 2008). Species of the *Baccharis* genus are generally shrubs, vines and trees, with wide dispersion from sea level to higher regions (Müller, 2006). Phytochemical studies demonstrates the presence of flavonoids, triterpenes and diterpenes, with a greater amount of flavones and flavonols as well as labdane and clerodane diterpenes (Verdi et al., 2005).

*Baccharis polycephala* is a native shrub, approximately 1.20 m high. It is widespread in the mountainous region of Bolivia and Argentina (Tropicos.org, 2012), and no previous investigation regarding the contents of secondary metabolites of this specie has been reported in the literature.

#### 1.3.1. Chemical constituents isolated

The aerial parts of *B. polycephala* were collected in April 2008. Six phenolic compounds were isolated from the chloroform extract as described in Scheme 2. The structures of compounds 25-30 (Figure 13) were established by 1D and 2D NMR spectroscopy, as well as HRMS.

**Figure 13** Compounds isolated from *Baccharis polycephala*

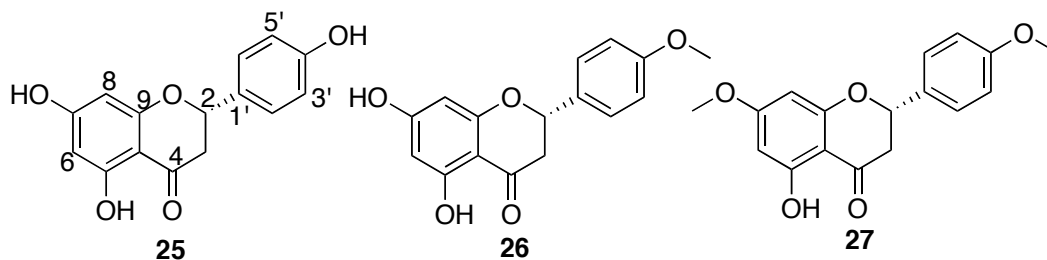

**Figure 14** Compounds isolated from *Baccharis polycephala* (continued)

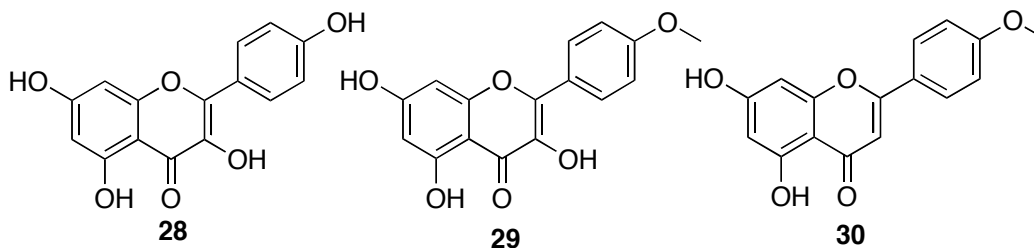

**Scheme 2** Sequential fractionation of the chloroform extract from *B. polycephala*

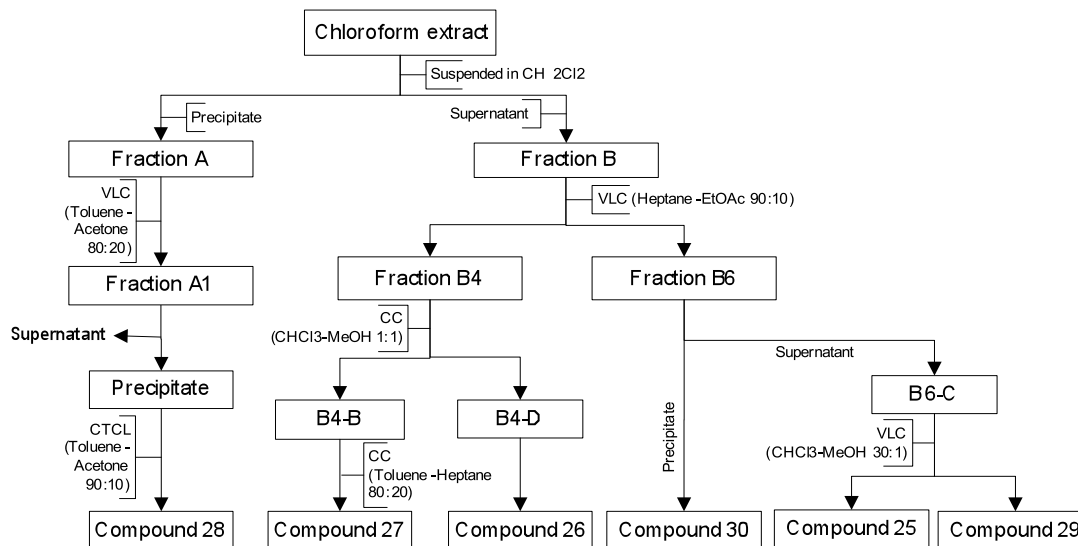

Compound **25**, known as naringenin, was obtained as a yellow oil. The ATR-IR spectrum showed bands at 1637, 1518 and 3306 cm<sup>-1</sup> indicating the presence of a conjugated carbonyl group, an aromatic ring and a hydroxyl group, respectively. Its molecular formula of C<sub>15</sub>H<sub>12</sub>O<sub>5</sub> was established on the basis of the HR-ESI-MS and <sup>13</sup>C NMR spectra. **25** has ten degrees of unsaturation. The <sup>13</sup>C NMR spectrum (recorded in CD<sub>3</sub>OD) showed only thirteen signals so it was assumed that **25** contains two pairs of equivalent carbon atoms. It displayed a signal at δ 197.9, which indicated the presence of a carbonyl group, it also showed ten aromatic signals between δ 95.0 and 169. The remaining signals appeared at δ 80.5 and 44.0.

The  $^1\text{H}$  NMR spectrum revealed the presence of three-proton spin system at  $\delta$  5.34 (1H, dd,  $J=13, 3$ ; 2-H),  $\delta$  3.11 (1H, dd,  $J=13, 17.1$ ; 3-Ha) and  $\delta$  2.69 (1H, dd,  $J=17.1, 3$ ; 3-Hb), which are typical proton signals of flavanone (Koteswara Rao et al., 2004). The aryl substituent at C-2 is obviously *para*-substituted, and this was indicated by the second order pattern of protons 2'/6'-H and 3'/5'-H at  $\delta$  7.32 (2H, d,  $J=8.6$ ) and  $\delta$  6.82 (2H, d,  $J=8.6$ ), respectively. HMBC correlations from 2-H to C-1' and C-2'/6', from 2'/6'-H to C-2, C-2'/6' and C-4', as well as from 3'/5'-H to C-1', C-3'/5' and C-4' confirm that the C-2 substituent is 4-hydroxyphenyl and that **25** in fact is a flavanone. The remaining benzene ring has two protons at  $\delta$  5.90 (1H, d,  $J=2.1$ ; 8-H) and  $\delta$  5.88 (1H, d,  $J=2.1$ ; 6-H), and is consequently 1,2,3,5-tetra-substituted. HMBC correlations from 6-H to C-5, C-7, C-8 and C-10, as well as from 8-H to C-6, C-7, C-9 and C-10 establish that **25** is 5,7,4'-trihydroxyflavanone, previously isolated from *Euphorbia tuckeyana* (Duarte et al., 2008).

The HR-ESI-MS spectra of compounds **26** and **27** suggested the elemental compositions  $\text{C}_{16}\text{H}_{14}\text{O}_5$  and  $\text{C}_{17}\text{H}_{16}\text{O}_5$ , respectively. The NMR data of compounds **26** and **27** (recorded in  $\text{CDCl}_3$ ) are similar to those of **25**, except that **26** has one and **27** has two methoxy groups. The same NMR experiments as discussed above were carried out with **26** and **27**, showing that both are flavanones oxygenated in positions 5, 7 and 4'. As a confirmation, the chelated 5-OH is visible in the  $^1\text{H}$  NMR spectra (recorded in  $\text{CDCl}_3$ ) of both compounds at just above 12 ppm. HMBC correlations from the methoxy protons to C-4' in **26** and to C-7 as well as C-4' in **27** demonstrate that **26** is 5,7-dihydroxy-4'-methoxyflavanone while **27** is 5-hydroxy-4',7-dimethoxyflavanone. **26** was isolated from *Artemisa campestris subsp. maritima* (Vasconcelos et al., 1998), while **27** has previously been reported from an *Aniba sp.* (Rossi et al., 1997).

Over the years, numerous studies have reported that flavanones exhibit a variety of health benefits including antioxidant, anti-inflammatory, antitumor and anti-carcinogenic activities (Pietta, 2000, Nijveldt et al., 2001, Nishimura et al., 2013, Khan et al., 2014).

Naringenin (**25**), one of the most commonly flavanones found in citrus fruits, has been reported to show anticancer and anti-proliferative effects, and cause apoptotic cell death in various cancer cells (Frydoonfar et al., 2003, Kanno et al., 2005, Ekambaram et al., 2008). Gao and co-workers demonstrated that naringenin (**25**) stimulated the induction of DNA repair enzymes in prostate cancer cells. The investigation conclude that naringenin (**25**) may contribute to the cancer preventive effects associated with an increased dietary intake of fruits containing flavonoids (Gao et al., 2006). Ekambaram and co-workers have reported anti-carcinogenic activity of naringenin (**25**) in gastric carcinoma-induced rats (Ekambaram et al., 2008). Besides the evidence on the anti-carcinogenic and anti-tumor activities, naringenin (**25**) has been shown to possess antioxidant activity. A

review of flavonoids mentions that the antioxidant activity of these natural products depends on the molecular structure and the substitution pattern of functional groups. Moreover, they also point out that there is a broad agreement that hydroxyl groups endow flavonoids with antioxidant ability, and hydroxyl groups on the B-ring are the most significant determinant of antioxidant activity. A 5,7-*m*-dihydroxy arrangement increases the activity. Planarity permits conjugation, and a corresponding increase in antioxidant activity. On the other hand, inhibition of antioxidant activity by *O*-methylation may reflect steric effects that perturb planarity (Heim et al., 2002). This information suggests that naringenin (**25**) is the most effective antioxidant followed by compounds **26** and **27**. Several authors have documented the antioxidant activity of naringenin (**25**), e.g., in vitro experiments showed that naringenin (**25**) is able to protect DNA from UV-induced DNA damage (Kootstra, 1994). The antioxidant effects of naringenin (**25**) has been demonstrated by Nishimura and co-workers, where naringenin (**25**) significantly decrease the reactive oxygen species production in different experimental models (Nishimura et al., 2013).

Compound **26** inhibits the hypoxia inducible factor 1 (HIF-1), which is a transcription factor that mediates major adaptive responses to hypoxia (state of low oxygen concentration, on the cell) (Hattori et al., 2011). Hypoxia is associated with increased risk of invasion, metastasis, and patient mortality (Semenza, 2003).

Compound **26** has shown beneficial effects in prevention of cardiovascular diseases by preventing the aggregation of platelets (antiaggregatory activity). Platelets are involved in haemostasis, thrombosis and inflammatory processes; hence as a consequence of that physiological role heart stroke and cerebrovascular insult can occur. Bojic and co-workers reveal that the increase in the number of *O*-methyl groups at the rings A and B increases antiaggregatory activity (Bojić et al., 2011). In this sense, an increased activity is expected by compound **27**.

Compound **28** contains only unsaturated carbons according to the NMR data (recorded in CD<sub>3</sub>OD), which are typical for a flavonol. According to HR-ESI-MS experiments, **28** has the elemental composition C<sub>15</sub>H<sub>10</sub>O<sub>6</sub>, which is in agreement with a trihydroxylated flavonol. The <sup>1</sup>H NMR spectrum showed two signals for *meta*-coupled protons at δ 6.37 (1H, d, *J*= 2.1; 8-H) and δ 6.16 (1H, d, *J*= 2.1; 6-H) with the corresponding HMBC correlations discussed for **25** above, indicating that A-ring has hydroxyl groups in positions 5 and 7. Two doublets at δ 8.07 (2H, d, *J*= 9; 2'/6'-H) and δ 6.89 (2H, d, *J*= 9; 3'/5'-H) suggest the presence of a typical AA'BB' coupling system, in this case a *para*-hydroxy substituted B-ring. Compound **28** was therefore found to be 5,7,4'-trihydroxyflavonol, identical to kaempferol previously isolated from *Polygonatum polyanthemum* (Gvazava and Kikoladze, 2011). The NMR data of compound **29** (recorded in CD<sub>3</sub>OD) is similar to those of **28**, except for the presence of a methoxy group in **29**. Consequently, the elemental composition of **29** should be C<sub>16</sub>H<sub>12</sub>O<sub>6</sub> and this was confirmed by



HR-ESI-MS experiments. The position of the methoxy group was determined by the HMBC correlation from the methoxy protons to C-4', and **29** is 5,7-dihydroxy-4'-methoxyflavonol. **29** has previously been reported from a *Hippophae* species (Pandurangan et al., 2011).

Kaempferol (**28**) has been identified in many edible plants, e.g. pumpkin, carrots, black tea and lemon grass (Miean and Mohamed, 2001), as well as in many plant species commonly used in traditional medicine, e.g. *Aloe vera* and *Ginkgo biloba*. A review by Calderon and co-workers, indicates that several studies have shown that the presence of a double bond at C2-C3 in conjugation with an oxo group at C4, and the presence of hydroxyl groups at C3, C5 and C4', endow the flavonol an increased antioxidant activity, indicating the potent antioxidant activity of compound **28** (Calderon-Montano et al., 2011).

Cancer, atherosclerosis, diabetes, depression, heart disease, stroke and some neurological disorders, such as Alzheimer's disease and Parkinson's disease-these diverse diseases have a common denominator: chronic inflammation. However, the review also denotes that numerous *in vitro* and *in vivo* studies have revealed that compound **28** has anti-inflammatory activity and have shown several mechanisms that may participate in this activity (e.g. kaempferol inhibits NF- $\kappa$ B activity, it can inhibit TNF- $\alpha$  activity, as well as the activation of AP-1) (Calderon-Montano et al., 2011).

Several studies have found a positive association between the consumption of kaempferol (**28**) and derivatives containing in foods and a reduced risk of cancer (Hertog et al., 1992, Kris-Etherton et al., 2002, Neuhouser, 2004). It has been shown that kaempferol (**28**) is able to modulate various cellular mechanisms involved in the signal transduction, linked to apoptosis, angiogenesis, inflammation and metastasis (Chen and Chen, 2013).

The 1D NMR data of compound **30** do not suggest that it is a flavanone or flavonol, although it appears to be a flavonoid. The elemental composition of **30** was determined to be C<sub>16</sub>H<sub>12</sub>O<sub>5</sub>, from HR-ESI-MS experiments and the 1D NMR spectra recorded in DMSO-*d*<sub>6</sub>. The <sup>1</sup>H NMR spectrum showed a signal at  $\delta$  6.88 (1H, s), characteristic for a proton at C-3 in flavones. The presence of a doublet at  $\delta$  6.20 (1H) and  $\delta$  6.51 (1H) (both with  $J= 2.0$ ) was attributed to the protons at 6-H and 8-H in A-ring, while doublets at  $\delta$  7.11 (2H; 3'/5'-H) and  $\delta$  8.04 (2H; 2'/6'-H) (both with  $J= 8.9$ ) were attributed to the AA'BB' spin system in B-ring. HMBC correlations from 3-H to C-4, C-10 and C-1', from 2'/6'-H to C-2 and C-4', as well as from 3'/5'-H to C-1' and C-4' determine the structure of **30**, which consequently is 5,7-dihydroxy-4'-methoxyflavone. **30** has previously been reported from *Cirsium japonicum* (Peng, 2011). All data reported for the six compounds are in agreement with those in this investigation.

Flavones constitute a large and diverse group of biologically active plant chemicals that have been identified in several plant genera such as *Thymus*, *Petroselinum*, *Apium*, *Citrus* and citrus peel (Yao et al., 2004, Girones-Vilaplana et al., 2014). However, many researchers over the world have reported that flavones display a remarkable spectrum of biological activities including antimicrobial, anti-inflammatory, antioxidant, antimutagenic, anticancer and anticarcinogenic activity (Harborne and Williams, 2000).

Compound **30**, known as acacetin, has been reported to possess significant antioxidant activity towards scavenging of DPPH radicals (Nawal and Atta, 2013, Rauf et al., 2013). Most importantly, acacetin (**30**) exerts a broad spectrum of biological effects by targeting molecules involved in regulation of tumor cell proliferation, the cell cycle, and apoptosis, thus reducing the risk of cancer or inhibiting the growth of tumor cells. In this sense, acacetin (**30**) showed a strong cell growth inhibition accompanied by cell death against prostate cancer, LNCaP and DU145 cells (Singh et al., 2005). The research concluded that acacetin (**30**) causes the cell cycle arrest by regulating the level of the proteins which are involved in the cell cycle. It has been demonstrated to inhibit the proliferation in a human liver cancer cell line, Hep G2 (Hsu et al., 2004), as well as, in human gastric carcinoma AGS cells (Pan et al., 2005a), and to inhibit the growth of human breast cancer MCF-7 cells (Hye-Young et al., 2007), by inducing apoptosis and arresting cell cycle progression.

Acacetin (**30**) was reported to exhibit antimicrobial activity and synergistic effects with antibiotics against common bacterial species present in oral cavity (Cha et al., 2013). In addition, it was also reported to present synergistic effects when administered with oxacillin or ampicillin against clinical isolates of Methicillin-resistant *Staphylococcus aureus*. Thus, acacetin (**30**) is an important and valuable compound that enhances antimicrobial activity of antibiotics (Cha et al., 2014).

#### 5,7,4'-trihydroxyflavanone (**25**).

Pale yellow oil.  $[\alpha]_D^{20} -10^\circ$  (*c* 0.46, Acetone). HR-ESI-MS calculated for  $C_{15}H_{12}O_5$   $[M+H]^+$  273.0763; found: 273.0776. ATR-IR  $cm^{-1}$ : 3306, 2933, 1637, 1599 and 1518.  $^1H$  NMR (Methanol- $d_4$  400 MHz):  $\delta$  2.69 (1H, dd,  $J= 3, 17.1$ ; 3-H), 3.11 (1H, dd,  $J= 17.1, 13$ ; 3-H), 5.34 (1H, dd,  $J= 13, 3$ ; 2-H), 5.88 (1H, d,  $J= 2.1$ ; 6-H), 5.90 (1H, d,  $J= 2.1$ ; 8-H), 6.82 (2H, d,  $J= 8.6$ ; 3'/5'-H), 7.32 (2H, d,  $J= 8.6$ ; 2'/6'-H).  $^{13}C$  NMR (Methanol- $d_4$  100 MHz):  $\delta$  44.0 (C-3), 80.5 (C-2), 96.1 (C-8), 97.0 (C-6), 103.3 (C-10), 116.3 (C-3'/5'), 129.0 (C-2'/6'), 131.1 (C-1'), 159.0 (C-4'), 164.9 (C-9), 165.5 (C-5), 168.3 (C-7), 197.9 (C-4).

#### 5,7-dihydroxy-4'-methoxyflavanone (**26**).

Pale yellow oil.  $[\alpha]_D^{20}$   $-8^\circ$  (*c* 0.23, Acetone). HR-ESI-MS calculated for  $C_{16}H_{14}O_5$   $[M+H]^+$  287.0919; found: 287.0913. ATR-IR  $cm^{-1}$ : 3294, 2934, 1637, 1612 and 1515.  $^1H$  NMR (Chloroform-*d* 400 MHz):  $\delta$  2.78 (1H, dd,  $J=17.2, 3$ ; 3-H), 3.10 (1H, dd,  $J=17.2, 13$ ; 3-H), 3.83 (3H, s; 4'-OCH<sub>3</sub>), 5.37 (1H, dd,  $J=13, 3$ ; 2-H), 5.98 (1H, d,  $J=2.2$ ; 8-H), 5.99 (1H, d,  $J=2.2$ ; 6-H), 6.95 (2H, d,  $J=8.5$ ; 3'/5'-H), 7.38 (2H, d,  $J=8.5$ ; 2'/6'-H), 12.05 (1H, s; 5-OH).  $^{13}C$  NMR (Chloroform-*d*100 MHz):  $\delta$  43.3 (C-3), 55.5 (5-OCH<sub>3</sub>), 79.1 (C-2), 95.6 (C-8), 96.8 (C-6), 103.3 (C-10), 114.4 (C-3'/5'), 127.9 (C-2'/6'), 130.4 (C-1'), 160.0 (C-4'), 163.4 (C-9), 164.4 (C-5), 164.7 (C-7), 196.2 (C-4).

5-hydroxy-4',7-dimethoxyflavanone (**27**).

White amorphous solid. mp 115-118 °C.  $[\alpha]_D^{20}$   $-4^\circ$  (*c* 0.14, Acetone). HR-ESI-MS calculated for  $C_{17}H_{16}O_5$   $[M+H]^+$  301.1076; found: 301.1077. ATR-IR  $cm^{-1}$ : 2935, 1637, 1574 and 1516.  $^1H$  NMR (Chloroform-*d* 400 MHz):  $\delta$  2.78 (1H, dd,  $J=17.1, 2.9$ ; 3-H), 3.10 (1H, dd,  $J=17.1, 13.1$ ; 3-H), 3.80 (3H, s; 7-OCH<sub>3</sub>), 3.83 (3H, s; 4'-OCH<sub>3</sub>), 5.37 (1H, dd,  $J=13.1, 2.9$ ; 2-H), 6.05 (1H, d,  $J=2.3$ ; 8-H), 6.08 (1H, d,  $J=2.3$ ; 6-H), 6.95 (2H, d,  $J=8.6$ ; 3'/5'-H), 7.38 (2H, d,  $J=8.6$ ; 2'/6'-H), 12.03 (1H, s; 5-OH).  $^{13}C$  NMR (Chloroform-*d*100 MHz):  $\delta$  43.2 (C-3), 55.4 (5-OCH<sub>3</sub>), 55.7 (7-OCH<sub>3</sub>), 79.0 (C-2), 94.2 (C-8), 95.1 (C-6), 103.1 (C-10), 114.2 (C-3'/5'), 127.7 (C-2'/6'), 130.3 (C-1'), 160.0 (C-4'), 162.9 (C-9), 164.1 (C-5), 167.9 (C-7), 196.0 (C-4).

5,7,4'-trihydroxyflavonol (**28**).

Yellow powder. mp 269-270 °C. HR-ESI-MS calculated for  $C_{15}H_{10}O_6$   $[M+H]^+$  287.0556; found: 287.0549. ATR-IR  $cm^{-1}$ : 3335, 1652, 1604 and 1509.  $^1H$  NMR (Methanol-*d*<sub>4</sub> 400 MHz):  $\delta$  6.16 (1H, d,  $J=2.1$ ; 6-H), 6.37 (1H, d,  $J=2.1$ ; 8-H), 6.89 (2H, d,  $J=9$ ; 3'/5'-H), 8.07 (2H, d,  $J=9$ ; 2'/6'-H).  $^{13}C$  NMR (Methanol-*d*<sub>4</sub>100 MHz):  $\delta$  94.4 (C-8), 99.2 (C-6), 104.5 (C-10), 116.3 (C-3'/5'), 123.7 (C-1'), 130.6 (C-2'/6'), 137.1 (C-3), 148.0 (C-2), 158.2 (C-9), 160.5 (C-4'), 162.5 (C-5), 165.6 (C-7), 177.3 (C-4).

5,7-dihydroxy-4'-methoxyflavonol (**29**).

Yellow powder. mp 200-202 °C. HR-ESI-MS calculated for  $C_{16}H_{12}O_6$   $[M+H]^+$  301.0712; found: 301.0722. ATR-IR  $cm^{-1}$ : 3348, 1652, 1601 and 1509.  $^1H$  NMR (Methanol-*d*<sub>4</sub> 400 MHz):  $\delta$  3.88 (3H, s; 4'-OCH<sub>3</sub>), 6.19 (1H, d,  $J=2.1$ ; 6-H), 6.41 (1H, d,  $J=2.1$ ; 8-H), 7.06 (2H, d,  $J=9.2$ ; 3'/5'-H), 8.18 (2H, d,  $J=9.2$ ; 2'/6'-H).  $^{13}C$  NMR (Methanol-*d*<sub>4</sub> 100 MHz):  $\delta$  55.9 (4'-OCH<sub>3</sub>), 94.5 (C-8), 99.3 (C-6), 104.5 (C-10), 114.9 (C-3'/5'), 125.0 (C-1'), 130.5 (C-2'/6'), 137.5 (C-3), 147.5 (C-2), 158.3 (C-9), 162.5 (C-4'), 162.6 (C-5), 165.9 (C-7), 177.4 (C-4).

5,7-dihydroxy-4'-methoxyflavone (**30**).

Yellow powder. mp 259-261 °C. HR-ESI-MS calculated for C<sub>16</sub>H<sub>12</sub>O<sub>5</sub> [M+H]<sup>+</sup> 285.0763; found: 285.0775. ATR-IR cm<sup>-1</sup>: 3143, 1637, 1599 and 1495. <sup>1</sup>H NMR (DMSO-*d*<sub>6</sub> 400 MHz): δ 3.86 (3H, s; 4'-OCH<sub>3</sub>), 6.20 (1H, d, *J*= 2.0; 6-H), 6.51 (1H, d, *J*= 2.0; 8-H), 6.88 (1H, s; 3-H), 7.11 (2H, d, *J*= 8.9; 3'/5'-H), 8.04 (2H, d, *J*= 8.9; 2'/6'-H), 10.87 (1H, br, 7-OH), 12.93 (1H, s, 5-OH). <sup>13</sup>C NMR (DMSO-*d*<sub>6</sub> 100 MHz): δ 55.6 (4'-OCH<sub>3</sub>), 94.0 (C-8), 98.9 (C-6), 103.5 (C-3), 103.8 (C-10), 114.6 (C-3'/5'), 122.8 (C-1'), 128.3 (C-2'/6'), 157.3 (C-9), 161.5 (C-5), 162.3 (C-4'), 163.3 (C-2), 164.2 (C-7), 181.8 (C-4).

## 1.4. *Podocarpus parlatorei* Pilger (IV)

The genus *Podocarpus* belonging to the family Podocarpaceae, comprises about 107 species of shrubs and trees which mainly are distributed in the southern hemisphere (Barker et al., 2004). *Podocarpus* species are important timber trees in their native areas, and are used for furniture making, boat building, interior works and house building (Abdillahi et al., 2010). The fruits of some *Podocarpus* species are eaten raw or cooked. Various species of *Podocarpus* are used in traditional medicine to treat fever, asthma, coughs, cholera, distemper, chest complaints and venereal diseases (Abdillahi et al., 2010).

*Podocarpus* species are well known to contain various terpenoids and norditerpene dilactones (Itô and Mitsuaki, 1976, Matlin et al., 1984), as well as biflavonoids (Miura et al., 1968, Roy et al., 1987), and such natural products are considered to be taxonomic markers for the genus (Abdillahi et al., 2010). The chemical constituents of *Podocarpus* species have been investigated as a results of the isolation of natural products possessing biological activities, such as antitumor, antimicrobial, plant growth regulatory, insect growth regulatory and gastro-protective activity (Abdillahi et al., 2010).

*Podocarpus parlatorei* is an endemic plant that grows naturally in Bolivia. It is a cold-tolerant perennial tree, and the unique conifer that occupies the eastern-most flanks of the Andes of northwestern Argentina and Bolivia (Quiroga et al., 2012). It is distributed in the Sub-Andean Amazonian Forest regions of Bolivia, and is known as "pino de monte" by the natives of the region (Zárate et al., 1999). *P. parlatorei* is an important commercial timber source (Wood, 2005, Quiroga et al., 2012).

### 1.4.1. Chemical constituents isolated

The aerial parts of *P. parlatorei* were collected from south of Cochabamba-Bolivia in 2008. Dried aerial parts of *P. parlatorei* were pulverized and extracted with ethanol at room temperature. The solvent was removed under reduced pressure to give the crude extract. The ethanol extract was dissolved in methanol-water (5:1) and the suspension was submitted to L-L partition with chloroform, three times, to give the corresponding fractions (A, B and C). Fraction A was successively partitioned by VLC, CC to afford compounds **31-36** (Figure 14) as described below. Fraction A was subject to VLC eluted with heptane-ethyl acetate gradient to give seven fractions (A1-A7). The compound **35** (5 mg) was purified from fraction A3 by CC using a mixture of heptane-ethyl acetate (80:20) as a solvent. Fraction A4 was applied to repeated silica gel VLC (chloroform-methanol (80:20) and chloroform) and CC on Sephadex LH-20 (chloroform-methanol (50:50)) to

yield compound **34** (5 mg). Fraction C was subject to VLC on silica gel eluted with chloroform-methanol to give two main fractions C1 and C2. Fraction C1 (1.4 g) was subject to CC on Sephadex LH-20 eluted with chloroform-methanol (50:50) to give eight fractions (1-8). Fraction 1 (140 mg) was precipitated with methanol to give compound **36** (5 mg). Fraction 2 (200 mg) was precipitated with methanol to give compound **33** (3 mg). Fraction 3 (380 mg) was precipitated with methanol to give compound **31** (7 mg). Finally, fraction 8 was washed with cold acetone and filtered to yield compound **32** (1.5 mg).

**Figure 15** Compounds isolated from *Podocarpus parlatoresi*.

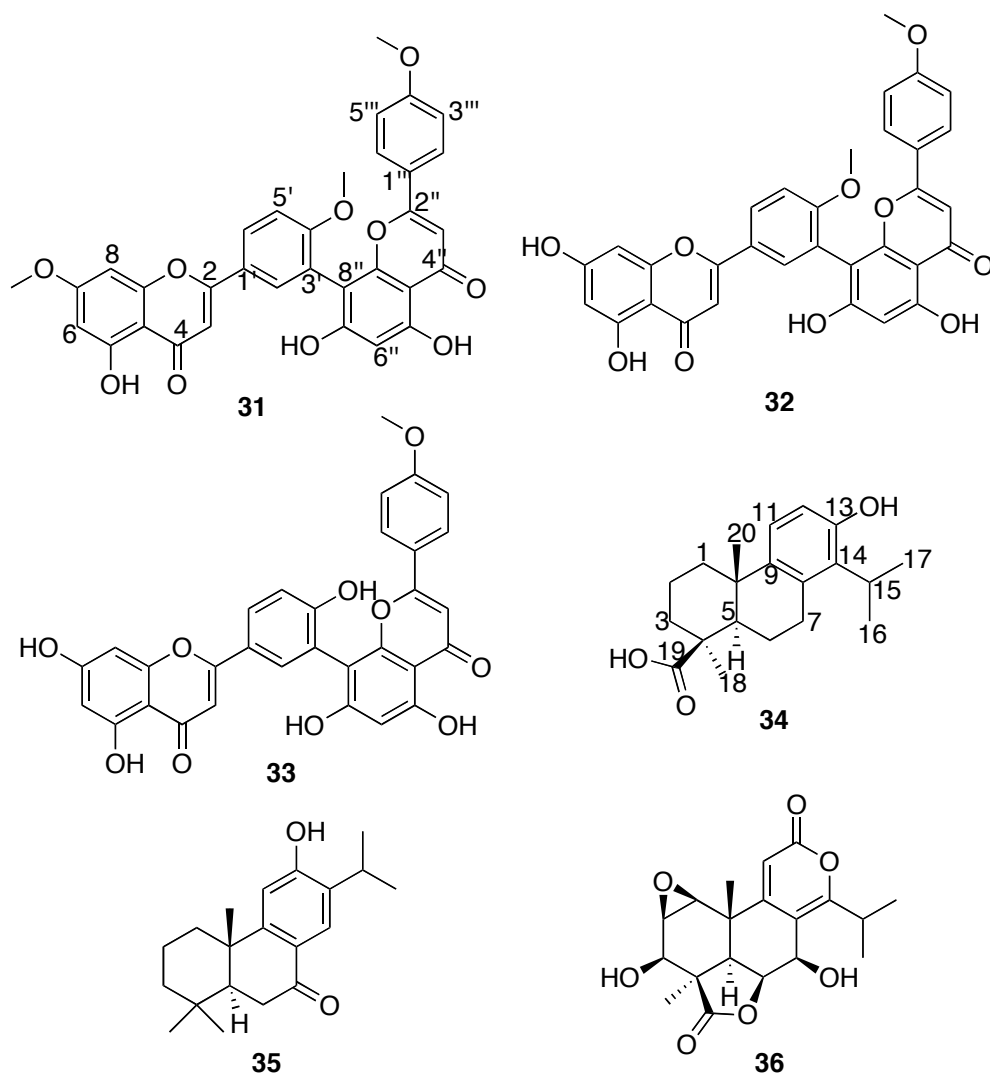

The elemental composition of compound **31** was determined to be C<sub>33</sub>H<sub>24</sub>O<sub>10</sub>, based on the 1D NMR spectra as well as HR-ESI-MS data, indicating twenty-two degrees of unsaturation. The <sup>13</sup>C NMR spectrum only displayed 31 signals, and it was assumed that **31** contains two pairs of equivalent carbon atoms. Two carbonyl groups and three methoxy groups were also identified. The remaining signals were observed in the aromatic region between δ 90 and 170 ppm. The <sup>1</sup>H NMR spectrum (recorded in DMSO-*d*<sub>6</sub>) displayed signals corresponding to three methoxy groups and twelve aromatic protons. The methoxy groups at δ 3.75 (3H, s), 3.79 (3H, s) and 3.82 (3H, s) linked to C-4', C-4''' and C-7, respectively, were assigned by their HMBC correlations. Two singlets at δ 13.05 and 12.91, indicating the presence of two chelated hydroxyl groups, which were assigned to OH groups at C-5 and C-5'', respectively, by their HMBC correlations from 5-OH to C-5, C-6 and C-10, and 5''-OH to C-5'', C-6'' and C-10''.

The analysis of the 1D <sup>1</sup>H NMR and 2D COSY spectra of **31** revealed that the following proton systems were incorporated in the structure: one tetra-substituted aromatic ring with a pair of *meta*-coupled protons at δ 6.36 (1H, d, *J* = 2.2) and 6.79 (1H, d, *J* = 2.2); a spin system of three aromatic protons at δ 7.37 (1H, d, *J* = 8.9), 8.08 (1H, d, *J* = 2.4) and 8.23 (1H, dd, *J* = 2.4, 8.9); a singlet at δ 7.00 (1H; 3-H), characteristic for a proton at C-3 in flavonoids; one penta-substituted aromatic ring with a single proton at δ 6.42 (1H, s); an AA'BB' aromatic spin system at δ 7.60 (2H, d, *J* = 9.0) and 6.93 (2H, d, *J* = 9.0); and a singlet signal at δ 6.90 (1H; 3''-H), which is a characteristic signal in flavonoids.

The HMBC spectrum (Figure 15) showed correlations from 6-H (δ 6.36) to C-5, C-7, C-8 and C-10, as well as from 8-H (δ 6.79) to C-6, C-7, C-9 and C-10, identifying the tetra-substituted aromatic A-ring. The proton signal of 5'-H (δ 7.37) showed correlations to C-1' and C-3', and the proton of 2'-H (δ 8.08) to C-4', C-6' and C-8'', determining the B-ring, finally correlations from 3-H (δ 7.00) to C-2, C-4 and C-1', closing this unit of the molecule as 5-hydroxy-4',7-dimethoxy-flavone. Additional examination of the HMBC spectrum showed correlations from the only aromatic proton in A<sub>1</sub>-ring at δ 6.42 (6''-H) to C-5'', C-7'', C-8'' and C-10''. Furthermore, correlations from 2'''/6'''-H (δ 7.60 for both) to C-2'', C-4''' and C-6'''/2'', as well as from 3'''/5'''-H (δ 6.93 for both) to C-1''' and C-5'''/3''' (B<sub>1</sub>-ring), and from 3''-H (δ 6.90) to C-2'', C-4'' and C-1'', establishing the second unit of the molecule (5,7-dihydroxy-4'-methoxy-flavone). With the above mentioned HMBC correlation between 2'-H to C-8'', the link between the units is now established. **31** is a 5,5'',7''-trihydroxy-4',4''',7-trimethoxy-3',8''-biflavone (sciadopitysin), with a C-3'-C-8'' inter-flavonoid linkage. **31** has previously been isolated from *Taxus cuspidata* (Choi et al., 2006).

**Figure 16** Selected HMBC correlations observed with **31**.

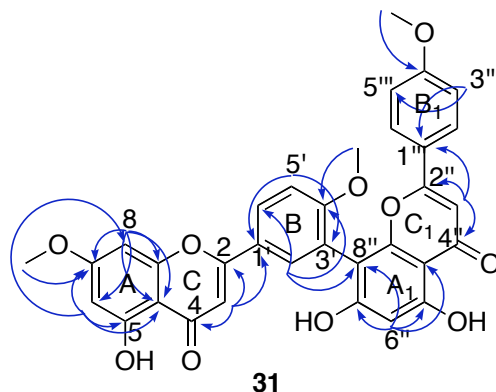

The elemental composition of compounds **32** and **33** were determined to be  $C_{32}H_{22}O_{10}$  and  $C_{31}H_{20}O_{10}$ , respectively, based on the 1D NMR as well as HR-ESI-MS data. The  $^1H$  and  $^{13}C$  NMR spectra of **32** and **33** were similar to those of **31**. The analysis of  $^1H$  NMR and HR-ESI-MS data showed that **32** has one methoxy group less than **31**, while the data of **33** revealed the absence of two methoxy groups. Carbons and protons were assigned on the basis of 2D NMR data (COSY, HMQC and HMBC). Based on their data, the structures were established as 5,5'',7,7''-tetrahydroxy-4',4''-dimethoxy-3',8''-biflavone (**32**) (isoginkgetin) and 4',5,5'',7,7''-pentahydroxy-4''-methoxy-3',8''-biflavone (**33**) (podocarpusflavone A) (Markham et al., 1987). Compound **32** has previously been isolated from *Ginkgo biloba* (Hanrahan et al., 2003), while **33** has been reported from *Podocalyx loranthoides* (Suárez et al., 2003).

Biflavonoids belong to the group of flavonoid family with a varied chemical structures and biological activities of high relevance, such as anti-inflammatory (Kim et al., 2008, Zhou et al., 2011), anticancer (Silva et al., 1995, Li et al., 2014), antibacterial (Kaikabo and Eloff, 2011), antiparasitic (Weniger et al., 2006, Kunert et al., 2008), antiviral (Coulerie et al., 2013) activity. In addition, biflavonoids show antioxidative ability *in vitro* and *in vivo* and can be used as antioxidants to protect cells from free radical damage (Ye et al., 2012). Biflavonoids (sciadopitysin (**31**), isoginkgetin (**32**) and ginkgetin) of *Ginkgo biloba* have shown a remarkable cell protective effect against ultraviolet B-induced cytotoxicity, the author suggest that the results may reflect the antioxidant properties of bioflavonoids because UVB induced cytotoxicity levels are closely related to free radical damage (Kim, 2001).

An investigation showed that compounds podocarpusflavone A (**33**) and isoginkgetin (**32**) have inhibitory activity against the enzyme  $\beta$ -secretase 1



(BACE-1), which plays an important role in the production of the amyloid- $\beta$  peptides (A $\beta$ ) (Sasaki et al., 2010). The cerebral deposition of these peptides (A $\beta$ ) is an early and critical feature of Alzheimer's disease (Vassar et al., 1999). The investigation also indicates that the amentoflavone-type biflavonoids, linked at the C3'-C8" position, have significant BACE-1 inhibitory activity. Sciadopitysin (**31**) was found to be the active component of *T. chinensis* with a significant inhibitory (A $\beta$ ) aggregation activity and neuroprotective effects against A $\beta$ -induced toxicity. Therefore, sciadopitysin (**31**) is a promising compound for the further development for treating Alzheimer's disease (Gu et al., 2013).

Cathepsin B is an enzymatic protein that plays various roles in maintaining the normal metabolism of cells. Endogenous inhibitors, cystatins A, B and C, regulate its activity. The imbalance between cathepsin B and inhibitors (overexpression) is an important factor in invasion and metastasis in cancer cells, subsequently cathepsin B is a potential target for cancer therapy (Nomura, 2005). Interestingly, podocarpusflavone A (**33**) showed significant inhibitory activity on the enzymatic protein cathepsin B (Pan et al., 2005b).

Biflavone podocarpusflavone A (**33**) has also been isolated from *Garcinia livingstonei* leaves (Kaikabo et al., 2009), and shown to possess antibacterial activity against *Mycobacterium smegmatis* (Kaikabo and Eloff, 2011).

Protozoal diseases represent one of the major health problems in various tropical and subtropical regions worldwide. *In vitro* assays have shown biflavonoids with relevant antiparasitic activity; isoginkgetin (**32**) showed leishmanicidal activity against *Leishmania donovani*, as well as antitrypanosomal activity against *Trypanosoma cruzi* and *Trypanosoma brucei rhodesiense* (Weniger et al., 2006).

The molecular formula of compound **34** (C<sub>20</sub>H<sub>28</sub>O<sub>3</sub>) was established by <sup>13</sup>C NMR and HR-ESI-MS data, which indicates seven degrees of unsaturation. The <sup>13</sup>C NMR spectrum suggest the presence of one carboxylic group, six carbon signals assigned to an aromatic ring, of which one signal was downfield to  $\delta$  154.8 and should be an oxygenated aromatic carbon. The remaining carbon signals appear between 20 and 55 ppm. These facts indicated that 34 is tricyclic. Its ATR-IR spectrum displayed bands for hydroxy group at 3387, carbonyl group at 1693 and aromatic C=C at 1589 cm<sup>-1</sup>. The <sup>1</sup>H NMR and 2D COSY spectrum showed that the following proton systems are present in the molecule: One methine proton of an isopropyl group at  $\delta$  3.24 (15-H) and two non-equivalent methyl doublets at  $\delta$  1.31 (16-H<sub>3</sub>) and 1.32 (17-H<sub>3</sub>). The aromatic region exhibited two *ortho*-coupled doublets at  $\delta$  6.52 (12-H) and 6.92 (11-H), which indicated the presence of a 1,2,3,4-tetra-substituted aromatic ring. Three methylene groups assigned to A-ring at  $\delta$  2.22/1.27 (1-H<sub>2</sub>), 2.02/1.55 (2-H<sub>2</sub>) and 2.21/1.08 (3-H<sub>2</sub>). Furthermore, a methylene group at  $\delta$  2.23/1.94 (6-H<sub>2</sub>) showed cross peaks correlation to protons at  $\delta$  2.92/2.61 (7-H<sub>2</sub>) and 1.44 (5-H) (B-ring). Besides the methyl groups of the

isopropyl group, two methyl singlets resonating at  $\delta$  1.28 and 1.12 were assigned to C-18 and C-20, respectively. On the basis of HMBC spectrum, the methyl protons of isopropyl 16-H<sub>3</sub> and 17-H<sub>3</sub> exhibited correlations to C-14; and the hydrogen 12-H showed correlations to C-13, C-14 and C-9, which indicated that the isopropyl group was at carbon C-14 and the hydroxy group at C-13. Another further correlations were observed from 11-H to C-10 and to the aromatic carbons C-8, C-13, closing the C-ring. On the A-ring, the methyl at  $\delta$  1.28 (18-H<sub>3</sub>) was located at C-4 via HMBC correlations to C-3, C-4, C-5 and the carboxylic carbon C-19. Furthermore, long-range correlations from the hydrogens at 3-H<sub>2</sub>, 5-H and 18-H<sub>3</sub> to C-19 showed that the carboxyl group was present at C-4. The proton 5-H exhibited correlations to C-4, C-6, C-7, C-9, C10, C-18 and C-20. Finally, the protons 20-H<sub>3</sub> showed correlations to C-1, C-5, C-9 and C-10 (Figure 16). The relative stereochemistry of **34** was determined by NOESY spectrum, this analysis suggested that 5-H $\alpha$ , 1-H $\alpha$  ( $\delta$  1.27), 3-H $\alpha$  ( $\delta$  1.08), 7-H $\alpha$  ( $\delta$  2.61) and 18-H<sub>3</sub> ( $\delta$  1.28) are co-facial, while 20-H<sub>3</sub>, is on the opposite face. Thus, the structure of **34** was concluded to be identical to 4 $\beta$ -carboxy-19-nor-totarol, previously reported from *Podocarpus nagi* (Ying and Kubo, 1991).

**Figure 17** Selected HMBC correlations observed with compound **34**.

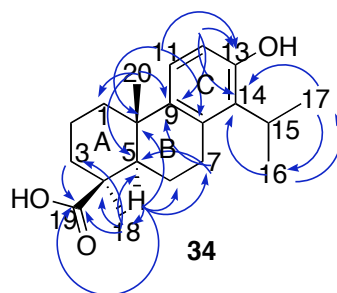

Phytochemical studies of various *Podocarpus* species have led to the isolation and elucidation of various totarol-type diterpenes (Cambie et al., 1983, Ying and Kubo, 1991, Becerra et al., 2002, Sato et al., 2008). Among these diterpenes, totarol (**37**) has been shown to display a range of interesting biological activities. It has been shown to be a potent natural antibacterial, and display a broad-spectrum antibacterial (Kubo et al., 1992, Muhammad et al., 1996). It is especially active against Gram-positive bacteria, including those antibiotic-resistant microorganisms, such as methicillin-resistant *Staphylococcus aureus*, penicillin-resistant *Streptococcus pneumoniae*, erythromycin-resistant *Streptococcus pyogenes*, gentamicin-resistant *Enterococcus faecalis* (Evans et al., 2000). Totarol (**37**) and totarol-type diterpenes were found to potentiate the activities of standard antibiotics against resistant strains, reducing the minimum inhibitory concentration of the antibiotic (Muroi and Kubo, 1996, Nicolson et al., 1999). Totarol-type

diterpenes also showed antifungal activity against *Aspergillus sp.*, *Fusarium fujikuroi*, *F. ciliatum*, *Mucor miehei*, *Nematospora coryli*, *Penicillium notatum* and *Penicillium notatum* (Becerra et al., 2002).

Cytotoxic activity was exhibited by totarol (**37**) against three human proliferative cell lines (CH 2983, HeLa and MG 63), the authors conclude that totarol (**37**) is not significantly toxic to non-proliferating cells at concentrations below those which result in inhibition of proliferation (Evans et al., 1999).

Totarol (**37**) have displayed larvicidal activity against mosquito larvae *Culex pipiens* Coquillett (Lee et al., 2000). In addition, Totarol is now commercially produced from *Podocarpus totara* as Totarol<sup>TM</sup>, and is effective as a topical anti-inflammatory agent (Abdillahi et al., 2011).

Compound **34** was isolated from *Podocarpus macrophyllus* D. Don, and screened against eight oral pathogenic microorganisms, the compound screened had activity against six microorganisms (*Streptococcus sobrinus*, *Staphylococcus aureus*, *Actinomyces viscosus*, *Porphyromonas gingivalis*, *Fusobacterium nucleatum*, and *Actinobacillus actinomycetemcomitans*) (Sato et al., 2008). In addition, the cytotoxic property of compound 34 was reported against the A 2780 ovarian cancer cell line (Reynolds et al., 2006).

The molecular formula (C<sub>20</sub>H<sub>28</sub>O<sub>2</sub>) of **35** was determined by HR-ESI-MS. Its ATR-IR spectrum displayed bands for hydroxy group at 3237, carbonyl group at 1648 and aromatic C=C at 1592 cm<sup>-1</sup>. As 34, compound 35 is a tricyclic natural product with seven degrees of unsaturation, including one aromatic ring and one carbonyl group. The <sup>1</sup>H NMR spectrum showed the presence of three tertiary methyl groups at δ 0.95 (19-H<sub>3</sub>), 1.03 (18-H<sub>3</sub>) and 1.23 (20-H<sub>3</sub>), one isopropyl group consisting of a methine proton at δ 3.21 (15-H) and two methyl doublets at δ 1.20 (16-H<sub>3</sub>) and 1.21 (17-H<sub>3</sub>). Furthermore, two aromatic singlets at δ 6.76 (11-H) and 7.79 (14-H) were observed, indicating a *para*-substituted aromatic. In addition to this, three methylene groups at δ 2.28/1.52 (1-H<sub>2</sub>), 1.83/1.68 (2-H<sub>2</sub>) and 1.54/1.31 (3-H<sub>2</sub>) (A-ring) and a second order system at δ 2.61/2.59 (6-H<sub>2</sub>) and 1.84 (5-H) (B-ring). From the HMBC data, the position of the carbonyl function was placed at C-7 by correlations between 14-H, 6-H<sub>2</sub> and C-7. The isopropyl and hydroxy groups were located at C-13 and C-12, respectively, by correlations from 14-H to C-15, C-9, C-12 and from 11-H to C-8, C-12 and C-13, as well as from 16-H<sub>3</sub> and 17-H<sub>3</sub> to C-13 (Figure 17). All these results indicated that the structure of **35** was identical to 12-hydroxyabieta-8,11,13-triene-7-one (sugiol), previously reported from *Podocarpus nagi* (Ying and Kubo, 1991).

**Figure 18** Selected HMBC correlations observed with compound 35

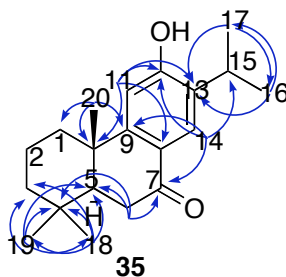

Abietane diterpenes have been described in various genera of the conifer families, especially Cupressaceae, Taxodiaceae and Podocarpaceae (Otto and Wilde, 2001). They are known to possess a wide variety of biological activities, such as antioxidant, cytotoxic, antitumor, antiprotozoal, antibacterial and antifungal activity (Iwamoto et al., 2003, Machumi et al., 2010, Burmistrova et al., 2013, Mothana et al., 2014).

Fronza and co-workers reported the cytotoxic effects of various abietane diterpenes against human pancreatic cancer cell line (MIAPaCa-2) and melanoma tumor cell line (MV-3), where diterpenes **35** (sugiol), **37** and **38** exhibited cytotoxic activity in both cell lines (Fronza et al., 2011). Similarly, the cytotoxic property of ferruginol (**39**) has been reported against mouse lymphocytic leukemia (P-388), human nasopharyngeal (HONE-1) and human colon adenocarcinoma (HT-29) cancer cell lines (Yao et al., 2012).

Smith and co-workers isolated, characterised and screened the two diterpene abietanes from *Prumnopitys andina* ferruginol (**39**) and 2 $\beta$ -acetoxyferruginol (**40**), which have been reported to possess antibacterial activity against four and two *Staphylococcus aureus* strains, respectively. 2 $\beta$ -Acetoxyferruginol (**40**) was also active against *Propionibacterium acnes* (Smith et al., 2008).

Chromatographic fractionation and antimicrobial studies of *Clerodendrum eriophyllum*, led to the isolation of various abietane diterpenoids, of which compounds **41** and **42** exhibited potent antifungal activity against *Cryptococcus neoformans* (Machumi et al., 2010), which is a fungus causing most lung infections. However, fungal meningitis and encephalitis, especially as a secondary infection for AIDS patients, are often caused by *C. neoformans* making it a particularly dangerous fungus (Mitchell and Perfect, 1995). Compounds **35**, **41** and **42** showed strong antibacterial activity against *Staphylococcus aureus* and methicillin-resistant *S. aureus*. In addition, compound **41** exhibited potent antileishmanial activity against *Leishmania donovani* (Machumi et al., 2010).

Studies have found that sugiol (**35**) possess a variety of biological activities. It is a potent therapeutic compound against *Candida* species. It is well known that *Candida* species are ubiquitous fungi that represent the most common fungal pathogens that affect humans, and it was confirmed in this assay that sugiol (**35**) possess significant antifungal activity against *Candida* species (Bajpai et al., 2012).

The cytotoxicity of sugiol (**35**) was verified against the human pancreatic cancer cell line (MIA PaCa-2), where it significantly inhibited the relaxation activity of topoisomerase I (Fronza et al., 2012), which is an enzyme that alter the supercoiling of double-stranded DNA. The topoisomerase I acts by transiently cutting one strand of the DNA to relax the coil and extend the DNA molecule. The regulation of DNA supercoiling is essential to DNA transcription and replication. The inhibition of topoisomerases and subsequent DNA damage can influence cell division and cell cycle progression.

Experimental studies have indicated the antitumor activities of sugiol (**35**), **39**, **45** and **46** in human tumor cells (SW620 colon, MDA-MB-231 breast, HCT116 colon, NCI-H23 lung, and A549 lung) (Son et al., 2005).

There has been investigations indicating that certain abietane diterpenoids are effective in exerting antioxidant activity. Kabouche *et al.* showed that abietane diterpenoids isolated from *Salvia barrelieri* possess antioxidant activity. Among these diterpenoids, compounds **43** and **44** showed the highest antioxidant activity (Kabouche et al., 2007). Nine abietane-type diterpenes were isolated from the heartwood of *Taiwania cryptomerioides*, their antioxidant activities were evaluated and ferruginol (**39**) exhibited the most significant inhibitory activity against the DPPH radical (Wang et al., 2002).

The molecular formula of compound **36** was established to be C<sub>19</sub>H<sub>22</sub>O<sub>7</sub> HR-ESI-MS and the 1D NMR spectrum, which indicates nine degrees of unsaturation. The ATR-IR spectrum displayed bands at 3444, 1770 and 1714 cm<sup>-1</sup>, which are indicative of hydroxy,  $\gamma$ -lactone and  $\delta$ -lactone moieties, respectively. The <sup>1</sup>H NMR spectrum showed the presence of two methyl singlets at  $\delta$  1.31 and 1.33, assigned to C-18 and C-20, respectively, and one singlet olefinic proton at  $\delta$  6.27 (11-H). Furthermore, two protons at  $\delta$  3.56 (1-H) and 3.32 (2-H), correlated in the HMQC spectrum with carbons at  $\delta$  56.9 and 50.6, respectively, allowed to establish the presence of an epoxy ring which was located at C-1/C-2 on the basis of HMBC correlations from 1-H to C-2, C-9 and C-10, and correlations from 2-H to C-1, C-3, and C-4. Three spin systems were evident in the COSY spectrum: correlations between two methyl doublets at  $\delta$  1.20 (16-H) and 1.17 (17-H), and the isopropyl methine proton at  $\delta$  3.27 (15-H), which appeared as a septet, were attributed to an isopropyl group, the proton signal at  $\delta$  3.32 (2-H) correlated with 3.56 (1-H) and 4.23 (3-H), which correlated with the hydroxy proton at  $\delta$  5.29 (3-OH). The proton

signal at  $\delta$  4.88 (6-H) correlated with 2.05 (5-H) and 5.21 (7-H), which correlated with the hydroxy proton at  $\delta$  5.78 (7-OH). HMBC correlations: from 11-H to C-8, C-12 and C-14; as well as from 7-H to C-9 and C-14; and from 15-H to C-8 and C-14 confirmed the assignment of  $\delta$ -lactone ring carbons. The location of the  $\gamma$ -lactone between C-19 and C-6 was established by the correlations observed in the HMBC spectrum between 18-H<sub>3</sub> and C-19, and between 7-H as well as 5-H and C-6 (Figure 18). The NOESY spectrum exhibited correlations between 5-H, 6-H, 7-H and 18-H<sub>3</sub>, suggesting the  $\beta$ -orientation of the  $\gamma$ -lactone and the hydroxy group with the proton at  $\delta$  5.78 (7-OH). NOESY correlations between 1-H, 2-H, 3-H and 18-H<sub>3</sub> suggest that the hydroxy group at  $\delta$  5.29 (3-OH) was  $\beta$ -oriented, as well as the epoxy group. Hence, compound **36** was concluded to be a nor-diterpene dilactone type-A, known as nagilactone C (Hayashi et al., 1968, Itô and Mitsuaki, 1976). Compound **36** has previously been isolated from *Podocarpus nagi* (Hayashi et al., 1968).

**Figure 19** Selected HMBC correlations observed with compound **36**.

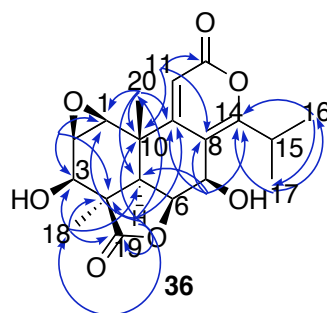

Nagilactones and other related podolactones-class natural products have been isolated from plants and fungi species (Matlin et al., 1984, Barrero et al., 2003, Faiella et al., 2012). Podolactones are diterpenes whose cyclic framework is considered derivative from totarane. Their tetracyclic basic skeleton contain a  $\gamma$ -lactone between C19-C6 and a  $\delta$ -lactone between C12-C14, which are their characteristic groups (Barrero et al., 2003). These isolated constituents have attracted a great deal of interest because of their biological activities, including antitumor activity (Kupchan et al., 1975), plant-growth regulatory (Sasse et al., 1981), antimicrobial and antifungal (Barrero et al., 2002), and insecticidal activities (Kubo et al., 1984). A few examples are cited below.

Podolide (**47**) was the first dilactone reported to show tumor-inhibitory activity (Kupchan et al., 1975). Other examples of antitumor compounds are reported against Yoshida Sarcoma cells by nagilactones F (**48**) and E (**49**), and inumakilactone B (**50**) (Barrero et al., 2003). Purdilactone A, B and C (**51-53**) isolated from *Podocarpus purdieanus* Hook exhibited significant cytotoxicity

against mouse lymphocytic leukemia (9PS) and in human tumor cell lines lung carcinoma (A-549), breast adenocarcinoma (MCF-7) and colon adenocarcinoma (HT-29) (Wang et al., 1997). Nagilactone C showed potent antiproliferative activity against human fibrosarcoma (HT-1080) and murine colon carcinoma tumor (26-L5) cell lines (Shrestha et al., 2001).

**Figure 20** Selected abietane diterpenes and podolactones with biological activities

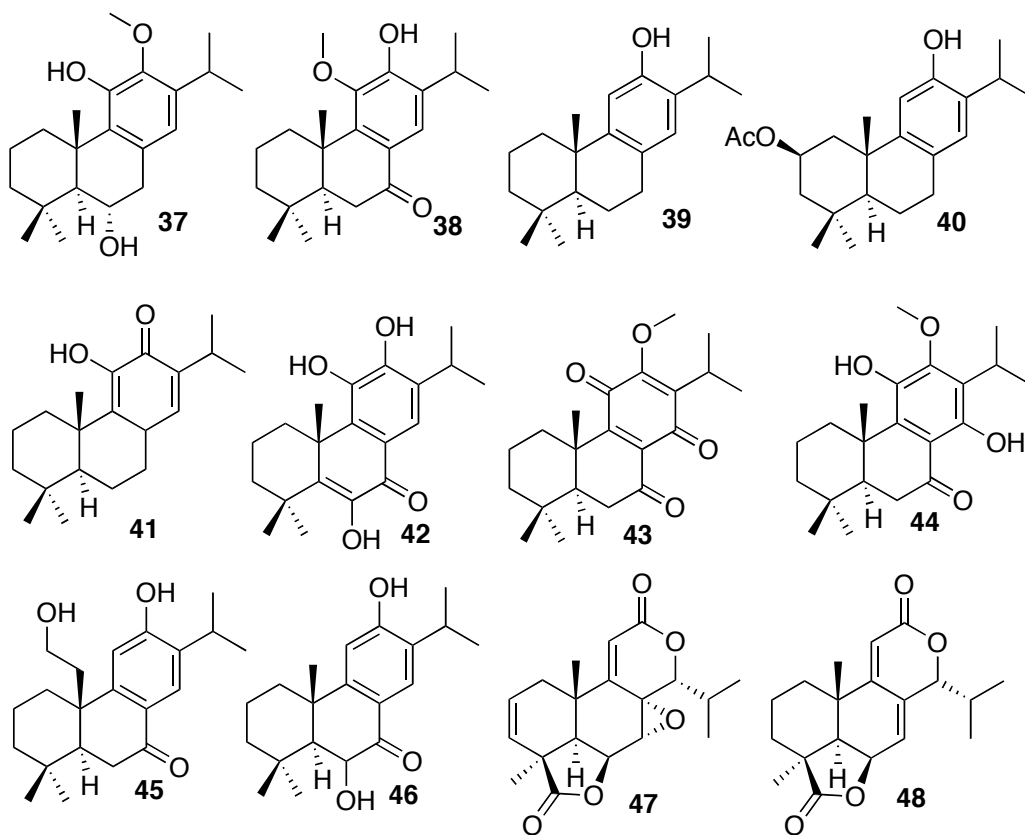

**Figure 21** Selected abietane diterpenes and podolactones with biological activities (continued)

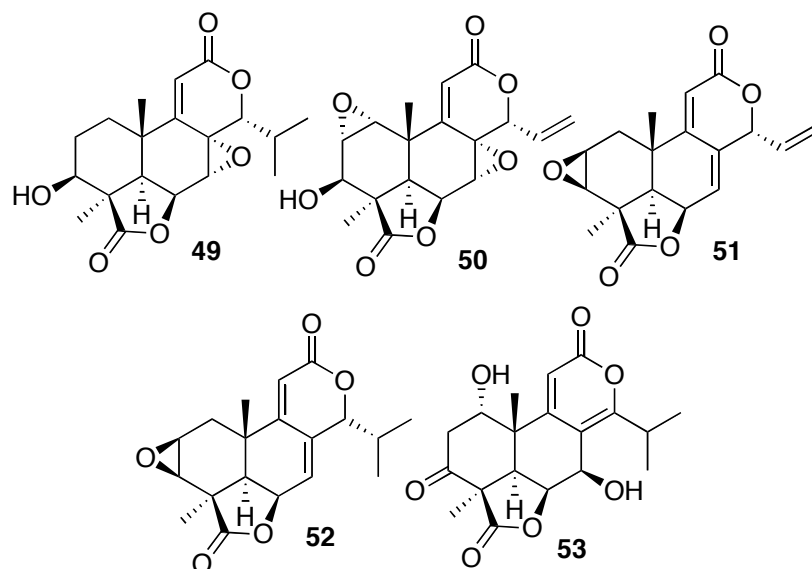

5,5'',7''-trihydroxy-4',4''',7-trimethoxy-3',8''-biflavone (sciadopitysin) (**31**).

Yellow powder. mp 285-288 °C. <sup>1</sup>H NMR (DMSO-*d*<sub>6</sub> 400 MHz): δ 7.00 (1H, s; 3-H), 6.36 (1H, d, *J*= 2.2; 6-H), 6.79 (1H, d, *J*= 2.2; 8-H), 8.08 (1H, d, *J*= 2.4; 2'-H), 7.37 (1H, d, *J*= 8.9; 5'-H), 8.23 (1H, dd, *J*= 8.9, 2.4; 6'-H), 6.90 (1H, s; 3''-H), 6.42 (1H, s; 6''-H), 7.60 (2H, d, *J*= 9.0; 2'''/6'''-H), 6.93 (2H, d, *J*= 9.0; 3'''/5'''-H), 3.82 (3H, s; 7-OMe), 3.75 (3H, s; 4'-OMe), 3.79 (3H, s; 4'''-OMe), 12.91 (1H, s; 5-OH), 13.05 (1H, s; 5''-OH). <sup>13</sup>C NMR (DMSO-*d*<sub>6</sub>100 MHz): δ 163.6 (C-2), 103.9 (C-3), 182.0 (C-4), 161.1 (C-5), 98.2 (C-6), 165.2 (C-7), 92.8 (C-8), 157.4 (C-9), 104.8 (C-10), 122.4 (C-1'), 130.9 (C-2'), 121.6 (C-3'), 160.6 (C-4'), 111.8 (C-5'), 128.4 (C-6'), 163.1 (C-2''), 103.2 (C-3''), 182.1 (C-4''), 160.7 (C-5''), 98.7 (C-6''), 161.8 (C-7''), 103.7 (C-8''), 154.4 (C-9''), 103.6 (C-10''), 122.8 (C-1'''), 127.8 (C-2'''), 114.6 (C-3'''), 162.3 (C-4'''), 114.6 (C-5'''), 127.8 (C-6'''), 56.1 (7-OCH<sub>3</sub>), 55.5 (4'-OCH<sub>3</sub>), 56.0 (4'''-OCH<sub>3</sub>). HR-ESI-MS *m/z* 581.1453 [M+H]<sup>+</sup>. Calculated for C<sub>33</sub>H<sub>24</sub>O<sub>10</sub>, 581.1448.

5,5'',7,7''-tetrahydroxy-4',4'''-dimethoxy-3',8''-biflavone (isoginkgetin) (**32**).

Yellow powder. mp 202-204 °C. <sup>1</sup>H NMR (acetone-*d*<sub>6</sub> 400 MHz): δ 6.72 (1H, s; 3-H), 6.25 (1H, d, *J*= 2.0; 6-H), 6.53 (1H, d, *J*= 2.0; 8-H), 8.15 (1H, d, *J*= 2.3; 2'-H), 7.39 (1H, d, *J*= 8.8; 5'-H), 8.19 (1H, dd, *J*= 8.8, 2.3; 6'-H), 6.78 (1H, s; 3''-H),



6.45 (1H, s; 6''-H), 7.67 (2H, d,  $J=9.0$ ; 2'''/6'''-H), 6.94 (2H, d,  $J=9.0$ ; 3'''/5'''-H), 3.87 (3H, s; 4'-OMe), 3.80 (3H, s; 4'''-OMe), 12.99 (1H, s; 5-OH), 13.14 (1H, s; 5'''-OH).  $^{13}\text{C}$  NMR (acetone- $d_6$ 100 MHz):  $\delta$  164.6 (C-2), 104.1 (C-3), 183.4 (C-4), 163.4 (C-5), 99.7 (C-6), 165.0 (C-7), 94.8 (C-8), 158.9 (C-9), 105.3 (C-10), 124.2 (C-1'), 132.1 (C-2'), 122.8 (C-3'), 161.9 (C-4'), 112.5 (C-5'), 129.1 (C-6'), 164.8 (C-2''), 104.7 (C-3''), 183.1 (C-4''), 162.5 (C-5''), 99.8 (C-6''), 162.6 (C-7''), 104.8 (C-8''), 155.8 (C-9''), 105.4 (C-10''), 124.2 (C-1'''), 128.8 (C-2'''), 115.3 (C-3'''), 163.6 (C-4'''), 115.3 (C-5'''), 128.8 (C-6'''), 56.4 (4'-OCH<sub>3</sub>), 55.9 (4'''-OCH<sub>3</sub>). HR-ESI-MS  $m/z$  567.1290 [M+H]<sup>+</sup>. Calculated for C<sub>32</sub>H<sub>22</sub>O<sub>10</sub>, 567.1291.

4',5,5'',7,7''-pentahydroxy-4'''-methoxy-3',8''-biflavone (podocarpusflavone A) (33).

Yellow powder. mp 240-242 °C.  $^1\text{H}$  NMR (DMSO- $d_6$  400 MHz):  $\delta$  6.83 (1H, s; 3-H), 6.18 (1H, d,  $J=2.0$ ; 6-H), 6.46 (1H, d,  $J=2.0$ ; 8-H), 7.99 (1H, d,  $J=2.2$ ; 2'-H), 7.16 (1H, d,  $J=8.6$ ; 5'-H), 8.01 (1H, dd,  $J=8.6, 2.2$ ; 6'-H), 6.89 (1H, s; 3''-H), 6.42 (1H, s; 6''-H), 7.68 (2H, d,  $J=9.0$ ; 2'''/6'''-H), 6.93 (2H, d,  $J=9.0$ ; 3'''/5'''-H), 3.76 (3H, s; 4'''-OMe), 12.97 (1H, s; 5-OH), 13.07 (1H, s; 5'''-OH).  $^{13}\text{C}$  NMR (DMSO- $d_6$ 100 MHz):  $\delta$  163.8 (C-2), 103.0 (C-3), 181.7 (C-4), 161.4 (C-5), 98.8 (C-6), 164.1 (C-7), 94.0 (C-8), 157.4 (C-9), 103.7 (C-10), 121.0 (C-1'), 131.4 (C-2'), 119.9 (C-3'), 159.5 (C-4'), 116.2 (C-5'), 127.9 (C-6'), 163.2 (C-2''), 103.3 (C-3''), 182.2 (C-4''), 160.5 (C-5''), 98.7 (C-6''), 161.9 (C-7''), 104.0 (C-8''), 154.5 (C-9''), 103.7 (C-10''), 123.0 (C-1'''), 128.0 (C-2'''), 114.5 (C-3'''), 162.2 (C-4'''), 114.5 (C-5'''), 128.0 (C-6'''), 55.5 (4'''-OCH<sub>3</sub>). HR-ESI-MS  $m/z$  553.1161 [M+H]<sup>+</sup>. Calculated for C<sub>31</sub>H<sub>20</sub>O<sub>10</sub>, 553.1135.

4 $\beta$ -carboxy-19-nor-totarol (34).

Yellow oil.  $[\alpha]_D^{20} + 119^\circ$  ( $c$  0.38, MeOH). ATR-IR  $\nu_{max}$  3387, 2954, 2872, 1693, 1589, 1448, 1357, 1274, 1183  $\text{cm}^{-1}$ .  $^1\text{H}$  NMR (methanol- $d_4$  400 MHz):  $\delta$  1.25 (1H; 1-H $\alpha$ ), 2.22 (1H; 1-H $\beta$ ), 1.55 (1H, m; 2-H $\alpha$ ), 2.02 (1H, m; 2-H $\beta$ ), 1.08 (1H, td,  $J=13.5, 4.3$ ; 3-H $\alpha$ ), 2.21 (1H; 3-H $\beta$ ), 1.44 (1H, dd,  $J=11.2, 1.2$ ; 5-H), 2.23 (1H; 6-H $\alpha$ ), 1.94 (1H, m; 6-H $\beta$ ), 2.61 (1H, ddd,  $J=16.6, 12.6, 6.3$ ; 7-H $\alpha$ ), 2.92 (1H, dd,  $J=16.6, 4.8$ ; 7-H $\beta$ ), 6.92 (1H, d,  $J=8.6$ ; 11-H), 6.52 (1H, d,  $J=8.6$ ; 12-H), 3.24 (1H, m; 15-H), 1.31 (3H, d,  $J=7.1$ ; 16-H<sub>3</sub>), 1.32 (3H, d,  $J=7.1$ ; 17-H<sub>3</sub>), 1.28 (3H, s, 18-H<sub>3</sub>), 1.12 (3H, s, 20-H<sub>3</sub>).  $^{13}\text{C}$  NMR (methanol- $d_4$ 100 MHz):  $\delta$  41.8 (C-1), 21.5 (C-2), 38.9 (C-3), 44.9 (C-4), 53.8 (C-5), 22.8 (C-6), 31.4 (C-7), 134.7 (C-8), 141.1 (C-9), 39.7 (C-10), 125.0 (C-11), 115.5 (C-12), 154.8 (C-13), 132.1 (C-14), 28.9 (C-15), 20.8 (C-16), 20.7 (C-17), 29.4 (C-18), 181.8 (C-19), 23.9 (C-20). HR-ESI-MS  $m/z$  317.2130 [M+H]<sup>+</sup>. Calculated for C<sub>20</sub>H<sub>28</sub>O<sub>3</sub>, 317.2117.

12-Hydroxyabieta-8,11,13-triene-7-one (sugiol) (**35**).

White amorphous solid. mp 290-292 °C.  $[\alpha]_D^{20} + 20^\circ$  (*c* 0.06, MeOH). ATR-IR  $\nu_{max}$  3237, 2955, 2929, 2863, 1648, 1592, 1303, 1268  $\text{cm}^{-1}$ .  $^1\text{H}$  NMR (methanol- $d_4$  400 MHz):  $\delta$  1.52 (1H; 1-H $\alpha$ ), 2.28 (1H; 1-H $\beta$ ), 1.68 (1H; 2-H $\alpha$ ), 1.83 (1H; 2-H $\beta$ ), 1.31 (1H, td,  $J = 13.5, 3.9$ ; 3-H $\alpha$ ), 1.54 (1H; 3-H $\beta$ ), 1.84 (1H; 5-H), 2.61 (1H; 6-H $\alpha$ ), 2.59 (1H; 6-H $\beta$ ), 6.76 (1H, s; 11-H), 7.79 (1H, s; 14-H), 3.22 (1H, septet,  $J = 6.9$ ; 15-H), 1.20 (3H, d,  $J = 6.9$ ; 16-H $_3$ ), 1.21 (3H, d,  $J = 6.9$ ; 17-H $_3$ ), 1.03 (3H, s, 18-H $_3$ ), 0.95 (3H, s, 19-H $_3$ ), 1.23 (3H, s, 20-H $_3$ ).  $^{13}\text{C}$  NMR (methanol- $d_4$  100 MHz):  $\delta$  39.1 (C-1), 19.9 (C-2), 42.5 (C-3), 34.2 (C-4), 51.1 (C-5), 36.8 (C-6), 200 (C-7), 124.0 (C-8), 158.4 (C-9), 39.1 (C-10), 110.4 (C-11), 162.4 (C-12), 134.6 (C-13), 127.0 (C-14), 27.8 (C-15), 22.8 (C-16), 22.7 (C-17), 21.7 (C-18), 33.0 (C-19), 23.5 (C-20). HR-ESI-MS  $m/z$  301.2179  $[\text{M}+\text{H}]^+$ . Calculated for  $\text{C}_{20}\text{H}_{28}\text{O}_2$ , 301.2168.

Nagilactone C (**36**).

White amorphous powder. mp 300-305 °C.  $[\alpha]_D^{20} + 5^\circ$  (*c* 0.88, DMSO). ATR-IR  $\nu_{max}$  3444, 3274, 2249, 2122, 1770, 1714, 166, 1050, 1007, 820, 758  $\text{cm}^{-1}$ .  $^1\text{H}$  NMR (DMSO- $d_6$  400 MHz):  $\delta$  3.56 (1H, d,  $J = 4.5$ ; 1-H $\alpha$ ), 3.32 (1H; 2-H $\alpha$ ), 4.23 (1H, dd,  $J = 5.9, 5.0$ ; 3-H $\alpha$ ), 2.05 (1H, d,  $J = 6.8$ ; 5-H), 4.88 (1H, dd,  $J = 8.5, 6.8$ ; 6-H $\alpha$ ), 5.21 (1H, dd,  $J = 8.5, 4.5$ ; 7-H $\alpha$ ), 6.27 (1H, s; 11-H), 3.27 (1H, septet,  $J = 6.8$ ; 15-H), 1.20 (3H, d,  $J = 6.8$ ; 16-H $_3$ ), 1.17 (3H, d,  $J = 6.8$ ; 17-H $_3$ ), 1.31 (3H, s, 18-H $_3$ ), 1.33 (3H, s, 20-H $_3$ ), 5.29 (1H, d,  $J = 5.0$ ; 3-OH), 5.78 (1H, d,  $J = 4.5$ ; 7-OH).  $^{13}\text{C}$  NMR (DMSO- $d_6$  100 MHz):  $\delta$  56.9 (C-1), 50.6 (C-2), 66.4 (C-3), 49.0 (C-4), 49.8 (C-5), 72.2 (C-6), 58.7 (C-7), 111.3 (C-8), 165.0 (C-9), 36.9 (C-10), 105.8 (C-11), 161.2 (C-12), 169.4 (C-14), 28.5 (C-15), 20.1 (C-16), 20.3 (C-17), 25.5 (C-18), 176.8 (C-19), 18.3 (C-20). HR-ESI-MS  $m/z$  363.1450  $[\text{M}+\text{H}]^+$ . Calculated for  $\text{C}_{19}\text{H}_{22}\text{O}_7$ , 363.1444.



## 2 Conclusions and Future Perspectives

This very last part of the thesis summarizes the results of the research carried out in the framework of this study, and, at the same time, provides some outlooks for further continuation of this research.

Plant selection was based on the traditional medicine or its endemic presence. This study led us to the isolation and characterization of a number of secondary metabolites, the structure elucidation of the isolated compounds was achieved by combination of spectroscopic techniques, and it has to be pointed out that there were no phytochemical studies on these species reported in the literature. This study has so far not included the biological assaying of the isolated compounds, although this will be carried out in the future.

The study of the secondary metabolites from *Senecio clivicolus* led us to the isolation and characterization of four furanoeremophilanes, the literature survey indicates that sesquiterpenoids of the furanoeremophilane type may be considered as potential antitubercular leads (Gu et al., 2004). In this respect, pharmacological studies are necessary in order to develop these metabolites as effective antituberculosis natural product.

In the course of our ongoing phytochemistry research, an isoflavone (5,2'-dihydroxy-5'-methoxy-6,7-methylenedioxy isoflavone) and a lignan ((8 $\beta$ ,8' $\alpha$ )-3,4:3',4'-bis-methylenedioxy-2',6' dimethoxy lignano-9,9'-lactone) were isolated from the chloroform extract of *P. exigua*. A huge number of biological activities of isoflavones in humans and other living organisms are known (Vacek et al., 2008). On the other hand, lignans have a number of medically important biological activities, e.g. antitumor, antimycotic and antiviral properties (MacRae and Towers, 1984, Saleem et al., 2005). No report about the compounds isolated from *P. exigua* are at hand, and it is obvious that *P. exigua* requires thorough phytochemical and pharmacological studies in order to find useful phytochemicals.

The diversity, ubiquity, and biological activity of flavonoids make these compounds of interest to a wide variety of research. Flavonoids are most commonly known for their antioxidant activity. Through the present study, *Baccharis polycephala* appears to be a rich source of flavonoids that can be used to design and develop potentially useful therapeutic agents. In particular,

flavonoids and diterpenes are natural products most frequently mentioned in the majority of species *Baccharis* (Verdi et al., 2005, Abad and Bermejo, 2007).

Sciadopitysin, isoginkgetin and podocarplusflavone A, together with the diterpenes sugiol, nagilactone C and 4 $\beta$ -carboxy-19-nor-totarol were isolated from *Podocarpus parlatoresi*. The isolated compounds are taxonomic markers of the *Podocarpus* genus. The biological activities of biflavonoids are well known and diverse. They include anti-inflammatory, antibacterial, antifungal, antiviral, anticancer, and immune suppressive activities (Kim et al., 2008). Nor-diterpene dilactones and totarol type diterpenes from *Podocarpus* are known to have cytotoxic activities against several forms of cancer (Abdillahi et al., 2010).

Finally, it is important to continue the phytochemistry research of Bolivian plants to find out not only new compounds, but also active or lead compounds that could serve for drug development. This work should preferentially be carried out in collaborations with biologists and pharmacologists that can assess the biological activities of the compounds and guide the fractionation procedures towards the most interesting compounds.

### 3 References

- Abad, M. J. & Bermejo, P. 2007. *Baccharis* (Compositae): a review update. *ARKIVOC*, Commemorative Issue in Honor of Prof. Atta-ur-Rahman on the occasion of his 65th anniversary, 76-96.
- Abad, M. J., Bessa, A. L., Ballarin, B., Aragon, O., Gonzales, E. & Bermejo, P. 2006. Anti-inflammatory activity of four Bolivian *Baccharis* species (Compositae). *Journal of Ethnopharmacology*, 103, 338-344.
- Abdillahi, H. S., Finnie, J. F. & Van Staden, J. 2011. Anti-inflammatory, antioxidant, anti-tyrosinase and phenolic contents of four *Podocarpus* species used in traditional medicine in South Africa. *Journal of Ethnopharmacology*, 136, 496-503.
- Abdillahi, H. S., Stafford, G. I., Finnie, J. F. & Van Staden, J. 2010. Ethnobotany, phytochemistry and pharmacology of *Podocarpus sensu latissimo* (s.l.). *South African Journal of Botany*, 76, 1-24.
- Arancibia, L., Naspí, C., G., P. & Arce, M. 2013. Actividad biológica de un furanoeremofilano aislado de *Senecio filaginoides* var. *Filaginoides*. *Bol.latioam. y del Caribe de Plant.med.y aromat. Boletín Latinoamericano y del Caribe de Plantas Medicinales y Aromaticas*, 12, 18-23.
- Araujo, N., Mü Ller, R., Nowicki, C. & Ibisch, P. 2005. *Análisis de Vacíos de Representatividad del Sistema Nacional de Áreas Protegidas*, La Paz, Fundación Amigos de la Naturaleza (FAN). Asociación Boliviana para la Conservación (TROPICO). Centro de Estudios y Proyectos (CEP). Agencia Nórdica para el Desarrollo y la Ecología.
- Arciniegas, A., Perez-Castorena, A. L., Nieto-Camacho, A., Villasenor, J. L. & De Vivar, A. R. 2009. Chemical constituents of *Psacalium sinuatum*. *J. Mex. Chem. Soc. Journal of the Mexican Chemical Society*, 53, 229-232.
- Arias Cassara, M. L., Borkosky, S. A., Sierra, M. G., Bardon, A. & Ybarra, M. I. 2010. Two New Furanoeremophilanes from *Senecio santelisis*. *Chem Biodivers*, 7, 1745-1753.
- Bajpai, V. K., Baek, K. H. & Kang, S. C. 2012. Inhibitory effects of sugiol, a biologically active abietane type diterpenoid from *Metasequoia glyptostroboides*. *Romanian Biotechnological Letters*, 17, 7287-7294.
- Balunas, M. J. & Kinghorn, A. D. 2005. Drug discovery from medicinal plants. *Life Sciences*, 78, 431-441.

- Barker, N. P., Muller, E. M. & Mill, R. R. 2004. A yellowwood by any other name : molecular systematics and the taxonomy of *Podocarpus* and the Podocarpaceae in Southern Africa. *South African Journal of Science*, 100, 629-632.
- Barrero, A. F., Arseniyadis, S., Quílez Del Moral, J. F., Herrador, M. M., Valdivia, M. & Jiménez, D. 2002. First Synthesis of the Antifungal Oidiolactone C from trans-Communic Acid: Cytotoxic and Antimicrobial Activity in Podolactone-Related Compounds. *The Journal of Organic Chemistry*, 67, 2501-2508.
- Barrero, A. F., Quílez Del Moral, J. F. & Herrador, M. M. 2003. Podolactones: A group of biologically active norditerpenoids. In: ATTA-UR, R. (ed.) *Studies in Natural Products Chemistry*. Elsevier, 453.
- Becerra, J., Flores, C., Mena, J., Aqueveque, P., Alarcón, J., Bittner, M., Hernández, V., Hoeneisen, M., Ruiz, E. & Silva, M. 2002. Antifungal and antibacterial activity of diterpenes isolated from wood extractables of Chilean Podocarpaceae. *Boletín de la Sociedad Chilena de Química*, 47, 151-157.
- Beyaoui, A., Chaari, A., Ghouila, H., Ali Hamza, M. & Ben Jannet, H. 2011. New antioxidant bibenzyl derivative and isoflavonoid from the Tunisian *Salsola tetrandra* Folsk. *Natural Product Research*, 26, 235-242.
- Bohlmann, F. & Zdero, C. 1979. Neue C10-säureamide, furanoeremophilane und andere inhaltsstoffe aus Bolivianischen Senecio-arten. *Phytochemistry*, 18, 125-128.
- Bojić, M., Debeljak, Ž., Tomičić, M., Medić-Šarić, M. & Tomić, S. 2011. Evaluation of antiaggregatory activity of flavonoid aglycone series. *Nutrition Journal*, 10, 73-80.
- Borris, R. P. 1996. Natural products research: perspectives from a major pharmaceutical company. *Journal of Ethnopharmacology*, 51, 29-38.
- Bourdy, G., Oporto, P., Gimenez, A. & Deharo, E. 2004. A search for natural bioactive compounds in Bolivia through a multidisciplinary approach: Part VI. Evaluation of the antimalarial activity of plants used by Isoceño-Guaraní Indians. *Journal of Ethnopharmacology*, 93, 269-277.
- Bourgaud, F., Gravot, A., Milesi, S. & Gontier, E. 2001. Production of plant secondary metabolites: a historical perspective. *Plant Science*, 161, 839-851.
- Brophy, J. J., Goldsack, R. J. & Forster, P. I. 2006. Chemistry of the Australian Gymnosperms Part VIII. The Leaf Oil of *Prumnopitys ladei* (Podocarpaceae). *Journal of Essential Oil Research*, 18, 212-214.
- Buchanan, B. B., Gruissem, W. & Jones, R. L. 2000. *Biochemistry & Molecular Biology of Plants*, Rockville, Md., American Society of Plant Physiologists.

- Burmistrova, O., Simões, M. F., Rijo, P., Quintana, J., Bermejo, J. & Estévez, F. 2013. Antiproliferative Activity of Abietane Diterpenoids against Human Tumor Cells. *Journal of Natural Products*, 76, 1413-1423.
- Bustamante, G. Z., Escalante, L. A., Mejia, U. V., Valdivia, M. O. & Soria, I. J. 2001. *Estudio etnobotánico y actividad antimicrobiana de las plantas medicinales de los Valles bajos de Cochabamba*, Universidad Mayor de San Simón, Cochabamba-Bolivia.
- Butler, M. S. 2004. The Role of Natural Product Chemistry in Drug Discovery†. *Journal of Natural Products*, 67, 2141-2153.
- Calderon-Montano, J. M., Burgos-Moron, E., Perez-Guerrero, C. & Lopez-Lazaro, M. 2011. A review on the dietary flavonoid kaempferol. *Mini reviews in medicinal chemistry*, 11, 298-344.
- Cambie, R. C., Cox, R. E. & Croft Anddavid Sidwell, K. D. 1983. Phenolic diterpenoids of some Podocarps. *Phytochemistry*, 22, 1163-1166.
- Canel, C., Moraes, R. M., Dayan, F. E. & Ferreira, D. 2000. Podophyllotoxin. *Phytochemistry*, 54, 115-120.
- Cárdenas, M. 1968. Contribuciones a la dendrologia económica de Bolivia, los Pinos de Monte. *Revista de Agricultura de Ciencias Agropecuarias - UMSS.*, (11), 15-20.
- Cha, J.-D., Choi, S.-M. & Park, J. H. 2014. Combination of Acacetin with Antibiotics against Methicillin Resistant *Staphylococcus aureus* Isolated from Clinical Specimens. *Advances in Bioscience and Biotechnology*, 398-408.
- Cha, J. D., Jeong, M.-R., Choi, M.-R., Hwang, S.-M., Ko, E.-S., Choi, K.-M., Bang, M.-A., Jeong, U. S., Bu, H. O., Song, W. S., Lim, J.-Y. & Kang, J.-R. 2013. Antibacterial actions of acacetin against oral pathogens. *Journal of Antimicrobials Photon*, 128, 269-277.
- Chen, A. Y. & Chen, Y. C. 2013. A review of the dietary flavonoid, kaempferol on human health and cancer chemoprevention. *Food Chemistry*, 138, 2099-2107.
- Choi, S.-K., Oh, H.-M., Lee, S.-K., Jeong, D. G., Ryu, S. E., Son, K.-H., Han, D. C., Sung, N.-D., Baek, N.-I. & Kwon, B.-M. 2006. Biflavonoids inhibited phosphatase of regenerating liver-3 (PRL-3). *Natural Product Research*, 20, 341-346.
- Cimino, P., Gomez-Paloma, L., Duca, D., Riccio, R. & Bifulco, G. 2004. Comparison of different theory models and basis sets in the calculation of <sup>13</sup>C NMR chemical shifts of natural products. *Magnetic Resonance in Chemistry*, 42, S26-S33.
- Clarke, D. B., Perry, N. B. & Weavers, R. T. 1994. Foliage Oil Terpenes of *Prumnopitys ferruginea* (D. Don) Laubenf. Variation in Acorenone Levels. *Journal of Essential Oil Research*, 6, 549-554.
- Cordell, G. 2002. Natural products in drug discovery – Creating a new vision. *Phytochemistry Reviews*, 1, 261-273.



- Cos, P., Maes, L., Vlietinck, A. & Pieters, L. 2008. Plant-Derived Leading Compounds for Chemotherapy of Human Immunodeficiency Virus (HIV) Infection – An Update (1998–2007). *Planta Med*, 74, 1323-1337.
- Coulerie, P., Nour, M., Maciuk, A., Eydoux, C., Guillemot, J.-C., Lebouvier, N., Hnawia, E., Leblanc, K., Lewin, G., Canard, B. & Figadère, B. 2013. Structure-Activity Relationship Study of Biflavonoids on the Dengue Virus Polymerase DENV-NS5 RdRp. *Planta Med*, 79, 1313-1318.
- Cragg, G. M. & Newman, D. J. 2013. Natural products: A continuing source of novel drug leads. *Biochimica et Biophysica Acta (BBA) - General Subjects*, 1830, 3670-3695.
- Deharo, E., Bourdy, G., Quenevo, C., Muñoz, V., Ruiz, G. & Sauvain, M. 2001. A search for natural bioactive compounds in Bolivia through a multidisciplinary approach. Part V. Evaluation of the antimalarial activity of plants used by the Tacana Indians. *Journal of Ethnopharmacology*, 77, 91-98.
- Dixon, R. A. & Strack, D. 2003. Phytochemistry meets genome analysis, and beyond. *Phytochemistry*, 62, 815-816.
- Dominguez, D. M., Reina, M., Villarroel, L., Fajardo, V. & Gonzalez-Coloma, A. 2008. Bioactive Furanoeremophilanes from *Senecio otites* Kunze ex DC. *Zeitschrift fur Naturforschung. C, A journal of biosciences.*, 63, 837-842.
- Duarte, N., Lage, H. & Ferreira, M.-J. U. 2008. Three New Jatrophone Polyesters and Antiproliferative Constituents from *Euphorbia tuckeyana*. *Planta Med*, 74, 61-68.
- Ekambaram, G., Rajendran, P., Magesh, V. & Sakthisekaran, D. 2008. Naringenin reduces tumor size and weight lost in N-methyl-N'-nitro-N-nitrosoguanidine-induced gastric carcinogenesis in rats. *Nutrition Research*, 28, 106-112.
- Engelhardt, U., Sarkar, A. & Linker, T. 2003. Efficient Enantioselective Total Synthesis of (-)-Epipodophyllotoxin. *Angewandte Chemie International Edition*, 42, 2487-2489.
- Evans, G. B., Furneaux, R. H., Gainsford, G. J. & Murphy, M. P. 2000. The synthesis and antibacterial activity of totarol derivatives. part 3: modification of ring-B. *Bioorganic & Medicinal Chemistry*, 8, 1663-1675.
- Evans, G. B., Furneaux, R. H., Gravestock, M. B., Lynch, G. P. & Scott, G. K. 1999. The synthesis and antibacterial activity of totarol derivatives. part 1: modifications of ring-C and pro-drugs. *Bioorganic & Medicinal Chemistry*, 7, 1953-1964.
- Faiella, L., Temraz, A., De Tommasi, N. & Braca, A. 2012. Diterpenes, ionol-derived, and flavone glycosides from *Podocarpus elongatus*. *Phytochemistry*, 76, 172-177.
- Farjon, A. & Page, C. N. 1999. *Conifers : status survey and conservation action plan*, Gland, Switzerland, IUCN World Conservation Union.

- Flores, C., Alarcón, J., Becerra, J., Bittner, M., Hoeneisen, M. & Silva, M. 2001. Extractable compounds of native trees chemical and biological study I: Bark of *Prumnopytis andina* (Podocarpaceae) and *Austrocedrus chilensis* (Cupressaceae). *Boletín de la Sociedad Chilena de Química*, 46, 61-64.
- Fournet, A., Barrios, A. A. & Muñoz, V. 1994. Leishmanicidal and trypanocidal activities of Bolivian medicinal plants. *Journal of Ethnopharmacology*, 41, 19-37.
- Fronza, M., Lamy, E., Günther, S., Heinzmann, B., Laufer, S. & Merfort, I. 2012. Abietane diterpenes induce cytotoxic effects in human pancreatic cancer cell line MIA PaCa-2 through different modes of action. *Phytochemistry*, 78, 107-119.
- Fronza, M., Murillo, R., Ślusarczyk, S., Adams, M., Hamburger, M., Heinzmann, B., Laufer, S. & Merfort, I. 2011. In vitro cytotoxic activity of abietane diterpenes from *Peltodon longipes* as well as *Salvia miltiorrhiza* and *Salvia sahendica*. *Bioorganic & Medicinal Chemistry*, 19, 4876-4881.
- Frydoonfar, H. R., Mcgrath, D. R. & Spigelman, A. D. 2003. The variable effect on proliferation of a colon cancer cell line by the citrus fruit flavonoid Naringenin. *Colorectal Disease*, 5, 149-152.
- Gao, K., Henning, S. M., Niu, Y., Youssefian, A. A., Seeram, N. P., Xu, A. & Heber, D. 2006. The citrus flavonoid naringenin stimulates DNA repair in prostate cancer cells. *The Journal of Nutritional Biochemistry*, 17, 89-95.
- Garduno-Ramirez, M. L., Trejo, A., Navarro, V., Bye, R., Linares, E. & Delgado, G. 2001. New modified eremophilanes from the roots of *Psacalium radulifolium*. *Journal of Natural Products*, 64, 432-435.
- Girones-Vilaplana, A., Moreno, D. A. & Garcia-Viguera, C. 2014. Phytochemistry and biological activity of Spanish Citrus fruits. *Food & Function*, 5, 764-772.
- Graham, J. G., Quinn, M. L., Fabricant, D. S. & Farnsworth, N. R. 2000. Plants used against cancer – an extension of the work of Jonathan Hartwell. *Journal of Ethnopharmacology*, 73, 347-377.
- Gu, J.-Q., Wang, Y., Franzblau, S. G., Montenegro, G. & Timmermann, B. N. 2004. Constituents of *Senecio chionophilus* with potential antitubercular activity. *Journal of Natural Products*, 67, 1483-1487.
- Gu, Q., Li, Y., Chen, Y., Yao, P. & Ou, T. 2013. Sciadopitysin: active component from *Taxus chinensis* for anti-Alzheimer's disease. *Natural Product Research*, 27, 2157-2160.
- Gvazava, L. & Kikoladze, V. 2011. Flavonoids from the plants *Polygonatum polyanthemum* and *P. glaberrimum*. *Chemistry of Natural Compounds*, 47, 818-819.
- Hajdu, Z. & Hohmann, J. 2012. An ethnopharmacological survey of the traditional medicine utilized in the community of Porvenir, Bajo Paraguá Indian Reservation, Bolivia. *Journal of Ethnopharmacology*, 139, 838-857.

- Hanrahan, J. R., Chebib, M., Davucheron, N. L. M., Hall, B. J. & Johnston, G. a. R. 2003. Semisynthetic preparation of amentoflavone: A negative modulator at GABAA receptors. *Bioorganic & Medicinal Chemistry Letters*, 13, 2281-2284.
- Harborne, J. B. & Williams, C. A. 2000. Advances in flavonoid research since 1992. *Phytochemistry*, 55, 481-504.
- Hariprasath, L., Raman, J. & Nanjian, R. 2012. Gastroprotective effect of *Senecio candicans* DC on experimental ulcer models. *Journal of Ethnopharmacology*, 140, 145-150.
- Hartmann, T. 2007. From waste products to ecochemicals: Fifty years research of plant secondary metabolism. *Phytochemistry*, 68, 2831-2846.
- Hattori, H., Okuda, K., Murase, T., Shigetsura, Y., Narise, K., Semenza, G. L. & Nagasawa, H. 2011. Isolation, identification, and biological evaluation of HIF-1-modulating compounds from Brazilian green propolis. *Bioorganic & Medicinal Chemistry*, 19, 5392-5401.
- Hayashi, Y., Takahashi, S., Ona, H. & Sakan, T. 1968. Structures of nagilactone A, B, C, and D, novel nor- and bis-nor-diterpenoids. *Tetrahedron Letters*, 9, 2071-2076.
- Heim, K. E., Tagliaferro, A. R. & Bobilya, D. J. 2002. Flavonoid antioxidants: chemistry, metabolism and structure-activity relationships. *The Journal of Nutritional Biochemistry*, 13, 572-584.
- Hertog, M. G. L., Hollman, P. C. H. & Katan, M. B. 1992. Content of potentially anticarcinogenic flavonoids of 28 vegetables and 9 fruits commonly consumed in the Netherlands. *Journal of Agricultural and Food Chemistry*, 40, 2379-2383.
- Hsu, Y.-L., Kuo, P.-L. & Lin, C.-C. 2004. Acacetin inhibits the proliferation of Hep G2 by blocking cell cycle progression and inducing apoptosis. *Biochemical Pharmacology*, 67, 823-829.
- Hye-Young, S., Jong-Hwa, P., Hyun-Dong, P., Seung-Yeol, N., Darrick, S. H. L. K. & Ye Sun, H. 2007. Acacetin-induced Apoptosis of Human Breast Cancer MCF-7 Cells Involves Caspase Cascade, Mitochondria-mediated Death Signaling and SAPK/JNK1/2-c-Jun Activation. *Mol. Cells*, 24, 95-104.
- Ibisch, P. L. 1998. *Bolivia is a megadiversity country and developing country*, Berlin, Springer.
- Ibisch, P. L. & Beck, S. G. 2003. *Espermatófitas*, Santa Cruz de la Sierra, Bolivia, Editorial FAN.
- Ibrahim, S. R. M., Mohamed, G. A. & Al-Musayeib, N. M. 2012. New Constituents from the Rhizomes of Egyptian *Iris germanica* L. *Molecules*, 17, 2587-2598.
- Ishikawa, H., Colby, D. A., Seto, S., Va, P., Tam, A., Kakei, H., Rayl, T. J., Hwang, I. & Boger, D. L. 2009. Total Synthesis of Vinblastine,

- Vincristine, Related Natural Products, and Key Structural Analogues. *Journal of the American Chemical Society*, 131, 4904-4916.
- Itô, S. & Mitsuaki, K. 1976. Nor-diterpene Dilactones from *Podocarpus* Species. *Heterocycles*, 4, 595-624.
- Iwamoto, M., Minami, T., Tokuda, H., Ohtsu, H. & Tanaka, R. 2003. Potential Antitumor Promoting Diterpenoids from the Stem Bark of *Thuja standishii*. *Planta Med*, 69, 69-72.
- Jimenez-Estrada, M., Chilpa, R. R., Apan, T. R., Lledias, F., Hansberg, W., Arrieta, D. & Aguilar, F. J. A. 2006. Anti-inflammatory activity of cacalol and cacalone sesquiterpenes isolated from *Psacalium decompositum*. *Journal of Ethnopharmacology*, 105, 34-38.
- Kabouche, A., Kabouche, Z., Öztürk, M., Kolak, U. & Topçu, G. 2007. Antioxidant abietane diterpenoids from *Salvia barrelieri*. *Food Chemistry*, 102, 1281-1287.
- Kaikabo, A. A. & Eloff, J. N. 2011. Antibacterial activity of two biflavonoids from *Garcinia livingstonei* leaves against *Mycobacterium smegmatis*. *Journal of Ethnopharmacology*, 138, 253-255.
- Kaikabo, A. A., Samuel, B. B. & Eloff, J. N. 2009. Isolation and activity of two antibacterial biflavonoids from leaf extracts of *Garcinia livingstonei* (Clusiaceae). *Natural product communications*, 4, 1363-6.
- Kanno, S.-I., Tomizawa, A., Hiura, T., Osanai, Y., Shouji, A., Ujibe, M., Ohtake, T., Kimura, K. & Ishikawa, M. 2005. Inhibitory Effects of Naringenin on Tumor Growth in Human Cancer Cell Lines and Sarcoma S-180-Implanted Mice. *Biological and Pharmaceutical Bulletin*, 28, 527-530.
- Khan, M. K., Zill, E. H. & Dangles, O. 2014. A comprehensive review on flavanones, the major citrus polyphenols. *Journal of Food Composition and Analysis*, 33, 85-104.
- Kim, H. P., Park, H., Son, K. H., Chang, H. W. & Kang, S. S. 2008. Biochemical pharmacology of biflavonoids: Implications for anti-inflammatory action. *Archives of Pharmacal Research*, 31, 265-273.
- Kim, S. J. 2001. Effect of biflavones of *Ginkgo biloba* against UVB-induced cytotoxicity in vitro. *The Journal of dermatology*, 28, 193-9.
- Klayman, D. L., Lin, A. J., Acton, N., Scovill, J. P., Hoch, J. M., Milhous, W. K., Theoharides, A. D. & Dobek, A. S. 1984. Isolation of Artemisinin (Qinghaosu) from *Artemisia annua* growing in the United States. *Journal of Natural Products*, 47, 715-717.
- Kootstra, A. 1994. Protection from UV-B-induced DNA damage by flavonoids. *Plant Molecular Biology*, 26, 771-774.
- Koteswara Rao, Y., Vimalamma, G., Venkata Rao, C. & Tzeng, Y.-M. 2004. Flavonoids and andrographolides from *Andrographis paniculata*. *Phytochemistry*, 65, 2317-2321.

- Krasovskaya, N. P., Kulesh, N. I. & Denisenko, V. A. 1989. Natural antioxidants. Furanoeremophilanes from *Cacalia* roots. *Chemistry of Natural Compounds*, 25, 545-548.
- Kris-Etherton, P. M., Hecker, K. D., Bonanome, A., Coval, S. M., Binkoski, A. E., Hilpert, K. F., Griel, A. E. & Etherton, T. D. 2002. Bioactive compounds in foods: their role in the prevention of cardiovascular disease and cancer. *The American Journal of Medicine*, 113, 71-88.
- Kubo, I., Matsumoto, T. & Klocke, J. 1984. Multichemical resistance of the conifer *Podocarpus gracilior* (Podocarpaceae) to insect attack. *Journal of Chemical Ecology*, 10, 547-559.
- Kubo, I., Muroi, H. & Himejima, M. 1992. Antibacterial Activity of Totarol and Its Potentiation. *Journal of Natural Products*, 55, 1436-1440.
- Kunert, O., Swamy, R. C., Kaiser, M., Presser, A., Buzzi, S., Appa Rao, A. V. N. & Schühly, W. 2008. Antiplasmodial and leishmanicidal activity of biflavonoids from Indian *Selaginella bryopteris*. *Phytochemistry Letters*, 1, 171-174.
- Kupchan, S. M., Baxter, R. L., Ziegler, M., Smith, P. M. & Bryan, R. F. 1975. Podolide, a new antileukemic norditerpene dilactone from *Podocarpus gracilior*. *Experientia*, 31, 137-138.
- Lee, D.-Y., Seo, K.-H., Jeong, R.-H., Lee, S.-M., Kim, G.-S., Noh, H.-J., Kim, S.-Y., Kim, G.-W., Kim, J.-Y. & Baek, N.-I. 2012. Anti-inflammatory Lignans from the Fruits of *Acanthopanax sessiliflorus*. *Molecules*, 18, 41-49.
- Lee, K.-H. & Xiao, Z. 2003. Lignans in treatment of cancer and other diseases†. *Phytochemistry Reviews*, 2, 341-362.
- Lee, S. E., Park, E. K. & Kim, J. G. 2000. A Mosquito Larvicidal Diterpenoid Isolated from *Podocarpus totara* D. Don ex Lambert. *Journal of entomological science.*, 35, 474.
- Li, J. W.-H. & Vederas, J. C. 2009. Drug Discovery and Natural Products: End of an Era or an Endless Frontier? *Science*, 325, 161-165.
- Li, S., Zhao, M., Li, Y., Sui, Y., Yao, H., Huang, L. & Lin, X. 2014. Preparative Isolation of six Anti-Tumour Biflavonoids from *Selaginella Doederleinii* Hieron by High-Speed Counter-Current Chromatography. *Phytochemical Analysis*, 25, 127-133.
- Lodewyk, M. W., Siebert, M. R. & Tantillo, D. J. 2011. Computational Prediction of 1H and 13C Chemical Shifts: A Useful Tool for Natural Product, Mechanistic, and Synthetic Organic Chemistry. *Chemical Reviews*, 112, 1839-1862.
- Lorimer, S. D., Mawson, S. D., Perry, N. B. & Weavers, R. T. 1995. Isolation and synthesis of  $\beta$ -mimoside an antifungal furanone glucoside from *Prumnopitys ferruginea*. *Tetrahedron*, 51, 7287-7300.
- Machumi, F., Samoylenko, V., Yenesew, A., Derese, S., Midiwo, J. O., Wiggers, F. T., Jacob, M. R., Tekwani, B. L., Khan, S. I., Walker, L. A. &

- Muhammad, I. 2010. Antimicrobial and antiparasitic abietane diterpenoids from the roots of *Clerodendrum eriophyllum*. *Natural product communications*, 5, 853-8.
- Macía, M. J., García, E. & Vidaurre, P. J. 2005. An ethnobotanical survey of medicinal plants commercialized in the markets of La Paz and El Alto, Bolivia. *Journal of Ethnopharmacology*, 97, 337-350.
- Macrae, W. D. & Towers, G. H. N. 1984. Biological activities of lignans. *Phytochemistry*, 23, 1207-1220.
- Mahdi, J. G., Mahdi, A. J. & Bowen, I. D. 2006. The historical analysis of aspirin discovery, its relation to the willow tree and antiproliferative and anticancer potential. *Cell Proliferation*, 39, 147-155.
- Markham, K., Sheppard, C. & Geiger, H. 1987. <sup>13</sup>C NMR studies of some naturally occurring amentoflavone and hinokiflavone biflavonoids. *Phytochemistry*, 26, 3335-3337.
- Markham, K. R., Webby, R. F., Whitehouse, L. A., Molloy, B. P. J., Vilain, C. & Mues, R. 1985. Support from flavonoid glycoside distribution for the division of Podocarpus in New Zealand. *New Zealand Journal of Botany*, 23, 1-13.
- Matlin, S. A., Prazeres, M. A., Bittner, M. & Silva, M. 1984. Norditerpene dilactones from *Podocarpus saligna*. *Phytochemistry*, 23, 2863-2866.
- Mcchesney, J. D., Venkataraman, S. K. & Henri, J. T. 2007. Plant natural products: Back to the future or into extinction? *Phytochemistry*, 68, 2015-2022.
- Mercado, M. 1998. Vegetación de la ceja de monte yunguena en el Parque Nacional Carrasco. *Revista Boliviana de Ecología y Conservación Ambiental*, 4, 55-75.
- Miean, K. H. & Mohamed, S. 2001. Flavonoid (myricetin, quercetin, kaempferol, luteolin, and apigenin) content of edible tropical plants. *Journal of Agricultural and Food Chemistry*, 49, 3106-12.
- Mitchell, T. G. & Perfect, J. R. 1995. Cryptococcosis in the era of AIDS--100 years after the discovery of *Cryptococcus neoformans*. *Clinical Microbiology Reviews*, 8, 515-48.
- Miura, H., Kihara, T. & Kawano, N. 1968. New bisflavones from *Podocarpus* and *Chamaecyparis* plants. *Tetrahedron Letters*, 9, 2339-2342.
- Mohamed, A. E.-H. H. & Ahmed, A. 2005. Eremophilane-Type Sesquiterpene Derivatives from *Senecio aegyptius* var. *discoideus*. *Journal of Natural Products*, 68, 439-442.
- Morales, G., Paredes, A., Sierra, P. & Loyola, L. A. 2008. Antimicrobial Activity of Three Baccharis Species Used in the Traditional Medicine of Northern Chile. *Molecules*, 13, 790-794.
- Mothana, R., Al-Said, M., Al-Musayeib, N., Gamal, A., Al-Massarani, S., Al-Rehaily, A., Abdulkader, M. & Maes, L. 2014. In Vitro Antiprotozoal

- Activity of Abietane Diterpenoids Isolated from *Plectranthus barbatus* Andr. *International Journal of Molecular Sciences*, 15, 8360-8371.
- Muhammad, I., Mossa, J. S. & El-Ferally, F. S. 1996. Additional Antibacterial Diterpenes from the Bark of *Juniperus procera*. *Phytotherapy Research*, 10, 604-607.
- Müller, J. 2006. Systematics of *Baccharis* (Compositae-Astereae) in Bolivia, including an Overview of the Genus. *Systematic Botany Monographs*, 76, 1-341.
- Muñoz, V., Sauvain, M., Bourdy, G., Callapa, J., Bergeron, S., Rojas, I., Bravo, J. A., Balderrama, L., Ortiz, B., Gimenez, A. & Deharo, E. 2000. A search for natural bioactive compounds in Bolivia through a multidisciplinary approach: Part I. Evaluation of the antimalarial activity of plants used by the Chacobo Indians. *Journal of Ethnopharmacology*, 69, 127-137.
- Muroi, H. & Kubo, I. 1996. Antibacterial activity of anacardic acid and totarol, alone and in combination with methicillin, against methicillinresistant *Staphylococcus aureus*. *Journal of Applied Bacteriology*, 80, 387-394.
- Nawal, H. M. & Atta, E. M. 2013. Cytotoxic and Antioxidant Activity of *Marrubium vulgare* and its Flavonoid Constituents. *2nd International Conference on Chemical, Environmental and Biological Sciences (ICCEBS'2013)*. Dubai.
- Nazir, N., Koul, S., Ahmad Qurishi, M., Chandra Taneja, S., Purnima, B. & Nabi Qazi, G. 2008. New isoflavones from *Iris kashmiriana*. *Journal of Asian Natural Products Research*, 10, 1137-1141.
- Neuhouser, M. L. 2004. Review: Dietary Flavonoids and Cancer Risk: Evidence From Human Population Studies. *Nutrition and Cancer*, 50, 1-7.
- Nicolson, K., Evans, G. & O'toole, P. W. 1999. Potentiation of methicillin activity against methicillin-resistant *Staphylococcus aureus* by diterpenes. *FEMS Microbiology Letters*, 179, 233-239.
- Nijveldt, R. J., Van Nood, E., Van Hoorn, D. E., Boelens, P. G., Van Norren, K. & Van Leeuwen, P. A. 2001. Flavonoids: a review of probable mechanisms of action and potential applications. *The American Journal of Clinical Nutrition*, 74, 418-425.
- Nishimura, F. D. C., De Almeida, A. C., Ratti, B. A., Ueda-Nakamura, T., Nakamura, C. V., F., X. V. & Silva, S. D. O. 2013. Antioxidant effects of quercetin and naringenin are associated with impaired neutrophil microbicidal activity. *Evidence-based complementary and alternative medicine : eCAM*, 2013, 7.
- Nomura, T. K. N. 2005. Involvement of cathepsins in the invasion, metastasis and proliferation of cancer cells. *J. Med. Invest. The Journal of Medical Investigation*, 52, 1-9.
- Oberlies, N. H. & Kroll, D. J. 2004. Camptothecin and Taxol: Historic Achievements in Natural Products Research. *Journal of Natural Products*, 67, 129-135.

- Otto, A. & Wilde, V. 2001. Sesqui-, di-, and triterpenoids as chemosystematic markers in extant conifers—A review. *The Botanical Review*, 67, 141-238.
- Pan, M.-H., Lai, C.-S., Hsu, P.-C. & Wang, Y.-J. 2005a. Acacetin Induces Apoptosis in Human Gastric Carcinoma Cells Accompanied by Activation of Caspase Cascades and Production of Reactive Oxygen Species. *Journal of Agricultural and Food Chemistry*, 53, 620-630.
- Pan, X., Tan, N., Zeng, G., Zhang, Y. & Jia, R. 2005b. Amentoflavone and its derivatives as novel natural inhibitors of human Cathepsin B. *Bioorganic & Medicinal Chemistry*, 13, 5819-5825.
- Pandurangan, N., Bose, C. & Banerji, A. 2011. Synthesis and antioxygenic activities of seabuckthorn flavone-3-ols and analogs. *Bioorganic & Medicinal Chemistry Letters*, 21, 5328-5330.
- Pelser, P. B., Nordenstam, B., Kadereit, J. W. & Watson, L. E. 2007. An ITS phylogeny of tribe Senecioneae (Asteraceae) and a new delimitation of *Senecio* L. *Taxon*, 56.
- Peng, W. 2011. Constituents from charred *Cirsium japonicum*. *Chemistry of Natural Compounds*, 47, 279-280.
- Pérez, C., Agnese, A. M. & Cabrera, J. L. 1999. The essential oil of *Senecio graveolens* (Compositae): chemical composition and antimicrobial activity tests. *Journal of Ethnopharmacology*, 66, 91-96.
- Pérez-Castorena, A. L., Arciniegas, A., Villaseñor, J. L. & Romo De Vivar, A. 2004. Furanoeremophilane Derivatives from *Psacalium beamanii*. *Journal of the Mexican Chemical Society*, 48, 21-23.
- Phillipson, J. D. 2007. Phytochemistry and pharmacognosy. *Phytochemistry*, 68, 2960-2972.
- Pietta, P.-G. 2000. Flavonoids as Antioxidants. *Journal of Natural Products*, 63, 1035-1042.
- Quiroga, M. P., Pacheco, S., Malizia, L. R. & Premoli, A. C. 2012. Shrinking Forests under Warming: Evidence of *Podocarpus parlatorei* (pino del cerro) from the Subtropical Andes. *Journal of Heredity*, 103, 682-691.
- Rauf, A., Rehan, K. & Naveed, M. 2013. Antioxidant studies of various solvent fractions and chemical constituents of *Potentilla evestita* Th. Wolf. *Afr. J. Pharm. Pharmacol. African Journal of Pharmacy and Pharmacology*, 7, 2710-2713.
- Reina, M., Santana, O., Domínguez, D. M., Villarroel, L., Fajardo, V., Rodríguez, M. L. & González-Coloma, A. 2012. Defensive Sesquiterpenes from *Senecio candidans* and *S. magellanicus*, and their Structure-Activity Relationships. *Chem Biodivers*, 9, 625-643.
- Reynolds, M., Prakash Chaturvedula, V. S., Ratovoson, F., Andriantsiferana, R., Rasamison, V. E., Guza, R. C. & Kingston, D. G. I. 2006. Cytotoxic diterpenoids from *Podocarpus madagascariensis* from the Madagascar rainforest†. *Natural Product Research*, 20, 606-610.



- Ríos, J. L., Giner, R. M. & Prieto, J. M. 2002. New findings on the bioactivity of lignans. *Studies in Natural Products Chemistry*, 26, 183-292.
- Rodríguez-Hahn, L., Guzmán, A. & Romo, J. 1968. The constituents of *Cacalia decomposita* A. Gray—IV: Structure of decompostin. *Tetrahedron*, 24, 477-483.
- Rossi, M. H., Yoshida, M. & Soares Maia, J. G. 1997. Neolignans, styrylpyrones and flavonoids from an *Aniba* species. *Phytochemistry*, 45, 1263-1269.
- Roy, S. K., Qasim, M. A., Kamil, M. & Ilyas, M. 1987. Biflavones from the genus *Podocarpus*. *Phytochemistry*, 26, 1985-1987.
- Saleem, M., Kim, H. J., Ali, M. S. & Lee, Y. S. 2005. An update on bioactive plant lignans. *Natural Product Reports*, 22, 696-716.
- Sasaki, H., Miki, K., Kinoshita, K., Koyama, K., Juliawaty, L. D., Achmad, S. A., Hakim, E. H., Kaneda, M. & Takahashi, K. 2010.  $\beta$ -Secretase (BACE-1) inhibitory effect of biflavonoids. *Bioorganic & Medicinal Chemistry Letters*, 20, 4558-4560.
- Sasse, J. M., Rowan, K. S. & Galbraith, M. N. 1981. Distribution of podolactone-type plant growth inhibitors in the coniferae. *Phytochemistry*, 20, 2195-2204.
- Sato, K., Sugawara, K., Takeuchi, H., Park, H. S., Akiyama, T., Koyama, T., Aoyagi, Y., Takeya, K., Tsugane, T. & Shimura, S. 2008. Antibacterial novel phenolic diterpenes from *Podocarpus macrophyllus* D. Don. *Chemical & Pharmaceutical Bulletin*, 56, 1691-7.
- Schmidt, B., Ribnicky, D. M., Poulev, A., Logendra, S., Cefalu, W. T. & Raskin, I. 2008. A natural history of botanical therapeutics. *Metabolism*, 57, Supplement 1, S3-S9.
- Semenza, G. L. 2003. Targeting HIF-1 for cancer therapy. *Nat Rev Cancer*, 3, 721-732.
- Shrestha, K., Banskota, A. H., Kodata, S., Shrivastava, S. P., Strobel, G. & Gewali, M. B. 2001. An antiproliferative norditerpene dilactone, Nagilactone C, from *Podocarpus neriifolius*. *Phytomedicine : international journal of phytotherapy and phytopharmacology*, 8, 489-491.
- Silba, J. 1984. *An international census of the Coniferae / compiled by John Silba*, Plainfield, N.J. :, H.N.Moldenke, and A.L. Moldenke.
- Silva, G. L., Chai, H., Gupta, M. P., Farnsworth, N. R., Cordell, G. A., Pezzuto, J. M., Beecher, C. W. W. & Douglas Kinghorn, A. 1995. Cytotoxic biflavonoids from *Selaginella willdenowii*. *Phytochemistry*, 40, 129-134.
- Singh, R. P., Agrawal, P., Yim, D., Agarwal, C. & Agarwal, R. 2005. Acacetin inhibits cell growth and cell cycle progression, and induces apoptosis in human prostate cancer cells: structure–activity relationship with linarin and linarin acetate. *Carcinogenesis*, 26, 845-854.
- Singh, S., Pandey, V. B. & Singh, T. D. 2011. Alkaloids and flavonoids of *Argemone mexicana*. *Natural Product Research*, 26, 16-21.

- Smith, E. C. J., Wareham, N., Zloh, M. & Gibbons, S. 2008. 2 $\beta$ -Acetoxylferruginol—A new antibacterial abietane diterpene from the bark of *Prumnopitys andina*. *Phytochemistry Letters*, 1, 49-53.
- Son, K.-H., Oh, H.-M., Choi, S.-K., Han, D. C. & Kwon, B.-M. 2005. Anti-tumor abietane diterpenes from the cones of *Sequoia sempervirens*. *Bioorganic & Medicinal Chemistry Letters*, 15, 2019-2021.
- Stockey, R. A. & Frevel, B. J. 1997. Cuticle Micromorphology of *Prumnopitys Philippi* (Podocarpaceae). *International Journal of Plant Sciences.*, 158, 198.
- Suárez, A., I., Diaz M, B., Delle Monache, F. & Compagnone, R. S. 2003. Biflavonoids from *Podocalyx loranthoides*. *Fitoterapia*, 74, 473-475.
- Thomas, E., Semo, L., Morales, M., Noza, Z., Nuñez, H., Cayuba, A., Noza, M., Humaday, N., Vaya, J. & Van Damme, P. 2011. Ethnomedicinal practices and medicinal plant knowledge of the Yuracarés and Trinitarios from Indigenous Territory and National Park Isiboro-Sécure, Bolivian Amazon. *Journal of Ethnopharmacology*, 133, 153-163.
- Tropicos.Org. 2012. *Tropicos.org. Missouri Botanical Garden* [Online]. Available: <<http://www.tropicos.org>> [Accessed 20 Sep 2012].
- Umehara, K., Nemoto, K., Matsushita, A., Terada, E., Monthakantirat, O., De-Eknamkul, W., Miyase, T., Warashina, T., Degawa, M. & Noguchi, H. 2009. Flavonoids from the Heartwood of the Thai Medicinal Plant *Dalbergia parviflora* and Their Effects on Estrogenic-Responsive Human Breast Cancer Cells. *Journal of Natural Products*, 72, 2163-2168.
- Vacek, J., Klejduš, B., Lojko, L. & Kubín, V. 2008. Current trends in isolation, separation, determination and identification of isoflavones: a review. *Journal of separation science*, 31, 2054-67.
- Vandebroek, I., Thoomas, E. & Ametrac. 2003. *Las plantas medicinales para la atención primaria de la salud. El conocimiento de ocho medicos tradicionales de Apillapampa (Bolivia)*, Industrias Gráficas Serrano, Cochabamba-Bolivia.
- Vargas, I., Lawrence, A. & Otazu, M. E. 2000. *Árboles y arbustos para sistemas agroforestales en los Valles Interandinos de Santa Cruz, Bolivia, guía de campo.*, Santa Cruz de la Sierra, Bolivia, Editorial FAN.
- Vasconcelos, J. M. J., Silva, A. M. S. & Cavaleiro, J. a. S. 1998. Chromones and flavanones from *Artemisia campestris subsp. maritima*. *Phytochemistry*, 49, 1421-1424.
- Vassar, R., Bennett, B. D., Babu-Khan, S., Kahn, S., Mendiaz, E. A., Denis, P., Teplow, D. B., Ross, S., Amarante, P., Loeloff, R., Luo, Y., Fisher, S., Fuller, J., Edenson, S., Lile, J., Jarosinski, M. A., Biere, A. L., Curran, E., Burgess, T., Louis, J.-C., Collins, F., Treanor, J., Rogers, G. & Citron, M. 1999.  $\beta$ -Secretase Cleavage of Alzheimer's Amyloid Precursor Protein by the Transmembrane Aspartic Protease BACE. *Science*, 286, 735-741.

- Verdi, L. G., Brighente, I. M. C. & Pizzolatti, M. G. 2005. Genero *Baccharis* (Asteraceae): Aspectos químicos, económicos e biológicos. *Quim Nova*, 28, 85-94.
- Villarroel, L., Torres, R., Gavin, J., Reina, M. & De La Fuente, G. 1991. 9-Oxo-10 $\alpha$ H-furanoeremophilanes from *Senecio chilensis* and *Senecio patagonicus*. *Journal of Natural Products*, 54, 588-590.
- Wall, M. E. & Wani, M. C. 1995. Camptothecin and Taxol: Discovery to Clinic—Thirteenth Bruce F. Cain Memorial Award Lecture. *Cancer Research*, 55, 753-760.
- Wall, M. E. & Wani, M. C. 1996. Camptothecin and taxol: from discovery to clinic. *Journal of Ethnopharmacology*, 51, 239-254.
- Wang, S. Y., Wu, J. H., Shyur, L. F., Kuo, Y. H. & Chang, S. T. 2002. Antioxidant Activity of Abietane-Type Diterpenes from Heartwood of *Taiwania cryptomerioides* Hayata. *Holzforschung*, 56, 487-492.
- Wang, X., Cai, P., Chang, C.-J., Ho, D. K. & Cassady, J. M. 1997. Three New Cytotoxic Norditerpenoid Dilactones from *Podocarpus Purdieanus* Hook. *Natural Product Letters*, 10, 59-67.
- Weniger, B., Vonthron-Sénécheau, C., Kaiser, M., Brun, R. & Anton, R. 2006. Comparative antiplasmodial, leishmanicidal and antitrypanosomal activities of several biflavonoids. *Phytomedicine*, 13, 176-180.
- Wink, M. 2010. *Annual Plant Reviews, Biochemistry Of Plant Secondary Metabolism*, John Wiley & Sons.
- Wollenweber, E., Stevens, J. F., Klimo, K., Knauff, J., Frank, N. & Gerhäuser, C. 2003. Cancer Chemopreventive in vitro Activities of Isoflavones Isolated from *Iris germanica*. *Planta Med*, 69, 15-20.
- Wood, J. R. I. 2005. *La guía "Darwin" de las Flores de Los Valles Bolivianos*, London, Darwin Initiative.
- Wu, K. K. 2000. Aspirin and Salicylate: An Old Remedy With a New Twist. *Circulation*, 102, 2022-2023.
- Yao, F., Zhang, D.-W., Qu, G.-W., Li, G.-S. & Dai, S. J. 2012. New abietane norditerpenoid from *Salvia miltiorrhiza* with cytotoxic activities. *Journal of Asian Natural Products Research*, 14, 913-917.
- Yao, L. H., Jiang, Y. M., Shi, J., Tomás-Barberán, F. A., Datta, N., Singanusong, R. & Chen, S. S. 2004. Flavonoids in Food and Their Health Benefits. *Plant Foods for Human Nutrition*, 59, 113-122.
- Ye, Y., Guo, Y., Luo, Y.-T. & Wang, Y.-F. 2012. Isolation and free radical scavenging activities of a novel biflavonoid from the shells of *Camellia oleifera* Abel. *Fitoterapia*, 83, 1585-1589.
- Ying, B.-P. & Kubo, I. 1991. Complete <sup>1</sup>H and <sup>13</sup>C NMR assignments of totarol and its derivatives. *Phytochemistry*, 30, 1951-1955.
- York, T., De Wet, H. & Van Vuuren, S. F. 2011. Plants used for treating respiratory infections in rural Maputaland, KwaZulu-Natal, South Africa. *Journal of Ethnopharmacology*, 135, 696-710.

- Zárate, M., Goitia, D. & Lazarte, G. 1999. Estudio estructural y ecológico de los bosques relictos de tres especies de pino de monte en Cochabamba-Bolivia. *Revista Boliviana de Ecología y Conservación Ambiental*, 5, 51-59.
- Zhou, H.-F., Xie, C., Jian, R., Kang, J., Li, Y., Zhuang, C.-L., Yang, F., Zhang, L.-L., Lai, L., Wu, T. & Wu, X. 2011. Biflavonoids from Caper (*Capparis spinosa* L.) Fruits and Their Effects in Inhibiting NF-kappa B Activation. *Journal of Agricultural and Food Chemistry*, 59, 3060-3065.



## 4 Acknowledgements

My most sincere gratitude to the personnel and friends at Lund University for all the help and support I have received during the course of this research.

I must express my gratitude to the Swedish International Development Agency (SIDA) for the valuable financial support.

I would like to express my deep gratitude to Professor Olov Sterner, my research supervisor, for his patience, guidance and assistance in the development of this research.

I would also like to thank Nelson Hinojosa, Jose Luis Balderrama and Antonio Vilaseca, my supervisors in Bolivia, for their assistance in the PhD program.

I would also like to thank Maria Levin and Bodil Eliasson for all the help I received during my stay at Lund University. My grateful thanks are also extended to Karl-Erik Bergquist for his help with the NMR analysis, to Einar Nilsson, who helped me with the mass spectroscopy and Anders Sundin for his help in the computational calculations.

I would like to express my special thanks of gratitude to the OS group.

Finally, I wish to thank my family for the support they provided me through my entire life and in particular special thanks should be given to Paola and Valentina, without whose love, I would not have finished this thesis.