



LUND UNIVERSITY

Industrialized construction - explorations of current practice and opportunities

Malmgren, Linus

2014

[Link to publication](#)

Citation for published version (APA):

Malmgren, L. (2014). *Industrialized construction - explorations of current practice and opportunities*. [Doctoral Thesis (compilation), Division of Structural Engineering]. Faculty of Engineering and Division of Structural Engineering.

Total number of authors:

1

General rights

Unless other specific re-use rights are stated the following general rights apply:

Copyright and moral rights for the publications made accessible in the public portal are retained by the authors and/or other copyright owners and it is a condition of accessing publications that users recognise and abide by the legal requirements associated with these rights.

- Users may download and print one copy of any publication from the public portal for the purpose of private study or research.
- You may not further distribute the material or use it for any profit-making activity or commercial gain
- You may freely distribute the URL identifying the publication in the public portal

Read more about Creative commons licenses: <https://creativecommons.org/licenses/>

Take down policy

If you believe that this document breaches copyright please contact us providing details, and we will remove access to the work immediately and investigate your claim.

LUND UNIVERSITY

PO Box 117
221 00 Lund
+46 46-222 00 00

Industrialized construction

Explorations of current practice and opportunities

Linus Malmgren



LUND
UNIVERSITY

Copyright © Linus Malmgren

Faculty of Engineering and Division of Structural Engineering

Report TVBK-1045

ISSN 0349-4969

ISRN LUTVDG/TVBK-1045/14-SE

ISBN 978-91-979543-8-9

Printed in Sweden by Media-Tryck, Lund University

Lund 2014



Preface

To get the opportunity to do research has been a great privilege. To get the chance to explore ideas and develop my understanding of a subject has been a great experience. That there is a potential to improve how we design and build houses is something that I believe strongly in, and hopefully will continue to work with.

My background as a consultant both within construction and IT- and management consulting has helped me develop my understanding of the issues and potential for industrialized construction, it has as well affected how I reason. Consequently my professional experiences have affected the direction of the project both consciously and subconsciously.

I would first of all like to thank my supervisors Sven Thelandersson and Ronny Andersson, for all the support during the project. I would also like to extend my gratitude to the project partners for all help and support, especially thanks to Frida Hallqvist, Rolf Kling and Hans Söderling. A special thanks also to MKB Fastighets AB for making me feel welcome throughout the project. For financial support MKB and SBUF are gratefully acknowledged. I would also like to extend my gratitude to the colleagues at the Division of Structural Engineering, who made daily work more interesting and inspiring.

Finally thanks to my family for all support. Especially to my wife Jessica for taking care of me as well as our son Elias during the last year of my thesis work when we were also building our own house.

To Jessica

Contents

Preface	
Contents	
Sammanfattning	1
Summary	3
Definitions and abbreviations	5
Publications	7
Appended papers	7
Other publications	8
1 Introduction	9
1.1 Background	9
1.2 Purpose and motivation for the research	11
1.3 Objective and limitations	11
1.4 Research questions	12
1.5 Thesis outline	13
2 Research approach	15
2.1 Research process	15
2.2 Methods	16
2.3 Empirical data collection	17
2.4 Validation	18
3 Frame of reference	21
3.1 The industrialization of construction	21
3.1.1 History and background	21
3.1.2 A Swedish governmental initiative	25
3.1.3 Timber house manufacturers	25
3.1.4 Definitions and influences	25
3.1.5 Enablers and barriers	28

3.2	Lean and agile principles	29
3.3	Production strategies	30
3.3.1	Japanese house building	30
3.3.2	Production strategies for construction	31
3.4	The product specification process	33
3.5	Mass customization	37
3.6	Modularization	40
3.7	Product platforms and product development	42
3.8	Information technology in industrialized construction	43
4	The client role in industrialized construction and renovation	47
4.1	Current role	47
4.2	Client led change in construction	49
5	Renovation of multi family houses	51
6	Examples from current practice	55
6.1	Introduction	55
6.1.1	Timber house manufactures	55
6.1.2	Client opportunities	55
6.2	Industrialized timber frame house manufactures	56
6.2.1	ICT support for industrialized production of houses	56
6.2.2	Information management for industrialized building design	57
6.2.3	Product modeling of configurable building systems	58
6.3	Construction clients and their relationship to industrialization	60
6.3.1	Introduction	60
6.3.2	MKB Fastighets AB	60
6.3.3	Pre-study and previously unpublished results	63
6.3.4	Planning of renovation and maintenance	66
6.3.5	Demand and supply for the renovation industry	69
6.3.6	Opportunities for industrialization of renovation	72
7	Current situation and future opportunities	73
7.1	Introduction	73
7.2	A view of current practice	73
7.2.1	Timber house manufacturers	73
7.2.2	Renovation and the situation of property owners	75
7.3	Acting from current situation	76
7.4	Going forward	77
8	Conclusions	79
8.1	Introduction	79

8.2 Timber house manufactures	79
8.3 Client opportunities	80
8.4 Future research	82
8.5 Final remarks	82
9 References	85

Sammanfattning

Industriellt byggande tagit sig olika uttryck och gått igenom olika faser beroende från var inspiration har hämtats. Detta projekt har studerat möjligheterna med industriellt byggande i två applikationer: trähusbyggande och renovering av flerbostadshus.

I Sverige är träbaserad industriell produktion av bostäder en relativt stark sektor, men man befinner sig någonstans mellan industriell produktion och den traditionella byggsektorn, vilket har lett till viss ambivalens. IT-stöd och produktokumentation återspeglar till stor del hur det ser ut i resten av byggsektorn, vilket gör att man får svårt att utnyttja potentialen i industriellt byggande fullt ut.

Industriell produktion av trähus skulle kunna förbättra sin effektivitet genom att på ett bättre sätt utnyttja möjligheterna med IT stöd och ha en bättre överensstämmelse mellan de interna processerna och affärsmodellen. Dessutom behöver man tänka över hur man dokumenterar produkter för en industriell kontext. Dessa förändringar kommer oundvikligen att få effekter för hur man är organiserad, kräva nya eller förändrade processer samt ha påverkan på hur man kan använda produktokumentation.

I Sverige finns det starka fastighetsägare som skulle kunna ta en aktiv roll i det industriella byggandet om man hade rätt kunskap och verktyg. En intressant del av byggsektorn är renovering av flerbostadshus – idag är investeringarna i renovering större än i nybyggnad. Renoveringsbehovet av flerbostadshus i Sverige så väl som i resten av Europa är stort. Hur det ska finansieras och genomföras är problem som många fastighetsägare brottas med och olika strategier har använts. Exempelvis stambyte är ett stort och kostnadsdrivande ingrepp i byggnader och många byggnader är i stort behov. Sammanräknat renovering och nybyggnad kan flera svenska beställare komma upp i volymer över 1 000 badrum per år, vilket skulle kunna motivera satsningar på industriella strategier. Ett fallstudieföretag i projektet har valt ett angreppssätt där man standardiserar stambyten till ett begränsat antal lösningar. Detta kan ses som en början till industriell strategi.

För ytterligare industrialisering krävs att fastighetsägare tar ett samlat grepp kring utveckling och standardisering av produkter, samt att man ser till att

bättre kontrollera processerna för genomförande av stambytesprojekt. Insatsen för att skapa industriella strategier är inte ouppnåbar, men det kräver investeringar och kompetens som dagens fastighetsägare normalt inte har. Om fastighetsägare skulle agera som konceptägare för industriella plattformar för renovering och nybyggnad finns potentialen att skapa en ny marknad.

Summary

Industrialized construction has over the years taken different expressions and gone through different phases depending on where inspiration has come from. In this project, industrialized construction has been studied in two applications: timber house manufacturing and renovation of multi-family houses.

In Sweden industrialized production of timber houses is relatively strong in the housing sector, it however resides somewhere between industrial production and the traditional construction sector, which has led to some ambivalence. IT support and product documentation largely reflects the traditional construction sector, which means that they find it difficult to use the potential of industrialized construction in full.

The efficiency of production of timber houses could be improved by more effective use of IT support, as well as better coherence between internal processes and the business model. Further, they need to consider how to document products in an industrialized context. These changes will inevitably have an impact on how they are organized and would require new or changed processes. It will also have an impact on how product documentation can be used.

In Sweden there are strong property owners who are able to take an active role in industrialized construction if they were provided with the right knowledge and tools. An increasingly interesting sub-sector of construction is the renovation of multi-family houses, today investment in renovation is larger than in new construction. The renovation need in multi-family houses in Sweden, as well as in the rest of Europe, is large. How it will be financed and implemented is a problem that many property owners struggle with and different strategies have been used. For example pipe renovation is a major and costly action and many buildings are in great need. Several Swedish property owners can altogether show volumes over 1000 bathrooms per year in renovation and new construction, this could justify investments in industrialized strategies. A case study company in the research project has adopted an approach that standardizes pipe renovation to a limited number of solutions. This can be seen as a first step of an industrial strategy.

For further industrialization, clients need to implement a comprehensive approach to the development and standardization of solutions, as well as ensuring better control of processes for implementing pipe renovation projects. The effort to create industrialized strategies is not unattainable, but it requires investments and expertise that property owners today typically do not have. If property owners would act as concept owners for industrialized platforms for renovation and new construction, it has the potential to create a new market.

Definitions and abbreviations

Below are explanations to some commonly used expressions and abbreviations that are used throughout the thesis.

BIM	Building Information Modeling
Client	A person or organization that procures construction or renovation projects
Customer	The recipient of a service or a product
Configuration	An arrangement of functional units according to customer specifications to meet specific functions or performance
ICT/IT	Information and Communication Technology / Information Technology
LCC	Lifecycle costs
MFD	Modular Function Deployment. A method to modularize products and to encapsulate functionality.
Partnering	A contracting form where contractor and client jointly agree on the extent of the project and the reimbursement for the job. Often there is economic openness between the contractor and client.
Property owner	An owner of buildings or other real estate property
PPA	Public Procurement Act. A law that defines procurement for public bodies and publicly owned companies in Sweden.
QFD	Quality Function Deployment. A method to transform customer requirements to product properties.

Publications

Appended papers

- Paper 1** Johnsson, H, Malmgren, L, and Persson, S (2007) ICT support for industrialized construction. Bringing ICT knowledge to work: proceedings of CIB W78, Maribor. Vol. 1
- Paper 2** Persson, S, Malmgren, L and Johnsson, H (2009) Information management in industrial housing design and manufacture. Journal of Information Technology in Construction. Vol. 14.
- Paper 3** Malmgren, L, Jensen, P and Olofsson, T (2010) Product modeling of configurable building systems. Journal of Information Technology in Construction. Vol. 15.
- Paper 4** Malmgren, L (2013) Modeling pipe renovation need in multi-family houses. Submitted.
- Paper 5** Malmgren, L (2013) Renovation offers and the needs of real-estate property owners. Submitted.
- Paper 6** Malmgren, L (2013) Industrialization of renovation – a case study of client opportunities. Submitted.

In paper 1 Linus Malmgren performed interviews, documentation of processes, collection of documentation and verification of data at 3 of the 6 case study companies. Analysis was performed jointly with Helena Johnsson, Luleå University of Technology and Stefan Persson, Lund University. Writing was performed by Linus Malmgren and Helena Johnsson, with support from Stefan Persson.

Paper 2 is based on the same data as paper 1, with the addition of data collection from element producer 1 and 2, which was performed by Stefan Persson. Linus Malmgren performed the analysis together with Stefan Persson. Writing was performed together with Stefan Persson with support from Helena Johnsson. Linus Malmgren approximately did 50% of the writing.

In paper 3 Linus Malmgren performed design of the case study. Interviews and collection of documentation at the case study company was performed together with Patrik Jensen, Luleå University of Technology. Conceptual model development and analysis was performed jointly with Patrik Jensen. The majority of the writing was performed by Linus Malmgren. Throughout the work valuable input was received from Thomas Olofsson, Luleå University of Technology.

In papers 4-6 Linus Malmgren performed all work.

Other publications

- Technical report** Johnsson, H, Persson, S, Malmgren, L, Tarandi, V and Bremme, J (2006) IT-stöd för industriellt byggande i trä. Technical report 2006:19. Luleå University of Technology, Luleå.
- Conference proceeding** Jensen, P, Olofsson, T, Sandberg, M and Malmgren, L (2008) Reducing complexity of customized prefabricated buildings through modularization and IT-support. Proceedings of CIB W78 25th Conference on information technology in construction, Santiago de Chile.
- Licentiate thesis** Malmgren, L (2010) Customization of buildings using configuration systems. Report TVBK-1041. Division of Structural Engineering, Lund University, Lund.
- Technical report** Olofsson, T, Rönneblad, A, Berggren, B, Nilsson, L-O, Johnsson, C, Andersson, R and Malmgren, L (2012) Kravhantering, produkt- och projektutveckling av industriella byggkoncept (in Swedish). Technical Report. Luleå University of Technology, Luleå.

1 Introduction

1.1 Background

The construction industry has for many years endured claims of low or non-existent productivity development as well as low quality. At the same time prices for buildings are increasing at a faster rate than other products. Many reports have addressed the situation and needs in the construction sector and the problems are well known and documented by both academia as well as the industry.

Industrialization has been suggested as a solution to the poor productivity and quality in the construction industry. By increasing efficiency and quality it is believed that also costs can be reduced. Industrialization of the construction industry aims to break the project focus and instead focus on continuous processes that are evaluated and improved over time. It also aims to introduce the use of product platforms that can be configured to different needs of various construction applications. Prefabrication of components or complete modules has also had a strong position, although it is not necessary for industrialization. Altogether there is a focus on continuous development of processes and technology platforms that increases predictability.

In some contexts the industrialization of construction has however been seen as less successful, primarily because of poor urban planning and quality problems (Winch, 2003). Also poor maintenance after completion has contributed to the perception of failure of industrialized construction.

The automotive industry and other internationally competitive industries, have influenced contemporary industrialized construction in Sweden (Björnfot, 2006), (Robertsson and Ekholm, 2006). Japanese car manufactures, Swedish truck builders, the ship building industry and many more have been the subject for case studies and comparisons in different research projects, which has lead to the accumulation of knowledge. Also the principles of Lean production and Lean construction have influenced industrialized construction. Based on modern thinking of production strategies and process orientation, the industrialization efforts in construction have found influence from different, more mature areas and have continued to build a sustainable approach to

address the problems in the construction industry. For instance industrially produced multi-family houses today have a market share of 15% in Sweden (Jansson, 2010), for single-family houses the market share is even larger. Altogether industrialization has by many been seen as the most feasible way to increase effectiveness (Ekholm and Molnár, 2009).

Industrialization has gained a lot of attention in recent years and several initiatives have been started. But the development of industrialized construction in Sweden has experienced a turbulent period during the last decade. Several new, large initiatives were started, but unfortunately several were closed down or had to change strategies. These new initiatives were primarily targeted at multi-family house building. During the same period the market has been extremely volatile, the number of started single-family house project has dropped from around 14 000 to 4 000 from the beginning of 1990's. This has lead to the bankruptcy of several timber house manufacturers, which has also affected the perception of industrialized construction.

Industrialized construction has not succeeded to reach a break-through as a mainstream future method for the construction industry. But in specific sub-industries it has a significant share, for example single-family houses. Despite the failure to reach a wide market, industrialization has earned attention both in industry and academia due to it's potential to increase quality and productivity. After all, the problems of the construction industry have not yet been solved and the search for better solutions continues in a sector not known for rapid changes.

Renovation has besides house building become an increasingly important market. The investments in renovation are today larger than new construction, thus renovation is an increasingly important market also from the industrialization perspective to address quality, cost and productivity.

Construction clients and property owners as a group has not been especially active in the development of contemporary industrialized construction. The development has mostly been led by suppliers and contractors. But there is a potential for large and active clients to participate and possibly lead the direction of the development in industrialized construction towards a demand driven market. Many large clients that also own and operate buildings possess knowledge and the incentives to engage in construction and renovation projects as well as technical platforms. Their role should make them care for not only the price of a construction or renovation project, but also for the operating and future maintenance costs that plays a large role in the life cycle perspective.

1.2 Purpose and motivation for the research

Industrialized construction has so far been driven and initiated by suppliers and contractors with the primary aim to increase the internal efficiency. But unlike many other industries from where industrialized construction has been influenced, clients in the construction industry often take an active role in the process. The role of strong, professional clients as decision makers in industrialized construction has only during later years received attention, cf. (Hedgren, 2013), (Engström, 2012). But the participating role of professional clients in the industrialized construction process remains to be defined.

Industrialization builds on repetitive use of processes and technology. One of the problems so far has been to find volumes large enough to motivate the additional costs of standardization. From the perspective of large clients who build, own and operate buildings, repetitive work exists that could be suitable for industrialized construction. The need for pipe and bathroom renovation for example has increased in importance during later years. Together with the construction of new bathrooms, large clients especially, could provide necessary volumes each year. This is potential volumes large enough for standardization of technical platforms and processes. Clients and property owners have the potential to move from a purchaser of construction projects to an active participant with an industrialized strategy and thus lead the way towards industrialized construction where demand and client requirements are in center.

1.3 Objective and limitations

The objective of the project is to further the understanding of the applicability of production strategies and product models for industrialized construction and to increase the knowledge of building platforms. The objective is additionally to investigate barriers and how well the prerequisites for implementation are met, the role of configuration and IT-support and whether clients has the potential to act as platform owners.

Timber house manufacturers were studied to understand the opportunities and issues with current industrialized construction. Focus in these studies has been information technology and product platforms. To understand the demand and market potential for industrialized construction, large clients were studied. They were identified as a potential target group for industrialized strategies, hence they were the focus of the study. The project has narrowed in on

industrialized strategies primarily for renovation of multi-family houses, which is an increasingly important segment. The largest case study was performed at a public property owner, and several other property owners that were included were also public property owners. The aim of the thesis is to understand the requirements to implement industrialized construction and give examples of what the prerequisites are for large professional clients. It is believed that the barriers are not mainly technical or organizational.

The research project as a whole has focused on the technical systems, processes and information management of industrialized construction. Business models, organizational structures and market logic influence the analysis, but it has not been the main focus of the project.

The studies in the project have been limited to timber house manufacturers and renovation of multi-family houses. The studies do not compare directly, because there is no direct link between the two groups. Instead it should be seen as the understanding of industrialized construction that was gained from the studies of timber house manufacturers have been necessary knowledge build-up in the analysis of clients from the perspective of industrialized construction.

1.4 Research questions

Based on the research objective, several research questions have been formed that aim to lead up to identification of opportunities and recommendations for clients who aim to actively participate in the industrialization of construction.

- How can product modeling improve the management of design and manufacturing for timber house manufactures?
- What is the improvement potential for timber house manufacturers?
- How can the client role and attitudes in renovation projects with respect to technical solutions and process standardization be developed?
- How can clients gain from industrialized construction and what would a possible role be?

1.5 Thesis outline

The main part of this thesis consists of six appended academic papers that deal with industrialized construction in terms of prerequisites and opportunities in two different settings; timber house manufacturers and property owners. The research process and the data collection methods that have been used throughout the project are presented in chapter 2.

To provide background and a frame of reference to the research, chapter 3 provides descriptions of concepts that have been used in the project. To understand the client role in industrialized construction, chapter 4 provides an overview. Chapter 5 explains the need of renovation in multi-family houses, which has been the central case of the project. In chapter 6-8 the results from the studies performed within the project are presented, analyzed and lastly the conclusions of the project are presented together with a discussion of further research needs.

2 Research approach

2.1 Research process

This research project has been an exploration of current practice and opportunities of industrialized construction in two different contexts: timber house manufacturing and renovation of multi-family houses. During the course of the project, knowledge has been built up and the detailed plans for how and what studies to conduct have been finalized as the project has progressed. Consequently the research strategy and specific methods have been decided based on the continuous build-up of results and knowledge about industrialized construction, property management and renovation of multi-family houses.

The overall purpose of this research is to describe the opportunities and current practice in industrialized construction. The research in this project has its background in interpretivism, the aim is to understand given situations, but model development has also been a part of the project. Interpretivism implies that the researcher interprets data, therefore the results cannot objectively be considered the truth as they are dependent on context. The chosen research methods have led to close and continuous contacts with several companies active within property management and industrialized construction. Therefore, for example answers to interview questions given by interviewees are affected by the researcher as a person and the researcher also interprets the information provided.

The project takes a starting point in research of industrialized construction and production strategies suitable for construction. The data is collected and analyzed in a deductive approach where the aim has been to test theory in new contexts. Case studies were chosen as an overall research strategy to address the research questions because it can provide answers to complex situations and circumstances at the study objects. Qualitative methods were deemed needed to find the required data to answer the research questions and case studies are appropriate when “investigating contemporary phenomenon within real-life context” (Yin, 2003). The chosen methods are further explained in chapter 2.2.

The research project has been divided in two parts with slightly different directions. The first part aimed to understand industrialized construction, especially how information technology is used and how technical platforms are documented. The aim was to understand and suggest how timber house manufacturers can better use IT and configuration systems. The results were summarized in a licentiate thesis and appended papers 1-3. Most of the work in the first part of the project was conducted between 2007-2008. The first half of the project was a part of the research program LWE (Lean Wood Engineering) that was focused on industrialized construction in Sweden.

The second part of the project consisted of several studies to understand how large property owners plan and execute renovation projects in multi-family houses, i.e. to explain how they act as a client in renovation projects. The aim was to study and describe the planning and renovation process and to use previously gained knowledge of industrialized construction to describe how they as clients could adopt industrialized strategies for renovation. This part of the project was conducted between 2010-2013.

Altogether the aim of the project has been to describe different perspectives and views of industrialized construction from the industry perspective and to identify barriers and opportunities.

2.2 Methods

The specific methods used in each paper are described within that specific paper. General comments to the choice of methods are described below.

Case study has been the main research strategy throughout the project, as it can provide holistic descriptions and characteristics to real-life events (Yin, 2003). Further, explanatory case studies are preferred when seeking the answer to “how” or “why” questions, where it is not possible for the researcher to control events (Yin, 2003). But in case studies the researchers pre-understanding and background of the concepts being studied has relevance. Therefore a brief introduction of my experiences is provided in the preface.

The most common methods in which information is collected in qualitative case studies are interviews, observations and study of documents (Yin, 2003). Multiple sources give the opportunity to use triangulation, which can address potential problems of validity. The focus throughout the project has however been to understand why and how companies manage certain topics in the way that they do. This has been done through multiple studies of both timber house manufactures and property owners. The case studies have however been

complemented with model development to show practical possibilities and opportunities.

Qualitative methods were chosen rather than quantitative as the barriers and attitudes towards implementation of industrialized construction were perceived as difficult to obtain from quantitative studies. It was believed to be difficult to obtain in depth answers and to find root causes without qualitative methods.

For the first part of the project, methods were chosen to fulfill the purpose to describe the current situation of timber house manufacturers. The aim of the studies was specifically to find out more about their current use of IT and how they manage product information in design and production. To find out the current use and also to identify possible opportunities, the relevant processes had to be understood as well. Therefore the first studies were executed as a multiple case study where IT and processes were in focus. Data were collected through interviews, studying of documentation and observation.

The next study of timber house manufacturers was a case study with focus on the technical platform. This study consisted of deeper interviews and study of documentation to understand how the building system worked and was used in practice. A method for documenting product structures was then applied to document the building system to understand the applicability for industrialized construction.

The studies of property owners originated from an opportunity to study a specific property owner, thus the methods are conceived to suit the company based on what studies that were possible to conduct. Thus the project started with a pre-study to find suitable direction of further studies. The main study was a case study that included many different parts. It was complemented with minor studies to confirm the results from the case study. Outlooks consisted of interviews and a questionnaire.

2.3 Empirical data collection

Table 1 shows a compilation of all studies that were completed during the project. The details and type of each data collection method is described.

Table 1 Data collection methods

Table 1 displays an overview of data collection methods in the project and where the data has been used.

Name	Type	Authors contribution	Description	Used in
IT support for industrialized construction	Case study	Participated in collection data, analysis and reporting	Map and describe processes and technical platforms from an information technology perspective	Papers 1, 2
Building platforms as product families	Case study	Collection of data, analysis and reporting	Study product family documentation, product documentation systems, design and manufacturing processes. Development of product views based on a product model.	Paper 3
Pre-study property owner	Case study	All work	Identify issues and set scope for main study	Pre-study
Interviews with property owners	Interview	Performed in collaboration with Magnus Jönsson, MKB	Identify how clients regard and think about property management	Pre-study
Workshop with stakeholders in renovation projects	Workshop	All work	Aim was to find out the issues in renovation projects as they are perceived by the stakeholders	Pre-study
Case study MKB	Case study	All work	Current renovation process, strategy and planning. Investigate the potential for industrialized strategies	Papers 4, 5, 6
Survey client requirements	Survey	All work	On-line survey, design, distribution and analysis of results.	Paper 5
Interviews with renovation contractors	Interviews	All work	Interviews with contractors to establish their offerings and operations within renovation	Paper 5

2.4 Validation

Case studies are noted for the difficulties of generalization, which is a requirement to present scientifically valid results (Yin, 2003). Consequently validity becomes important to consider. Internal validity describes how well the

collected data corresponds to reality (Yin, 2003). To increase internal validity Yin (2003) recommends the use of multiple data sources, directed content analysis or pattern matching, considerations of rivaling explanations and logical explanations. In this thesis internal validity has been addressed by triangulation by collecting data from multiple sources and discussions with other property owners to verify the results.

External validity considers the generality of findings, Yin (2003) emphasizes the use of multiple case studies and replication studies in similar cases in order to increase the external validity. Generalization can also be addressed by choosing cases that are representative to the studied phenomenon. In this project timber house manufactures can be argued to be representative within that sector. It is however difficult to distinguish whether MKB is representative for large, professional property owners in Sweden or not because not many property owners were studied closely enough. MKB are however considered a responsible and forward thinking company and could be a model for other property owners to follow.

For qualitative research, reliability implies that other researchers would come to the same result and make the same conclusions based on the documentation of the research project (Yin, 2003). Reliability is however problematic in case studies as real-world cases are often dynamic and the researcher's previous experiences affect the data collection and analysis. Yin (2003) suggests analytical generalization where the results are generalized to broader theory. This implies that the results must be tested in other cases to be proved as generalizable. In this project no verification cases were performed, this must be noted as further research to improve the reliability and generalization of the results.

3 Frame of reference

3.1 The industrialization of construction

3.1.1 History and background

The industrial revolution that began in Great Britain sometime around 1760 meant profound changes to manufacturing processes, when craftsmanship based production was abandoned for serial production. The rapid increase in productivity resulted in reduced production costs and economies of scale, which made products available to a larger market. The founding ideas of industrialization have been one of the corner stones also for industrialized construction, the transition from craftsmanship to industrial production. Production paradigms have however evolved over time since the beginning of the industrial revolution in Great Britain and are today much more specialized.

In the beginning of the twentieth century the car manufacturer Henry Ford developed the assembly line, which divided work into small repetitive activities. This meant that isolated tasks could be improved and also automated. Mass production was born (Liker, 2004). Later in the century a man named Eiji Toyoda visited Ford Motor Company. He learned from what he saw and brought back lessons to Japan (Womack *et al.*, 1991). Together with Taiichi Ohno he developed what became known as the Toyota Production System (TPS). Eventually the production system of the car manufacturer Toyota grew strong and proved to be a valuable asset in efficient manufacturing.

Again much later TPS was studied by American researchers with the aim to improve American car manufacturing (Womack *et al.*, 1991). Following the visits, TPS has been called “the next major evolution in efficient business processes after the mass production system invented by Henry Ford” (Liker, 2004). TPS has been thoroughly studied and analyzed and is well recognized around the world in many different industries. Outside Japan TPS is often referred to as Lean production and has been thoroughly described in the books *The machine who changed the world* and *Lean Thinking* (Womack *et al.*, 1991), (Womack and Jones, 1996).

Lean has later been spread all over the world as a remedy to poor quality and productivity issues in many industries. It has made some impression also in the construction industry through its transformation into Lean construction. In construction it has for example resulted in the planning tool Last Planner, efficient processes and customer focus. Lean construction has to some extent also been an inspiration to research in industrialized construction (Björnfot, 2006).

The construction industry has many times been blamed for poor productivity, quality and high costs (Egan, 1998), (SOU, 2002), (Josephson and Saukkoriipi, 2007). The discouraging results of the reports were followed by investigations and further visits to Japan by British researchers c.f. (Barlow *et al.*, 2003). The aim was to bring back knowledge to the British construction industry. The results of these studies, especially concerning production strategies and prefabrication, have come to be an inspiration for the development of industrialized construction in Sweden. The Swedish construction sector was scrutinized by governmental and industry commissions in the early 2000's. They concluded that there was a need to reduce costs, increase quality and to develop production methods. Industrialization was seen as a method to achieve the goals (SOU, 2002). Some examples of industrialized construction are presented in figure 1.



Figure 1 Swedish industrialized production of houses
Examples of industrialized house production in Sweden, previously published in paper 1.

At the same time, the productivity development in the construction sector has been stagnant and construction prices continue to increase at a rapid rate (figure 2). For customers it is getting increasingly expensive to build houses, which is seen as one of the explanations to the current low rate new construction projects.

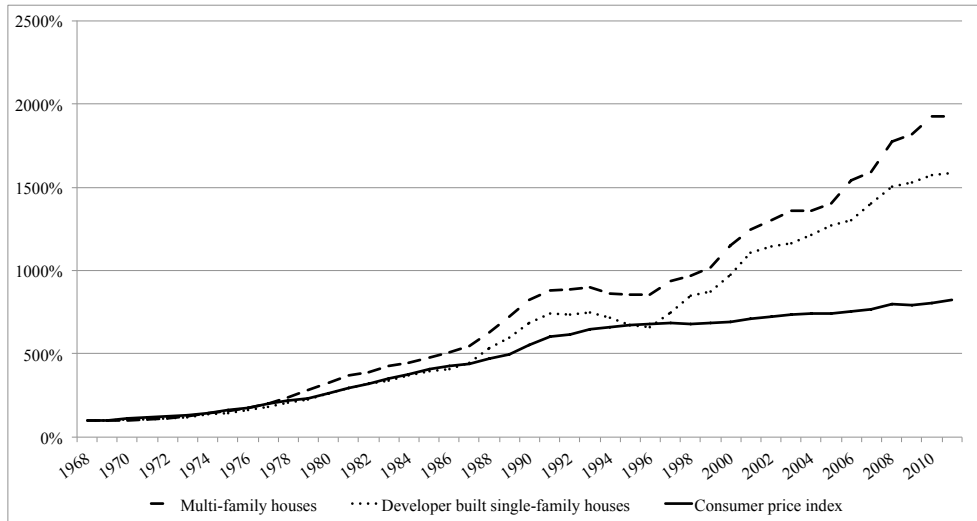

Figure 2 Construction price index compared to consumer price index

In the period 1968-2010 construction prices in Sweden has increased at a rapid rate compared to the consumer price index (Statistics Sweden, 2012), (Statistics Sweden, 2013). Prices for both multi-family houses and single-family houses have increased significantly more than consumer price index, however prices for multi-family houses have increased slightly more.

In the early twentieth century new actors showed interest in the development of industrialized construction. New efforts and initiatives were fueled by investigations and research projects that pointed out the benefits of production strategies and prefabrication (Latham, 1994), (Egan, 1998), (SOU, 2000). Industrialized construction was however seen mostly as a tool for contractors and house manufacturers.

Many of the new efforts incorporated production strategies inspired by the automotive industry, influences from Lean Production, effective logistics etc. After an initial phase with much media attention, many of the initiatives were struggling with issues and several were cancelled due to various reasons, see further in (Andersson *et al.*, 2009).

3.1.2 A Swedish governmental initiative

In Sweden the period from the mid 1960's and ten years onwards represents another period where significant change occurred in production strategies for multi-family houses. A governmental initiative was set to build one million homes during a period of ten years, during this time subsidized loans were given to developers, which contributed to low production costs and paved the way for affordable living. Standardization of design and large-scale prefabrication of concrete elements contributed to efficient production, but it also resulted in replicate designs. The quality and service-life of multi-family houses built during this period have been questioned. Likewise, many of the neighborhoods that were built during the period have been associated with social problems (Blomé, 2011).

3.1.3 Timber house manufacturers

Timber house manufacturers represent another segment of industrialization within construction. They have a long tradition of prefabrication and factory based production of single-family houses, but there are also some examples of multi-family houses. Industrialization within this segment often consists of various levels of prefabrication of elements or volumes for single-family houses coupled with automation and ICT support.

3.1.4 Definitions and influences

Many authors have described the concept of industrialized construction, but it has lacked a clear definition (Lessing, 2006). The term industrialized building system has for example been used to describe the technical methods or the processes of the building industry, it has also been used to describe the philosophic approach to the building industry (Elliot, 2003).

The understanding and meaning of industrialized construction has evolved over time and in recent years it has come to include prefabrication as well as processes and ICT (Lessing, 2006). It has become increasingly important for the understanding of industrialized construction to refer to processes, organization and collaboration, which leads to a wider definition.

(Lessing, 2006) attempted to define industrialized house-building based on current and earlier understandings, together with inspiration from production paradigms such as Lean and supply-chain management. The definition emphasizes well-defined processes and organizations that use “highly

developed components ... in order to create maximum customer value". Central to Lessing's definition is also the separation of construction projects and the continuous development of technology and processes, see figure 3.

Industrialized construction has been described as consisting of a framework of eight different areas which include both processes and technical systems as well as support mechanisms for these (Lessing, 2006):

- Planning and control of the processes
- Developed technical systems
- Off-site manufacture
- Long-term relations
- Logistics integrated in the building process
- Customer focus
- Use of ICT
- Performance measurement and re-use of experiences

These eight areas represent a comprehensive and current description of industrialized construction. When implemented in different sub-sectors of industrialized construction, the different areas will have different importance.

The industrialization of house building has during different eras throughout history been influenced in different ways. Industrialization of construction however builds on the idea that continuous development of processes and technology should be in focus, rather than unique construction projects (Lessing, 2006). A key to the contemporary industrialized construction has been the influences of production paradigms and other influences from outside construction. Over time there has been a number of attempts to introduce flexible production systems in house building (Barlow, 1998), but the focus of industrialization of construction have been primarily in reducing the elements that makes the construction process inefficient, so that for example Lean techniques developed in manufacturing can be used (Ballard and Howell, 1998).

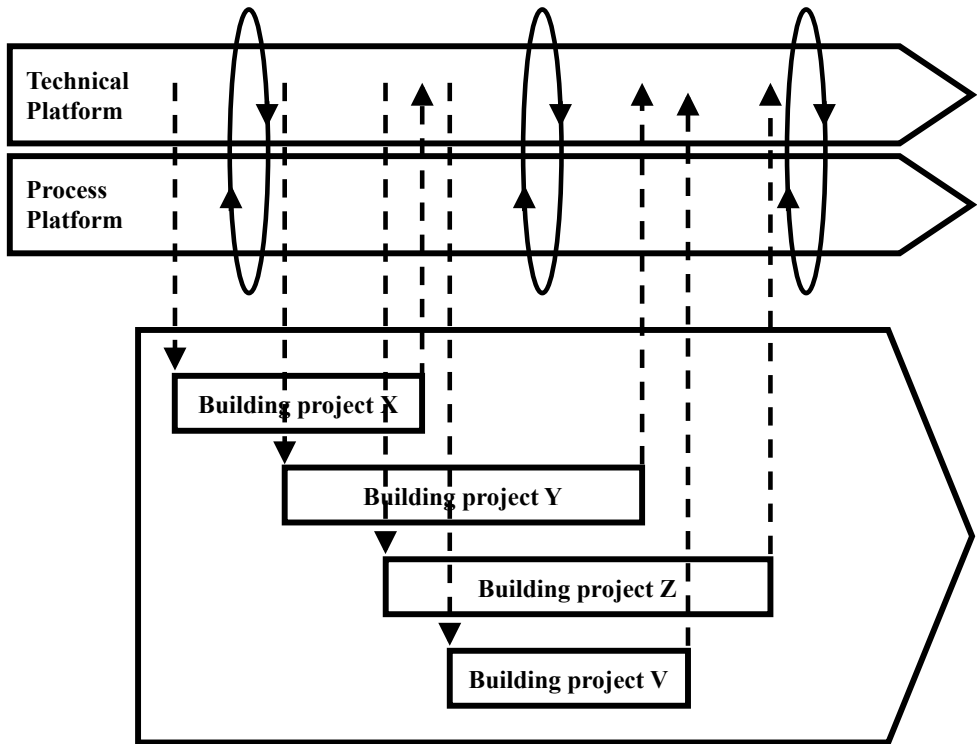

Figure 3 A definition of industrialized construction

Industrialized construction as defined by Lessing (2006) requires management of the interfaces between projects and continuous processes.

A Swedish governmental investigation (SOU, 2000) has, as previously mentioned, identified industrialized construction as a way to increase quality and reduce costs. It is implied that industrialization means rationally coordinated processes, but not new technology, although this can be a consequence or precondition. According to the definition by Lessing (2006) there is equal importance between the eight different areas, processes and technology are of the same importance, which is a more correct description. Lessing however also gives equal importance to support mechanisms such as ICT and performance measurement, which may not have the same significance.

Winch (2003) focuses on new-building and major refurbishments in his discussion of production models for construction, because here comparisons between industrialized construction and manufacturing can be made. According to Winch repair and maintenance must be excluded from the discussion, because they do not have a counterpart in manufacturing. He further argues that the construction sector has to be broken down into sub-industries to be able to be analyzed in this context. Based on these assumptions

Winch (2003) defines three different clusters within construction where production strategies can be applied:

- Private housing production, which is the only sector of construction that sells to final customers
- Meeting the needs of clients in a wide variety of facilities with well-known technical specifications. Traditionally this grouping has included public sector housing.
- Major projects, which include much infrastructure development but also highly engineered buildings such as hospitals and high-rise offices.

To not address major repair and maintenance in the reasoning of production models in construction might however be to exclude a large renovation need in mainly multi-family houses, where both commonalities and large volume exist. But it of course depends how production strategies are defined and where the line between repair and maintenance, and major refurbishments is drawn.

3.1.5 Enablers and barriers

The enablers, or opportunities for industrialized construction are to address the high costs, low productivity etc. In a recent newspaper article, the president of NCC argues that the costs could be cut with up to 30% by using industrialized approaches (Bengtsson, 2013). Another contemporary example is Peab who continues their efforts on construction platforms. But lowering costs must also mean lower prices to have an impact amongst clients.

The barriers to change the ineffective house-building sector in the UK were described as the lack of competition, lack of strategy and the fear of change (Barlow, 1998). Several of the denominators are the same in the Swedish house-building sector, although change is ongoing. Barlow (1998) further argues that there are few technical barriers to increased customization of house building and refers to the Japanese modular house building which is much more advanced, however one should note that the Japanese market conditions are different. A significant barrier is also the investment costs that industrialization incurs. The potential market volume for a concept must justify investments, therefore the formation of concepts must be considered carefully.

3.2 Lean and agile principles

The principles of the Toyota Production System (TPS) have been widely spread beyond its origin in the Japanese car manufacturing industry. The goal of TPS is to increase production efficiency by the elimination of waste (Ohno, 1988). In the 1980's TPS was studied and exported around the world by American researchers. Lean is primarily focused on efficiency and relies on certainty in procedures and processes to reduce disturbances and thus reduce costs to a minimum. To achieve its goal, Lean requires that stability is engineered into the processes (Naim, 1997). This of course requires a stable and well defined business.

The principles of Lean production have been used also by house manufacturers, for example Toyota has used cross-industry learning to transfer knowledge from its car manufacturing to its house production division (Gann, 1996). But to effectively use Lean production for house manufacturing requires factory based production. There are however elements in construction that is unique, thus all solutions cannot be copied from Lean production or TPS directly (Ballard and Howell, 1998). As a consequence the development of Lean construction has emerged with the aim to address the specific characteristics of construction that cannot be addressed by general production principles.

Lean production, and by extension Lean construction have been sources of inspiration for process orientation and efficient production in industrialized construction. Over time, parts of the construction process will undoubtedly be transformed into industrial production, but the main challenges for Lean construction is however described as how to manage the interfaces between the traditional construction projects and the industrial, off site manufacturing (Bertelsen, 2004). The development of Lean construction has so far mostly been focused on improving the management of the traditional, on-site construction (Björnfot, 2006). Consequently Lean construction has had a limited direct impact on the industrialization of construction. Instead the implementations of Lean production have been seen as a way to increase efficiency by companies that utilize factory based production. The intersection between the continuous processes and the construction projects remain one of the greatest challenges to tackle, not just for Lean construction, but also for industrialization of the construction industry as a whole.

Agile house building originates from some of the Lean principles. The aim with agile house building systems is to ensure better response to client requirements in early stages as well as effective execution of projects (Barlow, 1998). Lean approaches, such as Lean production and construction aims to create an efficient physical process of manufacturing, by eliminating waste and

reducing costs. Agile on the other hand emphasizes effectiveness in terms of high levels of service through flexibility and customization (Naim and Barlow, 2003). In short, Lean is technical efficiency of processes, agility means process responsiveness. The agile process is focused on effectiveness – to give customers exactly what they want, i.e. a customized product (Naim and Barlow, 2003). These are important factors to consider for industrialized construction, because it implies the standardization of technology and at the same time emphasizes flexibility for customers.

Looking back almost ten years, the future challenges for Lean construction were described as to manage the complexity in construction seen from the perspective of the client and how to incorporate modularization as a strategy for manufacturing (Bertelsen, 2004). Especially large repeat clients (clients who frequently procure houses) can have a large influence on the construction process and their role should be clarified. Further, modularization can be a method to achieve variety in products at the same time as efficient production remains the overall goal.

3.3 Production strategies

3.3.1 Japanese house building

The similarities and differences between car manufacturing and industrialized construction in Japan have been investigated with the aim to transfer knowledge to the UK house building sector, c.f. (Gann, 1996), (Barlow *et al.*, 2003), (Naim and Barlow, 2003). They explored how production concepts like Lean, agile and mass customization could be used to increase efficiency.

In Japan industrialization of construction was a logical step, because production could effectively meet the needs of clients in terms of volume and type of products (Gann, 1996). The modular house market segment has worked for industrialization, because of the circumstances that exist. That is to say that the success cannot be replicated in other sectors without a thorough market analysis and adaption to the specific market conditions.

Because of the size of the Japanese house market, it has provided an opportunity to develop mass produced housing systems that allow clients to customize solutions, c.f. (Gann, 1996). In the 1990's the dominating Japanese single home manufactures did not originate from the construction industry, instead they had a background in other industries. Several of the companies were owned by large conglomerates that supported them with production

knowhow and gave them the opportunity to invest in production facilities and research and development (Gann, 1996). Over time the modular house manufacturers learned to manage customer choices by learning from manufacturing processes in their mother companies. This led to effective production and customer satisfaction. A contributing factor to that they were able to offer a wide range of customer choices were that they owned and managed the whole production system, from supply-chain to production and onwards to on site work (Gann, 1996). This involves a fine balance between standard components and flexibility in the assembly lines. However, houses are different from car manufacturing and although much can be learned from other industries, the comparisons may be hard to transfer entirely (Gibb, 2001), (Winch, 2003).

Cross learning in the Japanese construction sector has also occurred from other industries than car manufacturing. Focus of the cross learning were to transfer knowledge of managing design, engineering and development, R&D and coordination of supply chains (Gann, 1996).

3.3.2 Production strategies for construction

Current industrialized housing production is somewhere between craft production and mass production (Barlow, 1998). But at the same time, variation lies in the nature of construction, which makes it prone to invent new solutions that often lead to quality issues and rework. To make industrialization of the construction industry possible it cannot be treated as one homogenous segment. It needs to be broken down into sub-industries with separate missions and means (Winch, 2003). Thus there is no “one strategy fits all” approach to production strategies for industrialized construction.

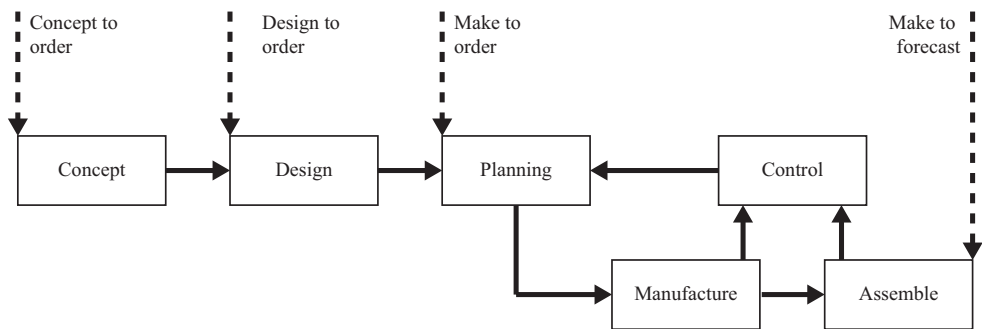

Figure 4 Production strategies

Four production strategies and a process flow for construction was suggested by Winch (2003). Depending on what stage of the process flow the client enters, it will imply changes to the production system.

Winch (2003) identified and tested the appropriateness for the construction sector of 4 production strategies, see figure 4 and table 2 for explanations. Winch reasoned that the appropriate model for construction depends on the sub-industry being analyzed, however the most appropriate production strategy for construction would be a design-to-order strategy (DtO) where integrated teams can supply clients on a turn-key basis. DtO implies that clients enter the construction process in the design phase and can influence the design within the frame of the concept (see figure 4). To be able to use a DtO strategy there are requirements that have to be fulfilled, for example a development process needs to be established where concepts are developed and defined. Others have argued that the industrialized production of houses must be configured for the specific client or project to meet their specific needs, in a make-to-order strategy (Häkkinen *et al.*, 2007). This indicates a more elaborate product development, which may reduce flexibility further.

Specialized sub-markets may use make-to-order strategies, for example single-family houses. Winch (2003) further speaks of the point in the process where the customer enters the information flow; procurement, tender or new product development. In table 2 the strategies are described as they are explained by Winch. The customer entry point is further described by (Hoekstra and Romme, 1992), (Barlow *et al.*, 2003), (Hvam *et al.*, 2008) and will be discussed in the next chapter.

Table 2 Production strategies

Production strategies suitable for construction, as explained by Winch (2003).

Production strategy	Explanation
Concept to order (CtO)	Where the customer (client often in this case) enters at the start of the information flow – nothing happens until the client initiates production.
Design to order (DtO)	Where the firm has already a basic product concept, but significant engineering design work is performed for that particular client/customer both pre-bid and post contract.
Make to order (MtO)	Where there is a fully detailed design which can be configured to suit a customer's particular requirements. MtO is what has become known as mass customization - or where no additional design work needs to be done, but the material flow does not start until the customer places an order.
Make to forecast (MtF)	Where the product is produced for stock and sold after it is manufactured or sometimes during manufacture.

3.4 The product specification process

The variant specification process is where products are specified to client requirements. The specification process decides how and when the customer enters the process (see figure 5), thus it has links to the descriptions of production strategies by Winch (2003). There are different approaches to the specification process, similar to the different production strategies described in the previous chapter, c.f. (Hvam *et al.*, 2008). The meaning and implications for the process are similar, but the names are slightly different, see table 3 for the different specification processes.

Table 3 Product specification process

The product specification process describes how products are specified to client requirements. Table 3 displays different production strategies connected to how products are specified as described by Hvam *et al.* (2008).

Production strategy	Explanation
Engineer to order	Engineer to order is typical for companies supplying complex products or plants, such as cement factories, spray drying plants or enzyme factories. In this type of company, a considerable amount of work goes into the design and specification of each individual plant. This task is performed using previously designed plants, modules, design manuals and so on as the starting point.
Modify to order	Modify to order is very similar to the engineer to order process and is seen in companies manufacturing customized products. MtO specification process differs from EtO in that the products are less complex and the creation of a product takes place based on pre-defined modules and using clear sets of rules for how to create a customized product. This means that the specification task is based more on routine and fixed rules.
Configure to order	Configure to order process describes a specification process where the specifications are worked out automatically by using a configuration system, and where the task of working out the specifications takes place within a finite solution space. This is amongst other things made possible by the use of standard parts and modules, which can be put together in accordance with a set of predefined rules.
Select variant	Choice of product variant denotes a type of specification process in which one chooses a standard product, which to the greatest possible extent fulfills the customer's needs. That is to say, a process in which the seller analyses the customer's needs and, for example by using product catalogues or product databases, selects the product which best matches the customer. The task in this specification process consists in identifying the customer's needs, and then finding the product which best suits the customer in question.

The descriptions of production strategies by Winch (2003) and specification processes by Hvam *et al.* (2008) are alike, although they approach the area from different perspectives. (Hvam *et al.*, 2008) has a narrower, more specific focus on the specification of products and there is no equivalent to the Concept to Order strategy, which is a common approach in construction today.

Construction has been described as one of the largest ETO (engineer-to-order) sectors (Gosling and Naim, 2009), but it has also been concluded that ETO hinders parameterization of platforms in construction (Jansson *et al.*, 2013). Consequently the changing client requirements that forces manufactures to adopt ETO is possibly impeding productivity gains that could be obtained

through a better defined platform. Therefore more consistent demand from clients could have a positive effect on productivity.

They both however denote the customer entry point, and recognize its effect on the design of the process. The decoupling point differentiates the supply and demand side of the supply chain, where the latter is more focused on delivery (Naim and Barlow, 2003), see figure 5 and 6. The customer order decoupling point will have a large effect on any effort to modularize building systems in connection to the production strategy (Duray *et al.*, 2000). The decoupling point is an important element in designing the supply chain so that maximum value can be delivered to the client. The supply chain may be defined as a system that includes material suppliers, production facilities, distribution and clients, linked together via a feed forward flow of materials, a feedback flow of information or demand (Stevens, 1989).

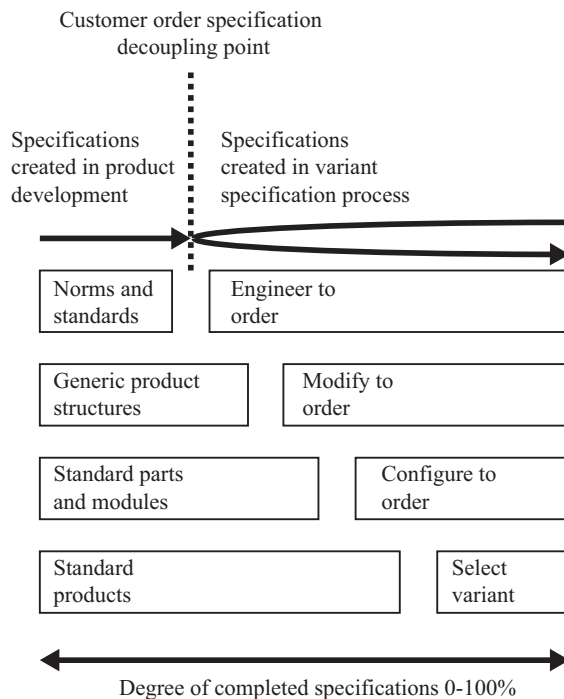

Figure 5 Product specification process

The decoupling point separates product development from the variant specification process (Hansen, 2003). The different specification processes affects also the production strategy.

The principles of Hvam and Winch have been used to describe industrialized construction in Sweden (Jensen *et al.*, 2008), (Jensen, 2010), (Olofsson *et al.*,

2012). It can be a guide to how to define production system in connection to market segments.

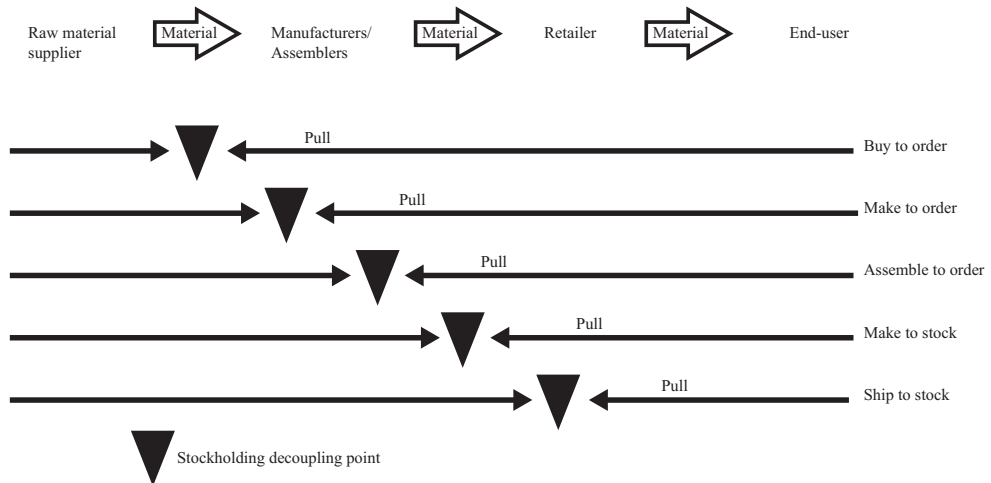

Figure 6 Decoupling point

The decoupling point describes the point that separates push and pull in the manufacturing process (Hoekstra and Romme, 1992).

The level of pre-definition that is created in the product development process can span from just an identification of codes, norms and standards, which are used to engineer customer specific products, to the development and production of standard products where customers can chose a variant (Hansen, 2003).

In recent years the industry has leaned towards changing the specification processes so that companies have better possibilities to adapt to customer needs (Hvam *et al.*, 2008). As an example, the product specification processes of timber house manufacturers have generally paid little attention to customer requirements during product development, which lead to more customization in each project, and eventually to higher costs. This implies a DtO/EtO strategy. Using configuration would be a step towards the adoption of mass customization, which affects production as well as the organizational structure of the company (Duray, 2002), (Simpson, 2004).

Configuration builds on the information in a product model. It can be seen as a way of using the content of the product model to configure products according to customer requirements (Hvam *et al.*, 2008). Figure 7 shows an example of the role of a configuration system in the product specification process.

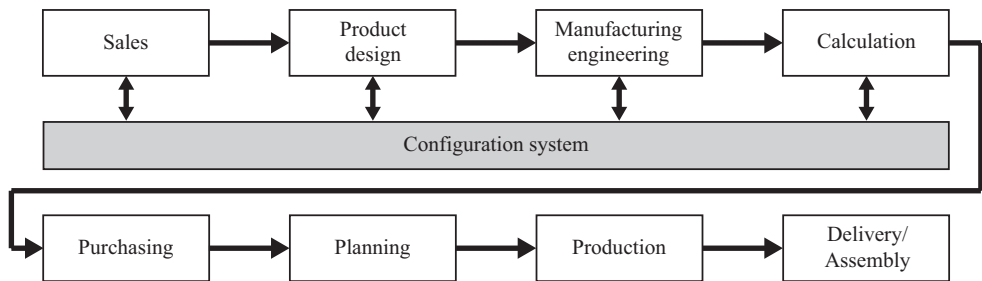

Figure 7 How configuration can support the specification process

Configuration systems can support and integrate the activities in a company's specification process (Hvam *et al.*, 2008)

3.5 Mass customization

Customers are not a homogeneous group, they are individuals with different wants and needs that can be fulfilled (Pine, 1993). Today many construction clients demand maximum choice and are comfortable with pre-assembled buildings that look like they are produced conventionally, which has led to an interest for mass customization in the construction industry (Gibb, 2001). Industrialized approaches in construction have good opportunities to combine client satisfaction with the use of technical platforms, possibly with mass customization as an inspiration.

Mass customization can be defined as designing and building products to customer specifications using modular components, to achieve economies of scale. Olofsson *et al.* (2012) discusses how standardization of concepts increase with the transition of offers from being a service, where design is developed in collaboration with the client, to a product offer. Olofsson *et al.* (2012) reasons that mass customization could be used to leverage the use of product families and platforms in construction. Mass customization has also been argued to provide a conceptual model to effectively offer large variety and improved quality to clients in the construction sector (Roy *et al.*, 2003). There is no single form of mass customization, it can be supported by several supply-chain models (Barlow *et al.*, 2003). To transform traditional housing to mass customization is claimed to include modular design, pre-assembly, supplier partnership and continuous improvements (Barlow, 1998), (Roy *et al.*, 2003), which is consistent with many of the characteristics of industrialized construction.

Although the characteristics are not the same on different markets and Barlow (1998) has the conditions of the British house building market in mind, the

reasoning should not be impossible to transfer to other markets with similar characteristics.

		MODULARITY TYPE			
		Design	Fabrication	Assembly	Use
POINT OF CUSTOMER INVOLVEMENT	Design	FABRICATORS		INVOLVERS	
	Fabrication	FABRICATORS		INVOLVERS	
	Assembly	MODULARIZERS		ASSEMBLERS	
	Delivery	MODULARIZERS		ASSEMBLERS	

Figure 8 Mass customization archetypes

Mass customization archetypes as described by Duray (2002). Modularity is used to create “mass” in mass customization, point of customer involvement provides “customization”. Customer involvement in the value chain is a key indicator of the degree of customization that is available. It provides a practical indicator of the degree of product customization that is possible. Modularity is key to achieve low cost customization. Modularity allows part of the product to be made in volume as standard modules, with customization achieved through combinations of modules. Here, modularity is assigned to the phases of the product cycle. For example during design and fabrication, modules can be altered to provide unique requirements. During assembly and use, standard modules are combined, but no components or modules can be altered.

Customer participation and modularity are interrelated topics. Considered together, four mass customization archetypes are suggested that also imply different manufacturing systems (Duray, 2002). The archetypes suggest different means to fulfill customer requests, see figure 8 and table 4. Fabricators are the archetype that mostly incorporates craft manufacturing practices – this is also where construction most often would be found. Industrialized strategies may however provide the opportunity to change the position according to figure 8, but it will require companies to define technical

platforms and processes, which could help them move the modularization- and customer involvement point. It can be necessary for companies to understand their position to see opportunities and limitations.

Table 4

The characteristics of the four different archetypes of mass customizers in figure 8, are described below.

Production strategy	Explanation
Fabricators	Include both customer involvement and modularity in design and fabrication stages of production. Unique designs can be realized or major revision can be made in the products. Fabricators resemble a pure customization strategy but uses modularity to increase commonality of components.
Involvers	Incorporate customer involvement in product design during the design and fabrication stages but use modularity during the assembly and use stages. Customers are involved early in the process although no new modules are fabricated
Assemblers	Mostly resembles standard producers, employs modularity and customer involvement in the assembly and use stages. Assemblers use modularity to present customers with a wide range of choices. Assemblers differ from mass producers in that the products have been designed so that the customer can be involved in specifying the product.
Modularizers	Modularizers involve customers during assembly and delivery but incorporate modularity earlier in the production cycle, in the design and fabrication stages. Thus they may not gain full customization advantages from modularity. Together with assemblers, modularizers most closely resemble standard product producers due to the late point of customer involvement

By leveraging mass customization together with modularization and configuration in the product specification process, companies are given the opportunity to change their business model and more efficiently meet varying customer needs. A benefit of mass customization is that it can accommodate a large population at the same time as it can address a large variety of client needs, see figure 9. At the same time poor quality is addressed through the standardization of components, compared to one of a kind production. In the mass customization paradigm modularization becomes a product strategy or production strategy. Configuration as a tool becomes a link in the specification process between clients and company.

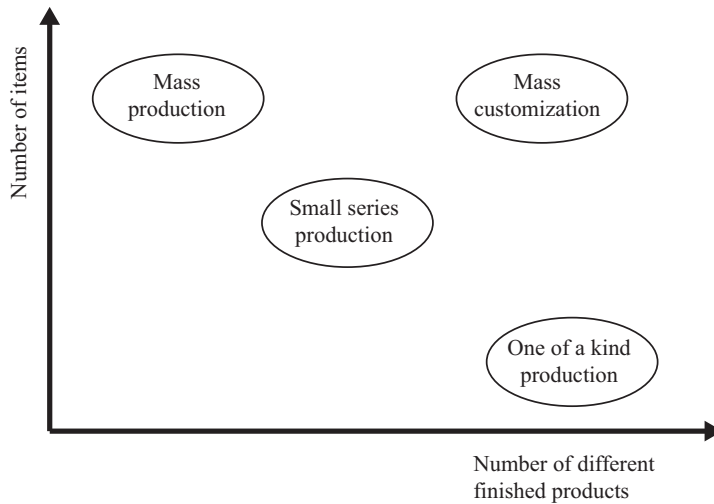

Figure 9 Main types of industrial companies (Hvam *et al.*, 2008)

In mass customization the possible number of different products increases compared to mass production. In one of a kind production the main problem is to separate product development from the specification process – not unlike construction.

3.6 Modularization

Modularization is a way of reusing product knowledge in new products, instead of creating unique one-of-a-kind products. The drivers for modularization include: increased product variety, reduced complexity, increased commonality amongst others (Erixon, 1998). Despite the benefits, many companies in the manufacturing industry are hesitant towards the implementation of product modularity because of fear that they will lose their competitive advantage on a relatively small market, (Simpson, 2004). There is however a difference between variety and modularity – variety implies more products to choose from, but does not allow the customer to specify any product features (Simpson, 2004). Large product variety can also inflict substantial cost in a company, so in fact – more product variety means higher costs, (Ulrich, 1995), (Simpson, 2004). Modularity instead aims to reduce complexity of the product models and to simplify them.

Product designs or systems can in general be integral or modular. An integral design does not build on predefined modules that are put together to client specifications, instead each component is optimized to achieve best performance. Modular designs on the other hand are based on the idea that functionality is separated into different modules. When modules then are

combined, the required functionality can be achieved to ensure client satisfaction. Modular approaches cannot be optimized in the same way as integral designs, because they need to be able to fit in many different configurations. But a product family made flexible through modularization has the potential to improve many sides of the product and product platforms play a major role in facilitating a customization process compared to an integral design (Simpson, 2004). Modularity is however a relative property (Ulrich and Eppinger, 2011) and products rarely are strictly modular or integral. Instead products generally have varying degrees of modularity, so it is seldom easy to say that a product is strictly modular or integral. Although modularity has been the theme of many books and research papers, applications in construction are still relatively unusual.

The Swedish based heavy truck manufacturer Scania is however a long time user of modularization. They have created a process for designing trucks individually to meet any particular customers' specific needs (Johnson and Bröms, 2000). Modularization has been a cornerstone for Scania to be able to achieve high degree of variation based on the use of standard components. Although heavy trucks and house building are different, the Scania example shows the possibility to use modularization to achieve rational design and production of customized products. In the same way as trucks, houses can however be decomposed into core elements. Each element in turn then may consist of several components, thus a house can be explained as a system consisting of components that together create a whole (Naim and Barlow, 2003). These structures create the basis for modularity.

Product family maps and market segmentation grids are tools that can support planning for modularity from a management perspective, which can provide a good starting point for companies entering modularization. But these aids are not detailed enough for development engineers that require a much finer level of detail of information to design the product platform components and commonality, which is part of the platform development (Simpson, 2004). MFD (Modular Function Deployment) is presented as one of several methods to modularize existing product families based on the features required by customers (Erixon, 1998). This can be a feasible way to include modularity in industrialized construction. QFD (Quality Function Deployment) see further (Akao, 2004), is a more general method to transform customer requirements to product functionality. Applying methods such as QFD might be easier in industrialized construction compared to the traditional construction process due to that they own a larger part of the process. QFD has been suggested as a method for capturing client requirements in industrialized construction (Jensen *et al.*, 2008). QFD and MFD might be useful tools to minimize the variation in the platforms used by timber house manufacturers today.

3.7 Product platforms and product development

The product development process is significantly more important in industrialized construction than in traditional construction projects, where most of the design takes place in projects. With the use of production strategies that relies on predefined solutions or platforms, the product development process gains importance. The introduction of this process changes construction from project based, to process based (Lessing, 2006) and argues also that changes in the organizational structure are necessary within companies. Product development constitutes an important ingredient of industrialized construction, because it is the founding ideas of repetitive use of platforms and implementation of continuous improvements. A strategic focus on systematic approaches and prefabrication has however been reported to inhibit innovation in construction (Ivory, 2005). Possibly because standardization is interpreted as less deviation from the standardized process, but a product development process can have room for innovation, while the processes of customer specification is kept standardized. Further, fluctuations in demand may be a disincentive for contractors to invest in new technology, as a consequence they have often the recipients of innovations by suppliers (Gann, 1996).

How manufacturing techniques are used relate to the conditions of the market segment, thus different markets require different manufacturing techniques (Gann, 1996). Consequently product platforms for single-houses, multi-family houses or renovation require different approaches to development and management. The structure of the product development process and the organizational structure are therefore also highly dependent on the design and structure of the product platform.

The product platforms of industrialized house producer's offer value that extends beyond functional performance, because platforms can better cater for long term quality (Björnfot, 2006). Time and effort have been invested in continuous development of the platforms, which in many cases can assure better quality compared to traditional construction design which is not gradually improved by feedback in the same way as platforms. Predictable quality comes through well-conceived technical platforms or systems (Björnfot, 2006). Given the use of pre-assembled components however requires thorough planning (Gibb, 2001), (Geier *et al.*, 2012). The extra effort made in planning however reduces the need for on-site problem solving and facilitates better on-site management. Altogether the use of standardization and pre-assembly potentially increases predictability and efficiency in construction projects (Gibb, 2001).

It is important to recognize that technology innovation in construction involves not only products, but also the processes (Ivory, 2005). Consequently it is important to understand the relationships between products and processes to design successful platforms. The change of construction processes, from project focus to the use of product platforms may change how projects are managed – therefore clients, as an active participant in construction projects should play a major role.

A product development process also increases the importance of product documentation. A distinct product documentation is needed for several reasons, for example industrialization of construction can involve design for modularity, process engineering and efficient supply chain management (Roy *et al.*, 2003), which will require thorough documentation. Likewise pre-fabrication or automated factory based production requires a product documentation as a base for the information strategy (Ford *et al.*, 1995). Also Winch agrees that greater attention to the information flows that initiate and control the material flows in the process is needed (Winch, 2003).

3.8 Information technology in industrialized construction

IT in industrialized construction is today used according to the same principles as for on-site construction (see paper I). Systems are mostly used separate from each other, which affects collaboration negatively. To improve customization in the construction process, IT however has a key role (Bergström, 2004). In the traditional construction process, the lack of integration is managed differently because separate stakeholders manage and own separate parts of the process, although BIM (Building Information Modeling) is currently changing the possibilities for collaboration. In the industrialized construction process however, the same company is often responsible for most activities of the process, thus they also control the flow of information and system integration could lead to significant benefits. The ability to optimize the design and construction process together as a whole, provides better possibilities to avoid sub-optimization and utilize the potential to improve overall productivity. In the timber house manufacturing industry, IT maturity has however not so far been adequate to benefit from the use of business IT (Bergström, 2004).

Information management in building design has been identified as a key area for improvement. Currently the energy put on producing drawings and specifications for each new object, is often out of proportion compared to the

benefit (Nasereddin *et al.*, 2007). Consequently structured use of product platforms and IT has the potential to increase productivity. The use of modern business systems and other IT also enables more sophisticated, standardized processes (Gibb, 2001), but implementations of IT systems require companies to be able to produce formal process maps, product structures and not least a strategy for what they want to accomplish through the use of IT. It has also been suggested that fewer and more long-term relationships with suppliers lead to improved information flows amongst house buildings, which is a prerequisite for efficient use of IT systems (Barlow, 1998). Thus timber house manufactures has several areas to address and for IT to make a change, companies need to put more focus on processes, product documentation and strategies, regardless of what software system they may choose to use in a later stage.

Today IT managers in construction have a large influence over IT investments, (Dehlin and Olofsson, 2008) but the level of business integration may be questioned. Consequently IT needs to be a more integrated part of the business so that investment decisions can be taken based on correct and comprehensive information in relation to business strategies. Companies need to find ways of how to see IT as a business driver instead of being support function.

Industrialization of the house building sector supports long-term investments at the expense of short term thinking (Ekholm and Molnár, 2009), meaning that long-term investments will need to suppress existing short-term thinking. This further emphasizes that companies must create an IT strategy that can add value to the business and that proves to be successful not just for the moment. For example, an implementation of a configuration system should not only be managed as an IT project, because it affects several processes within the company. Thus it is a project of strategic importance.

A company's products and processes should be included in the formation process of the IT strategy. The business strategy should generate an information systems strategy, which in turn generates the IT strategy, see figure 10 (Björnsson, 2003). In construction there is a general need for information management systems that can better support the development and maintenance of product platforms in the product development processes (Simpson, 2004), and for industrialized construction it is especially important that companies gain knowledge about information systems and how to use and manage them properly (Gerth, 2008).

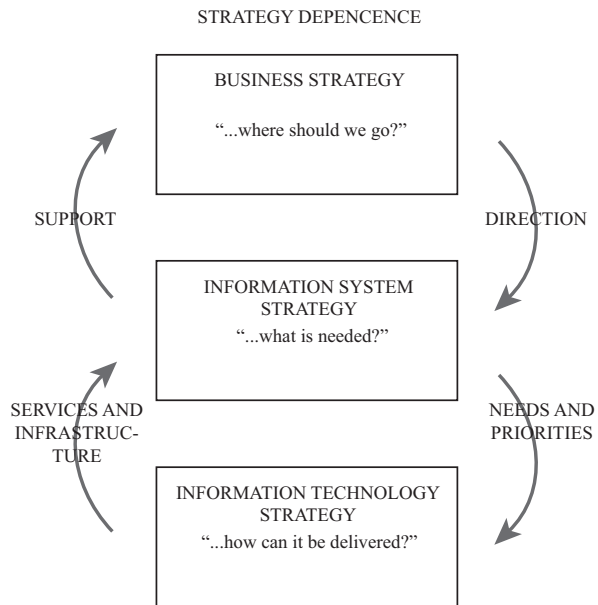

Figure 10 Strategy dependence

The business strategy should generate an information strategy, which in turn generates the IT strategy (Björnsson, 2003). Thus there is dependence between business strategy, information systems strategy and information technology strategy.

4 The client role in industrialized construction and renovation

4.1 Current role

Unlike many industrialized mass production markets, the client often plays an active role in construction (Hartmann *et al.*, 2008), (Olofsson *et al.*, 2012). In construction the client has often been described as focused on the individual construction projects, with focus on *what* to achieve rather than *how* it is achieved (Vennström, 2008). But too much focus on the financial results of individual projects may be a sub-optimization from the life-cycle perspective of buildings, which includes also operating costs and future maintenance- and renovation costs. With an understanding of how project results are met, more robust and sustainable solutions may be achieved where clients are part of, for instance quality assurance, instead of only making sure that time and cost requirements are met. Clients may view projects as trying to maximize the value of money through competitive tendering between prospective contractors, but there is a risk that this results in that contractors are signed to the lowest price with little hope of future work for the contractor (Cox and Thompson, 1997). This also promotes short-term relationships and opportunistic thinking rather than long term commitments between clients and other stakeholders.

Clients have historically been reluctant to change the traditional roles and responsibilities in the construction industry (Bröchner *et al.*, 2002). In industrialized construction clients have been described as non-supportive to the development and many still perceive it as new and different (Engström, 2012), a reasonable explanation is that they lack information to make informed decisions (Engström *et al.*, 2009). The reluctance to support industrialized construction can also partially be explained by how industrialized construction is described and how it has developed. Clients or customers may be in focus or at the center of the processes, but close collaboration with clients are seldom described. The role of the client in industrialized construction is however a characteristic that is different from traditional construction and must attain separate focus. Further, it has been shown that clients often lack information

about the special conditions of industrialized construction (Engström, 2012), which could explain the lack of interest and participation.

In the manufacturing industry most clients are interested in the product, but rarely concerned with the processes of manufacturing the product (Gibb, 2001). In a construction sector with good competition there would be no need for clients to interfere with the process, but today detailed management is seen as a way to ensure quality by some clients. Therefore it is only natural for professional clients that possess the knowledge to suggest improvements, to also engage to improve the process. However many clients do often not have the knowledge to participate in the process. Johnsson (2013) emphasizes the impact of relations to clients in platform construction from the manufacturers perspective and according to Jonsson and Rudberg (2013) the customer requirements have not explicitly been addressed in terms of output of manufacturers. Thus manufacturers have to be more sensitive to the requests and initiatives by clients and adapt accordingly.

The Swedish Transport Administration has recently adopted a client strategy where they buy design and build contract based on performance criteria (Wester, 2013). The goal is to perform 50% of all projects as design and build by 2018. Their ambition is to leave details in the execution to the contractors. They argue that too much detail in the contracts will inhibit innovation and productivity in projects, because there are no incentives for contractors to improve. This approach however requires the ability to describe functionality instead of solutions. Although a desirable situation, it requires stable conditions so that contractors feel secure enough to innovate or to invest to increase productivity. At the same time clients could end up with many different technical solutions that may be difficult to maintain, or worse, they could end up with experimental solutions.

With the introduction of performance criteria's in projects a difficult task is introduced for clients – they have to verify that the criteria have been met by the contractor. Clients then have to be able to verify that for example the service-life is met by the specific solution chosen by the contractor, which can be difficult to evaluate at project completion for structures with very long service-life. This requires clients to have significant capabilities within all areas that are subjected to performance criteria.

Different collaboration models for industrial energy efficient retrofitting of buildings have been evaluated in seven European countries with the aid of demonstration projects. It showed that the use of industrialized approaches to renovation can provide replication effects and new market opportunities (Geier *et al.*, 2012). In the project they also describe barriers to industrialization as the

different interests of project stakeholders and time expectations, as well as limited cooperation possibilities in the early stages (Geier *et al.*, 2012).

Lifecycle cost (LCC) is described as a driver towards increased customer focus for public property owners (Naim and Barlow, 2003). LCC in construction projects can promote considerations of maintenance, energy consumption etc. for property owners when they are acting as clients. To include LCC considerations into contracts without taking part in how the solution is designed may be more difficult than to have an active role in the design phase. A potential risk is that a property owner could end up with new solutions in each new project, depending on the contractor if they are not influencing the design. This will result in buildings that are unique and perhaps more difficult to maintain. It has been suggested that the industrialization of renovation requires separate attention (Winch, 2003), thus the skills, potential benefits and barriers for industrialization may not be the same as for construction. In renovation, the client could potentially play an even more central role in the process. Especially large clients who do repetitive work have a large potential to standardize processes (Gibb, 2001), and also technical platforms.

4.2 Client led change in construction

Construction work is often site specific and consists of solutions that are unique for the project. This often results in “*quasi-supply networks*”, which lead to cost inefficiencies for clients as new suppliers has to climb a new learning curve in each project (Cox and Thompson, 1997). Further the focus of clients lie more in the project specific issues that on contextual factors (Vennström, 2008). There are also good examples of the opposite, where clients actively participate in projects and the development of new and innovative solutions. For example (Ivory, 2005) reports of a client organization that have put together integrated teams of suppliers. The teams work together during five years, sometimes co-located.

A strategic client focus could favor standardization and prefabrication over innovation because clients prioritize reduced build-times and reduced risks over innovation (Ivory, 2005). Instead of taking an active part in innovation, their strategy is to take advantage of innovation by others. In practice however clients with a long-term property management perspective benefit from fruitful cooperation and good communication between clients and other stakeholders, as exemplified in Geier *et al.*, (2012).

The involvement of the client in successful construction innovation has been emphasized by several authors (Nam and Tatum, 1997), (Hartmann *et al.*, 2008). Arguing that industrialization can be compared to innovation, the success of industrialization is dependent on that incentives are created for clients to actively participate in the future development of industrialized construction or renovation, as well as in the implementation in projects. For public clients in Sweden however the PPA (Public Procurement Act) has been described as restraining clients from engaging in industrialized construction (Hedgren and Stehn, 2013). At the same time there is a willingness from clients to improve construction efficiency. The obstacles are however not insolvable and the PPA alone cannot be the reason for slow development.

Conservatism in construction projects can come from limited knowledge and often an increased technical competence eliminates that behavior (Nam and Tatum, 1997). By building a knowledge bank separate from projects, clients can better understand and mitigate the risks in projects (Hartmann *et al.*, 2008). Thus the buildup of knowledge independently from projects is a key capability to strengthen the role of the client in industrialized construction. As an example, top executives in innovative firms actively take responsibility for technical decisions (Nam and Tatum, 1997), because they have both the competence to understand the problem and the authority to take decisions. (Lessing, 2006) suggests a separation of the continuous development of the process- and technical platforms from its application in construction projects. Thus this development takes place independent of projects and implies an organization with an understanding of process orientation and product development. But innovation also requires a high level of client involvement as well as slack resources for good results (Nam and Tatum, 1997). Both these aspects require clients to see beyond the projects' short term economic success and instead acknowledge the potential long-term benefits. Lessing (2006) for example suggests that clients as well as suppliers could be part of the process management team in construction projects, thus improving both communication and collaboration, which is a key for successful results in industrialized projects (Geier *et al.*, 2012). Still many clients choose participants for construction projects solely based on their specific competence for the project, not considering their ability to communicate (Vennström, 2008).

5 Renovation of multi family houses

Renovation is becoming an increasingly important area as many houses are approaching a critical age. Today the investments in renovation are larger than those in construction (The Swedish Construction Federation, 2013). In 2012 the investments in renovation were almost 8 billion Euro in Sweden, compared to 6,4 billion in new construction in total (ibid.)

The incentives for renovation of multi-family houses are commonly based on outdated technology or poor performance (Thuvander *et al.*, 2012). A typical Swedish bathroom built in the 1950's will need extensive renovation during its life cycle to maintain functionality (figure 11). For example sewage pipes will need to be replaced within 30-60 year (VVS-Företagen, 2009). The practical service life varies significantly depending on usage and material conditions, which makes predictions difficult. Pipe exchange is nonetheless an action that causes significant disruptions in the building. The exchange of water and sewage pipes are often combined with other actions, for examples kitchen replacement or a general modernization of the building that might in some cases also include actions to improve energy efficiency.

SERVICE LIFE OF BATHROOM COMPONENTS

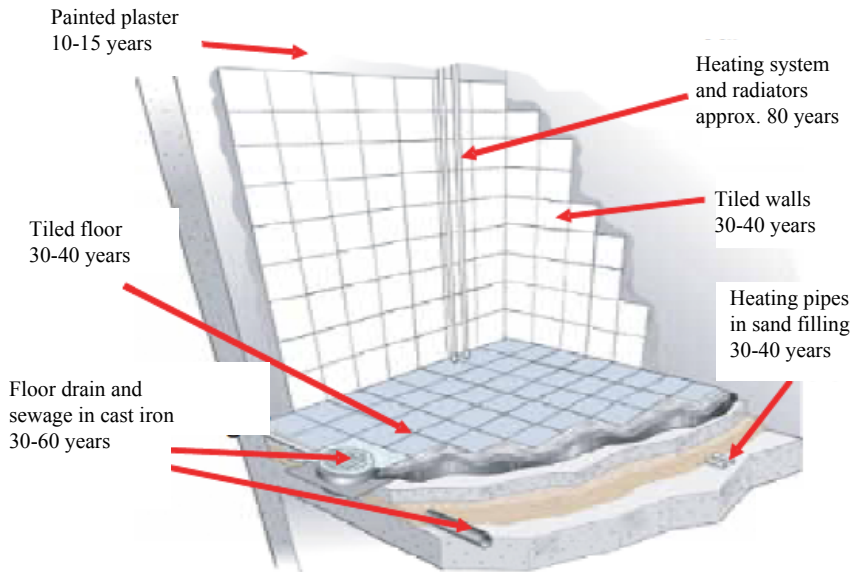

Figure 11 Service life of bathroom components

Figure 11 displays components in a typical Swedish multi-family house bathroom. The theoretical service life spans from 10 to 80 years, but vary depending on use and material quality (VVS-Företagen, 2009).

In Europe, Sweden is among the countries that have the highest percentage of buildings built before 1970, both single-family and multi-family houses (Meijer *et al.*, 2009). Consequently, the need for renovation is high in Sweden and the issues are frequently discussed in academia, industry and press. A large share of multi-family houses is municipality owned (68% of all multi-family houses). Thus one can make the assumption that there are many responsible and long-term property owners in Sweden interested in effective renovation and concerned with making the right choices. The current pace of renovation in Sweden have however been too low in relation to the need and will need to increase significantly (Boverket, 2003).

The renovation of multi-family houses can vary from very limited actions caused by urgent needs, to extensive investments that change the building profoundly. Modernizations of kitchens and bathrooms are however the most common renovation activities and many projects take place before the

components' end of service life (Meijer *et al.*, 2009). Also Swedish property owners have prioritized bathroom and kitchen renovations highly amongst upcoming renovations (Industrifakta, 2008).

The property owner as a client in renovation projects can take different positions, from very active in design and execution, to the opposite position. Often projects build on traditional construction processes, although the contracting forms can be very different depending on how involved the client is.

Improved energy efficiency has been put forward as an important part of the modernization of multi-family buildings, and can potentially contribute to better investments through savings on heating. Consequently, several of the large contractors consider energy efficiency improvements as part of the renovation offer.

6 Examples from current practice

6.1 Introduction

This research project has consisted of two main bodies of findings. The results of the studies are presented separately and reflect the development of the project as it progressed. The chapter summarizes the research that is presented in the appended papers and explains it in the context of the overall project. The two main bodies represent different explorations into industrialized construction with an overall focus on solutions and technical platforms. Supporting functions such as IT and processes has been incorporated into the research, as they are connected and contribute to efficient use of building systems.

6.1.1 Timber house manufactures

Two different case studies were performed amongst Swedish timber house manufactures, in total seven different companies were included in the two studies. The aim was to describe the current situation and the future opportunities for implementing IT and product modeling to support the factory based manufacturing of houses. The studies consisted of both single-family and multi-family house manufacturers. The hypothesis was that timber house manufactures could use configuration systems to aid the specification process to efficiently produce customized buildings. All timber house manufacturers included in the first part of the project were well-established companies with industrialized construction as a part of their corporate strategy.

6.1.2 Client opportunities

The second part of the project describes professional clients in the construction industry, specifically their activities in renovation projects, and their role and potential to be part of the industrialization of renovation.

Central in the second part of the project is a case study of a large client and property owner in Sweden – MKB Fastighets AB (MKB). For the duration of the study, full access was given by MKB to documentation and digital resources. Invitations to internal and external meetings were also given, as well as the ability to freely book interviews with employees at MKB. Special attention of the study was on the renovation process of multi-family houses with focus on pipe renovation. The area was chosen by MKB because of their perceived challenges in terms of high volumes, as well as for the complexity of the renovation projects.

The objective has been to describe how professional clients work and to identify opportunities for industrialization that can be found in renovation of multi-family houses for large, professional clients.

6.2 Industrialized timber frame house manufactures

6.2.1 ICT support for industrialized production of houses

The aim of the early research was to find IT strategies for industrialized construction. The background is that there should be a potential to develop industrialized construction, because there are many promising elements already present. Off-site production and standardized solutions offer possibilities to efficiently produce houses. But the resemblance to the traditional construction sector constitutes a barrier. The lack of product documentation, defined processes and IT support was identified as obstacles to effective off-site house building.

An IT strategy should aim to efficiently be able to manage information and support the value adding activities within the organization. Based on the results of a multiple case study of six medium-sized timber house manufacturers, the study focused on finding elements that could be included in an information strategy suitable for industrialized construction. To find the appropriate content a literature study was performed, demonstrators were built in a parallel project and common practice in other manufacturing industries were investigated. The study has been presented in paper 1.

Despite the commonalities and shared market with the traditional construction industry, industrialized producers operate differently. Most of the companies that were included in the study use prefabrication to some extent. Prefabrication changes the organization and requires different capabilities compared to traditional construction as well as investment in production

facilities. Because of the distinguishing features of industrialized construction it also opens for different supporting tools, for example IT support and product modeling.

In traditional construction most projects are designed and built specifically for that unique project. An organization of specialists purposely put together for the project, leads and conducts the work within the project. After the project has ended, the project team often parts and it is often overlooked to make sure lessons learned are transferred to the next project. The logic of industrialized construction is somewhat different. The standardization of design and prefabrication of components and modules presents the possibility to systematically use standardized design principles. But the standardization of design requires a different approach to product documentation compared to project based designs to be effective. Likewise, prefabrication will have difficulties to accommodate constant changes to design, with the result that benefits and investments are difficult to realize. To find relevant examples from where industrialized construction could learn how to use the benefits of product documentation, common practice in other industries have been investigated and presented.

Timber house manufacturers are in between industrial production and the construction industry today concerning information and product management. A starting point for improving the information management of is to look further into the common practice of other industries. Many industries exist where products are manufactured based on similar logic and with unique configurations each time, for example shipbuilding, where methods of product documentation can be transferred.

The study into the IT support for industrialized construction concludes that it is possible to improve quality and productivity for timber house manufacturers by addressing their current issues with information management, which have been reported in paper 1. The main objective of this study has been to establish the current situation of timber house manufacturers and suggest several possible directions that can be pursued to improve IT and the management of product related information.

6.2.2 Information management for industrialized building design

Based on the same multiple case study of six timber house manufactures, data was also gathered to more thoroughly explore product modeling and modularization as a way to structure products and to use as a design philosophy. A systematic approach is required to create a product specification process that can be used downstream to configure products to the individual

specifications requested by clients. It was believed in the beginning of this study that product modeling presents opportunities for the industrialized construction sector to gain efficiency.

In paper 2 examples of the basics of product modeling were studied and some examples of how it is used in other industries are presented. Based on the studies of current practice in other industries, it is suggested that information management needs to attain more focus from timber house manufacturers. There are interesting opportunities to use the possibilities that industrialized construction presents, factory based production and repetitive use of technology opens for more efficient ways of managing product related information that can increase the efficiency and reduce the need of unique solutions even more through the use of other production paradigms.

Timber house manufacturers need to focus on three areas: process orientation, product documentation and information systems strategies to make better use of the possibilities that lies at hand. But the investments in time, effort and systems need to be accomplished by each company alone. Effective use of product documentation and IT support needs attention of each company to be adjusted to the specific conditions and requests. Therefore sector wide efforts where companies co-develop solutions will probably render less effective solutions. Further it is also suggested that timber house manufacturers could investigate the potential effects of introducing a product development process to better control the development and adding of new features to the building system. A product development process could also facilitate feedback to further improve building systems.

6.2.3 Product modeling of configurable building systems

Based on the results presented previously in the chapter, further studies were made to test the feasibility of using product modeling to document building systems for industrialized construction. Independent of the previous multiple case study, an additional timber house manufacturer was approached. They agreed on making their building system including drawings and technical documentation available for the study. The studying of documentation was complemented with interviews. In parallel a survey to establish some common customer requirements were conducted. In paper 3 the results of the survey were used to compare the features of the building systems with customer requirements to understand how much the building system had to be customized in each customer project. The aim of the study was both to test the feasibility of documenting the building system in a product model and to test how well the building system could accommodate customer requirements.

The building system in the case study was not a complete match with the customer requirements, custom changes had to be made in many orders to accommodate common requests. This can possibly be a contributing reason to that so much specification is done in each order at the case study company. If the building system by default could accommodate all commonly requested modifications, the specification process could be more efficient. Fewer modifications in each order would mean that less unique design and development would be needed in each order, thus the quality of solutions would be able to be verified beforehand because they had been built before. Consequently platforms that are designed so that they can meet common customer requests will lead to decreased costs and better ability to comply with the market requests.

Product modeling has a central role in building system design, because it can be used as a way to document the building system for internal use and a way to keep track of features and commonality of the platform, which facilitates overview and direction as well as the strategy of the company. In this way it becomes clearer what the product can, and cannot do. As a result, the product model can work as a manual for the company in communication with customers as well as internally.

In the case study an information model structure was created to organize the information of the product model in four views according to the information need of the case study company, see paper 3. The views were formed to reflect the information requirements in engineering, customization, production and on-site assembly activities. On the whole the information model has the potential to visualize and provide a good overview of the building system.

The case study again showed that companies need to put efforts in IT and product modeling as individual companies. It was also concluded that companies need to introduce new product features in a structured way, for example in a product development process, to keep track of changes of the platform. The decision to introduce new features should be a strategic decision, not something that is decided from project to project. An observation was also that companies were better at transferring knowledge downstream the value-flow than upstream. Not being able to transfer information upstream may mean less opportunity for feedback loops.

6.3 Construction clients and their relationship to industrialization

6.3.1 Introduction

Clients view the industrialization of construction from a different perspective than timber house manufactures. Traditionally clients have not had an active role, instead they have been a passive receiver of the concepts and ideas that have been developed by contractors and suppliers. Their incentives to participate in the development of more systematic approaches to construction have so far not been put forward. This chapter aims to clarify how clients think and act in renovation projects, which will provide background for how clients can participate in, and benefit from, industrialized construction. The incentives and rationales between property owners acting as clients in construction and renovation projects are different from how timber house manufacturers participate in the construction process. Thus this study will at first be different from the description of timber house manufactures in both focus and approach. It was also necessary to approach property owners differently because of their different focus and attitudes.

Clients do not often have an industrialized approach to construction, which makes them different from suppliers. Focus lies in finding balanced solutions that render investments profitable, and to keep tenants and owners content. Eloquently put one can say that contractors make money from maximizing the extent of projects, property owners save money by not doing more than necessary. One of the greatest dilemmas for property owners in renovation is timing and extent – knowing when to act and what to do represent two of the biggest challenges. In the end everything comes down to cost and not spending more than necessary show responsibility towards both owners and tenants.

From an industrialization perspective, large clients have the potential to cut costs by rationalization in renovation projects by the use of systematic approaches that ensures quality both in projects and in long term maintenance. Focus here lies on describing the current situation and finding how they can implement industrialized strategies and what it would imply.

6.3.2 MKB Fastighets AB

MKB is a municipality owned property owner in Malmö, Sweden founded in 1946. They provide rental apartments in the city of Malmö as their main

business. With almost 23 000 apartments, MKB has a market share of 33% of all rental apartments in Malmö, and a market share of 15% of the total dwelling stock in Malmö. Figure 12 shows an example of their buildings. MKB has 268 employees, of which 20-30 are project managers, engineers and technicians engaged in maintenance and renovation. Four project managers work specifically with project management and tenant communication in pipe renovation projects.



Figure 12 Typical multi-family buildings from the 1950's
The photo displays some of MKB's buildings in Malmö, Sweden.

The construction of MKB's buildings is concentrated to the period 1950-1970 (figure 13). Because of the aging property stock many houses' technical systems are now in need of renovation. In 2008 MKB completed an extensive investigation to quantify the need and to create an action plan. It was concluded that there were an estimated need for renovation of water and sewage pipes in 12000-15000 apartments during the coming years. The current plan to address the issues stretches to 2027. The conclusions were based mainly on three data sources:

- Physical inspections of buildings to determine and document status of systems and materials
- Interviews with staff who do daily maintenance
- IT-systems to check earlier maintenance

The investigation resulted in a strategy where three approaches to pipe renovation were developed. These are further explained later in this chapter. They constitute a recommendation based on the technical status and reparation costs.

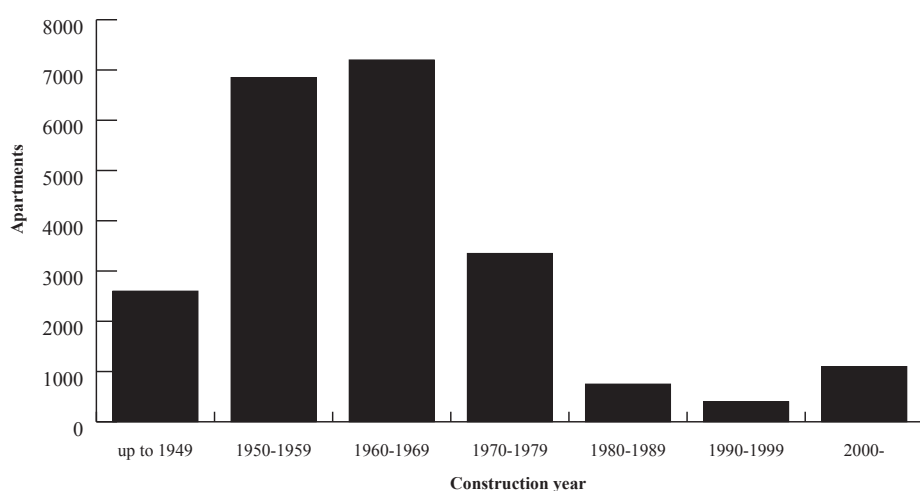

Figure 13 MKB buildings by construction year

The diagram shows all MKB's apartments by year of construction. As many other property owners MKB has a peak around 1950-1970, which is the main reason for the current large need of renovation and modernization.

Pipe renovation with bathroom modernization is one of the largest and most complex types of renovation projects at MKB. Currently MKB performs pipe renovation in about 500 apartments per year. Other than pipe renovation MKB performs many other types of renovation projects, but this study has focused on the pipe renovation process because of its complexity and urgency for many property owners. Pipe renovation is also often a triggering factor for opportunistic renovation (Lind and Muyingo, 2012), where other actions are performed simultaneously.

6.3.3 Pre-study and previously unpublished results

Prior to the main study that led to the appended papers 3-6, two studies were performed to help understand the current situation of property owners with large renovation need. First a pre-study at MKB was performed, it consisted of interviews and studying of documentation about renovation planning and execution. Also process maps of the pipe renovation process at MKB were created, presented in figure 14. A workshop with stakeholders representing different interests in renovation projects was also conducted mid-term in the project. Additionally, interviews were performed with 10 property owners in Sweden to understand their view of planning and financing of renovation projects.

The objective of the pre-study was to identify issues in renovation and maintenance at MKB that could be focal points for the rest of the second part of the project. Based on interviews and studies of documentation, several potential areas were identified:

- Renovation project contracting forms
- Information management
- Purchasing of products and materials
- Internal decision process for renovation projects
- Client choices in renovation projects
- Long-term planning of pipe renovation
- Pipe renovation process efficiency
- IT strategy and systems support
- Strategic choice of products and solutions

The most prevalent issues were the relations with project stakeholders, especially contractors. Another problem that was brought forward by management was the timetable and timing of pipe renovation projects, i.e. the long-term planning. Although MKB has a relatively structured and analytic approach, they see better understanding of optimal timing for pipe renovation is as an improvement. The reason why MKB is eager to better understand the optimal time for pipe renovation is from the economic perspective. They naturally want to balance the yearly damage costs related to water leakage, with the costly investment of pipe renovation that will also result in increased rent for the tenants. From a property owners perspective it is poor judgment to tear down structures and components that still have a value. From a research perspective it was also interesting to further investigate how a strategic choice of products and solutions could influence quality, time and cost in renovation projects, i.e. industrialized approach. Addressing products and solutions could potentially also create more stable conditions for the relationships with contractors in renovation projects because of predictability and long-term focus instead of project focus.

The pre-study was confirmed in interviews with MKB project managers. They spoke of many issues related to the renovation projects and the relations with contractors. Project managers identified problems mainly related to projects, which is only natural because the success and failures of renovation projects is what they experience on a daily basis. But there is a chance that project managers identifies problems too limited, with focus only within the project. This may lead to a sub-optimization from the perspective of MKB as a whole.

The workshop aimed to better understand the view of other stakeholders active in renovation projects and to identify the biggest challenges that lie within. 17 participants representing industry organizations, contractors, property owners and academia participated in the workshop. The main findings were that the participants agreed that the future of renovation lies in better collaboration in projects and to develop better contracting forms, for example partnering.

In collaboration with MKB, interviews were conducted with 10 property owners about how they plan renovation. The interview study concluded that many companies share the view of MKB that renovation is a complicated economic matter and many are constantly seeking better answers. All property owners have to deal with the financing of renovation, but how strict they view profitability is different. There have also been initiatives by public property owners that allowed them to decrease profit for limited periods, to instead invest in renovation. This of course leads to different logics and decision-making mechanisms within these companies.

The summarized view after the pre-studies was that:

- Renovation of multi-family houses is a large issue for property owners from several perspectives. They own the problem, thus most of the solutions must come from property owners.
- To some companies the economic circumstances that surrounds renovation is of high importance and influence the extent of renovation projects
- There is a mutual understanding that efficiency of renovation projects can be increased
- All stakeholders are open to new contracting forms
- Property owners showed low interest in purchasing solutions and materials, despite potential benefits related to scale and quality control.

6.3.4 Planning of renovation and maintenance

Property owners today often need to make decisions about renovation based on vague information and under pressure. At the same time as the increased need for renovation in Swedish multi-family houses are unveiled at a rapid rate in the public discussion, property owners are required to take informed decision seen from many perspectives – tenant consideration, financial benefits, service-life are all factors that needs to be considered. In addition, the decision on one hand needs to consider the imminent needs, on the other hand it needs to consider the long-term effects in the property stock. The increasing need of

renovation together with demands of profitability also for maintenance projects, implies that property owners are experiencing a difficult situation – especially since an increasing share of all investment within the construction sector relates to renovation.

It is a challenging task to fully understand how the need for pipe renovation develops over time and consequently to know when the optimal time to take action is. In the pre-study MKB expressed this as one of the most challenging tasks in maintenance planning, because it involves so many parameters and uncertainties. The optimal point of time can be considered to be a risk problem, it is related to risks in service-life, cost of reparations, how tenants react to disturbances and availability of contractors. Property owners must decide how to prioritize between all factors. A precondition is however that data is available, so that an informed decision can be made. One more consideration that troubles property owners is whether maintenance actions should be performed individually to optimize service-life of components, or if all actions should be packaged into one big project that provides benefits of scale.

The study of maintenance planning presented in paper 4 focused on two objectives: to understand the motivation and reasoning that surrounds maintenance projects, specifically pipe renovation, and to investigate the possibilities to formalize the practical decision process for pipe renovation. The formalization of the decision process resulted in a simple decision support model that made the previously man-made analysis more transparent and available.

The model that was developed within the study showed that with relatively simple means it is possible to produce a model that can help to prioritize the need for pipe renovation within a property stock. The structure of the model is shown in figure 15. This particular model ranked buildings on a scale from 1-10, based on input relating to building facts, usage and current status. The study also underlined the importance of available data as a key issue. During the development of the model and in the subsequent tests performed in a student thesis work, it was clear that not all data needed as input to the model was easily available (Cederström and Strandqvist, 2013). MKB however previously based their planning on the same data, but it was difficult for MKB to present the data when needed. The information that constitutes the basis for property maintenance planning at MKB is currently dependent on knowledge that is linked to individuals. For decision-support tools to work as intended, knowledge must be formalized. The model was kept simple to be able to be applicable in real-world situations.

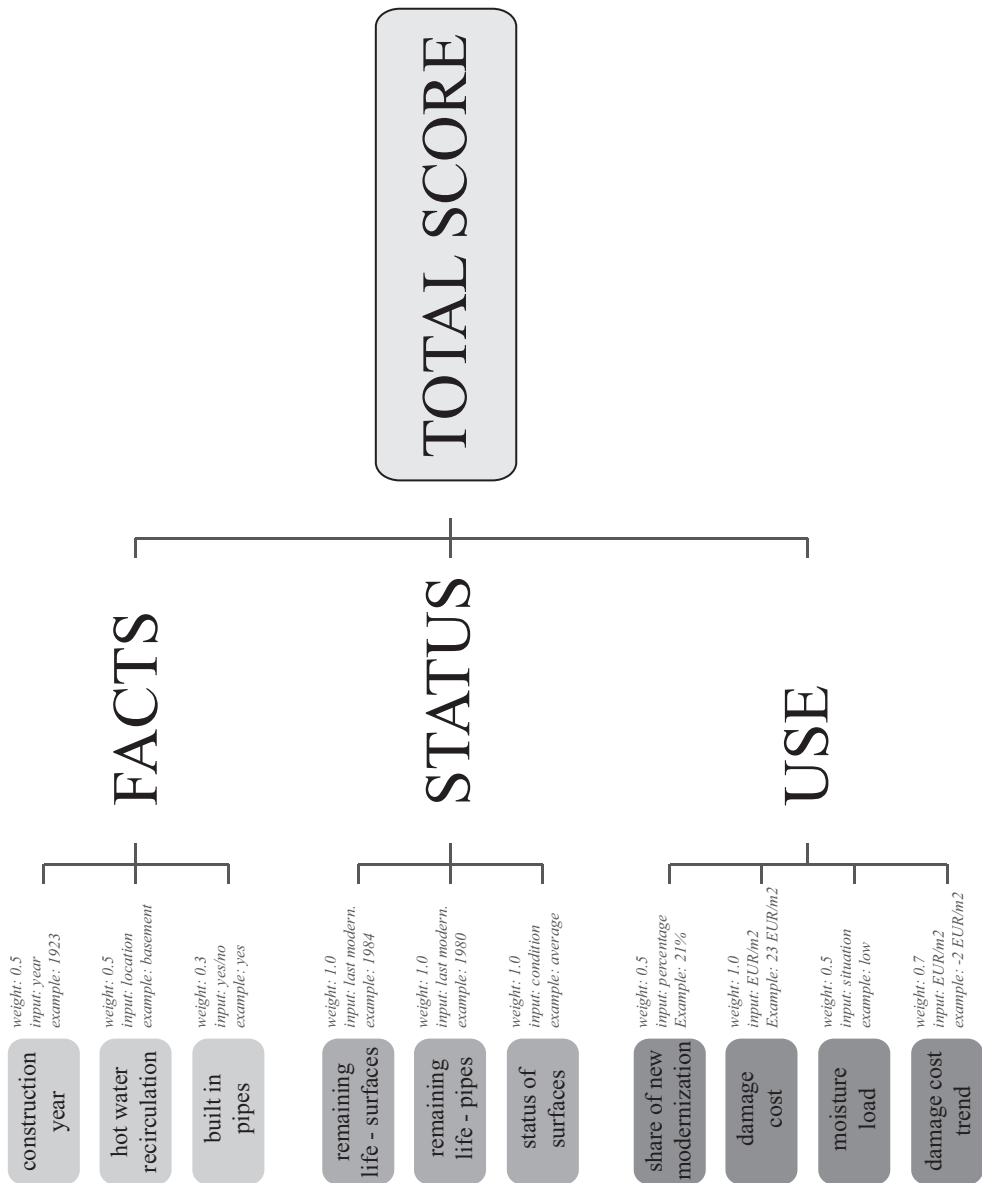

Figure 15 Pipe renovation prioritization model

The pipe renovation prioritization model can help property owners to decide in what order to perform pipe renovation within a group of buildings.

The lessons learned about how property owners plan maintenance is firstly that public property owners are very willing to share information and lessons learned with their peers. Because there is no competition between them (they are owned by the municipalities and are thus only active in one municipality)

they can freely exchange information. How clients in general plan maintenance is very individual. The approach is much up to the knowledge of the individuals in the organization. One general observation was that public property owners often have more technical staff. Perhaps that is a contributing reason why they also do more maintenance, measured in maintenance investments per square meter.

The approaches to pipe renovation projects can be very different between different property owners. Some choose to combine several different actions into one package to minimize disturbance for tenants and to take advantage of, for example only having to establish a work site once. A combination can consist of pipe renovation, electrical systems, new kitchens and bathrooms, extra insulation of the facades etc., but no upper limit exist. One of the conclusions from this study was that further studies had to be made of how property owner would like to execute renovation projects, and what contractors currently offer.

6.3.5 Demand and supply for the renovation industry

The first studies focused on the renovation needs of MKB and their peers. The initial impressions were that client needs in terms of how they want to conduct renovation projects and what they require from contractors can change both over time and between different clients.

Depending on how and what clients ask for, the tendering processes will attract different groups of contractors. The relative importance of renovation for contractors are increasing and large contractors target the renovation market with specific offers. The objective of this study was to understand how large clients act and what they ask for in renovation projects, as well as to understand what services and solutions that are offered by contractors and suppliers. Besides presenting the results, it was also the aim to see if clients or contractors and suppliers have incorporated any systematic approaches to solutions, information management or processes that would indicate elements of industrialization.

A questionnaire was sent to large property owners about their capabilities and attitudes towards renovation projects. In total the respondents own and operate more than 200 000 apartments throughout Sweden. The results show that many property owners have good capabilities to plan and analyze maintenance. Many are nevertheless open to large, extensive projects and initiatives where the contractors take a leading role in the project. Many of the property owners describe how they are satisfied with how renovation projects currently work.

They do however regard communication, quality and cost as issues in renovation projects.

Property owners were also asked what contractor characteristics they look for. The most prominent features listed by clients were competence and good communication skills, which can be said to be skills required within the current, well-established practice of renovation projects.

The study presented in paper 5 show that both the identified problems and what clients look for in contractors are characteristics that are often used to describe the construction industry in general. Therefore it is plausible to argue that respondents represent traditional views and goals of what renovation projects should achieve, and the perceived problems are the same as in the rest of the construction industry. During projects, clients appreciate good communication, planning skills and ability to finish according to schedule as most important. Clients could have the potential to use their influence to enforce better control of prices and quality, but from the results of the study this does not seem like a prioritized area for them.

In terms of industrialization and standardization, the study does not indicate much interest from clients to engage in standardization of solutions or processes. In the questionnaire, clients were also asked if they standardize technical solutions for renovation in the purchasing process. The results showed that there are different levels of standardization between clients.

The interviews with contractors active on the renovation market showed that in general their offerings build on flexibility. Their willingness to adapt may however be a marketing strategy rather than how they internally discuss preferred practices. But the lack of standardized approach of course promotes flexibility. Renovation projects pose different demands on contractors compared to construction, which may explain the perceived need for flexibility, for example existing structures adds complexity.

Renovation in Sweden follows the same structures as construction with local or regional markets where companies of different sizes compete for the same contracts. Many interviewees explained how they are able to adapt their solution to different circumstances and client demands. Local markets may also explain the flexibility - many of the companies compete for the same contracts, thus it becomes important to be able to adapt to different client demands. Clients may initially welcome flexibility, but there is a risk that it limits possibilities for standardization and continuous learning, if all projects provide new and unique solutions.

The introduction of renovation concepts by large contractors is probably both because of market conditions and for technical reasons. The impression was

however that contractors do not turn down a project if it would go outside the boundaries of the established concept – flexibility is still an important capability. The goal of the concepts has however been to better understand clients' business logic and help to find incentives for renovation by improving profitability of renovation projects. For example energy efficiency has been put forward as good investments.

Systematization can be seen to some extent in the large contractors' conceptualization. At the center of this effort is the centralization and systematization of well-known solutions into a knowledge repository. It is however up to each region within the company how they would like to use the knowledge, which is very much up to how and what clients ask for. Large contractors say that they have been able to shorten project time in large projects where the work crews are able to learn from previous stages of the projects.

The developments of methods and solutions are still lead by contractors, however several clients still specify what kind of solutions they want for specific projects. According to the study the demand for new and innovative solutions and collaboration forms is low. This may lead to inhibited development and to preserve the status quo in renovation projects. Several of the contractors emphasized that they would like to enter the design phase as early as possible, preferably before the design has been detailed. If contractors can influence how the solution is defined, then they are able to design the solution so that it is familiar to them, which reduces risk. At the same time it may become more problematic for clients to ensure effective operation and maintenance.

Neither clients nor contractors expressed any need for structural changes or development that goes outside the current structure of renovation projects. Both sides seem content with the flexibility that currently characterizes many of the offerings. But because of the flexibility it is relatively hard to distinguish different contractors from each other. The study concludes that property owners ask for traditional renovation projects, and that many clients are content with the current situation on the market. The main problems lie in communication and reoccurring issues with quality and price. There are opportunities for new business models and for innovation where the client could take a more active role. But it requires commitment and new capabilities from both property owners and contractors.

Clients ultimately decide what solutions that are selected and used. If clients could be consistent in the solutions they choose, it could create better possibilities for contractors to standardize offers.

6.3.6 Opportunities for industrialization of renovation

Based on the understandings of industrialized construction and the previously gathered information of MKB's current practice in renovation, the last part of the project aimed to understand the opportunities for property owners in using industrialized strategies. The objective of this study was to understand and describe the effort needed by MKB to industrialize the renovation of pipes and bathrooms and to see it as a process instead of a series of projects.

The findings in paper 6 show that the opportunities for MKB to adopt simple industrialized strategies are attainable with relatively little effort. To adopt an industrialized strategy for pipe renovation would require adaption and investments in standardization of solutions and processes. The efforts needed to industrialize, mostly require relocation of staff dedicated to the activities related to industrialization, for example product development.

The study shows a potential for property owners acting as construction clients to increase quality and predictability in renovation projects by adopting industrialized strategies. The change could potentially mean better control of technical solutions, processes and information management. But the realization of the potential also means less flexibility.

If clients start to implement industrialized strategies by standardization of technology, it can potentially create a new market. New market conditions could mean that clients better can influence the solutions they purchase.

Clients that see a potential in industrialized construction should start by building on their existing knowledge, which is often centered around the technology. For MKB it could be to start building on the solutions that works well in pipe renovation, but it should also be noted that the holistic perspective is important from the start of the implementation.

7 Current situation and future opportunities

7.1 Introduction

In this chapter the findings from the separate studies are reflected upon from the perspective of all collected data. The goal is to analyze the collected research with regard to what has happened and to identify future possibilities.

Timber house manufactures and property owners acting as clients in renovation projects do not often cross paths, first of all they do not act in the same market segment. But still many of the challenges and opportunities are the same both on buyer and supplier side in the industrialized construction process. At the center of industrialized construction is the creation of value for the customer, so the goals of lower costs and increased efficiency in all steps from the early phases of planning to maintenance are common for all stakeholders.

7.2 A view of current practice

7.2.1 Timber house manufacturers

The timber house manufactures that were studied in the project have worked with off-site production and standardized technical platforms for a long time. In that sense they apply industrialized strategies and methods. There have been an interest for new methods of industrialized construction, e.g. (Lessing 2006), however few major changes that affects how they work have been implemented in existing companies. The reluctance to implement changes and make investments could be connected to the downward going trend for single-family houses during later years, which makes costly investments more difficult to motivate to management.

The fluctuations of the market force timber house manufacturers to constantly be adaptable to the surrounding conditions: in economic upturns they can be

more selective and primarily accept orders that they can produce efficiently, but in times with less demand they have a history of making deviations from the commonly used technical solutions, which also leads to less efficient production. Various modifications to common practice lead to an undermining of the technical platform, if obsolete solutions are not removed. When the platform has come to accommodate too many variations, it becomes difficult to navigate and the design process comes to resemble traditional design where new designs are created for each project. One can argue that the longer a company has been in business, the harder it becomes to apply industrialized strategies because the technical platform loses in relevance.

From the perspective of IT- and technical platforms, the requirements for an implementation of a product model and use of configuration has not been fully present in the companies that were studied. The reasons are connected to the fluctuating demand and also to traditions. Several companies prioritize to have the ability to make changes to accommodate many different customer demands. Further, in an interview a member of the technical staff at one company said that they see themselves as a construction firm and not as an industrial manufacturer. This view does not promote platform thinking.

Single-family timber house manufacturers operate on a market where there are many companies on a small market, which has led to several bankruptcies. At the same time the will to change seemed to be low, consequently not many large changes have been made to how design and production are managed. Many companies continue their business relatively unchanged despite the market conditions and the development of industrialized construction during later years. The reasons why they have not changed is difficult explain from the results in this project. It could however be possible that investments made in already well-established design and production resources acts as a barrier to change. For timber house manufacturers to change, there might be a need to rethink their current position and start over to apply modern industrialized construction. They need to define a clear customer segment for the technical platform and develop specific, clearly defined solutions to make it possible to use their production resources effectively to reduce design and production costs. This would however require investments for companies on a market that has decreased with more than 60% over a relatively short time. Understanding of the market and specialization could however be success factors to offer cost efficient, qualitative solutions.

7.2.2 Renovation and the situation of property owners

Contractors generally offer flexible solutions for renovation of multi-family houses. Several stated that they are required to offer flexibility to accommodate different requirements from clients. The disparate client requirements may act as a barrier towards the implementation of technical platforms and standardized processes for the renovation market. The desire of contractors to appear as flexible could partly also be explained by marketing concerns, to get contracts they need to appeal to many different clients. Consequently much of the responsibility to improve the current situation falls on the clients. Change or innovation in renovation of multi-family houses must involve clients, because they ultimately determine the conditions of the market and often possess most of the knowledge of the houses they own, thus also about the renovation needs.

Several contractors have however initiated efforts to improve their efficiency and quality in renovation projects. For example, one contractor have collected best-practice solutions that can be systematically reused. Contractors have also said that keeping work crews intact between stages in large projects have shortened project time significantly in later stages of the project. Experience from the specific conditions of buildings in large projects, as well as learning and improving over time, have been success factors. The examples show that repetitive use of solutions and learning from experience can help to create better predictability and lower cost.

Amongst clients in renovation, industrialization has not been frequently used and some clients describe it as mostly benefiting contractors. There are however examples where certain components have been standardized. But the level of standardization of project designs and contracting forms were different between clients in the studies. In general, the individual client project manager can have a large influence over the design and execution of projects. For example at MKB there were few examples of easily available standardized designs that could be reused between projects, which makes the job of project managers more difficult. Informal feedback and reuse are however frequently used.

Some interesting initiatives were observed on an industry level. Industry organizations have great potential to show the possibilities for clients to take initiative. The client organization for municipality owned property owners in Sweden (SABO) has for example procured complete offers to build affordable multi-family houses, which can be used by all members. This shows the potential of what clients can do if there is a clearly defined demand in combination with a market size that is acceptable for contractors and suppliers. But in renovation the experiences from this project is that clients often are

content with being recipients of services and products where contractors and suppliers have control. The approach of less involvement and control may lead to more time efficient project management for clients, but less involvement may eventually lead to a degradation of knowledge as well as little contribution to development and innovation.

7.3 Acting from current situation

During later years most initiatives within industrialized construction has been led by contractors and manufacturers, for example the timber house manufacturing are since a long time a well-established market. An interesting future potential is however how professional clients can better take advantage of industrialized strategies. There is a potential for clients to take part in the development of concepts and solutions based on their extensive experience of renovation and construction projects. But for industrialized construction to have relevance, the general view of the benefits for clients must be made clearer and more concretized. As long as the benefits are perceived by clients as to mostly improve the internal efficiency of contractors and suppliers and not significantly affect price, time or any other clearly visible benefit of clients, industrialized construction will find it hard to compete with traditional offers. Clients may also perceive the risk of trying something new as too high and if industrialized concepts are priced in accordance to what the market can tolerate instead of being based on actual costs, there are few visible benefits to clients. But large clients should recognize their own responsibility to create a more effective construction sector. As long as they continue to ask for the same solutions as they previously has, there is a high probability that nothing will change.

A knowledge barrier may partly inhibit the adoption of industrialized strategies amongst clients. Clients as a group have been described as less knowledgeable than their counterpart, the contractors. At the same time, clients are the group that could benefit most from the positive effects of industrialization. To mitigate the knowledge gap should not require extensive actions. The first actions for clients are to organize and present knowledge and solutions that they would like to promote, so that it can be conveyed to other stakeholders. The focus on an industrialized strategy also requires a change in competence for many clients, which also would mean investments in resources as well as introducing new activities. The knowledge that is required is related to technical systems and product development. Clients also need to understand how the process changes when they introduce product development that is

separated from the renovation projects. A platform owner and routines for knowledge transfer between projects as well as the continuous processes needs to be established. Similar to the initiative by SABO, it is important also for clients to show that they can offer a market that appeals to contractors and suppliers. This requires stable demand over time and repetitive use of solutions.

7.4 Going forward

Industrialized construction cannot only be a concern for contractors and suppliers. Single-family timber house manufacturers constitute a limited market where the customers mainly are private persons. The need for customer focus is important in all market segments, but the conditions of the market are different compared to multi-family houses, thus also strategies should be different. Customers should not be directly involved or affect the processes for development, but companies should have well-established routines to incorporate customer feedback and requests in their development.

Professional clients in construction do however often take an active part in the construction or renovation process. So in any thoughtful effort to develop industrialized strategies, the client has to be included in the process and be allowed to have an active role where they can participate and influence designs. Without the demand from clients there will not be a market to develop, therefore perceiving large clients as merely recipients of services is risky. An interesting development would be that clients themselves lead the development to define their role and take responsibility to make sure that they receive the solutions, cost and quality they prefer. Especially large, repeat clients with stable and uniform demand can play an important role and can potentially influence how the market develops. By posing consequent demands, clients act responsibly and can contribute to creating a stable market.

The large demand for renovation of multi-family houses makes renovation a possible segment for industrialized strategies. The challenges for clients in renovation lie in understanding and evaluating the need for renovation and classifying the need so that they can use their resources efficiently. An evaluation is essential to understand which parts that are suitable for an industrialized strategy. Likewise there are large challenges for clients in the subsequent renovation process, in developing appropriate solutions. If industrialization is considered as an option, it must be included on a strategic level, because it affects what resources are needed.

New market conditions could come from clients or client organizations developing concepts or industrialized approaches to renovation. A market based on these conditions could mean more influence for professional clients, which in turn can lead to a more customer influenced process where focus lies on the solutions requested by clients instead of those promoted by contractors.

8 Conclusions

8.1 Introduction

Industrialization of construction is about the systematic approach to technology and processes, and to learn from previous experiences. The more open term industrialized strategies include more stakeholders and opens for different approaches. But a systematic approach requires openness and collaboration between stakeholders. From the work in this project it is clear that the engineering perspective dominates, thus it is natural that the technical platforms dominate. But additional competences can be added to the platform: IT, processes, organizational changes etc.

Without a role where clients can take an active part in industrialized construction, it is hard to see how the benefits will reach further than to reduce the costs of suppliers and contractors. There are currently few professional clients who proactively choose industrialized solutions.

Below the research questions are answered.

8.2 Timber house manufactures

The focus and entry point of the early research in this project have been the possibility to utilize product data modeling and IT, but the introduction of these will affect also other areas. The use of product data modeling and IT to support the internal work will require structure and formalized routines. Thus the processes and possibly also the organization will be affected by these changes.

There is a potential of using product modeling for timber house manufacturers. Many of the preconditions are in place, much because they control process and production. They also have an organization that can make use of the benefits of a more effective specification process. Configuration and product modeling should however not be considered as IT projects. The benefits of product modeling is better control, quality and increased interaction with the customer, benefits that are not connected solely to IT or product development. Thus the

incentives for these kinds of efforts should come from, or be supported by the management.

Timber house industries can increase efficiency through a strategic approach to product data management and information management. If fully implemented it will mean significant changes, thus changes will probably need to come progressively to be accepted within the organization. The first thing that needs to change is a better understanding of how IT can drive business forward – the technology is often already available. But each company needs to act independently, waiting for an industry standard will probably take too long time.

There exists an improvement potential for timber house manufactures in several areas. The main benefit are that they own the process from sales to on-site work, which makes it possible to engage in the abovementioned specification process and configuration as well as modularization and product modeling. To be able to take advantage of the benefits the maturity must however increase and industrialized producers of houses can learn from manufacturing.

8.3 Client opportunities

The interest of clients in renovation towards the standardization of technical solutions and processes was surprisingly low. The majority of the clients that were included in the study did not support more client control over either of the areas. Instead they were relatively content with current situation and were open to large projects where contractors take responsibility. Clients did look for reliability and quality, which they did not associate with industrialized construction. There were however several clients who in interviews expressed problems with more contractor control, but the lack of resources and capability may be a short-term explanation to the overall positive view of contractor control. How clients view the long-term development of their role has not been investigated enough to provide an answer.

Clients could however gain from industrialization in several ways. They are the customers in the renovation and construction process, making sure that the process creates maximum value should be of the highest interest to clients. The increase in control over the products and solutions that are built into their buildings would be an obvious benefit in long-term property management. But it requires that clients specify solutions that are reused in many projects over time. The case study company for instance renovates up to 500 apartments per

year, in addition they build up to 500 more per year. With a focus also on the processes where the technical platform is used, both internally and externally, they have the possibility to include several other aspects of industrialization, for example continuous development of processes and solutions. Clients should have the potential because they have experience of many kinds of solutions, they can control purchasing and they have the incentives to implement improvements over time. By prescribing different levels of technology standardization, clients can in practice include or exclude different contractors based on their experience. Industrialization however comes with increased costs for development and management.

In order to obtain the benefits, industrialization requires changes in client behavior and roles in the renovation process. To control technical solutions and processes requires a product development process where solutions are developed and maintained, which is separate from the renovation projects. Likewise, processes need to be defined according to the needs of the company. If clients have certain preferred solutions for renovation they also need to be documented for several purposes. Development, purchasing, specification, tendering, production and maintenance are areas that can be addressed with an industrialization perspective, but they require information. Thus an information strategy and product data as a source of information is also needed. But the formalization of knowledge means that parallel solutions cannot exist, so there is a need to harmonize the internal staff and solutions.

The advantages for industrialized construction have so far not been compelling enough for clients in relation to the risks and to many it is still perceived as new and experimental, which is a problem. But potential opportunities for clients lie in their involvement in development of technical platforms and processes. From an outside perspective there are potential gains in that property owners own or specify technology that they know work, that they can maintain effectively and that are not chosen only for its low initial cost. There are several clients in Sweden that are large enough to standardize technology and processes. By making the systematic design and processes for renovation and construction publicly available, they can create stable conditions for the market where contractors and suppliers can learn the solutions over time. If large clients took the responsibility to create stable conditions with consistent requirements a new market could be created.

8.4 Future research

There is a need to further establish the role of active clients in the industrialized construction market segment. Practical cases where client involvement are implemented and evaluated may help to further concretize the benefits and establish appropriate roles. To provide best practice scenarios that allow clients to feel confident to engage in industrialized strategies is also important. Consequently models and strategies that describe the client role in industrialized construction need to be evaluated and further developed to prove generalizability of the results in this study.

The total sales of single-family timber houses have seen a significant decline in recent years and many manufacturers struggle to survive. But still few significant changes to how production and design is managed by companies have been seen in the studies. It should be further investigated why, besides cost, timber house manufactures are reluctant to implement better-defined product platforms.

This research project has shown the feasibility of industrialized strategies in both renovation as well as in construction. It is however of interest to further investigate what an industrialized strategy within a client organization can encompass. Can for instance the same strategy include both new construction as well as renovation of existing buildings? To outline future definitions of industrialized strategies for clients, the commonalities in industrialized strategies for renovation and construction in terms of degree of predefinition of solutions, client role and drivers would need to be further investigated.

8.5 Final remarks

The goal of this thesis has been to show potential improvements for a better construction process through the adoption of industrialized strategies. The means are production strategies, standardization and improved information management and the goal is to increase quality, cost effectiveness and predictability. There is an undoubted need for change in the construction industry – and together we must experiment and put forward successful examples.

There are several challenges with industrialized construction, which has inhibited it from being widely accepted. The technocratic, resource based perspective of contractors and manufactures may have been a contributing reason. Although the benefits of industrialization have been shown, some of the

clients in this study still perceived industrialized construction as a way to lower production costs, not price. True or not, the perception has to be changed for the adoption of industrialized strategies. Further, there is an information asymmetry where suppliers and contractors often have more knowledge about industrialized construction. Clients and property owners need to better understand how to use the benefits of industrialized construction as well as to learn how to formulate and verify requirements. Client lead or influenced industrialization could be what is necessary as one of the next steps for industrialization of the construction industry. Here contractors have a mission in educating and making professional clients active participants in the development of platforms and concepts. New strategies and industrialized roles for clients are currently lacking.

9 References

- Akao, Y (2004) Quality function deployment: Integrating customer requirements into product design. New York: Productivity Press.
- Andersson, R, Apleberger, L and Molnár, M (2009) Erfarenheter och effekter av industriellt byggande i Sverige (in Swedish). Report No. 0905, Malmö: FoU-Syd.
- Ballard, G and Howell, G (1998) What kind of production is construction? In Sixth annual conference of the international group for lean construction (IGLC'98), Guarujá, Brazil.
- Barlow, J (1998) From craft production to mass customization? Customer focused approaches to housebuilding. In Sixth annual conference of the international group for lean construction (IGLC'98), Guarujá, Brazil.
- Barlow, J, Childerhouse, P, Gann, D, Hong-Minh, S, Naim, M and Ozaki, R (2003) Choice and delivery in housebuilding: Lessons from Japan for UK housebuilders. Building Research and Information, 31(2), 134.
- Bengtsson, S (2013) Ser storheten i de små projekten. In: Byggvärlden 2013(12), Täby: Nordic construction media.
- Bergström, M (2004) Industrialized timber frame housing - managing customisation, change and information. Report 2004:45. Department of Civil and Environmental Engineering, Division of Structural Engineering, Luleå University of Technology.
- Bertelsen, S (2004) Lean construction: Where are we and how to proceed? Lean Construction Journal, 1(1).
- Björnfot, A (2006) An exploration of lean thinking for multi-story timber housing construction: Contemporary Swedish practices and future opportunities. Report 2006:51. Department of Civil, Environmental and Natural Resources Engineering, Division of Structural and Construction Engineering, Luleå University of Technology.
- Björnsson, H (2003) IT-strategier i företag och projekt, in Byggandets informationsteknologi, Stockholm: Svensk Byggtjänst.
- Blomé, G (2011) Organizational and economic aspects of housing management in deprived areas. Report 2011:4. Department of Real Estate and Construction Management, KTH Royal Institute of Technology.
- Boverket (2003) Bättre koll på underhåll (in Swedish). Report no. 2081-2114/2002. Karlskrona: Boverket.
- Bröchner, J, Josephson, P E and Kadefors, A (2002) Swedish construction culture, quality management and collaborative practice. Building Research and Information, 30(6), 392-400.

- Cederström, A and Strandqvist, A-S (2013) Beslutsstödsmodell för stambyte (in Swedish). Department of Urban Studies. Malmö: Malmö University.
- Cox, A and Thompson, I (1997) 'Fit for purpose' contractual relations: Determining a theoretical framework for construction projects. *European Journal of Purchasing and Supply Management*, 3(3), 127-35.
- Dehlin, S and Olofsson, T (2008) An evaluation model for ICT investments in construction projects. *Journal of Information Technology in Construction*, 13, 343-61.
- Duray, R (2002) Mass customization origins: Mass or custom manufacturing? *International Journal of Operations and Production Management*, 22(3), 314-28.
- Duray, R, Ward, P T, Milligan, G W and Berry, W L (2000) Approaches to mass customization: Configurations and empirical validation. *Journal of Operations Management*, 18(6), 605-25.
- Egan, J (1998) Rethinking construction: Report of the construction task force, London: The construction task force.
- Ekhholm, A and Molnár, M (2009) ICT development strategies for industrialization of the building sector. *Journal of Information Technology in Construction*, 14, 429-44.
- Engström, S (2012) Managing information to unblock supplier-led innovation in construction. Department of Civil, Environmental and Natural Resources Engineering, Division of Structural and Construction Engineering. Luleå University of Technology.
- Erixon, G (1998) Modular function deployment - a method for product modularization. Department of Manufacturing Systems, KTH Royal Institute of Technology.
- Ford, S, Aouad, G, Kirkham, J, Brandon, P, Brown, F, Child, T, Cooper, G, Oxman, R and Young, B (1995) An information engineering approach to modeling building design. *Automation in Construction*, 4(1), 5-15.
- Gann, D M (1996) Construction as a manufacturing process? Similarities and differences between industrialized housing and car production in japan. *Construction Management and Economics*, 14(5), 437-50.
- Geier, S, Ehrbar, D and Schwehr, P (2012) E2rebuild - evaluation of collaboration models. Project Deliverable D2.1. E2ReBuild.
- Gerth, R (2008) En företagsmodell för modernt industriellt byggande (in Swedish). Report 0806. Production Engineering, KTH Royal Institute of Technology.
- Gibb, A (2001) Standardization and pre-assembly - distinguishing myth from reality using case study research. *Construction Management and Economics*, 19, 307-15.
- Gosling, J and Naim, M (2009) Engineer-to-order supply chain management: A literature review and research agenda. *International Journal of Production Economics*, 122, 741-54.
- Häkkinen, T, Vares, S, Huovila, P, Vesikari, E, Porkka, J, Nilsson, L-O, Togerö, Å, Jonsson, C, Suber, K, Andersson, R, Larsson, R and Nuorkivi, I (2007) ICT for whole life optimization of residential buildings. VTT Research Notes 2401. Espoo: VTT.

- Hansen, B L (2003) Development of industrial variant specification systems. Department of Management Engineering, Technical University of Denmark. Vedbaek: IKON Tekst & Tryk A/S.
- Hedgren, E (2013) Overcoming organizational lock-in decision-making – construction clients facing innovation. Department of Civil, Environmental and Natural Resources Engineering, Luleå University of Technology.
- Hedgren, E and Stehn, L (2013) The impact of clients' decision-making on their adoption of industrialized building. *Construction Management and Economics*, 1-20. In press.
- Hartmann, A, Reymen, I and van Oosterom, G (2008) Factors constituting the innovation adoption environment of public clients. *Building Research and Information*, 36(5), 436-49.
- Hoekstra, S and Romme, J (1992) *Integral logistics structures: Developing customer-oriented goods flow*. London: McGraw-Hill.
- Hvam, L, Mortensen, N H and Riis, J (2008) *Product customization*. Berlin, Heidelberg: Springer-Verlag.
- Industrifakta (2008) *Förnyelse av flerbostadshus 1961-1975 (in Swedish)*. Helsingborg: Industrifakta.
- Ivory, C (2005) The cult of customer responsiveness: Is design innovation the price of a client-focused construction industry? *Construction Management and Economics*, 23(8), 861-70.
- Jansson, G (2010) *Industrialized housing design efficiency*, Department of Civil, Mining and Environmental Engineering, Luleå University of Technology.
- Jansson, G, Johnsson, H and Engström, D (2013) *Platform use in systems building*. *Construction Management and Economics*. In press.
- Jensen, P (2010) *Configuration of modularised building systems*, Department of Civil, Environmental and Natural Resources Engineering, Luleå University of Technology.
- Jensen, P, Sandberg, M and Malmgren, L (2008) Reducing complexity of customized prefabricated buildings through modularization and IT support. In proceedings of CIB-W78 International conference on information technology in construction, Santiago de Chile: Universidad de Talca.
- Johnsson, H (2013) *Production strategies for pre-engineering in house-building: Exploring product development platforms*. *Construction Management and Economics*, 31(9), 941-958.
- Johnson, T and Bröms, A (2000) *Profit beyond measure*. New York: Free press.
- Jonsson, H and Rudberg, M (2013) *Classification of production systems for industrialized building: A production strategy perspective*. *Construction Management and Economics*. In press.
- Josephson, P E and Saukkoriipi, L (2007) *Waste in construction projects: Call for a new approach*. The centre for management of the built environment, Building economics and management. Chalmers University of Technology

- Lessing, J (2006) Industrialised house-building : Concept and processes. Department of Construction Sciences, Lund University.
- Liker, J (2004) The Toyota way. New York: McGraw-Hill.
- Lind, H and Muyingo, H (2012) Building maintenance strategies: Planning under uncertainty. *Property Management*, 30(1), 14-28.
- Meijer, F, Itard, L and Sunikka-Blank, M (2009) Comparing European residential building stocks: Performance, renovation and policy opportunities. *Building Research and Information*, 37(5-6), 533-51.
- Naim, M (1997) The book that changed the world. *Manufacturing Engineer*, 76(1).
- Naim, M and Barlow, J (2003) An innovative supply chain strategy for customized housing. *Construction Management and Economics*, 21(6), 593-602.
- Nam, C H and Tatum, C B (1997) Leaders and champions for construction innovation. *Construction Management and Economics*, 15(3), 259-70.
- Nasereddin, M, Mullens, M A and Cope, D (2007) Automated simulator development: A strategy for modeling modular housing production. *Automation in Construction*, 16(2), 212-23.
- Ohno, T (1988) Toyota production system - beyond large scale production. New York: Productivity Press.
- Olofsson, T, Rönneblad, A, Berggren, B, Nilsson, L-O, Jonsson, C, Andersson, R and Malmgren, L (2012) Kravhantering, produkt- och projektutveckling av industriella byggkoncept (in Swedish). Department of Civil, Environmental and Natural Resources Engineering. Luleå University of Technology.
- Pine, B J (1993) Mass customization: The new frontier in business competition. Boston: Harvard Business School Press.
- Robertsson, A and Ekholm, A (2006) Industrialized building, project categories and ICT - a comparison with shipbuilding. In proceedings of ECCPM, Valencia.
- Roy, R, Brown, J and Gaze, C (2003) Re-engineering the construction process in the speculative house-building sector. *Construction Management and Economics*, 21(2), 137-46.
- Simpson, T W (2004) Product platform design and customization: Status and promise. *AI EDAM - Artificial intelligence for engineering design analysis and manufacturing*, 18(1), 3-20.
- SOU (2000) Från byggsekt till byggsektor (in Swedish). SOU 2000:44. Stockholm: Näringsdepartementet.
- SOU (2002) Skärpning gubbar! Om konkurrensen, kvaliteten, kostnaderna och kompetensen i byggsektorn (in Swedish). SOU 2002:115. Stockholm: Näringsdepartementet.
- Statistics Sweden (2012) Byggnadsprisindex (BPI). Stockholm: Statistics Sweden. Accessed 2013-09-10. http://www.scb.se/Pages/Product___12483.aspx
- Statistics Sweden (2013) Konsumentprisindex (KPI). Stockholm: Statistics Sweden. Accessed 2013-10-27. http://www.scb.se/Pages/TableAndChart___33837.aspx.
- Stevens, G (1989) Integrating the supply chain. *International journal of physical distribution and logistics management*, 19(8), 3-8.

- Swedish Construction Federation (2013) Fakta om byggandet. Stockholm: The Swedish Construction Federation
- Thuvander, L, Femenías, P, Mjörnell, K and Meiling, P (2012) Unveiling the process of sustainable renovation. *Sustainability* 4(6), 1188-213.
- Ulrich, K (1995) The role of product architecture in the manufacturing firm. *Research Policy*, 24(3), 419-440.
- Ulrich, K T and Eppinger, S D (2011) *Product design and development* 5th ed. New York: McGraw-Hill/Irwin.
- Vennström, A (2008) The construction client as a change agent: Contextual support and obstacles. Report 2008:31. Civil and Environmental Engineering, Construction Management, Luleå University of Technology.
- Wester, K (2013) Trafikverket blir beställarproffs. In: *Samhällsbyggaren* 2013(1), Stockholm: Samhällsbyggarna.
- Winch, G M (2003) Models of manufacturing and the construction process: The genesis of re-engineering construction. *Building Research and Information*, 31(2), 107-18.
- Womack, J and Jones, D (1996) *Lean thinking - banish waste and create wealth in your corporation*. New York: Free press.
- Womack, J, Jones, D and Roos, D (1991) *The machine that changed the world*. New York: HarperCollins.
- VVS-Företagen (2009) *Renoveringshandboken för hus byggda 1950-1975*. Stockholm: VVS-Företagen.
- Yin, R (2003) *Case study research – designs and methods*. Third edition. Thousand Oaks: Sage.

Paper I

ICT SUPPORT FOR INDUSTRIAL PRODUCTION OF HOUSES – THE SWEDISH CASE

Helena Johnsson¹, Linus Malmgren^{2,3}, Stefan Persson^{2,3}

¹ Div. of Structural Engineering, Luleå University of Technology, Sweden

² Div. of Structural Engineering, Lund Institute of Technology, Sweden

³ Tyréns AB, Sweden

ABSTRACT: The Swedish construction sector is currently undergoing great changes. The large costs for labour have forced the construction companies to rationalise and minimise labour intense work operations. Therefore, the current trend in construction to adopt the principles of lean production and transform it into lean construction, suits the Swedish way of working and the entire Swedish construction sector has caught on. A growing market is the prefabrication of building elements that are transported to site and then erected. The development has been taken so far that modular houses i.e. vol-umes/rooms are prefabricated.

Companies in the prefabrication industry within construction fall between two sectors; the construction industry and the manufacturing industry. In terms of IT support the contradiction between the two sectors become evident. Software developed for the construction sector seldom provide enough detailing to suffice as a basis for industrial production, while software supporting the manufacturing industry are incapable of delivering standard construction documentation.

The current study presents a multiple case study where six Swedish industrial manufacturers of timber houses were studied. The process from tender acceptance to module delivery is described. Alongside, a survey of the building system revealed that much still needs to be done in terms of documenting a building system. The results show that the question of IT support is more a question of consequent information strategies than eloquent IT tools. The pressing need for a method for documenting building systems is stressed and different methods are discussed.

KEYWORDS: timber houses, industrial construction, lean construction, timber buildings.

1 INTRODUCTION

Currently the Swedish construction sector is undergoing great changes. In order to meet demands from the market the sector needs to become more efficient in several areas, quality and reliability being two of the most prominent. There is a trend to transfer methods as lean production from the successful manufacturing industry (e.g. cars) into lean construction for the construction industry, (Koskela 1992). One move towards a more industrialised approach is to prefabricate elements in factories and transport them to the building site for erection. Later years have seen an increasing degree of prefabrication and currently companies involved in modular house prefabrication foresee a strong development, (Nasereddin et al 2007). The prefabrication strategy changes construction companies from object-oriented builders to production oriented manufacturers. Unfortunately, the ICT-tools developed for the construction sector do not support an automated manufacturing, while the tools developed for the manufacturing industry lack support for structural design and detailing, (Johnsson et al 2006).

When designing buildings extensive amounts of information is generated and often time is spent searching, sharing and recreating this information, activities that can be

seen as waste. Information management in building design is a key area for improvement when aiming at lean construction, since the energy put on producing drawings and specifications for each new object is out of proportion compared to the benefit, (Nasereddin et al 2007). One of the first steps towards automation is a distinct documentation of the product as a base for an information strategy, (Ford et al 1995).

This paper presents a case study of six medium-size Swedish manufacturers of prefabricated timber buildings. This paper focus on describing what properties an information strategy should have for an application in industrialised construction. The feasibility in industrialised construction of some established product modelling tools are discussed. The importance of a rational information management within the companies is identified as a success factor.

2 THEORY

Several methods for documenting product structures exist in the research community, although few have been fully implemented in the construction industry. The following

chapter will present some possibilities, however alternative methods exist.

2.1 Product modelling with CRC cards

The purpose of CRC (Class, Responsibility, and Collaboration) cards is to document objects primarily for software programming. The concepts and modelling techniques of CRC have later been adopted (Hvam and Riis, 1999) to product modelling within the construction industry, visualising products prior to actual software programming. CRC cards are used to record objects, their behaviour, responsibilities and relationships. The CRC card method is a low-tech, easy way of documenting products, transferring knowledge from domain experts, possessing knowledge about the product, to system developers who perform the actual programming. The method defines, besides the CRC cards, different phases where objects are identified, structured, understood and documented in a product model. CRC cards can also fulfil a purpose once the software is implemented supporting maintenance and further product development.

The CRC card, fig. 1 is used for interpretation of the physical product into programming code, a configuration software. For various purposes different views of the product model are created. Sales, design and manufacturing preparation etc. have different information needs and therefore various viewports are established, in compliance with Gross (1996). A general sketch of the hierarchical product structure must be presented in addition to the CRC cards, establishing the relationships between the parts. Together they present enough information to construct a configuration tool.

Implementation of configuration software is described by Haug and Hvam (2006) in steps where CRC cards constitute one phase. Implementing configuration tools is a process that involves far more than the technical description of the product, however it is an important step. The following seven steps are suggested (Haug and Hvam, 2006):

1. The processes in which product specification is made are mapped out. There has to be an understanding of what the configuration tool are to support.
2. Product analysis, existing product ranges are analysed.
3. Object oriented analysis, results in a specification of requirements for the product structure
4. Object oriented design of configuration software. The analysis model created in step 3 is adapted to the configuration software.
5. Programming. Existing software is adapted or new software is developed. The CRC cards are used when programming the system with objects and rules.
6. Implementation of the completed configuration software and future specification process.
7. Maintenance and further development

If using CRC cards for maintenance and product development it is an advantage if they are handled digitally, eventually integrated with the code in the configuration software. In this way changes in rules can be made in the system and the software can tell which cards are affected by the changes, or even update them automatically.

Object no.	Object name	Date	Author
Object mission:			
Superparts:		Superclass:	
Subparts:		Subclass:	
Sketch:			
Responsibilities		Collaborations	
Object knows			
Object does			

Figure 1. CRC Card (Hvam and Riis, 1999).

2.2 Product family modelling

Most implementations of product modelling regarding construction are primarily oriented towards establishing a Building Information Model (BIM) and general information modelling of the traditional building process.

A theory based on mass customization (MC) is described by Jørgensen and Petersen (2005), where product fundamentals for being applicable to product configuration are listed. A series of product variants building up a product model is described. Applied to buildings, a product model could be represented by a family of houses all originating from the same design. The product model must fulfil not only the purpose of describing all modules included, but also the rules for how they relate to each other. One important aspect brought up by Jørgensen and Petersen (2005) is that most methods for product configuration are focused on modelling the geometrical solution space of a configuration process. It often describes possible choices and how to build actual product structures, whereas it is just as important to include information concerning customer, logistics etc. Information can typically be prices, stock etc.

Jørgensen and Petersen (2005) also bring up the aspects of modular properties, which are connected to customer requirements. Customers do not need to specify the technical solution; instead a range of product properties is chosen which corresponds to a certain combination of modules and components, fig. 2. The technical specification can be handled by technical staff or a salesperson instead of the customer.

According to Jørgensen (2005) “a model can serve as a foundation for the configuration process because it has a set of open specifications, which has to be decided to determine or configure an individual product in the family”. In construction the amount of open specifications tend to be massive. Therefore it is fundamental that detail and context of the model is set in a way that facilitates the specification process as much as possible. The easiest way of product configuration is selecting a set of pre-defined modules, assuming it is unnecessary to adjust or construct new modules. However, if modules have to be modified or added, the configuration tools must be constructed accordingly.

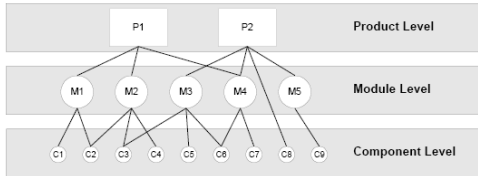

Figure 2. Combining components to modules and products, (Jørgensen 2005).

Product development using a product family modelling approach has to apply the modular design concept. New products and modules must be developed for modular design. Also it is vital that the company not only defines implementation of a configuration tool as an ICT-project (Jørgensen 2005). Besides understanding the ICT-tools it is essential to gain knowledge of the product range, business processes, and organisation and markets demands in order to succeed with a configuration system. This is not just a question of choosing the best ICT-tool on the market.

The benefits of using configuration systems have been explored in Denmark and Finland by Jørgensen (2005) and Männistö et al. (1998) respectively:

Männistö et al. (1998)

- Ability to fulfil a wide range of customer requirements
- Shorter lead times in the sales-delivery process
- Increased control of the production
- Reduction in customer-specific design
- Efficient way to offer a broad product line
- Improved quality

Jørgensen (2005)

- Establish a link between the sales department and the production
- Secure fully specified orders
- Secure valid product documentation
- Easier to deal with large number of variants
- Less maintenance of production documentation
- A tool for proactive sales

Both research groups find increased quality and control as the main benefits, which is exactly what industrialised construction is about.

2.3 IFC for the construction industry

IAI (International Alliance for Interoperability) has taken on the challenge to standardize information exchange in the building sector through launching Industry Foundation Classes (IFC). The IFC standard is an object oriented

data model for the building industry and facilities management. Within the IFC model, geometry, building component properties, costs etc. can be incorporated. Information can be made interpretable by virtually any application that works with structured data handling of AEC building projects, (Froese 2002). IFC models are intended to work as a neutral information exchange format. IFC development work is based on the EXPRESS data definition language that is part of the STEP standard.

Rönneblad and Olofsson (2003) developed and implemented IFC models for precast concrete elements in the expert system IMPACT, an application used to design precast concrete elements with automatic generation of drawings. IMPACT functions as a manufacturing preparation tool and imports the architectural model with windows, openings etc. The precast designer then uses the geometry created by the architect to model precast concrete elements. The refined model was then exported to the IFC model server attributed with BSAB classification codes. (BSAB is a Swedish industry standard for labelling and classification of building object). The BSAB code is later used for extraction of data to estimation and scheduling software. The information transfer through IFC was not complete e.g. information about cast in material was lost in the export due to lack of support for precast elements in IFC 2.0.

Conclusions on IFC drawn by Rönneblad and Olofsson (2003) coincides with Ekholm et al (2000), who states that “The main criticism that can be addressed to IFC is the prominent lack of an expressed basic philosophy and pedagogical descriptions related to practical needs“. In reality this means that the same type of problem is not solved consistently throughout the different parts of the IFC standard. There is also an underlying criticism towards the top-down approach of the implementation of the standard, not connecting to practical needs.

According to Froese (2002) significant portions of IFC is currently a mature and stable standard, however work still remains in specific areas. Efforts have been made to develop IFC, e.g. for precast concrete elements and structural timber, both of which are partly included in the latest release IFC 2x3. The work in structural timber is still ongoing and has the goal of supporting automatic exchange of data between computer systems from design through to automated manufacturing.

2.4 The information engineering method

A comprehensive introduction to the information engineering method (IEM) is given by Martin (1986). It builds on a gradual increase of level of detail, from abstraction to physical facts. The process is facilitated by the Information Engineering Facility (IEF) Computer Aided Software Engineering (CASE) tool. The main strength of IEM is that it connects the information strategy to the industrial goals of the company. IEM is realised in seven steps:

1. Information Strategy Planning
2. Business Area Analysis
3. Business Systems Design
4. Technical Design
5. Construction
6. Transition
7. Production

The CASE tool is similar to a CAD tool, but for software development and produces graphical representations of processes. The distinction between data modelling, activity modelling and product modelling is made clear. These three areas have their own special tools, where product modelling e.g. can be realised through IFC and activity modelling through IDEF0. The feasibility of the information engineering method in the construction sector was tested by Ford et al (1995). Findings were that IEM is useful on a strategic level, but must be completed with object-oriented methods when reaching more detailed levels.

3 CASE STUDY

The case study involved six companies with a clear pre-fabrication strategy. The companies are medium-sized, approximately 100 employees, with around 20% of the staff working with design and administration and the remaining engaged in production. All six companies use timber for the load-bearing structure, a heritage from the dominant position of timber on the Swedish market for single-family dwellings. Five of the companies have chosen to manufacture modular houses inside a factory, reducing the building site to mere montage, fig. 3. The volume elements are finalised with claddings and HVAC installations, which are connected on site. Buildings using the modular technique can be up to five stories high. The sixth company produces flat elements (walls and floors) and mounts them on site.

Two of the companies sell directly to private customers, while four of them work with professional customers who in turn sublet dwellings or public premises. Two of those companies work mainly with public premises, such as schools and prisons. They are forced to follow drawings and specifications made by a third party consultant under the restriction of the Government Procurement Agreement (GPA) and compete with traditional construction firms on the open market.

Organisation in the studied companies is often clear, however not process oriented in any formal way. Building projects follow predefined paths, which involve multiple departments. There is no clear process orientation or process leader, which can create complications in co-operation between departments. The ownership of improvements concerning multiple departments or product development does not seem to have an appointed function. Theoretically the companies have all the prerequisites to control both the processes and the resources used, but in reality an organisation focusing on streamlining the production has not yet been established, which is consistent with the findings of Nasereddin et al (2007).

All companies were visited and studied at their production plants, interviewing employees from all departments from sales to production to screen the process. Drawings were studied to describe the documentation of the building system. Questions were also posed on the information strategy and its implementation.



Figure 3. Modular house production.

3.1 The sales process

The two companies working directly with private persons as customers use sales agents spread out through Sweden as the communicator of the building system. The sales agent works with an extranet, where information regarding the product range, including choices of material and prices etc. have been posted. The company itself remains idle until a contract between the customer and the company has been signed. Detailing is then decided iteratively, through communication between the design department and the sales agent.

This is a process that generates much information in form of documents, emails etc. and there is no system for managing this data. The finalised product specification is gathered in a manufacturing order, which follows the product through manufacturing. The manufacturing order is the main document where specifications are recorded, but there is no ICT tool coupled to its conception or re-

finement, it remains a written paper throughout. When the process of product specification has come to so much detail that an application of a building permit can be submitted, drawings are made by the design department at the company.

The four companies working with professional customers do not use sales agents, but have skilled salespersons in-house, whose main task is to establish good relations with customers and satisfy all their requirements. The salesperson must have good knowledge of the building system, good conception of costs and constantly be aware of the order stock to present a correct product offer to the customer. Two of these companies work mainly with design-and-build contracts, controlling design, specification, manufacturing and erection in-house. The two others work with public premises, under the restriction of the Government Procurement Agreement (GPA). This means that the companies have limited possibilities to change specifications in the tender, which leads to inefficient design for industrialised manufacturing.

3.2 *The design process*

The two companies working with sales agents use standard type houses as templates for the production of drawings. The standardisation has inspired these two companies to invest in ERP-systems (Enterprise Resource Planning) for economical follow-up and material and resource planning (MRP). Unfortunately, the CAD software and the ERP system does not communicate with each other, resulting in the product (the building) being defined in two different ways, not seldom with discrepancies. Standard CAD software for construction is used to produce drawings printed on paper. Bill of materials is produced as quantity take-off directly from drawings and listed in Excel (no link between CAD and Excel for this purpose). The specifications needed for manufacturing are listed using Excel or Word.

The four companies working on the open market with professional customers cannot use standard type houses, since the customer defines the main characteristics of the building. Standardisation is instead sought in the manufacturing process, by defining standard joints, standard stairwells, standard wall and floor sections etc. Since the layout of the building affects the manufacturing to a large extent, strategic alliances with architects and customers are sought to streamline the design process. Building design is performed in two stages; first the architectural design that defines the building envelope and divides it into modules suitable for manufacturing; secondly the detailed design where the elements building up each module is documented on manufacturing drawings. HVAC installations are also designed twice; on a building level and on an element level, in some cases by in-house consultants and in some by external ones. Standard CAD software for construction is used to produce drawings printed on paper. Bill of materials is produced as quantity take-off directly from drawings and listed in Excel (no link between CAD and Excel for this purpose). The written specifications needed for manufacturing are listed using Excel or Word. Ordering of materials is made based on the bill of materials as a manual action.

3.3 *The manufacturing process*

The design process results in a bunch of manufacturing drawings and lists, which are used as steering documents for manufacturing. None of the studied companies have automated their production plants, but plans exist in several of them. Work is based on craftsmanship with hand-held tools. The factory seems to work as a stand-alone production unit and the drawings produced have a strong resemblance to those used for on-site construction.

The capacity of the production plants vary, on the average 150 m² finished volume elements are produced each day. The degree of prefabrication is taken as far as possible; the finished volumes contain fully equipped kitchens, finalised bathrooms and all interior claddings. Only components at risk for theft are delivered directly to the building site.

3.4 *Building system documentation*

The results of the study show that the technical platforms, i.e. the building systems, very much build on the same principles. The degree of prefabrication is what differs between the companies. Parts can be categorized in two main groups of information – detail and type solutions. Detail solutions describe meetings between components for example a joint between two wall segments. Detail solutions can also encompass specific methods for e.g. mounting kitchen assemblies. Type solutions describe general solutions for elements with a cross section, e.g. walls and floors, but not their geometrical extent, only the layer constitution.

Rules regarding assembly and limitations of the technical platform are not consistently described. They exist on different levels in the organisation and are not documented with a consistent method. Many of these rules have not been documented at all and exist only in the mind of the employees. The rules affect the modularisation in the design process, which is one of the reasons why they must be documented methodically.

Type and detail solutions are documented in a drawing archive at the studied companies. These drawing archives often lack possibilities for attributing search tags, which makes it difficult to find specific information. No specific person is assigned the function of managing the building system. This means that product development is not a separate process within the companies, but rather an activity that arises in project after project. Therefore, the change of the building system over time is not traceable. There is a risk for reinvention of already used solutions, but more severely the non-existent product development process prevents the use of modularisation strategies and consistent handling of rules for the building system.

3.5 *ICT tools*

All of the companies work with a range of ICT tools to support their production. However, the linkage between the ICT tools is poor, leading to information loss and iterative recalculations of the same data. Two of the studied companies use ERP systems to keep track of the material flow, material orders and stock take-off. The ERP system and the CAD software do not use the same data exchange

format c.f. The Design Process above. The communication problem between the systems arises since the CAD software stems from the construction industry, while the ERP system is developed for the manufacturing industry – differing data formats and database technology hinders the information flow. So why cannot the companies exchange one of the systems? If deciding to use a CAD software from outside construction, all templates and symbols needs to be redefined. Furthermore, suppliers of materials (e.g. windows) also supply CAD-symbols ready-for-use predominantly in AutoCad format. ERP systems developed directly for the construction sector seem non-existent. General time plans for the project from the ERP system are enhanced and revised in other ICT tools at each department in the company. Apart from the larger systems, individual solutions with Excel and VB-scripts are extensively used to automate smaller sub-tasks. The data is not migrated into any receiving system.

The four companies that do not use ERP systems instead have problems with information management. It is clear that the process focus has not yet reached the design process. Information is dependent on individuals and the lack of an overall process management is prominent. There is no central management system that controls the progress of the process; therefore it is difficult for individuals to keep track of the progress. Projects are defined in the early stages through CAD-drawings and PDF documents with specifications. CAD data is seldom re-used in the following detailed design, merely as print-outs. Bill of materials are not produced with CAD data as the basis, but are Excel lists enhanced with a VB-script to automate the process. Scheduling for manufacturing is done by the plant manager who also controls the supply of materials. The work is manual with standard tools (Excel, MS Project).

4 ANALYSIS AND DISCUSSION

First of all, industrialised construction is a mixture of two worlds. To stay competitive on the market, these companies need to stay compatible with the tools available in their field (templates from suppliers, common estimation data) and also deliver data that is accepted by the customer (relational documents in the correct format). Any deviation from this route creates immediate problems, increasing in-house administration, which is exactly what these companies try to avoid. On the other hand, an industrialised process is sought, to improve quality and control. Industrialisation is not supported by common ICT tools for construction, therefore companies want to learn from the manufacturing industry and attempts have been made to incorporate tools such as ERP systems. Once again, the link to established construction software is missing, increasing in-house administration.

This is seemingly a problem that could be overcome by using a neutral exchange format such as IFC or STEP. The only problem is that IFC is developed for the construction sector and STEP for the manufacturing industry. Suppliers of ICT tools have the same specialisation in sectors and tend to support one of the formats, not the other. Traditionally, the level of detail in modelling soft-

ware in the construction sector is poor (e.g. studs are usually represented as belonging to a layer and nails are not even incorporated). As preparation tools for manufacturing, common CAD tools do not perform well. A complete model including details as nails might on the other hand be too heavy to work with. Modularised ICT tools would serve well. Today, there are some tools that have the potential of filling this gap, but their main drawback is that the support for HVAC installations is non-existent. The strategy for a single company is individual and at this moment, there is no common clear working method that is recommendable or reliable.

If the aim is to industrialise production it is painfully clear that the companies must learn to document their own product. All automation relies on well-documented products including the connection between the product modules. All of the studied companies can easily document their product structure in terms of what building parts their system consists of and how they are built up in detail. This type of information is well communicated today. Even working methods for detailing are documented e.g. specifying nailing distances or mounting instructions for windows. What is missing is a systematic approach to describing and realising the connections between building parts, such as Product Family Modelling. According to Hvam and Riis (1999) experiences from a number of Danish companies show that the implementation of product models done without a proper method or modelling technique often resulted in an unstructured and undocumented system, which made it very difficult or nearly impossible to maintain and develop the product model further. An alternative to product family modelling could be the information engineering method using the IEF CASE tool, Ford et al. (1996).

In the IFC standard, the connection between parts is represented by a direct parent-child relation. IFC have mostly been used in the traditional construction process, facilitating communication with model based CAD. However, the authors would like to raise the question if it is possible to use IFC as a foundation for building generic product structures, instead of just documenting existing instances. In the case study presented, companies will have to build product structures that can serve as a product model for customer adapted instances. Eventually, IFC could be used as this generic product structure. The idea was tested in Ekholm et al (2000) with discouraging results. In the industrial production of timber houses companies control far more of the value-chain and thus chances of success are greater. A strong factor against the approach is the companies' lack of understanding for the benefits of a standardised product model and the efforts needed to establish it. Männistö et al. (1998) further claims that *“STEP is fundamentally based on a fixed standardized product schema that cannot be extended for the purposes of a company. In our view, this seriously limits the potential of STEP when companies start utilizing more advanced product modelling concepts.”* The same statement should hold true also for IFC as it is based on the STEP standard.

CRC cards on the other hand, are more focused on relations between parts and might be a good working method for a company in the documentation of their current building system. The question is whether it is good strategy or

not to pursue CRC cards and move on to the development of a configuration system? Jørgensen (2005) and Männistö et al. (1998) both claim better conditions for industrialisation using configuration systems in terms of quality control and process orientation. Still, the development of a configuration system for the industrialised construction sector needs to stay compatible with the construction sector in general, different from the approach in Gross (1996). The configuration system needs to offer a support for manufacturability without becoming yet another administrative burden. This calls for a development where both the working methods and the tool itself are taken into account, providing a possibility to simultaneously improve internal work processes and ICT support.

The actual product definition within the studied companies seems to be debated. Administration claims that the product is defined already in the ERP system fed from the manufacturing order. The structural designer does not agree, since detailing is never done in the early stages, and instead claims that the CAD software defines the product. Follow-up using the ERP system is then difficult to perform since the data created in CAD cannot migrate back to the ERP system automatically. The work flow with interacting product data and economic management is common in the manufacturing industry, where work flows and information paths generally are better documented, (Johnsson et al. 2006). This is a need that must be addressed in the future, both by companies deciding on an information strategy and by ICT developers providing reliable solutions. Once again, a good documentation of the information flow within companies is the first step towards a strategy, (Ford et al, 1996). The process, the ICT tools and the building system are tightly linked to each other, which means that improvements must address them simultaneously in a context, not separate from one another.

5 CONCLUSIONS

This paper has identified the need for well-documented building systems at companies striving to industrialise their production. Methods to achieve a description exist, but generally there is a lack of methods describing connections between modules in a consistent manner. To achieve a reliable description of a building system a combination of methods is proposed. CRC cards can be used for screening and mapping the building system, (Hvam and Riis 1999). To take control of the manufacturability, a configuration system is useful. The core of the configuration system could possibly be based on the IFC standard, opening up a path for neutral communication between ICT tools. The key point to succeed with ICT and industrialisation is to recognise the dependency between the development of working methods and ICT tools. This could be addressed with the information engineering method as an umbrella, (Ford et al. 1996). Companies wanting to develop in this direction cannot wait until ready ICT solutions are at hand, and ICT suppliers need to truly understand what industrialised construction is about.

5.1 Future work

There is a gap between the developed, large standards for information exchange and the true needs of smaller companies. There is room for a condensation of methods, narrowing down to sector specific problems, in order to support industrialisation. This might eventually lead to a reformulation of existing methods and standards. The near future goal of this ongoing project is to make a documentation of a building system, with the aim of establishing a configuration system for industrialised construction. This will present a good evaluation test for the applicability of existing standards for industrialised construction.

REFERENCES

- Ekhölm A., Häggström L., Tarandi V., Thåström O. (2000). Application of IFC in Sweden – phase 2. Working report A15, The Swedish Building Centre, Stockholm, Sweden, <http://www.itbof.com/2002/slutrappporteng.pdf>.
- Ford, S. et al. (1995) En information engineering approach to modelling building design, *Automation in Construction*, 4(1995), pp. 5-15.
- Froese T. (2003) *Future directions for IFC-based interoperability*, ITcon Vol. 8, pp. 231-246, <http://www.itcon.org/2003/17>
- Gross, M.D. (1996) *Why can't CAD be more like Lego?* *Automation in Construction*, 5(1996), pp. 285-300.
- Haug A. and Hvam L. (2006) CRC-cards for the development and maintenance of product configuration systems. In *Customer Interaction and Customer Integration*, GITO-Verlag, Berlin, ISBN: 3-936771-73-1.
- Hvam L. and Riis J. (1999). "CRC Cards for Product Modelling." In *proc. of the 4th Annual International Conference on Industrial Engineering Theory, Applications and Practice*, San Antonio, Texas, Nov 1999. <http://www.ipl.dtu.dk/Forskning/Før%202004.aspx?lg=showcommon&id=186875>.
- Johnsson H., Persson S., Malmgren L., Tarandi V., Bremme J. (2006) *IT-stöd för industriellt byggande i trä (in Swedish)* Technical report 2006:19, Div. of Structural Engineering, Luleå University of Technology. <http://epubl.ltu.se/1402-1536/2006/19/LTU-TR-0619-SE.pdf>.
- Jørgensen K.A. (2005) *Product Configuration and Product Family Modelling*, <http://www.iprod.auc.dk/~kaj/documents/common/ProductConfigurationAndProductFamilyModelling.pdf>.
- Jørgensen, K.A. and Petersen, T.D. (2005) Product Modelling on Multiple Abstraction Levels. *International Mass Customization Meeting 2005 (IMCM'05)*, Klagenfurt, Austria, 2005.
- Koskela, L. (1992). *Application of the new Production Philosophy to Construction*. CIFE, Technical Report #72, Stanford University.
- Martin, J. (1986) *Information Engineering*. Vol. 1-4. Savant.
- Männistö T., Peltonen H., Martio A., Sulonen, R. (1998). "Modelling generic product structures in STEP" *Computer-Aided Design*, Elsevier, 30(14) 1111-1118.
- Nasereddin, M., Mullens, M.A., Cope, D. (2007) *Automated simulator development: A strategy for modeling modular housing production*. *Automation in Construction*, 16(2007) pp. 212-223.
- Rönneblad A and Olofsson T (2003) Application of IFC in design and production of precast concrete constructions, *ITcon Vol. 8*, pp. 167-180, <http://www.itcon.org/2003/13>

Paper II

INFORMATION MANAGEMENT IN INDUSTRIAL HOUSING DESIGN AND MANUFACTURE

PUBLISHED: June 2009 at <http://www.itcon.org/2009/11>

EDITOR: Björk, B-C

Stefan Persson, Tech. Lic.
Div. of Structural Engineering, Lund University, Sweden
stefan.persson@tyrens.se

Linus Malmgren, M. Sc.
Div. of Structural Engineering, Lund University, Sweden
malmgren.linus@gmail.com

Helena Johnsson, Ph. D.
Div. of Structural Engineering, Luleå University of Technology, Sweden
helena.johnsson@ltu.se

SUMMARY: Industrialized production of building components, or entire houses, reduces activities at the construction site to the assembly of parts and has the potential to increase productivity and reduce the design effort invested in every project. However, in order to realize all of the potential efficiency gains that use of predefined components could deliver effective, interoperable information management systems are required. This article presents a multiple case study investigating the processes, products and ICT environment involved in industrialized house construction from an information management perspective, focusing on six Swedish companies that manufacture timber frame elements and one that makes precast concrete elements. The aim of the study was to identify critical aspects of information management related to industrialization in the sector. The findings show that companies aiming to enhance control and productivity by improving information management need a better understanding of the requisites for efficient industrialized construction in terms of ICT support. Changes in the perspectives of the construction companies appear to be needed in terms of not only the manufacturing processes, but also information management. Three main areas are identified that should be prioritized before any investments in ICT can be implemented effectively: formal description of the relevant processes, detailed description of the product range and its full variety, and creation of an appropriate information systems strategy.

KEYWORDS: Timber frame houses, precast concrete elements, industrialized construction, information management, building product model

REFERENCE: Persson S, Malmgren L, Johnsson H (2009) Information management in industrial housing design and manufacture, *Journal of Information Technology in Construction (ITcon)*, Vol. 14, pg. 110-122, <http://www.itcon.org/2009/11>

COPYRIGHT: © 2009 The authors. This is an open access article distributed under the terms of the Creative Commons Attribution 3.0 unported (<http://creativecommons.org/licenses/by/3.0/>), which permits unrestricted use, distribution, and reproduction in any medium, provided the original work is properly cited.



1. INTRODUCTION

Several modular house companies are currently manufacturing complete volumes/elements off-site in Sweden. Use of the prefabrication strategy changes construction companies from project-oriented building contractors to production-oriented manufacturers. Unfortunately, however, information management within the companies has not developed at the same pace, and documentation of their projects in many respects still resembles that of on-site construction projects.

The building design process generates large amounts of information, and time is often wasted searching for, sharing and recreating information. One reason for this is the lack of interoperability between software used in the various stages of the building process. Gallaher et al. (2004) estimated that the annual cost of inadequate interoperability in U.S. capital facilities amounts to as much as \$15.8 billion. Therefore, information management in building design is a key area for improvement in attempts to improve the efficiency of the construction process (Nasereddin et al, 2007).

The study presented here identifies problems related specifically to information management in industrialized house design and manufacture – which are likely to impede overall growth in productivity and the exploitation of economies of scale in the sector – and considers their underlying causes. We believe that more refined information management systems and the use of product models could serve the same purposes in the industrial prefabrication of construction units as in manufacturing industries, i.e. facilitate the timely and efficient use of information, reduce lead times and costs of processes such as product specification, and tighten quality control.

2. FUTURE PERSPECTIVES FOR INFORMATION MANAGEMENT IN INDUSTRIALIZED CONSTRUCTION

Tailoring ICT support presents a strategic opportunity for optimizing information management in industrialized construction, and hence reducing the inefficiencies highlighted by Gallaher et al. (2004) and Nasereddin et al. (2007). Furthermore, as noted by Björnsson (2003), use of an apt information system (IS) strategy – i.e. set of information resources organized for the collection, storage, processing, maintenance, use, sharing, dissemination, disposition, display and/or transmission of information (CNSS, 2006) – provides valuable support for a company’s business strategy. Thus, appropriate IT infrastructure and services, as illustrated in Fig. 1, are required.

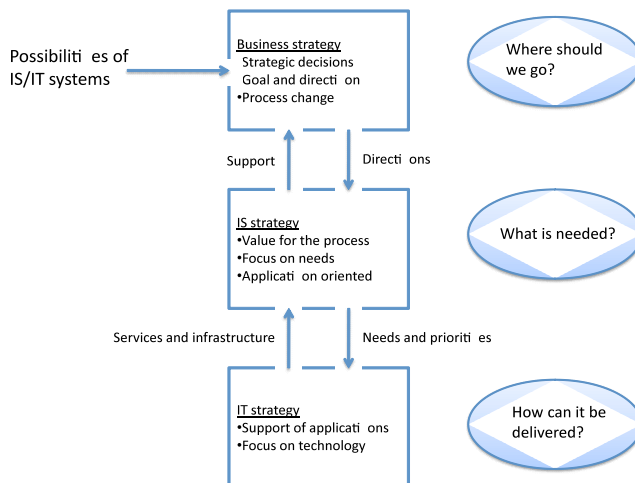

FIG 1: Information system. Adapted from Björnsson (2003).

This paper focuses on components of a company’s information system that describe its products, rather than the overall system. In a computer-based information system, formal descriptions of products (ideally designed and specified using compatible digital tools) can be stored in product data models. In the literature there are numerous definitions of such models, e.g. one by Shaw (1989), and specifically regarding product models for the building and construction sector the following definition by Björk (1995)... "A type of conceptual schema where the universe of discourse consists of buildings throughout their design, construction, operation and maintenance. A building product data model models the spaces and physical components of a building directly and not indirectly by modeling the information content of traditional documents used for building descriptions."

It could be established that a product model incorporates a formal and structured definition of product information of a manufactured artifact. Further on, the product data model is described in a conceptual schema expressed in an information modeling language. The procedure for defining a building product data model

usually starts with activities to capture the domain knowledge of a certain business or engineering process. This procedure, referred to as product modeling, generally involve collaborative efforts between domain experts and product modeling experts (Lee et al, 2007). An essential starting point is to establish specific purposes or objectives for the model, in order to identify the types of information that should be included (especially since construction products often contain large numbers of diverse components, thus if the purpose of the model is not clearly established at the outset the resulting model is likely to become unnecessarily complex).

In the building construction industry the term Building Information Modeling (BIM) is sometimes used, rather than product modeling, to describe the processes of generating and managing data during the entire life cycle of a building (Lee 2006). Hence, according to Succar (2009), BIM can be regarded as a methodology to manage product data throughout a building's life-cycle consisting of a set of interacting policies, processes and technologies. Smith (2008) states that "A basic premise of Building Information Modeling is collaboration by different stakeholders at different phases of the life-cycle of a facility to insert, extract, update or modify information in the Model to support and reflect the roles of that stakeholder".

A formal method that can be used to describe a product, and to define and conveniently reuse information required throughout the knowledge capturing and product modeling phases is the Georgia Tech Process to Product Modeling (GTPPM 2008; Lee et al. 2007). GTPPM is divided into several steps from acquiring domain knowledge to implementing a product model. Two of the phases are Requirements Collection and Modeling (RCM), including process modeling and specification of product information, and Logical Product Modeling (LPM). The RCM phase is equivalent to general process modeling, a key objective of which is to establish the processes that will be used to manufacture the product. Various approaches can be applied to meet this objective, and various commercial tools can be used, *inter alia* Flowchart, UML and IDEF0 (Lee et al, 2007). Process modeling essentially provides a way of understanding the process, which will be subsequently supported by the product model. In addition, the RCM phase includes the capture of product information used in the process, which can be described in the terminology used by the specific company.

The Center for Product Modeling (CPM)¹ has developed a method for designing and implementing product models to support product configuration processes. By including knowledge regarding various aspects of the product, information can be made more accessible throughout the company. The method developed by Hvam et al. (2000) includes the following seven steps:

- Mapping the processes of product specification.
- Product analysis, in which existing product ranges are analyzed. Product knowledge and product-related knowledge are identified and structured.
- Object-oriented analysis, which results in specification of requirements for the product structure.
- Object-oriented design of configuration software.
- Programming
- Implementation of the completed configuration
- Maintenance and further development

The product modeling methods mentioned above include both process and product analysis phases as a way to capture the domain knowledge, thus process and product documentation is important in any kind of product modeling effort. The product modeling methods mentioned above include both process and product analysis phases, and are cited to illustrate the importance of capturing relevant domain knowledge using interoperable systems, and thus the importance of appropriate process and product documentation in any kind of product modeling effort.

A term used by the CPM in its literature is "product range", which is used in the same sense as the term "product architecture", defined by the *Product Development and Management Association* Glossary for New Product Development as "*the way in which the functional elements are assigned to the physical chunks of a product and the way in which those physical chunks interact to perform the overall function of the product*". According to Smith (2007), there are two main types of product architecture: modular and integral. Modular architectures have high degrees of flexibility in product development and manufacture, each "chunk" incorporates one or a few functional elements and the interactions between them are well defined. In contrast, integral architectures have high degrees of stability and optimization, overall functions of the products are satisfied using more than one chunk, but each chunk incorporates many functional elements, and the interactions between chunks are ill-defined. However, modularity is a relative property (Ulrich and Eppinger, 2008), i.e. a product is rarely strictly

¹ CPM (Center for Product Modeling). The Association for Product Modeling, Denmark. Available from: <<http://www.productmodels.org>>, [Accessed: 4 June 2008].

modular or integral, instead products generally have varying degrees of both modularity and integrity in their architecture.

3. METHOD

This article is based on a multiple case study investigating processes, the ICT environment and product documentation in seven industrialized construction companies with the intention to elucidate the current status of information management in the sector, ways in which information is used throughout their processes and the requirements for adopting a product model approach. Current information management strategies were investigated, in terms of process and product documentation.

The case study material was gathered mainly through interviews with 3-4 key employees of each company, at their respective workplaces, involved in activities ranging from sales to manufacturing. Together with the subjects, the process from sales to manufacturing and assembly in their respective companies was mapped out, either on a whiteboard or using post-IT notes to minimize the risk for misinterpreting communications. The results were later transferred to IDEF0 process maps. In the same sessions information flows were also discussed to acquire an understanding of the information related to the various steps of the process. It should be noted that the two IDEF0 diagrams presented in the article were prepared by two different researchers. To obtain a complete overview of the ways in which information was processed and transferred in the companies, each company's Chief Information Officer was contacted to verify our model of their ICT systems. The information acquired was formalized in schemas. Additional information and various documents were gathered at the time of the visits to obtain an understanding of the companies' product ranges and product documentation strategy.

4. CASE STUDY

4.1 Brief introduction to the companies

Relevant information on the companies included in the case study (excluding their names for reasons of confidentiality) is summarized in Table 1.

Table 1: A brief introduction to the companies

Company	Architectural and Detailed Design	HVAC Drafting	Manufacturing
<i>Volume module producer 1</i>	<ul style="list-style-type: none"> Interface from sales: text documents, master time plan from separate software, calculations for offer from separate software Arch. Design: 2D AutoCad Detailed design: second CAD-system Bill of materials in spreadsheet 	<ul style="list-style-type: none"> Interface HVAC: import and export in Auto-Cad format. Occasionally paper drawings for detailed design. Made by external resources in Auto-Cad format 	<ul style="list-style-type: none"> Interface Manufacturing: printed drawings, data from second CAD-system feeds wall production, manual quantity take-off from drawings. Manual work apart from wall production Written documentation and printed drawings.
<i>Volume module producer 2</i>	<ul style="list-style-type: none"> Interface from sales: text documents, master time plan from separate software, calculations for offer from separate software Arch. Design and detailed design: 3D AutoCad format Bill of materials in spreadsheet 	<ul style="list-style-type: none"> Interface HVAC: import and export in Auto-Cad format. Made by internal resources in Auto-Cad format 	<ul style="list-style-type: none"> Interface Manufacturing: printed drawings, manual quantity take-off from drawings. Manual work Written documentation and printed drawings.
<i>Volume module producer 3</i>	<ul style="list-style-type: none"> Interface from sales: text documents, master time plan from separate software, calculations for offer from separate software Arch. Design and detailed design: 3D AutoCad format Bill of materials and time planning made in a calculation system 	<ul style="list-style-type: none"> Interface HVAC: import and export in Auto-Cad format. Made by internal resources in Auto-Cad format 	<ul style="list-style-type: none"> Interface Manufacturing: Written Printed drawings. Manual quantity take-off from drawings. Manual work Written documentation and printed drawings.
<i>Volume module producer 4</i>	<ul style="list-style-type: none"> Interface from sales: text documents, master time plan from separate software, calculations for offer from separate software Arch. Design and detailed design: CAD-system DDS Bill of materials and time planning made in spreadsheet 	<ul style="list-style-type: none"> Interface HVAC: Import and export in Auto-Cad format. Made by external consultant in AutoCad format 	<ul style="list-style-type: none"> Interface Manufacturing: Printed drawings. Manual quantity take-off from drawings. Manual work Written documentation and printed drawings

Volume module producer 5 (single homes)	<ul style="list-style-type: none"> Interface from sales: sales support system coupled to the ERP system, customer specifications transferred Arch. design made by external architect or in-house in 3D AutoCad format Detailed design in the same CAD-system. Bill of materials and time planning made in an ERP system 	<ul style="list-style-type: none"> Not necessary, single-family homes seldom have complex HVAC technology 	<ul style="list-style-type: none"> Interface Manufacturing: Printed drawings. Automatic quantity take-off from ERP system. Manual work Written documentation and printed drawings
Element producer 1	<ul style="list-style-type: none"> Interface from sales: sales support system coupled to the ERP system, customer specifications transferred Arch. design made by external architect or in-house in 3D AutoCad format. Detailed design in the same CAD-system Bill of materials and time planning made in an ERP system. 	<ul style="list-style-type: none"> Not necessary, single-family homes seldom have complex HVAC technology 	<ul style="list-style-type: none"> Interface Manufacturing: Printed drawings. Automatic quantity take-off from ERP system. Manual work Written documentation and printed drawings
Element producer 2	<ul style="list-style-type: none"> Interface from sales: master time plan, quantities and cost estimations in Excel spreadsheets Design and specifications are produced in CAD-system and product data including bill of materials are managed in a database 	<ul style="list-style-type: none"> Not necessary, since the producer only manufactures filigree floors and double walls 	<ul style="list-style-type: none"> Interface Manufacturing: NC data generated machine files Highly automated production line Control and monitoring, lift instruction, quality control reports, marking labels and marking labels through UniCAM

4.2 Timber frame houses

Six of the companies examined in this multiple case study construct timber frame housing using prefabrication strategies. The companies are medium-sized, each with approximately 100 employees, ca. 20 of whom are involved in design and administration, while the others are engaged in production. Five of the companies have chosen to manufacture factory-built modular houses, reducing activities at the building site to mere assembly, Fig. 2. The volume elements are prefabricated with claddings and HVAC installations, which are connected on site. The sixth company produces wall and floor panels that are assembled on-site.



FIG 2: Modular house production

The organization in the studied companies is often clear, not process-oriented in any formal way. Building projects follow predefined paths, which involve multiple departments. Theoretically, the companies have all the essential tools to control both the processes and the resources used but, in accordance with the findings of Nasereddin et al. (2007) they have not yet established an organization tailored for streamlining production.'

4.2.1 Process Model

Two of the companies deliver directly to private persons, and use sales agents spread throughout Sweden as communicators of the building system. The sales agents use an extranet, which provides them with information regarding the product range, including available materials and prices etc. The production facilities remain idle until a contract between a customer and the company has been signed. Detailed specifications are then decided iteratively through communications between the design department and the sales agent, as shown in the IDEFO lower-level (A2) child diagram presented in Fig 3, which provides details of the design phase in the overall process from the sale to the manufacture of modular houses outlined in a parent diagram (A0, not shown).

The sales process generates large amounts of informal data in the form of documents, emails etc., but currently there is no system for managing this information. The finalized product specifications are gathered in a manufacturing order, which follows the product through manufacturing. The manufacturing order is the main

document in which specifications are recorded, but there is no ICT-tool coupled to its conception or refinement; it remains written on paper throughout the manufacturing process.

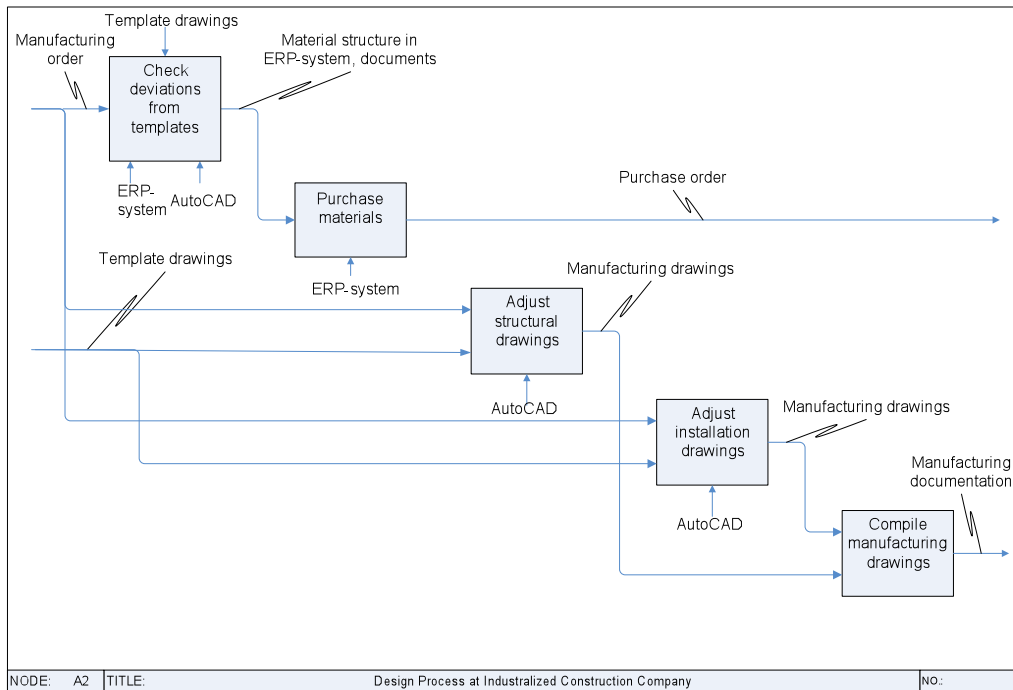

FIG 3: Extract (IDEF0 A2 child diagram) of the design phase from a process model at a Swedish company manufacturing modular houses

The other four timber frame companies operate in the open market with professional customers, and hence cannot use standard types of houses since the customers define the main characteristics of the buildings they require. Standardization is instead sought in the manufacturing process, by defining standard joints, stairwells, wall and floor sections etc. Since the layout of each building strongly influences its manufacture, strategic alliances with architects and customers are sought to streamline the design process. Each building is designed in two stages: first an architectural design is drafted that defines the building envelope and divides it into volumes suitable for manufacture, then a detailed design is prepared in which the elements contributing to each volume are documented in manufacturing drawings. HVAC installations are also designed in a two-step process, at a building level and at an element level, in some cases by in-house consultants and in others by external consultants.

The design process results in manufacturing drawings and bills of materials, which are used to control the manufacturing process. None of the studied companies have automated their production plants, but several are planning to do so. Work is based on craftsmanship with handheld tools. At each case company the factory seems to operate as a standalone production unit and the drawings produced have strong resemblance to those used for on-site construction. The capacities of the production plants vary, but on average 150 m² finished volume elements are produced per day at each plant. The degree of prefabrication may be very high; finished volumes may contain fully equipped kitchens, finalized bathrooms and all interior claddings.

4.2.2 ICT Models

All of the companies use a range of ICT tools to support their production. However, the links between their ICT tools are poor, leading to loss of information and iterative recalculations of the same data. Two of the companies use Enterprise Resource Planning (ERP) systems to keep track of the material flow, material orders and stock take-off. However, their ERP system and CAD software do not use the same data structures or compatible database programs (see section 4.2.1 above), which severely hinders the information flow between the systems, because the CAD software stems from the construction industry, while ERP-systems are not developed

specifically for construction. In addition, from the larger systems, individual solutions with Excel and VB-scripts are extensively used to automate smaller sub-tasks. The data are not migrated into any receiving system.

The four companies that do not use ERP-systems instead have problems with information management, and insufficient attention has clearly been focused on optimizing and integrating the design phase of the process to date. There is no central management system to control progress during the process, so it is difficult for individuals to keep track of the progress. Commissioned buildings are defined in early stages in CAD drawings and PDF documents with specifications, but the CAD data are seldom re-used in the following detailed design phase, they are merely used as printouts. Bills of materials are not based on CAD data either, but are compiled in the form of Excel lists enhanced with a Visual Basic script to automate the process.

4.2.3 Product Range Documentation

The findings of the study show that the technical platforms, i.e. the building systems, are very similar in many respects, the main differences between them are in the degree of prefabrication. Further, the parts they use can be categorized and described in two main groups of information – detail and type solutions. Detail solutions describe connections between components, e.g. a joint between two wall segments and may also encompass specific methods, e.g. for mounting kitchen assemblies. Type solutions describe general solutions for elements with a cross section, e.g. walls and floors, but they do not describe their geometry and dimensions, only the constitution of the layers.

Rules regarding the assembly and limitations of the technical platform are not consistently formulated, and they are not built into the CAD software. Instead, the rules originate at various levels in the organization and are not documented by a consistent method; in fact many of these rules have not been documented at all and exist only in the minds of the employees. Thus, there are few restrictions preventing designers creating designs that do not align with the building system, and in order to optimize the overall process systematically followed rules should be incorporated in the building breakdown structure from the start of the design phase onwards.

Type and detail solutions are documented in drawing archives, which often lack facilities for assigning search tags, which makes it difficult to find specific information. Furthermore, no specific person is assigned the task of managing the building system. Hence, product development is not a separate process within the companies, but rather an activity that is undertaken on project-by-project basis. Therefore, changes in the building system over time are not traceable and there is a risk for reinvention of solutions that have already been used and, more seriously the lack of a product development process prevents the use of coherent modularization strategies and consistent handling of rules associated with the building system.

4.3 Precast Concrete Elements

The studied Swedish concrete element company designs, manufactures and sells precast concrete structures for housing, offices, industries and farm buildings. Production capacity is 400 000 m² cast area per year at full utilization. In the factory, concrete elements, filigree floors and double walls are produced. In a building project, this production method means that walls and joists are produced at the plant, and then filled with concrete at the building site. No stock is kept at the factory; production and logistics are intended to deliver building components when needed, according to “just in time” principles. The components are placed on loading pallets in assembly order according to the erection plan. At delivery, the double walls are ready for installation, since electronic boxes, electronic tubes, sleeve couplings and recesses are fitted at the factory.

4.3.1 Process Model

An overall model of the process at the precast concrete company, in IDEF0 diagram form, is shown in Fig. 4. As illustrated in the diagram, a project starts when the marketing and sales department receives an order to deliver precast concrete structures for a building project. The sales department sends a number of documents, with analogical information on paper, to the design department, then product specifications of double wall elements and filigree floor elements are produced in AcadWand and AcadDecke (developed by IDAT), a CAD-system for the precast concrete industry. To increase flexibility the plant has also adapted its ICT system to enable design with IMPACT, a Swedish software package (developed by StruSoft) for the precast industry. This makes it possible to buy designs from consultants with access to these systems.

When elements have been specified, the system generates a machine file. To enable this, the CAD-system has been adapted according to the production control and monitoring system. The design department receives basic data digitally from architects and installation contractors as .dwg or .plt files.

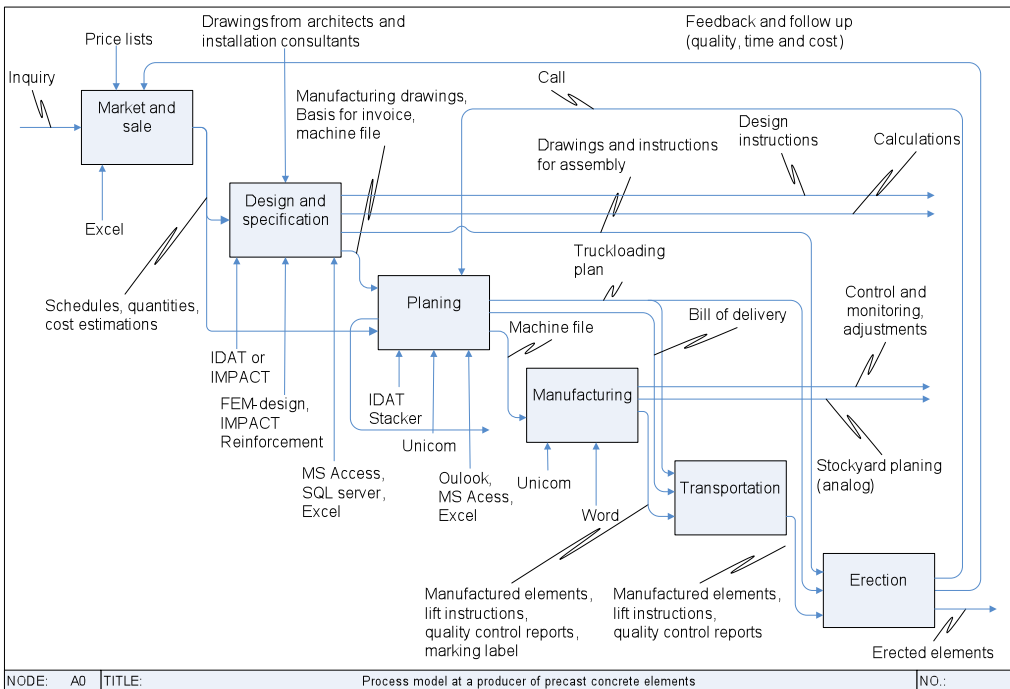

FIG 4: IDEF0 process and information model for the Swedish precast concrete company (element producer 2 in table 1)

During planning pre-production engineering is conducted, in which the generated machine file is tested by an error search before it is sent to the manufacturing apparatus via the control and monitoring system. In the planning tool IDAT Stacker a loading and detailed plan is made to determine the optimal range of production. The order of assembly on the pallets determines how the elements should be loaded, and thus the order in which the elements should be manufactured. The planning department also prints the construction drawings.

In IDAT Stacker the machine file is prepared for manufacturing. The file is sent to a control and monitoring system called Unicom. Here, any required adjustments to the machine equipment are made. Labels are printed from the system to keep track of the elements during transport. The manufacturing department provides the transport company with documents for inherent control. Lifting instructions are described in Word documents. The documentation of any temporary storage and loading plans is handled analogically at the plant. The planning department creates a delivery note for the transport company, and loading lists for both the transport company and the erection company.

During the interviews the personnel were clearly aware of the sub-processes and had mutual agreement regarding most aspects of the process relevant to their work, but such awareness was much less apparent when trying to map the information flow during the process. Furthermore, no defined product development process could be described, even though there is a close linkage between product development and the development of the production system due to the highly automated production line (so every change in the product affects the production system and vice versa).

4.3.2 ICT Model

Corresponding to the process and information model, there is an ICT system model showing interoperability between some (but not all) of the systems involved in the process, see Fig. 5. The ICT systems use different databases, and for them to be able to communicate with other systems several interfaces have been developed between different systems. The IDAT solution consists of a database and three main software modules (An administration, a “stacker” and a design tool module). The administration module handles the projects, and administrates the data files and the database. The “Stacker” module handles the data concerning the manufacturing process, and the “Design tool” module uses AutoCAD ADT to allow the user to design the

required concrete elements, in a CAD environment. The product data used in the design and manufacturing process are stored in a MS SQL-database, and MS Access is used as a user interface to communicate with the database.

With the IMPACT solution, product data used in the design process are managed in an Ingres database and design work is carried out in a module integrated within the AutoCAD ADT system. The machine file is generated through IDAT or IMPACT. The control system, UniCAM, uses a MS Access database to manage the data during the manufacturing process.

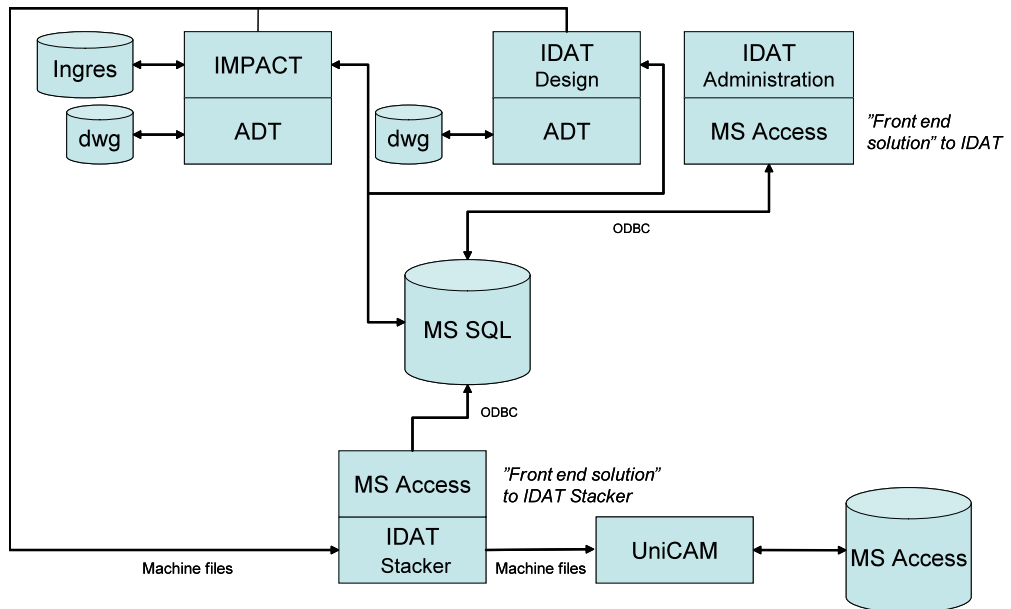

FIG 5: ICT model of the process at the Swedish precast concrete company (element producer 2 in table 1)

4.3.3 Product Range Documentation

In this case company there is no documentation of the product range to communicate with different stakeholders. However, the product range could be found in the information structure compiled in the databases and the CAD applications in IDAT or IMPACT. To illustrate the product range offered by the precast concrete company we use IMPACT as an example. For each precast company IMPACT develops a factory standard, which includes a product structure and allowed variants of the double walls. An extract showing the variants that could appear for each type of material used is presented in Fig. 6. The labels are numbers used for the identification of various articles managed at the company.

Relations and rules that define how different sub-assemblies and parts connect to each other are also implemented in IMPACT. In interviews with the employees at the company and the managing director of the company that developed IMPACT it was clearly apparent that the procedure applied to set these rules and relations in attempts to capture relevant domain knowledge is time-consuming when there is no formal independent documentation of the product range.

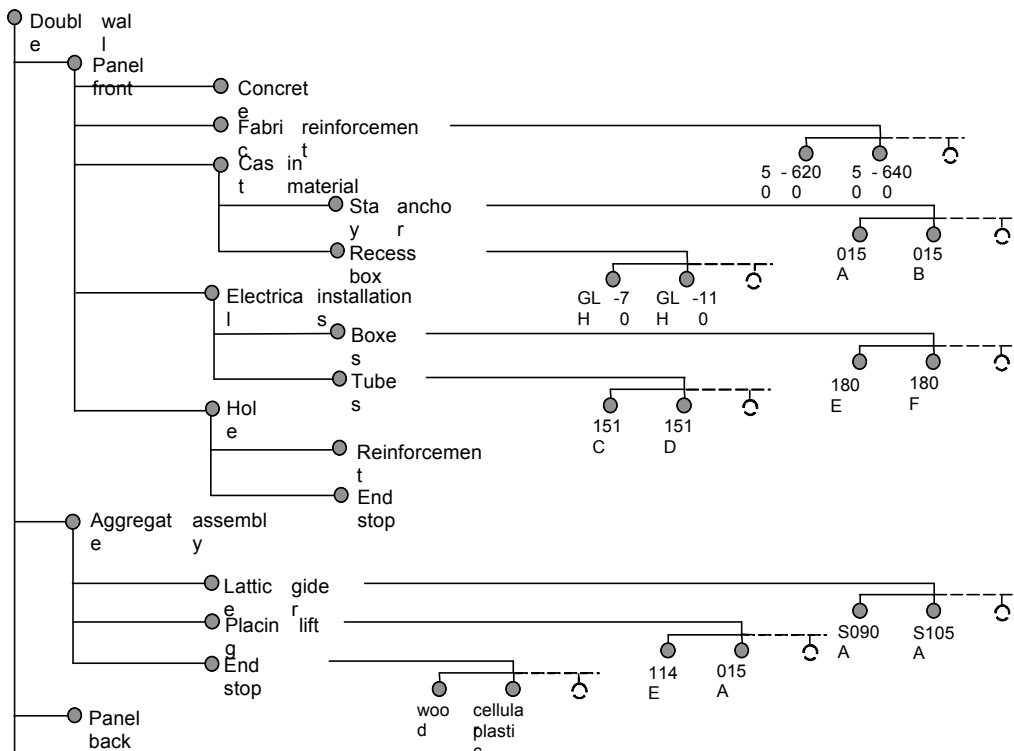

FIG 6: Extract from a product structure in IMPACT of variants in the design of a double wall that could be produced by the Swedish precast concrete company (element producer 2 in table 1)

5. INFORMATION MANAGEMENT ANALYSIS

Our analysis of the current situation in the case companies shows that much work remains to be done to implement rational and effective information management systems, especially within the studied timber frame companies. The systems are more closely integrated in the company that produces precast concrete elements, but even here potential improvements have been identified. Three main aspects of information management at the companies included in the study that could be substantially improved have been identified:

- Process orientation
- Product range documentation
- Information systems strategy

5.1 Process orientation

In this multiple case study the investigated companies in both the timber frame construction and precast concrete industries showed a lack of understanding of their existing business processes as well as difficulties in communicating them to other stakeholders. These deficiencies were clear even during the interviews with employees of the companies, since the interviewees were unable to describe their respective companies' workflows. None of the companies in the case study appear to have a distinct product development process in which building platforms are defined, instead major efforts are put into the design and adaption of every customer order, thereby exacerbating the lack of clarity of product definitions and the tendency of the designers to make changes in every project.

The industrial producers of the modular timber houses examined here need to gain more knowledge of the benefits they could acquire from a product development process. The findings indicate that there is an urgent need to introduce a product development process that accounts for the specific conditions of house manufacturing. At the manufacturer of precast concrete elements there is awareness that the product

development affects the manufacturing process due to the high degree of automation. However, product development is not considered a separate process, and thus there is a lack of strategy concerning issues other than the feasibility of manufacturing new or modified products.

5.2 Product range documentation

In all of the studied companies there is a need to describe the product range thoroughly in a formal way that provides a better overview than the current approach. The incomplete descriptions of the offered products do not cover the full range that the companies can provide customers and leave much scope for interpretation in every project. A contributory reason for the under-definition of the product ranges are that opinions differ amongst staff in the companies regarding the product assortment and its definition, so product specifications cannot be too rigorous. The overall product descriptions of the product ranges at the precast concrete company are incorporated in program instructions of the design module tools. Nevertheless, there are no visual descriptions of the product range that could be used to communicate with various stakeholders or support a product development process. Hence, one objective that has to be considered in both the timber frame and precast concrete companies is to internally agree on a mutual company view of the product range.

Timber frame house manufacturing is often seen as a trade with great traditions and has always been dependent on skilled craftsmen. Customer demands are fulfilled by applying specific solutions, but the same customer request may be fulfilled by various solutions depending on the designer, which results in unwanted product variety. A contributory factor to this variety is the lack of guidance provided by the CAD tools at the six timber frame manufacturers included in this case study. In contrast, at the precast concrete manufacturer the CAD tools do provide guidance, and demands for product variety are met by adding more part types and interfaces, which rapidly increases the complexity of the products, and the associated information. More variety means more product articles to manage in an information system, and thus higher costs (Ulrich 1995). For the investigated precast concrete manufacturer, its automated production equipment restrains product variety. In early stages of the process the company has to either accept or decline an order depending on whether or not its design is compatible with its production equipment, which sets the parameters of its product variety, since the costs of adjusting it to suit single, customized orders would widely exceed any profit.

A requirement for using ICT tools optimally to manage house design and manufacture is a formal description of the complete product range (Lee et al 2007, Hvam and Riis 1999), which should be provided by either product modeling of existing products or a product development process. However, there are no such formal descriptions as yet at any of the companies included in the study. Hence there is a need to create them, especially for the timber frame house companies, which lack product models that describe their products. Instead, they regard the drawings that describe the various elements they manufacture as their product documentation, and information associated with specific applications or types of document types is stored in various forms (analog or digital) with little interoperability. Furthermore, the documentation is incomplete and could not be used as a basis for implementation in an ICT system (Hvam et al, 2008) due to the lack of a data model that facilitates information management involving multiple systems.

When constructing a complex product (a building for instance) from modules, the addition of more parts rapidly increases the complexity of the product and the possible interactions amongst the parts (Erixon, 1998), which thus increases the interfaces required and the amounts of associated information. Hence, managing the manufacture of a complex product requires well-defined product structures and well-developed information systems; the simpler the product model can be kept, the more efficiently it can be managed. For buildings this is especially relevant because of the complexity and high numbers of components they contain. However, regardless of the type of product being made, it is important to thoroughly define the product structures in order to maximize the efficiency of the information management.

5.3 Information systems strategy

In the precast concrete case company the information system includes several data models describing different aspects of the product and the manufacturing process. Consequently, there is a more refined strategy for managing information than in the timber frame construction companies. Nevertheless, synchronization between models and the production of information in the product development process could be improved. A hindrance is that the description of the product is embedded in different ICT systems and not accessible in a visual format to facilitate communication with different stakeholders. An alternative for the company is to develop an independent product model that supports the company process model and the product range, thereby improving the interoperability between the different data models.

Many complications arise when information has to be transferred from one system to another within all of the studied companies. This is a common complication associated with inadequate information management and information system strategies within the companies. For example, computer applications used within the timber frame companies are basically the same as those used in traditional building design, purchase and scheduling. However, these tools may not be optimal for companies that straddle construction and manufacture. Current applications for construction do not provide sufficient detail and ability to structure information in a way that facilitates industrialized construction. In addition to the companies' inability to specify appropriate demands for ICT tools, there is a pronounced lack of capability to formulate long-term information system strategies that align with the strategies for products and manufacturing systems.

6. CONCLUSIONS

Systematic information management and better tailored information systems could yield substantial benefits for the timber frame manufacturers and precast concrete element manufacturer included in this study. It is apparent that structuring information more effectively, and applying a holistic information strategy at management level that incorporates use of information systems throughout the company as a whole could considerably reduce the costs of information processing. In order to realize these improvements, companies will have to prioritize the following areas:

- Describing the relevant processes formally
- Explicitly describe the product range and its variety
- Creating an appropriate, interoperable information systems strategy

Based on the case study findings, the authors conclude that the general level of knowledge concerning information management in industrialized construction within Sweden must be increased. This will hopefully lead to better and more precise demands for information systems that can be subsequently supported by specific hardware and software. For a company that is eager to boost productivity through tailored use of ICT, more knowledge should first be acquired about what they want to accomplish through the use of ICT (rather than seeking tools for specific applications. Industrialization should change perspectives on not just the manufacturing system, but also on information management. Higher levels of industrialization place greater, more sophisticated demands on information management, thus investments in industrial production also require adequate information management.

The need for a product data model that accounts for the specific needs of industrial house manufacturers has been recognized in this article. Future priorities in this respect include development of a model capable of describing the product range of industrial construction companies that could facilitate information management in terms of product specification and production. Such a model should consider the three critical areas specified in this article.

ACKNOWLEDGEMENTS

For financial support the Swedish Governmental Agency for Innovation Systems (VINNOVA), the Development Fund of the Swedish Construction Industry (SBUF) and Tyréns Ltd. is gratefully acknowledged. This work was performed within the Lean Wood Engineering Competence Centre at Luleå University of Technology, Linköping Institute of Technology and Lund Institute of Technology, all in Sweden.

REFERENCES

- Björk B-C. (1995). *Requirements and information structures for building product data models*, Doctoral dissertation, Technical Research Centre of Finland (VTT), Espoo, Finland.
- Björnsson H. (2003). *IT-strategier i företag och projekt (in Swedish)*. In: Wikforss Ö. ed. *Byggandets informationsteknologi (in Swedish)*. Svensk Byggtjänst, Stockholm, 51-87.
- CNSS (2006). *Instruction no. 4009 National Assurance (IA) Glossary*, CNSS Secretariat – National Security Agency, Ft. Meade, MD, USA.
- Eastman C. (1999). *Building product models: computer environments supporting design and construction*. Boca Raton, FL: CRC Press.

- Eastman C., Teicholz P., Rafael S., Liston K. (2007). *BIM Handbook: A Guide to Building Information Modeling for Owners, Managers, Designers, Engineers and Contractors*. ISBN: 978-0-470-18528-5. John Wiley and Sons.
- Erixon G. (1998). *Modular Function Deployment – A Method for Product Modularization*, Doctoral thesis, Dep. of Manufacturing Systems, Royal Institute of Technology, Stockholm, Sweden.
- Gallaher M., O'Connor A., Dettbarn J. and Gilday L. (2004). *Cost Analysis of Inadequate Interoperability in the U.S. Capital Facilities Industry*, NIST GCR 04-867, U.S. Department of Commerce Technology Administration (National Institute of Standards and Technology), Gaithersburg, MD, USA.
- GTPPM (2008) *Georgia Tech Process to Product Modeling Tool – User Manual*. Dept. of Architectural Engineering, Yonsei University, Seoul, Korea, available from: <<http://arch.yonsei.ac.kr/biis/gtppm/>>, [Accessed: 8 June 2008].
- Hvam L., Mortensen N. H. and Riis J. (2008). *Product Customization*, Springer-Verlag, Berlin Heidelberg, Germany.
- Hvam L. and Riis J. (1999). *CRC Cards for Product Modeling*, in Proceedings of the 4th Annual International Conference on Industrial Engineering Theory, Applications and Practice, San Antonio, TX, Nov 1999.
- Hvam L., Riis J., Malis M. and Hansen B. (2000). *A procedure for building product models*, In Proceedings of Product Models 2000 – SIG PM, Linköping, Sweden.
- Lee G., Sacks R. and Eastman C. (2006). *Specifying parametric building object behavior (BOB) for a building information modeling system*. Automation in Construction 15 (2006) 758 – 776.
- Lee G., Sacks R. and Eastman C. (2007). *Product data modeling using GTPPM – A case study*, Automation in Construction, Vol. 16, No. 3, 392-407.
- Nasereddin M., Mullens M.A. and Cope D. (2007). *Automated simulator development: A strategy for modeling modular housing production*, Automation in Construction, Vol. 16, No. 2, p. 212-223.
- Smith D. (2009). *Building Information Modeling (BIM) – Introduction*. National Building Information Modeling Standard. National Institute of Building Sciences. <<http://www.wbdg.org/bim/bim.php>>, [Accessed: 3 April 2009].
- PDMA (2008) *The PDMA Glossary for new Product Development*. Product Development and Management Association, available from: <<http://pdma.org>>, [Accessed: 31 January 2008].
- Shaw N. K., Susan Bloor M. and Pennington A. (1989). *Product data models*, Research in Engineering Design, Vol. 1, No. 1, 43-50.
- Smith P. (2007). *Flexible Product Development*, Jossey-Brass, San Francisco, CA, USA.
- Succar B. (2009). *Building information modelling framework: A research and delivery foundation for industry stakeholders*. Automation in Construction 18 (2009) 357–375
- Ulrich K. (1995). *The role of product architecture in the manufacturing firm*, Research Policy, Vol. 24, No. 3, 419-440.
- Ulrich K. and Eppinger, S. (2008). *Product Design and Development*, McGraw-Hill, New York, NY, USA.

Paper III

PRODUCT MODELING OF CONFIGURABLE BUILDING SYSTEMS – A CASE STUDY

SUBMITTED: December 2009
REVISED: August 2010
PUBLISHED: May 2011 at <http://www.itcon/2011/41>
EDITOR: Turk Ž.

Linus Malmgren, M. Sc.
Div. of Structural Engineering, Lund University, Sweden
mailto:linus.malmgren@kstr.lth.se

Patrik Jensen, M. Sc.
Div. of Construction Engineering and Management, Luleå University of Technology, Sweden
mailto:patrik.jensen@tyrens.se

Thomas Olofsson, Prof.
Div. of Construction Engineering and Management, Luleå University of Technology, Sweden
mailto:thomas.olofsson@ltu.se

SUMMARY: *This paper investigates a Swedish house manufactures building system regarding the documentation and information structures. The aim is to evaluate how product modeling technology can be used to facilitate product customization. By dividing the product in four different views the complexity of the product can be reduced and each view represent the interest of customer, engineering, production and assembly respectively. The analysis shows that the connections between the different view, i.e. the information transfer, is an area for potential improvements and little attention has been devoted to transfer information upstream from manufacturing and engineering to the customer view. The lack of information transfer can often lead to ad-hoc solutions in the customization process. We believe that successful cooperation and information exchange between these four views is the key to future development and customize-to-order configuration.*

KEYWORDS: *industrialized construction, modular houses, building product model, product customization*

REFERENCE: *Linus Malmgren, M. Sc., Patrik Jensen, M. Sc., Thomas Olofsson, Prof., M. Sc. (2011) Product modeling of configurable building systems – a case study, Journal of Information Technology in Construction (ITcon), Vol. 16, pg. 697-712, <http://www.itcon.org/2011/41>*

COPYRIGHT: © 2011 The authors. This is an open access article distributed under the terms of the Creative Commons Attribution 3.0 unported (<http://creativecommons.org/licenses/by/3.0/>), which permits unrestricted use, distribution, and reproduction in any medium, provided the original work is properly cited.



1. INTRODUCTION

Production methods of Swedish house manufacturers vary from almost manual carpentry to highly automated manufacturing units. Earlier studies in Sweden have concluded that information management in Swedish timber house manufacturing is relatively poor and similar to on-site construction (Johnsson et al. 2006; Persson et al. 2009). The information gap between sales, engineering and production departments often leads to situations where customer requirements are implemented using ad-hoc solutions that are not suitable for the existing production system. Traditional methods and use of project oriented IT-tools do not support the industrialization and automation of the house manufacturing industry (Johnsson et al. 2007). Therefore, new methods and IT systems need to be developed and integrated in the design and production of manufactured houses.

On the other hand, many of the developed building systems have evolved during decades and cannot easily be adapted to fluctuating markets. Also, the lack of proper description of the building system makes it harder to adapt to volatile customers' requirements. Development of modularized product platforms is one strategy for mass customization (Erixon 1998) that often has been used by the manufacturing industry. The customization process needs information about the product structure, its constraints as well as the customer requirements in order to develop a successful configuration and modularization strategy (Yang et al. 2008). The product documentation in construction industry often consists of drawing files in CAD libraries (predominantly AutoCAD) that make the products difficult to use in a customization process. According to Nasereddin et al (2007), adequate documentation of the product structure and customization processes is essential for the productivity and quality of the end product. The "ad-hoc" customization of initially well-standardized technical solutions is one of the main reasons for the decreasing profits in the Swedish prefabricated single-house industry (Bregre 2008).

This paper evaluates a product family of a Swedish industrialized house manufacturer from two perspectives: (1) how the product is designed, how information is shared and how the product is offered to customers, and (2) what features customers request. The intention is to find a successful form for product documentation that will grasp product information from customer design through engineering and production of the final product. The case study has been performed on a product that is offered at a competitive price with limited possibilities for customization. This makes it easier to see if it can really be managed to foresee customer demands, and if the product can be modularized according to customer needs.

2. OBJECTIVES AND METHOD

The objective of the study is to investigate how product modeling technology can be used by industrialized house manufacturers in the customization of a building system. More specifically three research questions are formulated:

1. How can an existing building system be documented using product modeling methodology to cover the process from sales to the realization of a customized building?
2. How well can the existing building system be adapted to customers' requirements?
3. How is the flow of information from sales to realization of the building affected by the use of product modeling technology?

An investigation of a Swedish company has been performed where three methods of collecting information were used for the case study of the building system in the research project:

- Studying drawings and documents of the building system as well as the production system
- Interviews with sales and engineering department
- Workshops with the engineering department to verify the product model of the building system.

The existing description of the building system is used as a basis for creating the product structure presented in section 4. From drawings and documents a first description of the product design and production constraints were established. This part of the study was performed with the intention to create a first product model of the case study building system. The information was then illustrated in product views (see section 4.4.1-4.4.4), which were used to refine and verify the product structure of the building system with the engineering department in a workshop. The refined version presented after the final workshop is the version published in this paper.

Two methods were used to define a set of general requirements from a typical customer used in the study described in section 4.5:

- Information gathered from a Swedish survey of housing standards (Horsman 2008)
- Interviews with the sales department in the company.

3. BACKGROUND

3.1 Information and product models

An information model represents a part of the real world, in some cases referred to as the universe of discourse (Björk 1995). All information models are unique, as well as the process of creating them. According to Schenck and Wilson (1994) an information model should be precise, complete, non-ambiguous, minimally redundant and implementation independent.

Companies that develop, manufacture and sell complex products need to define and manage product information during all stages of the life cycle (Claesson et al. 2001). These information models that contain data of both the product and the processes supporting the product's life cycle are generally referred to as product models. A building information model, BIM, is a product model defined for building products. A well known model standard for buildings is the Industry Foundation Classes (IFC) of the BuildingSmart initiative (BuildingSmart 2009). The team defining the set of rules used to interpret the data in the product model, i.e. the model schema, consists of product modeling experts and domain experts possessing knowledge of the product and the supporting life cycle processes. The definition of product model schemas often contains a mix of various methodologies, for example top-down and bottom-up in an iterative process (Hvam et al. 2008).

According to Björk (1995) the creation of a product model for buildings start by defining the classes of the main building parts and the systems they form, i.e. structural system, installation system etc. The next step is the definition of the most important attributes of these classes and the relationships between these object classes needed in many applications. A similar approach is suggested by Schenck and Wilson (1994), where basic classes and relationships often can be extracted from the domain experts by frequently used nouns and verbs, where nouns represent the physical objects and verbs represent the relationships between the objects.

There are aspects that have significance in the choice of the information modeling language (Björk 1995):

- Capability for modeling the semantics of the universe of discourse without simplifications caused by the information modeling language
- Capability for modeling the designer's intents and aims
- Support for the evolutionary process of design (extendibility of the schema)
- Usefulness for the exchange of data between heterogeneous computer applications in construction
- Technical feasibility for implementation using current commercial software
- Realistic possibilities for achieving standardization (in terms of reaching consensus in standardization bodies and expenditure)

A popular language used in many product model applications such as the STEP and IFC model standard is the EXPRESS modeling language (ISO 10303-11 2004).

3.2 Product configuration

Product configuration is described as an effective mean of structuring products and standardization, but also a way of presenting the product for the customer (Hvam et al. 2008). Also, the structuring of products in product models becomes a common view of the product ranges in the company that can be shared by the people involved in the support of the product life cycle, e.g. sales, design, production and maintenance. Before a configuration project is initiated, the following issues need to be resolved:

- The range of products to be part of a configuration system need to be structured in some form of product structure. Often conflicting views exist in the company regarding rules, degree of detail etc., these issues have to be resolved before any product modeling initiative is launched.

- Companies have to decide what parts of the product range should be included in a product configuration system. Probably, not all products are suitable for configuration.
- The information needed for the product configuration project has to be collected. This information often resides in documents, CAD files and different types of management systems such as ERP, SCM and CRM. It is also to be found as tacit knowledge of the product specialists within the company.
- How should product information be stored, updated and maintained? The product model will have to be constructed so that these parameters are effectively considered.

Leckner and Lacher (2003) pointed out that customer oriented product modeling is governed by the flexibility required in the product configuration process. They defined different types of flexibility or degrees of freedom of a product:

- *Alternative component models* where the customer can choose exactly one from a set of mutually exclusive alternative components
- *Optional component models* where the customer can select optional components not obligatory for the product in an add-on configuration process
- *Attribute enumerated set model* where the customer can choose a component with one value from a predefined set of possible values
- *Attribute numerical interval model* where the customer can choose a component with one value within an interval boundary.

The result of a product configuration is a customer specific product model where the product properties and functions are determined and specifications of what modules and components will be produced and assembled are given (Jørgensen 2001).

3.3 Customer requirements

The increasing demands on products matching customers' individual preferences put pressure on manufacturing companies to offer more product varieties (Veenstra et al. 2006). Still, the economical benefits of mass production need to be retained to keep the production cost at an acceptable level.

Since the cost of developing a building system is high, system analysis and customers surveys of the target market segments are important in the design of modularized product platforms (Bertelsen 2005). This approach is well known in the manufacturing industry but often overseen in construction companies; hence customer requirements are treated only in the specific one-off project and often specified by the client in a building program. However, a product platform needs to be adapted to a variety of customers in the targeted market segment to be competitive. Therefore, a number of methods have been developed to map customer demands against product properties. Quality Function Deployment (QFD) is a widely used method that emerged in Japan (Akao 1990). QFD introduces the customer needs and requirements early in the process and governs the product development in many ways.

The transformation of customer values and requirements into product properties are often performed by a multi-discipline QFD-team. In traditional procurement systems where different people perform design and construction, the QFD methodology can potentially create problems. The "cross-functionality" approach often used when conducting a QFD, can be difficult to achieve in traditional construction projects where the design, engineering and production planning and execution phases are separated. The QFD methodology can be suitable for projects where one part is responsible for both the design and production, and the functional requirements for both the product and the production can be defined in an early stage of the project and not as a parade of trades (Dikmen et al. 2004).

The QFD analysis needs the customer values or requirements as input. This is often evaluated in market surveys where different market segments are surveyed using statistics and customer questionnaires (Eldin et al. 2003).

4. CASE STUDY

4.1 Investigated company

The investigated company is one of Sweden's leading modular family house manufacturers. Since the start over 50 years ago, approximately 43 000 houses have been built. The company delivers turnkey ready houses and takes total responsibility for the delivery. Sales, design, manufacturing and on-site assembly are performed by in-house staff. The company exports houses to Denmark, Germany and Japan. Customers include both private individuals and business to business clients. In 2008, the turnover was € 91 Million and in total the company employs a workforce of approximately 320 people. Houses are manufactured in both contemporary and classic designs and the targeted end customer group is predominantly middle- and upper middle class.

4.2 The investigated product family

The investigated product family is an affordable house model offered by the manufacturer. It features five alternate models all based on the same construction principles. The design is classic/contemporary with a relatively high standard regarding kitchen appliances, surface materials etc. All models are detached houses spanning between 100-180 square meters of living space, manufactured in the production facilities of the manufacturer and delivered and assembled as turnkey houses to the customers.

The product family is offered at a competitive price with limited possibilities for customization. The product family is designed by the company associated architect with the intension of creating solutions that do not need to be modified. The strategy is to streamline house production and minimize one-of-a-kind operations. The customization options are mainly selection of façade, kitchen appliances and surface materials.

4.3 Product documentation system

CAD is the predominant product description system for the investigated product family. Plain AutoCAD¹ is used for design and customization of all house models in the company. The AutoCAD system is used for the architectural, structural and HVAC design. Production design rules have been implemented in AutoCAD using the VBA interface². The production design rules with associated parameters are stored in a MS Access database. The company is also using an in-house developed MRP/CRM-system (Material Resource Planning / Customer Relation Management) that keeps track of stock and orders linked with customer data. Product related information is consequently kept in two systems, the AutoCAD and MRP system, depending on where the information is created, i.e. design information is kept in the CAD system and information related to purchase, stock and customer is kept in the MRP/CRM system.

As a complement to the design rules in the CAD system, written manuals exist that contain information about rules and limitations of the building system. There is also a manual describing the design rules of the building system to external users, for example architects, structural engineers and sales agents. It includes the main aspects such as, facade heights, floor plan, openings, roof and floor structure, etc. Other product related information is mostly distributed within the organization through documents and drawings.

4.4 Current process

The sales department is often asked to adapt the offered product to fit customer's individual needs. These changes are often not possible to fulfill without violating the rules of the building system. Despite the managements' intention to have relatively restricted customization policy, changes to the original concept are often introduced by the sales department to satisfy customers. Consequently, these adaptations cause problems both in engineering and production when ad-hoc solutions need to be applied to specific customers. Also, the implications, i.e. additional costs for adaption of the product by the engineering and production teams, are hard to evaluate. Furthermore, these ad-hoc solutions are often not reused in other projects since the specific solutions are not analyzed in an attempt to modify and incorporate the changes in the product family.

¹ <http://usa.autodesk.com/adsk/servlet/pc/index?id=13779270&siteID=123112#>

² Visual Basic for Applications, <http://usa.autodesk.com/adsk/servlet/index?siteID=123112&id=770215>

Findings from interviews with sales and engineering emphasize that there are important issues that need to be resolved in order to improve efficiency:

- The product documentation needs to be adapted to the different processes in the company, e.g. in the sales, engineering and production views.
- Changes in one view, e.g. sales view, should be easily traceable in the engineering and production views and vice versa.
- Changes of the product concept affecting the production system should be made in a product development process from a strategic point of view making the building product more adaptable to customers' requirements. Otherwise, the costs of introducing ad-hoc solutions should be part of the offer to the customer.

In the next section, we present a conceptual solution of the product documentation issue using different views of a product model of the investigated product family.

4.5 Organizing the product information in product views

Hvam et al. (2008) suggest a methodology based on the representation of the product in a hierarchical structure using the Unified Model Language (UML)³. These representations or *product views* of the product model are used to package and present the product information for a targeted set of stakeholders (knowledge domain). IKEA is an example of a company working with different product views. IKEA's kitchen configuration program makes it possible to design and get a price of a custom made kitchen directly on their website (IKEA 2009). Information essential for the customer such as cabinet doors and colors etc, are presented in the customer view of the product. In the production view of the customized kitchen the types of colors and cabin doors is described by article numbers, color codes and other related information used in the production of the custom made kitchen. This information is added in the manufacturers CAD application, which is different from the one used on the web site.

The use of process related product views is common in the manufacturing industry and to some extent also in the construction industry. However, the different views in the construction industry are mostly connected to the architectural, HVAC and structural disciplines using drawings and documents, thereby making the integration and coordination between these different disciplines a tedious manual task prone to errors (Jongeling and Olofsson 2007).

The product views with their related product structures also constitute the point of departure for organizing, storing and communicating product information both internally and externally. This would facilitate information sharing in the customization process (Hvam et al. 2008; Johnson et al. 2007).

Accordingly, in our case study the following product views were defined:

- The *Customer view* represents an instance of the product model as seen by end customers and sales agents which represent the company. This view represents the features of the product family requested by customers.
- The *Engineering view* represents the various customized alternatives of the product model from an engineering point of view. This view represents the most important systems for the technical realization of the product features requested by the customers (such as structural, installation etc.).
- The *Production view* describes the different building parts to be manufactured at the production facility. It contains information relevant for the supply chain and the factory production units.
- The *Assembly view* describes how the product will be assembled on site. Assembly instructions, the order of delivery and assembly of prefabricated elements, schedules etc. are example of information relevant in the assembly view.

Compared to the model presented by Hvam et al. (2008) the assembly view has been added to the product views in the case study because this is one essential factor that differentiates the construction industry from manufac-

³ <http://www.uml.org/>

turing. The assembly of the final product on site needs to be managed separately, in contrast the manufacturing industry, in general, considering the product finished when it leaves the factory.

4.5.1 Customers view

Fig. 1 a) – d) shows the customers view of the product family. The customization options consist of selecting between two types (henceforth referred to as type 1 and 2) of models within the product family. Within the type 1 concept, the customer can for example choose from changing the floor plan to consist of either two or three bedrooms, an adjustable roof slope with two optional colors (red, black), two types of façade paneling and two types of windows. In Table 1 and Fig. 1 the different types of flexibility and alternatives are exemplified by the type 2 house. Table 1 summarizes the flexibility types of the customer views of the product family concept according to Leckner and Lacher (2003).

TABLE 1: Flexibility of the product family in the customer view

Alternative	Flexibility
Type 1 or Type 2	Alternative component model
Type 2 – Floor plans: 2 or 3 bedrooms	Optional component model
Type 2 – Roof: 27° or 45°	Attribute enumerated set model
Type 2 – Roof: red or black color	Attribute enumerated set model
Type 2 – Façade: vertical or horizontal paneling	Attribute enumerated set model
Type 2– Façade: Window type 1 or 2	Attribute enumerated set model

The alternative floor plan with three bedrooms is not a true add-on configuration (optional component model) since the alternative will affect the size of the living room.

The customer product view shows the choices that are important in the context of the sales process. Prominent parameters of this view are (1) architectural expression of the floor plan, and (2) exterior. The details of the structural system, installations etc. are not included because they are not important to the customer. Nevertheless, the engineering and production parameters need to be verified already in the sales stage to avoid the creation of ad-hoc solutions propagating downstream to engineering and production.

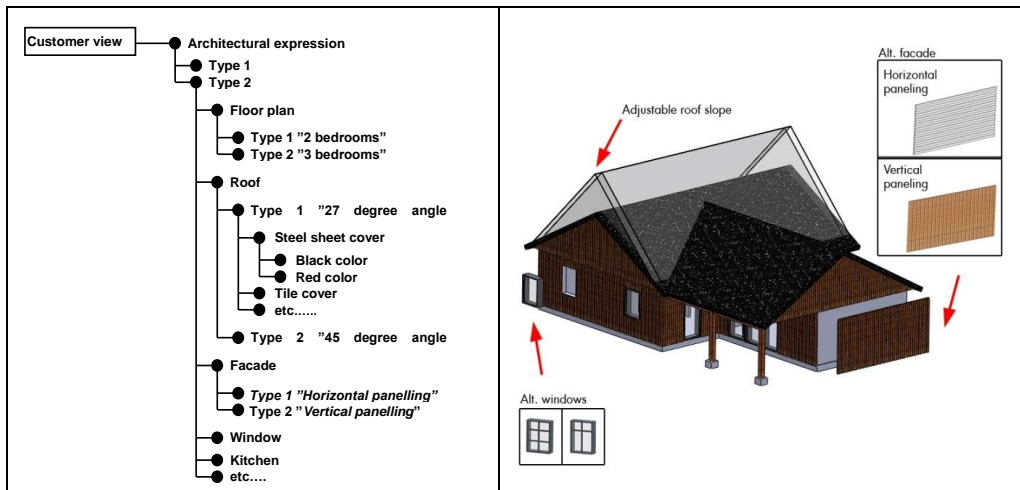

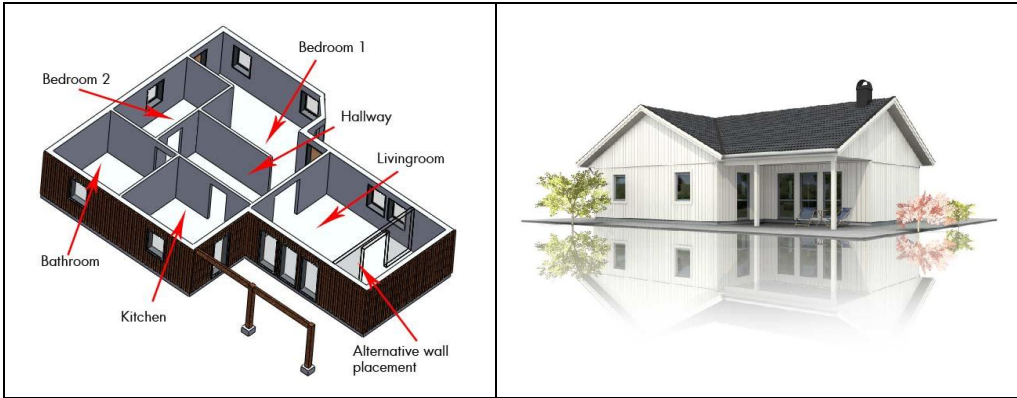
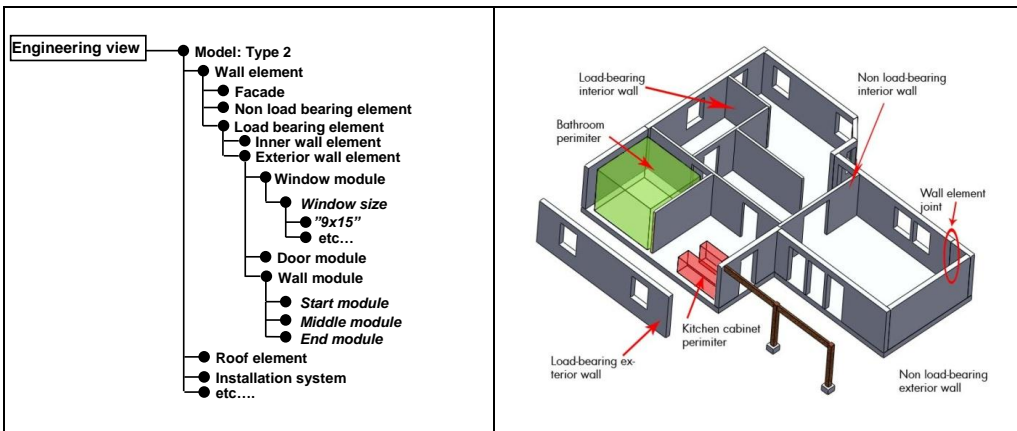

FIG. 1: The customer view of the product family Type 2 alternative. FIG 1a) shows the product structure, 1b) the façade, 1c) the interior floor plan and 1d) an example how the configured product is presented for the customer.

4.5.2 Engineering view

Fig. 2 shows the engineering view that ensures that the company can technically realize the customers' choices. This view represents the technical solutions that fulfill the features requested by the customer. The engineering view is meant to be used in the design of new products or new features in a product family considering the constraints given by standards, regulations, production system, etc.

In the engineering view, the structural system of the product family is shown in Fig. 2a). The load bearing and non load bearing wall blocks including openings for doors and windows are shown to be able to test the structural integrity of the product family model. In Fig. 2b) space objects have been inserted in the bathroom and kitchen as carriers of functional and customization requirements, e.g. bathroom and kitchen requirements on the walls facing these rooms, such as noggin pieces for kitchen cabinets and bathroom gypsum boards that go behind the tiles. Figs. 2c) and 2d) show how a wall can be decomposed or modularized in units that can be reused in product development. The combination of these engineering modules into different wall types in the product must abide the rules of the production system, i.e. they must be able to be produced by the production system.



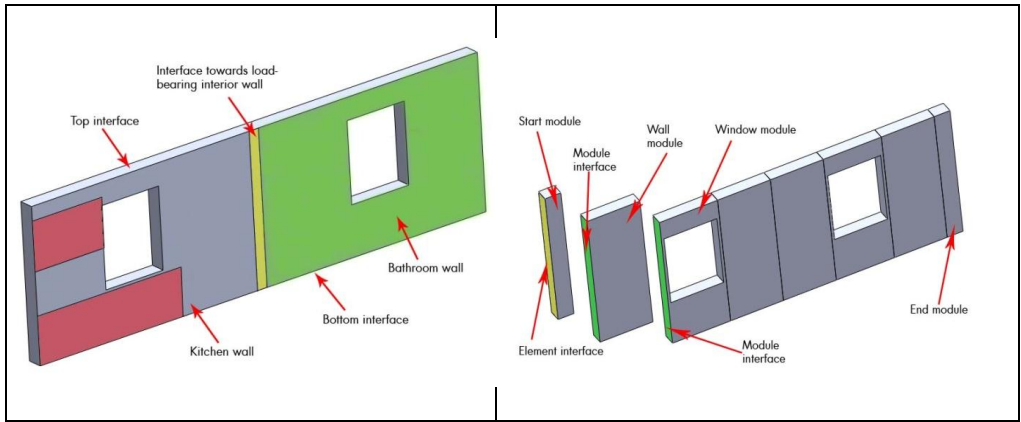

FIG. 2: The Engineering view of the product family type 2.

FIG. 2a) shows the product structure, 2b) the structural view of the interior floor, 2c) an example of a load bearing exterior wall and 2d) its modular composition.

4.5.3 Production view

The production view gives a detailed description of the building parts to facilitate the pre-manufacturing in the factory. It contains information relevant for the supply chain and the production system. The production product structure can also be used to create the bill of materials (BOM), and hence link the production view to the MRP (Material Resource Planning) and ERP (Enterprise Resource Planning) systems in the company.

Fig. 3 illustrates the product from the production point of view. Here, the elements to be pre-manufactured are presented with the necessary information for production. Fig. 3b) shows an exploded view of a wall, Fig. 3c) the wall framework while Fig. 3d) contains BOM list and information necessary for manufacturing the wall assembly. CAD applications used in manufacturing industry are often able to connect to various PDM (Product Data Management) and PLM (Product Lifecycle Management) systems, but CAD applications in the AEC industry are seldom used together with PDM or PLM systems.

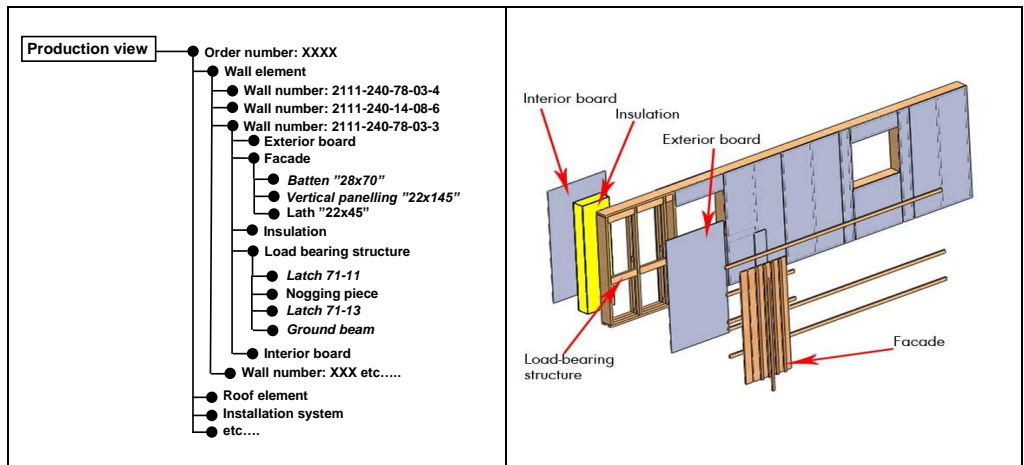

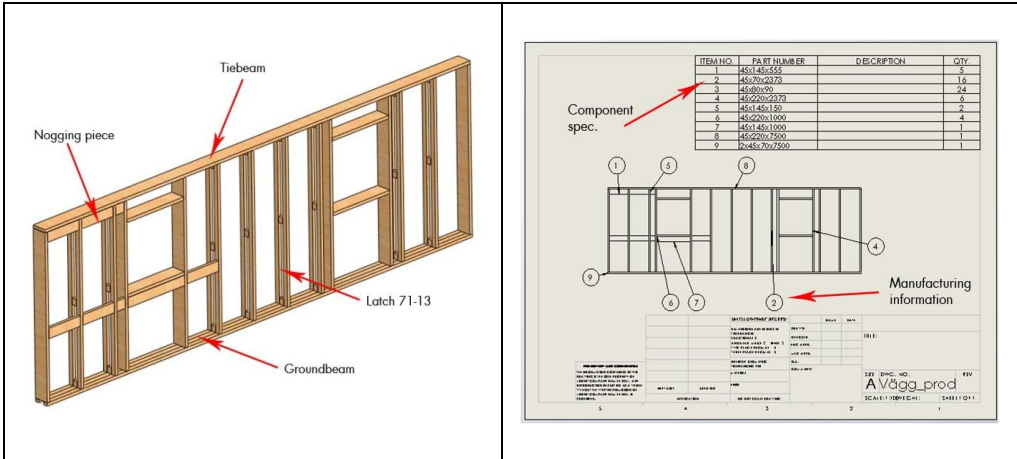
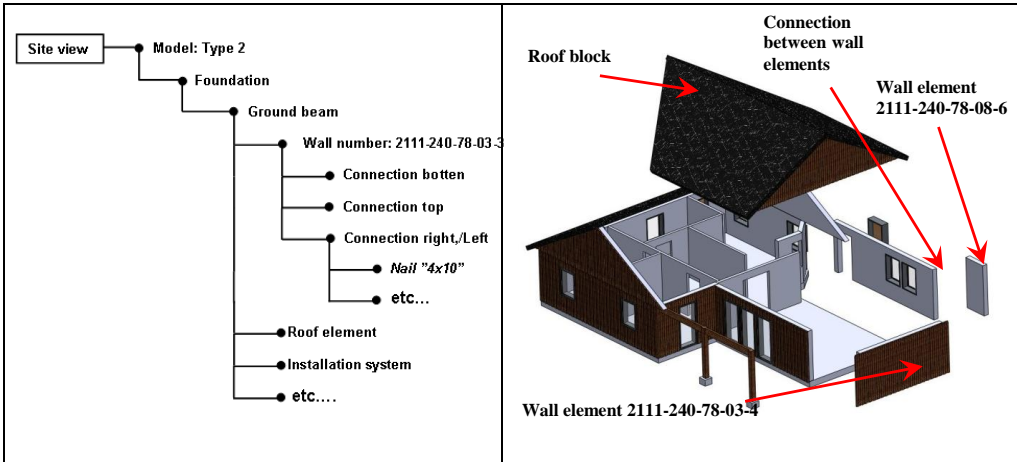

FIG. 3: The Production view of a customized order. FIG. 3a) shows the product structure, 3b) an exploded view of the highlighted wall element, 3c) the framework of the wall and 3d) its BOM list and manufacturing information.

4.5.4 Assembly view

Fig. 4 shows the assembly view that provides information on how the product will be assembled on site. Information needed in this view is assembly instructions, the order in which the prefabricated elements such as roof blocks and wall elements needs to be delivered to the assembly site and the schedule. Fig. 4a) shows the assembly product structure, 4b) an exploded view of the product to be assembled, 4c) connection details between assembly components and 4d) a flow line view of the assembly schedule. The assembly drawing focuses on the connections between different elements to be assembled. The proposed scheduling method is flow-line or Line-of-Balance because of its ability to plan and analyze the assembly for workflow and the possibility to combine with 4D visualization (Jongeling and Olofsson 2007).

Next, we will analyze the product family model, type 2 concept, from a customers point of view represented by a recent Swedish customer survey performed on the Swedish housing market.



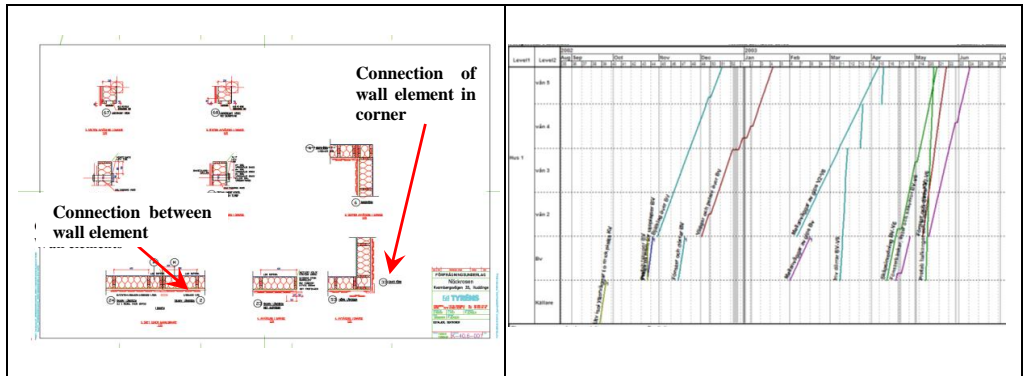

Figure 4: The Site view of a customized order.

Figure 4a) shows the assembly product structure, 4b) an exploded view of the assembly structure, 4c) assembly drawing of connections and 4d) the assembly schedule expressed in a flow-line diagram.

4.6 Customer Requirements

According to the company the house models are targeted towards families looking for a customizable house with relatively high standard regarding materials and construction but not with too many other choices, see possible alternatives in Table 1. Actually, the studied case company refers to itself as an engineering company that focuses more on the demands from the production department than demands from the customers. However, if these models are to be successful on the market, the alternatives must be based on market analysis of the consumer segment.

According to Eldin et al. (2003) customers' requirements must be based on market research using surveys and interviews with prospective customers. To exemplify the importance of adapting the product to market trends, the product offers of the product model have been compared with a recent survey of the Swedish housing market regarding demands and wishes (Horsman 2008). The Internet survey, performed in 2008, received about 5000 answers where some 1600 answer came from people living around the city of Stockholm. The respondents varied in age between 18 to 65 years. The result of the survey was also confirmed with customer demands received by the sales office in Stockholm in interviews with key employees. In Table 2 the top ten demands from the survey and the willingness to pay are compared with the product offers of the product model.

TABLE 2: Customer top ten demands compared with the product offers of the product model (Horsman 2008)

Housing	Rank	Willingness to pay	Offer
The housing have central controlled functions that is connected to internet, such as possibility to check the fire stove, turn on alarm, etc.	1	34%	no
It is possible from a central place to control environmental climate systems and light system etc.	2	40%	no
There is a possibility to have built in speakers and media players etc.	3	25%	no
It is easy to rebuild the floor plan for handicap requirements	4	28%	no
The house is easy to access with Wheel chairs and baby carriage	5	28%	yes
Possibility to compensate for climate	6	38%	no
Flexible floor plan with for example movable walls etc.	6	18%	no
The housing is build in a way that lower sound disturbances between bedrooms etc.	8	40%	no
There is a high standard regarding kitchen and bathroom	9	55%	yes
The building is close to culture and activities performed in spare time for example restaurants and theaters etc.	10	28%	n. a.

Remote control of indoor climate, flexible floor plans, noise reducing walls between rooms, high standard in kitchens, etc, are among the top alternatives where customers indicate a relatively high willingness to pay. In a survey undertaken in Holland “type of kitchen” also ended up as the most important customization property (Hofman et al. 2006). These types of customer surveys provide valuable information for customization options for the house manufacturers.

5. ANALYSIS

5.1 Organizing the product documentation

Less complex information models of the reality that are better adapted to working processes probably have a better chance of success (cf. Sandberg et al. 2008). As illustrated in section 4, the product model was structured in four views, capturing the information needs in the customization, engineering, production and assembly processes respectively. The control over the product comes from the ability and the way these views are described and connected, i.e. the transformation of information downstream and upstream the value chain. Fig. 5 illustrates how different views of the same product intervene with each other, for example the chosen kitchen type in the customer view will affect the engineering view with how the noggin pieces will be placed, but also the production view in the actual production of the wall element. This will also affect the assembly view when assembling the kitchen on site. The transformation of information is therefore critical to ensure that ad-hoc solutions are kept to a minimum.

Today, experiences from earlier projects are seldom documented; they exist only as tacit knowledge in the people working at different departments (Sandberg et al. 2008). The company knowledge of the product becomes fragmented since it can only be transferred to co-workers in close proximity. This was also evident in the case study company, since informal knowledge had been noted on personal copies of CAD files and product documents. Benefits of integration of product knowledge using product model technology are manifold – less problems with ad-hoc solutions, a better and faster product specification process, ability to develop and modularize technical solutions to better match customer requirements, integration of the flow of information between sales, engineering, production and site assembly, etc.



FIG. 5: The separate views of the same product and how they overlay each other.

Today, there exists a multitude of product modeling technologies and systems that can manage complex products. However, most methods and tools are still limited to support the design, development and production only of single products (Claesson et al. 2001). Often only the geometric description of products generated by CAD systems is managed directly (Sudarsan et al. 2005). Instead, the extent of the product family should be modeled (digitally represented) and IT systems must be adapted to the manufacturer's product portfolio and economical and organizational abilities.

5.2 Customer requirements versus product offers

Many of the highest ranked customer needs cannot be offered by the product family investigated. The comparison between the customer survey and the customization options indicates that there is a mismatch between product offers and requirements in the market segment. This can be one reason for the ad-hoc solutions observed in order to satisfy the customer. Another possible cause is the inability of the company to transfer information of rules and constraints of the building system to the sales organization. Also the company self image as an engineering company might underestimate the importance of adapting the building system to the end customer requirements. The product should be continuously developed to adapt to customers volatile requirements and trends in the market segment. Therefore, experiences from the sales department should always be analyzed and incorporated in development of the building system. New product options should only be implemented as a result of a strategic decision to develop the building system.

5.3 Information flow with product modeling technology

An order is verified against a checklist which describes the customization rules (constraints). This checklist contains detailed information of the house to ensure that products can be efficiently manufactured, giving the impression that the company uses a bottom up approach, i.e. let the customer decide then adapt the design to the system. However, the interviews provide the opposite impression that a top-down approach is used – the customer chooses a model which then can be modified according to certain rules. According to sales office, they do not have contact with engineering and production departments before the customer signs the contract. However, to sell the product they need to agree on certain changes of the product, to be able to satisfy the customer. These statements indicate that the link between customer view and the other views (engineering, production and assembly) is weak. When the

customization process violates the rules of the building system, this information is not automatically transferred to the engineering and production view which is a major source of ad-hoc solutions in production. Attempts to reduce ad-hoc customization have been to offer fewer options, but this also increases the risk of removing the wrong options from a customer perspective.

It has also been shown that it is much easier for companies to transfer information downstream the value chain than transferring information, rules and constraints upstream, see Fig. 6. Thus, problems related to information transfer should be addressed by creating paths and tools for information exchange upstream the value chain and agree on mutual views of the product. If the information and constraints illustrated in the separate views can be described for all disciplines involved in the process “ad-hoc” solutions can be minimized. The constraints are often too many to manage without the support of integrated information systems such as PDM and ERP systems in the customization of the product.

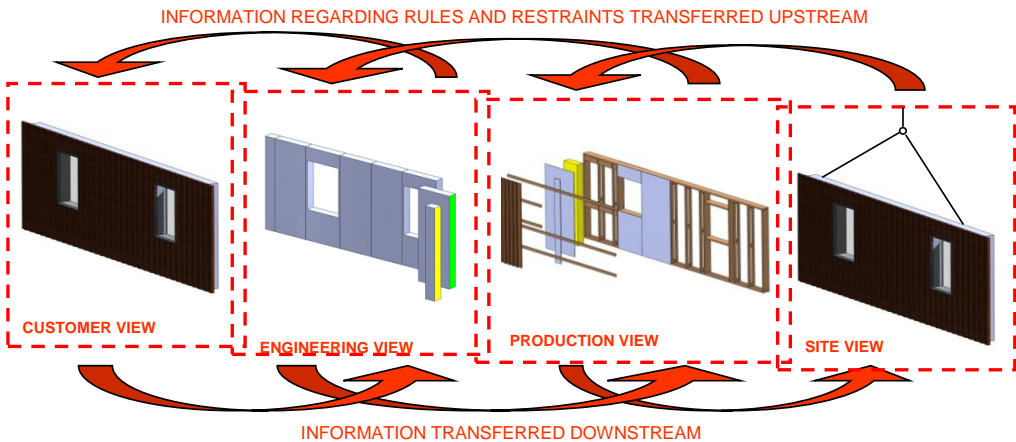

FIG. 6: The connection and integration of information between the separate views

6. CONCLUSIONS

Product modeling is a suitable technology to describe the product structure of modular houses. It gives the manufacturer the opportunity to get a view of the entire product range. Creating adapted views makes the product structure less complex to implement and easier to split in more than one release. The integration between the different views consists of information transferred downstream from the customers view to the engineering, production and assembly views. The rules and constraints of the building system are transferred upstream from the assembly, production and engineering views to the customers view and hence define the customization limits of the product family.

The presented case study also showed that product development of modular houses must start from customers' requirements. Too little attention of adapting the production system to the changing customers' expectations increases the risk for ad-hoc solutions propagating to manufacturing and assembly on-site with considerable higher costs as a result. Eventually, the product will become harder to sell. It is also evident that the ICT-tools used to create and manage the different views should be *view specific*, as long as the information and constraints can be transferred between the tools. We believe that successful cooperation and information exchange between these four views is a key to future development and customize-to-order configuration, because it provides an explanation model of the information transfer needs and it also provides a good visual overview of the goals set out to accomplish by a company in terms of information management. Using the four views will give companies a structure for how to plan and organize information transfer.

However, there are some evident barriers for companies who want to implement information management systems. Currently there is a lot of tacit knowledge within the studied companies that needs to be formalized before

it can be used in an IT system. Several companies also need to go through a process of unifying their view on product information within the company, so that they have a common ground to stand on when taking on new challenges. Another issue is that the general level of IT maturity is lower compared to other industries. Regarding the choice of system there are no specific systems for integrating information in this relatively small sector, which means that custom development is one probable solution. Going forward companies need to be prepared that regardless of what system they decide to use, it will probably need customization to work with their specific needs and processes. This implies that the company has to be more involved in the development or customization, the right competence for this might need to be built up before a project can be initialized.

The main lesson learned from the studied project is that it proved beneficial to use the presented four views as a way of visualizing the information flow from customer requirements to a turnkey-ready house. This approach also showed useful as an analysis model – by using the views to assess how well integrated information transfer is achieved within a company. We have also learned that a mismatch between the technical platform and customer requirements will lead to more ad-hoc customization downstream, which in turn leads to a product platform that might grow without control. Instead, new product features should be introduced as a result of strategic decisions that are aligned with the overall company strategy.

ACKNOWLEDGEMENTS

The financial support of Tyréns AB and the Swedish Governmental Agency for Innovation Systems, VINNOVA, is gratefully acknowledged. This work was performed within the competence centre Lean Wood Engineering at Luleå University of Technology, Linköping Institute of Technology and Lund Institute of Technology, all in Sweden.

REFERENCES

- Akao Y. 1990. *Quality Function Deployment QFD, Integrating customer requirements into product design*, Productivity Press, New York, US.
- Bertelsen S. 2005. *Modularization – A Third Approach to Making Construction Lean?*, in Proc. 13th Annual Conference of the International Group for Lean Construction, Sydney, Australia.
- Björk B-C. 1995. *Requirements and information structures for building product data models*, Doctoral dissertation, Technical Research Centre of Finland (VTT), Espoo, Finland.
- Brege S. 2008. *Presentation at the workshop for Lean wood engineering program*, Dept. of Management and Engineering, Linköping University, Linköping, March 2008.
- BuildingSmart 2009. www.iai-tech.org, accessed on 2009-12-07.
- Claesson A., Johannesson H. and Gedell S. 2001. *Platform Product Development: Product Model a System Structure Composed of Configurable Components*, in Proc. DETC'01 / ASME 2001, Joint Design Engineering Technical Conference and Computers and Information in Engineering Conference, Pittsburgh, PA, Sept. 9-11, 2001.
- Dikmen I., Birgonul M. T. and Kiziltas S. 2004. *Strategic use of quality function deployment (QFD) in the construction industry*, Building and Environment, Vol. 40, No. 2, pp. 245-255, Pergamon.
- Eldin N. and Hikle V. 2003. *Pilot Study of Quality Function Deployment in Construction Projects*, Journal of construction engineering and management, Vol. 129, No. 3, pp. 314-329, ASCE.
- Erixon G. 1998. *Modular Function Deployment – A Method for Product Modularization*, Ph.D. Thesis, Dept. of Manufacturing Systems, Royal Institute of Technology, Stockholm.
- Hofman E., Halman J.I.M. and Ion R.A. 2006. *Variation in Housing Design: Identifying Customer Preferences*, Housing Studies, Vol. 21, No. 6, pp. 929–943.
- Horsman W. M. 2008. *Botrender 08, En rapport om framtidens boende* (in Swedish), Tyréns AB, Stockholm.
- Hvam L., Mortensen N. H. and Riis J. 2008. *Product Customization*, Springer-Verlag, Berlin Heidelberg.
- IKEA 2009. www.ikea.se. Accessed on 2009-12-07.

- ISO 10303-11:2004. *The EXPRESS language reference manual*, <http://www.iso.org>.
- Johnsson H., Malmgren L. and Persson S. 2007. *ICT support for industrial production of houses – the Swedish case*, in Proc. CIB W78, Maribor, June 2007.
- Johnsson H., Persson S., Malmgren L., Tarandi V. and Bremme J. 2006. *IT-stöd för industriellt byggande i trä* (in Swedish) Technical report 2006:19, Div. of Structural Engineering, Luleå University of Technology, Luleå, Sweden.
- Jongeling R. and Olofsson T. 2007. *A method for planning of work-flow by combined use of location-based scheduling and 4D CAD*, Automation in Construction, Vol. 16, No. 2, pp. 189-198, Elsevier.
- Jørgensen K. A. 2001. *Product configuration- Concepts and methodology*, in Proc. 4th SMESME International conference, Aalborg, May 2001.
- Leckner T. and Lacher M. 2003. *Simplifying configuration through customer oriented product models*, International conference on engineering design, ICED 03 Stockholm, August 2003.
- Lee G., Sacks R. and Eastman C. 2007. *Product data modeling using GTPPM – A case study*, Automation in Construction, Vol. 16, No. 3, pp. 392-407, Elsevier.
- Nasereddin M., Mullens M.A. and Cope D. 2007. *Automated simulator development: A strategy for modeling modular housing production*, Automation in Construction, Vol. 16, No.2, pp. 212-223, Elsevier.
- Persson S., Malmgren L. and Johnsson H. 2009. *Information management in industrial housing design and manufacturing*, ITcon Vol. 14, pp. 110-122.
- Sandberg M., Johnsson H. and Larsson T. 2008. *Knowledge-based engineering in construction: the prefabricated timber housing case*, ITcon Vol. 13, pp. 408-420.
- Schenck D. and Wilson P. 1994. *Information Modeling: The EXPRESS Way*, Oxford University Press, NY.
- Sudarsan R., Fenves S.J., Sriram R.D. and Wang F. 2005. *A product information modeling framework for product lifecycle management*, Computer-Aided Design, Vol. 37, No. 13, pp. 1399-1412, Elsevier.
- Vennstra V.S., Hallman J. I. M. and Voordijk J. T. 2006. *A Methodology for Developing Product Platforms in the Specific Setting of the House Building Industry*, Research in engineering design, Vol. 17, No. 3, pp. 157-173, Springer-Verlag.
- Yang D., Dong M. and Miao R. 2008. *Development of a product configuration system with an ontology-based approach*, Computer-Aided Design, Vol. 40, No. 8, pp. 863-879, Elsevier.

Paper IV

Modeling pipe renovation need in multi-family houses

Author:

Linus Malmgren

Division of Structural Engineering

Lund University

linus.malmgren@kstr.lth.se

Abstract

Purpose – Planning of pipe and bathroom renovation is often subjected to uncertainty and personal judgments. The purpose of this article is to suggest a model approach to support decision-making for property owners.

Design/methodology/approach – Based on interviews and studying of maintenance planning documentation, a model has been developed that can assist in prioritizing between buildings based on the need for pipe renovation.

Findings – The 10 parameters that were used can describe the need for pipe renovation, the parameters include building information, status and use. The initial validation of the model shows that the prioritization of the model represents real-world decisions. The quality of any model is however dependent of good quality data and well defined parameters, which can be problematic.

Research limitations/implications – Further validation of the model through more cases and different kinds of buildings are necessary improve validation and generalization.

Practical implications – The model can act as a data analysis tool for real-estate property owners that would like to gain an overview of the need for pipe renovation. It can serve as one of several decision support tools and provide maintenance recommendations from a technical perspective.

Originality/value – This model can contribute to the objective data analysis of pipe renovation needs. It is however necessary for property owners to consider definitions and availability of data.

Keywords: service-life, property management, maintenance planning, pipe renovation

Classification: Research paper

1 Introduction

1.1 Background

In Sweden 1.3 million apartments were built between 1950 and 1975, this constitutes a large part of all apartment buildings in Sweden. Many of these are now in need of major renovation and it has been estimated that 35 million Euro needs to be spent on renovation of these buildings (Industrifakta, 2008). The current pace of renovation in Sweden however is too low and will need to increase significantly in the coming years (The Swedish National Board of Housing, 2003). The legal term *real-estate property* (henceforth called *property*) is here defined as a piece of land and the buildings on it. Hence a property owner is here defined as an owner of land and it's buildings (henceforth called *property owner*). To estimate the future need of renovation is a complex issue according to a group of property owners that were interviewed within the research project. Service-life is often difficult to determine accurately, the life of sewage-pipes (cast iron) can for example span from 30 to 60 years (Dahlblom, 2001; VVS-

installatörerna and VVS-inspektörer, 2002), which is not accurate enough for good maintenance plans. For bathroom components, service-life can be decided by measurements or destructive testing, often there is also a statistical basis and the accumulated knowledge of companies and experts. In a book for property owners, service-life of a number of components are listed, which are based on investigations and experience (VVS-Företagen, 2009). In Dahlblom (1999) an effort is made to find and compile sources of service-life estimations. 12 sources were found that list common sources of information and data, including: literature studies, interviews and surveys, inspections, statistical databases and laboratory tests. Figure 1 shows a typical bathroom in an apartment building with expected service-life of key components. Previous studies have however shown that by only using service-life to evaluate the need for renovation, the need is often overestimated (Bejrums, 1987). The lack of actual failure and maintenance data has been established as a issues from both academia and industry perspectives (Wu *et al.*, 2003). The lack of data and different opinions on service-life makes maintenance planning a complex issue for property owners.

SERVICE LIFE OF BATHROOM COMPONENTS

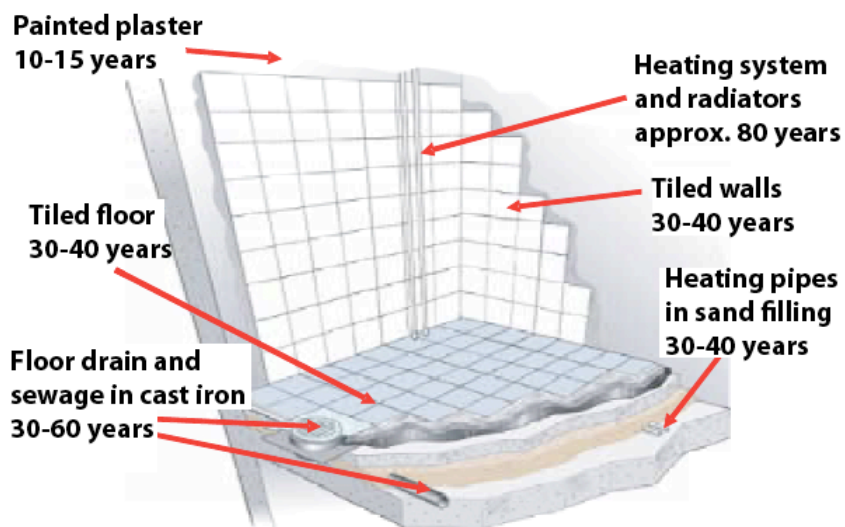

Figure 1 Typical service-life of components and materials in bathrooms. (VVS-Företagen and Ventilation, 2008)

The main reasons for bathroom renovation are technical, economical and health/convenience (Dahlblom, 2001), but also esthetics is a common reason. Over the past three years, but also in the coming years, the highest costs for renovation in Sweden can be found in building service systems (The Swedish National Board of Housing, Building and Planning, 2010). As there is much room for individual opinions regarding when costly repairs due to water damages start to occur (Lind and Lundström, 2011), property owners are directing their attention towards the improvement of maintenance planning. The focus of this study is the renovation of water and sewage pipes (henceforth called pipe renovation) in apartment buildings built between 1950-1975. Water damages

incur costly repairs and during 2011, 66 % originated from leakage in water, heating and sewage pipes and 17% were caused by leakage through water proofing (Vattenskadecentrum, 2011). Because of the costly repairs it is relevant to be able to assess the future need for pipe renovation. With good decision support, property owners can apply preventive actions, which also means less disturbance for tenants. To address the future need of pipe renovation, the possibilities of modeling prioritization of pipe renovation is evaluated in this paper.

1.2 Aim and purpose

The purpose of this article is to identify on what basis property owners plan maintenance and to propose a way to facilitate and structure planning through the use of a model. The aim of the model is to provide a simple, adaptable starting point.

2 Maintenance planning

The ambition ambitions of property owners are different, they are usually dependent on owner directives and the financial situation. Högberg *et al.* (2009) categorized property owners in four ideal types based on their investment policy (regarding energy efficiency actions), spanning from strictly profit maximizing to administration led ambitious companies. Similar to energy efficiency there is an investment policy that influences renovation, which will affect maintenance planning.

There are many models and much research performed on bridge and infrastructure maintenance. One reason for the elaborate maintenance planning may be that the consequences of failure are much more severe, whereas the consequences of failure in a sub-system of a building may be more acceptable. Reliability based models are divided in two parts; a deterioration- and a decision model (Frangopol *et al.*, 2004). The deterioration model explains how the intended function deteriorates over time, the decision model puts forward possible solutions. When optimizing bridge repair strategies, a method consisting of six steps is suggested by Estes and Frangopol (1999) with includes the identification of relevant failure modes and parameters, then a overall system model is developed. Based on the above steps a model that describes the deterioration and loads are developed. The abovementioned steps describes the system and deterioration, this approach is used in the development of the maintenance model in this article.

Rosenfeld and Shohet (1999) suggest a methodology for how to index the state of buildings based on known facts. They use the index model to compare both building facts and renovation options. The model is divided in four modules and encompasses preliminary survey, evaluation, generation of feasible alternatives and a technical and economic evaluation. It does however not go into detail of the assessment of the current status of the building. Alanne (2004) put forward a multi-level model which returns a rating based on a combination of possible actions. This model addresses only the selection process of renovation alternatives. Altogether there are several models that address the selection of renovation alternatives. Those that exist have been described as well defined, rule-oriented, for example aids for financial analysis, insurance and taxation (Okoroh and Torrance, 1999). Few models however in a practical manner can facilitate the evaluation of building status and the prioritization between buildings that property owners are faced with.

3 Method

To build a model that can structure information and predict the urgency of pipe renovation, the first step was to gather information on how property owners plan maintenance. The planning process, key parameters and how they influence the planning were learned through interviews and studying of documentation.

In an ongoing case study at a Swedish public property owner full access to documentation was given, this constitutes the main empirical material. The case study has encompassed participating in meetings, studying documents and interview. This was complemented with interviews with 5 property owners including the case study company, to gain understanding of the planning process. All property owners are located in growth regions of Sweden and own apartment buildings, they provide rental apartments as their main business. All companies have long-term owner strategies, i.e. their aim is to keep the properties over a long period of time. The semi-structured interviews focused on planning of maintenance from a technical perspective; hence the financial situation of each company and how it affects the maintenance planning have not been considered, although identified as an important factor. The interviewees were people in charge of maintenance planning or in a managing position with insight into maintenance.

The subsequent development and validation of the model were made in collaboration with the case study company. It was developed in Microsoft Excel in iterations with continuous validation through real-world cases taken from the case study company. After developed, the model was validated in a number of cases by comparing the prioritization provided by the model with the expert judgments of the case study company that participated in the study.

4 Maintenance planning by five Swedish property owners

To understand which parameters influence maintenance planning, interviews were conducted to determine what should be included in the model and how it should be built. The property owners that were interviewed are presented in Table 1. Below follows a summary of the results.

Table 1 Participating property owners

Property owner	No. of apartments	Owner status	Market
#1	23 000	Public	Local (city)
#2	5 000	Private	National
#3	400	Private	Local (city)
#4	12 000	Public	Local (city)
#5	24 000	Private	National

Most property owners work with maintenance planning on several levels, where they have a short "action plan" and a 3-5 year plan. In addition, some property owners work with 10-year forecasts. It is often up to individual managers to analyze and establish the need for renovation. Public companies have to a larger extent, dedicated staff for maintenance planning and renovation projects, private companies often integrate this responsibility with general facility management. Thus it seems that public property owners are better equipped for strategic maintenance compared to their private counterparts. Companies showed different approaches for how to gather and analyze data,

public companies generally had better potential for rational decision making because of their dedicated staff. This gives them the ability to act more proactively, whereas private companies in general act more reactively. But also other circumstances influence the level of maintenance, for example owner directives and company size. Some of the property owners have computer-based systems for facility management that can serve as a base for planning. But the quality of data depends on how good companies are in collecting information. Larger companies, especially public, generally have more established processes for maintenance planning and have more data available.

Maintenance planning is generally based on a combination data, budget and technical know-how. Several of the companies are however vulnerable because they are dependent on skilled individuals. Maintenance planning requires experience and the ability to see the bigger picture and often employees who possesses the necessary skills are limited. The interviews showed that public property owners spend more time and money on maintenance planning and analysis compared to private. One of the reasons might be that there is more pressure on public owners to optimize maintenance. Private companies have stricter demands of delivering return on any investment, which is a reason why they are more selective.

The maintenance planning process at the case study company was used as a starting point in the development of the model. The data from the interviews supported and complemented the development of the model structure. The interviews were used to get a general overview and to identify the most decisive parameters for determining the need for pipe renovation. The parameters form the basis for the model and are presented in Table 2.

5 A model for evaluating pipe renovation need

5.1 Model background

The aim is to aid property owners to determine how urgent the need for pipe renovation is within a portfolio of apartment buildings and to prioritize between them. The model is calibrated to emulate the decisions taken by the interviewed property owners. It was decided to collect data and present results on *property* level, for most companies this represents a commonly known and manageable structure. The main challenges was to select parameters that characterize the need using available data and still provide the results needed. In the development of method, inspiration was found in reliability-based assessments see Estes and Frangopol (1999). In creating a structure for the model other models within similar contexts were surveyed (Alanne, 2004), (Rosenfeld and Shohet, 1999). The only considered failure mode in the present model is water leakage, which often leads to serious consequences in several parts of the buildings.

A description of the model logic was made before the development started. On a top level the model should assign each property a score depending on how urgent the need for pipe renovation is – higher score implies greater need. That means that all parameters need to be assigned a score, which are then added up to form the overall score for each property. To compensate for different importance of parameters, a weighting system was introduced. To provide good overview, the parameters are structured in a hierarchy where the score of each property can be traced backwards to the lowest level.

5.2 Developing the model

Microsoft Excel was chosen as a platform for the model, as it is a flexible and widely available. It can both manage data and present the results in a structured and visually appealing. It was decided to use a scale from 1-10 to rate each parameter, a higher score means a worse situation, thus higher risk. The score is based on the input given and is calculated by the model. The relative importance of each parameter is considered by a weighting between 0-1. In the model the score of each parameter is multiplied with the weighting, which gives the weighted score for each parameter. The parameters, their meaning and weight are described in Table 2.

Table 2 Model input parameters

Model input parameters					
Group	Parameter	Unit	Input	Weight	Comment
Fact	Construction year	Year	Year of construction	0.5	Between 1-10 depending on the inherent risk of the construction
	Hot water recirculation	-	Basement / Basement and vertical	0.5	States if there is hot water recirculation only horizontally in the basement (1), or both horizontally and vertically (10)
	Built-in pipes in apartment	-	Yes/No	0.3	Yes (10), no (1). Built in pipes gives larger secondary damages.
Status	Remaining service-life of surfaces	Year	Year of last renovation	1.0	Score between 1-10 depending on remaining service-life for surfaces in bathrooms
	Remaining service-life of pipes	Year	Year of last renovation	1.0	Score between 1-10 depending on remaining service-life for water and waste pipes in buildings
	Status of surfaces	-	Good/Average/Poor	1.0	Score of 1-5-10 depending on the perceived condition of surface materials
Use	Share of apartments with new surfaces	Percent	Percentage of modernized apartments	0.5	Score between 1-10 depending on the percentage of modernized apartments after last renovation
	Damage cost	EUR/m ²	Damage cost per square meter, mean of last 5 years.	1.0	Score between 1-10 depending on damage cost. Definition of the case study company used here – includes direct damage cost, consultancy cost, upgrades and maintenance. Mean value of the last 5 year is calculated by the model.
	Moisture load	-	Low/Medium/High	0.5	Score 1-5-10 depending on the perceived moisture load.
	Damage cost trend	EUR/m ²	Yearly change in damage costs per square meter for the last 5 years	0.7	Score between 1-10 depending on how the damage costs have developed during last 5 years. Positive development gives higher scores. Defined as the linear regression.

Most parameters have a straightforward scoring method – older or higher cost means higher score. But *construction year* and *share of apartments with new surfaces* are not immediately obvious. They are dependent on circumstances that need to be described in a more complex way. The scoring had to be based on expert opinions. For example, during

the 1950's the quality of cast iron pipes were generally low, so the score for *construction year* is high during this period compared to before and after. For *share of apartments with new surfaces* a large share means that many bathrooms have new surfaces with little need for renovation.

After all inputs have been converted into weighted scores they are grouped into three categories: *facts*, *status* and *use*, which describe building information, building status and current use respectively. The score of the three groups are then added together and normalized into one final score between 1 and 10. The score indicates the need for renovation of one property in relation to the other properties that are evaluated based on the same conditions. When filled with data the model provides a snapshot of the pipe renovation need within a group of properties based. See figure 2 for example of how the score is calculated. The prioritization made by the model will provide documentation of the status of the properties. If updated data is provided regularly the model could work as a documentation tool of the need for pipe renovation over time.

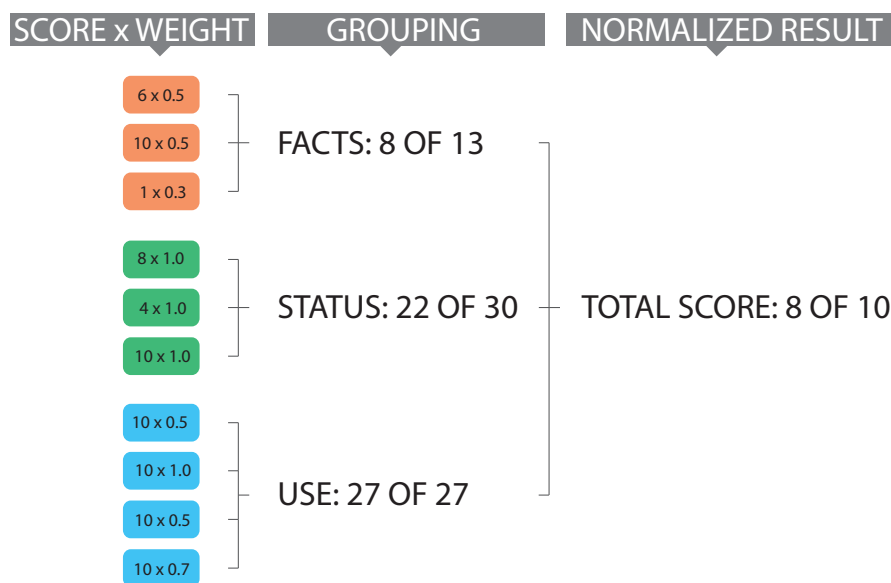

Figure 2 Model calculation example

5.3 Validation

Property owners that took part in the development were also engaged in a validation of the model. The purpose was to see how well the model could reproduce the pipe renovation priorities made by experts. Each company were given a presentation of model and asked for their opinion regarding how it could be used to predict need of pipe renovation. The case study company was then asked to identify the most influential parameter, this parameter was assigned the weight of 1. Then the experts specified the relative importance of all other parameters compared to the most influential. Finally the case study company provided data from buildings with varying need for pipe renovation. According to the experts the model could be used to predict the need for pipe renovation, although some minor adjustments were identified and corrected.

Cast iron pipes manufactured in the years following the Second World War and plastic pipes manufactured between 1970-1979 were identified as having poor quality. Consequently the parameter *construction year* needed to be adjusted to yield high scores for these periods. It was also pointed out by the respondents that *construction year* reflects the situation of today, which may change over time. The parameter *remaining service-life of pipes* currently assigns a common service-life for sewage and water pipes. In reality water pipes have shorter service-life. If a common service-life should be used, the experts recommended that 40 years be used. *Damage cost* was identified as an important parameter, although hard to identify correctly for some companies. For the model to show relevant damage cost, only the cost related to pipes and moisture barriers should be identified. If not defined correctly, it reflects more than pipe related damages and loses credibility. *Damage cost* will possibly fluctuate more in small buildings because the parameter is measured per square meter, making it less useful in the model. It was suggested that instead of using subjective estimates to determine the *moisture load*, the consumption of hot water for the building could be used as an indicator of moisture load. *Share of new apartments with new surfaces* says more about what action to take than what state the bathroom is in. It can be a decisive parameter of which properties to renovate first if other parameters give equal status. If nearly 100% of the bathrooms already have been modernized after the last renovation, then property owners probably would consider smaller, more targeted efforts instead of large renovation programs.

The model is mainly directed at large renovation programs where there is an established need for renovation, consequently the result will be more accurate in this situation. It was discussed how the model would react to high-rises and lower buildings respectively. A water leakage on one of the top floors of a high-rise typically leads to larger consequential damage – thus property owners commonly tolerate lower risk in high-rises. Compensation for different houses has not been addressed in this version of the model.

To test how the model prioritizes properties compared to experts, seven properties with known statuses were fed to the model. The test resulted in that ongoing pipe renovation projects got a rating of 8-8,5. Properties scheduled for lighter upgrades received a score of 6,5-7. Properties recently exposed to pipe renovation got a score between 2,5-3,5 (see Figure 3). Theoretically the model can produce results between 0-10, but the score of a property can never be zero, because there is always an inherent risk due to construction method etc. So a low score, as seen here, would be considered low risk. When comparing one property that was just subjected to pipe renovation to one that is ongoing with similar characteristics, they have scores of 3.2 and 8.0 respectively. The damage costs for the two properties are almost identical, because the renovation has not yet given any effect in terms of decreased damage cost.

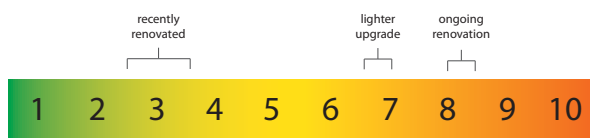

Figure 3 Validation results

There is a considerable variation in *damage cost* between all seven properties that were tested, despite that they were estimated to have the same need of pipe renovation. There were also variations of cost between years for the same property, which lead to variation in the parameter *damage cost trend*. Despite the variation in *damage cost* the results were

satisfying, it shows that individual parameters can give misleading results but together they provide a fuller picture.

6 Results

Experts were part of the development and their opinions are central to the results that the model provides, but the model may not match individual expert opinions. The validation of the model shows that it can produce results that match the prioritization of property owners, given that the parameters are defined equally for all properties. The parameters identified as most important by experts and that have most influence of the result is service-life of pipes and surfaces together with the use parameters. The damage cost data provided in the validation showed large variations from year to year for single properties and also between properties that were beforehand believed to have the same prioritization. Despite the inconsistent data, the model provides acceptable results, thus showing that a margin of error can be allowed for individual parameters.

The aim of creating the model was to develop a structure where parameters are interchangeable and their individual importance could be altered. Because property owners evaluate the status of their properties in a similar way, most property owners could use the model for structuring the need. The primary use of the model is for estimating the need for pipe renovation. Its strength is that it uses not only service-life, but incorporates also usage parameters and history of each property. From the interviews it was understood that the need for renovation is first based on several individual judgments, by using a model those individual opinions would be eliminated. A routine for obtaining the data needed, as well as regular evaluations, should be part of the implementation of the model. Another benefit of using the model is that it provides context and insight also for people used to interpret data.

From the interviews it was clear that property owners define parameters differently, hence the model will need to be adjusted for new circumstances at new companies. Currently there are no coherent definitions for many of the parameters, thus it is hard to compare the renovation need between different property owners. Neither are different buildings equally sensitive to damages, the model does currently not account for different types of buildings. Going forward a large-scale test with more properties or an evaluation after some years of use would provide interesting results to analyze in terms of how the model performs when subjected to many different types of conditions and buildings.

7 Discussion and conclusions

The use of models should be seen as one of several decision supports that forms the renovation plan for property owners. Management directives, budget etc. is not included and must be considered separately. All together the model provides a more balanced view than just looking at service-life or damage cost and the element of personal opinion can be minimized. The model is a flexible structure that allows companies to adapt and organize the planning of pipe renovation. Because each company defines parameters differently, the model is developed so it can easily be manipulated. Access and definitions of data is essential for the quality of the results and many property owners has a potential for improvement.

There is a connection between maintenance strategy and owner directives; if owner directives are expressed in terms of profitability, there is a risk of maintenance being more reactive and selective. The model presented here could act as a counterweight and

provide a maintenance prioritization overview from a technical and usage standpoint, regardless of profitability.

8 References

Alanne, K. (2004). Selection of renovation actions using multi-criteria “knapsack” model. *Automation in Construction*, 13, 377-391. doi:10.1016/j.autcon.2003.12.004

Bejrums, H. (1987). *Underhållspolicy för bostadshyresfastigheter i långtidsperspektiv (in Swedish)*. (Report No: TRITA-FAE 1025). Stockholm: Tekniska högskolan. Inst för fastighetsekonomi.

The Swedish National Board of Housing, Building and Planning (2003). *Bättre koll på underhåll (in Swedish)*. Karlskrona: Boverket. ISBN:91-7147-785-3

The Swedish National Board of Housing, Building and Planning (2010). *Teknisk status i den svenska bebyggelsen - ett resultat från projektet BETSI (in Swedish)*. Karlskrona: Boverket. ISBN: 978-91-86559-71-7

Dahlblom, M. (1999). *Installationer ur ett livscykelperspektiv (in Swedish)*. (Report No. TABK--99/3058). Lund: Dept. of Building and Environmental Technology – Building Services.

Dahlblom, M. (2001). *Orsaker till byte av VVS-installationer (in Swedish)*. (Report No. TABK—01/1020). Lund: Dept. of Building and Environmental Technology – Building Services.

Estes, A. C. & Frangopol, D. (1999). Repair optimization of highway bridges using system reliability approach. *Journal of structural engineering*, 125, 766-775. Retrieved from: <http://ascelibrary.org/journal/jsendh>

Frangopol, D. M., Kallen, M-J. & van Noortwijk, J. M. (2004). Probabilistic models for life-cycle performance of deteriorating structures: review and future directions. *Progress in Structural Engineering and Materials*, 6, 197-212. doi:DOI: 10.1002/pse.180

Högberg, L., Lind, H. & Grange, K. (2009). Incentives for improving energy efficiency when renovating large-scale housing estates. *Sustainability*, 1, 1349-1365. doi:10.3390/su1041349

Lind, H. & Lundström, S. (2011). *Hur ett affärsmässigt bostadsföretag agerar (in Swedish)*. (Report No. 2011:1, Meddelande. Inst. för fastigheter och byggande). Stockholm: KTH, School of Architecture and the Built Environment, Real Estate and Construction Management, Building and Real Estate Economics.

Okoroh, M. I. & Torrance, V. B. (1999). A model for subcontractor selection in refurbishment projects. *Construction Management and Economics*, 17, 315-327. doi:10.1080/014461999371529

Rosenfeld, Y. & Shohet I. (1999). Decision model for semi-automated selection of renovation alternatives. *Automation in Construction*, 8, 503-510. doi:10.1016/j.bbr.2011.03.031

Vattenskadecentrum (2011). *Vattenskadeundersökningen 2011 (in Swedish)*. Retrieved from Vattenskadecentrum:
http://www.vattenskadecentrum.se/download/222/VSC_Total_2011.pdf

VVS-Företagen (2009) *Renoveringshandboken för hus byggda 1950-1975 (in Swedish)*. Stockholm: VVS-Företagen.

VVS-Företagen and Svensk Ventilation (2008). *Här renoveras... flerbostadshus byggda 1950-1975. Klart 2015? (in Swedish)*. Retrieved from VVS Företagen:
<http://www.vvsforetagen.se/?use=document&cmd=download&slug=renovering-pagar-336>

VVS-installatörerna and Föreningen Sveriges VVS-inspektörer (2002). *Stambyte med våtrumsrenovering (in Swedish)*.

Wu, S, Neale, K, Williamson, M and Hornby, M (2010) Research opportunities in maintenance of office building services systems. *Journal of Quality in Maintenance Engineering*, **16**(1), 23-33.

Paper V

Renovation offers and needs of real-estate property owners

Author:

Linus Malmgren
Division of Structural Engineering
Lund University
linus.malmgren@kstr.lth.se

Abstract

Purpose – This article aims to investigate the correlation between demand and supply of services for renovation. It will also discuss how the low interest for development can be addressed.

Design/methodology/approach – Interviews were performed with contractors and a survey amongst property owners were sent out to provide insight in the Swedish situation. The results of the two studies were then compared and the findings were analyzed.

Findings – There is a correlation between demand and supply, but there is at the same time little interest of development. Many are satisfied with the situation, but poor communication, quality and high prices are identified as issues. Contractors in general offer flexible solutions and claim to be able to adapt their solutions to the specifications of clients.

Research limitations/implications – To strengthen the generalization of the results, more property owners and contractors should be investigated, including other countries.

Practical implications – The results of the study can provide better understanding of client requirements in renovation and provide a starting point for a discussion regarding development.

Originality/value – The incentives for innovation and development is low and there is a need to put forward good examples of renovation of multi-family houses. To reduce unwanted flexibility and to learn from past experiences could be a way to address the issues expressed in the study.

Keywords – property management, client requirements, renovation, maintenance

Classification – Research paper

1 Introduction

Many houses were built during the mid-twentieth century in Sweden. During the period 1965-1975, nearly 25% of all current houses in Sweden were built (Boverket, 2003) and the situation is similar in many countries. Today many of these buildings are in need of renovation, but the current pace of renovation in Sweden must more than double in the coming years to keep up with the demand (Boverket, 2003). The estimated cost to cover the minimum need is 5.8 billion Euro in buildings from 1961-1975 alone (Sabo, 2009), the total spend needed to modernize these buildings are however debated; it is estimated to 20-100 billion Euro. Concerns have been raised for the cost of maintenance in both Sweden and internationally (Lind and Muyingo, 2012) and effective, sustainable renovation is the subject of several ongoing research projects (Thuvander *et al.*, 2012), (Geier *et al.*, 2011).

Swedish real-estate property owners have listed bathroom and kitchen renovation including pipe renovation, as a prioritized area during the coming years (Industrifakta,

2008). Pipe renovation is the repair or exchange of the water and sewage pipes in buildings. This is a major intrusion in the building and a demanding task. It is capital intensive for property owners, complicated for building contractors, and not least demanding for tenants who often continue to live in apartments throughout the renovation. Successful renovation aims to minimize tenant disturbance and to produce sustainable, high quality solutions with low maintenance costs, hence it requires good cooperation between clients and contractors. The focus during recent years on renovation has increased the attention from contractors and a development of offers specifically for renovation has been seen. The industrialization of the construction industry has meant more focus on platforms and processes, see e.g. (Lessing, 2006), which to some extent also may inspire renovation. For contractors who can meet client demands combined with efficient execution, renovation offers a great potential. Some property owners however find it difficult to identify offers that match their needs and the core competences of property owners have been described as the internal checklists and in-house expertise together with guidance from directives and business plans, while construction and architectural design, evaluations etc. are commonly purchased (Thuvander *et al.*, 2012).

This paper presents a study of supply and demand on the Swedish renovation market and aim to further the knowledge of renovation and better understand the rationale and needs of clients. The correlation between demand and supply is discussed and recommendations to future development are given.

2 Renovation of multi-family houses

The incentives for renovation in multi-family houses are often technical or based on poor performance (Thuvander *et al.*, 2012). Given the composition of housing the need is increasing at the same time the declining construction rates increases the relative importance of renovation, but currently the investments in renovation is lower or equal to the investments in new construction in the residential sector (Meijer *et al.*, 2009). A comprehensive study showed that Germany, Sweden, Switzerland and UK have the largest percentage of dwellings built before 1970 (Meijer *et al.*, 2009), both single-family and multi-family dwellings. Thus there is an high need for renovation in these countries. Within the study Sweden and Switzerland have the largest sector of rented multi-family dwellings, 87 and 80% respectively of all multi-family houses. Additionally Sweden has a large share of multi-family houses that are socially rented, 68% of all multi-family houses. Consequently renovation is of high importance for both property owners and contractors in these countries.

Modernization of kitchens and bathrooms are the most common renovation activities and most of the modernizations take place before the components' end of service life (Meijer *et al.*, 2009). Barriers to a more sustainable approach to renovation are the lack of knowledge and negative cost-benefit relations. Further explanations to the low pace of renovation could be solutions that are not suitable for renovation, lack of experience and few best-practice examples (Meijer *et al.*, 2009). Consequently there is a need for development in several areas. Several small studies regarding demand and supply in the renovation sector have focused on understanding what clients want, but these studies have often been initiated by contractors, the conclusions have shown both that property owners would like to have control over the renovation process, and that they would like to place most of the details of the solution and project management with the contractor. The position of the client in renovation needs further investigation.

The positioning of large Swedish contractors has mostly been focused on multi-family houses from the period 1961-1975, where there is a large documented need and an

ongoing debate. Holistic approaches to renovation can be seen as a part of later years interest for conceptualization and industrialization in construction where focus lies on systematic approaches to processes and technology. Compared to construction there are however several differences in renovation, the most prominent are the sometimes unknown conditions of renovation, which increases the demand for project management and tenants who continue to live in buildings during projects.

3 Concepts and platforms

The founding ideas of the renovation concepts employed by some contractors can be linked to the development of industrialization of construction, which aims to increase quality through established processes and technical platforms (Lessing, 2006). Concepts with high degree of standardization, i.e. low flexibility, however need to show customers that concepts have benefits that compensate the sacrifice in flexibility (Olofsson *et al.*, 2012). An idea can be thought of as a concept or mental impression. From Latin, concept is translated as a thing conceived, thus it could be described as a general idea for marketing and design. For an organization it can be interpreted as how the organization is designed. To conceptualize is consequently to gather services and products to form an overall idea. Several large construction contractors in Sweden have formed offerings targeting the needs of the renovation market – sometimes referred to as concepts. The offerings include several aspects of renovation, for example energy efficiency, synergy effects, social factors, see e.g. (NCC, 2012), (Peab, 2012), (Skanska, 2012). From a construction point of view they form a holistic idea of how to modernize multi-family buildings and could be described in terms of a concept that addresses property owners needs. There are however little research in how the concepts have been received by property owners.

Renovation concepts generally need to have a high degree of flexibility to accommodate for the variations of existing buildings. Increasing the standardization of concepts transforms the offer from being mostly a service contract to a product offer (Olofsson *et al.*, 2012), thus having an impact on the business model. The industrialization ideas and solutions in construction are today most often supplied by an industrialized partner (Häkkinen *et al.*, 2007), which today most often is a contractor supplying a closed concept. So far design-build contracts are the only feasible traditional contracting form for industrialized concepts, unless the client acts as a concept owner (Olofsson *et al.*, 2012). There could however be a potential new role for clients in the industrialization of renovation, which includes participation in concept development and changed collaboration forms.

4 Business models as an analytical tool

To easily be able to explain the logic of what and how a company does can be a useful tool for many different reasons. Business models describe business ideas and can thus explain how companies work. The business model concept can help capture, understand and visualize business logic (Osterwalder and Pigneur, 2005). Three factors have been described as to build up business ideas; the external environment, the offering and the internal factors (Normann, 2001). The external environment is the surrounding that the company operates in, offering refers to the service or product that the company offers and the internal factors are the internal resources, capabilities and structure of the company. The business model perspective can be a good way for companies to see how products, services and competences form an offer based on their operative platform, suitable for their market position. Osterwalder and Pigneur (2005) proposed a general business model terminology that can be used to describe business models. It is based on nine building blocks and builds on a synthesis of several business model descriptions.

The building blocks led up to the definition of the business model canvas, see Osterwalder and Pigneur (2010), which contains the same groups of building blocks as described by Normann (2001), excluding financial aspects.

The business model concept can be used as an analytic tool to understand companies (Osterwalder and Pigneur, 2005), thus making it useful as an analysis framework (Kindström, 2005). It can provide means to analyze existing operations or to develop new models, it can also help outsiders understand and describe companies as they appear. Business models have before been used as a framework to analyze industrialized construction in Sweden (Andersson *et al.*, 2009). In this study business models are used to structure information about contractors.

5 Method

The aim of this study is to understand the correlation between demand and supply of renovation services for multi-family houses. The study has targeted both public and privately rented buildings, together this segment constitutes 87 % of the Swedish multi-family residential house market (Meijer *et al.*, 2009). The empiric data collection consisted of interviews with renovation contractors and a questionnaire amongst property owners.

The questionnaire aim to establish the demands posed by property owners of rented buildings. It is a straightforward approach to obtain descriptive answers and to study attitudes and beliefs (Robson, 2002). In addition it is a more effective method for reaching out to many respondents compared to interviews. The selection criteria were large property owners with long-term maintenance strategies, who actively engage in renovation and have high ambitions in property management and maintenance. 41 companies were contacted and the final response rate was 41% (76 % public property owners, 18% privately owned and 6% cooperatively owned) The participating companies together owns and maintains over 200 000 apartments. Because of the relatively small selection, the results were analyzed qualitatively. The questionnaire presupposes that respondents are knowledgeable enough to understand and analyze the renovation market. In questionnaires there can also be a difference between attitude and behavior (Robson, 2002), which can affect the validity negatively. The questionnaire included four areas: property owners' general perception of the renovation market, their preferred project setup, requirements on the tendering- and renovation process. The intention was to reflect the different stages of the renovation process and to capture the respondent's general views. The questionnaire was created online, as a form in Google Docs (Google, 2013). Before sent out the questionnaire was tested in a pilot on a property owner and on academic peers.

The interviews aim to describe different categories of renovation contractors that provide services in the segment where the identified property owners are active. A simplified business model structure inspired by Normann (2001), Osterwalder and Pigneur (2005) was used to structure the interviews according to operational platform, market position and offering. It emphasizes the relation between internal competences and external environment of contractors (Kindström, 2005), thus making it a useful tool to analyze a market from the perspective of supply and demand. Four different categories of companies were identified for the study: HVAC, small and medium sized (SME), large and system suppliers. These groups are identified as representing the market of multi-family house renovation. Two companies were identified from each group, in total 8 companies were contacted, 7 responded. Semi-structured interviews were performed with persons in managing positions, the interviews lasted about 2 hours.

The results from the questionnaire are then analyzed and compared to the interviews. The correlation between demand and supply are discussed in terms of whether the market can supply what client's request and opportunities for development are also discussed.

6 Renovation contractors

The study showed many similarities, especially in the flexibility to adapt the offer to specific client demands, see table 1. The companies are however different in terms of specialization, organizational structure and which market segments they are active in. All companies are however active on a local or regional market regardless of company size and geographical presence.

Table 1 Operational platform, market position and offer of renovation contractors

	Operational platform	Market position	Offer
Large contractors, 2 companies	<ul style="list-style-type: none"> Central coordination and documentation of knowledge. Access to specialists. Use established processes and experience High operational efficiency through the use of experienced teams Every region is responsible for bidding and execution. No formal relationships with sub-contractors, but same are often used 	<ul style="list-style-type: none"> International/National companies, but they operate and compete on local markets Have packaged existing knowledge as a response to the growing renovation market Clients span between different type of owners Can and prefer to control the solution 	<ul style="list-style-type: none"> Offer large and comprehensive initiatives to modernize buildings Also have the flexibility to compete on the terms specified by the client Have various tools that can help clients to optimize the investments, for example by energy savings or reduced operating costs Short project duration
SME contractors 2 companies	<ul style="list-style-type: none"> Heterogeneous group of companies Rely on experienced and dedicated project managers Focus on traditional execution of renovation projects Varying need of sub-contractors 	<ul style="list-style-type: none"> Active on a local/regional market Specialize in specific client segments, but accept a variety of projects Do not engage in proactive sales Little engagement in sector development and conceptualization as their clients do not request it Compete with quality and good reputation to get jobs, not price 	<ul style="list-style-type: none"> Different offerings and reimbursement models depending on company Focus on quality, flexibility and reliability, not project time Push experienced project managers as guarantee for good results
System suppliers 2 companies	<ul style="list-style-type: none"> Have separated product development from projects Well defined product, logistics and process Organization mainly consists of product development, logistics and sales Have physical logistics center or manufacturing facilities 	<ul style="list-style-type: none"> Supplier of a solution Can deliver nationally Must enter the process early for adaption to concept Still at an early stage – not many projects completed Can be used for a majority of buildings according to themselves 	<ul style="list-style-type: none"> Fast bathroom and pipe renovation – reduces time, disturbance and total cost for the client Standardized, well defined solutions – client knows what they get, but offers low flexibility Their client is the contractor and indirectly the property owner
HVAC contractor 1 company	<ul style="list-style-type: none"> Specialized knowledge in HVAC No central conceptualization or solution management Lacking project management skills for large projects with many subcontractors No formal relationships with sub-contractors, but same are often used 	<ul style="list-style-type: none"> International/National company, but operates and competes on local markets Main market for design build contracts are housing associations Rely on quality and good reputation for jobs 	<ul style="list-style-type: none"> Can accept large design build contracts, if they can perform 50% or more of the work Traditional offer built on experience Offer flexibility, can adapt solution to clients requirements Can act as HVAC-subcontractor in large renovation projects

The large contractors have gathered their existing competence under an umbrella (i.e. concept) to help clients see the advantages of choosing a contractor that can assist in finding the right content both in terms of technical solution and profitability. Concepts

focus on building knowledge and work with feedback so that the concepts gradually improve. There are no large investments in the concepts, which make them responsive to cope with changing requests. Competence and experienced teams make them well equipped to manage large projects. Large contractors are organized so that local organizations are responsible for the execution of projects, where they are free to choose solution also outside the concept. What and how comprehensive the project becomes is up to the client.

The SME contractors that were interviewed rely on good execution and their reputation on the local market. They do not have the same capacity to formalize knowledge as large contractors, instead they rely on experienced and dedicated project managers to ensure operational efficiency. Their flexibility makes the potential client segment wide, but in reality the individual companies are more specialized compared to large contractors and their offerings vary depending on their skills. They promote experience, flexibility and reliability as key content of their offer.

System suppliers are companies that supply a complete solution and the knowledge of how to install it. Thus their clients are primarily contractors and only indirectly the property owner. Consequently it is critical for them to find contractors that understand the benefits of using the concept. Their offer is standardized and offers little flexibility. The development the offer has however helped them to learn what they can and cannot do well. Their dilemma is however that they need to convince both contractor and client of the benefits compared to a traditional solution.

HVAC contractors are similar to the SME contractors. The company that was interviewed is large and international with several business areas. They expressed the ambition to integrate knowledge to create concepts similar to the large contractors. Currently the company is however more specialized on a specific technology compared to the others in the study and can thus also act as subcontractor in large projects. The solutions they offer for pipe renovation is flexible and can be adapted to specific projects. They rely on good reputation and quality for work.

7 Client situation

Company size and the average year of construction differed between the responding companies (figure 1), most of the companies however answered that they perform most of the planning in-house without the use of consultants. This shows that companies probably are competent in understanding their needs and can put up correct demands towards contractors.

Company size (number of apartments)

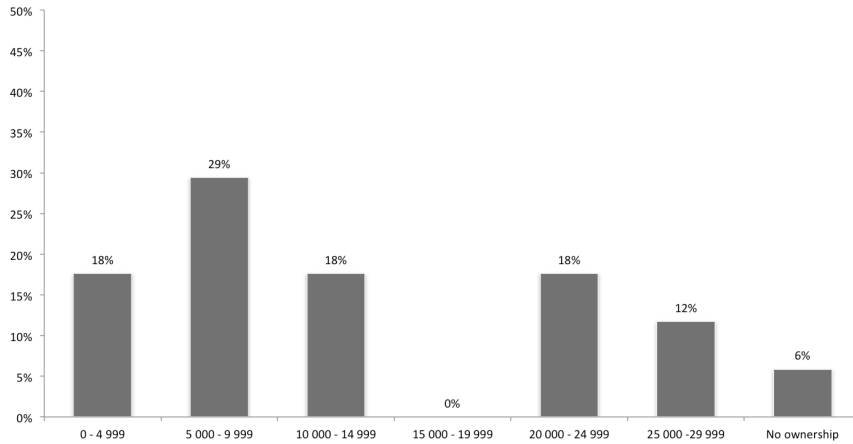

Figure 1 Company size by number of apartments (one of the responding organizations builds and maintain for cooperative tenant ownership organizations)

Large projects or individual actions

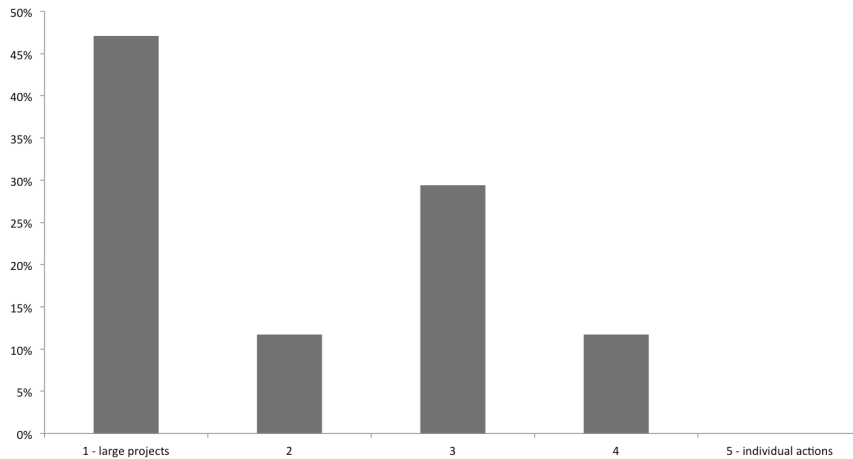

Figure 2 Large projects or individual actions.

The pace of renovation in terms of apartments per year varied between companies, probably in relation to the size of the company or how old the buildings are. Most favored project sizes were 20-500 apartments (figure 2). Almost 50% of the companies preferred to gather several actions in large projects, which can be a benefit for large contractors who have conceptualized their offers. The pace of renovation is governed by the maintenance budget and the ability to control projects, which should indicate that organizational capabilities and financial prerequisites controls renovation (figure 3). The most reoccurring problems were perceived as communication, quality and cost, which are commonly described problems of the construction sector. 41% however said the market is working just fine and 47% said that contractors provide similar solutions, which coincides with the flexibility that contractors say they offer (figure 4).

Influence on the pace of renovation

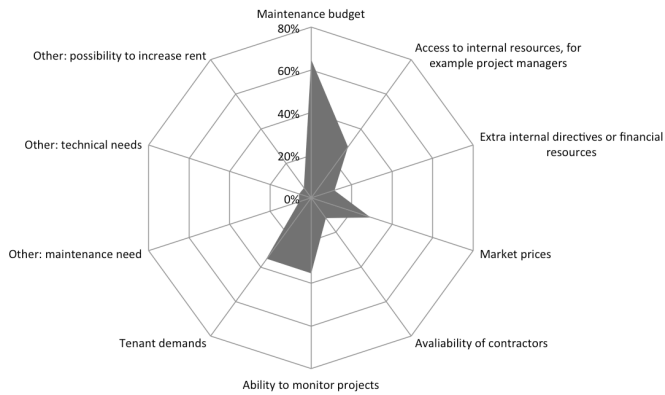

Figure 3 Influence on the pace of renovation.

Client opinions on the renovation market

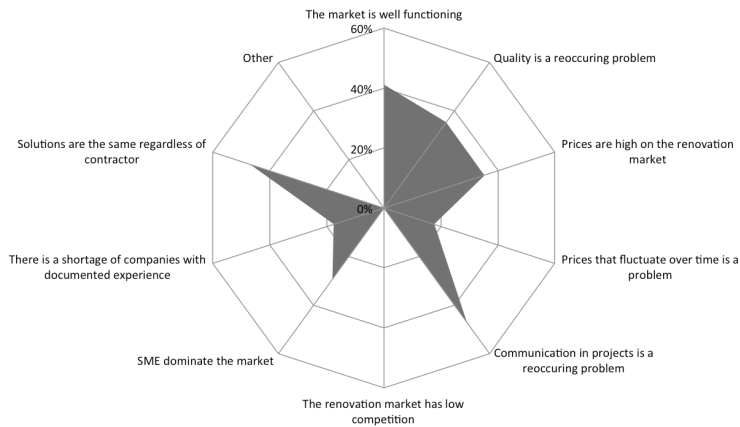

Figure 4 Client opinions of the renovation market.

Many of the respondents state that contractors prefer to offer design-build contracts (59%), but also that there are some interest in partnering contracts (35%). From the contractors design-build contracts are appealing because it gives them control over the process from design to execution and allows them to use existing knowledge and solutions. The most valued contractor characteristics in procurement is competence, followed by experience from working with tenants and competent site managers, only 6% valued if the contractor had established processes and routines, or the ability to help motivate project benefits (figure 5). During the execution effective communication, project planning and the ability to keep schedule were ranked highest (figure 6). There was a low acceptance amongst clients to pay extra for contractors with good references. The appreciated characteristics reflect traditional values of project-based construction. The interest for conceptualization or innovation seem low from the perspective of clients, however the competence of clients can provide opportunity to be more proactive.

Contractor characteristics valued in procurement

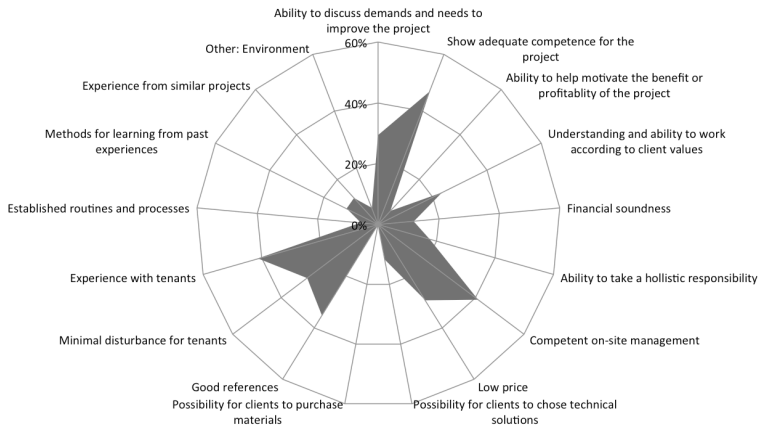

Figure 5 Contractor characteristics valued in procurement.

Contractor characteristics valued during execution of renovation projects

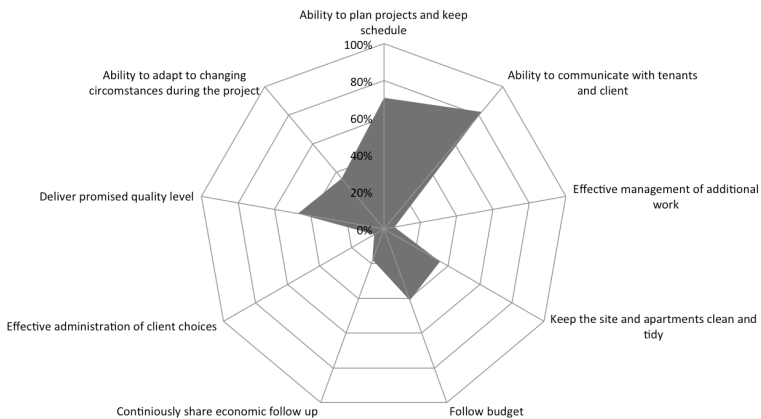

Figure 6 Contractor characteristics valued during execution of renovation projects.

8 Demand and supply

8.1 Clients' perspective

Clients give a contradictory picture in their description, a possible explanation to that clients are satisfied with the market could be that they are competent and have learned to control complicated renovation projects. Quality issues have been reported many times before in the construction industry, e.g. (Bygghögskolan, 2002). From an outside perspective this can be seen as an indicator of weak incentives for improvements amongst contractors. On the other side, there were only a limited number of clients that

wanted to better control the process of defining solutions, only one respondent valued contractors that have established processes. Despite that clients have the potential to use their influence to enforce better control of prices and quality, this does not seem like a prioritized area. By changing their position in the value chain by for example taking better control of the solution, they could reinforce their position and become less dependent on contractors for solutions. This could be a starting point for repetitive use of solutions that could gain both the success of renovation projects as well as the long-term property management.

The findings here are partially consistent with Hatush and Skitmore (1997), who also identified technical ability and management capability as the most common criteria's in procurement. The abilities that clients appreciate in projects are what one can expect from any contractor in a construction project and shows that clients continue to reinforce traditional views. To engage more actively could be a way for clients to gain knowledge and commitment to the processes and solutions of renovation.

8.2 Contractors' renovation offerings

Renovation poses special demands on contractors, it often requires work in apartments where tenants live. Working within existing structures and systems also adds complexity. Effective renovation projects require experience and the skills to minimize deviations from plans, which is dependent on a solution that can provide predictable results. Many of the large renovation projects are complex and require project management that small and specialized contractors do not have, instead they act as sub-contractors. Likewise small companies do not have the capacity or the incentives to build concepts. A probable reason is that they lack internal resources to leverage a platform. Many companies explained that they are able to adapt their solution according to different client specifications, perhaps because they compete more or less for the same clients and agility becomes a prerequisite. From the clients' perspective this is perhaps ideal, but the downside is that there are limited possibilities for standardization and continuous learning if every solution is unique.

Concepts for renovation are probably an effect of the growing market. There might however be a conflict between leveraging knowledge and established processes, versus offering flexibility. To make a difference, concept requires clients that do not have intentions to involve too much in the renovation process. System suppliers have a different situation; they are suppliers to the contractors and do not meet the client directly. They supply a complete solution that requires special skills from the contractor. They are also limited to buildings that are physically suitable for their solution.

8.3 The correlation between demand and supply

Based on the results of this study there is a match between demand and supply. But clients do not seem to be searching for new structures and contracting forms, for example innovations such as industrialization. Instead they are focused on improving the current process, asking for reliable, dependable contractors. It is the details in the execution that is lacking according to the clients; communication, planning and quality. The clients' capability to define or purchase robust solutions may be important for the quality of the result. But the more clients define, the more they need to know about the possible implications of the solutions and the contractors that they include or exclude from the bidding, which means more work. There is also a potential conflict between what the client wants and what the contractor can best deliver. In Sweden construction contractors have a strong position relative to the clients, which can create an information asymmetry leading to an imbalance of power. If contractors develop offers based on their operational platform instead of client needs, there is a gap between demand and supply, which leads to renovation projects that might fail to meet the requirements.

Property owners have stated that they prefer to manage maintenance planning, but many are not interested in the design of solutions. But often they still need to manage tenants during projects, and would like to decide specific details in some cases. This could affect the project and lead to unclear responsibilities and roles, which could lead to communication issues that have been stated as one of the problems. The flexibility offered by the contractors is twofold. It is contributing to a good and open market, but it can also make every solution unique. Low reuse gives both contractors and clients fewer possibilities for learning and building knowledge. The interest from property owners in concept solutions was low. One reason could be that good concept solutions require contractors to enter the process early. As long property owners themselves manage the early process this will constitute a barrier. System suppliers are offering a different kind of renovation that builds on established processes and standardized solutions. It offers less flexibility, but can deliver predictable results within a short timeframe with low disturbance for the tenant. The lack of references has been an argument against the solutions from clients. As long as clients are reasonably happy with the current structure, they may not see the need to take a risk with a new solutions, despite that it could mean potential benefits.

9 Conclusions

Neither clients nor contractors seem to see benefits in a development that goes outside the current logic of renovation projects. As long as property owners continues to ask for traditional renovation projects, the offers will continue to be homogeneous and flexible. What separates contractors may just be quality and price and it takes good purchasing capabilities to identify the best alternative. Contractors seem to feel forced to offer flexibility to meet varying needs from clients. But at the same time this flexibility may hinder the use of repetitive solutions and standardized processes. The results of this study can hopefully contribute to initiate a strategic dialogue between contractors and clients, which could improve understanding and development of offers.

So far the development of methods and solutions has mostly been lead by contractors. But as long as there are no demands for innovative solutions, this will inhibit development and preserve the status quo in renovation, the final responsibility for efficient solutions is dependent on the involvement of clients. There is a potential for change if clients can demand and promote new solutions, but the incentives has to be highlighted and made visible. Going forward there are opportunities to define new concepts and business models for renovation where clients can take an active role. But it will take commitment and new capabilities from both contractors and property owners. To suggest new solutions and collaboration models will require more research into why clients act conservatively in renovation projects. More research are also needed to improve generalization of this study.

10 References

- Andersson, R, Apleberger, L and Molnár, M (2009) *Erfarenheter och effekter av industriellt byggande i Sverige (in swedish)* Report No. 0905, Malmö: FoU-Syd.
- Boverket (2003) *Bättre koll på underhåll (in swedish)* Report No. 2081-2114/2002. Karlskrona: Boverket.
- Bygghögskolekommisionen, S (2002) *Skärpning gubbar! Om konkurrensen, kvaliteten, kostnaderna och kompetensen i byggsektorn* SOU 2002:115. Stockholm: Socialdepartementet.
- Google *Google docs*. [Available online from <http://www.docs.google.com>.]

- Häkkinen, T, Vares, S, Huovila, P, Vesikari, E, Porkka, J, Nilsson, L-O, Togerö, Å, Jonsson, C, Suber, K, Andersson, R, Larsson, R and Nuorkivi, I (2007) *Ict for whole life optimization of residential buildings*. Espoo: VTT.
- Hatush, Z and Skitmore, M (1997) Criteria for contractor selection. *Construction Management & Economics*, **15**(1), 19-38.
- Industrifakta (2008) *Förnyelse av flerbostadshus 1961-1975 (in swedish)*, Helsingborg: Industrifakta.
- Kindström, D (2005) *The integration of e-business into mature and established companies: A business model approach*, Department of management and economics, Linköpings University.
- Lessing, J (2006) *Industrialised house-building : Concept and processes*. Lund : Department of Construction Sciences, Lund University.
- Thuvander, L, Femenías, P, Mjörnell, K and Meiling, P (2012) Unveiling the process of sustainable renovation. *Sustainability*(6), 1188-213.
- Geier, S, Ehrbar, D and Schwehr, P (2012) Evaluation of collaboration models. Project report. E2ReBuild.
- Lind, H and Muyingo, H (2012) Building maintenance strategies: Planning under uncertainty. *Property Management*, **30**(1), 14-28.
- Meijer, F, Itard, L and Sunikka-Blank, M (2009) Comparing european residential building stocks: Performance, renovation and policy opportunities. *Building Research & Information*, **37**(5-6), 533-51.
- NCC (cited 2012) *Hållbar renovering*. [Available online from [http://www.ncc.se/sv/Projekt-och-koncept/byggkoncept/Hallbar-Renovering/.](http://www.ncc.se/sv/Projekt-och-koncept/byggkoncept/Hallbar-Renovering/)]
- Normann, R (2001) *Reframing business: When the map changes the landscape*. Chichester: Wiley.
- Olofsson, T, Rönneblad, A, Berggren, B, Nilsson, L-O, Jonsson, C, Andersson, R and Malmgren, L (2012) *Kravhantering, produkt- och projektutveckling av industriella byggkoncept (in swedish)*. Technical Report, Luleå University of Technology.
- Osterwalder, A and Pigneur, Y (2005) Clarifying business models: Origins, present, and future of the concept. *Communications of AIS*, **16**, 1-25.
- Osterwalder, A and Pigneur, Y (2010) *Business model generation*. Wiley.
- Peab (cited 2012) *Bolyftet - ett hållbart ombyggnadskoncept från peab*. [Available online from [http://www.peab.se/Om-Peab/Press-och-media/Nyhetsarkiv/Bolyftet/.](http://www.peab.se/Om-Peab/Press-och-media/Nyhetsarkiv/Bolyftet/)]
- Robson, C (2002) *Real world research*. Second Edition ed. Oxford: Blackwell Publishing.
- SABO (2009) *Hem för miljoner - förutsättningar för upprustning av rekordårens bostäder (in swedish)*, Stockholm: SABO
- Skanska (cited 2012) *Om miljonhemmet*. [Available online from [http://www.skanska.se/sv/Bygg-och-anlaggning/Miljonhemmet/Om-miljonhemmet/.](http://www.skanska.se/sv/Bygg-och-anlaggning/Miljonhemmet/Om-miljonhemmet/)]

Paper VI

Industrialization of renovation – a case study of client opportunities

Linus Malmgren¹

Abstract

Industrialized construction is considered a method to improve quality and cost in construction. This article will investigate the feasibility of using strategies for industrialized construction in renovation of multi-family houses. The importance of renovation is increasing and the investments are expected to pass those in construction of new buildings in the coming years. The renovation sector is however in need of modern and efficient approaches and clients have a key role in implementing new strategies. The aim is to provide guidance to client to how they can approach industrialized strategies for renovation. Production strategies suitable for construction has been evaluated and an adapted model for renovation is suggested, the feasibility is evaluated in a case at a professional client. The findings show that it is possible for clients to apply industrialized strategies to renovation, but it requires changes to organization and capabilities. The results indicate that there is a potential to increase quality and predictability, a starting point for clients can be to formalize the technology that is currently used.

CE Database subject headings: Construction industry, Construction management, Renovation, Residential buildings, Maintenance

Author keywords: renovation, industrialization, property owner, multi-family buildings, residential buildings

1 Introduction

The craft and resource based renovation sector is gaining interest and importance in comparison to new construction as the need in multi-family houses are increasing in many countries in Europe. The sector has been identified as in need of improvements to increase innovation and energy performance, for example by industrialization (Geier *et al.*, 2012). In Sweden property owners face major renovation needs, the exchange of water and sewage pipes is for example an imminent need that is attaining focus of the industry as well as the government (Boverkets, 2002). The case study company for example, annually spends 70-80 million Euro on maintenance and renovation, which is high compared to their peers. The high costs and impact on society makes renovation a prioritized area of improvement from several perspectives.

The industrialization of construction builds on the idea that continuous development of processes and technology should be in focus, which are then applied in construction projects (Lessing, 2006). The same thoughts could be applied also to renovation. Renovation projects today are often characterized by project specific, on-site solutions that require extensive planning and design in each project and cause large disturbances for tenants. Industrialization

¹ Ph.D. candidate. Division of Structural Engineering, Lund University. Box 118, 22100, Lund, Sweden. Email: linus.malmgren@kstr.lth.se.

has the potential to shorten the implementation process and can create replication effects for processes and technology. It can also provide new market opportunities in a growing renovation market (Geier *et al.*, 2012).

Unlike the situation in many mass-production markets, clients in the construction sector do not play a passive role (Hartmann *et al.*, 2008). Clients often have an important role and ownership in traditional renovation projects and there is a potential for clients to exert control over processes and technology by the use of industrialization. To compare, the success of construction innovation has been described as largely dependent on the involvement of the client (Nam and Tatum 1997), (Ivory 2005), (Hartmann *et al.*, 2008). If industrialization of construction can be equaled to innovation, then the success is dependent on the acceptance of the clients. Consequently the benefits for clients have to be highlighted, as well as the knowledge required to actively participate.

Industrialization of the construction industry has so far been focused on contractors with the ambition to cut costs by reducing complexity and increasing the predictability of projects. The interest from clients in taking an active role has so far been low, possible explanations could include lack of relevant experience, resources or tangible benefits. Some clients have however standardized parts of the solutions for renovation, but have often lacked a systematic approach that includes the holistic perspective. The objective of this study is to describe feasibility and the efforts needed by clients to introduce industrialized strategies for pipe renovation in multi-family houses. It is believed that professional clients do not have to change competence or organization profoundly to take active part in the development of industrialized strategies for renovation.

2 Industrialized construction

2.1 Production strategies

Japan's house building industry was explored by construction researchers attempting to transfer knowledge to the UK house-building sector (Gann, 1996), (Barlow *et al.*, 2003), (Naim and Barlow, 2003). At the same time the Swedish construction sector was scrutinized by governmental and industry commissions, industrialization was seen as a method to reduce costs, increase quality and to develop production methods (SOU, 2000). The concept of industrialized construction has been described by many authors, but it has earlier lacked a clear definition (Lessing, 2006). As an example the term "industrialized building system" has been used to describe both the technical methods and the processes of the building industry. In Japan, researchers explored how production concepts like Lean and Agile could be used to increase efficiency, the possibilities of using mass-customization as production strategy for the house-building sector was also explored. Winch (2003) identified and described four production strategies and tested their appropriateness for the construction sector:

- Concept-to-order
- Design-to-order
- Make-to-order
- Make-to-forecast

The most suitable production strategy for construction depends on the sub-sector being analyzed, however the most appropriate would be a design-to-order strategy (Winch 2003),

where significant engineering design is performed for the specific project although based on a basic product concept. Häkkinen *et al.* (2007) on the other hand argues that industrialized products must be configured in a make-to-order strategy. A make-to-order strategy consists of fully detailed design, which can be configured to suit particular customer requirements. To use either of the two strategies however requires development of solutions separate from their implementation in projects, which is a central in industrialized construction.

Prefabrication is another aspect of industrialization, which requires thorough planning. Gibb (2001) argues that the extra effort made in planning reduces the need for on-site problem solving and facilitates better on-site management (which should be a natural consequence of better planning). Altogether the use of standardization and pre-assembly potentially increases predictability and efficiency in construction projects (Gibb, 2001).

A definition of industrialized construction has been proposed based on current and earlier understandings that emphasizes well-defined processes and organizations that use “*highly developed components ... in order to create maximum customer value*” (Lessing, 2006). Central to Lessing’s definition is the separation of construction projects and the continuous development of technology and processes, which is also emphasized by Olofsson *et al.* (2012). Industrialization implies a shift of focus for companies and better understanding of production strategies can provide continuity, but it requires new capabilities and changes to the organization.

2.2 Client role in construction

Clients have been described as project focused and to rely on external project managers for the execution of construction projects, (Vennström, 2008). Furthermore clients are claimed to be driven by “value of money” in projects, through competitive tendering. This may result in that contractors and suppliers are procured to lowest price in on-off projects, with little guarantee for continued collaboration for the contractor (Cox and Thompson, 1997). Thus contractor-client relationships are focused on short-term relations, which inhibit the use of industrialization. Site specific work and solutions that are unique for the project have resulted in temporary organizations and cost inefficiencies for clients as a new learning curve has to be climbed in each project (Cox and Thompson, 1997). The short term perspective is described as an aspect of the industry culture that constitutes a barrier to change (Vennström, 2008), the focus on systematic use of solutions and processes through industrialization can however offer a way to address long-term development.

Many of the definitions of industrialized construction are however focused on the internal processes and production strategies of contractors and suppliers, clients are seldom mentioned as part of the process. At the same time there is an increasing interest in developing more cooperative contractor-client relationships, but clients have historically been reluctant to change the traditional roles (Bröchner *et al.*, 2002). Clients have even been described as non-supportive to the development of industrialized construction and to many it is still perceived as new and different (Engström, 2012). The lack of client role may hinder effective cooperation and consolidate current roles. There is a need to better understand the client role because misunderstandings and unclear responsibilities can cause interference in projects, which industrialized construction is especially sensitive to (Geier *et al.*, 2012).

An initiative by the client organization for Swedish publicly owned property owners (SABO) have resulted in a frame agreement for the construction of multi-family houses, where suppliers have used platforms and concepts to deliver buildings (SABO 2012). This is an

interesting development of the client role, because a client organization can provide larger volumes, thus it can provide appealing possibilities for contractors to develop platforms. The focus in the frame agreement lies on cost and quality and it is interesting to note that stricter demands in cost has led contractors to respond with industrialized concepts.

2.3 Industrialization of renovation

An increasing number of stakeholders take interest in the development of industrialized applications for renovation, for example property owners in Sweden and throughout Europe, see e.g. (Geier *et al.*, 2012). It is estimated that renovation will pass construction as the dominating activity in terms of importance and turnover in the coming years (Meijer *et al.*, 2009), thus there should be an increasing interest to create effective solutions. Industrialized approaches in renovation have been reported to provide positive effects that could lead to improved solutions, there are although barriers that have to be resolved (Geier *et al.*, 2012). Risks include insufficient planning time and collaboration within design or construction teams (Geier *et al.*, 2012). It appears that the attempts so far to implement industrialization in renovation has been within the existing project organization. For effective implementation the process would need to change and clients need to take a holistic approach.

2.4 Industrialized strategies for renovation

The research in property maintenance has been described as underdeveloped (Wu *et al.*, 2010) and repair and maintenance does not have comparable activities in manufacturing (Winch, 2003), thus the industrialization of renovation require separate attention. Based on production strategies, a model that describes renovation from the position of the clients is adapted from the structure of the product specification process by Hvam *et al.* (2008), see figure 1. The product specification process describes the appropriate level of pre-definition of solutions suitable for different manufacturing organizations (Hvam *et al.*, 2008). The level of pre-definition can span from an identification of codes and standards, which are used to engineer customer specific products, to the development and production of standard products where customers choose a variant (Hansen, 2003). The model aims to increase clients' influence in renovation by strengthening the use of standardized approaches. Four different strategies based on a separation of development of technology and processes are suggested, which can potentially change the role of clients to concept owners.

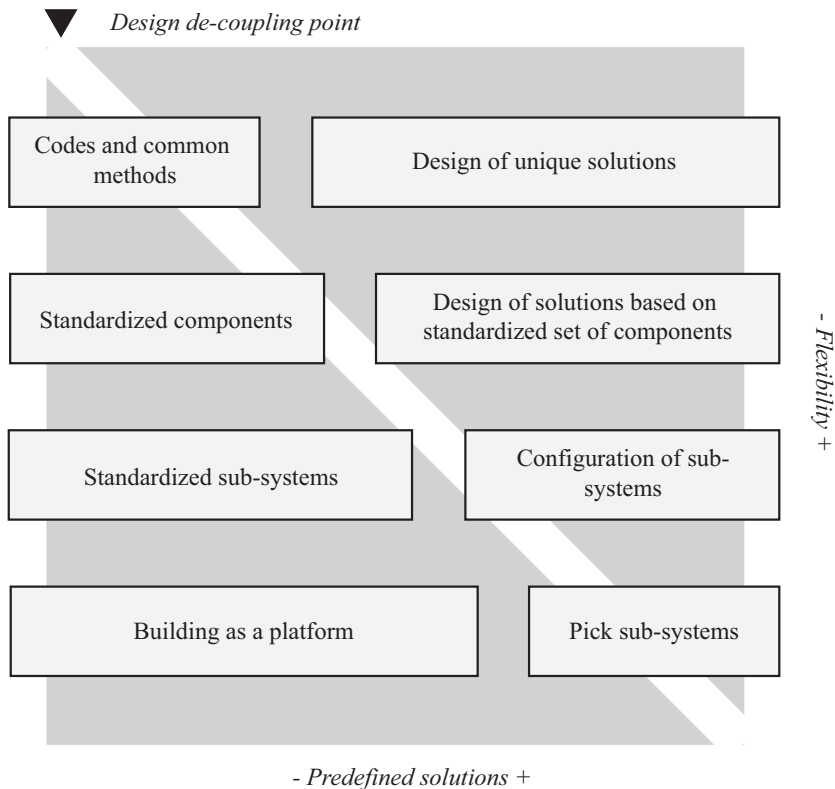

Figure 1 Production strategies for renovation.

The model is based on the separation of the continuous development of solutions and processes, and the project specific activities. The left side of figure 1 represents design performed independent of projects, i.e. product development. The right side represents design that is specific for each project. The design de-coupling point is the stopping point for the product development process. Increased definition of solutions provides less flexible solutions, on the other hand it requires less design in each project and offers better predictability. The strategies represent different levels of systematic use and definition of the solutions.

In the *project strategy* all design is created specifically for the project, based on codes and regulations. It provides flexible solutions that can be optimized to specific buildings and projects. Knowledge can be reused based on the participants' individual experiences, but because project groups often are temporary, systematic reuse of knowledge from earlier projects is difficult to implement. Processes are difficult to formalize because of changing practice depending on who participates.

The *component strategy* means that key components are defined and included in all projects where applicable. Still a large part of the solution is designed in the project, but based on design concepts and standardized components. This option offers standardization at the expense of some flexibility and requires clients to arrange processes to choose and evaluate components. The systematic use of components better allows for feedback and evaluation to

support continuous improvements. A component strategy can further include information or instructions for contractors of how to install components, similar to a manual.

The *sub-system* level implies that components have been put together into solutions that cover sub-systems of the building, for example for pipe- and bathroom renovation. The sub-system and its' interfaces are defined independent of projects in a product development process. Here processes and information can be detailed even further compared to the component level. The level offers more predictable results because of known and tested designs. Likewise the ability to evaluate solutions becomes more beneficial because of the high level of reuse.

The *platform strategy* means that buildings are treated as several sub-systems that together form a platform that includes all major functions of the building. This allows for most parts of buildings to be pre-designed. The platform level provides the opportunity to implement processes and information systems that can support many aspects of the design and construction phase, for example purchasing, logistics, and continuous development. It however requires a design that is well conceived and integrates building systems well. Little design is performed in the projects, thus it changes the processes and roles significantly. This strategy corresponds to the make-to-forecast approach (see chapter 2.1), which becomes difficult to implement in a majority of renovation projects because of changing conditions.

According to the model more pre-definition means more predictable quality and cost as well as the possibility to include different aspects of the supply-chain, for example purchasing. Depending on the strategy chosen, it however requires different capabilities of clients. Solutions that are developed independent of projects generate information that can be managed differently to allow effective use. The project development process put clients closer manufacturing companies, thus inspiration to product data management could be found here. Also, the introduction of new production strategies will affect clients on a strategic level and require change to many aspects of how clients engage in projects.

4 Method

A case study approach was chosen to be able to in depth describe the real-life context of a large property owner as well as to be able to have a continuous discussion about their attitudes towards industrialization (Yin, 2003). It was conducted at a large Sweden public property owner and construction client. The aim was to describe how they currently manage pipe renovation projects, as well as to understand the feasibility and potential implications and benefits to an increased focus on design and standardization of solutions for pipe renovation.

The first part of the case study aimed to understand the current situation and included participation in project- and internal meetings as well as work-site visits. Also technical and financial information were accessible at the case study company during this phase, which increased the general understanding. The case study company was in the middle of a program to formalize processes, data was collected through participation in meetings and workshops that resulted in process documentation. Interviews and discussions with several mid- and high-level managers, as well as several project managers were held to describe how the case study company works today and to understand their opinion to an increased ownership of solutions.

Using industrialization strategies suitable for construction as a basis, the case company was then matched to identify suitable client strategies for pipe renovation. The required capabilities for industrialized strategies and extended focus on solutions were compared and analyzed to the model presented in chapter 2.4. The implications for the pipe renovation process were then evaluated and the potential effects on the case study company are discussed. This is a first suggestion to a model, to improve generalization of the results will require more evaluation of different cases.

5 Case description

5.1 Need for modernization and pipe renovation

The case study company is a municipality owned property owner in one of the largest cities in Sweden and were founded more than 60 years ago. They provide rental apartments as their main business. With almost 23 000 apartments they have a market share of 33 % of all rental apartments and a market share of 15 % of the total dwelling stock in the city where they are present. They have almost 300 employees of which around 30 are working with technical maintenance and 4 specifically work with project management and tenant communication in pipe renovation projects. As a publicly owned property company they abide under the Public Procurement Act (PPA), which put demands on all purchasing above a certain amount. It obliges them to set up fixed criteria for purchasing and evaluation of bids. According to the PPA, it is not free to contract whoever they deem most appropriate. Many of the buildings were built during the period 1950-1970 (figure 2), because of the aging property stock many houses' technical systems are now in need of renovation.

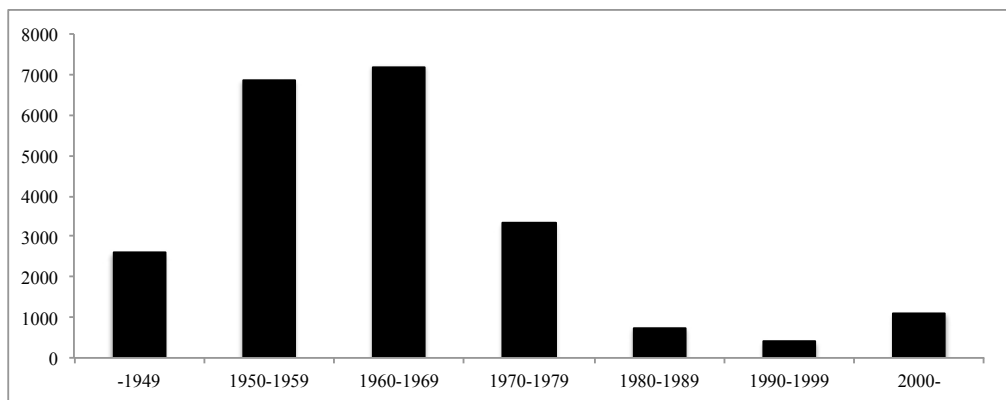

Figure 2 Case study company apartments by construction year.

In 2008 the case study company completed an extensive investigation to quantify the need for pipe renovation and to form an action plan. There was an estimated need for renovation in 12 000-15 000 apartments during the coming years. The current planning to address the issues stretches to 2027. The conclusions of the investigation were based on three data sources:

- Physical inspections of buildings to determine and document status of systems and materials
- Interviews with staff who do daily maintenance

- Maintenance- and damage history documented in IT-systems

The investigation resulted in a strategy where three approaches to pipe renovation were decided, these are further explained in chapter 5.2. Pipe renovation with bathroom modernization is one of the largest and most complex types of renovation projects and currently they perform pipe renovation in about 500 apartments per year as a result of the investigation. The approaches constitute a recommendation based on the technical status and renovation costs. Because of the high costs of pipe renovation the investment also has to be approved by the top management.

5.2 Pipe renovation approaches

The three different approaches to pipe renovation (see table 1) have been formed to address the varying need in the buildings. The case study company aim is to optimize the service-life of existing components instead of using the same solutions throughout, thus achieving financial benefits by not doing more than necessary. The savings is estimated to almost 30% for each building where they do not have to perform the most intrusive approach. The criterion for choosing alternative is based on the judgment of the maintenance planners and builds on the status of the buildings in combination with the requests of the property managers of the specific buildings.

Table 1 Pipe renovation approaches employed by the case study company.

Approach	Description
#1 New water and sewage pipes, refitting of bathrooms	Total refitting of the bathrooms including new tiles and floors. New pipes for water and sewage are installed throughout the building. Often the electrical system in the apartments is exchanged as well. In some projects new kitchens have been included. When this kind of project is performed in the building, tenants get the opportunity to choose between shower and bathtub as well as chose tiles. They also get the opportunity to upgrade, for instance kitchens with dishwasher. This alternative requires approximately 8 weeks of work in each apartment before the tenant can use the bathroom again.
#2 New water pipes	This alternative replaces the incoming water pipes in the building. New vertical pipes are installed in shafts, often in the stairwells. New horizontal pipes on each floor extend to the kitchen and bathroom in each apartment. This alternative only requires minimal work in each apartment, thus the disturbance for tenants is minimal.
#3 Relining of sewage pipes	In buildings where #2 has been performed the sewage pipes remains to modernize. In buildings where applicable, a relining of the existing pipes are performed instead of an exchange. This procedure is much quicker, cheaper and offers less disturbances for tenants compared to #1.

Approach 1 is for buildings where there is a combined need of renovation for bathroom interior and water as well as sewage pipes. This approach require approval from all tenants before project start, because the project makes it eligible to increase the rent. The rent increase is part of the budget and motivation in the financial evaluation. Approach 2 is motivated by leaking water pipes at the same time as there is little need for renovation of sewage pipes and bathroom interior. By performing a partial renovation they can address only parts the where the service life has expired, thus they reduce project cost and time, as

well as minimize the disturbance for the tenants. Approach 3 addresses only sewage pipes where relining of existing pipes is applicable. The status of the pipes must however be of above a certain level for this approach to be possible, otherwise a complete renovation (approach 1) must be chosen instead. Approach 3 has the same benefits as 2 in terms of cost, time and disturbance. Approach 2 and 3 represents lighter alternatives for buildings with a partial renovation need. They are performed separately from bathroom interior renovation, which can be performed at a later stage when the need occurs. 2 and 3 has the benefit of not needing tenant approval and does not incur rent increase, thus the planning is shorter.

The approaches differ in the extent of the renovation and do only address strategic concerns, not the technical content. Especially in approach 1 there is room for different contractual and technical solutions. The need for flexibility and adaption to the unique conditions of each project has been expressed as necessary due to variation between buildings. In approach 1 the extent of the project and detailed solutions are up to the project manager and the consultants in each project. The 2 and 3 approaches are less extensive projects and are managed as continuously ongoing activities and also procured differently.

5.3 The pipe renovation process at the case study company

The pipe renovation process in approach 1 can be divided in three separate sub-processes: planning and prioritization, tenant interactions, the design and execution. Hereafter the process is described from the perspective of the property owner as a client in the design and execution of renovation projects. Figure 3 shows the process in detail (current practice as of 2012).

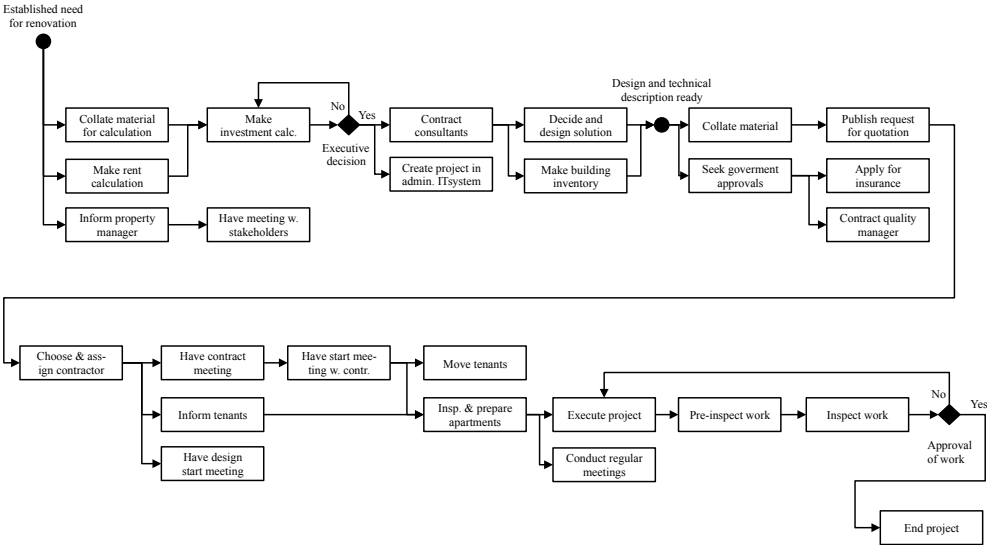

Figure 3 Case study company pipe renovation process.

When a project is handed over to a project manager the first step is to calculate the benefits of the investment. The calculation accounts for rent increases, historical and expected damage costs and the total project cost. The project is then evaluated for the duration of the calculation period, the profitability and any remaining values. If the calculation returns an investment that does not meet the standard, the project will stop at this stage. At this stage the

cost estimates for the project is based on experience, because neither contractor nor consultants are involved at this stage. In parallel the appointed project manager informs about the proposed forthcoming renovation in a meeting with all internal stakeholders.

If the project is approved, external consultants and designers are contracted to design a proposed solution. During this phase the client and consultants examine buildings and meetings are continuously held. When drawings and technical documentation are completed, a request for tender is published. When a contractor has been selected and deemed qualified for the job according to the PPA, a contract is signed.

It is common practice at the case study company that most of the tenants continue to live in the building during the project, with temporary toilets and bathrooms placed in the courtyard or in the basement. The work in the building then progresses according to the contractors' schedule. Project meetings are held every three weeks. Frequent visits and controls are however made by the project manager during the course of the project. The project manager is also standby to solve problems.

When the contractor has finished the work they report to the client and a pre-inspection of the work is performed to identify eventual errors and sub-standard work. When the work has been approved in a final inspection, the apartments are handed back to the tenants and the project is ended. There is no formal process for knowledge reuse, but an internal meeting is held after completion.

5.4 Technical solutions

The case study company has a procurement function that manages the purchase of standard components, materials and services. The responsibility spans from kitchen cabinets, to floors, to windows and standard contractor services, the main incentive is to obtain lower prices. The use of tiles and pipe modules are currently standardized in all pipe renovation projects, but it is so far only a small part of the technical content in the project that is procured centrally and only well-defined components.

Throughout the study there was a reluctant attitude to more standardization of components or materials, because of perceived extra work and few benefits. Logistic responsibilities for material on-site, extra project management and responsibility were mentioned as reasons. During later interviews the opinion had moved towards less responsibility in projects, which would further decrease their influence. In pipe renovation the case study company is currently involved in the design phase through consultants, where they can influence the solution. A solution is designed based on the specific conditions of the project and the standardized components supplied by the company. They are dependent on external consultants because they have no in-house design capability and technical consultants contribute to the design with their previous knowledge and information. Consistent use of technical solutions is thus dependent on the use of the same consultants or project managers that can correctly communicate the requirements of the case study company. There is a lack of structured coordination between projects that would help to maintain a technical standard. Currently this is up to the individual project managers. The three approaches to pipe exchange are on a conceptual level, thus no documentation of solutions has been decided necessary. Consultants are most active in the design phase, after the design has been completed their involvement in the project ceases. No formal routines or systems to gather feedback after project completion were identified in the case study, which makes it hard to

evaluate solutions. As a consequence much of the information is not made available to the rest of the organization.

5.5 Reflections

According to the management, the overall potential to develop maintenance and renovation effectiveness lies in repetition by the use of a project methodology and in creating a learning organization. Until now they have seen no incentive to standardizing more solutions or taking a larger responsibility in projects. Their view is that industrialization so far mainly has benefited the productivity of contractors. It was expressed that a competitive market would be able to provide good quality products at the right price, thus there should be no need for clients to engage in increasing the effectiveness of renovation projects.

In several interviews and reflections it was expressed that the financial project examination exhibits a large barrier that all renovation projects have to go through before they are approved. It was described as time consuming, rigid and only evaluates one project at the time and thus misses any long-term benefits. Top management sees the examination as a tool to control costs and to make sure that the most financially sound projects are executed. They constantly have to balance the long-term benefits and the profitability of each project. Project managers also expressed a large potential in better information management, especially for project related information.

6 A suggestion to a sub-system strategy for pipe exchange

6.1 Current conditions

The long-term ownership strategy of the case study company provides a great potential to see renovation in a life cycle perspective. Many of the problems that were described in the first step of the study stem from the current pipe renovation process, which may be a reason to that they have tried several different approaches. But constant changes make a systematic approach more difficult and may risk overseeing potential long-term benefits. The introduction of a systematic approach that includes both solution and processes could provide needed stability. The current direction towards less direct involvement in the process might eventually lead to the loss of knowledge and capabilities. Today the case study company already chooses part of the solution, which shows long-term thinking – but at the same time they evaluate success on project level and not whether the next project is more effective than the previous. The systematic use of components that have been introduced allows them to specify part of the solution for renovation projects, but at the same time less involvement indicates an ambivalent attitude. The changes over time in how they choose solutions and collaborate with contractors make learning from past experiences difficult.

Today consultants and contractors are the primary users of solution information in renovation projects at the case study company, they are however exchanged over time, thus information and experiences frequently has to be conveyed to new project participants, which is both unproductive and a potential source of error. As a consequence, consultants and project managers carry information instead of documented routines and systems.

6.2 Potential and implications of a systematic approach for the case study company

A sub-system approach can provide a good balance between flexibility and predefinition of solutions without significant changes to the organization. Renovation in contrast to new construction often may require more flexible solutions because of the fixed preconditions of existing buildings. It could give benefits in terms of continuity and control without fundamental change to processes and solutions. It will however shift focus of project-based design to a continuous development and improvement of well-established solutions (figure 4). In projects the appropriate solution could instead be configured based on the already specified solutions that constitute a sub-system for pipe exchange, which can shorten time and provide known quality.

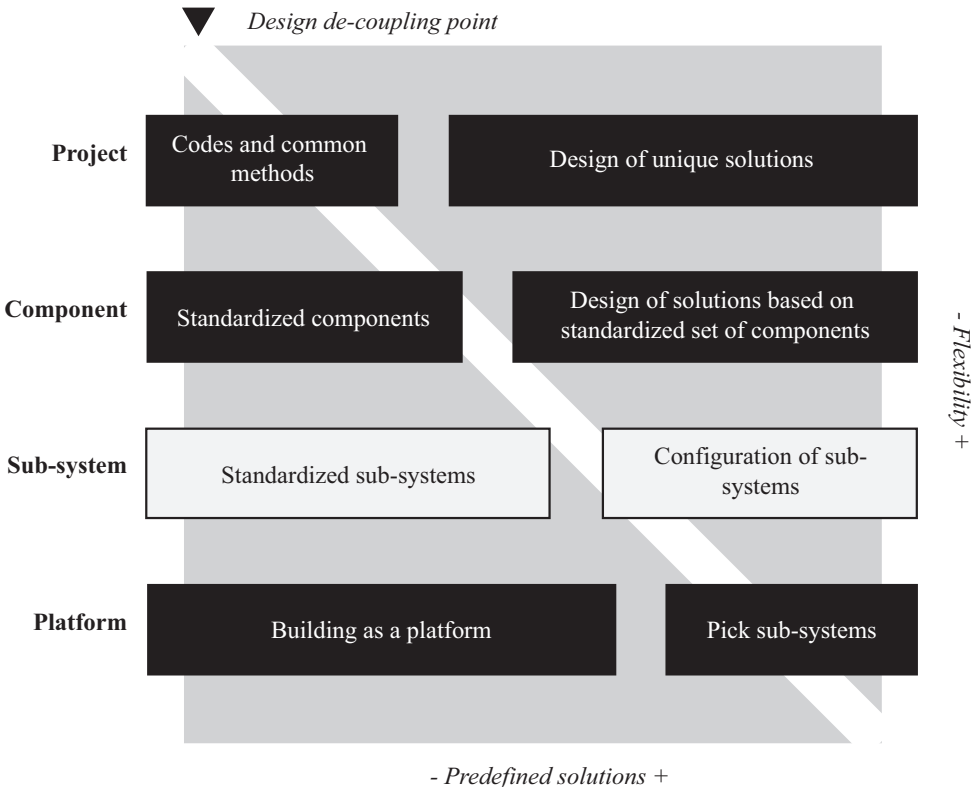

Figure 4 Sub-system approach selected for pipe renovation.

The transformation from in-project design to sub-system strategy changes the ownership and responsibility of design and development of solutions from contractors and consultants to clients. Necessary changes include defining, or redefining, processes for product development, continuous improvements and the execution of projects. With the introduction of a product development process, design activities currently performed in projects will be moved (see figure 3) thus reducing the execution process. Routines for continuous platform development will need to be added, as it has not been a part of the execution process before. Also the quotation process changes because of more detailed specifications of the solutions. More detailed specifications that comes with the platform makes the executive decision based on better known facts instead of estimations as in the current process. The change also

presents the possibility to create work instructions for contractors, based on experience and also the possibility to better define the expected result. Over time less errors can be expected because solutions are tried and tested. With a better defined ownership for the technical platform and increased design capabilities, there can be a more strategic direction of the development. The creation of a platform gives the possibility to procure solutions and materials as an option for clients. The case study company has however argued that today contractors obtain better prices and that there are not interested in the extra work connected to managing materials.

A systematic approach must accommodate necessary flexibility, functionality and ability to manage the interfaces to the surrounding structure, which require design capabilities. Transferring consultants from the case study company's current in-project design could be a solution for the need of continuous maintenance and development.

The case study company has previously measured success based on the project result in terms of budget and schedule. The separation of design and development from projects makes long-term evaluations of solutions more important and processes for how to reuse knowledge and implement improvements have to be designed. Solutions separated from projects also provide opportunities for documentation of solutions independently, that can introduce version management and the ability to maintain a standard solution. But a requirement is that solutions can be effectively distributed to project participants, so that information transfer between development and projects is considered. This can be accomplished through an information structure internally based on a product structure with component trees and variants, see e.g. Malmgren *et al.* (2010).

Systematic use of solutions can aid cost estimations and thus make better budgets because the solutions are well known. It may also lead to that issues are identified and remedied, thus also contributing to lower cost. There are also several risks with the implementation of sub-system seen from the case study company's perspective:

- From a technical perspective it may be a risk if buildings are so different that it is hard to find enough common denominators to create a systematic approach.
- From a business perspective, a change in renovation strategy could mean that solutions are rendered unnecessary.
- The internal acceptance and sponsorship is important for long-term stability.
- For successful implementation, the solutions will need to have a certain volume to justify the investments as well as to be an effective strategy. With low volumes, contractors will not see the need to adapt their current practices to the client and the market cannot exist.
- Investments in resources, for example staff, will be necessary for design and development.

7 Discussion

The traditional focus of clients has often been in the project specific issues (Vennström, 2008), consistent with the views of project managers in the case study. Industrialization could however help to better see the long-term benefits. A contributing factor to the short-term view is the financial examination that many property owners subject their renovation

projects to. A project by project economic evaluation may miss learning aspects as well as the life-cycle effect of solutions.

There is a potential for clients in using industrialized strategies for renovation. The case study company has already standardized some components for pipe exchange as well as the over all approach, which they can continue to build on. In the short term perspective the change of strategy will make investments and reorganization necessary, which potentially can create confusion and add extra costs. Investments are however necessary to achieve the long-term benefits, thus perseverance is necessary. The case study showed that there in some aspects exist an ambivalent attitude to standardization, which has to be more coherent going forward. Otherwise the mix between standardized components and project specific details may risk to create confusion and missed benefits.

Solutions specified by clients could potentially create a new market for renovation. Stability through the continuous use of solutions creates an opportunity for contractors to learn how clients work and what they expect. If clients can guarantee volume and consistent use, client led strategies and concepts could provide contractors with the opportunity to specialize. This would mean a shift from today where consultants or contractors often suggest and develop solutions. The PPA has however been problematic to tackle for public clients. They have continuously during the study discussed how they best can collaborate with contractors in accordance with the PPA. So far the impression is that the case study company has felt hindered to choose the best partner from a long-term perspective, thus impeding collaboration.

Industrialized strategies could alternatively be led by industry organizations, which would mean that more companies can use the same solutions, at the same time it creates larger volumes. The examples that exist today seldom include development of solutions, instead they focus on efficient purchasing and volume. Larger volumes could create a more viable market and the costs of necessary development could be shared between more participants.

8 Conclusions

The study has concluded that:

- Clients could potentially increase quality and predictability, as well as reduce costs in renovation projects by adopting industrialized strategies.
- The potential lies in better control of technical solutions, processes and information management, but with it comes reduced flexibility.
- Industrialized strategies also have the potential to create a new market where clients have a strong position.

The different approaches presented in this paper aims to create guidance for clients and can be used as an aid to develop strategies. By strong engagement, clients can affect the construction process to create more customer value, i.e. value for themselves. Quality, sustainability and effective property management should be in focus for property owners, not low cost in each project. At the same time contractors have the potential to learn how specific clients work, which may mean lower risks, more precise schedules and better cost estimates. The standardization of technology and processes can become a platform for continuous improvements, therefore industrialization should be considered for its' long-term benefits.

Clients that see a potential in industrialized renovation should start with building on the existing knowledge within the organization. A starting point could for example be to formalize routines for technology that is frequently used in renovation projects. Processes and information structures that facilitate cooperation could be added over time.

Acknowledgements

MKB Fastighets AB and SBUF (The Development Fund of the Swedish Construction Industry) are gratefully acknowledged for financial support.

9 References

Barlow, J, Childerhouse, P, Gann, D, Hong-Minh, S, Naim, M and Ozaki, R (2003) Choice and delivery in housebuilding: Lessons from japan for UK housebuilders. *Building Research & Information*, **31**(2), 134.

Boverket (2002) *Bättre koll på underhåll (in swedish)* Report No. 2081-2114/2002. Karlskrona: Boverket.

Bröchner, J, Josephson, P E and Kadefors, A (2002) Swedish construction culture, quality management and collaborative practice. *Building research and information*, **30**(6), 392-400.

Cox, A and Thompson, I (1997) 'Fit for purpose' contractual relations: Determining a theoretical framework for construction projects. *European Journal of Purchasing & Supply Management*, **3**(3), 127-35.

Engström, S (2012) *Managing information to unblock supplier-led innovation in construction*, Department of Civil, Environmental and Natural Resources Engineering, Luleå University of Technology.

Gann, D M (1996) Construction as a manufacturing process? Similarities and differences between industrialized housing and car production in japan. *Construction Management & Economics*, **14**(5), 437-50.

Geier, S, Ehrbar, D and Schwehr, P (2012) *E2ReBuild - evaluation of collaboration models*. Project report. E2ReBuild.

Gibb, A G F (2001) Standardization and pre-assembly - distinguishing myth from reality using case study research. *Construction Management and Economics*, **19**, 307-15.

Häkkinen, T, Vares, S, Huovila, P, Vesikari, E, Porkka, J, Nilsson, L-O, Togerö, Å, Jonsson, C, Suber, K, Andersson, R, Larsson, R and Nuorkivi, I (2007) *Ict for whole life optimization of residential buildings*. Espoo: VTT.

Hansen, B L (2003) *Development of industrial variant specification systems*, Department of Management Engineering, Technical University of Denmark.

Hartmann, A, Reymen, I M M J and van Oosterom, G (2008) Factors constituting the innovation adoption environment of public clients. *Building research and information*, **36**(5), 436-49.

- Hvam, L, Mortensen, N H and Riis, J (2008) *Product customization*. Berlin, Heidelberg : Springer-Verlag Berlin Heidelberg, 2008.
- Ivory, C (2005) The cult of customer responsiveness: Is design innovation the price of a client - focused construction industry? *Construction Management & Economics*, **23**(8), 861-70.
- Lessing, J (2006) *Industrialised house-building : Concept and processes*. Lund: Department of Construction Sciences, Lund University, 2006.
- Malmgren, L, Jensen, P and Olofsson T (2010) Product modeling of configurable building systems. *Journal of information technology in construction*, **15**.
- Meijer, F, Itard, L and Sunikka-Blank, M (2009) Comparing european residential building stocks: Performance, renovation and policy opportunities. *Building Research & Information*, **37**(5-6), 533-51.
- Naim, M and Barlow, J (2003) An innovative supply chain strategy for customized housing. *Construction Management & Economics*, **21**(6), 593-602.
- Nam, C H and Tatum, C B (1997) Leaders and champions for construction innovation. *Construction Management and Economics*, **15**(3), 259-70.
- Olofsson, T, Rönneblad, A, Berggren, B, Nilsson, L-O, Jonsson, C, Andersson, R and Malmgren, L (2012) *Kravhantering, produkt- och projektutveckling av industriella byggkoncept (in swedish)*. Technical report, Luleå Technical University.
- SABO (cited 2013) *Sabos kombohus plus*. [Available online from <http://www.sabo.se/kunskapsomraden/nyproduktion/saboskombohusplus/Sidor/default.aspx>.]
- SOU (2000) Från byggsekt till byggsektor, SOU 2000:44. Näringsdepartementet, Stockholm.
- Vennström, A (2008) *The construction client as a change agent : Contextual support and obstacles*. Luleå university of technology: 2008:31, Luleå, 2008.
- Winch, G M (2003) Models of manufacturing and the construction process: The genesis of re-engineering construction. *Building Research & Information*, **31**(2), 107-18.
- Wu, S, Neale, K, Williamson, M and Hornby, M (2010) Research opportunities in maintenance of office building services systems. *Journal of Quality in Maintenance Engineering*, **16**(1), 23-33.
- Yin, R (2003) *Case study research – designs and methods. Third edition*. Sage, Thousand Oaks, CA.