



LUND UNIVERSITY

Energy-Efficient Window Systems - Effects on Energy Use and Daylight in Buildings

Bülow-Hübe, Helena

2001

[Link to publication](#)

Citation for published version (APA):

Bülow-Hübe, H. (2001). *Energy-Efficient Window Systems - Effects on Energy Use and Daylight in Buildings*. [Publisher information missing].

http://www.ebd.lth.se/fileadmin/energi_byggnadsdesign/images/Publikationer/Rapport_TABK-01-1022_Helena.pdf

Total number of authors:

1

General rights

Unless other specific re-use rights are stated the following general rights apply:

Copyright and moral rights for the publications made accessible in the public portal are retained by the authors and/or other copyright owners and it is a condition of accessing publications that users recognise and abide by the legal requirements associated with these rights.

- Users may download and print one copy of any publication from the public portal for the purpose of private study or research.
- You may not further distribute the material or use it for any profit-making activity or commercial gain
- You may freely distribute the URL identifying the publication in the public portal

Read more about Creative commons licenses: <https://creativecommons.org/licenses/>

Take down policy

If you believe that this document breaches copyright please contact us providing details, and we will remove access to the work immediately and investigate your claim.

LUND UNIVERSITY

PO Box 117
221 00 Lund
+46 46-222 00 00

Energy-Efficient Window Systems

Effects on Energy Use and Daylight
in Buildings

Helena Bülow-Hübe

Doctoral Dissertation

Key words

window, glazing, low-emittance coating, building, energy demand, heating, cooling, solar protection, shading device, solar energy transmittance, thermal transmittance, simulation, daylight, user aspects, operative temperature, comfort, perception

© copyright Helena Bülow-Hübe and Division of Energy and Building Design.
Lund University, Lund Institute of Technology, Lund 2001.
Layout: Hans Follin, LTH, Lund
Cover Photo: Jean-Yves Dion

Printed by KFS AB, Lund 2001

Report No TABK--01/1022
Energy-Efficient Window Systems. Effects on Energy Use and Daylight in Buildings.
Department of Construction and Architecture, Lund University, Division of Energy and Building Design, Lund

ISSN 1103-4467
ISRN LUTADL/TABK--1022-SE

Lund University, Lund Institute of Technology
Department of Construction and Architecture
Division of Energy and Building Design
P.O. Box 118
SE-221 00 LUND
Sweden

Telephone: +46 46 - 222 73 52
Telefax: +46 46 - 222 47 19
E-mail: ebd@ebd.lth.se
Home page: www.byggark.lth.se

Abstract

This thesis deals with energy-efficient windows in Swedish buildings. Parametric studies were performed in the dynamic energy simulation tool Derob-LTH in order to study the effects of window choices on energy use and indoor climate for both residential and office buildings. A steady-state program was used to evaluate two years of measurements of energy use and indoor temperatures of an energy-efficient row-house. Two behavioural studies regarding (1) daylight transmittance, view and room perception using super-insulated windows and (2) the satisfaction with the daylight environment and the use of shading devices in response to daylight/sunlight were conducted in full-scale laboratory environments exposed to the natural climate.

Results show that as the energy-efficiency of buildings increase, window U -values must decrease in order not to increase the annual heating demand, since the heating season is shortened, and useful solar gains become smaller. For single-family houses with a window-to-floor area ratio of 15 % and insulated according the current Swedish building code, the U -values should thus on average be lower than $1.0 \text{ W/m}^2\text{K}$. For houses insulated according to 1960s standard, the U -value may on average be $1.6 \text{ W/m}^2\text{K}$. For colder climates (northern Sweden), the U -values should be somewhat lower, while slightly higher U -values can be tolerated in milder climates of south Sweden. Thermal comfort during winter is improved for energy-efficient windows. However, overheating problems exist for both super-insulated houses and highly glazed office buildings showing a need for very low U -values in combination with low g -values. Daylight experiments indicate that the use of two low-emittance coatings tints the transmitted daylight enough to be appreciated, and colours may be perceived as more drab and rooms more enclosed. A compromise between energy-efficiency and daylighting may be needed, and it is suggested that only one coating be used except when very high energy-efficiency is required.

Contents

Key words	2
Abstract	3
Contents	5
List of symbols	9
List of articles	11
Foreword	13
1 Introduction	15
1.1 How to read this thesis	15
1.2 Goals	15
1.3 Methods	16
1.4 Limitations	18
1.5 The context	18
1.5.1 Energy related environmental problems	18
1.5.2 Energy use in buildings	20
1.6 Main topic area 1: The role of windows in the energy system	22
1.7 Main topic area 2: Daylighting and view	23
2 Technology status of windows	27
2.1 Performance requirements	28
2.1.1 Sunlight and daylight penetration	28
2.1.2 View out and view in	28
2.1.3 Thermal insulation	29
2.1.4 Air flow, ventilation control and condensation	29
2.1.5 Rain and snow protection	30
2.1.6 Sound insulation	30
2.1.7 Mechanical strength and rigidity	31
2.1.8 Durability	33
2.1.9 Fire protection and fire escape	36
2.1.10 Burglary protection	36
2.1.11 Insect protection	36
2.1.12 Operation, window cleaning and child safety	37
2.1.13 Aesthetically appealing	37
2.1.14 Economical	38
2.1.15 Sustainability	39

2.2	Background to current window design	40
2.2.1	Changes to building code requirements	42
2.2.2	Technology procurement of energy-efficient windows	45
2.2.3	Aesthetical development	48
2.3	Windows of today	49
2.3.1	Guarantees	52
2.3.2	Quality labelling, P-labelling of windows	53
2.3.3	Energy labelling	53
2.4	Windows of tomorrow	55
3	Basic window physics	57
3.1	UV-transmittance	59
3.2	Light transmittance	59
3.3	Solar energy transmittance	59
3.4	Multiple panes and angle-dependent properties of glass	60
3.5	Glazing for energy-efficiency	62
3.6	Glazing for solar control	66
3.7	Thermal insulation of windows	66
3.7.1	Glazing	67
3.7.2	Sash and frame	74
3.7.3	Total window U-values	76
4	Windows and daylight	81
4.1	General lighting terms	81
4.1.1	Illuminance, E	81
4.1.2	Luminance, L	82
4.1.3	Daylight factor, DF	82
4.1.4	Glare	82
4.2	The sun as the source of daylight	83
4.2.1	Luminance and radiance models of the sky	83
4.2.1	Luminous efficacy	87
4.3	Daylight calculation methods	88
4.3.1	Hand calculation methods	89
4.3.2	Radiosity methods	89
4.3.3	Ray-tracing methods	90
4.4	Daylighting software	90
4.4.1	Pure daylighting programs	90
4.4.2	Thermal programs with daylighting routines	91
4.4.3	Derob-LTH daylight module	93
4.5	Daylight utilisation	94
4.6	Lighting quality and visual comfort	96
4.6.1	Common recommendations for illuminance and luminance.	98
4.7	Psychological aspects of windows	99
4.7.1	View	100
4.7.2	Window size, shape and position	101
4.7.3	Window transmittance and tint	102

4.7.4	Avoidance of glare	105
4.7.5	Sunlight penetration	106
4.8	Non-visual effects of light	107
4.8.1	Physiological effects of solar radiation on the (human) skin	107
4.8.2	Physiological effects of daylight and artificial illumination entering the eye	108
4.8.3	Psychological effects of light and colour	109
5	Windows and energy	111
5.1	Single family house	112
5.1.1	Window types	114
5.1.2	Insulation levels and ventilation	116
5.1.3	Effects of window choice on energy demands and indoor temperatures	120
5.1.4	Cost efficiency of window replacement	127
5.1.5	Effects of orientation	130
5.1.6	Effects of site/climate	131
5.1.7	Effects of reduced emittance	135
5.2	Single-person office room	138
5.2.1	Electric lighting savings through daylight utilisation	143
5.3	Office space fully glazed on three sides	145
6	Conclusions and recommendations for further research	155
6.1	Technology status of windows	156
6.2	Energy-efficient windows: the compromise between energy demand and daylight quality?	157
6.3	Shading devices	158
6.4	Thermal comfort	159
6.5	Tools for daylight calculation	159
6.6	Further research	160
Summary		161
Acknowledgements		169
References		171

List of symbols

α_3	deduction of window U -value with respect to insolation ($\text{W}/\text{m}^2\text{K}$)
ε	(hemispherical) emittance (-)
ε_{eff}	effective emittance (-)
λ	wavelength (m)
μ	viscosity (kg/m,s)
θ	incidence angle ($^\circ$)
ρ	density (kg/m^3)
σ	Stefan Boltzmann's constant ($5,67 \cdot 10^{-8} \text{ W}/\text{m}^2\text{K}^4$)
Ψ	linear thermal transmittance ($\text{W}/\text{m},\text{K}$)
A	area (m^2) or absorptance (%)
A_{cog}	projected area of centre-of-glass (m^2)
A_{env}	aggregate area of surfaces towards heated indoor air (m^2)
A_{eog}	projected area of edge-of-glass (m^2)
A_f	projected area of frame (including sash) (m^2)
A_{heat}	heated usable floor area (m^2)
A_w	aggregate area of windows, doors etc. (m^2)
A_{win}	projected area of window (m^2)
A_{in}	inward flowing fraction of absorbed energy (-)
A_{out}	outward flowing fraction of absorbed energy (-)
d	gap width (m)
DF	daylight factor (%)
E	illuminance (lux)
G	degree-hours ($^\circ\text{h}$)
g	total solar energy transmittance (-)
\bar{g}	annual mean value of g
h	heat transfer coefficient ($\text{W}/\text{m}^2\text{K}$)
h_c	convective heat transfer coefficient ($\text{W}/\text{m}^2\text{K}$)
h_e	external heat transfer coefficient ($\text{W}/\text{m}^2\text{K}$)
h_i	internal heat transfer coefficient ($\text{W}/\text{m}^2\text{K}$)
h_r	radiative heat transfer coefficient ($\text{W}/\text{m}^2\text{K}$)
h_{rb}	black-body radiative heat transfer coefficient ($\text{W}/\text{m}^2\text{K}$)
I	solar irradiance (W/m^2)
I_{dH}	diffuse horizontal irradiance (W/m^2)

I_N	direct normal (beam) irradiance (W/m ²)
$I_{N,max}$	theoretical direct normal irradiance for clear sky (W/m ²)
K	luminous efficacy (lm/W)
k	thermal conductivity (W/m,K)
L	luminance (cd/m ²)
l_g	perimeter of visible glass area (m)
Nu	Nusselt number (-)
P_i	lighting load for hour i (W)
P_{max}	installed lighting power (W)
$P_{real,i}$	realistic lighting load for hour i (W)
Q	net energy transport during the heating season (Wh/m ²)
Q_{loss}	thermal heat loss during the heating season (Wh/m ²)
Q_{solar}	solar heat gain during the heating season (Wh/m ²)
q	heat transfer (W/m ²)
R	reflectance (%) or thermal resistance (m ² K/W)
R_{gap}	thermal resistance of gap between panes (m ² K/W)
R_{glass}	thermal resistance of glass pane (m ² K/W)
R_{se}	external surface resistance (m ² K/W)
R_{si}	internal surface resistance (m ² K/W)
R_{sol}	solar reflectance (%)
R_{tot}	total thermal resistance (m ² K/W)
R_{vis}	visible reflectance (%)
S	accumulated solar irradiation (Wh/m ²)
SSP	sunshine probability (-)
t_1, t_2	surface temperatures (K or °C)
t_b	balance temperature of a building (°C)
t_m	mean temperature (K or °C)
T	transmittance (%)
$T_{sol,dir}$	solar direct transmittance (%)
$T_{sol,tot}$	total solar energy transmittance (%)
T_{uv}	transmittance of UV-radiation (%)
T_{vis}	transmittance of visible radiation (%)
U	thermal transmittance (W/m ² K)
U_{ave}	average, area weighted, thermal transmittance (W/m ² K)
$U_{ave,req}$	required average thermal transmittance (W/m ² K)
U_{cog}	thermal transmittance of centre-of-glass (W/m ² K)
U_{eog}	thermal transmittance of edge-of-glass (W/m ² K)
U_f	thermal transmittance of frame (including sash) (W/m ² K)
U_{win}	thermal transmittance of window (W/m ² K)
$U_{win,p}$	practical thermal transmittance of window (W/m ² K)

List of articles

- I Bülow-Hübe, H. (1993). The Solar Village in Dalby – Evaluation of an Energy-Efficient Row House with Attached Sunspace. *Proceedings of the 3rd Symposium Building Physics in the Nordic Countries*. Copenhagen, Denmark, Sept 13-15 1993. Vol. 2, 427-431.
- II Bülow-Hübe, H. (1998). The Effect of Glazing Type and Size on Annual Heating and Cooling Demand for Swedish Offices. *Proc. of Renewable Energy Technologies in Cold Climates '98*. Montréal, Québec, Canada, May 4-6 1998. 188-193.
- III Bülow-Hübe, H. (1995). Subjective reactions to daylight in rooms: Effect of Using Low-emittance Coatings on Windows. *Lighting Research and Technology*. 27(1), 37-44.
- IV Bülow-Hübe, H. (2000). Office Worker Preferences of Exterior Shading Devices: A Pilot Study. *Proc. of EuroSun 2000*, Copenhagen, Denmark, June 19-22 2000. 7 pp.
- V Bülow-Hübe, H. (2001) Validation of daylight module in DEROB-LTH. (submitted to Energy and Buildings).

Foreword

When I started my career as researcher in 1990, the intent was never to come this far as a doctoral dissertation. I was driven by interest in the issues I encountered. My first taste of the academic world was through a delegation appointed by the Swedish government with the aim to look at the “environmental status” and development of a region in Sweden, Western Scania. I participated in the project on energy, where we made predictions of how the energy supply and demand could change over a longer time period. At that time, the abolishment of Swedish nuclear power had not yet begun, and one of the aims of the energy project was to see if it was at all possible, through energy-efficiency improvements, and changes to the supply system, to meet this goal over a time frame of 20 years.

Given my background as a civil engineer, the energy project awoke my current interest in the (smaller) energy system of the building. My second project was therefore to analyse measurements of energy use and temperatures of an energy-efficient row house with some ecological features. The house was built with a higher insulation standard than required by the building code. This included for example windows with low-emittance coatings and a sunspace. The energy demand for this row-house (100 kWh/m²,yr) was lower than the average house, but still not as low as some of our most optimistic predictions in the energy project above. Why was this so? One reason was the leakage rate, another was probably the windows used.

With the high insulation standard of this row house and, for that case, for most new built houses around 1990, one of the weaker chains was still the window. The U -value of walls were perhaps on the order of 0.2 W/m²K, while normal windows at that time were approx. 2 W/m²K. Thus, windows loses 10 times more energy per unit area, at least during the night. NUTEK, the National board for Technical and Industrial Development realised this, and decided to improve Swedish window standards by challenging the industry with a “competition” or technical procurement program. In 1992, they elected two winners.

The two winning windows both had quadruple panes of glass, of which two or three panes had low-emittance coatings. This resulted in total window U -values (including the sash and frame) of less than $0.8 \text{ W/m}^2\text{K}$.

However, how far can one go in the hunt for energy-efficiency improvements? These windows had a daylight transmittance of less than 60 %, and the low-e coatings made them look green. Was this too much, or was this acceptable? I studied this in two full-scale rooms using 95 subjects as my “measuring instrument”.

Later I performed a study involving 50 subjects to look at the lighting preferences of office workers regarding two external shading devices.

The latest project that I have been involved in, deals with the development of a computer tool to estimate daylight levels in a room. I believe that it is important and necessary to intergrate daylight and energy calculations, in order to estimate the potential for control and regulation of systems, but it is not sufficient. The human aspects are still not accurately known. Glare is one aspect, but the constantly changing levels of daylight is something that is profoundly built into our understanding of the real world, and is probably most stimulating, and affecting our well-being in a positive way. Attempts to interweave my knowledge as an engineer with acquired skills on the understanding of human nature, has thus always been my leading star.

Helena Bülow-Hübe, October 2001

1 Introduction

1.1 How to read this thesis

The major body of the work behind this thesis is presented in the 5 articles attached at the end of this book, and also partly in chapter 2 and 5. A background for the work, a summary of its contents and the limitations of the work is given in this chapter. Chapter two is a review regarding mainly performance requirements and also a form of state-of-the-art regarding energy aspects of windows. It is based on an earlier report published in Swedish (Bülow-Hübe, 1996). Chapter 3 can be read independently, and is included for those who are not familiar with energy and physics. It is purposely written for a general audience. Chapter 4 deals with windows from the daylighting point of view. It begins with some general knowledge regarding daylight and the lighting of buildings for those not familiar with the subject. Thereafter follows some notes on the calculation of daylight and a short presentation of daylighting software. Benefits and drawbacks of daylight utilisation are presented both from a technical point of view, as well as from a psychological one. Chapter 5 deals with windows from an energy point of view, and contains parametric studies on the effect of window choice on annual energy demands and peak loads. Aspects on economy, daylight utilisation and thermal comfort are also included. Conclusions from this work and recommendations for further research are finally given in chapter 6.

1.2 Goals

There are several motives for using energy-efficient windows, ranging from the global/national level (e.g. reducing environmentally harmful emissions) to the individual level (e.g. lower heating bills, better thermal comfort). However, windows are here to provide for daylight and view. Therefore, this thesis focuses on the following two, sometimes conflicting, topic areas:

- 1) to provide for a good thermal protection against the outdoor environment with a minimum of used energy
- 2) to provide for a good visual daylight environment which satisfies human needs.

The main goals have been to estimate the potential energy savings with energy-efficient window systems, and to study the resulting daylight environment, in order to be able to find the optimum solution in various Swedish settings and climates. Therefore, the thesis deals mainly with windows and glazing that have a rather high visual transmittance, and good thermal insulation (i.e. low U -value). Five articles were written on different aspects of this subject, and are attached at the end of this book. One of the articles deals with shading devices, which are usually needed to prevent from glare and overheating.

Articles I-II falls within the first topic area and represents traditional engineering work. Articles III and IV represent the second topic area. Article V is concerned with the calculation of daylight in an energy simulation program. It represents one important but not sufficient attempt to link together the two topic areas. Further studies on the interaction between the two topic areas are necessary in order to learn how we in varying situations can provide for a good thermal protection against the outdoor environment that at the same time yields a low energy use and a good visual environment, satisfying human needs.

1.3 Methods

The role of the window in the energy balance of buildings has been studied, mainly by simulations. Two years of measurements of energy use and indoor temperatures of an inhabited row-house were also available. Computer tools have thus been an important aid to systematic studies on the effect of e.g. window insulation, solar energy transmittance, window size, orientation and climate. In some cases other factors such as internal loads and ventilation rates have been studied to put the potential energy savings from the window into perspective.

In this thesis two different types of programs have been used, (1) a steady-state program for the estimation of heating demands on a monthly basis, the BKL-method (article I), and (2) a dynamic program (on an hourly basis) for the simulation of heating and cooling demands, indoor temperatures etc., Derob-LTH, (chapter 5, articles II, V).

The BKL-method, developed by Källblad (1994), has been the basis for a commercial program ENORM which is commonly used among Swedish consultants. The BKL-method is quick and simple to use. However, it only estimates heating demands. Cooling demands and indoor temperatures cannot be calculated with this program.

Derob-LTH is a tool used frequently at the department of Construction and Architecture. It originates from Austin, Texas, (Arumi-Noé & Wysocki, 1979; Arumi-Noé, 1979), but has been further developed at the department for Construction and Architecture at Lund University, Lund Institute of Technology (LTH) over the last 15 years. Its advantages and capabilities to predict heating and cooling demands accurately has been demonstrated in several validation studies and comparisons with full-scale measurements (Wall, 1996 and Wall & Bülow-Hübe, 2001). Derob-LTH currently has a pleasant user-interface in the MS Windows environment (Kvist, 2000).

The choice of programs fell on these two since they have both been developed and validated at our department. There is thus a large knowledge about the methods used and the limitations of the two programs. When large glazed surfaces are studied, for example the current trend of fully glazed façades in office buildings (see chapter 5), or in atria, it is important to have tools that use a geometrical description of the building, and that treat the distribution of solar radiation within a space in a detailed way, as demonstrated by Wall (1997).

In articles III and IV, I have used methods from a research field called environmental psychology. This field is concerned with the environment as a *determinant* or influence on behaviour and mood. It is also concerned with the *consequences* of behaviour on the environment (Bell et al., 1996). People, or *subjects*, have been used in a laboratory setting in order to measure certain aspects of the perceived environment. These aspects were e.g. the daylight and perception of a room using two different types of glazing. So called repeated measures (within-person) designs were used, which means that each person judged the two situations in order to reduce the variance, and the number of people required for the experiment.

1.4 Limitations

The limitations of this thesis are the following: Windows are studied from a Swedish perspective, which means that mainly Swedish window types have been selected in various parametric studies and in Chapters 2 and 5. Also, only Swedish climates have been used in the simulation of energy demands. However, this does not mean that the results can not be transferred to other climates. Especially southern Sweden has a climate comparable to several other north-European countries.

Further, the system border has been put around the heated rooms, which means that only the energy required for heating or cooling the room to a certain temperature has been calculated. The energy demands have not been converted to bought energy except for in article I or to primary energy, since this requires several assumptions regarding the supply system (both in the building and in society in general), and on the mix of primary energy sources. However, a recent summary over efficiencies and specific emission levels can be found in a report from the Swedish Environmental Protection Agency (Naturvårdsverket, 1999).

In the two studies where subjects were used to measure certain aspects of the environment (article III and IV), these were both performed as full-scale laboratory studies. This gives more realistic results than performing scale model experiments, which have been quite common in early work within the field of environmental or architectural psychology. In some ways it is better than performing field studies (e.g. in real offices), since confounding factors can be limited and controlled for.

One drawback is however the short exposure time, each subject has only stayed in each room between 10-15 minutes. Long-term effects of lighting, such as headaches and eye-strain, cannot be captured in such short experiments. Rather, it is the immediate impression of the daylight situation of the room that is captured.

1.5 The context

1.5.1 Energy related environmental problems

Energy use in buildings is strongly connected to serious environmental problems such as the greenhouse effect, acid rain, eutrophication of land and waters etc., through the burning of fossil fuels. Nuclear proliferation, north south problems etc. are also strongly linked to energy use (Goldemberg et al., 1988).

The Swedish problem is how to arrive at the goals of nuclear phase-out and not exploiting the last 4 wild rivers for hydropower without increasing carbon dioxide emissions. There are several other goals as well, concerning protection of valuable biotopes and emissions reductions of e.g. volatile organic compounds, particles, sulphur dioxide and nitrogen oxides, ammonia and heavy metals (Naturvårdsverket, 1999). Improving the energy-efficiency has been identified as the main key to be able to maintain our current standard of living, and still allow for a reduction of harmful emissions of e.g. CO₂, NO_x and SO_x, or at least to maintain them at current levels (Goldemberg et al., 1988; Mills, 1991). The observation made is that “electricity *per se* is not of interest, but rather the demand for electricity is a reflection of the demand for *services* it can provide: hot showers, cold herring, clean clothes, illumination, motive power, maintenance of comfortable indoor climate, data storage/retrieval and so on” (Bodlund et al., 1989). The term electricity use above can of course be replaced by energy use in general, since we are interested in all the services provided or the tasks accomplished in society.

It may seem difficult to meet the sometimes conflicting environmental goals. However, several studies have shown that it would be possible to do so, but that it would require quite dramatic changes to the energy system (Naturvårdsverket, 1999; Bodlund et al., 1989).

In the studies cited above, the energy use is calculated by an end-use accounting model. Energy use in society is first divided into sectors of use, (e.g. industries, agriculture, housing etc), then into areas of services provided or *activities* (lighting, heating, clothes washing etc). Tomorrow’s energy demand is calculated by multiplying each activity with its *intensity*, which is a reflection of the service desired (Mills, 1991). By applying different intensities for tomorrow, and by multiplying with expected growth rates and summing over all sectors, scenarios for total future energy demand are created. The calculated energy demands are then matched with different supply scenarios, describing some available options regarding the main types of energy carriers (primary energy sources) chosen, and the technologies used to produce electricity and district-heat. Finally, emissions and costs can be calculated.

These types of studies can also be made for individual countries or even regions or communities. This was done in 1991 for the region of Western Scania (Gustavsson et al., 1992) and also for the two largest communities in that region: Malmö (Johansson, 1990) and Helsingborg (Bülow-Hübe, 1990). On the demand side we started by collecting statistics of the current energy-use, and made predictions of the energy-use

for 2010¹ for three different levels of efficiency improvements. The calculated energy demands were then matched with four supply scenarios, with increasing efficiency and use of renewable sources. The supply scenarios ranged from condensing power with natural gas to cogeneration with biomass and extensive use of wind power.

In our scenarios for Western Scania we could see that by a consequent use of the most energy-efficient technologies on the market, cogeneration, and by introducing biomass on a large scale (short-rotation forests) and wind-power, it would be possible to phase out nuclear power, not increasing hydropower and maintaining strong economic growth. At the same time 75 % reductions in carbon dioxide emissions, and 50 % reductions in acidifying gases were achieved compared to the levels of 1988 (Gustavsson et al., 1992).

It must be stressed that it is not predictions of future energy use or emissions that are made, rather it is a method to identify which measures are needed to achieve a certain goal, e.g. a reduction of greenhouse gas emissions or nuclear phase out.

Today, 10 years later, only one of twelve nuclear reactors has been shut down, and the energy supply system has not changed dramatically. Some efficient power plants for reserve power have even been shut down, and Sweden imports electricity generated with coal in inefficient condensing plants during the winter. It seems like the aim of abolishing nuclear power by the year 2010 will be very hard to reach, given the slow start during the last 10 years.

Today's problem seems to be how to get rid of the barriers preventing the scenarios from becoming our future reality. For example, more energy-efficient technologies do enter the market all the time, but if the rate is high enough to be able to reach the goal we set up for the year 2010 has not been further studied here. It is likely that incentive programmes are needed to speed up the process. It also seems like energy-efficiency improvements are not the only solution to achieve a sustainable society, lifestyle changes are probably also necessary.

1.5.2 Energy use in buildings

The total energy use within the building and services sector accounted in 1999 for 150 TWh, or approximately 40 % of Sweden's total use of energy. The industry sector accounts for another 40 %, and transportation

1. The end year 2010 was partly chosen because this is the year when nuclear power should be totally phased out, according to a public referendum in 1980.

for the remaining 20 %. To this comes distribution and conversion losses, and foreign maritime trade. The building sector thus has a potentially large effect on the environment due to its large share of total energy use.

Efficiency improvements have however already lead to a decreased use of specific gross energy expressed as kWh/yr,m² of heated floor area. This is clearly demonstrated by the fact that the energy use within the building and services sector has remained practically constant since 1970, even if the heated area has increased by over 50%! (Energimyndigheten 2000; Byggeforskningsrådet, 1995). To give some more figures, the specific gross energy use (including space heating, domestic hot water and household/operation electricity) in 1970 was about 340 and 330 kWh/yr,m² for one- and two-dwelling buildings and multi-dwelling buildings respectively, and about 380 kWh/yr,m² for service buildings. In 1994, the specific energy use had decreased to 210 and 220 kWh/yr,m² for one- and two-dwelling buildings and multi-dwelling buildings respectively, and about 300 kWh/yr,m² for service buildings. These values apply to the whole building stock. For new buildings (produced after 1986), the specific final energy use is about 150 and 175 kWh/yr,m² for one- and two-dwelling buildings and multi-dwelling buildings respectively, and about 220 kWh/yr,m² for service buildings (Byggeforskningsrådet, 1995). The heating demands of buildings thus show a quite remarkable improvement during the last 30 years. New experimental buildings (see below) also demonstrate that significant further improvements can be achieved, at least for future buildings.

The electricity use in the sector for buildings and services has however increased dramatically from 1970 to today: by more than a factor of 3 (Energimyndigheten, 2000). This is of course partly due to an increase of activities. The switch of primary energy sources that have taken place between 1970 and today is probably even more important: from mainly oil in 1970, to especially nuclear power, and increased hydro power and biomass today. The increase in electricity use also reflects some other changes, for example an increased use of mechanical ventilation in buildings and an increased use of air-conditioning systems and an increased use of electrical equipment (computers, copy-machines, TVs, videos etc.) in both offices and homes.

In article I, measurement from an energy-efficient two-storey row house in Solbyn, Dalby, was evaluated, see also Bülow-Hübe & Blomsterberg (1992). The dwelling, located at a gable, had a usable floor area of 116 m². The specific use of bought energy was 100 kWh/m² of electricity, including space heating (direct electric heating), domestic hot water and ventilation, and household electricity. The main features of the dwelling was an insulation standard above the requirements in the building code,

controlled ventilation with air-to-air heat recovery, attached sunspace towards south, and small windows towards north. The energy efficiency of the heat recovery unit was high, about 77 %. The envelope U -values were: attic ceiling $U=0.11$, external walls $U=0.17$, slab on ground $U=0.20$ and windows $U=1.5 \text{ W/m}^2\text{K}$. It was shown that the main features leading to a rather low specific energy use was the heat-recovery and the increased insulation of the building envelope. The attached sunspace contributed in an insignificant way to the low energy use, mainly because it was attached on the outside of the well insulated external wall, and of single glazing. The specific gross energy use was thus about half compared to the average multi-dwelling unit, and about 30-40 % lower compared to buildings erected after 1986.

Probably the most energy-efficient row-house built so far in Sweden is designed to have a specific use of bought energy (all electricity) of only 45-50 kWh/yr,m². This experimental project was erected in 2001 in Lindås outside of Gothenburg, and measurement results of energy use are expected within a year or two. These houses are even better insulated than Solbyn, extremely air-tight, and uses a mechanical ventilation system with a very efficient air-to air heat recovery unit. The windows are super-insulated ($U=0.85 \text{ W/m}^2\text{K}$) and solar energy is expected to provide about 50 % of the energy needed for domestic hot water (Maria Wall, Lund University, personal communication, Aug 2001). If the low predicted energy use can be achieved, these houses will only use half of the energy used in Solbyn!

1.6 Main topic area 1: The role of windows in the energy system

In the type of energy scenarios described in section 1.5.1, the individual house and its energy demand is treated much like a black box. *How* these improvements can be made are left to the building engineers and architects. The role of the window is not specified by itself, rather it is assumptions on the combined effect of energy-efficiency improvements to the building envelope that is considered, e.g. higher insulation levels, better windows and air-tightness, heat-recovery of exhaust air etc.

In article II the importance of the window on the energy demand of an office room has been especially studied. It is shown that the annual cooling demand of a single-person office room in a Swedish climate is largely influenced by (in descending order) glazing size, window orientation, ventilation rate, internal load and daylight utilisation. The heating

demand is mainly affected by the ventilation rate, climate, orientation and glazing type. It is demonstrated that daylight utilisation has a potential of reducing cooling demands without also increasing the heating demands. Further, it is demonstrated that south facing super-insulated windows will gain energy over the year, i.e. they are better than having an opaque wall. The cooling demand is not higher for the super-insulated window than for other windows of moderate to high U -values.

In chapter 5 it is again shown that the cooling demand is largely affected by the glazing size, both for the annual cooling demand and for peak cooling loads. The solar energy transmittance of the glazing also plays a major role. However, the annual heating demand is mainly influenced by the U -value, and not by the solar energy transmittance. Thermal comfort is also largely dependent on the glazing. During the cooling season, glazing size and solar energy transmittance are important parameters, while the glazing size and U -value are important during the heating season.

1.7 Main topic area 2: Daylighting and view

The admission of daylight through windows and the provision of a view out are the primary functions of windows. If daylighting can be used in a larger extent to replace artificial lighting, it might be seen as “renewable” lighting. In earlier studies this was referred to as daylight utilisation, but later the more specific term “daylight responsive (linked) lighting systems” was invented. This term refers to advanced control systems that regulate the light output of the artificial lighting system in response to the incoming daylight. In this report I have chosen to use the shorter term daylight utilisation as a synonym for daylight responsive lighting systems.

Computer tools are valuable to be able to estimate the effect of daylight responsive lighting systems. Preferably, it should be possible to calculate effects on heating and cooling loads simultaneously with lighting energy savings. Some solutions exist, for example DOE-2, which is now being modernised and merged with BLAST into the new simulation engine Energy-Plus (Crawley et al., 2001). Adeline (a lighting simulation platform, see chapter 4 and Erhorn & Stoffel, 1996) can also be used, but calculations on lighting energy savings have to be done previous to the

energy simulation, which is a drawback. Radiance has been used in interactive loops together with both TRNSYS and ESP-r (Kovach-Hebling et al., 1997; Clarke et al., 1997).

A first step to provide for daylight simulations in Derob-LTH, and later to allow for daylight responsive control of shading devices within Derob-LTH, is presented in article V. The presented model has some limitations compared to full-fledged lighting simulation programs like Radiance, but it still seems to satisfy many needs and may become a useful tool.

No matter how important the energy-efficiency improvements are seen in the global context, we must not introduce new technologies that might possibly be harmful to our health or reduce the comfort and satisfaction of occupants. Then we have not provided the same service as before.

For energy-efficient windows the question arises mainly around the effects of introducing one or several low-emittance coatings. The low-e coatings are made to reduce the thermal losses while affecting the visual transmittance as little as possible. However, they cannot totally achieve the same transmittance as ordinary clear glass. Some coatings have a slightly green or blue tone (silver-based coatings) and some have a slightly brownish tone (tin-oxide coatings). The effects of using several low-e coatings on the perception and daylight of a space were therefore studied (article III). The study shows that quadruple-pane glazing with two low-e coatings have a significant effect on the daylight transmitted to a room compared to triple-pane clear glazing, both regarding the amount of daylight, and also regarding its spectral composition. The results show that people could distinguish between the two situations, and found the room with the super-insulated window to be more enclosed and darker, and the daylight was perceived as more tinted. A situation with a similar triple-pane glazing with two low-e coatings was never studied with subjects, but measurements of the spectrum of the transmitted daylight revealed that the spectrum was closer to that of the super-insulated quadruple glazing, than to that of the triple-clear window (Bülow-Hübe, 1994). This suggests that it is the use of the two low-e coatings that have the most profound effect on the spectral composition, and thus on perception, while the fourth, clear glazing only lowers the daylight level slightly. Therefore, also triple-pane super-insulated window with two low-e coatings may have negative effects on daylight and perception.

Solar shading devices is another energy-efficient technology, which is used together with windows. With a good solar shading system, cooling demands can be reduced dramatically (up to 80 %), see Dubois (1998). Cooling systems may even be omitted, which will dramatically lower the cost for the HVAC system (both first cost and running costs). Visual

comfort, satisfaction and view out are aspects that need to be considered when solar shading systems are chosen. In an attempt to start to learn more about user behaviour and their preferences regarding shading devices, a pilot study was performed on two shading devices, an awning and an exterior Venetian blind (article IV). This study showed no significant difference between the two systems, although the awning was appreciated as slightly easier to operate. The effects on view out were moderate and equal for the two devices. Interestingly enough, it was not possible to find any correlations between the amount of daylight entering the room (illuminance on desk) or between the luminance of the sky seen through the window, and to how much occupants decided to pull the shading devices. Only if there was a sunlight patch somewhere in the room, was there a weak correlation. This suggests that finding control algorithms that take human response into account, may be very hard to find.

2 Technology status of windows

This chapter is an updated and shortened version of an earlier report in Swedish, see Bülow-Hübe (1996).

The main purpose of a window is to admit light into a building, provide for a view out and to protect us from the sometimes-harsh outdoor climate. However, there are many more aspects to window design than this. Once I was told that a window has to satisfy about 20 different functions, and they can all be fulfilled by building a wall instead of a window. In the Swedish performance requirements for windows there are namely no requirements of windows regarding daylight admission!

However, without daylight penetration we can no longer call it a window. Windows in buildings play a major role in providing quality, comfort and satisfaction. The different performance requirements for windows can be summarised in a list:

- Sunlight and daylight penetration
- View out and view in
- Thermal insulation
- Control of air flow and ventilation
- Control of water vapour flow
- Protection against rain and snow
- Sound insulation
- Mechanical strength and rigidity
- Durability
- Fire protection
- Fire escape
- Burglary protection
- Insect protection
- Easy to open
- Window cleaning
- Child safety
- Aesthetically appealing
- Economical
- Sustainability

2.1 Performance requirements

2.1.1 Sunlight and daylight penetration

The primary purpose of a window is to admit daylight, and to create a visual contact between inside and outside. This should be done without distorting the colour of the transmitted light. In residential buildings it is often desirable to capture the heat from the sun during the heating season for passive climatization. At the same time the room heat should be kept indoors. In office buildings solar radiation may be more of a problem, since it will increase an often-existing cooling demand. Here, a high daylight transmittance along with a low solar transmittance is desirable. The UV-part of the radiation is usually not wanted, since it bleaches textiles, wallpapers etc.

The right to a direct access to daylight is often stipulated in the building codes, as in the Swedish code (BBR 1999): "Rooms where people stay more than temporary, shall have a good access to direct daylight. This is valid for space containing work places, if it is not unreasonable in consideration to the type of activity. Dwellings shall have access to direct sunlight." The following advice is given in the code regarding the size of windows: The window glass area should be at least 10 % of the floor area. If building parts or other buildings block the daylight more than 20° of the view angle, the glass area should be increased.

2.1.2 View out and view in

The provision of view out is closely linked with the previous requirement. To be able to see the changes of the light and weather, to watch over children etc. are essential aspects of a window. There may also be more unconscious benefits to windows than previously believed. These concern the influence on life satisfaction as well as environmental satisfaction (Kaplan, 1983, 1985). A nice view with greenery has also been associated with faster recovery in post-surgical hospital wards (Ulrich, 1984).

In general, there are four general benefits of windows: (1) access to environmental information; (2) access to sensory change; (3) a feeling of connection to the world outside; and (4) restoration and recovery (Heerwagen, 1990).

Privacy is another issue, which must be dealt with in the architectural design. Heerwagen uses the two concepts visual access and visual exposure. Visual access is directly linked to the ability of occupants to see out. Visual exposure is the – sometimes unwanted – possibility to be seen.

There must be a balance between access and exposure that is appropriate to the context and for the personal preferences of the occupant. Heerwagen draws the following matrix between visual access and exposure, Fig. 2.1.

		VISUAL ACCESS	
		High	Low
VISUAL EXPOSURE	High	The goldfish bowl (<i>can see and be seen</i>)	The interrogation room (<i>cannot see, but can be seen</i>)
	Low	Ideal (<i>can see, without being seen</i>)	The cave (<i>cannot see, cannot be seen</i>)

Figure 2.1 Visual Access and Visual Exposure Matrix (after Heerwagen, 1990).

2.1.3 Thermal insulation

The basic principle is that room heat is lost through the window when it is warmer indoors than outdoors. The thermal performance is described by the U -value. This is a measure of the heat flux through the window per unit surface area and degree temperature difference between inside and outside. It is given in ($\text{W}/\text{m}^2\text{K}$). It is sometimes called the dark U -value, since it only accounts for heat being lost through the window (e.g. night-time) and not for incoming solar radiation. Today, when a window U -value is given, it usually applies to the whole window, including the sash and frame (U_{win}). Glass manufacturers however, usually only gives the centre-of-glass U -value (U_{cog}) for the glazing combination itself.

Since the U -value of the glass in modern windows is usually better than that of the frame, the total U -value should always be stated, since a bad sash/frame construction can spoil the U -value of an otherwise acceptable glazing combination.

2.1.4 Air flow, ventilation control and condensation

Windows should be airtight to avoid air leakage, which can affect heat losses, sound insulation, comfort and risk of condensation. Placing draught excluders between sash and frame does this. To avoid moisture transport from inside to outside, the strip is placed on the inner side of the window. Otherwise, humid air can enter between the panes in a coupled

window, and condensate on the inside of the cold outer pane. To reduce dirt accumulation, a dust-absorbing strip is often placed between the sashes, which allows for some ventilation.

A new phenomenon, which has appeared with highly insulated windows, is condensation forming on the *outside* of the outer pane (NUTEK, 1995). The condensation can happen during clear nights, and in locations where the window “sees” a large part of the sky. In the radiation exchange between the sky and the window, energy is lost to the sky. Since the heat transport out through the window is small, the outer glass thus becomes colder than the surrounding air, and condensation is formed. The frequency of this phenomenon has been studied by Jonsson (1995). It was found that it usually appears in the spring and autumn during periods when the air is very humid and the temperature swings between day and night are high. The condensation starts to form at the bottom of the glass (the coldest part), and in some cases it is spread over the whole glass height. The condensation becomes visible in the morning, but usually dries up a few hours after sunrise. The phenomena starts to appear at a U_{cog} of approximately 1-1.3 W/m²K but becomes more frequent with lower U -values.

2.1.5 Rain and snow protection

Protection against rain and snow penetration is done primarily through the constructive design of the window, for example with grooves to reduce pressure differences and to drain incoming rain water etc. (Fig. 2.2), and through a proper mounting of the window in the wall. For example, it is important to make sure that water penetrating the outer panel is drained outwards, and does not remain at the top of the window frame.

2.1.6 Sound insulation

The two main properties affecting the sound insulation of a window is the distance between the panes, and the glass thickness. A large air gap is desirable, since a coupled window with 30-40 mm glass distance has approximately the same sound insulation as a triple insulating glass unit (IGU) with two air gaps of 12 mm. It is also preferable to have glass panes of different thickness, and – in triple-pane windows – to have air gaps of different thickness (Göransson, 1995).

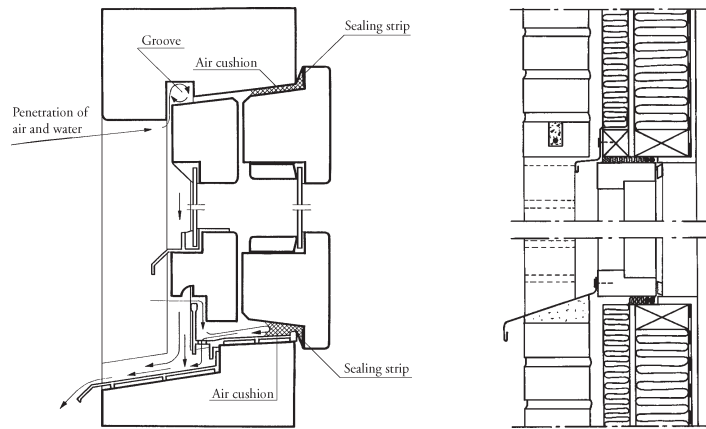

Figure 2.2 *Groove to reduce pressure differences and to drain rain water (left). Details at top and bottom of window showing rain screen at a stud frame with brick cladding (from Mur 90, 1991) (right).*

Replacing the air in IGU's for a gas, for example sulphur hexafluoride (SF_6), can also improve the acoustical properties. However, for traffic noise, the sound insulation may even decrease when using SF_6 , and is therefore not recommended (Jonasson, 1994).

Air-tightness is very important, and several strips improve the sound insulation. Air-inlets in the frame can drastically reduce the sound insulation. When a very high sound insulation is required, the mounting of the glass to the sash, as well as the design of sash and frame becomes important. Windows with good sound insulation can become heavy and harder to operate.

Total sound insulation is usually not wanted. Informative noise such as hearing when the mail arrives, or when a child is calling is important.

2.1.7 Mechanical strength and rigidity

It is necessary to consider the window as a whole, and make sure that the sash and frame have adequate dimensions for the load of the glass and of normal use. The window must also be able to sustain different external loads such as wind load. Sometimes there are higher requirements on the strength than that of normal float glass. Apart from increasing the glass thickness there are a number of alternative glazing products available, see below. After Carlson (1992) and Button & Pye (1993).

Toughened (tempered) glass

By heating the glass to 650 °C, and then cooling it rapidly, compression stress is built into the surfaces, and tensile stress into the core of the glass. The bending and tensile strength is thus increased by 4-5 times. It is neither harder (scratches just as easily) or stiffer (bends down just as much) as ordinary glass, but it can bend more before it breaks. When toughened glass fractures, many small pieces (dice) without sharp edges are formed. This makes it suitable as safety glass. Toughened glass must be cut or otherwise processed before tempering, since it shatters at all attempts of processing after tempering. It is also sensitive to mechanical damage at the edges, or for a sharp object penetrating the compression zone. It can be used as safety glass for example in offices which are glazed all the way from the floor and in shop-windows.

Heat strengthened glass

Heat strengthened glass is manufactured in a similar way to toughened glass, but the cooling process is slower. The strength thus becomes twice that of ordinary glass. At breakage, larger pieces of glass are formed, which resemble the fracture of ordinary glass. Therefore, it cannot be used as safety glass. As with toughened glass, heat strengthened glass cannot be processed after heat treatment. A main use is for façades.

Laminated glass

Laminated glass is manufactured by bonding two or more sheets of glass together with a plastic material or resin. Laminated glass built by ordinary float glass is not stronger than ordinary glass, but at fracture the pieces are kept in place by the plastic foil. The glass pane's ability to remain within the construction is also improved. Laminated glass is often used in glass roofs to prevent the glass from falling down at a potential fracture, or anywhere where there is a risk that people may fall through due to a difference in floor levels, for example on balconies. Another use is for shop-windows, where the plastic film can also be supplied with an additional UV-filter to reduce bleaching.

Wired glass

Another way of ensuring that the pieces of glass are kept in place at fracture is by embedding a steel wire mesh within the sheet of glass at manufacture (in a rolling process). The mechanical strength is lower than for ordinary glass, and it is also more sensitive to temperature induced stress. For glass that can become sunlit, the fixing point is critical. Wired glass should be avoided in places where projected shadows occur. It is used for fire-protection, burglar protection etc.

2.1.8 Durability

Window durability

Large facility managers often have requirements on long maintenance intervals. Thus, the Swedish market for pure wooden windows is reduced to mainly single family houses. Today, larger facility managers mainly choose wooden windows with an outer aluminium cladding, aluminium windows, or to a small extent, plastic windows (Hans Öqvist, SNIRI,² personal communication, June, 1995).

During the late 1970's a large number of damages to rather new windows were brought to public attention. The damaged windows were mainly found in multi-family housing from the 1960's, in the so-called million-programme³ (*miljonprogrammet*). A number of large investigations regarding the size and cause of the damage were carried out. The demands on durability were then raised by building owners and from the side of the authorities.

The damage was often caused by a combination of factors, where the increasingly faster and more industrialised construction of course played a part. New types of housing, mainly taller buildings, new building technology, window placement in unprotected locations (pelting rain) were other factors. The main cause was however lost demands of the treatment of the timber throughout the production chain, and new types of paint. At this time the production volume was high, which led to an increased rationalisation within the window industry. There were no demands on the quality or treatment of the raw timber material used in windows, hence young quickly grown pieces were used in windows. Timber which had been stored in water was accepted which later led to an increased spreading of the damage.

Today there has been an improvement, and today's wooden windows have better durability than those of the million-programme do. Many wooden windows are today delivered with aluminium cladding, which prevents water penetration into the wood, which of course is the main cause of rot. A large part of the existing windows have also been covered with an external metal cladding. In order for this to work, the cladding must allow for a proper ventilation, an air space of at least 6 mm is rec-

2. SNIRI, The National Association of the Swedish Joinery Factories is the Swedish trade organisation for producers of joinery, doors, windows, kitchen interiors, staircases and special interior designs.

3. Caused by a large shortage of housing during the 1950's, the Swedish government issued a housing policy with the goal to build one million apartments during a period of 10 years. This was also done, and the result is referred to as the *million-programme*.

ommended, with air inlets and outlets. Today it is also recommended that the wood is primed with oil and oil-based paint (alkyd or linseed oil) to create a water-repellent ground layer.

According to Gunilla Billgren, Wasakronan (personal communication, May 1995), a large part of the knowledge that was gained during the late 1970's and beginning of the 1980's is falling into oblivion. But there is a lot of knowledge to be found in somewhat older literature. Today the discussions are mainly about the timber raw material and about the paint systems used, and less about the constructive aspects of windows and window and wall assembly.

According to Karin Wennerståhl, SP (personal communication, May 1995) it is important to separate between the durability of paint systems and of the wood itself. Earlier, the chemists only focussed on the film of paint, which was one of the causes of the widespread use of latex paints for outdoor use, since they were so weather durable. The fact that they did not work so well together with the wood was an expensive experience gained a few years later. Today the pendulum has swung in the other direction and the main approach is from the viewpoint of building physics or wood technology. The attention is now directed towards the durability of the wood, and the paint is mostly considered as just a protective layer.

Insulating glass unit durability

Another issue is the durability of insulating glass units. If the sealant of the insulating glass fails, this will result in air and moisture penetration. Milk-white glass is a characteristic sign of such a failure of the IGU.

The edge of the insulated glass unit is the weakest part. Traditionally, a metal spacer is used to keep the glass panes at the desired distance. The spacer can be of galvanized steel, extruded aluminium or other low-conductivity materials. The metal spacer is attached to the glass with a polyisobutylene (butyl) sealant, which also acts as the diffusion barrier (Wolf & Waters, 1993). An additional sealant of e.g. polysulphide is applied for extra mechanical stability, i.e. a dual-seal unit, Fig. 2.3. Since spacers are usually hollow, they are filled with a desiccant to avoid condensation forming within the cavity of the unit by the moisture entrapped at the time of production. Today, the metal spacers usually have bent corners, and are welded together at one of the long edges. Together with the dual-seal system, this greatly reduces the risk of potential puncture of the IGU. (Earlier, single-seal systems were common and the spacer frame was usually made by four bars connected with corner-keys).

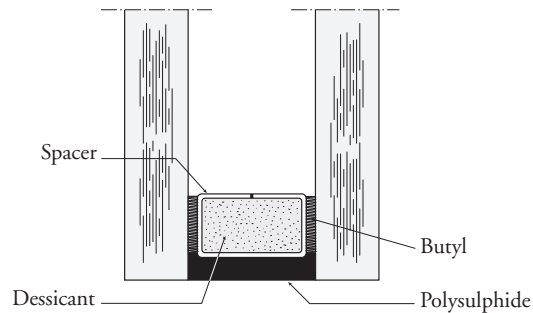

Figure 2.3 Section through the edge of an insulated glass unit.

In addition, modern IGUs often have low-emittance coatings to reduce radiation losses through the window. The cavity between the panes is then usually filled with a heavy gas (e.g. argon) to reduce convection and conduction losses. This puts extra demands on the long-term stability of the sealed edge of the IGU in order to retain the thermal performance during the service life of the IGU. One question is whether the gas concentration within the cavity is the same as that claimed by manufacturers, another is how quickly or slowly this concentration will decrease over time (gas retention capacity).

There are two common techniques for filling the units with gas: the lance filling (gas displacement) method and the vacuum chamber method. In the first method, two holes are drilled at one side of the IGU. Gas is filled into the lower hole, and air is exhausted through the upper hole. When the gas concentration in the upper whole is high enough, the filling process is terminated, and the holes are sealed with e.g. rivets. In the second method, the IGU is sealed within a vacuum chamber filled with gas. The level of gas filling depends on the attainable vacuum level and the time allowed for filling the chamber with gas (Elmahdy & Yusuf, 1995). Both methods may thus lead to an underfilling of gas within the cavity. Elmahdy & Yusuf claim that filling levels of 95-98 % are attainable, but when testing a large number of samples, levels of 50 % or lower can be found. In their study of 42 IGUs produced in North-America covering 7 types of spacers, the initial argon levels were found to vary considerably (Elmahdy & Yusuf, 1995). While 52 % of the units had initial concentrations of over 90 %, 10 % of the units were below 70 %. All units had lower concentrations than the 95 % or higher claimed by the manufacturers. After a series of accelerated ageing, high humidity and volatile (fogging) tests, most of the units retained the argon gas. A loss between 1 to 5 % was observed which would correspond to a maxi-

imum loss of 1 % per year, since the accelerated ageing test was assumed to correspond to 5 years of normal use. While two units were found to be tight, they had very low initial fill levels (30 and 50 %) which means that the filling process was inadequate. A few others lost all of the argon during the tests due to pin-holes in the sealant or to defective corner-keys.

Wolf (1988) reckons that dual-sealed insulating glass units can have a service life of over 25 years. Today, when corner keys are abandoned, and if mounted properly (ventilated and dry) representatives from the industry believes in a service life of up to 60 years.

2.1.9 Fire protection and fire escape

For some spaces and premises there are certain requirements on fire-resistance of building components. Windows can be divided into different categories regarding fire-resistance. For windows with stipulated requirements on fire-protection special glass is needed, for example toughened glass, laminated glass or wired glass.

There also exists special fire-protective glazing which are built on either of two main principles: (1) by a phase-change induced by heat or (2) by reduced transmittance. The first principle is used in glazing with a water-based gel. When the glass pane closest to the fire becomes hot, it separates from the gel and granulates. The gel thereafter stands for the fire resistance until it dries out. The other principle is used in glazing with one or more layers of water glass integrated between the panes. This glazing function in the way that the water glass rises and forms an opaque heat shield when the glass has reached a temperature of approx. 120°C.

The fire-protective requirements can also imply that a window must function as a means for evacuation, i.e. fire escape.

2.1.10 Burglary protection

To increase the protection against burglary, insurance companies sometimes require the use of key locks on windows. Usually these requirements apply to personal property insurance above a certain sum and for windows under a certain height from the ground (e.g. 4 m).

2.1.11 Insect protection

In Sweden there are no requirements for insect protection in windows, but in other countries, for example in North America, it is very common to provide windows with a net against mosquitoes and other insects.

2.1.12 Operation, window cleaning and child safety

These demands are more or less linked together. Windows that can be opened must be operated in an easy way that does not require too much force, so that all groups of people can handle them. Further, it should be possible to clean all sides in an easy way. Windows that can be opened in premises where children can stay must have some sort of locking device to prevent them from opening the windows and falling out. These requirements do not apply to windows on the ground floor.

2.1.13 Aesthetically appealing

Windows are often called the eyes of a building. The window plays a major role in the appearance of a building, which the architect shapes. He/she has a difficult task to coordinate demands on aesthetics, maintenance, durability, economy etc., to pursue his idea with the building. Many new materials are involved, and the window manufacture is highly industrialized, see also sec. 2.2.3.

In the renovation of older buildings it is important to pay attention to the original idea with the building. Windows are often replaced. The reasons can be draughty windows, high maintenance costs, high energy costs etc. The new windows are sometimes simplified with respect to number of lights, colour, thickness and design of sash and frame, etc. compared to the original ones. This may influence the way people perceive the building. Olsson-Jonsson (1988) has shown that a simplification of the window influences many aspects of the perception: for example the meaningfulness and pleasantness of the façade is reduced. More lights than originally will on the other hand increase the perception of articulation and detailing, while the meaningfulness of the façade is decreased.

There are usually many aesthetical and other qualities (e.g. high wood quality) in windows from approximately 1950 and earlier, which make renovation both desirable and worthwhile, instead of putting in new windows. Several methods to facilitate renovation have been developed, and a new trade has been introduced – window craftsmen – combining the skills of the carpenter, painter, glazier, plasterer and blacksmith (Pearson, 1994).

By using these new skills, and combining them with modern technology in a sensitive way, additional qualities can be introduced. Fredlund (1999) showed that a renovated double-pane window from 1880 could reach a total U -value of $1.60 \text{ W/m}^2\text{K}$ by replacing the clear inner

pane with an energy saving glass, i.e. a glass with a low-emittance coating (Sec 3.5). The achieved U -value was even better than that of a triple-glazed window from 1982, which had a U -value of 1.83 W/m²K!

2.1.14 Economical

First cost is often a considerable factor in the choice of windows. In Table 2.1 an example of the investment cost of a bedroom window is given. The example shows that the investment cost is about 5 % of the total investment cost per square m assuming a total cost of 10.000 SEK/m² or 10 % of the direct building cost excl VAT and clients cost. Table 2.1 also includes an example for the annual cost of the window. Despite some uncertainties (e.g. that capital costs are strongly related to actual interest rates, and that thermal losses through windows vary with U -values, orientation etc.) the fact still remains that the annual cost for a window can be around 50 SEK/m²,yr or approximately 5 % of the housing cost. (Bengt Hansson, Lund University, personal communication, Aug 2001).

Table 2.1 An example of investment and annual cost for a window, 1.2 by 1.2 m, (inward opening 1+2 construction) in a 10 m² bedroom. Examples provided by Bengt Hansson, Lund University (personal communication, Aug 2001).

Production cost:

Material (purchase, transport, insurance)	4 200 SEK
Labour (assembly, yarning, jointing and trimming)	400 SEK
Site cost	552 SEK
Contractors fee	412 SEK
Total production cost	5 564 SEK

Total specific production cost, (5564 SEK/m² / 10 m²=) 556 SEK/m²

Annual cost:

(Expected service life 50 years, average interest rate 6 %, maintenance cost 450 SEK every 20 years).

Capital cost	353 SEK
Running cost	100-200 SEK
Maintenance cost	12 SEK
Total annual cost	465-565 SEK

Total specific annual cost 46-56 SEK/m²

For large facility managers, demands on durability and maintenance are often deciding as to what type of window is chosen. Windows with very low U -values are seldom chosen solely on the fact that heating bills will be lower during the life-time of a building, since they who are responsible for the purchase seldom are those who will pay for the running costs of the building. The incentives are here diverging. If the synergistic effects of energy-efficient windows are considered, (e.g. simplified heating systems, better thermal comfort), then this may be a strong enough reason for purchase.

2.1.15 Sustainability

There are several definitions of the term sustainability or sustainable development, see for example the following web site:

(www.sustainable.doe.gov/overview/definitions.shtml, 2001-08-22).

However, all definitions encompass ecological, economical and social aspects. Perhaps the most well-accepted definition comes from the United Nations Conference on Environment and Development (UNCED) in Rio de Janeiro in 1992:

“Sustainable development meets the needs of the present without compromising the ability of future generations to meet their own needs.” – United Nations World Commission on Environment and Development.

The above mentioned performance requirements considers mainly the first use, or the first lifetime, of the window. Several of these requirements are also appropriate for the sustainability requirement. There are however some other aspects to the term sustainability, which have not been previously mentioned. These regard for example the use of energy and resources during both production and maintenance. Environmental impacts after first use should also be considered. Can the window be reused and is it suited for material recycling? Both reuse and material recycling may cause the need of disassembly. If the window is reused, is it well suited for the new building (good thermal insulation, etc.)? Regarding material recycling, one main question which arises is whether the different materials can be separated without contaminating each other? A discussion around the terms recycling and disassembly of building components can be found in Thormark (2001).

2.2 Background to current window design

In Sweden, due to the harsh winter climate, single-pane windows were abandoned early on. The first solution was that the traditional, outward opening window was equipped with an inner sash, which was mounted directly on the inside of the frame during winter, Fig. 2.4. Such windows have been found in buildings already from the late 17th century. Towards the end of the 19th century, such inner sashes became equipped with hinges. These loose inner sashes existed until the 1920's. In 1889, Flodquist and Hallberg patented the coupled double-pane sash, which became very common from 1910 and on. Windows were now often side-hung, inward opening since this was more practical in the taller buildings of the growing cities, see Antell & Lisinski (1988). The coupled double pane window was thus the most common type in housing from 1910 and forward. The heat loss was approximately halved with the introduction of the double pane, since the U -value drops from about 6 (single pane) to about 3 W/m^2K .⁴

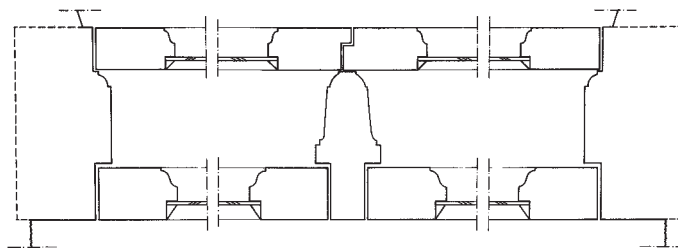

Figure 2.4 Double-pane window from 1883 with a separate, loose, inner sash. (From Antell & Lisinski, 1988).

In 1956 came the Suez-crisis, where the for oil transport so important Suez-canal was closed during several months. Even if the feared shortage of oil was exaggerated, it was an alarm clock. Between approximately 1956-58, the Swedish government issued advantageous loans for those who installed triple-pane windows, and used extra insulation. During this short period the majority of new single-family housing were built with triple-pane windows. However, it was with three coupled sashes,

4. If the frame and sash is accounted for, the total U -value is somewhat lower. A coupled window from 1930 was found to have a U -value of 2.6 before and 2.3 W/m^2K after renovation, while a window similar to that in Fig 2.4 had a U -value of 2.4 before and 2.1 W/m^2K after renovation (Fredlund, 1999).

which meant that 6 sides needed cleaning! When these subsidy loans were removed, the coupled double-pane window again became “standard” (Bo Adamson, personal communication, April, 2001).

During the 1970’s, Sweden was heavily dependent on imported oil. The oil crisis in 1973 was thus very noticeable to the Swedish society. One solution to reduce the dependency of oil was to use the energy more efficiently, another was to shift over to other energy sources. Sweden thus implemented a quite rigorous energy-code in 1975, as a direct answer to the oil crisis. This code (SBN 75) laid down rather strict requirements on U -values for individual building components (walls, windows, roofs, floors etc.), see Table 2.2, and established limitations of window size (max. 15 % of the floor area). For windows, the 1975 code required a window U -value of $2 \text{ W/m}^2\text{K}$, thus three panes were needed to accomplish this. The technology was known and tried in the late 1950’s, but was not competitive enough to become prevailing on its own. Actually, insulating glass units were already patented in 1865, in Ohio, USA (Wolf, 1988). In Sweden, the furniture designer and architect Bruno Mathsson had experimented with double-glazed sealed and fixed units and floor heating in houses that he designed already in the 1940s. Ventilation was provided through openable vents above the windows. In 1950, he built an exposition hall for his furniture, where he further developed his ideas and also after American inspiration built buildings with whole façades of glass, with triple-glazed sealed units and electric floor heating. The window pane he invented was called the “Bruno pane”, (Böhn-Jullander, 1992). In 1975, sealed insulating glass units was a common technology also in Sweden. This meant that window cleaning was much easier. However, the traditional coupled window was kept, but modified in that way that the inner sash was equipped with a double-glazed IGU. This was probably due to that the in Sweden much popular Venetian blind could be kept between the glass panes. Another reason for keeping the coupled construction is the lower replacement cost at potential failure. Especially large facility managers use this as an argument. (If the inner IGU breaks, the tenant has to pay, but if the outer pane breaks, the facility manager pays).

Today, a U -value of 2 can easily be reached in a double pane window with a low-emittance coating, but in 1975, the technology was not fully developed. Triple-pane windows have thus been “standard” in Sweden since the end of the 1970’s, and the manufacturing lines are adapted to producing these windows. During the years there have been (1) triple-pane windows in three coupled sashes (6 sides to clean!), (2) 1+2 constructions with a double IGU in the inner sash and a single clear glazing in the outer sash, and (3) a triple IGU in one single sash. While the first con-

struction has disappeared from the market, the two others exist side by side, but are partly marketed for different target groups (e.g. larger facility managers versus private home-owners). (See also Sec. 2.3).

Today, there is also a trend to go back to double glazing, especially within the commercial sector, since rather low U -values can be achieved with modern solar control/low-emittance glazing. Glazing systems become both lighter and cheaper if the third pane can be omitted, which is especially desirable for the builders in the current trend of very large glazed areas.

2.2.1 Changes to building code requirements

A building energy code usually lays down the bottom line for energy-efficiency. Sometimes this stimulates the market to improve the energy-efficiency of products, sometimes these improvements are market-driven. In the case of windows, the building code of 1975 (SBN 75), which came into force 1977, certainly acted as the driving force for permanently introducing the triple-pane window. The required U -values were specified for each building component, with slightly higher requirements for northern Sweden, Table 2.2.

As mentioned above, the 1973 oil crisis was the start of introducing energy requirements into the building code as a means to improve the energy-efficiency of buildings. Large efforts were also made to improve existing buildings. Extra façade insulation, improved air-tightness of windows and window replacement were typical examples. Simultaneously, the mentioned shift from oil to other energy sources occurred. For residential housing in 1970, the main heating system was individual oil furnaces connected to a water-heating system. Such systems could be converted quite easily by replacing the oil furnace with e.g. a combined electricity and oil or wood furnace. A few solar systems appeared, and heat pumps using heat from outdoor air, drilled bore holes or the ground were later introduced. District-heating systems were also growing rapidly in size, connecting both new areas, and existing housing. However, perhaps the most radical change to other energy sources was made possible through nuclear power. At the beginning of the 1980's, 12 Swedish reactors were coming on line, one by one. Suddenly Sweden was faced with a large electricity surplus. (The projections of growth rates in electricity demand, which the nuclear build out was based on, were found to be strongly exaggerated). Therefore, a stricter supplement to the Building code was

introduced in 1984, the so called ELAK⁵ code (Byggforskningsrådet, 1987). In residential housing, which complied with this code, direct electric heating was allowed. The code required wall U -values of $0.17 \text{ W/m}^2\text{K}$ and heat recovery from exhaust air. Today, when the phase-out of nuclear power has begun, this has introduced a new problem, since it is very costly to convert these direct-electric heating systems to other energy-carriers. Energy-efficient windows ($U_{win} < 1 \text{ W/m}^2\text{K}$) can be one important answer, since radiators placed under windows can be omitted, allowing for simpler heating solutions.

The building codes of 1980 and 1985 (SBN 80, SBN 85) brought no changes to the section on energy compared to SBN 75. In 1988 the building code was reformed again with the introduction of NR 1 (BFS 1988:18). This had a new, systems approach. Where the old code had laid down requirements on individual building components, the new code focussed on the requirements or performance of the whole building, and on fulfilling certain functions, without specifying exactly how this should be done. The new requirement was shaped as a maximum permissible average U -value for the building, e.g. the sum of individual U -values times their surface area divided by the total enveloping area, Table 2.3. For windows this meant that the old requirement of $U_{win} < 2$ was omitted. Solar gains through windows were accounted for by reducing the dark U -value of windows with an orientation dependent value, α_3 , see Table 2.4. In theory, this new approach means that windows are allowed to have a higher U -value than 2, if only the requirement on the average U -value of the house is fulfilled.

NR 1 has been revised a couple of times, the current code is the BBR 99 (1998). The changes compared to NR 1 regarding energy is however very marginal. A chapter has been added regarding the electricity efficiency of buildings, but this goal has not been quantified.

5. ELAK: ELAnvändningskommittén förslag för direktelvärmda småhus. (The energy use committee's proposal for direct electric heating in one or two-family houses).

Table 2.2 Example of U -value requirements (W/m^2K) for residential buildings according to the building code of 1975 (SBN 75). Temperature zone I-II was south of a line through the cities of Strömstad - Örebro – Gävle, Zone III-IV was north of this line.

Building part	Temperature zone	
	I-II	III-IV
Wall towards the ambient or through earth towards the ambient	0.25	0.30
Roof or attic ceiling with roof above	0.17	0.20
Floor towards the ambient	0.17	0.20
Floor towards closed outdoor-ventilated crawl space	0.30	0.30
Floor directly on ground	0.30	0.30
Window and door towards the ambient		
Non-glazed part of door	1.00	1.00
Window and window in door (including sash and frame)	2.00	2.00
Wall and floor towards space heated to between +10°C and 0°C	0.50	0.50
Wall and floor towards space heated to between +18°C and +10°C	1.00	1.0

Table 2.3 Example of U -value requirements for buildings according to the building code of 1988 (NR 1), which is still valid (BBR 1999).

$$U_{ave,req} \text{ for dwellings} = 0.18 + 0.95 A_w / A_{env}$$

$$U_{ave,req} \text{ for non-residential premises} = 0.24 + 0.95 A_w / A_{env}$$

The maximum proportion of the area A_w which may be taken into consideration is $0.18 A_{heat}$.

$U_{ave,req}$ maximum permissible average total thermal transmittance (W/m^2K).

A_w aggregate area (m^2) of windows, doors and similar, calculated over the external frame dimensions.

A_{env} aggregate area (m^2) of the surfaces, in contact with the heated indoor air, of enclosing elements of structure. The term enclosing element of structure refers to elements which separate the heated parts of dwellings or non-residential premises from the external air, the ground or partly heated or unheated spaces.

A_{heat} heated usable floor area (m^2) as defined in SS 02 10 53, (i.e. measured from the inner side of exterior walls, and incl. of interior walls).

Table 2.4 Values of α_3 , the allowed subtraction on dark U -values of windows according to window orientation in NR 1 and BBR 99.

Window orientation	α_3
SO - SV	1.2
SO - NV, SV - NV	0.7
NO - NV	0.4
If window orientation is unknown	0.7

2.2.2 Technology procurement of energy-efficient windows

In 1992, the National Board for Industrial and Technical Development (NUTEK) performed a technology procurement program to promote super-insulated windows (NUTEK, 1992). The background was that window development had more or less ceased since the development of the triple-pane window during the late 1970's. Occasionally, low-e coated glass was used. To compare, modern walls usually have a U -value of 0.2 W/m^2K , or 10 times better than windows per unit surface area, since window U -values typically were around 2.0. The requirements in the competition was a total window U -value of 0.9 W/m^2K , with a bonus for a U -value lower than 0.8. The requirements on both daylight transmittance and total solar energy transmittance was 60 % (at normal incidence).

Two windows were elected winners, both were quadruple-pane wood, or mainly wood, windows with 2 or 3 low-e coatings and argon gas fillings, see Fig 2.5. They had U -values of 0,88 and 0,73 respectively which was below the required value. It was found harder to achieve the required short-wave transmittance, both the daylight transmittance (55-54 %) and the solar energy transmittance (51-44 %) was a bit to low. A few thousand of these windows were installed in refurbishing and new projects, which was also part of the technology procurement program; i.e. a guaranteed market for these windows.

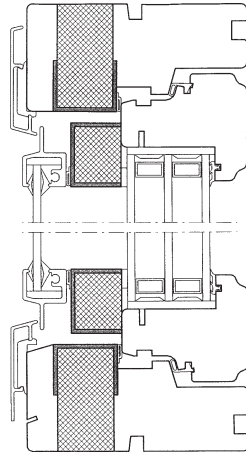

Figure 2.5 One of the award winning windows with total U-value of 0,88 W/m^2K . Vertical section showing the thermal break in frame and sash with polyurethane imbedded in a PVC-profile. The quadruple glazing consisted of: 4 mm – 94 mm Air – 4 mm LE – 16 mm Ar – 4 mm – 16 mm Ar – LE 4 mm, where LE indicates the position of the low-e coating and Ar stands for Argon gas.

However, the “market” did not welcome these windows with open arms. Architects accused the windows of being clumsy and having too poor a daylight transmittance. (These windows look very green placed before a white wall). The green tint came partly from the fact that four 4 mm glass panes were used, but mostly from the use of two to three low-e coatings. In a study I performed, it was shown that people perceived a room with such a window as darker and more enclosed than a room with an ordinary triple-pane window (without coatings) and the daylight was perceived as more tinted (article III), which thus supported the accusations of poor daylight quality of these windows. These windows were also heavier, leading to the need for special mounting tools on the building site.

The benefits of the window was, apart from the lower heating bill, the much improved thermal comfort during winter, see Wallentén (1993), allowing for simplified heating systems (the radiator under the window becomes unnecessary) or larger glazing surfaces, (NUTEK, 1993, 1995). Also, the sound insulation was improved. However, when these synergistic effects do not benefit the constructor, it is hard for him/her to motivate a larger first cost.

NUTEK therefore continued to support the development of these windows. The U -value requirement was raised from 0.9 to 1.0 $\text{W}/\text{m}^2\text{K}$ to allow for triple-pane windows, see Fig 2.6. The name was simultaneously changed from super-insulated to energy-efficient windows. Two low-e coatings were however still necessary to achieve the desired U -value, since a rather traditional wooden frame and sash construction was used. The daylight transmittance was thereby improved slightly. Argon or krypton gas fillings, and traditional spacer materials were mostly used. In one case a stainless steel spacer with a slightly lower conductance was used.

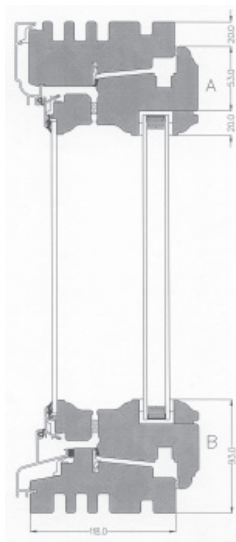

Figure 2.6 Example of window from the second round of the technology procurement program with total U -value of 1 $\text{W}/\text{m}^2\text{K}$. The triple glazing consisted of: 4 mm LE – 70 mm Air – 3 mm – 15 mm Ar – LE 3 mm.

Condensation appearing on the outside of the outer pane was a new phenomenon, which was observed on some of the first super-insulated windows installed (see section 2.1.4). This was studied further, see e.g. Jonsson (1995). This phenomenon is likely to appear on some occasions already on windows that have a centre-of-glass U -value of approximately 1.0 $\text{W}/\text{m}^2\text{K}$, but the frequency will increase with decreasing U_{cog} . If taken as a sign of a well-insulated window, this might be acceptable, but for a few people it is perceived as very disturbing and unacceptable. Within the Swedish glazing and window industry, it is still a hot topic for debate.

2.2.3 Aesthetical development

There is certainly an enormous difference between today's windows and those from one hundred years ago. A review of window architecture, typical shapes, styles, wood dimensions etc. can be found in Antell & Lisinski (1988) and Stockholms byggnadsnämnd (1988). Of course, fashion has changed dramatically over the years (Fig. 2.7), but that is not the whole reason why windows look the way they do today.

At the beginning of the 1900's, each carpenter still put his own character to the windows he made, by the choice of profiles and fine detailing of the sash and frame. Architects were also heavily involved into the design of windows, and its fine details, which can be seen on old architecture drawings. The window and its trimmings was built and painted on site, and was treated as a whole. Later, around 1940, when the window manufacturing had become more industrialised, the design of windows had to conform to a standard in the Swedish standardisation system. The first window standard was issued in 1945, and was revised from time to time. Naturally, this led to a very high uniformity in window design, with the same details on sash and frame.

Around 1970, window manufacturers no longer had to conform to a standard, and suddenly (without really knowing it) it was up to them to design the window. Architects or industrial designers were hardly involved in the design process. Instead, demands on wind and snow penetration, durability, and all the others steered the design process. The result is the – with few exceptions – criticised clumsy, heavy windows we see today (Hjorth, 1992).

After NUTEK in 1992 had conducted their technology procurement for energy-efficient windows, I thought this would also lead to a development on the aesthetical side. NUTEK granted some money so that architects could be involved in the manufacturers' design process, and some good examples of aesthetically appealing energy-efficient windows were shown. Another example from approximately the same time was the architect driven project "Good building components", in which coupled double-pane windows with one low-e coating were developed (Byggforskningsrådet, 1993). However, the impact seem to have been only temporary, and today almost 10 years later, the design of new windows is – with few exceptions – more or less the same as during the 1980's.

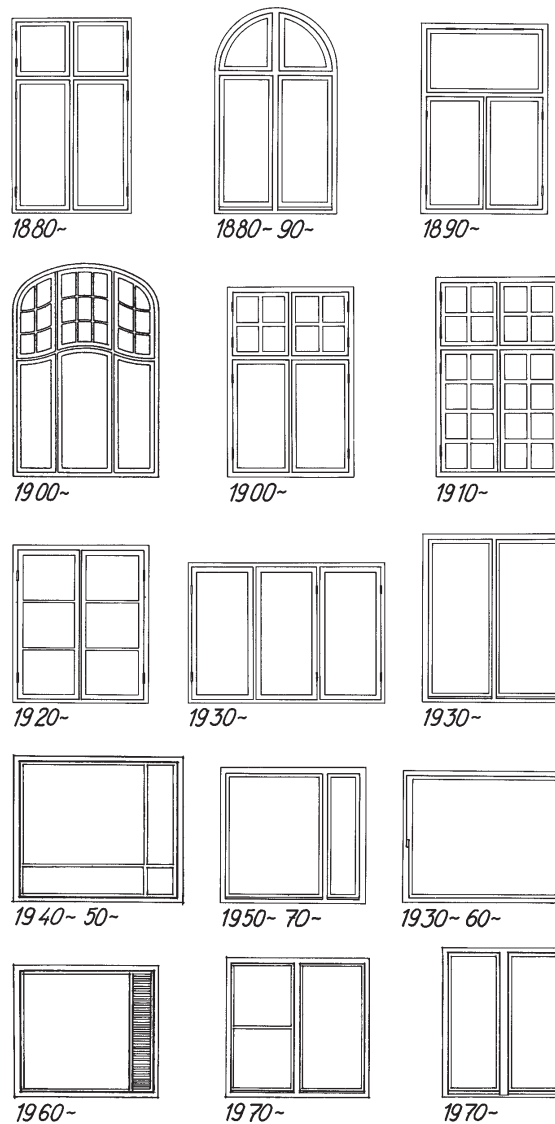

Figure 2.7 Changes of window styles from 1880 to 1980. (Modified from Björk et al., 1984).

2.3 Windows of today

In Sweden, the triple-pane wood window is still dominating, either as a 1+2 construction or as a triple-pane IGU. Aluminium cladding on wood windows is common among larger facility managers, while ordinary wood windows are still the most commonly used type in single-family housing.

Aluminium windows and vinyl windows still have small market shares. The total volume of window sales in Sweden year 2000 was approximately 1.2 million window lights, of which 66 % were wood windows, 30 % were wood-aluminium, 3 % aluminium and 1 % vinyl windows (Leif G Gustafsson, SNIRI, personal communication, April, 2001).

Unfortunately, there are no easily available statistics for the share of low-e coated windows. After having communicated (April-May, 2000) with the 7 largest window manufactures, covering about 80 % of the market, I estimate that around 70 % of the windows sold in Sweden 2001 were delivered with a low-e coating. The share of coated windows shows a quite remarkable increase since 1995, see discussion of *Elitfönster* below. The market share for such windows is probably highest within the small-house industry (e.g. prefabricated houses). However, about 50–70 % of current sales goes directly to consumers (via building material retailers) for the renovation of older houses and here the picture is more diverse. Since these consumers are mostly interested in a low price, they are less susceptible to low *U*-value arguments (Leif G Gustafsson, SNIRI, personal communication, April, 2001). This was emphasised at SP windows who can see a decline in low-e glass during the summer period, while it is higher during autumn and spring. Among the companies I spoke to, there is also a widespread “fear” of selling windows with very low *U*-values to the consumer market due to the condensation phenomena discussed in Sec. 2.1.4. While some companies deliver windows with both one low-e coating and argon gas as standard, others have omitted the argon gas to reduce the risk of condensation. The average *U*-value of windows sold today is thus estimated to roughly between 1.3 and 1.6 W/m²K.

Of the windows sold today, triple-glazed windows accounted for over 80 % of the volume, and double-glazed windows for the remaining 20 %. For the triple-glazed windows, 75 % were sold with a triple IGU, and 25 % with a coupled 1+2 construction. A similar situation was found for double-glazed windows: 76 % were with a IGU and 24 % were coupled which means that coupled windows continue to decrease. Of the 7 interviewed companies, only the smallest one have a large production of double-pane IGU windows (70 % of their sales). These were then equipped with one low-e coating, but usually not with argon.

This shows that it is still hard to convince Swedish consumers that a double-pane window can have an equivalent or slightly better *U*-value than a clear triple-glazed one. However, since the low-e coated share of triple-glazed windows has increased over the last few years, the consumer will for the most part also get a better product with the triple-glazed window. In a national perspective it is also important to keep the triple-glazed construction in order to continue the improvements on energy-

efficiency. The risk is that the market share for double-glazed windows increases, something that some of the interviewed companies believe will happen.

It is sometimes claimed that the market share for low-e coated glass in Sweden is much lower than in other European countries, and should thus be increased. This might have been true, but today the market share seems to be quite high. The background with the early introduction of a triple-pane window must also be remembered. The market for low-e coated glass has also fluctuated according to the general economic state of society: During the building recession around 1992-1998 the market share for low-e coated windows probably reached a temporary low. One example is given for one large Swedish window manufacturer, Elitfönster (Anders Browall, Elitfönster, personal communication, 1994, 2001).

Elitfönster's share of low-e coated glass was 23 % in 1990, which dropped to 13 % in 1994. At the same time the largest part of the already low share went on export to Germany, leaving the Swedish market almost without coated glass. In 1990, the export to Germany was also much smaller. Before the recession, the low-e coated glass mainly went to the small-house industry. In 1994, this construction had almost stopped. However, in 1998, Elitfönster changed their production when they installed a new production line for their insulated glass units. They have since March 1998 sold triple-pane windows with one low-e coating and one argon gas filling as their standard product. The insulated glass unit is sealed in a vacuum chamber filled with argon, and the traditional filling process through two holes in the spacer has thus been omitted. A clear triple-pane window now costs extra! Their windows have a total window *U*-value of 1.2-1.5 depending on window type and size.

This picture is supported by statistics given from the glass and glazing manufacturing industry. Their production data from the last eleven years show that the low-e coated share of IGU's took a marked step upward in 1999 and was about 45 % in year 2000 (Lars Genberg, Pilkington, personal communication, June 2001), see Fig. 2.8. Elitfönster's move to introduce low-e coated glass as a standard product in 1998 is the main reason to this large increase, since it has also pushed other companies to follow.

While Swedish window manufacturers have long been conservative regarding the use of traditional metal spacers, at least one glazing manufacturer has recently started offering one "warm-edge" alternative, what they call a thermo-plastic spacer. However, none of the window companies that I spoke to have taken it in to their standard production, even if several have it as an alternative. The conservatism is partly due to a fear of

introducing a new technology that would possibly jeopardise the life-time of the IGU. Another reason is the cost. One manufacturer estimated that the extra cost for the consumer is around 150 SEK/m².

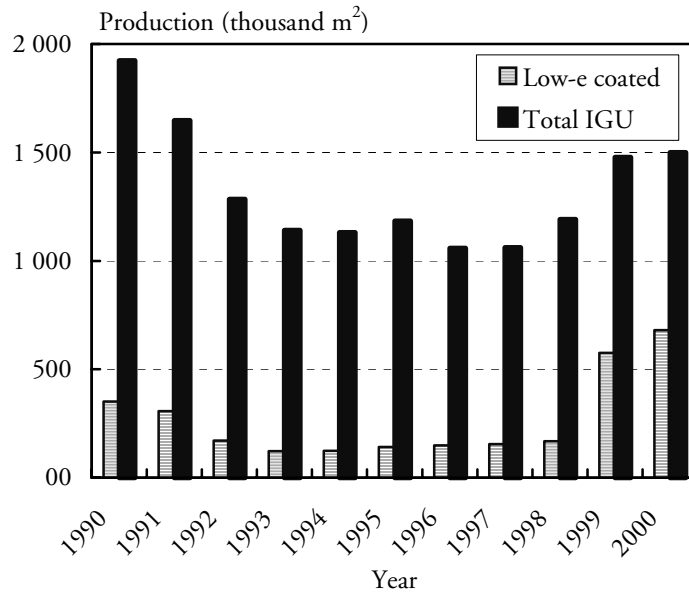

Figure 2.8 Statistics over insulated glass unit production in Sweden from 1990 until today.

2.3.1 Guarantees

Today some companies give a 10-year guarantee on windows. The P-label is often the basis for the guarantee, see below. The window must also be stored, mounted and maintained according to the specifications of the manufacturer. The guarantee concerns wood rot, condensation between panes in insulating glass units (IGU) and the function of windows and their fittings. In other cases the normal construction guarantee, which comprises two years, apply.

A guarantee of five years is normally given on rectangular IGUs. However, in the case of an extended guarantee (10 years) of windows, the guarantee is also usually prolonged to 10 years for the IGU itself. The guarantee concerns condensation between the panes.

2.3.2 Quality labelling, P-labelling of windows

The P-label is the name of a system for certification and quality control of industrially manufactured products issued by the Swedish Testing and Research Institute (SP). A P-labelled window must fulfil a number of different quality criteria drawn up by SP (Brolin, 1987, 1990). The system implies that the manufacturer performs internal quality control and that it submits to continuous spot tests from SP to ensure that the production always fulfils the quality criteria. P-labelling thus acts as a sort of warrantor for good quality, and is sometimes used as a basis of issued product guarantees, see above.

The general function criteria for a P-labelled window concern the following: air tightness, rain tightness, safety against wind load, thermal insulation, condensation, mechanical strength and stability, manoeuvrability, fire safety and temperature stability (metal windows). There are also certain requirements on the timber raw material for wood windows, profiles of sash and frame regarding water drainage, surface cladding, surface treatment, glueing, fittings, glass panes and glazing, putty, sealant and strips, and finally handling instructions. As an extra, windows can be classified regarding both fire safety and sound insulation, and they can be tested regarding burglary protection. According to SNIRI (the Swedish association of joinery shops), over 70 % of all wooden windows produced today are P-labelled (Leif G Gustafsson, SNIRI, personal communication, April, 2001).

2.3.3 Energy labelling

There are a number of different glass types, glass distances and gases, frame and sash constructions etc. which make it difficult to estimate the thermal performance and solar and daylight properties of windows. In an attempt to establish common standards for the calculation and labelling of windows, The National Fenestration Rating Council (NFRC) was formed in the US in 1989. The standards regard calculation and labelling of window U -values, total solar energy transmittance (or solar heat gain coefficient, SHGC), shading coefficient, daylight transmittance, and condensation. The computer tool WINDOW 4.1 (LBL, 1992) was developed at LBNL to facilitate calculations of window performance. (The newest version will be WINDOW 5, it exists now as a beta-version). Today there are five different NFRC standards. One advantage of the NFRC-labelling system is that it is cheaper than laboratory testing. The label is shown in Fig. 2.9. Since the US is a federation of individual

states, it is up to each state to decide on following the NFRC standards or not. As of April 2000, eight states require NFRC certification and labelling of some window products. An additional 21 states or jurisdictions have adopted the 1995 Model Energy Code or the 1998 International Energy Conservation Code, both which reference NFRC as the preferred source for fenestration performance ratings (NFRC, 2000).

		World's Best Window Co. Millennium 2000+ Casement <small>CPD#0098-xyz-001</small> <small>Vinyl-Clad Wood Frame • Double Glaze</small> <small>Argon Fill • Low E • Solar Control Coatings</small>				
<small>National Fenestration Rating Council</small> CERTIFIED		ENERGY Performance				
<ul style="list-style-type: none"> • Energy savings will depend on your specific climate, house and lifestyle • For more information, call 1-800-WBW-1234 or visit NFRC's web site at www.nfrc.org 						
Technical Information						
Res	U-Factor	.32	Solar Heat Gain Coefficient	.45	Visible Light Transmittance	.58
Non-Res		.31		.45		.60
<small>Manufacturer stipulates that these ratings conform to applicable NFRC procedures for determining whole product energy performance. NFRC ratings are determined for a fixed set of environmental conditions and specific product sizes.</small>						



Figure 2.9 Energy labelling according to NFRC (left) and the Swedish symbol for energy-efficient (mainly electrical) equipment (right).

In Europe, there is not really an equivalent of the NFRC rating system at the moment, but energy labelling is currently a question of debate among researchers, see e.g. Duer et al. (2000). There already exist a number of different standards for the calculation of U -values, light and solar transmittance etc., see for example (EN 673, ISO 10077-1:2000, ISO/DIS 10077-2 / prEN 10077-2, ISO/DIS 15099, ISO 9050:1990).

In practise, SP in Sweden in their contact with window manufacturers works quite a lot like the American system, allowing manufacturers to perform calculations of U -values instead of intensive laboratory testing. Programs that can be used are mainly VISION/FAME from Enermodal Engineering, WINDOW from LBNL, USA, Canada and WIS from Europe, available via University College Dublin, Ireland.

NUTEK has developed a symbol (Eloff strömsnål) for energy-efficient products, mainly electrical equipment, which can also be applied to energy-efficient windows, see section 2.2.2. Windows to which this symbol may be applied, must have a well thought-out aesthetical design and fulfil the following technical requirements: U -value (whole window) < 1.0 W/m²K; glass ratio > 65 %; daylight transmittance > 63 % (normal incidence); no change of the colour perception (from inside to outside);

no optical distortion (from inside to outside); the colour of the outside glass surface must not be remarkably different to that of ordinary glass; frame thickness < 140 mm; good sound insulation; guarantee of at least 10 years; service life of at least 30 years. Further, the window must fulfil the requirements on rain and air-tightness, security against wind load, mechanical strength and stability, manoeuvrability, and risk of condensation according to Swedish standard. Child safety and fittings must be according to the Swedish building code. It must be possible to clean all glass surfaces within reach from the inside according to prevalent methods. Measurements should be done on windows of the size 1.0×1.2 m. The aesthetical appeal is judged by a group of architects appointed by NUTEK (Agneta Persson, personal communication, Oct 1995).

2.4 Windows of tomorrow

What will be the window of tomorrow? I can already say that I do not want to elaborate on this highly hypothetical question. However, it is difficult not to mention by a single line technologies that are under study by scientists of today, for example vacuum glazing, aerogels, chromogenics etc.

If the Kyoto-protocol about emission reductions shall be fulfilled, and we plan to keep our current standard of living, the solution seems to lie within new technologies, or at least with a proper use of the technologies available today and through good building design. To reduce winter heating demands, further *U*-value reductions of windows might be solved by new technologies like aerogels or vacuum glazing, see Duer (2001), since the thin film technologies probably do not have much more to offer than what already exist on today's markets. However, there is a large potential (and challenge) already within available technologies, to make the average technology equal to that of the best on the market.

Overheating and daylight (glare) problems in the summer require solutions that can control throughput of solar energy and daylight, here chromogenics has to compete against traditional shading devices and their control systems. The solar energy control problem is the most straightforward to solve, since it deals only with thermodynamics. The daylight issue is more complex, since here we need to deal with the dynamics of people and to gain their acceptance or satisfaction of the system.

3 Basic window physics

The heat flow through a window is a complex process. Room heat is transported outwards through the window construction when it is warmer indoors than outdoors, see Fig 3.1 showing the principles of long-wave radiation, conduction and convection.

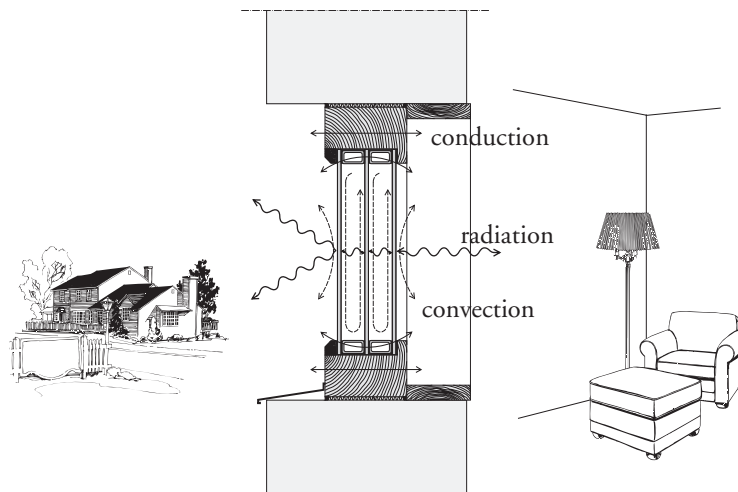

Figure 3.1 Principles of heat transport (during darkness) through a triple-pane window showing radiation, conduction, and convection.

Short-wave solar radiation is transported inwards during daytime. The major part is of course when there is direct solar radiation, but also the diffuse parts (from sky and ground) give significant contributions. Part of this radiation is "visible" and provides lighting indoors. Therefore, it is of interest to divide the electromagnetic spectrum into wavelength intervals (Roos, 1994), see also Fig 3.2:

- 1) $\lambda < 380$ nm (UV-radiation). Non-visible ultraviolet radiation that has little meaning for the energy balance of buildings. It can however be harmful for people, plants and textiles.

- 2) $380 \text{ nm} < \lambda < 780 \text{ nm}$ (visible radiation). The most important wavelength interval that contains approximately 50 % of the solar radiation. Ordinary window glass has a high transmittance in this interval.
- 3) $780 \text{ nm} < \lambda < 2500 \text{ nm}$ (near-infrared radiation). The part of solar radiation reaching the surface of the earth which is not visible. Approximately 40 % of the energy content from the sun are found within this interval.
- 4) $\lambda > 2500 \text{ nm}$ (IR-radiation). All surfaces at room temperature emit energy in this interval. Ordinary window glass is opaque for these wavelengths. The radiation is however absorbed and then re-radiated both inwards and outwards. A major part of the heat loss through an ordinary window happens in this way.

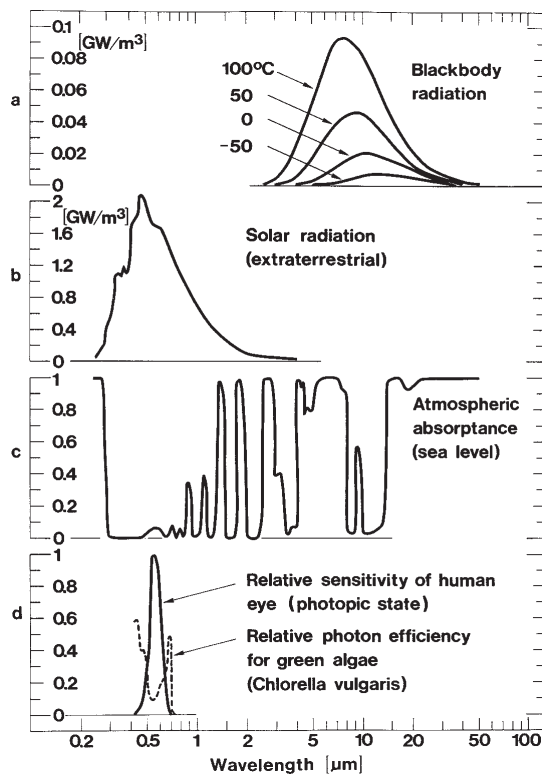

Figure 3.2 Spectrum for a) a black body at four temperatures, b) extraterrestrial solar radiation, c) typical absorption of the whole atmosphere, d) relative sensitivity of the human eye (after Grankvist, 1981). (1000 nm = 1 μm).

3.1 UV-transmittance

The transmittance of UV-radiation, T_{uv} , through ordinary glass is rather low. For example, it is usually said that it is not possible to get a suntan behind a window, see also section 4.8.1. However, even if the transmittance of ordinary glazing is very low, the energy content of these short wavelengths is still high, and may cause bleaching of textiles and paintings. If this is of special concern, a special UV-filtering glass can be laminated to the window, to further reduce bleaching. Some bleaching may still occur, since sunlight up to the red part of the spectrum is known to cause bleaching (IESNA, 1993).

3.2 Light transmittance

The transmittance of solar energy within the visible region, weighted against the photopic sensitivity of the eye, is called the *light transmittance*, T_{vis} , but the term LT also appears in the literature. For ordinary clear float glass, approximately 90 % of the light that hits the surface at normal incidence is transmitted. Approximately 8 % of the energy is reflected ($R = 4$ % at each surface), and the remaining 2-3 % is absorbed as heat in the glass. The more window panes that are used, the lower is of course the transmittance.

3.3 Solar energy transmittance

The transmission of solar radiation within wavelength intervals 1-3 is called the solar energy transmittance. A distinction is made between the directly transmitted energy, *solar direct (or primary) transmittance* $T_{sol,dir}$ (which is comparable to the light transmittance) and energy gain from secondary heat transfer processes (absorption). The secondary part consists of the fraction of absorbed energy in the glazing that is transported inwards to the room, A_{in} , see Fig. 3.3. When the secondary part A_{in} is added to the directly transmitted part, we call this the *total solar energy transmittance*, $T_{sol,tot}$. Expressed as a ratio it is also denoted the *g-value* (*g* for gain) or SHGC (solar heat gain coefficient). It is usually only slightly lower than the corresponding light transmittance, but can for special solar control glass be significantly lower, see sec 3.6. For single clear float glass $T_{sol,dir}$ is approximately 83 % and $T_{sol,tot}$ is 86 %.

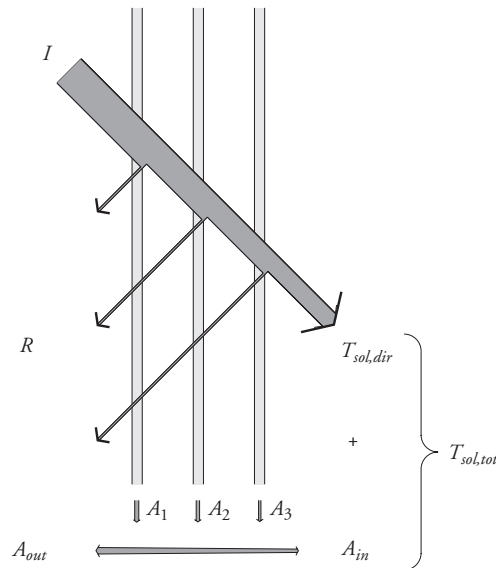

Figure 3.3 Scheme over reflected, directly transmitted and absorbed solar radiation in a triple-pane window. Multiple reflections not shown.

3.4 Multiple panes and angle-dependent properties of glass

To be able to calculate the transmittance of a multiple-pane window, it is necessary to take into account multiple reflection between the panes. Polarisation of light must also be considered. The calculation procedure for the transmittance for different wavelength regions is described in ISO 9050:1990.

A rough estimation of the transmittance is to multiply the transmittance of the individual panes. An ordinary (clear glass) double-pane window will thus have a light transmittance of about 80 % and a triple-pane window 72-73 %.

The transmittance is also dependent on the incidence angle: It is largest for normal incidence, remains fairly constant to about 50-60°, and then drops quickly to 0 % at 90° incidence angle, see Fig. 3.4. If the physical properties of the glass are known (thickness, refraction and extinction coefficients), the angle-dependent properties can be calculated using Fresnel's equations and Snell's Law.

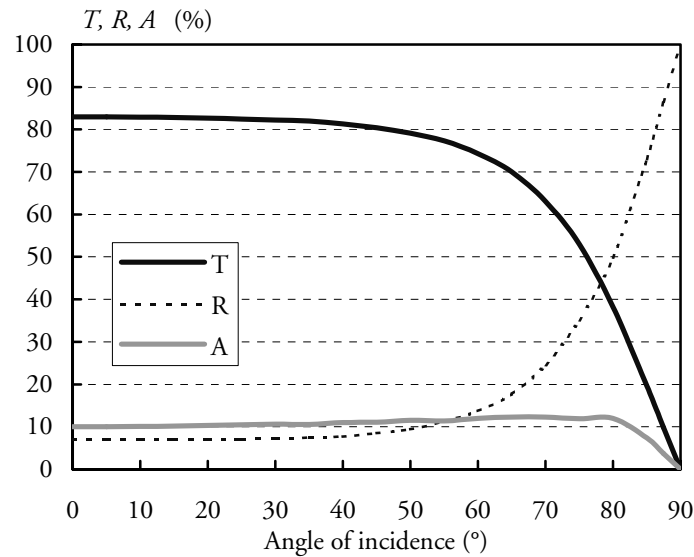

Figure 3.4 The angle dependence of transmittance, reflectance and absorptance of clear float glass for incidence angle θ (from the surface normal).

For special glazing, such as absorbing or coated glass, the angle-dependent properties are usually slightly different than for clear glass. They can be calculated if all material properties of the coatings (thickness, refractive indices) are known, but it is a more tedious work. Material properties must also be known on a spectral basis, i.e. for each wavelength. Since such data are not readily available, it becomes the work of a material scientist. Some attempts have been made to fit polynomials to the angle-dependent curves of the g -value, in order to facilitate this calculation (Roos, 1997; Karlsson & Roos, 2000; Karlsson, Rubin & Roos, 2001). These methods still require some knowledge about the materials used in the coatings, but this could probably be built into an expert-system depending on the relationships between g , T_{vis} , emittance, etc.

When the transmittance for a single glass is calculated or measured, it is necessary to weigh the results for each wavelength against a “standardized” solar spectrum. For the light transmittance, D65 is a widely used spectrum. For the solar energy transmittance, references to two solar spectra are given in the ISO 9050 (Perry Moon air mass 2 and CIE 85), and both of these are widely used by manufacturers in Europe. In the US, a different spectrum is used, ASTM E87-891, which corresponds to ISO 9845-1:1992, see Fig. 3.5. Standardisation work is in progress with the aim to

change from the spectra referred to within ISO 9050 to the spectrum given in ISO 9845. The industry is however resisting this change, since the values for g can be as much as 3-4 % higher when calculated with the ISO 9845 spectrum. (Arne Roos, Uppsala University, personal communication, 2000). Care must therefore be taken when performance data on products from different manufacturers are compared. Hopefully, this problem will eventually disappear when everyone conforms to the same calculation procedure.

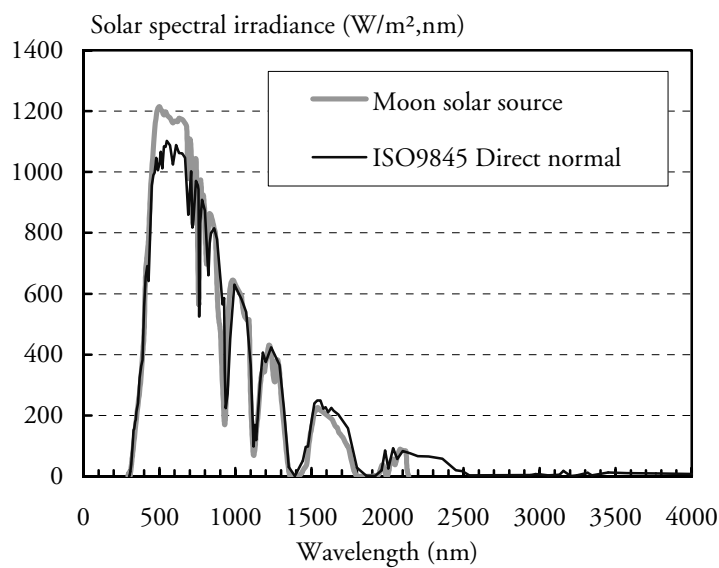

Figure 3.5 Solar spectral irradiance for two spectra: Perry Moon and ISO 9845 Direct normal irradiance, Tab 1, col. 2. The source for Perry Moon was found in Optics5 from LBNL.

3.5 Glazing for energy-efficiency

Low-emittance (low-e) coatings are special types of spectrally selective coatings designed to increase the energy-efficiency of windows. The main characteristic of these coatings is that they have a high reflectivity in the long-wave part of the spectrum, thus giving them a low emittance, ϵ (<20 %) in the same wavelength region. While normal glass absorbs most of the heat radiation from the room surfaces ($\epsilon = 84$ %) and re-radiates outwards and inwards, low-e coated glass suppresses the radiation outwards, resulting in the long-wave radiation being reflected back to the

room. The increase in heat insulation is equal to, or better, than adding an extra pane of glass. Normal low-e glass is designed to have a transmittance within the visible region as close as possible to that of ordinary glass, Fig. 3.6. However, depending on the type of coating, they can give a slight tint to the glass towards e.g. brown or green in transmission, and a brown or pink tint in reflection.

Two main types of coatings appear on today's market: soft and hard. The soft coatings are sensitive to wear, window cleaning etc., and must be protected in an insulated glazing unit (IGU). They are usually made of a thin silver layer (Ag), on the order of 100\AA , giving them an emittance of about 10 %. Recent developments is the race between manufacturers for extremely low emittances; 4 % or less is reached by a thick or double silver coating.

The hard coatings are durable, which enables the use of these as single panes or in coupled double-pane windows. The hard coatings are made of a doped tin-oxide (SnO_2), on the order of 4000\AA thick. The emittance is approx. 15-16 %. At the same time, the solar transmittance, $T_{sol,top}$ is higher than for the silver coatings, see Table 3.1.

Table 3.1 Approximate physical data of some commonly used glass types: Visual transmittance (T_{vis}); Visual reflectance, exterior and interior side ($R_{vis,1}$; $R_{vis,2}$); Direct solar transmittance ($T_{sol,dir}$); Solar reflectance, exterior and interior side ($R_{sol,1}$; $R_{sol,2}$); emittance, exterior and interior side (ϵ_1 ; ϵ_2). The coatings are placed on the side they normally appear in a glazing combination.

Glass type	T_{vis}	$R_{vis,1}$	$R_{vis,2}$	$T_{sol,dir}$	$R_{sol,1}$	$R_{sol,2}$	ϵ_1	ϵ_2
Clear float	0.90	0.08	0.08	0.83	0.07	0.07	0.84	0.84
Low-e (Ag)	0.85	0.05	0.04	0.62	0.16	0.20	0.84	0.10
Low-e (Ag)	0.85	0.08	0.06	0.58	0.22	0.28	0.84	0.04
Low-e (SnO_2) ^{a)}	0.83	0.10	0.11	0.71	0.10	0.12	0.84	0.16
Absorbing green	0.75	0.07	0.07	0.46	0.05	0.05	0.84	0.84
Absorbing grey	0.44	0.05	0.05	0.45	0.05	0.05	0.84	0.84
Solar control	0.72	0.10	0.17	0.45	0.35	0.29	0.06	0.84
Adv. solar control	0.75	0.08	0.09	0.35	0.49	0.33	0.02	0.84
Adv. solar control	0.56	0.09	0.15	0.26	0.45	0.34	0.02	0.84

a) hard coating, can be used as single pane

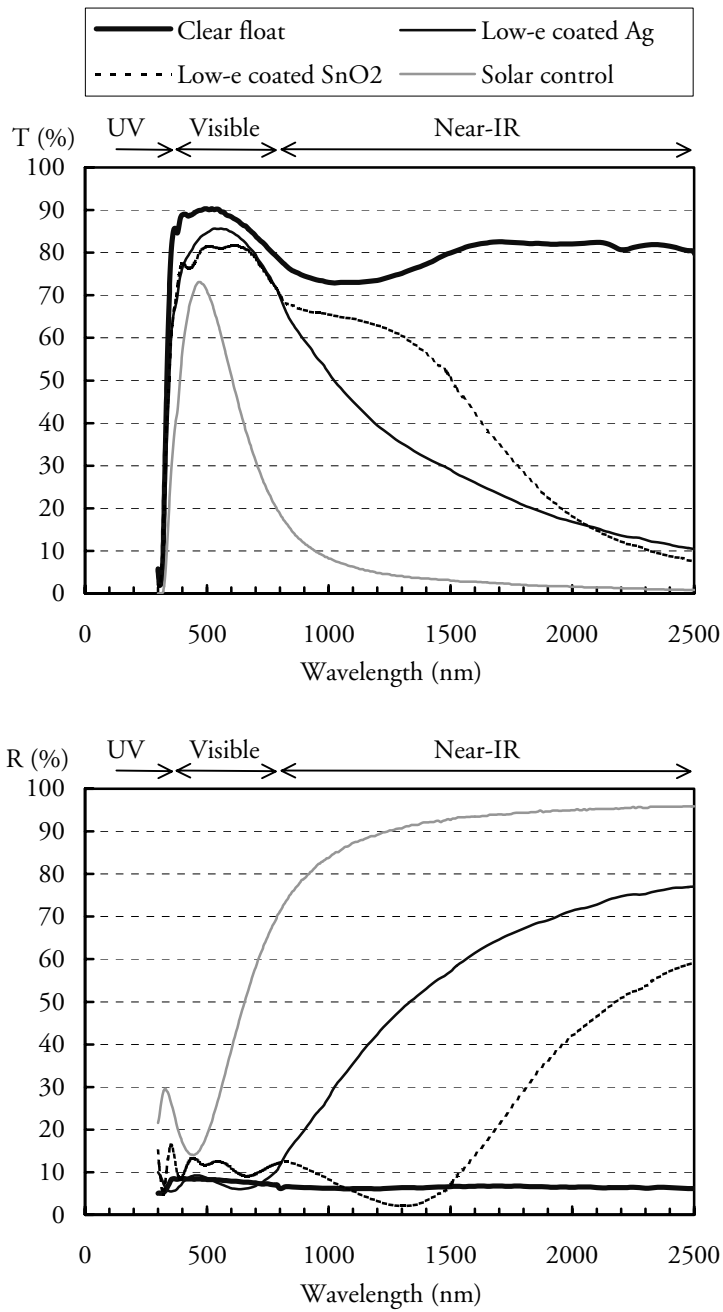

Figure 3.6 Transmittance (top) and reflectance (bottom) for ordinary float glass and some types of low-e coatings.

From a physical point of view, it would be more accurate to classify low-e coatings as thin or thick. Tin-oxide coatings would then belong to the thick category, while all silver coatings are (more or less) thin. The spectral selectivity of a tin-oxide coating stems from its material properties (e.g. low electron density). Silver-based coatings, which have a high electron density, need to be thin in order to be transparent. Thus, by changing the thickness of the silver coatings, quite different transmittance spectra can be achieved, see Fig. 3.7.

A low-e coating is usually applied on the outside of the inner pane, to achieve a high g -value (pos. n-1). In super-insulated triple-pane windows with two low-e coatings they are usually applied to the outside of the inner pane (pos. 5), and to the inside of the outer pane (pos. 2). The mid-pane is better left uncoated, since the rather high absorption of solar radiation would otherwise cause excessive temperatures, which could lead to a failure of the IGU.

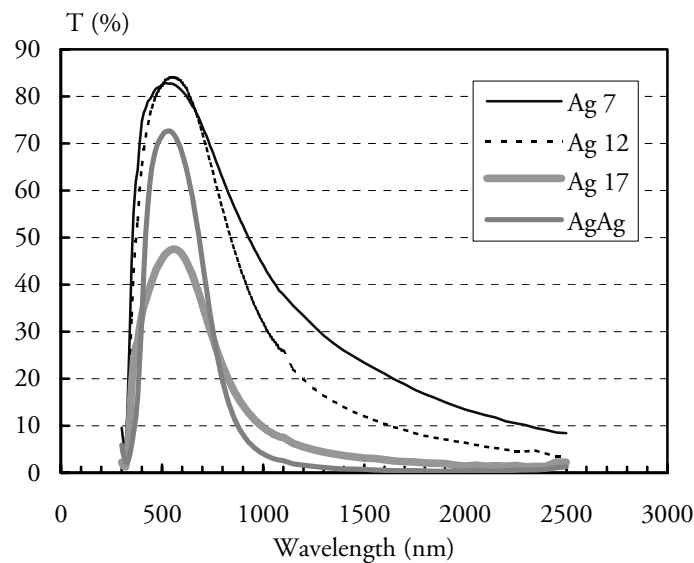

Figure 3.7 Transmittance for silver-based coatings of various thickness. Film thickness in (nm). (Ag) for single silver layers, and (AgAg) for double silver layers. Data supplied by Joakim Karlsson, Uppsala University.

3.6 Glazing for solar control

Traditionally, solar control glass was achieved by adding a metal oxide (for example iron, cobalt or selenium oxide) to the glass melt to create a body tinted (un-coated) absorbing glass, for example green or grey glass. This glass was placed as the outer pane in a window combination, and the absorbed heat would be mostly re-radiated and convected to the outside. Later came the coated glass with active parts of stainless steel (SS) or titanium nitride (TiN), for example reflective coatings (high visual reflectance). These coatings are hard, and can be used in single layers.

Another type of solar control glass tries to combine solar control properties with energy efficiency. Such glazing is usually based on a soft silver layer, giving it a low emittance, but which also requires that it is put in an IGU. Such glazing is placed as the outermost pane, coating facing inward.

The newest development in solar control glazing is coated glass which have a very high ratio between T_{vis} and $T_{sol, tot}$, which is approaching the physical limit of 2. This means that such glazing let in a large part of the daylight, but cuts out most of the solar radiation in the near-infrared region. These advanced coatings have multiple layers, where the active part is a double silver layer (AgAg). They are soft (must be placed in an IGU), and have a very low emittance (down to 2%), making them a combination of solar control and energy-efficient coatings. They are placed as the outer pane (coating inwards) in an IGU in order to achieve a low g -value.

3.7 Thermal insulation of windows

The thermal insulation of a window is usually measured by its U -value, or thermal transmittance, which is the heat flux (in W) through the window per unit surface area (m^2) at a temperature difference between inside and outside of 1 degree (K or $^{\circ}C$). Thus, the lower the U -value, the better the insulation.

The overall window U -value, U_{win} , is the energy loss from indoor air to outdoor air divided by the total window area and the temperature difference. It can be calculated as the area-weighted sum of the U -values for the centre-of-glazing, U_{cog} , and for the sash/frame, U_f . Thermal-bridge effects around the edges of the glass (two-dimensional heat flow) are treated in either of two separate ways:

(1) The edge of glass is given a higher U -value, U_{eog} , than the centre (Eq. 3.1a). The edge effect is according to ASHRAE assumed to stretch 63.5 mm into the glass, but in some work 100 mm is used.

$$U_{win} = \frac{A_{cog}U_{cog} + A_{eog}U_{eog} + A_fU_f}{A_{cog} + A_{eog} + A_f} \quad (\text{W/m}^2\text{K}) \quad (3.1a)$$

(2) A linear “ U -value”, or thermal transmittance Ψ (W/m,K), accounting for the edge effects is multiplied by the perimeter of visible glass l_g , and added to the overall U -value (Eq 3.1b).

$$U_{win} = \frac{A_gU_{cog} + A_fU_f + L_g\Psi}{A_g + A_f} \quad (\text{W/m}^2\text{K}) \quad (3.1b)$$

where A_{cog} , A_{eog} and A_f are the projected areas of the different regions in the window and A_g is the total glass area ($= A_{cog} + A_{eog}$). While the first method is mostly used in north America, the second method is mostly used in Western Europe.

3.7.1 Glazing

The heat through the glazing is due to (1) long-wave radiation exchange between the individual panes and the panes and their surroundings and to (2) convection in the gaps of the glazing system and at the exterior and interior surfaces. In a double-pane window radiation is dominating (approx. 70 %). The thermal resistance of the glazing can be expressed as the sum of the resistances of the different gaps, R_{gap} , and of the individual glass panes, R_{glass} , plus the internal and external surface resistances, R_{si} and R_{se} :

$$R_{tot} = \sum R_{gap} + \sum R_{glass} + R_{si} + R_{se} \quad (\text{m}^2\text{K/W}) \quad (3.2)$$

The U -value is the inverse of the thermal resistance R_{tot} :

$$U_{cog} = 1/R_{tot} \quad (\text{W/m}^2\text{K}) \quad (3.3)$$

The surface resistances can be determined either by calculations, see for example Arasteh et al. (1989) or by using standardised values taken from a building code. In calculations, the convective/conductive part is often separated from the radiative part, but in the codes, the two effects are usually combined. In Sweden the Building code values are:

External surface resistance $R_{se} = 0.04 \text{ m}^2\text{K/W}$

Internal surface resistance $R_{si} = 0.13 \text{ m}^2\text{K/W}$

Note that the inverse of the surface resistance is called the heat transfer coefficient h . The building code values above gives $h_e=25$ and $h_i=8$.

Heat transfer in gaps

The long-wave radiation exchange between two panes with respective temperatures t_1 and t_2 (in Kelvin) is described by:

$$q_{1,2} = \varepsilon_{eff} \sigma [t_1^4 - t_2^4] \quad (\text{W/m}^2) \quad (3.4)$$

where ε_{eff} is the effective emittance between the surfaces and σ is Stefan-Boltzmann's constant ($5.67 \times 10^{-8} \text{ W/m}^2\text{K}^4$).

The effective emittance ε_{eff} is determined by the hemispherical emittance ε of the two surfaces as follows:

$$\varepsilon_{eff} = \frac{1}{\frac{1}{\varepsilon_1} + \frac{1}{\varepsilon_2} - 1} \quad (-) \quad (3.5)$$

Equation 3.4 above can also be expressed as:

$$q_{1,2} = h_{rb} \varepsilon_{eff} (t_1 - t_2) = h_r (t_1 - t_2) \quad (\text{W/m}^2) \quad (3.6)$$

where h_{rb} is the radiative heat transfer coefficient between two black bodies ($\varepsilon=1$), t_1 , t_2 are the surface temperatures and h_r is the radiative heat transfer coefficient. h_{rb} is given in Fig. 3.8 for a temperature difference between the surfaces of 10°C .

The heat transfer in the gap due to convection is determined by:

$$q_{1,2} = h_c (t_1 - t_2) \quad (\text{W/m}^2) \quad (3.7)$$

where h_c is the convective heat transfer coefficient. It accounts both for conduction and convection in the gap (i.e. conduction when the air is standing still, convection when the air is moving). It is defined as:

$$h_c = k Nu / d \quad (\text{W/m}^2\text{K}) \quad (3.8)$$

where k is the thermal conductivity for the gas in the gap (W/m,K) (see Table 3.2), Nu is the Nusselt number and d is the width of the gap (m). The Nusselt number is a function of the height and width of the gap (aspect ratio), of the Rayleigh number, and of the inclination of the window. It has been determined experimentally, and the following works are usually used: (Hollands et al., 1976; ElSherbiny et al., 1982; Fergusen & Wright, 1984).

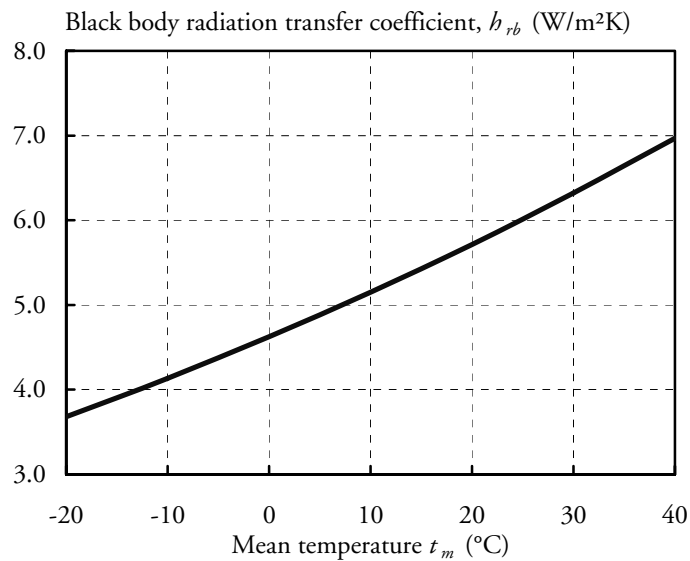

Figure 3.8 Black body radiation heat transfer coefficient h_{rb} for varying mean temperatures of two surfaces, and a temperature difference of 10°C.

Table 3.2 Thermal conductivity k , density ρ , and viscosity μ for some commonly used gases in windows.

Gas	k W/m,K ($\times 10^{-2}$)	ρ kg/m ³	μ kg/m,s ($\times 10^{-5}$)
Air	2.41	1.29	1.73
Argon	1.62	1.70	2.11
Krypton	0.86	3.74	2.28
Xenon	0.52	5.89	2.26
CO ₂	1.46	1.98	1.39
SF ₆	1.30	6.70	1.45

Values of h_c are shown in Fig 3.9. for vertical panes and for different gap widths and different gases.

The thermal resistance of the gap can now be calculated as

$$R_{gap} = \frac{1}{h_r + h_c} = \frac{1}{h_{rb}\epsilon_{eff} + h_c} \quad (\text{m}^2\text{K/W}) \quad (3.9)$$

The resistance of ordinary glass R_{glass} is approximately 0.001 m²K/W per mm.

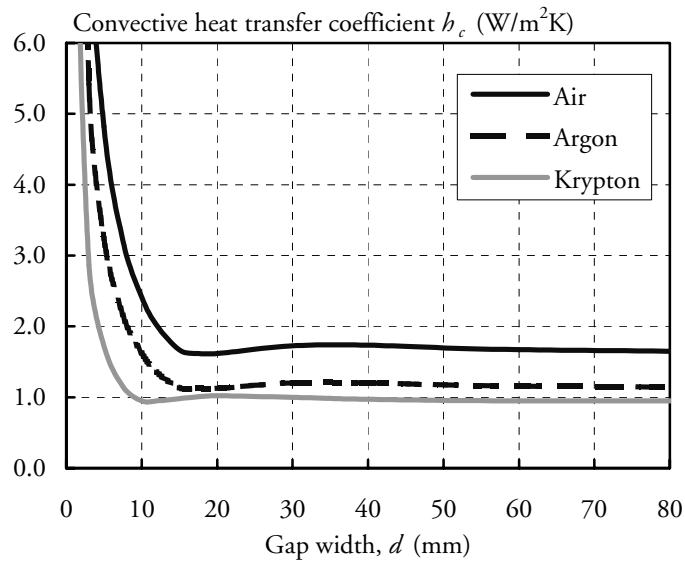

Figure 3.9 The convective heat transfer coefficient as a function of gas and gap width. Calculated for a vertical window of 1.2 m height, a mean temperature of 15°C, and a temperature difference of 10°C according to ElSherbiny et al. (1982).

The total resistance of a glazing combination of for example a triple-pane IGU (T4-12) can then be calculated as follows:

$$R_{tot} = R_{se} + R_{pane1} + R_{gap1} + R_{pane2} + R_{gap2} + R_{pane3} + R_{si} \quad (\text{m}^2\text{K/W}) \quad (3.10)$$

The resistance of each gap in this triple-pane window is approximately equal to (suppose that $t_{m1} = 5^\circ\text{C}$, and $t_{m2} = 12^\circ\text{C}$, gap width = 12 mm, ordinary glass gives $\epsilon_{eff} = 0.72$):

$$R_{gap1} = 1/(4.88 \cdot 0.72 + 2) = 0.181 \text{ m}^2\text{K/W}$$

$$R_{gap2} = 1/(5.26 \cdot 0.72 + 2) = 0.173 \text{ m}^2\text{K/W}$$

The resistance of the whole glazing combination then becomes:

$$R_{tot} = 0.04 + 0.001 \cdot 4 \cdot 3 + 0.181 + 0.173 + 0.13 = 0.536 \text{ m}^2\text{K/W.}$$

This is equivalent to a U_{cog} of $1.87 \text{ W/m}^2\text{K}$. If the inner pane is replaced by a low-e coating with $\varepsilon = 10 \%$, U_{cog} becomes 1.32 , and if the air in the same gap is replaced with argon, U_{cog} drops to 1.13 . These values can be compared to results obtained by a detailed calculation (including temperature distribution calculation) as given in Table 3.3. The methodology given above can thus be used to roughly estimate the U -value for any glazing combination, the limitation is that the temperature distribution of the individual panes is not known, which affects mainly the radiative losses.

Thus, for the glazing, the heat loss may be decreased by adding more panes, by applying low-emittance coatings to the glass to reduce radiation losses, and by using heavier gases (such as argon, krypton or even xenon) to reduce convection losses. The distance between the panes also affects the U -value somewhat, see Fig. 3.10. This shows that the commonly used gap width 12 mm is not the optimum, at least not from an energy point of view.

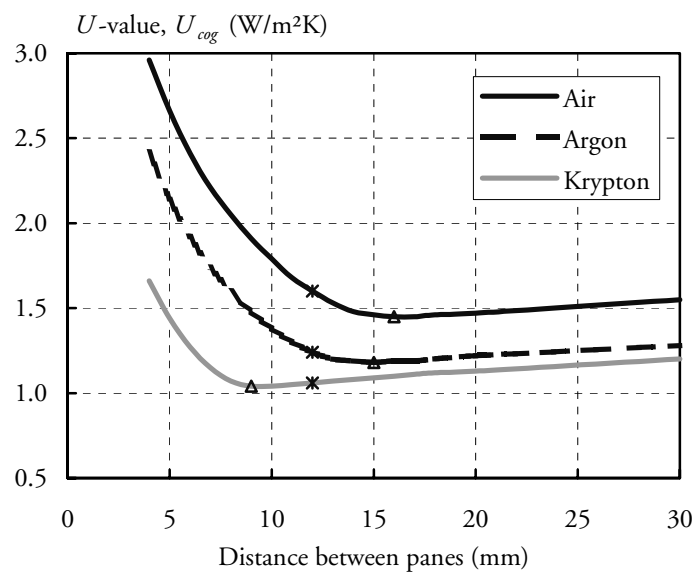

Figure 3.10 U_{cog} as a function of gap width for a double-pane unit with one low-e coating. Typical distance in IGUs of 12 mm is marked with a cross and minimum values with a triangle. (Calculations performed in WINDOW 4.1, $\varepsilon = 4 \%$, $T = 0/20^\circ\text{C}$, wind speed 5 m/s).

The U -value is often thought of as a constant, but it is in fact temperature dependent, which was already demonstrated in Fig. 3.8. Fig 3.11 show some examples of this temperature dependency for some glazing combinations. It is evident that glazing with 15 mm gap distance, especially double glazing, is very sensitive to the temperature difference Δt across the glazing, while some triple-glazing is almost unaffected. This has some implications for the U -values reported by manufacturers, which are often based on $\Delta t=15^\circ\text{C}$ according to the European standard EN 673. In Sweden a Δt of 20°C ($0/20^\circ\text{C}$) has often been used, and when U -values are measured in a guarded hot-box, $-5/25^\circ\text{C}$ have previously been used as boundary conditions. In the NFRC documentation, the window U -value shall be calculated at $-18/21^\circ\text{C}$. Using a high temperature difference can be motivated for cold climates and for keeping measurement errors small. Other boundary conditions which may vary between different sources of information are the internal and external surface resistances, which are sometimes fixed, sometimes calculated.

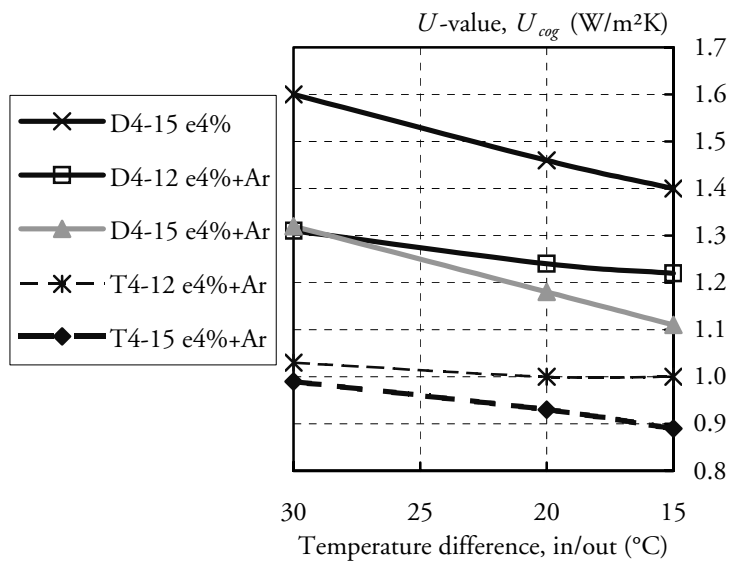

Figure 3.11 Effects on U_{cog} due to the temperature difference between inside and outside.

The requirements on good thermal insulation may come into conflict with both the solar and the daylight admittance, since a better thermal insulation is achieved through the use of more panes and/or low-e coatings, Table 3.3. Thus, the better the thermal insulation, the worse the

transmittance. Depending on how the improved thermal insulation is achieved (for example the type of low-e coating used), the beneficial solar gains may be reduced more or less, since a lower U -value is usually accompanied by a lower g -value, see Fig. 3.12. However, a lower U -value usually more than outweighs the lower solar and daylight gains, see article II.

Table 3.3 U_{cog} , g and T_{vis} for some glazing combinations with clear glass and low-e coatings (le) of various emittances. (Calculations performed in WINDOW 4.1 for three sets of inner and outer temperatures, wind speed 5 m/s). The low-emittance coating is in all cases placed on the outside of the innermost pane (pos. n-1), except for 4le-30-(D4-12). In that case the le-coating is placed on the inside of the single outer pane (pos. 2). When two coatings are used, the second one is placed on the inside of the outermost pane (pos. 2). D stands for Double and T for Triple insulating glass unit. (For example, D4-12 is a double pane unit with 4 mm glass and 12 mm gap width). If any gas fillings are used, they are marked with Ar for argon and Kr for krypton. The gas is always in the same gap as the low-e coating.

Emittance of pane	Glazing combination	U_{cog} (-5/25°C)	U_{cog} (0/20°C)	U_{cog} (2.5/17.5°C)	g	T_{vis}
$\epsilon=84\%$	D4-12	2.84	2.79	2.76	0.76	0.82
	D4-30	2.83	2.71	2.63	0.76	0.82
	T4-12	1.87	1.85	1.84	0.68	0.74
	4-30-(D4-12)	1.84	1.79	1.75	0.68	0.74
$\epsilon=16\%$	D4-12 le	1.91	1.87	1.85	0.71	0.75
	D4-30 le	1.97	1.81	1.70	0.72	0.75
	4le-30-(D4-12)	1.41	1.32	1.26	0.61	0.69
$\epsilon=10\%$	D4-12 le	1.79	1.75	1.73	0.65	0.77
	D4-12 le+Ar	1.48	1.41	1.40	0.65	0.77
	T4-12 le	1.33	1.32	1.31	0.58	0.70
	T4-12 le+Ar	1.14	1.12	1.11	0.57	0.70
	4-30-(D4-12 le+Ar)	1.11	1.08	1.07	0.58	0.70
	T4-12 2le+2Ar	0.81	0.80	0.80	0.47	0.66
	T4-12 2le+2Kr	0.68	0.62	0.62	0.47	0.66
	D4-12 le	1.64	1.60	1.58	0.59	0.77
$\epsilon=4\%$	D4-12 le+Ar	1.31	1.24	1.22	0.59	0.77
	D4-15 le+Ar	1.32	1.18	1.11	0.60	0.77
	D4-12 le+Kr	1.19	1.06	0.98	0.60	0.77
	T4-12 le	1.24	1.23	1.22	0.53	0.70
	T4-12 le+Ar	1.03	1.00	1.00	0.53	0.70
	T4-12 2le+2Ar	0.70	0.69	0.69	0.42	0.65
	T4-12 2le+2Kr	0.56	0.50	0.46	0.42	0.65

For daylighting the issue is more complex. Lower light levels may, in the worst case, lead to an increased use of artificial lighting. This problem can be resolved by using slightly larger windows. The filtering effect or the colouring of the daylight that happens when one and in particular several low-e coatings are used, can however not be compensated by larger windows, and this conflict thus poses larger difficulties. The problem is further described in article III.

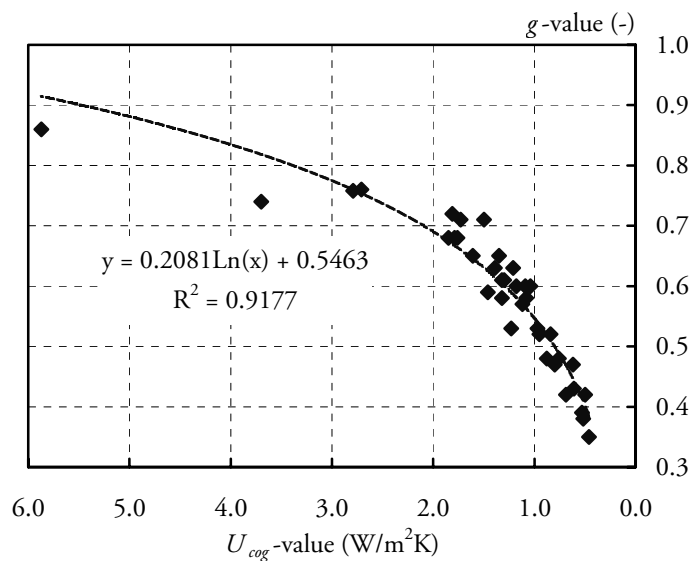

Figure 3.12 The g -value (total solar energy transmittance) as a function of U_{cog} . Values calculated for various glazing combinations in WINDOW 4.1 (0/20°C, 5 m/s).

3.7.2 Sash and frame

The heat losses for the sash and frame is mainly due to conduction. Thus, the thermal properties of the frame material is important, as well as the geometry. Therefore, wood frames are rather good, since wood has a low conductivity, especially in comparison to aluminium frames. However, as the glazing U -values are starting to drop from around $2 W/m^2K$ to 1 or even lower, the glazing becomes better than the traditional wooden sash/frame. It then becomes important to reduce heat losses also in the sash and frame in order to achieve a low window U -value, U_{win} . This can be done by using more highly insulating materials in the sash and frame, see Table 3.4. The design can also be changed, for example the IGU can be embedded deeper into the sash to increase the path length that the

heat has to travel, or the frame can be made deeper. Today there are several programs to study two or three-dimensional heat flow, for example HEAT2&3 (Blomberg, 1996), FRAMETMPlus, THERM and others, whereby it is possible to study the heat losses with different details and materials in the design.

Table 3.4 Thermal conductivity of some materials for spacers, thermal brakes, frame insulation materials and frames. From Thyholt et al. (1994).

Material	Thermal conductivity (W/m,K)	Main usage as
Aluminium	220	spacer/frame
Steel, galvanized	48	spacer
Steel, stainless	14.3	spacer
Polyamide, reinforced	0.40-0.65	thermal break
Cast polyurethane, reinforced	0.20-0.30	thermal break
PVC extruded profiles	0.16	thermal break
Polycarbonate	0.20-0.23	frame insulation
Polystyrene	0.14-0.18	frame insulation
Wood	0.12-0.14	frame
Polyurethane foam	0.02-0.03	frame insulation

The traditional metal spacer (either aluminium or galvanized steel) in the IGU has a high conductance and is a significant thermal bridge in the unit itself. Nowadays, there are several spacers with a lower conductance on the world market, Fig. 3.13. They are usually marketed as “warm-edge” technologies. The improvement on U_{win} is often rather marginal ($\Delta U_{win} = 0.1-0.2 \text{ W/m}^2\text{K}$), but the risk of condensation on the bottom of the inside pane is greatly reduced, (Jonsson, 1985 and Frank, 1994), see also Table 3.5. The usage in Sweden has thus far been very limited, but an increased interest can be traced at the moment, especially for a thermo plastic spacer marketed three years ago (Bally & Lenhardt, 1999). The thermal effect of different frames and edge seal technologies have been studied by several authors (e.g. Carpenter & McGowan, 1993; Thyholt et al., 1994; Reilly, 1994). Depending on materials chosen in the frame and spacer the frame U -value, U_f , can vary significantly. Thyholt reports U_f -values between 5.4 and 1.8 $\text{W/m}^2\text{K}$, depending on frame and spacer material for operable two-pane windows (aluminium windows without thermal brakes excluded).

Table 3.5 Linear thermal transmittance for different spacers and two insulating glass units, from (Frank, 1984). Calculations performed with a wood frame with $U_f=1.6 \text{ W/m}^2\text{K}$

Spacer	Linear thermal transmittance Ψ (W/m,K)	
	Double IGU $U_{cog}=2.7 \text{ W/m}^2\text{K}$	Double IGU low-e $U_{cog}=1.2 \text{ W/m}^2\text{K}$
Aluminium	0.046	0.057
Silicone foam	0.020	0.023
Silicone foam with integral stainless steel spacer	0.023	0.028
Swiggle strip	0.029	0.035
Double aluminium, thermally broken	0.035	0.047
U-shaped stainless steel	0.029	0.033
Fibreglass, hollow	0.030	0.039



Figure 3.13 Alternative spacer products or “warm-edge” technologies.

3.7.3 Total window U -values

Despite the technological development, not that much has happened regarding the design of sash and frame during the past decades in Sweden. In the NUTEK procurement program (see Sec. 2.2.2), there was one so called energy-efficient window ($U_{win} < 1 \text{ W/m}^2\text{K}$) that used a stainless steel spacer (a triple IGU window) but the coupled windows used ordinary galvanized steel spacers. There were also some examples where the thermal bridge of the wood frame was broken by another material, e.g. polyurethane, but otherwise these solutions have been used restrictively, since it has not been certain how they will behave in the long run regarding for example moisture transport and service life. Wood frames are still the most common construction, along with double or triple IGU units with traditional metal spacers. The resulting U -values for different areas of the window for three commonly sold window types are shown in Table 3.6. The table shows that it is harder to achieve a low U_{win} in a triple IGU

window than in a coupled window (1+2), because the thermal bridge along the edge-of-glass is more pronounced. In fixed windows the frame height is lower, which usually results in higher U -values for the frame. These U -values can also be used to estimate U_{win} for other window sizes than that shown. This is demonstrated in Fig 3.14 which shows the estimated U_{win} for square windows of different sizes. The effect on the total U -value is rather large: The total U -value increases by 0.23-0.30 W/m²K when the window size is reduced from 1.5 m side length to 0.5 m side length.

Table 3.6 U -values for some modern Swedish wooden windows of size 1.18 × 1.18 m as calculated in the FRAME program. Wood frames and dual seal IGU with galvanized steel spacers. (Source: Elitfönster AB).

Projected area	Coupled window 1+2		Triple pivoted window		Triple fixed window	
	Area (m ²)	U -value (W/m ² K)	Area (m ²)	U -value (W/m ² K)	Area (m ²)	U -value (W/m ² K)
Frame, top/side	0.281	1.38	0.321	1.44	0.178	1.74
Frame, bottom	0.129	1.74	0.124	2.16	0.063	1.63
Edge-of-glass, top/side	0.172	1.24	0.169	1.57	0.188	1.72
Edge-of-glass, bottom	0.064	1.28	0.062	1.44	0.068	1.48
Centre-of-glass	0.747	1.00	0.716	1.00	0.895	1.00
Total	1.392	1.19	1.392	1.29	1.392	1.24

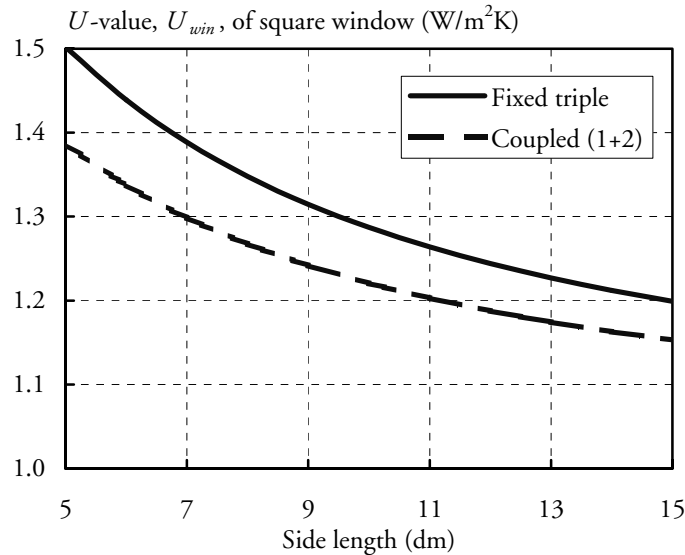

Figure 3.14 Total window U -value as a function of window size. A square window is assumed.

In Germany there has been a development of super-insulated windows for use in so called passive housing (Feist, 1995). There are probably a dozen window types with a U_{win} of around $0.7 W/m^2K$ on the German market today. These windows often have sash and frame almost purely made of polyurethane or other highly insulating materials, Fig. 3.15. The glazing is usually a triple-pane construction with two low-e coatings and krypton gas fillings.

When the U -value of the sash/frame is to be improved, it is important that this is done without introducing more clumsy designs, which are not desirable from the architectural point of view. Expected service life is another important issue. It is questionable if these issues are resolved in, at least some of, the German super-windows available on today's market.

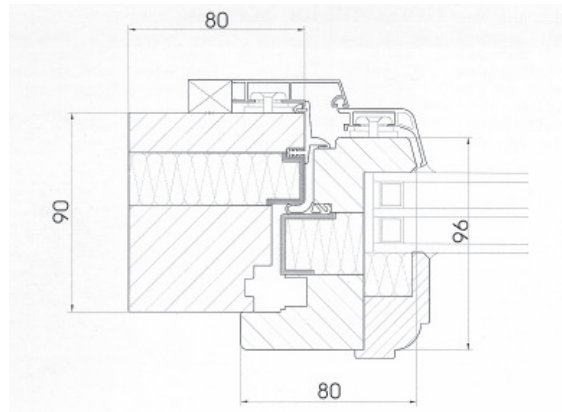
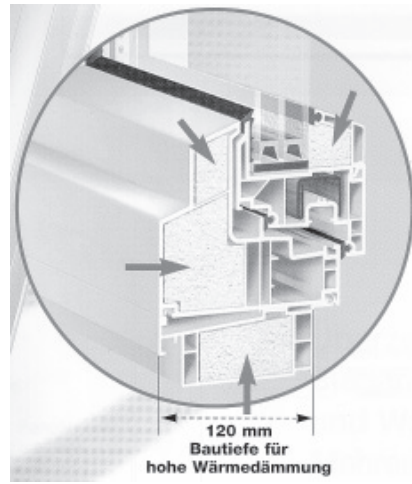

Figure 3.15 Two examples of German windows with total window U -values around $0.7 \text{ W/m}^2\text{K}$.

4 Windows and daylight

Windows are the eyes of a building. They provide lighting and view out, but also the sometimes unwanted possibility of view in. This chapter will discuss windows from several aspects, all regarding daylight. After introducing some general lighting terms and the source of daylight this chapter continues by discussing calculation methods for the prediction of daylight levels and the concept of daylight utilisation. Human aspects are also discussed, both in terms of visual quality, perception and psychology. Finally, the so called non-visual effects on humans are briefly reviewed.

The major factors affecting the daylight in a room are the size, shape and position of windows and the room depth. Further factors are the transmittance of the glazing and any external obstructions such as shading devices, opposing buildings or vegetation. Generally, tall windows compared to wide windows of the same size admit the light further into the room. Dividing the window area into several surfaces, preferably on opposing walls, is often considered favourable since it gives a more even and pleasant impression.

4.1 General lighting terms

In order to understand this chapter on daylight, it is important to start by defining some commonly used lighting terms, here adapted from Illuminating Engineering Society of North America IESNA (1993). For a broader discussion on lighting terms, vision, etc., the reader is referred to the general literature on this subject.

4.1.1 Illuminance, E

Illuminance describes the amount of luminous flux arriving at a surface, i.e. the incident flux per unit area. It is measured in lux. It is a commonly used unit, since it is easy to measure.

4.1.2 Luminance, L

Luminance describes the light reflected off a surface and is directly related to the perceived “brightness” of a surface in a given direction. It depends not only on the illuminance on an object and its reflective properties, but also on its projected area on a plane perpendicular to the plane of view. Thus luminance is what we see, not illuminance. However, the perceived brightness of objects depend, apart from their luminance, also on the state of adaptation of the eye. Luminance is measured in lumens per square meter per steradian⁶ or in candelas per square meter (cd/m^2).

4.1.3 Daylight factor, DF

The daylight factor DF is defined as the ratio of indoor daylight illuminance to the simultaneous exterior illuminance on a horizontal plane from the whole of an unobstructed sky of assumed or known luminance distribution. Since the daylight penetration is lowest during overcast weather, the daylight factor is calculated for this condition. This also implies that the daylight factor is largely unaffected by window orientation. Since the exterior illuminance varies constantly, the daylight factor has been considered as a rather good measure of the available daylight in a space. Although it is not possible to judge the quality of a space based only on the daylight factor, some general guidelines can be given. A daylight factor below 1 % is considered too low, a minimum of 2 % has sometimes been used in building codes, between 2-5 % is considered good, at 5 % daylight autonomy is assumed to be reached, and above 10 % glare problems are likely to occur. Under sunny conditions a similar approach can be used, which is then called the sunlight factor (Christoffersen et al., 1999a).

4.1.4 Glare

In everyday language, glare is a word used to describe an unpleasant visual experience. In the more stringent scientific context, glare is the unwanted visual effects caused by large differences in luminance levels within the field of view, or by strong light sources close to the direction of view. Both skylight and sunlight can become glare sources when seen directly

6. The unit of measure of solid angles.

through a window, or reflected off surfaces. A distinction is usually made between disability and discomfort glare (Hopkinson et al., 1966; IESNA, 1993).

Disability glare

A reduction in contrast of an image due to light being scattered in the eye, causing impaired vision. A typical example is the reduction in visibility from oncoming car headlights. A long corridor lit only at the end by a window is another example where vision can be obscured.

Discomfort glare

Discomfort glare is a sensation of annoyance or pain caused by high or nonuniform distributions of brightness in the field of view. Discomfort glare may be caused by viewing a light source directly (direct glare) or by viewing a reflection of the light source from a specular / semispecular surface (indirect glare). The expression 'veiling reflections' is used for the indirect glare (IESNA, 1993).

While disability glare is very obvious to the individual, discomfort glare often goes by unnoticed. Even when it causes headaches and eye-strain, the source of these symptoms (i.e. a bad lighting situation) might not be identified.

4.2 The sun as the source of daylight

4.2.1 Luminance and radiance models of the sky

The dominant weather type in Northern Europe is the overcast or partially overcast days. Clear sunny days are rare, see measured solar radiation data for Lund 1988. Figs. 4.1 and 4.2. Therefore, the diffuse sky is the main source for lighting a room, not direct sunlight. Sunlight can however provide pleasant aesthetical effects when present. In order to perform accurate daylight calculations, the luminance distribution of the sky must be known. Since measurements of sky distributions still are not commonly available for more than a few sites worldwide, we are usually obliged to use standardised sky distributions.

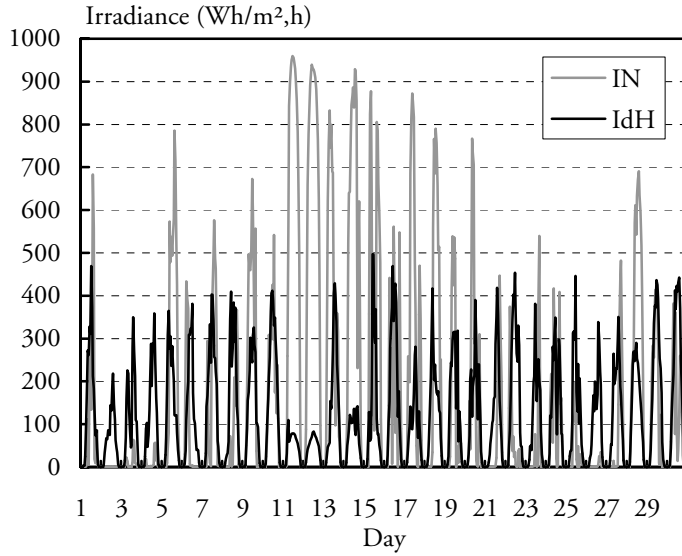

Figure 4.1 Measured direct normal, I_N , and diffuse horizontal, I_{dH} , irradiance ($Wh/m^2,h$) in June for the reference year Lund 1988.

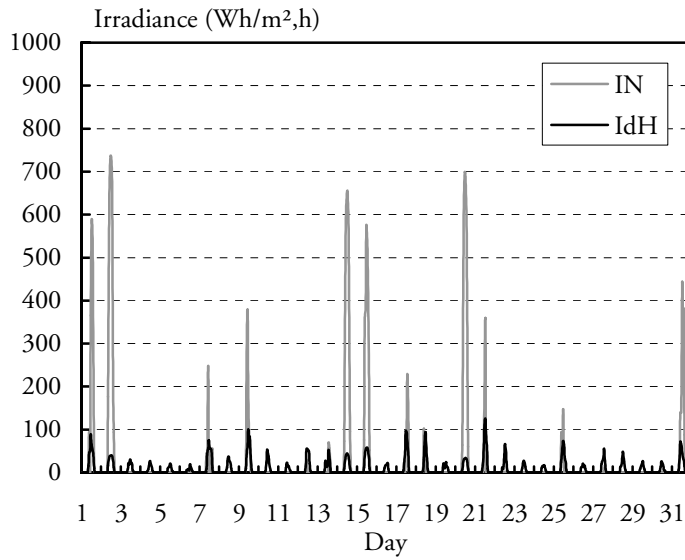

Figure 4.2 Measured direct normal, I_N , and diffuse horizontal, I_{dH} , irradiance ($Wh/m^2,h$) in December for the reference year Lund 1988.

For overcast conditions, the two most used models are the CIE⁷ overcast sky adopted in 1955 and the much older uniform sky model. The uniform (isotropic) sky, defined already by Lambert in 1760, is equally bright in every point, while the graded CIE overcast sky (also called the Moon and Spencer formula) is three times brighter at the zenith than at the horizon (CIE, 1994), see Fig. 4.3. There are also several other sky models suggested by other researchers, for example by Muneer & Angus, Perez et al., Coombes & Harrison, Perraudau and Hooper & Brunger. With the uniform sky model the resulting ratio between the vertical and horizontal outdoor illuminance is 0.5, while it is 0.396 with the CIE standard overcast sky.

For clear blue skies a model proposed by Kittler has been adopted as the standard, the CIE clear sky with or without sun. The luminance distribution, shown in Fig. 4.4, is characterised by a bright aura of light around the sun, areas of horizon brightening, and a deep blue patch approximately 90° from the sun, moving around the sky with the movements of the sun. For clear skies with a slight haze, the luminance distribution of the sky is more even than for the perfectly blue sky. This is taken care of in the formula by a turbidity factor, indicating how turbid the atmosphere is.

Between the two extremes clear and fully overcast, there are in reality an infinite variety of sky luminance distributions. In a report by Kittler et al. (1988), a whole set of sky types have been classified and analysed for both frequency of occurrence and absolute levels. The presented standard luminance distributions were based on luminance scans of the skies in Berkeley, Tokyo and Sydney. According to Kittler, the current CIE standards for the overcast as well as the clear skies are justified, but are to be seen as extremes rather than averages. The uniform sky can occur on unique occasions, especially in dense fog. Further, the uniform sky can represent an ideal mean sky linking the decreasing gradation of overcast skies with the increasing gradation of clear skies respectively. That the uniform sky may be a better representation than the CIE sky for overcast weather was recently concluded by Muneer (1998) in a study of Japanese data. According to Muneer, the available daylight will be significantly underestimated within building interiors with the CIE overcast sky model. On the other hand, in a comparison of several formulae for overcast conditions performed by Enarun & Littlefair (1995) it was shown that for

7. CIE is the abbreviation of Commission Internationale de l'Éclairage, an international organisation for lighting issues.

conditions where the sun disc is totally invisible, the CIE overcast sky still performs the best, although it may depend on how the overcast days are selected.

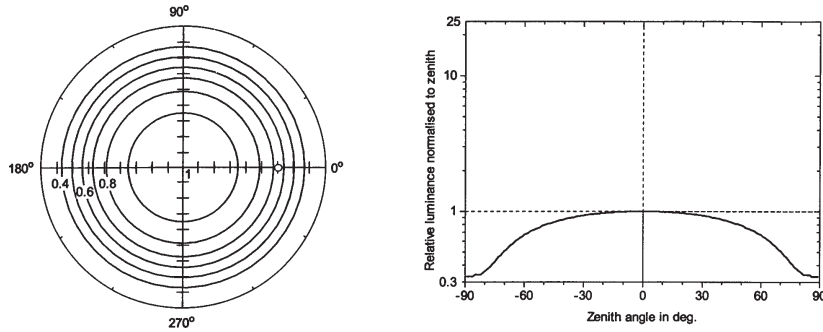

Figure 4.3 The CIE overcast sky is three times brighter at the zenith than at the horizon (from Kittler et al., 1988).

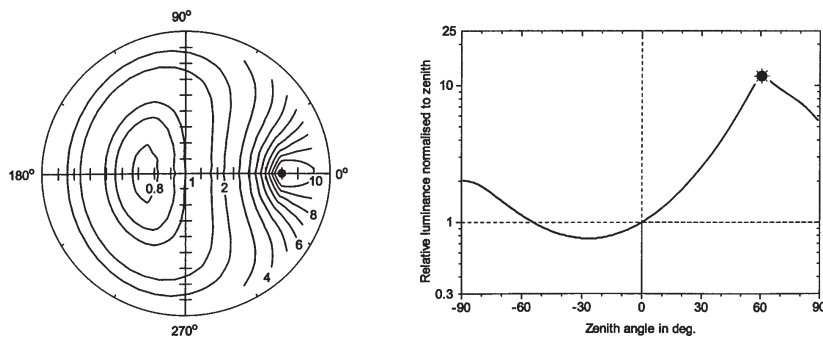

Figure 4.4 The CIE clear sky has a clear solar corona and a dark blue patch about 90° from the sun (from Kittler et al., 1988).

As well as there are sky models available for daylight purposes, there are also models of the radiance distribution of skies for solar engineering purposes. The main difference is of course that the daylight models use the photometric term luminance, which means that it is defined for visual light weighted by the sensitivity of the human eye, while the other models use radiance which is defined for the whole solar spectrum. Generally, solar sky models seem to be less detailed than daylight sky models. Duffie & Beckman (1991) present only three clear sky models, one isotropic model and two anisotropic ones: the Hay & Davies model and the HDKR model (the Hay, Davies, Klucher, Reindl model). However, they

do mention the existence of other models by for example Skartveit & Olseth and by Perez. The isotropic model derived by Liu & Jordan includes three components: beam, isotropic diffuse, and solar radiation diffusely reflected from the ground.

The Hay & Davies model estimates the fraction of the diffuse radiation that is circumsolar and simply adds this fraction to the beam radiation. Thus they consider that all of the diffuse radiation can be represented by the two parts isotropic and circumsolar. The ratio between the two parts is determined by the use of an anisotropy index which is the ratio of the measured beam radiation to the extraterrestrial solar radiation. The anisotropy index is thus a measure of the transmittance of the atmosphere. When the sky is very clear the anisotropy index will be high, and most of the diffuse radiation will be assumed to be forward scattered. When there is no beam, the Hay & Davies model becomes equal to the uniform sky. The HDKR model is an extension of the Hay & Davies model that adds a term accounting for horizon brightening.

4.2.1 Luminous efficacy

Luminous efficacy, K , is the ratio of light output (in lumens) to energy use (W). It is used to characterise the efficacy of light sources such as incandescent or fluorescent lighting, and also for skylight and sunlight. The luminous efficacy of daylight is thus expressed as the ratio of illuminance (lux) to irradiance (W/m²). When only solar radiation data is available for a site – which is quite common – the luminous efficacy can be used to translate the solar data to illuminance levels.

Values for luminous efficacies have been estimated by several authors by correlating simultaneous measurements of solar radiation and illuminance, see for example Littlefair (1985) for a good review. Since the luminous efficacy can depend on solar altitude, cloud cover, and amount of aerosol and water vapour content in the atmosphere, different values apply for different sky conditions. Some values for clear and overcast skies are given below. Values for intermediate (partly cloudy) and average skies have also been suggested, see for example Littlefair (1985, 1988), but they have been omitted here. Generally, the values fall between the two extremes clear and overcast.

Clear skies

Direct (beam) luminous efficacy

In several studies, measured values of direct luminous efficacies are correlated with solar altitude. Some authors have also found correlations with aerosol and water vapour content. Littlefair (1985) cite values between 70 to 105 lm/W for increasing solar altitudes. In later measurements (in Garston, Hertfordshire, UK) he found values from 70 lm/W at 10° to 95 lm/W at 60° solar altitude (Littlefair, 1988). However, average values often perform on par with more advanced models, as demonstrated by Muneer & Angus (1995), who give an average value of 104 lm/W for Edinburgh, UK. A similar value was observed in data from Vaerloose, Denmark, 103 lm/W (Petersen, 1982, cited in Christoffersen, 1999a).

Diffuse sky (cloudless) luminous efficacy

Clear sky radiation (i.e. from the blue sky vault) has a higher luminous efficacy than direct solar radiation. A typical value between 120-140 was cited by Littlefair (1985), while both Muneer & Angus and Littlefair (1988) measured an average of 144 lm/W, similar to Petersen's measured average of 146 lm/W.

Global luminous efficacy

For the global luminous efficacy of clear sky and sun, Littlefair (1985) gave typical values in the range 95-115 lm/W. Later, Littlefair (1988) measured on average 107 lm/W, while Muneer & Angus measured 110 lm/W and Petersen obtained a value of 113 lm/W.

Overcast skies

For the overcast sky condition, Littlefair gave a typical range of 105-120 lm/W, fairly independent of solar altitude. Muneer & Angus' measured average was 115 lm/W, equal to that of Littlefair (1988), while Petersen found a value of 121 lm/W.

4.3 Daylight calculation methods

To accurately estimate the daylight distribution within a space is a complex task. The source of daylight, the sky and the sun, is constantly varying, from minute to minute, and from season to season. In our climate, it is mostly the cloudy sky that is used for design purposes, but in other

climates e.g. in sunny climates, the sun can also be used as an illumination source. As previously mentioned, the luminance distribution of the cloudy sky varies with cloud cover. However, due to lack of better data, a standard overcast sky e.g. CIE overcast sky, is usually used in the design of buildings.

Daylight distribution can be estimated in scale models, but there are also several lighting programs along with hand calculation methods that can be used. An overview of these methods is given in Christoffersen et al. (1999a). With advanced lighting and thermal programs it is also possible to estimate the performance of different daylighting systems and control strategies and to evaluate the impact on the overall building energy use (e.g. illumination, heating and cooling).

4.3.1 Hand calculation methods

At the Building Research Station in England hand calculation methods for the determination of the daylight factor in both side-lit and top-lit rooms were developed over 50 years ago (Hopkinson et al., 1966). The method is referred to as the BRS Daylight Protractors, since they developed special transparent templates (protractors), which facilitated the determination of the DF directly on drawings. The method is also described by Löfberg (1987).

The method is based on the observation that the daylight in a point can be determined as the sum of three components: light from the visible part of the sky (the sky component), light reflected directly onto the point from the surroundings outside the window (outdoor reflected component) plus light reflected from the room surfaces (indoor reflected component). This method is also called the split-flux method.

4.3.2 Radiosity methods

In radiosity methods, the light distribution is determined by calculating the light flow between small surfaces areas, *patches*, that see each other. The distribution over a (fictitious) surface is then smoothed out between the different patches. View or form factor calculations are therefore synonymous to radiosity methods. Usually, all surfaces are assumed to have a perfectly diffuse reflectance (Lambertian surfaces). It is computationally much faster than ray-tracing. However, if the patches are shrunk to infinitesimal points, ray-tracing is actually performed (Ashdown, 1996). Superlite is an example of a program using the radiosity method.

4.3.3 Ray-tracing methods

Ray-tracing is a method to determine the light distribution in which rays of light are followed in space, through multiple reflections until they are distinguished. Rays can be followed forwards from the light source to the surfaces or backwards from the viewer to the light source. In forward ray-tracing a large part of the sent out rays are absorbed along the way, and therefore never reaches the eye or camera. This is eliminated by following the rays backwards, from the viewer, into the environment until they reach a light source. Backward ray-tracing is thus more efficient than forward ray-tracing. The drawback is that only values for the specified view are calculated. If a new view is chosen, the calculation must be redone. Ray-tracing gives the optimal opportunities for calculating light distribution accurately, both regarding illuminance and luminance, colour effects, specular surfaces, glare, photorealistic images (renderings) etc. Examples of ray-tracing programs are Radiance, Genelux, Lightscape and others.

4.4 Daylighting software

4.4.1 Pure daylighting programs

There are several lighting calculation programs on the market today. From very simple, intuitive programs like LESO-Dial (Paule et al., 2000) – aimed at architects for very early design decisions – to very advanced rendering programs like Radiance (Ward Larson & Shakespeare, 1998), which is considered as the most accurate architectural rendering program available. Radiance was created at the Lawrence Berkeley National Laboratory, and can be downloaded free over the Internet. Apart from creating very realistic ‘photographic’ renderings, also illuminance levels, luminance distributions, various glare indices etc. can be calculated. Radiance itself is just a powerful calculation engine that requires users with very advanced skills. In order to facilitate the rendering process several “menu shells” have been developed for Radiance. One such example is Adeline, a platform for the two programs Superlite and Radiance (Erhorn & Stoffel, 1996). This shell also incorporates pre-processors to import the geometry from a CAD program, and post-processors to calculate hourly lighting electricity use for various control systems, Superlink and Radlink. These data can then be used as input in a thermal simulation program like TRNSYS, DOE2, SUNCODE, TSBI3 or even Derob-LTH.

Other menu shells for Radiance are for example Desktop Radiance, which integrates Radiance with the CAD program AutoCAD, and Rayfront, which can be run as an AutoCAD or Intellicad extension, or as a standalone program. Lightscape and Genlux are other examples of advanced commercial programs, both using the radiosity approach with major ray-tracing extensions.

In a validation study the following programs were compared with each other and with scale model measurements: Superlite, Genlux, Radiance and Leso-Dial (Fontoynt et al., 1999). The comparison showed that direct illuminance inside buildings can be calculated with an accuracy of about 5 %, and that total illuminance (including multiple reflections) can be calculated with an error of less than 10 %. The programs were thus reasonably consistent with each other, despite the different calculation methods employed (both radiosity, ray-tracing and simple techniques were used). However, it was shown that calculation results are very sensitive to the input data, e.g. the light source description, material photometry, building geometry and other simulation parameters. Especially the exact luminance distribution of the outdoor environment was pointed out to be very important, in particular of the sky close to the horizon and the luminance of the ground. It was striking to note that the radiosity programs performed on par with the more advanced ray-tracing programs, but then the geometries and the diffuse surface reflectances were also well suited for radiosity programs.

4.4.2 Thermal programs with daylighting routines

Since about half of the solar energy is within the visible range (daylight), the use of daylight and solar energy are strongly interconnected. Daylight can be used to replace artificial lighting, see section 4.5, and visual comfort criteria may often decide when shading devices need to be used. The trend has thus been to include daylight routines into energy simulation programs. These incorporated daylight modules vary from being very simple to quite advanced.

One program that early on implemented daylighting calculation routines into the thermal simulation program was the American program DOE-2. It used a separate lighting module for calculating daylight factors for standard sky conditions (using the split-flux method), discomfort glare indices, and use of electric lighting for a few control strategies. Links were provided to the thermal simulation program for adjusting shading devices and internal loads on an hourly basis (Winkelmann & Selkowitz, 1985).

Today, the two separate programs DOE-2 and BLAST are being integrated into one modern calculation engine: EnergyPlus (Crawley et. al., 2001). The existing daylighting module in DOE-2 is being ported to this new version. The module can take into consideration interior illuminance from windows and skylights, dimming of electric lighting, effects of dimming on heating and cooling, and glare simulation and control.

Another program which incorporates a daylight module to estimate the thermal effects of daylighting is ENERGY-10 (SBIC, 1996). In the newly released Danish energy simulation program BSIM2000, there is also a daylight routine for estimating the daylight factor (Grau & Wittchen, 1999). This is however limited to estimation of daylight factors for the uniform sky model.

A different approach has been to start with a free standing light simulation program, and then produce an output file that can be passed to practically any energy simulation program. The lighting simulation platform Adeline (Erhorn & Stoffel, 1996) have such links to thermal programs. For example, the post-processor Superlink can calculate the annual hourly lighting electricity use for different control strategies, and this file can be used as an internal load file in the thermal calculation. However, this method has the drawback of lacking interactivity with the thermal calculation since the light calculations are performed first. This means that the daylight program cannot be used to control shading devices. Another problem is that the power demand for continuous dimming systems are underestimated when dimmed, since the program does not take into consideration the high base load of a fully dimmed system, see Christoffersen (1995).

Others have tried to overcome the problem of lacking interactivity by building direct links between thermal programs and the advanced lighting program Radiance, e.g. Clarke et al. (1997), Janak (1997) used Radiance together with ESP-r. A similar approach has been used between Radiance and TRNSYS (Kovach-Hebling et al., 1997). The two largest drawbacks are: (1) the still fairly long calculation times required in Radiance when high accuracy is wanted and when all daylight hours of the year have to be calculated; (2) that Radiance is such an advanced program that it takes an expert to perform these calculations. Solutions to the first problem have been suggested, for example the use of a set of pre-calculated daylight coefficients, covering all hours of a year (Tregenza & Waters, 1983; Reinhart & Herkel, 2000).

4.4.3 Derob-LTH daylight module

A daylight calculation module for the thermal program Derob-LTH was developed, see article V. It currently works as a stand-alone post-processor to Derob-LTH but the intention for the future is to integrate it more closely with the thermal program. The aim of the module is to provide input for daylight-responsive control of shading devices. The work on the daylight module coincides with a modernisation of the whole structure of the Derob-LTH calculation engine, a work that is still in progress. The main motivation for this modernisation is that the current version of the Derob-LTH program does not allow for a changing geometry during the simulation, and thus not for control of shading devices. The computer code has over the years also become badly arranged and hard to work with. The new calculation engine will in many ways be improved. The current limitation of 27 surfaces enclosing a volume will for example be removed, and time-steps can be varied.

The proposed daylight estimation method is based on the fact that Derob-LTH already calculates the distribution of solar radiation (direct and diffuse components) in a space using a radiosity method. The solar radiation distribution is then translated to visual radiation via the luminous efficacy. Last, the radiation levels are amplified using the ratio of visual-to-solar transmittance to yield the final illuminance level.

Validation was performed for overcast and clear days against mainly Radiance for a side-lit room and for a simple atrium. For the overcast sky, the accuracy is acceptable for both vertical and horizontal windows for the midpoint of the room. For the sunny sky, Derob-LTH accurately predicts the size and illuminance level of the sunpatch, at least for the tested vertical window. For the purpose of using it for daylight-linked control of shading devices, the accuracy of the developed model seems sufficient. However, if it is to be used as a proper daylight tool further work is needed mainly on eliminating the diffuse glazing transmittance of the diffuse radiation component, and to increase the number of nodes used for the diffuse radiation distribution. If this is done, the luminance of the surfaces could be calculated easily, which would also make calculations of for example glare indices possible.

4.5 Daylight utilisation

That daylight can be used to replace artificial lighting have since long been identified as an interesting electricity saving technique, and many articles have been produced on the subject, see for example (Verderber & Rubinstein; 1984, Szerman, 1994; Christoffersen, 1995). What makes daylight utilisation (or a daylight responsive/-linked lighting system) so interesting compared to other electricity saving alternatives is that daylight is most abundant during spring, summer and autumn, and of course during normal office hours, i.e. the same hours when overheating in offices is likely to occur. It therefore has the potential of also reducing cooling demands without simultaneously increasing the heating demands, see for example article II.

The potential of the electric lighting savings is of course strongly related to many parameters such as window size, glazing type and orientation, room geometry, sensor position, control system, installed lighting power etc. Therefore, estimated lighting savings found in the literature vary greatly. In comparisons between simulated and measured savings it has also been found that real savings may be lower than predicted ones, see for example Andresen et al. (1995). They showed that measured lighting energy savings were significantly lower than estimations performed through lighting calculations in Superlite/ Superlink (measured savings were 16-32 % compared to 34-47 % calculated for continuous dimming systems). Apart from factors mentioned in the report (e.g. use of shading devices not accounted for in the simulation, climatic data differed), the discrepancy might also be due to an error in the Superlink routine, see Christoffersen (1995), which leads to lighting loads which are much too low. Simulations performed for the preparation of article II will also demonstrate this, see section 5.2.1.

There it is shown that lighting energy saving can be expected to be around 55 % for offices with rather large windows (when 50 % of the façade wall is glazed) and around 40 % when 30 % of the façade is glazed. It was however concluded that this might be an optimistic estimation, since it was compared with a case where the lights were on all day. In a real building, people are not always in their offices, and some people do not always turn on their own lights.

If lighting energy savings and the synergistic effects on cooling loads are the major economical benefits of daylight utilisation, what other advantages or potential drawbacks are there? First, daylight utilisation implies the presence of windows in the immediate surrounding of the workplace. This has many both psychological and physiological advan-

tages as will be described below. The quality of natural illumination may also be highly desirable. Daylight entering through windows located on the sidewall of a building provide a directional component to the general illumination which can contribute to the modelling of objects (Collins, 1976).

The drawbacks are to my opinion few, but they may include how people perceive the electric lights at a dimmed state, and the effects on room perception in general. There are for example studies that show that if the sky is bright, people will want to increase the indoor lighting in order to reduce contrast (Inui & Miyata, 1973). Therefore, any control algorithm that is developed, must not only aim at reaching a desired illuminance level, but must take peoples reaction and satisfaction of the system into consideration. People also have an inbuilt understanding of the main direction of light as coming from above. This was illustrated very clearly by Hesselgren (1987) in a famous photograph of metal bumps on a riveted cylindrical tank. When viewed the right way, the highlights and shadows gave the impression that the bumps were dents but when the picture was viewed upside down, the dents were turned into bosses, and the rivets looked like dents. According to Hesselgren the most preferable light direction is about 30° to the horizontal plane. Without a directional component the shadows on objects in the room will be unfavourable, and with a completely uniform lighting there will be no lustre, which make objects appear dead. Therefore, if the daylight is evened out by a sophisticated lighting installation that meet every engineers dream of a perfectly even illuminance, this might go against our intuitive understanding of light, and thus be perceived as unpleasant, unsatisfactory or awkward.

Finally, it is evident that daylight utilisation requires rooms that are not too deep. An old rule of thumb has been that the room depth should not exceed 2-2.5 the distance from the floor to the top of the window, which yields rooms of about 4 to 6 m deep. Many modern buildings have floor plans much deeper than that, 18-20 m is not uncommon. No matter how much glazing is put into the façade, this will leave a core of the building that will have to be artificially lit. Even if there are new ways of bringing daylight into deep buildings, e.g. light pipes, the contact with the outside will still be lost.

4.6 Lighting quality and visual comfort

Naturally, visual comfort and a good quality of the lit environment are desirable in any setting. However, visual comfort has become a word of fashion, and is often used without too much reflection upon how it should be achieved. Often it is used as an analogy to thermal comfort. When the research on visual comfort is critically analysed, it is clear that we still know very little about what criteria should be fulfilled in order to achieve a good visual comfort (i.e. preferred luminance, luminance distribution, uniformity, flicker rate, spectral power distribution).

Christoffersen et al. (1999a) criticise the wording visual comfort, since it can lead to the belief that there is a form of neutral comfort situation, just like in the thermal situation, where neither more or less lighting is desired. They claim that the basic difference between the two concepts lies in the fact that lighting, and especially daylighting, is much more complex. What they also could have said is that vision is the most sophisticated of our senses. Our perception is based on the reception and interpretation of a number of dynamic visual and sensory impressions from everything that lays in the field of view. Contrary to the thermal comfort situation – where each change in temperature will lead to reduced comfort – the lighting situation can always be improved according to Christoffersen.

Hopkinson et al. (1966) made the following definition of visual comfort:

“The term visual comfort describes the lack of the psychological sense of pain, irritation or distraction, but visual comfort does not aim at covering sensations of aesthetical appeal or discomfort of the surroundings.”

Lighting quality is another term that is often used instead of visual comfort, but it is not quite synonymous. Sometimes, lighting quality covers only the following factors: the adaptation of the eye, the colour of the light source (colour temperature) and its colour rendering, the main direction of the light, ability to reveal shapes, shadows and lustre, absence of glare and flicker, etc.

Ljuskultur AB⁸ in Stockholm has developed a simple light chart to help occupants judge their own light quality at work, Fig. 4.5. Although it was developed for artificial lighting, it can also be used for the combined daylight/artificially lit workplace. The light chart is a simple round

8. Ljuskultur AB is an informational body for the Swedish lighting industries.

disc to be put on the table, and it has eight questions and small reading tests printed on it. The purpose is to roughly test if the illuminance level is sufficient, if the surroundings are sufficiently bright, if the colour rendering of the artificial light is good, if the work place is free of disturbing shadows and to check for direct and indirect glare. It is intended as a starting point for a more thorough evaluation of the workplace.

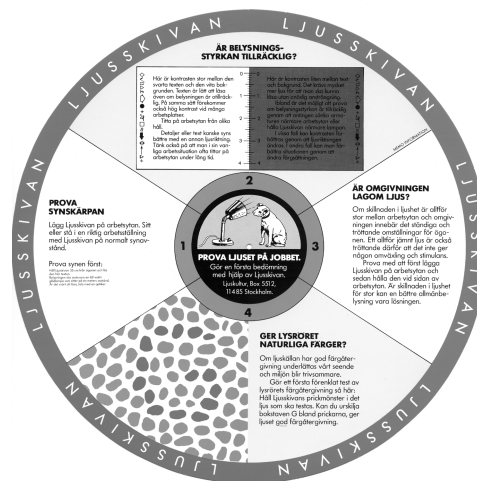

Figure 4.5 Light chart from Ljuskultur AB, Stockholm.

Liljefors & Ejhed (1990) hold the opinion that the following factors can be used systematically for a visual evaluation of the lighting quality: light level (how bright or dark it is in the room), light distribution (where is it darker/brighter), shadows (where do they fall and their character), reflexes (where they are and their character), glare (where it is and how obvious), light colour (if the colour of the light is perceived as warm/cold etc.) and colour (if they look natural or distorted).

Veitch & Newsham (1996a, b) broadens the term lighting quality with the following definition: "The degree to which the luminous environment supports the following requirements of the people who will use the space: visual performance, post-visual performance (task performance and behavioural effects other than vision), social interaction and communication, mood state (happiness, alertness, satisfaction, preference), health and safety, and aesthetic judgments".

By this wide definition lighting quality is not directly measurable, but it directly relates the lit space to the tasks accomplished by the people working there.

4.6.1 Common recommendations for illuminance and luminance.

In order to ensure that a task can be performed with normal speed and accuracy a minimum required illuminance level needs to be established. Several documents provide tables or flow charts for finding the proper illuminance for various tasks, e.g. The Illuminance Selection Procedure (IESNA, 1993), the Lighting Schedule (CIBSE 1994), and Belysning inomhus (Ljuskultur, 1990). For paper-based (reading and writing) office work, the recommended illuminance is usually around 500 lux. Computer-based work may need lower levels, e.g. 300 lux. There are however several studies that indicate that preferred light levels might be much higher, up to 2000 lux or even 5000 lux, and may increase with age, see review by Velds (1999).

In order to avoid annoying glare, the luminance of the visual field should not be too high. Basically all recommendations for luminance distribution ratios are based on an old paper by Luckiesh (1944), Velds, 1999). The widely used recommendations are that the luminance ratios should not exceed the following:

between paper task and adjacent VDT (Video Display Terminal)	3:1 or 1:3
between task and adjacent surroundings	3:1 or 1:3
between task and remote surroundings	10:1 or 1:10
between luminaires, windows or skylights and adjacent surfaces	40:1

The same values are given in guidelines for good lighting quality in offices by NUTEK (1994). The NUTEK requirement for maximum allowed luminance level is 1000 cd/m² within the field of view and 2000 cd/m² outside the normal field of view. This is based on preserving visibility of video display terminals (VDT) that have a luminance on the order of 100 cd/m².

When windows and daylight are introduced in the workplace, it becomes difficult to fulfil such strict limitations on luminance ratios and maximum luminances, since the sky can easily have a luminance of 10'000 cd/m² and above. Thin white clouds reflecting the sunlight may even have a luminance above 100'000 cd/m². This will require the use of some kind of shading device. Studies on discomfort glare by Velds (1999) have however shown that it is difficult to establish a maximum tolerable sky luminance that is acceptable to a majority of the individuals.

4.7 Psychological aspects of windows

The last two sections started to touch upon human aspects of daylighting. In this section a literature review of the psychological benefits and drawbacks of having windows will be given. Aspects that relate to the work in articles III to IV are given separate subsections.

Generally, people prefer windowed space over windowless environments (Collins, 1976). People also tend to prefer daylight to artificial light. In a recent survey of 1800 Danish office workers in 20 buildings, the three most positive aspects of windows were: ability to see out, ability to follow changes of weather, and ability to air a room (Christoffersen et al., 1999b). Further benefits can also be attributed to windows. As Rusak et al. (1996) puts it, “the obvious benefits of windows are the desirability of having a view to the external world, an expansive sense of contact with the outdoors, positive mood effects of seeing sunshine, and desire for the warmth and atmosphere provided by sunlight in interiors at certain times of day”. Perceived spaciousness has also been found to increase with the presence of windows (Inui & Miyata, 1973).

Heerwagen (1990) suggests that there are four general benefits of windows: (1) access to environmental information; (2) access to sensory change; (3) a feeling of connection to the world outside and (4) restoration and recovery. Heerwagen speculates that the first benefit may have to do with our evolutionary past, that is was crucial for survival and health to keep track of time of day, weather and other changing environmental data. However, change is a basic characteristic of the natural world. In contrast, interior space is deliberately kept at constant temperatures, ventilation rates, illumination levels etc. Doubts have started to grow that constant levels are not the optimum. There is evidence that sensory change is fundamental to perception and may well be essential for efficient functioning of the brain. Sensory change can also give a pleasant experience independent of the data provided and, for many people, windows are the only source of changing levels of sensation. The third point stated by Heerwagen is that windowless space makes people feel enclosed and shut off from the outside world. “Windows provide access to events and situations in the world beyond our walled boundaries”. The fourth point, restoration and recovery, is based on some evidence that nature, and especially trees, have restorative effects, e.g. Ulrich (1984).

Heerwagen also points out that windows are not always beneficial. View out also brings the possibility of view in. For some people privacy is extremely important and windows create the possibility for unwanted

visual exposure. A discussion around the balance between visual access and visual exposure, and her visual exposure matrix was already given in Sec. 2.1.2.

4.7.1 View

Today, when mechanical ventilation and artificial lighting can provide us with necessary air and light, view remains as perhaps the most important aspect of windows. Apart from connecting us with the outside, view content has been associated with a number of different health outcomes. Wilson (1972) found that post-operative delirium was more than halved among surgical patients with access to windows, and concluded that windows were highly desirable for the prevention of sensory deprivation. This was later supported in a similar study by Ulrich (1984) where patients with a natural view had fewer complications, recovered faster, and needed less pain-killers than those overlooking a brick wall.

Markus (1967) divides the view into three elements; (1) upwards, the sky as the main source of light; (2) the horizontal part providing view of landscape or city; (3) downwards, the view of ground and the activities going on upon it. Almost all views have a horizontal stratification, i.e. they contain a layer of ground, a layer of city or landscape and a layer of sky. According to Markus, at least some small portion of all layers should be present in a view, rather than one layer alone. He suggested that vertical windows would allow for this. Also, tall buildings may require a lower window placement for top floors than for bottom floors. Moreover, dividing lines between layers are very important and windows which are otherwise generous but which obstruct these dividing lines lose much of their orientating effect.

The satisfaction with the view is strongly related to the contents of the view. In the study by Christoffersen (1999b), natural landscapes, trees, vegetation and sky gave a stronger response of satisfaction than did parking lots, tall buildings and industry. Further, satisfaction was related with floor level of the occupant, with satisfaction increasing for those sitting higher up in buildings.

Similar results were found by Markus (1967), in an assessment of 400 office workers in a 12-storey open-plan office in Bristol. About 88 % of the subjects preferred views of the distant city and landscape, while only 12 % preferred a view of ground level buildings or of the sky. Markus also found that people who sat far from the window expressed a greater desire to sit near the windows, but that this may have been a complex response conditioned partly by status, partly a feeling of real view deprivation, and partly by thermal or lighting conditions.

Cooper et al. (1973) found that subjects rated views with a greater variety of distant objects as more satisfying. View content, height above ground and age of the subject also affected judgements of the adequacy and pleasantness of the view.

4.7.2 Window size, shape and position

In the next chapter it is demonstrated that large windows may lead to thermal comfort problems and high energy costs both winter and summer. Therefore, window size may be restricted in order to meet demands of energy efficiency.

Ne'eman and Hopkinson (in Collins, 1976) studied the minimum acceptable window size using scale model experiments. They found that for 50 % of the subjects, the smallest acceptable window size was 25 % of the window wall, while a window size of 35 % was accepted by 85 % of the subjects. Further, the acceptable window size was affected by several parameters such as view content, distance from window, window height and visual angle.

Keighley (in Collins, 1976) found that people preferred wide rather than tall windows, contrary to predictions by Markus (1967). He also found that window areas of 10 % or less of the window wall area was highly unsatisfactory. Satisfaction increased for windows occupying 20 % of the window wall, and was highest for 30 % or above.

In the recent Danish study, Christoffersen et al. (1999b) found that more than 80 % of the employees were satisfied with their window (i.e. glazing) size, which varied between 18 to 49 % of the façade area. Despite this, there was a significant relationship between window size and assessment of adequate size. For large window areas, the number of complaints of 'too large' windows increased, as well as there were more complaints with 'too small' windows when window size decreased. Thus, the optimum window size was found for a glazing-to-wall area ratio (GWAR) of about 30 %. Window size was also the one aspect that people wanted to change the most. This was especially marked in buildings with very narrow windows (0.5-0.6 m). Window placement was also surveyed. In one building with a large sill height (1.35 m), 72 % of the surveyed desired a lower window placement. Further, the satisfaction of the indoor temperature decreased with window size, and for west facing offices the dissatisfaction was higher than the satisfaction with GWARs above 25 %.

4.7.3 Window transmittance and tint

Glazing for solar control may severely reduce light transmittance as well as changing the spectral composition of the transmitted daylight (tint). There are several hearsay stories of complaints regarding such glazing, both concerning mood effects and problems with colour rendering. For example, one architectural firm was said to be very disappointed with their hand-coloured drawings when they saw them outdoors for the first time, as they were delivering them to the customer. However, only a few studies have been performed on the effects of low transmittance glazing.

Cooper, et al. (1973) studied the effects of absorbing and reflecting glass. In a pilot experiment little adverse effect was found from solar absorbing glass. However, two types of solar reflecting glass with light transmissions of 12 % and 15 % elicited complaints about the dark depressing view out, the need to rely on artificial light and distracting reflections from the glass on dark days. In their main experiment, 902 office workers in 11 buildings were surveyed. They found no effects of the glazing on the reported pleasantness or brightness of the view or on interior colours, except for a small adverse effect on pleasantness and view for reflective glass. However, only one of the eleven buildings had glazing with the same low light transmittance as had evoked adverse effects in the pilot study. Cooper et al. concluded that the glazing material is not noticed if the view to the outside is sufficiently interesting, except for cases where more than one glazing material is used.

Boyce et al. (1995) performed a simple experiment on minimum acceptable glazing transmittance, defined by the criterion that 85 % of people consider the transmittance acceptable. A scale model of an office was placed overlooking a parking lot, a building and parts of the sky. A set of window panes + filters with varying transmittance could be positioned in front of the window hole. The resulting transmittances ranged from 9 to 82 %. For each glazing combination the 25 subjects were asked to look around the scale model office and say whether the glazing was acceptable for a modern office or not. Boyce et al. concluded that the minimum acceptable glazing transmittance lies in the range 25 % to 38 %. The variation was associated with glass type and sky condition, where a brightness-enhancing glass was acceptable at a lower transmittance than a spectrally neutral or brightness-reducing glass.

In article III, a super-insulated quadruple-pane window with two low-emittance coatings was compared to a clear, triple-pane window. The light transmittance of the glazing was 55 % and 73 % respectively. Without being told of the real purpose of the study, 95 subjects were able to distinguish between the room with the clear triple-pane window and the

room with the super-insulated window. The room with the super-insulated window was perceived as darker and more enclosed, and the daylight as more tinted. The difference was thus large enough for people to detect, but how people will be affected on the long term is still an unanswered question.

Similar well-insulated windows appear on today's market. Usually, these windows have three glass panes and two silver-based low-e coatings. The daylight spectrum transmitted through such a glazing was compared to the clear triple-pane window (Bülow-Hübe, 1994). The difference in the tinting effect was not found to vary significantly from the quadruple-pane window, Figs. 4.6 and 4.7. It was concluded that the two low-e coatings were mainly responsible for the tinting of the daylight, and not the fourth glass pane.

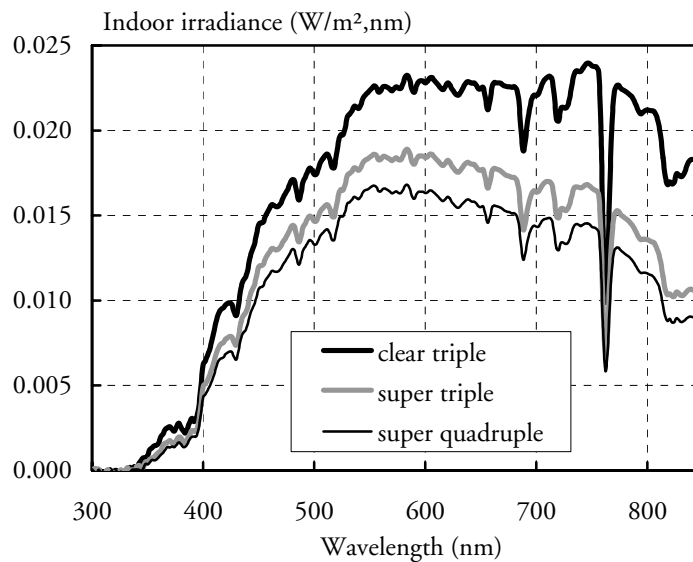

Figure 4.6 Indoor spectral irradiance on desktop for superinsulated quadruple-pane and triple-pane windows (both with two low-e coatings) and a normal clear triple-pane window. Measurement in Lund 940506 at noon, clear sky with sunshine, average of 6 scans.

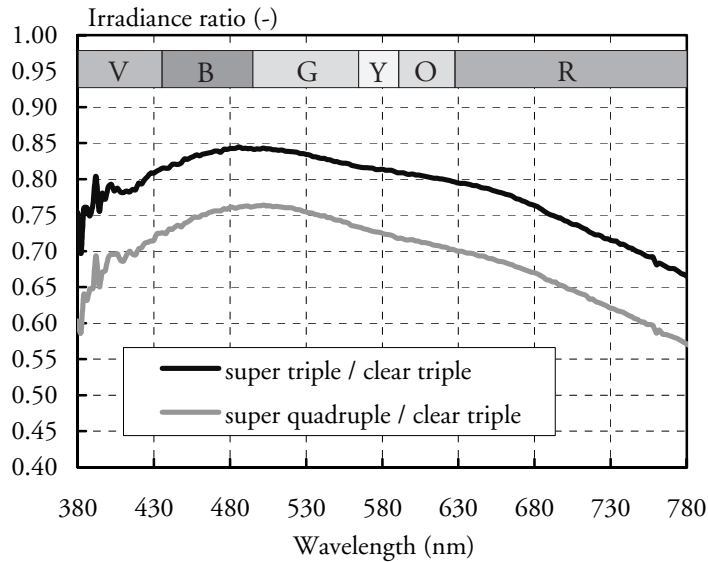

Figure 4.7 Irradiance ratio between the clear triple-pane window and two superinsulated windows: quadruple-pane and triple-pane with two low-e coatings. Measurement in Lund 940506 at noon, clear sky with sunshine, average of 6 scans.

Daylight of different wavelengths gives rise to different colour sensations. The following division is widely accepted: violet, ranging from 380 to 436 nm, blue from 436 to 495, green from 495 to 566, yellow from 566 to 589, orange from 589 to 627, and red from 627 to 780 nm (Küller, 1981). The relative sensitivity of the eye in the photopic state (daytime vision) is highest for 555 nm, which corresponds to a green sensation. In Fig. 3.7 it was demonstrated that silver-based low-e coatings, depending on thickness, have a rather sharp transmittance peak between 530 to 560 nm, which thus corresponds to a green or yellow-green sensation. Clear glass itself also has a transmittance peak in the green, which stems from iron oxide contained in the glass. The peak is however much less sharp, Fig. 3.6. The filtering effect of the glass is emphasised when several panes and especially when several coatings are used, since the effect is multiplicative. The Swedish discussion around daylight quality and super-insulated windows has mainly revolved around the absolute transmittance (in percent) (Sec.2.2.2). To my opinion, there are however two main effects of using more coatings and glass panes in a window: (1) the general illu-

mination level or daylight factor will be lower; and (2) the filtering effect or distortion of the spectrum will become more pronounced. Using slightly larger windows can easily solve the first problem of low illuminance. However, the sky luminance will remain the same. Resolving the second one is much more difficult, and further studies are needed to study the long-term satisfaction of such windows in real environments.

4.7.4 Avoidance of glare

In the Christoffersen study (1999b) the optimum window size was found for a G_{WAR} of 30 %. It was not directly concluded if this had to do with glare or overheating at large glazing-to-wall area ratios. However, a significant relationship was found between window size and disturbing glare, which increased with increasing window size. It is however not obvious that large windows will increase the risk of glare, since they at the same time will increase the general illumination level in the room, and thus reduce contrast. The most effective measure is to reduce sky luminance without reducing window area (Ludlow, 1976). Flexible shading systems such as window blinds, retractable awnings, and curtains can reduce glare when sky luminance is high, and be removed on dull days to increase daylighting. Daylighting systems (e.g. anidolic systems, laser-cut panels, holographic optical elements) are other modern alternatives.

In the study by Christoffersen et al. (1999b) the office workers were sometimes or often bothered by glare. Nevertheless, they wanted to sit near to windows, and over 70 % of the surveyed had the computer placed there.

In article IV it was hypothesised that the sky luminance seen through the window in the close surrounding of the VDT would indicate when shading devices were needed. However, neither this nor the interior desk illuminance had a significant effect on the use of shading devices. However, the presence of a sunlight patch anywhere in the room showed a significant relationship to the use of shading devices, although it only explained a small portion of the variance. It was also obvious that there was a large individual variation in the amount of glare that was tolerated. This has also been found in previous studies, e.g. Velds (1999).

Office work has changed dramatically over the last decades with the massive introduction of the personal computer and VDT in virtually all of today's workplaces. Indeed, in the Christoffersen study 95 % of the employees used a computer at work, and they did so for 55 % of their working time. The main effect of this is that the visual task is no longer mainly on paper lying horizontally on the office desk but vertical on the VDT. Thus, the main sight line is not downwards but almost horizontal

(preferably slightly downwards), which often brings the window into the immediate line of sight. In open-plan fully-glazed offices it may be very difficult to find a good placement for the VDT, since the sky seen through the windows, also at a large distance, may be a cause of annoying glare.

The old rule of thumb for luminance ratios of 10:3:1 for artificial illumination given in Sec. 5.6.1 will be very hard to reach with large windows without the use of some type of shading device. Osterhaus (2001) agrees with the findings of Christoffersen that windows are an extremely important feature in offices and that daylight in general seems to pose less of a problem than one might otherwise expect. Indeed, more research is needed to establish preferred luminance ratios and to help understand factors contributing to discomfort glare from daylight.

4.7.5 Sunlight penetration

Given the discussions of glare and overheating in the previous sections, one may conclude that a total avoidance of sunlight would be the best. However, some sunlighting is usually wanted since it has positive effects on mood. According to a review by Collins (1976), almost all people want to have sunshine in their dwellings, at least in Northern Europe where we are not spoiled by an abundance of sunny days. Studies have indicated that sunshine may be even more important than view, illumination, balconies etc. It is easy to understand that sunlighting is desired in the home where movement is unrestricted: one can decide to sit in the sunpatch to benefit from the heat, or avoid it if the lighting is too bright. In an office a sunlight patch may be more disturbing since people are tied to a rather small working surface, especially today with a computer screen on the desk. Even so, the recent survey by Christoffersen (1999b) indicated a strong preference for sunlight in the office, 60 % desire some sunlight during one or several seasons. This supports the findings of a much earlier study by Markus (1967), where an overwhelming majority (86 %) of 400 surveyed office workers in a highly-glazed building preferred sunshine all year round.

Boubekri & Boyer (1991) studied the effects of window size and sunlight penetration on office workers' emotional state and degree of satisfaction. They failed to demonstrate that window size affected mood and satisfaction, but sunlight penetration significantly affected the feeling of relaxation. The relaxation was highest for moderate sunlight penetration, and decreased with both small and large sunlight patches.

4.8 Non-visual effects of light

For many years, environmental and lighting design was based on the assumption that light only affected visual performance. The research on the central vision of the eye began already in the beginning of the 20th century, and is very extensive. One has also known that both lighting and colours contributes to the impression of architectural space. At the same time research has demonstrated that light entering the eye has a number of other effects on humans. It has been shown that there is an activation of various organs in the brain, especially the pineal gland, pituitary gland, and the reticular formation of the brain stem. Light affects the diurnal rhythm, metabolism, pulse frequency, blood pressure and the production of hormones. Light may even increase the immune defence against certain types of infections.

The awareness and the importance of the non-visual effects of lighting, and especially of daylight, is growing rapidly. Many popular articles around light therapy as a means to cure winter depression is appearing in the newspapers and magazines. The lighting industry has caught on, and is nowadays selling bright light sources for home use. In some countries, the natural sleep hormone melatonin is being offered freely as a dietary supplement – marketed for insomnia, winter depression, slowing the ageing process and as a cure for jet lag.

The non-visual effects of light (and colour) have been summarised in an extensive bibliography by Küller (1981). He has divided the effects of light into three main headings: physiological effects of solar radiation on the (human) skin, physiological effects of daylight and artificial illumination entering the eye, psychological effects of light and colour. The second of these areas has been extensively treated in an updated bibliography (Küller & Küller, 2001). Some of the psychological effects associated with daylight have been mentioned in the previous section, and are thus not repeated here.

4.8.1 Physiological effects of solar radiation on the (human) skin

There are several well-known effects of solar radiation on the human skin. For example, UV-C radiation (100-280 nm) has a strong germicidal effect and can cause superficial erythema and conjunctivitis. UV-B radiation (280-315 nm) causes vitamin D formation in the body (vital for calcium intake), and has erythematous (reddening of the skin) and pigmentation (tanning) effects. Ordinary window glass absorbs essentially

all radiation within this range. However, UV-A radiation (315–400 nm) passes through most types of glass, but has no effects on vitamin D formation. Although UV-A light is less effective as a tanning agent, it is most often used in tanning equipment. UV light is also known to cause skin cancer (Küller, 1981, Rusak, et al., 1996).

4.8.2 Physiological effects of daylight and artificial illumination entering the eye

Light entering the eye has a synchronizing effect on the diurnal and seasonal rhythms prevalent in human beings, for example the sleep-wake cycle and the production of hormones. Sunlight has been shown to inhibit the secretion of melatonin – a sleep hormone produced by the pineal gland in the brain – and adaptation to the day–night cycle and to seasonal changes in day length are thus mediated by this mechanism. If our internal clock is not reset daily, we go into our own sleep-wake cycle (which is usually longer than 24 hours), we become circadic. This was first shown amongst totally blind people and also amongst mine workers (Hollwich, 1979). While bright artificial light (approx. 2500 lux) has been shown to suppress melatonin levels, ordinary indoor light levels may not do so. (Wetterberg, 1978, Boyce & Kennaway, 1987). Some psychiatric disorders such as SAD (seasonal affective disorder) have also been associated with the lack of daylight (Küller & Küller, 2001; Tonello, 2001).

Küller & Lindsten (1992) reported that the seasonal hormone cycle of morning cortisol (a stress hormone) in school children situated in classrooms without daylight differed from that of children in ordinary classrooms. There also seemed to be some effects on sociability and body growth, and they recommend that classrooms without windows should be avoided for permanent use. In another study on the subterranean environment, Küller & Wetterberg (1996) found some interesting differences in spaces below and above ground. On average, the illumination was twice as high in offices above than below ground. The level of morning cortisol displayed a substantial annual variation in personnel above ground, but the variation was much less pronounced in personnel below ground. The variation between daytime and nighttime melatonin levels was much larger for underground personnel, and on average they slept half an hour longer than personnel above ground.

While there seem to be ample evidence that light entering the eye acts as a synchronizer for biological clocks, it is not yet quite certain whether it is the amount of light, its spectral composition or variations in the day length that are decisive. The current belief is that light intensity is the

most important factor. This hypothesis is intuitively correct when one compares typical indoor and outdoor levels, especially for spaces far away from windows: indoor levels can range from 50 lux (typically found in a corridor etc.) to 200-500 lux for office work and about 1500 lux for very detailed work. Outdoors we may experience anything between 5'000-10'000 lux on an overcast day up to 100'000 lux on a sunny day. The amount of illumination we are exposed to in artificially lit environments is thus only a tiny fraction of the exposure outdoors, and it is evident that daylight acts as a very strong signal. Many authors seem to consider that there are possible health risks of spending too much time indoors. It is however difficult to increase interior light levels for several reasons: we do not want to waste electrical energy, and it is more difficult to create a pleasant, glare free atmosphere with bright artificial lighting. Küller et al., (1999) has demonstrated that people who work further than 2 m from a window are more likely to experience SAD or SAD-like symptoms. Küller recommends that people should sit near to a window, and/or to take a daily walk outside, preferably in the morning.

There are also effects of light on the activation of the central and autonomic nervous systems, i.e on the physiological arousal level. One example is flicker from conventional fluorescent light sources. Although the flicker is not perceived by the visual system, it may influence the basic brainwave pattern (EEG) of the central nervous system. This has been suspected to cause undue stress resulting in headaches and eye-strain (Wilkins et al, 1989, Küller & Laike, 1998).

4.8.3 Psychological effects of light and colour

There is a long history of speculation that light and colour can influence task performance, comfort and well-being. A large part of the work in this field concern the artificially lit environment and preferences for various conditions. There are several bibliographies and reviews for the interested reader (Küller, 1981; Rusak et al., 1996; Veitch, 2001). The evaluation of discomfort glare indices also takes a central position. A discussion of glare indices is presented in Velds (1999) and Dubois (2001).

5 Windows and energy

In order to illustrate the effect of window choice on the heating demand, cooling demand and indoor temperatures, some calculation examples for both residential and office buildings are given in this chapter.

There exist some simple methods to estimate the net energy gain through windows, taking into account both thermal losses, Q_{loss} , and solar gains, Q_{solar} , e.g. (Karlsson & Brunström, 1987; Roos & Karlsson, 1994; Nielsen & Svendsen, 2000; Karlsson, Karlsson & Roos, 2001). These methods usually incorporate some form of degree-day method in order to look at the energy gain over the heating season only. The heating season can be either fixed, or defined by the balance temperature of the house. In the (Björn) “Karlsson” window formulae, the net annual energy transport through the window, Q , is defined as:

$$Q = Q_{solar} - Q_{loss} = \bar{g}S(t_b) - UG(t_b) \quad (5.1)$$

where \bar{g} is the annual mean value of the total solar energy transmittance (-), S is the total solar radiation impinging on the window summed up to the balance temperature ($\text{Wh}/\text{m}^2\cdot\text{yr}$), U is the U -value of the window ($\text{W}/\text{m}^2\text{K}$), and G is the degree-hours summed up to the balance temperature of the building ($^\circ\text{h}/\text{yr}$). The balance temperature is defined as the average outdoor temperature above which the building does not need to be actively heated, and thus differs slightly from the usual definition. For the climate in Älvkarleby (lat 60°N) Roos & Karlsson (1994) found that \bar{g} could be represented by the g -value for 55° incidence angle. With climatic data for Älvkarleby 1985, an indoor temperature of 20°C and a balance temperature of 13°C , the equation becomes (in $\text{kWh}/\text{yr}, \text{m}^2$ window area), (Merkell, 1989):

$$\text{South windows: } Q = \bar{g} \cdot 465 - U \cdot 127 \quad (5.2a)$$

$$\text{East windows: } Q = \bar{g} \cdot 324 - U \cdot 127 \quad (5.2b)$$

$$\text{West windows: } Q = \bar{g} \cdot 234 - U \cdot 127 \quad (5.2c)$$

$$\text{North windows: } Q = \bar{g} \cdot 130 - U \cdot 127 \quad (5.2d)$$

Later, Joakim Karlsson improved this method by calculating the energy balance on an hourly basis, thus employing the correct angular dependent g -value, $g(\theta)$, for each hour. The method was released as a simple computer tool, WinSel (Karlsson, 2000).

In all of these methods it is required that either the length of the heating season or the balance temperature is defined from previous experience, since it will depend on the general insulation level of the house, the ventilation rate, and the internal gains. Further, these methods usually only look at the window alone, and not on the interaction with the whole building. Even if the formulae can be adapted to look at cooling demands, it will still be difficult to estimate potential overheating problems since ventilation and internal load schemes, storage effects in the thermal mass of the building etc. are difficult to account for. I have therefore chosen to perform the calculations in the dynamic energy simulation program Derob-LTH, which is described elsewhere in this report, see for example Sec. 1.3 and articles II and V.

5.1 Single family house

A detached 1.5 storey single-family house without basement was modelled. The ground floor is 8.1 by 11.9 m, and the living area is 150 m². The geometry of the house is identical to the reference house selected within IEA/SHC Task 28/ Annex 38: “Sustainable Solar Housing” (Smeds & Wall, 2001a).

The total window area is 22 m², which gives a window-to-floor area ratio (WFAR) of 15 %. The house is thus moderately glazed but rather typical for Swedish houses built from 1975 and on. The relationship between glazing and frame area was assumed to be 70/30 %. General data of the house are given in Table 5.1 and the geometry of the Derob-model is shown in Fig. 5.1.

In order to illustrate the effect of different window U -values on the heating demand for houses from various time ages, three insulation levels were chosen corresponding to typical levels from 1960, 1980, and today (2000). A hypothetical case (2020) for an extremely well insulated building was also constructed – perhaps the standard of year 2020? The insulation levels in this house correspond to those of some newly erected row houses in Lindås, outside of Gothenburg, designed by EFEM Arkitektkontor, see also Chapter 1. For simplicity, no thermal bridges accounting for extra heat losses at connections between wall-roof, floor-wall etc. have been accounted for. To obtain the predicted low heating demands of es-

pecially the houses 2000 and 2020 will in reality require extreme care in the design of these connections, in order to avoid thermal bridges that can otherwise significantly increase the thermal losses.

In the first set of simulations, the houses were all placed in the climate of Stockholm (climate year 1988), and the main façade facing south. The houses were later also studied for the climates of Lund (1988) and Luleå (1988). Thus, by the case 'Stockholm 2000' is meant a house with the insulation levels of year 2000, placed in the Stockholm climate for reference year 1988.

The internal loads were taken from IEA/SHC Task 28, and in all cases but 2020 the case REF 2+2 was chosen (Smeds & Wall, 2001b). This is a case that models a family of two adults and two children, and with older household equipment. For the house 2020 the high performance case, HP 2+2, was used, and this is a case that reflects the internal loads for the same family, but with modern energy-efficient household appliances.

The case Stockholm 2000 was studied for the main façade oriented in all four major directions (S, E, N and W). The choice between windows 7-9 (see Table 5.2) was also evaluated for this case.

The calculations focus on the heating demand of the houses as a function of window U -value, and do not include electricity use for the mechanical ventilation needed. However, modern systems use about 20-35 W per fan, and in air-to-air heat recovery systems two fans are needed, thus the annual electricity demand for the ventilation system is rather small, between 175 and 310 kWh. Older systems may use more electricity, due to higher power of the fans. In for example Solbyn, the energy use for the ventilation system was measured to 900 kWh/yr, including intermittent defrosting of the heat recovery unit (see article I).

Table 5.1 Information of the 1.5-storey detached single family house.

General		Window areas	
City, climate year	Stockholm 1988	South	9 m ²
Latitude	59°N	East	3 m ²
Ventilated volume	85 % of 400 m ³	North	1 m ²
Living area	150 m ² (96+54)	West	9 m ²
Occupants	2 adults + 2 children		
Thermostat setting	20°C, constant		

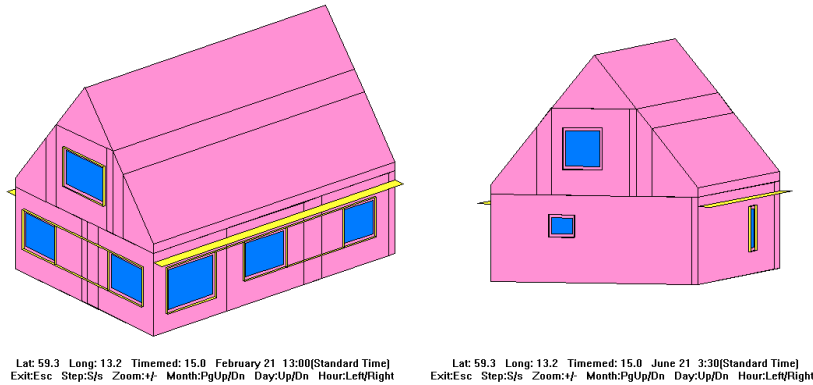

Figure 5.1 *Derob-model of the 1.5-storey house. The light-coloured surfaces are shading elements that model the window reveal and the eaves. Window frames and doors are modelled as rectangular wall surfaces.*

5.1.1 Window types

Five glazing combinations were selected along the $U(g)$ -curve presented in Fig. 3.12. The graph is again presented here, showing the selected glazing combinations as uncoloured circles, Fig. 5.2. Five realistic frames were matched with these glazings to create the five main window types 1-5: (1) a coupled double-pane window; (2) a clear triple-pane IGU window; (3) a triple IGU window with one low-e coating and argon; (4) a 1+3 window with one low-e coating and argon; and (5) a triple IGU window with 2 low-e coatings and krypton in both cavities. The frame U -values U_f were calculated from the practical window U -values, $U_{p,win}$ and the center-of-glass U -values U_{cog} . This means that all additional heat losses due to thermal bridges etc. are accounted for in U_f . Window types 1-3 are “standard” window types on today’s market, window 4 is usually not produced, and window 5 can be specially ordered.

Some alternative windows were also studied in a few other cases. Window type 6 was selected as a renovation alternative of window 1 where the clear inner pane is replaced with a hard tin-oxide low-e coating. Window types 7-9 are all double-pane insulated glass units with low-e coatings and argon, the only difference is that the emissivity of the coating is successively reduced from 16 % to 10 % and finally 4 %. These coatings can all be found on the market today, although the 16 % alternative is usually not used in IGUs, and the 10 % emittance coating is more and more being replaced by the 4 % coating. Window type 10 is another

commonly sold window type today, it corresponds to a 1+2 construction (coupled) with one low-e coating and argon gas. The thermal and solar properties of the selected windows are given in Table 5.2.

Consumer prices for the windows were gathered from the window manufacturer SP Fönster, Table 5.2 (Anders Jonsäll, SP fönster, personal communication, 2001). However, since the quadruple-pane window (#4) is not in production, an assumption was made that it would be 500 SEK more expensive than window type 10. These prices were then used to study the economy of replacing windows in different situations.

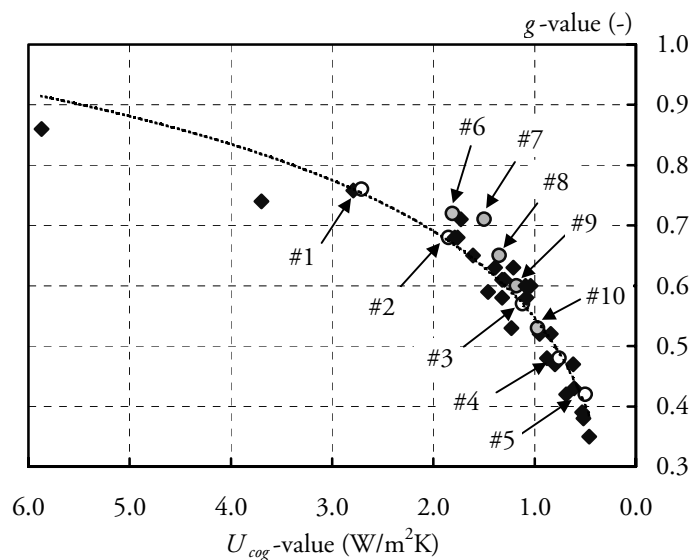

Figure 5.2 Selected glazing types. The main glazing types (1-5) are chosen along the dotted $g(U)$ curve. Glazing 6 is similar to 1, but with a hard low-e coating on the inner pane. Glazings 7-9 are all double-pane low-e coated IGUs with argon, but the emittance is successively decreased from 16 %, to 10 % and 4 %. Glazing 10 is similar to 3, but the emittance of the low-e coating is 4 instead of 10 %.

Table 5.2 Thermal and solar properties and consumer price (excl VAT) of the 10 selected window types. The U -values of the window are based on a window 1.0×1.2 m. T stands for triple, and D for double-pane IGU, e.g. T4-12 is a triple IGU with 4 mm glass and 12 mm gap widths. Since a practical U -value of windows is usually given as $U_{\text{win}} + 0.05$, this additional heat loss is accounted for in the frame U -value. The window prices are based on the same size as the U -value, and are the prices of white painted windows.

Window	Description	U_{cog}	U_f (W/m ² K)	$U_{p,\text{win}}$	g (-)	Price (SEK)
1	4-30-4	2.71	2.09	2.50	0.76	1495
2	T4-12	1.85	2.14	1.95	0.68	2860
3	T4-12 e10%+Ar	1.12	2.30	1.52	0.57	3092
4	4-46-(T4-15 e4%+Ar)	0.76	1.49	1.01	0.48	3724
5	T4-12 2 e4%+2Kr	0.50	2.14	1.06	0.42	3546
6	4-30-4 e16%	1.81	2.09	1.90	0.72	1688
7	D4-15 e16%+Ar	1.50	2.57	1.86	0.71	2195
8	D4-15 e10%+Ar	1.35	2.57	1.76	0.65	2162
9	D4-15 e4%+Ar	1.18	2.57	1.60	0.60	2162
10	4-30-(D4-12 e4%+Ar)	0.97	1.80	1.25	0.53	3224

5.1.2 Insulation levels and ventilation

The chosen ventilation and infiltration rates and the U -values of the building components for the different houses are given in Table 5.3. A brief characterisation of the houses is given below.

House from 1960

The house from 1960 was assumed to have 9.5 cm of wall insulation, 12 cm in the roof and 7 cm on the slab on ground. With window type 1 as standard, the house neither fulfils the requirements of SBN 75/80 nor those of NR 1/BBR 99, see Sec 2.2.1 for a discussion of Swedish building codes.

The ventilation was assumed to be 0.5 ach of the ventilated volume. Since many houses from this time do not have mechanical ventilation, no heat recovery was assumed.

House from 1980

The house from 1980 was assumed to have 19 cm of wall insulation, 24.5 cm in the roof and 5-7 cm under the slab on ground. With window type 2, the house fulfils the requirements of SBN 75/80 but not of NR 1.

The ventilation was assumed to be 0.5 ach of the ventilated volume, with 50 % heat recovery.

House from 2000

In order to find typical U -values of modern houses, a Swedish manufacturer of prefabricated houses was contacted (Myresjöhus). The U -values for the house 2000 were selected as identical to the current production of Myresjöhus. Therefore, the walls have 24 cm of insulation, the horizontal roofs have 45 cm of loose fill insulation, and there is about 10-15 cm of insulation under the slab. With window type 3, the house fulfils the requirements of both SBN 75/80 and NR 1/BBR 99.

The ventilation was assumed to be 0.5 ach of the ventilated volume, with 50 % heat recovery.

House from 2020

The insulation levels in this house are rather typical for so called “passive houses”, houses that do not need more than 15 kWh/yr,m² floor area for heating, and where the total energy demand (heating, domestic hot water and household electricity) does not exceed 42 kWh/yr,m². The U -values for this house roughly corresponds to walls with 45-50 cm of insulation, the horizontal roofs have 60 cm loose fill insulation, and there is about 30 cm of insulation under the slab.

With window type 5 the house more than fulfils the requirements of NR 1/BBR 99. The ventilation was assumed to be 0.5 ach of the ventilated volume, with 85 % heat recovery. The infiltration rate was halved to 0.05 ach. Further, the internal load corresponds to very energy-efficient equipment plus people as before, resulting in lower free heat gains.

Heating demand and useful solar gains

The annual heating demand for the Stockholm climate was simulated in Derob-LTH for the four houses described above. Every house was simulated with a window type typical for each house, see Table 5.3. The useful solar gains were found as the difference of two consecutive runs, without and with solar radiation from the climate file. The results are presented in Fig. 5.3. This clearly demonstrates that the annual heating demand is dramatically reduced when the insulation of the building envelope is improved. Compared to the house of 1960, the heating demands (aux. heating) are reduced by 47% for the house 1980, by 59% for the house 2000 and by 83% for the house 2020! Since the thermal losses are much smaller for the newer houses, transmitted solar radiation covers an increasingly larger fraction of the total demand for space heating.

Table 5.3 Ventilation rates and insulation levels for the four houses. The average U -values U_{ave} and $U_{ave,req}$ are calculated according to NR1/BBR99, which includes a subtraction of 0.7 for all window U -values. This subtraction of 0.7 is however not used in the dynamic simulations.

		Construction year of house			
		1960	1980	2000	2020
Ventilation (ach)		0.5	0.5	0.5	0.5
Heat recovery efficiency		0%	50%	50%	85%
Infiltration (ach)		0.1	0.1	0.1	0.05
Building comp.	Area (m ²)	U -value (W/m ² K)			
Floor on ground	96.4	0.30	0.25	0.19	0.10
Ext. walls	106	0.47	0.25	0.17	0.08
Walls to attic	50.0	0.36	0.16	0.16	0.11
Roof, 45°	20.2	0.36	0.16	0.16	0.11
Roof, horizontal	82.1	0.34	0.17	0.12	0.08
Doors	3.6	2.19	1.00	0.80	0.80
Windows	22.0	2.50	1.95	1.52	1.06
U_{ave} (NR1/BBR 99)		0.454	0.268	0.195	0.107
$U_{ave,req}$ (NR1/BBR 99)		0.244	0.244	0.244	0.244
Fulfils SBN75/80		no	yes	yes	yes
Fulfils NR1/BBR 99		no	no	yes	yes

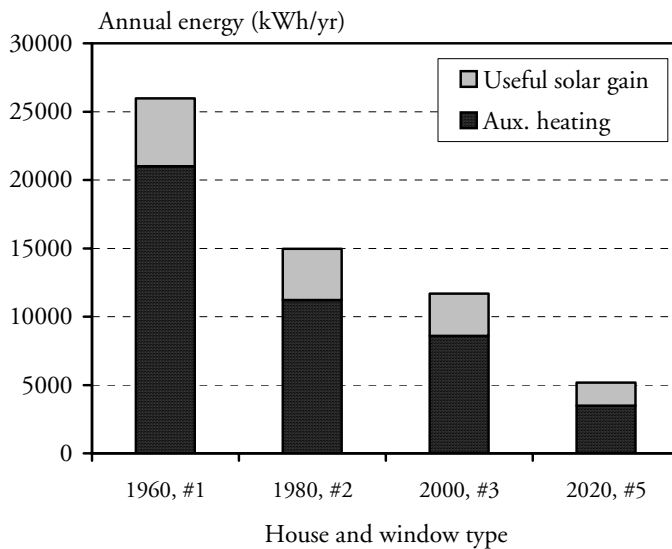

Figure 5.3 Simulated annual heating demand with sun (aux. heating) and useful solar gains in (kWh/yr) for four houses in Stockholm built between 1960-2020 with window types typical for each time period.

The heating demand with and without sun, and the resulting useful solar gains are also presented on a monthly basis for the four houses, Fig. 5.4. The incident solar radiation S (on the outside of the glass areas) is also shown, and it is of course the same for the four houses. These graphs illustrate several interesting facts: (1) in the winter, especially between December and February there is very little solar radiation available. The auxiliary heating demand (simulation with sun) is thereby not much lower than a simulation without sun during this period; (2) during March, April, October and November, all houses benefit from solar gains in a substantial way, and the peak for useful solar gains occurs in April and October; (3) for the super-insulated house, the incident radiation is much higher than the heating demand already in April, and the house risks to get overheating problems that may last until the end of September, see also sec. 5.1.3. However, the g -value of the window is also lower, which is beneficial since the transmitted solar radiation is reduced. The ratio between useful solar gains and the incident radiation S is shown in Fig. 5.5, and this graph illustrates the combined effect of reduced U -values and reduced g -values of highly insulated windows (and buildings).

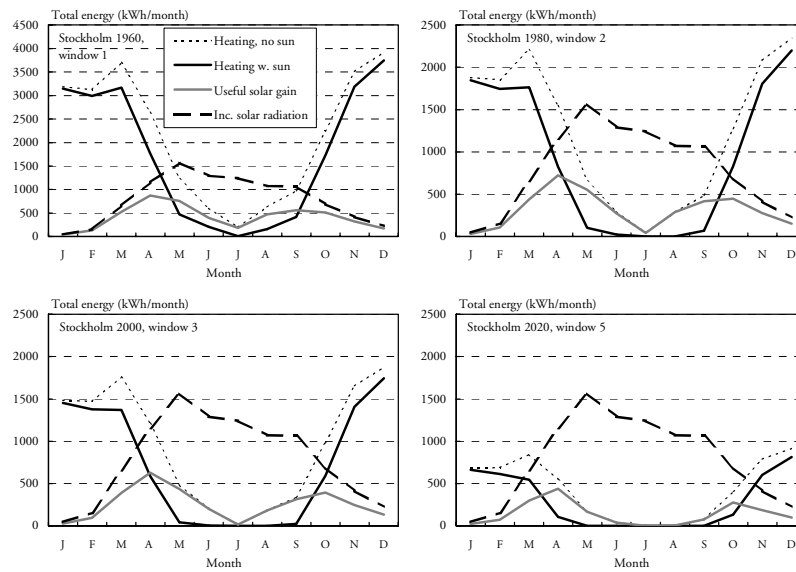

Figure 5.4 Monthly heating demand with and without sun, resulting useful solar gains and incident solar radiation (on the outside of the glass area) in (kWh/month) as a function of window U -value and construction year of house. Stockholm climate.

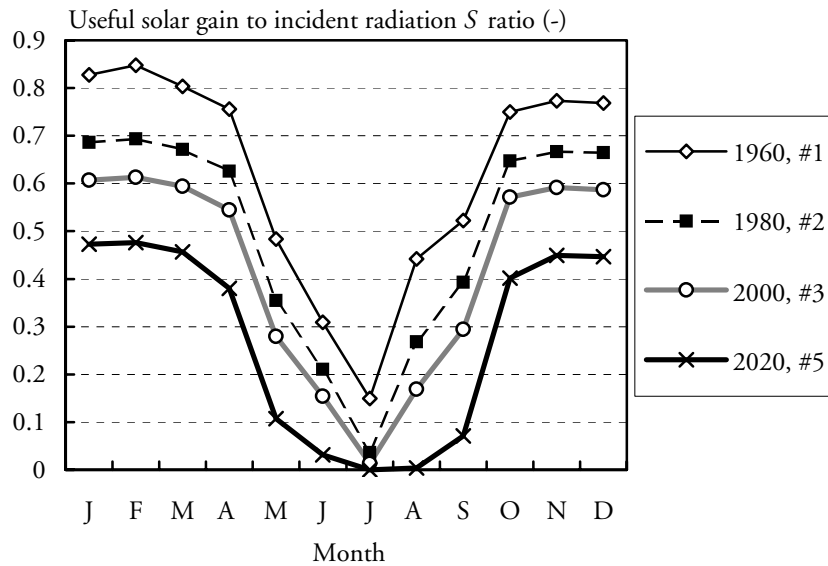

Figure 5.5 Ratio between useful solar gain and total incident radiation S (on the outside of the window glass) (-) as a function of window type and construction year of house. Stockholm climate.

5.1.3 Effects of window choice on energy demands and indoor temperatures

The effects of the choice of window type (U -value and g -value) will be further studied below. The previous section demonstrated that the total heating demand is very different for the four houses, Fig. 5.3. Here, and in the following sections, new sets of simulations are presented where the heating demand for each house has been determined for the window types 1-5, ranging from double-clear windows to energy-efficient low-e coated triple and quadruple-pane windows.

General results for houses in Stockholm

Figure 5.6 shows that the heating demand increases almost linearly with the total window U -value. The heating demand for each house without windows was also calculated, and is shown in the same graph (no windows). In these cases the window area (both glass and frame) was replaced by opaque walls with the same U -value as the rest of the exterior walls. It is clear that solar radiation gains through windows give significant contributions to the heating of the house, since the heating demand is about the same for a house without windows compared to a house with windows (which have a significantly higher U -value).

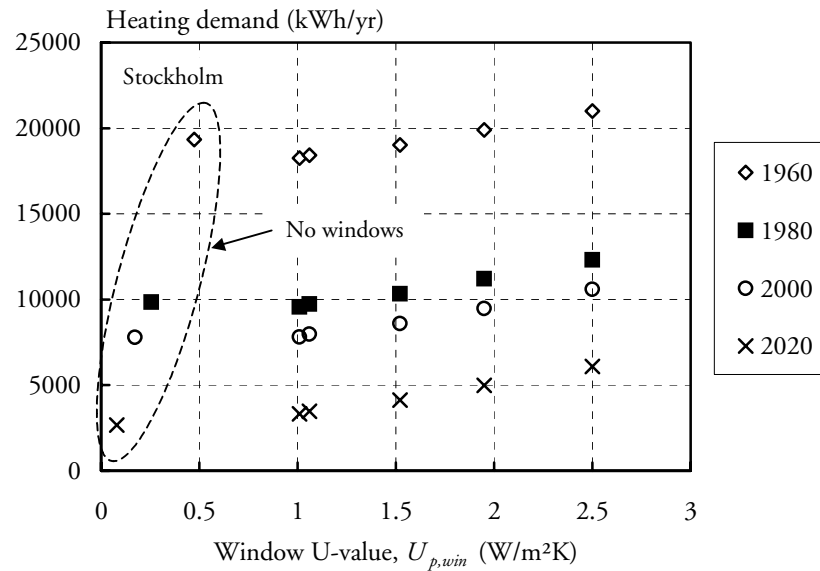

Figure 5.6 Total heating demand (kWh/yr) as a function of window U -value and construction year of house. Calculations performed for the Stockholm climate.

In order to clearly illustrate the breakpoint for which window U -value is required in order for the window to be better than the wall, the incremental heating demand was calculated. This was done by – for each house – taking the energy demand associated with each window type and subtracting the corresponding energy demand for the house without windows (when the whole window area is replaced by wall area) and divide by the total window area. The resulting incremental heating demand for the four houses in the Stockholm climate is shown in Fig. 5.7. For the poorly insulated house (1960), it is always better to replace the wall area with window area as long as the U -value of the windows is about 1.6 W/m²K or lower. For the house from 1980, the window must have a U -value of 1.2 or lower to be better than the wall. For the house of today (2000) the U -value should be lower than 1.0 and for the extremely well-insulated house (2020), the U -value should be better than 0.65.

The peak heating load shows a linear relationship with the total window U -value, see Fig. 5.8. The peak load is always higher for a windowed house, and this is natural since the peak load occurs when there is no solar radiation, and the windows are replaced by walls of lower U -value.

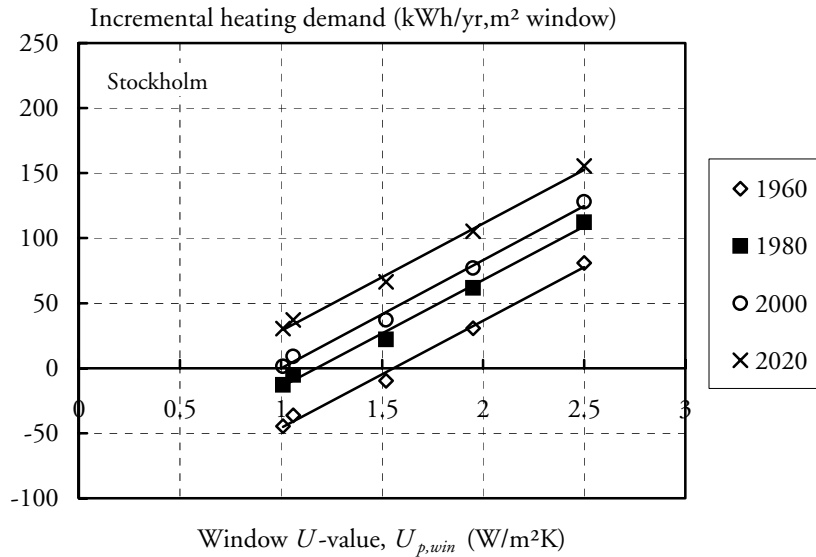

Figure 5.7 Incremental heating demand (kWh/yr, m² window area) as a function of window U -value and construction year of house. Simulations for Stockholm and window types 1-5 according to Table 5.2.

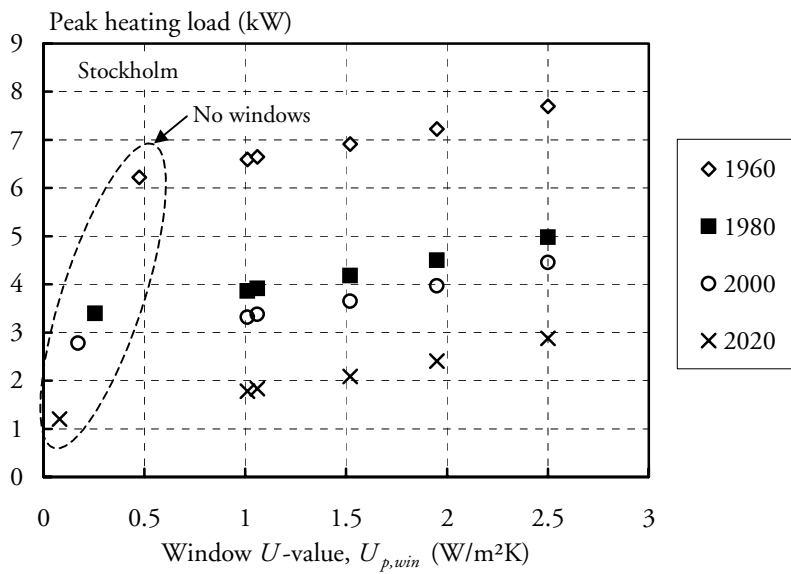

Figure 5.8 Peak heating load (kW) as a function of window U -value and construction year of house. Simulations for Stockholm and window types 1-5 according to Table 5.2

What happens with the indoor climate when both the U -values of the house and the windows are improved? Naturally, the indoor temperatures will increase. This is demonstrated in Fig 5.9, which shows the duration curves of the operative temperature for the ground floor for window type 3 for the four houses. The simulations were done for a constant ventilation rate all year round and with the heat recovery unit in place all through the year, also during the non-heating season (even if it is normally better not to use it during the summer).

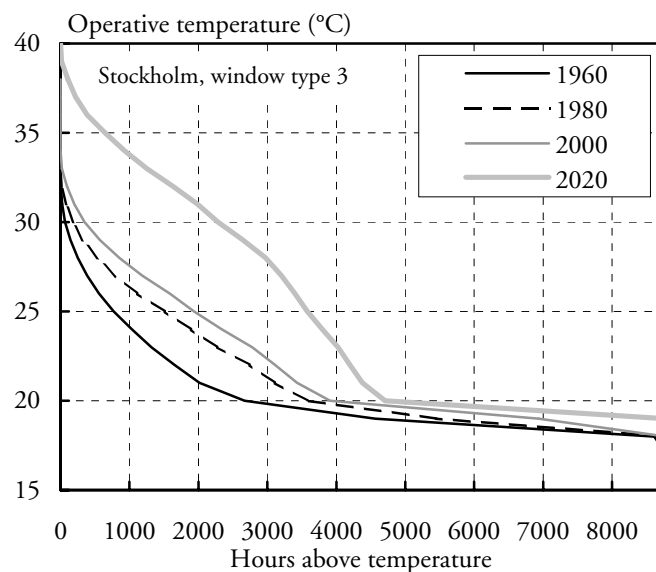

Figure 5.9 Global operative temperature ($^{\circ}\text{C}$) of the ground floor (midpoint of room) as a function of construction year of house. Window type 3 in the Stockholm climate.

First of all, one can see that the minimum operative temperature is about $17\text{--}18^{\circ}\text{C}$, even if the air temperature never goes below 20°C (thermostat set-point). According to the building code, the operative temperature should be above 18°C (BBR 1999) and this is the case for the house 2000 (the requirements on the operative temperature are further described at the end of sec. 5.3). During the heating season, the improved insulation levels are demonstrated as fewer hours with operative temperatures below 20°C . During the non-heating season it is evident that overheating problems may occur as the insulation levels increase. Especially the super-insulated house suffers from extreme overheating problems. Some shading will naturally occur, from curtains or blinds, outdoor vegetation and

surrounding buildings. If the ventilation is increased during the summer (e.g. by-passing the heat recovery unit), the situation will be improved. However, for extremely well-insulated buildings the over-heating problem must not be neglected, and external shading devices may become a necessity.

As the g -value is reduced, the amount of primarily transmitted solar radiation decreases. This is independent of the insulation level of the house, and only depends on the climate and window type, see Fig 5.10. Although the difference is large, the net result on the operative temperatures is quite small, since the window area is just a small share of the total surface area of the house. This is demonstrated in Fig. 5.11, which shows the operative temperatures for the house 2000 for windows 1, 3 and 5. During the non-heating season, there is not a significant difference between the window types, although the lower g -value of window 5 is reflected as a slightly lower operative temperature. During the heating-season, this window naturally results in a higher operative temperature, since it has the lowest U -value. However, close to the window, the differences between windows of various U -values will be much larger than shown for this large volume which has a relatively small window area. This can be seen in the Figs. 5.12-5.14 produced by the COMFORT program, a post-processor to Derob-LTH.

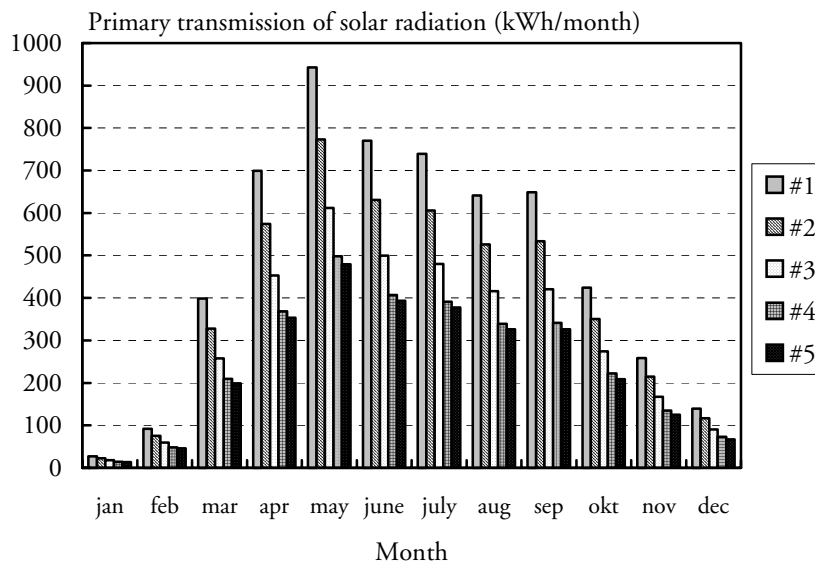

Figure 5.10 Primary transmission of solar radiation (direct and diffuse components) (kWh/month) through all windows of the house as a function of window type. Stockholm climate.

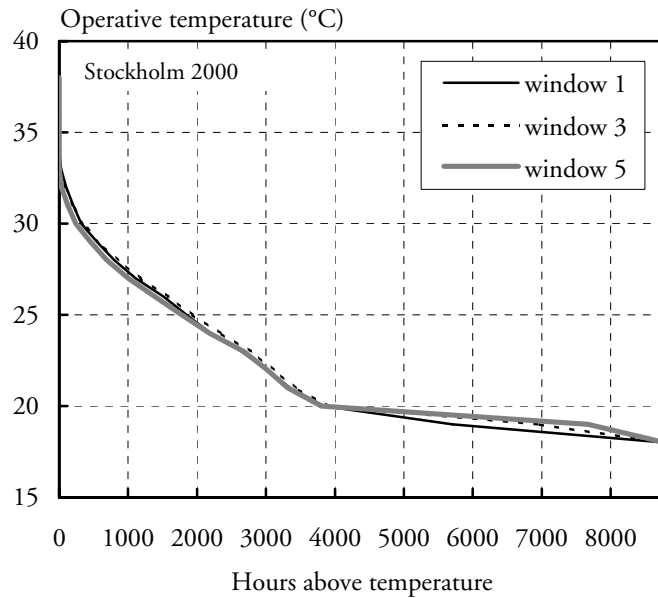

Figure 5.11 Global operative temperature of the ground floor (midpoint of room) as a function of window type for the house Stockholm 2000.

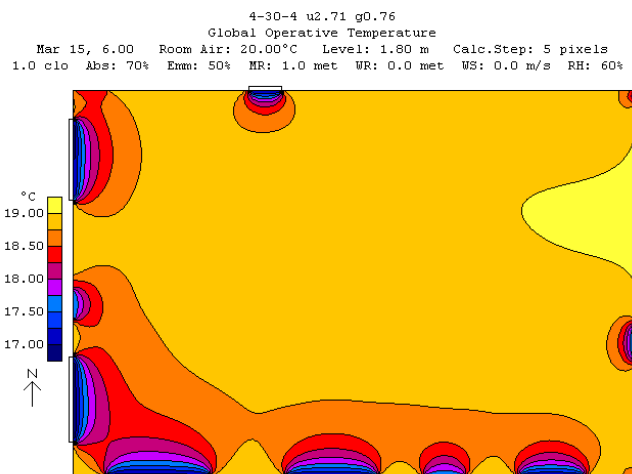

Figure 5.12 Global operative temperature distribution (°C) at 1.8 m above floor for the ground floor for house 2000, window type 1 at an outdoor temperature -10°C , no solar radiation. Generated by the post-processor COMFORT.

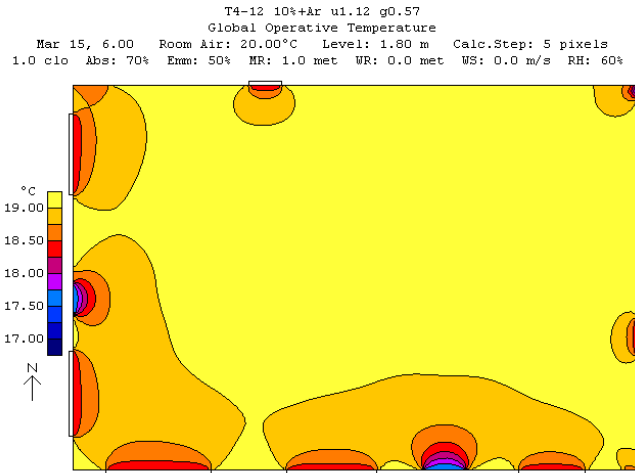

Figure 5.13 Global operative temperature distribution ($^{\circ}\text{C}$) at 1.8 m above floor for the ground floor for house 2000, window type 3 at an outdoor temperature -10°C , no solar radiation. Generated by the post-processor COMFORT.

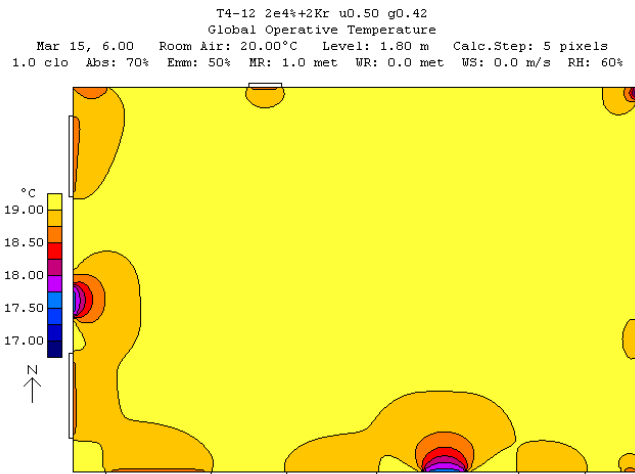

Figure 5.14 Global operative temperature distribution ($^{\circ}\text{C}$) at 1.8 m above floor for the ground floor for house 2000, window type 5 at an outdoor temperature -10°C , no solar radiation. Generated by the post-processor COMFORT.

5.1.4 Cost efficiency of window replacement

The following examples are made to illustrate the possible energy savings of either replacing old windows or selecting slightly better ones than first thought, and the associated costs. The investment costs are annualised using an interest rate of 6% and an assumed service life of 30 years, which gives an annuity factor of 0.0726. The annualised investment costs can then be directly compared to the annual savings (the energy saving times the energy price) to see if an alternative is cost-effective or not. Alternatively, the annual savings can be divided by the annuity factor to obtain the maximum “allowed” investment cost for a measure to be cost-effective, and this method is employed here. The house is assumed to have 16 windows, and for simplicity, we assume that the cost for each window is equal to that of a 1×1.2 m window.

House from 1960

In this example we assume that the original windows, coupled double pane, are in such a bad condition that either renovation or replacement is necessary. In the simplest alternative we assume that the window can be renovated. With rather small measures, the window can be upgraded by replacing e.g. the inner pane of the window by a hard low-e coating (window 6). In the other (replacement) alternatives, we assume that the house-owner has decided to buy a triple IGU window (#2), and we only look at the additional cost for selecting better alternatives (i.e. windows with a lower U -value). Therefore, the calculated costs do not mirror the whole cost of renovation or replacement, since costs associated with e.g. new sealants, trimmings, paint work in the window recess etc. is considered to be done in any case, and are thus not accounted for. Figure 5.15 shows the annual savings in heating demand calculated for the Stockholm climate.

In the renovation alternative (1→6, double clear to hard coated double-pane window) Fig. 5.15 shows that the annual saving is 90 kWh/window. With three assumed levels of the variable cost for heating energy the low-e pane may cost the consumer (incl 25% VAT), 301 SEK for an energy price of 1 SEK/kWh, 211 SEK if the energy price is 0.7 SEK/kWh and 120 SEK if the energy price is 0.4 SEK/kWh assuming a service life of 30 years and a 6% interest rate. This might therefore be a cost-effective measure (except for the lowest energy price) since a low-e coated glass applied at the factory cost about 240 SEK extra per window. How-

ever, small glaziers may charge the consumer anything between 300 to 800 SEK per window, since the ordered quantities are small, and with such prices, it is not a cost-effective alternative.

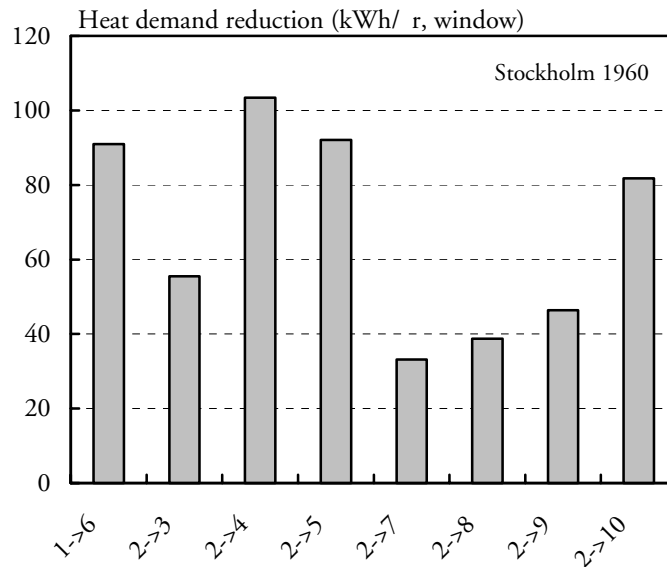

Figure 5.15 Annual savings in heating energy per window as a function of window type replacement. Stockholm 1960. Window types according to Table 5.2.

In the replacement alternatives, the energy savings have been calculated as the additional saving compared to window type 2 (triple-pane clear), Fig 5.15. The allowed additional investment costs have been calculated for various energy prices, Table 5.4. The real additional investment cost for these alternatives have been estimated based on the purchase prices given in Table 5.2, to serve as a guide for cost comparison. Alternatives 3 and 7-10 all seem justified from this simple cost analysis. Especially windows 7-9 seem very cost effective, since the first cost of these windows are even lower than for the triple-pane IGU window chosen as the base case (window 2). This explains why the real estimated costs are negative for these alternatives. However, it must be remembered that the energy savings are smaller compared to other alternatives, e.g. window 10.

Table 5.4 Allowed replacement cost for various energy-efficiency improvements compared to estimated real costs for a house from 1960 in Stockholm. Cost-efficient alternatives are shown in bold-face.

Allowed replacement cost Energy price (SEK/kWh)	Window replacement alternative						
	2->3	2->4	2->5	2->7	2->8	2->9	2->10
1.0	764	1423	1267	457	533	638	1126
0.7	535	996	887	320	373	447	788
0.4	306	569	507	183	213	255	450
Estimated cost	290	1080	858	-831	-873	-873	455

House from 2000

In this example we consider a house that is to be built today, therefore the house 2000 is used as a basis for the calculations. Since today's houses often are built with better windows than window 2, we consider that window 3 (triple, low-e + Ar) is our first choice. However, for a small additional cost, we can also choose other alternatives that will provide additional savings (i.e. windows 4, 5, and 10). Window type 9 (double, low-e + Ar) has also been included as one possible alternative. Even if the U -value is slightly worse, the price seems very attractive. It was also made sure that the house 2000 will fulfil the requirements of the current building code with any of these windows. Otherwise, the same principles are applied as in the example from 1960. The annual savings in heating energy are shown in Fig. 5.16.

The allowed and real additional investment costs are found in Table 5.5. Alternatives 4 and 5 do not seem justified since the allowed cost is always lower than the real estimated cost. Alternative 10 seem to be cost-effective or – for the lowest energy price – close to being so. The negative values for type 9 perhaps need some explanation. The allowed cost is negative, since the quality of this window is slightly lower than for window 3 (i.e. higher U -value which leads to a higher heating demand). However, this window (a double-pane alternative) is much less expensive in purchase (negative estimated cost), therefore it might be chosen even if the thermal comfort and heating demand will be slightly worse than for the other alternatives.

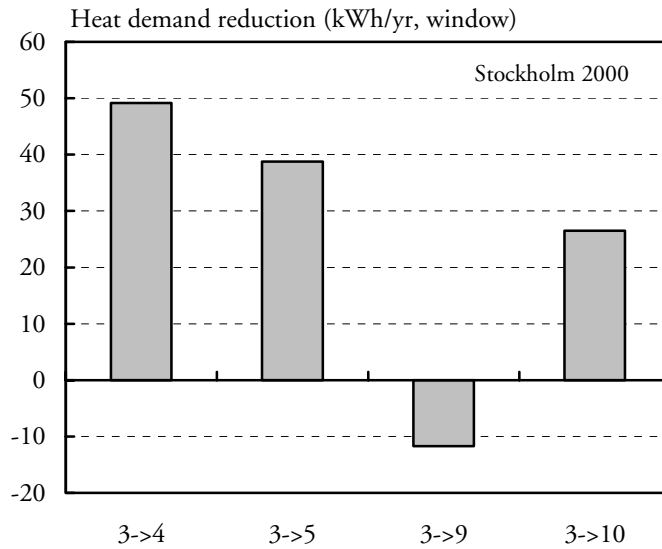

Figure 5.16 Annual savings in heating energy per window as a function of window type replacement. Stockholm 2000. Window types according to Table 5.2.

Table 5.5 Allowed additional cost for various energy-efficiency improvements compared to estimated real costs. Cost-efficient alternatives are shown in bold-face.

Allowed additional cost Energy price (SEK/kWh)	Alternative window choice			
	3->4	3->5	3->9	3->10
1.0	677	534	-161	364
0.7	474	373	-113	255
0.4	271	213	-64	146
Estimated cost	790	568	-1163	165

5.1.5 Effects of orientation

With the original layout, the selected house has its main (long) façade towards south. The window area towards south and west is 41 % respectively, 14 % is against east and 5 % towards north. Therefore, the heating demand will be approximately the same for the main façade to-

wards both south and east orientation. Consequently, results for the main façade towards west and north orientation will also be similar, Fig 5.17. The higher heating demand for the northerly orientation, compared to the southerly, corresponds to an increase of 6-7 % for all window types. It is clear that the window U -value has a much larger impact on the heating demand than the orientation, at least for this moderately glazed house.

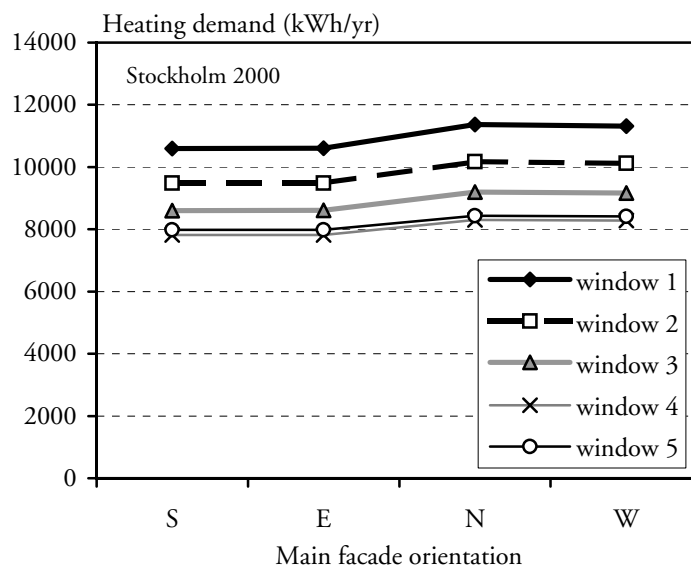

Figure 5.17 Annual heating demand (kWh/yr) as a function of main façade orientation. House Stockholm 2000.

5.1.6 Effects of site/climate

As the window choice may be affected by the local climate, some of the previous simulations were redone for the climates of both Lund (lat 56°N) and Luleå (lat 65°N), using the climate years of 1988.

First, the annual heating demand was calculated. The results for certain combinations of house insulations and window types are presented in Table 5.6. It is clear that the total demand for heating increases quite dramatically for northern cities in Sweden. Compared to Lund, the heating demand for Stockholm is about 25 % higher, and for Luleå it is about 70 % higher.

Table 5.6 Annual heating demand (kWh/yr,m² floor area), as a function of insulation level of house and window type.

Site	Construction year of house, window type			
	1960, #1	1980, #2	2000, #3	2020, #5
Lund	112.8	58.4	44.0	15.9
Stockholm	140.1	74.7	57.4	23.2
Luleå	193.2	106.9	83.4	36.7

The incremental heating demand as a function of window U -value was simulated using the same methodology as in Sec. 5.1.3 in order to determine which U -values are required in order not to increase the heating demand compared to a house without windows. The results for Lund are similar to Stockholm, but the milder climate is reflected as slightly higher allowed U -values of windows, see Fig 5.18 and Table 5.7. In Luleå, the winter is colder and longer than in both Stockholm and Lund. Therefore, the maximum allowed U -values are even lower for Luleå, see Fig 5.19 and Table 5.7.

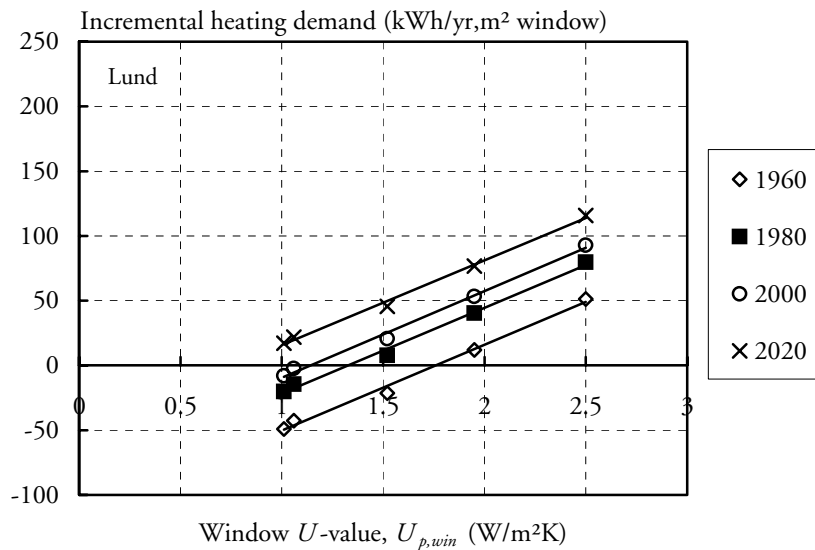

Figure 5.18 Incremental heating demand (kWh/yr,m² window area) as a function of window U -value and construction year of house. Simulations performed for the Lund climate.

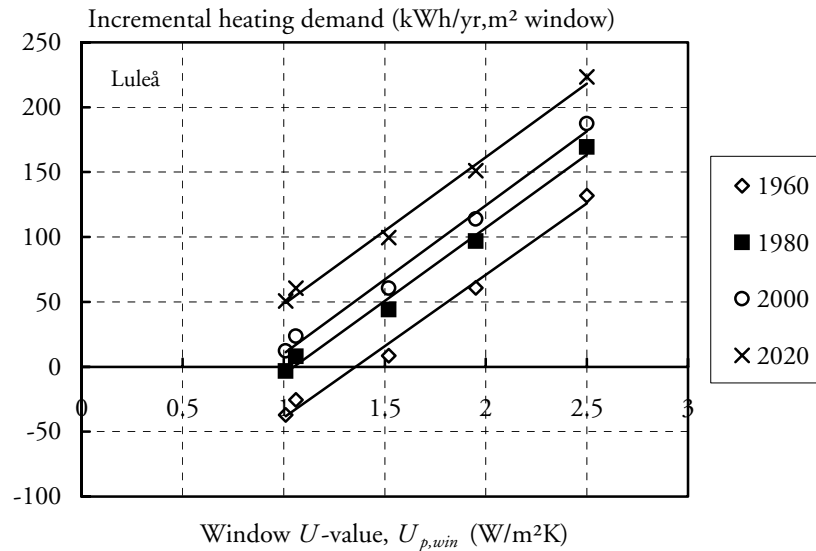

Figure 5.19 Incremental heating demand (kWh/yr, m² window area) as a function of window U-value and construction year of house. Simulations performed for the Luleå climate.

Table 5.7 Maximum allowed window U-value (W/m²K) as a function of construction year of house on the criterion that the windows should not increase the total heating demand compared to an opaque house.

Site	Construction year of house			
	1960	1980	2000	2020
Lund	1.76	1.33	1.14	0.76
Stockholm	1.56	1.18	1.00	0.65
Luleå	1.36	1.05	0.91	0.57

A summary of potential overheating problems is given in Table 5.8. Surprisingly, the overheating problems seem to increase as the house is moved further north. This might be explained by the fact that the summer is short but very intense, and generally the solar radiation during the summer months is higher in Luleå than in both Lund and Stockholm (Wall, 1994). Further, the solar altitude is lower which gives a smaller incidence angle to the window, and hence a larger part of the solar irradiation is transmitted. Since the house Luleå 2020 does not behave as expected, the duration curve of the operative temperature was plotted for

this house and for the climates Lund and Stockholm as well, Fig 5.20. Here it is clearly seen that the maximum operative temperature is higher in Luleå, but the peak is much more sharp. These extremely high operative temperatures will in reality not be tolerated. People will provide for ventilation by opening doors and windows and/or install some type of shading device, e.g. an awning.

Table 5.8 Number of hours with an operative temperature above 27°C as a function of climate and insulation level of house. Window type 3.

Site, climate year	Construction year of house			
	1960	1980	2000	2020
Lund, 1988	122	281	598	2919
Stockholm, 1988	253	540	853	2974
Luleå, 1988	375	792	959	2021

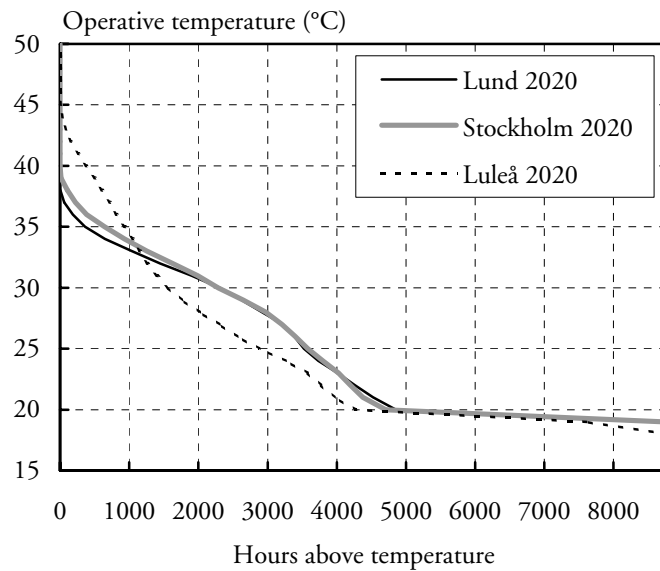

Figure 5.20 Global operative temperature (°C) of the ground floor (midpoint) as a function of climate. Window type 3 in house 2020.

However, the effect seen for Luleå might be due to that the climate years are not fully comparable concerning a few summer months, since they were mainly selected to be typical over the whole year (Wall, 1994). For

example, in both Lund and Stockholm, the solar radiation in May was slightly above the 10-year period average from which the climate years were chosen (1983-1992). The June values were average, and the July values were lower than average. For Luleå however, the solar radiation was average to high for the same months. Also in April the radiation was higher than average in Luleå. However, the differences in solar radiation and outdoor temperatures for the selected climate years have not been studied in detail.

5.1.7 Effects of reduced emittance

The effect of varying emittance of the low-e coating was studied for the case Stockholm 2000. This is interesting since the improved U -value is accompanied by a lower g -value as well. Three similar double-pane windows with argon (7, 8, 9) were compared, with the respective emittances of 16%, 10% and 4%. The resulting annual heating demands for the three window types are given in Table 5.9. The net energy savings for windows 8 and 9 (compared to window 7) were 101 and 240 kWh/yr respectively.

Table 5.9 Annual heating demand (kWh/yr) and net energy savings (kWh/yr), for window types 7-9 in the house Stockholm 2000.

Annual demand and saving (kWh/yr)	Window type		
	(7)	(8)	(9)
Heating demand	9031	8930	8791
Net energy saving	0	101	240

As the net energy savings of windows 8 and 9 are hard to evaluate on their own, the effects of the improved U -value and the reduced g -value were studied separately. The U -value effect was studied by a new series of simulations under conditions with solar radiation in the following way: Two fictitious glazing types were constructed (8' and 9'), with the same emittances (i.e. U -values) as windows 8 and 9 respectively, but with the g -value of glazing 7 ($g = 0.71$). The g -value effect was studied in the same manner by creating two other fictitious glazings (8'' and 9'') with the same g -values as windows 8 and 9 respectively, but with the U -value of glazing 7 ($\epsilon = 16\%$). The performance of the real and the fictitious glazings are given in Table 5.10, and the corresponding annual energy demands and the net savings are found in Table 5.11. The U -value effect gives

savings of 239 and 499 kWh/yr for windows 8 and 9 respectively. The energy savings due to the g -value effect are negative, -137 and -265 kWh/yr respectively, which is due to the decreasing solar gains.

As the net energy saving is the sum of the U -value and g -value effect, it should be equal to the first simulation given in Table 5.9, and this is also roughly correct, Table 5.11.

Table 5.10 Thermal and solar transmittance of the original and fictitious glazings.

	Glazing type						
	(7)	(8)	(9)	(8')	(9')	(8'')	(9'')
U_{orig} (W/m ² K)	1.5	1.35	1.18	1.35	1.18	1.5	1.5
g (-)	0.71	0.65	0.60	0.71	0.71	0.65	0.60

Table 5.11 Annual heating demand (kWh/yr) and expected energy savings for (I) the U -value improvement alone (kWh/yr), and (II) for the g -value reduction alone (kWh/yr). Net energy saving (kWh/yr) for the combined effect of (I) and (II). Window types 7-9 in the house Stockholm 2000.

	Glazing type		
	(7)	(8')	(9')
I) U -value effect, Equal g -value			
Heating demand	9031	8792	8532
Expected saving	0	239	499
II) g -value effect, Equal U -value	(7)	(8'')	(9'')
Heating demand	9031	9168	9296
Expected saving	0	-137	-265
Net energy saving	(7)	(8)	(9)
(I+II)	0	102	234

Finally, a comparison with the ‘Karlsson’ window formulae, outlined in the beginning of this chapter, was performed. First, the degree-hours G for this house and climate were determined, using the approach given in Eq 5.1. In order to do this, the balance temperature of the building must be determined. This was done by plotting the simulated hourly heating demand against the outdoor temperature for the house 2000 (with window 7), see Fig 5.21. The balance temperature 13.6°C was found from where the regression line crosses the x-axis, and the corresponding degree-hours G are 113.4 k°Ch.

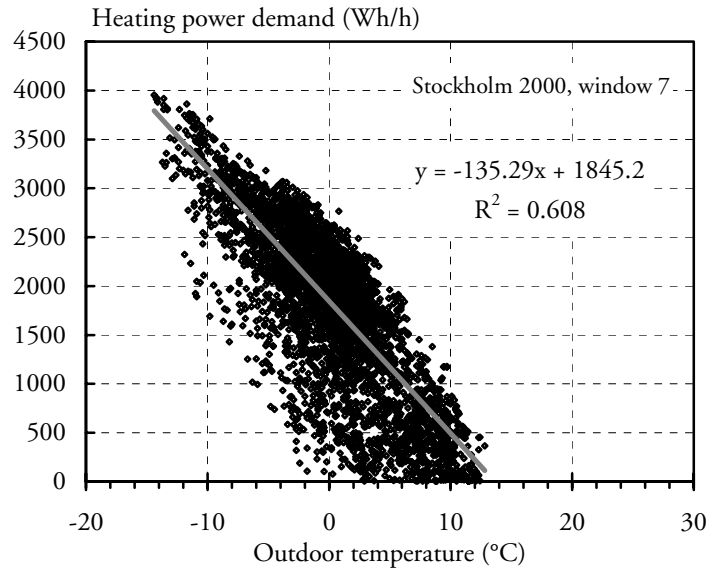

Figure 5.21 Heating power demand (Wh/h) for the house Stockholm 2000 as a function of the outdoor temperature. Window type 7. All hours with zero heating demand have been eliminated from the graph.

The hourly solar radiation was equally summed up to the balance temperature t_b , which gives $S(13.6)=274$ kWh/m²,yr. This was easy to do, since the total solar radiation on the exterior side of transparent surfaces is given in the results-file of the Derob simulation. This value of S includes some shading of both the roof and the reveal, since a small reveal was modelled in the Derob simulations (protruding 10 cm out from the façade at 10 cm distance from the glazing edge), see Fig 5.1. It is also an average for all window orientations, in this particular case south = 41 %, west = 41 %, east = 14 %, and north = 5 %. The energy savings that can be expected from the improved U -value, ΔQ_{loss} , and from the solar gains, ΔQ_{solar} , were then determined as:

$$\Delta Q_{loss} = \Delta U_{cog} \cdot A_{glass} \cdot G \quad (5.3a)$$

$$\Delta Q_{solar} = \Delta \bar{g} \cdot A_{glass} \cdot S \quad (5.3b)$$

The value of the solar transmittance for the windows was taken as the g -value for 55° incidence angle. The respective $g(55^\circ)$ values for glazings 7-9 were thus approximately determined to 0.63, 0.58 and 0.53. However, since this is only an approximate method, the values for normal inci-

dence could also have been used, since the g -value difference between the glazings are similar for the two angles. The glazing area was 15.5 m². The resulting savings are shown in Table 5.12.

Table 5.12 Expected net energy savings for the 'Karlsson' window formulae with the effects of U -value improvement and g -value reduction separated. Window types 7-9 in the house Stockholm 2000.

Expected saving, Karlsson's method	Window type		
	(7)	(8)	(9)
U -value effect, ΔQ_{loss} ($G=113.4$ k°Ch)	0	263	561
g -value effect, ΔQ_{solar} ($S=274.3$ kWh/m ² ,yr)	0	-212	-424
Net energy saving	0	51	137

The discrepancy between the dynamic computer simulations and the Karlsson method is rather small regarding the incremental heat losses (around 10 %, compare Tables 5.11 and 5.12). In the Derob-LTH simulations, the U -values are temperature dependent (see chapter 3), and the dynamic effects of varying temperatures and internal gains are all accounted for, the building never reaches steady-state conditions. The solar radiation is however the part that varies the most. The reduction of the solar gains using the degree-hour method is 55-60 % larger compared to the estimations using Derob-LTH. Here, the choice of the balance temperature seems to be very critical, and a lower balance temperature should be applied. However, the balance temperature that approximately matches the Derob-results regarding the insolation is as low as 7°C. All in all, the net energy savings using the Karlsson method are thus only about half of those estimated by Derob-LTH. Since the Karlsson formulae is an approximate method, these kinds of discrepancies are to be expected.

5.2 Single-person office room

In article II is presented a calculation example of a single-person office room with the glazing-to-wall area ratio (GWAR) varying from 0 to 50 %. It was demonstrated that the cooling demand increases more rapidly than the heating demand as the GWAR increases. This will be made clearer in the following section, where some further calculations based on the same example are made. The geometry of the office space is again repeated here, Fig. 5.22.

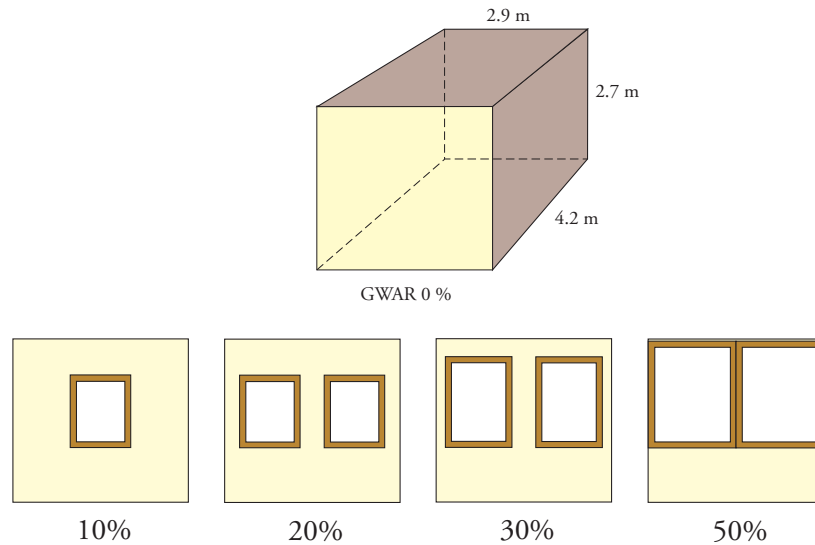

Figure 5.22 The geometry of the office model with Glazing-to-Wall Area Ratios of 0, 10, 20, 30 and 50 %.

In the examples below, the incremental heating and cooling demands are calculated for both a south and north facing office room for five glazing types. Four of them are identical to those in article II. A fifth glazing type is added which is a triple glazing with one low-e coating and argon, identical to that of window type 3 in the residential example above, see Table 5.13. The incremental energy demand is here defined from the non-glazed wall (GWAR 0 %), and presented as the annual demand per square meter of floor area.

Table 5.13 Window alternatives, thermal and optical performance. The total window U -value applies to a window 1.1×1.3 m, used in the case GWAR 30 %. Glass distance 12 mm. U_{cog} calculated at 0/20°C, 5 m/s in Window 4.1. Coating position is counted from the outermost glass surface and inwards.

Glazing type	No. of panes	Coating position	Gas filling	U_{cog}	U_f (W/m ² K)	U_{win}	g (-)	T_{vis} (%)
double, clear	2	-	Air	2.79	2.16	2.61	0.75	80
triple, clear	3	-	Air	1.85	2.16	1.94	0.66	72
triple, e10%	3	5	Air	1.32	2.16	1.56	0.57	69
triple, e10%+Ar	3	5	Ar	1.12	2.16	1.42	0.57	69
triple, 2e10%+2Kr	3	2, 5	Kr	0.62	1.70	0.94	0.50	66

For the south facing office, the incremental heating demand varies significantly with both GWAR and window U -value, Fig 5.23. As expected, the clear double-pane window displays a significant increase in heating demand as the quite well-insulated wall is replaced by a larger and larger window of a significantly higher U -value. The clear triple-pane window displays a moderate increase, while the two low-e triple-pane windows are hardly affected by changes to window area. It is again clearly shown that the superwindow will gain energy over the year, as demonstrated by the decreased heating demand for large GWARs.

While the incremental heating demand varies significantly with window U -value, the incremental cooling demand is almost equal for all window types, Fig 5.24. This is explained by the relatively small difference in g -value between the cases. The clear double-pane window has the highest g -value, and consequently displays the highest increase in cooling demand. However, the superwindow does not show the lowest increase in cooling demand, even if its g -value is lowest in the group. Since its U -value is also very low, less energy is also lost to the outside. This example demonstrates that there can be a fine balance between solar gains and thermal losses.

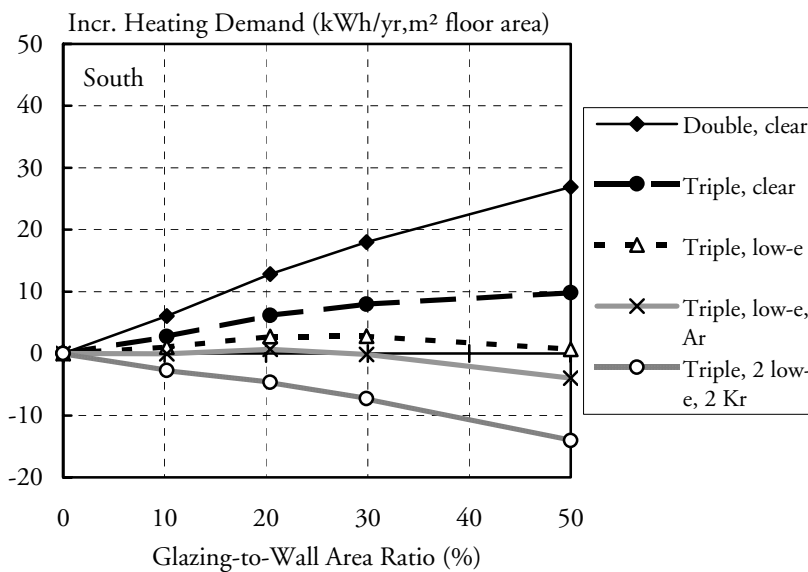

Figure 5.23 Incremental heating demand (kWh/yr, m² floor area) as a function of GWAR and window type for a south facing office in Lund.

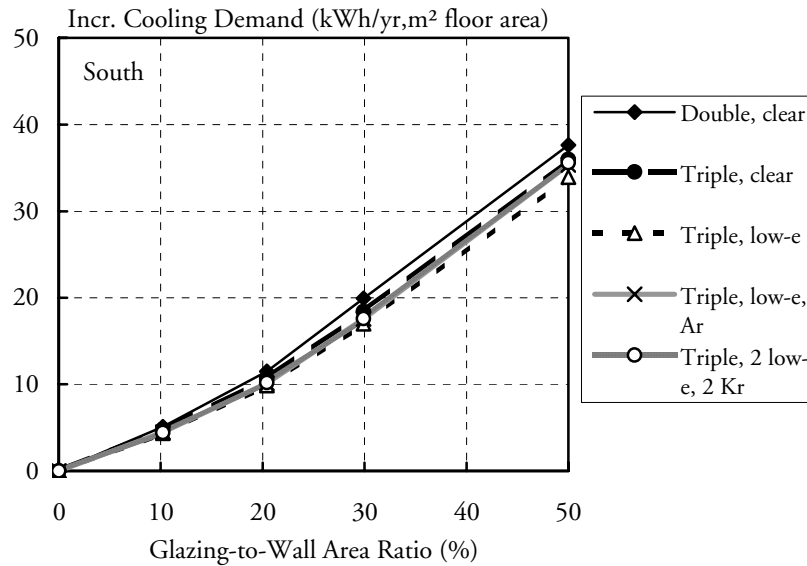

Figure 5.24 Incremental cooling demand (kWh/yr, m² floor area) as a function of GVAR and window type for a south facing office in Lund

For a north facing office room, the incremental heating demand is of course very large for the clear, double-glazing. Only the superwindow shows a moderate increase in heating demand as the window area is enlarged, Fig 5.25. One can also see that the superwindow towards north behaves similar to the clear triple-window towards south, compare Figs. 5.23 and 5.25.

Although small, there does exist a cooling demand for north facing offices. The incremental cooling demand is similar for all glazing types, Fig 5.26.

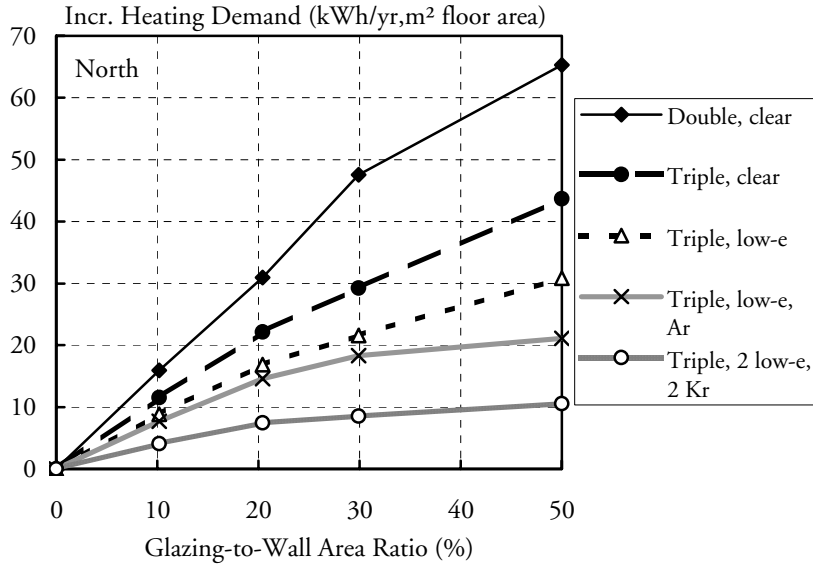

Figure 5.25 Incremental heating demand (kWh/yr, m² floor area) as a function of GWAR and window type for a north facing office in Lund.

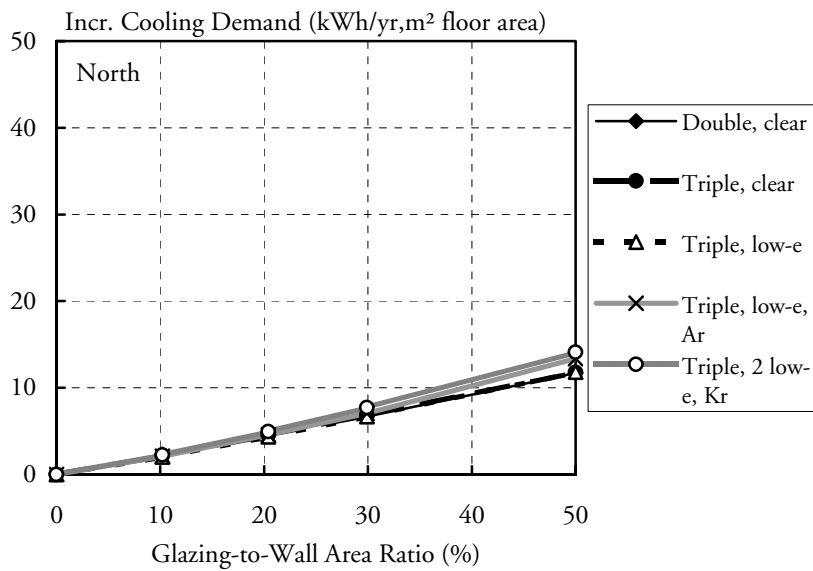

Figure 5.26 Incremental cooling demand (kWh/yr, m² floor area) as a function of GWAR and window type for a north facing office in Lund.

5.2.1 Electric lighting savings through daylight utilisation

The effect of daylight utilisation (see Sec 4.5) on heating and cooling demands was studied in article II. This required that simulations of the electric lighting use were performed. The simulations were not described in article II, but are presented here. The lighting simulations were performed using Superlite and Superlink in the ADELIN 2.0 program package (Erhorn & Stoffel, 1997). Thereby, output files with hourly power needs for the lighting were created, using hourly values of sunshine probability based on the Lund climate.

The sunshine probability, SSP , is an attempt to link the actual weather pattern to the set of standard skies used in Superlite (i.e. CIE overcast sky, and CIE clear sky with and without sun), see Szerman (1994). Since the Superlink program had a problem with the format of the Swedish weather file (for direct normal radiation), the SSP was derived from the weather file in the following manner:

$$SSP(i) = I_N(i)/I_{N,max} \quad 0 \leq SSP \leq 1 \quad (5.4)$$

where $SSP(i)$ is the percentage of sunshine during hour i , $I_N(i)$ is the direct solar radiation for the i^{th} hour of the year, obtained from the weather data, and $I_{N,max}$ is the maximum possible direct radiation during the same hour (assuming a perfectly clear sky). A routine for generating the SSP -values from the weather file was built which involved calculating solar angles, and the direct radiation through Linke turbidities, relative optical air mass and optical thickness of the atmosphere according to a model described by Grenier et al. (1994).

Electric lighting savings were calculated for two lighting installations of different efficiency: (1) *high efficiency* with a lighting power density of 10 W/m² (used in article II), and (2) *low efficiency* with a lighting power density of 18 W/m². In both cases it was assumed that the installation would provide 500 lux in the midpoint of the room at desk level.

When a continuous dimming strategy is used, the lighting is dimmed exactly to the amount of available daylight. In Superlink, the power demand of the lighting is reduced in direct proportion to the light output (one to one), i. e. when the light output goes from 100 to 0 %, the power demand goes from 100 to 0 %. This is not correct and has been described by Christoffersen (1995). Reality, is not so ideal: the lights are designed to be most efficient (highest lumens per Watt) at full power. For a typical fluorescent light source with electronic ballast, the power demand goes from 100 to about 30 % when the lighting is dimmed from 100 to 10 %.

The power demand for the lighting was therefore recalculated according to the following formula, adopted from specifications by Philips Lighting (1997), before creating internal load files for Derob-LTH:

$$\text{for } P_i/P_{max} \geq 0.10: \quad P_{real,i} = (0.75 \cdot P_i/P_{max} + 0.25) \cdot P_{max} \quad (5.5a)$$

$$\text{for } P_i/P_{max} < 0.10: \quad P_{real,i} = 0.325 \cdot P_{max} \quad (5.5b)$$

where P_i is the lighting load for the i^{th} hour according to Superlink (Wh/h), P_{max} is equal to the installed power (W), and $P_{real,i}$ is the recalculated (realistic) lighting load for the same hour (Wh/h). This means that the lowest lighting load (base load) during working hours was 32.5 % of the installed power. The results calculated according to Eq. 5.5 are called “realistic” dimming.

In the original Superlink results the base load was close to zero. In order to see how much this would affect the calculated lighting savings the original loads in Superlink were also evaluated, and the results are referred to as “ideal” dimming. Additional control strategies, e.g. switching off the lighting when it has been fully dimmed for some time interval, were not applied. All calculations were performed for the four major orientations (S, N, E, W) and the resulting savings shown in Fig 5.27 are the average values for the four orientations.

The savings in Fig. 5.27 should be compared to the annual electricity use for lighting without dimming which was 23 kWh/m²,yr and 43 kWh/m²,yr for the two lighting power densities 10 and 18 W/m² respectively. Naturally, the largest savings occur for the largest windows. For GVAR 50 % they amount to 13 kWh/m²,yr for the high-efficiency lighting and to 24 kWh/m²,yr for the low-efficiency alternative, which in both cases corresponds to a saving of approx. 55 %. However, the potential error of not recalculating the lighting load (the ideal dimming cases) would have lead to estimated savings of almost 80 %, which is significantly higher than for the realistic cases.

The difference in savings with respect to window type is however almost negligible: The double, clear window yield at most 10 % higher savings, and never more than 2.5 kWh/m²,yr compared to the super-window.

It should be emphasised that all savings are optimistic estimates since they are compared to having the lighting on all day. In a real case, the lighting will sometimes be switched off.

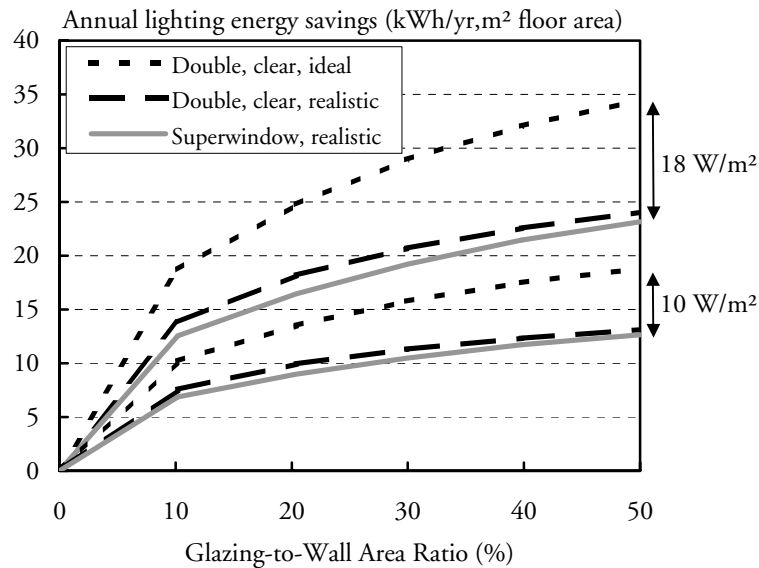

Figure 5.27 Annual electric lighting savings (kWh/yr, m² floor area) calculated in Superlite/Superlink as a function of Glazing-to-Wall Area Ratio for two lighting power densities (10 and 18 W/m²) and two glazing types (double, clear and superwindows). Two cases of continuous dimming are shown: realistic and ideal. Average of S, N, E, and W orientations for Lund 1988.

5.3 Office space fully glazed on three sides

In the previous sections only clear windows and windows with dedicated low-e coatings were compared. However, for offices the current trend is to use very large glazed surfaces, up to 100% of the wall area. This poses a potentially huge stress on the cooling system if no solar control measures are taken. Therefore, for such buildings the term energy-efficient takes on a new meaning: energy-efficiency is now achieved by a low g -value to reduce or totally avoid the need for air-conditioning during the summer. However, a low U -value is also necessary to prevent bad thermal comfort during the dark and cold winter period, since a wall U -value of around 0.2 W/m²K is replaced by a much higher U -value of the glass, normally on the order of 1.0-1.2 W/m²K.

A low g -value can be achieved through the use of solar control glass, shading devices or a combination of both. Exterior devices have a much larger potential to reduce solar gains since the absorbed heat is dissipated

to the ambient air. However, these solutions are sometimes not wanted due to various local factors, e.g. maintenance, wind sensitivity, aesthetics etc. Nevertheless, some type of shading device is always needed, if not for solar control, at least to control glare, see Chapter 4.

Below is presented an example of an office space in Lund glazed on three sides; towards east, west and north. The space is located on the top floor and in the north-west corner of a larger office building. The east wall faces a courtyard, and is therefore partly shaded during the morning hours, see Fig 5.28. The dimensions of the space are 4.2 by 7.8 m and the ceiling height is 3.2 meter. The intended use of this space is as a conference room for 12 people, but it could also be used as an office space for two people. The assumed internal loads and ventilation/infiltration rates are given in Table 5.14. The inlet temperature of the air was constant at 17°C.

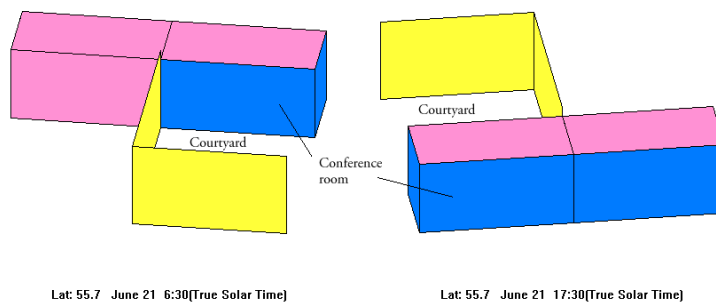

Figure 5.28 Solar views of the modelled space, fully glazed towards east, west and north, and a neighbouring office space. Seen from the direction of the sun in the morning (6:30) and afternoon (17:30), true solar time.

Table 5.14 Assumed internal loads (W) and ventilation/ infiltration rates during summer and winter periods.

hour	12 people		2 people		remark
	summer 1/4-30/9	winter 1/10-31/3	summer 1/4-30/9	winter 1/10-31/3	
00-07	0	0	0	0	
07-08	500	700	500	700	lighting
08-18	1700	1900	700	900	lights + people
18-19	500	700	500	700	lighting
19-24	0	0	0	0	
ventilation	144	144	40	40	(l/s)
infiltration	0.25	0.25	0.25	0.25	(ach)

A clear triple glazing (#1) was selected as a base case for the calculations. This was then compared to three other glazing alternatives: (#2) a double-pane glazing with an advanced solar control coating with high visual transmittance; (#3) a double-pane, advanced solar control glazing with slightly lower visual and solar transmittance than #2, but with a similar U -value; and (#4) where a third, low-e, pane was added to #2 in order to obtain a lower U -value. The glazing data are given in Table 5.15. In an additional case (#2+screen), an exterior solar screen with a transmittance of 27 % and absorptance of 19 % was applied to glazing alternative 2 to study the efficiency of exterior solar shading devices.

Table 5.15 Glazing alternatives, thermal and optical performance.

Glazing	Description	No. of panes	Coating position	Gas filling	Gap width (mm)	U_{cog} (W/m ² K)	g (-)	T_{vis} (%)
#1	clear glass	3	2	Air	12	1.65	0.68	72
#2	solar A	2	2	Ar	15	1.14	0.36	64
#3	solar B	2	2	Ar	15	1.12	0.27	51
#4	solar A+le4%	3	2, 5	Ar	12	0.67	0.21	43

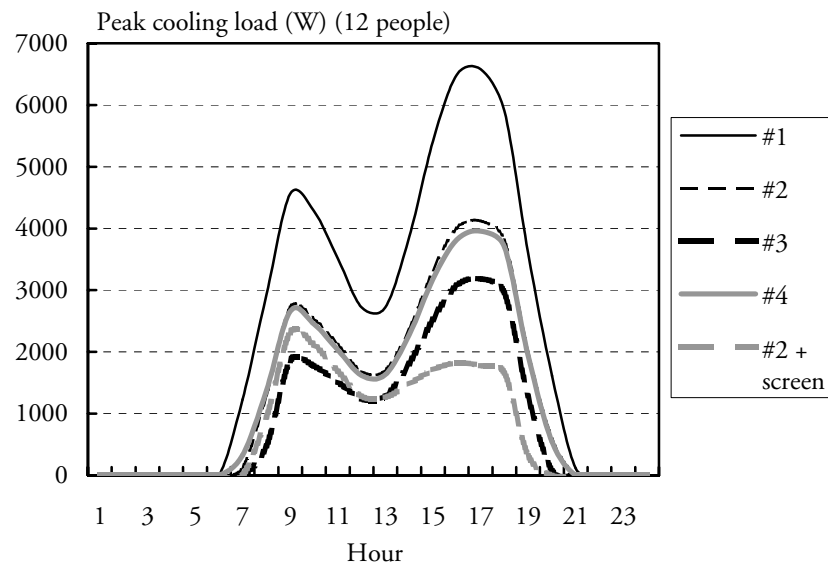

Figure 5.29 Peak cooling load as a function of glazing type and exterior shading for internal loads and ventilation corresponding to 12 people. Fictitious climate with maximum outdoor temperature of 28°C.

The peak cooling load was calculated for a fictitious climate corresponding to a maximum outdoor temperature of 28°C, sinking to 17°C at night, and a rather intense solar radiation for the latitude in Lund. ($I_N=906$, $I_{dH}=116\text{ W/m}^2$, solar height of June 11). The space was cooled to 25°C. Fig. 5.29 shows that there is a small morning peak, due to the partly shaded east façade, and a larger afternoon peak due to the unobstructed view of the west façade. The triple, clear glazing (#1) gives rise to a very high peak load of 6.6 kW, which will be almost impossible to get rid of with traditional cooling baffles, since the space is rather small (33 m²). However, glazings #2 and #4 reduces the peak load by around 40 % (to 4.1 and 4.0 kW), and with glazing #3, the cooling load is halved to 3.2 kW. In the additional case #2+screen, an exterior fabric screen was applied on the west façade only. This reduces the afternoon peak by almost 75 % (to 1.8 kW) compared to clear triple glazing.

The annual energy demand was calculated for the Lund 1988 climate with internal loads and ventilation corresponding to two persons. Since this space may not be fully occupied as a conference room every day of the year, this seemed like a more conservative assumption. The thermostat set-points were 20°C for heating and again 25°C for cooling. As Fig. 5.30 shows, the annual heating demand depends mainly on the window U -value. It is highest for glazing 1, glazings 2 and 3 (with similar U -values) give similar results, while the better window 4 gives a significantly lower heating demand. This is also demonstrated in Fig. 5.31, which shows that the annual heating demand depends linearly of the U -value. Glazing 2 has a slightly higher heating demand with the screen than without, since the screen was applied throughout the year (i.e. lower beneficial solar gain).

Fig. 5.29 demonstrated that the cooling demand depends mostly on the g -value, however, the relationship is not perfectly linear, Fig 5.32. Although glazing 4 has a low g -value, it also has a lower U -value than the other glazings. This prolongs the cooling season, and the peak load becomes similar to glazing 2, which has a much higher g -value.

To the calculated demands for space heating and cooling, the energy for keeping the inlet air constant at 17°C should be added. This requires 235 kWh/yr,m² floor area of heating, and 7 kWh/yr,m² of cooling energy. However, these demands will normally be cut down via heat recovery systems in the HVAC system.

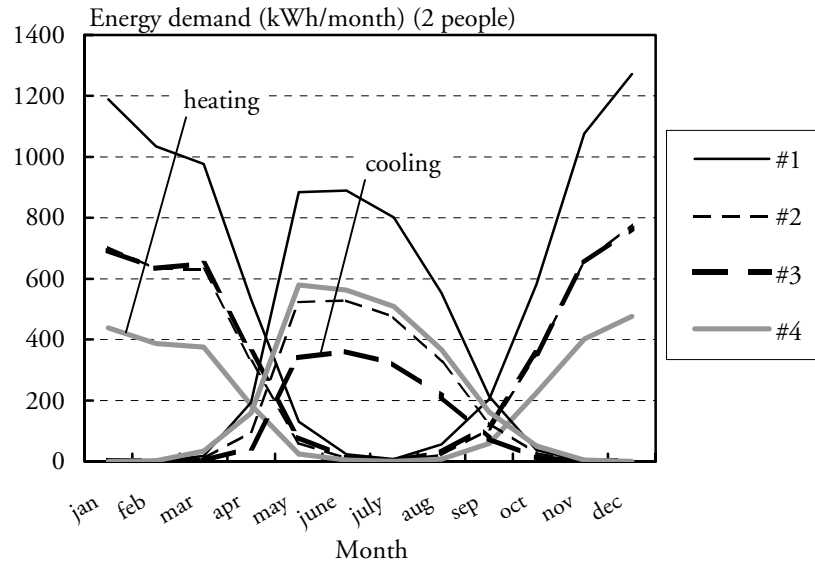

Figure 5.30 Monthly demand for heating and cooling (kWh/month) as a function of glazing type. Lund 1988.

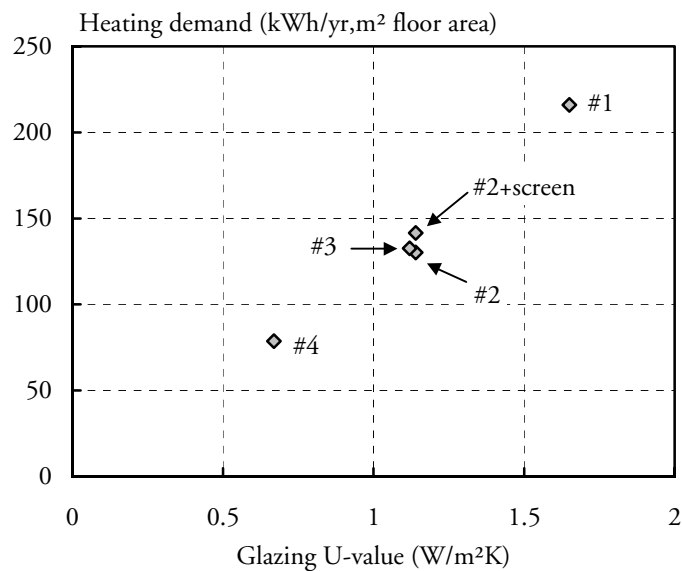

Figure 5.31 Annual heating demand (kWh/yr, m² floor area) as a function of glazing U-value.

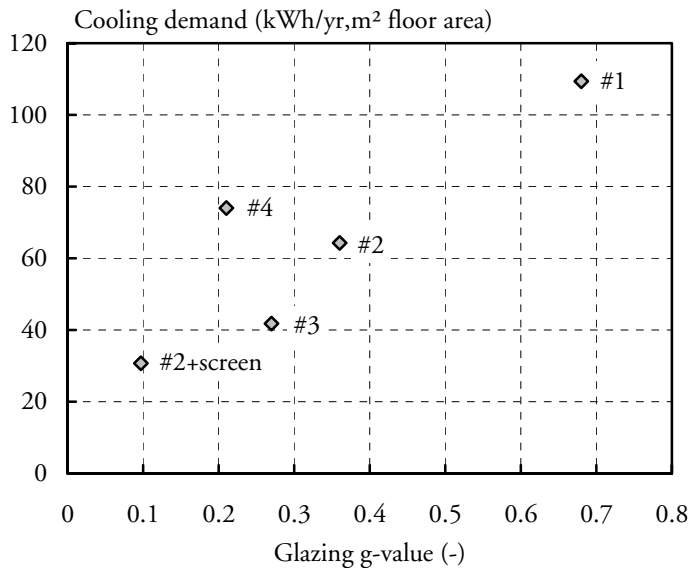

Figure 5.32 Annual cooling demand (kWh/yr, m² floor area) as a function of glazing g-value.

The resulting thermal comfort in the space is demonstrated in the following graphs, which were produced by the Derob-LTH post-processor COMFORT, Figs 5.33-35. They show the global operative temperature at 1.2 m for (1) a summer case (+19°C, and intense solar radiation during an afternoon hour) and (2) a winter case (-5°C and no solar radiation). The winter case does not include any radiative heating, as all the energy for heating is supplied directly to the air.

In the summer case (Figs. 5.33-34) the operative temperature of the space is uncomfortably high during a clear sunny afternoon, even if the air temperature is cooled to 25°C. This is because the internal glass surfaces become very warm. A low g -value of the window system is essential during sunny conditions. In the first glazing alternative (#1) (Fig. 5.34, top), the inner side of the sunlit pane is 39°C. It is reduced slightly to 34°C for glazing 2, to 32°C for alternative 3, but increases to 36°C for glazing 4. Only the case 2 + screen gives a surface temperature similar to the non-sunlit glass surfaces, 28°C, Fig. 5.33. This demonstrates the great difficulty of achieving a good thermal comfort during summer periods with intense solar radiation.

In the winter case (-5°C), the triple clear glazing will yield an unsatisfactory thermal environment, since the surface temperature of the glazing will be low (12°C), and the average operative temperature is only

17°C, Fig 5.35 (top). With glazing 2, a slightly better thermal environment is achieved, but still the operative temperature is low, on average 18°C, Fig 5.35 (middle). The corresponding surface temperature of the glazing is about 14°C. In order to achieve an operative temperature of above 18°C, a lower U -value is needed. This is done by glazing 4, where the operative temperature is about 19°C, and the glazing surface is about 16°C, Fig 5.35 (bottom).

The choice of the outside temperature (-5°C) is very modest, but on the other hand it is a temperature that occurs quite frequently in Lund. According to the building code (BBR 99), the operative temperature should be calculated for a dimensioning outdoor temperature DUT_{20} that statistically only occurs once every 20 years. The requirement is that the operative temperature shall not go below 18°C for certain points in the room as specified in the code (e.g. 1 m from the window). DUT_{20} is determined from the normal average temperature of the month of January, and from the time constant of the building according to Swedish Standard SS 02 43 10. In January, the average outdoor temperature is 0.7°C in Lund, -3.5°C in Stockholm and -10°C in Luleå. The corresponding values for DUT_{20} for a building with a short time constant (25 h) becomes -11°C for Lund, -19°C for Stockholm and -28°C for Luleå. For such low outside temperatures, it will be even more difficult to comply with the requirements in the building code for fully glazed buildings. All in all, this example demonstrates that fully glazed buildings are very dependent on the outside environment, and it can become very costly to achieve a good thermal environment throughout the year.

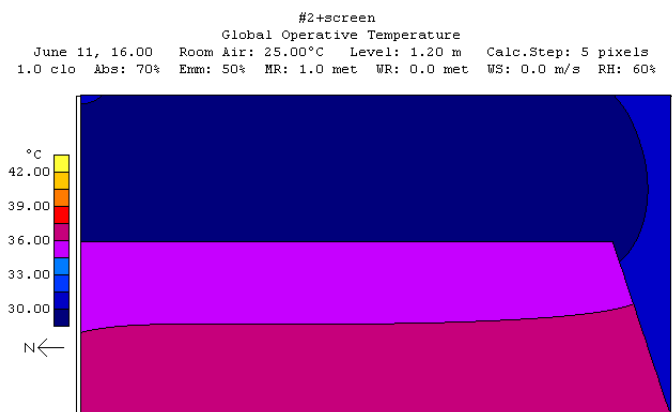
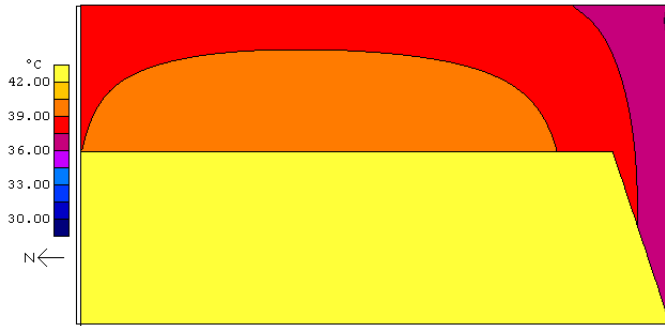
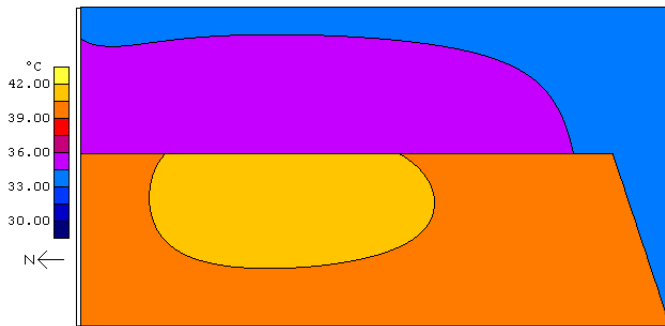

Figure 5.33 Global operative temperature at an outside temperature of 19°C , a direct normal radiation of 905 W/m^2 , and a diffuse radiation of 68 W/m^2 , June 11th at 16.00 hrs., for window type 2 with an exterior screen towards west.

#1
 Global Operative Temperature
 June 11, 16.00 Room Air: 25.00°C Level: 1.20 m Calc.Step: 5 pixels
 1.0 clo Abs: 70% Emm: 50% MR: 1.0 met WR: 0.0 met WS: 0.0 m/s RH: 60%



#2
 Global Operative Temperature
 June 11, 16.00 Room Air: 25.00°C Level: 1.20 m Calc.Step: 5 pixels
 1.0 clo Abs: 70% Emm: 50% MR: 1.0 met WR: 0.0 met WS: 0.0 m/s RH: 60%



#3
 Global Operative Temperature
 June 11, 16.00 Room Air: 25.00°C Level: 1.20 m Calc.Step: 5 pixels
 1.0 clo Abs: 70% Emm: 50% MR: 1.0 met WR: 0.0 met WS: 0.0 m/s RH: 60%

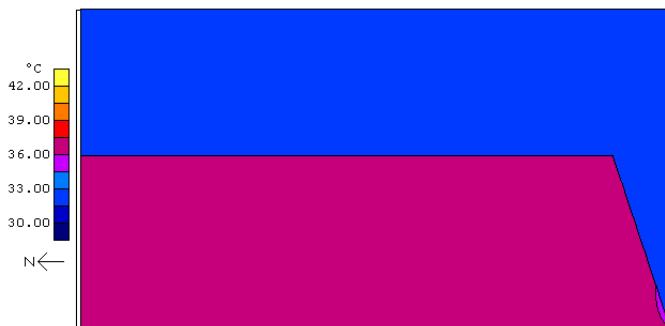

Figure 5.34 Global operative temperature at an outside temperature of 19°C, a direct normal radiation of 905 W/m², and a diffuse radiation of 68 W/m², June 11th at 16.00 hrs., for three glazing g-values: 0.68 (top), 0.36 (middle) and 0.27 (bottom).

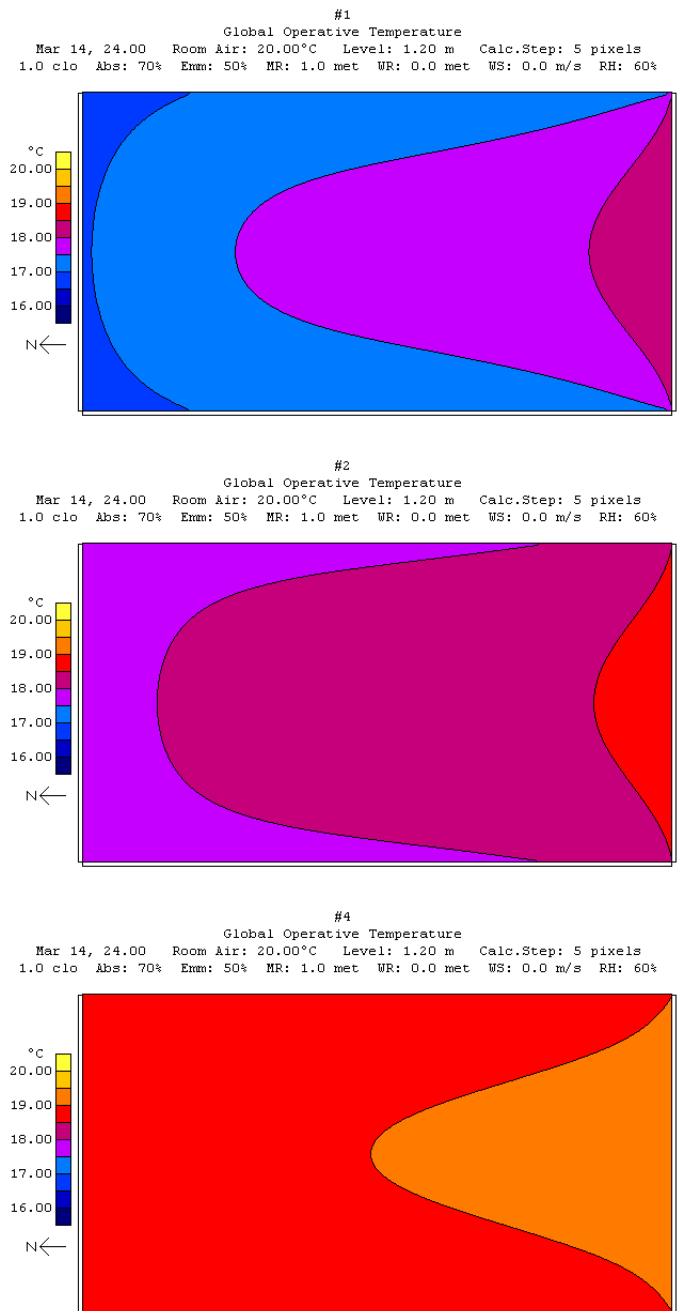

Figure 5.35 Global operative temperature at an outside temperature of -5°C , no solar radiation, for three glazing U -values: 1.65 (top), 1.14 (middle) and $0.67\text{ W/m}^2\text{K}$ (bottom).



To summarize this chapter, we have seen that the window has a significant impact on the energy balance of a building. The residential example demonstrates that when the total window U -value is reduced from 2.5 to 1.0 $\text{W}/\text{m}^2\text{K}$, the annual heating demand is reduced by 100 $\text{kWh}/\text{yr},\text{m}^2$ window area in Lund, by 125 $\text{kWh}/\text{yr},\text{m}^2$ in Stockholm and by 170 $\text{kWh}/\text{yr},\text{m}^2$ in Luleå, and these savings are independent of the building type (e.g. insulation, ventilation rates and internal gains). However, they depend on the actual distribution of window areas in different orientations. The simulations performed for the house in Stockholm with the main façade towards north instead of south showed that the annual heating demand will decrease by 140 $\text{kWh}/\text{yr},\text{m}^2$ window area for the same U -value reduction as above (from 2.5 to 1.0). The larger saving towards north is explained by the lower solar gains, which points to the well-known fact that windows towards north should have a lower U -value. The potential savings by using more energy-efficient windows are thus not only dependent on the U -value. The lower solar gain that follows from the lower g -value may approximately half the potential savings due to the improved U -value alone. Further, for extremely well-insulated buildings, the reduced g -value is beneficial, since the solar radiation during the summer may quickly create a severe overheating problem.

In the second example of a single-person office room, the effect of increasing window areas as well as the orientation effect was clearly demonstrated. However, the super-insulated windows gained energy over the year towards south, without simultaneously increasing the cooling demand in the summer. Finally, the fully glazed building showed that it is very difficult to establish a constant indoor temperature in such buildings, it swings between being either too cold or too hot.

6 Conclusions and recommendations for further research

What is the optimum window? The truth is that the best window will always depend on the situation. Each site has a different climate, and there is for example a large difference between northern and southern Sweden. Each building has a certain insulation level, and internal load. The orientation of windows is also important, especially for poorly to medium insulated houses. Due to solar gains, the window may have a higher U -value than the wall without increasing the annual heating load. The maximum permissible U -value will thus depend on the general insulation of the house, the climate and the window orientation etc. In southern unobstructed locations, triple-pane clear glazing may – on an annual heating basis – perform on par with super-insulated windows towards north. Further, since the U -value reductions are usually accompanied by lower solar gains (e.g. g -values) it is not certain that the window with the lowest U -value will always be the best. However, for extremely well-insulated buildings, the U -value should always be low, since the heating season is very short, and useful solar gain is small.

Thermal comfort problem will arise when windows are large, both during summer and winter. In such situations a low U -value is required to solve the winter problem, and a low g -value together with shading devices will solve the summer problem. The daylight issue should also be considered. Perhaps one low-e coating is sufficient in many cases, since two coatings will tint the light more than one. Which compromise is made in each situation is eventually up for the client to make. Tools are therefore needed to provide realistic data on the predicted behaviour of a planned building. To integrate daylight tools into thermal programs is thus one attempt to try to interlink the two sides of the same coin: the energetic side and the daylight side.

6.1 Technology status of windows

Triple-pane clear windows have for many years been the de facto standard in Sweden. They were introduced on a large scale at the end of the 1970s, when a strict energy code was enforced in the wake of the 1973 oil crisis. The code required a window U -value of $2 \text{ W/m}^2\text{K}$, and since low-emittance coated glass was not available at that time, the triple-pane window was the only solution.

During the last few years there has been a dramatic increase in the use of low-e coatings. The NUTEK procurement program for energy-efficient windows in 1992 was partly responsible for this. But especially in 1998 when a large window manufacturer changed the production into using low-e coated glass and argon (in triple-pane glazing) as the standard product, the market share took a marked jump upwards. Today, about 45 % of all insulating glass units (IGU) are equipped with coated glass, and an estimation is that the average U -value for windows sold today in Sweden is between 1.3 and $1.6 \text{ W/m}^2\text{K}$. However, the best windows on today's market have a total U -value of 0.7 - $1.0 \text{ W/m}^2\text{K}$.

The emittance of commercial low-e coated glass has decreased in recent years, and today soft silver-based coatings have an emittance of around 4 %. When used in a double-pane unit together with argon gas, and an optimised gap width of 15 mm, the U -value of the glazing can be as low as 1.1. It is then possible to achieve a window with a centre-of-glass U -value better than triple clear glazing and similar to that of triple low-e coated glazing. Although the market share for double-pane windows is still small, we might see more and more of them in the future, since the cost is lower. However, the centre-of-glass U -value of optimised double-pane glazing is very sensitive to varying inside and outside temperatures (boundary conditions), and may differ by as much as $0.2 \text{ W/m}^2\text{K}$ for a temperature difference across the glazing of 15 and 30°C respectively. It is also more difficult to achieve a low total window U -value than in for example a 1+2 construction, since the frame losses are more pronounced. If, from the national perspective, further improvements to window U -values are requested this will not be possible if double-pane low-e coated windows are introduced on a large scale.

New spacers, so called warm-edge technologies, can reduce the thermal losses around the perimeter of the IGU, but their market share is still too small to be seen in the statistics. The extra cost (about 150 SEK/window, consumer price) is still holding back the development. These spacers will reduce the total window U -value somewhat, but especially

the risk of condensation at the bottom edge of the glazing. In double-pane windows the extra cost is compensated by a lower glass cost, and the market share may increase quickly in the near future.

There are many performance requirements that a window has to fulfil, for example on thermal insulation, sound insulation, water and moisture penetration, ventilation, durability, mechanical strength and rigidity, etc. The main function is however to provide for daylight and view. As the energy-efficiency of windows is improved, the daylight transmittance will be reduced, and the transmitted daylight spectrum might become more and more distorted (like putting a selective filter on the glass). This is since the improved U -value is achieved by using three or four panes, and by using one or several low-e coated panes. These two goals may however come into conflict with each other.

6.2 Energy-efficient windows: the compromise between energy demand and daylight quality?

This work has demonstrated that low-e coatings have a large potential for energy-efficiency improvements in windows, especially in combination with argon or krypton gas fillings. However, it is clear that at some point there has to be made a compromise between daylight quality and heating energy savings.

From the energy point of view, decreasing emittance is accompanied by reduced g -value and solar gain. The potential saving is thereby approximately halved compared to the U -value reduction alone. In normal residential housing, solar gains provide valuable contributions to the heating demand, and for southerly orientations especially, the main goal is thus not to obtain the lowest possible U -value.

For extremely well-insulated residential buildings the heating season is dramatically shortened. During the dark Swedish winter months, there is practically no solar radiation of significance available, therefore a minimum U -value should be strived for. Due to the short heating season, the solar contribution quickly leads to an overheating problem during spring and autumn. Thus, a low g -value may even be desirable.

From the daylight point of view, my calculations show that the difference in daylight transmittance, and the potentially larger lighting electricity use with darker windows, is more than outweighed by the savings made on the heating energy. Super-insulated low-e windows thus seem to have only desirable effects, since the lower daylight transmittance can be

compensated by using larger windows without large sacrifices on the heating bill. However, the reported change to the daylight spectrum is more serious, with its potential effect on colour perception, colour rendering, satisfaction and perhaps even well-being. Larger windows can not compensate this effect, since it depends on the characteristics of the glass combination itself, which acts as a filter. Since these windows typically use two silver-based low-e coatings, which already have a transmittance peak in the green area, this effect becomes more pronounced. The use of more than one coating in a window can therefore be questioned and should be further studied. Applying coatings to glass with a low iron content has been discussed as one possible solution, but has not been evaluated in this work.

6.3 Shading devices

Energy efficiency is not only about achieving low U -values. In modern office buildings, especially today with the quickly growing trend of fully-glazed facades, the cooling demand can be significant also in Swedish climates. Solar gains then become a nuisance for the employee and a stress on the cooling system. Even if all sunlight should not be removed, glare and overheating should be avoided. It is important that the g -value of the whole system is low, either through solar control glazing or by using shading devices or a combination of both. Some type of shading device will always be necessary to control glare, but placed on the outside it will have a much larger potential to reduce cooling loads since the absorbed heat will be dissipated to the outside air.

Whatever system is chosen, it must be designed to also meet the needs of the employees, e.g. reduce the solar radiation, provide view, reduce glare, be easily manoeuvrable, allow for individual control etc. The impression so far is that visual criteria (e.g. disability or discomfort glare) are the main motivation for individual to use shading devices, at least in offices, while thermal criteria are of a second concern. However, the visual criteria that decide when shading devices in offices should be used have not yet been found.

6.4 Thermal comfort

With a dynamic energy simulation tool like Derob-LTH, it is possible to study the full interaction between the window, the space, the ventilation and internal loads generated by the occupants of the space. Especially the effects on indoor temperatures, thermal comfort, and peak loads can be studied during any climatic condition. This is the major advantage of a dynamic tool compared to steady-state programs like the BKL-method and for example degree-hour based methods for windows both of which take solar gains into account.

It is quite clear that energy-efficient windows not only brings a lower heating bill, but also provides a better thermal comfort during the winter, since the surface temperature of the glass increases by several degrees. With energy-efficient windows it has been demonstrated that radiative heating is no longer necessary under windows to avoid cold draughts. The glazing areas can also be made larger, and again we might see increased window areas in residential buildings, and more daylight in buildings.

However, when the glazing areas increase drastically, like in the example with the office fully-glazed on three sides, thermal comfort problems during the winter (as well as summer) may easily arise. Even if modern solar control glazing combines several advantageous factors (low emittance, low g -value and rather high visual transmittance), the U -value of the window walls will be much too high to achieve a pleasant operative temperature. This is easy to understand when we consider that a well-insulated wall (U -value around 0.2) is replaced with glazing of much higher U -value (perhaps around 1.1-1.3). The window wall must either have an even lower U -value (can be achieved with coated triple-glazing), or some other measures must be taken to heat the internal glass surfaces (e.g. electrically heated glass, radiative/convective heating, forced convective heating). In order not to increase the thermal losses, the best solution, (except for decreasing the glazed area), is of course to use a very low U -value of the glazing.

6.5 Tools for daylight calculation

We already have good tools to estimate the thermal behaviour of existing and planned buildings. Examples demonstrated in this thesis have shown what kind of information can be gained through a dynamic (hourly) simulation tool like Derob-LTH. The attempt to build a daylight module to this program is a natural step, since half of the solar radiation lies

within the visible range. The program Derob-LTH is well suited for integrating a daylight calculation routine, since it already calculates the distribution of solar radiation using view factors (i.e. a radiosity approach). The proposed method uses the view factor calculation in the existing post-processor COMFORT (Källblad, 1996). The radiation intensity (direct and diffuse components) is then translated to visual radiation via the luminous efficacy. Last, the radiation levels are amplified using the ratio of visual-to-solar transmittance to yield the final illuminance level. Validation was performed for overcast and clear days against mainly Radiance for a side-lit room and for a simple atrium. For the overcast sky, the accuracy is acceptable for both vertical and horizontal windows for the midpoint of the room. For the sunny sky, Derob-LTH accurately predicts the size and illuminance level of the sunpatch, at least for the tested vertical window. For the purpose of using it for daylight-linked control of shading devices, the accuracy of the developed model seems sufficient.

6.6 Further research

As the technological development never stops, there will always be a need for further research to analyse the consequences of the new technologies.

Several good computer tools are already available for studies on both the thermal and the daylight environment. Here, new demands from the users are driving the development further. One example is the daylight module in Derob-LTH, which was developed within the Solar Shading Project and validated by the author. This module still needs further development work to become a really useful tool, for example regarding calculation of luminance. This requires that the code in the underlying Derob-LTH calculation engine is further developed regarding the transmittance, and the number of nodes per surface, of diffuse radiation. More work is also needed to be able to allow for moveable shading devices, and to be able to study the effects of various control strategies.

Regarding the daylight issues, there is certainly room for more research. Studies have already indicated the numerous effects of daylight, e.g. on perception, mood, and health, the so-called non-visual effects of light. The perception of a space with tinted glass, especially with modern solar control glass, and other low transmission glass would be interesting to study in the field. Also, the criteria underlying visual comfort in daylight spaces are not yet fully understood. If these were found, it would facilitate the development of control strategies for both daylight-linked lighting and shading systems.

Summary

This thesis deals with energy-efficiency in buildings and especially with the role of windows. The main focus is on the following two, sometimes conflicting, goals:

- 1) to provide for a good thermal protection against the outdoor environment with a minimum of used energy
- 2) to provide for a good visual daylight environment which satisfies human needs.

The thesis deals mainly with windows that have a rather high visual transmittance and good thermal insulation (i.e. low U -value). The aim of the work has been to identify optimal window choices that satisfy both of the above mentioned goals.

The thesis is divided into one text part and one article part, which contains 5 conference and journal papers. The work conducted by the author in the text part is as follows: Chapter 2 is a literature review that describes the many performance requirements of windows and defines the current status of Swedish windows. Chapter 3 is a short course on window physics for those not familiar with the subject. Chapter 4 is a review of literature on daylight in buildings. Chapter 5 provides several examples demonstrating the effect of various window choices on heating, cooling, indoor temperatures and thermal comfort for both residential and office buildings.

Parametric studies have been performed in the dynamic energy simulation tool Derob-LTH in order to study the effects of window choices on energy use and indoor climate. A steady-state program (the BKL-method) was used to evaluate two years of measurements of energy use and indoor temperatures of an energy-efficient row-house. Two behavioural studies regarding (1) daylight transmittance, view and room perception using super-insulated windows and (2) the satisfaction with the daylight environment and the use of shading devices in response to day-

light/sunlight have also been conducted. Environmental or architectural psychology methods were employed in full-scale laboratory environments exposed to the natural climate.

The main limitation is that windows have been studied from a Swedish perspective only. This means that typical Swedish window types have been used in various parametric studies, and only Swedish climates have been used. Further, the calculated energy demands only concern the energy for either heating or cooling the room air to a certain temperature. Conversion losses and primary energy demands have not been calculated. Although the studies have been performed from a Swedish perspective, several results can be transferred to other climates.

One motive for studying energy efficient windows is that energy use in buildings is strongly connected to serious environmental problems such as the green house effect, acid rain and eutrophication of land and waters. Sweden also faces a major challenge with the goal of abolishing nuclear power, which now produces almost half of the electricity demand. The total energy use within the building and services sector accounts for about 40 % of the total energy use in Sweden. The window can thus play a significant role in reducing the energy use in buildings, or at least make sure that it does not increase.

Two-years of measurements of a row house in Dalby have shown that it is possible to build well functioning dwellings with a low specific use of space heating (33 kWh/yr,m² useable floor area). This is lower than the current standard of new housing, even if these houses were built over 10 years ago. The low energy use was achieved by good thermal insulation (better than the common standard), acceptable air-tightness and heat recovery of the exhaust air. Solar gains were substantial during April, May, June and September, and only short periods with overheating occurred. The *U*-values of the envelope were: roof=0.11; walls=0.17; floor=0.20 and windows=1.5 W/m²K. The windows had three panes and one low-e coating and were thus better than required in the building code.

A window has to fulfil many performance requirements, for example on aesthetics, thermal insulation, sound insulation, water and moisture penetration, ventilation, durability, mechanical strength and rigidity, etc. The main function is nevertheless to provide for daylight and view out.

Triple-pane clear windows have for many years been the de facto standard in Sweden. They were introduced on a large scale at the end of the 1970s, when a strict energy code was enforced in the wake of the 1973 oil crisis. The code required a window *U*-value of 2 W/m²K, and since low-emittance coated glass was not available at that time, the triple-pane window was the only solution.

During the last few years there has been a dramatic increase in the use of low-e coatings. The NUTEK procurement program for energy-efficient windows in 1992 was partly responsible for this. But especially in 1998 when a large window manufacturer changed the production into using low-e coated glass and argon (in triple-pane glazing) as the standard product, the market share took a marked jump upwards. Today, about 45 % of all insulating glass units (IGU) are equipped with coated glass, and an estimation is that the average U -value for windows sold today in Sweden is between 1.3 and 1.6 W/m²K. However, the best windows on today's market have a total U -value (U_{win}) of 0.7-1.0 W/m²K.

The emittance of commercial low-e coated glass has decreased in recent years, and today the centre-of-glass U -value (U_{cog}) can be as low as 1.1 for low-e coated double-pane glazing with argon. The U -value is then better than for triple, clear glazing ($U_{cog}=1.85$) and similar to that of triple low-e coated glazing ($U_{cog}=1.0-1.3$). Although the market share for double-pane windows is still small, we might see a growing trend that double-pane windows will replace triple-pane ones, since the cost is lower. However, it is more difficult to achieve a low total window U -value than in for example a coupled 1+2 construction, since the frame losses are more pronounced.

New spacers, so called warm-edge technologies, can reduce the thermal losses around the perimeter of the IGU, but the market share is still very low, probably due to the extra cost. These spacers will reduce U_{win} somewhat, but especially the risk of condensation at the bottom edge of the glazing.

If the national interest is to further improve the energy-efficiency of windows, e.g. by introducing stricter requirements than the current building code, this will be difficult to achieve if double-pane low-e coated windows are introduced on a large scale.

The energy balance of a window can be calculated via simple formulae using degree-hours and cumulated solar radiation summed up to the balance temperature of the building. The balance temperature is the outside temperature above which the building does not need to be actively heated. The simple methods are good, since they make the calculation very transparent and easy to understand. However, it may be difficult to estimate the balance temperature correctly, and thus the net energy transport through windows. This is avoided with detailed dynamic energy simulation programs, in which the full interaction with storage effects, ventilation rates, internal loads schemes etc. are accounted for. Further, much more knowledge is gained on potential overheating problems, cooling loads, thermal comfort etc., since the temperature of all interior as well as exterior surfaces are determined on an hourly basis.

In a calculation example of a detached 1.5-storey single-family house it was demonstrated that the heating demand may be reduced by a factor of 5 for super-insulated buildings compared to buildings from 1960. The lower heating demand is equivalent to a lower balance temperature, a much shorter heating season, and thereby lower useful solar gains. During the remaining heating-season there will be very little available solar radiation, since the Swedish winters have no available solar radiation of significance. At least between November and February the days are short, the solar altitude is extremely low, and there are many overcast days. Therefore, as the general insulation levels of the house increases, the window must have a lower U -value in order not to increase the annual heating demand compared to a house without windows. For a house insulated according to 1960 standard, U_{win} should be lower than 1.8 in Lund, 1.6 in Stockholm and 1.4 W/m^2K in Luleå. For a typical house of today, U_{win} should be lower than 1.1 in Lund, 1.0 in Stockholm and 0.9 W/m^2K in Luleå. For extremely well-insulated buildings, U_{win} should be lower than 0.8 in Lund, 0.7 in Stockholm and 0.6 W/m^2K in Luleå.

As the heating-season becomes shorter and shorter, severe overheating problems may occur, especially in so-called passive housing. Increased summer ventilation and external shading devices can avoid this problem.

A lower U -value is accompanied with a lower solar energy transmittance (g -value), since low- e coated glass reduces the solar transmittance outside of the visual spectrum. It was demonstrated that the net energy saving was approximately halved for double-pane windows with low- e coatings of decreasing emittances due to the accompanied g -value reduction. For poorly insulated to ordinary houses a high g -value is desirable and there this effect must be taken into account. For extremely well-insulated buildings the lower g -value is welcomed, since it helps to reduce unwanted solar gain. In such buildings it is essential to focus on a low window U -value.

In a comparison between clear and low- e coated glass in office buildings with cooling systems, it was shown that triple-pane glazing with one coating will not increase the heating demand for south facing offices when the glazed area increases. Energy-efficient windows (2 low- e coatings) will even gain energy over the year. At the same time the cooling demand is approximately the same for all glazing types. An energy-efficient window towards north displays the same annual increase in heating demand as a triple-clear glazing towards south. This implies that better windows should be installed in northerly orientations, but not necessarily towards the south. However, during the cold winter period, only the energy-efficient window will provide a good thermal comfort.

Thermal comfort problems will also arise in the growing trend of fully glazed offices. During the summer, intense overheating will occur if no measures are taken to reduce the transmittance of solar radiation, e.g. by shading devices and/or solar control glazing. Shading devices will always be needed to reduce glare, but placed on the outside they have a much greater potential to reduce cooling needs and indoor operative temperatures.

During the winter the operative temperature will be too low when the well-insulated wall is totally replaced by double-pane glazing. Measures can be taken to heat the glass surface, i.e. electrically heated glass, radiative/convective heating and forced convective heating. From an energy point of view, the best way is to use coated triple-pane glazing to achieve a very low U -value. However, condensation on the external side of the glazing can then be expected at some periods during the year, especially during early autumn.

Daylight in buildings has many positive aspects apart from providing light for vision. A literature review on daylight found that the obvious benefits of windows are the contact they provide with the outside: to be able to see the changing weather and the activities going on outdoors, positive mood and provision of warmth and atmosphere of seeing sunshine. The four general benefits of windows have been classified by Heerwagen (1990) as: (1) access to environmental information; (2) access to sensory change; (3) a feeling of connection to the world outside and (4) restoration and recovery.

Research also indicates that there are other effects of daylight apart from vision and mood. It has been shown that light leads to an activation of various organs in the brain, and that light affects the diurnal rhythm, metabolism, pulse frequency, blood pressure and secretion of hormones. For example Küller et al. (1999) demonstrated that people who work further than 2 m from a window are more likely to experience SAD (seasonal affective disorder) or SAD-like symptoms.

Glare is a visual comfort problem associated with windows. It derives both from sunlight entering a space, and from a direct view of the bright, unobstructed sky. Generally, it is the luminance distribution that will determine how we perceive a space, and not the illuminance distribution. Glare is thus linked to excessive luminance levels, and large contrasts. Visual comfort is a popular term today. However, it is hard to find what criteria shall be fulfilled in order for a person to have visual comfort. It is not certain that the commonly used rule of thumb of luminance ratios of 10:3:1 applies to daylight, since various studies have shown that people tend to tolerate more glare when the source is daylight.

Daylight utilisation is a term to describe when daylight is used to replace artificial lighting. A control system for electric lighting that reacts to the daylight levels in a space is called a daylight responsive lighting system. This system is of particular interest, since cooling loads can be reduced without simultaneously increasing heating loads.

As the energy-efficiency of windows is improved, the daylight transmittance is reduced. The effects on potential electric lighting savings were estimated via lighting calculations in Superlite/Superlink on a single-person office room. This demonstrated that with a continuous dimming system the savings might be around 40 % for the moderate Glazing-to-Wall Area Ratio (GWAR) 20 %, and 55 % for the larger GWAR 50 %. The difference between various clear and low-e coated window choices was however small.

Another effect of decreasing window U -values is that the transmitted daylight spectrum might become more and more distorted (like putting a selective filter on the glass). This is since the improved U -value is achieved by using three or four panes, and by using one or several low-e coated panes. The effect on the perception of daylight, view and the room in general was therefore studied for two identical rooms. The only difference between the rooms was the window: one room had a quadruple-pane super-insulated window, and the other had a triple-pane, clear window. The results showed that people were clearly able to distinguish between the two windows. They perceived the room with the super-insulated window as darker and more enclosed, and the daylight as more tinted. The super-insulated window also affected the colours of the room and of the view, making them look more subdued and drab. The effect was attributed to the two low-emittance coatings and not to the fourth glass pane.

As mentioned above, solar shading devices are often necessary in office environments to control glare and perhaps also to reduce cooling loads. Simple decorative interior curtains and traditional mid-pane Venetian blinds can therefore be classified as shading devices. Examples of external shading devices are awnings, fabric screens and external Venetian blinds. Some products are better than other to reduce solar gain, and this is for example studied in the Solar Shading Project at Lund University (Wall & Bülow-Hübe, 2001). The effects on daylight and view out, and how the occupant wants to control the shading devices in relation to the daylight environment has been less studied. A simple pilot study was therefore conducted in order to compare user preferences for two external shading devices: one Venetian blind and one awning. No significant difference between the two systems was found, although the awning was found easier to adjust and operate. It was not possible to find

any relationship as to how much the shading device was pulled down and traditional lighting parameters like the desktop illuminance and the sky luminance seen through the window. However, the existence of a sun-light patch showed some, although weak, correlation to the percentage of the window that was covered. A large individual variation as to how much glare was tolerated could also be observed.

A daylight module to Derob-LTH was developed in cooperation with Kurt Källblad, who performed the programming, and he is also the author of the COMFORT program, on which the daylight module was built. The method is based on a radiosity method where the distribution of solar radiation (direct and diffuse components) in a space is calculated and translated to visual radiation via the luminous efficacy. Last, the radiation levels are amplified using the ratio of visual-to-solar transmittance to yield the final illuminance level. Validation was performed for overcast and clear days against mainly Radiance for a side-lit room and for a simple atrium. For the overcast sky, the accuracy is acceptable for both vertical and horizontal windows for the midpoint of the room. For the sunny sky, Derob-LTH accurately predicts the size and illuminance level of the sunpatch, at least for the tested vertical window. For the purpose of using it for daylight responsive control of shading devices, the accuracy of the developed model seems sufficient.

What is the optimum window? The truth is that the best window will always depend on the situation. Each site has a different climate, and there is for example a large difference between northern and southern Sweden. Each building has a certain insulation level, and internal load. The orientation of windows is also important, especially for poorly to medium insulated houses. Due to solar gains, the window may have a higher U -value than the wall without increasing the annual heating load. The maximum permissible U -value will thus depend on the general insulation of the house, the climate and the window orientation etc. In southerly unobstructed locations, triple-pane clear glazing may – on an annual heating basis – perform on par with super-insulated windows towards north. Further, since the U -value reductions are usually accompanied by lower solar gains (e.g. g -values) it is not certain that the window with the lowest U -value will always be the best. However, for extremely well-insulated buildings, the U -value should always be low, since the heating season is very short, and useful solar gain is small.

Thermal comfort problem may arise during winter when window U -values are high. These problems are accentuated as the window areas increase. Highly glazed buildings and extremely well-insulated buildings will also suffer from summer problems with high operative temperatures

and high cooling needs. In such situations a low U -value is required to solve the winter problem, and a low g -value together with shading devices will solve the summer problem.

Küller's findings that seasonal affective disorder (SAD) or SAD-like symptoms are lower for people working closer than 2 m from windows, is then another argument for using energy-efficient windows, since the thermal comfort experienced close to such windows is improved. The daylight issue should also be considered. Perhaps one low-e coating is sufficient in many cases, since two coatings will tint the light more than one. Solar control coatings can be expected to affect the tint more than low-e coatings, and more research is needed on the effects on perception of daylight and rooms.

Which compromise is made in each situation is eventually up for the client to make. Tools are therefore needed to provide realistic data on the predicted behaviour of a planned building. To integrate daylight tools into thermal programs is thus one attempt to try to interlink the two sides of the same coin: the energetic side and the daylight side.

Acknowledgements

I wish to express my gratitude to my advisors during my last year of study, Maria Wall and Björn Karlsson for their enthusiasm, good ideas and wittiness. Especially Björn widened my knowledge on bandy and the bible. I am also very thankful towards Rikard Küller, an excellent tutor during my behavioural studies, who has always given me self-confidence and support throughout my years of study. Special thanks go to all my colleagues at Energy and Building Design, and at the former department of Building Science, especially Petter Wallentén, Marie-Claude Dubois and Kurt Källblad. Arne Roos and Joakim Karlsson from Uppsala University have been very helpful in providing data and knowledge regarding coated glazing. Along the way several other people as well as organisations have provided valuable information. I thank all of you, none mentioned, none forgotten.

Financial support has also been given both from the Swedish National Energy Administration and the Swedish Council for Building Research (now Formas, the Swedish Research Council for Environment, Agricultural Sciences and Spatial Planning).

Finally, I would like to express my greatest gratitude towards my family: Jean-Yves, Erika and Chloé, and my parents Lisbeth and Staffan, who all have liberated me from endless household chores and given me great support and freedom, especially during the intense period of finalizing this report.

References

- Andresen, I., Aschehoug, Ö. & Thyholt, M. (1995). *Computer simulations of energy consumption for lighting, heating and cooling for an office using different light control strategies*. (Report STF62 A95015). Trondheim, Norway: SINTEF Arkitektur og byggt teknik.
- Antell, O., & Lisinski, J. (1988). *Fönster. Historik och råd vid renovering*. (Windows. History and advice for renovation). Rapport RAÅ 1988:1. Stockholm: Riksantikvarieämbetet. (in Swedish).
- Arasteh, D., Reilly, S. & Rubin, M. (1989). A Versatile Procedure for Calculating Heat Transfer Through Windows. *ASHRAE Trans.* 95 Pt 2. 755-765.
- Arumi-Noé, F. & M. Wysocki, (1979). *The DEROB system volume I, User's manual for the DEROB system*. Austin, Texas, USA: University of Texas, School of Architecture, Numerical Simulation Laboratory.
- Arumi-Noé, F. (1979). *The DEROB system volume II, Explanatory notes and theory*. Austin, Texas, USA: University of Texas, School of Architecture, Numerical Simulation Laboratory.
- Ashdown, I. (1996). Lighting for Architects. *Computer Graphics World* 19(8) 38-44.
- Bally, M. A. & Lenhardt, K. (1999). TPS – Thermo Plastic Spacer System – A New, Revolutionary and Future-Oriented Production Technology for the High-Tech Insulating Glass of Tomorrow. Proceedings of *Glass Processing Days*, 13-16 June'99, Tampere, Finland.
- BBR 1999. (1998). *Boverkets Byggregler*. (Building regulations of the National Board of Housing, Building and Planning) BFS 1993:57 med ändringar t.o.m. BFS 1998:38. Boverket.
- Bell, P. A., Greene, T. C., Fisher, J. D. & Baum, A. (1996). *Environmental Psychology*. 4th ed. Fort Worth, TX, USA: Hartcourt Brace College Publishers.

- Björk, C., Kallstenius, P. & Reppen, L. (1984). 2nd ed. *Så byggdes husen 1880-1980*. (So were the houses built 1880-1980). (T1:1984). Stockholm, Sweden, Stockholms stadsbyggnadskontor och Statens råd för byggnadsforskning. (in Swedish).
- Blomberg, T. (1996). *Heat Conduction in Two and Three Dimensions. Computer Modelling of Building Physics Applications*. (Report TVBH-1008). Lund, Sweden: Lund University, Department of Building Physics.
- Bodlund, B., Mills, E., Karlsson, K. & Johansson, T. B. (1989). The Challenge of Choices: Technology Options for the Swedish Electricity Sector. In *Electricity: Efficient End-Use and New Generation Technologies, and Their Planning Implications*. Johansson, T. B, Bodlund, B. & Williams, R. H. (eds.). Lund: Lund University Press, pp. 883-947.
- Brolin, H. (1987, 1990). *Regler för P-märkning av fönster*. (Rules for P-labelling of windows). Report 1987:09Rev90. Borås: Statens Provninganstalt. (in Swedish).
- Boubekri, M., & Boyer L. L. (1992). Effect of window size and sunlight presence on glare. *Lighting Research and Technology* 24(2) 69-74.
- Boyce, P. & Kennaway, D. J. (1987). Effects of Light on Melatonin Production. *Biol. Psychiatry* 22 473-478.
- Boyce, P., Eklund, N., Mangum, S., Saafield, C. & Tang, L. (1995). Minimum acceptable transmittance of glazing. *Lighting Research & Technology* 27(3) 145-152.
- Button, D. & Pye, B. (eds.). (1993). *Glass in building: Guide to modern architectural glass performance*. Oxford: Butterworth Architecture.
- Byggnadsrådet (1987). *Energi i byggd miljö*. (Energy in the built environment). (Report G16:1987). Stockholm, Sweden: The Swedish Council for Building Research. (in Swedish).
- Byggnadsrådet (1993). *Arkitektens utvidgade ansvar*. (The extended responsibility of the architect. (Report T16:1993). Stockholm, Sweden: The Swedish Council for Building Research. (in Swedish).
- Byggnadsrådet (1995). *Energiboken*. (The energy book). (Report T21:1995). Stockholm, Sweden: The Swedish Council for Building Research. (in Swedish).

- Bülow-Hübe, H. (1990). *Helsingborgs kommuns energisystem nu och år 2010*. (The energy system of Helsingborg now and year 2010). Lund: Miljödelegationen Västra Skåne, Energiprojektet. (in Swedish).
- Bülow-Hübe, H. & Blomsterberg, Å. (1992). *Solbyn i Dalby. Utvärdering av en energisnål radhuslägenhet med glasrum*. (The Solar Village in Dalby. Evaluation of an energy-efficient row house with sunspace). (Rapport TABK--92/3003). Lund: Lunds tekniska högskola, Inst. för byggnadskonstruktionslära. (in Swedish).
- Bülow-Hübe, H. (1994). *Dagsljusaspekter på superisolerade fönster*. (Daylight aspects of super-insulated windows). (Rapport TABK--94/3024). Lund: Lunds tekniska högskola, Inst. för byggnadskonstruktionslära. (in Swedish).
- Bülow-Hübe, H. (1996). *Fönster. En kunskapssammanställning*. (Windows. A summary of knowledge). (Rapport TABK--96/3036). Lund: Lunds universitet, Lunds tekniska högskola, Inst. för byggnadskonstruktionslära. (in Swedish).
- Böhn-Jullander, I. (1992). *Bruno Mathsson Möbelkonstnären Glashusarkitekten Människan*. (Bruno Mathsson The furniture artist The glass house architect The man). Bokförlaget Signum, Lund. (in Swedish).
- Carlson, P.-O. (1992). *Glas - Möjligheternas byggmaterial*. (Glass – The building material of opportunities). (Report T16:1992). Stockholm: Byggeforskningsrådet.
- Carpenter S. & McGowan, A. (1993). Effect of Framing Systems on the Thermal Performance of Windows. *ASHRAE Transactions* 99(1) 907-914.
- Christoffersen, J. (1995). *Daylight Utilisation in Office Buildings*. (PhD thesis, SBI Report 258). Hørsholm, Denmark: Danish Building Research Institute.
- Christoffersen, J., Petersen, E. & Johnsen, K. (1999a). *Beregningsværktøjer til analyse af dagslysforhold i bygninger*. (Calculation tools for analysis of daylight conditions in buildings). (SBI Rapport 277). Hørsholm, Denmark: Statens Byggeforskningsinstitut. (in Danish).

- Christoffersen, J., Petersen, E., Johnsen, K., Valbjørn, O. & Hygge, S. (1999b). *Vinduer og daglys – en feltundersøgelse i kontorbygninger*. (Windows and daylight – a field survey of office buildings). (SBI Rapport 318). Hørsholm, Denmark: Statens Byggeforskningsinstitut. (in Danish).
- CIBSE (1994). *CIBSE Code for interior lighting*. London, Great Britain: The Chartered Institution of Building Services Engineers.
- CIE (1994). *Spatial Distribution of Daylight – Luminance Distributions of Various Skies*. Commission Internationale de l'Eclairage CIE, No. 110.
- Clarke, J. A., Hand, J. W. & Janak, M. (1997). Results from the Integrated Performance Appraisal of Daylight-Europe Case Study Buildings. *Proc. of Right Light 4, 4th European Conference on Energy-Efficient Lighting*. Copenhagen, Denmark, 19-21 Nov 1997. 1 117-124.
- Collins, B. L. (1976). Review of the psychological reactions to windows. *Lighting Research & Technology* 8(2) 80-88.
- Cooper, J. R., Wiltshire, T. & Hardy, A. C. (1973). Attitudes toward the use of heat rejecting/low light transmission glasses in office buildings. *Proc. CIE TC-42 Daylighting Symposium, Architectural Design Processes*, Istanbul. (Bruxelles: Comite National Belge de l'Eclairage).
- Crawley, D.B., Lawrie, L.K., Winkelmann, F.C., Buhl, W.F., Huang, Y.J., Pedersen, C.O., Strand, R.K., Liesen, R.J., Fisher, D.E., Witte, M.J. & Glazer, J. (2001). EnergyPlus: creating a new-generation building energy simulation program. *Energy and Buildings* 33(4) 319-331.
- Dubois, M.-C. (1998). *Solar-protective Glazing for Cold Climates: A Parametric Study of Energy Use in Offices*. (Report TABK--98/3053). Lund, Sweden: Lund University, Lund Institute of Technology, Dept. of Building Science.
- Dubois, M.-C. (2001). *Impact of Shading Devices on Daylight Quality in Offices: Simulations with Radiance*. (Report TABK--01/3062). Lund University, Dept. of Construction and Architecture, Division of Energy and Building Design. Lund (Sweden). (forthcoming).
- Duer, K. (2001). *Characterisation of advanced windows. Determination of thermal properties by measurements*. (Report BYG•DTU R-007). Lyngby: Technical University of Denmark, BYG•DTU.
- Duer, K., Svendsen, S. & Mogensen, M. M. (2000). Energy Labelling of Glazings and Windows in Denmark. *Proc. of EuroSun 2000*, Copenhagen, Denmark, June 19-22 2000.

- Duffie, J. A. & Beckman, W. A. (1991). 2nd ed. *Solar Engineering of Thermal Processes*. Wiley Interscience.
- Elmahdy, A. H. & Yusuf, S. (1995). Determination of Argon Concentration and Assessment of the Durability of High-Performance Insulating Glass Units Filled with Argon Gas. *ASHRAE Transactions* 101(pt1) 1026-1037.
- ElSherbiny, S. M., Raithby, G. D. & Hollands, K. G. T. (1982). Heat Transfer by Natural Convection Across Vertical and Inclined Air Layers. *Journal of Heat Transfer*, Feb 1982, 104 96-102
- EN 673 (1997). *Glass in building - Determination of thermal transmittance (U value) - Calculation method*.
- Enarun, D. & Littlefair, P. (1995). Luminance models for overcast skies: Assessment using measured data. *Lighting Research and Technology*. 27(1) 53-58.
- Energimyndigheten. (2000). *Energiläget 2000* (Energy in Sweden 2000). Eskilstuna, Sweden: The Swedish National Energy Administration.
- Erhorn, H. & J. Stoffel, (eds.) (1996). *ADELIN 2.0, Advanced daylighting and electric lighting integrated new environment, Documentation of the software package ADELIN, version 2.0* (9 volumes), IEA Solar Heating and Cooling Program, Task 12: Solar Building Energy Analysis Tools.
- Feist, W. (1995). *The Passive Houses at Darmstadt/Germany*. Darmstadt, Institute Housing and Environment (IWU).
- Ferguson, J. E. & Wright, J. L. (1984). *Vision: A computer program to evaluate the thermal performance of super windows*, Solar Energy program, National Research Council Canada, Report No Passice-10, June 1984.
- Fontoynt, M., Laforgue, P., Mitanchey, R., Aizlewood, M., Butt, J., Carroll, W., Hitchcock, R., Erhorn, H., De Boer, J., Dirksmöller, M., Michel, L., Paule, B., Scartezzini, J. L., Bodart, M. & Roy, G. (1999). *Validation of daylighting computer programs*. IEA SHC Task 21/ ECBCS Annex 29 Daylight in buildings. Vaulx-en-Velin Cedex, FR: Ecole Nationale des Travaux Public de l'Etat. Département Génie Civil et Bâtiment.
- Frank, T. (1994). *Thermische Verbesserung des Glasrandverbundes*. Statusseminar "Energieforschung im Hochbau", 15/16 Sep 1994. (in German).

- Fredlund, B. (1999). *Lågemissionsglas och renovering förbättrar äldre fönsters värmeisolering*. (Low-emittance glass and renovation improves older windows heat insulation). (Report TABK--99/3055). Lund, Sweden: Lund University, Lund Institute of Technology, Dept. of Building Science. (in Swedish).
- Goldemberg, J., Johansson, T. B., Reddy A. K. N. & Williams, R. H. (1988). *Energy for a Sustainable World*. New Delhi: Wiley-Eastern.
- Granqvist, C. G. (1981). Radiative heating and cooling with spectrally selective surfaces. *Applied Optics* 20(15) 2606-2615.
- Grau, K. & Wittchen, K. B. (1999). Building Design System and CAD integration. In *Proceedings of IBPSA Building Simulations '99*, 13-15 Sept 1999, Kyoto, Japan.
- Grenier, J. C., De la Casinière, A., & Cabot, T. (1994). A spectral model of Linke's turbidity factor and its experimental implications, *Solar Energy* 52(4) 301-313.
- Gustavsson, L. Johansson, B. & Bülow-Hübe, H. (1992). An Environmentally Benign Energy Future for Western Scania, Sweden. *Energy* 17(9), 809-822.
- Göransson, C. (1995). Fönstret en viktig del av fasadens ljudisolering. (The window is an essential part of the sound insulation of façades). *Provning & Forskning* (1)7. (in Swedish).
- Heerwagen, J. (1990). Windows, windowlessness and simulated view. *EDRA 21* 269-280 (Environmental Design Research Association).
- Hesselgren, S. (1987). *On Architecture. An architectural theory based on psychological research*. Lund, Sweden: Studentlitteratur.
- Hollands, K. G. T., Unny, T. E., Raithby, G. D. & Konicek, L. (1976). Free Convective Heat Transfer Across Inclined Air Layers. *Journal of Heat Transfer*, May 1976, 98 189-193.
- Hollwich, F. (1979). *The Influence of Ocular Light Perception on Metabolism in Man and in Animal*. New York, Springer Verlag.
- Hopkinson, R. G., Petherbridge, P. & Longmore, J. (1966) *Daylighting*. University College, London and Building Research Station, Garston, Watford, England. London: Heinemann Ltd.
- Hjorth, B. (1992). Utan fönster ingen arkitektur. (Without windows no architecture). *Arkitektur* (4) 52-57. (in Swedish).

- IESNA (1993). *Lighting Handbook*. 8th edition. New-York: Illuminating Engineering Society of North America (IESNA).
- Inui, M. & Miyata, T. (1973). Spaciousness in interiors. *Lighting Research & Technology* 5(2) 103-111.
- ISO 9050:1990. *Glass in building – Determination of light transmittance, solar direct transmittance, total solar energy transmittance and ultraviolet transmittance, and related glazing factors*.
- ISO 9845-1:1992. *Solar energy – Reference solar spectral irradiance at the ground at different receiving conditions – Part 1: Direct normal and hemispherical solar irradiance for air mass 1,5*.
- ISO 10077-1:2000. *Thermal performance of windows, doors and shutters – Calculation of thermal transmittance – Part 1: Simplified method*.
- ISO/DIS 10077-2. *Thermal performance of windows, doors and shutters – Calculation of thermal transmittance – Part 2: Numerical method for frames*.
- ISO/DIS 15099. *Thermal performance of windows, doors and shading devices – Detailed calculations*.
- Janak, M (1997). Coupling Building Energy and Lighting Simulation. Proc. of IBPSA, *Building Simulation '97* Prague, Czech Republic, Sep 8-10 1997. Vol 2 313-319.
- Johansson, B. (1990). *Malmö kommuns energisystem nu och år 2010*. (The energy system of Malmö now and year 2010). Lund: Miljödelegationen Västra Skåne, Energiprojektet. (in Swedish).
- Jonasson, H. (1994). *Luftljudsisolering*. (Airborne sound insulation). Borås: Sveriges Provnings- och Forskningsinstitut. (in Swedish).
- Jonsson, B. (1985). *Heat transfer through windows. During the hours of darkness with the effect of infiltration ignored*. (Document D13:1985). Stockholm: Swedish Council for Building Research.
- Jonsson, B. (1995). *Utvändig kondens på fönster. Mätningar i Borås 1994*. (External condensation on windows. Measurements in Borås 1994). (SP Report 1995:01). Borås: Sveriges Provnings- och Forskningsinstitut. (in Swedish).
- Kaplan, R. (1983). The role of nature in the urban context. In Altman, I. & Wohlwill, J. F. (eds.). *Behavior and the Natural Environment*. (pp. 127-159). New York: Plenum Press.

- Kaplan, R. (1985). Nature at the doorstep: residential satisfaction and the nearby environment. *Journal of Architecture and Planning Research*. 2 115-127.
- Karlsson, B. & Brunström, C. (1987). Characterization of transparent insulation materials. *Proc. of Building Physics in the Nordic Countries*. Lund, Sweden, Aug 24-26 1987.
- Karlsson, J. (2001). WinSel- a general window selection- and energy rating tool, *Proc. of WREN-2000*. Brighton, UK, July 1-7, 2000.
- Karlsson, J., Karlsson, B. & Roos, A. (2001). A simple model for assessing the energy performance of windows. *Energy and Buildings* 33(7) 641-651.
- Karlsson, J & Roos, A. (2000). Modelling the angular behaviour of the total solar energy transmittance of windows. *Solar Energy* 69(4) 321-329.
- Karlsson, J., Rubin, M. & Roos, A. (2001). Evaluation of predictive models for the angle-dependent total solar energy transmittance of glazing materials. *Solar Energy* 71(1) 23-31.
- Kittler, R., Darula, S. & Perez, R. (1998). *A set of standard skies. Characterizing daylight conditions for computer and energy conscious design*. Final report. Institute of Construction and Architecture, Slovak Academy of Sciences and Atmospheric Sciences Research Center, State University of New York. Bratislava: Polygrafia SAV.
- Kovach-Hebling, A., Goller, M., Herkel, S. & Wienold, J. (1997). Assessing the Energy Saving Potential of Daylighting Technologies for Non-residential Buildings in Germany. *Proc. of Right Light 4, 4th European Conference on Energy-Efficient Lighting*. Copenhagen, Denmark, 19-21 Nov 1997. Vol 2, 115-118.
- Kvist, H. (2000). *DEROB-LTH for MS Windows, User Manual version 99.02+3*. Lund: Lund University, Lund Institute of Technology, Dept of Construction and Architecture.
- Küller, R. (1981). *Non-visual effects of light and colour. Annotated bibliography*. (Document D15:81). Stockholm Sweden: Swedish Council for Building Research.
- Küller, R. & Küller, M. (2001). *The influence of daylight and artificial light on diurnal and seasonal variations in humans. A bibliography*. Technical Report No. 139. Vienna: International Commission on Illumination (CIE).

- Küller, R. & Laike, T. (1998). The impact of flicker from fluorescent lighting on well-being, performance and physiological arousal. *Ergonomics* 41(4) 433-447.
- Küller, R., Ballal, S. G., Laike, T. & Mikkilides, B. (1999). Shortness of daylight as a reason for fatigue and sadness. A Cross-Cultural Comparison. *Proceedings CIE 24th Session*, Warsaw, 1999. Vol. 1 Pt. 2 pp. 291-294.
- Küller R. & Lindsten C. (1992). Health and behavior of children in classrooms with and without windows. *Journal of Environmental Psychology* 12(4) 305-317.
- Küller, R. & Wetterberg, L. (1996). The subterranean work environment: Impact on well-being and health. *Environment International* 22(1) 33-52.
- Källblad, K. (1994). *The BKL-METHOD Computer Programme. User Manual*. (Report TABK--94/3019). Lund: Lund University, Lund Institute of Technology, Dept of Building Science.
- Källblad, K. (1996). *Comfort. A Computer Program for Thermal Comfort Simulation*. (Report TABK--96/3035). Lund, Sweden: Lund University, Lund Institute of Technology, Dept of Building Science.
- LBL (1992). *WINDOW 4.0: Program Description. A PC Program for analyzing the thermal performance of fenestration products*. (Report LBL-32091, TA-285). Berkeley, CA: Lawrence Berkeley Laboratory.
- Liljefors, A. & Ejhed, J. (1990). *Bättre belysning*. (Better lighting). (Rapport T17:1990). Stockholm: Bygghälsöversynsmyndigheten. (in Swedish).
- Littlefair, P. (1985). Luminous efficacy of daylight: a review. *Lighting Research and Technology*. 17(4) 162-181.
- Littlefair, P. (1988). Measurements of the luminous efficacy of daylight. *Lighting Research and Technology*. 20(4) 177-188.
- Ljuskultur. (1990). *Belysning inomhus, riktlinjer och rekommendationer*. (Indoor lighting, guidelines and recommendations). Stockholm. (in Swedish).
- Luckiesh, M. (1944). Brightness engineering. *Illuminating Engineering*, February 1944, 75-92.
- Ludlow, A. M. (1976). The functions of windows in buildings. *Lighting Research and Technology* 8(2) 57-65.

- Löfberg, H.-A. (1987). *Räkna med dagsljus*. (Count with daylight). Gävle: Statens institut för byggnadsforskning. (in Swedish).
- Markus, T. (1967). The Function of Windows – A Reappraisal. *Building Science* 2 97-121.
- Merkell, A.-L. (1989). *Årligt energiflöde genom fönster samt k-värden hos fönster med plastfolier och lågemitterande beläggningar*. (Annual energy flow through windows and U-values of windows with plastic foils and low-emittance coatings). Älvkarleby, Sweden: Vattenfall, Älvkarlebylaboratoriet. (in Swedish).
- Mills, E. (1991). *Evolving Energy Systems. Technology Options and Policy Mechanisms*. (Doctoral Dissertation). Lund, Sweden: Lund University, Department of Environmental and Energy Systems Studies.
- Muneer, T. & Angus, R. C. (1995). Luminous efficacy: Evaluation of models for the United Kingdom. *Lighting Research and Technology* 27(2) 71-77.
- Muneer, T. (1998). Evaluation of the CIE overcast sky model against Japanese data. *Energy and Buildings* 27(2) 175-177.
- MUR 90 (1991). *Murverkshandboken. Häfte 5 C. Byggnadsteknisk utformning*. (Masonry Handbook. Booklet 5 C. Technical construction details). Sveriges Tegelindustriförening/TCK AB.
- Naturvårdsverket. (1999). *Hållbar energiframtid? Långsiktiga miljömål med systemlösningar för el och värme*. (Sustainable energy future? Long term environmental goals and systems solutions for electricity and heat). Final report of the SAME project. ISBN 91-620-4965-8. (in Swedish).
- Nielsen T. R. & Svendsen, S. (2000) Determination of net energy gain from glazings and windows. *Proc. of EuroSun 2000*, Copenhagen, Denmark, June 19-22 2000.
- NFRC (2000). *National Fenestration Rating Council Update*, Vol. 9 (2) 2. March/April 2000.
- NR 1 (1988). *Nybyggnadsregler. Föreskrifter och allmänna råd*. (New Building Regulations. Directions and general advice). BFS 1988:18 Boverket, Stockholm: Allmänna Förlaget
- NUTEK (1992). *Teknikupphandling av energieffektiva fönster*. (Technology procurement of energy-efficient windows). Stockholm: NUTEK, Effektivare energianvändning. (in Swedish).

- NUTEK (1993, 1995). 2nd ed. *Möjligheter med installationssystem och energieffektiva fönster*. (Opportunities for building services systems and energy-efficient windows) (Rapport T 1993:4). Stockholm: NUTEK, Effektivare energianvändning. (in Swedish).
- NUTEK (1994). *Lighting Design Requirements - Office Lighting*. Stockholm: Dept of Energy Efficiency, Swedish National Board for Industrial and Technical Development.
- NUTEK (1995). *Kondens på fönster*. (Condensation on windows). Stockholm: NUTEK, Effektivare energianvändning. (in Swedish).
- Olsson-Jonsson, A. (1988). *Förbättring av fönsters värmeisolering samt upplevelse av fönsterbyten*. (Improvement of windows' heat insulation and perception of window replacement). (Rapport R40:1988). Stockholm: Bygghälsöversynsmyndigheten. (in Swedish).
- Osterhaus, W. K. E. (2001). Discomfort glare from daylight in computer offices: What do we really know? *Proc. of Lux Europa 2001*, Reykjavik, Iceland.
- Paule, B., Scartezzini, J.-L., Reynolds, M. & Baker, N. (2000). Handling daylight in the early design stage. *Proc. of EuroSun 2000*, Copenhagen, Denmark, June 19-22 2000.
- Pearson, D. (1994). *Earth to Spirit. In Search of Natural Architecture*. London, UK: Gaia Books Ltd.
- Philips Lighting (1997). Product specifications on HF dimmable reactors.
- prEN 10077-2. *Thermal performance of windows, doors and shutters - Calculation of thermal transmittance - Part 2: Numerical method for frames* (equal to ISO/DIS 10077-2:1998)
- Reilly, S. (1994). Spacer Effects on Edge-of-Glass and Frame Heat Transfer. *ASHRAE Transactions* **100**(1) 1718-1723.
- Reinhart, C. F. & Herkel, S. (2000). The simulation of annual daylight illuminance distributions – a state-of-the-art comparison of six RADIANCE-based methods. *Energy and Buildings* **32**(2) 167-187.
- Roos, A. (1994). *Bestämning av optiska egenskaper hos fönster*. (Determination of optical performance of windows). Uppsala: Uppsala Universitet, Teknikum. (in Swedish).

- Roos, A. & Karlsson, B. (1994). Optical and thermal characterization of multiple glazed windows with low U-values. *Solar Energy* 52(4) 315-325.
- Roos, A. (1997). Optical characterization of coated glazings at oblique angles of incidence: measurements versus model calculations. *Journal of Non-Crystalline Solids* 218 247-255.
- Rusak, B., Eskes, G. A. & Shaw, S. R. (1996). *Lighting and Human Health. A Review of the Literature*. Ottawa, Ontario, Canada: Mortgage and Housing Corporation.
- SBIC (1996). *Designing Low-Energy Buildings: Passive Solar Strategies & ENERGY-10 Software. Integrating Daylighting, Energy-Efficient Equipment, and Passive Solar Design in Commercial, Institutional, and Residential Buildings*. Washington DC, USA: Passive Solar Industries Council.
- SBN 75 (Swedish Building Code 1975). Supplement 1. Energy conservation etc. Stockholm, Sweden: National Board of Physical Planning and Building. (in Swedish).
- SBN 80 (Swedish Building Code 1980) Stockholm, Sweden: National Board of Physical Planning and Building. (in Swedish).
- SBN 85 (Swedish Building Code 1985) Stockholm, Sweden: National Board of Physical Planning and Building. (in Swedish).
- Smeds, J. & Wall, M. (2001a). IEA Task 28 / Annex 38: Sustainable Solar Housing, Subtask B: *Reference Detached House*, Internal document, sep 2001.
- Smeds, J. & Wall, M. (2001b). IEA Task 28 / Annex 38: Sustainable Solar Housing, Subtask B: *Internal Gains, Assumptions for simulations*, Working document, sep 2001.
- Stockholms Byggnadsnämnd 1987 (1988). *Fönster & balkonger vid ombyggnad*. (Windows and Balconies at Renovation) Stockholm. (in Swedish).
- Szerman, M. (1994). *Auswirkung der Tageslichtnutzung auf das energetische Verhalten von Bürogebäuden* (The effect of daylight utilisation on the energy performance of office buildings) (PhD Thesis), Universität Stuttgart, Konstruktive Bauphysik, Stuttgart, Germany. (in German).

- Thormark, C. (2001). *Recycling Potential and Design for Disassembly in Buildings*. (PhD thesis Report TABK--01/1021). Lund: Lund University, Lund Institute of Technology, Dept of Construction and Architecture, Div of Building Science.
- Thyholt, M., Andresen, I., Hugdal, B. & Aschehoug, Ø. (1994). *Frame and Edge Seal Technology. A State of the Art Survey*. IEA Solar Heating and Cooling Programme, Task 18, Case Study B9, Working Document T18/B9/WD1/94 STF62 A94004 Trondheim, NO: SINTEF Arkitektur og byggteknikk.
- Tonello, G. (2001). *Lighting, Mood, and Seasonal Fatigue in Northern Argentina. Comparison to Countries Close to and Further from the Equator*. (Doctoral Dissertation). Lund, Sweden: Lund University, Lund Institute of Technology, Environmental Psychology Unit.
- Tregenza, P. R. & Waters, I. M. (1983). Daylight coefficients. *Lighting Research and Technology* 15(2) 65-71.
- Ulrich, R. S. (1984). View from the window may influence recovery from surgery. *Science* 224 420-421.
- Veitch, J. A. & Newsham, G. R. (1996a). *Determinants of lighting quality I: State of the science*. (NRCC-39866). Paper presented at the 1996 Annual Conference of the Illuminating Engineering Society of North America, Cleveland, OH, August 5-7 1996.
- Veitch, J. A. & Newsham, G. R. (1996b). *Determinants of lighting quality II: research and recommendations*. (NRCC-40343). American Psychological Association 104th Annual Convention, Toronto, Ontario, 8/9/96, 1-55.
- Veitch, J. A. (2001). Psychological processes influencing lighting quality. *Journal of the Illuminating Engineering Society* 30 (1) 124-140.
- Velds, M. (1999). *Assessment of lighting quality in office rooms with daylighting systems*. (PhD-thesis). Delft, Holland: Technische Universiteit Delft.
- Verderber, R. R. & Rubinstein, F. M. (1984). Mutual impacts of lighting controls and daylighting applications *Energy and Buildings* 6(2) 133-140.
- Wall, M. (1994). *Projekteringshjälpmedel för inglasade rum. Klimat och energi*. (Design tools for glazed spaces. Climate and energy) (Rapport TABK--94/3023). Lund, Sweden: Lunds universitet, Lunds tekniska högskola, Inst f byggnadskonstruktionslära. (in Swedish).

- Wall, M. (1996). *Climate and Energy Use in Glazed Spaces*. (Doctoral Dissertation Report TABK--96/1009). Lund, Sweden: Lund University, Lund Institute of Technology, Dept. of Building Science.
- Wall, M. (1997). Distribution of solar radiation in glazed spaces and adjacent buildings. A comparison of simulation programs. *Energy and Buildings* 26 129-135.
- Wall, M. & Bülow-Hübe H. (eds.). (2001). *Solar protection in buildings*. (Report TABK--01/3060). Lund, Sweden: Lund University, Lund Institute of Technology, Dept. of Construction & Architecture.
- Wallentén, P. (1993). *Fönstrets betydelse för den riktade operativa temperaturen*. (The importance of the window for the directed operative temperature). Lund, Sweden: Lund University, Lund Institute of Technology, Dept. of Building Science. (in Swedish).
- Ward Larson, G. & Shakespeare R. (1998). *Rendering with Radiance: The Art and Science of Lighting Visualization*. San Francisco, CA: Morgan Kaufmann Publishers.
- Wetterberg, L. (1978). Melatonin in humans. Psychological and clinical studies. *J Neural Transm* 13 289-310.
- Wilkins, A. J., Nimmo-Smith, I., Slater, A. I. & Bedocs, L. (1989). Fluorescent lighting, headaches and eye-strain. *Lighting Research and Technology* 21 11-18.
- Wilson, L. M. (1972). Intensive care delirium. The effect of outside deprivation in a windowless unit. *Archives of Internal Medicine* 130 225-226.
- Winkelmann, F. C. & Selkowitz, S. (1985). Daylighting Simulation in the DOE-2 Building Energy Analysis Program. *Energy and Buildings* 8(4) 271-286.
- Wolf, A. (1988). New Development in the Field of Insulating Glass Units. *Construction and Building Materials* 2(3) 134-144
- Wolf, A. T. & Waters, L. J. (1993). Factors governing the life expectancy of dual-sealed insulating glass units. *Construction and Building Materials* 7(2) 101-107.

|

The Solar Village in Dalby - Evaluation of an Energy-Efficient Row House with Attached Sunspace

Helena Bülow-Hübe, MSc*

KEYWORDS: Energy-efficient housing, sunspace, ecological building

1. INTRODUCTION

This study presents the results of two years of continuous measurements of energy use and indoor climate of a two-storey row house. For more information see Bülow-Hübe et al (1992). The row house is one of 50 similar dwellings in the tenant-owner association The Solar Village in Dalby, located 10 km east of Lund, Sweden. The dwelling complex was built in 1987 with ecological overtones. This was done by providing all dwellings with biological toilets, garden allotments and earth cellars. Furthermore, the houses were built with better thermal insulation than was required by the building code at the time.

2. METHOD

2.1 Technical data on the dwelling

The experimental dwelling is located at a gable and has a usable floor area of 116.5 m². Its south facade is partly covered by a sunspace with single-glazing. The window area is mainly directed towards the south, while the northern windows are very small. All windows have three panes with one low-emission coating. Figure 1 shows a plan of the dwelling.

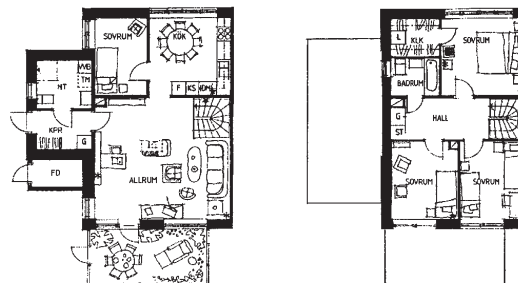

Figure 1 Plan of the experimental dwelling drawn by Avista architects.

* Department of Building Science, Lund University; Box 118, S-221 00 Lund, Sweden

BUILDING PHYSICS '93 - 3RD NORDIC SYMPOSIUM

Intermediate floors and walls between dwellings are made of concrete while infill walls consists of 240 mm lightweight studs. The thermal insulation consists of mineral wool, 285 mm in infill walls and 500 mm in the attic ceiling. The slab on the ground has an underlying insulation of 50-150 mm thickness. The U-values of the building envelope are given in Table 1.

Building element	Experimental dwelling	SBN80
Attic ceiling	0.11	0.20
External walls	0.17	0.30
Floor	0.20	0.30
Windows	1.50	2.00

Table 1 Actual U-values ($W/m^2\text{°C}$) of the building envelope compared to U-values required by the building code (SBN80).

The dwelling has direct electric heating, and domestic hot water is produced by an electric boiler in the apartment. Furthermore, it is equipped with one biological toilet and one low flush volume WC. The dwelling has controlled ventilation with air-to-air heat recovery placed in a cabinet above the kitchen stove.

2.2 Instrumentation and measurements

Energy-use, water-use, indoor temperatures, and outdoor climate was measured continuously. The air-tightness of the building envelope was measured by a compressive test. Air-flows in the ventilation system was measured at repeated occasions. The ventilation of separate rooms was determined by a continuous tracer gas technique. The dwelling was occupied during the measurements.

3. RESULTS

3.1 Function control

Results from the compressive test show an exchange rate of 2.8 ($\pm 10\%$) ACH at a pressure difference between outdoors and indoors of 50 Pa, slightly higher than the required 2.0 ACH in the Swedish building code. Since the dwelling has controlled ventilation this value should be even lower to keep exfiltration low. Blomsterberg (1990) recommends an exchange rate of 1.0 ACH.

The first measurement of air flows showed that the outdoor air flow was too low, and the extract air flow was too low at high speed. An adjustment was made to increase the extract air flow. Repeated measurements show that air flows are reasonable, except for the extract air flow that should be higher at high speed, see Table 2.

6. BUILDING ENERGY PERFORMANCE

	Design	1a	1b	2	3	4
Outdoor air	144	125	125	125	125	111
Extract air, normal speed	126	125	152	127	119	112
Extract air, high speed	198	169	178	146		

Table 2 Total air flows ($\text{m}^3/\text{h} \pm 8\%$) measured at fixed points. Design = as designed, 1a = first control before adjustment 880505, 1b = first control after adjustment 880505, 2 = second control 890822, 3 = third control 900608, 4 = fourth control 900904.

3.2 Energy-use and indoor climate

During the measuring year (Sept.88-Aug.89) the total electricity use was 11800 kWh (± 250) which corresponds to a specific energy use of 100 kWh/ m^2 usable floor area. Of the total use, 5200 kWh (± 100) was used for space-heating, 4300 kWh for household electricity (including 900 kWh for the ventilation system), 1800 kWh (± 50) for domestic hot water production and 400 kWh for a separate fan in the biological toilet.

The average indoor temperature during the heating season was 21.6°C which lasts between October and April. During the summer only short periods with overheating occurred.

The energy balance was calculated for the measuring year with the BKL-method, see Källblad et al (1984). This resulted in a heating demand of 9600 kWh, of which 5000 kWh comes from space-heating. The rest is assumed to be covered by insolation and "free heat" from habitants and household equipment (occupation heat), see Figure 2.

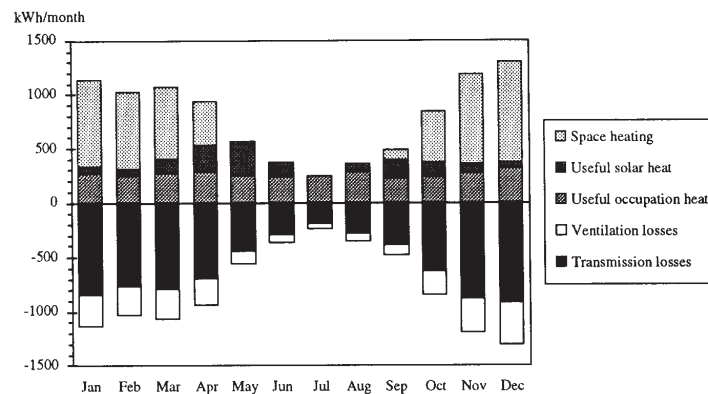

Figure 2 Calculated energy balance for the experimental dwelling during the measuring year (kWh/month).

BUILDING PHYSICS '93 - 3RD NORDIC SYMPOSIUM

3.3 Attached sunspace

The attached sunspace prolongs the outdoor season and is mainly used as an indoor patio. It can also be used as a green house for vegetables. From the beginning it was also thought that the sunspace could help reduce the heating demand of the dwelling, but this effect is in reality almost negligible. During the heating season the monthly average temperature of the sunspace is only between 1 to 3 degrees higher than the outdoor air. On sunny days the difference is higher. The total reduction in transmission losses is, therefore, only estimated to about 100 kWh/year. The reduction could have been slightly higher if the houses had been placed further apart. Now, the neighbouring houses cast their shadows on the sunspace when the sun stands at low altitudes, as is the case during mid winter.

3.4 Parametric studies of energy use

The energy balance is first calculated for a standard case, where energy-use and free heat is assumed to correspond to the living habits of a family with two adults and two children. This leads to the following assumptions regarding annual electricity-use: household electricity, 5000 kWh; domestic hot water production, 4000 kWh; biological toilet fan, 400 kWh. Finally, 1300 kWh/year in free heat from habitants is assumed. The thermostat setting is 20°C, the ventilation is assumed to be 0.5 ACH, and the exfiltration 0.15 ACH. The reference year for outdoor climate used throughout this section is Malmö 1971. With these assumptions, the transmission and ventilation losses are calculated to 8800 kWh for the standard case, see Table 3. Total energy use (or total electricity use) is then calculated to be 13300 kWh/year, which corresponds to 115 kWh/m² usable floor area.

Case No.	Trans. and vent. losses [kWh/year]	Useful occup. heat [kWh/year]	Useful solar heat [kWh/year]	Space heating [kWh/year]	Specific space heat. [kWh/m ² ,yr]
Standard case	8800	3800	1100	3900	33
Case 1	10400	4100	1400	4900	42
Case 2A	7400	3700	960	2800	24
Case 2B	8400	3770	1080	3500	30
Case 2C	9300	3830	1180	4300	36
Case 3	12400	3900	1500	6900	59
Case 4	15500	4100	1600	9800	84

Table 3 Energy balance, as calculated by the BKL-method, for standard case, case 1 with indoor temperature 22°C, case 2A with exfiltration 0, case 2B with exfiltration 0.1 ACH, case 2C with exfiltration 0.2 ACH, case 3 without heat recovery from extract air, and case 4 with thermal insulation according to SBN80 and without heat recovery.

6. BUILDING ENERGY PERFORMANCE

If the thermostat setting is increased by 2 degrees to 22°C, electricity use for space heating will increase by 1000 kWh, see Case 1, Table 3.

The sensitivity to exfiltration is studied in case 2. Three different levels of exfiltration are studied; 0, 0.1, and 0.2 ACH corresponding to cases 2A, 2B, and 2C respectively. Table 3 show that the energy demand is relatively sensitive to changes in exfiltration.

Case 3, without heat recovery from extract air, shows that the dwellings air-to air heat recovery unit saves around 3000 kWh/year which more than offsets the 900 kWh of electricity used by the unit and fans during the measuring year. It should be kept in mind, however, that the winter was so mild that neither the defrosting unit nor the inlet air preheating unit was used.

Table 1 showed the difference in actual and required U-values of the building envelope. If the house had been built according to the building code—and without heat recovery of extract air—the energy use would have increased by 5900 kWh/year; see Case 4 in Table 3.

4. CONCLUSIONS

Two years of measurements have shown that it is possible to build a well functioning dwelling with very good thermal insulation, and acceptable air-tightness. Apart from shorter periods with over-heating, reasonable indoor temperatures have prevailed.

Annual energy use for space-heating, hot water production and household electricity during normal weather conditions is 13300 kWh or 115 kWh/m² usable floor area. If the house had been built according to the Swedish building code, SBN 1980, and without the heat recovery unit, annual energy use would have been 19200 kWh or 165 kWh/m².year. The improved thermal insulation and the heat recovery unit contributes in equal amounts to the reduction in energy use. The energy savings due the attached sunspace is very small, or around 100 kWh/year.

5. REFERENCES

- Blomsterberg, Å. 1990. *Ventilation and air-tightness in low-rise residential buildings- Analyses and full scale measurements*. (Document D10:1990). Stockholm: Swedish Council for Building Research.
- Bülow-Hübe, H. and Å. Blomsterberg. 1992. Solbyn i Dalby. *Utvärdering av en energisnål radhuslägenhet med glasrum*. Rapport TABK-92/3003. Institutionen för Byggnadskonstruktionslära, Lunds Universitet, Lunds Tekniska Högskola.
- Källblad, K. and B. Adamsson. 1984. *The BKL-method: A simplified method to predict energy consumption in buildings*. (Document D8:1984). Stockholm: Swedish Council for Building Research.

||

THE EFFECT OF GLAZING TYPE AND SIZE ON ANNUAL HEATING AND COOLING DEMAND FOR SWEDISH OFFICES

Helena Bülow-Hübe, MSc

Lund University, Institute of Technology, Dept. of Building Science

PO Box 118, SE-221 00 Lund, Sweden. Fax: +46-46 222 47 19. E-mail: helena.bulow-hube@bkl.lth.se

ABSTRACT

Even in heating-dominated climates, cooling is often needed in offices due to high internal loads. Energy-efficient window design should limit both cooling and heating demands and allow daylight to replace artificial lighting. In order to determine optimal design for office windows for Swedish climates, a parametric study of heating and cooling demand was performed. In addition, the effect of a daylight-linked lighting control system was investigated. The daylight savings were calculated with ADELIN 2.0, while the thermal simulations were performed with DEROB-LTH. The studied windows included clear and low-e glazing with U-values ranging from 1 to 3 W/m²K. The sensitivity to window size and orientation, internal load, wall insulation, and ventilation was also studied. Preliminary results show that superinsulated windows (U≤1 W/m²K) outperform all other glazing types. For south orientation, the superwindow is even a net energy saver. Its cooling demand was the second lowest amongst glazing types tested. The differences in cooling demand were, however, small. A comparison with different climates in Sweden revealed substantial differences in heating demands, while cooling demands were similar. However, the study indicates that the cooling season is shorter in northern compared to southern Sweden leading to higher peak loads. The study shows that cooling demands can mainly be reduced by: increasing the ventilation rate, reducing the window size or the internal load, or by dimming the electric lighting in response to daylight. Windows oriented towards north also yields significantly lower cooling demands. The heating demand can be reduced by using highly insulating windows and walls, increasing the internal load, and by decreasing the window size. The lowest total energy use (heating, cooling and electricity) is achieved by small superwindows with low internal loads.

1. INTRODUCTION

Modern Swedish office buildings have much lower heating demands compared to older ones (before 1980) due to a successive sharpening of the building code. The code deals primarily with space heating. Consequently, electricity use has not decreased in modern offices, but has rather increased [1]. High internal loads from equipment and lighting combined with solar radiation, makes it at times necessary to remove excess heat. Air-conditioning has normally not been used in offices, but is now becoming more and more common even in the Swedish heating-dominated climate.

The trend has thus been to increase the insulation thickness, use better windows and improve the air-tightness of buildings. Better windows has meant using more panes, for example, the triple pane windows has been "standard" since the end of the 1970s. More recent trends, but still not so widely spread, are the use of low-e coatings and low-conductive gas fills. Since the beginning of the 1970s, Swedish total window U-values have dropped from around 3 to between 2 and 1 W/m²K, the lower value found among the best performing windows on today's market.

Daylight utilisation i. e. control of the electric lighting in relation to available daylight has often been mentioned as one option to reduce the lighting electricity use [2, 3], and also to reduce cooling loads. Highly insulating windows lead however to windows with lower visual transmittance, which, in turn, may reduce the potential of daylight utilisation. These windows may also affect the way daylight and rooms are perceived [4].

There exist many studies on the impact of windows on heating and cooling demand. Most of them are however

just calculations of a single building. One attempt to make a more systematic analysis was made by Johnson et al. [5]. Low-e coatings were however not part of this study, nor was this made for Swedish climates. Another study by Sullivan et al. [6], which included several high performance windows, stressed the importance of window solar transmittance for cooling demand and the combination of U-value and solar transmittance for heating demand.

2. METHODS

2.1 Description of the base case

In order to systematically study the effects of both glazing type and size, a single-person office module was chosen as a representative of commercial office design. The office had two windows in the south facade, the lower edge of the glazing was located 1 m above the floor, see Fig. 1. The glazing size and the thermal conductance of the wall, glazing and frame was chosen according to common Swedish building practise. The window was triple-glazed with clear glass (Table 2). A free horizon and no external shading was assumed throughout this study. All other surfaces (ceiling, floor, internal walls) were modelled as adiabatic (no net heat transfer).

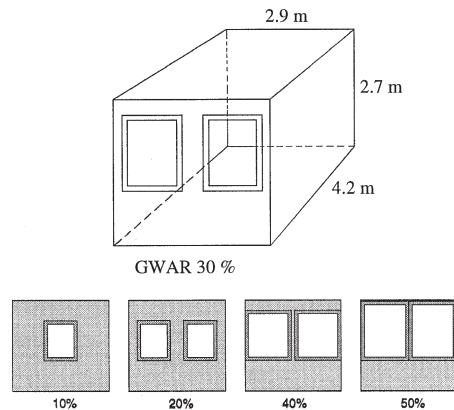

Fig. 1 The geometry of the base case with a Glazing-to-Wall Area Ratio (GWAR) 30 % (above) and wall view of other window sizes as seen from the inside (below).

Annual heating and cooling demand was calculated in DEROB-LTH, a dynamic building energy analysis program, originally from Austin, Texas [7], but continuously improved at the dept. for Building Science in Lund. It currently runs on a PC in the windows environment [8]. The calculations were performed with an improved window module [9], which treats the window in generally the same way as the WINDOW program [10].

At first no effects of daylight savings were considered. The internal heat load was held constant at 330 W during working hours (Mon-Fri between 8-17), except for at 12 (lunch), where it was 290 W. At night it was zero. The internal heat load comprised of three parts: equipment e.g. a computer with monitor (120 W); energy-efficient lighting (120 W) and one person (90 W). The lighting corresponds to an efficient installation with a lighting power density of 10 W/m² [11].

The climate file was Lund 1988 (lat. 55.72°N), which had an average outdoor temperature of 8.2°C. A constant ventilation rate of 10 l/s was used, which is close to the recommended minimum ventilation rate for hygienic reasons^a [12]. No heat recovery of exhaust air was assumed. Infiltration was 0.1 ach. The thermostat settings for heating were 20°C (8-17), with a night setback to 18°C. For cooling the settings were 24°C (8-17), with a night setback to 28°C. Other assumptions are shown in Table 1.

Table 1 Additional assumptions regarding the base case.

Exterior wall U-value	0.18 W/m ² ,K
Exterior wall	wood studs w. mineral wool
Interior walls	26 mm gypsum board on studs
Interior floor and ceiling	200 mm concrete
Interior absorptances: Ceiling/Walls/Floor	0.2/0.3/0.7
Ground reflectivity	30 %

2.2. Limitations of the study

Since daylight utilisation was one of the major interests of this study, only windows with relatively high visual transmittance were included. Visual quality aspects, such as glare, daylight and room perception, and visual interest, were excluded from the study. The calculated heating and cooling demands are the sum of the heating and cooling loads in the room itself, they do not refer to the energy that is delivered to the building. Further, the electricity use only refers to lighting and equipment in the room.

2.3. Parameters varied

The sensitivity to the following factors were studied: glazing size, type, and orientation; daylight utilisation; internal load; ventilation rate; wall insulation; and climate. The new glazing areas correspond to Glazing-to-Wall Area Ratios (GWAR) of 10, 20, 40, and 50 % (Figs. 1 & 2).

Three other window types were also studied: Double clear glazing, triple glazing with one silver-based low-e coating, and a triple glazed superinsulated window with two low-e coatings and krypton gas fillings, see Table 2. The window types were chosen as a representative selection of available windows on today's market and windows in the existing

^a The recommended minimum outdoor air flow is 7 l/s.person plus 0.35 l/s,m² floor area.

building stock. All windows (except the smallest one) were modelled as two separate windows with a 100 mm wide frame/sash around. The frame U-values were derived from typical Swedish total window U-values (U_{win}) [13]. Further, the centre-of-glass U-values were applied to the whole glazing area.

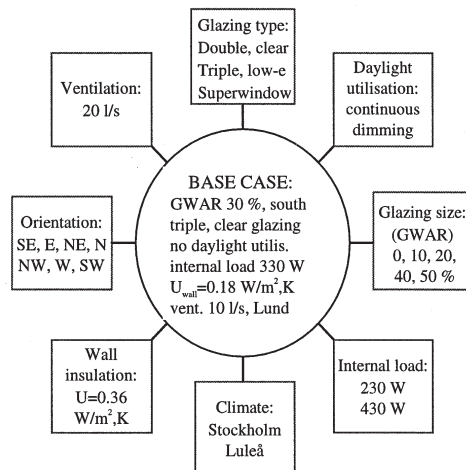

Fig. 2 Schematic overview of parametric study.

Table 2 Fenestration parameters. U-values (at $-5/+25^{\circ}\text{C}$, 5 m/s) for the total window are denoted U_{tot} , for the centre-of-glass U_{cog} , and for the frame/sash U_f . SHGC is the solar heat gain coefficient, and T_{vis} is the visual transmittance at near normal incidence.

Glazing design	U_{tot}	U_{cog}	U_f	SHGC	T_{vis}
	-<- (W/m ² ,K) ->-			-<- (%) ->-	
Double, clear	2.65	2.86	2.16	75	80
Triple, clear	1.97	1.89	2.16	66	72
Triple, low-e	1.57	1.33	2.16	57	69
Superwindow	0.97	0.67	1.70	50	66

The effect of window orientation was studied by turning the office model one revolution in 45 degree increments, starting with south orientation in the base case. Further, the sensitivity to the internal load was studied by varying the load during working hours with ± 100 W. The lower value (230 W) could be realistic if the efficiency of the equipment was improved, e.g. with flat screens instead of monitors. The higher value (430 W) is not unrealistic for older offices with less efficient lighting installations.

To study the effects of daylight utilisation, i.e. of a daylight-linked lighting control system, lighting calculations were performed using SUPERLITE and SUPERLINK in the ADELIN 2.0 program [14]. The light control strategy

chosen was continuous dimming since this has previously been shown to produce the largest daylight savings [2, 3]. The desired lighting level was set to 500 lux in the mid-point of the room at desk level. SUPERLINK produces an output file with hourly power needs for the lighting. These values were added to hourly equipment and person loads to produce a new internal load file for DEROB. The drawback of this is that there is no interaction between the lighting and thermal simulations. Shading devices can therefore not be activated when solar gain is excessive or when glare becomes intolerable. The electric lighting savings as well as the solar gains described below are therefore optimistic estimates.

In the public debate it has been mentioned that Swedish offices should be less insulated in order to reduce cooling loads. Therefore, the U-value of the exterior wall was for one case doubled to 0.36 W/m²,K. In another case the ventilation rate was doubled to 20 l/s. This rate is used as guideline with respect to smoking and computers [12]. Finally, two other geographic locations were studied, namely Luleå (lat. 65.55°N), and Stockholm (lat. 59.35°N). In 1988, they had average outdoor temperatures of 2.6°C and 6.5°C respectively.

3. RESULTS

3.1. Base case

The annual energy demand for the base case (Lund, GWAR 30 %, triple, clear glazing) was 68 kWh/m²,year for heating and 22 kWh/m²,year for cooling, in total 90 kWh/m²,year. The heating season starts approximately in October and lasts until April, while the cooling season begins in May and ends in September, see Fig. 3. The electricity use for lighting and equipment was 46 kWh/m²,year.

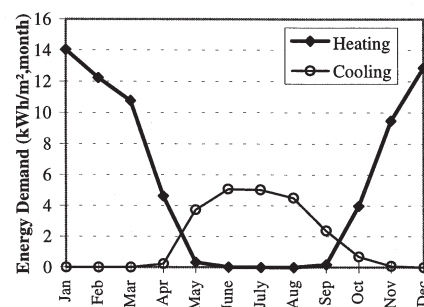

Fig. 3 The monthly heating and cooling demand (kWh/m², month) of the base case.

3.2. Glazing size and type

The effect of changing the window size is relatively large for the cooling demand, while the heating demand is much less affected, see Fig. 4. The cooling demand increases somewhat faster than linearly with the glazing area. A GWAR of 40% instead of 30% increases the cooling demand by 8 kWh/m²,year, while it decreases by 8 kWh/m²,year for a GWAR of 20%.

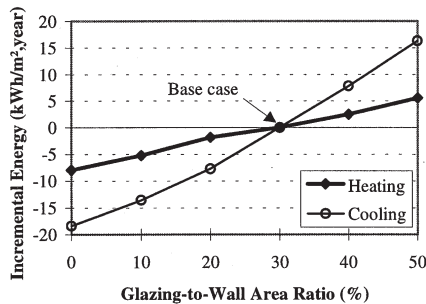

Fig. 4 Incremental energy demand (kWh/m²,year) as a function of glazing size.

The incremental heating and cooling demands for various glazing combinations are plotted against total window U-values in Fig. 5. As expected, the double-pane window performs worse than the triple-pane ones. Compared to the base case, both heating and cooling demands are higher: +10 kWh/m²,year and +2 kWh/m²,year resp. Consequently, the triple-pane window with one low-e coating performs better. Its heating demand is 5 kWh/m²,year lower and the cooling demand is 1 kWh/m²,year lower compared to the base case. Finally, the superwindow has a heating demand that is 15 kWh/m²,year lower and a cooling demand that is less than 1 kWh/m²,year lower than the triple, clear window. The heating demand for the superwindow is even lower than having no window at all, which means that the window is a net energy saver for south orientation. At the same time the cooling demand is slightly higher than for the triple, low-e window even if the solar transmittance is the lowest in the group. This shows that, during the cooling season, the balance between solar gains and thermal losses is slightly in favour for the triple, low-e window.

The heating demand shows an almost linear relationship with the U-value. This suggests that the difference in solar transmittance among the glazing types in this study have little or no influence. This is contradictory to what Sullivan et al. concluded for residential buildings in north American climates [6]. They said that both window U-value and solar transmittance was important for the heating performance.

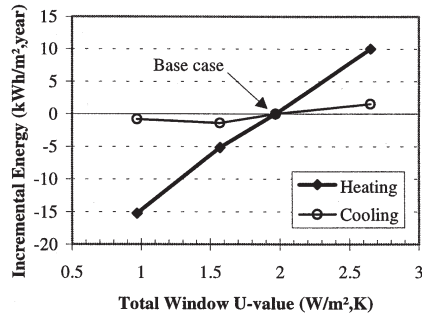

Fig. 5 Incremental energy demand (kWh/m²,year) as a function of total window U-value.

3.3. Orientation

The effect of window orientation is shown in Fig. 6. Naturally, north orientation has the highest heating demand (+21 kWh/m²,year) and the lowest cooling demand (-12 kWh/m²,year). East and west orientations show similar behaviour, although the cooling demand is slightly higher for east. In general, the cooling demand for both east and west is similar to south while the heating demand is significantly higher. North-east, north-west etc. orientations generally fall between the main orientations. The largest cooling demand occur for south-east orientation, plus 2 kWh/m²,year compared to south.

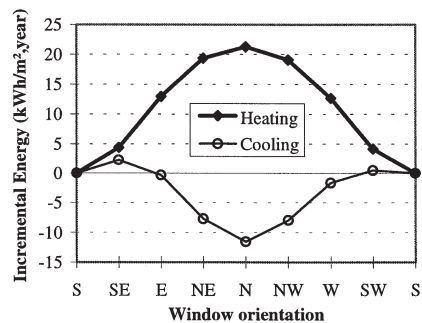

Fig. 6 Incremental energy demand (kWh/m²,year) as a function of window orientation.

3.4. Daylight utilisation, wall insulation and internal load

The parameters daylight utilisation, wall insulation and internal load were varied individually and the results are summarised in Fig. 7. The effect of daylight utilisation is a reduction of the cooling demand with 6 kWh/m²,year, while the heating demand increases by merely 4

kWh/m²,year compared to the base case. The electric lighting savings are approx. 10 kWh/m²,year (working Mon-Fri, 8-17) or a reduction of 47 % of annual use without dimming.

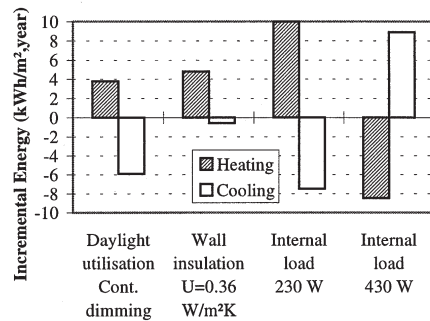

Fig. 7 Incremental energy demand (kWh/m²,year) for daylight utilisation, decreased wall insulation and for various internal loads respectively.

When the wall U-value is doubled to 0.36 W/m²,K the heating demand increases slightly (+5 kWh/m²,year), while the cooling demand is only reduced by 0.6 kWh/m²,year. Why the cooling demand does not decrease more is explained by the short time overlap between the heating and the cooling season, compare Fig. 3: in April and Oct. there is a small heating demand, but the cooling demand is almost zero. In May and Sept. the opposite is observed.

With an internal load of 230 W, the heating demand increases by 10 kWh/m²,year, while the cooling demand reduces by 7 kWh/m²,year. For an internal load of 430 W the heating demand instead decreases by 8 kWh/m²,year, while the cooling demand increases by 9 kWh/m²,year. Both incremental heating and cooling demand relationships are linear.

3.5. Climate and Ventilation

The climate has a large effect on mainly heating demands, see Fig. 8. For Luleå, the heating demand is doubled (+72 kWh/m²,year), and for Stockholm it is increased by 24 kWh/m²,year compared to Lund. The cooling demand is however the same for both Luleå and Lund, while it is slightly higher for Stockholm (+24 kWh/m²,year). Since the cooling season is shorter in Luleå than in Lund, peak power demands are, perhaps surprisingly, higher in Luleå.

Of all parameters tested, a doubling of the ventilation rate to 20 l/s shows the largest effect on the heating demand: It more than doubles (+80 kWh/m²,year), while the cooling demand decreases by 11 kWh/m²,year. (Fig. 8).

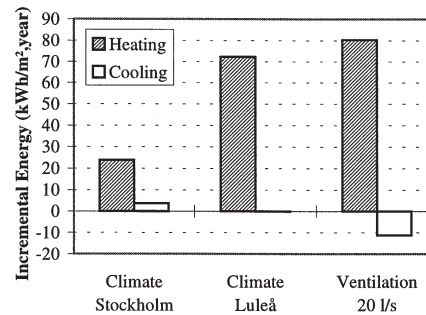

Fig. 8 Incremental energy demand (kWh/m²,year) for the Stockholm and Luleå climates and for an increased ventilation (Lund) respectively.

If we combine all results to get a hint about the best versus the worst design options, i.e. those that yield the lowest and highest total energy use (including electricity for lighting and equipment), and verify them by DEROB-simulations the following results are reached: (We keep the Lund climate, and don't consider a case without a window): Best design: base case plus GVAR 10%, internal load 230 W and superwindow. The demand for heating, cooling and electricity then becomes 58, 8 and 27 kWh/m²,year resp. Worst design: base case plus GVAR 50%, double pane window, 430 W internal load, east orientation with demands for heating, cooling and electricity equal to 185, 30, and 66 kWh/m²,year resp.

4. DISCUSSION

By varying one parameter at a time it is possible to see which one is the most important in reducing heating and cooling demands. The calculated differences between one case and the base case depend of course on how much the parameter is changed. Therefore, the steps should be realistic, which is also true for the parameter settings in the base case. It is difficult to establish what a realistic base case is, since most buildings are unique, and trends also vary over time. An attempt was however made to model a typical one-person office room which corresponds to current Swedish building practices and to find realistic steps for the parameters that were varied.

5. CONCLUSIONS

For the cooling demand, the following parameters show a large influence (in descending order): glazing size, window orientation, ventilation rate, internal load, and daylight utilisation. The heating demand is mainly affected by: ventilation rate, climate, orientation, and glazing type.

In search for the most promising energy-efficient technologies we firstly look for those that show simultaneous reductions in heating and cooling demand, and secondly those that reduce cooling demands significantly without causing large increases in heating demands. Among technologies identified in the first group are windows with very low U-values, especially the superwindow. For south orientation, the reduction in heating demand is even larger than having an unglazed wall, which means that the window actually gains energy over the year. At the same time the cooling demand is slightly lower than for a triple-glazed window. To limit the window size is also very important since the cooling demand depend strongly on the size. For all windows except the superwindow, both heating and cooling demands decrease with a decreased window size. In the second group, only daylight utilisation show some promise to reduce cooling loads, with only moderate increases in heating loads.

The orientation has quite a large effect on both heating and cooling, but this is only an alternative for new construction. And even then, the lot itself or a city plan may put restrictions on the building's design with regards to orientation. As little as the orientation can be changed for an existing building, as little is it possible to change the climate. However, the study reveals large differences in heating demands between southern and northern Sweden. This only emphasises the importance of well-insulated walls and windows for cold climates.

Increased ventilation has a large potential to reduce the cooling demand, but at the expense of a dramatically increased heating demand. There are a number of solutions to this, e.g. heat recovery of exhaust air, and variable ventilation rates depending on the cooling demand.

When the internal load is changed, both heating and cooling demands are changed by similar amounts. In percent however, cooling is affected more than heating. This points at the importance of keeping the internal load as low as possible. As this load arises from mainly artificial lighting and equipment it leads to electricity use, which cannot be replaced by another energy source.

Finally it can be concluded that it is not good to reduce the wall insulation in order to reduce cooling loads. Since the cooling demand occur when the temperature difference between inside and outside is low, the main effect will be that heating demands are increased, while the cooling demands are almost unaffected.

REFERENCES

- [1] Bygghälsöversynsgruppen. (1995). *Energiboken. Kunskapsläge och forskningsfront*. (The energy book. State of knowledge and research). (in Swedish). (Report T21:1995). Stockholm, Sweden: Bygghälsöversynsgruppen.
- [2] Christoffersen, J. (1995). *Daylight Utilization in Office Buildings*. (Rep. SBI 258). Danish Building Research Inst.
- [3] Szman, (1994). *Auswirkung der Tageslichtnutzung auf das energetische Verhalten von Bürogebäuden*. (The Effect of Daylight Utilisation on the Energetic Performance of Office Buildings). (In German). Stuttgart, Germany: Universität Stuttgart, Konstruktive Bauphysik.
- [4] Bülow-Hübe, H. (1995). Subjective reactions to daylight in rooms: Effect of using low-emittance coatings on windows. *Lighting Res. Technol.* 27(1) 37-44.
- [5] Johnson, R, Sullivan, S., Selkowitz, S., Nozaki, S, Conner, C. & Arasteh, D. (1984). Glazing Energy Performance and Design Optimization with Daylighting. *Energy and Buildings*. 6(4) 305-317.
- [6] Sullivan, R., Beck, F., Arasteh, D., & Selkowitz, W. (1995). *Energy Performance of Evacuated Glazings in Residential Buildings*. (Report LBL-37130). Berkeley, CA: Lawrence Berkeley Laboratory.
- [7] Arumi-Noé, F., & Wysocki, M. (1979). *The DEROB System Volume 1, User's Manual for the DEROB System*. Austin, Texas, USA: Numerical Simulation Laboratory, School of Architecture, University of Texas.
- [8] Kvist, Hasse (1995). *DEROB-LTH for Windows. User Manual*. (Report TABK--95/7019). Lund, Sweden: Lund Institute of Technology, Department of Building Science.
- [9] Källblad, Kurt (1997). *Thermal Model of Windows in DEROB-LTH*. (Interim report, March 1997). Lund, Sweden: Lund Inst. of Technology, Dept. of Building Science.
- [10] Arasteh, D., Reilly, S., & Rubin, M. (1989). A Versatile Procedure for Calculating Heat Transfer Through Windows. *ASHRAE Trans*. Vol. 95. Pt. 2.
- [11] NUTEK (1994, Ver. 2). *Office Lighting. 34 Examples of Good and Energy-Efficient Office Lighting*. Swedish National Board for Industrial and Technical Development, Department of Energy Efficiency.
- [12] AFS 1993:5 (1993). *Ventilation och luftkvalitet. Arbetskyddsstyrelsens författningssamling*. (Ventilation and Air Quality). (in Swedish). Solna, Sweden: Ordinance of The National Board of Occupational Safety and Health.
- [13] Elitfönster. (1996). *U-värde katalog*. (Catalogue of U-values) (In Swedish).
- [14] Erhorn, H. & Stoffel, J. (eds.) (1996). *ADELIN 2.0. Advanced Daylighting and Electric Lighting Integrated New Environment*. Documentation of the Software package ADELIN, Version 2.0 (9 volumes). IEA Solar Heating and Cooling Program, Task 12: Solar Building Energy Analysis Tools.

III

Lighting Res. Technol. 27(1) 37-44 (1995) Printed in Great Britain L293

Summary In this study, the impact of two different types of window glazing using two identical rooms was studied. In one experiment both rooms were furnished as an office, in another experiment as a bedroom. The only other difference between the two rooms was the glazing of the window. In one room a standard three-pane window (2+1) with 4 mm clear glass was used, in the other a super-insulated four-pane window (3+1) with two silver-based low-emittance coatings. The results showed that people were clearly able to distinguish between the two windows. The room with the four-pane window felt more enclosed, and the daylight felt less strong and clear. The four-pane window also affected colour perception, making the colours of the room and of the view look more subdued or more drab. Spectral measurements revealed that the four-pane window transmitted a relatively higher percentage of the green part of the spectrum. The results agree with what might be expected given the lower transmittance and different spectral distribution of the four-pane window. It is questioned how far one should go in reducing the daylight transmittance of windows.

Subjective reactions to daylight in rooms: Effect of using low-emittance coatings on windows

Helena Bülow-Hübe MSc

Department of Building Science and Environmental Psychology Unit, School of Architecture, Lund Institute of Technology, Box 118, S-221 00 Lund, Sweden

Received 13 June 1994, in final form 30 September 1994

1 Introduction

The most important trend in Swedish housing construction is, as in past decades, to reduce the energy losses of buildings. Building codes in Sweden have since 1975 required a U -value† of $2.0 \text{ W m}^{-2} \text{ K}^{-1}$ or less for windows, leading to three-pane windows now being the standard in modern housing. Window areas have also decreased since the 1960s. Launched during the 1970s, an intensive programme for energy-improvement in older multi-family buildings has led to the replacement of many double-pane windows with three-pane windows‡. Recent trends in window construction are the use of low-emittance (low- e) coatings and heavy gases. Today, windows with U -values as low as $1.2\text{--}1.5 \text{ W m}^{-2} \text{ K}^{-1}$ are sometimes used for new buildings. In 1991, the Swedish National Board for Industrial and Technical Development (NUTEK) invited 16 window manufacturers to compete in the development of a super-insulated window with a U -value lower than $0.9 \text{ W m}^{-2} \text{ K}^{-1}$. Further, it was to have a daylight transmittance of at least 60%, while fulfilling other standard requirements for a window as well. In 1992 two windows shared the first prize in the competition. Both included four panes of glass (3+1), two or three low- e coatings and argon gas. The daylight transmittance at normal incidence of these windows was around 55% as compared with 73% for three panes of clear glass⁽¹⁾. Anticipating the possibility that these or similar windows might become a new standard for future housing projects, it was considered important to examine the daylight properties of these new windows. Each pane of glass and each low- e coating added to a window reduces the level of incoming daylight and may also affect its spectral composition. The question arises of how far these energy improvements can continue, and where the limit should be placed. Here we must begin to consider how people react to these

†The U -value is a measure of the heat loss per square meter (window) at a temperature difference between inside and outside of 1 Kelvin.

‡Three-pane windows (2+1) have often been preferred in Sweden to the alternative double-pane window with one low- e coating. Both have a U -value of around $2.0 \text{ W m}^{-2} \text{ K}^{-1}$ compared with $3.0 \text{ W m}^{-2} \text{ K}^{-1}$ for a double-pane window with clear glass.

windows, and whether they are affected by the change in daylight transmittance.

1.1 Previous research

In addition to basic work on vision and visual performance, research on how humans are influenced by light has developed mainly along three lines: Perception of indoor spaces; the impact of light on chronobiology, and the influence of light on arousal, mood and cognition. After Küller, the last two areas were termed in 1981 the 'non-visual effects of light'⁽²⁾.

In perception research, the influences of colours, lighting conditions and window size on the perception of interiors have been studied. Aking and Küller⁽³⁾ had subjects assess colour slides of perspective drawings of living rooms in which the hue, lightness and chromatic strength of the colours of walls and some interior components were varied. The results showed a positive correlation between perceived openness and lightness of the room walls, and between perceived complexity and chromatic strength. Further, there was a positive correlation between blackness and social evaluation (i.e. the social status of the room, see Table 1). The first two correla-

Table 1 The eight dimensions of the semantic environmental description

Dimension	Definition
Pleasantness	The environmental quality of being pleasant, beautiful and secure
Complexity	The degree of variation or, more specifically, intensity, contrast and abundance
Unity	How well all the various parts of the environment fit together into a coherent and functional whole
Enclosedness	A sense of spatial enclosure and demarcation
Potency	An expression of power in the built environment and its various parts
Social status	An evaluation of the built environment in socio-economic terms, but also in terms of maintenance
Affection	The quality of recognition giving rise to a sense of familiarity, often related to the age of the environment
Originality	The unusual and surprising in the environment

H Bilow-Hübe

tions were also supported in a small full-scale study of hospital day rooms. In another study by Küller, subjects judged two rectangular rooms of identical size⁽⁴⁾. In one room the long walls had been painted dark grey and the short walls white; in the other the conditions were the opposite. The conclusion was that the dark walls 'attracted' and the light walls 'repelled' each other, changing the perceived shape of the room. Inui and Miyata⁽⁵⁾ had subjects look into a scale model of a room where the sky luminance, window size, interior illuminance, method of illumination and furnishing, were each kept at two different levels. They found a positive correlation between spaciousness and sky luminance, interior illuminance and window size. Spaciousness was not related to the method of illumination nor to the type of furniture. Satisfaction was most strongly related to the window size, a larger window giving greater satisfaction.

These earlier studies have shown that various environmental factors, such as room colours and window size, affect the way in which we perceive a room space. It is therefore reasonable to assume that different types of window glazing will also have perceptual effects. However, there have been few studies of window glazing. Cooper *et al.*⁽⁶⁾ studied the attitudes towards the use of heat-rejecting or low-light-transmission glasses in high-rise office buildings. Glass transmission factors in the sample ranged from 15 to 85%. A questionnaire concerning topics like having a view out, the content of and reactions to the view, and colours in the room, was answered by 900 office workers. The results suggested that tinted glass had little or no effect on the visual environment. The authors concluded: 'the minimal effect of the glass could well be due to adaptation of the visual system'. The lack of positive results could, however, also be due to factors not controlled in the design of the study.

Heerwagen and Heerwagen⁽⁷⁾ studied the office environment of a high-rise building with low-transmittance heat-reflective glazing. The paper only presents the results from the first distribution of a questionnaire (in November). Because of this, and the lack of a control group with normal clear glazing, it is difficult to draw any conclusions from their results on view gloominess and visual comfort.

2 The problem

The main hypothesis of the present study was that the perception of a room space will be affected by the type of window glazing used. It was assumed that the lower light transmittance of a super-insulated window will affect many parameters in a negative direction: Enclosedness was assumed to increase in this room, because perceived spaciousness has already been found to correlate with both interior illuminance and sky luminance⁽⁵⁾, and the lightness of the room⁽³⁾. Further, it was hypothesised that the social category would increase, due to higher blackness in the room with low light transmittance⁽³⁾. It was also hypothesised that the perceptual changes would include the view through the window. For example, architects often argue that low-*e* coatings will make the sky look darker, as if a thunderstorm were approaching⁽⁸⁾. It was also suggested that the perceptual changes might differ in different environments, for instance between a more official, work environment and a homely one. Non-visual effects relating to the differences in daylight spectrum and illuminance level were beyond the scope of this study.

3 Experimental design and methods

3.1 Laboratory space and windows

Two identical rooms were prepared in an experimental building at the School of Architecture in Lund. The rooms measured $3.0 \times 3.63 \times 2.45$ m (*av* \times *l* \times *h*). A window (1.2×1.3 m) was placed in the south-facing facade of each room. Both rooms were painted in a very pale yellow, had a white inner ceiling and a grey-blue-brown linoleum floor. They were furnished with curtains and furniture to look as realistic as possible (Figures 1 and 2). In one experiment both rooms were furnished as an office, in the other as a bedroom. The only other difference between the two rooms was the glazing of the window. In one room a standard three-pane window (2+1) with 4 mm clear glass was used, in the other a super-insulated four-pane window (3+1) with two silver-based low-*e* coatings. Their optical properties are shown in Table 2. The only source of illumination was daylight. The view outside consisted from left to right of a green tree, a one-storey house painted white, and a five-storey red brick building at some distance. In front of the white building was a lawn and some small bushes.

Table 2 Optical properties of the studied windows^(9,10), calculated using the solar spectrum in ISO 9845-1. T_{vis} is the daylight transmission at normal incidence. $x(R)$, $y(R)$ are the CIE chromaticity coordinates in reflection. $x(T)$, $y(T)$ are the CIE chromaticity coordinates in transmission.

Window	T_{vis} (%)	$x(R)$	$y(R)$	$x(T)$	$y(T)$
Standard three-pane	72.6	0.341	0.361	0.344	0.364
Super-insulated four-pane	57.3	0.325	0.351	0.348	0.371

3.2 Procedure and subjects

The study was conducted during the bright part of the year, in May 1993. During the first and fourth weeks both rooms were furnished as single-person offices, and during weeks two and three they were changed into single-person bedrooms. From one room one could see more of the green tree and less of the brick building than from the other room. Therefore halfway through the study the windows were rearranged to reduce possible effects of the slight difference in view.

The rooms were assessed by 95 subjects, in a balanced repeated-measure design, in which each subject judged both rooms

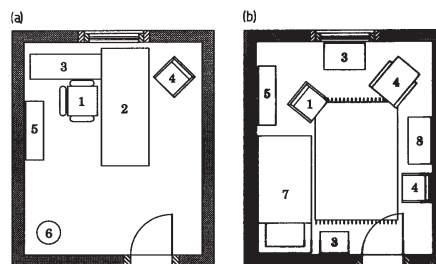

Figure 1 Plans of (a) office and (b) bedroom including positions of assessor (1); desk (2); table (3); chair (4); bookcase (5); stool (6); bed (7); chest of drawers (8)

Low-emittance window coatings and reaction to daylight



Figure 2 Views of (a) office and (b) bedroom

Table 3 Experimental design of the study

Furnishing	Location of 3-pane window	Order of judgement (first/last)	Subject No.	Assessment of 3-pane window	Assessment of 4-pane window
Office	Right room	3/4	1-11		
		4/3	12-23		
	Left room	3/4	24-35		
		4/3	36-47		
Bedroom	Right room	3/4	48-59		
		4/3	60-71		
	Left room	3/4	72-82		
		4/3	83-95		

H Bülow-Hübe

on the same occasion, the only difference being the type of window (Table 3). On the average, each person spent about 15–20 minutes in each room. Approximately one third of the subjects were first- or second-year students of civil engineering. The rest were recruited by advertisement in a local newspaper. A selection was made so as to achieve a suitable distribution of age and gender, and to ensure that architects or architectural students would not participate in the study. One person dropped out of the study, therefore the final group consisted of 51 females and 44 males between 18 and 72 years of age ($m = 35.0$, $SD = 14.7$). The subjects were not told of the real aim of the study. Instead, they believed that they were participating in a study on how the perception of rooms is influenced by the type of weather and time of day. On arrival at the laboratory the subjects were given instructions about the procedure, which in brief was that they were to judge two identical rooms one at a time. For this purpose there were two questionnaires in each room. The assessments were to be made sitting down at a certain place in the room. Afterwards, the subjects were paid a modest fee of 50 SEK (~£5) for their participation.

3.3 Assessment of the indoor space

The first assessment was of room perception. This was carried out by means of the standardised SMB form (semantic environmental description) developed by Küller^(1,12). The form consists of 36 seven-grade rating scales and gives estimates of the following architectural qualities: Pleasantness, complexity, unity, enclosedness, potency, social status, affection, and originality (Table 1). Reports of reliability vary between $r = 0.66$ and $r = 0.86$.

3.4 Subjective assessment of daylight quality

According to Liljefors and Ejhed⁽¹³⁾ light in interiors is characterised by seven dimensions: Lighting level, light distribution, shadows, reflexes, glare, light colour and colours. A lighting questionnaire was developed in which most of these dimensions were covered. The questionnaire focussed more specifically on the daylight, glare, colours and shadows in the room, and on the view through the window. It contained 12 general questions each followed by a number of seven-grade bipolar scales (Table 4). The form contained 29 such scales altogether, which in the following will be referred to as L1–L29. In order to make subjects' judgements more comparable, a small gypsum head (Beethoven) was used for the assessment of shadows and a large poster showing fruit for colours.

3.5 Light and temperature measurements

Before and after each subject assessed a room the illuminance and ambient room temperature were measured and the weather type recorded. The illuminance was measured in the middle of each room, 72 cm above the floor, with a Hagner digital luxmeter (EC1). The weather recordings were later analysed on a four-point scale: 1 = clear, 2 = half-clear, 3 = overcast, 4 = rain. The illuminance level of a third room, located between the two others, was recorded continuously by means of a Hagner universal photometer (S2) and plotter for use as a reference for the outdoor lighting level.

After the completion of the subjective assessment study, the spectral composition (irradiance) of the daylight entering the two rooms was measured at several occasions by a Li-Cor

Table 4 Questions and bipolar scales in the lighting questionnaire

Question	Bipolar scale (1–7)
1 How do you perceive the daylight in this room?	1 strong –weak 2 pleasant –unpleasant 3 warm –cold 4 hard –soft 5 tinted –clear
2 Do you perceive the room as a whole as light or dark?	6 light –dark
3 How well can you see in this light?	7 bad –good
4 How is the daylight distributed in the room?	8 varied –monotonous
5 How are the shadows on the sculpture?	9 diffuse –sharp 10 soft –hard
6 How are the colours on the fruit poster?	11 clear –drab 12 subdued –strong 13 warm –cold
7 How is the colour rendering of the fruit poster?	14 natural –unnatural
8 Are you disturbed by glare from the window?	15 much –little
9 Are you disturbed by glare from strongly lit surfaces?	16 much –little
10 How is the weather outdoors right now?	17 clear –hazy 18 overcast –no clouds 19 beautiful –dull 20 grey –sunny
11 How do you perceive the light outdoors right now?	21 light –dark 22 pleasant –unpleasant 23 warm –cold 24 glaring –mild 25 natural –unnatural
12 How do you perceive the colours outside the window?	26 clear –drab 27 subdued –strong 28 warm –cold 29 natural –unnatural

Spectroradiometer LI-1800. The measuring point was located horizontally in the middle of each room, 88 cm above floor level.

3.6 Statistics

The data were treated mainly by analysis of covariance using the SPSS MANOVA procedure; the design included both within-subject and between-subject variance^(14,15). The analysis treated each rating scale separately (in this case 8 + 29 separate comparisons). Therefore the risk increases of accepting a hypothesis that is not true. Significances at the 5% level were therefore considered as tendencies only, and instead the 1% level was considered as truly significant.

4 Results

4.1 Weather, light and temperature

One consequence of studying daylight in real environments is that this parameter is beyond the control of the experimenter. As it happened, the weather was considerably more sunny and stable during the period when the rooms were furnished as bedrooms. This may be one explanation as to why more parameters emerged as significant in the bedroom case, as will be shown below.

Even where the evaluations of the two rooms were carried out in close succession, the weather tended to be somewhat clearer when the room with the four-pane window was being assessed ($p = 0.055$). In order to compensate for this possible bias, weather was introduced as a covariate.

To pursue this issue, the mean illuminance value of the reference room during each assessment was derived from the plotter recordings. An analysis showed that there was no significant difference between the mean outdoor illuminance level during the three-pane and four-pane assessments respectively, and that there was therefore no need for further treatment of these data.

The mean illumination of the mid-point of each room was 830 lux in the room with the three-pane window and 630 lux in the room with the four-pane window ($p = 0.000$). The mean indoor ambient temperature during assessments was 22.5°C in the three-pane room and 22.2°C in the four-pane room ($p = 0.000$). Both differences are explained by the lower

Low-emittance window coatings and reaction to daylight

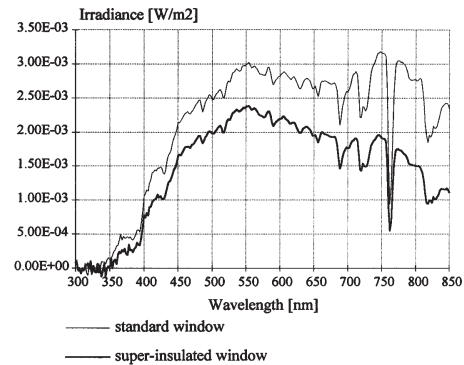

Figure 3 Spectral irradiance ($W m^{-2}$ versus nm) of the two rooms, measured horizontally in the midpoint of each room, 88 cm above floor level. Overcast weather, 21 October 1993 at 1200.

daylight and solar energy transmittance of the four-pane window. The measurements of spectral irradiance also show clearly that the illuminance level was lower in the room with the four-pane window. Further, they also reveal a qualitative difference in the indoor lighting (Figure 3). In the visible part of the spectrum, a relatively smaller part of both the short- and long-wave radiation comes through the four-pane window, which gives this room a greener appearance. This difference can be attributed to the two silver-based low- e coatings, which have a transmittance peak in the green part of the spectrum⁽¹⁾.

4.2 Appearance of the office space

The perceptual profile of the office shows a room with somewhat low complexity, social status and originality, but with fairly high affection (Figure 4). The impact of window type was significant for enclosedness ($p = 0.000$). (See Table 5.) The four-pane window room was perceived as more enclosed.

In the room with the four-pane window, the daylight was perceived as more tinted ($p = 0.009$) and weaker, but the latter

Table 5 Mean scores in environmental and lighting assessment for the two types of window glazing, with weather as covariate. Only rating scales with significant differences are included.

Variable	Office (N = 47)			Bedroom (N = 48)			Total (N = 95)		
	Score		Signif. level	Score		Signif. level	Score		Signif. level
	3-pane	4-pane		3-pane	4-pane		3-pane	4-pane	
Pleasantness	3.70	3.64	NS	4.32	4.18	NS	4.01	3.91	0.049
Complexity	3.11	3.16	NS	3.77	3.57	0.040	3.44	3.37	NS
Enclosedness	3.98	4.46	0.000	3.33	3.73	0.012	3.66	4.09	0.000
L1: strong-weak	3.13	3.57	0.042	2.77	3.54	0.000	2.95	3.56	0.000
L2: pleas-unpleasant	2.81	3.11	NS	2.25	2.73	0.039	2.53	2.92	0.024
L3: warm-gold	3.77	4.17	NS	2.88	3.33	NS	3.32	3.75	0.012
L5: tinted-clear	5.02	4.34	0.009	4.88	4.19	0.006	4.95	4.26	0.000
L6: light-dark	2.87	3.23	NS	1.94	2.56	0.007	2.40	2.90	0.005
L7: bad-good	5.72	5.68	NS	6.52	6.23	0.047	6.13	5.96	NS
L10: soft-hard	3.00	3.06	NS	3.31	2.81	0.005	3.16	2.94	NS
L12: subdued-strong	5.70	5.17	0.028	5.62	5.42	NS	5.66	5.30	0.009
L17: clear-hazy	3.02	2.98	NS	2.23	2.58	0.010	2.62	2.78	NS
L19: beautiful-dull	3.43	3.19	0.05	1.46	1.52	NS	2.43	2.35	NS
L21: light-dark	2.40	2.51	NS	1.48	1.85	0.003	1.94	2.18	0.014
L22: pleas-unpleasant	2.74	2.79	NS	1.92	2.21	0.020	2.33	2.50	NS
L24: glaring-mild	3.85	4.36	NS	3.35	3.90	0.020	3.60	4.13	0.003
L26: clear-drab	2.60	2.81	NS	1.85	2.42	0.002	2.22	2.61	0.005

Spectroradiometer LI-1800. The measuring point was located horizontally in the middle of each room, 88 cm above floor level.

3.6 Statistics

The data were treated mainly by analysis of covariance using the SPSS MANOVA procedure; the design included both within-subject and between-subject variance^(14,15). The analysis treated each rating scale separately (in this case 8+29 separate comparisons). Therefore the risk increases of accepting a hypothesis that is not true. Significances at the 5% level were therefore considered as tendencies only, and instead the 1% level was considered as truly significant.

4 Results

4.1 Weather, light and temperature

One consequence of studying daylight in real environments is that this parameter is beyond the control of the experimenter. As it happened, the weather was considerably more sunny and stable during the period when the rooms were furnished as bedrooms. This may be one explanation as to why more parameters emerged as significant in the bedroom case, as will be shown below.

Even where the evaluations of the two rooms were carried out in close succession, the weather tended to be somewhat clearer when the room with the four-pane window was being assessed ($p = 0.055$). In order to compensate for this possible bias, weather was introduced as a covariate.

To pursue this issue, the mean illuminance value of the reference room during each assessment was derived from the plotter recordings. An analysis showed that there was no significant difference between the mean outdoor illuminance level during the three-pane and four-pane assessments respectively, and that there was therefore no need for further treatment of these data.

The mean illumination of the mid-point of each room was 830 lux in the room with the three-pane window and 630 lux in the room with the four-pane window ($p = 0.000$). The mean indoor ambient temperature during assessments was 22.5°C in the three-pane room and 22.2°C in the four-pane room ($p = 0.000$). Both differences are explained by the lower

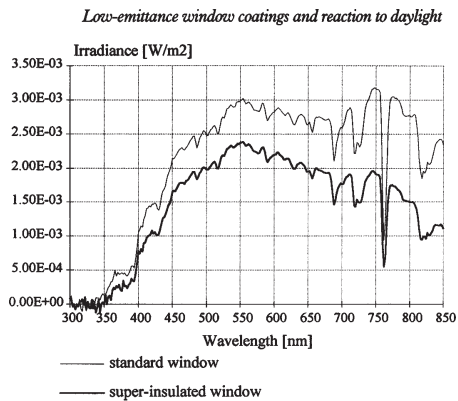

Figure 3 Spectral irradiance ($W m^{-2}$ versus nm) of the two rooms, measured horizontally in the midpoint of each room, 88 cm above floor level. Overcast weather, 21 October 1993 at 1200.

daylight and solar energy transmittance of the four-pane window. The measurements of spectral irradiance also show clearly that the illuminance level was lower in the room with the four-pane window. Further, they also reveal a qualitative difference in the indoor lighting (Figure 3). In the visible part of the spectrum, a relatively smaller part of both the short- and long-wave radiation comes through the four-pane window, which gives this room a greener appearance. This difference can be attributed to the two silver-based low- e coatings, which have a transmittance peak in the green part of the spectrum⁽¹⁾.

4.2 Appearance of the office space

The perceptual profile of the office shows a room with somewhat low complexity, social status and originality, but with fairly high affection (Figure 4). The impact of window type was significant for enclosedness ($p = 0.000$). (See Table 5.) The four-pane window room was perceived as more enclosed.

In the room with the four-pane window, the daylight was perceived as more tinted ($p = 0.009$) and weaker, but the latter

Table 5 Mean scores in environmental and lighting assessment for the two types of window glazing, with weather as covariate. Only rating scales with significant differences are included.

Variable	Office (N = 47)			Bedroom (N = 48)			Total (N = 95)		
	Score		Signif. level	Score		Signif. level	Score		Signif. level
	3-pane	4-pane		3-pane	4-pane		3-pane	4-pane	
Pleasantness	3.70	3.64	NS	4.32	4.18	NS	4.01	3.91	0.049
Complexity	3.11	3.16	NS	3.77	3.57	0.040	3.44	3.37	NS
Enclosedness	3.98	4.46	0.000	3.33	3.73	0.012	3.66	4.09	0.000
L1: strong-weak	3.13	3.57	0.042	2.77	3.54	0.000	2.95	3.56	0.000
L2: pleas-unpleasant	2.81	3.11	NS	2.25	2.73	0.039	2.53	2.92	0.024
L3: warm-gold	3.77	4.17	NS	2.88	3.33	NS	3.32	3.75	0.012
L5: tinted-clear	5.02	4.34	0.009	4.88	4.19	0.006	4.95	4.26	0.000
L6: light-dark	2.87	3.23	NS	1.94	2.56	0.007	2.40	2.90	0.005
L7: bad-good	5.72	5.68	NS	6.52	6.23	0.047	6.13	5.96	NS
L10: soft-hard	3.00	3.06	NS	3.31	2.81	0.005	3.16	2.94	NS
L12: subdued-strong	5.70	5.17	0.028	5.62	5.42	NS	5.66	5.30	0.009
L17: clear-hazy	3.02	2.98	NS	2.23	2.58	0.010	2.62	2.78	NS
L19: beautiful-dull	3.43	3.19	0.05	1.46	1.52	NS	2.43	2.35	NS
L21: light-dark	2.40	2.51	NS	1.48	1.85	0.003	1.94	2.18	0.014
L22: pleas-unpleasant	2.74	2.79	NS	1.92	2.21	0.020	2.33	2.50	NS
L24: glaring-mild	3.85	4.36	NS	3.35	3.90	0.020	3.60	4.13	0.003
L26: clear-drab	2.60	2.81	NS	1.85	2.42	0.002	2.22	2.61	0.005

H Bülow-Hübe

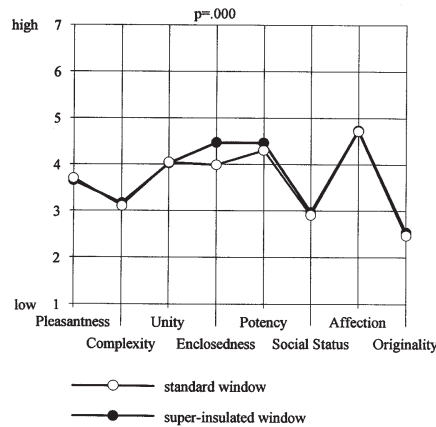

Figure 4 Perceptual profile of the office with three-pane (standard) and four-pane (super-insulated) window

was only a tendency (Table 5). There was a tendency to consider the colours of the poster showing fruit as more subdued. There was a somewhat surprising tendency to judge the weather outdoors as more beautiful with a four-pane window.

4.3 Appearance of the bedroom

The perceptual profile of the bedroom is shown in Figure 5. The overall pleasantness, complexity and social status were perceived to be slightly higher, while the enclosedness, potency and affection were slightly lower than for the office. The window type had a significant impact on the feeling of enclosedness ($p = 0.01$); the four-pane window room felt more enclosed. There was also a tendency to perceive this

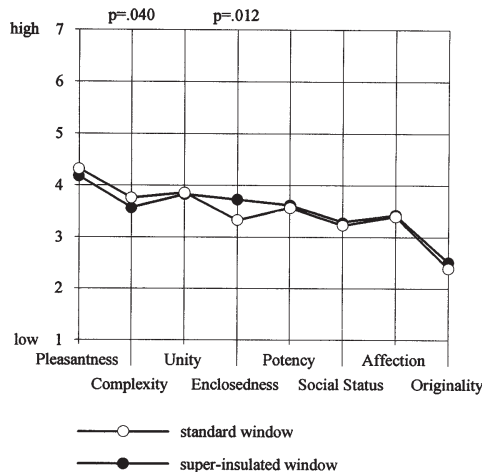

Figure 5 The perceptual profile of the bedroom with three-pane (standard) and four-pane (super-insulated) window

room as less complex.

In the case of the bedroom, the lighting in the room with the four-pane window was perceived as weaker ($p = 0.000$) and more tinted ($p = 0.006$). (Table 5). There was also a tendency to consider the lighting as more unpleasant. Further, the room was darker ($p = 0.007$) and more difficult to see in (tendency only). The shadows on the sculpture were softer ($p = 0.005$) but no difference was found for the colours of the poster showing fruit. Outdoors, the weather was perceived as more hazy ($p = 0.01$) and the daylight was darker ($p = 0.003$). There was also a tendency to consider the weather as more unpleasant and less glaring. The colours of the view were perceived as more drab ($p = 0.002$) when seen through the four-pane window.

4.4 Overall appearance of the indoor space

Generally speaking, since many of the effects coincided for the two different rooms, that is the office and the bedroom, the data were pooled in one major analysis of covariance considering both similarities and eventual differences between the two spaces. The results showed that the room with the four-pane window was perceived as more enclosed ($p = 0.000$). There was also a tendency to perceive it as less pleasant. (Table 5).

The daylight in the four-pane room was considered weaker ($p = 0.000$), less pleasant (tendency), colder ($p = 0.01$) and more tinted ($p = 0.000$). This room was also perceived as darker ($p = 0.005$). The colours of the poster showing fruit poster were perceived as more subdued ($p = 0.009$). The lighting outdoors was perceived as darker when seen through the four-pane window ($p = 0.01$) but also less glaring ($p = 0.003$). The colours outdoors were more drab ($p = 0.005$). All these findings agree with what could be expected because of the lower light transmittance of the four-pane super-insulated window.

5 Discussion

This study showed three consistent main effects of the type of window glazing: The room with the four-pane window felt more enclosed than the room with the three-pane window and the daylight in the four-pane window room felt less strong and less clear. The absolute difference in ratings was, however, always quite small. For the three main effects discussed above, the differences in ratings lie between 0.4 and 0.77 on a seven-grade scale. The differences are, however, highly significant in each of the two furnishings and in the overall analysis, which strengthen the results. It should also be borne in mind that the physical difference between the windows was rather small. (Compare Table 2.)

The hypothesis that a lower illuminance and sky luminance decrease the feeling of spaciousness was supported in this study^(3,5). In the four-pane window room, the illuminance was about 25% lower than in the other room, and this was apparently sufficient to affect both the feeling of enclosedness and the perceived strength of the daylight. We were a little surprised that these parameters emerged so strongly, since we ourselves perceived the difference between the rooms as subtle. The subjects were presented with the two rooms one at a time, with a few minutes pause in a neutral space in between. Accordingly, in no case could they go back and forth in order to compare the rooms. It may be assumed that the perceived differences between the two window types would become

even greater if subjects had the possibility of direct comparison.

The fact that the daylight felt less clear with the four-pane window could refer to the view, which may have felt less clear and distinguishable. The effect could be due to the lower daylight transmittance, which makes the sky look less bright and reduces the illuminance in the room. Alternatively, it could be due to the colour change, caused by the low-*e* coatings whose spectral transmittance curve peaks in the green. Most likely it is due to a combination of the two factors.

The low-*e* coatings were probably also responsible for the differences in colour perception. In the case of the office, the colours of the view were perceived as more subdued. For the bedroom view, the weather, lighting and colours outdoors were all affected. The hypothesis that the view through the four-pane window would be different from that through the three-pane window was thus only partly supported. Fewer parameters emerged as significant in the office experiment, which could be due to the more unstable weather conditions making comparisons more difficult. An alternative explanation is that people might be more sensitive or pay more attention to the light in a domestic environment. However, in this case the differences between the perceptions of the two rooms were thought to be due to the weather conditions and not to the furnishing *per se*. Yet another explanation is that people might be more sensitive to the spectral differences under certain weather types or sky conditions. Perhaps the differences become more obvious during dawn and dusk. This was not studied thoroughly in this experiment, since no assessments were carried out before 0800 h or after 1700 h.

There was no difference between the social evaluations of the two rooms. The hypothesis that the social evaluation would increase in the darker room was thus not supported⁽³⁾. The difference between the perceived colours of the walls was probably too small to make a difference in the overall assessments of the two identically furnished rooms.

Apart from the perceptual differences discussed above, we do not know whether low-transmittance glazing has any other negative effects on humans. One can however speculate that when the sky appears substantially darker than it is, as when seen through such glazing, this may affect our judgement of time. In the evening one might for example think that it is one hour later than it really is. Could the apparently lower sky luminance have more far-reaching effects, even affecting the setting of our biological clock? In chronobiological research it has been demonstrated that daylight entering the eye affects people not only visually, but also physiologically. The most conspicuous effect concerns the diurnal rhythm, relating the light and dark cycle to periods of wakefulness and sleep. Light also affects other bodily rhythms, for example the secretion of hormones, body temperature, food and water consumption, ovulation, and many other basic human functions^(2,16,17). Seasonal changes in the day length and the lack of sufficient daylight during winter have also been associated with psychiatric disorders, especially seasonal affective disorder (SAD)⁽¹⁸⁻²⁰⁾. While normal indoor lighting levels seem to be insufficient to remedy this lack of daylight⁽²¹⁾, higher artificial illumination may lead to increased stress⁽¹⁶⁾ and glare, and arousal of the central nervous system⁽²²⁾. Further, it would result in higher electricity bills and in some cases also in an increased need for cooling.

Vol. 27 No. 1 (1995)

Low-emittance window coatings and reaction to daylight

6 Conclusions

The aim of this study was to see whether people could distinguish between two window types, namely a four-pane window with two low-*e* coatings and a three-pane window with clear glass, and, if so, to identify what perceptual and daylight changes would follow. The conclusion is that people were clearly able to distinguish between the two situations. In two different room types involving two different groups of subjects, the enclosedness of the room emerged as one main effect: the room with the four-pane window felt more enclosed than the room with the three-pane window. Other main effects were that the daylight in the four-pane window room felt less strong and less clear.

The step-wise energy-saving improvements to windows that have occurred over the years have occurred at the cost of daylight transmittance. Each step in this chain has been quite small and easy to take when judged only against the previous one. Therefore the super-insulated four-pane window might seem acceptable by comparison with a clear three-pane window, at least on the basis of visual perception and during short-term exposure. But considering all steps simultaneously, there is a large difference between the 89% daylight transmittance of a single-pane window and the 57% of the super-insulated window used in the present study. The question arises as to whether there is a limit somewhere, at which people feel that the transmittance is too low. And in that case, where is this limit?

The present study does not answer this question. Neither does it tell us anything about the long-term effects of low-transmittance glazing. However, from studies in chronobiology, it may be inferred that it is important to get enough daylight, especially during winter. Even during summer we spend most of our time indoors, in environments where the intensity of light may be between one and ten percent only of that outdoors. Therefore we must argue for better daylighting, and it must be questioned how far one should go in reducing the daylight transmittance of windows.

7 Acknowledgements

The study was supported by a research grant from NUTEK. The author gratefully acknowledges Professors Rikard Küller and Bertil Fredlund (Lund University) for their continuous help and advice from the planning of the experiment until the preparation of this paper. Thanks to Arne Roos (Uppsala University) for supplying the optical properties for the windows. The window samples were provided by AB Överrum Fönsterfabrik, Sweden and Johs. Rasmussen A. S., Norway.

References

- 1 Roos A and Karlsson B Optical and thermal characterization of multiple glazed windows with low *U*-values *Solar Energy* 52(4) 315-325 (1994)
- 2 Küller R *Non-visual effects of light and colour: Annotated bibliography Document 15* (Stockholm: Swedish Council for Building Research) (1981)
- 3 Acking C-A and Küller R The perception of an interior as a function of its colour *Ergonomics* 15(6) 645-654 (1972)
- 4 Küller R *Rumspereception* Licentiate's dissertation (Lund: Lund Institute of Technology) (1971)
- 5 Inui M and Miyata T Spaciousness in interiors *Lighting Res. Technol.* 5(2) 103-111 (1973)
- 6 Cooper J R, Wiltshire T J and Hardy A C Attitudes towards the use of heat rejecting/low light transmission glasses in office buildings *CIE TC-42 Daylighting Symp., Architectural Design Proc., Istanbul 1973* (Bruxelles: Comité National Belge de l'Eclairage) (1973)

43

H Bülow-Hübe

- 7 Heerwagen J H and Heerwagen D R Heat reflective glazing: Effects on comfort and functioning at work *Proc. 9th National Solar Conf., Columbus, Ohio* (1984)
- 8 Frandsen S Om belysning og synsvilkår (About lighting and conditions for vision) *Arbidskæden* 95(10) 370–373 (1993) (in Danish)
- 9 ISO 9050:1990 *Glass in building — Determination of light transmittance, solar direct transmittance, total solar energy transmittance and ultraviolet transmittance, and related glazing factors* (Geneve:International Organisation of Standardisation) (1990)
- 10 Driscoll W G and Vaughan W (eds) *Handbook of optics* (New York: McGraw-Hill) (1978)
- 11 Küller R A semantic test for use in cross-cultural studies *Man-Environment Systems* 9(4&5) 253–256 (1979)
- 12 Küller R in Gärling T and Evans G W (eds) *Environment, cognition and action: An integrated approach* pp 111–147 (New York: Oxford University Press) (1991)
- 13 Liljefors A and Ejhed J *Bättre belysning Report TI17* (Stockholm: Swedish Council for Building Research) (1990)
- 14 Norusis M J *SPSS statistical software: SPSS for Windows Release 5.0.2* (1993)
- 15 Winer B J *Statistical principles in experimental design* (New York: McGraw-Hill) (1962)
- 16 Hollwich F *The influence of ocular light perception on metabolism in man and in animal* (New York: Springer) (1979)
- 17 Wurtman R J The effects of light on man and other animals *Ann. Rev. Physiol.* 37 467–483 (1975)
- 18 Wetterberg L Melatonin in humans, Physiological and clinical studies *J. Neural Transmission (Suppl.)* 13 289–310 (1978)
- 19 Lewy A J, Wehr T A, Goodwin F K, Newsome D A and Markey S P Light suppresses melatonin secretion in humans *Science* 210(2) 1267–1269 (1980)
- 20 Boyce P and Kennaway D J Effects of light on melatonin production *Biol. Psychiatry* 22(4) 473–478 (1987)
- 21 Küller R and Lindsten C Health and behavior of children in classrooms with and without windows *J. Environmental Psychol.* 12(4) 305–317 (1992)
- 22 Küller R and Wetterberg L Melatonin, cortisol, EEG, ECG, and subjective comfort in healthy humans: Impact of two fluorescent lamp types at two light intensities *Lighting Res. Technol.* 25(2) 71–81 (1993)

Discussion

A J Shepherd (Department of Experimental Psychology, University of Cambridge)

In the target article Bülow-Hübe has addressed an important issue concerning subjective reactions to daylight in interiors. An interesting result is that people can discriminate 'subtle' changes in the quality of light. There are, however, a few points on which I would like clarification.

Her main conclusion is that the use of glass with low-emittance coatings elicits greater feelings of 'enclosedness' than does clear glass. The clear glass windows used in her experiment, however, were three-pane and the coated glass windows four-pane. The number of panes in a window might also be expected to influence the sense of enclosedness of a room and thus represents a potential confounding factor in these experiments.

The size of trends shown in her results (Figures 4 and 5) is small, but nonetheless compelling since she used a large number of observers. I would question the use of parametric statistics for non-parametric (rating scale) data. A better approach,

given that she used 95 observers, would be to use a frequency-based measure, such as the median. Presented in isolation, means may be misleading. Inclusion of medians or ranges would make Table 5 more informative.

A related problem is created because 36 rating scales are collapsed into eight dimensions (pleasantness, enclosedness, etc - see Figures 4 and 5). Two ratings which appear identical on one dimension may have different underlying constituents. This cannot be assessed from the statistics presented since the relevant scales and their average ratings are not listed. More differences between the two types of glazing might emerge if these scales are treated individually.

A minor clarification needed is the difference between scales L6 and L21 in Tables 4 and 5. Both are described as 'light-dark'. Does one relate to the appearance of the room and the other to the appearance of the daylight?

Author's reply to discussion

First, I would like to comment on the different numbers of panes in the two windows. I do not want to enter into a discussion on how clear glass panes and low-emittance coatings affect the daylight transmittance, since I think this would lead too far. The main point of the experiment was to see if these super-insulated windows had any effect on the feeling of, for instance, enclosedness. How the reduction in daylight transmission came about was of less interest.

At the time when this experiment was started, it seemed as though the development of windows was tending to the wider use of these windows in Sweden. Many occupants would then experience the substitution of three or even two-pane windows by these extremely well insulated ones. NUTEK, who backed the development of the windows, has now taken a step back, and are instead attempting to promote a version of the super-insulated window which has three panes, but still two low-emittance coatings. This reduces, for example, cost and weight, and the daylight transmittance is slightly improved. My opinion is, however, that the two silver-based low-emittance coatings affect the daylight transmittance more than does the single clear pane, since they tend to bend the spectral transmittance curve more (i.e. they change the colour appearance of the incoming light more).

Ms Shepherd also questions the fact that the 36 rating scales of the SMB are collapsed into eight dimensions. When the SMB method was developed, many more rating scales were initially tried out. Using factor analysis, eight dimensions appeared which have been interpreted to describe different perceptual qualities of the environment. For the pleasantness dimension, eight rating scales were finally included. All the other dimensions are based on four rating scales each. The main reason for using factors instead of individual scales is that this will increase the reliability of the measurement. Whereas the scales within each factor demonstrate high inter-correlations, the eight factors are more or less orthogonal, that is, they do not correlate between themselves.

Concerning the meaning of the scales L6 and L21 I would like to point to the questions asked, namely: 'Do you perceive the room as a whole light or dark?', and 'How do you perceive the light outdoors right now?' respectively. I hope that this answers the question.

IV

**OFFICE WORKER PREFERENCES
OF EXTERIOR SHADING DEVICES:
A PILOT STUDY**

Helena Bülow-Hübe

Dept. of Construction and Architecture, Div. of Energy and Building Design, Lund University, P.O. Box 118,
221 00 Lund, Sweden, +46-46 222 73 56, +46-46 222 47 19, helena.bulow-hube@bkl.lth.se

Abstract – Solar shading devices are commonly used in offices to reduce cooling loads and glare from windows, but they also affect daylighting and the view to the outside. In this study, the function and operation of an awning and an exterior venetian blind as well as their influence on the view out was assessed by fifty office workers. The preferred position of the shading devices, the interior illumination and the weather conditions were recorded. An interior dimmable lighting fixture was introduced in order to see if there was a difference between the shading devices regarding the need of complementary electric lighting. The awning was found easier to adjust than the venetian blind. Both shading devices somewhat affected the view to the outside. The shading devices were used frequently to avoid glare from the window. However, preliminary results show no or weak correlation between common lighting concepts such as interior illuminance or sky luminance and how much the shading device was pulled down. On the other hand, there was a weak relationship between the existence of sunlight patches in the room and the position of the shading device. Further, the awning showed to be sensitive to wind, creating a disturbing “flickering” sunlight patch on sunny, windy days. There was no difference between the shading systems in the use of complementary electric lighting.

1. INTRODUCTION

Shading devices are often used in buildings, perhaps mainly to reduce cooling energy use, but also to control glare and daylighting. The control of daylighting is actually very central because it is linked to occupants’ satisfaction and performance.

At Lund University’s, Dept. of Construction and Architecture, there is a large ongoing project on solar shading devices in buildings (Wall & Fredlund, 1999). This project primarily deals with the thermal aspects of shading devices. However, the daylight aspects are equally important, not only the effects on illuminance levels, but also on the view out and the perception of a room. Further, increased knowledge on the preferences of occupants would be useful in the selection process of shading devices and also to improve automatic control systems.

According to Littlefair (1999) shading of windows is needed for three main reasons: to reduce overheating, to reduce glare from windows and to provide privacy. Even so, some sunlighting may still be wanted. The positive impacts of sunlight is to enhance the visual, emotional, and psychological well-being of occupants, or using it as a heat source (Boubekri et al., 1991). However, their study largely failed to demonstrate the effect of window size or sunlight patches on office worker’s mood and satisfaction. However, all subjects were exposed to sunny conditions and never to a condition without sunlight penetration. Compared to having no access to windows or view out, people generally prefer windowed space. (Collins, 1976).

1.1 Glare

Among the mentioned negative impacts of windows is glare. Since the luminance of the sky may well be several times higher than that of the interior walls – even on an overcast day – glare discomfort can arise from a direct view of the sky (Chauvel et al. 1982). They also found that glare from windows is perceived differently than glare from large artificial sources, due to the psychological differences in the contents of the field of view. Chauvel et al. also found large individual differences in the tolerance of glare. In another study on sunlight penetration, glare was only moderately affected by window size (Boubekri & Boyer, 1992).

1.2 Occupant behaviour

In a study on office worker’s behaviour, Rubin et al. (1978) changed the position of venetian blinds during weekends to either fully up, or down, closed, and then studied the occupant’s response by taking external photographs of the facades of the building. They found that most blind positions were changed only once per week. Moreover, they were generally put back in the same position as before the treatment. The most significant influence was that of the orientation: on the north side, blinds were generally kept more open than on the south side. There were also some effects, although more subtle, of climatic season and view out.

In another study, Vine et al. (1998) compared occupant response and satisfaction of an automated blind with an auto user control mode (manual override of auto mode) and with full manual control. Although no statistical analysis was made of the subjects’ responses, over 75% of the subjects preferred more daylight in the auto

mode. They were generally satisfied with the lighting in the auto user control mode, but experienced some glare in the manual mode.

Boyce (1997) claims that if people sitting near to a window have expectations of thermal or visual discomfort to occur, and if they consider that their electric lighting is adequate, they will leave the blinds down, unless they have strong values about the environment. He further believes that few people have such values. He calls this seemingly lack of response to changing environmental conditions for human inertia. For any new automation system to be successful, this inertia must be used to its advantage. He suggests that a simple timer might be enough: one that for example switches off the lighting at a time in the morning when the daylight is usually sufficient, or pulls up a blind at dawn.

2. EXPERIMENTAL DESIGN AND METHODS

2.1 Aim of the study

The aim of this study was to investigate the function, operation and effect on daylight of a couple of solar shading devices. Further, when people are allowed to control the shading devices we wanted to see how they decide to use them in relation to the outdoor climate.

Another issue was whether different shading devices need more or less complementary electric lighting. The experiment was considered as a pilot study to identify typical positions (or settings) of the shading devices for use in later studies.

Since this was considered as a pilot study to develop a test method only two different shading devices were included: one awning and one exterior venetian blind.

2.2 Test rooms and solar shading devices

At a laboratory at the Dept. of Construction and Architecture, there were already two identical south-facing office rooms, 3.0×3.6×2.45 m (W×D×H), used in an earlier study by Bülow-Hübe (1994). New office desks in blond wood were purchased, the walls were repainted in a warm white colour (NCS 0003-Y20R), trimmings and ceilings were white, and the linoleum floor had colours in beige-blue-brown. ($R_{\text{wall}} = 0.8$, $R_{\text{ceiling}} = 0.9$, $R_{\text{floor}} = 0.4$, $R_{\text{desk}} = 0.5$).

Each room was furnished and equipped with a computer to resemble a real office room. (Fig. 1). The lighting consisted of a pendant direct/indirect luminaire with dimmable HF-ballast, one T8 36 W facing upwards, and two downwards. The control mechanism was a potentiometer placed on the desk. Measured workplane illuminance was 900 lux at full light output (potentiometer setting = 35), fully dimmed it was 25 lux (setting = 0).

The 1.2×1.3 m, triple-glazed window was in one room equipped with an exterior retractable venetian blind with 80 mm aluminium slats. (Fig. 2). In the other room, it was equipped with an exterior retractable awning with a beige and brown striped fabric. (Fig. 3). In both rooms

the shading device could be operated from the inside by two buttons placed on the desk. One button was for retracting the shading device (up position), the other for closing it (down position). For the venetian blind, the adjustment of the slat angle was done with the same two buttons, which meant that to change the slat angle, the position of the bottom slat had to be changed somewhat. (Figs. 1-3).

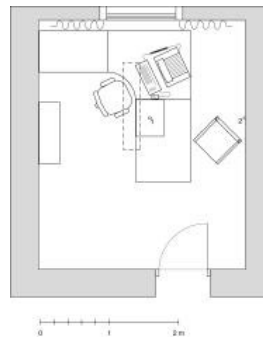

Figure 1 Plan of the offices with 2 points for illuminance measurements as indicated.



Figure 2 Interior of the office with a venetian blind.

2.3 Method for room assessment

The subjects performed two tasks. The first task consisted in adjusting the shading device until a pleasant daylight situation was created. A simple questionnaire was filled in containing three questions: (1) How well does the operation system of the shading device work? (bad-good) (2) How satisfied are you with the lighting conditions?

(unsatisfied–satisfied) (3) How does the shading device affect your possibility to see out? (not at all–to a large extent).

The second task was to see whether the lighting situation was improved with electric lighting, and if so adjust the light level until a pleasant situation was reached. This was followed by a last question: (4) How satisfied are you with the lighting conditions? (unsatisfied–satisfied).



Figure 3 Detail of the office with an awning.

On all 4 questions, the answers were given on seven-grade scales with the word-pair given in brackets above on either side of the scale.

2.4 Procedure and subjects

The study was conducted in September and October 1998. The rooms were assessed by 50 subjects in a balanced design with repeated measures. This meant that each subject assessed both rooms at one occasion.

Upon arrival to the laboratory, the subject was given a short introduction to the experiment. Thereafter, he/she was shown into the first room where further instructions were given on the computer screen. At the start of each experiment, the shading device was always fully open (up) and the lighting was turned off.

Before the experiment started, the experiment leader noted the weather and lighting conditions, time and temperature and measured the interior illumination levels (see below). The subject was then left alone to perform the first task.

The experiment leader then returned to note the position of the shade and repeat the lighting measurements before the subject could proceed with task 2. When this was finished, the lighting measurements were again repeated and the potentiometer setting was recorded. After that, the subject was guided to the other room to repeat the same procedure.

The subjects were recruited from the School of Architecture, and consisted of office workers: clerks, researchers and doctoral students. They were all used to working close to a window. Totally, 24 women and 26 men be-

tween 23 and 64 years participated ($mean = 43.3$; $SD = 10.8$).

2.4 Measurements

As a reference of the outdoor lighting conditions, both the interior horizontal illuminance level and sky luminance seen through the window of a neighbouring office room were measured continuously by two Hagner Universal photometers (S2) connected to a data logger.

Before and after each room assessment, the weather situation, lighting conditions in the room, time and indoor temperature were recorded. The illuminance level was measured at the desk (work surface) (pt. 1) and vertically on the wall in front of the person, 1.2 m above the floor (pt. 2, Fig. 1), with a hand-held Hagner digital luxmeter (EC1). If there was a sun patch in the visual field, this was noted as follows: 1 = no, 2 = sometimes (varying conditions), 3 = yes. The weather situation was rated on a four-grade scale: 1 = sun, some lighter clouds may exist, 2 = sunny, there are clouds that sometimes cover the sun, 3 = cloudy, there are some blue spots where the sun can be seen, and 4 = overcast, the sky is covered by thick clouds. Further, the cloudiness was rated on an 8-grade scale, that defines how many eighths of the sky are covered by clouds.

If the electric lighting was turned on, the potentiometer setting was recorded.

The position of the shades were assessed in the following way: For the awning we constructed and mounted a protractor on the boom which allowed for reading the boom angle with the accuracy of $\pm 1^\circ$. The boom angle ba was later transformed to the awning's slope by the simple relationship: $slope = 45 + ba/2$. (Fig. 4).

For the venetian blind, a scale was drawn next to the window, so that the bottom slat position could be read from the interior to the accuracy of ± 5 cm, while the slat angle was estimated manually.

2.6 Data analysis

The data from the rating scales was treated by analysis of variance using the SPSS MANOVA procedure (Norusis, 1993). The design included both within-subject and between-subject variance.

Further, regression analysis was used to study the relationship between the position of the shading device and the lighting and weather conditions.

Since the position of the shading devices had been assessed, a transformation of these data was made to determine which portion of the window surface was covered by the shade, called here the coverage of the shade.

For the awning it was made in a simple way: The measured boom angle was transformed to a percentage: when the awning was fully retracted, this was interpreted as a bare window (coverage = 0 %). The fully down position was interpreted as fully closed awning (coverage = 100 %). (Figure 4).

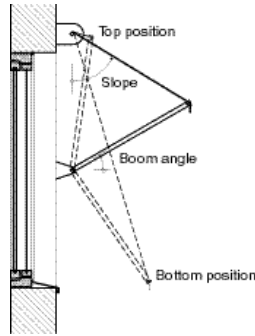

Figure 4 Section through window with awning, and definition of boom angle and slope.

For the venetian blind two factors were weighed together to estimate the coverage: (1) the distance of the bottom slat to the top of the window and (2) the slat angle. (Figure 5). From the position of the viewer, the percentage of how much of the window that was covered by the blind had previously been estimated for different slat angles. This value was then multiplied by the distance (1) (in per cent) to give the coverage.

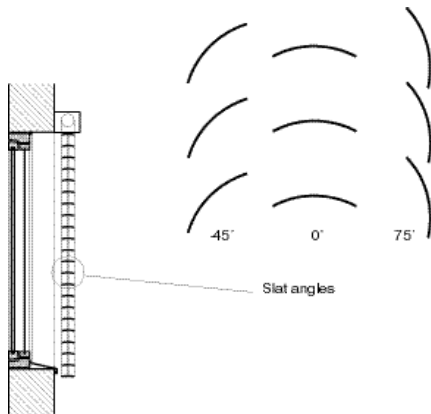

Figure 5 Section through window with exterior venetian blind, and examples of slat angles.

3. RESULTS

3.1 Weather, light and temperature

The illuminance levels, sky luminance, indoor temperature and weather recordings before and after the assessments in the two rooms are summarised in Table 1. The differences between the two rooms are very small and are not significant. Therefore, the environmental conditions must be considered equal between the two rooms (awning and venetian blind).

Table 1 Summary of measurements of environmental conditions before and after assessments. (Mean values).

	Awning		Venetian blind	
	Before	After	Before	After
Illuminance level (lux)				
Point 1	2590	675	2610	580
Point 2	950	460	875	400
Ref. room, pt 1	2500	2400	2960	2870
Sky luminance (cd/m ²)	14400	16400	14700	15200
Indoor temp. (°C)	20,7	20,7	20,4	20,4
Weather type (1-4)	2,60	2,66	2,60	2,60
Cloudiness (1-8)	4,36	4,38	4,36	4,38
Sun in visual field (1-3)	2,06	1,58	2,08	1,66

3.2 Perception of shading devices

The operation system of both the awning and the venetian blind was perceived to function well (*mean* = 6.4/4.9 awning/ ven. blind respectively on the seven-grade scale), but the awning was most easy to operate (*p* = 0.000). The subjects were rather satisfied with their lighting situation after task 1 (*m* = 5.5/5.7). After having tried the electric lighting in task 2, they were somewhat more satisfied with the lighting condition than before (*m* = 5.7/6.0). The possibility to see out was somewhat affected by the solar shading devices (*m* = 3.4/3.7). However, there were no significant differences between the shading devices in questions 2-4.

There was a grouping effect of age in question 2 (the satisfaction of the lighting condition): the older the subject, the more satisfied (*p* = 0.008). The subjects had then been divided into three age groups: (1) 23-38 years, *N* = 16; (2) 39-50 years, *N* = 18; (3) 51-64 years, *N* = 16.

The answers were also checked for interaction effects regarding sex and age, but no such effects were found.

3.3 The position of the shading devices

The shading devices were used frequently to control glare. They were not only used on clear sunny days, but also on overcast days. Typical positions of the shading devices are perhaps best described by frequency distributions as for the awning's slope in Figure 6. This shows that the awning was used by all but 7 subjects, and that

the most frequent position was when the boom angle was close to slope 45° (0 degrees boom angle). Only 7 subjects chose to pull it down significantly more than that.

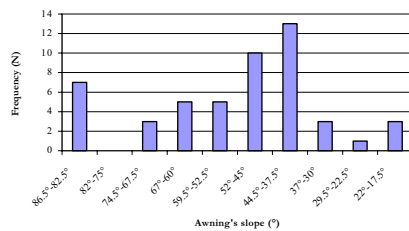

Figure 6 Frequency distribution of the slope of the awning.

For the venetian blind, most subjects did not pull it down fully. Over 50 % of the subjects pulled it down less than 70 cm compared to the glazing height of 120 cm. (Fig. 7). Normally, an automatic motorised blind will be pulled down fully, and the manual override is limited to adjusting the slat angles.

Concerning the slat angles, 75 % of the subjects chose a slat angle of 30° or larger. Only on 4 occasions did the subjects choose a negative (sky view) slat angle (Fig. 8). Beyond slat angles of approximately 45°, the view through the blind becomes very limited.

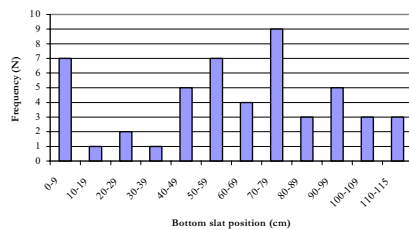

Figure 7 Frequency distribution of bottom slat position of venetian blind.

At a linear regression analysis between the coverage of the shading device and the measured parameters, no relationships were found between illuminance levels or sky luminance. However, a relationship was found between the coverage and the existence of sunlight patches in the field of view. This was found both for the awning and for the venetian blind. The cloudiness also appeared in the regression equation for the blind. The regression equations could however only explain a small part of the variation (adj. $R^2 = 0.22-0.34$).

Since the existence of sunlight patches appeared in the regression equations, two new variables were introduced: the azimuth of the sun's position (i.e. the angle between the horizontal projection of the sun and the south axis) and the perpendicular distance from the wall to the end of the sunlight patch. However, they did not appear in the regression analysis.

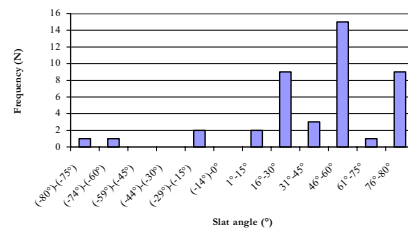

Figure 8 Frequency distribution of slat angles of venetian blind.

Another test was made with a logarithmic transformation of the measured lighting data. Both the logarithm (to the base of ten) of the desk illuminance and the sky luminance appeared in the regression equation, but only for the venetian blind. The adj. R^2 -value was also low (0.34). Since these variables only appeared for the blind, the interpretation of this regression equation was unclear.

3.4 Artificial lighting

The artificial lighting was used in about 30 % of the cases, just as often in connection with the awning as with the venetian blind. There was no significant difference in the use of this complementary lighting between the awning and the venetian blind. The potentiometer was used frequently to control the light level, and the average setting was 19 which corresponds to an additional 350 to 500 lux. (The uncertainty is due to how long the lighting has been turned on).

3.5 Comments

The subjects were encouraged to give their own comments on the questionnaire, and some of the more common ones have been put together here:

Regarding the artificial lighting: the user's ability to dim the electric lighting generated several positive comments, but it became obvious that the chosen lighting installation was not optimal. Many subjects commented on the fact that there was no individual light source, just the ceiling mounted luminaire. Most people wanted more light on the desk to be able to read, than on the computer screen, and this was not possible with the chosen solution. When the subjects chose a setting for the lighting it was obvious that most persons did this according to the

computer task, but more light was really needed for paper tasks.

Regarding the operation of the shades: The awning was more easy to adjust than the venetian blind as previously mentioned. Most subjects agreed that the venetian blind would have been more easy to operate if the function for adjusting the slat angle had been separated from the function of bringing the blind up or down, as was the case. The motor pulling the venetian blind up and down was also perceived as being too slow.

A few people said that they made a compromise between glare and the possibility to see out: they would have been more comfortable with the lighting situation if they had pulled down the shade even more, but they chose a more open position in order not to lose too much of the view out.

On windy days it became apparent that the awning was much more wind sensitive than the venetian blind. This led to a disturbing noise created by the fabric, but even more disturbing was the light flicker of the sunlight patch. On sunny afternoons, the sunpatch could often not be totally removed on the desk due to the oblique angle of the sun. As the sunpatch was in the field of view, the flickering effect that was created when the awning was blowing up and down in the wind gusts was rather disturbing.

The two shading devices also created quite different impressions of the two rooms. While the grey slats of the blind did not affect the colours in the room, the fabric of the awning gave a yellowish tint to the whole room. One person remarked that it reminded her of an old striped men's pyjamas, while for another person it recalled happy memories of childhood camping trips. A few others commented on the blinds: for them, the wide slats created associations with prison bars.

4. DISCUSSION

This study demonstrates the difficulty in predicting when and how much solar shading devices need to be pulled down, in order to create a good interior lighting environment. Glare or contrasts are probably responsible for when solar shading devices need to be used, but there seems to be a large individual spread as to how much glare people tolerate. This is in line with the findings of Chauvel et al. (1982). Given more measuring points on luminances in the field of view, it would perhaps have been possible to find relationships between these and the use of the shading devices, but in this study no relationships between the sky luminance or the interior illumination level and the use of the shading devices were found. One parameter showed a weak relationship to the use of the shading device: the existence of a sunpatch in the field of view. But this could only explain a small portion of the variance. Since the variance among people is large, even more subjects and more weather situations would also have been needed.

Generally, solar shading is needed as soon as the sun enters the room, since the sunpatch will often directly, or indirectly cause disturbing glare and reflexes in the computer screen. One example is when the sunpatch is on the wall behind the subject, it will be so strongly lit that it will cause disturbing reflexes on the screen. This agrees with the opinions of Littlefair (1999).

The placement of the computer and of the furniture in relation to the window will of course strongly influence the glare situation in each individual case. This will, in turn, affect when and to what extent shading is needed. It is however clear that computer tasks require some sort of glare control during a major part of the day, be it interior or exterior shading devices or curtains, single or in combination.

The fact that the shading devices and the electric lighting could be controlled was perceived as very positive. This is a general conclusion in experiments of similar nature: individual control over physical parameters in a person's environment are preferred to having no control (Bell et al, 1996).

This study also shows that there is no simple relationship between the use of electric lighting and the lighting parameter that is most often used to estimate the potential for energy savings of electric lighting through dimming: the interior illuminance on the work surface. Only when it became very dark outdoors (and indoors) was there a trend that the subjects used the electric lighting more frequently. Also here was there a large individual variation. However, it did not matter whether it was an awning or a venetian blind: the same amount of additional electric lighting was preferred.

Another conclusion is that individual task lighting should be present so that the lighting on the paper task can be different from that on the computer screen since more lighting is generally preferred on the paper than on the screen.

Clearly, shading devices can have effects on mood and the general perception of a room. Which effects, and if these are enough to affect satisfaction and performance remain to be answered.

This study indicates that several aspects of shading devices must be considered. Even if the solar shading properties of shading devices are central, it is also necessary to pay attention to the daylight properties, effects on view, presence of sunlight patches, adjustability, etc. For example we found that awnings caused disturbing flickering sunlight patches on sunny, windy days, an effect which was not present for the venetian blind. However, in measurements, Wallentén (1999) found that light coloured awnings had better shading properties than exterior venetian blinds.

5. CONCLUSIONS

The main conclusions from this study are:

- It is difficult to predict the use or need for shading devices by common measurable factors such as interior illuminance and sky luminance.
- There is some correlation between the use of shading devices and the existence of sunlight patches in the room.
- Shading devices are necessary to control glare in the working environment.

6. ACKNOWLEDGEMENTS

The author gratefully acknowledges Professor Rikard Küller and Dr. Torbjörn Laike (Lund University, Environmental Psychology Unit) for their good advice during this study.

REFERENCES

- Bell, P., Greene, T., Fisher, J. & Baum, A. (1996). *Environmental Psychology*, 4th edn. Harcourt Brace College Publishers, Fort Worth, USA.
- Boubekri, M., Hülliv, R. B., Boyer, L. L. (1991). Impact of window size and sunlight penetration on office workers' mood and satisfaction. *Environment and Behavior* 23(4) 474-493.
- Boubekri, M. and Boyer, L. L. (1992). Effect of window size and sunlight presence on glare. *Lighting Res. Technol.* 24(2) 69-74.
- Bülöw-Hübe, H. (1995). Subjective reactions to daylight in rooms: Effect of using low-emittance coatings on windows. *Lighting Res. Technol.* 27(1) 37-44.
- Chauvel, P., Collins, J. B., Dogniaux, R., Longmore, J. (1982). Glare from windows: current views of the problem. *Lighting Res. Technol.* 14(1) 31-46.
- Collins, J. B. (1976). Review of the psychological reaction to windows. *Lighting Res. Technol.* 8(2) 80-88.
- Littlefair, P. (1999). *Solar shading of buildings*. Building Research Establishment, Garston, UK.
- Norusis, M. J. (1993). *SPSS for Windows*. Software Documentation, SPSS Inc.
- Rubin, A. I., Collins, B. L., Tibbott, R. L. (1978). *Window Blinds as a Potential Energy Saver—A Case Study*. NBS Building Science Series 112. National Bureau of Standards, Washington, U.S.A.
- Wall M. and Fredlund B. (1999). *Solskydd i byggnader. Verksamhet 1997-1999. (Solar Shading of Buildings: Research 1997-1999)*. Report TABK—99/3057. Lund Institute of Technology, Dep. of Construction and Architecture, Lund, Sweden.
- Vine, E., Lee, E., Clear, R., DiBartolomeo, D., Selkowitz, S. (1998). Office worker response to an automated venetian blind and electric lighting system: a pilot study. *Energy and Buildings* (28) 215-218.
- Wallentén, P. (1999). Egenskaper hos solskydd – generaliserade mätresultat. (Performance of shading devices – generalised results of measurements). In Wall M. and Fredlund B. (1999). *Solskydd i byggnader. Verksamhet 1997-1999. (Solar Shading of Buildings: Research 1997-1999)*. Report TABK—99/3057. Lund Institute of Technology, Dep. of Construction and Architecture, Lund, Sweden.

Errata

The following reference should be added to the list above.

Boyce, P. (1997). Promoting Energy-Efficient Lighting: The Need for Parallel Processing. Right Light 4, *Proc. of the 4th European Conference on Energy-Efficient Lighting*, 19-21 Nov, 1991, Copenhagen, Denmark. pp 309-313. ISBN 87-87071-73-8

V

Validation of daylight module in Derob-LTH

(submitted to Energy & Buildings)

Helena Bülow-Hübe

Department of Construction & Architecture, Lund University

P.O. Box 118, SE-221 00 Lund, Sweden

Abstract

A daylight module has been developed for the energy simulation program Derob-LTH. Validation has been performed for overcast and clear days against mainly Radiance for a side-lit room and for a simple atrium. The proposed method is based on a radiosity method where the distribution of solar radiation (direct and diffuse components) in a space is calculated and translated to visual radiation via the luminous efficacy. Last, the radiation levels are amplified using the ratio of visual-to-solar transmittance to yield the final illuminance level. For the overcast sky, the accuracy is acceptable for both vertical and horizontal windows for the midpoint of the room. For the sunny sky, Derob-LTH accurately predicts the size and illuminance level of the sunpatch, at least for the tested vertical window. For the purpose of using it for daylight-linked control of shading devices, the accuracy of the developed model seems sufficient.

1. Introduction

1.1 Background

Within the research and consulting field there has traditionally been a border between energy and daylight simulations. Requirements on efficient use of energy in buildings, especially demands to minimise the cooling of commercial buildings, have however urged a need to estimate the potential of daylight utilisation. This has led to a trend in energy simulation programs to address the daylight issue and to include routines for the amount of daylight entering a space in order to estimate potential electricity/energy savings for daylight responsive lighting and/or shading control systems (Winkelmann & Selkowitz, 1985, Crawley et al., 2001, SBIC, 1996). This is a natural step since about half

of the solar radiation reaching us at the earth's surface is within the visible range. Tools are thus needed to be able to predict the simultaneous benefits of daylight on overall energy use and peak loads.

Another way of working around the problem has been to start with a lighting simulation program, for example ADELIN (Erhorn & Stoffel, 1996), in order to calculate the hourly lighting energy use, which then is used as input for an energy simulation. However, this method has the drawback of lacking interactivity with the thermal calculation since the daylight calculation is performed first. Further, the geometry of the space has to be built up twice.

At Lund University's department of Construction & Architecture, there is an ongoing project on solar shading devices (Wall & Bülow-Hübe, 2001). This project aims at measuring the total solar energy transmittance (g-value) of various shading systems, to develop calculation methods, and also to produce a validated yet simple calculation tool for the prediction of g-values, energy demands (heating and cooling) and indoor temperatures of arbitrary shading systems. A first version for exterior shading devices has already been released, ParaSol v1.0, (Wallentén et al., 2000). However, ParaSol is merely a user-friendly interface to an underlying calculation engine, the thermal program Derob-LTH, in which the developed calculation methods are implemented. In order to make daylight-linked control of shading devices possible in future releases of ParaSol, there was a need to develop a daylight calculation module to Derob-LTH, and this sub-project is reported here.

1.2 Brief description of Derob-LTH

The dynamic energy simulation program Derob-LTH is based on a three-dimensional description of the building. It has been proven to accurately estimate energy demands and temperatures in several measurement projects (Wall, 1996 and Wall & Bülow-Hübe, 2001). The advantage of incorporating a daylight module into Derob-LTH is that daylight calculations can be performed simultaneously with the energy calculations, and thus be used as a control parameter for moveable shading devices and in the future possibly even electric lighting.

In Derob-LTH, the building model is built of convex surfaces, from triangles to five-sided polygons. A radiosity method (view factors) is used to calculate the distribution of diffuse radiation, and a ray-tracer follows the direct (beam) radiation until it hits the first surface inside the space. Then, the reflected radiation is treated as perfectly diffused. Multiple reflections are accounted for, which means that the reflections are followed until all radiation is either absorbed in the room surfaces or re-transmitted out again through windows.

The Derob program was first developed in Austin, Texas (Arumi-Noé & Wysocki, 1979 and Arumi-Noé, 1979). The version Derob-LTH is being developed and maintained at Lund University, Dept of Construction and Architecture (Kvist, 1999). Improvements during later years include the window mod-

ule, and the shading of diffuse radiation. The window module assigns a thermal node to each glass surface, and treats convective and radiative heat transfer between panes in a detailed way (Källblad, 1998). The computer code is also being modernised at the moment, in order to allow for control strategies of shading devices, to allow for varying time-steps, and to facilitate future development and maintenance.

A post-processor, COMFORT, is coupled to Derob-LTH (Källblad, 1996). This program illustrates graphically the variations in Predicted Mean Vote (PMV), Predicted Percentage of Dissatisfied (PPD) based on ISO 7730, and Global Operative Temperatures. COMFORT has further limitations than Derob-LTH on the space that can be analysed, since only one volume at a time, and only parallelepiped rooms, can be analysed.

In the COMFORT program, the geometry of the room, air and surface temperatures, diffuse solar radiation reflected from the surfaces, and the beam solar radiation transmitted through windows are taken into account. The observation point is an infinitesimal cube whose surfaces have equal surface temperatures, absorptivities and emissivities.

The hypothesis was that by just looking at the solar radiation, it would be possible to convert the COMFORT program into a simple daylight program. Due to the construction of the observation point, it would be possible to look at illuminance values for both horizontal and vertical points at fictitious surfaces.

2. Modelling assumptions

2.1 Treatment of solar radiation

Derob-LTH models the sky as an isotropic (uniform) sky, where the intensity is changed in relation to the diffuse horizontal radiation. Further, the solar radiation in the weather file is given as direct normal (beam) radiation I_N , and diffuse horizontal radiation, I_{dH} . Solar angles are calculated 4 times per month. The diffuse and ground reflected radiation reaching the window is calculated according to the view factors as seen by the window. Derob-LTH allows shading screens of arbitrary shape to be put in front of the building, as long as they are convex polygons. The transmittance is variable from 0 to 100%. This makes them suitable for modelling fabrics as in for example awnings. Derob-LTH calculates shading of both direct and diffuse radiation of such shading screens, see (Wall & Bülow-Hübe, 2001).

Once diffuse radiation has passed through the window, it is applied as a diffuse source over the whole window surface. The diffuse radiation of interior surfaces is also treated so that each surface emits an equal amount of radiation over the whole surface (only one node per surface element). This is a limitation of Derob-LTH compared to lighting programs, which usually divide each surface into several nodes.

The direct radiation is followed through the window until it hits the first surface in the room. For this direct radiation, 81 (9×9) nodes are applied to each surface. After the first indoor reflection the light is treated as perfectly diffused. This is another limitation, which is however shared with other lighting programs that uses the radiosity method of calculation, e.g. Superlite.

Another limitation when trying to use Derob-LTH as a lighting calculation program is the choice of the uniform sky model. In energy simulation programs the uniform sky or the Hay & Davies model are commonly used (Duffie & Beckman, 1991). In lighting programs however, two (or three) models are used for an annual calculation depending on whether an hour is classified as sunny or overcast. The very first difference is that lighting programs uses models that are based on the luminance distribution of the sky, since the light distribution in a room strongly depends on this, thus photometric units are used. For overcast days, the CIE standard sky is the defacto standard, even if the uniform sky often is an option as well, as it is in Superlite and Radiance. The CIE sky model has a luminance that is three times higher at the zenith than at the horizon. For normal side-lit rooms the CIE sky will thus give lower light levels on the work surface than the uniform sky, an the contrary will happen for atria. While some authors believe that the CIE model is a good choice for overcast weather (Enarun & Littlefair, 1995), others seem to be of the opinion that it is an extreme case (Kittler et al., 1998). Muneer (1988) supported this later opinion in a study of Japanese data, which showed that the CIE sky always underestimates the average vertical illuminance. The author was of the opinion that the uniform sky is a better representation of the overcast situation.

In lighting programs the CIE clear sky with or without sun is usually used on clear days. This model accounts for circumsolar brightening, (also accounted for in the Hay & Davies model), the dark spot seen 90° across the sky from the sun, and horizontal brightening. There are also models for intermediate skies, and for annual calculations the light distribution is usually based on some sort of linear combination of various sky models (Littlefair, 1988a). Generally, lighting programs are more detailed regarding sky models than energy programs. Also, the overcast day is very much in focus in lighting programs, while the sunny day is more interesting for solar engineering purposes.

2.2 Conversion of solar radiation to “visible” radiation

Since Derob-LTH is a tool for energy simulations, climatic data in a weather file is always included in a calculation, see Sec 2.1. To convert the irradiance values in the file to illuminance, the luminous efficacy, K , can be used. This is the ratio of illuminance to irradiance, and has been measured around the world. Since the luminous efficacy is dependent of solar altitude, cloud cover, and amount of aerosol and water vapour content in the atmosphere, several models have been presented, see for example (Littlefair, 1985 and 1988b) and (Muneer & Kinghorn,

1997). However, Muneer and Angus (1995) have shown that simple models using average values perform on par with more advanced models. Therefore, in Derob-LTH average values from measurements in Vaerlose, Denmark (Petersen, 1982) are applied as default values:

Clear sky ($I_N > 200 \text{ W/m}^2$):	
For direct radiation I_N ,	$K = 103 \text{ lm/W}$
For diffuse radiation I_{dH} ,	$K = 146 \text{ lm/W}$.
Cloudy and intermediate sky:	
For direct radiation I_N ,	$K = 103 \text{ lm/W}$
For diffuse radiation I_{dH} ,	$K = 121 \text{ lm/W}$.

Other constant values of the luminous efficacy can easily be applied, since they can be manipulated every hour via the graphical interface. The clear sky level can also be modified. In the future, it would be a simple task to apply more advanced models of the luminous efficacy.

2.3 Daylight module interface

The Derob-LTH daylight module DAYLIGHT is currently a stand alone post-processor to the energy simulation program Derob-LTH. In order to perform daylight calculations, the volume has to be restricted to a parallel-epiped room. The calculations can be done for an arbitrary hour of the year, specified by the user via the graphical interface. Currently, it is possible to look at the light distribution over a fictitious surface in any of the six major orientations at a height above floor between 0.1 and $H-0.1$ m in steps of 0.1 m, where H is the room height.

A critical input is the ratio between the visual T_{vis} and the direct (or primary) solar transmittance $T_{sol,dir}$ of the glazing, here called the *VTS* (visual-to-solar) ratio. Our hypothesis was that this ratio could be applied after the solar radiation distribution has been determined, which would allow for “simultaneous” energy and daylight simulations, thus saving some calculation time, and still achieving a decent accuracy in the daylight calculations.

The output of the daylight module is a colour graph that shows the distribution of the illuminance over the specified plane in the chosen direction. This can either be saved as a bmp-file, or the illuminance values of the grid points can be saved to a file. The grid width can be changed in steps of 0,1 m, and by setting the calculation step to anything between 1 and 32 (display) pixels the accuracy of the view factor/interpolation/ calculation can be varied. A low number will increase the accuracy, but also the time needed for displaying the graph. A setting of 5 pixels assures a high accuracy, at only a few seconds of calculation time.

2.4 Limitations in Derob-LTH data input

Today, only the direct solar transmittance and reflectance of windows is given as input to Derob-LTH. The absorption in the panes and total solar energy transmittance ($T_{sol,tot}$ or g -value) is calculated by the program. In order to convert the solar radiation to visible radiation, the higher visual transmittance has to be taken into account. In the future, this should be given as input to the program already in the glass library. For the time being, the user has to input the visual-to-solar ratio, VTS . The main problem with this is that the VTS varies with incidence angle and glazing type. Especially for modern coated glass (e.g. solar control glass), the ratio can be quite high. For overcast hours the hemispherical VTS should be applied, and for sunny hours, the value for the actual incidence angle towards the window should be chosen.

Another limitation is that the absorptivity of internal surfaces is defined over the whole short-wave spectrum. The assumption used at present, is that the absorptivity (or reflectivity) of the surfaces is the same in the visible part of the spectrum. Normally, the reflectance is slightly higher in the visible region than over the whole solar spectrum.

3. Validation method

Validation of the daylight module has mainly been performed against other lighting simulation software, especially Radiance (via the Adeline menu shell, version 2.0NT). All Radiance runs were performed with parameters set to achieve a very high accuracy, see (Dubois, 2001). In a few cases Superlite and LESO-DIAL (Paule et al., 1999) were used. Measurements from the Daylight Laboratory at Danish Building and Urban Research (DBUR) in Hoersholm were also useful.

3.1 Rectangular room: DBUR daylight laboratory

A rectangular room with one façade aperture was modelled. The geometry was identical to the DBUR Daylight Laboratory in Hoersholm, north of Copenhagen (Fig. 1). The facility consists of a full-scale twin room with illumination sensors both indoors and outdoors (Christoffersen, 2001). A model of the laboratory was built in Radiance, and measurements were used to check this original Radiance model (see also Dubois, 2001). The reflectance values for interior surfaces were $R_{ceiling}=76\%$, $R_{wall}=80\%$, $R_{floor}=10\%$ (Basic case). The initial Radiance model was then simplified with respect to the outdoor surroundings in order to facilitate comparisons with Derob-LTH and other programs. This meant

that in all results shown below, the computer simulations were done for a room with a free horizon and a ground reflectance of 20 %, and without a window niche.

The sensitivity to different surface reflectances R was studied for two extreme cases: (1) a very white room, $R=80$ % for all surfaces (White case); and (2) a completely black room, $R=1$ % for all surfaces (Black case). The illumination was evaluated for a work plane height of 0,8 m above the floor.

The window in the laboratory was a double-pane insulating glass unit with one low-e coating. In both programs the glazing was modelled as two individual layers, with a resulting visual transmittance of 72 % and reflectance of 14 % (Radiance), and a direct solar transmittance of 49 % and forward reflectance of 27 % (Derob-LTH) for normal incidence. Although some work has been done to find simple formulas to model the angle dependent g-value for coated glazing, this work does not yet include the visual transmittance and reflectance (Karlsson, et al 2001). The low-e coated glass was thus treated as an ordinary Fresnel pane in Radiance, and in Derob-LTH the angular dependent properties were given in the form of a table. The resulting angular dependent properties for both the visual and solar range, calculated in Derob-LTH, is given in Table 1. This shows that VTS varies significantly with the incidence angle for the double low-e glazing. For diffuse light (overcast hours) the hemispherical value of 1.83 applies. Table 1 also shows the values for single clear glass used in Sec. 3.2.

Table 1 Visual and solar transmittance values and the visual-to-solar ratio for two glazing types as modelled in Derob-LTH.

Double-pane low-e coated window (DBUR laboratory)

Incidence angle	0°	10°	20°	30°	40°	50°	60°	70°	80°	90°	Hemis.
T_{vis}	71.6	71.5	71.2	70.7	69.6	67.2	61.7	48.2	22.8	0.0	62.8
$T_{sol,dir}$	49.1	49.0	48.6	47.6	46.2	43.5	38.1	27.5	12.4	0.0	34.3
VTS	1.46	1.46	1.47	1.49	1.51	1.54	1.62	1.75	1.84	-	1.83

Single pane clear float (Simple atrium)

Incidence angle	0°	10°	20°	30°	40°	50°	60°	70°	80°	90°	Hemis.
T_{vis}	90.0	90.0	89.9	89.6	88.9	87.0	82.3	70.4	43.8	0.0	82.6
$T_{sol,dir}$	83.0	82.9	82.7	82.2	81.2	79.1	74.3	63.0	38.1	0.0	75.1
VTS	1.08	1.09	1.09	1.09	1.09	1.10	1.11	1.12	1.15	-	1.10

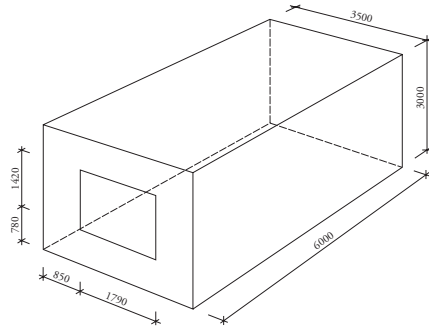

Figure 1 Geometry of the DBUR laboratory.

In Derob-LTH, the radiation distribution within the space is calculated using view factors, and from the intensity of each surface. Since each surface only has one node regarding the diffuse part of the radiation, this will tend to even out the light distribution in the room. Especially at the back of the room, the lighting will be slightly overestimated. Therefore, three Derob geometries were constructed in order to study the effect of increasing surface sub-division. In the first case (Case×1) no surface subdivision was performed. In the next case (Case×2) the side walls, floor and ceiling areas were each divided in two surfaces in order to increase the accuracy of the radiation distribution. Finally, the side walls, floor and ceiling were each divided into 6 surfaces (Case×6), which means that the current limitation of maximum 27 surfaces enclosing a volume was reached (Fig. 2).

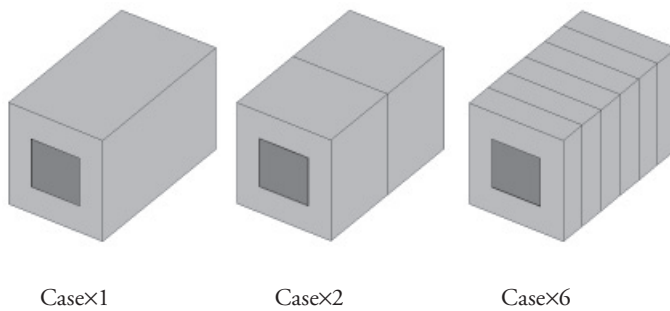

Figure 2 Geometry of the three Derob-LTH cases with increasing surface subdivision.

3.2 Simple atrium

A simple deep atrium was also modelled (Fig 3). The geometry was similar to the BRE scale model described by Fontoynt et al. (1999). One difference was that the roof aperture was equipped with a single glazing, since Derob-LTH does not allow for an open (non-glazed) aperture, see Table 1 for optical properties. Another difference was that the floor level was always at the bottom of the deep atrium, but virtual photocells were applied at different “floor” levels, corresponding to the BRE scale model measurements. Therefore, it was not possible to perform validations directly against the Fontoynt report, instead this was done against Radiance simulations, using the same geometry as the Derob-LTH model. The single glazing had $T_{vis}=90\%$ and $T_{sol,dir}=83\%$. The VTS ratio was thus 1,10 for diffuse light. The reflectance of interior surfaces (walls and floor) was successively changed from black (4 %) to dark grey (30 %), light grey (48 %) and white (85 %).

The Derob-LTH model was built similar to case Basic×6 of the DBUR laboratory, i.e. with 6 surfaces of equal size on each of the four walls of the atrium.

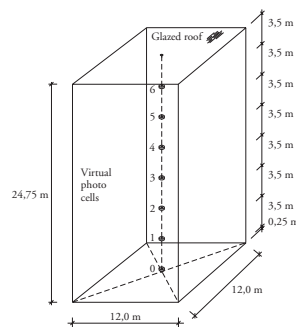

Figure 3 Geometry of the simple atrium.

4. Results

4.1 DBUR model: Overcast day

4.1.1 Comparisons for basic case

The daylight factor of the DBUR lab was calculated in Derob-LTH, LesoDIAL, Superlite and Radiance. Measurements for a CIE overcast day were also available. For the Derob-LTH calculations, an hour was found in the climate file where there was no direct irradiance, and where the diffuse irradiance I_{dH} was 100 W/m^2 . With the luminous efficacy set to 121 lm/W , this corresponds to an overcast sky of 12100 lux . Fig. 3 shows that Derob-LTH underpredicts the day-

light factor close to the window, and overpredicts it at the back of the room. The effect of increasing surface sub-division is shown in Table 2. For case Basic×2, the daylight factor increases with about 0.5 percentage-points at 1 m from the window, and decreases with the same amount at 5 m from the window compared to case Basic×1. However, the results between the two cases Basic×2 and 6 were just marginally different.

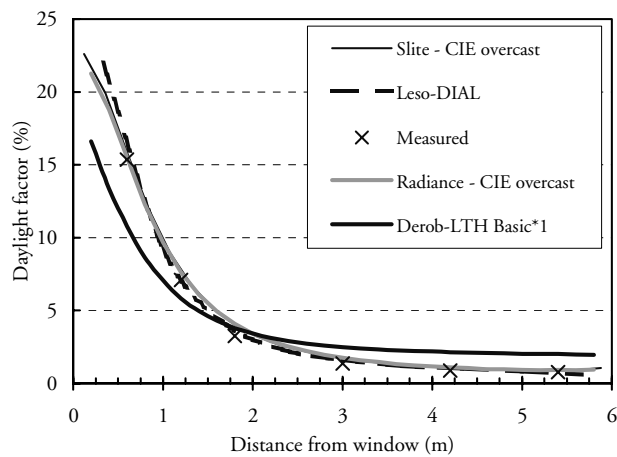

Figure 4 Comparison of Derob-LTH with other programs and measurements in Hørsholm, DK. For Superlite (Slite), Radiance and Leso-DIAL the calculations were done for the CIE overcast sky model.

Since Derob-LTH uses an isotropic (uniform) sky model, the Radiance calculations were redone for this sky. With the uniform sky model the daylight factor will always be higher, about 1.5 percentage points at 1 m from the window, and 0,4 percentage points at the back of the room (Fig. 5). The uniform sky assumption thus seems to explain why the illuminance is higher at the back of the room in Derob-LTH, but it does not explain the low illuminance seen close to the window.

A hypothesis was that this is due to the way diffuse radiation is treated. In Derob-LTH, the window is modelled as a diffusing surface regarding the diffuse part of solar radiation. Thus, for a vertical window, the mostly downward flowing light flux is redistributed to being forward flowing, which is illustrated in Fig. 6. For energy calculations this is an acceptable simplification, but for daylight calculations this has to be investigated, since the overcast day is the "design day" and thus used for analysis of daylight.

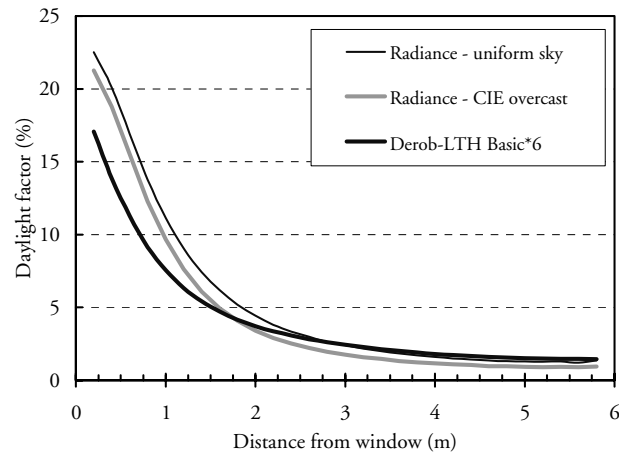

Figure 5 Comparison of daylight factor between Derob-LTH case Basic*6 and Radiance with the uniform and CIE sky model respectively.

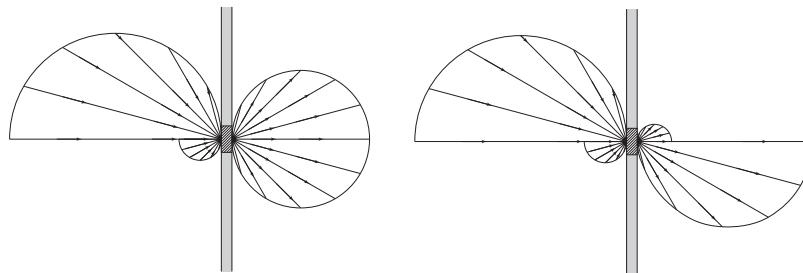

Figure 6 Schematic drawing showing the principle of transmittance of vertical glazing for diffusing glass (left) and clear glass (right). On the left side of the glazing is shown the intensity of the radiation arriving at a small surface element from a uniform sky and ground.

First, a comparison was made with a Radiance calculation where a diffusing curtain with 100% diffuse transmittance was placed close to the inside of the window. The uniform sky was chosen, since Derob-LTH uses this model. From Table 2, and Fig. 7 it is seen that the diffusing curtain reduces the daylight factor in Radiance from 11.1 to 8.1 % at 1 m from the window, which is close to the Derob-LTH result of 7.6 %. With the VTS ratio set to 1.83 (hemispherical), the average relative error was -8 %, which is quite satisfying.

Table 2 Daylight factor for the basic case ($R_{wall}=80\%$, $R_{ceiling}=76\%$, $R_{floor}=10\%$) for different sky models and window types (Radiance) and surface sub-divisions (Derob-LTH). The ratio VTS was set to 1.83.

Distance from window (m)	Radiance			Derob-LTH		
	CIE overcast, clear window	Uniform sky, clear window	Uniform sky, w. diffusing curtain	Basic×1	Basic×2	Basic×6
1	9.66	11.13	8.06	7.06	7.47	7.56
2	3.39	4.43	4.07	3.41	3.70	3.71
3	1.75	2.40	2.65	2.48	2.47	2.43
4	1.16	1.61	1.96	2.17	1.84	1.80
5	0.92	1.28	1.64	2.03	1.57	1.51

From Fig. 7 it is also seen that the intersection point between Derob-LTH and a Radiance run for a uniform sky and clear window is very close to the midpoint of the room. For the CIE sky model, the intersection point is at 1.7 m distance from the window.

4.1.2 Sensitivity to surface reflectance

The comparison between Derob-LTH and Radiance shown below were done for equal boundary conditions, i.e. uniform sky and a diffusing curtain inside the window. The Derob-runs were done with the geometry for Case×6, i.e. 6 surfaces on side walls. From Fig. 8 it can be seen that Derob-LTH responds well to a change in surface reflectance, and the results are very similar to Radiance results. The absolute differences are small, see Fig. 9, and correspond to relative differences between -4% and -8% . The somewhat erratic shape of the curves in Fig. 9 is intrinsic to the stochastic ray-tracing procedure used in Radiance.

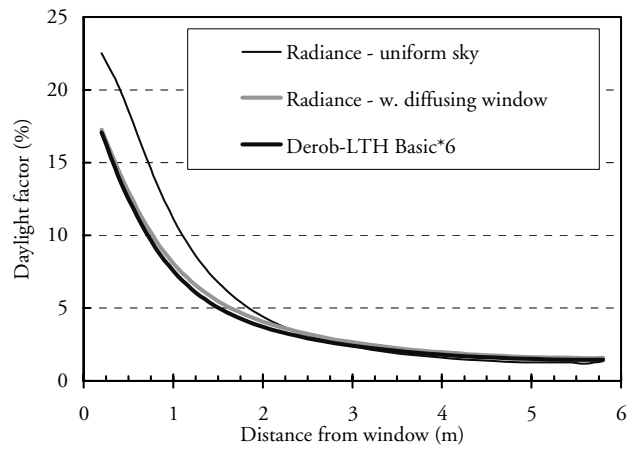

Figure 7 Comparison of daylight factor between Derob-LTH and Radiance with and without a diffusing window. Uniform sky model.

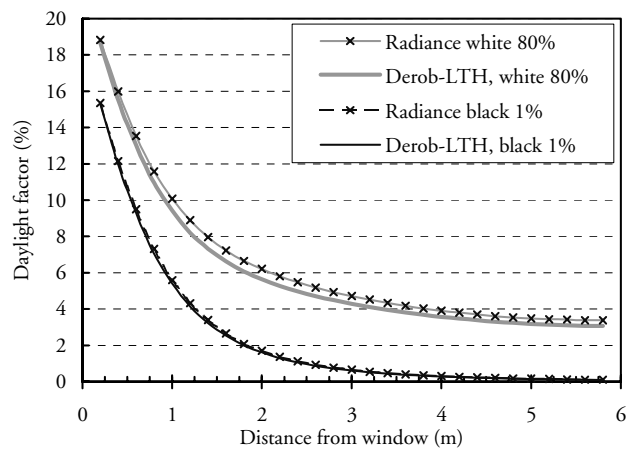

Figure 8 Comparison of daylight factor for black and white room. Window with diffusing curtain and uniform sky model. The geometry of CaseX6 was used in the Derob calculation.

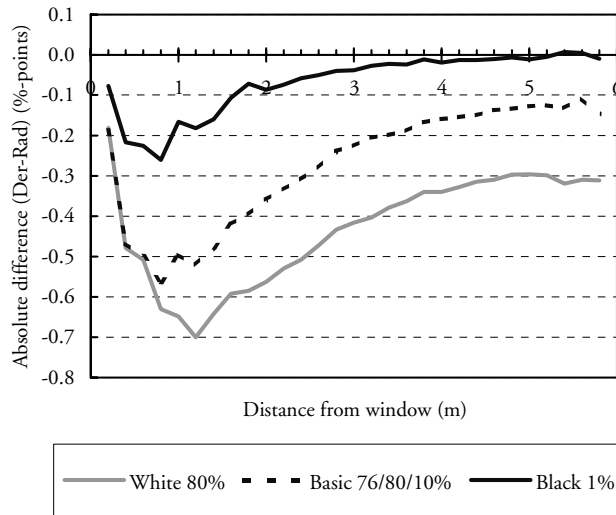

Figure 9 Relative difference in daylight factor between Derob-LTH and Radiance for similar boundary conditions. The somewhat erratic shape of the curves are intrinsic to the ray-tracing procedure used in Radiance.

4.2 DBUR model: Sunny day

The illuminance was calculated for a clear sunny day in Derob-LTH and Radiance. March 12 at 12 for Lund 1988 was chosen, since it was an hour with high direct and low diffuse radiation. The measured irradiance was $I_N=922.3 \text{ W/m}^2$, and $I_{dH}=76.0 \text{ W/m}^2$. The solar altitude calculated in Derob-LTH was 28.4° and the azimuth -8.5° . The measured direct normal irradiance I_N thus corresponds to 439.0 W/m^2 on the horizontal plane, and a horizontal global illuminance of 56 315 lux with the assumed luminous efficacies mentioned above. For the Derob-LTH calculations, the geometry of Case×6 was again used, and the VTS ratio was set to 1.49 (incidence angle 30°). Since the direct part is dominating for this hour, the Radiance calculations were performed with clear, not diffusing glass.

The indoor illuminance expressed as a percentage of the outdoor global illuminance is shown in Fig. 10 for the basic case. The general trend is that Derob-LTH shows a good agreement of the illuminance in the sunpatch, especially for the basic and black cases. Behind the sunpatch, it seems like Derob-LTH overpredicts the lighting when the inter-reflected component is high (white case), and underpredicts it slightly for the other cases, see Fig. 11. The differences seen are probably due to modelling differences regarding the sky model (direct component), and the treatment of the diffuse radiation in Derob-LTH. The angular dependent transmittance might also be different. Another difference is that the

VTS ratio was set to 1.49 for both direct and diffuse radiation, while the factor 1.83 should be applied to the diffuse part. This means that the diffuse illuminance component is underestimated in Derob-LTH.

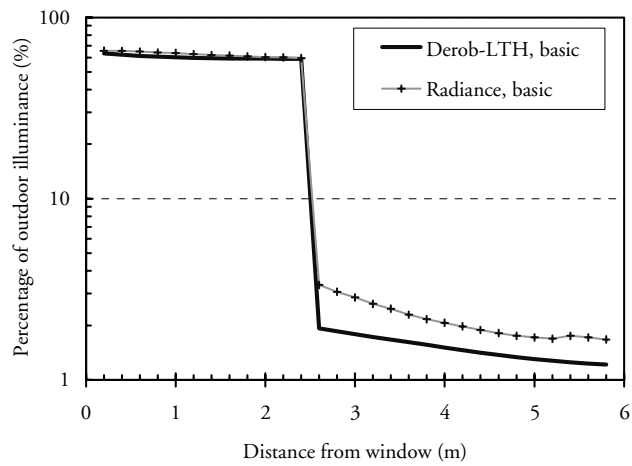

Figure 10 Percentage of indoor illuminance to outdoor global illuminance (solar factor) for sunny conditions, March 12 at 12. Comparison between Derob-LTH and Radiance for the basic case (internal reflectance 76/80/10 %).

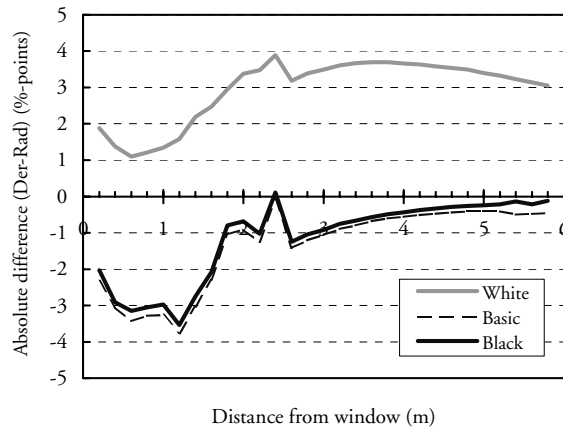

Figure 11 Absolute difference in solar factor (percent of outdoor global illuminance) between Derob-LTH and Radiance for sunny conditions, March 12 at 12 at three internal reflectances: white (80 %), basic (76/80/10 %), and black (1 %).

4.3 Simple atrium: Overcast day

Since the simple atrium only has a horizontal glazed roof the incoming diffuse radiation is already isotropic when reaching the window in the case where the uniform sky model is used. Therefore, it does not suffer from the limitation that the glazing diffuses the diffuse part of the solar radiation, see Fig. 12. Hence, the Radiance calculations were performed for clear glass. Figs. 13 and 14 show a comparison of results between Derob-LTH and two sky models in Radiance for the black and white room respectively. The agreement is rather good for the uniform sky. This is demonstrated again in Fig. 15, which shows the relative error between Derob-LTH and Radiance for the uniform sky model for 4 different surface reflectances. The error is smallest for the white atrium, but never exceeds 10 % in any case. When the CIE overcast sky is used, the daylight factor is always higher. At the bottom of the atrium, level 0, the difference is about 2-3 percentage points. Close to the top, level 6, the difference is larger, about 5-6 percentage points.

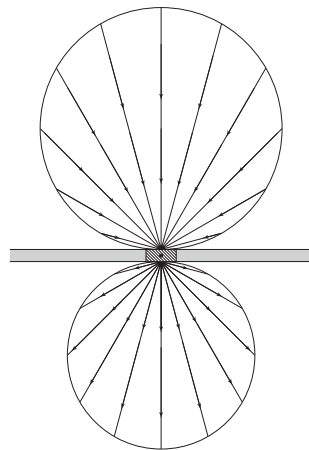

Figure 12 Schematic drawing showing the principle of radiation from a uniform sky arriving at a surface element of a horizontal diffusing glazing, and leaving it diffused.

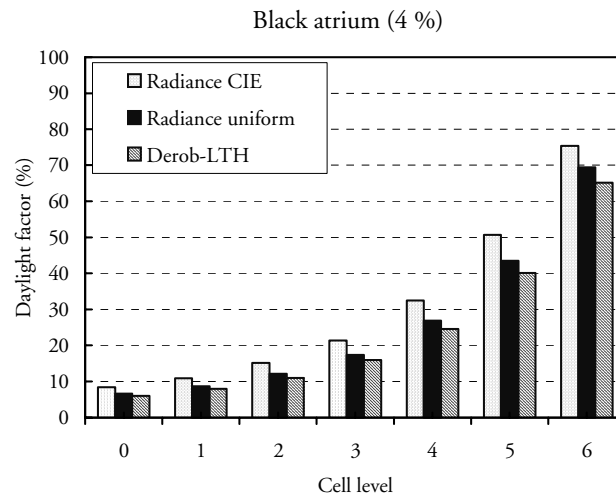

Figure 13 Daylight factors for black atrium ($R=4\%$) calculated in Derob-LTH compared to Radiance (for the two sky models CIE overcast sky and uniform sky respectively).

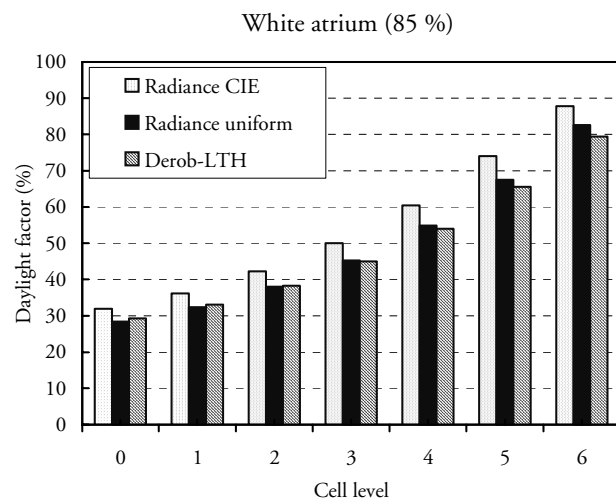

Figure 14 Daylight factors for white atrium ($R=85\%$) calculated in Derob-LTH compared to Radiance (for the two sky models CIE overcast sky and uniform sky respectively).

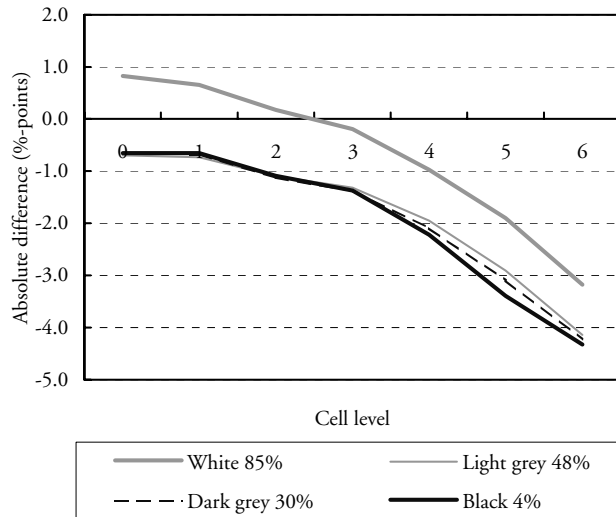

Figure 15 Absolute difference in daylight factor between Derob-LTH and Radiance simulations for various interior reflectances. Uniform sky model.

5. Discussion

The developed Derob-LTH daylight module shows a good agreement with simulation results in Radiance for similar boundary conditions. The proposed visual-to-solar ratio *VTS* works rather well, but the process should be automated, since it is important to choose the *VTS* according to the current incidence angle. It was also seen that the calculated illuminance was very sensitive to the *VTS* ratio, since this ratio can be high for real coated glazing. The exact modelling of the angle dependent transmittance of the glazing must thus be known both for the visual and the solar range. Further work is needed to develop such models for real glazing, especially for modern coated glass.

On overcast days, Derob-LTH suffers from some limitations, which regard the way diffuse radiation is handled. Firstly, Derob-LTH uses the uniform sky model, which was abandoned quite long ago within the lighting community. The use of the uniform sky compared to the CIE overcast sky will overestimate the lighting in rooms with vertical windows, and underestimate it in rooms with horizontal windows, such as atria. This is due to the nature of the CIE sky, which for the same outdoor illuminance will have a brighter sky at the zenith, and a darker sky at the horizon. However, since purely overcast days are only a part of all available daylight hours in a year, the problem is perhaps not that severe. There is also a great variety of the luminance distribution of real skies, and both the CIE and the uniform sky are just two theoretical varieties.

Secondly, Derob-LTH diffuses the diffuse radiation when it passes through the glazing. This will not affect the amount of radiation entering a room, but may lead to a change in the main direction of the light flow. This poses no problem for horizontal windows facing an unobstructed uniform sky. However, for vertical windows which “see” part of the ground and just half of the sky, the mainly downward flowing light will be redistributed to being forward flowing. Therefore, the lighting on a horizontal work plane will be underestimated close to the window, and more light will instead reach the ceiling and the back of the room. This seems like the largest drawback of the current limitations in Derob-LTH. However, for a point close to the midpoint of the room, these two main differences cancel each other out.

During sunny conditions, Derob-LTH performs rather well, especially within the sunpatch. The Derob-values can therefore be used as a trigger for controlling shading devices. Behind the sunpatch, the errors are larger, especially for extremely white rooms with a large inter-reflected component.

Historically, the lighting community has been very focused on daylight factors and thus on overcast days, since these are the most critical for lighting a room. From an energy point of view, the clear sunny day is most interesting, either in order to capture the solar heat, or to prevent from overheating. During a whole year however, a large number of hours fall between these extremes. For typical climate years in Sweden (Lund, Stockholm, Gothenburg and Luleå 1988), slightly less than half of all hours with measurable diffuse radiation can be classified as overcast (criterion $I_N < 10 \text{ W/m}^2$), and about 30-35% of the hours are clear (criterion $I_N > 200 \text{ W/m}^2$). Therefore, it will become necessary to automatize the selection of the proper sky model, or combination of these. This will require some further work regarding the proper criteria for the selection process (such as sunshine probability or cloud ratio), and the implementation of these into Derob-LTH.

6. Conclusions

A daylight module has been developed and validated for Derob-LTH. The proposed method is based on a radiosity method where the, in the energy program already calculated distribution of solar radiation in a space, is translated to visual radiation via a luminous efficacy. Last, the radiation levels are amplified using the ratio of visual-to-solar transmittance to yield the final illuminance level. For the overcast sky, the accuracy is acceptable for both vertical and horizontal windows for the midpoint of the room. For the sunny sky, Derob-LTH accurately predicts the size and illuminance level of the sunpatch, at least for the tested vertical window. For the purpose of controlling shading devices, the accuracy of the developed model seems sufficient.

In order to develop the model into a full-fledged lighting calculation program, further work is needed mainly regarding the transmittance of diffuse light, automatic surface subdivision and perhaps also regarding sky modelling. However, some previously mentioned works seem to indicate that the choice of the uniform sky is justified (Kittler et al, 1998; Muneer, 1998).

Further work is also needed regarding input of visual data for the glazing, and for selecting the proper combination of sky models for intermediate days to facilitate annual energy calculations.

Acknowledgements

The author would like to thank Kurt Källblad who developed the Derob-LTH daylight module, Marie-Claude Dubois for her assistance in Radiance modelling and Bengt Hellström for providing useful discussions. I also acknowledge the gracious support of the Swedish Council for Building Research and The Swedish National Energy Administration.

References

- F. Arumi-Noé, M. Wysocki, The Derob system volume I, User's manual for the Derob system, University of Texas, School of Architecture, Numerical Simulation Laboratory, Austin, TX, USA, 1979.
- F. Arumi-Noé, The Derob system volume II, Explanatory notes and theory, University of Texas, School of Architecture, Numerical Simulation Laboratory, Austin, TX, USA, 1979.
- J. Christoffersen, Danish Building and Urban Research – Daylight Laboratory, (internal report), Danish Building and Urban Research, Hørsholm, Denmark 2001.
- D.B. Crawley, L.K. Lawrie, F.C. Winkelmann, W.F. Buhl, Y. Joe Huang, C.O. Pedersen, R.K. Strand, R.J. Liesen, D.E. Fisher, M.J. Witte, J. Glazer, EnergyPlus: Creating a new-generation building simulation program, *Energy & Buildings* 33 (4) (2001) 319-332, Special Issue: Proceedings of the 6th International IBPSA Conference, Kyoto, Japan, 13-15 September, 1999.
- M.-C. Dubois, Impact of shading devices on daylight quality in offices, Simulations with Radiance, Manuscript to Report TABK--01/3062, Div. of Energy and Building Design, Lund Institute of Technology, Lund University, Lund, Sweden, 2001. (forthcoming).
- J.A. Duffie, W.A. Beckman, *Solar Engineering of Thermal Processes*, 2nd ed, Wiley Interscience, 1991.

- D. Enarun, P. Littlefair, P. Luminance models for overcast skies: Assessment using measured data, *Lighting Research and Technology*, 27 (1) (1995) 53-58.
- H. Erhorn, J. Stoffel, (Eds.), *ADELIN 2.0, Advanced daylighting and electric lighting integrated new environment*, Documentation of the software package ADELIN, version 2.0 (9 volumes), IEA Solar Heating and Cooling Program, Task 12: Solar Building Energy Analysis Tools, 1996.
- M. Fontoynt, P. Laforgue, R. Mitanchey, M. Aizlewood, J. Butt, W. Carroll, R. Hitchcock, H. Erhorn, J. De Boer, M. Dirksmüller, L. Michel, B. Paule, J.L. Scartezini, M. Bodart, G. Roy, *Validation of daylighting computer programs*, IEA SHC Task 21/ ECBCS Annex 29 Daylight in buildings, Ecole Nationale des Travaux Public de l'Etat, Département Génie Civil et Bâtiment, Vaulx-en-Velin Cedex, FR, 1999.
- J. Karlsson, M. Rubin, A. Roos, Evaluation of predictive models for the angle-dependent total solar energy transmittance of glazing materials, *Solar Energy*, 71 (1) (2001) 23-31.
- R. Kittler, S. Darula, R. Perez, *A set of standard skies. Characterizing daylight conditions for computer and energy conscious design*, Final report, Institute of Construction and Architecture, Slovak Academy of Sciences and Atmospheric Sciences Research Center, State University of New York. Bratislava, Polygrafia SAV, 1998.
- H. Kvist, *Derob-LTH for MS Windows*, User manual Ver 99.02, Dept. of Construction & Architecture, Lund Institute of Technology, Lund University, Lund, Sweden, 1999.
- K. Källblad, *Comfort – A Computer Program for Thermal Comfort Simulation*, Report TABK--96/3035, Dept. of Building Science, Lund Institute of Technology, Lund University, Lund, Sweden, 1996.
- K. Källblad, *Thermal Models of Buildings. Determination of Temperatures, Heating and Cooling Loads. Theories, Models and Computer Programs*, Doctoral Thesis, Report TABK--98/1015, Dept. of Building Science, Lund Institute of Technology, Lund University, Lund, Sweden, 1998.
- P.J. Littlefair, *The luminous efficacy of daylight: a review*, *Lighting Research and Technology* 17 (4) (1985) 169-181.
- P.J. Littlefair, *Predicting hourly internal daylight illuminances for dynamic energy modelling*, BRE 114/6/4, BRS 262/88, Building Research Establishment, Garston, UK, 1988.
- P.J. Littlefair, *Measurements of the luminous efficacy of daylight*, *Lighting Research and Technology* 20 (4) (1988) 177-188.

- T. Muneer, Evaluation of the CIE overcast sky model against Japanese data, *Energy and Buildings* 27 (2) (1998) 175-177.
- T. Muneer, R.C. Angus, Luminous efficacy: Evaluation of models for the United Kingdom, *Lighting Research and Technology* 27 (2) (1995) 71-77.
- T. Muneer, D. Kinghorn, Luminous efficacy of solar irradiance: Improved models, *Lighting Research and Technology* 29 (4) (1997) 185-191.
- B. Paule, J.-L. Scartezzini, M. Reynolds, N. Baker, Handling daylight in the early design stage. In: Proc. of EuroSun 2000, Copenhagen, Denmark, June 19-22, 2000.
- E. Petersen, Solstråling og dagslys – målt og beregnet, (Solar radiation and daylight – measured and calculated), Report nr 34, Lysteknisk Laboratorium, Lyngby, Denmark, 1982. (in Danish).
- SBIC, Designing Low-Energy Buildings: Passive Solar Strategies & ENERGY-10 Software. Integrating Daylighting, Energy-Efficient Equipment, and Passive Solar Design in Commercial, Institutional, and Residential Buildings, Passive Solar Industries Council, Washington DC, USA, 1996.
- M. Wall, Climate and Energy Use in Glazed Spaces, Doctoral Dissertation, Report TABK--96/1009, Dept. of Building Science, Lund Institute of Technology, Lund University, Lund, Sweden, 1996.
- M. Wall, H. Bülow-Hübe, (Eds.), Solar protection in buildings, Report TABK-01/3060, Lund, Sweden: Div. Energy and Building Design, Div Building Science, Lund Institute of Technology, Lund University, 2001.
- P. Wallentén, H. Kvist, M.-C Dubois, ParaSol-LTH: A User-friendly Computer Tool to Predict the Energy Performance of Shading Devices. In: Proc. of the International Building Physics Conference, Eindhoven, Holland, September 2000.
- F.C. Winkelmann, S. Selkowitz, Daylighting Simulation in the DOE-2 Building Energy Analysis Program, *Energy and Buildings* 8 (4)(1985) 271-286.

