

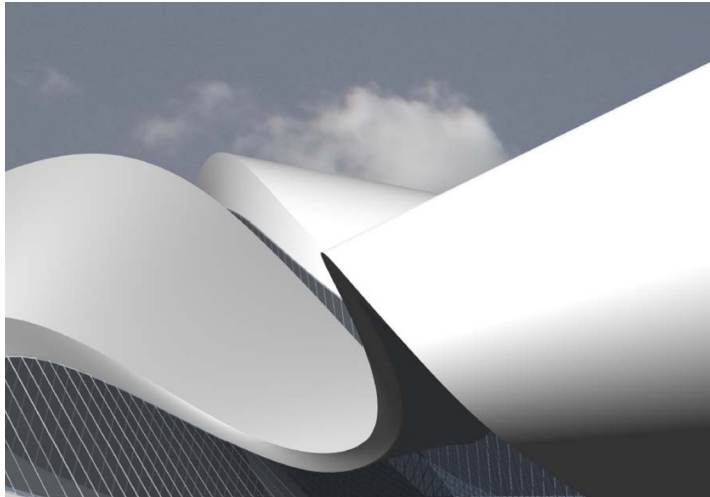

LUND
UNIVERSITY



STRUCTURE AS ARCHITECTURE

LOUISE PEDERSEN and JONAS TÄLJSTEN

Structural
Mechanics

Master's Dissertation

Department of Construction Sciences
Structural Mechanics

ISRN LUTVDG/TVSM--07/5149--SE (1-85)
ISSN 0281-6679

STRUCTURE AS ARCHITECTURE

Master's Dissertation by
LOUISE PEDERSEN and JONAS TÄLJSTEN

Supervisors:

Göran Sandberg, Professor, and Kent Persson, PhD,
Div. of Structural Mechanics

Morten Lund, Architect, Professor,
Div. of Theoretical and Applied Aesthetics

Copyright © 2007 by Structural Mechanics, LTH, Sweden.
Printed by KFS I Lund AB, Lund, Sweden, July, 2007.

For information, address:
Division of Structural Mechanics, LTH, Lund University, Box 118, SE-221 00 Lund, Sweden.
Homepage: <http://www.byggmek.lth.se>

Preface

The present master thesis has been made as an cooperation between the division of Structural Mechanics and the division of Theoretical and Applied Aesthetics at the Inst. of Technology at Lund University. The thesis consists of this book and a booklet, which both should be read together.

We would like to thank our supervisors, Göran Sandberg and Morten Lund, for their engagement, guidance and good critic. To see you cooperate gave a supplement to our thought about our own cooperation.

Also thanks to Kent Persson for being helpful with the programs we used and for giving good advice.

Last we would thank our jury at our presentation for being part of making a great discussion. Thanks to Peter Cook, Phil Ayres, Anna-Karin Persson and Abelardo Gonzalez.

Lund, Summer 2007

Louise Pedersen

Jonas Täljsten

Abstract

Title: Structure as Architecture

Writers: Louise Pedersen
Jonas Täljsten

Supervisors: Göran Sandberg, Professor,
Kent Persson, Ph.D.
Div. of Structural Mechanics
and
Morten Lund, Architect, Professor
Div. of Theoretical and Applied Aesthetics
Lund Inst. of Technology
Lund University

Problem: How does collaboration between architects and engineers work? Which are the advantages and disadvantages in the collaboration? How can you make the cooperation better?

Object: The purpose of this thesis is to make a connection between architect students and engineers, to find the differences between us and to try to collaborate. We wanted to know how difficult the cooperation could be, if there were any difficulties at all and what the reasons were. We were interested in how you could make architecture develop in better collaborations and if the structure could be expressed in architecture.

Method: The method was here to make ourselves Ginny pigs. We were ourselves supposed to collaborate in form finding. The form finding project was the architect competition, Museum of Modern Art in Warsaw. An outer form of the museum was found quite fast and the modifications were the large discussion areas.
We have then discussed both the problems in our collaboration and what other people have written and said.

Conclusion: With a better cooperation you can make more interesting buildings. If the engineer understands what the architects want, which impressions and expressions, he can try to find a solution that fits that but still is structurally efficient. And if the architect understands how the engineer thinks, and how different structures work, he can try to find solutions that will hold, but without destroying the architectural design. This means that with a better understanding of each others needs we could help each other find the best solutions.

Keywords: ...Architecture, Structure, Cooperation, Form finding

Index

Preface	i
Abstract	iii
1 Introduction	1
1.1 Background	1
1.2 Objective	1
1.3 Limitations.....	2
1.4 Outline of thesis	2
2 The collaboration	5
2.1 A structural engineer's way of working	5
2.1.1 The finite element method and programs used.....	5
2.2 An architect's way of working.....	6
2.3 Communication between architects and engineers.....	7
2.3.1 Formfinding according to Popovic Larsen and Tyas	8
3 The architect competition	13
3.1 Our process in the museum project.....	13
3.2 Formfinding process.....	14
3.2.1 The outside form	14
3.2.2 The supports	15
3.2.3 The curves	17
3.2.4 The middle.....	21
3.2.5 Under ground and windows	24
4 Optimizing the building	27
4.1 Different boundary conditions	27
4.1.1 A general beam	27
4.1.2 The Art Museum as a model in Abaqus	32
4.1.3 Fixed supported building	33
4.1.4 Roller supported building	36
4.1.5 Roller supported building with a column in the middle.....	38
4.1.6 Building supported by glass walls and cables	41
4.1.7 Comparing the different ways in supporting a building.....	45
4.2 Better material efficiency with lower density.....	47
4.2.1 Concrete shell with holes.....	47
4.2.2 A general beam	48
4.2.3 How to make calculations with holes	49
4.2.4 A model with holes only in the areas with low stress	51
4.2.5 A model with holes only in the areas with high deformation	52
4.2.6 A model with holes balanced over the whole body.....	53
4.2.7 Comparing the three different ways in making holes in the building.....	55
4.3 Different forms with different materials.....	56
4.3.1 Concrete shell or steel frame.....	56
4.3.2 A general beam	56
4.3.3 Concrete shell with reinforcement.....	57
4.3.4 Steel frame.....	59

4.3.5	Comparing the two materials	62
4.4	The wholeness of the building	63
4.4.1	Maze under ground and organic forms above ground.....	64
4.4.2	Glass windows with large angles.....	65
5	Result.....	67
6	Discussion.....	69
6.1	Pros and cons in our project.....	69
6.2	General cooperation	70
6.3	Improvement suggestions	71
7	References	73
	Appendix A – beam with fixed supports in both ends	75
	Appendix B – a roller supported beam	77
	Appendix C – a three supported beam.....	79
	Appendix D – reinforcement	81
	Appendix E – necessary size of the glass columns and of the cables.....	83
	Appendix F – thickness of the walls compared to the length between them	85
	Appendix G – windows	87

1 Introduction

1.1 Background

Throughout the history, buildings has mostly been designed and built by one person, the so called Master-Builder. The Master-Builder was an architect, engineer and constructor, all in one.

When the industrialization started, the constructions became more and more complex, and the demands of the buildings increased. Material and instruments developed with the technical development. This made it harder for one person to know everything, and to think about every factor in the constructing/ designing of a building or a bridge. The work was divided between the architect, the many different engineers, and the builder. [5]

With the distribution of work came other problems. The greatest was probably the communication between the different professions. A good communication is required in all building projects and collaborations. What in the past was one mans work became now a cooperation between many and the different professions grew at the same time longer apart from each other rather than closer.

In the last decade, this issue has got more and more focus, both in the universities and out on the field. It is clear that for the technical development of new architecture in the future and for the technical development in the construction business shall have a constructive and important role in the future it is necessary for architects and engineers to work together much closer, both in the school and out on the field. This thesis and the project we have chosen is about near cooperation between engineers and architects. We have chosen to do so because we are both convinced that more collaboration between architects and engineers gives much more possibilities and is a right step to take to develop complex architecture in the future and for the professions has a lot to offer each other.

1.2 Objective

This thesis was made in cooperation between the Division of Structural Mechanics in Civil Engineering and Division. of Theoretical and Applied Aesthetics at the Programme of Architecture. We, one student of architecture, Jonas Täljsten, and one of civil engineering, Louise Pedersen, were working together in a project to see if the architecture and structural efficiency can be improved with a good collaboration, and to figure out which problems there could be.

To understand better, we made ourselves Ginny pigs, and used a real project to test our capability to collaborate. Through the project we tried to be aware of the problems that would appear.

The project we agreed upon was an architect contest, which was to design a Museum of Modern Art in Warsaw. We wanted to find an exiting form and different solutions, perhaps not the most obviously but something that gives both construction and architecture a different expression. In both form and strength, the goal was to find the most effective construction material wise.

In comparison to our own work and views, we also read about other examples on collaborations between the two professions.

1.3 Limitations

Our limitations have mostly been in the limits of our imaginations and knowledge. In a project like this you have to find new ideas very quickly, so this has also been one of our limitations – time.

The largest limitation as we see it is the cooperation. Because of the collaboration, we have been limited in both of our professions. The focus in this thesis has been on the cooperation and therefore it is not like another architect thesis or another engineering thesis.

1.4 Outline of thesis

The project of the Museum of Modern Art in Warsaw was chosen and the surrounding was studied, mostly by the architect. From the surroundings and a few mechanical laws, we chose an outer form. This was the form that we later worked with on a deeper level.

We discussed different solutions with different prerequisites in order to find the form we wanted to have. The engineer made calculations of a variation of solutions, with the attempt to make the building as efficient as possible. From the calculations we discussed pros and cons in each model.

The decisions have been made in a few steps, to try to make our cooperation better. With some steps we could both follow the development of the building together and make a difference along the way.

The decision was made after making several tests.

The first step involved a homogenous shell, which were given different thicknesses after how it was supported.

- Fixed supported shell
- Roller supported shell
- Roller supported shell with column in middle
- Fixed supported shell supported by glass walls and steel cables

The second step was a question of making the material use more efficient.

- Shell with holes where the stresses are low
- Shell with holes where the deformation are high
- Shell with holes over the whole body

The third step was to choose material.

- Concrete shell with reinforcement over the areas with tension
- Steel frame

The fourth step was to connect both the symmetric forms above ground with the rest of the building underneath, so it would handle the heavy weight from above.

- Exhibition under ground connected with the symmetric form above.

The engineer student used two different computer programs to calculate the stresses and deformations of the building. Solid Works, which is a CAD-program, was used to draw the complex form from the first physical model which the architect did. This form was imported into Abaqus, which is a Finite Element Method-program that was used for the calculations. When the form was chosen it was imported into ADT, which is a CAD-program for architects. There was the form and surface refined into a complete building. With the Solid Works-model we also printed out the finished physical 3d model.

2 The collaboration

2.1 A structural engineer's way of working

“Engineers to many people, especially to the public, are mysterious figures. The most frequent remark is: ‘What do they do? They just make things stand up,’ as though this were not a noble thing to do. “*Peter Rice*[2]

What do engineers learn? Most engineers agree upon solving problems. Engineers are “problem solvers”. They try to find the best solution, which often mean the easiest and cheapest solution of the project they are working on. The projects are often a part of a bigger connection and often there are discussions about which solution is the best. For winning this argument, the engineer has to have proof in calculations of costs and productions. [1]

“Engineer: ‘this is so, because Newton said so’, ‘we should take this course of action because calculations indicate it will be the cheapest’” *Alan Holgate*[1]

Engineers do often work in teams, in large project teams where they each have a small part in the whole project. Engineers are specialists; they dig themselves in small details, which often are very important. Even though the details seem small for others, there are a lot of calculations that have to be done to know that it will hold for all the load cases that could be possible. However engineers can also dig themselves too deep into details and they are not always too keen on coming back up again. *Alan Holgate* [1]

Today when constructing a building there is often being used normalized elements and construction parts. These manufactured structures are often much easier and cheaper to build. However they also automatically become standard and dull. To make exciting forms in architecture, there has to be used special methods and programs. Of course there can also be made interesting modern buildings with standard elements, but if you want to go beyond that you have to have other tools. Complex forms are often very hard to analyze by hand calculations with the classic construction rules. They are often not as normal as a beam or a column. To analyze complex forms, for example with bows or special angles, different methods have been invented.

2.1.1 The finite element method and programs used

The method that is mostly used in structural engineering design today is the Finite Element Method. This is a numerical method of solving differential equations, which is used in all engineering mechanical calculations. The total region, which is supposed to be analyzed, is divided into small elements and each element is then solved with the method. When the differential equations of each element are solved they are put together in a so called finite element mesh, which shows the solution over the whole body. This means that even though the method is an approximation, the result can be very close to the reality. The smaller elements - the better approximation over the whole body. [4]

There are different types of finite elements. The elements which are used in our building are called isoparametric. These are special and very useful in a curvy form like ours, because they can have curved boundaries. Normally the boundaries are straight, like in a rectangular or triangular element.

The isoparametric elements are made by mapping for example a square element from the parent domain into the global domain, like shown in picture below.

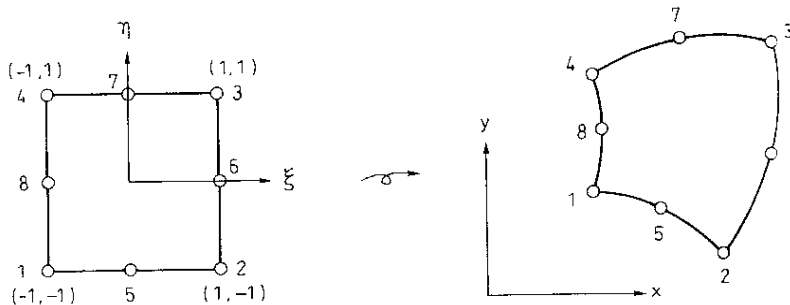

In this thesis there are used two programs for analyzing the form. Normally the program Abaqus is used for FEM-analysis. It is a program for calculations and not a CAD-program. Models can be made, but in this case, the model is a little bit too complex for Abaqus to handle it. The complexity depends on the curves in the form. Therefore Solid Works has also been used for making the round form from the coordinates of the physical model. So the model has been made as a part in Solid Works and then moved into Abaqus. It has then been given different properties, before it has been simulated and analyzed. Because a solid model is too complex to be studied in Abaqus our model was made as a shell. The thickness was then put as a property in the shell. To have different thicknesses and properties over the form it had to be partitioned. Therefore are the calculations with Abaqus not correct, they are an approximation. The smaller parts - the better approximation.

The elements used for our form is 8-node quadrilateral isoparametric thin shell elements, using five degrees of freedom. The first three degrees of freedom show the translation in three directions, and the two last degrees show the rotation around two different directions. Normally each node has six degrees, but because the model is a shell the last rotational degree is not necessary. If the nodes are supposed to be still through the simulation (for example at the supports), the different degrees are set to zero.

2.2 An architect's way of working

“Architect: ‘this wall should be brick because I feel it will express what I want to say about the nature of this building’” Alan Holgate[1]

An architect works with drawings, models, images and above all problem solving. An architect has to think both about the big perspective as well to details. He has to think in scale, proportions, rhythm, textual effects, lights, colour and hearing of architecture. He has to understand solids and cavities in architecture, emotions and how people experience architecture.

When an architect judges a building its appearance is only one of several factors which interest him. He studies plans, sections and elevations and maintains that, if it is to be a good building, these must harmonize with each other. Just what the architect means by this is not easy to explain. Architecture is not producing simply by adding plans and sections to elevations. It is something else and something more. It is impossible to explain precisely what it is - its limits are by no means well defined.

On the whole, art should not be explained: it must be experienced. The architect works with forms and mass just as a sculptor does and like the painter he works with colour and symmetry. But alone of the three, his is a functional art. It solves practical problems. It creates tools or implement for human beings and utility plays a decisive role in judging it. Architecture is a very special functional art; it confines space so we can dwell in it, creates the framework around our lives. In other words, the difference between sculpture and architecture is utility. The architect is a sort of theatrical producer, the man who plans the setting of our lives. But his job is difficult for several reasons. First of all the actors are quite ordinary people. He must be aware of their natural way of acting. Another great difficulty is that the architect's work is intended to live on into a distant future. Finally there is a very important feature which must not be overlooked in any attempt to define the true nature of architecture. That is the creative process, how the building comes into existence. Architecture is not produced by the artist himself as, for instance, paintings are. His drawings are not an end in themselves, a work of art, but a set of instructions, an aid to the craftsmen who construct his building. He composes the music which others play. Behind a building project there are a multitude of persons involved. Like ants toiling together to build an ant hill, quite impersonally contribute their particular skills to the whole, often without understanding that which they are helping to create. Behind them is the architect who organizes the work, and architecture might well be called an art of organization. The architect is forced to seek a form which is more explicit and finished than a sketch or personal study. Therefore architecture has a special quality of its own and great clarity. The fact that rhythm and harmony have appeared at all in architecture, whether a medieval cathedral or the most modern steel-frame building, must be attributed to the organization which is the underlying idea of the art. It is not enough to *see* architecture; you must experience it. You must observe how it was designed for a special purpose and how it was attuned to the entire concept and rhythm of a specific area. You must dwell in the rooms, feel how they close about you, and observe how you are leading from one to another. You must be aware of the textural effects, discover why just those colours were used. You have to think about the acoustics, the solids and the cavities, contrasting effects of solids and cavities, scale and proportions, etc.

The architect works with emotions but he also has to be a practical thinker. Nowadays his tools are different computer programs as CAD, Adobe, Sketch up and so on, but still his most important tool is the pen. To trying to judge architecture is a difficult thing. You cannot do it as in the school papers "A for that building", "B for that one", etc. It is a risky business. It is quite impossible to set up absolute rules and criteria for evaluating architecture because every worthwhile building, like all works of art, has its own standard. But if we ourselves are open to impressions and sympathically inclined, it will open up and reveal its true essence. It is possible to get as much pleasure from architecture as the nature lovers do from plants. He cannot say whether he prefers the desert cactus or the swamp lily. Each of them may be absolute right in its own locality and own climate. In the same way we should experience architecture.

2.3 Communication between architects and engineers

Most people agree on the best formfinding process is in a collaboration between both engineers and architects. But for this to work the two professionals have to respect and understand each others work. This is a necessity, but it can be even more helped if both professions get a better understanding of structural form.

2.3.1 Formfinding according to Popovic Larsen and Tyas

In the book *Conceptual structural design*[5], Olga Popovic Larsen and Andy Tyas explains the most important, according to them, sources of inspiration and formfinding procedures. Formfinding's sources of inspirations are divided into a few large sections.

The first is *the nature*. Many architects use the beauty in nature to find different forms, but what they might not think about is that knowledge about mechanics as well as looks can be found all around us. For example: trees can be very beautiful with their colours and their strange combination of branches. Many architects find them interesting and try to imitate them. Trees are not only nice to look at, but they also show a classical physical law. The branches are always thickest where they are supported and smallest in the ends. This can be compared to a normal cantilever. The most effective way of forming a cantilever is to do it as branches in trees.



Stuttgart Airport



The Millennium Dome

The next is *intuition or common sense*. This is what everybody has; even those who are not engineers know that you cannot use a cable as a column in a building or that a card in a card house will fall if it tries to stand on its own. These are the grounds on how the tents were developed. By trial and error our ancestors understood quickly that the skin or fabric had to be tensioned to be able to span over a distance. If it is not anchored in poles it will fall to the ground. The basic ideas can be seen in many of the modern tensed membrane structures; for example the Millennium Dome.

The third source according to Larsen would be *inspiration from precedent* engineers and architects, or Master Builders. Today we learn how to construct a building with scientific principles. We calculate, analyze, and use computers to find the best solutions. It has not always been like this. Before the industrialization, people learned by apprenticeship. You watched older, more experienced Master Builders, and if you were a good learner you could take over after your teacher. This is still used today, though not as specific. You learn from others mistakes or successes, and develop it. An example of this is the Egyptian pyramids; they were the precedents of I.M. Pei's Louvre Pyramid.



The Egyptian Pyramide



The Louvre Pyramide



The fourth is what is taught in technical education today, *scientific knowledge*. With the industrialization, the requirement came for faster, more effective and cheaper constructions of especially factories. New materials were being used, but for the builders to use it efficiently they needed to know more exactly than before how they worked, which properties it had and how it reacted on different loads. Scientific knowledge had already begun to develop, with for example Galileo who studied the stresses in a bending beam and later Leonard Euler with buckling of a beam. This is what the new builders used, and further developed to understand how different structural elements and materials worked. This development of theoretical analysis, made it possible to understand the structural behaviour of new forms before building it. Today's designers do not have to depend only on experience and intuition, to form new architecture.

The development of science also made it impossible for one person to know everything. The Master Builder was therefore divided up in different professions, as the engineer and the architect. However to construct a building, both professions were still needed. The problem came now to be the collaboration between the different people needed in the process. For a good collaboration, there has to be a respect and understanding for each other, which is not always there.



The Educatorium at the University of Utrecht

An example of a good cooperation is a new building at the University of Utrecht in the Netherlands, which were built by the architect Rem Koolhaas and the engineer Rob Nissje. The two-story building should with-hold a large restaurant, two big lecture theatres and examination halls. Koolhaas wanted to have a large concrete slab folded over it self, to function as both floor and roof. The problem came with the even thickness of 400 mm. In the first floor it would be more than enough but on the second floor, where the lecture theatres would be, it could not hold for the long span that was needed. The bending stresses were far too high for an even thickness. Nissje tried to make the middle thicker and still hold the even thickness on the edges where it would be seen. But when the concrete is thickened, the weight is increased and the slab should be made even thicker – an evil circle. He explained to the architect and he asked: “Why do you need this thickness in the centre of the span?” The engineer explained how bending in concrete works. A bigger distance between the compression and tension members decreases the stresses. The compression in the top was taken care of by the concrete and the

tension in the bottom by the steel reinforcement. Under high bending moments, the concrete around the reinforcement will crack. The architect asks: “The lower concrete cracks? Why do we bother putting in concrete if it is going to crack? Why not take the concrete out? There is a lot of weight associated with it, and it is not doing anything helpful.” The solution came to be a concrete slab on 200mm and to solve the problem in the middle the reinforcement that was needed, where hanging out below the concrete. Nissje:”And that is a very beautiful, where the reinforcement comes out of the slab, really a magical moment. It is expressing how the structure works. Rem Koolhaas likes it very much. No fairy tales. Only reality.”



The concrete shell reinforcement hanging out in the middle

The fifth source of inspiration Larsen means should come from *physical models*. By making small models of form you can understand how the large building should work. Often you do not have the same materials in the models and in the later construction, which have to be considered. But for formfinding it is a good solution. Normally it is hard to understand how different mechanics work by calculating and from using heavy computer programs. But by building, touching and looking at real models the learning could be helped. This is something that should be used even more in technical and architectural educations. Even professionals use it in their work. Anthony Gaudi, Frei Otto and Heinz Isler had a special way of formfinding – funicular models. These are models made of strings or a network of strings or cloth. You hang loads in it and the form is found. If you then freeze this form and turn it around it will be the ultimate compression form for that special loading case. Gaudi used it for his structural forms in for example Sagrada Familia church in Barcelona, Otto used networks to form the Munich Olympic Stadium, and Isler used cloth to find the form of the concrete shell structure at the Deitingen service station on A12 motorway in Switzerland.



Deitingen service station in Switzerland



A funicular model of Sagrada Familia



Sagrada Familia



The Olympic stadium of Munich

3 The architect competition

To experience the collaboration between an architect and an engineer we choose to find inspiration from a real architect competition. We found a competition in Warsaw. The competition was to create a Museum of Modern Art.

Because it was a Museum of Modern Art it would be necessary to give the building an impression to recognize. The architect got a challenge of making something exceptional that would fill the purpose of a recognizing building, and this building became then our object of cooperation.

A more detailed description of the competition can be found in the booklet, the other part of the thesis.

3.1 Our process in the museum project

To better understand the differences between architects and engineers, and to understand the difficulties in collaboration, we decided to make an experiment. We were supposed to design a building together. The museum of art in Warsaw was chosen to have an easy background instead of making it up all by our selves. Also we thought that the Warsaw project could be given an interesting form easily because it was museum of modern art.

We wanted to make a decision of a form as soon as possible, so that it was the development of the form that would be discussed and not be concentrating on finding the perfect new form. Because this was just an experiment and it was a master thesis we had to control our selves to not go into details. The overall job for us was to experiment with the form, to find one that was both befitting and structural efficient. The importance was to get a building where the force play would be shown in the form.

The engineer wanted to play with round, formactive structures, and tried to explain about this to the architect. The architect also wanted smooth, round forms, so the result became this organic, weaving form. But it was not at all a formactive structure. In some place it had actually less strength than if it had been a square building, for example in the curves. Here were the communication maybe not the best, but on the other hand the engineer understood that the building would not be that interesting if it should have a totally formactive structure. The engineer learned that no new forms would be made if you always followed the laws of mechanics. But it was not exactly what the architect wanted either. He wanted a stronger angle on the curves, but the engineer explained what kind of effect it would give the building if there would be such large angles.

We both thought that it was a good idea to make the middle area smaller. This would give the building a thinner and more elegant look, and on the same time the weight would be less which would give smaller deformations.

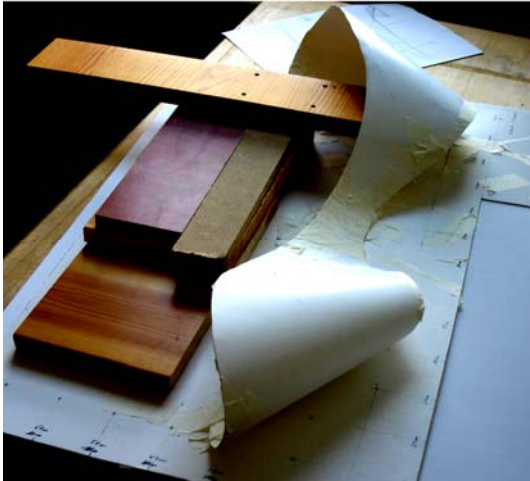

The architect made a model of thick paper to understand and see the form he wanted to find better. He then took out coordinates from this and the engineer made a first computer model out of it. To make the curves in the computer program we used splines with some of the coordinates. This made the computer model and the paper model not get exactly the same form but almost. The computer model was also changed a little bit by both the engineer and the architect to make it smooth also in the computer. The angles and curves were discussed and finally we had agreed upon an outer form of the museum.

We decided to hold that form and instead play with different situations and thicknesses to express strength and illusions. This was decided most of all because of the time schedule. To give the architect time to start on the cad-drawings and models, the form had to be set in an early stage.

The engineer then played with different supports, and how it would make the thicknesses of the form move and change. The results from the calculations were discussed and we chose a form that best suited both our wants.

3.2 Formfinding process

3.2.1 The outside form

The first intention both from the architect and the engineer was to design a building with a sculptural form, an organic complex shape with an impression and expression of structure, a form that was in somehow a contradiction to the laws of physics. Then it would be an experiment too, to make the building work as a structure with twisting and irregular shape, something that set given rules of structure at defiance. It would be a building that would be a challenge both for the engineer in structure and calculations as well as for the architect in function and structure. The language of the building should be a continuous, symmetric readable impression with a clean expression. A museum of modern art almost demands a special expression to be recognized as the intentions of modern

museums are. In consideration with the sites conditions, the different heights of the surroundings building and the character of the site, ideas of the design were growing. From the first beginning the form was developed by the architect in a physical model, with the intension that both the architect and engineer agree upon. The material for the experimentations, testing, creating a shape and a form in a physical model was hard paper. Paper is a superb material because it is easy to bend, stretch, turn and twist - perfect for a structure that we had in mind. Paper is also good to get a structure which is easy to change step by step as the progress to develop a form continues. It gives a clear apprehension about structure and fits for a building that will not be seen as clumsy. Because the building shall be a museum of modern art it is also suitable that the building gives a form that can also be readable as a sculpture or a piece of art. And for the site it is needed to have a building that contrasts the otherwise so stiff density. As a form sculpture with its intentions it is important that the shape harmonize to each side you look or contemplate at. Owing to that lie the big difficulties. It should be practical, work as a structure and in the same way give an expression of a sculpture. So there weaves form and building into one so it becomes much more difficult than just doing a sculpture. The process of working is to try and try and make model after model. Considerations and compromises have to be done, both for the architect as well as for the engineer.

In the process of form choice, there were different considerations to be handled. Things to be considered are discussed in this chapter.

3.2.2 The supports



Larger curve - larger stress/ smaller curve - smaller stress

Above you see the part where the building meets the ground, the support. This part has a very round form. The architect found this necessary to give the building the expression it should have. The architect actually wanted it even more round than it is showing here in this picture. The reason for this is to give it a smooth expression from many different angles.



On the other hand the engineer found this complicated. The laws of mechanics say that in a structure with that kind of bow, there will be a lot of bending stress. This stress could make the supports crack, if they are not strong enough. The best solution, in a mechanical way, would be to have the building meet the ground in a 90 degree angle. The building would then be subjected to a normal stress, which is easier to handle than a bending stress and vertical stress. But on the other hand with a 90 degree angel the building would loose its expression totally. And the challenge to make it stand, will no longer be a challenge.

The solution became a compromise between the two ways. The curve was not as extreme as the architect wanted, but to save the important expression of the building the rounded support was not abandoned. In the later chapters the calculations of the supports have been ignored. This is because in the programs it is hard to make a realistic cross section of the supports. In the pictures above you can see that the cross section is much larger than it is calculated.

In the production it is hard to make a real fixed support. In this case it would not be bad to have a support that could rotate a little bit. This would give the end of the form less stress but the total building more deflection.

3.2.3 The curves

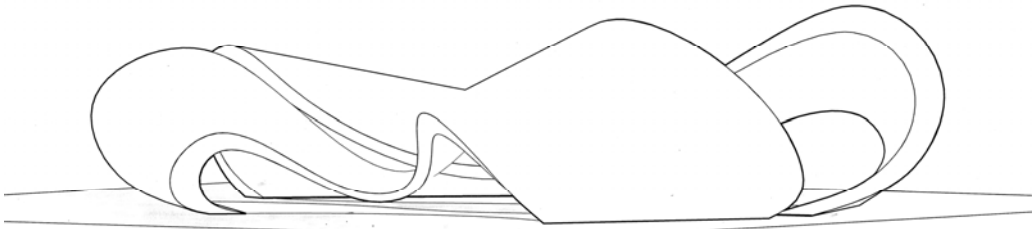

Point stresses



The biggest problem in this kind of form is the curves. According to the architect the building is more than a building. It is a sculpture, which also reflects that the building is an art museum. Therefore the expression of the building is viewable both as a sculpture and as a building.

The engineer is fascinated by the formative structures, which is one of the reasons that she was interested in a building with round forms. In a form with mostly an outspread load, it should not have any angles. The angles would then be subjected to large point stresses, because of the bending moments. With a smooth curve the stresses were more balanced.

Formactive structures are structures which are only subjected to either pure axial compression or pure axial tension at a certain load. A structure can be submitted to axial load, bending load or a combination of both. A structure with an axial load will be submitted to a constant axial stress over the cross section. This will give the most efficient use in material, because the whole cross section is stressed to its limit on the same time. The material provides full value of its weight. However a structure with a bending load will cause a bending stress, whose magnitude will vary along the cross section. Only the extremities will be stressed to its limit, and the rest will be understressed. This is a much more inefficient structure. A formactive structure is the most efficient structure that can be used. [3]

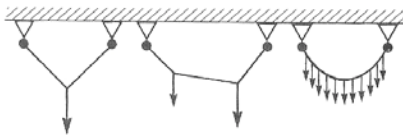

Tensile formative structures

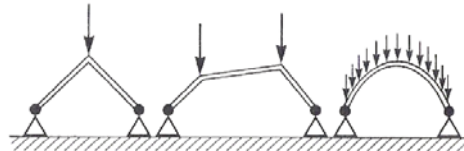

Compressive formative structures

However with a form like this museum, there came other problems.



Because of the load that the building should carry, the curves were subjected to large bending stresses. These stresses made the shell want to crack in the outer ends of the curves. To prevent this, the curves were given a greater thickness.

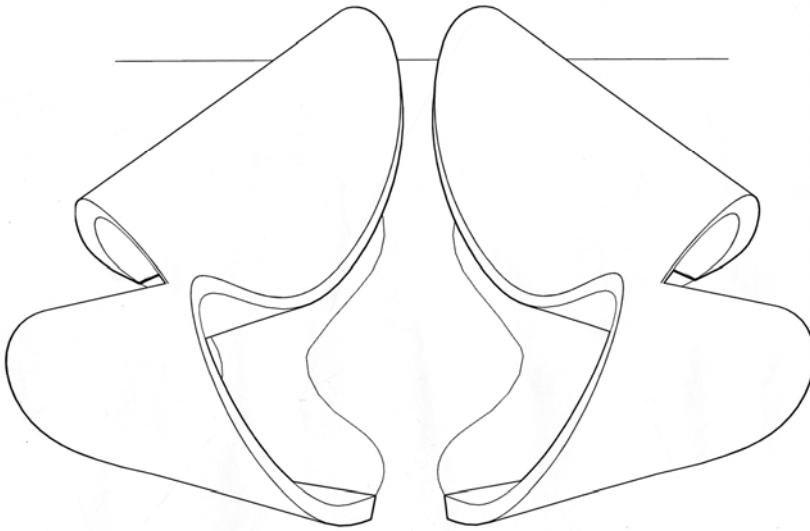

The complex asymmetric form of the shell opens up to other considerations. For example the two curves do not have the same size and roundness. This is one of the factors to that the two curves not are subjected to the same amount of stress and not in the same areas. This result can also come from other reasons. The support areas are not parallel to each other, but more with a 90 degree angle. The mass from the middle are asymmetric, and the masses are not divided equally over the area. These circumstances make it more difficult to say which the real reason is to a difference in stress situations. Because we do not know the reason, it is harder to understand what the solution should be to a more material efficient building. The solution have been as simple as giving more thickness to the most stressed areas. The pictures show that the small bow has the thickest cross section, which is because it had the most stressed part. The placement of the stressed areas depends among other things on the supports. The supports can be fixed or rollers, and placed in different ways. These various ways in supporting a building will also give it several varying expressions.

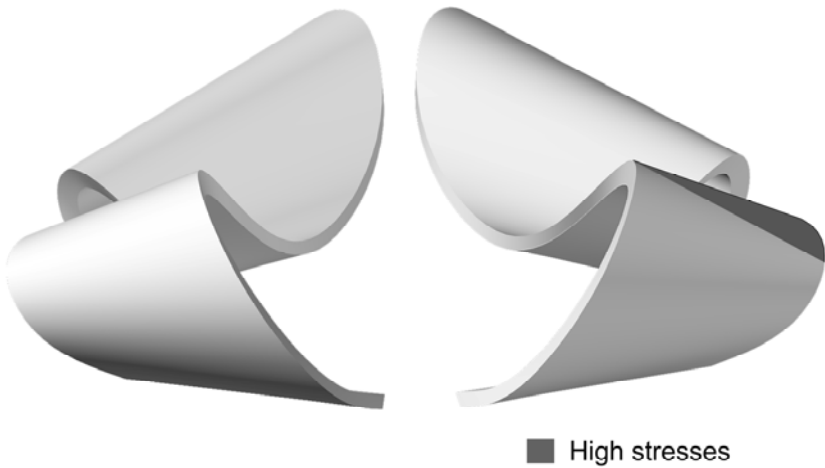

The complex form is also a factor to another problem. Because of the nonparallel ends and the twisting of the shell, the building seems to hang down on one side. It is sort of leaning to that side. This gives it an even more fascinating form, but on the same time a more complicated model to understand. However the leaning subjects the lowest parts of the curves to an even higher stress. These are the parts that should hold the whole building. The mass of the shell tries to compress the lower sections. The thickness here should therefore be unequal through the curve. The thickest parts should be in the lower section, and it should then be thinner and thinner on the way over to the other side.

The leaning form has been decided by the architect. He wants people to feel welcomed by the building. The museum greets them with open arms. With the shell leaning down it can also have an expression of the building is larger on the inside than on the outside. On the other hand, the great thickness could give the impression of this great building falling down on the visitors. This will be more of a contradiction instead of *architecture of structure*-impression – the building feels like it is falling down but it is not. What an effect!

3.2.4 The middle

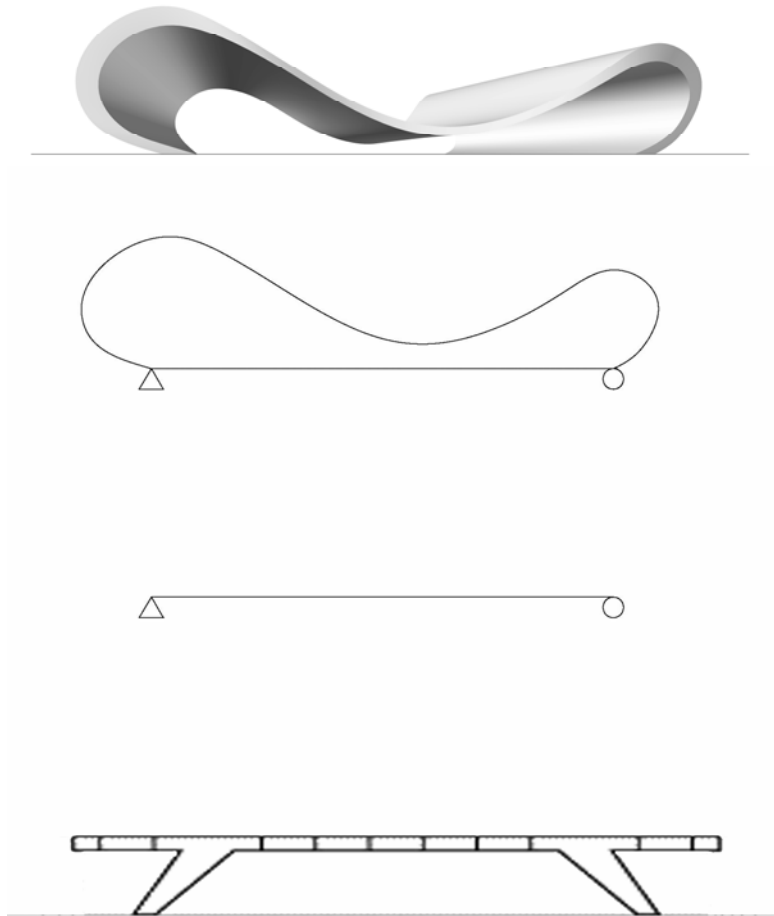

The building can be seen as a large beam. However it is a different beam. How many have for example seen a beam bridge with a span on over a hundred meters? The largest problem with a long spanned beam is the deformation. The largest deformation is, in a normal symmetric beam, always in the middle. Our building is as said before neither symmetric nor normal. From this maybe you will understand that in this form the largest deflection will not be in the middle. It will be a little bit displaced, because of the twisted, leaning, asymmetric form of the museum. Towards which direction the maximum deformation will be displaced depends on which supports it will have.

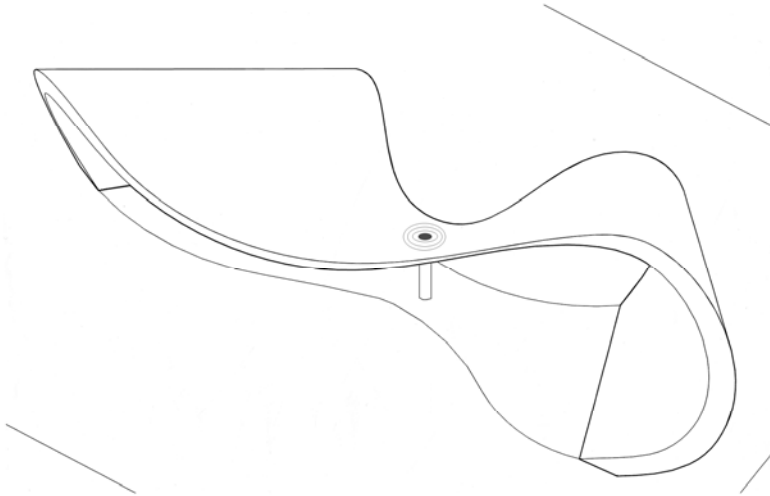

One solution to this problem could be to place an extra support underneath the area with the maximum deformation. This will however give the building a totally different expression. Without the support in the middle the form is clean and clear of any distractions. With a support you would have to think about the expression the support and the building would show together. Should they be one whole form or two separate? Should the support be hidden or brought out as a big part of the architecture? These are some of the many questions that could appear in this case. In our building we chose to not have the support and have then ignored these questions. We wanted to have a clean shell that should be able to stand without any extra supports. What was the challenge in having a crutch which would handle the weights? The total idea of the building would have lost. The challenge was to get the building to stand without supports in the middle, in some way, without losing the clean expression.

This was to give the shell an extra impression of a sculpture. There was also a challenge in getting the building to stand without any supports in the middle.

An extra support would subject the building to high point stresses around the support. Because of that the building should be thicker in the middle and the curves could be a little bit thinner than without the middle support.

Without a middle support, we had to find another solution to our problem. The deformation depends on how large the load is, and in our case the load depends mostly on the dead weight of the shell. Here does the complex form help. The part in the middle is a lot smaller than the curvy parts, which means that the form has a smaller load there. It is however not enough. The mass has to be reduced. This can be done with a lower density, for example by making holes in the shell, or with a thinner thickness. We have chosen both ways. By diminishing the thickness, the form is given a certain expression. When the curves are thicker and the middle hanging part is thinner, the building looks less stiff and more dynamic. The whole building gives an impression of lightness. The curves look like they are carrying the middle, which they also are. This is a typical 'Structure as Architecture'-expression in this project.



As discussed in a previous section in this chapter, the building is leaning a bit. This also have an effect on the middle. The maximum deformation is as described not situated exactly in the middle. This is partly because of the leaning situation. Because of this one side is hanging down and the other side is pushing upwards. To make a better balance here the load, which means the mass of the shell, have to be unbalanced. The mass is moved from the part that is hanging down to the part that wants to fly up. This will not be as expressed as other factors in the building, because you are not able to see both sides on the same time. Therefore has it not been as big a part of this thesis that it could have been. It has been remarked here for the readers to really understand how complex this building is and how many factors that can be considered.

3.2.5 Under ground and windows

The two huge shells can not hold the area of all the rooms that this gigantic museum should hold. Also it is necessary to have other sizes of rooms, to handle the many different functions the areas in a museum should have. Therefore we have decided to make more floors under ground. Such decisions lead to more problems. These floors should be able to carry the enormous weight from the shells. Therefore, the walls or columns in those floors have to be situated close to each other. You may say that the density of walls and/or columns should be high especially at the supports of the forms. Structurally, this means that either the walls/columns have to be thick or they have to be very close to each other. The balance between these is up to the architect to consider. When are the walls too thick and when is the space between the walls too small?

To make the huge complex forms above ground a larger impression on the visitors, the architect wants to make the buildings above ground and the floors under ground a bigger contrast to each other. This is done by making the rooms smaller, both in width and in height. The thought is to make some kind of narrow labyrinth with different sizes of wall pieces underneath the supports. The labyrinth will become less narrow the longer from the supports it gets.

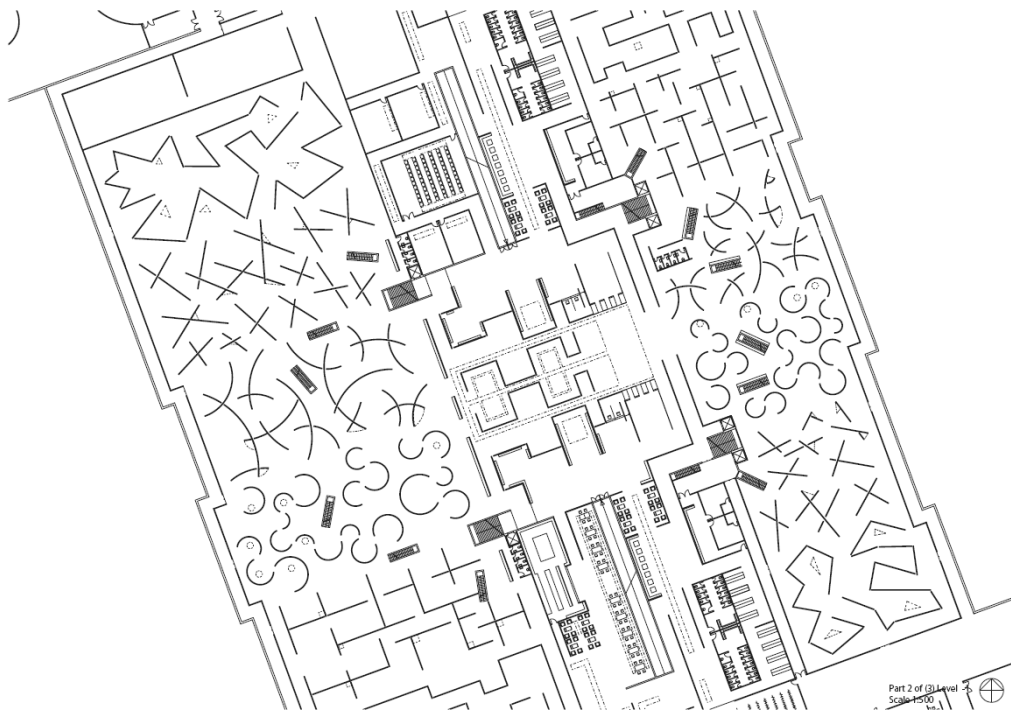

Windows

To get the total impression of the building, we felt that the sides should be covered in glass. The building would be see-through, and the feeling inside would be more airy. A large wall only made by glass is of course always a problem. However the structural problem was made even harder when the architect wanted the glass to follow the curve of the building. This meant that the glass wall would have an enormous angle in some places. This is a problem because glass has a good strength in pressure, but a very low bending strength.

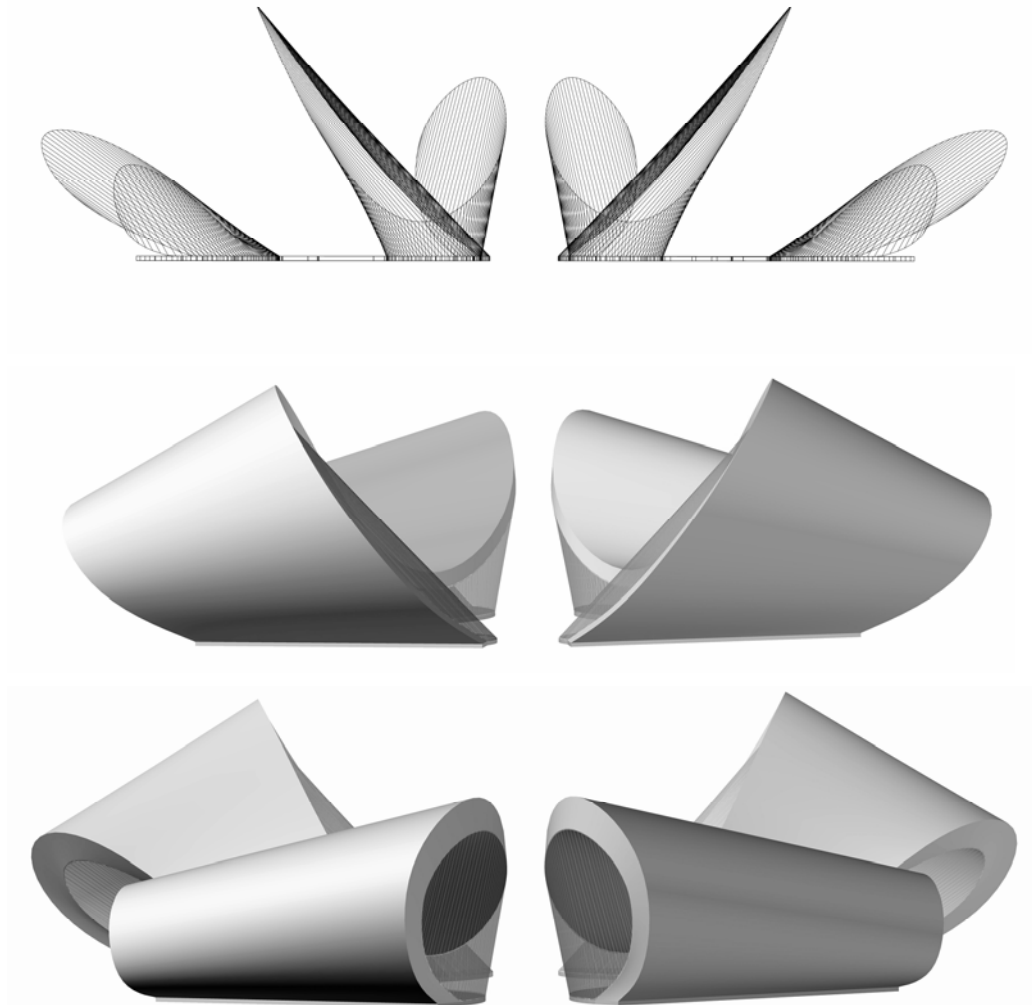

There are of course many other problems and aspects to discuss. We have though chosen to discuss the outer form more than all the inner problems. In the next chapter there has been made some examples of how to change the form. We have tried to think about the problems that have been discussed in this chapter. We have worked with imagination, experience and experiments to find the form that would suit us the best. The building is of course not complete but the interesting part is what we do to find the form.

4 Optimizing the building

In this chapter there will be an example of how to optimize this building. As discussed in previous chapter the form can be changed to make the use of material more efficient. The way to change the form can be made differently depending on the prerequisites. Some different conditions are discussed and analyzed here.

This should not be seen as a perfect model of finding the right form, but more as a process, a process where different prerequisites and views are discussed. It is mostly discussed from an engineer's point of view. In the process you can see how a form develops through just small changes, and how it can show different illusions.

- Different forms with different supports
- Different forms with different weight
- Different forms with different strength

4.1 *Different boundary conditions*

A homogenous shell with the same thickness all through the form is not always the most effective form of a structure. In this chapter it will be shown how to make the building more effective by changing the thickness. It will also be shown how different supports can make different forms.

Different boundary conditions will submit a variation of stress combinations and deformation forms to the structure. The stress and deformation are factors that decide the ultimate form of a structure.

4.1.1 A general beam

To understand how you could make the form of the Museum more efficient, we choose to look at a general beam. Different boundary conditions are subjected to the beam and the result is analyzed.

We have discussed four different ways in supporting the building.

- Fixed supports in the ends
- Roller supports in the ends
- Roller supports in the ends and a column in the middle
- Fixed supports in the ends and supported by glass walls and steel cables along the sides

The three first will be analyzed in the case of a normal beam.

First some typical pictures in structural mechanics are analyzed, forms from [6]. Here the thickness will be referred to the moment to which the beam is subjected. This is because the moment comes from which load the structure is supposed to hold, and from the moment you can calculate the ultimate height. This is done in appendix A, B and C.

$$M = \sigma W$$

$$W = \frac{bh^2}{6} \quad \text{This is how large a moment a beam with a special cross section can handle.}$$

Below is shown the different moment diagrams which come from different boundary condition cases. These moment diagrams help us to find the ultimate form of each case.

The left pictures show the load/boundary condition cases. The load is the same for each case; it is an evenly distributed load (q). The middle pictures show the moment diagram. In the positive areas (underneath the line) the beam is in tension, and in the negative (above the line) it is compressed. The right pictures show the ultimate forms of the beam in each case.

The beam with the column has an extra support in the middle which stands for the support from the column.

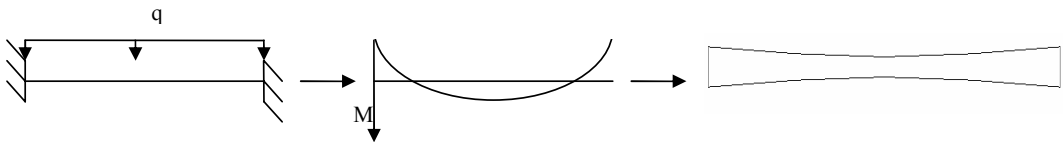

Fixed supports in the ends. $M_{\text{sup port}} = \frac{qL^2}{12}$; $M_{\text{field}} = \frac{qL^2}{24}$ [6]. This, with the form as shown above will give the beam a mass of around 0.33 units. See appendix A.

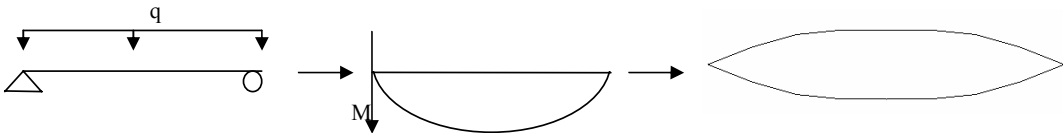

Roller supports in the ends. $M_{\text{field}} = \frac{qL^2}{8}$ [6]. This, with the form as shown above will give the beam a mass of around 0.58 units. See appendix B.

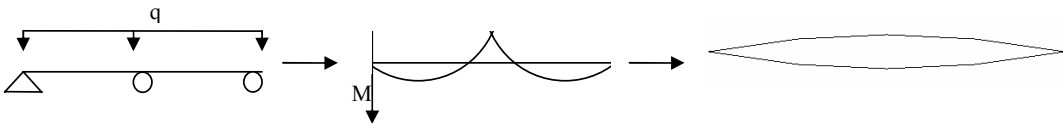

Roller supports in the ends and one in the middle. $M_{\text{sup port}} = \frac{qL^2}{32}$; $M_{\text{field}} \approx \frac{qL^2}{57}$ [6]. This, with the form as shown above will give the beam a mass of around 0.30 units. See appendix C.

To understand better, which boundary condition case is the most effective material wise the engineer student makes a simple calculation by hand (appendix A,B,C). The reason is to compare the different cases' ultimate masses.

As seen above the beam is given three totally different shapes, depending on the supports. As will our building but not likely in the same way, because of the form.

The beam has an expression of a very thin and slender structure, when it is fixed in both ends. On the contrary, when it has roller supports it looks clumsy and fat. Also the material efficiency varies. The mass for the fixed beam is just 60% of the mass for the roller supported beam's mass. This means that theoretically the fixed supported beam is much more efficient. In praxis it is harder to make a fixed support, and in production it could be more efficient to calculate it as a roller supported beam.

The difference with more or less supports is not in the form but in the overall thickness. The two cases with roller supports show this. The one with three supports is only half the size of the one with two supports.

The decision of supports depends on several factors. How many supports do you want? Do you want fixed or roller supports? How important are the material efficiency? And the biggest question here, what kind of expression do you want the structure to give?

Probably is the normal version of this, that the architect wants a special expression and the engineer has to find out the best solution, support wise.

This calculation is not totally correct if we look at this particular case. In the calculations it is assumed that the load is even through the whole model, but it is really not. Because the dead weight of the beam is the dimensioning load, the load will change with the change of height/thickness of the model. These circumstances are taken into consideration in the FEM-model in Abaqus, and therefore can these two calculations not really be compared. That is why the beam now will be tried in Abaqus as a FEM-model.

A beam in Abaqus

A straight beam is made with a cross section of 1x6m along the whole length. This beam is tested with fixed supports as well as roller layered supports (both two and three supports). These tests are then compared to tests with beams of the ultimate forms which were taken from former calculations. To better compare them they all have the same scales in the pictures, both in deformation and stress (the colours of the beams). The colour scale of the stresses is shown below, and the deformation scale is magnified 20 times. The grey areas are areas that exceed the colour scale. The material properties are the same for all the models. The numbers for stress and deformation are only to be used for comparison between the different forms.

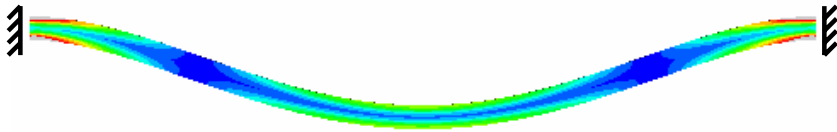
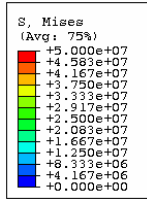

Fixed beam. Maximum deformation is 1.1m, and maximum field stress is 34 MPa

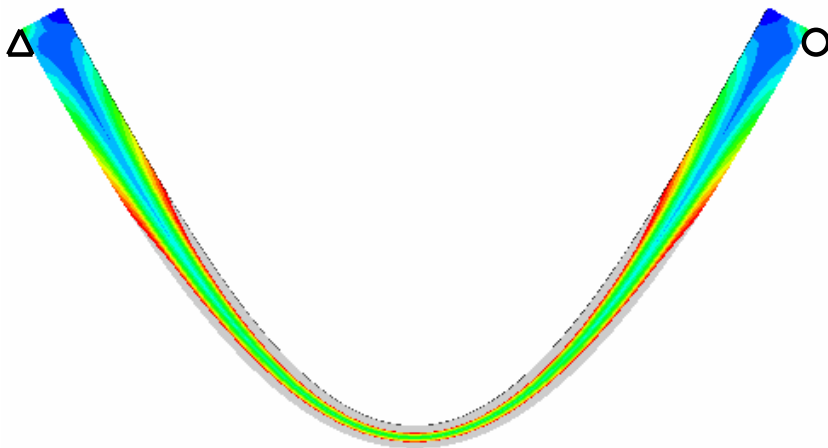

Roller supported beam. Maximum deformation is 5.6m, maximum field stress is 100 MPa



Roller supported beam. Maximum deformation is 0.12m, and maximum field stress is 14MPa

Both the stresses and the deformation are a lot larger in the beam with roller support. This can be compared to that the moment was larger in the calculations made by hand. The difference in deformation is 5 times larger in the case with the roller support. The three supported beam has almost no deformation at all compared to the other two, which is very logic, because the deformation length is halved. Also the field stress is a lot less. This is because the bending stresses are the highest in these cases. Where the stresses are situated is also a difference between the three. In the case with fixed boundary conditions, the highest stresses are where the supports are, which has a direct connection to that the beam is not able to rotate, it is not free. In the case with two roller supports, the stress is

largest in the middle. The large deformation subjects the beam to a large bending stress. In the last case the largest stress is a stress in one point, just over the middle support. The column can be seen as a point load from underneath. This gives the beam a very high stress in that point. In all, the stresses are lowered with more supports, but considerations have to be done about high stress in one point which can lead to holes and cracking in this point.

The beam is now moderated in height in the same way as in appendix A, B and C, without changing the mass in any meaningful way. The width is also the same as in former three cases.



Fixed beam. The largest heights (12m) are in the ends and it is smallest (1.6m) in the middle. Maximum deformation is 0.6m, and maximum field stress is 23 MPa

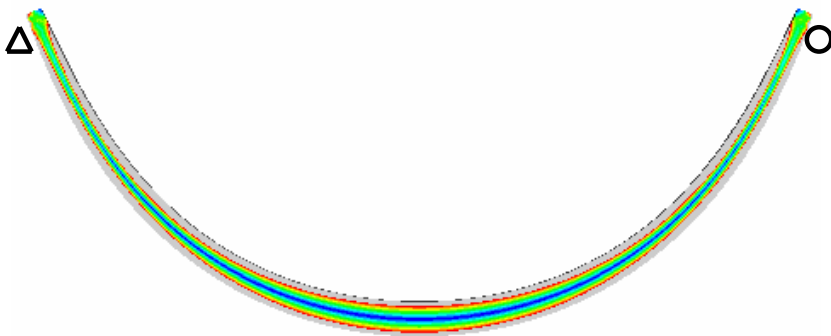

Roller supported beam. The largest height (9m) is in the middle and it is smallest (1.6m) in the ends. Maximum deformation is 3.9m, and maximum field stress is 66 MPa.

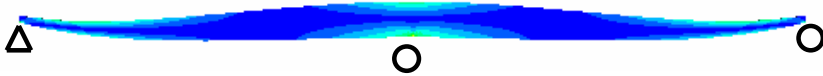

Roller supported beam. The largest height (9m) is in the middle and it is smallest (1.6m) in the ends. Maximum deformation is 0.13m, and the maximum field stress is 21MPa.

In the case with fixed support, is the deformation halved, after moderation of form. The stress is decreased with 30% in the middle of the beam. In the two-roller support case, the deformation has decreased by 30% and the stress also. These two have become more efficient, they have decreased the stress, without increasing the material use. However, the third has not changed at all to the better, almost to the worse. This could depend on a lot of factors. The moderation could be wrong; the

relation in height between the middle and the ends could be too big. The balance of the stress was maybe as good as it could be before the moderation; maybe it would look different with a longer beam.

If you compare the two first boundary condition cases after modeling with the form, you understand that from a structural engineer's point of view the fixed support is better. The deformations are almost 6 times smaller in that case, and the field stress is halved in comparison. On the other hand it is much harder to make a fixed support which in you can trust. No supports in the real world, will handle the stresses as in this fixed supported model.

Another question is, as asked before, what kind of expression should the beam, or in our case the museum, have. Different boundary conditions – different architectural expressions.

4.1.2 The Art Museum as a model in Abaqus

With the knowledge from above, the form of our building is being analyzed. From understanding were the stresses are located, and if they are tensed or compressed, it can be understood were the highest moments are. From that a moderated form can be made.

The model in Solid Works has been transferred into Abaqus to be analyzed as an elastic model with the Finite Element Method. The material has not been chosen, but for the stresses to be analyzed, material properties have to be chosen. We assume the material to be concrete, and then work with the density, module of elasticity and Poisson's ratio of a K60 concrete [6].

Material properties, boundary conditions, load conditions and element properties are chosen, and the model is being meshed, before the calculations are being done.

Material properties:

Density: 2400 kg/m³

Module of elasticity: 36 GPa

Poisson's ratio: 0.2

Boundary conditions:

These are the properties that will be changed in this chapter. Boundary conditions are being chosen after how the supports look. When the support is fixed in both ends, the degrees of freedom in these nodes are set to zero, which means that they are not able to neither move nor rotate. When the supports are roller supports, the first three degrees of freedom are set to zero. This means that the nodes are able to rotate but not move.

Load conditions:

Because of the huge density, the dimensioning weight will be the dead weight of the shell. The snow weight is ignored at this point, because of the high density of the dead weight.

Element properties: quadratical isoparametric elements

To understand how the building works, an analysis is made for a model with one thickness of 2m over the whole form. The thickness might sound big, but not if you think about the massive span of 100m, that the building should be able to handle. This building is then looked upon in the specific boundary conditions, to see where the highest respectively lowest moments are.

Abaqus analyze the result as principal stresses in tension and compression. The stresses in tension and compression can then be seen as a bending moment, and then it is easy to see where the form has to be thickened or thinned.

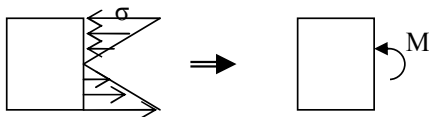

The pictures to the left show a positive moment. When the bottom is subjected to tension and the top to compression there lies a positive moment, and the other way around.

How you analyze the transition from stresses to bending moment is shown in the pictures above.

4.1.3 Fixed supported building

The fixed supported building (figure 1) should, if it works as the beam shown above, be slender in the middle and have large masses at the supports. But because of the complex form, the thinnest parts will not be exactly in the middle and the curves will not be equally thick on both sides. What is also shown is that the stress is not the same over the whole curve. This would mean that the thickness should also be varied over the width of the curves and not only over the length.

We believe this complexity in stress variation has something to do with that the form is being twisted, and that the masses are not exactly the same on both sides. Also, the curves are not equally high and round, and the probably strangest part is that the supports are not parallel but in almost a 45 degree angle towards each other. All these circumstances make it impossible to analyze as a straight beam. But with the understanding of mechanics, and how a beam reacts in different situations, you can try to understand how complex forms such as this works.

The building with an even form (2m) is analyzed below.

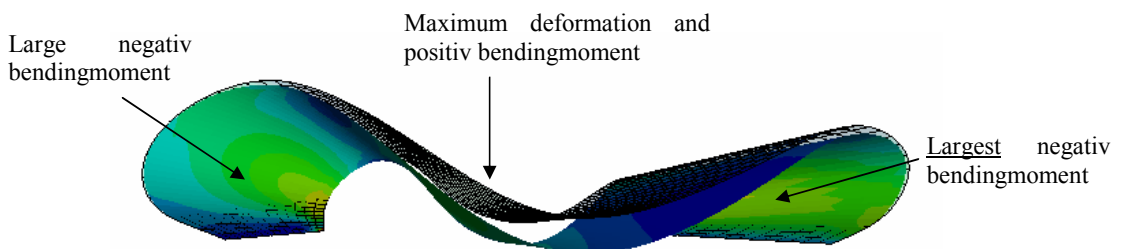
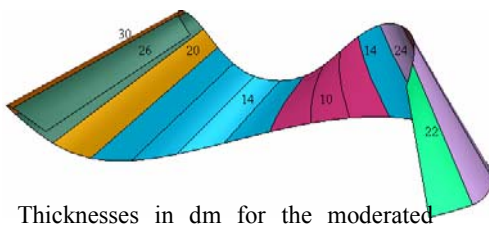

Figure 1: The figure shows Von Mises stress and deformation. The form with grids is before loading and the coloured is after. The green/yellow/red areas show large stress (red being the largest).

When the weight from the building is pushing the curves down, they also want to push outwards. This makes the curves be submitted to high bending moments, the highest being in the points furthest out. These are the ones that want to bend and crack, and are therefore subjected to the largest stresses. The part in the middle hanging down is also submitted to a moment. This is not as large. The difference between the curves and middle is that the curves are submitted to a negative moment and the middle to a positive moment. The negative moment comes from the deformation in the middle. After comparing this to the fixed beam above, the curves should be thickened and the middle should be thinned. This makes the curves stronger and gives the model a smaller deformation.

I have chosen to just vary the thicknesses in the length direction of the building and see what happens then. The model in Abaqus is being partitioned as shown below, and different thicknesses are put in the different parts.



Thicknesses in dm for the moderated model. Seen from below.



The resulting building.



The moderated thickness for the fixed supported building.

The result shows that without increasing the material, the maximum deformation is being halved. The maximum stresses did not change especially but they are not really interesting, because they are situated in the supports. I have instead chosen to compare the stresses in the middle and in the middle of the curves. I have chosen three different nodes and compared the two models in these nodes.

Normally the stresses would decrease equally to the deformation in the same node, because stress is linear to strain.

The decreasing percentage of the stresses in the middle is 25%, which is not the same as the percentage of the deformation. This is because the nodes are not the same.

The decreasing factors in the two curves are very different, 65% in the small curve respectively 40% in the large curve. This depends of course on the difference in thickness moderation. It is done to equalize the bending moments in the two curves. However the thickness moderation made the balance between the two, go the other way. The largest stresses are now in the large curve. The mass balance did therefore not have to be this extreme, but it does not matter here. The most important is to see how much you can decrease the stresses, without increasing the total mass of the shell.

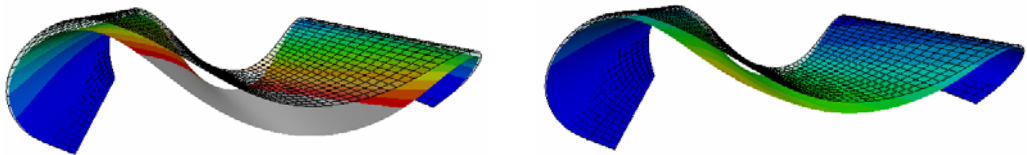
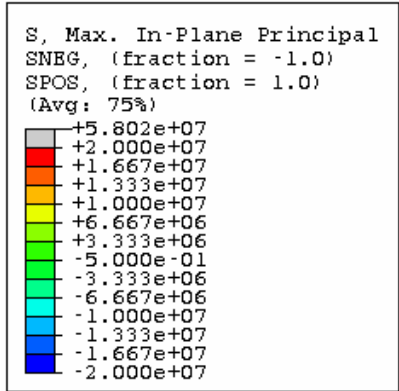
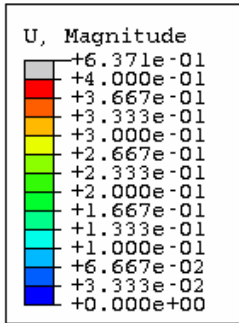

Here is the before (0.64m) and after (0.31m) picture of the deformation. The scale is the same in both pictures. Seen from the side.

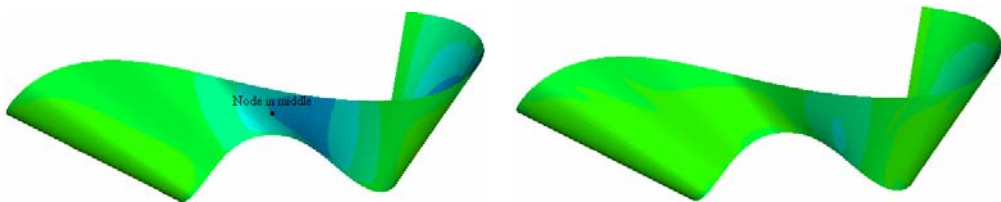

Minimum stresses / largest compression stresses are shown. Node (21MPa/3MPa) chosen in the middle part is marked. Seen from above.

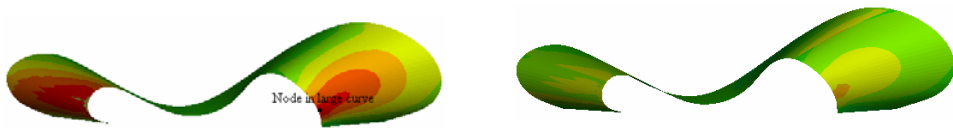

Maximum stresses / largest tension stresses are shown. Node (36MPa/21MPa) chosen for the large curve marked. Seen from the side, angled on the large curve.



Maximum stresses / largest tension stresses are shown. Node (41MPa/14MPa) chosen for the small curve is marked. Seen from the side, angled on the small curve.

In all the building has become much more effective in handling stress and deformation, and without using more material. The model can of course be even more moderated, both in length and in width. In the pictures above it is understood that especially the large curve should be moderated in the width as well. We have chosen not to do so in this project.

4.1.4 Roller supported building

In the same way as for the fixed supported building, this support system is modelled with an even thickness of 2m to understand where the largest bending moments and deformations are situated. The fixed supported figure from before have the same scales in size and colour as this one, for the ability to compare them.

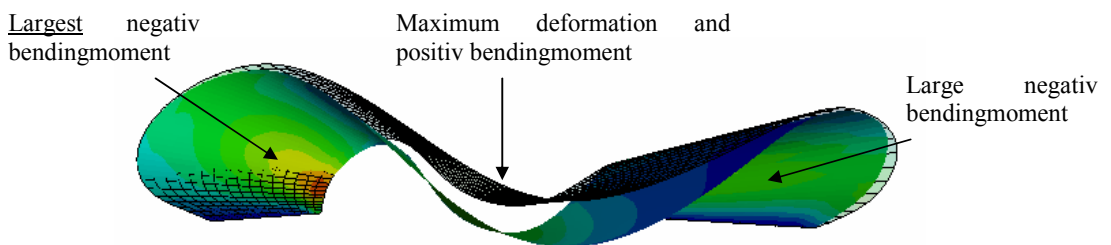
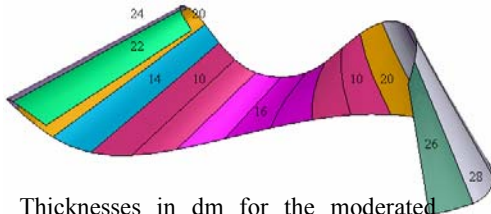

Figure 2: The figure shows Von Mises stress and deformation. The form with grids is before loading and the coloured is after. The green/yellow/red areas show large stress (red being the largest).

The maximum deformation point is placed in almost the same point as in the case with fixed supports, but here it is much larger. This is logic if you compare to the general beam. The deformation is almost always smaller in forms with fixed support. Because the deformation is bigger here, the bending moment automatically is higher as well. The largest moments are placed in the curves. The difference is however which curve that has the largest stress. Here it is the largest curve that has the highest stress, and therefore the highest moment. This means that the situation of the most mass is depending on how the form is supported. The mass is moving from one curve to the other depending on the support.

Another reaction in this case is that the middle part actually wants to lift up. It can be seen in the figure above in the left part of the middle. There is a little part which is bending the other way. In this kind of situation where the same size of area is bending first one way and then the other results in a larger bending stress than if it only bent one way. This is handled by making the area where it wants to lift heavier, which here will be thicker, and the area around it lighter.

The model is partitioned and different thicknesses are placed after where the moments and the deformation are.



Thicknesses in dm for the moderated model. Seen from below.



The resulting building.



The moderated thickness for the roller supported building.

The maximum deformation is also here halved, without increasing the mass of the shell. The same nodes as in the fixed model have been controlled.

The stress in the middle has decreased with 65 %, which is a lot more than the fixed supported case. This probably depends on that the part that is bending up and down submitted the part to such a large stress before the thickness moderation, and because the thickness was moderated in such good way it made the stress decrease a lot compared to the former supporting case.

The decreasing factors are here almost the same for each curve (50%). The stress in the large curve decreases a little bit more, but if the moderation should be really good it should have been even more. The reason for them to not have a larger difference in decrease is that there is not large difference in size of stress before the moderation. However it is more interesting to see how much the stresses and the deformations can decrease without enlarging the total mass.

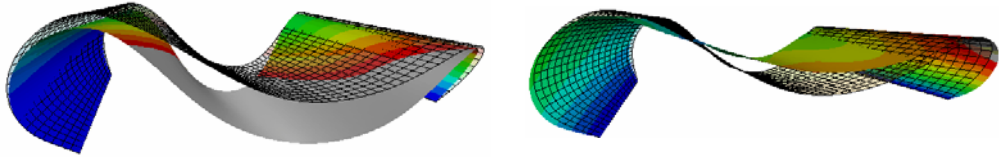

Here is the before (0.81m) and after (0.43m) picture of the deformation. The scale is the same in both pictures. Seen from the side.

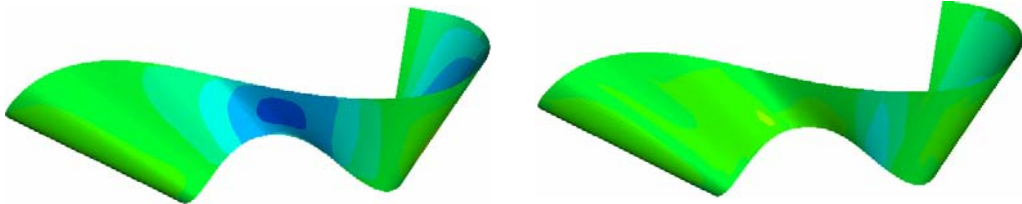

Minimum stresses / largest compression stresses are shown. Node (29MPa/13MPa) chosen in the middle part is marked. Seen from above.



Maximum stresses / largest tension stresses are shown. Node (42MPa/20MPa) chosen for the large curve marked. Seen from the side, angled on the large curve.

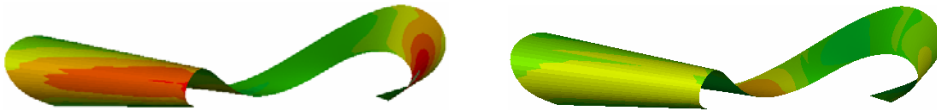

Maximum stresses / largest tension stresses are shown. Node (34MPa/17MPa) chosen for the small curve marked. Seen from the side, angled on the small curve.

In total the stress and deformation have been reduced a great deal even in this case, and as in the fixed case it can of course be even more balanced by partitioning even more and giving the different parts different thicknesses.

4.1.5 Roller supported building with a column in the middle

A normal way of reducing the stresses in a beam is to give it more supports. This is what the next model of our building has been submitted to. It has now three supports, two in the ends and one in the middle. Normally you would put an extra support where the deformation is the largest. Because the largest deformation is almost in the middle, it is almost the same. We decided that if there should be a support, it should be a column standing in the middle where the entrance is supposed to be. Here it could be seen by the visitors better, as a part of the structure – a big part.

It is now interesting if the stresses and deformations can be even more decreased than with only two supports. The supports here will all be roller supports, and therefore it will be compared with the two roller supported model. First it is analyzed with an even and uneven thickness.

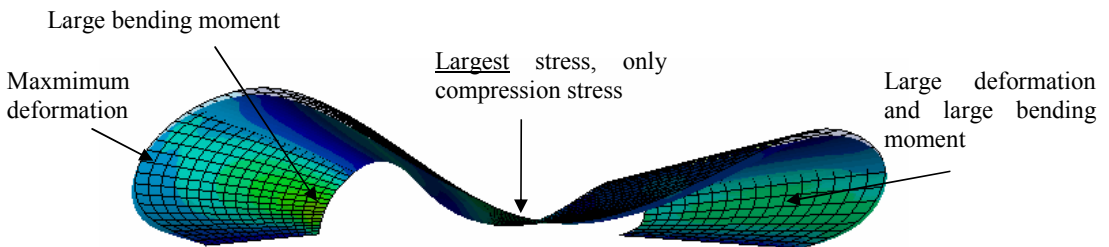

Figure 3: The figure shows Von Mises stress and deformation. The form with grids is before loading and the coloured is after. The green/yellow/red areas show large stress (red being the largest).

The maximum deformation is no longer in the middle because it is now supported there. The maximum deformation is now situated in the curves. When the mass is pushing curves down it is also pushing them out, and this is where the deflection is largest. The deflection is now horizontal instead of vertical.

The largest bending moments are still situated in the curves. They are though not as large as without the middle support. Because the support is roller supports, the balance between the two curves' stresses is the same as for the two roller supported model. This means that the large curve should be thicker than the small.

Before have the supports always been subjected to the largest stress. It is the same in this case, but the largest stresses are now situated in the middle. The middle support can be seen as a point-load from underneath. Point-loads always give a lot of local stress. Because the load from above is so large, the stressed area here almost only contains of compression stress. The area above the middle support has to be extremely thickened locally. To make the local stress less local, the column could be made a lot larger in the ends than in the middle. This would also make the column look more like a part of the shell, than an own small pillar in the middle of everything.

The different thicknesses after partitioning are shown below.

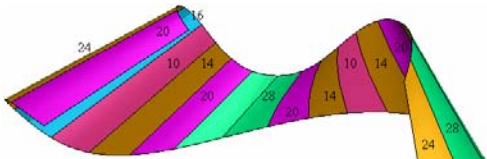

Thicknesses in dm for the moderated model. Seen from below.



The resulting building.



The moderated thickness for the roller supported building with a column in the middle.

The deformation has been reduced with 15%. The reason for the deformation not being decreased so much is probably because it is not especially large from the start. Therefore it is not that important.

In the figure which shows compression the large compression stress is not shown because it is situated in the bottom of the shell. The small yellow spot, in the middle of the model with the even thickness, is the tension which comes from the large stress from underneath. This can not be seen in the uneven model. This means that the point stress is lowered. The node which is controlled is not that interesting here. The stress in that node has increased, but it can mean that the stress has more evened out in the middle area, around the support.

The stress in the curves has decreased with 40% in the large curve respectively 25% in the small. The stress balance is now more evened out than before the moderation.

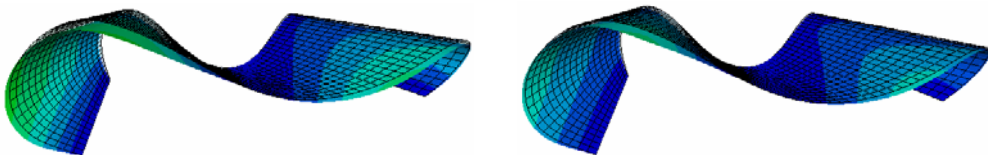

Here is the before (0.18m) and after (0.15m) picture of the deformation. The scale is the same in both pictures. Seen from the side.

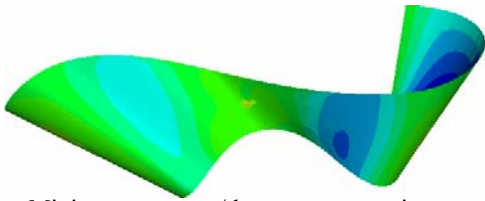

Minimum stresses / largest compression stresses are shown. Node (8MPa/14MPa) chosen in the middle part is marked. Seen from above.

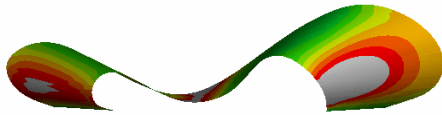
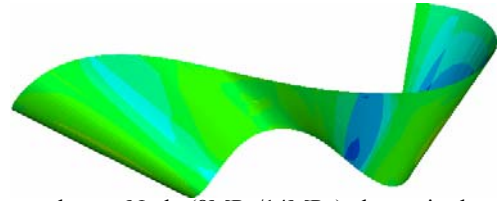

Maximum stresses / largest tension stresses are shown. Node (29MPa/18MPa) chosen for the large curve marked. Seen from the side, angled on the large curve.

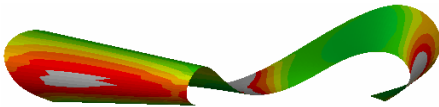

Maximum stresses / largest tension stresses are shown. Node (13MPa/10MPa) chosen for the small curve is marked. Seen from the side, angled on the small curve.

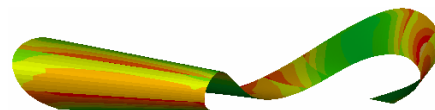

Also this model's stress and deformation could be decreased and equalized, without increasing the mass.

4.1.6 Building supported by glass walls and cables

The fourth way in supporting the museum that is discussed in this thesis is all around the edges. This way became interesting when we started thinking of the glass walls as supports. The windows them self could not hold the heavy building, but maybe as larger glass columns. Glass is very strong in compression and tension, but it is also very easily broken. It should not be subjected to bending, and that is why it is hard to build in. But in our building the glass columns could not hold the building by itself. This is because of the bending situation, but also because the angles in the form. The student of architecture wants to have the glass windows standing as shown in the picture. But the force from the shell and the columns will then, in some places, be in a 90 (or more) degree angle to each other.

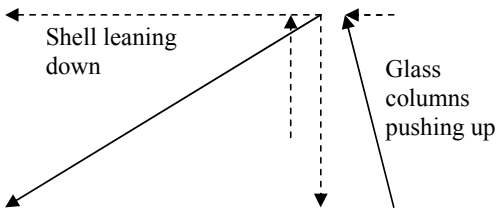
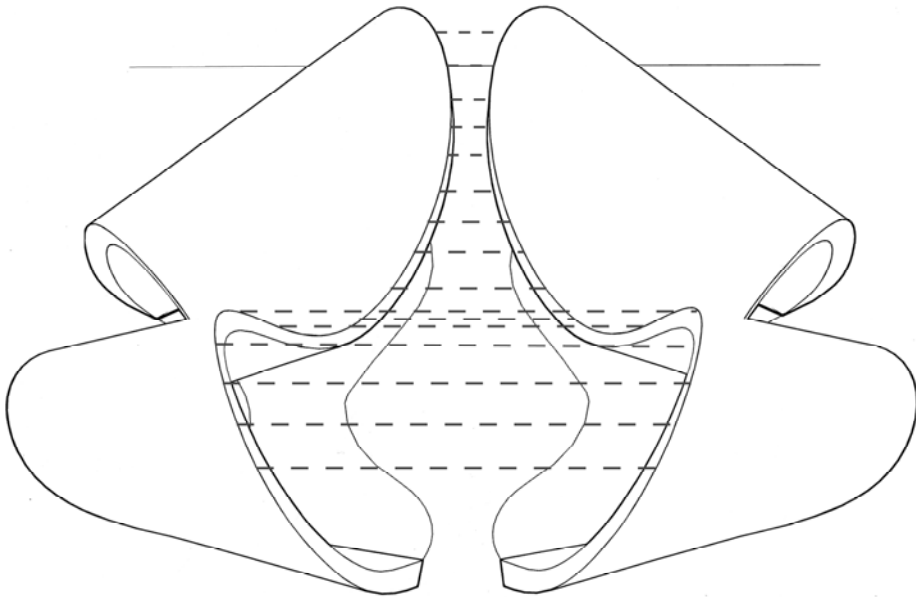

The vertical forces are working as they should, the glass columns are pushing the shell up when it wants to fall down. However the horizontal forces do not have any reaction force, they both drag to the left. For the structure to work there has to be other forces which will take care of the loads.

One way of handling this problem would be to put cables between the two buildings. The buildings are placed beside each other with the falling side outwards. When the buildings are placed like this, they can then with some kind of connection be used as counterweights to each other. The reason they can be used as this is that they have the same weight and are exactly equal. The cables can be used as the connection because they will only be subjected to tension. How big they have to be depends on the weight of the buildings. The forces will then look like below.

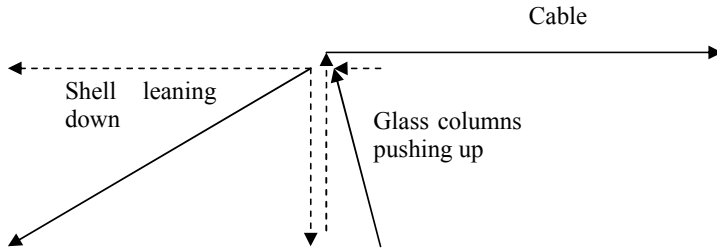

The size of the columns and the cables depends on the amount of the columns and the angle between the shell and the columns. An example of the amount of columns is done. In Abaqus the shell is given supports in an amount of nodes in the edges. The first three degrees of freedom in these nodes are set to zero, which means that the columns will be roller supported. After simulation in Abaqus, the reaction forces in the nodes can be viewed. These forces are the ones that the cable and the column should handle.



The arrows show the size and direction of the reaction forces.

A simple hand calculation (appendix E) is made on the reaction force that has been marked in the picture above. The size of the columns and the cables, also depends on the wind and the own weight. This has not been considered in the calculations. The calculations were made only to see if it at all is possible, and it attends to be. The dimensioning factor is the buckling phenomenon. But it can be handled with some kind of reinforcements along the length of the columns. The thinner the architect wants the columns, the more reinforcements there have to be. The balance would be decided between the amount of columns and cables, the size of the columns and the amount of horizontal reinforcements.

The architect thinks that it would look best with a lot of thin, long columns, because it would get the feeling of a large wall of glass – a gigantic window. But on the same time he does not like the idea of having many cables flying from one building to the other.

Now the building itself will be analyzed with this kind of support system. This model will have more in common with a plate than a beam. A beam is supported in its ends and has a about the same size in height and width. The plate can be supported on all its sides, and it has about the same size in width

and length, but the height is very small in comparison. Because our building has this strange form, it can not be decided if it is a beam or a plate just by looking at it. However from how it is supported and loaded, it can be compared to either a beam or a plate.

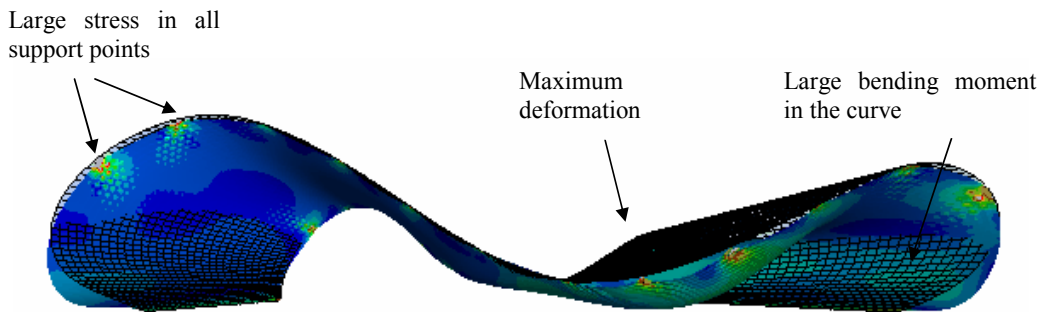

The figure shows Von Mises stress and deformation. The form with grids is before loading and the coloured is after. The green/yellow/red areas show large stress (red being the largest).

If it supported like this in all edges, it will not have as large a deformation as if it is supported as a beam. The largest deformation will happen where there is the largest 'loose' area. It is also here where the highest stresses will be, besides the stresses around the supports. The highest stresses will not, as in the other support cases, happen in the curves. This is because there are not as high a load there now. The load is spread out on more supports, which hold the building up from above the curves.

To make a more efficient model it would be most logic to decrease the mass in the area with the highest deflection and increase the mass in areas with large stresses, as done in the other cases. That would mean that the shell should be thinner in the area to the right of the middle if you look in the picture above. The place in the right curve, where the stress is large will be thickened.

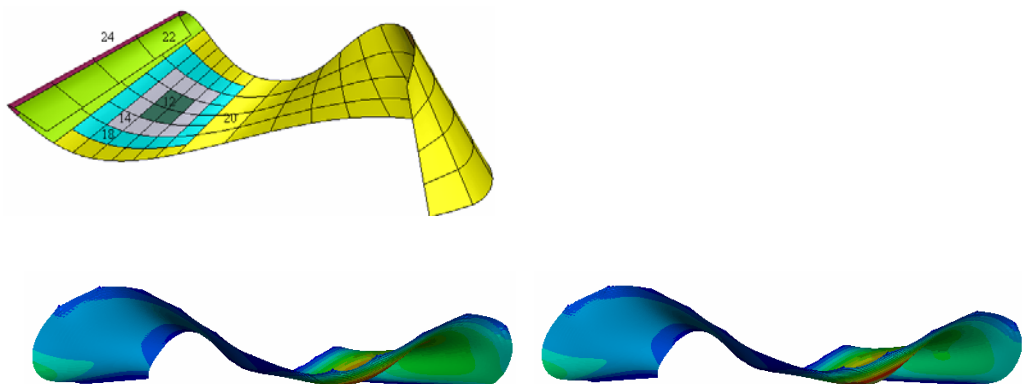

Here is the before (0.008m) and after (0.010m) picture of the deformation. Seen from the side.

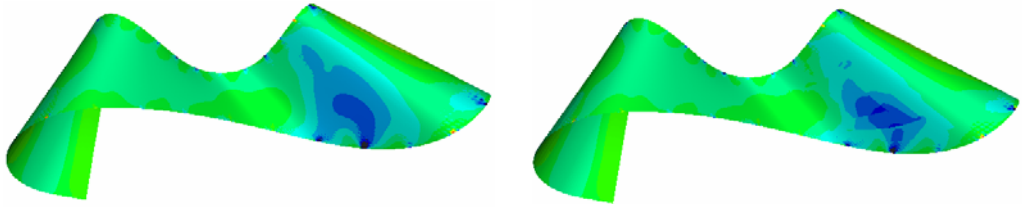

Before and after picture of the compression stress/minimum stress.

This time the model did not get more efficient. The stress is almost the same as before, and the deformation has even increased a little bit. This probably means that the form can not be better in any meaningful way. The form is as it should be, if the material is homogenous.

This kind of support and loading case is very much like the educatorium at the University of Utrecht. So if you would like to make the building even better the material should be divided into two, one which took mostly compression and one which handled tension. The distance between them would decide the thickness of the shell. The longer distance, the higher strength.

4.1.7 Comparing the different ways in supporting a building

We will now compare these different supporting systems.

Support system	Fixed support	Roller support	Roller support with column	Supported by glass walls
Maximum deformation (m)	0.31	0.43	0.15	0.008
Compression stress in middle (MPa)	3	13	14	0.3
Tension stress in large curve (MPa)	21	20	18	3.4
Tension stress in small curve (MPa)	14	17	10	1.2
Maximum compression (MPa)	86	36	27	17
Maximum tension (MPa)	53	42	25	32



The resulting building.

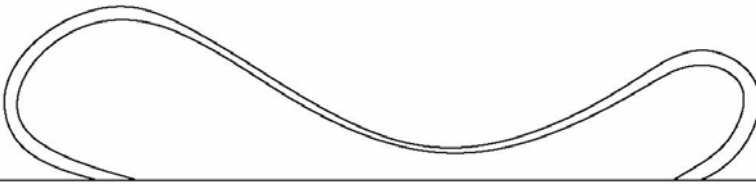

The moderated thickness for the fixed supported building.

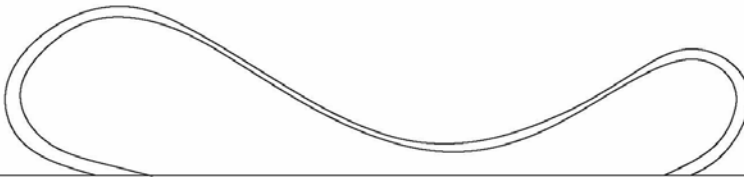

The moderated thickness for the roller supported building.

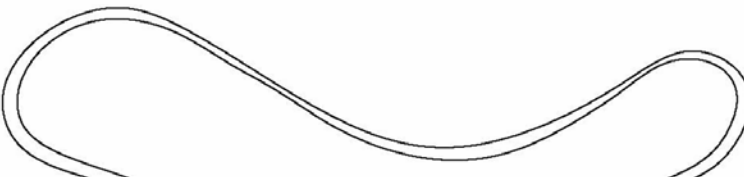

The moderated thickness for the roller supported building with a column in the middle.

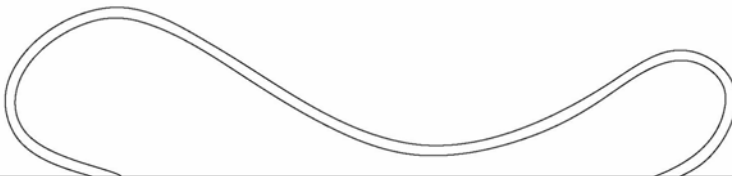

The moderated thickness for the building supported by glass walls and cables.

The one with the lowest stresses and deformation is without surprise, the one with the supports all around the edges of the shell. So if it was not for the cables which will fly between the buildings, it would be the best solution architectonic. According to the architect, the cables are in the way of the building. It feels like some kind of bandage, a thing that just has to be there if the building should be able to function. On the other hand could the shell be even thinner than it is now. The question is just how thin it has to be. In the pictures above the shell does already look quite thin. So the architect does not like this solution.

The one with lowest stresses and deformation of the other three support systems is the roller supported building with a column in the middle. The column could be designed as a part of the shell, like the shell would touch the ground in three places instead of two. The architect however feels that it would ruin the clean form and destroy some of the challenge.

Then there are two supporting systems left, either roller supported or fixed supported. The maximum stresses are a lot larger in the case with fixed support, but as said before this is in the support edges and these are larger in the real model than in the Abaqus shell model. The stresses are then not as large as they seem. The stresses in the curves are almost equal in both systems, so those do not matter. The stress in the middle and the deformation are smaller in the fixed supported model. In structural engineers' eyes, the fixed supported shell would be the best. However it is harder to build such supports, which means that in the constructors' eyes, the roller supported building is better.

Also the expressions of the buildings are different. The fixed supported shell is thinner in the middle than the roller supported. With a thin middle the building shows an impression of a large lifting base (the curves) with a small elegant load. The total building looks stronger, when the base is thicker and more robust.

The thickest curve is shifted from one side to the other depending on which support it has. The fixed model is thicker in the small curve, and the other way around in the roller model. For this we do not have an answer. The reason is possibly the difference in the size of curves, which amongst other matters is a difference in mass. Also the angle of how the building's ends meet the ground. The support areas are different in angles (both vertical and horizontal), length and width, which makes it even more complicated. In total it can be very hard to analyze an asymmetric and twisting building in a way that is correct and just not believes.

We chose a building to continue to analyze in other ways. The fixed model was chosen because of the slender expression in the middle, and because it does not have any crouches in the form, such as columns or cables.

4.2 Better material efficiency with lower density

4.2.1 Concrete shell with holes

From previous chapters it has been understood that the dead weight plays a huge role in the form of an effective building. Concrete has a large weight in its solid form, so now we would like to try to make it lighter and even more effective by making holes in the shell.

The holes can be placed in many different ways, and the form may change depending on where the holes will be situated. In this chapter we will examine a few variations of this and discuss it. It will

mostly be discussed after how effective in material the varied situations will be, but also in an architectural way.

Before testing our building in Abaqus, we will examine how a general beam reacts in different hole variations. Then the building will be discussed around three situations. With the same amount of mass these three will be compared in deformation and Von Mises stress.

4.2.2 A general beam

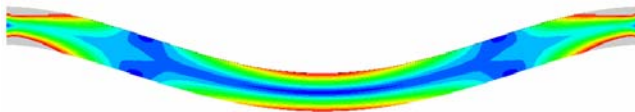

Solid beam without holes. Von Mises stress (bottom middle: 9.8MPa; max: 21.1MPa; max. deformation: 0.071m)

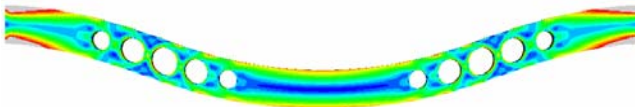

Beam with holes in areas with low stress. Von Mises stress (bottom middle: 8.5MPa; max: 18.6MPa; max. deformation: 0.067m)

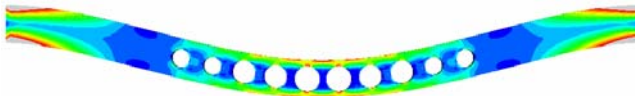

Beam with holes in areas with high deformation. Von Mises stress (bottom middle: 9.7MPa; max: 18.0MPa; max. deformation: 0.058m)

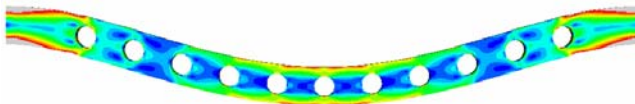

Beam with holes through whole model. Von Mises stress (bottom middle: 8.7MPa; max: 21.2MPa; max. deformation: 0.064m)

As done in some of the previous chapters, here is also first made some tests on a normal beam. A solid beam is compared to three beams with holes situated in different ways. The holes are tried to be situated after how the beam reacts on its dead load. One of the beams has holes placed in the areas that have the least stress. The other is considering the moments as they were placed in chapter 2. The biggest holes are then placed in the middle, and smaller holes close to the supports. The third has its holes evenly over the whole length.

The pictures all have the same scale both deformation wise and in the colour that shows the Von Mises stress.

The first picture shows the solid beam. The largest stresses are located in the supports which is normal for a fixed supported beam. Large stress is also in the middle where the bending is in its maximum phase. The stresses between these three places are almost none.

Where there is almost no stress it is the easiest and most natural part to place the holes. This is what is done in the second picture. Because of the small stress, it does not need as large a cross section here,

and therefore can the holes be put here. The result shows a better balance of stress in the whole beam. The stress has decreased with 13% in the middle, and the maximum deformation with 5%.

The third picture shows the results as if the holes were placed in the middle. As can be seen the beam will be even more unbalanced than it were without the holes. This is not what is wanted from this project. What is wanted is a better material efficiency, which means that the material should be, as much as possible, in the same stress over the whole body. This should even out the stress, which logically should lead to a lower maximum stress. But in this case the stress is actually lowered without balancing it. The decreasing of material in the middle gives the beam a smaller deformation. It is decreased with 18%. This means that the bending stress is lowered. It has decreased with 2% in the middle. This is not a lot, but this beam is still much more efficient material wise than the solid beam, because it has decreased in material without increasing in stress.

The last picture shows how a beam reacts if the whole form is lowered in density. The balance in stress has not changed at all, but the total stress has decreased. This is because the beam still has the same density along the whole form, but it is lowered and when the weight is lowered the stresses are of course lowered as well.

All the three beams with holes have decreased their masses with 15%.

These three different ways in decreasing the density, shows different results. The reason to choose the one over another depends on the expression you want. In the first picture you keep the thickness of the beam, and balance the stresses through placing the holes after where the stresses are highest. In the second you make the beam even more unbalanced, which in form could mean that you want an even more unbalanced thickness. And the last picture shows a way between the two others.

4.2.3 How to make calculations with holes

From this analyze it is understood that the holes in the Art Museum shell could be placed in two areas, or both, which means in the area with low stress and/or in the area with high deformation (downwards).

Three tests will be made here.

- A model with holes through the whole body
- A model with holes only in the areas with low stress
- A model with holes only in the areas with high deformation

In Abaqus, the building is built like a shell and not a solid, as the beam. This means that there can not be placed holes in the shell as in the beam. There is a function of different layers that can be made. As discussed before the model is being partitioned, and the parts are getting thicknesses. These different parts are now also being given different layers. The inner layer will be the one with the holes. Instead of making direct holes, the material in this layer is made with a lower density. Also there has to be considered the other material properties. A layer with holes is of course not as strong as a layer without holes. The material properties can be found as shown below.

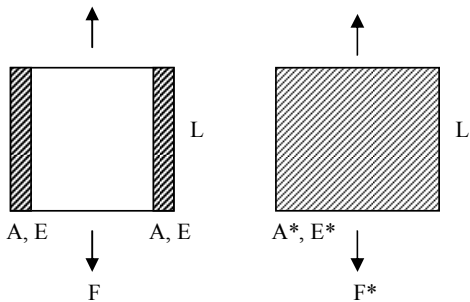

These two drawings are supposed to show the transformation from a material with holes to a material without holes. When the material is made without holes it is given a lower density.

$$\rho^* = \frac{\rho}{5}$$

$$A^* = 5A$$

$$k = \frac{EA}{L} \left\{ k^* = \frac{E^* A^*}{L} = \frac{E \cdot 5A}{L} = \frac{EA}{L} \right.$$

$$E^* = \frac{E}{5} \left. \right\}$$

$$k^* = k$$

$$F = k \cdot \Delta u$$

$$F^* = k^* \cdot \Delta u^* \left\{ \Delta u^* = \Delta u \right.$$

$$F = F^* \left. \right\}$$

$$\sigma = \frac{F}{A}$$

$$\sigma^* = \frac{F^*}{A^*} = \frac{F}{5A} \left\{ \sigma = 5\sigma^* \right.$$

ρ : density

A: area of material (without holes)

E: module of elasticity

L: length

F: force

σ : stress

k: constant

Δu : difference in tension

In the forms to the left it is shown how the other material properties change, or which properties that change and which are the same. The density and the module of elasticity are the properties that will have a lower input value in the FE-program. In the results, you have to increase the stress with the same amount that you decreased the density before the calculations (5 is an example number).

4.2.4 A model with holes only in the areas with low stress

To understand where the holes should be situated the model is analyzed without holes.

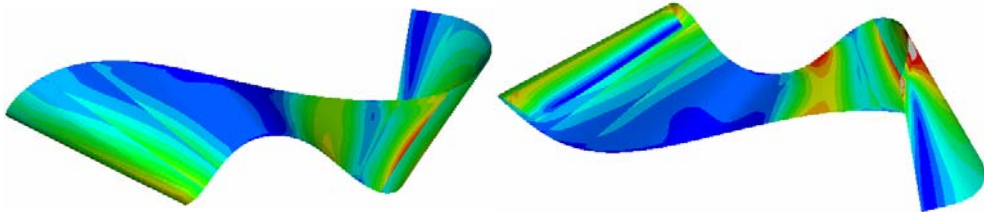

FE-model without holes. Von Mises stress (large curve: 21MPa; small curve: 14MPa; middle: 2.6MPa; hole area: 1.9MPa). To the left seen from above and to the right seen from below.

In the pictures above the blue colour show the lowest stress. The lowest stress is in the middle and a little bit to the side, and also close to the supports. Here are the holes placed.

The density is assumed to be 25% in the layer where the holes are. In Abaqus both the density and the module of elasticity is put to 25% of the real number.

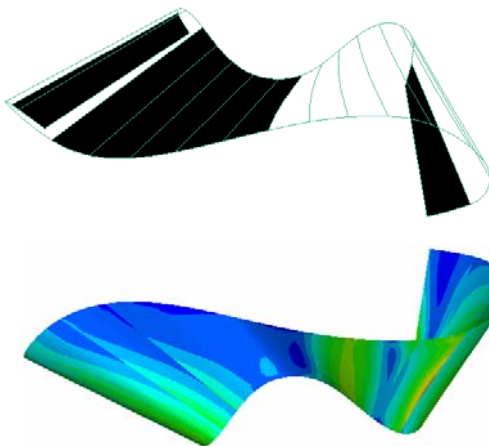

The black areas show the location of the holes.

FE-model with holes. Von Mises stress (large curve: 19MPa; small curve: 10MPa; middle: 1.4MPa; hole area: 3.1MPa). To the left seen from above and to the right seen from below.

The before and after model are compared in three nodes, in the middle and in the two curves. The locations of the nodes are the same as in chapter 4.1. The stress in the middle has almost been halved, and in the curves it has decreased with 10% in the large, respectively 25% in the small one. None of these nodes are in the areas with the holes. Another node is picked to compare the models in this area as well. The stress here has increased with 60%. The stress is being more balanced over the whole body, like in the tests with the regular beam. This is very positive; the mass has decreased with 10% and in the same time has the stress variation been more balanced and the deformation has decreased with 20% (from 0.31m to 0.25m).

In architectural understandings this means that the model could be made even thinner in the middle and also in the curves but not as much. If the model would react in thickness on the stress variations we have found with the hole making, it would be even more uneven. The curves would look even thicker than before compared to the middle.

4.2.5 A model with holes only in the areas with high deformation

A deformation diagram of the model without holes shows the extreme spots.

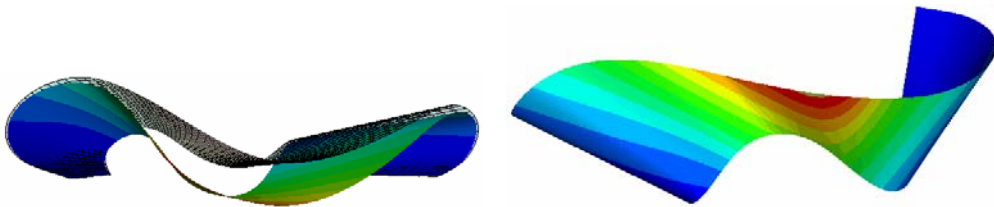

Deformation (max: 0.31m). Without holes. To the left a before/after picture seen from between the buildings. To the right a deformation diagram (red = largest deformation) seen from above.

From the pictures it can be read that the holes should be placed in the middle, and a little bit to the side. This may sound recognisable. The same words were written in the case where the holes should be situated in the areas with low stress. But if you compare the previous page about that case with this case you will see that “the little bit to the side”-part is not about the same side. In this case the holes will be placed on the opposite side of the middle.

The reason for that the maximum deflection is right there, is the complex form. It is twisting and turning on the same time. In the left picture above you may also see a little bend in the middle. This is also a reflection of the form that is so hard to understand. This bend may come from a difference in load, which is a reflection of the form’s difference in width along the length.

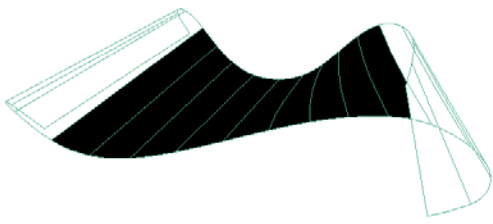

The black areas show the location of the holes.

The largest holes, percent wise, will be placed in the area with the highest deformation.

The deformation has decreased with 40%, which is double the percentage in comparison to the model with the holes in the areas with the lowest stress.

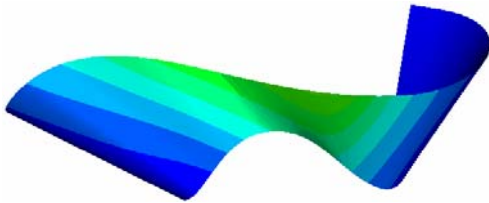

Deformation (max: 0.18) with the same scale as the before picture from above. With holes. Seen from above.

The reaction from a lower deformation is that there almost always turns out to be lower stresses as well. The same nodes as before are compared in stress variation. The stress in the curves has both decreased with 30% (large: from 21MPa to 15MPa; small: from 14MPa to 9MPa), and in the middle with 20% (from 2.6MPa to 2.1MPa).

The mass has on the same time decreased with 10%.

The architectural views would here be the opposite of the former model. The curves could be thinned out more than the middle. The balance of the thickness could then be better. But the question is if that is what the architect wants?

4.2.6 A model with holes balanced over the whole body

If a model is made with holes over the whole body, it would be the same as decreasing the density of the material. If the holes not are that large that the highest stress will be in the holes instead of on the outside of the shell, the holes will not make a difference in stress variation. The mass will be less, which is very efficient material wise. The stress and deformation will decrease over all, just as the beam from above.

The art museum is different from the beam in many ways and something that is a conflict in this situation, is the thickness variation. Because the form is taken from the former case where the difference in thickness was found, it is not even which the beam is. The size of the layers with holes is made percentage wise.

Total thickness (m)	Hole layer (m)
1	0.2
1.4	0.28
2	0.4
2.2	0.44
2.4	0.48
2.6	0.52
3	0.6

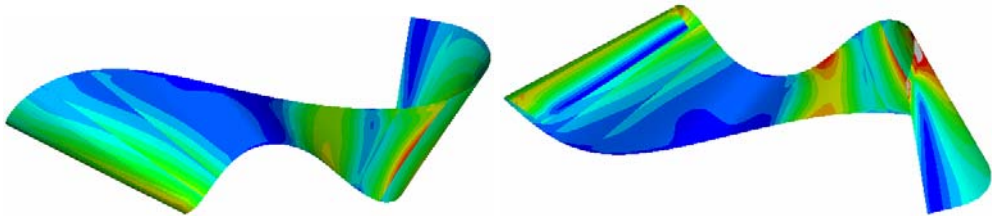

FE-model without holes. Von Mises stress (large curve: 21MPa; small curve: 14MPa; middle: 2.6MPa). To the left seen from above and to the right seen from below.

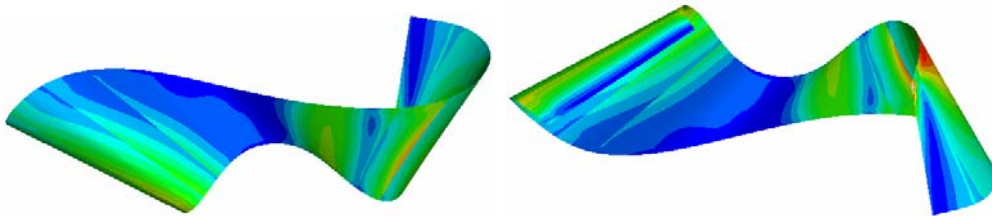

FE-model with holes. Von Mises stress (large curve: 19MPa; small curve: 13MPa; middle: 2.3MPa). To the left seen from above and to the right seen from below.

Three points have been compared in the before and after holes pictures considering stress. These three points have all decreased with the same percentage of stress, which concurs the discussion above. The deformation has also decreased with the same percentage (from 0.31m to 0.28m).

4.2.7 Comparing the three different ways in making holes in the building

	Before	Holes considering stress	Holes considering deformation	Holes even in total area
Deformation (m)	0.31	0.25	0.18	0.28
Stress in large curve (MPa)	21	19	15	19
Stress in small curve (MPa)	14	10	9	13
Stress in middle (MPa)	2.6	1.4	2.1	2.3

In the table above you can see an abstract of the results of this chapter. The conclusions you can make from this is that the most effective way in making holes is the one where you consider the deformation. This is not the same results as for the regular beam. The difference is probably dependable on the comparison between a regular form and a complex form. The enormous weight can also be a factor.

Because it is the variation after the deformation that is the most effective, you can begin to think about how the form of the building looks. The deformation is happening in the middle where the form from the start is deformed. The bow that is hanging down, we believe is a large factor in the result. Because it is hanging down already from the start it has more weight there, than if it was straight. This means that if the weight is decreased, it decreases more in percentage than if it was a straight line.

Another factor that could have made the model considering stress less effective may be that the model was varied in thickness. This had made the difference in stress smaller, and the holes would not make as big a difference as if the model from the start was even. Here the architect could say, that he wanted an even thickness of the form, and then the stress balancing could be done like this. Because our project is about showing the force play, we do not want to disguise it in holes, which people can not see.

Another way of making holes could be as windows through the thickness. These could be placed where the stresses are small and be used as extra lightings. But this was not of interest to the architect, because he wanted a clean form. Also the windows in the sides give more than enough light from outside.

4.3 Different forms with different materials

4.3.1 Concrete shell or steel frame

The moderated, in thickness and in density (with holes), shell from previous chapters is now given material properties. In this chapter the results will show if the museum at all will hold. This does not mean that the building could be built, but it is more a way to establish that this form is doable.

Different materials can give the building different forms, depending on the weight and strength of the building. We have chosen to compare the two materials concrete and steel. Steel weighs a lot more than concrete, but because of its high strength it can be made as a frame and still, with a very low dead weight, make the structure stand up. How this effects the form giving in our museum will be discussed in this chapter.

4.3.2 A general beam

As before, the discussion starts with an analysis of a normal beam. The difference in this case will be the loads. As said, the two materials have different densities, and different strength. A concrete shell as big as the one for our building, normally weighs that much in comparison to the outer loads, such as snow weight, that they can be ignored. The dead weight is then the only load, the structure has. The expression of this load then depends on how the building looks. Where the most mass is placed, is also where the loads is the largest. The load will not be an even load. The steel frame however, does not have a large dead weight because of the density of the frame. The outer loads will then have a larger effect on the structure. In this case the loads will be the snow weight and the wind. These loads are the same all over the building, and this structure will then have a much more even load than the concrete shell.

To show the difference between an even and an uneven load, the beams have been analyzed again. Only the beam with fixed support is considered, because this is the support case we have chosen for our building.

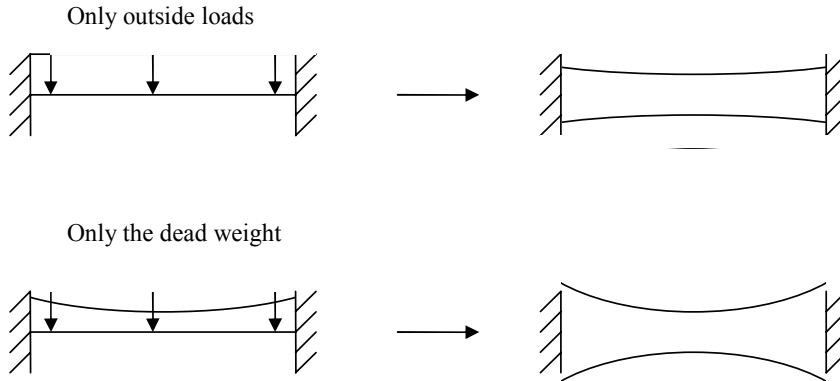

The top picture shows a beam with an even load. Its ultimate form is, as also shown in former chapters, a bit more slender in the middle than in the ends. If you then take this form and only submit it to its own weight, it would look like the bottom load case. That load case would give an even larger relation between the height of the ends and the height in the middle. The larger load in the ends compared to the middle, the larger relation in height.

4.3.3 Concrete shell with reinforcement

A reinforced concrete with the properties shown in table below was chosen.

Material	Concrete K60	Steel B500B
Density	2400 kg/m ³	7800 kg/m ³
Module of elasticity	36 GPa	
Poisson's ratio	0.2	
Security class	3	
Tension strength	1.39 MPa	362 MPa
Compression strength	23.6 MPa	

In reinforced concrete it is the concrete that will hold the compression and the steel reinforcement that will handle the tension stresses. First the model is tested in compression. The model from the former chapter will hold in compression, all over but one place. The one place is where the support will be situated. This can be ignored because the ends will not really be as they are modelled in Abaqus, they will have a larger cross section.

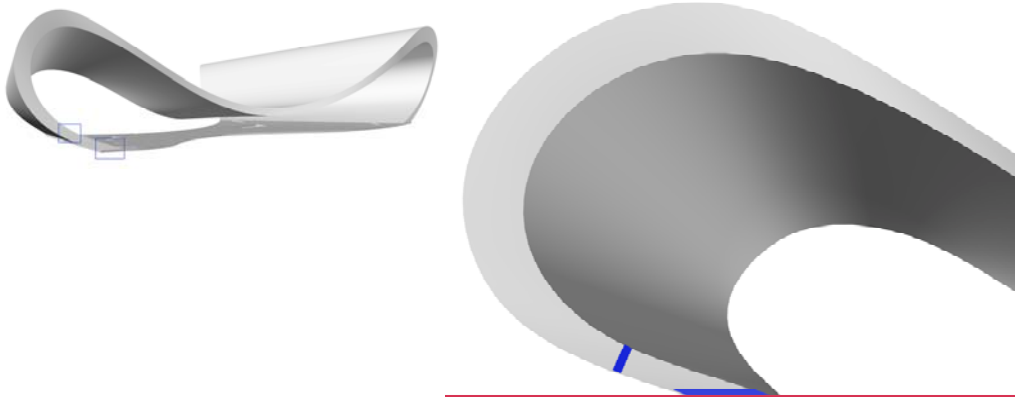

The blue colour show that the edge that meet the ground is larger than the thickness of the shell.

When the compression is handled the next step is to take care of the tension in the building. The tension areas, which can not be handled by the concrete, are reinforced with steel bars. An approximate calculation is done in appendix D.

A FEM-diagram is made to view the areas which can not be handled by the concrete.

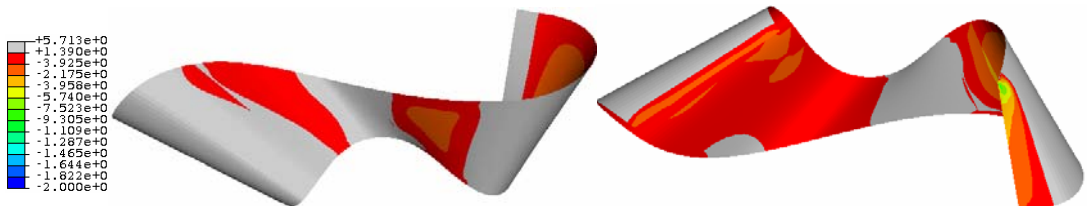

The grey areas above show which areas that the concrete can not handle in tension. In these areas the reinforcement will be placed.

There are huge areas that have to be reinforced. All these do not need the same amount of reinforcement, but to do this simple we assume that they do.

A new simulation was made with snow loading and the weight from the reinforcement, but as thought it did not make any big difference. This means that the building could have the same thickness and form with reinforcements, as long as there is enough room for them. Here lies the problem. The thinnest area with holes only has 20mm for the reinforcement, but four layers of bars will need 45mm. The holes in this area are made smaller, but it still does not matter for the form.

4.3.4 Steel frame

In the same way as for the concrete shell, the properties are decided first.

The material properties will be handled as in the chapter with holes. The steel frame, you could say, is made of holes. There will be three layers in the shell, which each represent a different amount of holes in the frame. The outer layers should be stronger because of the stress variation over the thickness. To make those stronger they have to have more mass. This gives them a higher density and a higher module of elasticity. The outer layers are chosen to have a mass of 1%, and the inner layers are given a mass of 3‰.

Material	Outer layer	Inner layer
Density	78 kg/m ³	23.4 kg/m ³
Module of elasticity	2.1 GPa	0.63 GPa
Poisson's ratio	0.3	0.3
Strength	280 MPa	280 MPa

Because this is not a homogenous shell, the results from former chapters can not be used. It has to be analyzed from the start. So the first model that is done, to understand how this material and load case would work, is made with a thickness of 2 meters.

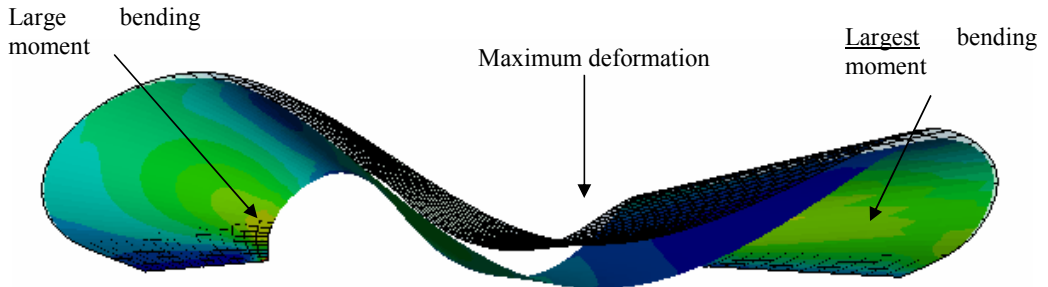

The figure shows Von Mises stress and deformation. The form with grids is before loading and the coloured is after. The green/yellow/red areas show large stress (red being the largest).

In the same way as for the concrete shell the largest bending moments are situated in the curves and the maximum deformation is placed in the middle.

Another model is made with uneven thickness, moderated like showed below.

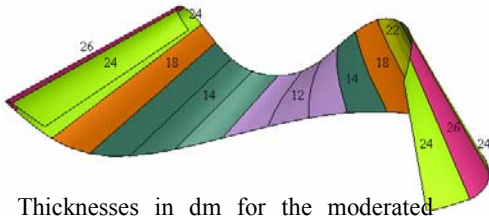

Thicknesses in dm for the moderated model. Seen from below.



The resulting building.



The moderated thickness for the model with steel frame.

As in the case with a homogenous shell the thinnest part will be almost in the middle. There is a small difference in stress between the two curves. This depends, as explained in previous chapters, on the support system. The difference is however so small that it will not be considered when moderating the thickness. In the curves are situated the largest bending stresses, and therefore are they being thickened.

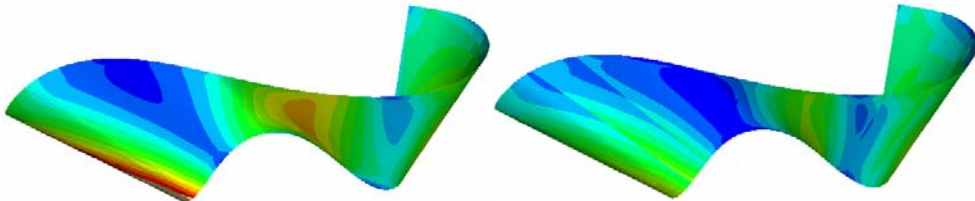

FE-model of steel frame seen from above. Before and after picture of the Von Mises stress. Maximum stress before is 420 MPa and after is 270MPa.

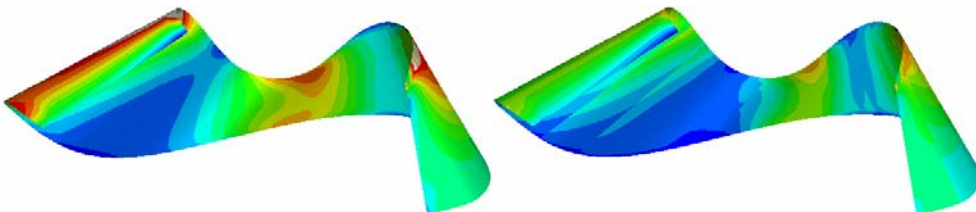

FE-model of steel frame seen from underneath. Before and after picture of the Von Mises stress.

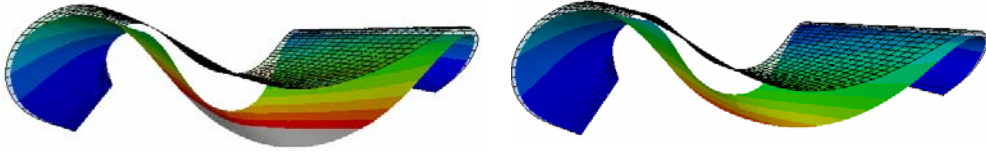

FE-model of steel frame seen from the side. Before and after picture of the deformation. Maximum deformation before is 0.99m and after is 0.72m.

The stress was reduced with 35%, and the deformation with 30%.

The largeness of the deformation (almost 1m) can be considered very bad. Some of the deformation can however be handled in the production of the building. The deflection, which only depends on the dead weight of the form, can be calculated. The building will then be built higher than it is supposed to be, and afterwards when it is deformed it will have the real form. This could make a great deal. Then we actually have to find out how large the deformation from outside loads is, to find it interesting and important to consider.

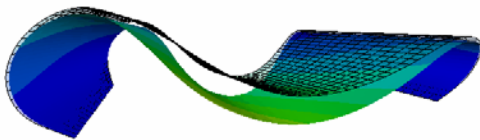

FE-model with steel frame seen from the side. Deformation (0.55m) from only outside loads

Another model is made with the moderated thickness, but only with the outside load snow. The deformation is still high, 0.55m.

If we only look at the stress-size which is calculated from Abaqus, the steel frame would work. But there has to be considered other aspects.

The large thickness forces the trusses in the frame to be very long, which is no problem in tension. But in compression the risk of the steel cracking could be extremely large. The trusses may have to be thicker which will make the density higher and the dead load heavier. This would make the stress larger and the evil circle is made. Here we have not made any more calculations, just established the fact, that there is a risk with this.

The other aspect is as discussed above, the deformation. A half meter deflection may not seem large in a gigantic building like ours, but the factor which is making it important is the walls of glass underneath. The architect wants to put large glass walls on both side of the form, so that it would be transparent. These walls can not handle the large deformations on their own. One attempt to handle it could be to put horizontal rubber lines between the glass windows in several places all the way from the ground to the top. This would make them more formable in both tension and compression.

4.3.5 Comparing the two materials

The deformation is more than three times larger in the model with the steel frame than with the concrete shell. Also the deformation in the steel frame can not be dealt with in the production. In the construction of the concrete shell the deformation can be built higher than it is supposed to be and then it will deform into its real shape from the load of its own weight. This is a great advantage for the concrete shell.

The mass for the concrete shell is about 23400ton and for the steel frame 255ton, which means that you would need almost 300 times more cubic meters of concrete than of steel. Here is a large difference, but it is not quite right to compare concrete and steel. Steel is stronger and more expensive, and the two materials do not at all work in the same way.

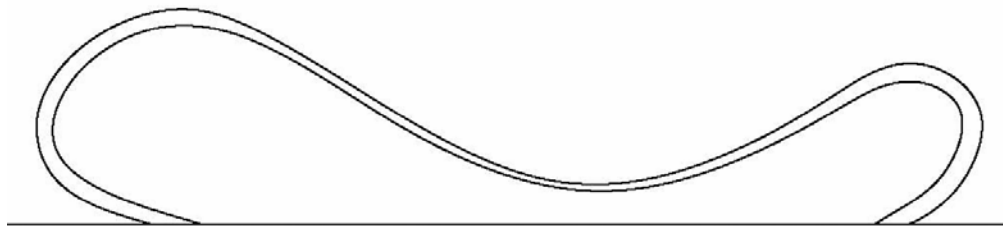

Reinforced concrete shell.

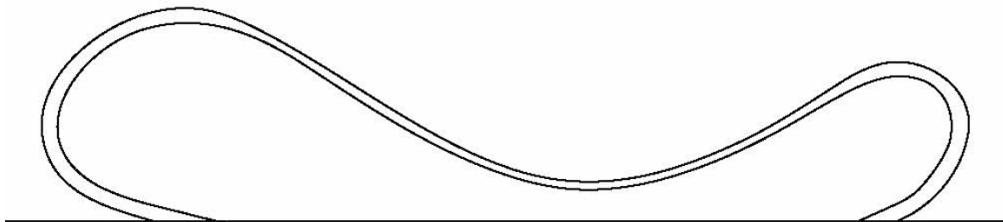

Steel frame.

The shapes which come from using the two different materials are not that different from each other. In the concrete shell the small curve are a little bit thicker than the other. In the steel frame they are both evenly thick. With the concrete model the difference in thickness is higher than in the steel frame. This could be either an advantage or a disadvantage, depending on what expression you want from the building. The steel frame give a more evenly picture of the form in total. The concrete shell however gives a stronger picture of that it is the curves which are carrying the middle section. This makes a lighter impression, which is wanted here. We also think that the structure is better shown in the concrete shell.

4.4 *The wholeness of the building*

As commented on before, this thesis is mostly about formfinding, and therefore it does not go into details about how the building is going to be used. However we decided to discuss two aspects, which were not about the form, but something that made it clearer that our thought was a building.

Because of the round form, it was hard for the architect to make the areas useful without diminishing the experience of the huge volumes of the curves. The idea that came up was to make one or more storeys in the ground underneath the two large buildings. The reason was to use the large volumes for large exhibitions and as concert halls, and make smaller rooms down under. This made it possible to not ruin the feeling of large forms also inside.

Another matter, to turn the forms into a building, was how to make the outer walls.

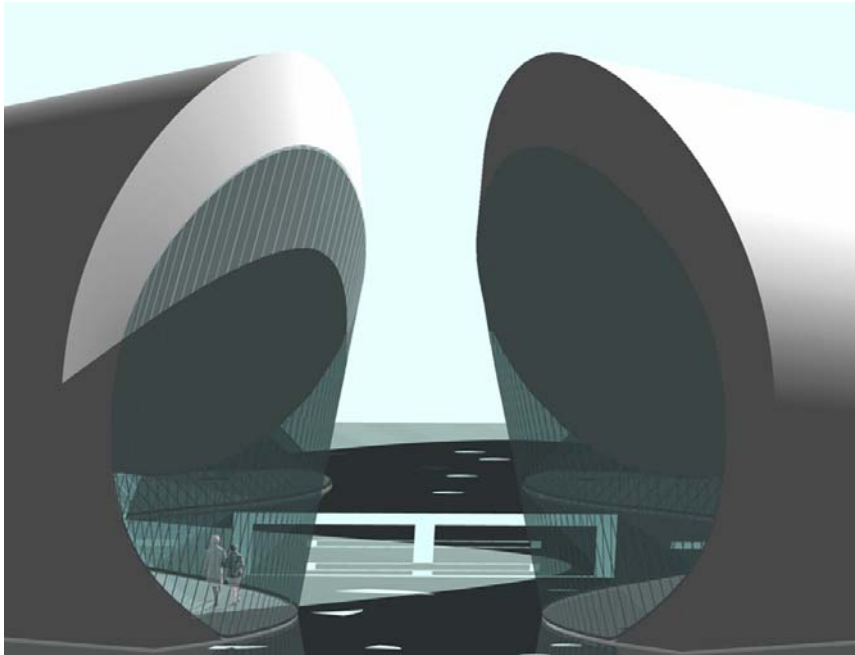

4.4.1 Maze under ground and organic forms above ground

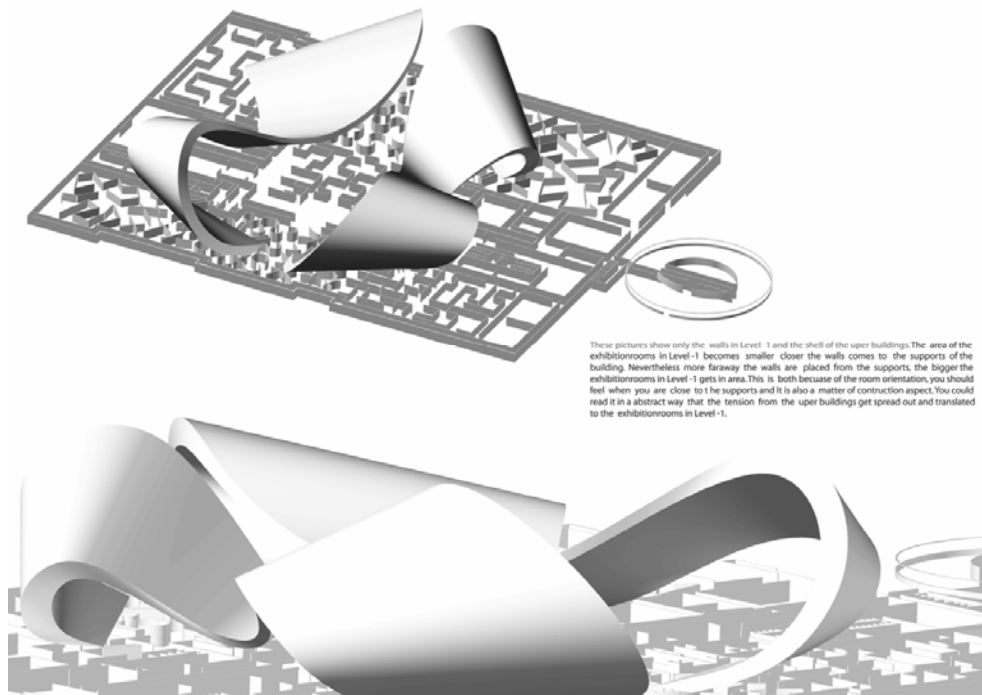

To make the huge organic forms even bigger and more magnificent, the architect wants to make the exhibition halls under ground small and narrow, in some places kind of like a maze. The visitors arrive in the middle and when they move further in the museum, the rooms get smaller and smaller. The walls are supposed to be closest to each other right underneath the supports for the huge organic forms. This indicates some kind of difference in density in the force play. The density is higher where the loads are heavier.

The thickness of the walls and the wideness between them are supposed to be calculated from how large the reaction forces are in each support. But here comes new problem with the programs not being compatible or good enough. As said before the drawing of the building had to be done in Solid Works and then be moved into Abaqus, to make the calculations. But the form used has to be a shell, which means that the exact model which is done in Abaqus is not the real. The real model has been done in Solid Works in cooperation between the engineer and the architect. Both because of this and that the thickness cannot truly be seen, because of the angles, the real model is thicker than the ones in Abaqus. This, along with the holes that cannot be made in Solid Works, makes the calculations of the reaction forces for the real model hard. An approximation has been done to show the idea of the structure of the walls.

From the approximation it is found that the load on the small curves support is about 140MN and in the large curve it is 160MN. The area underneath the large one is smaller than for the small. The large curve will be the dimensioning. The length of the support is about 40m.

Below is shown a table of how the thickness changes with the distance between the walls. In appendix F the calculation is shown.

Distance (m)	1	2	3	4
Thickness (mm)	90	150	260	400

4.4.2 Glass windows with large angles

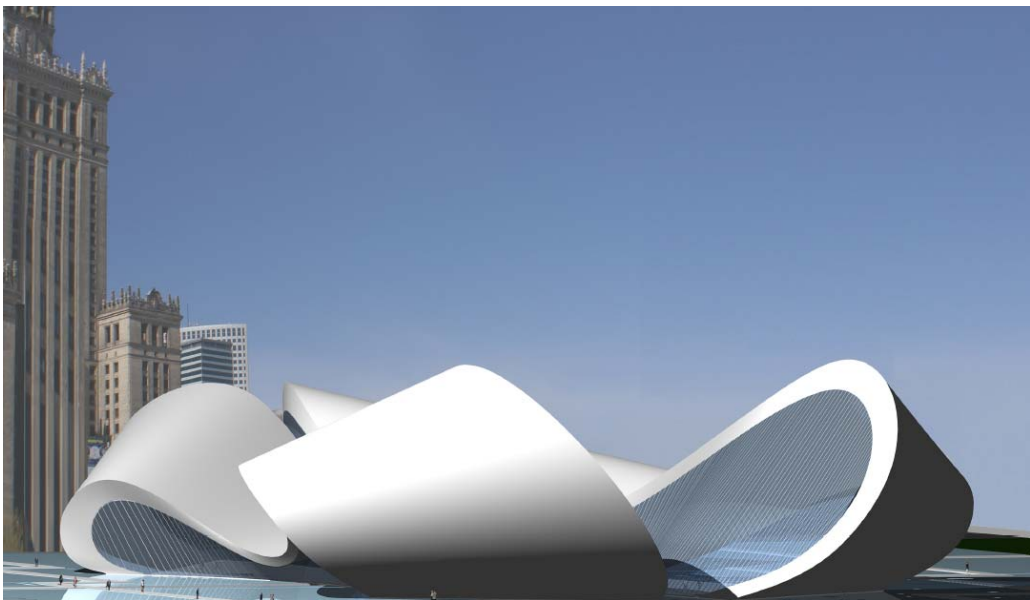

Because of the angle of the windows the glass will be subjected to great bending moments and as said before glass does not have a large bending strength. Wind, the dead weight and sometimes snow will be loads on this precious area. So the glass walls have to be reinforced by something, the most obvious would be steel beams and columns. Then would the steel actually be the carrying part and the glass should only be able to carry itself.

The glass walls could have many different appearances. For an example we have made an easy choice of a grid of steel. The calculation is shown in appendix G.

5 Result

To show the result of our discussions, imaginations and calculations there are a few pictures of the finished 3D-model shown here. To see and understand more about the result of our museum we would like to refer to the booklet that is the other part of this thesis of cooperation.

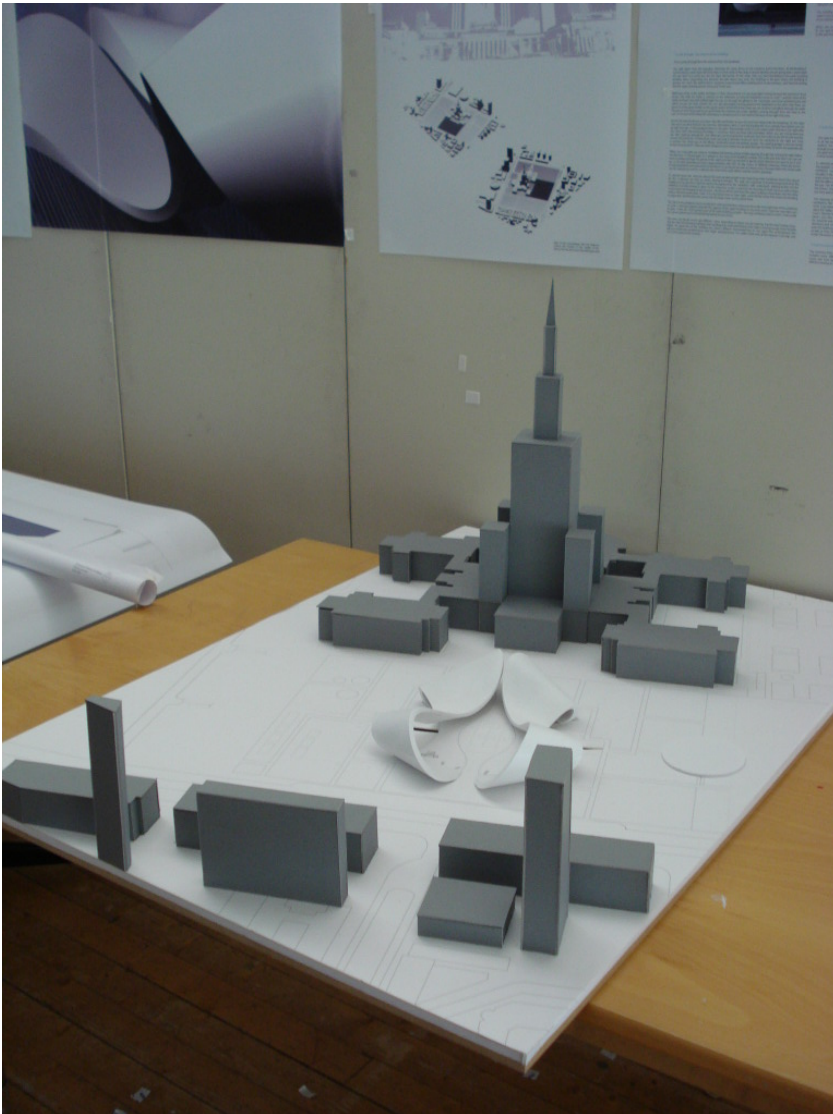

6 Discussion

This may sound easy but it was not at all easy, for us especially because of the lack of time. When the engineer made calculations and simulations in Abaqus, the architect was forced to already be drawing the building as if it had its finished form. Therefore there was not a lot of space for form finding together in the process if the result was supposed to be a building. On the other we found a first form, which we both agreed upon, very quickly. Still this model could have been even more optimized. We feel more that we just planted the idea of more processes like this than creating a model to follow.

This project is kind of a pilot project for the educations, and we would like it to be evaluated as an experiment. Our hope is that other students will continue this idea and work over the borders of the different education and divisions. You learn a lot about cooperation, problem solving, time planning, understanding for the different educations and professions. You also get a more substantial understanding of the teamwork between engineers and architects, and how differently you actually think in certain situations.

In the beginning there were discussions about what the thesis would be about and how we would accomplish that. We both had different views and thoughts, which surely originates in the educations that are very unlike each other. Engineering students are characterized by the rules of physics, and do then often do exactly what they are told. Sometimes they block themselves in thinking only in possible directions and take their point of departure from that view. In opposite to the architectural students who somehow have plans for things that in a matter of fact are impossible. They work with the project and often the result is nothing like the starting point. Architecture is often a matter of opinion, and in the education of architecture you learn to defend your own views. Because this kind of cooperation was new to our school, we had to make the rules ourselves. This was hard with two people with totally different prerequisites.

6.1 *Pros and cons in our project*

The first problem was to get started. As said before we had some difficulties on agreeing in what it would be about.

When we decided to work on the Modern Museum of Art in Warsaw, it was hard to find enough material on the surroundings and the building area. This, you could say, was also a problem in communication. Just this time it was between us and the polish committee of the competition.

All through the process there were confusions about what to do, how to do it and which order to do it. Especially the last aspect was hard. We believe that the normal way, to make an offer to a competition, is to let the architect decide how it should look. Then the engineer will make some calculations of if it will work, and last the architect will make his drawings of the form that they have found together. This is also how we wanted to play it, but with more collaboration. However the time plan would not hold for this and we had to work with each our part on the same time. The engineer had to start calculating before the outer form was ready, and the architect had to start drawing before the calculations were finished and we knew how the building would look. Of course it was meant to be a collaboration process, but it was still a little bit stressful.

Another problem was the computer programs, they were too many. The engineer had to have a program that could make calculations, and the architect wanted a program that could make serious drawings. We then spent a lot of time on exporting and importing the model, after the time we used to find a method to connect the several programs used. The reason that this was harder than it could have been was the round forms of the building; many programs have problems with that. This is something

we do not understand. You would think that the connection between the engineers and the architects work would be a little bit easier. To have a good collaboration also needs good instruments to make it work. The total time we got delayed because of computer problems was 20-30%. We feel that even though we are students, there should be better computers to ease our work, especially in a time like this, where everything depend on computers.

We found it tough working together with the different views and aspects of how the process was supposed to be. There were no clear rules but we easily took on our typical roles in the game, and if we knew in the beginning how it would be we maybe would have done it differently. The engineering student feels that the cooperation in the beginning could have been better. We should possibly have taken more time to discuss the ideas in the start, instead of rushing through it just to be ready. Also the brainstorming for new solution that should work structurally is hard for a student. It is easy to be uncertain and wanting proofs for everything. However it was a great learning experience. These are the roles we will have in the working life. Therefore we believe that collaborations should be used as early as possible in the student period.

6.2 General cooperation

By doing this project together we understand some of the problems which can appear between architects and engineers. Often is the largest problem that we do not listen to each other. We are too buried in our own problems that we can not see the other person's, and they may even be the same, but from different angles. We could possibly help each other a lot more if the ideas and questions were viewed with different eyes and discussed by people with different ideal. Engineers often work in teams, because one person not can know every detail in a building process and do not have the time to think about all the details by himself. Another reason is also that you can discuss different solutions with your co-workers. We all think differently, but the engineers still think alike. How many ideas would then not be even better if they were discussed between the architect and the engineers? Other views and ideas would be considered, if only the engineers would try to explain the problems for the architects, like Nissje did to Koolhaas.

On the other hand, sometimes the absence of communication can lead to a more interesting solution. One of our supervisors, Morten Lund, told us a story about an entrance roof. The engineer had gotten a drawing of the gigantic roof from the architect. Because of the long span, there could be some problem in deformation, and the engineer assumed that the architect did not want to have a column in the middle. Therefore he had to find another solution. This of course took some time and effort, but in the end he put a beam in the edge of the roof. The beam would have a stiffening effect, and the deformation would then not be as large. When the architect then saw the solution, he asked the engineer: 'Why didn't you just put a column there? This is a typical example on a communication failure, which was positive; because of course the architect was happy there was no column in the middle. However, I believe that the engineer would not have done this if he were not experienced in working with architects – he knew and understood the architects' thoughts before they were said. If the understanding of each others work and simple ideas is learned early, thoughts like these do not even have to be discussed. You can then use the time to find even greater and more interesting solutions.

6.3 Improvement suggestions

After writing this thesis, we believe even stronger that understanding and respect makes a better job. The understanding of each others work gives a better prerequisite in future cooperation between our two professions. The architects should know more about mechanics and what it is that makes buildings stand. They should understand how the forms, which they use, react structurally. Engineers on the other hand should be able to understand the importance of wholeness and reality visions. It is important to look at the use of the house, which impression the users will have. Engineers have to see that architects are much more than just artists.

For engineers and architects to better understand each other, there have to be more exchange between the educations. We were actually very surprised that they did not have more cooperation between our schools, even though they are neighbours. This is something for our school leaders to think about. We believe it will only come good from it.

You have to teach the students more about each other. You could have more courses together. The engineering student should learn what is important for the architects and why is important to develop new architecture. The architect students could learn more simple mechanics, and they could be taught why some solutions work and others not. But it also lies in the student's own interest to take courses from the different programs, for the reason to get a better foundation. One of the absence and risks in both educations are that you get so specialized in your own work that you forget the whole perspective and picture.

All the students should be trained to improve their explaining skills. You should teach them to understand their audience, what knowledge does the audience have, what do they not know. The audience could be one person who knows less than you in some areas, and more in others. This is how it was for us. The trick is to know what too much information is and what is too little, what is boring because they know it all and what is boring because they do not understand any word.

To make an easier and better work environment for the people that cooperates, even though just for part of the process, there should be better programs. Better programs which can both draw interesting forms and calculate on them afterwards. The architect and the engineer should be able to use the same programs or there should be a better connection between them.

Least but not the less – the time. It takes time to be innovative and discuss different aspects of a certain project. Time costs money. Businesses have to put money on innovation and collaboration time. We believe that it would be worth it in the end, but do the business leaders dare to take the chance?

7 References

- [1] Holgate, Alan (1986). *The Art in Structural Design*. Clarendon Press, Oxford.
- [2] Rice, Peter (1994). *An Engineer Imagines*. London
- [3] Macdonald, Angus J. (2001). *Structure and Architecture*. The Cromwell Press, Wiltshire.
- [4] Ottosen, N.S. and Petersson, H. (1992). *Introduction to the Finite Element Method*.
Prentice Hall, New York.
- [5] Larsen, O.P. and Tyas, A. (2003). *Conceptual Structural Design: Bridging the Gap
Between Architects and Engineers*. T. Telford, London.
- [7] Mårtensson, A. and Isaksson, T. (2000). *Tabell- och Formelsamling*. Lunds Tekniska Högskola,
Lund.
- [6] ABAQUS

Appendix A – beam with fixed supports in both ends

In this appendix and the two next, there is made a calculation by hand to see which load case that is best material wise.

They are assumed to have the same material properties (strength, density, length) and load. They also have the same width, and the only property that changes is the height. The different moments are taken from a beam table. In the two first cases the ultimate height, changing over the length, can be seen as a second degree curve. The area is found by integrating the function and with that the mass can be calculated. In the third case the mass will be calculated with triangles.

$$M = \sigma W$$

$$W = \frac{bh^2}{6} \quad \text{This is how large a moment a beam with a special cross section can handle.}$$

$M_{support}$: maximum moment at the supports (Nm)

M_{field} : maximum moment in the area between the supports (Nm)

q: load spread out over the whole beam (N/m)

L: length of the beam (m)

h : the ultimate height of the beam (m)

σ : material strength in beam (Pa)

b: width of the beam (m)

m: ultimate mass of the beam (kg)

ρ : density of material used in the beam (kg/m^3)

$$M_{\text{sup port}} = \frac{qL^2}{12}$$

$$M_{\text{field}} = \frac{qL^2}{24}$$

$$h_{\text{sup port}} = \frac{1}{2} \sqrt{\frac{M_{\text{sup port}} 6}{\sigma b}} = \frac{1}{2} \sqrt{\frac{qL^2 6}{12\sigma b}} = \frac{L}{4} \sqrt{\frac{q}{\sigma b}}$$

$$h_{\text{field}} = \frac{1}{2} \sqrt{\frac{M_{\text{field}} 6}{\sigma b}} = \frac{1}{2} \sqrt{\frac{qL^2 6}{24\sigma b}} = \frac{L}{8} \sqrt{\frac{q}{\sigma b}}$$

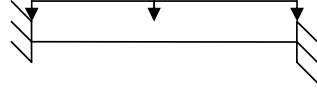

$$y = Ax^2 + Bx + C$$

$$\begin{cases} h_{\text{sup port}} = 0A + 0B + C \\ h_{\text{field}} = (L/2)^2 A + (L/2)B + C \\ h_{\text{sup port}} = L^2 A + LB + C \end{cases} \Rightarrow \begin{cases} A = \frac{1}{2L} \sqrt{\frac{q}{\sigma b}} \\ B = -\frac{1}{2} \sqrt{\frac{q}{\sigma b}} \\ C = \frac{L}{4} \sqrt{\frac{q}{\sigma b}} \end{cases}$$

$$A = \int_0^L \frac{x^2}{2L} - \frac{x}{2} + \frac{L}{4} dx \sqrt{\frac{q}{\sigma b}} = \left[\frac{x^3}{6L} - \frac{x^2}{4} + \frac{Lx}{4} \right]_0^L \sqrt{\frac{q}{\sigma b}} = \frac{L^2}{6} \sqrt{\frac{q}{\sigma b}}$$

$$m = \rho b A_{\text{tot}} = \rho b \cdot 2A = \rho b \cdot 2 \frac{L^2}{6} \sqrt{\frac{q}{\sigma b}} = \frac{1}{3} L^2 b \rho \sqrt{\frac{q}{\sigma b}}$$

Appendix B – a roller supported beam

M: maximum moment (Nm)
 q: load spread out over the whole beam (N/m)
 L: length of the beam (m)
 h : the ultimate height of the beam (m)
 σ : material strength in beam (Pa)
 b: width of the beam (m)
 m: ultimate mass of the beam (kg)
 ρ : density of material used in the beam (kg/m^3)

$$M = \frac{qL^2}{8}$$

$$h_{\max} = \frac{1}{2} \sqrt{\frac{M6}{\sigma b}} = \frac{1}{2} \sqrt{\frac{qL^2 6}{8\sigma b}} = 0.43L \sqrt{\frac{q}{\sigma b}}$$

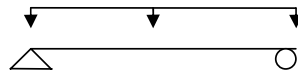

$$y = Ax^2 + Bx + C$$

$$\begin{cases} h_{\min} = 0A + 0B + C \\ h_{\max} = L^2A + LB + C \end{cases} \Rightarrow \begin{cases} A = -\frac{1.73}{L} \sqrt{\frac{q}{\sigma b}} \\ B = 1.73 \sqrt{\frac{q}{\sigma b}} \\ C = 0 \sqrt{\frac{q}{\sigma b}} \end{cases}$$

$$A = \int_0^L -\frac{1.73x^2}{L} + 1.73x dx \sqrt{\frac{q}{\sigma b}} = \left[-\frac{1.73x^3}{3L} + \frac{1.73x^2}{2} \right]_0^L \sqrt{\frac{q}{\sigma b}} = 0.29L^2 \sqrt{\frac{q}{\sigma b}}$$

$$m = \rho b A_{\text{tot}} = \rho b \cdot 2A = \rho b 2 \cdot 0.29L^2 \sqrt{\frac{q}{\sigma b}} = 0.58L^2 \rho b \sqrt{\frac{q}{\sigma b}}$$

Appendix C – a three supported beam

$M_{sup\ port}$: maximum moment at the supports (Nm)

M_{field} : maximum moment in the area between the supports (Nm)

q: load spread out over the whole beam (N/m)

L: length of the beam (m)

h : the ultimate height of the beam (m)

σ : material strength in beam (Pa)

b: width of the beam (m)

m: ultimate mass of the beam (kg)

ρ : density of material used in the beam (kg/m³)

$$M_{sup\ port} = -0.125q(L/2)^2 = 0.0313qL^2$$

$$M_{field} = 0.0703q(L/2)^2 = 0.0176qL^2$$

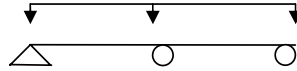

$$h_{sup\ port} = \frac{1}{2} \sqrt{\frac{M_{sup\ port} 6}{b\sigma}} = \frac{1}{2} \sqrt{\frac{0.0313qL^2 6}{b\sigma}} = 0.217L \sqrt{\frac{q}{b\sigma}}$$

$$h_{field} = \frac{1}{2} \sqrt{\frac{M_{field} 6}{b\sigma}} = \frac{1}{2} \sqrt{\frac{0.0176qL^2 6}{b\sigma}} = 0.162L \sqrt{\frac{q}{b\sigma}}$$

$$R = 0.375qL/2 = 0.188qL$$

$$M_{field} = Rx - \frac{qx^2}{2}$$

$$0.0176qL^2 = 0.188qLx - \frac{qx^2}{2} \Rightarrow x^2 - 0.375Lx + 0.0352L^2 = 0 \Rightarrow x = 0.188L$$

$$m = \rho b A_{tot} = \rho b (A_1 + A_2) 2 =$$

$$\rho b \left(\frac{0.162}{2} 0.188L \cdot 2 + \left(\left(\frac{0.217 - 0.162}{2} \right) + 0.162 \right) (L - 2 \cdot 0.188L) \right) L \sqrt{\frac{q}{\sigma b}} = 0.298 \rho b L^2 \sqrt{\frac{q}{\sigma b}}$$

Appendix D – reinforcement

The place with the largest stress in tension is found, and the stress there is 15MPa. The support areas are ignored. The concrete's strength in tension is not enough. To make approximate calculation the concrete's strength is ignored in both tension and compression, and the area is assumed to be subjected only to a simple bending moment.

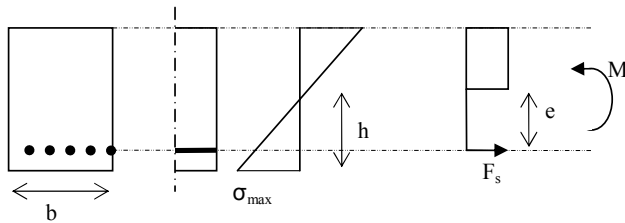

σ_{\max} = maximum tension stress
 b = width (calculated per meter)
 h = half the height
 e = moment arm for the reinforcement
 Φ = the reinforcements bar area
 F_s = force from reinforcement
 M = the moment that the stress subjects on the area
 W = elastic bending resistance

$$\sigma_{\max} = \frac{M}{W}$$

$$W = \frac{bh^2}{6} = \frac{1 \cdot 1.5^2}{6} = 0.375 \text{ m}^3/\text{m}$$

$$M = F_s e$$

$$e = h - (\phi + 0.01) = 1.5 - (0.04 + 0.01) = 1.45 \text{ m}$$

$$F_s = f_{st} A_s$$

$$A_s = \frac{\sigma_{\max} W}{f_{st} e} = \frac{15 \cdot 10^6 \cdot 0.375}{362 \cdot 10^6 \cdot 1.45} = 0.0107 \text{ m}^2/\text{m} = 9 \text{ bars}/\text{m}$$

In one meter there is room for maximum:

$$x = \frac{b - 0.02}{3\phi} = 8 \text{ bars}/\text{m}$$

This means that the bars have to be placed in two rows. Therefore will the moment arm be smaller.

$$e = h - (2.75\phi + 0.01) = 1.38 \text{ m}$$

$$A_s = 0.0113 \text{ m}^2/\text{m} = 9 \text{ bars}/\text{m}$$

In our building the reinforcement will be placed in two directions, which means that there will be four layers. The shortest moment arm will also be calculated.

$$e = h - (7.75\phi + 0.01) = 1.18m$$

$$A_s = 0.0132m^2/m = 11bars/m$$

This will give a weight of 206 N/m².

Appendix E – necessary size of the glass columns and of the cables

An example of one point of support shows the forces that the columns and cables should be able to handle. RF1, RF2, and RF3 show the forces in each direction.

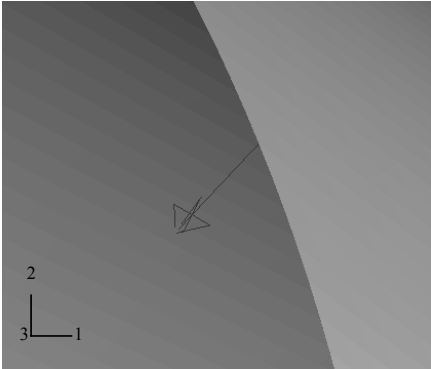

Magnitude: 1454 kN
 RF1: -357 kN
 RF2: -649 kN
 RF3: 1252 kN

From the numbers above it is understandable that the column does not just have an angle in one direction but in two. We would like to concentrate on the angle that depends on the tensioned line. Therefore the engineer makes a fast calculation of the angle in the not so interesting case. It would be around 30°.

$$\tan \alpha = \frac{649}{1252}$$

$$RF23 = \sqrt{649^2 + 1252^2} = 1410$$

According to the architect the glass column should angled outwards in this area. The angle could be about 30°.

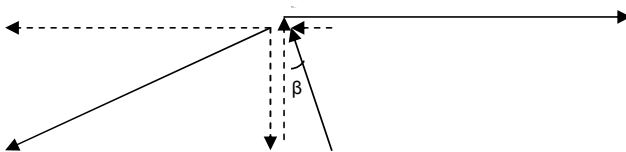

$$\frac{1410}{\cos 30} = 1628 \text{ kN}$$

$$1628 \cdot \sin 30 = 814 \text{ kN}$$

$$357 + 814 = 1171 \text{ kN}$$

The column is supposed to hold 1628 kN in compression and the line should be able to hold 1171 kN in tension.

Glass has strength in compression of about 1000 MPa. So for the column to hold it should be about 0.0016 m², which would be a cylinder with a radius of 3 cm.

With a tensile strength of about 1500 MPa the line should be 2 cm in radius.

Because glass is very fragile, the buckling has to be analysed as well.

Euler's buckling formula:

If the column is able to rotate in both ends the maximum load can be calculated like this.

I: moment of inertia (m ⁴)
P _k : how large the force can be before the column cracks (N)
E: module of elasticity (Pa)
l: length of column
P: force (N)

$$I = \frac{\pi r^4}{4} = \frac{\pi \cdot 0,03^4}{4} = 6,36 \cdot 10^{-7} \text{ m}^4$$

$$P_k = \frac{\pi^2 EI}{l^2} = \frac{\pi^2 \cdot 75 \cdot 10^9 \cdot 6,36 \cdot 10^{-7}}{30^2} = 523 \text{ N} \ll 1628 \text{ kN}$$

Here is shown that there is no way that this will hold for cracking. One way to make it work is to not make it as long as it is. The glass could be supported along the way somewhere.

The length would have to be not longer than:

$$l = \sqrt{\frac{\pi^2 EI}{P}} = \sqrt{\frac{\pi^2 \cdot 75 \cdot 10^9 \cdot 6,36 \cdot 10^{-7}}{1628 \cdot 10^3}} = 0,54 \text{ m}$$

With a radius of 10 cm the length could be 35m, which would be more than enough.

Appendix F – thickness of the walls compared to the length between them

The wall-parts are decided to be 4m long.

If there would be 2 meters between the walls, each wall would have a load of 8MN. The thickness is assumed to be 15cm wide.

$$A = 4 \cdot 0.15 = 0.6m^2$$

$$I = \frac{bh^3}{12} = 11.25 \cdot 10^{-4} m^4$$

$$\frac{l_c}{i} = \frac{3}{\sqrt{I/A}} = 69 > 22 \text{ slender column} \Rightarrow$$

use the second degree moment

$$\text{Excentricity : } e = \frac{h}{30} = 5mm \text{ though at least } 20mm$$

$$\text{Initial curvature : } e_0 = \frac{L}{300} = 10mm$$

$$M_o = N_d(e + e_0) = 240kNm$$

$$M_d = \frac{M_o}{c} \text{ Assume } c = 0.67 \Rightarrow M_d = 358kNm$$

Assume reinforcement : $\phi 8$ + byglar

$$d \approx 150 - 1.5 \cdot 8 \cdot 10 - \frac{8}{2} = 124mm$$

$$\left. \begin{array}{l} \frac{N_d}{bdf_{cc}} = 0.82 \\ \frac{M_d}{bd^2 f_{cc}} = 0.30 \end{array} \right\} \omega_{os} = 0.25 \Rightarrow A_s = \frac{\omega_{os} bdf_{cc}}{f_{st}} = 0.0067m^2 \Rightarrow 51\phi 8$$

Check :

$$N_u = k_c \frac{A_c f_{cc}}{1 + k_\varphi \varphi_{ef}} + k_s A_s f_{st}$$

$$\frac{l_c}{h} = 20 \Rightarrow \left\{ \begin{array}{l} k_c = 0.69 \\ k_\varphi = 0.24 \\ k_s = 0.62 \\ \varphi_{ef} = 3 \end{array} \right. \Rightarrow N_u = 19.8MN$$

$$\frac{N_d}{N_u} = 0.404 \Rightarrow c \approx 0.44 \Rightarrow M_d = 106kNm < 358kNm \text{ OK!}$$

Concrete K50: f_{cc} : 19.7 MPa

Reinforcement B500B: f_{st} : 362 MPa

A: cross section area (m^2)

I: moment of inertia (m^4)

b: cross section width (m)

h: cross section height (m)

l_c : crack length (m)

e: excentricity (m)

e_0 : initial curvature (m)

N_d : load (N)

M_o : first degree moment (Nm)

M_d : second degree moment (Nm)

d: distance from edge in compression to the reinforcement

A_s : reinforcement area (m^2)

Appendix G – windows

PROPERTIES: STEEL COLUMN S355	
f_{yk}	345 MPa
f_{yd}	288 MPa
E_k	210 Gpa
Density	7800kg/m ³
Cross section width	20 mm
Cross section height	200 mm
PROPERTIES: GLASS	
Density	2500kg/m ³
Thickness	20 mm
LOADS:	
Snow	1kN/m ²
Wind	1kN/m ²

The windows will be built as a grid of steel with window plates attached to it. Here are made calculations of how large the grid of columns could be. The widths between the steel columns are assumed to be 1m.

A: cross section area (m²)
 I: moment of inertia (m⁴)
 W: elastic bending resistance
 N_{Red} : maximum force strength of structure (N)
 M_{Rd} : Maximum moment strength of structure (Nm)
 l_c : crack length (m)
 i: inertia radius
 λ_c : slenderness parameter
 ω_c : reduction factor for buckling
 η : form factor for bending
 x: length of column (m)

$q_1 = \text{glass dead weight} + \text{snow}$

$q_2 = \text{wind}$

$$q_1 = (2500 \cdot 10 \cdot 0.02 + 1000)x = 1100x$$

$$q_2 = 1000x$$

$$q = (q_1 + 7800 \cdot 10 \cdot 0.02 \cdot 0.2) \cdot \cos 30^\circ + q_2 \cdot \sin 30^\circ = 1450x + 270 \text{ N/m}$$

$$M_s = \frac{qL^2}{8} = 730x + 130 \text{ Nm}$$

$$N_s = (q_1 + 7800 \cdot 10 \cdot 0.02 \cdot 0.2x) \cdot \sin 30^\circ + q_2 \cdot \cos 30^\circ = 1570x \text{ N}$$

$$A = 0.004 \text{ m}^2$$

$$I = 1.3 \cdot 10^{-5} \text{ m}^4$$

$$W = 1.3 \cdot 10^{-4} \text{ m}^3$$

$$N_{Rcd} = \omega_c \cdot f_{yd} \cdot A$$

$$\lambda_c = \frac{l_c}{i\pi} \sqrt{\frac{f_{yk}}{E_k}} = \frac{2}{0.0033 \cdot \pi} \sqrt{\frac{345}{210 \cdot 10^3}} = 7.7 \Rightarrow \omega_c = 0.015$$

$$N_{Rcd} = 17300 \text{ kN}$$

$$M_{Rd} = \eta \cdot W \cdot f_{yd}$$

$$\text{Anta } \eta = 1 \Rightarrow M_{Rd} = 38400 \text{ Nm}$$

$$\left(\frac{N_s}{N_{Rd}} \right)^{0.8} + \left(\frac{M_s}{M_{Rd}} \right)^{1.7-0.6} \leq 1.0$$

För $x = 4 \text{ m} \Rightarrow \text{capacity ratio} = 0.52$

With a different width between the columns the height would of course also change.