

WIND

Master Thesis - Sustainable Urban Design - Maëlle Ducreux

UNWIND

PORT OF LEITH : EDINBURGH WATERFRONT REGENERATION

Thesis Supervisor: Louise Lövenstjerne

Master of science in Architecture with specialisation in Sustainable Urban Design
School of Architecture, Lund University

AxSUD
Axelsson-Johnson Institute for
Sustainable Urban Design

SUDES
Sustainable Urban Design



MASTER THESIS WRITTEN REPORT

Submitted in partial fulfilment of the requirements for the degree of

Master of science in Architecture

with specialisation in Sustainable Urban Design

by

Maëlle C.M Ducreux

Faculty of Engineering

School of Architecture

Lund University

SEPTEMBER 2017

ABSTRACT

Wind turbines are most commonly located in remote areas to harness strong and constant winds, however, with the current growing rate of urbanisation, producing clean energy within the city closer to consumers is becoming crucial. Research has shown that the urban morphology has a strong capacity to influence air flow and 'street canyons' have the potential to channel the wind towards turbines in the urban scale. Yet, people and turbines do have a very conflicting relationship with wind. While turbines require a relatively strong and constant air flow, people prefer to find urban spaces away from the wind to keep a suitable body temperature and feel thermally comfortable. The redevelopment of the Port of Leith in Edinburgh, aims to address this conflicted relationship between generating wind energy and creating comfortable outdoor spaces within the urban fabric: Wind // Unwind

ACKNOWLEDGMENTS

I am very grateful for all the help and valuable guidance I received from the SUDes team for this thesis : Louise Lövenstjerne, Andreas Olsson, Peter Siöström & Harrison Fraker.

Thank you to Moohammed Wasim Yahia for sharing his expertise in climatology and providing important guidance regarding CFD software.

Finally, I want to express my endless gratitude to William for his tireless support, encouragements, patience and understanding during these two years spent apart.

TABLE OF CONTENTS

Abstract	ii	c. Historical context	12
Table of contents	iii	d. Current built structure	13
List of figures	iv	e. Microclimate & existing urban morphology	14
		f. Existing connections	15
		g. Analysis conclusion, challenges & vision	16
Chapter 1 : INTRODUCTION	1		
1.1 Background	1	3.2 Strategy	17
1.2 Aim & Objectives	2	a. Preserved built structure	17
1.3 Thesis outline	3	b. Street canyons existing and proposed	17
		c. Proposed connections	18
		d. Block design : CFD analysis	19
		e. Energy needs and produced	21
Chapter 2 : OUTDOOR COMFORT, WIND ENERGY & URBAN MORPHOLOGY - EXISTING EVIDENCE	3	3.3 Design principles	25
2.1 Outdoor comfort	3	a. Overall site programme	25
2.2 Urban air flows	4	b. Wind strategy	25
2.3 Design characteristics of climate sensitive urban design	4	c. Street design	26
2.4 Wind energy & urban morphology	6	d. Character	29
2.5 Urban wind turbines types & specifications	7	e. Wind and our senses	30
		f. Resident weekly routine	38
		g. Phasing	39
Chapter 3 : PROPOSAL FOR THE PORT OF LEITH EDINBURGH	9	Chapter 4 : CONCLUSION	40
3.1 Analysis : The site characteristics	9	4.1 The characteristics of a comfortable outdoor space	40
a. General Location and city strategy	9	4.2 The opportunities for wind energy within the urban scale	40
b. Landscape	10	4.3 Proposal for the Port of Leith	40
		4.4 Further thinking	40
		Reference list	41

LIST OF FIGURES

Fig. 1 Terrestrial Beaufort Scale ^[20]	3
Fig. 2. Urban air flows ^[13]	4
Fig. 3. Bo01 : block structure analysis	5
Fig. 4. Street canyon dimensions and principle ^[1]	6
Fig. 5. Southbank centre, London : detail	7
Fig. 6. Parc de la villette, Paris	7
Fig. 7. Rijnhaven, Rotterdam	7
Fig. 8. Southbank centre, London : at night	7
Fig. 9. Horizontal Axis Wind Turbines (HAWT)	8
Fig. 10. Vertical Axis Wind Turbines (VAWT)	8
Fig. 11. Array of optimisation for VAWT ^[33]	9
Fig. 12. Edinburgh within the Firth of Forth	10
Fig. 13. Leith within Edinburgh's waterfront	10
Fig. 14. Site context : Bird's view	11
Fig. 15. Harbour expansion from 1560 to 2016	12
Fig. 16. Current built form and contour lines (5M)	13
Fig. 17. Fishmarket and Martello tower	14
Fig. 18. Leith wind rose : yearly distribution in %	14
Fig. 19. Average temperature and rainfall per month in Edinburgh	14
Fig. 20. Bernard street : urban morphology	15
Fig. 21. Existing connections	16
Fig. 22. Preserved built structure	17
Fig. 23. Three types of street diagrams	17
Fig. 24. Existing and proposed street canyons	18

Fig. 25. Proposed connections : Tramline, pedestrian & boat	18
Fig. 26. Block study : air flow and shade at 10 am in winter	20
Fig. 27. Block study : air flow and shade at 12 pm in winter	20
Fig. 28. Block study : air flow and shade at 2 pm in winter	20
Fig. 29. Block study : section through block with air flow	20
Fig. 30 General concept WIND // UNWIND	21
Fig. 31. Wind turbines organisation on site	22
Fig. 32. Part of Landscape plan 1 : 6000	23 - 24
Fig. 33. Roof profile study of airflow	25
Fig. 34. Corner study of airflow	26
Fig. 35. Three streets types ratio	26
Fig. 36. Part of Masterplan 1 : 2000	27
Fig. 37. Detailed plan 1 : 1000	28
Fig. 38. Section pedestrian street :turbines integration 1 : 200	29 - 30
Fig. 39. Section plan through boulevard 1 : 350	31
Fig. 40. Section plan through secondary street 1 : 250	32
Fig. 41. Section plan through pedestrian street 1 : 250	33
Fig. 42. Section collage Dock waterfront 1 : 200	34
Fig. 43. Section collage Firth of Forth Waterfront 1 : 200	35-36
Fig. 44. Physical model 1:200 : street canyon view	37
Fig. 45. Physical model 1:200 : bird's eye view	37
Fig. 46. Detailed air flow through the entrance of the pedestrian street	37
Fig. 47. Air flow in the entrance of the pedestrian street	37
Fig. 48. Weekly routine map for Mary	38
Fig. 49. Phasing diagrams	39

Chapter 1 : INTRODUCTION

1.1 Background

Wind is a natural phenomenon, globally created by the rotation of the earth and its uneven heating by the sun. The total power which can be harnessed from the wind on the earth is said to account for ten times the power of water ^[1]. Harnessing energy from unlimited natural resources such as the wind was the norm for much of human history ^{[2][3]}. Wind was used to power sailing boats (5000 BC) or ventilate buildings (4000 BC) ^[1]. Around 700-900 AD, the ancestor of the windmill - set of wheels on vertical axis powered by the wind - first appeared in Persia to mill grain or pump water ^[1] ^[4]. Windmills with horizontal axis were first built in Europe around the eleventh century for the same purpose and largely developed over the centuries until the industrial revolution^[1]. The increase of human dependency on fossil fuels, such as coal and oil, greatly reduced the use and interest in renewable energies ^[3]. Nevertheless, in 1887, the first wind turbine was built in Ohio with a height of 17 meters and a power of 12KW and the first windmill for producing electricity was created in Scotland in the same year. In Denmark, the first industrial wind turbine generating electricity was developed a few years later and the first offshore wind farm was built in 1971^[1]. Following the oil crises in 1973, fossil fuels prices brutally increased and resource depletion started to be acknowledged. Interest and research on modern use of renewable energies started ^[3].

While wind energy is nowadays the third most competitive renewable energy technology in the world ^[3], it is the most

popular in Scotland before hydropower ^[5]. The country has developed its renewable strategy since 2007 and has set ambitious targets to best take advantage of its varied landscape and its potential for wind, tidal and wave power. It aims to generate 100% of its gross electricity by 2020. In 2016, they were already producing 60% of it from renewables, of which 66% from the wind onshore and offshore ^[5]. There has been growing public support for wind energy development in Scotland, however, onshore wind facilities in some areas are creating debate regarding their scale, proximity and impact on existing character and landscape ^[6].

Energy facilities, conventional and renewables, have usually been developed in remote areas, where land is available and it creates less disturbance on residents. Still, in Scotland as anywhere else in the developed world, most consumers are located in or around cities network and getting electric power to consumers may be as much of a challenge as creating it. Electrical power is delivered through a very large network of complex high-voltage transmission and distribution system, known as the grid. Created piece by piece over decades, it has become increasingly stressed in recent years. The difference in scale compared to conventional energy facilities, makes the renewable energy technologies best suited to integrate within the urban scale and provide clean energy near consumers ^[3]. If well combined, it doesn't require additional land and it also eliminates the transmission loss, 7 to 10% of the electricity transported ^{[1][7][8]}. Energy produced closer to people, invite them into a different relationship with the energy source ^[3]. Production and performance can be measured and understood at the scale of the neighbourhood and it encourages residents and businesses to conserve energy as it was seen in BedZed, London ^{[8][9]}. The disconnection that

exists today between consumption and production of energy is contrasting with the relationship our ancestors had with their energy provider. For example, animals that worked the fields were living next or with humans to provide heat ^[3]. With the current rapid urbanisation, scenarios predict that more than 80% of the world population will live in cities by 2050 putting more pressure on urban areas to address sustainability challenges ^[10]. As cities evolve, urban design must adapt ^[11]. Both urban and rural communities will have to be accustomed to the sight of energy infrastructure, shaping people as not only consumers but as stakeholders in the energy process ^[3].

Urban wind turbines have already been developed to be combined with built structure or in micro forms as part of the streetscape, but it remains at a rather small scale ^[1]. While we know that urban morphology affects air flows ^{[1][12][13]}, wind turbines and people have a different relationship with wind, especially in temperate to cold climate like Scotland. While the turbines require a relatively strong and constant air flow, people prefer to find urban spaces away from the wind to keep a suitable body temperature and feel thermally comfortable ^[12]. Outdoor comfort is a crucial feature for creating successful and attractive places where both local and global climate are taken into account ^[14].

In light of these debates, this thesis focuses on the design characteristics of a dual urban environment which controls air flows for the energy generation on one hand and outdoor comfort in the other. The concept will be tested with a proposal for a new mixed-use development in the Port of Leith in Edinburgh's waterfront.

1.2 Aims & objectives

This thesis aims to examine the conflicted relationship between generating wind energy and creating comfortable outdoor spaces within the urban fabric.

The research is underpinned by three objectives :

- 1 . to define the characteristics of a comfortable outdoor space encouraging lengthy outdoor stay
 - Understand the concept of outdoor comfort
 - Identify the aspects of the urban morphology which improves or worsens the microclimate

2. to determine the opportunities for wind energy generation within the urban scale
 - Identify the features of the urban morphology which boosts or prevents wind energy generation
 - Define the characteristics of the major types of urban wind turbines

3. to illustrate the findings with a proposal for the Port of Leith with wind turbines integrated to the urban fabric
 - Understand the characteristics, challenges and opportunities of the site
 - Develop a strategy for wind generation and outdoor comfort
 - Details the characteristics of the place which boosts wind energy generation and encourage outdoor stays

1.3 Thesis outline

The thesis is structured over four chapters. Chapter one defined the background of the research and outlined the overall aim for the thesis. Chapter two reviews the literature on outdoor comfort and wind energy generation in the urban scale. Chapter three details the proposal for the Port of Leith. Finally, chapter four concludes the thesis.

Chapter 2 : OUTDOOR COMFORT, WIND ENERGY & URBAN MORPHOLOGY - EXISTING EVIDENCE

2.1 Outdoor comfort

Understood as a quality dimension linked to human health and physiological well-being ^[15], outdoor comfort has a direct impact on the type and duration of activities that takes place in an urban space: ‘Lengthy outdoor stay means lively city’ ^[15]. Strolling, window-shopping, sitting at the terrace of a café or a restaurant, meeting or chatting, can only occur in pleasant environmentally comfortable spaces ^[12].

Comfortable outdoor environments are made of objective and subjective criteria such as the familiarity of settings and people, smells and visual conditions, acoustic, convenience and physical comfort, feeling safe and microclimate ^{[17][18]}. In cold climates, it can be argued that wind has the strongest effect on microclimate. Acting as both a dynamic force and a coolant, it can dramatically change our heat balance regardless of the air temperature or the solar heat. There are two aspects regarding our relationship to the wind: Wind comfort and thermal comfort ^[12]. Wind comfort refers to the mechanical impact of wind on people and objects, from a light breeze on the skin to people being blown away by strong gusts. The terrestrial Beaufort scale (fig.1) describes ten ranks of the wind effects at pedestrian level (h= 1.75m), from calm to strong gale ^{[19][20]}. However, the frequency at which these events occur on a small timescale also plays a vital role in wind comfort ^[21]. On average, a wind speed greater than 6 m/s create discomfort in people.

Beaufort Number	Description	Wind speed (m/s) at h = 1.75m	Wind effect
0	Calm	0 - 0.1	Smoke rises vertically
1	Light air	0.2 - 1.0	No noticeable wind
2	Light breeze	1.1 - 2.3	Wind felt on face
3	Gentle breeze	2.4 - 3.8	Hair disturbed, clothing flaps, newspaper difficult to read
4	Moderate breeze	3.9 - 5.5	Raises dust and loose paper, hair disarranged
5	Fresh breeze	5.6 - 7.5	Force of wind felt on body, danger of stumbling when entering a windy zone
6	Strong breeze	7.6 - 9.7	Umbrella used with difficulty, hair blown straight, difficult to walk steadily, wind noise on ears unpleasant
7	Near gale	9.8 - 12.0	Inconvenience felt when walking
8	Gale	12.1 - 14.5	Generally impedes progress, great difficulty with balance in gust
9	Strong gale	14.6 - 17.1	People blow over

Fig. 1 Terrestrial Beaufort Scale ^[20]

Thermal comfort refers to the heat balance between the human body and the outdoor environment where the body internal temperature is maintained at around 37 degrees. 'It is the condition of mind (subjective) expressing satisfaction with the thermal environment (objective)' [22] [12]. Objectively, it includes solar radiation, humidity, metabolic heat by human activity, flow velocity, clothing level and air temperature [23]. While subjectively, it refers to the way people experiences the thermal condition of an environment depending on their psychological, physical, physiological and cultural state. Even on a cold day, if the sun shines and the wind is calm, the body can balance its temperature more easily and feel thermally comfortable [16].

2.2 Urban air flows

The starting point of modern urban microclimate and outdoor comfort arguably started in London with Howard (1833) who first identified meteorological differences between town and country [24]. In fact, the urban fabric brings significant effects on the climate within the built-up area and the atmosphere around it [12]. It modifies the radiation, temperature, moisture and aerodynamic of the surrounding environment [13].

The 'urban boundary layer' (UBL) is the lowest part of the atmosphere in an urban area and it extends ten times the height of the buildings (Fig. 2). The lowest of its sublayer is the 'urban canopy layer' (UCL) and includes the volume from the ground level to the top of the roofs, trees or other elements [12]. It is governed by the nature of the general urban surface and is produced by the micro-processes within the 'street canyons' between buildings [13]. This layer is highly heterogeneous and strongly influenced by plumes and wakes caused by individual urban elements such as buildings, trees and topography [12].

While wind reduces with friction with terrain and vegetation, sharp corners and roof profile will accelerate and reverse flow [13] [16]. Tall buildings create large turbulences at their base and can define a hostile environment for pedestrian [13].

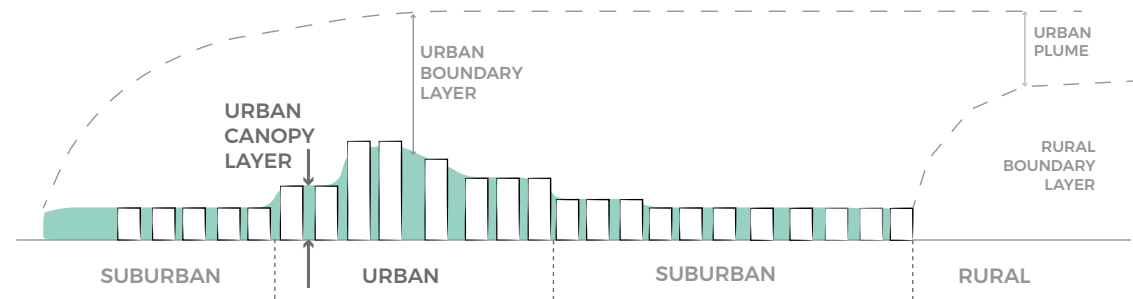

Fig. 2. Urban air flows [13]

2.3 Design characteristics of climate sensitive urban design

Consideration for the weather and climate can be seen in vernacular architecture around the world where the urban forms, choices of materials and vegetation respond to the local climate to create more comfortable outdoor spaces refined by trial and error [12] [25].

Wind coming from the sea is a constant feature in countries along the Atlantic and North Sea coasts. Sharp (1946) described in its *Anatomy of a Village* that in fact taking advantage of seaward views was not a common feature in an old seaside village [26]. Hiding or turning its back to the sea, villages were built recognising the potential roaring wind in winter, battering the urban fabric and worsening the outdoor microclimate. Consideration for the wind can also be found in

classical architecture, where for example Vitruvius (ca. 80-70 BC to 15 BC) warns planners for the wind violently sweeping streets if they are oriented in the same direction [27]. Wide streets were recommended by Palladio (1508-1580) for cities with cold climate to allow the sun to come in [28]. Old cities carefully adapted to the low angle of sunlight and constant wind in winter. They usually boast buildings typically two or three stories high with pitched roofs clustered together [16]. Block like geometry creates the possibility for radiation trapping and air stagnation: it lets the sun in but keeps the cold and fast wind out, diverted above buildings. [13]

Bo01 in Malmo, Sweden, built at the beginning of the century was organised to best embrace its surroundings on the waterfront while creating a comfortable microclimate. The neighbourhood was designed with blocks defining two contrasting types of outdoor spaces : an 'inside' and an 'outside' [29]. The outside offers views over the water, unprotected from the wind. While the inside is surrounded by five to seven storey buildings facing the prevailing wind coming from the West and diverting it above the blocks (fig.3). They are separated by small gaps and positioned at odd angles to deflect the wind. Buildings inside the block, two to four stories high are positioned near those gaps to deflect



the wind further and provide a comfortable environment. The inside streets are organised on the north south axis and façades are positioned at slight angle to one another to best take advantage of solar radiation. Therefore, the block successfully creates inside spaces where the wind is calm and the sun shines and, outside spaces where the wind can roar. Together, these contrasting environments provide a permeable layout and enrich the experience of the place providing different character to each space depending on the wind exposure.

2.4 Wind energy & urban morphology

As the biggest consumer of energy, cities have to contribute to the reduction of energy by emphasizing on clean energy solutions, which can play a vital role in the field of urban design, in the nature of urban realm, communities and neighbourhoods. Arguably, strategies for including renewables of any types in the urban fabric should focus on the public realm because it affects the city and its residents as a whole^[2]. Including parks, plazas, pedestrian pathways, streets and streetscape, public realm is defined as a space shared communally by the public and their design responds to societal changes, encourages human growth and contributes to the survival of culture. Three elements shape the physical aspect of a space: the enclosure (the space itself), enclosing elements (defining the space) and elements within the enclosure (enhancing the use of space)^[2]. In Galil et al (2016), looking at renewables and their integration potential within the urban fabric, wind turbines were found to be best suited as an element within the enclosure of a street space^[2].

The energy generator of a wind turbine is determined by the

average wind speed which needs to be at least 5 m/s and the consistency of the wind resource^[2]. Wind turbines have been found to be most effective in remote areas with proven consistent high winds and smooth airflows. However, several studies have found that the effect of the wind on buildings can offer favourable conditions for wind turbines in cities^[2]^[1]. Regarding public realm, Wang (2015) described the 'street canyon' discussed by Oke (1987) as having the greatest potential for wind turbines: buildings along a street with little difference in height^[1]^[13]. The organisation requires the building enclosing the street to be at least 6 m high and the width of the streets to be twice its height (fig. 4)^[1]^[13].

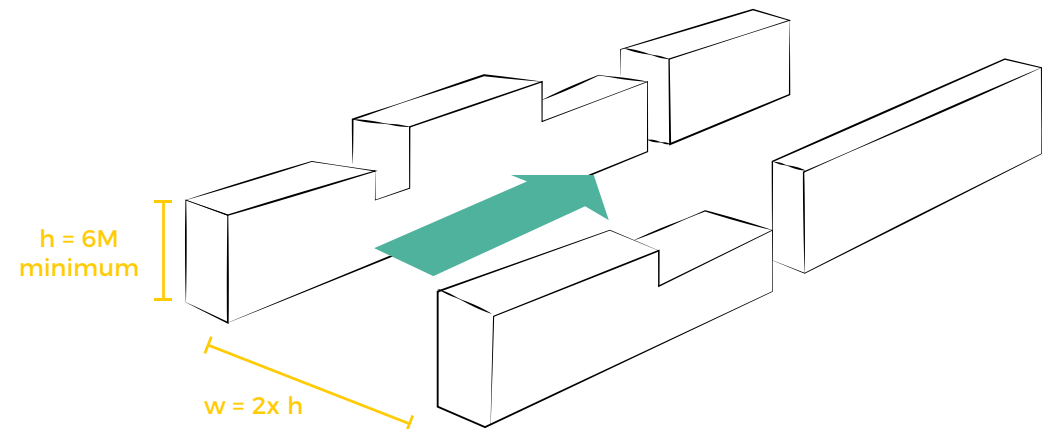

Fig. 4. Street canyon dimensions and principle [1]

2.5 Urban wind turbine types and specifications

Wind energy generation is defined as extracting the kinetic energy out of the wind with a turbine and converting it into electrical energy with a generator [12]. Since the 1970s, there has been a large amount of interest and research in wind energy generation and today there are five types of wind turbines depending on the power of the generator [3]: Very large turbines (> 1MW), large turbines (1MW to 500KW), medium turbines (500KW to 50KW), small turbines (50KW to 1.5KW) and micro turbines (<1.5KW). An urban wind turbine is defined as being in the urban scale near or around buildings [30]. The best suited for the urban scale are the small and micro turbines, however, medium turbines can be accommodated in industrial or low density areas [1]. It has been shown that to be accepted by nearby residents, the rotor sweep area has to be less than 5 m² [31]. Stand-alone urban wind turbines can be found along avenues, motorways, open spaces like in the Parc de la Villette in Paris (fig. 6), or next to a tall building or along rivers like along the Rijnhaven in Rotterdam (fig. 7). As well as producing energy, some wind turbines are installed to decorate the city like public art. In Southbank center, London, micro turbines generate light from LED while rotating (fig. 5 & 8) [1].



Fig. 5. Southbank centre, London : detail



Fig. 6. Parc de la villette, Paris



Fig. 7. Rijnhaven, Rotterdam

Fig. 8. Southbank centre, London : at night



There are two general types of turbines differentiated by the position of their axis: Vertical Axis Wind Turbines (VAWT) and Horizontal Axis Wind Turbines (HAWT).

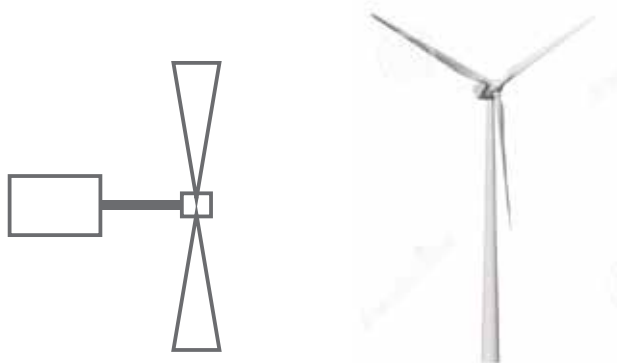

Fig. 9. Horizontal Axis Wind Turbines (HAWT)

HAWT (fig.9) have a higher rotation speed and are able to reach the theoretical Betz limit of 59.3%^[32] described as the maximum amount of the wind kinetic energy that a turbine can convert into a mechanical energy turning rotor^[1]. Nevertheless, they greatly under perform in a turbulent environment, including near buildings or too close to other HAWT. For the wind turbines achieving the same level of efficiency as a turbine in isolation, a space of twenty times their rotor diameter ($20D =$ around 500 m) is needed between them for the air flow to re-energize before reaching the downstream turbines^[33]. Therefore, they take a large portion of land and the ratio of power per unit area of land is low. Most research has usually focused on the HAWT and it is nowadays the most technologically advanced and the most used. Still, research on VAWT has slowly found advantages which are compatible with an urban setting.

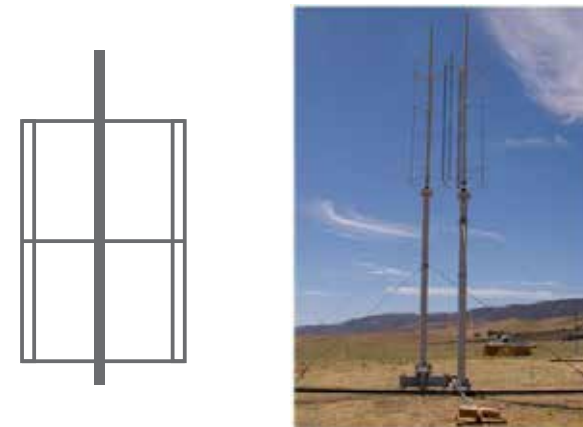

Fig. 10. Vertical Axis Wind Turbines (VAWT)^[33]

VAWT (fig. 10) have a 20-30% lower rotation speed compared to the HAWT and no design has so far managed to reach the Betz limit. Most of the VAWT experience difficulties in starting rotation and often needs a strong or turbulent air flow to start^[1]. However, they are more aesthetically pleasing and light in shape as their gearbox and generator can be on the ground, they produce less noise and vibrations and they experience minimal changes to performance in turbulent environment, such as in an urban setting. Furthermore, recent researches have shown that the wake of a VAWT only needs four to six times the rotor diameter ($4-6D =$ around 10M) to recover. If the VAWT are organised in arrays, they could produce eight times more power per unit area of land than HAWT^[33].

A recent research by Brownstein et al (2016) found that through a very specific organisation array (fig.11), a group of one co-rotating and two counter-rotating VAWT can enhance the performance of downstream turbines compared to the upstream one^[33]. This optimisation array is predicted to

enhance the performance by 30% compared to equivalent array of isolated turbines ^[33]. The VAWT in this research are micro turbines with power generator of 1.2KW mounted on a 6M pole and with a rotor sweep area inferior to 2m². These dimensions comply with studies of acceptable wind turbines scale for the urban area ^[31]. Combined with the fact that VAWT respond well to turbulence, they could be best suited for urban environment.

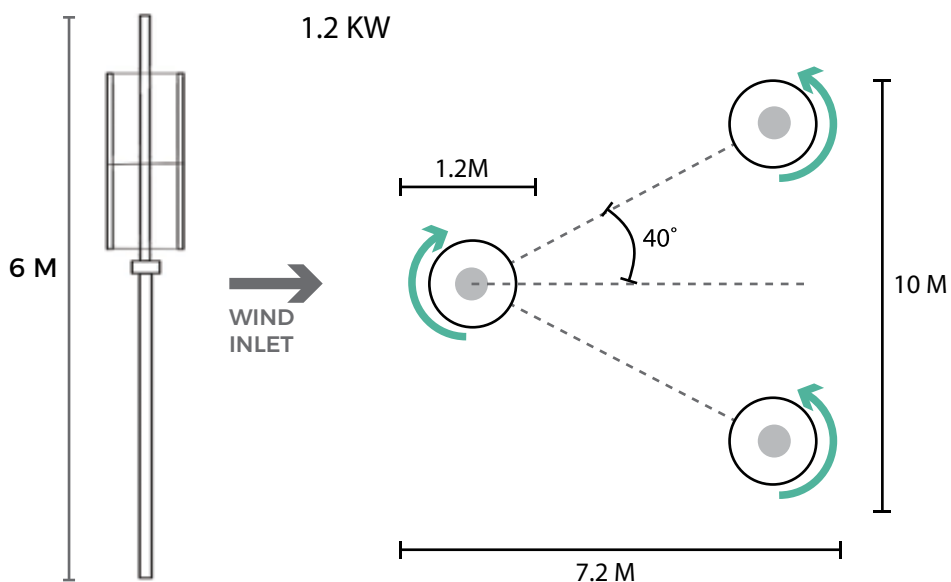

Fig. 11. Array of optimisation for VAWT ^[33]

Chapter 3: PROPOSAL FOR THE PORT OF LEITH, EDINBURGH

3.1 Analysis : the site characteristics

a. General location and city strategy

Scotland's capital city, Edinburgh has a population of 465,000 inhabitants. Along its boundary with the inner Firth of Forth - the estuary of the river Forth -, lie extensive areas of land given over to port and industrial activity for the past centuries (fig.12). Both activities have declined considerably in the last forty years and the land is slowly being released for new residential developments. It is one of the largest and most complex regeneration projects in Europe.

The regional population is set to increase by 200,000 inhabitants in the next 5 years, increasing the need for housing in Edinburgh. Development happening inside the city boundary on brownfield land means that rural lands are preserved. Therefore, Edinburgh's waterfront present a unique opportunity for the most significant contribution to strategic regional housing and business needs using vacant and under used brownfield rather than greenfield land. It could also offer the opportunity to open the city to its surrounding landscape and set new standards of urban design and sustainability.

The waterfront has been divided in different areas which are meant to be developed in their own times (fig.13): from the west to the east, Granton, Granton harbour, Trinity, Leith, the Port of Leith and Seafield/Portobello. Among all the sites of the waterfront, Leith and its port have the best connection opportunity with Edinburgh's city centre as the main artery, called Leith Walk, connects to Leith directly in a

1.2 km boulevard. The site sits at the mouth of the Water of Leith, along the Firth of Forth and is nearly flat and partially unobstructed from the prevailing wind. It provides a prime opportunity to reconnect the city to its surrounding landscape and propose a new type of urban form integrating wind turbines. In fact, the Scottish Government recognised the port of Leith as a site with the ambition to secure growth from renewable energy.

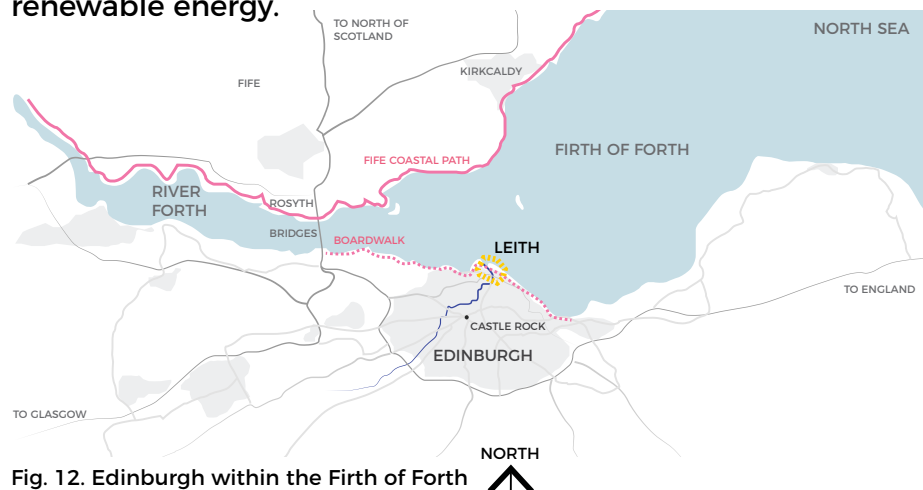

Fig. 12. Edinburgh within the Firth of Forth

b. Landscape

The site is a unique part of Edinburgh with a dual connection to water providing links to natural habitats and scenery, with two rivers meeting on the site: the Water of Leith and the Firth of Forth.

The river Forth is one of Scotland's major river (47kms) taking its source near Stirling in central Scotland. As it widens and passes the Queensferry Crossing, Forth Road bridge and Forth Rail Bridge between Fife and Edinburgh, the river Forth reaches the North Sea with a wide estuary called the Firth of Forth. The estuary is very active with many large boats reaching the main harbour in the west of Scotland, Rosyth,

on the other side of the estuary compared to Edinburgh. Many islands are located in the Firth and are visible from the site and varied sea life can usually be seen such as seals and sometimes orcas. The edge of the Forth with the site is made of three large partially submerged craigs - rock boulders - and two sandy beaches gently sloping to the water (fig.32).

In the contrary, the Water of Leith is a small river starting in the south west of Edinburgh and going through Edinburgh's city centre to reach the sea through the Firth of Forth in Leith. The very accentuated topography renders the water almost unknown to residents in the city centre but makes a wonderful green and calm walkway within the city, which is nicknamed 'a silver thread in a ribbon of green'. Around Leith the topography is less dramatic and the city can reach the edge of the river with its unique urban waterfront. The Water of Leith connects to the urban area with the hard edges of the docks with a difference in height of three meters.

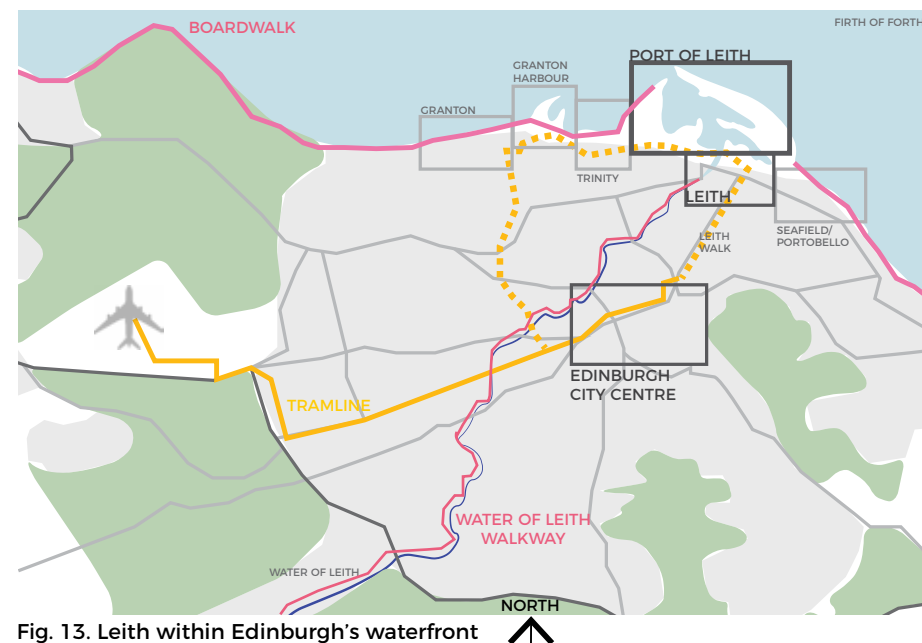

Fig. 13. Leith within Edinburgh's waterfront



ARTHUR'S SEAT

SCOTTISH PARLIAMENT

THE MEADOWS

CASTLE ROCK

WAVERLEY STATION

EDINBURGH CITY CENTRE

SEWAGE TREATMENT PLANT

LEITH LINKS

HISTORIC LEITH

LEITH WALK

TO PORTOBELLO

EDINBURGH DRY DOCK

EDINBURGH DOCK

ALBERT DOCK

THE SHORE
VICTORIA BRIDGE
& LISTED

VICTORIA DOCK

IMPERIAL DOCK

OCEAN TERMINAL
SHOPPING CENTRE

IMPERIAL DRY DOCK

ROYAL YACHT BRITANNIA
MAIN TOURIST ATTRACTION IN LEITH

WATER OF LEITH

PORT OF LEITH
DEEP SEA PORT

TO GRANTON

MARTELLO TOWER

HARBOUR
LOCK GATES

FIRTH OF FORTH

NORTH

Fig. 14. Site context : Bird's view

c. Historical context

Leith was a small fishing village when it was designated by Edinburgh in 1329 to become its main port. The attractive feature was that the Water of Leith provided a hidden location protected from the wind while still giving a fast access to the North Sea. The historical harbour was therefore located along the Water of Leith, on a dock called 'the Shore' which is today an attractive leisure place with pubs and restaurants (fig. 14). The position of Leith as Edinburgh's main port transformed it as the capital's main getaway to the sea. Goods and merchandise were transported from Edinburgh to Leith through Leith Walk which transformed it into the main artery between the two settlements. Large industries, innovations, discoveries and social advances transformed the small town into a vibrant part of Edinburgh. Among other things, Leith once had the largest fleet for whaling in the world (1616), printed one of the first newspaper (1651), wrote the first rules of golf (1744), had the largest brewery in Scotland (1810), built the first passenger cargo ship to cross the Atlantic using its own power (SS Sirius) (1837) and was the first hospital in Scotland to accept female students (1886).

Leith was a concentration of working class while Edinburgh housed the bourgeoisie, which accentuated the differences between the two. Its strong independent and creative minded culture pushed Leith to vote for its independence from Edinburgh in 1833, which lasted until it was reluctantly amalgamated with Edinburgh in 1920. It was definite that Leith could not expand anymore as the urban areas of Edinburgh and Leith were already merging. Today, Leith still has its strong identity, different from Edinburgh and the matches between the two football teams of Edinburgh are an

occasion to affirm it further: one team comes from Leith and the other from the south west of Edinburgh.

Several developments changed the shape of the place over the centuries with large land expansion over the Firth of Forth and the construction of several wet or dry docks and bridges across the Water of Leith. There are currently four wet docks remaining : Victoria dock (1852), Albert dock (1869), Edinburgh dock (1881) and Imperial dock (1904); and three dry docks remaining: Alexandra dry dock (1860), Edinburgh dry dock (1890) and Imperial dry dock (1910). Victoria bridge over the Water of Leith was once the largest swing bridge in the UK and was built in 1874 near the Shore (fig. 14). It provides a focal point and a landmark for the historical harbour. While Leith was once directly on the shore of the Forth, the harbour expansion means that today Leith is more than 400m away from it. This fact strongly increased the disconnection between the two water bodies. In fact, 75% of the site is on reclaimed land (fig 15).

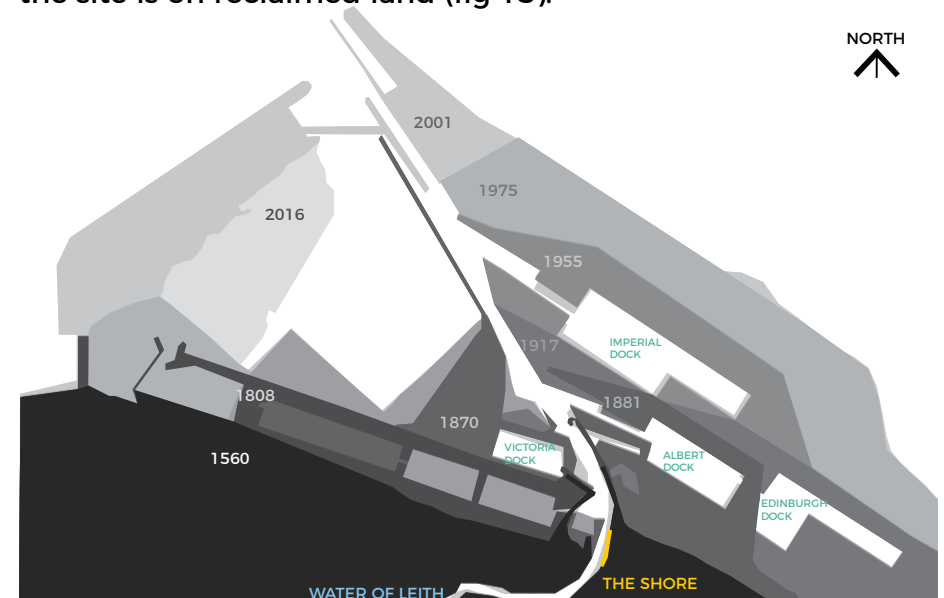

Fig. 15. Harbour expansion from 1560 to 2016

The harbour today is partially active with cargo, medium size cruise liners and North Sea vessel using the docks. All the boats enter the harbour through lock gates on the north west of the site, which allows the port to have an even water level all the time. The Port of Leith is a deep-sea port which was once very attractive, nevertheless, the difficult entrance of the harbour through craigs has meant that a lot of activities have now moved to the other side of the Forth, in Rosyth.

Leith is also a centre for art with a renowned art school created in 1987. Leith art Festival started in 1907 attracts 500,000 visitors in June and Edinburgh Festival, which has many events in Leith, attracts four million in August.

At the end of the 1990s, the site has been the focus of a large regeneration program which produced a masterplan providing 4,000 residential units separated in nine 'villages' along the Forth. The Scottish Government relocated its main offices in Leith in 1995 to boost the proposal and the Royal Yacht Britannia decommissioned by Elizabeth II was docked in the port in 1998 to create a museum. (fig. 14). The whole project was centred around a large shopping centre and a tram line. However, with financial issues and opposition to the development, only the large shopping centre - Ocean Terminal - was built in 1998. The tram line was postponed and the residential development was cancelled.

d. Current built structure

The site is 235 hectares and includes the historical centre of Leith to offer a strong connection to an existing concentration of activities and better connect to Edinburgh, as a whole. The site can be divided in two main areas, Leith historical centre

and the north of the site. Leith historical centre is dense and built up with residential - flats and terraced houses - and commercial units - offices, retail and a large shopping centre, Ocean terminal - near the Water of Leith. The Scottish Government's main office is located in Victoria dock and is one of the main employer in the area. Like most buildings in Edinburgh, Leith has sandstones and slates buildings with a maximum of five storeys. Some larger more recent buildings are made of concrete and can reach ten storeys. The highest building on site is an office building of 22 storeys located in front of the seven-storey high Ocean terminal, on the north-western edge of the site. (fig.16). The Royal Yacht Britannia is docked next to the shopping centre and is the only top ten tourist attraction of Edinburgh located in Leith. It attracts four million visitors per year. There are 10,150 people already living on the site with a density of 8,464 inhabitants/km². The largest green area is Leith Links to the south east of the site.

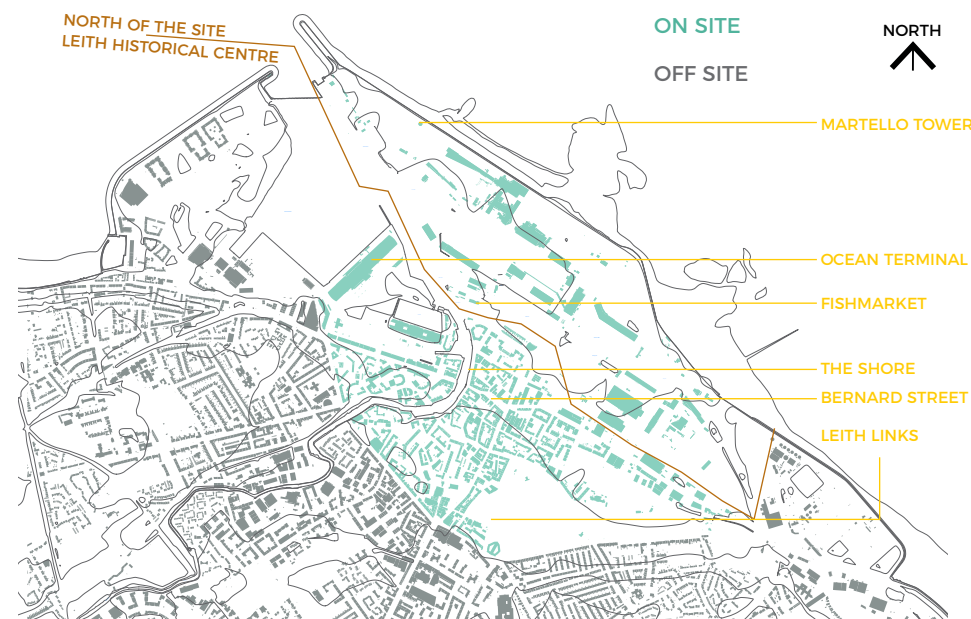

Fig. 16. Current built form and contour lines (5M)

The north of the site along the Forth is largely underused and is made of a succession of water basin (wet and dry dock) and several industrial warehouses made of metal and concrete which can rise up to 20 storey high. A large sewage treatment facility is located on the eastern edge of the site. Only a Martello tower - circular tower - built on the North of the site during the Napoleonic wars and the fishmarket to the south are made of sandstone (fig. 16 & 17).

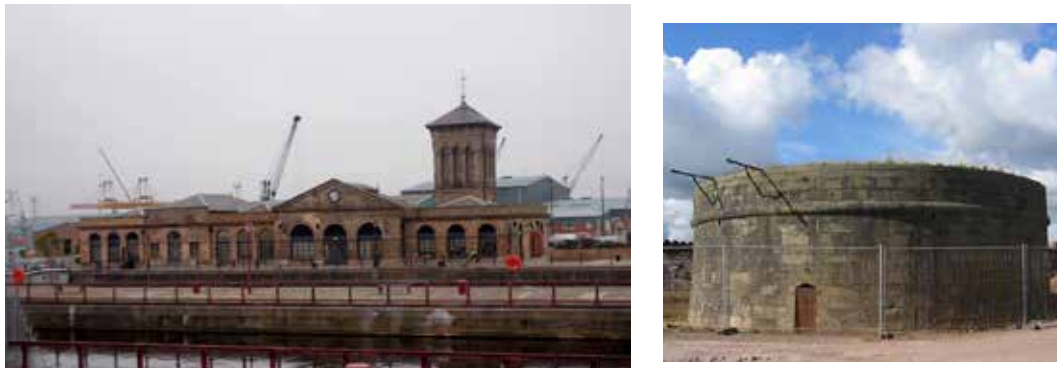

Fig. 17. Fishmarket and martello tower

e. Microclimate and existing urban morphology

With an average speed of 5 m/s and gusts up to 35 m/s, the prevailing wind comes from the south-west-west along the valley of the River Forth and reaches the nearly flat site in an almost unobstructed path, creating a suitable setting for a development focused on wind energy generation.

The sun can shine for 17 hours 30min in summer at a maximum angle of 57 degrees, while in winter it is only visible for 7 hours at a minimum angle of 10 degrees. In Edinburgh, temperature usually remains above 0 with an average temperature in winter of 3 degrees and in summer of 14. Rainfalls are generally heavier during the summer month

with 65 mm in July, August and September, while in February, March and April it remains around 40 mm on average.

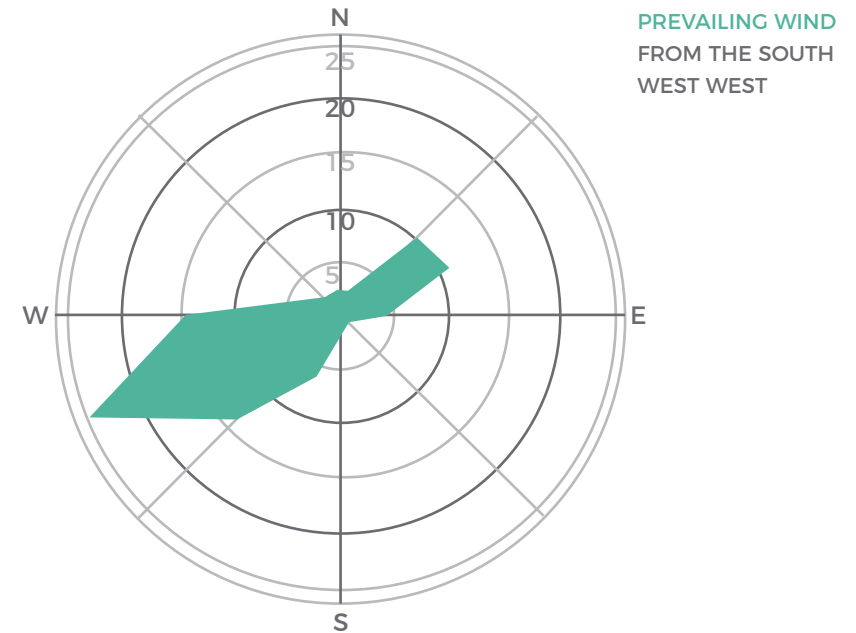

Fig. 18. Leith wind rose : yearly distribution in %

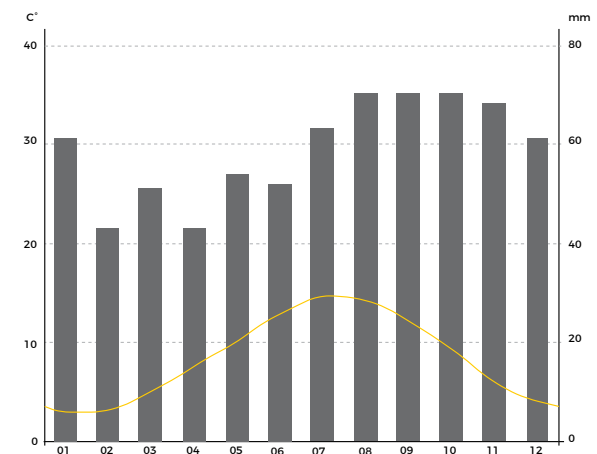

Fig. 19. Average temperature and rainfall per month in Edinburgh

The urban morphology in the historical part of Leith gives clues regarding the microclimate. Bernard street, located at right angle compared to the Shore on the east-west axis has a narrow entrance on the west and widens towards the east (fig. 20). In January, the sun directly hit the south façade at 12 and buildings protect from the prevailing wind. It is a very attractive street where many shops are located. Nonetheless, it is open to traffic and the sidewalks are narrow which can makes the street very uncomfortable at places. The waterfront along the Water of Leith is usually windy, however, the blocks and courtyard do protect against the gusts. Blocks are relatively small and compact with narrow pathways and streets.

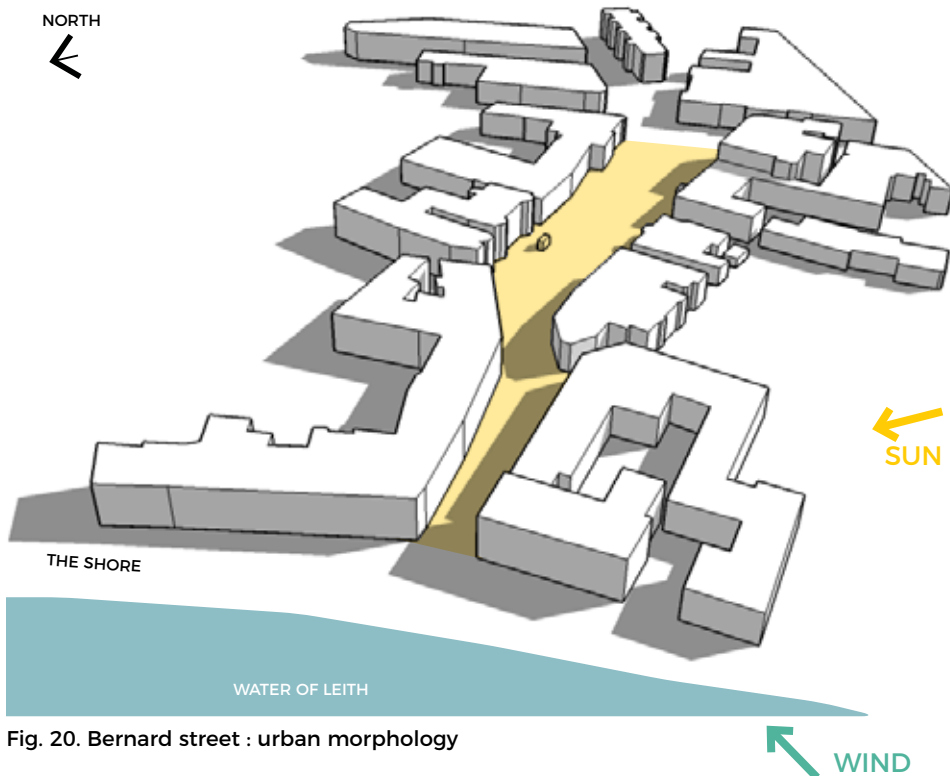

Fig. 20. Bernard street : urban morphology

f. Existing connections

As explained earlier (3.3, c.), Leith is disconnected from the Forth and it is more apparent when looking at connections within the site. Being mostly industrial, the north of the site is closed to the public and roads end at the northern edge of Leith, 350M from the Forth. The paths that continue are narrow and rudimentary. There are no public roads or pathways through the north of the site. Only disused train tracks coming from Portobello in the east reaches the middle of the area. The inaccessibility and the lack of permeability shapes a large barrier between the city and the sea. A large trunk road goes through Leith and does the connection between the north east and the north west of Edinburgh along the waterfront. The northern end of Leith walk connects to the southern boundary of the site and directly connects to the city centre (fig. 21)

The city has made attempts to reconnect all parts of the waterfront between Granton and Portobello through Leith with a boardwalk for pedestrian and cycle to mirror the Fife coastal path on the other side of the Forth (fig. 12). However, some sections are not continuous. The path reaches the site on the west and eastern boundary without linking with each other.

The Water of Leith walkway, for pedestrian and cycle, follows the river through the city in a nearly flat and continuous path in the greenery. The path reaches the south of the site on the Shore in Leith.

As discussed earlier (3.3, c.), the city had the project to create a tramline going from the airport, passed the city centre and to Leith and Granton. However, the tram has now been built

and only goes to the city centre from the airport. It would have provided the opportunity to better connect Leith to Edinburgh. Currently it is only connected with buses through Leith walk which end their routes next to Ocean Terminal. The route and lengths of time it takes to go to the city centre makes Leith unattractive for businesses and residents. The use of cars is widespread, where most available spaces in historical Leith - courtyard, plazas, street sides - are used for parking.

In 2007, proposals were made to link the two sides of the Forth between Portobello and Kirkcaldy, Fife, to decrease congestion for commuters on the Forth road and rail bridge upstream. The passenger ferry provided a trial for two weeks

during the summer and was very successful. Yet, the project was discontinued.

g. Analysis conclusion, challenges & vision

Some of the main challenges facing the regeneration of the site is the fact that connections within and out of the site, around water and across water bodies are difficult. It greatly lacks permeability. The well implemented identity of Leith with its industrial pride, innovations and art scene is a strong centre of activity to rely on, however, fitting with it could be a challenge. The harbour is partially still active providing jobs and requiring access for different size of boats (cargo, cruise ships and North sea vessels).

Microclimate is both a challenge and an opportunity as the site is open to strong wind coming from the Forth valley. Outdoor spaces can become uncomfortable but it creates a favourable environment for turbines. As seen in the historical Leith, block like urban morphology have been successful. Moreover, the surrounding landscape and the availability of a large array of natural elements - beach, craigs, the Firth of Forth, the Water of Leith and wet docks- makes the site an attractive place. The walks and cycleways reaching the edge of the site - the boardwalk and the Water of Leith - are an opportunity for the place to be better linked to its surrounding landscape and the whole of Edinburgh through various ways.

The vision for the site is therefore to transform the area into a new mixed-use district in its own right, which is able to produce some of its energy from the wind and which offers access to the surrounding landscape with a series of attractive, memorable and comfortable outdoor spaces.

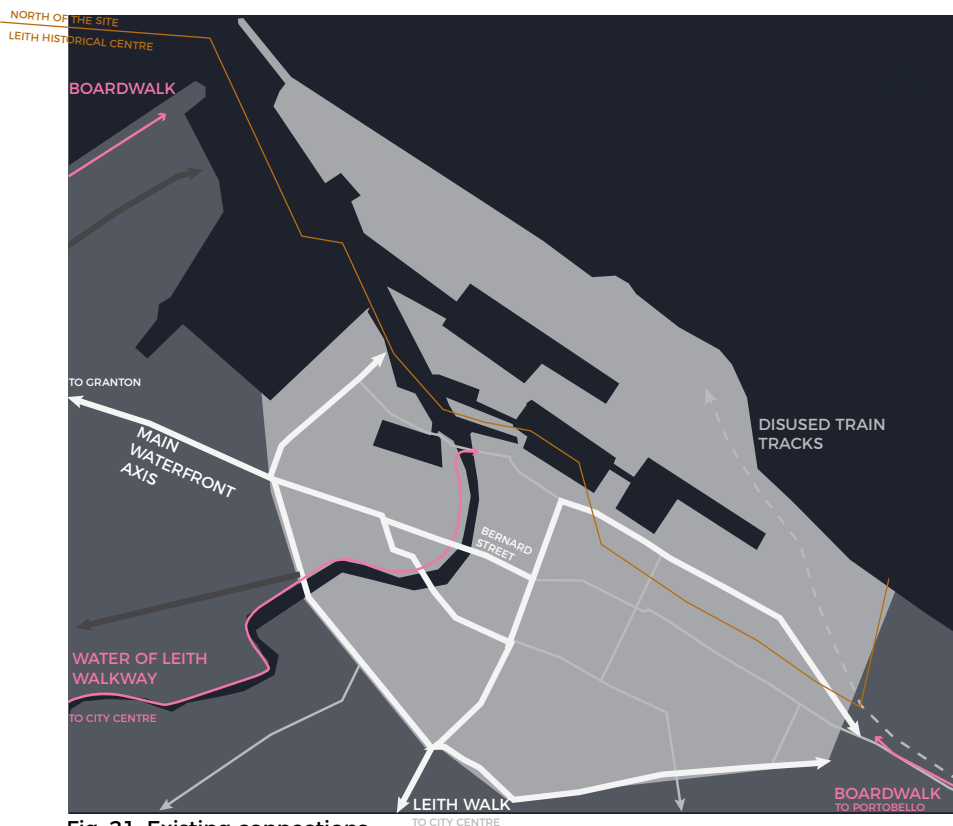

Fig. 21. Existing connections

3.2 Strategy

a. Preserved built structure, current population size

The site has been divided into two different areas: the project area where lies historical Leith and the design area which is the north of the site. No buildings were removed from the project area; however, decision was made to remove most of the buildings in the design area (fig. 22). They are all industrial buildings with materials, scale and roof profile difficult to combine with residential buildings regarding air flow. Their heights, sharp or loose corners and odd-angled roofs were particularly difficult to accommodate. Only two buildings remain: the Martello Tower on the north and the fish market in the south of the design area, because they are only two storeys high. The design area is 115 hectares.



Fig. 22. Preserved built structure

b. Street canyons existing and proposed

As discussed by Oke (1987) and Wang (2015), the 'street canyon' provides a suitable morphology to channel the wind and harness its kinetic energy with urban wind turbines [1] [13]. In the design area, three types of streets were proposed: the boulevard and the secondary are parallel to the prevailing wind and have a difference in width and height. The sunny streets are perpendicular to the wind and provide shelter while letting the sun in (fig. 23).

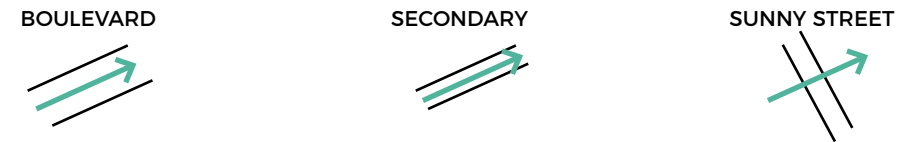

Fig. 23. Three types of street diagrams

Several existing street canyons were found in the project area with good potential for wind turbines and they were sorted by the three streets types proposed (fig. 23). For the boulevard, two examples were found (fig. 24). Leith Walk is a wide, straight and long boulevard enclosed with tall buildings oriented in the north-east and south-west axis with very few trees. Wind can go through this artery very fast and provide a suitable environment for wind turbines. The 22-storey office building on the west of the project area provides an interesting air flow issue. Being located in front of Ocean Terminal which is seven storeys, this tall building creates large turbulences at its base and through the canyon in between the two buildings, like a boulevard.

A few other streets are not necessarily parallel to the wind direction but the enclosure and the lengths of them can provide a suitable environment to frame the wind. They are assimilated to the secondary type of street (fig.24).



Fig. 24. Existing and proposed street canyons

Bernard street, near the Water of Leith, is the equivalent of a sunny street as it provides shelter and let the sun in (fig. 25).

c. Proposed connections

Proposed car accesses make the connection with the project area where existing ones used to end. They cross the design area in the direction of the prevailing wind and reach the

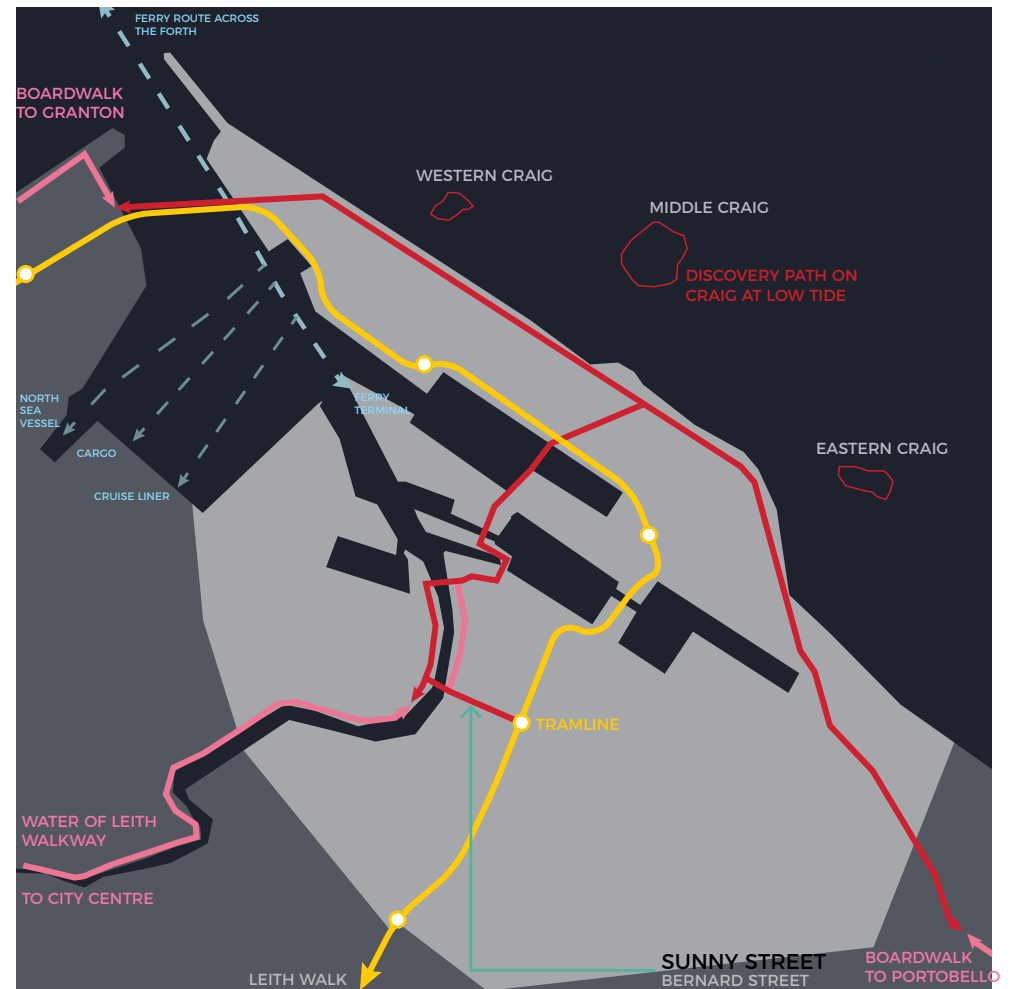

Fig. 25. Proposed connections : Tramline, pedestrian & boat

Forth waterfront. There are three mixed use boulevards connected to Leith through one existing and three proposed bridges over the docks. Six residential secondary streets divide the blocks further. The sunny streets designed as shared streets or home zone cut the blocks in the north-west and south-east axis (fig. 24).

A wide pedestrian link makes connections through the design area between the two ends of the boardwalk, the Water of

Leith walkway and the historical centre of Leith. A pedestrian street is created in the design area to provide safe and easy access in the centre of the site with a new bridge going directly to the Shore and Bernard street, the newly pedestrian street (fig. 25).

The Forth waterfront and the docks are designed to have a different character. The docks enjoy a great orientation regarding the sun and, if protected from the wind, can be a lively place. To further develop this potential, the docks are for pedestrian and only a tramline go through it. The discontinued proposal from Edinburgh city council for a tramline connecting the waterfront to the city centre is developed on site and it connects from the existing tramline to Leith, through the docks and in direction of Granton. It passes on the waterfront and stops at one occasion near the water and three others within the site.

In comparison, the Forth waterfront only has the sun in the morning in summer and doesn't provide as much potential as the docks. Therefore, it is used for vehicle access.

To provide an even greater multiplicity of choice ^[34], a ferry passenger service is proposed to link both side of the Firth of Forth. The Ferry terminal is planned on site near Ocean terminal and a tram stop. Burntisland, Fife, across the Forth was selected because the harbour is located a few meters away from the train station linking to the north of Scotland. The travelling time from one side of the Forth to the other is assumed to be 30 minutes. It could transform Leith and the proposal not only as a destination but also as part of a route.

The harbour is limited to the large dock at the entrance where all boats - cruise liners, cargo and North sea Vessel - can

currently access their final destinations : cruise liner terminal, industries and basis dock. This area can be visible from the site waterfront and offer interesting view on harbour activities.

A swinging bridge is proposed over the lock gates at the entrance of the harbour. The intention is to build it high enough for the passenger ferry being able to come and go several times per day without disrupting the traffic. The bridge would only open for all other boats which requires access to the harbour and which are too tall.

d. Block design : CFD analysis

The blocks defined by the street are on average 100M x 200M and are divided into several sub blocks defined by sunny streets and pedestrian paths. The lengths of the buildings never exceed 60M.

The blocks are designed in the same way as Bo01 and as Oke (1987) described: to divert the wind above the buildings and let the sun in, even in winter ^[13]. The block structure was developed through trial and refinement with the wind flow software CFD to properly act on the air flow as wanted. The wind does in fact divert above the buildings with an average wind speed outside the block at a height of 1.75M of 6 m/s and within the block of 1.5 m/s. In Bo01 the axis of the prevailing wind and the sun at its zenith are at right angle which makes a perfect opportunity to provide spaces in the sun sheltered from the wind even in winter. Nevertheless, in Port of Leith, the site's microclimate does not provide such great opportunities. The axis of the prevailing wind and the sun are at an angle of 60 degrees. Therefore, the study looked at three times of the day - 10AM, 12PM and 2PM - to

understand the impact of the shade in winter on outdoor spaces. The aim was to provide outdoor spaces where the wind is calm and to maximise solar access between 10AM and 2PM in parts of the streets, courtyards and public spaces. With this block design, analysis of the urban morphology alone shows that the wind is in fact going through the street canyons and has different layers of intensity (fig. 26, 27, 28 & 29): at 2M high along the facade the speed is 1.5 m/s, and at 6M in the middle of the street, it is around 6m/s. This gives the potential for a dual quality in the street with a vertical zoning. Associated with the optimisation array of VAWT discussed in chapter 2 (2.5) [33], the bottom of the street can be for pedestrian with a relatively calm wind controlled by vegetations and the higher part of the street could be for wind turbines producing energy. The concept of the project is derived from this statement (fig. 30).



Fig. 27. Block study : air flow and shade at 12 pm in winter

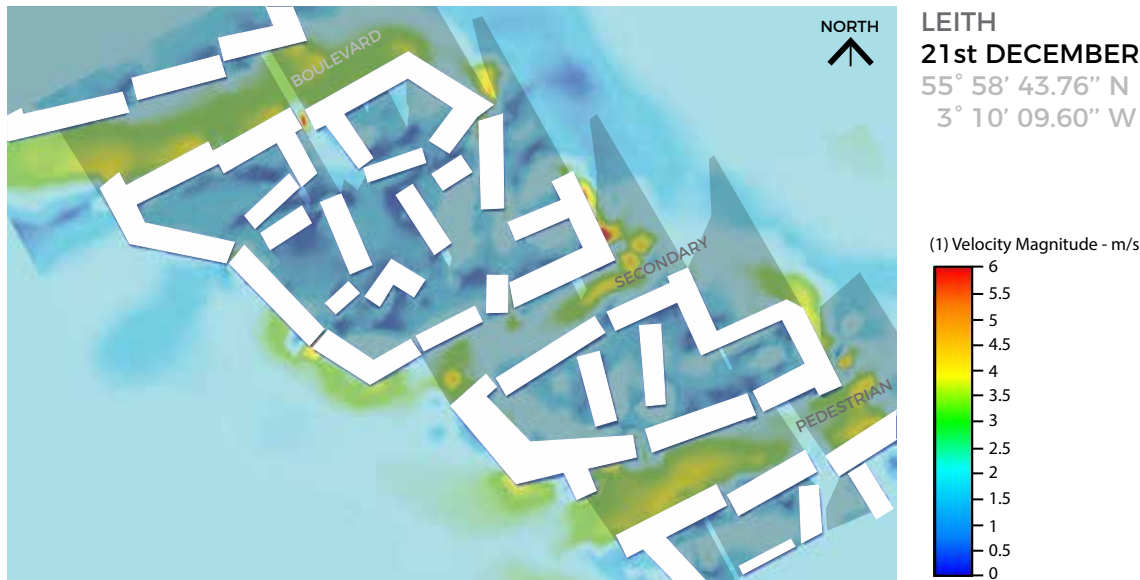

Fig. 26. Block study : air flow and shade at 10 am in winter



Fig. 28. Block study : air flow and shade at 2 pm in winter

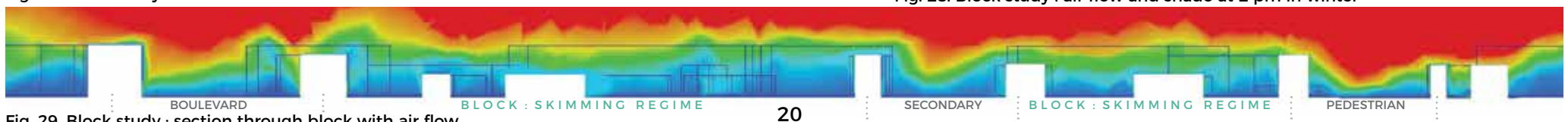

Fig. 29. Block study : section through block with air flow

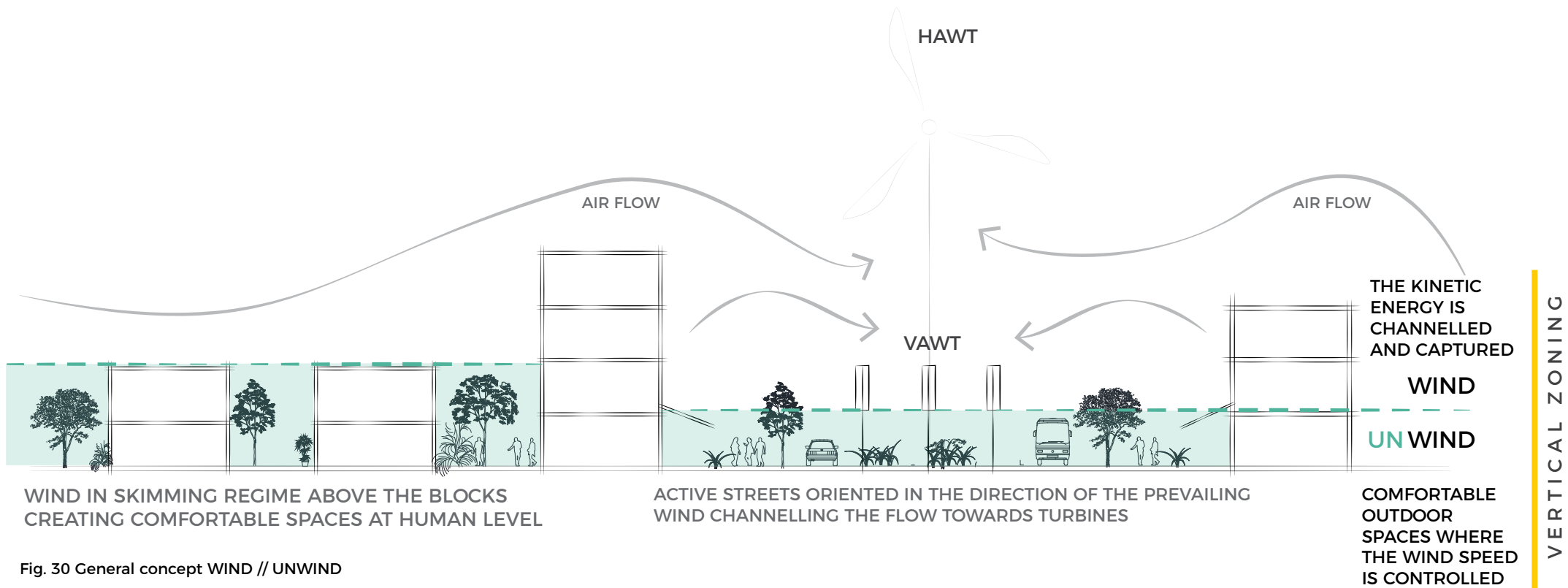

Fig. 30 General concept WIND // UNWIND

e. Energy needs and produced

POPULATION AND YEARLY ELECTRICITY NEEDS

Average energy consumptions are calculated every ten years in the UK and in 2011, the average electricity consumption per household in the UK was calculated at 3,300 KWh per year^[35].

There are 10,150 people already living in the project area and the proposal is expected to create 4,200 residential units in the design area. According to statistics collected by the national census in 2011, household in Edinburgh have an average size of 2.04 people ^[36].

$$10,150 / 2.04 = 4,979$$

The project area has therefore an average of 4,979 households

$$(4,979 + 4,200) \times 3,300 \text{ KWh} = 30,290,700 \text{ KWh/year}$$

The electricity needs of the total population is 30,290.7 MW per year

YEARLY TOTAL PRODUCTION OF TURBINES

With the network of street canyons existing and proposed, the optimisation array of three VAWT defined by Brownstein et al (2016) has been installed on site both in the design and project area to better connect the two ^[33]. There are 1,089 1.2KW VAWT in total on site. The performance of these

turbines being relatively low compared to other HAWT, they are combined with six 1.6MW HAWT located 250M to reduce the noise and vibrations of the rotor, on or near the crags to the north of the site in front of the boulevards and the pedestrian street to create a focal point (fig. 31).

Since the wind is not continuous through the year, the turbines will never turn at a stable speed and produce a constant amount of electricity. This is called the annual output or capacity factor. The annual output varies depending on location and the type of turbine. All different types of turbine are said to have an annual output in between 20 and 40% [1]. Knowing the exact number in this location would require site testing with adequate equipments. Therefore, the annual output of both HAWT and VAWT are assumed to be at 35% because of the urban morphology which would theoretically help the air flow.

$6 \times 1.6\text{MW} \times 365 \text{ days} \times 24 \text{ hours} \times 35\% \text{ annual output} = 21\,024\,000 \text{ KWh/year}$

The total energy produced by the six HAWT is 21,024 MWh per year.

$1\,089 \times 1.2\text{KW} \times 365 \text{ days} \times 24 \text{ hours} \times 35\% \text{ annual output} = 4\,006\,640 \text{ KWh/year}$

The total energy produced by the 1,089 VAWT is 4 006.64 MWh per year.

According to Brownstein et al (2016), the optimisation array could potentially enhance the performance of VAWT by 30% [33].

$4\,006\,640 \times 30\% = 5\,208\,640 \text{ KWh/year}$

The total energy produced by the optimised 1,089 VAWT is

5,208.64 MWh per year.

The total energy produced from the wind turbines on site is 26 332.64 MWh per year. The electricity needs of the total population being 30,290.7 MW per year, the percentage of it produced on site from the wind is assumed to be 87%. The electricity needs of the population could reduce over the years and other renewables could be used to complete the production or provide clean electricity to non-domestic uses^[9].



Fig. 31. Wind turbines organisation on site



Fig. 32. Part of Landscape Plan 1 : 6000

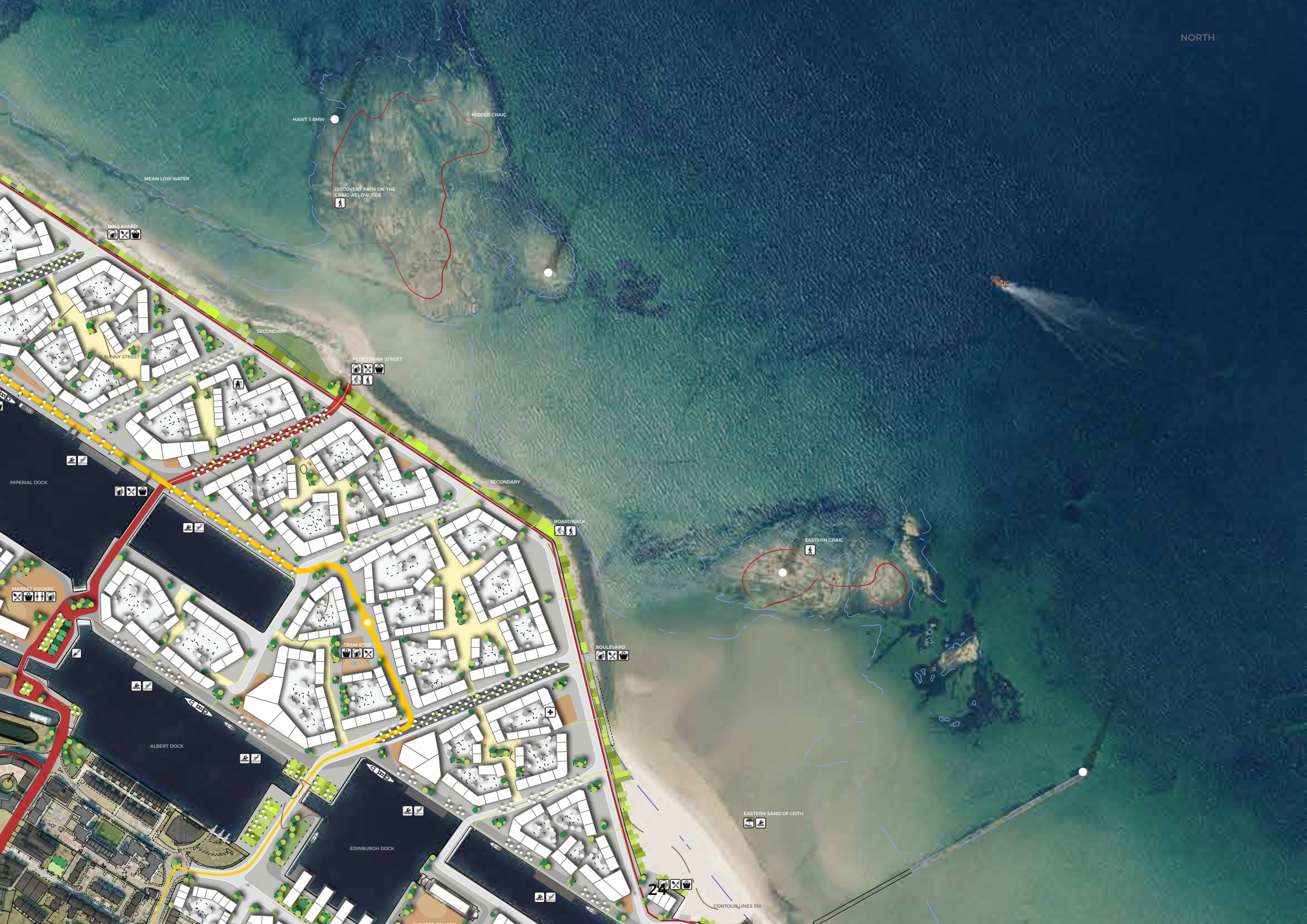

HAWT 1.6MW

MIDDLE CRAIG

MEAN LOW WATER

DISCOVERY PATH ON THE CRAIG AT LOW TIDE

BOULEVARD

SECONDARY

SUNNY STREET

PEDESTRIAN STREET

SECONDARY

BOARDWALK

EASTERN CRAIG

IMPERIAL DOCK

MARKET SQUARE

ALBERT DOCK

EDINBURGH DOCK

BOULEVARD

EASTERN SAND OF LEITH

24

CONTOUR LINES 5M

3.3 Design principles

In order to best illustrate the proposal, three scales aim to capture its qualities, the landscape connection and the wind strategy. The landscape plan defines the connection to Leith, Edinburgh, the rest of the waterfront and the landscape (fig. 32). The masterplan details the relation between street canyons and blocks (fig. 36). The detailed plan describes the quality of the streetscape with the integration of the turbines and the outdoor comfort strategy (fig. 37).

a. Overall site programme

The proposal provides 4,200 residential units with a mix of flats and houses organised around a shared courtyard with playpark, bike sheds, BBQ area, resting places, All houses and ground floor have a front and back garden to provide intimacy as well as access to the courtyard. Flats have balconies looking over the courtyard or the Forth waterfront to provide a private outdoor space. This is an average of 36 units per hectare with a density of 7,380 inhabitants per km² in the design area, compared to a density of 8,464 inhabitants/km² in the project area (Leith centre). In addition of residential units, the sites also include 150,000 m² of retail, grade A offices and creative industries spaces, a museum, a theatre, hotel, schools, nursery, medical centre, transport hub, located around transport nodes, next to public places or along the boulevards.

A large park is proposed on the eastern edge of the site to create a buffer with the sewage treatment facility and offer a continuity with Leith Links towards the Forth (fig. 32).

b. Wind strategy

The street canyons are proposed to harness the wind energy but their design has to compromise between the performance of turbines and the comfort of people. The aim is not to stop the wind for people to feel comfortable but rather to control it at pedestrian level (1.75M). Study in the roof profile of the street canyons and the blocks defined issues that could greatly worsen the comfort of people in the street. Therefore, all buildings proposed are mono pitched, made of zinc to reduce the porosity and parallel to the wind to divert it well above the urban canopy layer instead of directing it back down in the street where it would become trapped and create further turbulences (fig. 33).

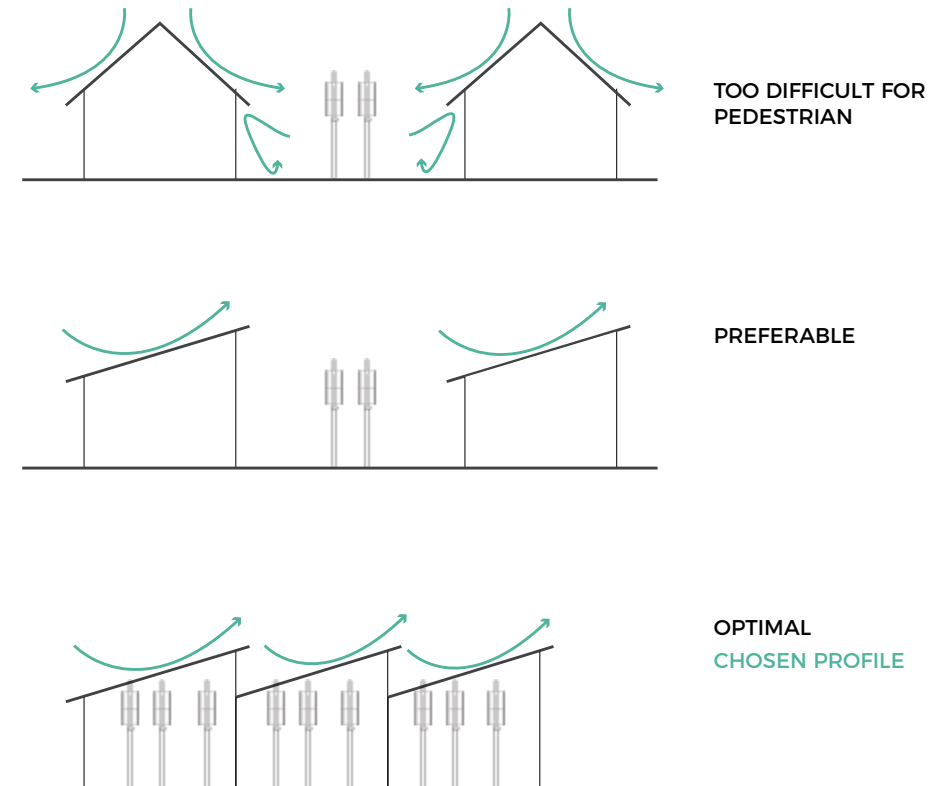
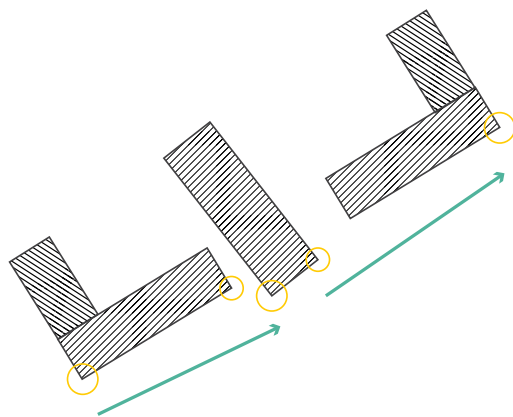

Fig. 33. Roof profile study of airflow

Buildings are at slight angle from each other to divert the wind towards the middle of the street and away from the façade. This organisation creates areas near the façade fully protected from the wind and which can be in the sun depending on the time of the year. Pocket parks or terraces are organised in these places to offer comfortable and attractive spaces (fig. 36).

Vegetations is used along the street to slow down the wind in the corners of buildings, at the entrance of the streets and buildings or near the gaps between buildings. Within the blocks, bushes and trees are located near gaps, corners and in the middle of the courtyard to ensure the wind stays above the block (fig. 36).

SHARP CORNERS CREATE TURBULENCES, ESPECIALLY IN A STREET ORIENTED IN THE PREVAILING WIND DIRECTION



CHAMFERED CORNERS HELP IMPROVE THE AIR FLOW.

CORNERS WHICH WERE POINTED OUT BY CFD AS CREATING TURBULENCES HAVE BEEN CHAMFERED ON THE MASTERPLAN

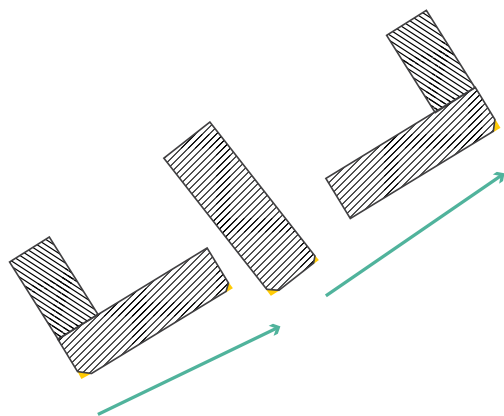

Fig. 34. Corner study of airflow

c. Street design

The three types of street are designed with an average ratio of 1:3 or 1:2, with a minimum height of 6M and comply with Wang (2015) specification of the street canyon [1]. The minimum height of buildings also ensure to frame the VAWT which are 6M high (fig. 35). Boulevard are meant to be mixed use with cafes, restaurant and offices on the ground floor and flats in the upper floors. Secondary streets are residential with front garden at street level to provide a transition space between the streets and the dwelling and also control the wind with vegetations (fig. 39, 40 & 41).

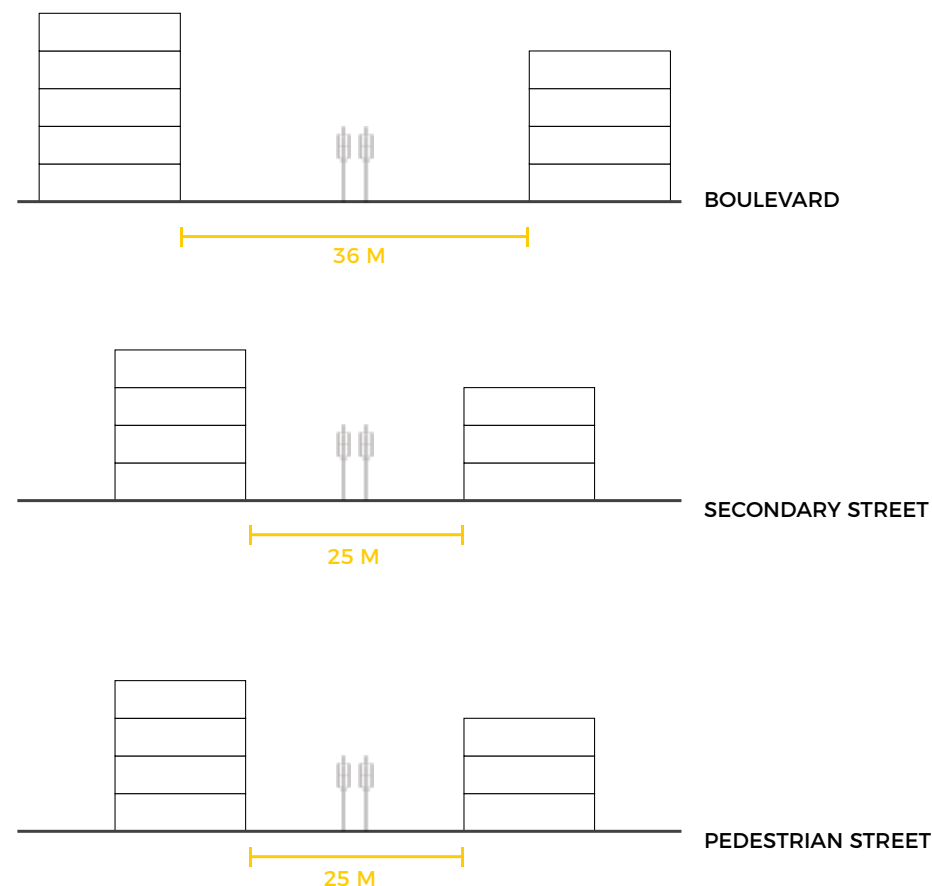
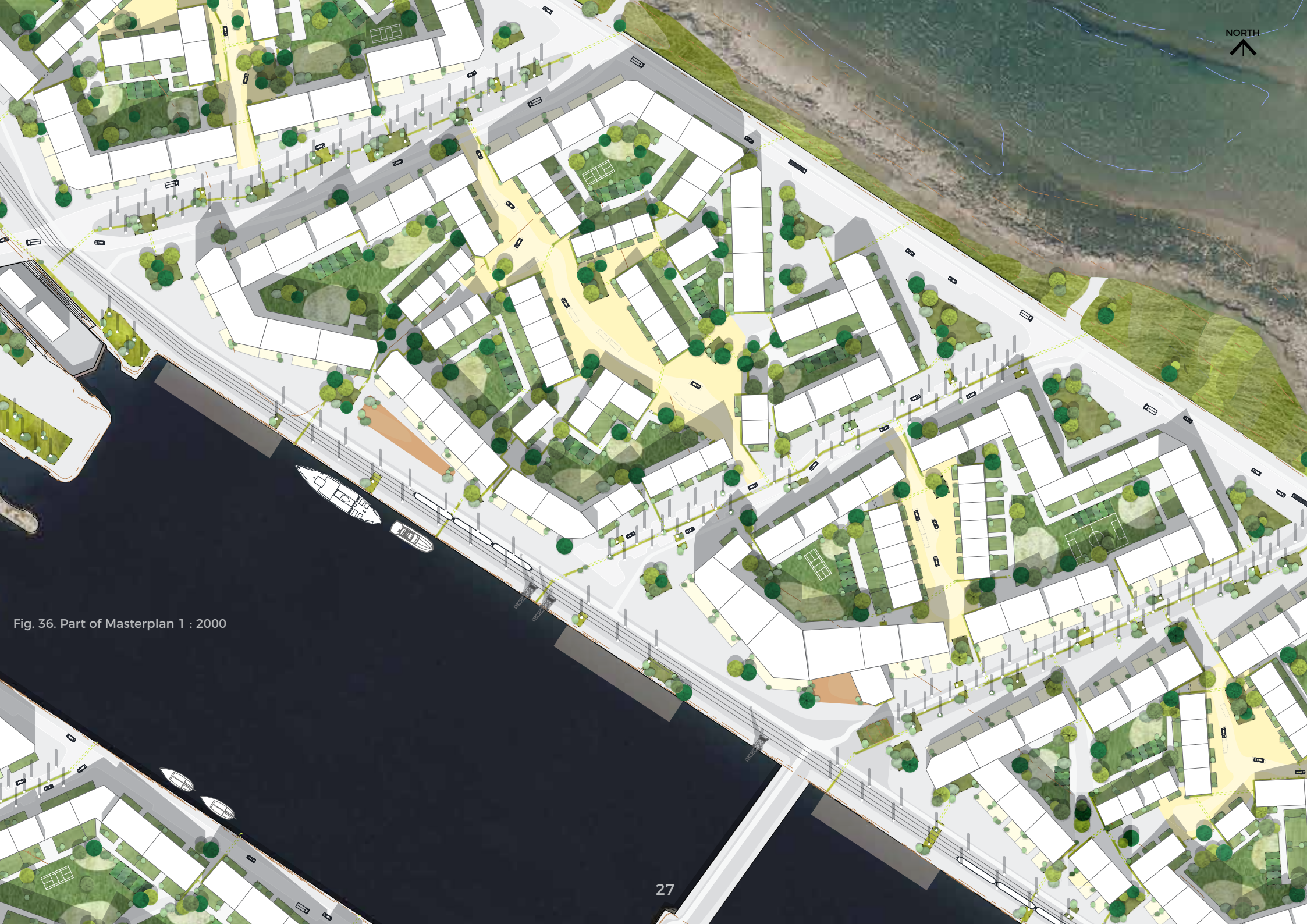

Fig. 35. Three streets types ratio



NORTH
↑

Fig. 36. Part of Masterplan 1 : 2000

HEAR, SEE, FEEL

Multisensory relationship with space the wind



ROUGH SEA



OCEAN GRASS



AUTUMN LEAVES

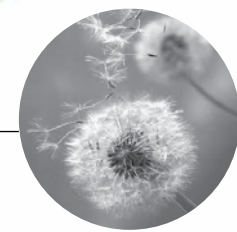

POETIC FLORA REVEALING THE WIND



LAUNDRY DANCING ON THE LINE

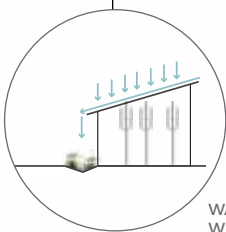

WATER DRAINAGE PAIRED WITH ROOF PROFILE

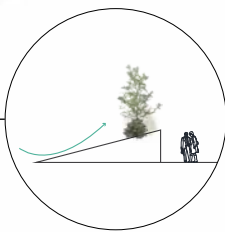

WIND CONTROL THROUGH MODIFICATION OF THE TOPOGRAPHY

Fig. 37. Detailed plan 1 : 1000

While the top of the turbine is mainly for producing electricity, the bottom 2M will have most impact on people. Indeed, defined by Galil et al (2016) as an element within the enclosure [2], the VAWT create an edge within the public realm. Turbines identify areas to stop against, next to, play around or put things next to [37] (fig. 38). Combined with vegetation, it can create a new room within the streetscape to observe the environment, protected from the wind and in the sun. At the same time the turbines can reduce the amount of vertical elements within the streets and integrate other purpose : street lights, decorations, tram wires, signs, etc. The intention is to render the VAWT a natural part of the street.

d. Character

The proposal aims to be a succession of spaces with different characters, relation to the wind, views and proximity to nature. Set close to a wide array of landscape the urban morphology

frames, hide or reveal the landscape around. The waterfront on the docks and on the Forth give a different access to water (fig. 42 & 43). While the docks are a hard edge dropping down to floating platform and to the water, the Forth provides a soft slope through ocean grass, to the beach and the water. Three large docking cranes were preserved on the docks and give a link to the passed history of the place and add to the special character of this side of the district.

Discovery pathways on the craig in the north of the site are only accessible at low tide, bringing the notion of temporality (fig. 32). From the isolated spot, people can look at the city, appreciate the size of the Firth of Forth or get closer to the HAWT. As well as the already available landscape, pockets park are located at different corners of the urban fabric to offer calm areas and restful places where people can survey the street and look at the activity.

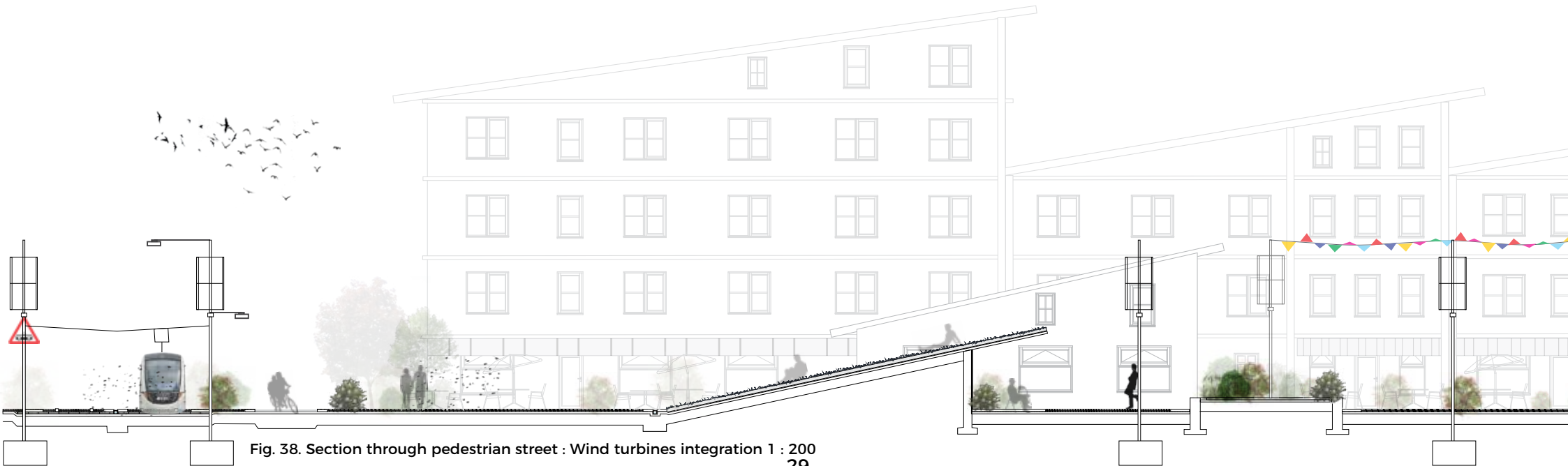

Fig. 38. Section through pedestrian street : Wind turbines integration 1 : 200
29

e. Wind and our senses

Integrating wind turbines in the city should not be reduced to create a singular relationship between people and the wind as consumer and producer of electricity respectively. The new district aims to offer different opportunities for people to relate to the wind in different manners - hear, feel, see - to create a more meaningful and multi-sensory relation with the wind and enrich people's experience of the urban ^[38] (fig. 37). The wind is an invisible force revealed by the movement it induces on other objects. Looking at birds playing in the wind, the waves crash on the shore or the laundry dance on a drying line. Hearing it roar through narrow corridors, sweep around the autumn leaves in the street or whisper through tall grass moving from one side to the other. Feel the pressure of a strong gust in a stormy day and battle the wind to stay upright or appreciate the calm breeze of the air on the skin on a dry day.

Therefore, most of the trees are deciduous to offer this relation with the leaves falling down in the fall. Some have to be evergreen to continue to provide wind protection even in winter. Views are maximised to take advantage of the sea and the shore on a calm or on a stormy day. The edge with the Forth is softened with a range of ocean grass dancing with the wind. A water drainage system is combined with the roof profile to direct the water to the sea. They are swales with tall grass and shrubs to act on and reveal the wind as well as dealing with water.

The swales could be an indicator of the power of the wind in some spaces and give clues to people. They can then choose which path to go through depending on their mood and the intensity of the wind they prefer to feel. Tall grass elements are also paired with wind turbines in the street to contrast with their rigidity (fig. 36 & 37).



meter/second

meters

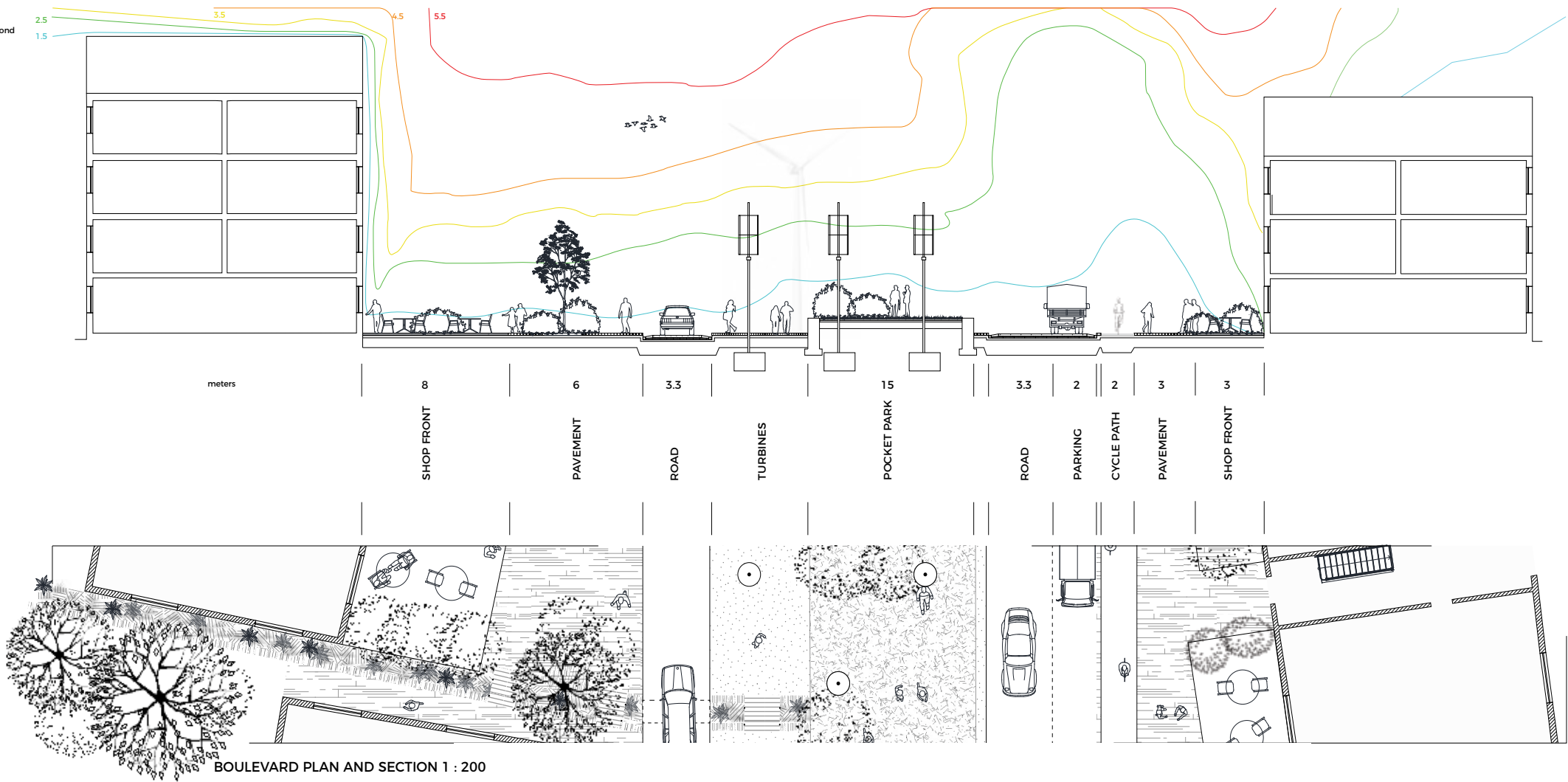

Fig. 39. Section plan through boulevard 1 : 350

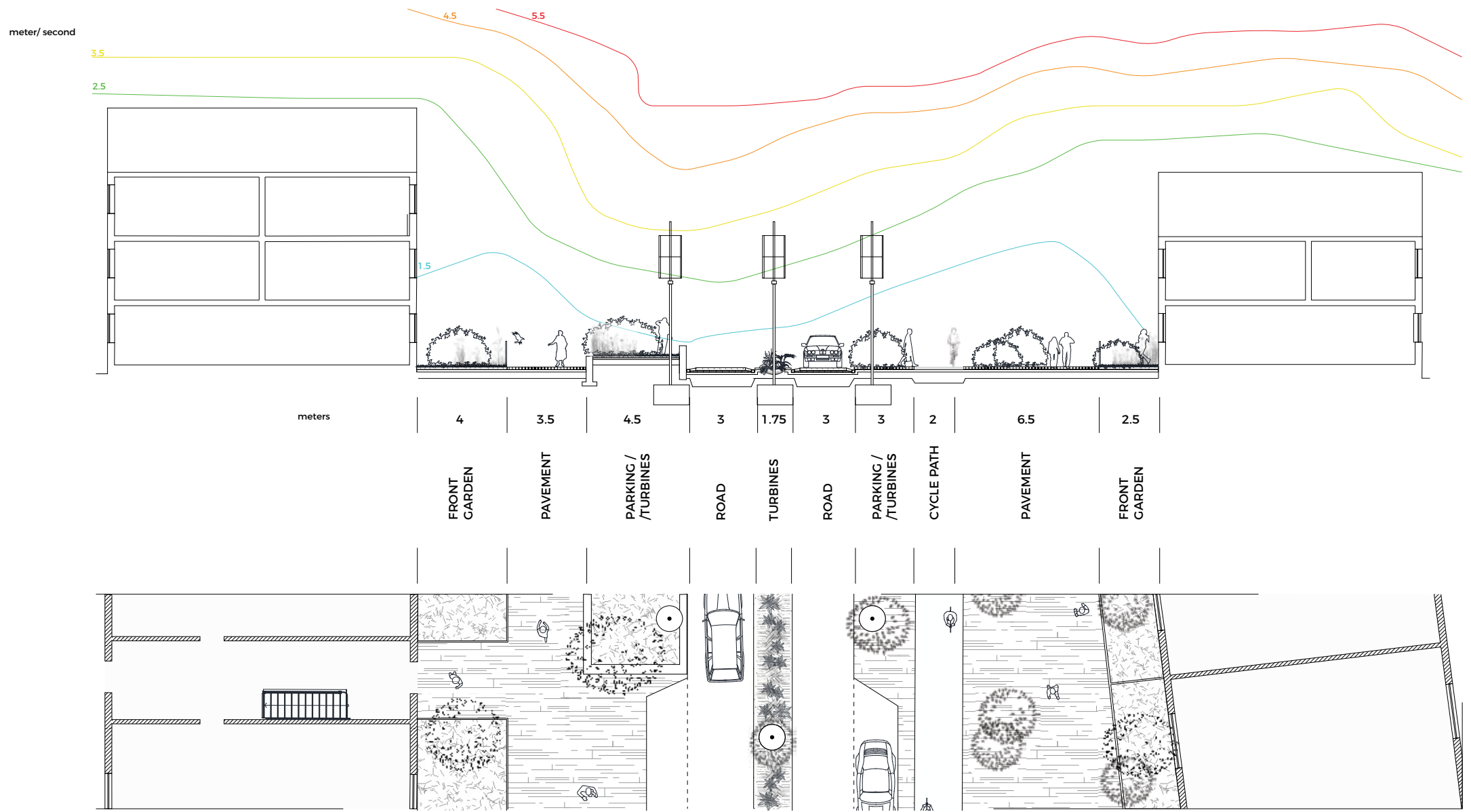
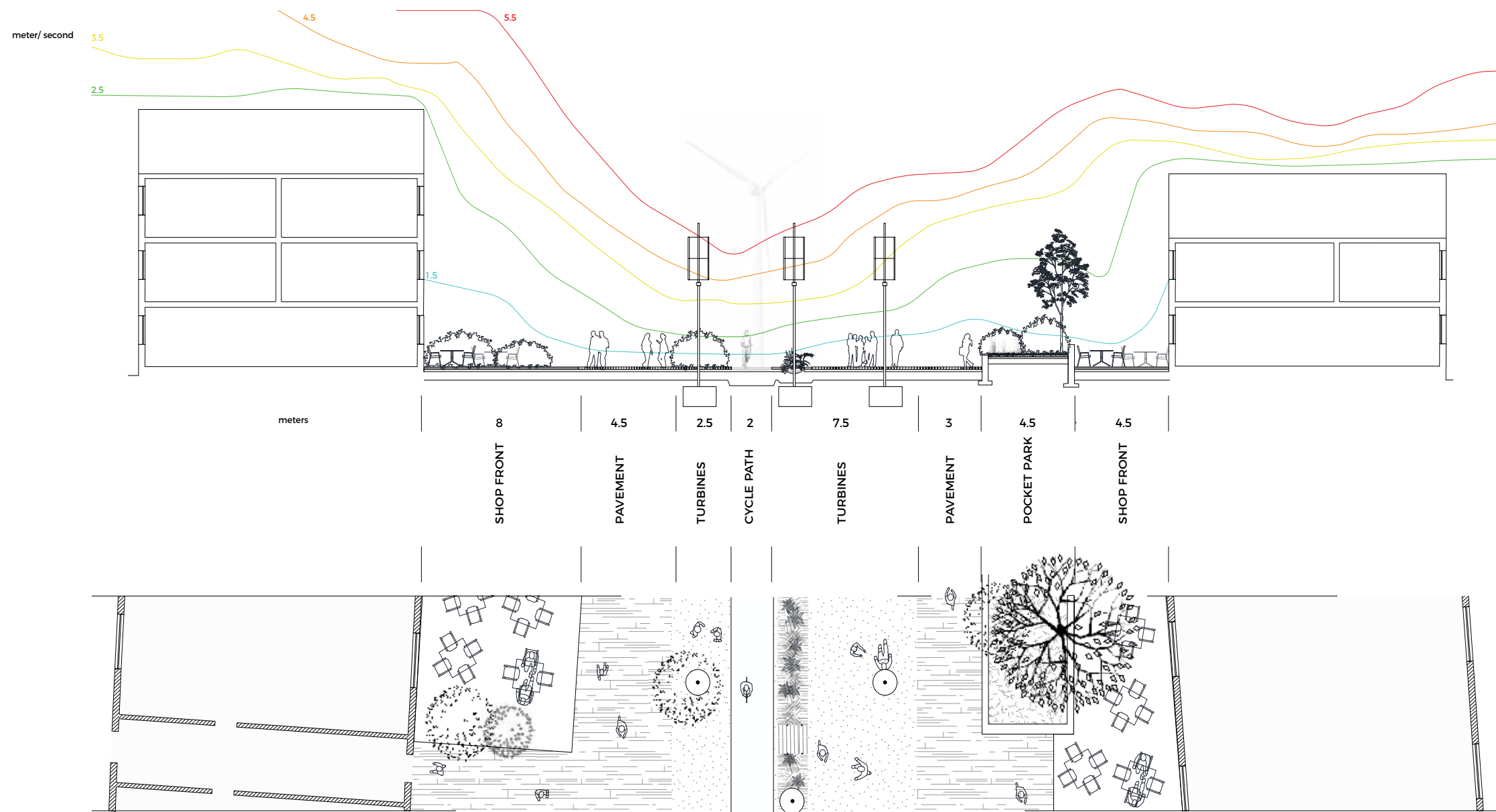

Fig. 40. Section plan through secondary street 1 : 250



PEDESTRIAN STREET PLAN AND SECTION 1 : 200

Fig. 41. Section plan through pedestrian street 1 : 250

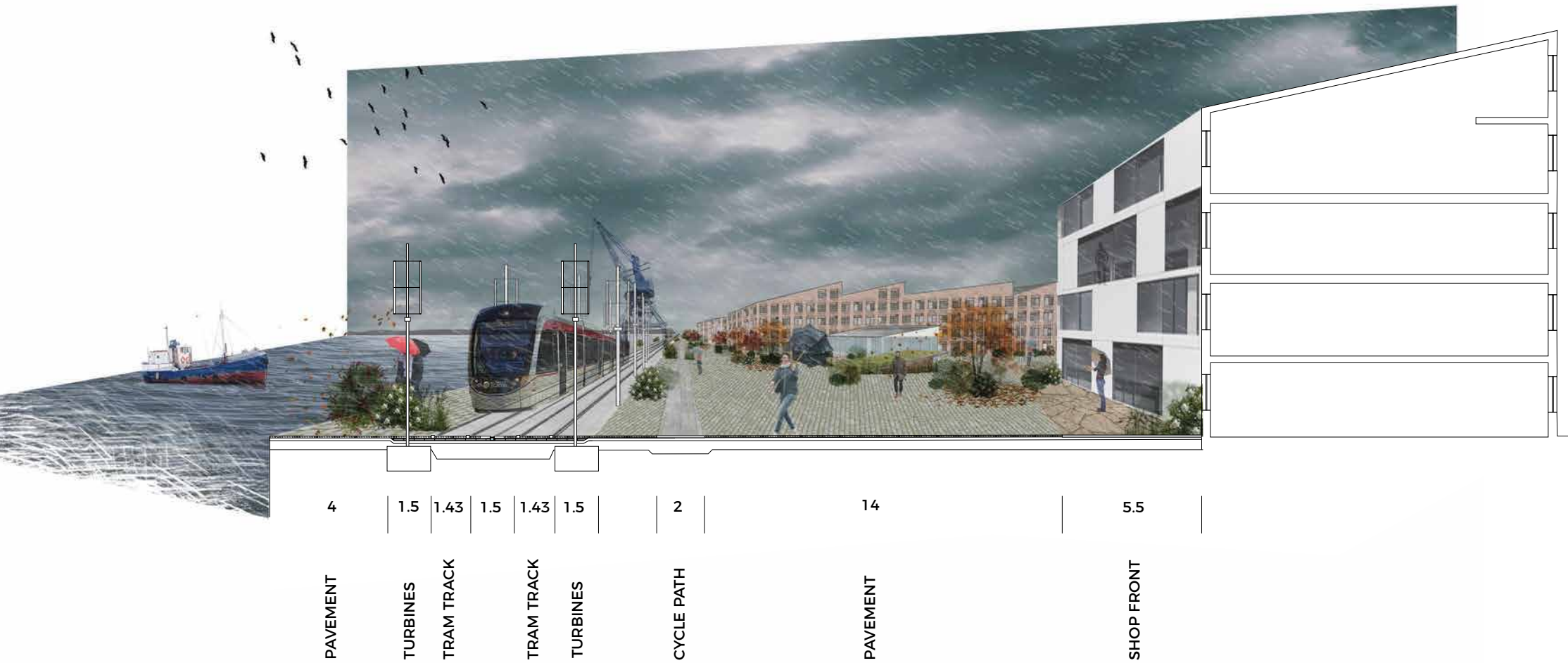

Fig. 42. Section collage dock waterfront 1 : 200



Fig. 43. Section collage Firth of Forth waterfront 1 : 200



6.5

2

5

ROAD

CYCLE PATH

PAVEMENT



Fig. 44. Physical model of the entrance of the pedestrian street 1:200 : street canyon view



Fig. 45. Physical model of the entrance of the pedestrian street 1:200 : bird's eye view

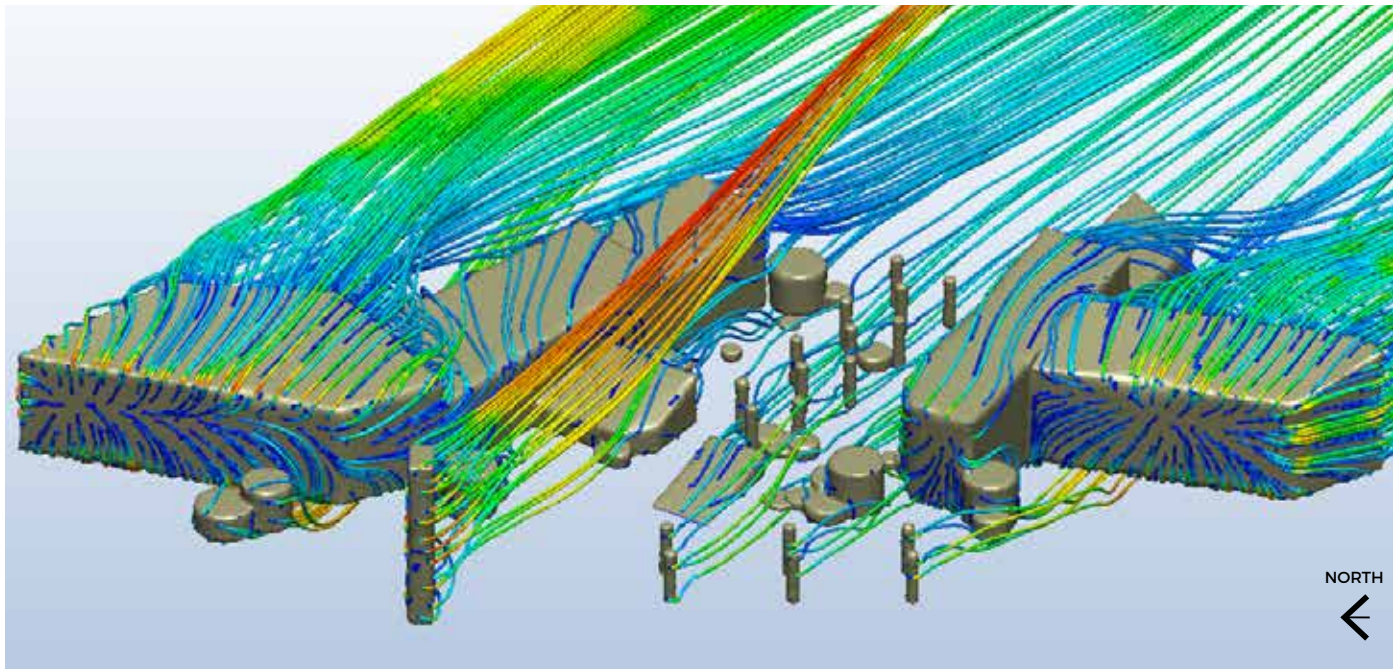

Fig. 46. Detailed air flow through the entrance of the pedestrian street

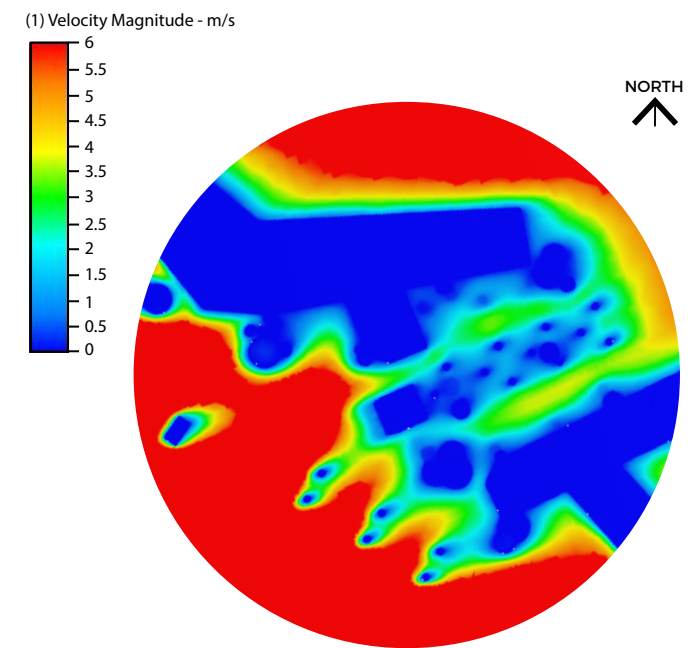

Fig. 47. Air flow at pedestrian level (h=1.75M) the entrance of the pedestrian street

f. Resident weekly routine:

In order to give a feel of what life could be in the new district, a fictional character is created and her story imagined: Mary, 25, lives in a flat overlooking the Firth of Forth. While having her breakfast, she enjoys the morning light over the water with large container ships breaking the waves and the tall wind turbines slowly turning in the haze. She works in a publishing firm on the first floor at imperial dock and she can see the tram going pass from her desk and the cruise liner slowly docking at the terminal.

If the sun is out at midday, she has her lunch break on the dock. Her favourite spot is in the corner of a building in a small quiet pocket park from where she can see without being seen, people walking, or sitting down on the edge of the water or at the terraces, seagulls trying to grab their crumbs from the table, children running around.

After works she goes to meet some friends at their usual place in Albert dock where if it's sunny they would sit outside. At the weekend, she likes to go for a stroll on the beach, meet friends in a café on the boulevard or read a good book in the sun in the quiet courtyard of her building. She also like to go cycle along the boardwalk to Portobello for the Arts shows. On the Saturday night, she prefers to go to the Edinburgh Dry Dock theatre. Even late after a good night, she knows she can find her way back home following the turbines along the street.

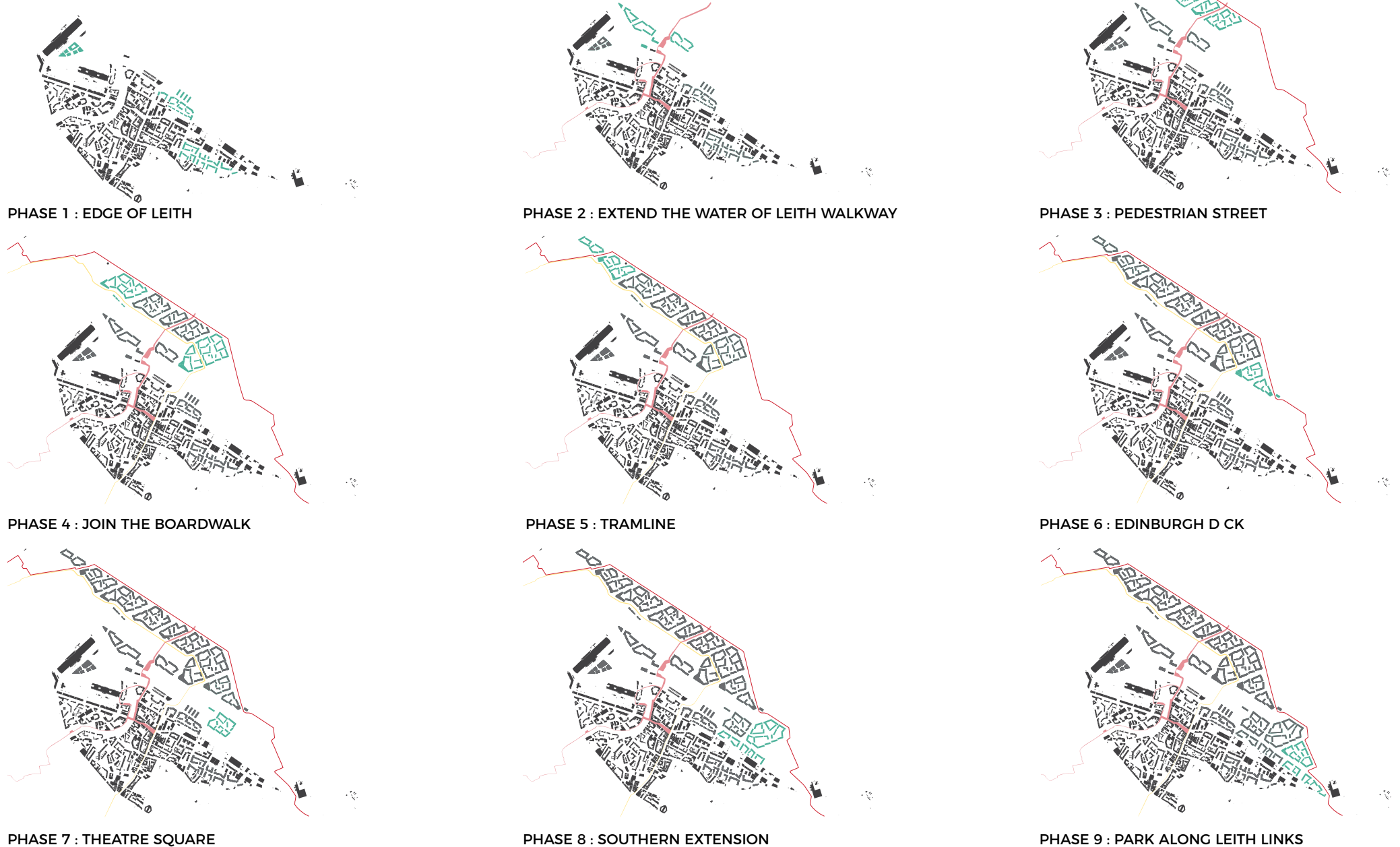

Fig. 48. Weekly routine map for Mary

g. Phasing

Fig. 49. Phasing diagrams 

The phasing strategy focuses on the pedestrian axis and the tramline to develop around these corridors and make the transport plan viable



Chapter 4: CONCLUSION

The thesis aimed to examine the conflicted relationship between generating wind energy and creating comfortable outdoor spaces within the urban fabric. The research was underpinned by three objectives which were, first to define the characteristics of a comfortable outdoor space encouraging lengthy outdoor stay, secondly to determine the opportunities for wind energy generation in the urban scale and lastly to illustrate the findings with a proposal for the Port of Leith with wind turbines integrated.

4.1 The characteristics of a comfortable outdoor space

Outdoor comfort is a crucial dimension of urban design. The idea to be protected from the weather by the urban morphology can provide lively spaces and enrich the city experience: Being protected from the wind and in the sun, is the best combination to enjoy a space. For centuries, settlement have been built regarding local climate and with constant refinement, provide comfortable outdoor microclimate. Low height buildings clustered together, diverting the wind above and letting the sun come in is the best organisation described.

4.2 The opportunities for wind energy within the urban scale

From the literature, it was highlighted that cities have a major effect on air flow and wind turbines have already been included within the urban fabric at a small scale. The effect of street canyons was defined as having the greatest impact on wind energy generation and the VAWT were described as

having the greatest potential to fit the urban environment. In addition, the optimisation array was seen as a good opportunity to enhance the performance of the VAWT and reduce their number within the urban scale.

4.3 Proposal for the Port of Leith

The Port of Leith's proposal was drawn from all the findings from chapter 2 and aimed to develop a successful mixed-use district connected to Edinburgh, its surrounding landscape and generating its own electricity. The new area benefits from a strong transport network providing multiplicity of choice other than the car. A wide array of activities are available to bring people from the district or Edinburgh as a whole closer to the landscape. The wind strategy provides a meaningful network of comfortable outdoor spaces inside and outside the blocks and rich living quarters with shared space to promote the community feeling. The relationship between residents and people was thought to be deeper than between consumers and producers. Various opportunities to connect the wind to people's senses was develop across the site.

4.4 Further thinking

The thesis only focused on the street canyons morphology. Introducing more CFD visualisation of various types of urban morphology in other settings would enrich future research into creating optimal spaces which work for both wind energy generation and for people's comfort. Indeed, such research is necessary to develop cities' abilities to adapt to climate change and over time, render them more sustainable.

Reference list

- [1] Wang, B. (2015) Les impacts de la morphologie urbaine sur le vent: performance d'énergie éolienne à l'échelle de quartier (The impacts of the urban morphology on the wind: Win energy performance at the neighbourhood scale), *Energie électrique*, INSA Toulouse
- [2] Galil, R.A. & Shiqwarah, N. (2016) Suitability of Renewable Energy Technologies in the Public Realm, *Procedia Environmental Sciences* **34**, p. 387-400
- [3] Pagnoni, G.A. & Roche, S. (2015) *The Renaissance of Renewable Energy*, Cambridge University Press
- [4] Smil, V. (2008) *Energy in Nature and Society, General Energetics of Complex system*, Cambridge: AEI Press
- [5] Scottish Government (2015) *Energy in Scotland*, Energy Statistics [online]: www.scotland.gov.uk/scotstat (Accessed on 23rd March 2017) [pdf]
- [6] Scottish Government (2014) *National Planning Framework 3* [online]: <http://www.gov.scot/Resource/0045/00453683.pdf> (Accessed on 23rd March 2017) [pdf]
- [7] Zeng, H. (2011) *Integration of renewable energy with urban design, Based on the examples of the solar photovoltaics and micro wind turbines*, Tsinghua University
- [8] Allen, S.R., Hammond, G.P. & McManus, M.C. (2008) Energy analysis and environmental life cycle assessment of a micro-wind turbine, *Proceedings Institution of Mechanical Engineers Part A - Journal of Power and Energy* **222** (7), p. 669-684
- [9] Lazarus, N. (2009) *BedZed : Toolkit Part II - A practical guide to producing affordable carbon neutral developments*, BioRegional Development Group
- [10] Cajot, S., Peter, M., Bahu, J.M., Koch, A. & Marechal, F. (2015) *Energy planning in the urban context: challenges and perspectives*, *Energy Procedia* **78**, p. 3366-3371
- [11] Barnett, J. (1989) *Redesigning the Metropolis: The Case for a New Approach*, American Planning Association **55**(2), p.131-135
- [12] Ebrahimabadi, S. (2015) *Outdoor Comfort in Cold Climates, Integrating Microclimate Factors in Urban Design*, Lulea University
- [13] Oke, T.R (1987) *Boundary Layer Climates*, 2nd Edition, University Press Cambridge: Routledge
- [14] Carmona, M. Heath, T., Oc, T. & Tiesdell, S. (2003) *Public places - Urban spaces : The dimensions of urban design*, 1 edition, Oxford: Architectural Press/ Elsevier
- [15] Lynch, K. (1984) *Good city form*, Cambridge, Massachusetts: MIT Press
- [16] Gehl, J. (2010) *Cities for people*, Washington, DC : Island Press
- [17] Mehta, V. (2014) *Evaluating Public Space*, *Journal of Urban Design* **19** (1), p. 53-86
- [18] Reiter, S. & De Herde, A. (2003) *Qualitative and quantitative criteria for comfortable urban public spaces*, 2003, In-house publishing
- [19] Lawson, T.V. & Penwarden, A.D. (1977) *The effects of wind on people in the vicinity of buildings*, K.J. Eaton, ed. In: *4th International Conference on Wind effects on buildings and structures 1977*, Cambridge University Press, p. 605
- [20] Blocken, B. & Carmeliet, J. (2004) *Pedestrian wind environment around buildings: Literature review and practical examples*, *Journal of Thermal Envelope and Building Science* **28**(2), p. 107-159
- [21] Bottema, M. (2000) *A method for optimisation of wind discomfort criteria*, *Building and Environment* **35**(1), p. 1-18
- [22] ASHRAE (1981) *Thermal environmental conditions for human occupancy : ANSI/ASHRAE standard 55 - 1981*, Atlanta, Georgia : ASHRAE
- [23] Parsons, K.C. (1993) *Human thermal environments*, London: Taylor & Francis
- [24] Howard, L. (1833) *Climate of London*, 2nd edition
- [25] Brown, R.D. (2010) *Design with microclimate: the secret to comfortable outdoor spaces*, Washington: Island Press
- [26] Sharp, T. (1946) *The Anatomy of a Village, Chapter 1: Characteristics of English villages*, London: Penguin
- [27] Vitruvius and Morgan, M.H. (1914) *The ten books on architecture*, Cambridge: Harvard University Press
- [28] Rykwert, J. (1988) *The idea of a town: the anthropology of urban form in Rome, Italy and the ancient world*, 1st edition, Cambridge, Massachusetts: MIT Press
- [29] Fraker, H. (2013) *The Hidden Potential of Sustainable Neighborhoods, Lessons from Low-Carbon Communities*, Washington: Island Press
- [30] WINEUR (2007) *Aspects socio-economiques et acceptabilité des éoliennes en milieu urbain*, France, project WINEUR
- [31] Beller, C. (2011) *Development of a simulation tool to predict urban wind potential*, in R.J. Howlett, L.C. Jain & S.H. Lee (Eds), *Sustainability in Energy and Buildings*, volume 7, 2011, p.111-120
- [32] Johansen, J., Madsen, M.A., Gaunaa, M., Bak, C. & Srensen, N. (2009) *Design of a wind turbine rotor for maximum aerodynamic efficiency*, *Wind energy* **12**, p. 261-273
- [33] Brownstein, I.D., Kinzel, M. & Dabiri, J.O. (2016) *Performance enhancement of downstream vertical-axis wind turbines*, *Renewable Sustainable Energy* **8**, p 533- 546
- [34] Jacobs, J. (1961) *The life and death of great American cities*, New York : Random house
- [35] OFGEM (2011) *Typical domestic energy consumption figures*, Factsheet 96, 18.01.11 [online]: <https://www.ofgem.gov.uk/ofgem-publications/76112/domestic-energy-consump-fig-fs.pdf> (Accessed on 15th February)
- [36] Edinburgh City Council (ECC) (2013) *Census 2011 Edinburgh : Population, age structure and household overview*, Edinburgh : Planning Information, Planning & Building standards, Services for Communities, City of Edinburgh Council
- [37] Gehl, J. (1996) *Life between buildings: using public space*, 3rd edition, Copenhagen: Arkitektens Forlag.
- [38] Sioström, P. & Xie, H. (2015) *City senses: Hidden dimension of urban places*, Beijing: China architecture of Building press