

Comparison of energy efficiency between macro and micro cells using energy saving schemes

KOUSTUBH SHARMA

MASTER'S THESIS

DEPARTMENT OF ELECTRICAL AND INFORMATION TECHNOLOGY

FACULTY OF ENGINEERING | LTH | LUND UNIVERSITY





Master's Thesis

Comparison of energy efficiency between macro and micro cells using energy saving schemes.

By

Koustubh Sharma

Department of Electrical and Information Technology
Faculty of Engineering, LTH, Lund University
SE-221 00 Lund, Sweden

Abstract

With the rapid development of Information and Communication Technology (ICT) industry the demand for power has also increased. ICT tends to play a significant role in global greenhouse gas emissions. It was responsible for 10% of world's total energy consumption in 2010 and is doubling in every 10 years [1]. Cellular networks are among the main energy consumers in the ICT field.

To have an environment friendly transit into the new era of internet of things, we need to focus on energy consumption by these networks. There are various approaches for densifying the present network that we have; we will compare the approaches to cater to the traffic demands with macro cells versus micro cells deployments.

In the project, we had set up a dense urban real like scenario and compared energy efficiencies between macro cells centric deployment versus a micro cells centric deployment, we made use of energy saving schemes like micro TX, lean carrier and MBSFN to reduce the power consumed in the network.

With results presented in this thesis, we will contribute to the understanding of how these cells behave in a realistic traffic scenario and how much energy saving can we achieve by implementing the above-mentioned schemes. To keep the results more generic and not specific to any particular set of radio base stations, we implemented EARTH power model to calculate power consumption. The energy saving schemes proved out to save a lot of energy in the operations of both macro and micro cells. The amount of savings from these energy saving schemes depend upon the utilization and sleep time of these nodes, The energy saving schemes saved up to 17% of energy in macros and 33% of energy in micros. Comparing macro without energy saving scheme to micro with lean carrier energy saving scheme results in 55% of energy savings. So, from an energy saving point of view, it would be much better to implement a heterogeneous network with more micro cells with energy saving features than just macro cells.

Acknowledgments

I would like to give my sincerest gratitude to all the people at EIT and Ericsson who supported me throughout the thesis. Special thanks to Maria Kihl for her constant guidance and feedback. Also, to Swedish Institute for providing me scholarship to study at LTH and connecting me to 'Network for Future Global Leaders', which helped me to grow as a person on a global platform. Last but not the least to my parents and my brother for their constant support and motivation.

Koustubh Sharma

Popular Science Summary

What if I told you that your usage of mobile phone networks is directly connected to the homeless polar bears. Yes, ICT industry in total is responsible for as much carbon emissions as aviation industry. And, cellular networks are among the main energy consumers in the ICT industry. Last year in Germany alone mobile network operators spent more than 200 million Euros on electricity bills and 80% of that cost was from cellular networks. And, as per the EU regulations the cost of electricity is likely to increase more in coming years.

In the new era of internet of things and connected cars these cellular networks are likely to densify furthermore so, there is a pressing need to focus on energy consumption by these networks. There are various approaches for densifying the present networks; in this project we have made a comparison between macro cells centric deployment versus micro cells centric deployment with respect to their energy consumption. Macro cells are big base stations which consumes a lot of energy from 100W to 450W, but they do provide a larger coverage up to tens of kilometers whereas, micro cells consume lesser energy; up to 150W, but provide limited coverage of a few hundred meters.

We had set up a real like dense urban city scenario with buildings, streets, pavements etc. in our simulator and compared energy efficiencies between these two approaches. We made use of energy saving schemes like micro TX sleep, lean carrier and MBSFN to reduce the power consumed in the network. These schemes basically shut down the cell when there is no traffic load on the base station thereby, saving the energy.

With results presented in this thesis, we will contribute to the understanding of how these cells behave in a realistic traffic scenario and how much energy saving can we achieve by implementing the above-mentioned schemes. To keep the results more generic and not specific to any particular set of radio base stations, we implemented the EARTH power model to calculate power consumption. The EARTH power model gives the generic equations for calculating power consumption in different types of cells.

The energy saving schemes proved out to save a lot of energy in the operations of both macro and micro cells. The amount of savings depends upon the utilization and sleep time of these cells. Using the energy saving schemes in macro cells deployment can give savings as much as 17% and in

micro cells deployment it was around 33%. A micro cell with lean carrier energy saving scheme was 55% more energy efficient than a macro cell without energy saving scheme. So, from an energy consumption point of view, it would be much better to densify a heterogeneous network with more micro cells with energy saving features than just macro cells.

Table of Contents

Abstract	2
Acknowledgments	4
Popular Science Summary	5
Table of Contents	7
CHAPTER 1	9
Introduction	9
1.1 Introduction.....	9
1.2 Background and Motivation.....	9
1.3 Previous Work.....	11
1.4 Purpose of the Project	12
1.5 Outline of the thesis	13
CHAPTER 2	15
Theory	15
2.1 Heterogeneous Networks	15
2.1.1 Macro Cells	17
2.1.2 Micro Cells.....	17
2.1.3 Pico Cells	17
2.1.4 Femto cell.....	17
2.2 LTE Basics	18
2.2.1 OFDM (Orthogonal Frequency Division Multiplex).....	18
2.2.2 MIMO (Multiple Input Multiple Output).....	18
CHAPTER 3	21
Power Model	21
3.1 Power distribution in base station	21
3.2 Power consumed at maximal load	22
3.3 Variable load power consumption of BS	25
3.3.1 Energy consumption references	26
3.3.2 Energy per bit.....	26
3.3.3 Power per unit area	27
3.4 Average power consumption	27
3.5 Average power consumption over a day.....	28
3.6 Energy Saving schemes	28
3.6.1 Micro TX sleep	29
3.6.2 MBSFN sub-frames	30
3.6.3 Lean carrier	30
CHAPTER 4	33
Methodology	33
4.1 The Simulator.....	33

4.2	Setup.....	33
4.3	Deployment.....	34
4.4	Traffic.....	36
CHAPTER 5		39
Results and Discussions		39
5.1	Comparison between macro and micro without energy saving schemes	39
5.2	Comparison of macro with and without energy saving schemes	45
5.3	Comparison of micro with and without energy saving schemes	48
5.4	Comparison between macro and micro with energy saving schemes	51
5.5	Daily power consumption	55
CHAPTER 6		57
Conclusions		57
CHAPTER 7		59
Future Work		59
References		60
List of Tables		62

CHAPTER 1

1 Introduction

1.1 Introduction

Energy plays an important role in our lives, almost every industry depends heavily on energy. In recent times with the rising global temperature and climate change, it is very important to save the energy. With the rapid development of Information and Communication Technology (ICT) industry the demand for power has also increased. ICT tends to play a significant role in global greenhouse gas emissions. It was responsible for 10% of world's total energy consumption in 2010 and is doubling in every 10 years [1]. Cellular networks are among the main energy consumers in the ICT field. With increased need for broadband speed, the demand for energy and density of the networks is likely to increase. High energy efficiency is becoming a mainstream concern for the design of future wireless communication networks.

1.2 Background and Motivation

The global mobile data traffic grew by 63 percent in 2016 [2]. It stood at 7.2 billion Giga bytes per month during the ending of 2016. And by 2021 it will be 49 billion Giga bytes.

In 2016 almost half a billion new mobile devices got added. According to the Ericsson's forecast there will be 50 billion connected devices by 2020.

Since the mobile networks got introduced; the focus has often been on optimizing the network to fulfil the coverage, capacity and quality requirements. On these key requirements; products got developed and

network were deployments. But the focus has shifted a bit during recent years, operators have started to investigate how energy gets consumed in mobile networks. The understanding has increased on how to cut the energy consumption and environmental awareness has gained importance in the mobile telecom industry. The challenge with designing an energy-efficient network is to avoid reducing the quality or coverage.

Around 0.5% of the world energy consumption is from mobile radio networks [3]. In mobile networks; base stations (BSs) are the ones which consume the most amount of energy. Comparing the life cycle of a mobile and base station, a mobile would contribute to green-house gases the most at the time of its manufacturing while for the base station, it is during its life time as a serving node. A lot of research has been done to make mobile more efficient with consuming battery power, but base stations stay behind their counterparts. Radio access network consumes around 80% of the total energy in mobile networks and majorly in base stations which comes around to be 60% of all [3], which stresses on the call for reducing energy consumption at the base station (BS) side.

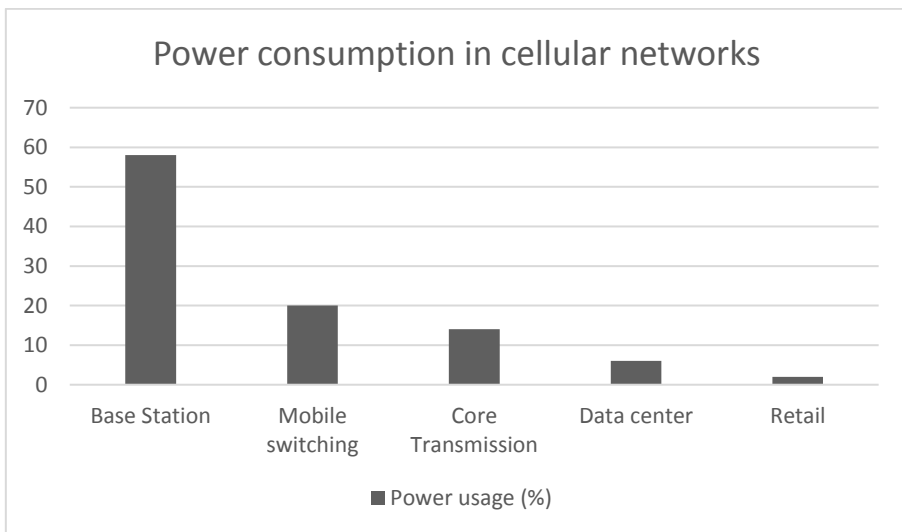

Figure 1. Breakdown of energy consumption in cellular networks [4].

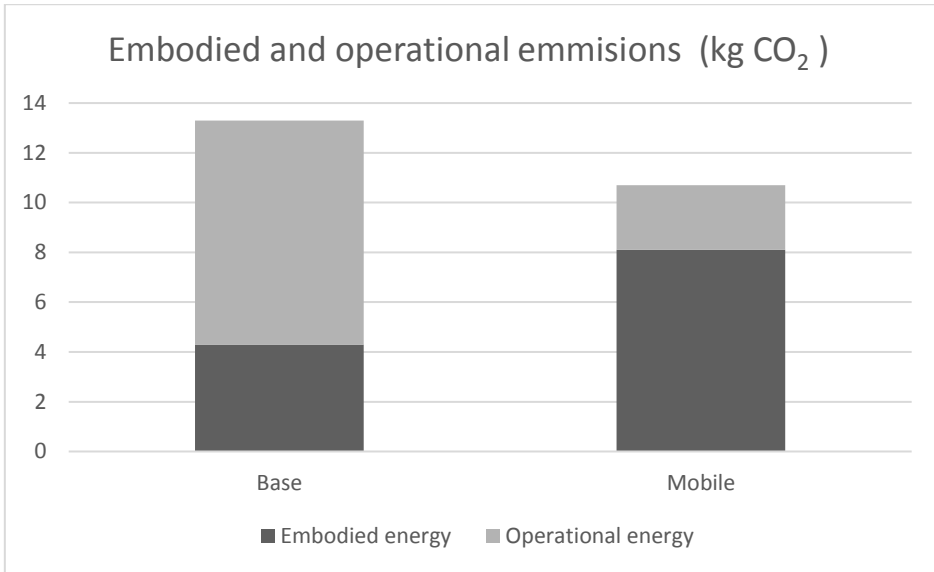

Figure 2. The operational and the embodied CO₂ emissions by base stations and mobile phones per subscribers per year [4].

1.3 Previous Work

There had been various studies related to improvement of the base stations energy consumption. In 2010-2012 a study was conducted under Energy Aware Radio and neTwork tecHnologies (EARTH) project [5] in which researchers from around the world tried to achieve deliverables which proved to become standardized principles for working on energy efficiency concepts for base stations.

The EARTH project gave the mathematical power model for calculating the energy consumption in the base stations in various scenarios of rural, sub-urban and dense urban. The project developed a linear power model which could be used in generic simulations. It also gives the internal breakdown of energy consumed within different sizes of nodes such as macro, micro, pico and femto.

In [5], the study was conducted to break up the energy consumed by different components of the BS in macro, pico and other cells that support the 3GPP LTE standard. It was based on the Earth Project's state of the art (SoTA) power model.

In [6], a “Manhattan-type city grid” is analyzed for energy performance in which macro cells were off-loaded with indoor cells. It was proven that indoor cells are more energy-efficient.

The dense urban scenario was studied in [7], wherein it was discovered that the indoor nodes were worse than the macro BS grid.

A dense network was studied in [8]. In which; it was found out that the deployment of smaller cells reduces the transmit power of large base stations (BSs). The idle time and the backhaul were the energy wasters.

A heterogeneous network scenario was studied in [9]. In this study the user performance was improved by reducing the transmission time for the sent packets which lead to a longer idle time in nodes. Pico node sleep mode was implemented in the study to reduce the energy consumption.

We will make use of energy-saving schemes like micro TX, lean carrier and MBSFN in the nodes. We will use Ericsson’s static network simulator which will present us a realistic three-dimensional model of a city; with buildings, pavements and open spaces. The simulator uses ray-tracing propagation models like BEZT.

1.4 Purpose of the Project

With the outset of 5G, many cities will be deployed with small cells. The networks density will increase at a very fast pace. The Internet of Things (IoT) would need denser networks with lower latency and higher throughput for self-driving cars, buses etc. New technologies like augmented reality and virtual reality are bound to demand higher data rates. These advancements will call for strengthened mobile broadband networks.

To have an environment friendly transit into the era of Internet of Things, it is important to focus on energy consumption by these networks. There are various approaches to increase the present network density; we will compare the approaches to cater to the traffic demands with macro cells versus micro cells deployments.

We will setup a dense urban real like scenario in our simulator and compare the energy efficiencies between macro cells centric deployment versus a micro cells centric deployment, and we will make use of energy-saving schemes like micro TX, lean carrier and MBSFN to cut the power consumed

in the network. We will compare between the deployments with the units like energy per bit, power per unit area and power consumed over a day.

With results presented in this thesis, we will contribute to the understanding of how these cells behave in a realistic traffic scenario and how much gains can we achieve by implementing the above-mentioned energy-saving schemes. To keep the results more generic and not specific to any particular set of radio base stations we will make use of the EARTH power model.

1.5 Outline of the thesis

In this thesis; chapter 1 deals with the introduction, background and motivation of this project, chapter 2 is about the theory of BSs which describes about various cells used in a typical LTE heterogeneous deployment and the transmission techniques used by these BSs like MIMO and OFDM, chapter 3 is where we explain about the Earth Power model and the energy-saving schemes, chapter 4 deals with the simulation setup, followed by chapters on results and discussions, conclusion and future work.

2 Theory

2.1 *Heterogeneous Networks*

With the onset of 5G, there will be a lot of deployment of densified networks to satisfy the demand for increased traffic. Most of the mobile traffic around 70% will be concentrated around high traffic centers like downtown of an urban city [10] [11]. There will be small cells which would be deployable as ‘plug and play’ which is going to save a lot of CAPEX (capital expenditure) for the operators and as these smaller cells will have a small coverage area which will make frequency reuse possible being close to each other; which will provide large capacity improvement [6]. For the incoming 5G spectrum allocation; speculations are that frequency spectrum for 5G will lie in a very high frequency of the order 30 GHz, according to studies the coverage and penetration of these waves in indoor environment will be very problematic. “Achieving indoor coverage at 30 GHz is highly problematic for all cases, and it is concluded that smaller base stations are necessary if frequencies of 10 GHz and above are to be used in future mobile networks.” [12]. Here are some details about the cells which will constitute a densified heterogeneous network.

Specification	Femtocell	Picocell	Microcell	Macrocell
Transmit Power	20 dBm	30dBm	30dBm	45dBm
Power Consumption	Low	Low	Moderate	High
Coverage distance	Less than 30m	Less than 100 m	Less than 500m	Several kms
Deployment	Indoor	Indoor and Outdoor	Outdoor and Indoor	Outdoor
Backhaul connectivity	DSL, cable, fiber	Microwave, mm	Microwave, Fiber	Microwave, Fiber
Installation	User	Operator	Operator	Operator

Table 1. Comparison between different types of nodes in a heterogeneous network.

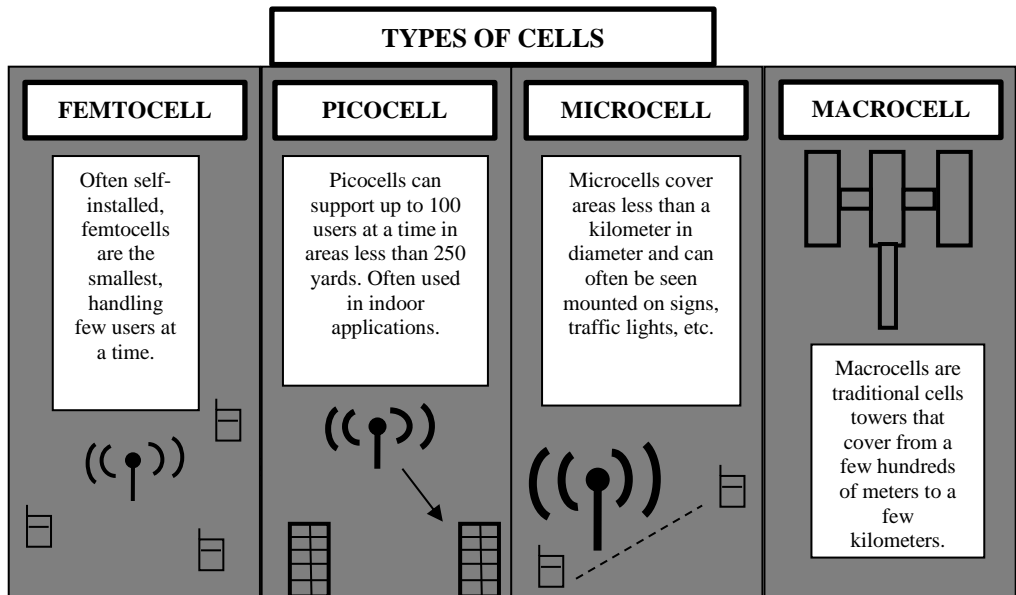

Figure 3. Small cells pictorial representation.

2.1.1 Macro Cells

These cells are the base stations that provide coverage to a large area with Inter Site Distance (ISD) from hundreds of meters to several kilometers. depending upon the density. They fulfill the baseline coverage for any LTE network, providing connectivity and up all the time. The power consumption varies from 100W to 450W; they have sectored antennas normally covering 120 degrees per sector.

2.1.2 Micro Cells

Micro cells have lower transmit power than macro BSs, they are smaller base stations with full features that are used to cover both indoor and outdoor crowded areas. It can typically cover a range of few meters to one or two kilometers. The power consumption ranges from 50W to 150W. They are generally used for indoor purposes as well as outdoor such as hot-spots. [11]

2.1.3 Pico Cells

Pico cells have lower transmit power than macro BSs, they have omnidirectional antennas unlike macro BSs which are sectored. The transmit power ranges from 250mW to 2W. They are generally used for indoor purposes around hot-spots like offices, railway stations etc. Pico cells are connected over X2 interface [11].

2.1.4 Femto cell

Femto cells are also known as HeNBs are deployment for small rooms and home requirements generally for a very small range coverage less than 30m. They have omnidirectional antennas, transmit power is around 100mW. They could be plugged in using a DSL line or modem cable [11].

2.2 LTE Basics

2.2.1 OFDM (Orthogonal Frequency Division Multiplex)

In LTE, OFDM modulation technique is used to produce the orthogonality between the sub-carriers in frequency domain. A sub-carrier is of 180 kHz. The OFDM provides resistance to interference in between LTE sub-carriers, the LTE uses Orthogonal Frequency Division Multiple Access (OFDMA) in down link radio access and Single Carrier Frequency Division Multiple Access (SC-OFDMA) in uplink radio access. OFDM provides high data rates and tightly spaced orthogonal sub-carriers providing high spectrum efficiency.

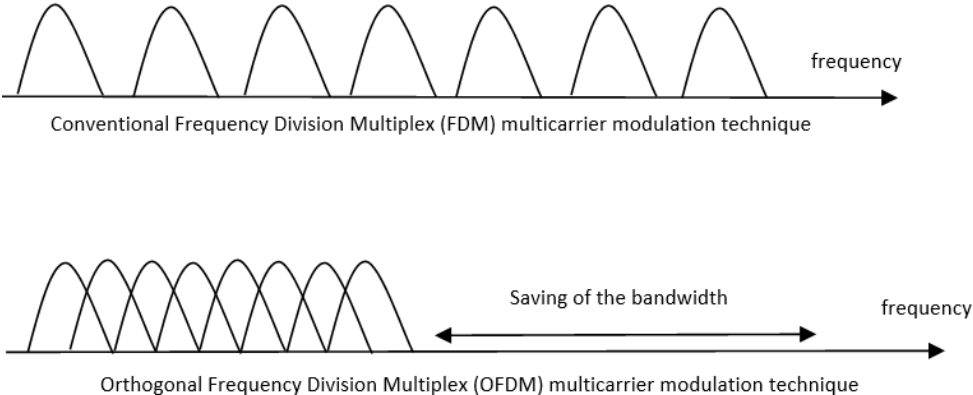

Figure 4. Comparison between conventional FDM modulation technique and OFDM modulation technique.

2.2.2 MIMO (Multiple Input Multiple Output)

A key radio access feature for LTE is MIMO. The data streams going in and out of antenna in radio channel forms beam and transmit diversity. The diversity will result in low correlation of fading and this could be used for receive and transmit diversity. Better reception could be generated by sending simultaneously the copies of the same data through the channel and

receiving using multiple antennas. MIMO provides spatial multiplexing i.e. sending different data streams transmitted in parallel over separate antennas. MIMO could be used to increase the throughput. As per the need 2 x 2, 4 x 2, or 4 x 4 antennas could be used in LTE deployment.

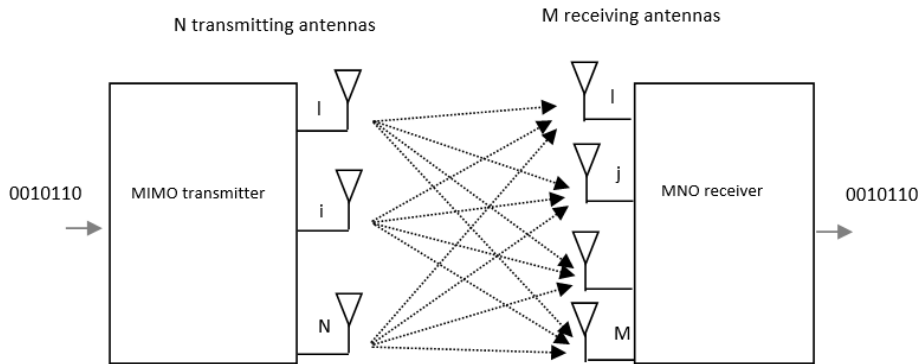

Figure 5. Representation of MIMO scheme.

CHAPTER 3

3 Power Model

3.1 Power distribution in base station

This section defines how could we breakdown and understand comprehensively the energy consumed by the BSs. As per the findings of the Earth Project, power amplifier (PA) remains by far the major contributor to energy consumption. Understanding the root cause of this consumption can help us to eradicate the problems and nip the issues which lead to high energy consumption.

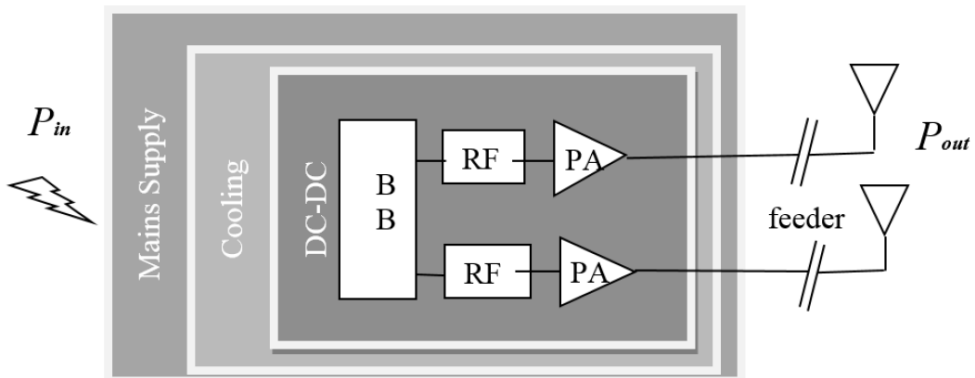

Figure 6. Different components within a base station.

Figure6 shows how the block diagram of a typical BS, it could be macro, micro, pico or femto. There could be multiple transceivers in a BS. Each transceiver contains the baseband (BB) module, radio frequency module (RF module), power amplifier (PA), DC to DC power converter, cooling system and a power supply connected to the mains. For macro BS the sector antenna

is at large distance from the PA which leads to high feeder losses, which needs to be compensated by PA [13].

The PA connects to the antennas of the base station after providing the required power gain. The PA has poor power efficiency as it is made to work in non-saturated region which is to avoid nonlinear distortion from channel interference. In macro BS digital pre-distortion is used to improve the PA efficiency [7].

Radio Frequency module is used to convert analog signals to digital signals. Base Band module serves as digital signal processor for digital up and down conversion of signals, it also does OFDM modulation of the signal. Typical functionalities for BB are filtering, FFT for OFDM modulation and IFFT for OFDM demodulation, signal detection, channel estimation, it acts as the brain of transceiver [13].

The active cooling is only applicable to macro base station and not for smaller base station versions. The power model takes into account the power consumed in active cooling of the macro base station while for smaller base stations such as micro, pico and femto the active cooling is not required. So, the power consumed within a BS can be defined as;

$$P_{Total} = P_{BB} + P_{RF} + P_{PA} + P_{Overhead} \quad (3.1)$$

3.2 Power consumed at maximal load

The losses in DC-DC power supply, mains supply and active cooling varies linearly with the power consumption of other components. They can be calculated with loss factors σ_{DC} , σ_{MS} and σ_{cool} respectively [15].

The EARTH power model [14] breaks down the power consumption within a BS at maximum load, $P_{out} = P_{max}$ as:

$$P_{in} = N_{TRX} \cdot \frac{\frac{P_{out}}{\eta_{PA} \cdot (1 - \sigma_{feed})} + P_{RF} + P_{BB}}{(1 - \sigma_{DC})(1 - \sigma_{MS})(1 - \sigma_{cool})} \quad (3.2)$$

The power consumption in PA is $P_{PA} = P_{out} / \eta_{PA}$. The efficiency is $\eta = P_{out} / P_{in}$, and the loss is defined by; $\sigma = 1 - \eta$. The power increases linearly with the number of transceiver chains, N_{TRX} . Below table lists the energy consumed among different parts of BS in different cells [15].

			Macro	Remote Radio	Micro	Pico	Femto/Home
PA	Max Transmit rms power	[dBm]	46.0	43.0	38.0	21.0	17.0
	Max Transmit rms power	[W]	39.8	20.0	6.3	0.1	0.1
	PAPR	[dB]	8.0	8.0	8.0	12.0	12.0
	Peak Output	[dBm]	54.0	51.0	46.0	33.0	29.0
	Pdc	[W]	102.6	51.5	22.1	1.6	1.0
	Power-Added Efficiency	[%]	38.8	38.8	28.5	8.0	5.2
TRX	Max Transmit rms power	[dBm]	-8.0	-11.0	-13.0	-13.0	-17.0
	TX Pdc	[W]	5.7	5.7	2.9	0.4	0.2
	RX Pdc	[W]	5.1	5.1	2.6	0.4	0.2
	Total Pdc	[W]	10.9	10.9	5.4	0.7	0.4
BB	Radio [inner rx/tx]	[W]	5.4	5.4	4.6	0.6	0.5
	LTE turbo [outer rx/tx]	[W]	4.4	4.4	4.1	0.7	0.6
	Processors	[W]	5.0	5.0	5.0	0.2	0.1
	Total Pdc	[W]	14.8	14.8	13.6	1.5	1.2
DC-DC	σ_{DC}	[%]	6.0	6.0	6.4	8.0	8.0
Cooling	σ_{COOL}	[%]	9.0	0.0	0.0	0.0	0.0
Main Supply	σ_{MS}	[%]	7.0	7.0	7.2	10.0	10.0
Total 1 Radio		[W]	160.8	88.0	47.0	4.5	3.1
# Sectors		#	3.0	3.0	1.0	1.0	1.0
#PAs/Antennas		#	2.0	2.0	2.0	2.0	2.0
# Carriers		#	1.0	1.0	1.0	1.0	1.0
Total N Radios		[W]	964.9	527.9	94.0	9.0	6.2

Table 2 SoTA estimation of power consumption in different LTE BSs.

MACRO

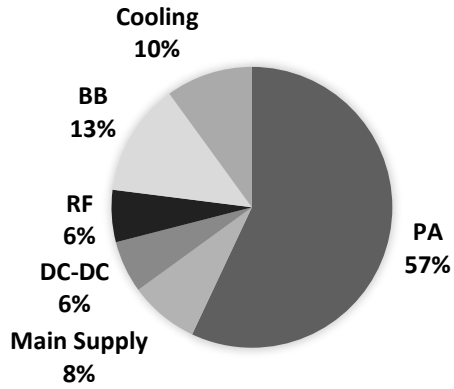

MICRO

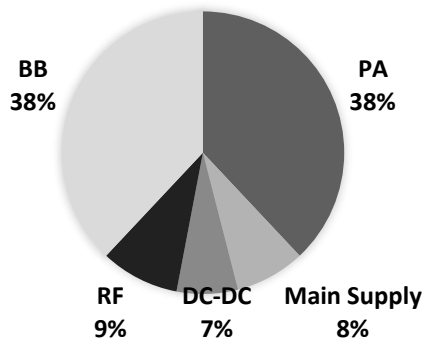

PICO

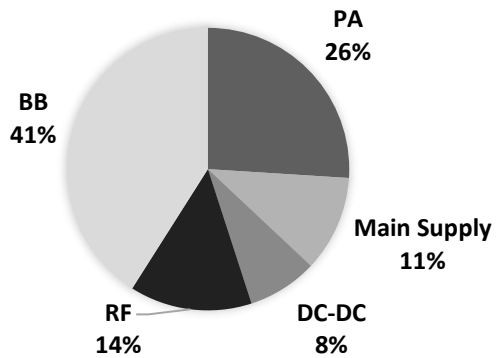

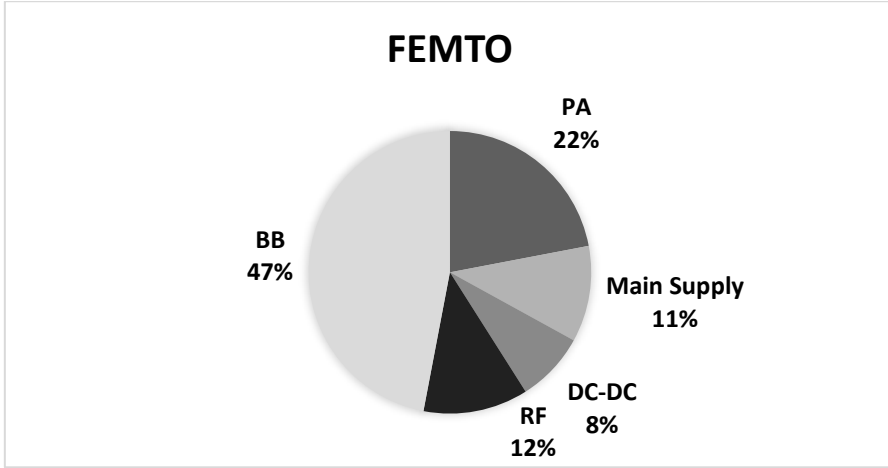

Figure 7. Power consumption in different components of BSs.

Figure 7 shows the breakdown of power consumption in various base stations [15]. We can see over here that power amplifier consumes the most amount of energy in macro and micro base stations; whereas base band becomes the major component in pico and femto cells.

3.3 Variable load power consumption of BS

As we have seen earlier that power amplifier amounts to the most part of energy consumption in macro and micro base stations. It is because power amplifier's energy consumption scale linearly with traffic load; higher the traffic load higher the power consumption will be. The pico and femto cells have very little load-dependency as for these low power base stations, the effect of power amplifier is very little [15].

The relation between the RF output power and the power consumed by base stations are roughly linear in nature [14]. The mathematical equation of this relation could be represented as:

$$P_{in} = \begin{cases} N_{TRX} \cdot (P_0 + \Delta_p P_{out}), & 0 < P_{out} \leq P_{max} \\ N_{TRX} \cdot P_{sleep}, & P_{out} = 0 \end{cases} \quad (3.3)$$

This represents the linear approximation of the power model. Here P_{in} would represent the power consumed in the BS and P_{out} is the RF output power, at maximum load the output power would be P_{max} . Power consumption at zero load is given by P_0 , Δ_p represents the slope of the curve. P_{sleep} represents the constant sleep mode power consumption in the BS and N_{TRX} is the number of transceiver chains. Table 3 provides parameters of power model for different base stations [15].

BS type	N_{TRX}	$P_{max}[W]$	$P_0[W]$	Δ_p	$P_{sleep}[W]$
Macro	2	40	130.0	4.7	75.0
Micro	2	10	56.0	2.6	39.0
Pico	2	0.13	6.8	4.0	4.3
Femto	2	0.05	4.8	8.0	2.9

Table 3 Parameters of power model for different base stations.

3.3.1 Energy consumption references

Power per unit area and Energy per bit are the standard units for comparison of energy performance; thus, we will use these units to compare the energy consumption in different scenarios.

3.3.2 Energy per bit

It is the amount of energy consumed in delivering a single bit from the transmitter. Dividing the total energy consumed, E over a time interval of, T by the total number of transmitted bits, B during that duration will give the Energy per bit. It is expressed in [W/bps].

$$ECI_{E/B} = \frac{E}{B} = \frac{P}{R} \quad (3.4)$$

3.3.3 Power per unit area

It is the amount of power consumed in the network divided on average by the coverage area. It is expressed in $[W/m^2]$.

$$ECI_{P/A} = \frac{P}{A} [W / m^2] \quad (3.5)$$

3.4 Average power consumption

The simulator used in the project is a static simulator which runs from $0 - T$ and takes the average of the power consumed during that time period. This falls in confirmation of our model as power consumption is a function, $u(t)$ which depends upon the traffic generated at a time instant t . The average power consumed over the time interval is:

$$\bar{P}_T = \frac{1}{T} \int_0^T P_{in}(t) dt \quad (3.6)$$

So, by applying eq. 3.3 in 3.6 we get

$$\bar{P}_T = \frac{1}{T} \int_0^T N_{TRX} (P_0 + \Delta_p P_{max} u(t)) dt \quad (3.7)$$

$$\bar{P}_T = N_{TRX} \left(P_0 + \Delta_p P_{max} \frac{1}{T} \int_0^T u(t) dt \right) \quad (3.8)$$

$$\bar{P}_T = N_{TRX} (P_0 + \Delta_p P_{max} \bar{u}_T) \quad (3.9)$$

3.5 Average power consumption over a day

Above equation defines the instantaneous power consumption at a moment t . To get an idea of the power consumption over the entire day, we need to average the power consumed over a day. The simulator which we have uses statistical tools to model the traffic. It measures the networks parameters for a small period of time while keeping the total traffic to be constant. Therefore, to know the network performance over a varied load, we sweep the total traffic value over a sufficient range.

In real scenario the traffic values change over the day in a pattern which is given in [15]. By taking the traffic profile as described in [15] we can estimate the traffic for every hour as a fraction of the peak throughput. Here we take the case of an urban traffic scenario which shows the average pattern of traffic over a day on hourly scale.

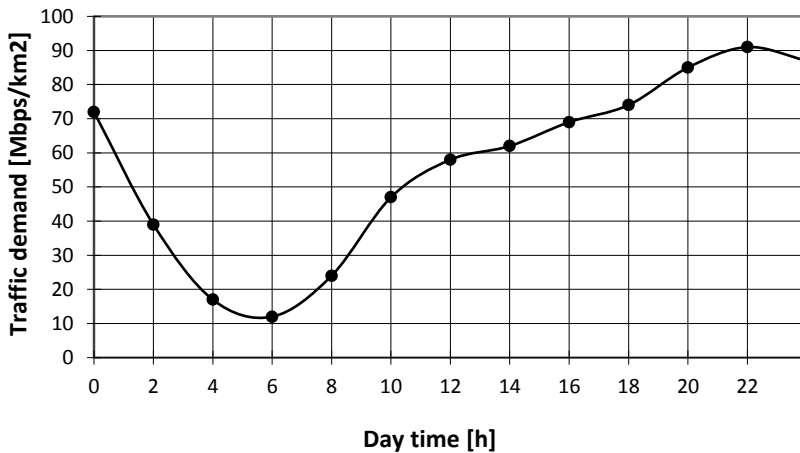

Figure 8. The figure shows the variation of peak throughput percentage over the whole day.

3.6 Energy Saving schemes

We will consider the following energy-saving schemes in our deployment of macro and micro nodes. These energy schemes are supposed to be implemented in future mobile networks on a large scale.

3.6.1 Micro TX sleep

The Radio Unit (RU) component of a base station does not transmit all the time. There are time slots when the radio can be put to sleep mode depending upon the traffic handled and the scheduled transmissions. At this point the biasing of the final stage amplifiers is turned off, which can be achieved by sending a strobe signal based on the information of the data that DU needs to send. This information is sent in a message that gives the symbols which will be sent over the radio during the transmission time interval [17].

The LTE RU transmits 140 OFDM symbols per radio frame consisting of cell-specific radio signal (CSRS) and physical downlink control channel (PDCCH). Assuming a no-load situation when there are no scheduled users; out of 140 OFDM symbols, power amplifier could be put in sleep mode for 73 of them with 37 wake up events. This equals to 4.1ms of sleep time during each radio frame or 41% of time.

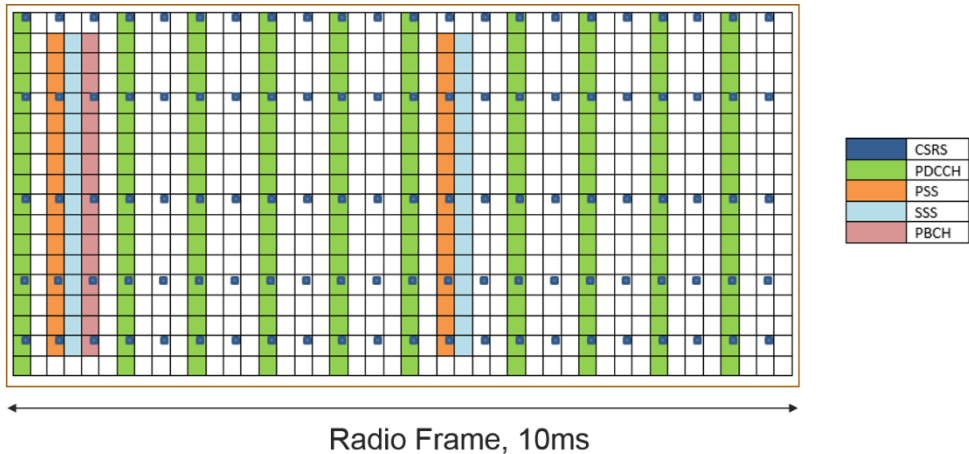

Figure 9. LTE radio frame representation, where PA could be put to sleep when no symbol is being transmitted.

3.6.2 MBSFN sub-frames

In a LTE radio frame six out of ten sub-frames can be Multicast and Broadcast Single-Frequency Network (MBSFN) for FDD system [18]. The MBSFN sub-frames are used to predict the future traffic load for a base station. Using MBSFN sub-frames a base station could calculate the load it needs to handle in subsequent frames and the resources required to cater to the traffic. This load prediction is made based upon the previously served load information exchanged between the base stations over X2 interface. Load prediction is used to turn off the idle resources and setup the switch off intervals. Moreover, the MBSFN sub-frames have less number of reference signals than normal sub-frames, which gives an opportunity to turn off these sub-frames when there is no data available. [19]

Using MBSFN scheme in no load condition we get 91 OFDM symbols with 19 wake up events per radio frame. This gives a window of 5.9ms or 59% with sleep mode enabled.

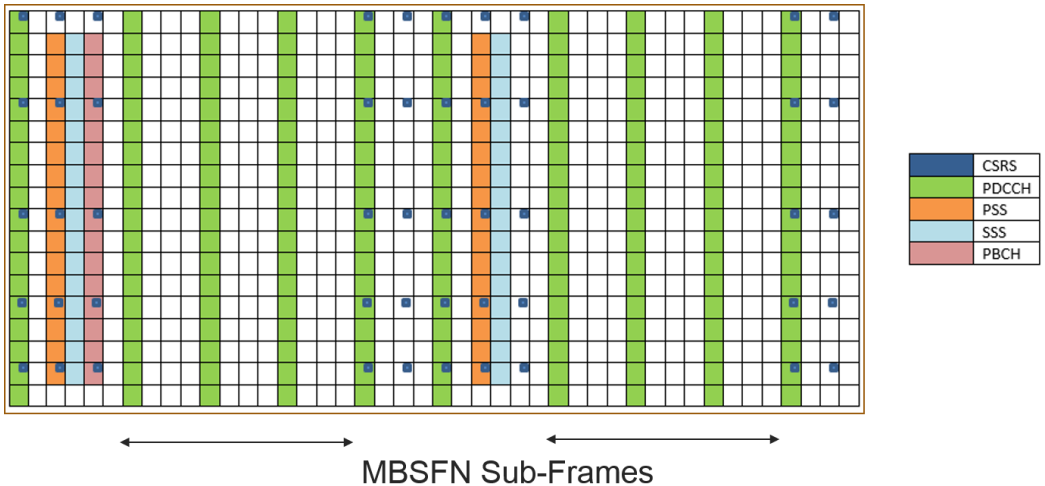

Figure 50. LTE radio frame with six MBSFN sub-frames.

3.6.3 Lean carrier

In lean carrier the cell is switched off when there is no transmission of data. It makes use of different features like transmitting the signal only when

required, transmitting faster with higher modulation scheme, effectively utilizing the carrier aggregation to have large spectrum and making use of beam forming antennas. These features reduce extraneous signaling and interference.

Minimizing the overhead cell specific reference signaling and using the spectrum flexibility, it reduces energy consumption. For synchronization it only makes use of extended synchronization signal (eSS) after every 5 sub-frames making it possible to achieve fraction of sleep at no load condition to 100%. More details about lean carrier can be found in [16].

CHAPTER 4

4 Methodology

In this chapter we will explain about the simulator and the deployment strategy used in running the simulations for this project.

4.1 *The Simulator*

The simulator used is Ericsson's internal network simulator. It is a time static system level simulator implemented in MATLAB. It provides various propagation models from statistical models to ray-tracing based models [12]. The model used in our thesis makes use of statistical model that determines the utilization of the base stations running at a particular load. The utilization values of base stations are used to calculate of the power being consumed by the whole network.

4.2 *Setup*

We setup a "real like" dense city scenario, in which we are deploying the city with streets, buildings, base stations and users. The deployment is made keeping in mind of a typical dense urban network with high-rise buildings in the center and lesser dense and low height buildings outer wards. This sort of setup is very close to a realistic scenario than just being a statistical propagation analysis.

We are simulating with ray-tracing propagation model called BEZT. It makes use of multipath propagation model that calculates the path gain between the user and the base station. The channel gains over these paths are stored in a huge gain matrix which are used to estimate the throughput for every user, in the central part of the map

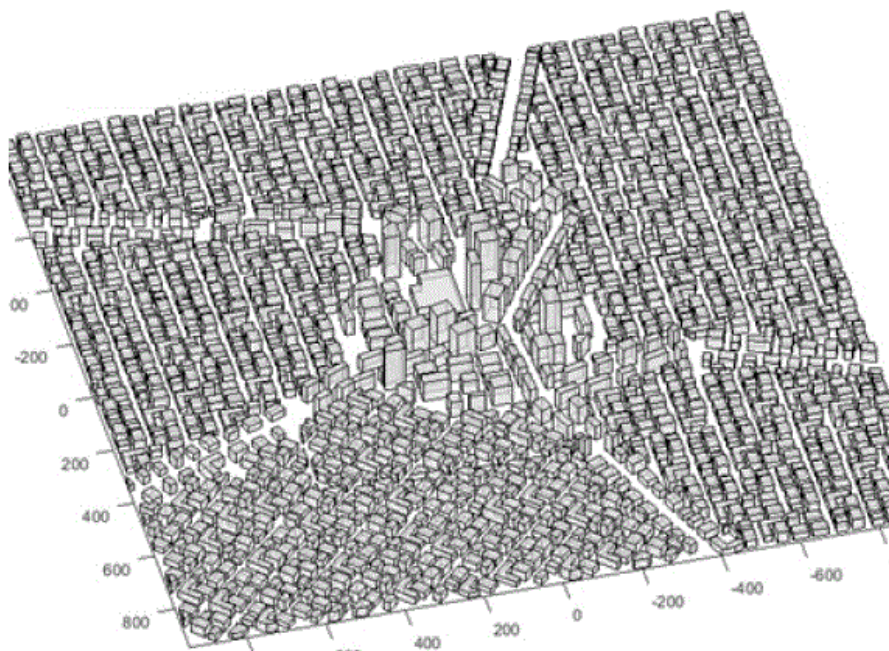

Figure 61. The figure shows the 3D model of the city with buildings and streets, the city center has high rise buildings.

4.3 Deployment

We are deploying a real like city scenario in which the outer layer of macro grid will provide baseline coverage, we will refer to it as surrounding macro layer. In first scenario, we deploy macro cells in the city center complemented by the surrounding macro grid and in second scenario we deploy small micro cells in the city center complemented by the surrounding macro grid.

In the first scenario setup, we have taken 21 macro cells deployed in the central grid of the city with inter-site distance of 200m surrounded by a base layer of macro cells with inter-site distance of 400m.

In the second scenario setup, we have taken 28 micro cells deployed in the central grid of the city with a base layer of macro cells inter-site distance of 400m.

The system under consideration is a LTE network with carrier frequency of 2 GHz, highest modulation scheme is 64 QAM, each site has three-sectors. The central grid area is 1000x1000m.

For macro cells; the max Output Power out per antenna in DL is 40 W, $P_0 = 130\text{W}$, $\Delta_p = 4.7$ and $P_{sleep} = 75.0$.

For micro cells; the max Output Power out per antenna in DL from the micros is 10 W, $P_0 = 56\text{W}$, $\Delta_p = 2.6$ and $P_{sleep} = 39.0$.

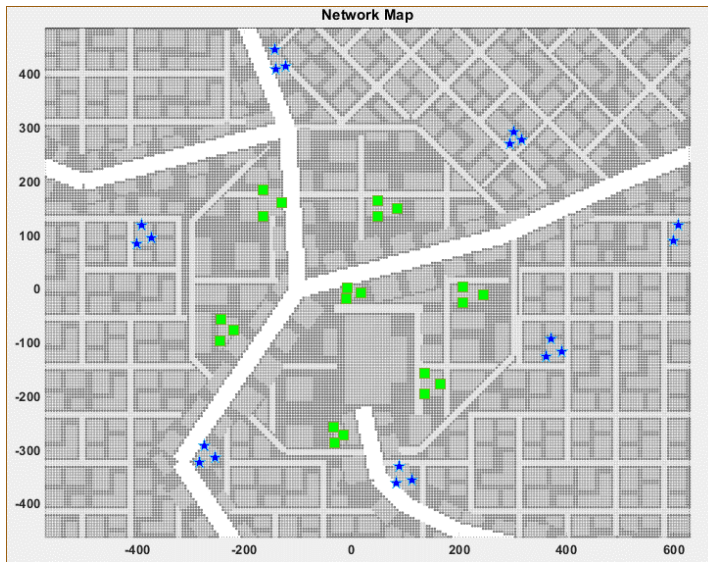

Figure 12. The figure shows macro cells deployed in the center of the city.

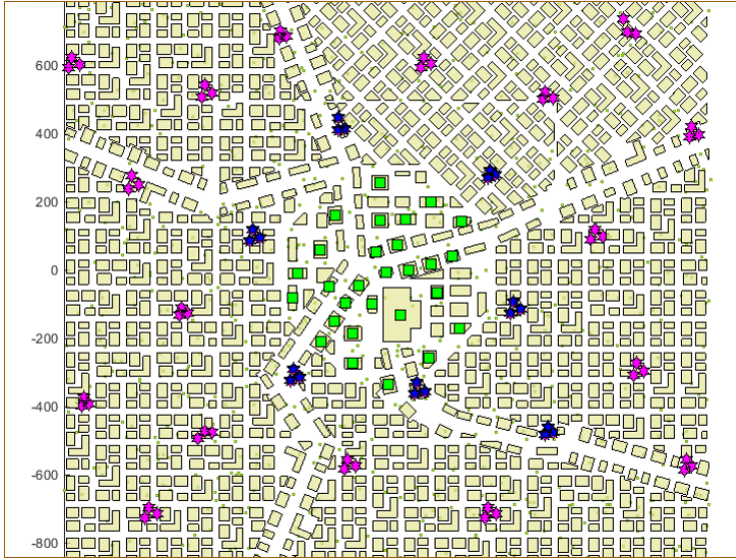

Figure 13. The figure shows deployment of micro cells in the center of the city with macro cells in the surrounding area.

4.4 Traffic

We deploy buildings, streets, base stations and users in the simulator. The simulator calculates the SINR between each user and node deployed on macro or micro layer. Using the propagation model, the interference, gain or the propagation loss is calculated for each link. To simulate the dynamic network where the download sessions by users happens at random; equal buffer traffic model is utilized. Each session is of fixed file size where the request comes as per the Poisson distribution. The users fully utilize the link bit rate during the file download. The total air traffic could be given by offered traffic per m^2 . Because of the capacity limitations the served traffic is lower than offered traffic. In the simulations, we sweep through varying loads of offered traffic and make use of the served traffic to compare performances.

Parameter	Value
Carrier frequency	2.0 GHz
Bandwidth	20 MHz
Modulation scheme	64 QAM
Packet traffic model	Equal buffer model
Macro TX Power	40 W per sector
Micro TX Power	10 W
Macro cells in central grid	21
Micro cells in central grid	28
Feeder loss	10 dB

Table 4. Simulation parameters

CHAPTER 5

5 Results and Discussions

In this chapter, we discuss about the results which we got after running the simulations for the deployed scenarios.

5.1 Comparison between macro and micro without energy saving schemes

Here we will compare the energy performance and the network performance of deploying the large cells of macro grid in the city center versus small cells of micro grid without any energy saving schemes.

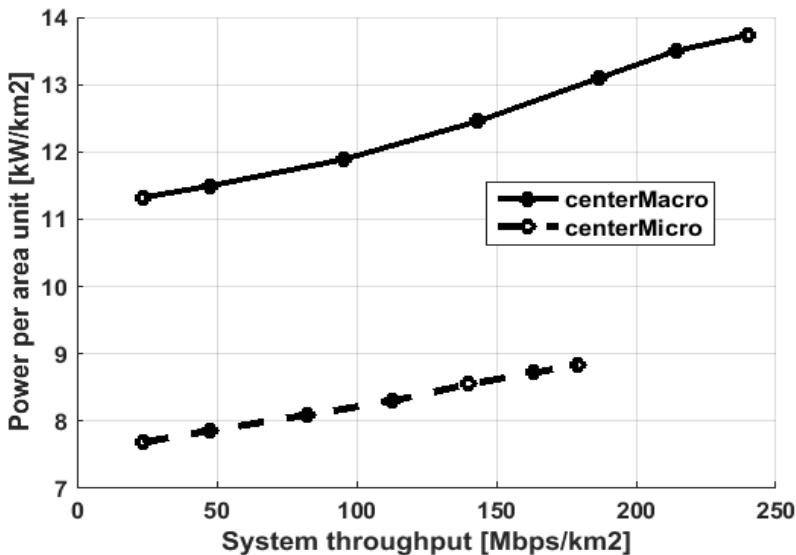

Figure 14. Comparison of Power per area unit versus System throughput for central deployment of macro cells and micro cells.

The Power per unit area is measured for power per 1 km² around the central area of the map. We calculate the utilization of each node which is taken as a factor for calculating the total power consumed by that node in the network. As we can see in Figure 14 the power per unit area for micro cells is lesser than the macro cells. Here we are sweeping the simulation for various loads to test the system for varying units of system throughput. We can see that the Power per area unit increases as the throughput increases as we predicted by the earth power model. Power per unit area difference between macro and micro at 100 Mbps/km² is 31%.

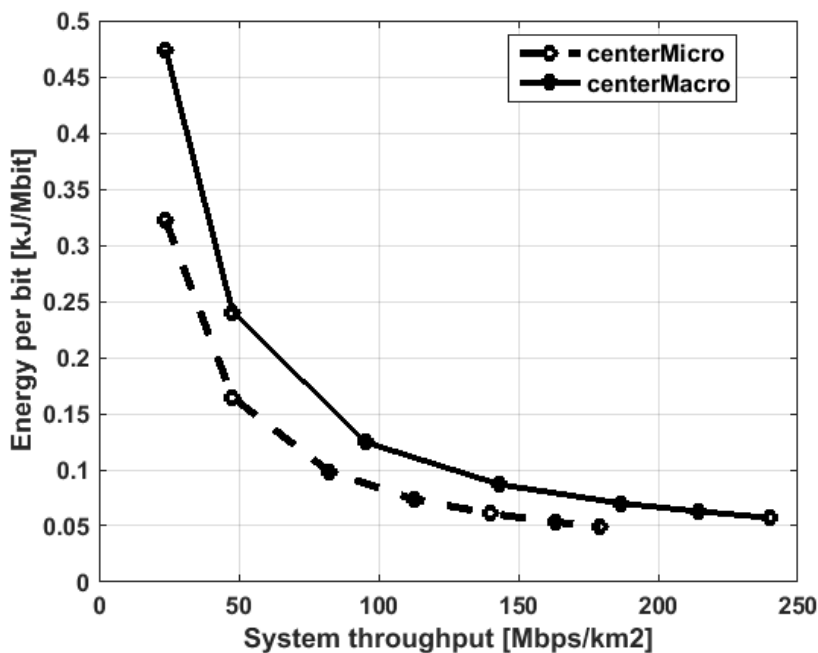

Figure 15. Comparison of Energy per bit versus System throughput for central deployment of macro cells and micro cells.

In Figure 5 we compare the energy performance with respect to the energy per bit. For calculating the energy per bit, we divide the total energy consumed by the serving nodes by the total traffic served by them. Energy

per bit tells us that how much energy is needed in the system to deliver a single bit. As we can observe that the deployment of micro cells proves out to take lesser energy per bit as the power amplifier in the micro cells do not ramp up the energy consumption with the load as much in macro units. The energy per bit is higher for lower load because the system throughput increases faster than the power consumption in the serving nodes.

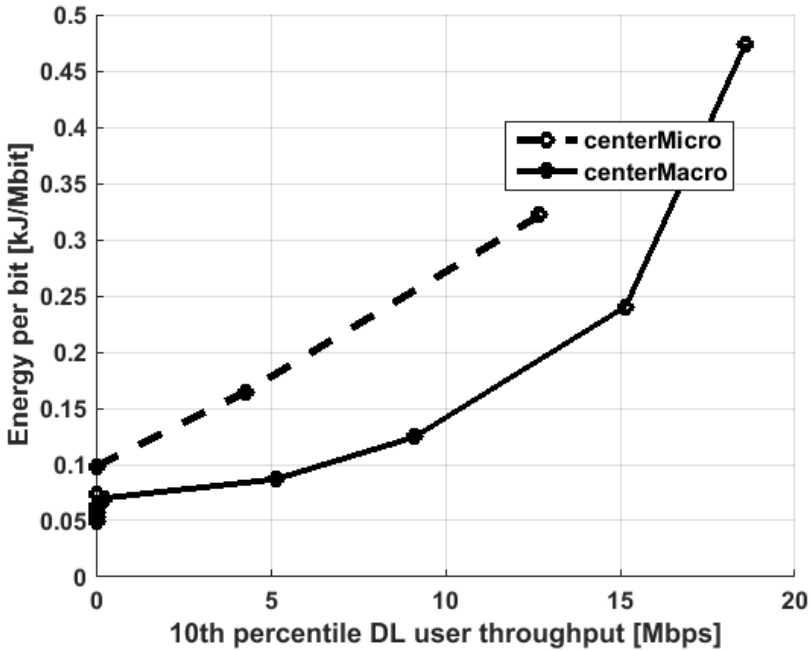

Figure 76. Comparison of Energy per bit versus 10th percentile DL user throughput for central deployment of macro cells and micro cells.

In Figure 76 we do a critical analysis of quality of service down to the 10th percentiles of users, these users have the worst downlink throughput and they could be considered as edge cell users. To deliver a good throughput to the edge cell users say, 11 Mbps we can see the macro cells need something around 0.18 kJ/Mbit while micro cells need 0.3 kJ/Mbit. Here the macro cells come out to as winner because of they can handle a higher load than micro cells as well as the increased load compensates for the increased power consumption in macro cells.

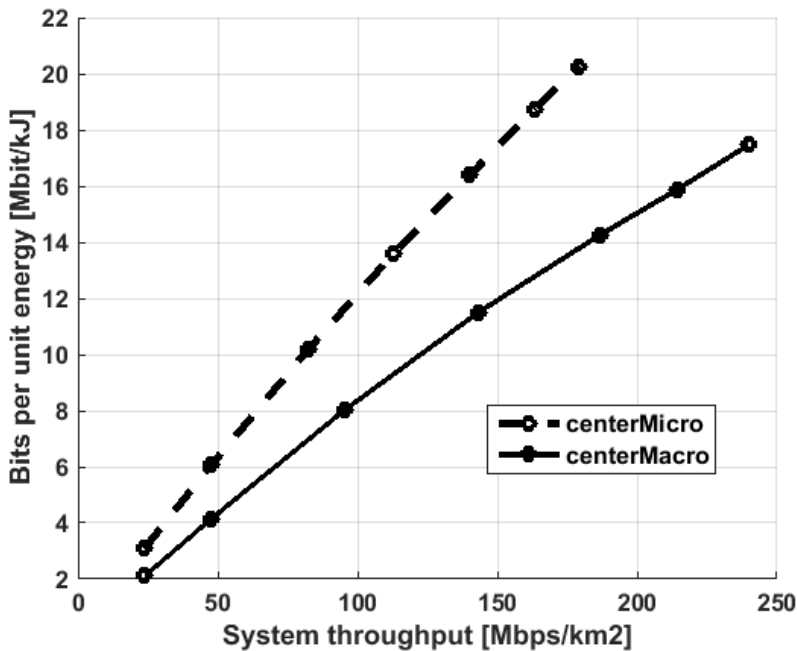

Figure 87. Comparison of bits per unit energy versus system throughput for central deployment of macro cells and micro cells.

Bits per unit energy is the inverse of energy per bit, to calculate this, we divide the total traffic by total power consumption. In Figure 87 we can see that the micro cells can transfer more bits per unit energy than the macro cells and as the power consumption in micro cells increases less with served traffic load, the number of bits transferred in unit energy (Mbit/kJ) is higher for smaller cells than the large macro cells.

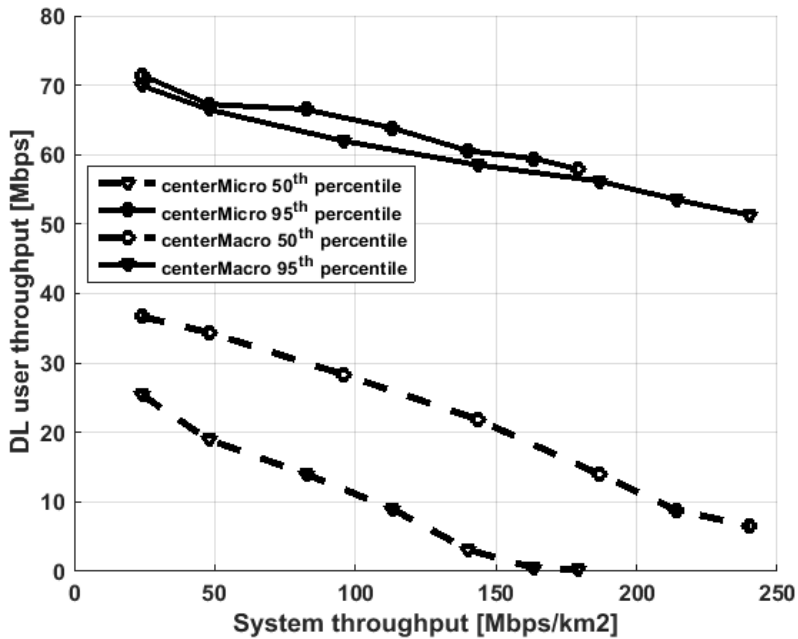

Figure 18. Comparison of DL user throughput for 50th and 95th percentile versus system throughput.

The DL user throughput is calculated for 10th, 50th and 95th percentile. The 10th percentile refers to the edge cell users, the 50th percentile is the median user data rate for the served traffic, the 95th percentile users are the best-case users with top 5% data rates. In figure 16 the 95th percentile users have similar data rates in macros and micros. The 50th percentile users experience difference in data rates because the data rates at the user side increases with transmit power.

We can also observe that the DL data rate decreases with the increasing traffic load, this is because at lower load there are enough of resources available for the cells to serve the users with high data rates, but as the traffic load increases the bandwidth and the available resources reduces and hence it leads to lowered data rates.

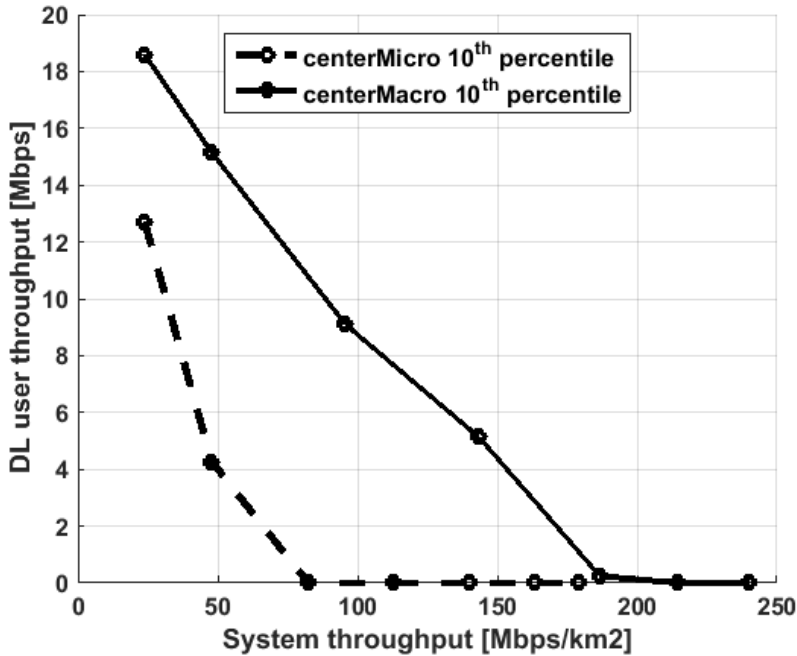

Figure 19. Comparison of DL user throughput for 10th percentile versus system throughput.

The 10th percentile users represents the edge cell users; the figure 19 compares the data rates for the cell edge users between the micro grid and the macro grid. When the data throughput drops to zero then it represents that the total traffic in the area is so high that the cell edge user could not be served. The data rates for these users decreases rapidly for micro case which proves that it is not the best choice for coverage purpose. This clearly shows that the coverage of macro cells is more than micro cells.

5.2 Comparison of macro with and without energy saving schemes

Here we will compare the energy performance and the network performance of deploying the large cells of macro grid in the city center with and without energy saving schemes.

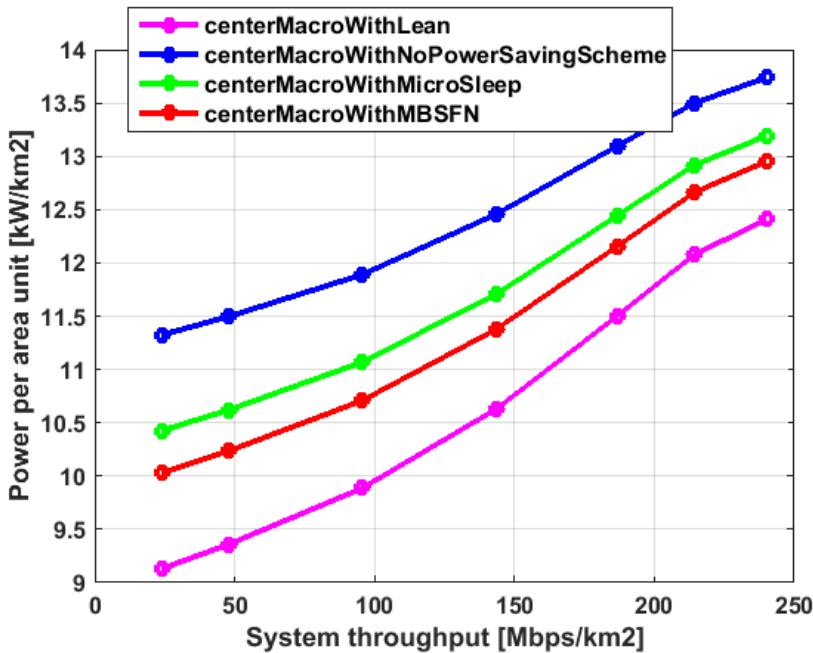

Figure 20. Comparison of power per area unit versus system throughput for central deployment of macro cells.

As we can see in figure 20 the power per unit area for macro cells with energy saving schemes is lesser than macro cells without energy saving schemes. Here we can see that as the traffic load increases the power required to serve that traffic also increases. At 100 Mbps/km² the energy saving from micro TX, MBSFN and lean carrier are 7%, 10% and 17%. The Lean energy saving scheme seems to be more energy efficient than MBSFN and micro TX sleep because the sleep time for cells is more in this scheme.

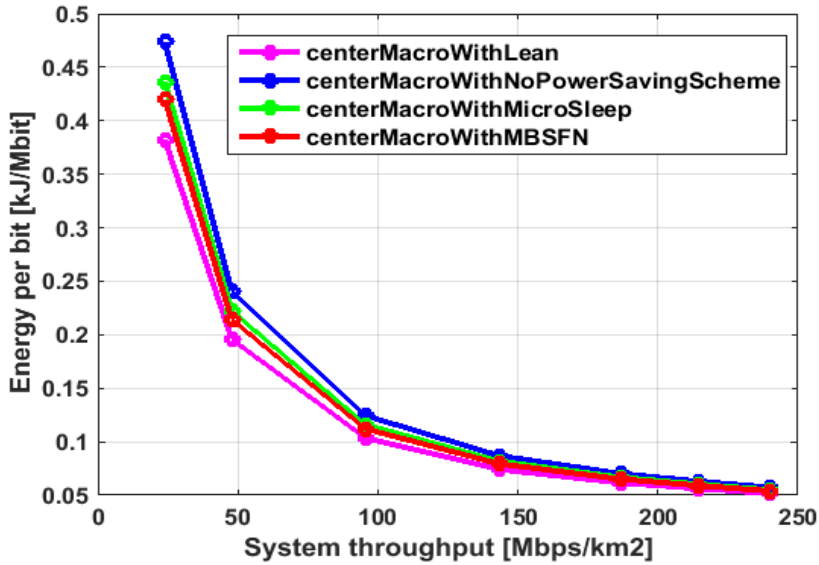

Figure 21. Comparison of energy per bit unit versus system throughput for central deployment of macro cells.

From figure 21 we can derive that there is some difference in energy needed to transmit a bit for lower traffic load in different schemes, but as we gradually move towards higher loads this difference comes close together because at higher traffic loads there will be less idle time for the cells to save energy.

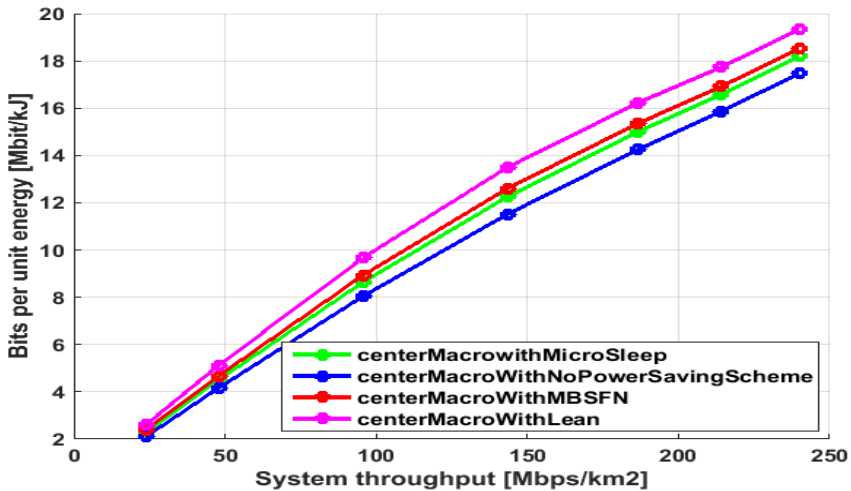

Figure 22. Comparison of bits per unit energy versus system throughput for central deployment of macro cells.

In continuation to previous figure 21 we plot the bits per unit energy versus traffic demand in figure 22 we encounter that there are more number of bits which could be transferred per unit energy when we make use of energy saving schemes.

5.3 Comparison of micro with and without energy saving schemes

Here we will compare the energy performance and the network performance of deploying small cells of micro grid with and without energy saving schemes.

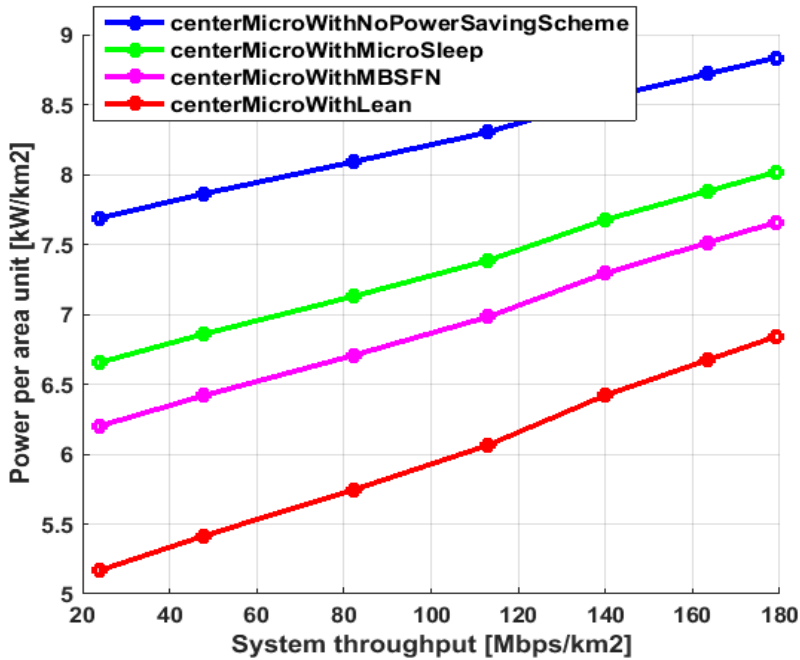

Figure 23. Comparison of Power per area unit versus System throughput for central deployment of micro cells.

As we can see in figure 23 the Power per area unit variation for micro cells also follows the similar pattern as in the power per unit area for macro cells. The energy saving schemes can save up to 2 kW/km² than micro cells without energy saving schemes. Here we can see that as the traffic load increases, the power required to serve that traffic also goes up. At 100 Mbps/km² the energy saving from micro TX, MBSFN and lean carrier are 10%, 16% and 27%.

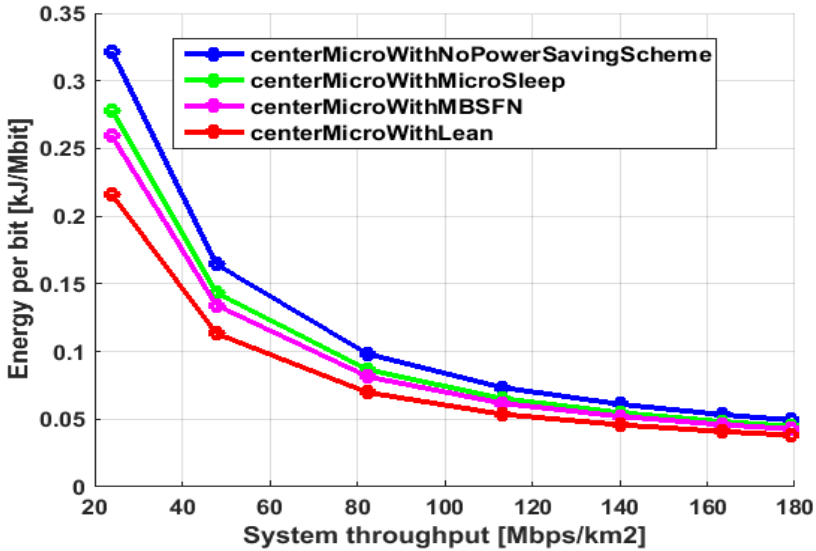

Figure 24. Comparison of energy per bit unit versus system throughput for central deployment of micro cells.

Figure 24 follows the same pattern as the one we saw in central macro deployment case however the energy per bit needed in micro is lesser than that of macros. The energy saving schemes can save upto 25% on energy per bit for micro deployment.

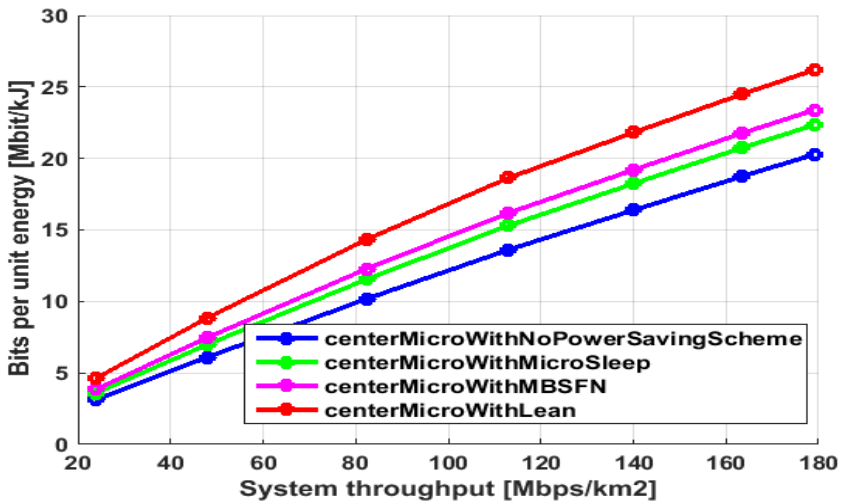

Figure 25. Comparison of bits per unit energy versus system throughput for central deployment of micro cells.

In figure 25 we see the behavior as expected, deployment with energy saving schemes have potential to fit in upto 30% more bits per unit energy than deployments without energy saving schemes.

5.4 Comparison between macro and micro with energy saving schemes

Here we will compare the energy performance and the network performance of deploying the large cells of macro grid in the city center versus small cells of micro grid without any energy saving schemes.

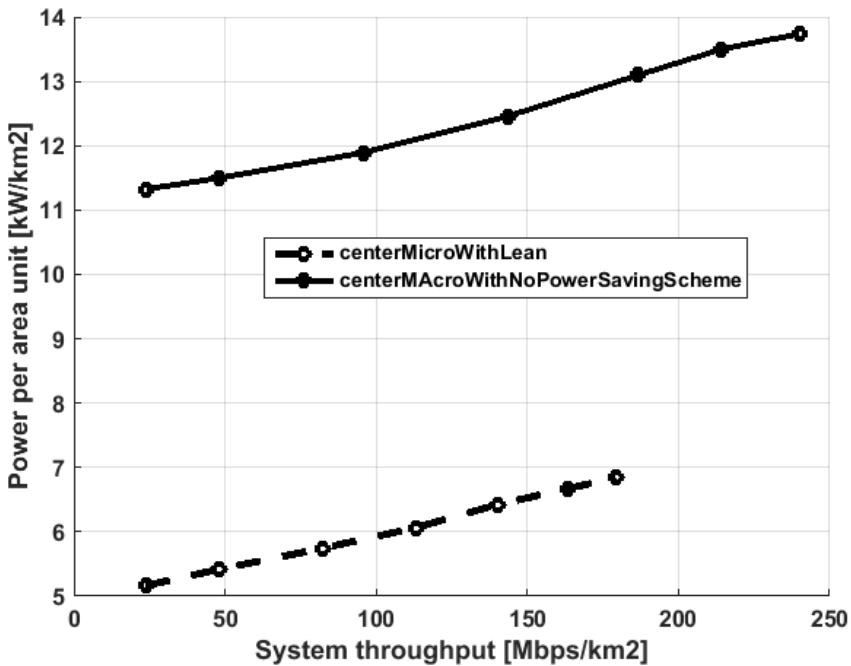

Figure 26. Comparison of Power per area unit versus System throughput for central deployment of macro cells versus micro cells.

In figure 26 we can compare the amount of energy savings we can achieve by having a micro cell with lean carrier energy saving scheme against a macro cell with no energy saving schemes. For 100 Mbps/km² of system throughput the micro cells consume 6 kW//km² whereas, macro cells consume double than that 12 kW//km² . Implementing a scheme like this one can reduce the power consumption to half.

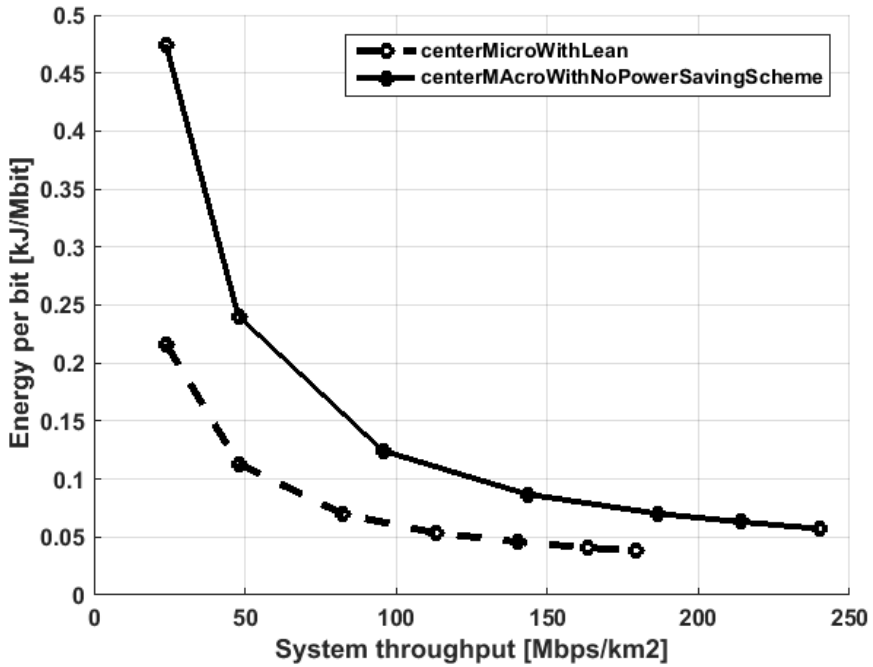

Figure 27. Comparison of energy per bit unit versus system throughput for central deployment of micro cells versus macro cells.

Now let's consider the energy per bit, we can see in figure 27 the energy per bit requirement for micro cells with energy saving scheme is much less than that of macro counterpart. The energy per bit is high for low traffic load because the total served traffic is low for less load.

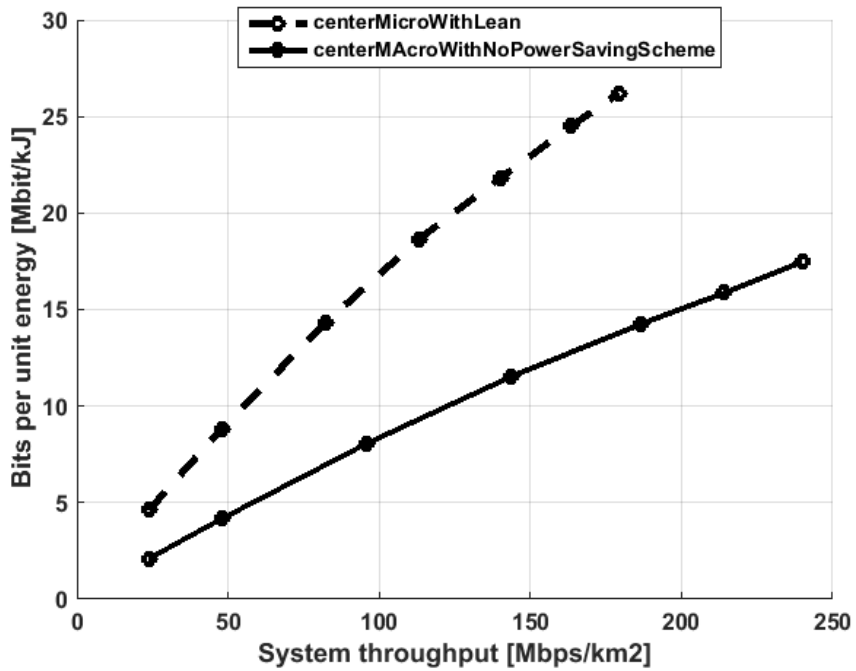

Figure 28. Comparison of bits per unit energy versus system throughput for central deployment of micro cells versus macro cells.

The bits per unit energy for micro cells with lean carrier energy saving scheme is almost double than that of the macro cells without energy saving schemes as seen in figure 28.

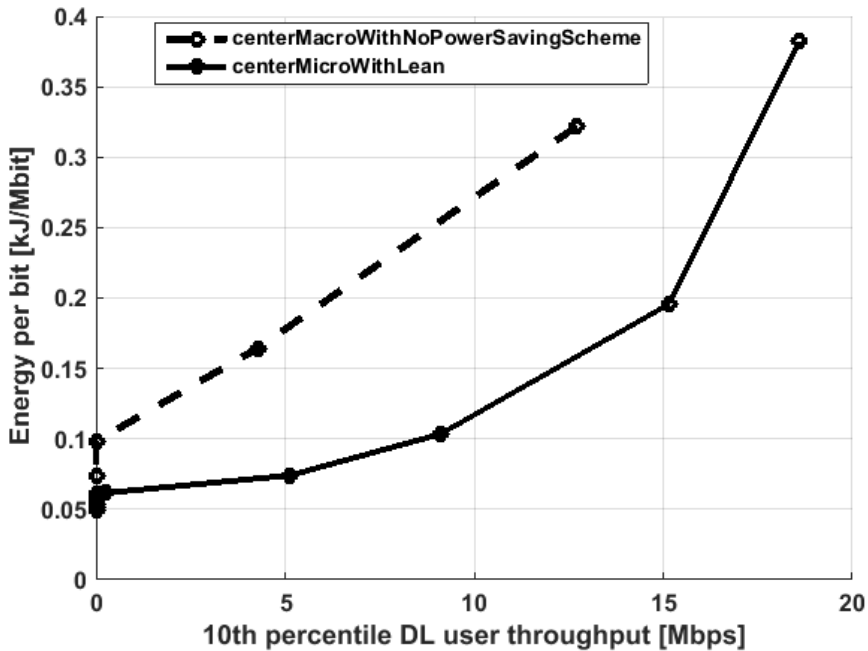

Figure 29. Comparison of energy per bit unit versus system throughput for central deployment of micro cells versus macro cells.

When it comes to reaching the last mile of user throughput, the micros could not provide as good user throughput as macros do. That's why in figure 29 the energy per bit needed for providing high throughput for the edge cell users is high in case of micro cells. So, the macro cells are needed to provide a good coverage area and decent throughput to the bottom 10th percentile users.

5.5 Daily power consumption

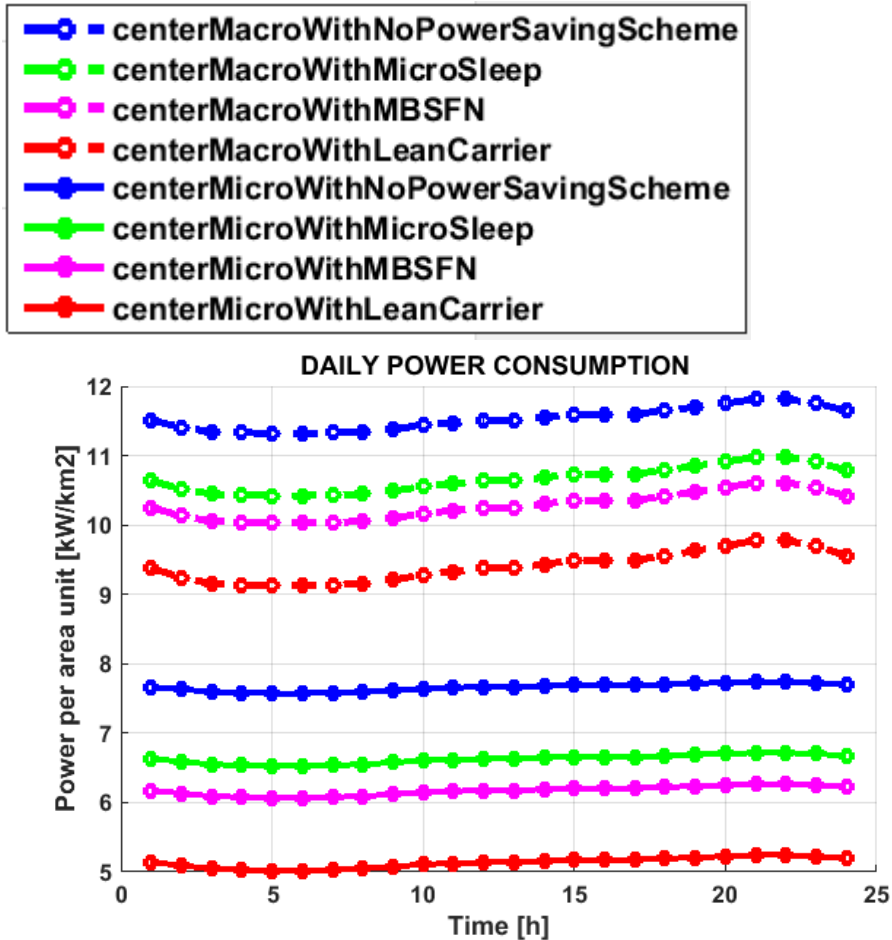

Figure 30. Comparison of daily power consumption in central deployment of micro cells versus macro cells.

For calculating the daily power consumption we kept a DL threshold of 10 Mbps for 10th percentile users during the peak hours. Figure 30 shows the power consumption of macros and micros with different energy saving schemes.

At peak load for macro deployment, there is a possibility of 17% saving using the lean carrier energy saving scheme and 20% energy saving could be achieved at low load.

In case of micro deployment, at peak load we can see 29% saving using the lean carrier energy saving scheme and a good 33% energy saving at low load. This is because lower utilization of nodes at lower loads gives more scope for energy saving schemes to be implemented.

Also from these patterns we can verify that the traffic demand is low during early morning hours and is high during the evening hours.

CHAPTER 6

6 Conclusions

For macro cells; as the number of resources are limited so, as the traffic load goes up the resources are needed to be shared among the UEs. This leads to reduced data rates for UE and longer time to receive a file. Therefore, it is advantageous to complement macro cells in the network with micro cells for increased quality of service and improved data rates. The results on the energy savings were much better by using the micro only base stations as they saved almost half of the energy required to run the network when implemented with energy saving schemes. The energy saving features does not affect the resultant data rates to the users. The data rates remain the same regardless of using the energy saving schemes

The energy saving schemes proved out to save a lot of energy in the operation of both macro and micro cells. The amount of savings from the energy saving schemes depend upon the utilization and sleep time of the nodes.

- 1) For Macro deployment, the power consumption for a day without using any energy saving scheme was 283.44kWhr/km^2 which is 103455.6kWhr/km^2 for a year. Using micro TX energy saving scheme it was 263.52kWhr/km^2 which is 96184.8kWhr/km^2 for a year. Using MBSFN energy saving scheme it was 254.64kWhr/km^2 which is 92943.6kWhr/km^2 for a year. Using lean carrier energy saving scheme it was 234.62kWhr/km^2 which is 85637.76kWhr/km^2 for a year.
- 2) For Micro deployment, the power consumption for a day without using any energy saving scheme was 185.80kWhr/km^2 which is 67819.92kWhr/km^2 for a year. Using micro TX energy saving scheme it was 161.23kWhr/km^2 which is 58849.68kWhr/km^2 for a year. Using MBSFN energy saving scheme it was 150.24kWhr/km^2 which is 54837.6kWhr/km^2 for a year. Using lean carrier energy saving scheme it was 125.85kWhr/km^2 which is 45937.44kWhr/km^2 for a year.

So, we can see that using energy saving schemes in macro cell deployment can give savings as much as 17% and 33% in micro cells over a year.

And comparing the macro without energy saving scheme to micro with lean carrier energy saving scheme results in 55% of energy saving. Therefore, from an energy saving point of view, it would be much better to implement a heterogeneous network with more micro cells and small cells with energy saving schemes than with more number of macro cells.

This sort of heterogeneous cell deployment would help the network engineers in analyzing which type of cells are better suited for energy efficient deployment.

Here we can also see that macro grid performs much better when it comes to coverage, as the performance of the big macro cells is better than micro cells for the 10th percentile users, for this reason we need to deploy the small cell networks complemented by the macro cells to provide sufficient coverage to the edge cell users.

At last I would like to conclude that, it would be more efficient to substitute macro cells with micro cells especially in the parts of the city which require higher data rates, and this will be a backbone for 5G deployments. Applying the energy saving schemes in across thousands of sites in a mobile network will accumulate to tens of millions of kilowatt hours (kWh) in power savings annually. However, it would be the responsibility of the network planners to ensure that these cells are placed in the areas where they are needed the most otherwise adding small cells on top of the macro cells will only result in higher energy consumption.

CHAPTER 7

7 Future Work

As the simulations were carried out for a realistic dense urban scenario, there is scope for finding out the energy efficiency gains in other scenarios as well such as sub-urban and rural. These scenarios are equally important for instance, a huge amount of diesel energy is consumed for fueling up the cells in rural environment.

As the results are dependent over the deployment of the cells, one could might as well deploy the cells on other buildings to analyze the energy and throughput efficiencies.

The propagation model used in this study was BEZT however, there are various other propagation models like WINNER II etc. that could be used to calculate propagation losses in a real city like environment.

As the simulator which was used is a static, one can also make use of dynamic simulators to analyze the traffic and latency in each of the energy saving schemes.

References

- [1] K. Dufková, M. Bjelica, B. Moon, L. Kencl och J.-Y. Le Boudec, "Energy Savings for Cellular Network with Evaluation of Impact on Data Traffic Performance".
- [2] "Cisco Visual Networking Index: Global Mobile Data Traffic Forecast Update The Cisco ® Visual Networking Index (VNI) Global Mobile Data Traffic Forecast Update," 2016.
- [3] F. Richter, A. J. Fehske och G. P. Fettweis, "Energy Efficiency Aspects of Base Station Deployment Strategies for Cellular Networks," 2016.
- [4] C. Han, T. Harrold, S. Armour, I. Krikidis, S. Videv, P. M. Grant, H. Haas, J. S. Thompson, I. Ku, C. X. Wang, T. A. Le, M. R. Nakhai, J. Zhang och L. Hanzo, "Green radio: Radio techniques to enable energy-efficient wireless networks," *IEEE Communications Magazine*, vol. 49, nr 6, pp. 46-54, 2011.
- [5] C. Desset, B. Debaillie och F. Louagie, "Towards a Flexible and Future-Proof Power Model for Cellular Base Stations".
- [6] S. Yunas, M. Valkama och J. Niemelä, "Spectral and energy efficiency of ultra-dense networks under different deployment strategies," *IEEE Communications Magazine*, vol. 53, nr 1, pp. 90-100, 2015.
- [7] H. Forssell och G. Auer, "Energy Efficiency of Heterogeneous Networks in," pp. 53-58, 2015.
- [8] S. Tombaz, K. W. Sung och J. Zander, "Impact of densification on energy efficiency in wireless access networks," *2012 IEEE Globecom Workshops*, pp. 57-62, 2012.
- [9] L. Falconetti, P. Frenger, H. Kallin och T. Rimhagen, "Energy efficiency in heterogeneous networks," *Online Conference on Green Communications (GreenCom), 2012 IEEE*, pp. 98-103, 2012.
- [10] E. A. – Chenguang Lu, M. Berg, E. Trojer, P.-E. Eriksson, K. Laraqui, O. V. Tidblad och H. Almeida, "Connecting the dots: small cells shape up for high-performance indoor radio," 2014.
- [11] S. Landström och F. Anders, "Ericsson Review: Heterogeneous networks-increasing cellular capacity," 2011.
- [12] V. Rydén, "Outdoor to Indoor Coverage in 5G Networks," 2016.
- [13] G. Auer, V. Giannini, I. Gódor, M. Olsson, M. Ali Imran, D. Sabella, M. J. Gonzalez, O. Blume, A. Fehske, J. Alonso Rubio, P. Frenger och

C. Desset, "How Much Energy is Needed to Run a Wireless Network?".

- [14] A. D. Domenico och S. Petersson, "Final Integrated Concept," 2012.
- [15] O. Blume, V. Giannini och I. Gódor, "D2. 3: energy efficiency analysis of the reference systems, areas of improvements and target breakdown," *EARTH Deliverable 2.3*, pp. 1-69, 2010.
- [16] Ericsson AB, "5G energy performance," *Ericsson White Paper*, no. Uen 284 23-3265, 2015.
- [17] K. O. Mecklenburg och A. Blomgren, "Energy Optimization of Radio," Lund, 2016.
- [18] D. Migliorini, G. Stea, M. Caretti och D. Sabella, "Power-Aware Allocation of MBSFN Subframes Using Discontinuous Cell Transmission in LTE Systems," i *2013 IEEE 78th Vehicular Technology Conference (VTC Fall)*, 2013.
- [19] K. Kanwal, G. A. Safdar, M. Ur-Rehman och X. Yang, "Energy Management in LTE Networks," *IEEE Access*, vol. 5, pp. 4264-4284, 2017.

List of Tables

Table 1. Comparison between different types of nodes in a heterogeneous network.....	16
Table 2 SoTA estimation of power consumption in different LTE BSs....	23
Table 3 This table provides parameters of power model for different BSs	26
Table 4. Simulation parameters	37



LUND
UNIVERSITY

Series of Master's theses
Department of Electrical and Information Technology
LU/LTH-EIT 2018-624

<http://www.eit.lth.se>