

# Smart Environment - Early Wildfire Detection using IoT

---

ANDRÉ ZREIK AND CARL HIDESTÅL

MASTER'S THESIS

DEPARTMENT OF ELECTRICAL AND INFORMATION TECHNOLOGY

FACULTY OF ENGINEERING | LTH | LUND UNIVERSITY





LUNDS TEKNISKA HÖGSKOLA  
Lunds universitet



## Bachelor's Thesis

# Smart Environment - Early Wildfire Detection using IoT

By

André Zreik and Carl Hidestål

Department of Electrical and Information Technology  
Faculty of Engineering, LTH, Lund University  
SE-221 00 Lund, Sweden

## Abstract

Problems with extreme weather, such as drought, has increased due to greenhouse emissions. As one of the consequences to this, forest fires have emerged more frequently on a global level. This became obvious in Sweden, in the summer of 2018, which has been stated to have been the worst affected year of forest fires in modern time. In a state investigation of emergency preparedness and the operational extinguishing work of forest fires, it was stated several issues with the extinguishing work. One of these issues was the time aspect where the investigation urged that "the importance of quickly detecting arising fires and early efforts to extinguish these cannot be emphasized enough".

Today, costly, and unreliable methods are used to monitor large parts of Sweden's, as well as the world's, forests. With the help of new technology this is something that can be changed. With a system for detecting a forest fires at an early stage, both economic and environmental benefits can be achieved.

In order to cover the gaps that the current fire detection system has, the project aims to develop an IoT-based (Internet of Things) system, with the aim of detecting fires in a forest environment at an early stage and being able to geographically locate the fire. To achieve this functionality, the system must be connected to a network and equipped with sensors. When the system alerts, a predetermined route to the nearest unit in the system suitable for emergency personnel could be sent, as well as an estimated geographical location for the fire based on triangulation, wind direction and wind strength. This leads to a safer working environment for the firefighters who extinguish the fires and less damage to the forest, which makes both forest owners, insurance companies, extinguishing personnel, and society, big winners.

By taking advantage of the latest technology in communication and power harvesting, it is possible to create very energy-efficient and self-sustaining units with a long service life that can, after installation, take care of monitoring the forest environment for a long period.

During the project various fire detection techniques have been tested and compared. For the need to detect forest fire at a distance, the focus has been on a particle sensor from the sensor company Sensirion. This sensor has been tested in the field together with the fire department in north-western Skåne, the conclusion from the field test show that this particle sensor is able to swiftly detect a fire from 80 metres away. An IoT platform, developed by Sigma Connectivity and Ericsson, has been tested for this purpose with success.

Keywords:

- Internet of Things
- Wildfire
- Forest fire
- Narrowband-IoT
- Particle detection

## Sammanfattning

Problem med extremt väder, som torka, har ökat på grund av växthusutsläpp. Som en av konsekvenserna för detta har skogsbränder dykt upp mer frekvent globalt. Detta blev uppenbart i Sverige sommaren 2018, vilket sägs ha varit det hårdast drabbade året av skogsbränder i modern tid. I en statlig utredning av beredskap och det operativa släckningsarbetet för skogsbränder uppgavs flera problem med släckningsarbetet. En av dessa frågor var tidsaspekten där utredningen poängterade att "vikten av att snabbt upptäcka uppkommande bränder och tidiga ansträngningar för att släcka dessa inte kan betonas tillräckligt".

Idag används dyra och opålitliga metoder för att övervaka stora delar av Sveriges såväl som världens skogar. Med hjälp av ny teknik är detta något som kan ändras. Med ett system för att upptäcka en skogsbrand i ett tidigt skede, kan både miljömässiga och ekonomiska fördelar skapas.

För att täcka de luckor som de nuvarande branddetekteringssystemen har, syftar projektet till att utveckla ett IoT-baserat (Internet of Things) -system, i syfte att upptäcka en brand i en skogsmiljö i ett tidigt skede, att geografiskt lokalisera branden och, i händelse av en pågående brand, förutsäga brandbeteendet. För att uppnå denna funktionalitet måste systemet vara anslutet till ett nätverk och utrustat med sensorer. När systemet varnar ska en förutbestämd väg till närmaste enhet i systemet som är lämplig för akutpersonal skickas, liksom en uppskattad geografisk plats för branden baserad på triangulering, vindriktning och vindstyrka. Detta leder till en säkrare arbetsmiljö för brandmän som släcker bränderna och mindre skador på skogen, vilket gör både skogsägare, försäkringsbolag, släckningspersonal och samhället som helhet till stora vinnare.

Genom att dra nytta av den senaste tekniken inom kommunikation och kraftavverkning är det möjligt att skapa mycket energieffektiva och självhållande enheter med lång livslängd som efter installationen kan ta hand om övervakningen av skogsmiljön under en lång period.

Under projektets gång har olika tekniker för branddetektering testats och jämförts. För behovet att upptäcka skogsbrand på avstånd har fokus lagts på en partikelgivare från sensorföretaget Sensorion. Denna givare har testats i fält tillsammans med brandförsvaret i nordvästra Skåne. Fälttestets slutsats visar att partikelgivaren snabbt kan detektera en brand 80 meter från källan. En IoT-plattform, utvecklad av Sigma Connectivity och Ericsson har testats, med framgång, för ändamålet.

Nyckelord:

- Internet of Things
- Skogsbrand
- Partikeldetektion
- Branddetektion

## **Acknowledgements**

Firstly, we want to thank Mats Andersson, our supervisor and mentor at Sigma connectivity for providing us with his great knowledge in sensors and product development. Also, for being at great help with research concerning the choice of sensors and for being at huge support during the entire process. Mats Andersson have in a very educational way guided us through this entire process and we are very grateful for all the help we received. We also want to thank Mats Lilja, our mentor at LTH for great support during this project.

Secondly, we want to thank Jonathan Sjöberg at Fire Department Skåne NW for making it possible for us to test our sensors during a live fire and for being at support answering general questions regarding firefighting.

We want to thank Björn Strandmark, Felix Björk and Joel Baranji for their support and having patience with us in the process of developing the prototype at Sigma. Lastly, we would like to show our gratitude towards Jonas Bergh for giving us this opportunity.

# Table of contents

<b>1</b>	<b>Introduction</b>	<b>1</b>
1.1	<i>Background</i>	2
1.2	<i>Purpose</i>	3
1.3	<i>Goal Setting</i>	3
1.4	<i>Problems</i>	3
	• What sensors are suitable for detection of fire?	4
	• In the case of a fire, is it possible to pinpoint the geographical location?	4
	• What is the most suitable way to harvest energy in a forest environment?	4
	• How do you communicate with central servers from an IoT-device in a forest environment?	4
1.5	<i>Motivation</i>	4
1.6	<i>Limitation</i>	4
<b>2</b>	<b>Technical background</b>	<b>5</b>
2.1	<i>Properties of Fire</i>	5
2.2	<i>Internet of Things – IoT</i>	5
2.3	<i>ARDESCO (Approved Reference Design by Ericsson and Sigma Connectivity)</i>	6
2.4	<i>Solar harvesting</i>	8
2.5	<i>Radio communications</i>	9
2.5.1	IoT – Narrowband	10
2.5.2	LTE CATEGORY-M1	12
2.5.3	Mesh networking	12
2.6	<i>Sensors</i>	13
2.6.1	Particles	13
2.6.2	SPS-30 Particle matter from Sensirion	14
2.6.3	BME680 environmental sensor	16
2.7	<i>Wind</i>	16
2.8	<i>Algorithms</i>	17
<b>3</b>	<b>Method</b>	<b>19</b>
3.1	<i>Implementation</i>	19
3.2	<i>Source criticism</i>	19
<b>4</b>	<b>Analysis</b>	<b>23</b>
4.1	<i>Ardesco as development platform</i>	23
4.2	<i>Choice of sensor</i>	25
4.2.1	Field Test of SPS-30	26
	Purpose	26
	Research questions	26
	Theory	26
	Hypothesis	27
	Material	27

Method / implementation	27
4.3 <i>Software development</i>	29
<b>5 Result</b>	<b>31</b>
5.1 <i>Results from field test of SPS-30</i>	33
<b>6 Conclusion &amp; Discussion</b>	<b>39</b>
6.1 <i>Future work</i>	40
6.2 <i>Reflections regarding ethical aspects</i>	40
<b>7 Vocabulary</b>	<b>41</b>
<b>8 References</b>	<b>43</b>

# 1 Introduction

Climate change, as a part of the environmental issue, is a subject that has received attention due to its threat to today's civilization. It has been found that the human climate impact (in the form of increased greenhouse gas emissions and deforestation, among other things) is so large that it causes a global temperature increase [26]. Global warming causes consequences for water supply, ocean acidification, human safety, food production, health, ecosystems and increases the risks of natural disasters [46]. The category of natural disasters includes so-called "extreme weather", which means that heat waves, storms, and extreme cold increases in the result of the warmer climate [59]. According to a report from the World Meteorological Organization, the number of extreme weather events reported has doubled in all continents since the 1970 [67]. In Sweden, this can be exemplified by the heat wave that happened in the summer of 2018 [10]. Heat waves may cause land to be dried out, which in turn leads to increased risk of forest fires [59]. This, among other things, happened in the summer of 2018, when Sweden was hit by the most extensive forest fires in modern times and many forest owners was adversely affected by this. The emergency services made about 7,000 calls and a total of approximately 25,000 hectares of land was burned [10].

A state investigation of the emergency preparedness and the operational extinguishing work states that "the importance of quickly detecting fires and early efforts to extinguish these cannot be stressed enough" [10].

In current time, aerial firefighting is used, consisting of voluntary organizations and private companies, to locate and combat wildfires. The investigation believes that aerial firefighting is a key resource, and that more aviation resources are used abroad for monitoring and working with wildfires, which is a desirable direction for Sweden's management of future wildfires. However how great as it seems, there is also a problem in relying on aviation resources in the event of forest fires, partly because it is the costliest method when combating wildfires [10].

The method can also be called into question because of the great reliance on visual fire detection made by the human eye, in combination with the large area that must be monitored. The investigation also notes that one of the most serious deficiencies in the management of forest fires during the summer of 2018 was that the rescue service arrived too late. According to Jonatan Sjöberg (Interview, 2020-01-30), chief operating officer for the rescue service in north-western Skåne, this was often due to the fact that it was difficult to find a useful route to the fire itself that was usable for emergency vehicles in a harsh forest environment, even if the fire was detected ocular with the help of aircraft. It is thus possible to argue that the current forest fire detection is inadequate, and that it should be investigated whether there can be more effective alternatives - both from a cost perspective, but also in terms of detection time to speed up the extinguish process.

In 2019 drones were used on trial to detect fires, which has been of great help [18]. Although it may be more cost effective than aircraft, however, the fact remains that a person needs to control the drone and that the drone must be flown over large areas (in addition to that; also, at a lower speed than aircraft and helicopters can handle). It creates both a time barrier and a human dependency and in principle only solves the cost aspect. However, it is not just droning that is being tested. Researchers at the Swedish Royal Institute of Technology are trying to devise a method for detecting fires using satellite imagery. The method is already used in the US and Canada to detect and monitor forest fires automatically, which is based on



algorithms learning to recognize changes in satellite images. Radar systems also allow fires to be detected if the visibility is obscured by clouds or if it is night-time. However, the problem with this method in its current state is that the fires in Sweden are generally smaller than those in the US and Canada. The algorithms are therefore not developed according to the precision needed to detect smaller fires, such as those in Sweden - but also other countries with smaller land area. Additional problem areas that exist are that the most high-resolution images at present can only be delivered every three days [29], which is of course a critical problem regarding the time of discovery.

The need for fire monitoring can thus be summed up in three critical factors, as there is currently no methodology that does not depend on:

- Large cost sums
- Time dissonance
- Human dependency

With a developed, smart, and scalable system to protect forests, forest owners around the world can feel secure with their investments. Many times, people or companies have all their assets in the forest. With a land mass of 70% forest, the forest is thus an important asset for Sweden, not least for the economy and welfare. Of Sweden's total goods exports, the forest industry accounts for 10% and makes a significant contribution to Sweden's trade balance - since imports of forest industry products are relatively small. Exports of forest industry products are so great that Sweden is the world's second largest exporter of pulp, paper, and sawn timber. The importance of the forest is also great from an employment perspective. In several counties, the forest industry accounts for 20% or more of industrial employment and provides direct work for 70,000 people in Sweden [30].

However, the value of the forest cannot be measured solely financially. The forest also has a great environmental value and binds a lot of carbon dioxide, which contributes to the reduced impact of greenhouse gases in the atmosphere. The Swedish forest binds about 140 million tonnes per year [22] and thus constitutes an important component of the environmental issue. In addition to this, the forest also has a great value for many forest owners - which should not be neglected.

## **1.1 Background**

The bachelor's thesis is carried out on an international tech-company by the name of Sigma Connectivity, which in turn is part of the business group Sigma AB. Sigma Connectivity is an international consulting company with high competence. They offer solutions within the areas of consumer products, production technology, cleantech, MedTech, on-site engineering, and IoT.

The thesis involves a newly created product, developed by Sigma Connectivity in collaboration with Ericsson. The product (Ardesco) is a circuit board for the IoT market, with both NB-IoT and LTE-M at its disposal. The product has not yet been released on the market, nor is it available for already existing customers, hence, this bachelor's thesis is the first attempt to build a prototype based on it.

The purpose of this thesis is to develop a Proof-of-concept prototype for wildfire detection based on IoT solutions.

## 1.2 Purpose

Forests is of great value, both environmental and economical and things of great value should be protected. According to M. Helin (no date) one square kilometre of woodland is worth approximately 5.5 million SEK, which according to Forex is 575808.75 USD in today's exchange rate (2020-01-24). This is the value of the property. Social economic benefits are not considered. Benefits like work opportunities. Considering a large proportion of the landmass in Sweden consists of forest a fire prevention system is highly relevant in his country [32].

In an online article "Svea skog", a government owned company and the biggest owner of forest land in Sweden, state that the landmass in Sweden consists of 57 % percent forest. With the value of one square kilometres at approximately 575808 USD that gives the value of Swedish forests 147 791 766 616 USD [58].

Forests account for a proportion of the chemical transformation in our atmosphere from carbon dioxide to oxygen. It also binds carbon dioxide from the air, a process that is beneficial for the greenhouse effect as it prevents it to amplify. [52]

The reason this subject got chosen is because it is highly topical and relevant considering the ongoing forest fires this winter 2019/2020 in Australia as well as the forest fires in Sweden in summer of 2018 and 2014.

People are very keen on preserving forests especially since there is an ever-increasing deforestation in benefit for agriculture and therefor there might be a demand for systems designed for protecting forests.

Combining a forest protection system with IoT which is highly modern today sums up to an interesting project that also matches the competence at Sigma Connectivity very well along with knowledge acquired at LTH.

## 1.3 Goal Setting

The main goal of the project was to manufacture at least one Internet of Things prototype device, for placement in a forest environment, capable of communicating with central servers and gather relevant information about ongoing weather as well detecting signs of fire. The gathered information was then supposed to be sent to a central server for processing and retrieval and presented in any form.

In addition to this, research was to be made about possibilities to harvest energy in its surrounding environment, and how communications efficiently can be carried out in a forest.

## 1.4 Problems

An attempt to answer following questions will be made during the thesis:

- What sensors are suitable for detection of fire?
- In the case of a fire, is it possible to pinpoint the geographical location?
- What is the most suitable way to harvest energy in a forest environment?
- How do you communicate with central servers from an IoT-device in a forest environment?

### **1.5 Motivation**

The subject of the bachelor's thesis was chosen due to the great interest in telecommunications and sensors. The opportunity to participate and develop a new product based on the latest technology within telecommunications and for a good purpose would be very interesting, but also challenging. It would provide a great opportunity to utilize various skills acquired during the education and provide new ones along the journey. Knowing how heavy this task would be was a huge motivational boost as the effort required to complete this task would be very educational, both in terms of knowledge and on an individual level.

### **1.6 Limitation**

This project is limited to manufacturing a minimum of one and maximum three prototype devices for testing of functionality concerning communications, smoke, and weather detection.

Things necessary for a real product that will not be processed in detail in this project is the following: questions about mechanical engineering like mounting and encapsulation, economical questions, forest environmental attributes, environmental resistance, and certifications.

## 2 Technical background

This chapter aims to describe the subjects that are relevant for the prototype development and its functionality. The prototype will be built on a circuit board together with sensors. Ideally the prototype will have its application area aimed towards forest environment with promising functionality. It is therefore important to understand how wireless communication in a forest environment could be established with the help of the latest technique within telecommunications. Some key aspects must therefore be considered when going from idea, to prototype.

### 2.1 Properties of Fire

This subchapter will later help determine the decision-making regarding the selection of sensors. This subheading does not fall under the educational plan, it will therefore be mentioned vaguely to motivate previous claim later in this report.

What are the properties of a fire, and what is the smoke made of? For a fire to burn there are three key properties that must be fulfilled. There must be fuel, like wood, there must be oxygen and there must be heat. Dependent on the supply of these three key components the fire behaves differently. A fire with more oxygen and more heat generally produces decay products like smoke made up of smaller particles [24].

The smoke from a fire can cause health issues due to the small particles and chemicals created. Smoke contains particles with the size down to 0.1 microns as well as chemicals like aldehydes, acid gases, sulphur dioxide, nitrogen oxides, polycyclic aromatic hydrocarbons (PAHs), benzene, toluene, styrene, metals, and dioxins.

During a fire there is especially an emission of large amounts of particles and huge amounts of CO<sub>2</sub> and CO according to a white paper written by Rajmund Kuti, release by University of Gyor. The CO (carbon oxide) is created due to an incomplete combustion process. This gas is harmful for living creatures since it prevents the lungs from taking up oxygen. Both this gas and carbon dioxide (CO<sub>2</sub>) is heavier than air [24].

Smoke from a fire can travel a long way since particles of a very small size is created, and these kinds of particles may never settle on the ground due to its small mass. Instead they are kept suspended in the air due to the turbulence in the atmosphere. Initially they rise with the heat from the fire to a higher altitude due to the heat from the heat from the fire [57].

### 2.2 Internet of Things – IoT

When hearing about IoT (Internet of Things) the first time it could be difficult to comprehend, which is understandable. The name itself contains two words, Internet, and Things, which itself does not define the given title's working areas [34]. This subchapter will sketch the technical structure behind IoT, focus will be directed towards a thorough understanding to support future topics with greater impact in this report.

The world as we see it today is heading in the direction of trying to outsource human interaction and replace it with technical gadgets, which in turn has led to an increasing importance of IoT. In today's terms, when IoT is mentioned it is usually in relations to sensors [60]. The fundamental functions of internet are the ability to send and receive data.

When sensors are connected to the internet, they add another feature. The ability to send and receive data, as mentioned before, but also combined with the function of collecting data from your environment and how to act on the data given.

The sensor itself will be able to communicate with its surroundings and servers, sharing vital data to one or another where the information gathered might be useful [39].

A more comprehensive view aids easier access to vital information, all to support a user for private purposes to an industrial level [39]. There are billions of sensors and other gadgets already connected and more to come within the next five to ten years, hence the Things [60]. To clarify, IoT is not only sensors connected to the internet. They can be bundled with other devices as a part of it. An IoT-device in whole can perform many other actions, like a car providing you the shortest route due to GPS communicating with the satellite, or your phone, where you can communicate with your smart Home-system adjusting temperature or air conditioners [39]. Systems can even follow predefined rules, to minimize human interaction and limit this to emergency only.

One could therefore say IoT is the next step in the technological evolution to minimize human interference and for systems to become more self-propelled, while making the world a more connected place as one of its cornerstones.

### **2.3 ARDESCO (Approved Reference Design by Ericsson and Sigma Connectivity)**

This chapter will treat information about the Ardesco development board. Due to the products classified schematics and CAD, references to some of the following statements is not possible.

ARDESCO is an acronym for “Approved Reference Design by Ericsson and Sigma Connectivity”. Ardesco is an IoT platform used by and developed by Sigma Connectivity in collaboration with the telecom/tech company Ericsson. The main thought behind Ardesco is to shorten the time to develop a proof of concept (PoC) and bring a product to market.

For communications Ardesco rely on the nRF9160 chip which contain both an application processor called ARM Cortex M33 and a modem for NB-IoT or/and CAT-M, two technologies later mentioned in this report. This is a natural choice since the main target for Ardesco is IoT and NB-IoT/CAT-M is designed for just that purpose. As software development kit (SDK) nRF Connect is used and applications are written in C.

Applications on Ardesco runs on the Zephyr operating system (OS) which is an open source operating system designed for the embedded environment. Zephyr is optimal for IoT development in general. Zephyr is specifically designed for the embedded, resource-constrained environment which Ardesco is. A huge advantage with integrating Zephyr on the Cortex processor is the vast open-source community surrounding the Zephyr operating system, this makes it easy to find existing libraries and saves a lot of time developing software and debugging.

On top of Zephyr is the Nordic SDK. Applications for Ardesco is written in C and to upload applications to the chip SEGGERs J-link is utilized.

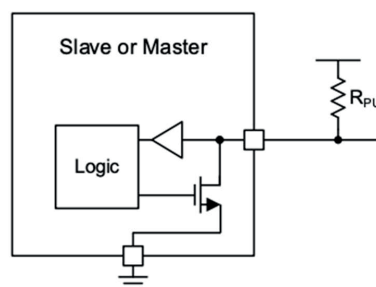
When debugging the Ardesco card, there is the possibility to connect through both an 8-pin connector for flashing and a USB-C for getting the serial output. If using a windows PC, a tool that works for reading the serial output is PuTTY which have a CLI (command line interface). If using a MacBook or Linux computer, the application “screen” is an alternative for getting the output.

Ardesco utilize the ADP545x PMIC (Power Management Integrated Circuit) for supply of power.

On the chip there is also an environmental chip integrated called BME680. This is a multi-sensor chip with capabilities to measure temperature, air pressure and air quality. This chip will be discussed later in the report.

The Ardesco card is fitted with a groove-connector which allows four cables to easily be attached. This connector is in turn connected to 3.3 V, ground, and two analog/digital general pin in/out (GPIOs) which could be programmed to hardware I2C (explained in the next paragraph) to act like a serial data line (SDL) and a serial clock line (SCL). The SCL and SDL lines are necessary for using an I2C connection which is a suitable way to connect more integrated chips to the Ardesco card.

Inter-Integrated Circuit (I2C) is a popular way to communicate between different integrated circuits on a PCB (printed circuit board). One of the benefits with this bus is its usage of only two different lines for communication. However, the I2C-protocol is initially designed as a communications protocol for “on chip communication”. A drawback is that it is sensitive to interference. This can however be overcome with short data lines and proper shielding. The I2C bus allows for one or multiple masters to communicate with one or multiple slaves. Slaves on the I2C bus can for example be sensors or displays while the master might be a microcontroller or microprocessor. The I2C bus utilize a single data line for bidirectional dataflow. This is achieved using an open-drain/open-collector on the same line as an input buffer [52].



**Figure 2.1** - Internal structure for SDA/SCL lines using I2C (J. Valdez, J. Becker, 2015)

Given the internal structure in figure 2.1, a pull-up resistor is necessary for communications. This pull-up resistor is usually integrated in the chip utilizing I2C. This kind of technology allows for a bidirectional data flow without communications issues. If the line is in use by another component this is easily detected by other devices since the entire data bus is pulled to ground. If a device wants to transmit a logic high, it simply opens the pull-down FET which leaves the bus floating which allows the pull-up resistor to pull the bus to high [52].

On the I2C bus, the master is defined as a controller, the master is the device which initiate communication with other devices. Slave-devices simple transmit, read, or write when told so by the master. All devices however have an, in every circuit, often unique I2C-adress consisting of eight-bit binary digit which allows for 256 different addresses. Each device may also have internal registers with their own addresses used for reading, writing, or storing data [52].

In a document from Texas Instruments the communication over the I2C-bus between a master-device and slave-device is described as the following [52]:

1. Suppose a master wants to send data to a slave:
  - a. Master-transmitter sends a START condition and addresses the slave-receiver
  - b. Master-transmitter sends data to slave-receiver
  - c. Master-transmitter terminates the transfer with a STOP condition
2. If a master wants to receive/read data from a slave:
  - a. Master-receiver sends a START condition and addresses the slave-transmitter
  - b. Master-receiver sends the requested register to read to slave-transmitter
  - c. Master-receiver receives data from the slave-transmitter
  - d. Master-receiver terminates the transfer with a STOP condition

## 2.4 Solar harvesting

This subchapter will describe solar energy and the possibility to harvest energy from the sun. Power harvesting in general is something crucial for powering low energy devices in remote areas where the purpose is to operate for a long time without changing batteries or performing any other necessary services.

According to the paper “Business Insider” the energy produced by the sun’s rays hitting the surface of Earth for one hour is greater that the entire power consumption of humanity in one year. The sun is basically an unlimited source of power, yet only a fraction of our power consumption comes from solar energy. The reason behind this is inconsistent power flow and lagging battery technology. When the sun does not shine none, or little power is produced. Another factor is inefficiency in solar panels. Modern solar panels have an efficiency of 20% [32].

For low power application there is no need for a high-power output from the solar panel and the small amount of energy produced outside direct sunlight might be sufficient. In a report issued by the “Centre of Excellence for Advanced Sensor Technology” the conclusion is made that solar power generation for IoT devices is possible under a closed forest canopy.

They carried out research and measurements on this topic in Malaysian forests. They found that the average energy produced during a day is  $74.50 W/m^2$  which translates to  $44.29 mAh/m^2 @ 3.3 V$ . This is to be compared with the small programmable integrated chip (PIC) ATTiny13 which according to ATMEL the producer draws  $1.6 mA$  or the particle sensor SPS30 which according to the Sensirion, the manufacturer, draws  $100 mA @ 3 V$  when active and measuring [28].

## 2.5 Radio communications

In terms of fire prevention and usage of efficient algorithms as well as supervision of the system, communications is fundamental. There are different ways to solve the communications obstacle and the different kind of techniques solve different problems. Point to point mobile solutions and ad hoc mesh networks as well as other kinds of communication techniques will be discussed in this chapter. The subtopics in this chapter all have in common that they are using radio frequencies (RF) and signals transmitted using radio frequencies.

One thing all radio waves have in common is that they decrease in attenuation with distance. The “free space path loss” formula (Equation 2.1) describes the relation between attenuation and distance. Where “d” describes the distance between the antennas, “f” describes the frequency,  $G_{Tx}$  describes the gain of the transmitter and  $G_{Rx}$  describes the gain of the receiver [6].

$$\text{Equation 2.1: } FSPL = 20\log_{10}(d) + 20\log_{10}(f) + 20\log_{10}\left(\frac{4\pi}{c}\right) - G_{Tx} - G_{Rx}$$

As can be seen by the equation the loss increases rapidly with when transmitting on higher frequencies or over greater distances. This can however be compensated with gain in the transmitter- or receiver antenna [6].

Cellular devices typically communicate over radio waves in the ultra-high frequency band. The ultra-high frequency band includes frequencies between 300 MHz and 3 GHz [6].

The Signal to Noise Ratio (SNR) is a unit describing how clearly the carrier signal can be interpreted. It is depending on the signal gain as well as the background noise. If you got an intermediate signal gain and plenty of noise, there is a risk that it is not possible for the receiver to interpret the carrier signal to receive data.

The SNR is calculated using equation 2.2. Higher is better [51].

$$\text{Equation 2.2: } SNR \text{ in dB} = 20\log\left(\frac{S}{N}\right)$$

Modulation of radio waves is used to transmit data. FM-radio for example is modulating the frequency to transmit data and AM-radio modulate the amplitude of the radio wave. These changes are in turn interpreted and processed in the receiver [51].

There are more kinds of modulations other than AM and FM. With a high modulation more data can be sent on the carrier wave but with more data on the carrier wave the demand for a stronger signal and high signal to noise ratio is required [51].



As mentioned previously it is possible to send more data using a higher form of modulation. If the SNR drops there is a risk sent packets are lost if it is not possible to read the transmitted data. This leads to a time-out and therefor packets will have to be resent. This in turn leads to a higher latency and packet loss which is the opposite of why to use a higher form of modulation [51].

Modern systems however automatically choose the highest possible modulation to be able to send as much data as possible over the carrier wave with the current SNR. If the SNR drops the transceiver and receiver negotiate for a new modulation. This leads to fewer lost packets and there for a more stable connection all whilst transmitting at the highest possible data rate [51].

One common type of modulation for cellular communications is QAM (Quadrature amplitude modulation). QAM is a form of combination between AM, FM which allow two independent carrier waves to be transmitted on the same frequency, one lagging 90 degrees out of phase. QAM can be varied with different suffixes like QAM16, QAM64, and QAM256 and so on. Since there are two signals the bits are always in a multiple by two, they are also usually evenly squared. Therefor modulations like QAM-16/-64/-128 are the most common [51].

### 2.5.1 IoT – Narrowband

Narrowband IoT (NB-IoT) is based on existing Long-Term Evolution (LTE), a standardization issued by 3<sup>rd</sup> Generation Partnership Project (3GPP) [1, 36, 45, 54]. It has lesser functionalities to optimize battery power consumption and the need for robust and reliable long-range communications, amongst other things for cellular devices [36, 54]. It is designed to let IoT devices operate via carrier networks either within an existing GSM carrier wave, in an unused guard band between LTE channels, or independently [4, 45, 54] on a bandwidth frequency of 200KHz [45]. It has a range up to 10-15 km [8, 45] in rural areas and several km's in urban [8]. As of its promising features, NB-IoT is considered a Low-Power-Wide-Area-Network (LPWAN) technology for wireless communication [45]. As LTE is already deployed worldwide with nearly full coverage in populated areas [21], NB-IoT does not require new infrastructure to operate [54], making it available for all IoT users supporting this new technology. NB-IoT is however not suitable in areas lacking LTE coverage as it is limited to LTE base stations [45].

When deciding application area for cellular devices, the need for mobility must therefore be taken into consideration, as NB-IoT is optimized for stationary use case only (to enhance previous mentioned characteristics). To clarify, initially when the NB-IoT device is set at place, a network scanning is issued to clarify with the network where it is located. The network gets it registered and both the network and the device save that registration [27, 61] - ideally never to do it again. If it would occur again, the device most likely changed location and a new registration must be made. This takes away all the benefits with NB-IoT if the procedure would become repetitive, since one of its objectives is to extend battery lifetime.

One of those features enabling this is Power Saving Mode (PSM). Ideally, when NB-IoT devices are active, only primary components should consume power to extend battery lifetime. One major power-consuming component is the device radio when transmitting.

When the device is inactive, PSM takes effect, turning the device radio off. The device is still registered with the network during this state, the same applies when it “wakes up” [27, 61]. This avoids the need of re-registration with the network [61], which results in power saving benefits. The device is therefore unreachable while it is “sleeping” [61]. However, data sent to the device during its PSM state will not be lost as it is a requirement by 3GPP that all pending data must be stored by the network during this state [61].

Another power consumption mode is extended Discontinuous Reception (eDRX) [40, 41, 48, 61]. Depending on the desired behaviour of the device, eDRX could work independently or together with other power saving configurations, like PSM, to add additional power savings [48, 61]. The configuration is based on the precursor DRX, commonly used in smartphones to prolong battery life [48]. DRX is used when in “sleeping mode”, meaning when idle, the receiver will be turned off during that period [48]. How long the device will be sleeping depends on the sleeping cycle (couple of seconds) [48]. Extending the cycle’s duration will increase battery life further, which is what eDRX is designed to do (hence the name) [41, 48]. The duration of the sleeping state could vary between a couple of minutes, to hours [40, 41, 61], which is a significant difference compared to regular DRX. For devices where it is acceptable to be unreachable for longer periods this could be beneficial, from a power consumption perspective.

Something further to consider using NB-IoT is its latency and transmission speed. NB-IoT is most suitable for those applications where high latency and low data rates are considered [43, 54]. The delay is between 1-10 seconds [3, 43, 54], situations where that kind of delay is acceptable without drawbacks could be for monitoring applications. For example, the fuel level in a tank, where this delay could be considered arbitrary. With a speed around 50-70 kbps [3, 35, 43], NB-IoT is most suited for low data transmissions, since the bigger the packages are that it has to send (for example, 1 Mb), the longer the LTE radio remains in that high-power active state. Thus, the purpose of extending battery life would be counterproductive.

Three major factors can therefore summarize the benefits with NB-IoT:

**Low cost**

Cheaper design, due to less technical complexity. For example, with the need of only one, less powerful LTE radio, the price per unit could be decreased. Dismantling of the basic LTE technical specifications to suit the demands for NB-IoT also affect the cost as the unit can be built on cheaper, less powerful components.

**Extended lifetime**

With all the power saving configurations, life expectancy could be more than ten years.

**Robust and long-range communication**

Great coverage, deep penetration through several thick walls (like concrete) and floor levels, makes NB-IoT units deployable in challenging environments.

Thus, the need in challenging environments where difficulties as processing power, network connectivity or battery life could be problematic can now be considered excluded with NB-IoT.

## 2.5.2 LTE CATEGORY-M1

LTE CATEGORY-M1 (LTE CAT-M1, or CAT-M), also known by the terms eMTC (enhanced Machine Type Communication) and most commonly by LTE-M (Long Term Evaluation for Machines), is another standard issued by 3GPP [19] for cellular devices [2, 50]. Mentioned with NB-IoT, this standard also allows LTE-M to operate within the same LTE spectrum.

Usually when talking about NB-IoT and LTE-M, they are put against each other [37] for technical comparison and efficiency in conceivable areas of application. LTE-M, as with NB-IoT, is also a LPWAN technology [40] and with software upgrades [39], being able to be deployed in already existing LTE networks [40]. As mentioned earlier with NB-IoT, LTE-M also offers low power consumption and the same power saving configurations (*see chapter 8.1 about eDRX, and PSM*) [40], and long-range networks [40]. In comparison with NB-IoT, LTE-M operates on a wider bandwidth frequency, around the 1MHz spectrum [3, 14], with greater data rates (around 300-400 kbps down/uplink) and lower latency, around the millisecond field [14]. Another distinctive feature, when comparing the two, is that LTE-M supports mobility use case [3], whereas NB-IoT is most suitable for stationary use case (*see subchapter 2.5.1 for explanation*). Another unique feature is that LTE-M supports voice calls [56].

Comparing these two should not cause misunderstanding as it is not intended to be a competition. Overall, the end-goal is to create the better application area for the end user in terms of cost savings and enhanced specifications provided by the standard [15]. Depending on the consumer's desired behaviour of the IoT device to achieve maximal use case, these two can be compared to each other, allowing the consumer to determine best suited application area and thus result in cost savings when designing the IoT device.

## 2.5.3 Mesh networking

Mesh technology is a description of a technology where different nodes communicate with each other and/or with a gateway usually, but not necessarily, connected to the Wide Area Network (WAN). There are plenty of benefits using the mesh topology. Firstly, the benefit of this technology is that there is no need for a point to point connection between the master node and every node in the network. Secondly it is highly scalable, if more nodes need to be added to the network, all the work needed is just to connect the nodes to the network without thinking much about it. If there is a need for a node where there is no coverage there is the possibility to add further nodes between the new node and the gateway to expand the network. Thirdly, there is no real single point of failure. There is of course a gateway connected to the WAN which could fail but this is overcome using multiple gateways and if a single node goes down the network is able to "selfheal" and continue working [25].

There are many benefits with the mesh topology. However, there are of course drawbacks as well. Firstly, with increased nodes a package must travel through the latency is increased and the chances for a packet getting lost is greater. This is a crucial drawback for applications which relies on a stable and fast connection between the different nodes in the network. Secondly, the complexity of the network is increased. Compared to a point to point connection where all a node must do is transmit and receive data from a single point, a mesh node must be more complex. This is because every node must act like a router. Every node must be able to receive data from all its neighbours and transmit to every neighbour to

eventually reach the target. This makes it an environment which is a lot more complex to set up even though it is simpler to expand [33].

A technology suitable for long range and low power meshing is Long Range Wide Area Network (LoRaWAN). It utilizes the attributes of carrier waves on the relative, compared to other wireless technologies, lower frequencies which leads to attributes like better penetration and low power consumption. When the nodes communicate with each other the distances often decrease which leads to less power consumption when transmitting. Examples where this is useful in vast areas where it is difficult and costly to provide full coverage to every node in the network or in low power devices. However, there are drawbacks with this kind of system. One of the main drawbacks is the tighter bandwidth which leads, to relative to other methods, slower rates of transmission. [33].

## 2.6 Sensors

The purpose with this subchapter is to create an understanding of why the following sensors would later be discussed as potential use case for wildfire detection.

### 2.6.1 Particles

Particles are divided into different sizes measured in microns. It is standard to use the unit “PM” which stands for particle matter. For example, PM1 stands for particles with the diameter of 1 micron or  $1 \cdot 10^{-6} m$ . The diameter of a human straw of hair is around 60 microns, pollen is 10 to 1000 microns in diameter [20].

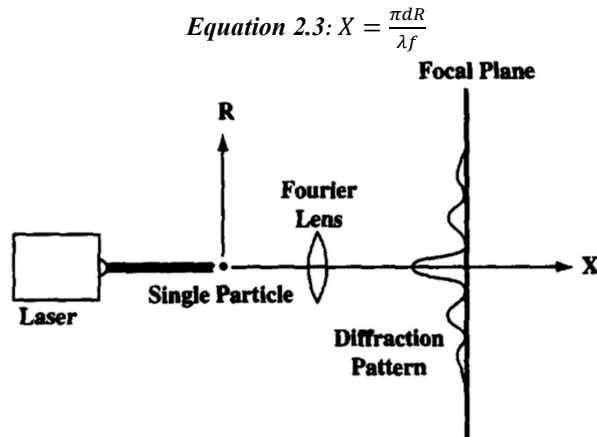
During a fire is burning there are a lot of different particles emitted of different sizes. Usually when the fire is intense, the temperature is high, and the supply of oxygen is proper the particles emitted are smaller while when the oxygen is limited particles of a bigger size is emitted. The size of the emitted particles also depends on the type of material that is burning. When wood is burning the size of the particles usually vary between 0.2 to 3 microns in diameter [57].

Aerosols is particles smaller than 10 microns in diameter that are suspended in the air and consists of solid matter. Aerosols usually classifies as dusts, mists, and smokes. Particles above 10 microns are big enough and consists of enough mass to rapidly fall to the ground and therefor will not be suspended in mid-air. Particles smaller than 1 micron may never settle because of turbulence in the atmosphere. They can however be washed out by water such as rain [42].

Particle measurements during ongoing wildfires have been carried out by amongst others by the department of agriculture in the USA. They observed a prominent peak in the mass concentration of particles sized 0.2 - 0.3 microns at 3.3 kilometres downwind from the fire [57].

To determine and measure particles sized differently it is possible to use laser-based techniques. This was done in 1996 by the department of mechanical engineering at Brigham Young University. They used a formula to get a dimensionless unit for size, described as equation 2.3. Equation 2.3 describes the dimensionless unit where “X” is the dimensionless size parameter, “d” is the particle diameter, “R” is the radial distance in the focal plane

measured from the optical axis, “λ” is the laser wavelength and “f” being the focal length of the receiving lens [11].



**Figure 2.2 - Light scatter from a single particle on the focal plane [11].**

As described by the formula, a laser of defined wavelength is required to calculate the size of a particle. Detectors are also required; detectors usually consist of arrays of photosensitive silicon diodes [11].

In general, bigger particles generate a high intensity scattering at a narrow angle while the opposite applies for smaller particles, they generate a low intensity scattering at a wider angle like shown in figure 2.2. With this data collected it is possible to determine different size particles using algorithms. [11].

### 2.6.2 SPS-30 Particle matter from Sensirion

The sensor company Sensirion has developed a particle sensor using the previously mentioned laser-based particle detection system. Their sensor can detect and measure particles down to 0.3 microns in diameter with an accuracy of  $\pm 10 \mu\text{g}/\text{m}^3$  @ 0 to  $100 \mu\text{g}/\text{m}^3$  or  $\pm 10\%$  @ 100 to  $1000 \mu\text{g}/\text{m}^3$  [53].

The physical connection on the sensor is a male plug called ZHR-5 from JST Sales America with 5 pins shown as figure 2.3 and described by table 2.1.

**Table 2.1: Pin assignment using I2C on the SPS30 sensor [53].**

Pin	Name	Description	Comment
1	VDD	Supply Voltage	5V $\pm$ 10%
2	SDA	I2C: Serial data input / output	TTL 5V and LVTTTL 3.3V
3	SCL	I2C: Serial clock input	TTL 5V and LVTTTL 3.3V
4	SEL	Interface select	Pulled to ground for I2C

5	GND	Ground	Housing on ground
---	-----	--------	-------------------

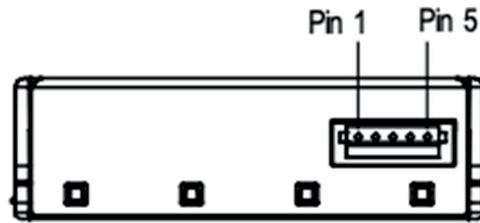


Figure 2.3 - The Communication interface [53]

The SPS30-sensor can connect to another chip either as an I2C slave or through UART. By pulling pin 4 to ground on start up for the sensor I2C is selected. If pin 4 is left floating UART is selected [53].

The sensor operates through three main operating modes: sleep, idle and measurement. When in sleep mode the sensor operates in the micro amps area and to be specific it uses less than 50 microamperes. During sleep all functions of the sensors are shut down, measuring is not possible because the internal lasers are shut down, communications through I2C or UART is also shut down. Entering sleep-mode is only possible through idle-mode. To exit sleep-mode a wake-up sequence is necessary as described in figure 2.4. It is possible to activate the I2C-interface for 100 milliseconds while in sleep-mode by sending a low pulse on the SDA line. If a wake-up command is not sent during the 100 milliseconds following the low pulse, the sensor is put back to sleep. To start the device, the low pulse is supposed to be followed by a wake-up command while the I2C interface temporarily is activated. When this command is successful the sensor enters idle mode. During idle mode most electronics is still turned off, the device is however ready to receive commands through the interface, this leads to a power consumption of approximately 330 microamperes. When in idle-mode the sensor is also ready to enter measurement-mode. During measurement, the sensor is consuming 45-65 milliamperes, this is due to all the electronics being started, including a fan and laser for measurements. It is possible to get a new measurement every second while in measurement-mode. Also, when the sensor is in measurement-mode, a fan-cleaning procedure is triggered periodically following a definable interval. During the fan-cleaning procedure the fan is turned on to maximum to clean out all accumulated dust inside the sensor. This is one of many procedures which make the sensor work for a long time (>10 years) without service according to the manufacturer [53].

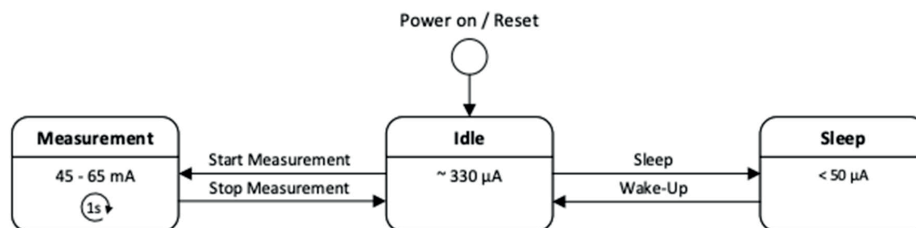


Figure 2.4 - Operating modes SPS30 [53]

### 2.6.3 BME680 environmental sensor

BME680 is an environmental sensor developed by BOSCH with several individual characteristics, able to measure relative humidity, barometric pressure, ambient temperature, and a broad range of gases, such as Volatile Organic Compound (VOC) [13]. To summarize its capacity, it is called a four in one (4-in-1) sensor, as this sensor module acquires more than one possible range of use in a measurement perspective [12, 13].

It promises high precision measurement in all areas and low power consumption [12, 13], ideal for battery powered IoT devices.

Most of the application areas are wide. What could be considered suitable, but not limited for the BME680 are towards indoor environment. However, to give a reasonable insight into its possible applications, it ranges from measuring the air quality in vehicles and transportation, to being able to act as pedometers and calorie-tracker for fitness purposes [13].

The sensor module has a square shape design with 3.0 x 3.0 mm length and 1.0 mm in height. It provides both SPI and I2C digital interface. The module can operate in 2 modes: sleep mode and forced mode. To obtain minimal power consumption during sleep mode, no measurements are performed during this state. During force mode, all four sensors are operational and performs measurements sequentially [12].

The module has different power consumption depending on current state and ongoing measurements. Table 2 shows its low consumption depending on ongoing readings [13].

**Table 2.2:** Power consumption related to active sensors [13]

Active sensors	current consumption (1Hz data refresh rate)
Humidity and temperature	2.1 $\mu$ A
Pressure and temperature	3.1 $\mu$ A
Humidity, pressure, and temperature	3.7 $\mu$ A
Gas	0.09-12 mA

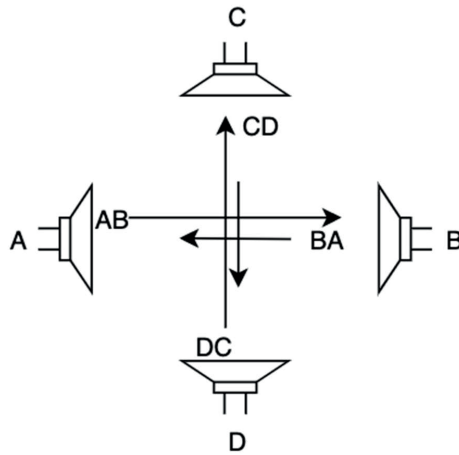
### 2.7 Wind

Traditionally wind direction and velocity have been measured by a wind vane which is able to give an inaccurate estimation of both. This has evolved to the commonly seen three cup anemometer combined with a wind-vane for wind direction. One disadvantage with this method is the mechanical stress using moving parts. Moving parts breaks and need service and if obstructed by a branch from a tree or similar they stop working and the obstruction needs to be removed [6].

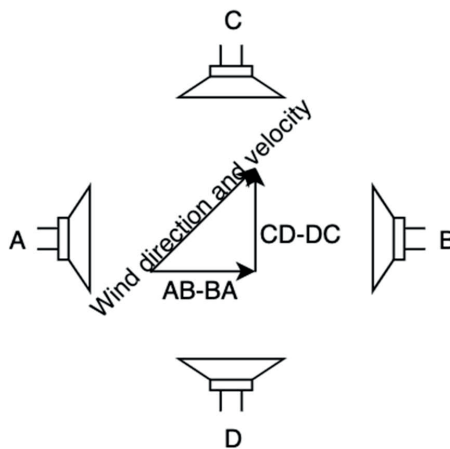
With modern technologies it is possible to measure both wind direction and wind velocity using a single unit without moving parts. This kind of sensor uses ultrasound along with the knowledge of sound velocity in air at a given temperature and at a given pressure. Since the sound move more quickly traveling downwind it is possible to calculate velocity in one dimension using a transmitter and a receiver for ultrasound and measuring the time of flight. With this configuration a one-dimensional wind vector is given. By altering the configuration and using two transmitters and receivers placed at a 90-degree angle from each other a second wind vector is given. By combining the two-dimensional vectors, realistic wind

attributes are given. Theoretically the same functionality could be given by using only three transmitters and receivers [6].

Another method is to take the given vectors and sum them together. This method is described in figure 2.5 and figure 2.6 [6].



**Figure 2.5** - Cross configuration ultrasound sensors for sensing wind direction and wind velocity



**Figure 2.6** - Summarize given vectors by ultrasound sensors

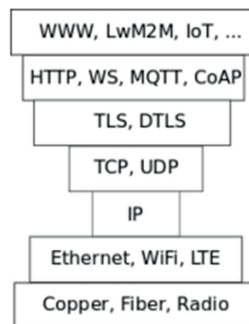
## 2.8 Algorithms

The lightweight machine to machine protocol (LWM2M) is developed and standardized by the organization “Open Mobile Alliance (OMA)”. LWM2M is a device management protocol with the purpose, as the name suggest, and solve the communication between machines. It is



a protocol in the rise and grows as the IoT-market grows since this is its main target device [48].

The LWM2M-protocol runs on the application layer and utilize User Datagram Protocol (UDP) to send its packages. UDP allows fast communication with minimal transmission which is beneficial for units and applications which have power constriction like IoT-devices without a direct source of power. The drawback using this protocol however is that packets might get lost in transmission. This can however be overcome in the application layer and in extension in the lwm2m protocol. For security, the LWM2M relies on Datagram Transport Layer Security (DTLS) as described in figure 2.7 [48].



**Figure 2.7** - Stack which LwM2M is built on [65]

The architecture of LWM2M is built so that every client connected to the server sends Internet Protocol for Smart Objects (IPSO) object to the server. These IPSO objects are, like the LWM2M-protocol standardized with unique instance ID's for specific functions [48].

Leshan is a project by Eclipse, which is mostly known for its Integrated Development Environment (IDE). It provides libraries to help with setting up a server and clients. They also provide a bootstrap application for setting up a simple server and demonstrating the Leshan environment. Leshan is a platform for handling LWM2M-object [17].

### **3 Method**

At the beginning of the thesis, a decision had to be made on how the information gathering would proceed. Since there were many elements to consider and due to time pressure, the most efficient path had to be determined.

Knowledge had to be acquired to reach a reasonable conclusion whether the questions at issue were feasible or not by information gathering, to create an understanding and perspective of the thesis. Consultation between students and both supervisors helped determine the priority of the work. Remaining questions were postponed, dismissed, or reconstructed to make the most out of the time.

Realizing how NB-IoT and LTE-M works had to be taken into consideration when deciding which protocol to use for the purpose of the prototype. As it would lay the foundation of how the information gathering would proceed and what aspects to take into consideration in terms of power consumption and deployment.

An interview with a chief operating officer for the rescue service in north-western Skåne, addressed some of the questions regarding potential improvements of today's wildfire encountering. Assistance with kindling would be provided for future field-tests.

With a perspective of the expectation of the thesis in terms of what was considered achievable, the next phase included access to the Ardesco-scheme. Meetings with key personnel related to the working field was one of the approaches to get a deeper understanding. With the knowledge gathered about Ardesco, the next phase in search for suitable sensors began. A potential sensor, BME680, was already integrated within the Ardesco.

The decision was to go with two sensors developed by the company Sensirion AG. SPS-30, for particle matter detection and SVM-30, a sensor combo module with the attributes of measuring gas, humidity, and temperature. Due to the choice of these sensors, a bundle of components could be added from the same company, which allowed a plug-and-play mechanism with completed interface for data presentation.

#### **3.1 Implementation**

After receiving the Ardesco from the lab, the implementation phase could begin. Meetings with key personnel was an approach on educating how the programming would proceed. A J-link was required for flashing purposes. For convenience, the decision was made to use Visual Studios as an IDE due to being familiar with this software from earlier experience. The decision was also made to use CMake as compiler and PuTTY as Command-Line-Interface (CLI). This software was recommended by personnel in the working area, as assistance could be provided if support were needed.

#### **3.2 Source criticism**

Since the technology used in this work is relatively new on the market, and is even still being revised and updated, the scientific articles had to be supplemented by information directly given by the active industry. Hence, tech organizations and companies were also used as

sources. The benefits from using these kinds of sources are that the facts are up to date, which is crucial in a fast-moving environment as the tech industry. Meanwhile, there must also be an understanding that these companies might reinforce the benefits of certain technologies in their field, as well as downplay the disadvantages since it might be a solution they are offering. To get pass this, we have turned to several different organizations and companies, to get such a comprehensive picture as possible. Among these it also exists associations. These are organizations within the telecommunications industry, working in collaborations over the globe that mainly focus on specifying standards and specifications for the industry. Since the information that has been gathered from these sources can be classified as industry standards, they are considered trustworthy (for example, 3GPP and GSMA). These include the following sources: [1], [2], [13], [14], [19], [21], [25], [27], [32], [33], [35], [36], [37], [40], [50], [56], [62] and [63].

[3] and [43] is considered trustworthy as they have similar context and is mentioned in other trustworthy sources, like [35] and [54].

The theory chapter of this thesis is, to the greatest extent possible, based on publications in scientific journals, to secure that the work is built on trustworthy sources. They are considered reliable since these articles has been through peer review. These include the following sources: [4], [5], [8], [9], [11], [17], [24], [28], [29], [42], [44], [45], [48], [49], [51], [54], [55].

[6], [20] and [57] is considered trustworthy sources of information since it is by a nonprofit organization which goal mainly is to spread knowledge.

Datasheets and other purely technical information are considered a highly reliable source of information since it is not used mainly as a tool of sales but rather as an unbiased source of information about the product. It should not however be neglected that the information is written by the companies which is also selling the product. Datasheets as sources are the following: [7], [12], [16], [47], [53], [64] and [65].

[10] could be considered a trustworthy source since it is a report from the Swedish government.

[15] If this source is trustworthy or not could be discussed. However, the content from this source used in this report could be considered an “obvious” statement and therefore could it also be considered as trustworthy.

Associations outside of telecommunication companies were also used as sources, when describing the background of forest fires. The information in these sources have been biased in the way that it is from a forest industry perspective. Since this thesis perspective is based on a forest conservation perspective, these are also considered trustworthy. These include the following sources: [18], [22], [23], [26], [30], [45], [46], [58] and [67].

[29] is considered trustworthy as the article is published by ATL (Lantbrukets affärstidning). The article is not angled to point out the pros and cons, but more to enlighten the reader about the development in forest preservation.

It is discussable whether or not the information in the following sources are credible since they are newspapers and scientific blogs. The information taken from these sources are non-crucial for the report: [31], [52] and [59].

[34] and [39] is considered trustworthy as the article is written by the same author of the eBook.

[41] is considered trustworthy as its content is mentioned in other trustworthy sources like [40], [48], [61].

[60] The company Thrive Global is a mix of a tech- and media company, the content could therefore be considered trustworthy as the author is not an employee by the company. The content does not affect the company's marketing.

[61] is considered a trustworthy source, as other sources like GSMA, [27] (p.19), mention the same thing and is considered trustworthy due to its credibility.



## 4 Analysis

At the early stage of the project restrictions had to be set to achieve the goal of having at least one functional prototype, to reach a conclusion regarding the thesis. The decision was made to make the category power harvesting theoretical as a part of the thesis, instead of the prototype design, since it would be too challenging and time consuming to fulfil.

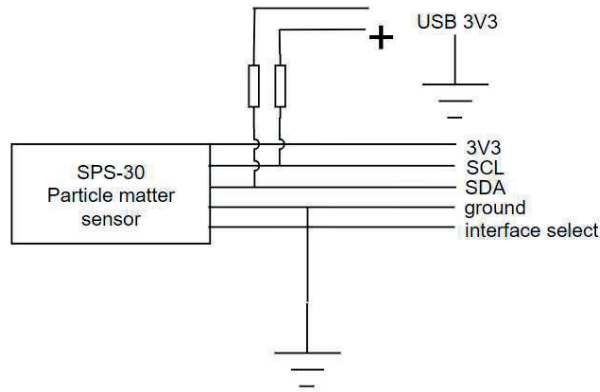
One idea was whether one could utilize the derivative in the temperature change in the event of a fire. Consultation with supervisors dismissed the idea as there are better approaches to detect fires. If time allowed, the theory could be tested. The Ardesco already had BME680 integrated, with temperature as an attribute. An external version was also on site, ready for usage to ease testing of this theory. Further investigations led to the choice of SPS-30.

Installations of software required for programming in embedded systems was challenging and time consuming. Guidelines were distributed online regarding the nRF9160, following a checklist with the software to ensure the installations would occur without errors. This was however not always guaranteed as the software would malfunction later. Troubleshooting was possible but very complicated, whereas the process had to be repeated from the beginning. Approaching some of the software engineers familiar with Ardesco was rewarding as the progress could proceed with haste. Similar complications had been experienced by the personnel and for that reason the decision was to install recommended software mentioned earlier (*in next subchapter 4.1*). A new problem occurred with one of the computers while installing this software, whereas the decision was to leave only one computer operational for programming considering how time consuming it would be to re-install following procedures.

### 4.1 Ardesco as development platform

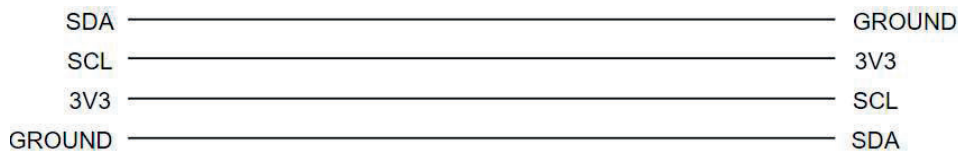
For this thesis it was predetermined to use the development platform Ardesco. This platform was still in an early development stage during the beginning of this thesis work and components for the board, for example the nrf9160, was still new on the market. This made troubleshooting difficult due to the lack of information on various forums, which otherwise often is a great place to look for solutions.

The physical interfaces on the particle matter sensor and the Ardesco card differed. For that reason, a custom cable was made so that the sensor easily could be connected. A groove-cable was spliced with a female ZHR-5 cable which is the physical interface on the particle sensor, on this cable a USB-cable was spliced in for powering the sensor and to provide a common negative. The fifth pin on the sensor, which is the “interface select” pin, was soldered to ground which forces the sensor into I2C when powering up. Pin two and three on the sensor was soldered to 5 volts through a 10k pull up resistor since this is required for the I2C-bus, as shown in figure 4.1.

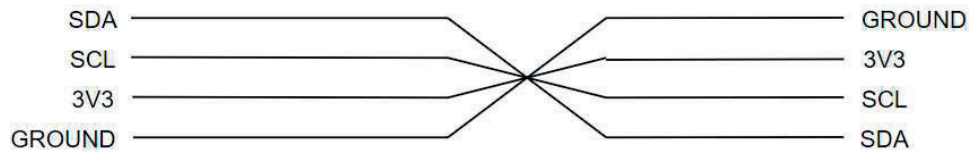


**Figure 4.1** - SPS30 configuration with interface select pulled to ground

When the cable was completed, measurements for continuity and resistance were carried out which turned out as expected. When plugging the cable into the different components, readings were given that initially did not make sense. It turned out that the groove-connector soldered on the Ardesco PCB was mounted in the wrong direction. This problem was solved simply by cutting the cable and splicing it in a mirrored direction. The problem is described in figure 4.2 and the solution in figure 4.3. A better but more time-consuming would have been to detach the groove connector to solder it in a correct position.



**Figure 4.2** - Problem with groove connector mounted in mirrored way



**Figure 4.3** - Solution, cable spliced in a mirrored direction

For this project it was crucial to set up a secondary I2C-bus since that was the only way to communicate through the groove-connector with the SPS30 particle sensor. This turned out to be a lot tougher than expected. The reason for this is that there already is an I2C-bus set up for the internal sensors on the Ardesco card. When setting up a secondary I2C-bus we received warnings about missing libraries when compiling the software. When doing research on the problem it was found out that this was a bug discovered in January 2020 and marked

with low priority by the developers at Nordic Semiconductors. Another reason this was a tough task is that the nRF9160 utilize the software development kit called Nordic SDK. This is rather new compared to other SDKs. There was a lot of help to be found on Nordics forums but most of the threads was about solutions using nRF5 SDK which is an older SDK.

One big factor that should not be ignored is due to the lack of experience in development in the C environment the software implementation was challenging without continuous assistance by more experienced engineers at sigma.

For testing purposes an I2C-bus was set up on an Arduino board which was successful.

## 4.2 Choice of sensor

Choosing sensors for the given application is almost a chicken or egg paradox. Since it is not possible to measure fire attributes without sensors and not possible to choose a suitable sensor without knowing the specific attributes for a fire. Therefor the choice of sensor relied on knowledge gained through previous research and partially knowledge gained through interviews with people working with firefighting.

The ideal sensor was probably not found and employed during this thesis work. There are a lot of aspects to take into consideration, aspects like power consumption, resilience against the nature, sensitivity, what to sense, interface, sensitivity against interference, physical size etcetera. When choosing sensor for the project the focus was on detection and compatible interface, the main things for a functional proof of concept. If a live product were to be developed more time for research would be beneficial.

Results from the field test of the SPS30 particle sensors shows that this sensor might be suitable for its purpose. A lot of time was put into researching a sensor with the right requirements. There must be made more extensive testing to make sure this kind of sensor works for all the requirements. The sensor is based on laser-scattering technologies and even though it has a self-cleaning mode where the built-in fan blows the sensor out there might be a possibility that the focal lens inside the sensor might get dirty over time. This could interfere with measurements.

Previous research pointed out that when wood is burning particles are created with the size of around 2.5 microns in diameter and this was the information laying as ground in the choice of particle sensor.

Since there is only two GPIOs (general pin in and out) available on the Ardesco card there was not a lot of different possibilities concerning the choice of interface. The two GPIOs are hardware SDC and SCL lines which are used for the I2C interface. Hence the particle sensor also utilizes the I2C-interface for communication with the application chip. The particle sensors applied field is thought to be on a remote IoT device with limited power and therefor it is crucial for the sensor not to draw too much power therefor this was also taken into consideration.

The choice of sensor was eventually the SPS-30 particle sensor along with the SVM-30, both from the sensor company Sensirion, which together can measure particles, humidity, and temperature. The SVM-30 was however dismissed during the process as integrating the SPS-



30 with Ardesco was struggling and had higher priority. No drivers could be found and during the project no customized drivers could be written without help, hence the decision.

One benefit which affects the choice of sensors is that the sensors come from the same company which makes it easier to get support on the sensors. Sensirion also have developed a simple GUI (graphical user interface) which makes testing simple.

Both sensors fulfil the main goal of having a compatible interface while being able to sense the main attributes of a forest fire.

The main drawback using these sensors is that they utilize 5V on the logical level while the Ardesco-card runs and communicates at 3V3. This problem was solved by using a bi-directional logic-level converter 3.3/5V. This is not the most optimal solution but according to us acceptable considering limitations of time, money, and previous knowledge.

The power issues were solved by using the USB-charging circuit on the Ardesco card. Since USB uses 5V which is stepped down on the Ardesco card, the entire unit can run on an external USB power bank. This is a very inefficient solution since the USB power bank charges the internal battery in the Ardesco card through a step-down converter while simultaneously powering the sensors running on 5V, but for the same reason as mentioned before this was considered as acceptable.

#### 4.2.1 Field Test of SPS-30

##### Purpose

The purpose of the field test carried out was to determine if and how well the chosen particle sensors function in a real test environment. It is important to get this information since the product is mainly based around the theory that particles are detectable at a far distance from the fire. To get a price model and see if the desired product is possible to fulfil its purpose it is necessary to determine at what range and how accurate the SPS-30 particle sensor can detect an ongoing fire. During this first test it felt more important to get a reading than testing the sensors limitations. Therefore the test was carried out in a way which made the chances to get a reading greater.

##### Research questions

1. Is it possible to determine a prominent peak in the particle concentration in air during an ongoing fire?
2. At what distances is it possible to detect that a fire is ongoing?
3. How long after the fire is started is it possible to detect a peak in the particle concentration in the air?
4. What sizes of particles is created during a fire fuelled by wood?

##### Theory

The field test was based on the theory that particles created during the fire fuelled by wood would travel with the wind to be detectable by particles sensors downwind. According to a study carried out by The Department of Agriculture in the USA it is possible to detect a peak in the concentration of particles even at ground level up to a couple kilometres downwind

from a forest fire. In the same study it is reported that particles that are detected at these ranges are in the size range of 2.5 microns in diameter which is detectable by the SPS-30 sensor. Other charts found online describe how particles of other sizes also may be formed and emitted from a fire [57].

## Hypothesis

Prior to the field test the hypothesis was that particles would travel downwind from the fire to be picked up by particles sensors. The time it would take for the particles to be detected is depending on wind velocity. The hypothesis also includes that a greater reading close to the ground would be possible with a higher wind velocity due to the smoke created will not escape vertically with large horizontal wind speeds.

## Material

During the field test the following material was used (table 4.1).

*Tabell 4.1 - Equipment used during field test*

<b>Item</b>	<b>Quantity</b>	<b>Comment</b>
SPS-30 particle matter sensor	3	NA
SPS30 EVAL KIT	3	Evaluation kit to SPS-30,
HP EliteBook	2	NA
MacBook Air	1	NA
Wooden pallets made of pine	3	With a mass of approximately 10 kg each
Diesel	NA	0.5 litre/0.4 kg

During the test, an application called Sensirion Control Centre was used on the computers. This is a software developed by Sensirion to easily connect the sensors to computers. It automatically establishes a UART-connection to the sensor and start measuring. When the measurement is stopped, a CSV (comma separated values) file is created and saved on the computer which then give all the measurement data at a given time.

## Method / implementation

The field test was carried out together with “Räddningstjänsten Skåne Nordväst – RSNV” (Fire Department in North West Scania, Sweden) at one of their training and education sites May the 14<sup>th</sup> 2020.



*Figure 4.4 - Test site for field test*

When arriving at the site, one computer connected to a sensor through the evaluation kit was placed on a pallet 10 meters from where the fire (latitude: 56.084611, longitude: 12.728908), shown by figure 4.4 was going to be lit, one sensor and computer was placed 20 meters from the fire (latitude: 56.084627, longitude: 12.729442) and one sensor 60 meters from the fire (latitude: 56.084567, longitude: 12.729694). The sensors were placed at approximately 10 centimetres from the ground downwind from the fire (as shown in figure 4.5). The fire was burning at the coordinates on the picture above.



*Figure 4.5 - Sensor connected to computer on pallet at test site*

Inside a small metal container (shown in figure 4.6) two pallets was added along with 0.3 litres of diesel. The diesel was soaking on the pallets for 5 minutes before the fuel was lit using a blow torch. After 5 minutes another pallet was added.



**Figure 4.6** - Container used during field test

During the test day it was blowing 7 m/s with gusts at 15 m/s. The wind direction was 300 degrees NW and the temperature were 14 degrees Celsius.

During the test, the sensors were stationary at their positions during the entire time. When the fire had almost died out and the sensors no longer gave any readings the test was considered done and measurements were stopped.

### **4.3 Software development**

Most of the required software was already made available as open source or already written by Sigma. The challenge was mainly to edit it to fit our requirements.

The development process was divided into smaller milestones. Firstly, an I2C-bus was set up in a familiar environment, an Arduino card, which succeeded. With success, an external BME680-sensor was connected to the I2C-bus and it was possible to get readings from the sensor.

Secondly, when the Ardesco card was made available for this project, a custom LWM2M object was created in the main code to later be injected with the external sensor data. This was also successful and dummy data was sent from the Ardesco card to the server inside the custom LWM2M object.

Thirdly, the goal was to connect the external particle matter sensor, SPS30, to the Ardesco card and inject readings from the sensor to the custom LWM2M object. This step failed however since a secondary I2C-bus never got successfully initialized.



## 5 Result

The initial goal setting was to at least develop a product capable of detect an ongoing forest fire and send information about this to a central server. This goal was almost completely fulfilled. Capable sensors were found through research and tested with promising results in the field, a communication with central servers through LTE-M was established. A LWM2M-object (shown in figure 5.2) was also created and sent to the central servers containing dummy data. The intent was to inject this object with data coming from the particle matter sensor, SPS30. A connection between the external sensors and the Ardesco card was however never successfully implemented and therefore it was not possible to send information from the external sensors to the server. There was progress made to set up the I2C-bus continuously but eventually the deadline for this project was reached and there was not more time for trial and error. The problems encountered could probably have been overcome but not during the time for this thesis. It could be argued that this was the last piece of the project. The project is described in figure 5.1.

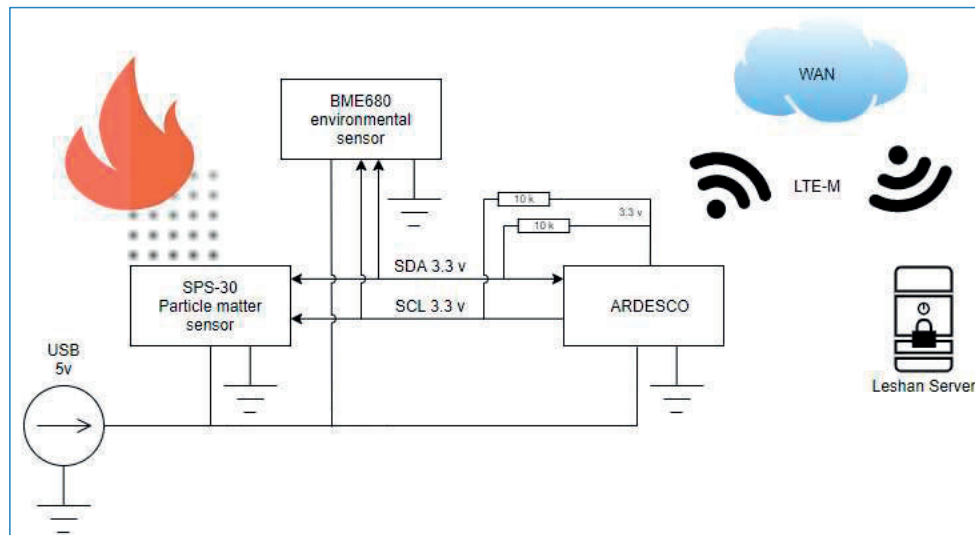


Figure 5.1 - Block diagram developed product

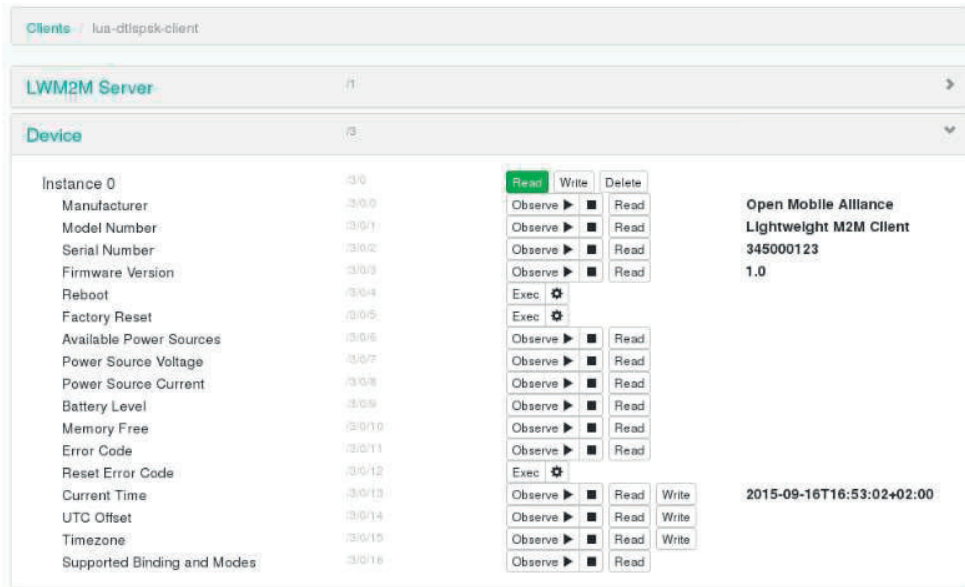


Figure 5.2 - LWM2M object displayed on the GUI from a Leshan server (see subchapter 2.8 about Leshan)

Theoretical studies show that it is possible to harvest enough solar energy in a forest environment to power IoT-devices. To be able to implement a solar harvesting solution to the Ardesco-card with external sensors it mainly depends on how often a reading should be carried out. This is because the external particle matter sensor draws current in milliamperes while measuring and microamperes while sleeping. There is however a great chance of success.

The ideal with the prototype was to implement it in a forest environment. As of this decision-making, regarding components and the very design of the prototype had to be taken into consideration like this event would have been carried out. This is with regards to the Ardesco, providing NB-IoT and LTE-M, both with the purpose of power savings and improved desired capabilities. From this, the decision of what protocol the prototype would use was determined, as the choice was in favour of NB-IoT due to the initial design of the prototype. Because the prototype would operate in a forest environment, the most suitable decision would have been to attach the module to a tree. The prototype itself would be battery-powered, this method would not neglect its functionality. In this case, it would have been stationary, beneficially with NB-IoT. It is not necessary for the prototype to provide instantaneous updates of data, hence a delay between potential fire and the data being displayed on the cloud was acceptable. This is due to the known facts that wildfire extinguishing relies on preventing the fire from spreading. This would only require small data transfers; hence the slow data rate was acceptable as well. However, it was told that the mobile operator deploying NB-IoT in Sweden was struggling. Telia with LTE-M had showed promising results with good coverage and SIM cards were available on site for usage at the time. This resulted in the use of LTE-M instead as this would not have any effect on the end-results.

There is not a mesh system developed for the Ardesco card today, but it is something that could prove to be a good solution for deployment in a forest environment due to the lack of

cellular coverage. Information gathered through theoretical research points to mesh networking being a good solution for the problem mentioned above. However, the coverage for NB-IOT and CAT-M is mostly sufficient in Sweden today considering maps provided by the cellular provider Telia.

As mentioned in the chapter about properties of fire, heat is one of the components needed for a fire. This benefits the product in some ways. Since there is a smaller risk for fire during the winter it could be possible to put the device in sleep-mode and charge the batteries. During hot weather, more effect from solar panels can be created and since there is a larger risk for a fire measurement could be carried out more frequently.

To determine the geographical location of a fire with particle detection it is crucial to know the wind speed and wind velocity. Tests of these kinds of sensors were not carried out but research about different alternatives was made. Mainly, there are two different kinds of sensors that could be used for detecting wind speed and direction. The first is a wind vane combined with a turbine, this is a common way for detection. There is however a risk that this is not a reliable solution when considering it to work for years in a forest environment since it easily could be obstructed by mechanical interference like branches and leaves. The second alternative is an ultrasonic sound sensor which has no moving parts. The lifespan of this kind of sensor could arguable be longer. This kind of sensor would however probably be less efficient considering power consumption since active speakers is used.

## **5.1 Results from field test of SPS-30**

Considering the hypothesis, the result was a success. It was possible to get readings from the fire regarding the particle mass concentration from all sensors. It was also possible to determine how long it took for every sensor to pick up particles from the moment the fire was started.

During the reference test the sensors did never pick up a reading above 1.4 in mass concentration for any particle size.

When looking at figure 4 (First minute, 20 metres from fire) it is possible to determine that a fire has been started already after 25 seconds. This result is however debateable since the fire was started with diesel which created a lot of particles in the air, this was easily determined by observing the smoke created during the first seconds of the fire. When looking at the other graphs like the graph showing the mass concentration for PM1 (figure 5) it could be argued that the particles created during the first 5 minutes came from the diesel being burnt. This is also confirmed by observations. After 5 minutes the fire had gotten started and another pallet was added, this is confirmed by all graphs since it is possible to observe a peak in the particle concentration after 5 minutes.

Even though the source of the particles created during the first 5 minutes could be discussed the readings still contain valuable data since it is possible to determine that it took 25 seconds for the sensors to pick up a reading after the fire was started 20 meters from the source of the fire. This is however not what was predicted in the hypothesis. The prediction was that particles would travel at the speed of the wind. Since the wind had a velocity of 7 (15) m/s on the day of the tests. It would take no more than three seconds for the sensor placed 20 metres from the source to pick up the particles, it took however 25 seconds. This can be explained by



side winds at the beginning of the trial or that it took a couple of seconds for the fire to get going.

It was however possible to detect particles clearly of sizes from 1 PM to 10 PM. Theoretical studies show that particles of smaller sizes mainly would be emitted. Why these results differ could be explained by the relatively close distance to the fire the measurements were carried out, or by the sensor not being able to pick up different sizes effectively.

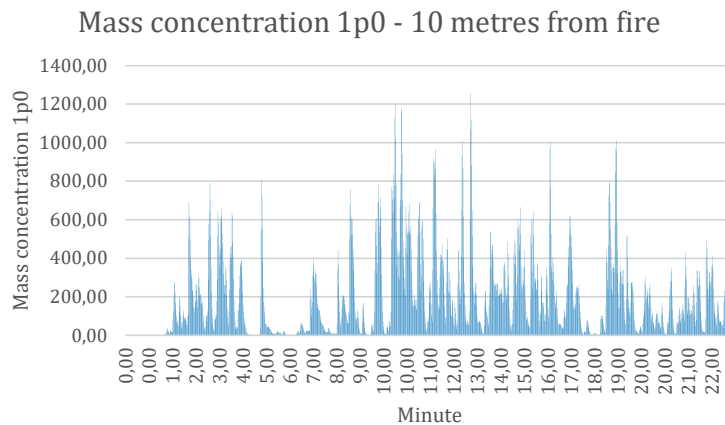
It is clearly possible to detect a prominent peak in the particle concentration when a fire is ongoing within 10, 20 and 80 metres from the sensors as shown in diagram 5.1, 5.2 and 5.3.

When looking at the different graphs it is important to notice the different ranges in the y-axis.

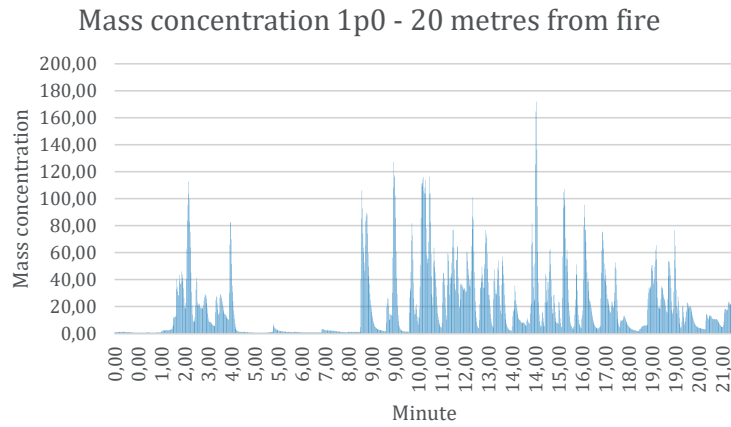
Further test should be carried out to test the absolute maximum range the sensors is able to detect a peak in particle matter due to a fire. It should also be tested in different environments and weathers.

Theoretical studies and field studies show that for long range detection, particle matter sensors are a suitable way to detect an ongoing fire. The field studies concluded that it is possible to detect an ongoing fire within one minute from 80 metres. This result calls for further testing to determine the maximum range of the sensors.

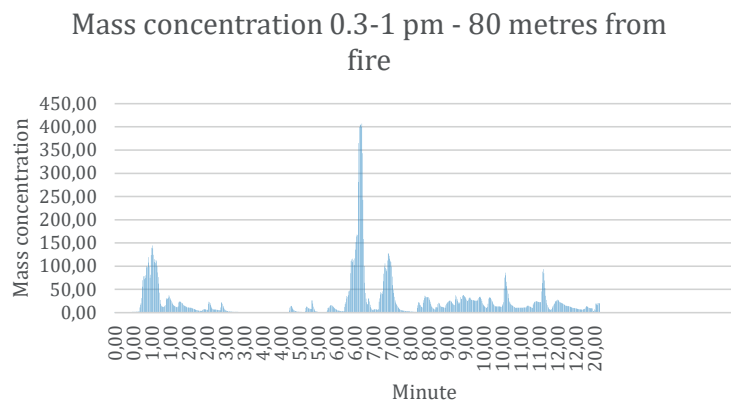
When analysing the graphs, it is noticeable that there is a delay of when the fire is picked up dependent on how far from the fire the sensor was placed, as shown in diagram 5.1, 5.2 and 5.3. It could be argued that if there was knowledge of real-time wind direction and velocity it could be possible to geographically determine where the fire is due to when particles was picked up.



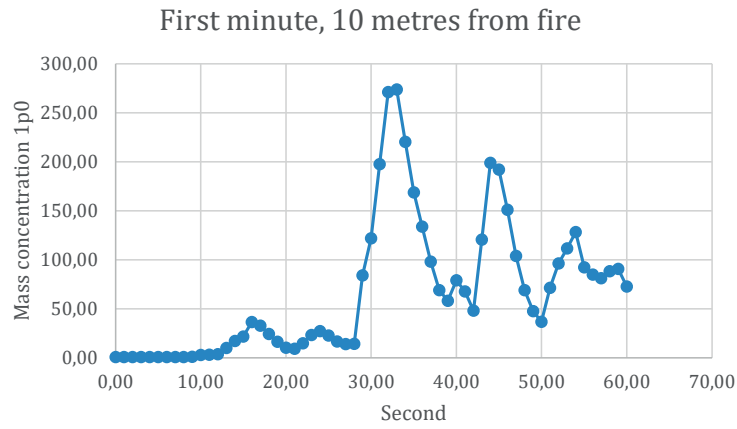
**Diagram 5.1 - Mass concentration 10 meters from fire**



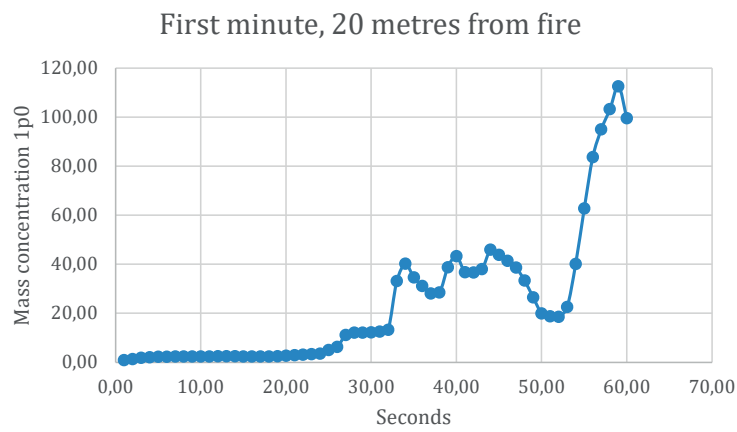
**Diagram 5.2 - Mass concentration 20 meters from fire**



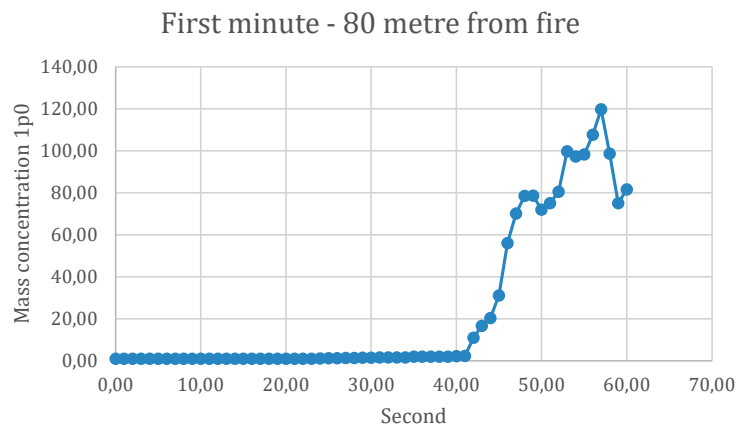
**Diagram 5.3 - Mass concentration 80 meters from fire**



**Diagram 5.4** - Mass concentration 10 meters from fire during the first minute



**Diagram 3.5** - Mass concentration 20 meters from fire during the first minute



**Diagram 5.4** - Mass concentration 80 meters from fire during the first minute



## 6 Conclusion & Discussion

Even though it is not possible to test every kind of sensor and since there is specific requirements for our applications, a very good candidate was found, the SPS-30 particle sensor from Sensirion. This sensor proved to be able to detect a fire swiftly after the fire being started. Therefore it is possible to say that particle detection using the SPS-30 is a reliable way to detect a fire.

To geographically determine the location of a fire it is possible to use triangulation if data from multiple sensors around the fire is gathered. This is shown during the field test even though it was not specifically tested. Since there is a delay dependent on the wind velocity it should be possible to approximate a location for the fire knowing the wind direction and velocity.

Using literature research, it is proven that it is possible to harvest the energy from the sun in a forest environment. However, this is heavily dependent on what algorithms for power saving is used. The field test found during the literature research is carried out in Malaysia much closer to the equator and with a sunnier weather than in Sweden. It is there for not possible to, with certainty, determine that a similar solution would be possible in a more northern environment.

In a forest environment there are a lot of natural obstructions. Therefore LTE-M and NB-IoT are good candidates for connecting to the WAN. This is due to them utilizing lower frequencies than ordinary cellular networks which make attributes like penetration and range much better. Since power is limited in a forest these techniques are beneficial due to them being more energy sufficient. Transmission is also more reliable since previous mentioned techniques utilize a lower form of modulation which leads to a higher SNR. Both protocols operate on existing infrastructure, a forest environment would not require new constructions in terms of communication towers if the intended application area has access to an LTE base station. The Ardesco board itself communicates with a Leshan server, whereas information is updated depending on the programmed behaviour of the Ardesco. Communication for cellular devices in forest environment could therefore be possible with LTE-M or NB-IoT.

A fully functioning prototype was never developed since time and knowledge limitations prohibited the final step of setting up a secondary I2C-bus. Except from this the project is a success since every goal was fulfilled on its own.

To make a conclusion about the project in general it could be considered successful even though the initial goal settings were not completely fulfilled. Working with Ardesco is challenging for a junior engineer since there is not much information and material online for the components in use. This is possibly because newly developed components are used in the development of Ardesco. Also, the lack of experience in the C environment makes application development for Ardesco a very tough task even though support is provided by more senior engineers.

## **6.1 Future work**

Considering the results from the field test, further testing of the SPS30-sensor should be carried out to test the sensor to its limits and see at what ranges it can pick up a change in the particle mass concentration suspended in air.

Further, live tests should be carried out to see how well the relatively newly deployed technologies like CAT-M and NB-IoT perform in a forest environment.

To make a real product of the project it is also necessary to perform a field study concerning energy harvesting from solar power under the canopy of a forest. This might not be possible and in that case other methods must be considered.

No algorithms for the gathered data was written during this thesis. For future work it would be possible to implement machine learning algorithms for locating an ongoing fire near the sensors.

## **6.2 Reflections regarding ethical aspects**

The vision during this thesis has always been to take the first step into launching a product to market which will benefit people's health and wellbeing by protecting the valuable forest environments. The product is based of entirely new technologies which will help bring technology forward and through this benefit other projects as well.

The project is based on the newly developed card, Ardesco. Which still is not on the market. For this thesis it is approved by Sigma Connectivity to write about and use the card but not to disclose the schematics and CAD.

Products designed for a forest environment must be able to harvest energy from its surroundings. This make the product run on entirely renewable energy from the sun. It also provides a proof of concept harvesting energy in a forest environment which could make way for future products designed with sustainability in mind.

## 7 Vocabulary

**IoT:** Internet of Things, generic term for connected units controlled centrally.

**LTH:** Acronym for “Lunds Tekniska Högskola” which translates to “Faculty of Engineering LTH at Lund University”

**4G:** Cellular network for connecting mainly mobile devices

**PIC:** Programmable integrated circuit

**LTE:** Long Term Evolution, 4G standardization for mobile broadband.

**3GPP:** 3<sup>rd</sup> Generation Partnership Project, including several standards organizations who all together develop protocols for mobile telecommunications.

**PCB:** Printed Circuit Board

**SCL:** System Control Language

**SDK:** Software Development Kit

**I2C:** Inter-Integrated Circuit, a bus for digital communication, designed to interconnect integrated circuits on the same board.





## 8 References

- [1] 3GPP (2016) *Standardization of NB-IoT completed*  
[https://www.3gpp.org/news-events/1785-nb\\_10t\\_complete](https://www.3gpp.org/news-events/1785-nb_10t_complete) (Accessed: 2020-05-03)
- [2] 3GPP, (2016) “Standards for the IoT”.  
[https://www.3gpp.org/news-events/1805-10t\\_r14](https://www.3gpp.org/news-events/1805-10t_r14) (Accessed: 2020-02-04)
- [3] Accent Systems (2020) “WHAT IS LTE-M”  
<https://accent-systems.com/Item/> (Accessed: 2020-02-08)
- [4] Andres-Maldonado, Pilar & Ameigeiras, Pablo & Prados, Jonathan & Navarro-Ortiz, Jorge & Lopez-Soler, Juan. (2017). NarrowBand IoT Data Transmission Procedures for Massive Machine Type Communications. IEEE Network. 31. 10.1109/MNET.2017.1700081.
- [5] Alade Olusope Michael. 2012. ‘Standardization of attenuation formula for radio waves propagation through freespace (LOS) communication links’. ‘Science Journal of Physics
- [6] American Meteorological society. Sonic anemometer. 2012  
[http://glossary.ametsoc.org/wiki/Sonic\\_anemometer](http://glossary.ametsoc.org/wiki/Sonic_anemometer)(Accessed: 2020-04-26)
- [7] ATmel. “Datasheet ATtiny13”. ‘Rev. 2535J–AVR–08/10.’  
<http://ww1.microchip.com/downloads/en/DeviceDoc/doc2535.pdf> (Accessed: 2020-04-23)
- [8] Ayoub, A. E. Samhat, F. Nouvel, M. Mroue and J. Prévotet, "Internet of Mobile Things: Overview of LoRaWAN, DASH7, and NB-IoT in LPWANs Standards and Supported Mobility," in *IEEE Communications Surveys & Tutorials*, vol. 21, no. 2, pp. 1561-1581, Secondquarter 2019, doi: 10.1109/COMST.2018.2877382.
- [9] Batra, A sand Alomari, a (2017) Power Harvesting via Smart Materials. SPIE / International Society for Optical Engineering. ISBN: 9781510608498
- [10] Björklund, J-Å: Regeringen (2019) Skogsbränderna sommaren 2018 (SOU 2019:7), Elanders Sverige AB, Stockholm  
<https://www.regeringen.se/4906d2/contentassets/8a43cbc3286c4eb39be8b347ce78da16/skogsbranderna-sommaren-2018-sou-2019-7.pdf>
- [11] Black, D., McQuay, M. and Bonin, M. (1996) ‘Laser-based techniques for particle-size measurement: A review of sizing methods and their industrial

applications', PROGRESS IN ENERGY AND COMBUSTION SCIENCE, 22(3), pp. 267–306.

- [12] BME680 Datasheet. "Bosch". 2017. [https://www.bosch-sensortec.com/media/boschsensortec/downloads/handling\\_soldering\\_mounting\\_instructions/bst-bme680-hs000.pdf](https://www.bosch-sensortec.com/media/boschsensortec/downloads/handling_soldering_mounting_instructions/bst-bme680-hs000.pdf) (Accessed: 2020-04-04)
- [13] Bosch Sensortec (2020) BME6801 <https://www.bosch-sensortec.com/products/environmental-sensors/gas-sensors-bme680/>
- [14] Le Bras, R (2019) *What is the Difference in Data Throughput between LTE-M/NB-IoT and 3G or 4G*. Orange <https://www.gsma.com/iot/resources/what-is-the-difference-in-data-throughput-between-lte-m-nb-iot-and-3g-or-4g/> (Accessed: 2020-02-09)
- [15] Clouder, A. "Choosing Between eMTC and NB-IoT". 2018. [https://www.alibabacloud.com/blog/choosing-between-emtc-and-nb-iot\\_593830](https://www.alibabacloud.com/blog/choosing-between-emtc-and-nb-iot_593830) (Accessed: 2020-02-11)
- [16] Eclipse. "Leshan". 2020. <https://github.com/eclipse/leshan/blob/master/README.md> (Accessed: 3 May 2020)
- [17] El Masri, A. et al. (2011) 'A Hybrid Mesh, Ad Hoc, and Sensor Network for Forest Fire Management'. doi: DOI: 10.1109/VETECEF.2011.6093169.
- [18] Elfström, J (2019) Drönare används för att upptäcka skogsbränder, Landskogsbruk, LRF Media <https://www.landskogsbruk.se/skog/dronare-anvands-for-att-upptacka-skogsbrander/>
- [19] eMTC (LTE Cat-M1). 'Halberd Bastion' <https://halberdbastion.com/technology/iot/iot-protocols/emtc-lte-cat-m1> (Accessed: 2020-05-05)
- [20] Engineering ToolBox, (2005). *Particle Sizes*. [online] Available at: [https://www.engineeringtoolbox.com/particle-sizes-d\\_934.html](https://www.engineeringtoolbox.com/particle-sizes-d_934.html) (Accessed: 2020-02-27)
- [21] Ericsson, Network Coverage <https://www.ericsson.com/en/mobility-report/reports/november-2019/network-coverage> (Accessed: 2020-05-14)
- [22] Eriksson, L & Larsson, M (2020) Skogen och klimatet, Skogsindustrierna, Föreningen Skogsindustrierna <https://www.skogsindustrierna.se/om-skogsindustrin/branschstatistik/skogen-och-klimatet/> (Accessed 2020-02-26)

- [23] von Essen, Malin (2019) Ständig beredskap nödvändig för att hantera skogsbränder, Skogsvärlden, volym 2, <https://www.skogssallskapet.se/kunskapsbank/artiklar/2019-06-03-standig-beredskap-nodvandig-for-att-hantera-skogsbrander.html>  
Published: 2019-06-03  
Updated: 2019-06-04
- [24] Földi, László & Kuti, Rajmund. (2016). Characteristics of Forest Fires and their Impact on the Environment. 15. 5-17. [https://www.researchgate.net/publication/329970190\\_Characteristics\\_of\\_Forest\\_Fires\\_and\\_their\\_Impact\\_on\\_the\\_Environment](https://www.researchgate.net/publication/329970190_Characteristics_of_Forest_Fires_and_their_Impact_on_the_Environment) (Accessed: 2020-03-28)
- [25] Glenn Schatz, 2016, *Mesh Network Topology: Pros and Cons For M2M Communication*. <https://www.link-labs.com/blog/mesh-network-topology-advantages-disadvantages> (Accessed: 2020-04-26)
- [26] Globala Målen, Mål 13: Bekämpa klimatförändringarna, <https://www.globalamalen.se/om-globala-malen/mal-13-bekampa-klimatforandringarna/> (Accessed: 2020-01-31)
- [27] GSMA (2019) *NB-IoT DEPLOYMENT GUIDE TO BASIC FEATURE SET REQUIREMENTS* <https://www.gsma.com/iot/wp-content/uploads/2019/07/201906-GSMA-NB-IoT-Deployment-Guide-v3.pdf> (Accessed: 2020-05-05)
- [28] Gunasagaran, R. et al. (2016) 'Internet of Things: Solar power under forest canopy', 2016 IEEE Student Conference on Research and Development (SCORED), Research and Development (SCORED), 2016 IEEE Student Conference on, pp. 1–4. doi: 10.1109/SCORED.2016.7810056.
- [29] Gustavsson, D (2019) Så ska skogsbränder upptäckas automatiskt, Lantbrukets Affärstidning, LRF Media <https://www.atl.nu/skog/sa-ska-skogsbrander-upptackas-automatiskt/>  
Published: 2019-05-03  
(Accessed: 2020-02-10)
- [30] Hallsten, K & Håkansson, C (2020) Skogsindustrins betydelse, Skogsindustrierna, Föreningen Skogsindustrierna <https://www.skogsindustrierna.se/om-skogsindustrin/skogsindustrin-i-korthet/skogsindustrins-betydelse/> (Accessed: 2020-02-26)
- [31] Harrington, R (2015) "This incredible fact should get you psyched about solar power". <https://www.businessinsider.com/this-is-the-potential-of-solar-power-2015-9?r=US&IR=T> (Accessed: 2020-02-16)

- [32] Helin, Markus. (no date). 'Rekordhøgt pris på skogsmark'. Available at: <https://blogg.lrfkonsult.se/rekordhogt-pris-pa-skogsmark> (Accessed: 2020-01-31).
- [33] Induo (2020) *Vad är LoRa? Och vad menas med LoRaWAN* <https://www.induo.com/s/g/vad-ar-lora/> (Accessed: 2020-02-17)
- [34] IoT for all (2020) What is IoT? - A Simple Explanation of the Internet of Things, McClelland, C, <https://www.iotforall.com/what-is-iot-simple-explanation/>  
Published: January 9, 2020  
Accessed: 14 May 2020
- [35] IoT summary, "3GPP"  
[https://www.3gpp.org/images/articleimages/iot\\_summary\\_large.jpg](https://www.3gpp.org/images/articleimages/iot_summary_large.jpg)  
Accessed: (2020-05-12)
- [36] Kuhlins, C and Törnqvist, M (2019) *What is NB-IoT? Practical tips to unlock its business potential*, Ericsson,  
<https://www.ericsson.com/en/blog/2019/10/what-is-NB-IoT>  
(Accessed: 2020-05-05)
- [37] Laird (2019) *Cellular NB-IoT vs LTE-M: Understanding the Differences*.  
<https://www.lairdconnect.com/resources/blog/cellular-nb-iot-vs-lte-m-understanding-differences>  
(Accessed: 2020-02-06)
- [38] Lei, B et al. (2013) 'Forest smoke detection in video images based on constant speed rotating platform', Proceedings of the SPIE - The International Society for Optical Engineering, 8908, p. (10 pp.). doi: DOI: 10.1117/12.2035026.
- [39] Leverage (2018) IoT 101, And introduction to the Internet of Things, First edition, Leverage LLC, <https://indd.adobe.com/view/2dbdc682-eba7-48bf-856a-2bb16551bf7b>
- [40] Link Labs (2016) *LTE eDRX and PSM Explained for LTE-M1* <https://www.link-labs.com/blog/lte-e-drx-psm-explained-for-lte-m1> (Accessed: 2020-05-07)
- [41] *LTE Quick Reference. "Share Technote"*  
[https://www.sharetechnote.com/html/Handbook\\_LTE\\_eDRX.html](https://www.sharetechnote.com/html/Handbook_LTE_eDRX.html) Accessed: 2020-05-08)
- [42] Lönnermaka, A et al, Y (2017) *Emissioner från bränder*. Räddningsverket, Karlstad  
(Accessed: 2020-02-27).

- [43] Maierhofer, Matthias. "LTE-M vs. Narrowband-IoT and the Internet of Things". 2019.  
<https://www.mavoco.com/lte-m-vs-narrowband-iot-and-the-internet-of-things/>  
 (Accessed: 2020-03-13)
- [44] Manatarinat, W; Poomrittigul, S. and Tantatsanawong, P. (2019) 'Narrowband-internet of things (NB-IoT) system for elderly healthcare services'. doi: DOI: 10.1109/ICEAST.2019.8802604.
- [45] Mekkia, K, Bajica, E, Chaxela, F, Meyerb, F (2019) A comparative study of LPWAN technologies for large-scale IoT deployment, Research Centre for Automatic Control of Nancy, Campus Sciences, *ICT Express*, vol 5. No 1, pp 1-7
- [46] Naturskyddsforeningen, Den globala uppvärmningens konsekvenser, <https://www.naturskyddsforeningen.se/vad-vi-gor/klimat/konsekvenser-global-uppvarmning> (Accessed: 2020-01-31)
- [47] Open Mobile Alliance. "Lightweight Machine to Machine Technical Specification". 2017.  
[http://www.openmobilealliance.org/release/LightweightM2M/V1\\_0-20170208-A/OMA-TS-LightweightM2M-V1\\_0-20170208-A.pdf](http://www.openmobilealliance.org/release/LightweightM2M/V1_0-20170208-A/OMA-TS-LightweightM2M-V1_0-20170208-A.pdf)
- [48] Rafid, Im. (2020). NB - IoT eDRX Configuration Introductory (Review Paper).  
 (Accessed: 2020-04-16)
- [49] Ratasuk, R. *et al.* (2017) 'Performance Analysis of Voice over LTE Using Low-Complexity eMTC Devices', *2017 IEEE 85th Vehicular Technology Conference (VTC Spring), Vehicular Technology Conference (VTC Spring), 2017 IEEE 85th*, pp. 1–5. doi: 10.1109/VTCSpring.2017.8108183.  
 (Accessed: 2020-02-10)
- [50] Reininger, Philippe. "3GPP Standards for the Internet-of-Things". 2016  
[https://www.3gpp.org/images/presentations/2016\\_11\\_3gpp\\_Standards\\_for\\_IoT.pdf](https://www.3gpp.org/images/presentations/2016_11_3gpp_Standards_for_IoT.pdf)  
 (Accessed: 2020-05-03)
- [51] Rutledge, D. 'Cambridge University'. 1999. "The Electronics of Radio".  
[https://books.google.se/books?id=ZvJYLhk4N64C&pg=RA2-PA310&dq=radio-teletype+fsk&redir\\_esc=y&hl=sv#v=onepage&q=qpsk&f=falsehttps://books.google.se/books?id=ZvJYLhk4N64C&pg=RA2-PA310&dq=radio-](https://books.google.se/books?id=ZvJYLhk4N64C&pg=RA2-PA310&dq=radio-teletype+fsk&redir_esc=y&hl=sv#v=onepage&q=qpsk&f=falsehttps://books.google.se/books?id=ZvJYLhk4N64C&pg=RA2-PA310&dq=radio-)

[teletype+fsk&redir\\_esc=y&hl=sv#v=onepage&q=qpsk&f=false](teletype+fsk&redir_esc=y&hl=sv#v=onepage&q=qpsk&f=false)  
(Accessed: 2020-03-11)

- [52] SCA (2020) Jonathan Valdez dioxide sink.  
<https://www.sca.com/en/about-us/sustainability/fossil-free-world/scas-forests-bind-carbon/>  
(Accessed: 2020-02-05)
- [53] Sensirion. “*Datasheet SPS-30 particle matter sensor*”. 2020.  
[https://www.sensirion.com/fileadmin/user\\_upload/customers/sensirion/Dokumente/9\\_6\\_Particulate\\_Matter/Datasheets/Sensirion\\_PM\\_Sensors\\_SPS30\\_Datasheet.pdf](https://www.sensirion.com/fileadmin/user_upload/customers/sensirion/Dokumente/9_6_Particulate_Matter/Datasheets/Sensirion_PM_Sensors_SPS30_Datasheet.pdf)  
(Accessed: 2020-02-15)
- [54] Sharan Sinha, R; Wei, Y; Hwang, S-H (2017) A survey on LPWA technology: LoRa and NB-IoT, Division of Electronics and Electrical Engineering, Dongguk, University-Seoul, Republic of Korea, *ICT Express*, Volume 3, Issue 1, March 2017, Pages 14-21
- [55] Sharma, H., Haque, A. and Jaffery, Z. A. (2018) ‘An Efficient Solar Energy Harvesting System for Wireless Sensor Nodes’, 2018 2nd IEEE International Conference on Power Electronics, Intelligent Control and Energy Systems (ICPEICES), Power Electronics, Intelligent Control and Energy Systems (ICPEICES), 2018 2nd IEEE International Conference on, pp. 461–464. doi: 10.1109/ICPEICES.2018.8897434.
- [56] SierraWireless (2018) “*LTE-M vs. NB-IoT: Make the Best Choice for Your Needs*”.  
<https://www.sierrawireless.com/iot-blog/iot-blog/2018/04/lte-m-vs-nb-iot/>
- [57] State of New York (2020) Exposure to Smoke from Fires,  
[https://www.health.ny.gov/environmental/outdoors/air/smoke\\_from\\_fire.htm](https://www.health.ny.gov/environmental/outdoors/air/smoke_from_fire.htm)  
(Updated January 2020)
- [58] Sveaskog (2020) Breif facts1: What is Swedish Forestry?  
<https://www.sveaskog.se/en/forestry-the-swedish-way/short-facts/brief-facts-1/>  
(Accessed: 2020-01-29)
- [59] Sveriges Television; Renman, F, Så påverkas vädret av klimatförändringarna,  
<https://www.svt.se/nyheter/utrikes/sa-paverkas-extremvadret-av-klimatforandringarna>  
Published: 2018-01-10  
Updated: 2018-01-21  
Accessed: 2020-01-31
- [60] Thrive Global (2019) The Future of IOT: 4 Predictions about the Internet of Things, Mehavarunan, <https://thriveglobal.com/stories/the-future-of-iot-4-predictions->

[about-the-internet-of-things/](#)

Published: 2019-10-07

Accessed: 2020-05-14

- [61] Twilio (2020) *Narrowband Power Optimizations for Massive IoT: eDRX and PSM*  
<https://www.twilio.com/docs/wireless/nb/nb-iot-power-optimizations-edrx-psm>  
(Accessed: 2020-05-05)
- [62] Ullerstig, S; Zaidi, A; Kuhlins, C (2019) *Know the difference between NB-IoT vs. Cat-M1 for your massive IoT deployment\**  
<https://www.ericsson.com/en/blog/2019/2/difference-between-NB-IoT-CaT-M1>
- [63] Ullerstig, S; Zaidi, A; Kuhlins, C (2019) *Know the difference between NB-IoT vs. Cat-M1 for your massive IoT deployment*, Ericsson  
<https://www.ericsson.com/en/blog/2019/2/difference-between-NB-IoT-CaT-M1>
- [64] Valdez, J; Becker, J (2015) Understanding the I2C Bus, Texas Instruments, Application Report, SLVA704, <http://www.ti.com/lit/an/slva704/slva704.pdf>  
(Accessed: 2020-02-15)
- [65] “White Paper Lightweight M2M 1.1: Managing Non-IP Devices in Cellular IoT Networks”, Sergey Slovetkiy, T-Mobile, Poornima Magadevan, T-Mobile, Yun Zhang, Ericsson, Sandeep Akhouri, Ericsson. 2018. <https://omaspecworks.org/wp-content/uploads/2018/10/Whitepaper-11.1.18.pdf> Accessed: 2020-15-17
- [66] Wright, Mike (2017) The next step in the evolution of 4G connectivity, Telstra Exchange, <https://exchange.telstra.com.au/the-next-step-in-the-evolution-of-4g-connectivity/>
- [67] WWF (2020) Klimatförändringarnas konsekvenser,  
<https://www.wwf.se/klimat/konsekvenser/>  
(Accessed: 2020-02-15)





**LUND**  
UNIVERSITY

Series of Bachelor's theses  
Department of Electrical and Information Technology  
LU/LTH-EIT 2020-772  
<http://www.eit.lth.se>