

Will the electrical grid sustain the change towards an electrified freight truck fleet?

A case study in northern Skåne of the impact on the distribution network due to electrification of heavy trucks

Kristin Bobeck
Lisa Salvin

Division of Industrial Electrical Engineering and Automation
Faculty of Engineering, Lund University

MASTER THESIS

Will the electrical grid sustain the change towards an
electrified freight truck fleet?

A case study in northern Skåne of the impact on the distribution network due to
electrification of heavy trucks

Kristin Bobeck & Lisa Salvin



LTH
FACULTY OF
ENGINEERING



Faculty of Engineering LTH at Lund University

Division of Industrial Electrical Engineering and Automation

Supervisors

LTH - Olof Samuelsson & Alice Jansson

Krafringen Nät - Håkan Skarrie & Andreas Vikström

4th June 2022

Abstract

The transport sector is facing major challenges to reduce the greenhouse gas emissions. The electrification of the freight fleet, which is an important step towards emission reduction, will result in capacity challenges in the grid. The aim of this thesis is to evaluate how the existing grid is affected by the electrification of heavy trucks and what solutions or reinforcements needs to be implemented to enable this. A case study is performed on two different logistics centres in Skåne. Charging profiles with different charging techniques are created in Matlab based on interviews with the logistics centres. Simple charging resulted in a power peak of 19.5 MW and 5.0 MW for the respective fleets in the case of a total electrification. Planned charging resulted in power peaks of 13.0 MW and 2.9 MW, respectively. Aggregated with the existing baseload the created charging profiles are simulated on grid models in PowerFactory to observe overloading in components. The existing grid allows only 4 % and 7 % electrification, respectively. Different solutions to allow further electrification are evaluated and batteries is considered to be the most suitable option. This thesis concludes that planned charging reduces the load with approximately 35 % compared to simple charging and that truck charging increases the load on the grid considerably compared to the baseload. Batteries are evaluated based on dimensioned size and cost and are considered to be a viable solution to alleviate the grid in some cases until grid reinforcement is possible. As the electrification of the society proceeds, it is important to evaluate the prerequisites of the existing grid. Implementations of further solutions such as flexibility, energy production and energy efficient vehicles are necessary to maintain a sustainable electrical network.

Preface

This master thesis was carried out in the spring semester of 2022 as a collaboration between the division of Industrial Electrical Engineering and Automation (IEA) at the faculty of Engineering at Lund University (LTH) and Krafringen Nät in Lund. This thesis is the final part of our five year education at LTH on the program Environmental Engineering with a specialisation in Energy Systems.

We would like to thank our supervisors Olof Samuelsson and Alice Jansson at IEA as well as Håkan Skarrie and Andreas Vikström at Krafringen. Our weekly meetings have been both pleasant and helpful. You have helped us collect our thoughts and motivated us when our work has felt confusing or difficult. Your expertise and knowledge within the area has been very helpful. Thank you to Huan Li, Mats Alaküla and Philip Johansson for giving us inspiration on how to create the charging profiles. We also want to send a thank you for the expertise from other people that we have been in touch with at Krafringen and to the representatives at the logistics centres. Especially thanks to Fredrik for showing us around to gain a deeper understanding. Thank you to the Krafringen office for an inspiring work place and for all the much needed coffee.

A big thank you also to our friends and family for supporting us. Especially thank you to the group of friends who are also conducting their master thesis at the same time as us. You have been a great support, both when we needed someone to brainstorm with and to ventilate frustration. Lastly we would like to thank each other for this last semester and all that it has been offering. Now on to new adventures!

4th June 2022

Lisa Salvin & Kristin Bobeck

Abbreviations

TSO	Transmission System Operator
DSO	Distribution System Operator
DC	Direct current
AC	Alternating current
LV	Low voltage (In this report, at and below 0.4 kV)
HV	High voltage (In this report, above 0.4 kV)
GHG	Greenhouse gases
PV	Photo voltaic
SOC	State of Charge
ZEV	Zero emission vehicle
CCS	Combined charging system

Contents

Abstract	i
Preface	iii
Abbreviations	v
Table of contents	viii
1 Introduction	1
1.1 Background	1
1.2 Purpose	2
1.3 Research Questions	2
1.4 Related work	3
1.5 Limitations	3
1.6 Thesis outline	3
2 Theory	5
2.1 Electrified trucks	5
2.1.1 Charging of trucks	5
2.1.2 Predicted future development	6
2.2 The electrical grid	7
2.3 Shortage of electricity	9
2.4 Limitations in grid components	9
2.4.1 Voltage regulation	9
2.4.2 Overloading	10
2.4.3 Resistance in cables	10
2.5 Distribution network planning	11
2.5.1 The connection process	11
2.5.2 Grid reinforcement	11
2.5.3 Probabilistic grid planning	12
2.6 Flexibility	12
2.6.1 Flexibility in demand	13
2.6.2 Storage of energy	13
2.7 Photovoltaic production	14
3 Method	15
3.1 Charging profiles	15
3.1.1 Charging scenarios	16
3.1.2 Model 1	17
3.1.3 Model 2	17

3.2	Grid simulations	17
3.2.1	Model 1	19
3.2.2	Model 2	20
4	Charging profiles	23
4.1	Simple charging	23
4.1.1	Model 1	23
4.1.2	Model 2	24
4.2	Planned charging	24
4.2.1	Model 1	24
4.2.2	Model 2	25
5	Grid simulations	27
5.1	Model 1	27
5.1.1	Low voltage components	27
5.1.2	High voltage components	29
5.2	Model 2	31
5.2.1	Low voltage components	31
5.2.2	High voltage components	31
6	Grid modification options	35
6.1	Analysis of solutions	35
6.1.1	Model 1	36
6.1.2	Model 2	37
6.2	Probabilistic analysis	38
6.2.1	Model 1	38
6.2.2	Model 2	39
7	Discussion	41
7.1	Charging profiles	41
7.2	Grid simulations	42
7.3	Grid modification options	43
7.3.1	Analysis of solutions	43
7.3.2	Probabilistic analysis	44
7.4	Future work	45
8	Conclusion	47
	Sources	49
A	Appendix	53
A.1	Model 1 - Baseloads	53
A.2	Model 2 - Baseloads	54

1 Introduction

1.1 Background

The Swedish national goal is net zero emissions of greenhouse gases (GHG) by 2045 as a contribution to the Paris Agreement to limit the global warming to 1.5 degrees (Ministry of Infrastructure, 2022b). The transport sector contributes to a third of the total emissions in Sweden today. It is the sector furthest from net zero emissions and is therefore facing challenges to reduce its carbon footprint. The national goal for transport within the country (flights excluded) is to reduce the greenhouse gas emissions by 70 % from 2010 to 2030. (BIL Sweden, 2020) According to SCB (2021b) the emissions between 2010 and 2020 were reduced by roughly 27 %. The reduction of emissions since 2010 is mainly due to an increase in biofuels and more energy efficient vehicles. The largest source of emissions within the transport sector is road-based traffic, it stands for 94 % of the total GHG emissions from the transport sector 2020. Within it passenger cars contribute with 67 % and heavy trucks follow with 21 %. The electrification of passenger cars is well on its way, more models are introduced on the market each year and the number of new registrations increases as well. The electrification is slower when it comes to heavy duty vehicles. According to BIL Sweden (2020) there were 57 000 new registered electric cars while only 48 new heavy electric trucks in 2021. According to Trafikanalys (2019) the heavy duty vehicles transport three quarters of the total freight in Sweden and 97 % are run on diesel.

The scenario with an electrified freight fleet will lead to an increase in the demand of power. This increase will cause a higher strain on the electrical network. It is therefore necessary to investigate how the grid will be affected by the increase in electrified vehicles. The majority of the Swedish electric grid was built during the 1950s through 1980s. The consumption has been close to constant since the 1990s, since there has been an increase in electrical equipment and additionally a development in energy efficiency. This has led to limited investments in the grid in the last decades. But the electrification of the society, with the electrified vehicle fleet as a large part, will increase the requirements for the Swedish electrical system.(Axberg et al., 2021) In a press release from February the Swedish Ministry of Infrastructure (2022a) has issued that they will put 550 million SEK towards the electrification of heavy transport in Sweden during the year of 2022. The government provides this financial support for regional pilot projects to ensure a faster transition towards an electrified transport sector. The financial aid is aimed towards actors in the industry that are aspiring to contribute to the building of an infrastructure with regional supply chains of charging stations.

One of the main routes in Sweden where new infrastructure for electrification is needed is the European route E4. It runs 1590 kilometres through Sweden from Helsingborg in the south to Haparanda in the north and is considered to be the backbone of the transport in Sweden. The southern half of the route

is a highway. The southern most region of Sweden, Skåne, is dense with both people and traffic. The region connects Sweden and the rest of Europe by ferries and a bridge and is therefore an important region for freight transport. The European Automobile Manufacturers Association (ACEA (2021a)) have expressed their full commitment in the work to reach net zero emissions before 2050. They have identified the minimum number of charging points needed in Europe in order to make electrification of the truck fleet possible, both for 2025 and 2030. ACEA (2021b) have published an interactive map suggesting suitable locations for charging stations for regional trucks. The map is based on already commonly used truck stops identified with the help of GPS coordinates of about 400 000 trucks in operation throughout Europe. Of these recommended locations some are located on the distribution network owned and managed by Krafringen.

Even with financial aid and a mapping of suitable charging points, the truck electrification still has practical challenges. In order to successfully integrate charging stations it is not only important to understand the maximum power required but also when it is required. It is also of interest to take the already existing loads into consideration and investigate how the grid will be affected by a new electricity consuming customer. Therefore, this master thesis investigates the grid impact at two logistics centres on the electricity network owned by Krafringen. The logistics centres differ in size of the building, size of the fleet, type of freight and driving patterns.

1.2 Purpose

The purpose of this master thesis is to investigate how the electrification of heavy trucks and the subsequent load affect the existing grid. A case study is conducted for two different logistics centres on the existing grid of Krafringen in the northwest region of Skåne. The study is based on the existing grid and existing consumption characteristics. The study investigates how the grid would be affected by adding charging of heavy trucks. Technical solutions are evaluated to ease the strain on the grid. The study could help distribution grid owners and aid ongoing research to understand the magnitude of heavy truck charging. Moreover, this thesis looks into probabilistic dimensioning of the grid as an alternative to the deterministic methods used today.

1.3 Research Questions

In order to achieve the purpose, the following research questions are answered:

- How can the activity at the logistics centres today be interpreted as a charging pattern?
- How will the load profile based on the charging pattern affect the existing electric grid?
 - How will the loading in the present cables and transformers be affected at different degrees of electrification?
 - Where in the grid is there a need for investments?
- What are potential solutions to enable electrification and facilitate high peaks of power?

1.4 Related work

As mentioned above, the electrification of trucks is evolving rapidly and there is substantial ongoing research and projects regarding this. Based on Swedish sources only, several master thesis reports are published with different approaches and research questions. Most of them originate from the questions of how far the electrification has come or how the energy system will be affected. In a master thesis by Nordhammer and Grankvist (2021) trends and prospects of truck electrification is investigated through interviews with truck fleet operators and manufacturers. The impact on the electrical grid is also considered by performing a case study on an industry dense area on the outskirts of Stockholm. Load profiles modelled by using input parameters of vehicle distribution, operational patterns, charging initiation and the maximal power needed are then compared with the maximal capacity of the area in focus. The authors express how the study only uses general charging profiles to give an indication on what impact the truck electrification might have on the grid. They encourage future studies to be conducted on real load data combined with how other loads might affect the grid.

Other ongoing projects are national and regional initiatives throughout Sweden. An example of this is that the administrative body, Region Skåne, is part of a project for electrification that is called Scale. In this project, regions in Sweden along route E6 are collaborating on electrification of freight transport. REEL is a national initiative in Sweden where several different actors on the Swedish market collaborate to develop electrified, emission free heavy transport. The results from this project will be a base for the continuation of the project REEL. (Region Skåne, 2021)

1.5 Limitations

The focus of this thesis is on the distribution electrical grid where the sub-transmission network is modelled as just a supply point, which is routinely represented by a voltage source and an impedance. The outlook for simulations are from a distribution grid owner's perspective.

It does not take into consideration that there might be additional charging points along the relevant transport routes in the making of the load profiles and simulations. Therefore, all charging of trucks is assumed to occur at the logistics centre.

In this master thesis it is decided that the acceptable load limits for transformers and cables are at 100 %, in reality the components are allowed to be overloaded for shorter periods of times. However, since our simulations are on a daily basis, the overloads in the system occurs several days a week and a load above 100 % will therefore damage the equipment in the long run.

1.6 Thesis outline

This thesis begins with introducing relevant theory in chapter 2. The method of each step is presented in chapter 3. Chapter 4, 5 and 6 presents the results. In chapter 4 the load profiles are presented and in chapter 5 the results of the grid simulations. The alternative solutions to enable increased electrification are evaluated in chapter 6, as well as a probabilistic analysis. The content of the entire study is discussed in chapter 7 and lastly the main objectives are summarised in chapter 8.

2 Theory

This chapter introduces the relevant theory for this study. It introduces electrified heavy trucks, such as different types of charging as well as an expected future development. Furthermore, it presents the Swedish electricity network and some limitations for the electric grid. It also introduces the grid connection process and dimensioning. Different grid alleviating solutions are presented.

2.1 Electrified trucks

There are several truck manufacturers that have committed to manufacture electric trucks. Volvo Trucks (n.d.) has a product catalogue of six electrical trucks, ranging from 16 to 44 tonnes. A first independent test drive of a Volvo electric truck was published in January 2022. It was the Volvo FH Electric which has a battery of 540 kWh and a gross weight of 40 tonnes. The energy consumption was measured to 1.1 kWh/km¹ and the driving range to 345 km (Volvo Trucks, 2022). According to Volvo, a few hundred electrical trucks over 16 tonnes have been registered in Europe so far and 40 % of those are Volvo trucks. Tesla (n.d.) announced a semi-truck in 2017 which is yet to be launched. It is said to have a driving range of roughly 480 km. There are other manufacturers that have launched electric trucks, Scania (n.d.) for example have a 29 tonne truck with a battery of 165 kWh or 300 kWh depending on the axle distance. They also have a 64 tonne truck in limited operation, with a driving range of 80 km (Scania, 2021).

2.1.1 Charging of trucks

Charging of trucks can be divided into three different types; the first and major part being depot charging. It is expected to represent about 80 % of the charging energy according to BIL Sweden (2020). Because the trucks are parked a longer time at the depot, the power does not need to be higher than 22 or 43 kW. The trucks are often parked over night and AC charging is used. The second type of charging is charging stations at logistics centres or other destinations where loading and unloading occur. The trucks does not stay as long at these locations and therefore the power must be higher, over 150 kW. This type is approximated to be 15 % of the total charging energy. The third type of truck charging is the public charging stations which are aimed to enable longer trips. These should be placed along the main roads and provide a power above 350 kW to enable fast charging. According to PowerCircle (2021) the maximum power from a CCS-plug-in is 400 kW for

¹The energy consumption for corresponding diesel vehicle Volvo FH is 29.8 litres per 100km (Volvo Trucks, 2020). One litre of diesel corresponds to 3.3 kWh (SustainabilityExchange, n.d.)

now, for higher charging power a pantograph is needed. By 2030 the prediction is that there will be 1 MW charging available.

There are different techniques for charging depending on the desired rate of charging. AC charging provides power from the electrical grid to the on-board charger of the vehicle where the AC is converted to DC, which is the type of current that the battery can receive. The AC charging capacity is therefore limited by the acceptance rate of the on-board charger. This type of charging is slower than DC charging, a schematic image of the charging process from grid to vehicle is illustrated in figure 2.1 below. DC charging provides power directly to the battery in the vehicle and does not require conversion through the on-board charger. Therefore, DC charging can be a faster option. (EV Safe Charge, n.d.)

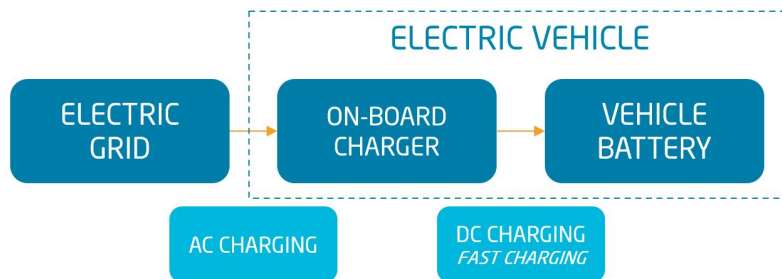

Figure 2.1: Schematic image of vehicle charging.

State of charge (SOC) is the ratio between the remaining charge in a battery and the maximum possible charge of the battery under the same conditions, see equation 2.1.

$$SOC(t) = \frac{Q(t)}{Q_n} \quad (2.1)$$

$Q(t)$ is the energy at a certain time and Q_n is the total possible energy that can be stored in the battery. The SOC is expressed in percentage, where 100 % is a fully charged battery and 0 % is a fully discharged one. A vehicle battery is seldom fully discharged, usually the SOC is discharged to 20 % meaning only 80 % of the available capacity is used (Battery University, 2021b). When charging a battery the rate (power) is high and rather constant up until 80 %, where the rate of charging slows down up until 100 % (Battery University, 2021a).

2.1.2 Predicted future development

ACEA (2021a) predicts there to be 40 000 electric trucks in operation by 2025 in Europe. By 2030 that number will be about 270 000. They express that the charging infrastructure must be established rapidly in order to match and enable the shift. Their recommendation is for the goal to be 10 000 to 15 000 public or semi-public high-power charging points by 2025. It is recommended that no later than 2030, 40 000 to 50 000 high-power chargers and 40 000 charging points with lower power needs to be in place along the roads.

The manufacturers Volvo, Scania and Mercedes have 95 % of the market shares in Sweden. Volvo has a goal to be fossil free by 2040. Scania has joined *The Climate Pledge* to produce 100 % zero emission

vehicles (ZEV) by 2040 and Mercedes has as well set a goal for 100 % ZEV by 2040. According to Scania² the manufacturers are close to ready for a large scale production of electrical heavy trucks. The present bottle neck is rather on a political level where decisions and legislation needs to be implemented in order for the manufacturers to invest in the right technology.

According to BIL Sweden (2020) an estimation is that 50 % of the new registrations of heavy trucks will be electrified in 2030. Based on this, PowerCircle (2021) have published a graph, seen below in figure 2.2. It shows the expected development for new registrations (full line) as an S-curve and the emission reduction from heavy trucks (dashed line) as an exponential curve. The absolute numbers are the approximate amount of electric trucks in Sweden each year until 2030. In 2030 the emission reduction is estimated to 15 %. It corresponds to a truck fleet with 15 % electric heavy trucks. The national goal of 70 % GHG emission reduction until 2030 is according to this graph predicted to be reached at approximately 2037 instead.

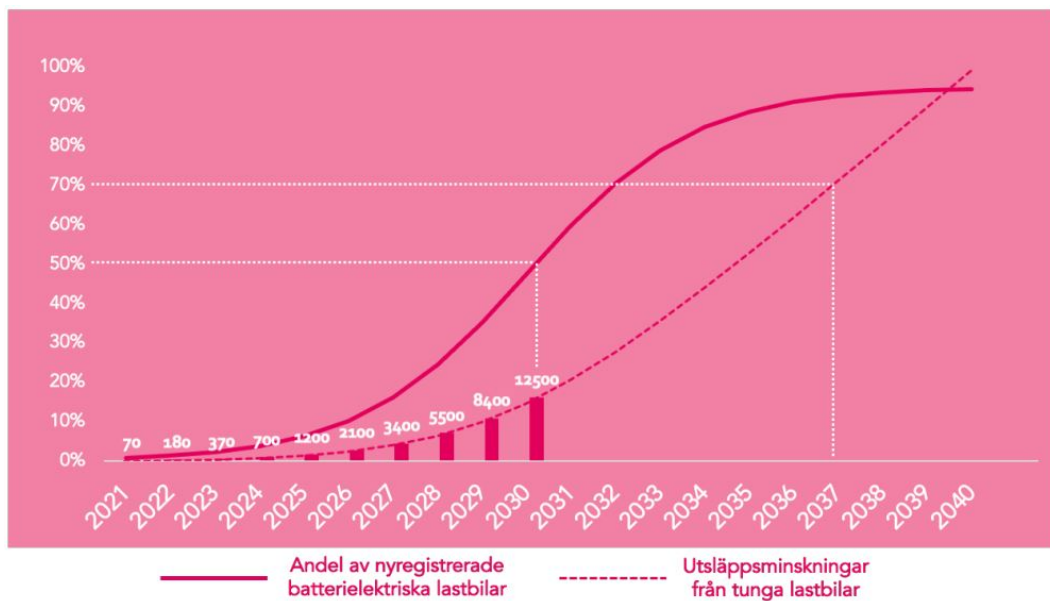

Figure 2.2: Predicted future development of electrification. (PowerCircle, 2021)

2.2 The electrical grid

The Swedish grid is divided into three levels, the transmission, sub-transmission and distribution networks. In figure 2.3 below, a representative picture of the different levels can be seen. The transmission grid is spread throughout Sweden and its main purpose is to transport electricity from the bigger power plants to the sub-transmission grids. The transmission grid is maintained by the Swedish transmission system operator (TSO), Svenska kraftnät and the voltage levels are 400 kV and 220 kV. In Sweden the three biggest sub-transmission network owners are Eon, Vattenfall and Ellevio. The sub-transmission network delivers the electricity from the transmission grid to the distribution grids and is at a voltage level between 30 kV and 130 kV. Some producers and larger consumers of electricity are directly connected to the sub-transmission grid. The distribution grid provides the end users with electricity and have a voltage level below 40 kV. A part of the distribution grid is called the low voltage (LV) grid, which has voltage levels at or below 0.4 kV. The electricity is gradually

²Anonymous, Senior Engineer at Scania, Conversation, Microsoft Teams [2022-03-24]

transformed to lower voltage levels throughout the grid and is for household customers normally at a level of 400/230 V. (Svenska Kraftnät, 2021b)

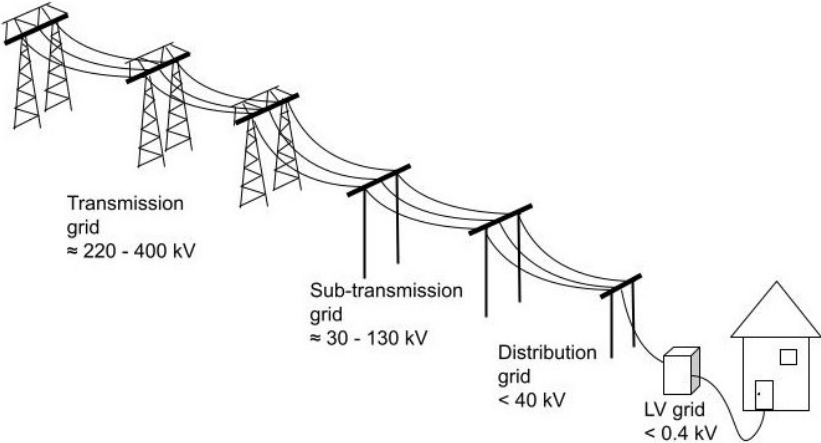

Figure 2.3: The Swedish electrical network system.

The Swedish distribution networks are usually operated radially and fed by a power transformer connected to the sub-transmission grid. The transformer stations have a primary voltage level of 145, 130 or 70 kV while the secondary voltage levels for distributing electricity are normally between 40 kV and 10 kV. The electricity is generally distributed at 10 kV to substations where the power is transformed down to 0.4 kV before being distributed to the end use customers. The substations can contain many different components and therefore substations are regarded as a collective name for stations that can look vastly different. However, they all contain load disconnectors, fuses and distribution transformers. A wiring diagram for a generic substation is seen in figure 2.4 below. (Jacobsson et al., 2016)

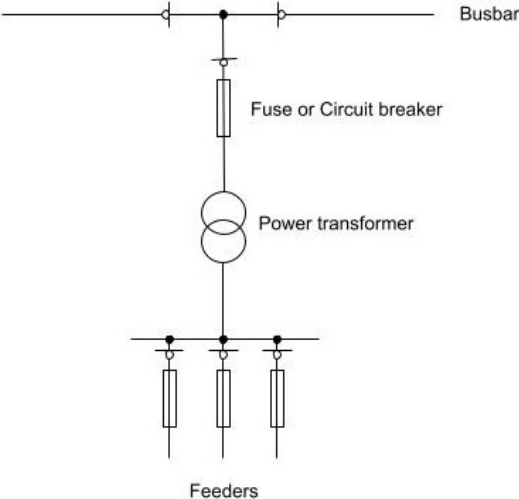

Figure 2.4: Example of a single line diagram of a substation.

2.3 Shortage of electricity

Shortage of electricity in the grid is often mentioned as an issue for further electrification. This can sometimes be hard to understand but to simplify, it can be divided into three main parts; shortage of energy, shortage of power and shortage of capacity. Shortage of energy is related to the amount of energy produced. If there is less electric energy produced than what the users consume, there is a shortage in energy. According to SCB (2021a) the production of electricity in Sweden in 2021 was 148.4 TWh while the consumption only was 124.8 TWh, therefore shortage in energy is normally not a problem for the Swedish energy system.

Shortage of power is when there is not enough electricity produced at a certain point in time to provide for the end users. There is a need for a balance of power in the system at all times for the network to function. The production and import of power should equal the export and use of power according to equation (2.2).

$$P_{production} + P_{import} = P_{use} + P_{export} \quad (2.2)$$

Capacity shortage is when the infrastructure of the grid is not adequate to transport the electricity produced at one location to where the demand of use is located. Therefore, the power produced can be enough for the total demand of power while there is still a capacity shortage due to limitations in the grid. As mentioned in the background, many parts of the Swedish electrical network has not been reinforced for today's consumption. Capacity shortage is the biggest limitation for further electrification in Sweden right now. (E.ON, 2021b)

2.4 Limitations in grid components

Capacity shortage occurs due to limitations in grid components. Typically, the limiting components in the system are transformers and cables. The capacity is limited mainly by voltage limits, thermal limits and network losses. (Leisse, 2013)

2.4.1 Voltage regulation

The voltage regulation in transformers are important to maintain the desired voltages within the grid. Tap changers within the transformers are used to regulate the voltages on the LV side of the transformer. When more loads are present in the grid it is equal to higher currents. This increases the voltage drop (ΔU) along the cables in the grid according to equation (2.3), where R and X represents the resistance and reactance in the cables and I is the current.

$$\Delta U = I \cdot (R + jX) \quad (2.3)$$

According to European standard EN50160, the voltage in LV grids is allowed to vary +/- 10 % (Leisse, 2013). The voltage is therefore regulated in the transformer to maintain the voltage in the grid when loads are present according to equation (2.4).

$$U_2 = U_1 \cdot \frac{N_2}{N_1} \quad (2.4)$$

Where U_1 is the primary voltage and U_2 is the secondary voltage. N is the number of windings at the respective sides of the transformer. U_2 can be regulated to uphold a certain voltage level by adjusting the windings. The regulation is performed by tap changers and is normally changed in steps of 1.67% of the rated voltage of the transformer. (Jacobsson et al., 2016)

2.4.2 Overloading

The life span of cables and transformers are affected by the surrounding temperature and the loading. Nominal conditions are characterised by around 20 °C and constant loading. It is inevitable that the loading is not constant but the transformer ages faster at high loadings. Overloading occurs when the absorbed current in the system is higher than the nominal current. The losses in a three phase system (P_{loss}) hence increases with the current, seen in equation (2.5) below, where I is the current and R the resistance in the winding or cable.

$$P_{loss} = 3 \cdot I^2 \cdot R \quad (2.5)$$

The losses give increased temperatures. It can occur in both cables and transformers. When a transformer is overloaded the efficiency decreases and the increased temperature causes more rapid aging of the isolation material. The current in cables increases during overloading as well, overheating causes an increased rate of aging. (Leisse, 2013)

2.4.3 Resistance in cables

The resistance (R) in a cable is inversely proportional to the area of the cable according to equation (2.6), where ρ is the resistivity of the material in the electrical wire and A is the cross sectional area of the cable. An increased area results in decreased resistance which enables more current to flow through the cable without excessive losses. (Jacobsson et al., 2016)

$$R = \frac{\rho}{A} \quad [\Omega/km] \quad (2.6)$$

As seen in the equation above, the resistance depends on the length of the cable. If the cables are short, the thermal overloading of the cables are the limiting factor. For long cables, the voltage is the limiting factor.

2.5 Distribution network planning

2.5.1 The connection process

In Sweden the companies that are grid owners possess a grid concession. This concession can take different forms but for distribution grid owners it is most common to have a concession regarding a certain area. This means that the grid company has exclusive right to build and are responsible for expanding the grid within the geographical area and certain voltage levels. According to Swedish law this concession also means the grid owner is obliged to connect new customers to the grid and provide the desired power level within reasonable limits. However, grid expansion takes time and coordination between different parts of the society and grid owners for forecasting of future needs have historically been inadequate. This, in combination with an increase in electrification, has lead to longer connection times for new customers on the grid in Sweden since the capacity in the grid is not sufficient for this new development. (Wiesner et al., 2019)

The grid connection process for a new customer is performed through a series of steps, see figure 2.5. First, the customer submits their request to the grid owner in the form of how much power the customer desires, where the new connection will be located geographically and at what point in time they wish to be connected. The grid owner will then look into the request, give an estimate of the cost for connecting to the grid, the time it will require and what technical solutions are necessary. These first steps usually take about nine months to perform. After this the grid owner analyses the grid and look into more detail on the requirements for the connection and how it should be implemented. This takes approximately another nine months. After this the physical construction required for the connection starts. The timescale for this varies depending on the connection but takes approximately 18 months. The total grid connection time for new customers is therefore expected to be about three years. Before the connection of a new customer is made a new connection agreement is signed between the grid owner and the customer. (E.ON, 2021a)



Figure 2.5: Schematic sketch of the grid connection process.

The size of the connection that the customer require is depending on the size of the fuse needed in the connection. This fuse size is the maximum current allowed to go through the fuse. Which indicates the maximum current allowed to go through the electrical equipment. When a customer wants to expand its connection and require more power they need to apply for a larger fuse size with the grid owner. The cost of a new or larger connection for the customer is depending on the size of the fuse required as well as the distance to the existing grid. (Krafringen, n.d.)

2.5.2 Grid reinforcement

To be able to handle higher currents and power, the grid needs to be reinforced. The cables with larger cross sectional area can transfer more current as mentioned above. The standard size of cables today

are 240 mm² according to Krafringen. More parallel cables allow more current to be transferred. The size of the transformer needs to match the power consumption. If the power transformer needs to be replaced with a larger one, the allowed outtake from the sub-transmission network needs to be raised. According to Krafringen standards, the maximum size of a distribution transformer is 0.8 MVA. If the power demand would be higher, most commonly the transformer is supplemented with a parallel transformer of the same size rather than being replaced with a larger one.

According to Krafringen network principles when a customer's power demand exceeds 800 kW, they go from being an LV to a high voltage (HV) customer. If the customer would become a HV customer, the connection point between them and the grid owner would be before the distribution transformer. This means that the customer itself is responsible for the operation and maintenance of the transformer and the underlying cables.

2.5.3 Probabilistic grid planning

Traditionally the dimensioning of the electrical grid is based on deterministic calculations. According to Leisse (2013), when dimensioning a distribution network the requirement is to satisfy all operational conditions, meaning even the worst case. The worst case is based on the highest power peak in the system. A deterministic model gives the same result every time it is run, in other words it does not include elements of uncertainties. A probabilistic model on the other hand does. The input for a probabilistic model is a stochastic variable with a certain probability distribution. Since the input is random values drawn from the probability distribution, the resulting values are random for each time the model is run (CIGRE, 2020). Some parameters are set as static values while other parameters vary. Since the model is run multiple times the results are in the form of a probabilistic distribution, from which the probability of different outcomes can be observed. Many parameters regarding the grid are uncertain and these can be conveniently included by a probabilistic approach when performing grid calculations. (Prusty and Jena, 2017)

2.6 Flexibility

A way to balance the shortage of capacity in the electrical grid is to use instruments of flexibility. Flexibility is the adjustment of consumption or generation for the sake of grid and power system operation. It can be utilised to reduce power peaks and even out the power demand. This is to ensure a more efficient use of the existing network. There are three common categories of flexibility; flexibility in the production of electric energy, storage of energy and a flexibility in demand. As a part of the Swedish Energy Markets Inspectorate's strategy for flexibility in the electrical grid, Rosenlind et al. (2020) emphasise the need for price signals that are effective, an effective use of the electrical grid and the importance of customers contributing to flexibility. These instruments can together create a more effective use of the electrical grid and reduce socio-economic costs for power system operation.

2.6.1 Flexibility in demand

Flexibility in demand is defined as ways for the end use customers in the grid to change their demand of electricity depending on different challenges within the grid, such as shortage of generation or high loads. The customers can ease loads on the grid by either decreasing their use of electricity when the grid is under a heavy load or increasing their use if the conditions are profitable for high renewable production of electricity. Household customers with electric heating as well as industries has been defined as key interests for a flexibility in demand. (Swenman et al., 2020)

The European Union has financed a project called CoordiNet to remedy the lack of capacity locally in the grid and to create incentives for a flexibility in demand. The project encourages new market based solutions where producers or consumers within the grid can offer their flexibility at times with high demands on the grid. This enables for distribution system operators (DSOs) to obtain extra flexibility when needed by purchasing flexibility services. In addition it is expected to help the DSOs to be more efficient in their grid planning since projects within CoordiNet aid capacity problems within a shorter time period than grid developments. (Svenska Kraftnät, 2021a)

2.6.2 Storage of energy

Batteries

Batteries can be placed in various parts of the electrical grid, the distribution system or in connection to the production or consumption. It can be utilised in different ways depending on where it is placed and how it is controlled. A battery integrated with local solar production can reduce the electricity cost by shaving peaks and increasing the systems self sufficiency. A battery can also contribute to ancillary services such as voltage control or reactive power control if it is placed on the distribution or transmission grid. (PowerCircle, 2020)

There are different types of batteries which can be used for energy storage systems, depending on the area of use. The weight of the battery as a stationary solution is not as important as it is for example for electrical vehicles, the focus lays more on the charging and discharging abilities. Lead acid batteries are well suited if only occasional discharge is needed. Sodium sulphur batteries and flow batteries are suitable for large systems where frequent and deep discharging is required. For small and medium systems, lithium-ion batteries are well suited due to its fast charging and discharging up to multiple times a day. The efficiency of a lithium-ion battery is over 90 %. (Sundén, 2019) According to BloombergNEF (2021), the price for lithium-ion batteries were about 1 300 SEK/kWh in 2021.

Hydrogen

Energy today is mainly stored in the form of fuels. One type of energy storage which is commonly referred to as a solution to high power peaks is hydrogen storage. There are multiple ways to produce hydrogen, both fossil based and renewable options. The challenge is the production of green hydrogen meaning electrolysis from renewable energy sources, this type of production leads to a low efficiency of about 20-30 %. Since hydrogen storage has such a low efficiency it is most commonly used to store

excess production of energy rather than being an integrated part in the grid. (Uniper, n.d.)

2.7 Photovoltaic production

Installation of photovoltaic (PV) cells adjacent to a building can be a way of easing the electrical grid and becoming more self-sufficient. The solar panels can be installed on the ground or on top of an existing roof for more efficient use of space. In figure 2.6 the hourly production in bidding area 4 of Sweden from PV throughout 2021 are presented based on values from Mimer (2021). The orange plot is the hourly production in kWh and the blue plot is the trend line representing the mean production.

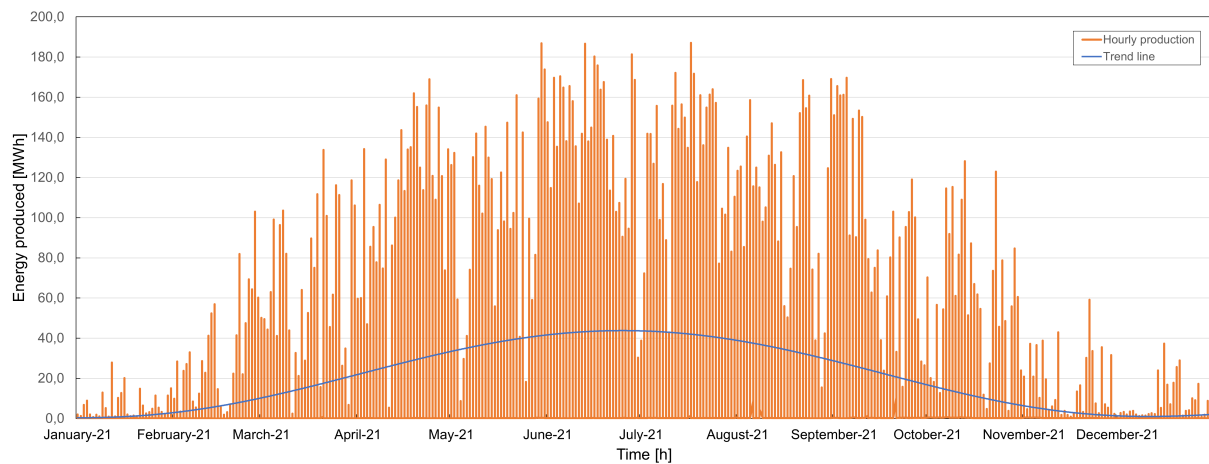

Figure 2.6: Energy produced from solar for the year of 2021 in bidding area 4.

The figure showcases the seasonal variation of solar electricity production. The production is quite high during the summer months, while in winter the production is substantially lower. The PV cells capture sunlight during daytime, even on cloudy days, but not when the sun is set at night. PV cells produce DC, to transfer it to the grid it needs to be converted to AC. It would however be suitable to charge a battery directly with PVs, since the current in a battery is also DC and therefore current conversion is not needed.

3 Method

This chapter explains the methods that are used to conduct this study. In figure 3.1, a flow chart is seen to visualise the different steps of the method and how they connect to one another. Continuously throughout the thesis, information has been collected by studying literature both online and in books. The logistics centres are referred to as model 1 and model 2 from this point forward.

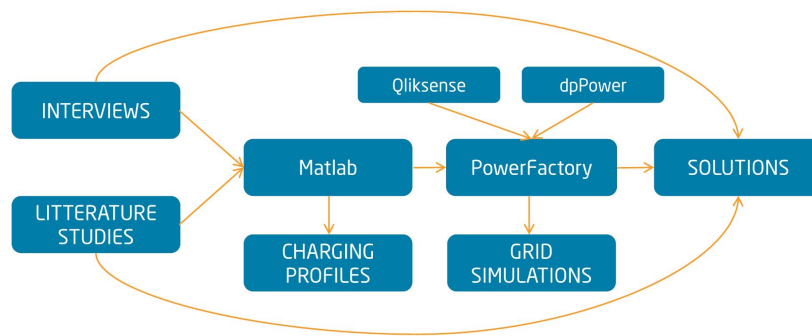

Figure 3.1: Flow chart displaying the different steps of the method.

3.1 Charging profiles

A load profile is a graphic representation of the power demand over time, an example is seen below in figure 3.2. It shows the measured baseload for model 1. Time is plotted on the x-axis and power on the y-axis. The five workdays and the weekend can easily be identified as the smaller loads.

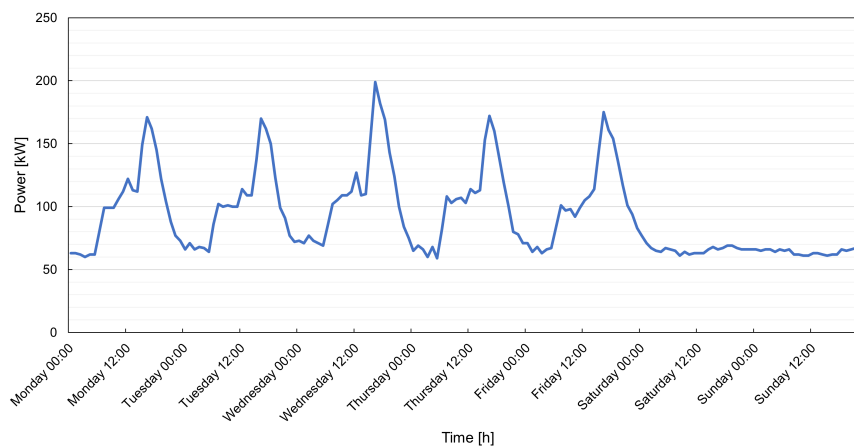

Figure 3.2: Example of a load profile. This load profile is the baseload for model 1.

A charging profile, which is created in this study, is a type of load profile. The charging profiles are built based on information acquired in interviews with two logistics centres connected to the grid owned by Krafrtingen. The parameters within the models are based on these interviews combined with assumptions made from literature. The charging profiles are made in Matlab using a probabilistic approach, described in section 2.5.3. The charging profiles are created to obtain the power demand over a week. All trucks at the logistics centres studied in this study have a weight above 40 tonnes and are long-haul distribution trucks. The electrified truck type is assumed to be a Volvo truck with a 540 kWh battery, mentioned in section 2.1, since that is the largest electric truck on the market up to date that also fulfils a satisfactory driving range.

3.1.1 Charging scenarios

Two types of charging scenarios are considered when making the charging profiles in Matlab. The first charging scenario is called *simple charging*. It means all trucks are charged with a 1 MW charger and charge with full constant power until they are fully charged or have reached their maximum SOC. Therefore, the parking time is based on the varying SOC according to equation (3.1). The trucks are modelled to arrive unanimously at the logistics centres every 30 minutes.

$$t_{parked} = \frac{E_{battery\ capacity} * (SOC_{departure} - SOC_{arrival})}{P_{charging}} \quad (3.1)$$

Where t_{parked} is the parking time of each truck in hours, $E_{battery\ capacity}$ the capacity of the battery in kWh. $SOC_{arrival}$ and $SOC_{departure}$ are the SOC of the battery at arrival to and departure from the logistics centre and $P_{charging}$ is the rated power of the charger in kW.

The second type of charging is called *planned charging* where the charging power is based on the time the trucks are parked at the logistics centre. The power needed for charging is calculated according to equation (3.2).

$$P_{charging} = \frac{E_{battery\ capacity} * (SOC_{departure} - SOC_{arrival})}{t_{parked}} \quad (3.2)$$

The charging power is added to the total charging profile for each hour the truck is parked at the docking station. Therefore, a total hourly power demand is retrieved for the entire logistics centre and plotted in a graph to visualise how the charging demand varies over a week, see section 4.2.1 below. The charging profiles are assumed to have a similar behaviour throughout the year.

Which input parameters that are probabilistic or deterministic can be seen in table 3.1 below.

Simple charging		Planned charging	
Probabilistic	Deterministic	Probabilistic	Deterministic
SOC	Battery size	SOC	Battery size
	Hourly activity	Parking time	Hourly activity
	Charging power		

Table 3.1: Probabilistic vs deterministic input parameters for each charging scenario.

To verify the model, it is iterated 1 000 times which means that random numbers are drawn from the distributions for the arbitrary parameters 1 000 times. This is to ensure that the charging profiles converge towards the same value even though some parameters are varied. Which means that if the model is run enough times it should show a consistent behaviour and have a similar average value each time. More iterations were tried but the converging behaviour is met at 1 000. The charging profile selected from the 1 000 iterations for the grid simulations is the one with the highest mean value of the power for a week. This is because a representative charging curve with rather high values is desired for the grid simulations.

3.1.2 Model 1

For the first logistics centre, it is assumed that there are 650 trucks arriving each day during the weekdays, where the majority arrives during the day (5 am to 8 pm) and less during the night. 10 % of the weekday truck fleet is assumed to arrive at the centres during the weekend. For planned charging the trucks are parked at the logistics centre between 30 minutes and 12 hours for model 1. The time each truck is parked is randomly picked from a uniform distribution with a two times higher probability for the truck to stay for shorter than 5 hours. The SOC is accounted for and varied randomly with a uniform distribution between 20 - 50 % for the trucks arriving and 80 - 100 % for the trucks departing from the centre.

3.1.3 Model 2

The second model is built for a smaller logistics centre with a maximum of 50 trucks per day. The activity at the centre varies for different days of the week. On Mondays and Tuesdays there is no activity at the centre, on Thursdays and Fridays there is less activity at the logistics centre and the busiest days occur on Wednesdays, Saturdays and Sundays. The trucks are assumed to arrive between 8 am and 6 pm. For planned charging the trucks stay between 2 to 4 hours to load and unload. The parking time parameter is picked randomly from a uniform distribution. The centre closes at 8 pm and therefore the trucks are modelled to leave the centre before this time. The trucks are modelled to arrive according to a normal distribution during the day since the maximum activity at the logistics centre is at mid day. The SOC when arriving or departing is assigned to every truck as mentioned in section 3.1.2 above.

3.2 Grid simulations

The power system analysis software PowerFactory is used to conduct the grid simulations. The loadings of transformers and cables are examined as well as the voltage drop throughout the network. The network models are built based on graphical and numerical information from dpPower, which is a software that combines geographical information with detailed data for networks and distribution management. In PowerFactory the cables are defined by length, material and rated voltage. For the transformers the rated power, rated voltage of each side, tap changer settings and impedance's are set. The busbars are defined by rated and nominal voltage. The feeding network above the HV substation is modelled as a voltage source with a specific network equivalent to represent it.

The feeder in which the logistics centre is connected on the HV busbar is modelled in more detail while the other feeders are modelled together as an aggregated load. The individual customers under each underlying LV substation in the relevant feeder are modelled as aggregated loads. The measured hourly loads are extracted from the database through the web based software QlikSense and entered to the existing loads in the network model, see appendix A.1 and A.2. 2021 is chosen because it is the latest full year data. Based on the relevant loads of each model it is determined that the week with the highest electricity consumption is February 8th-14th, and therefore the week which the simulations are based on.

The day with the highest power peak in the relevant LV substation is aggregated with the corresponding day from the calculated load profile, in both model 1 and 2 this day is February 10th. The load profiles of planned charging are used for the simulations because these are considered the most reasonable type of charging for future large scale implementation. The sum of each hour is simulated yielding a time series containing 24 points and run as quasi-dynamics power flow calculations in PowerFactory. The simulations are executed for 15 %, 50 % and 100 % electrification of the truck fleet in order to examine the strain on the grid at different degrees of electrification.

The single line diagram for the network connected to the logistics centres are shown in figure 3.3 and 3.4 below. The baseload of the logistics centre is named *LC* and the calculated charging profile as *LC Charge* at the bottom of the schemes. The relevant components are marked with circles and colour coordinated with the resulting graphs below in chapter 5.

3.2.1 Model 1

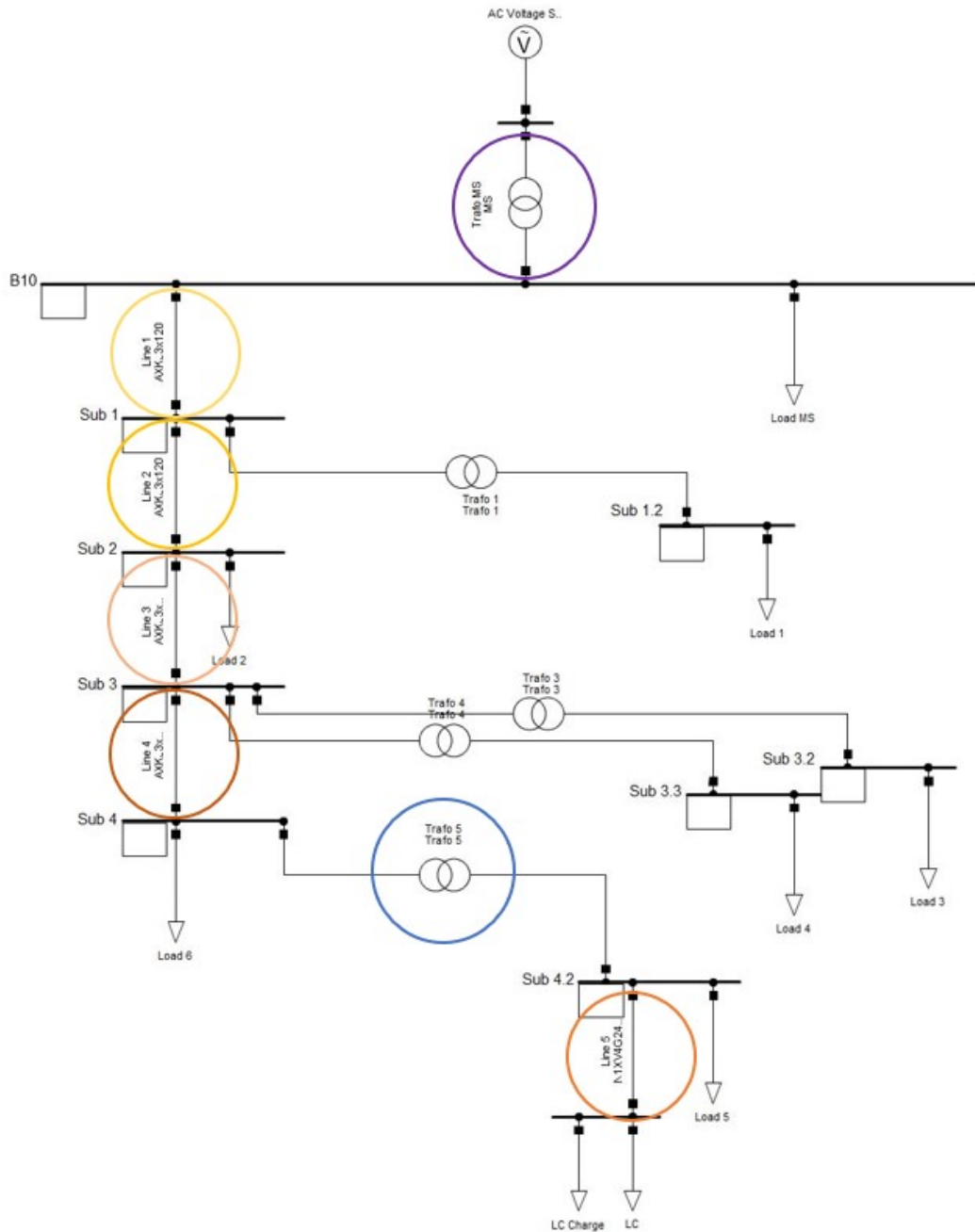

Figure 3.3: Single line diagram of electricity network for model 1. The circled components are investigated in the results.

In model 1 the HV substation is receiving 145 kV, transforming through a 30 MVA power transformer and providing 10 kV through the feeders to the underlying network. The 0.8 MVA distribution transformer feeds the LV cables to the customer. The relevant components which appear in the resulting graphs are the transformers *Trafo MS* and *Trafo 5* as well as the cables *Line 1-4* and *Line 5*, the latter which connects the logistics centre to the substation. See table 3.2 for the voltage levels of each component.

Component name	Voltage level (kV)
Trafo MS	145/10
Line 1-4	10
Trafo 5	10/0.4
Line 5	0.4

Table 3.2: Summary of key components in model 1.

3.2.2 Model 2

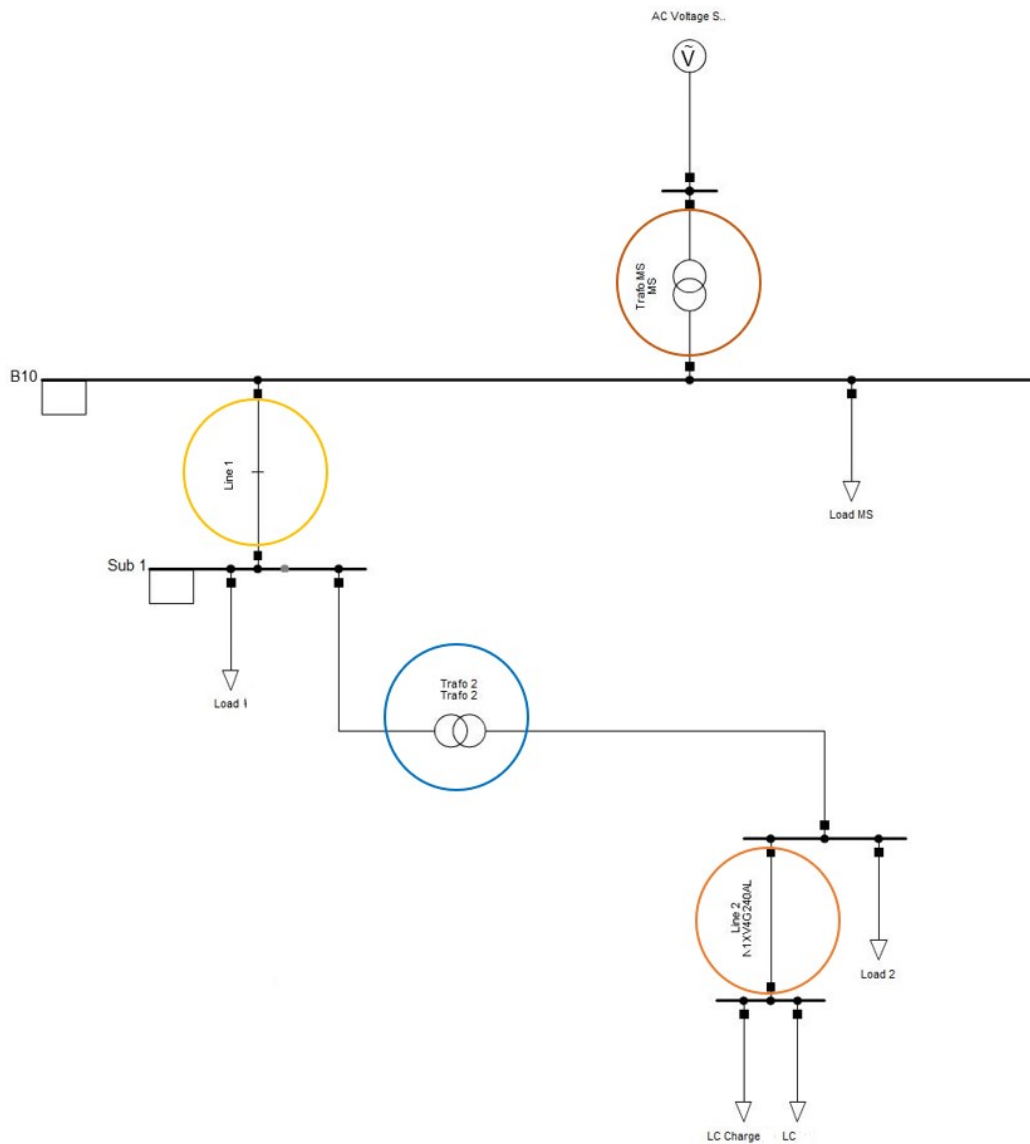

Figure 3.4: Single line diagram of electricity network for model 2. The circled components are investigated in the results.

In model 2 the HV substation receives 20 kV, transforming it through a 6.3 MVA transformer to 10 kV that goes out through the feeders. The relevant components which are plotted in the results are the transformers *Trafo MS* and *Trafo 2* as well as the cables *Line 1* and *Line 2*, the latter which

connects the logistics centre to the substation. The voltage levels of each component can be seen in table 3.3.

Component name	Voltage level (kV)
Trafo MS	20/10
Line 1	10
Trafo 2	10/0.4
Line 2	0.4

Table 3.3: Summary of key components in model 2.

4 Charging profiles

In this chapter the resulting load profiles obtained from Matlab of the electrification of heavy trucks on both logistics centres are presented.

4.1 Simple charging

4.1.1 Model 1

The charging profile for simple charging for 100 % electrification for model 1 can be seen in figure 4.1 below. It is observed that the maximum power for charging is between 5 am and 8 pm during the weekdays, where a power of 19.5 MW is needed. The trucks are fully charged after a maximum of 30 minutes, consequently the duration of parking is the same. At night and on weekends there is a lower demand of power with a maximum of 3.6 MW and 1.4 MW respectively.

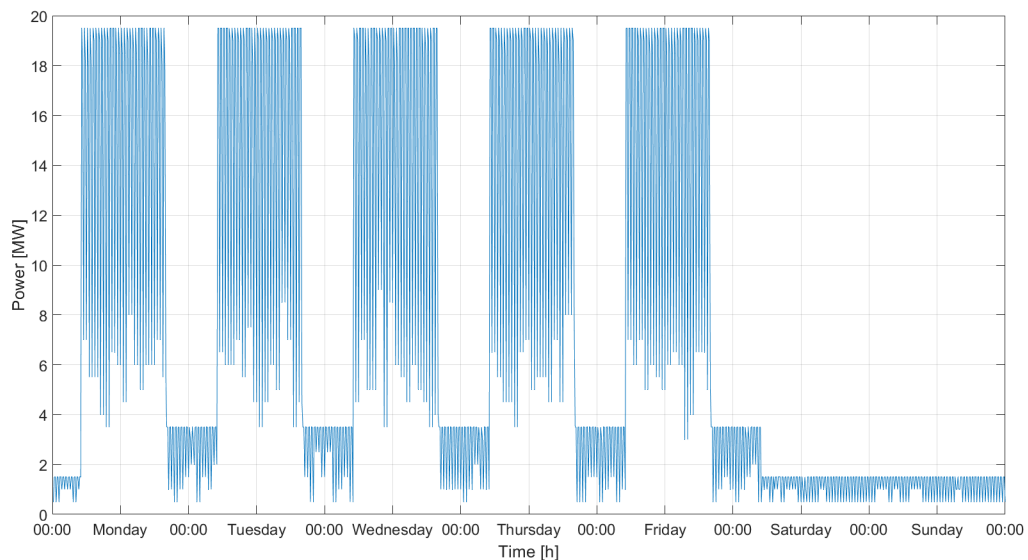

Figure 4.1: Simple charging over a week for model 1 with a maximum power demand of 19.5 MW.

4.1.2 Model 2

The simple charging profile for model 2 can be seen in figure 4.2 below. It can be observed that the maximum power is needed during midday on Wednesdays, Saturdays and Sundays, where a maximum power of 5.0 MW is needed. The parking time is at a maximum of 30 minutes. On Mondays, Tuesdays and at nighttime there is no activity at the logistics centre and consequently no power required for charging.

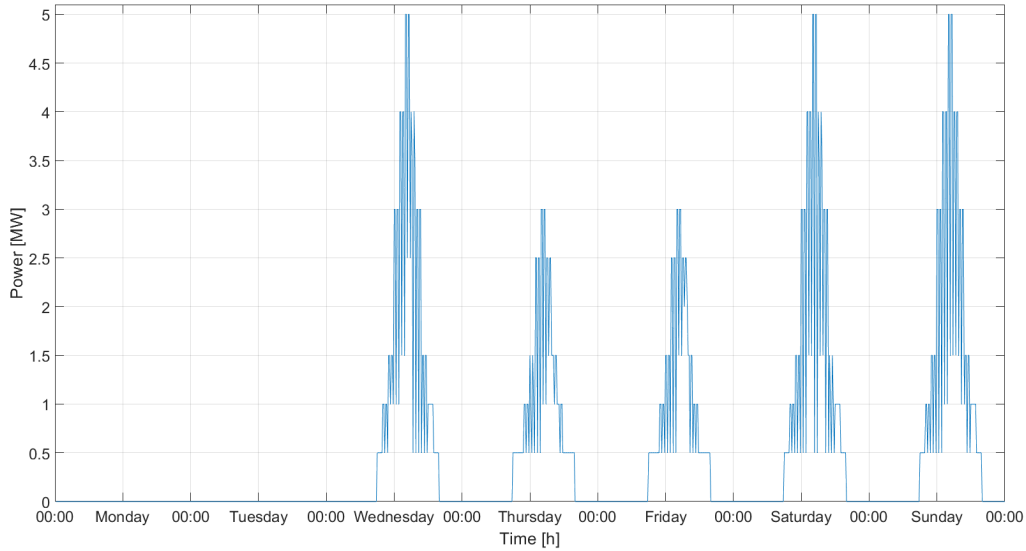

Figure 4.2: Simple charging over a week for model 2 with a maximum power demand of 5.0 MW.

4.2 Planned charging

The charging profiles are altered to consider scenarios where 15 %, 50 % and 100 % of the truck fleet is electrified. The baseload values are real measured data of the power consumption obtained from QlikSense for the week of 8th-14th of February as mentioned in section 3.2. Each day was modelled separately. Due to some varying input variables some differences between the days can appear in the graphs.

4.2.1 Model 1

In figure 4.3, the charging profiles for 15 %, 50 % and 100 % electrification of heavy trucks can be seen. The corresponding peak powers for the 10th of February (which is the day used for simulations) are 2.0, 6.5 and 13.0 MW. The baseload for the logistics centre is also seen in this picture with a peak power of 0.2 MW. This gives an aggregated peak power at 100 % electrification of 13.2 MW, 6.7 MW for 50 % electrification and 2.2 MW for 15 % electrification.

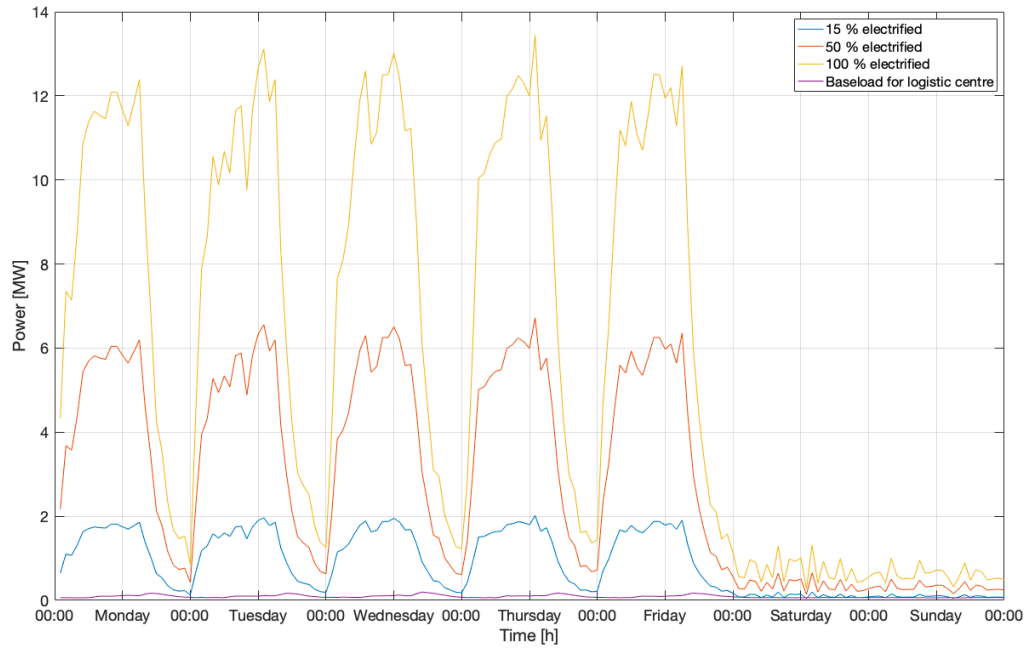

Figure 4.3: Planned charging over a week for three different degrees of electrification for model 1. The baseload is seen in the bottom of the graph.

Figure 4.4 illustrates the 15% electrification curve and the baseload from figure 4.3. It also displays a visual representation of the load profile when the baseload is aggregated with the charging profile.

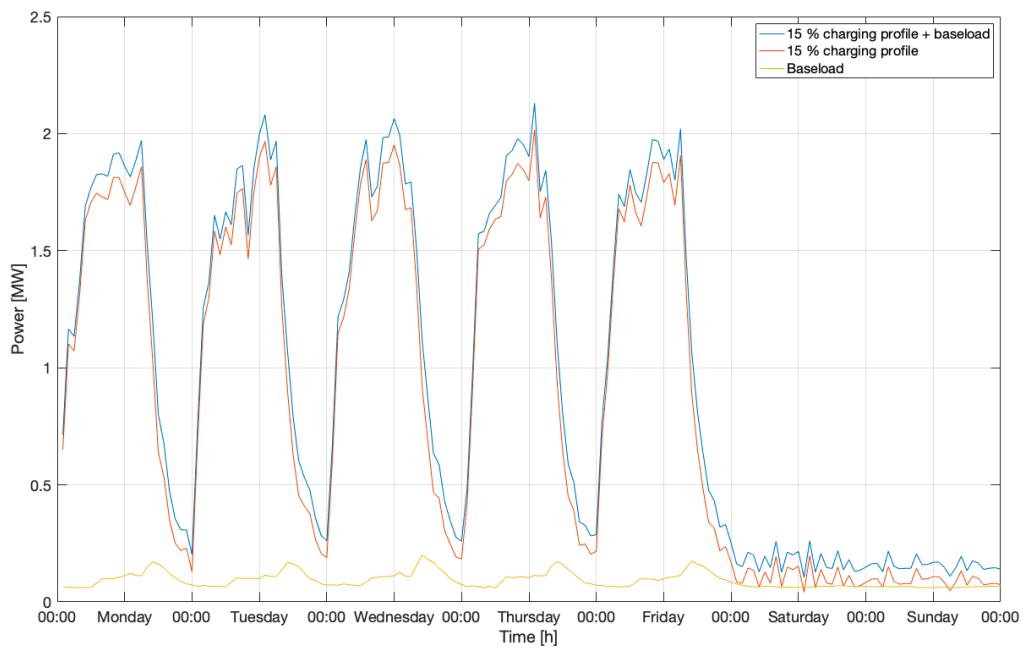

Figure 4.4: Planned charging over a week for 15% electrification in model 1.

4.2.2 Model 2

The results for planned charging for model 2 are seen in figure 4.5 and 4.6. The graph in figure 4.5 shows the charging profile for 15 %, 50 % and 100 % electrification as well as the baseload. The

corresponding peak powers for the 10th of February are 0.4, 1.4 and 2.9 MW. The baseload has a peak power of 0.1 MW. It can be observed that the charging profile is zero on Mondays and Tuesdays due to no activity at the logistics centre for these days. The aggregated peak power for 100 % electrification reaches a maximum value of 3.0 MW, 1.5 MW for 50 % electrification and 0.5 MW for 15 % electrification.

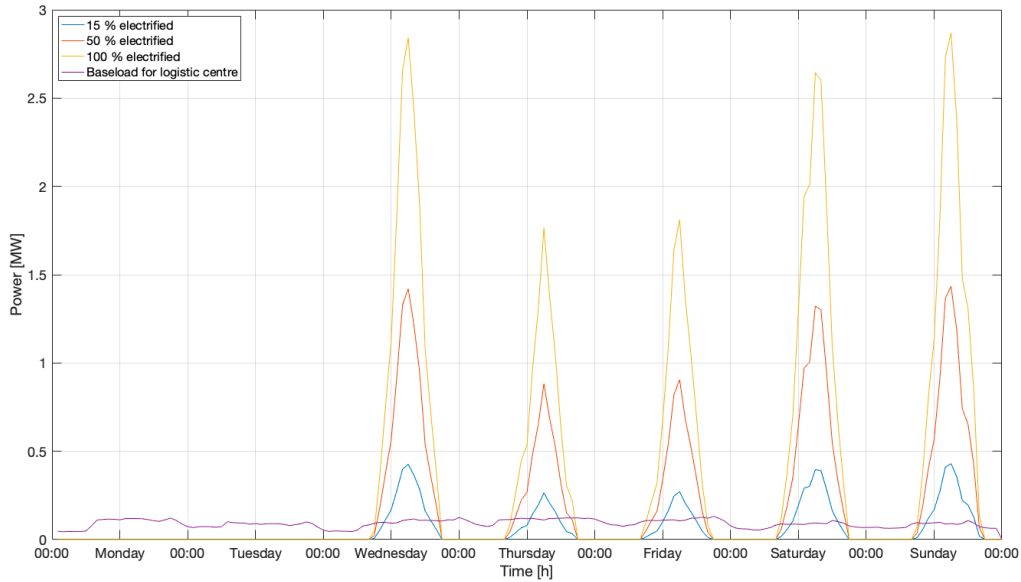

Figure 4.5: Planned charging over a week for three different degrees of electrification for model 2. The baseload is seen in the bottom of the graph.

Figure 4.6 illustrates the 15% electrification curve and the baseload from figure 4.5. It also displays a visual representation of the load profile when the baseload is aggregated with the charging profile.

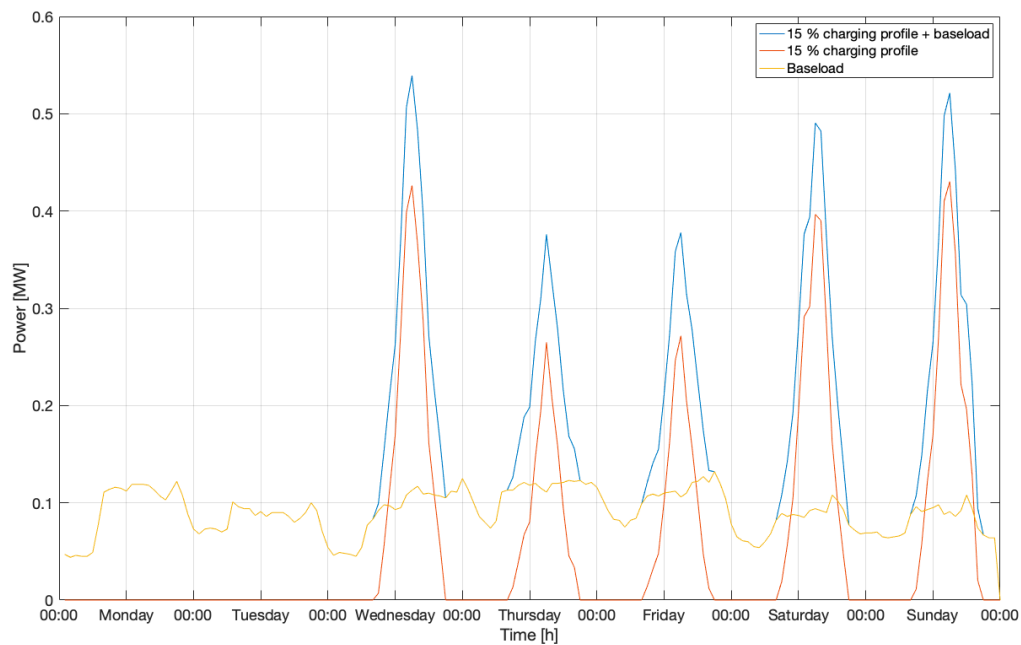

Figure 4.6: Planned charging over a week for 15% electrification in model 2.

5 Grid simulations

In this chapter the aggregated load profiles (planned charging profiles and existing baseload) after the electrification of heavy trucks from chapter 4 are simulated on grid models in PowerFactory. The results are presented in multiple graphs and in text. Firstly, the focus is on the LV components and secondly on the HV components.

5.1 Model 1

The grid simulations on model 1 in PowerFactory are based on the network model presented in figure 3.3. The circled components are colour coordinated with the graphs in the figures below. The voltage is observed to decrease further away from the transformer, but is still within allowed limits.

5.1.1 Low voltage components

Firstly the LV components are investigated, which are *Trafo 5* and *Line 5*. In figure 5.1 below, the loadings in percentage are presented for 15 % electrification, which corresponds to 97 electric trucks. As can be seen, *Trafo 5* reaches up to 300 % loading. *Line 5* reaches around 260 % loading while the HV cables and *Trafo MS* are well below the green 100 % loading limit.

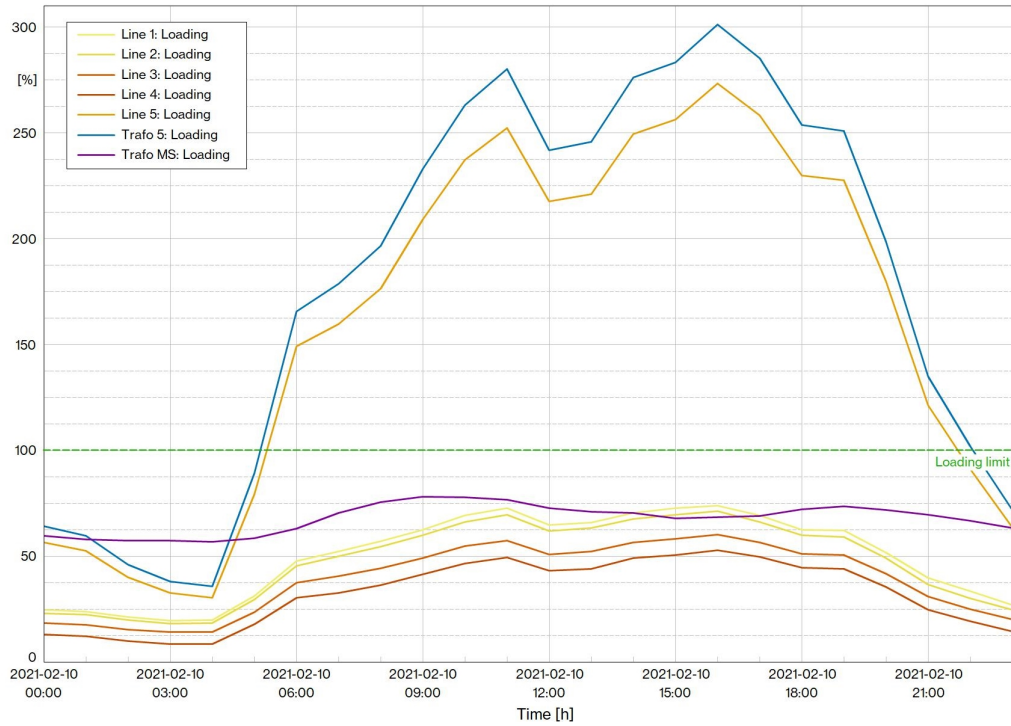

Figure 5.1: The loading of cables and transformers over 24 hours for 15% electrification in model 1.

In figure 5.2 below the results of the peak loadings in *Line 5* and *Trafo 5* are summarised. The green line is the 100 % loading limit, meaning the results above it are overloads in the grid. From the results it can be seen that both LV components are overloaded for more than 4 % electrification. This is equivalent to 26 electric trucks per day.

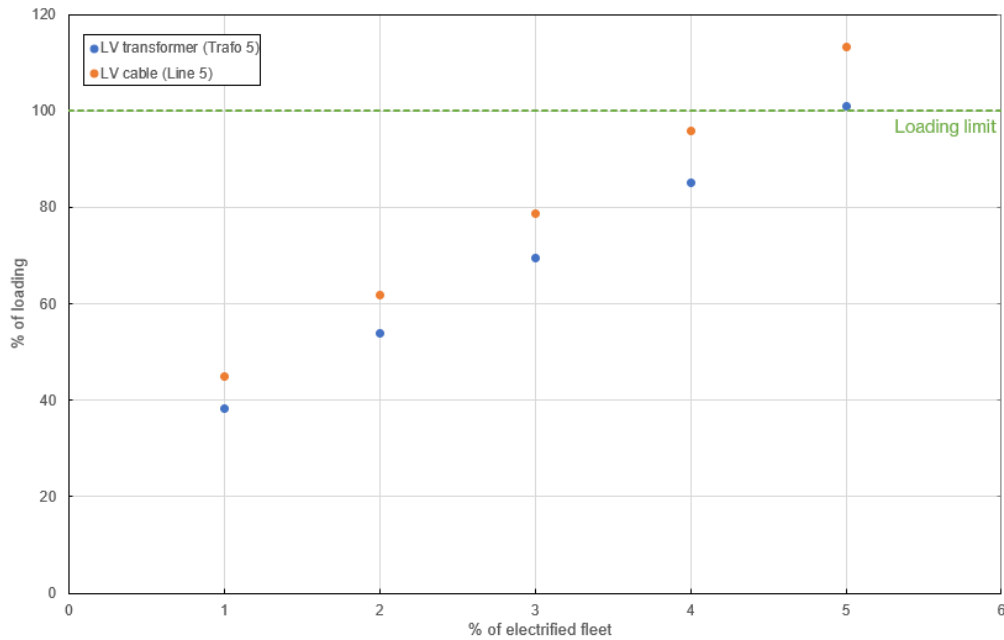

Figure 5.2: The overloading of LV components due to different degrees of electrification in model 1.

5.1.2 High voltage components

The simulations below focus on the strain on the HV components in the grid. Therefore, only the loadings for the HV cables called *Line 1-4* and the HV transformer *Trafo MS* are presented.

In figure 5.3 below the loading in percentage are presented for 15 % electrification. It is the same figure as figure 5.1 above but now with focus on the HV components only. As can be seen the peak loading in the cables vary between 52 % and 75 % while the transformer reaches a peak loading of about 79 %.

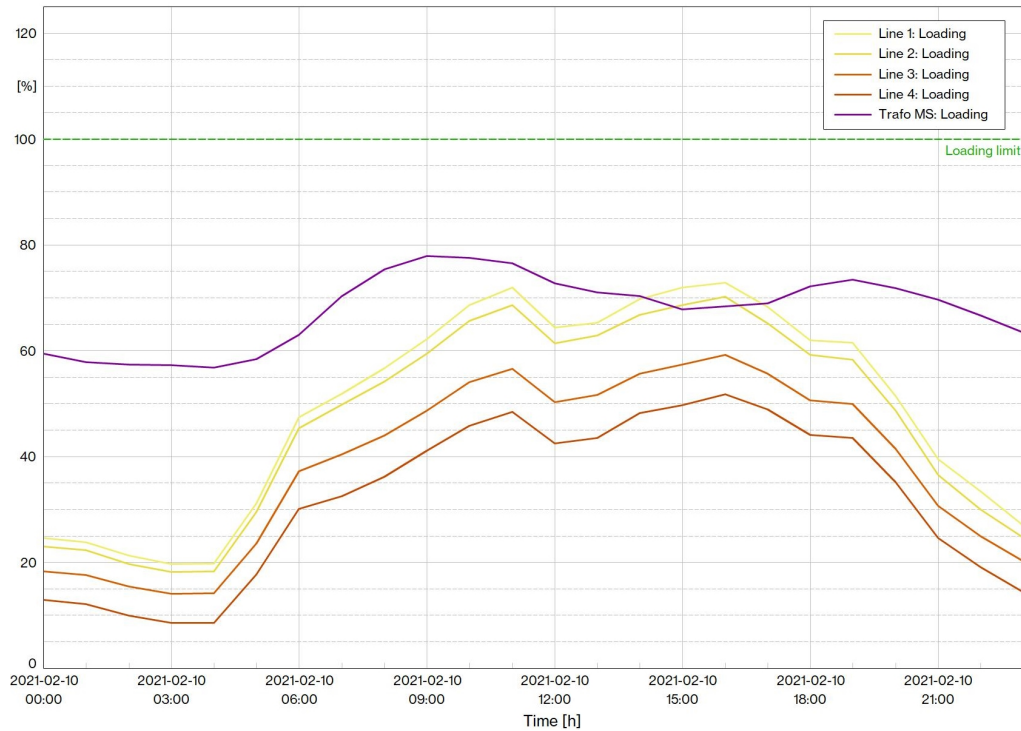

Figure 5.3: The loading of HV cables and transformers over 24 hours for 15 % electrification in model 1.

For the case of 50 % electrification of the truck fleet in model 1, which corresponds to 325 trucks each day, the cables and transformer are shown below in figure 5.4. The cables are now reaching peak loadings of 225 % to 270 % and are overloaded for about 15.5 hours between 5.30 am and 9 pm. The transformer reaches about 105 %, the overloading lasts for roughly an hour between 10 and 11 am.

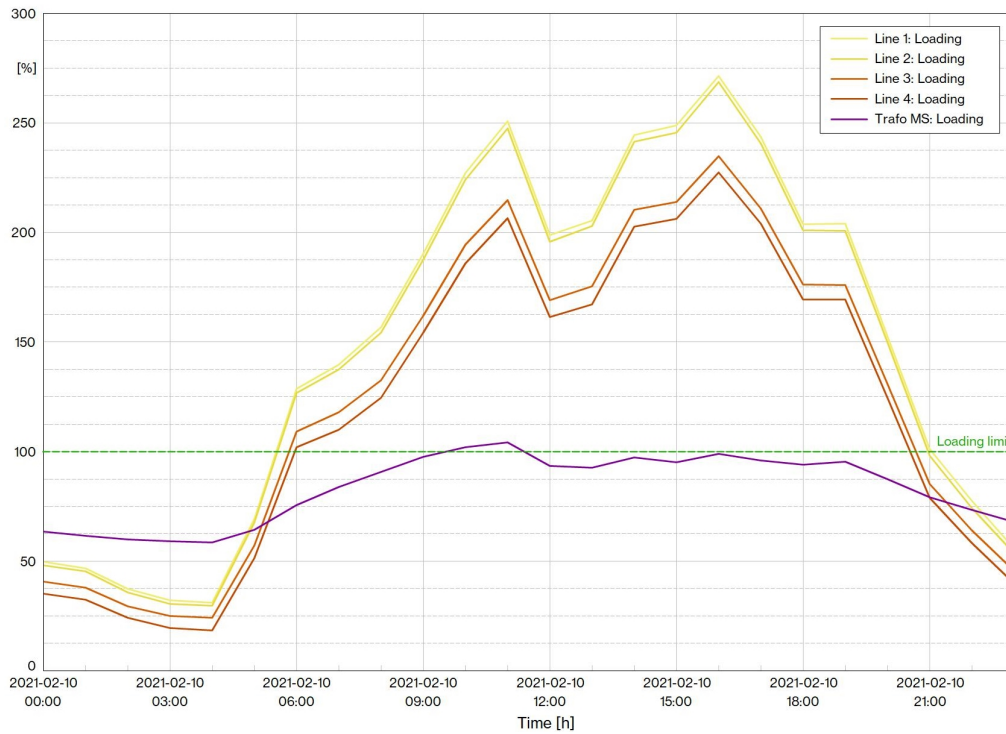

Figure 5.4: The loading of HV cables and transformers over 24 hours for 50 % electrification in model 1.

As can be seen in figure 5.5, in the case of a total electrification of the truck fleet the HV cables are at 400 % up to 460 % peak loading. The overloading in the cables occur during the whole work day, from 5 am to 11 pm. The transformer is at 130 % loading and is overloaded for about 13.5 hours between 7 am and 8.30 pm.

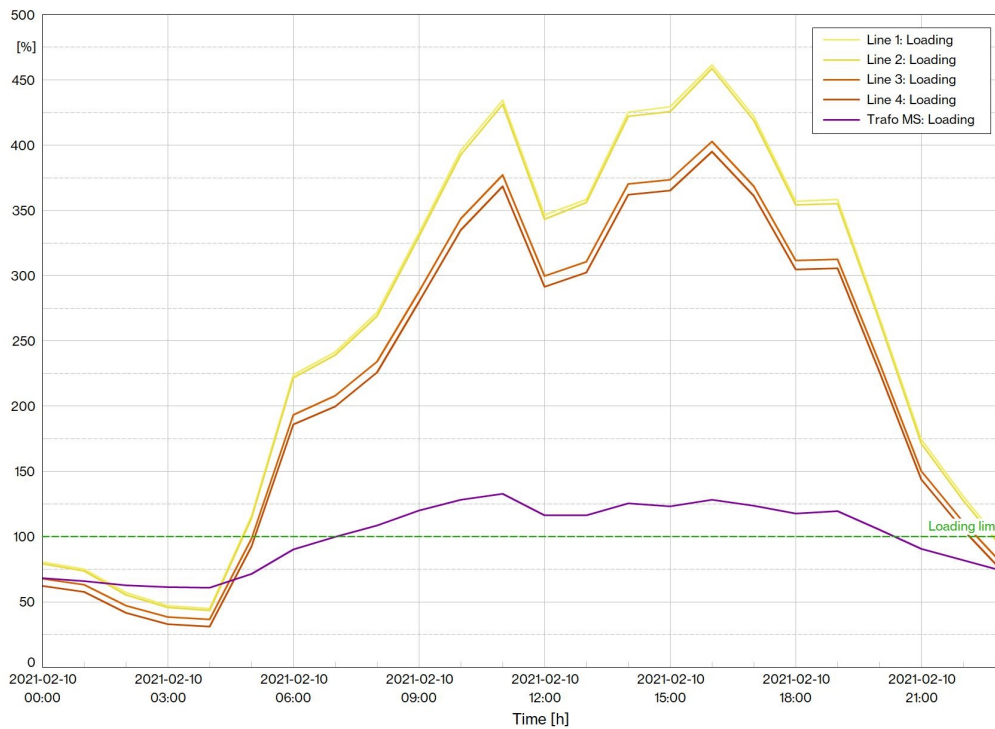

Figure 5.5: The loading of HV cables and transformers over 24 hours for 100 % electrification in model 1.

5.2 Model 2

The grid simulations of model 2 in PowerFactory are based on the network model presented in figure 3.4. The circled components in the figure are colour coordinated with the graphs presented below. The voltage in the grid is observed to decrease further away from the transformer, but is within allowed limits for this case as well.

5.2.1 Low voltage components

For model 2 the LV component results are presented in figure 5.6 below. The LV components in this model are *Trafo 2* and *Line 2*. The cable becomes overloaded after 7 % electrification which is equal to roughly a maximum of three electrified trucks. The distribution transformer becomes overloaded after 13 % which is equal to a maximum of six electric trucks.

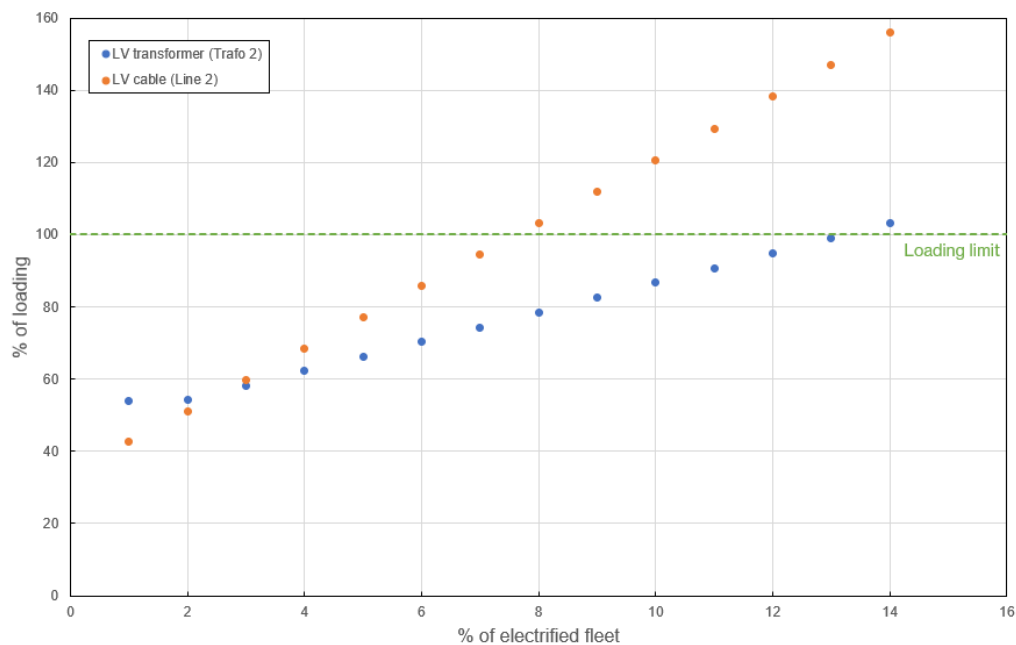

Figure 5.6: The overloading of LV components due to different degrees of electrification in model 2.

5.2.2 High voltage components

The simulations for the HV components include *Line 1* and the *Trafo MS*. The grid impact for 15 % electrification, corresponding to seven electric trucks, are shown in figure 5.7 below. The loadings in *Line 1* and *Trafo MS* are quite constant and at a maximum of 18 % and 35 %, respectively.

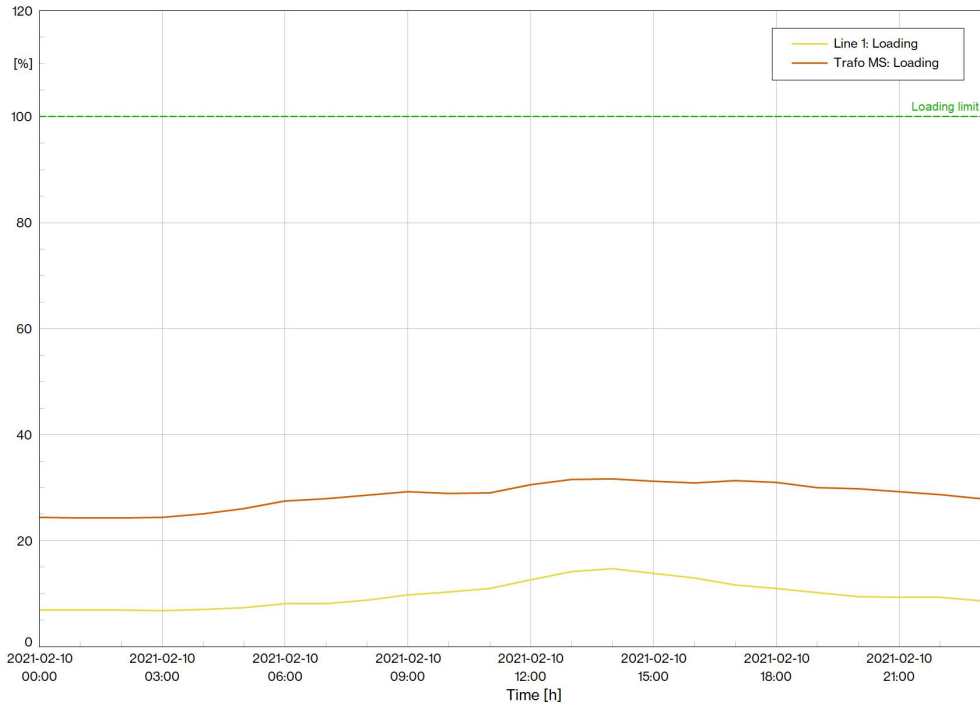

Figure 5.7: The loading of HV cables and transformers over 24 hours for 15% electrification in model 2.

The case of 50 % electrification which can be translated to 25 electric trucks are presented in figure 5.8 below. *Line 1* and *Trafo MS* are now slightly effected during the hour with the highest power demand but still do not exceed 30 % and 50 % respectively.

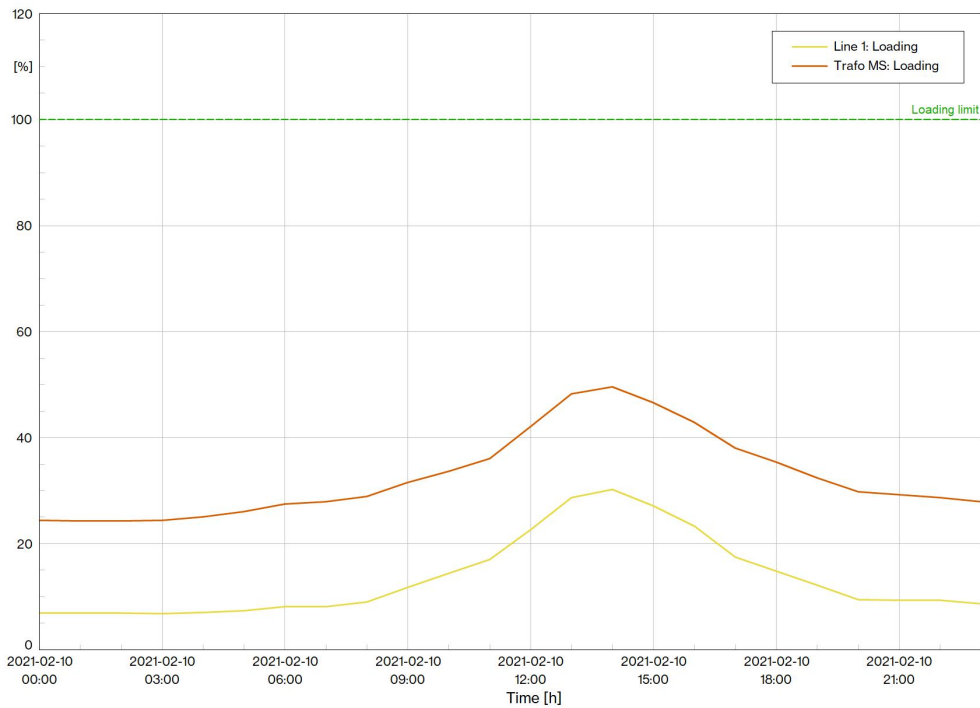

Figure 5.8: The loading of HV cables and transformers over 24 hours for 50% electrification in model 2.

For 100 % electrification of the truck fleet the simulation results are shown in figure 5.9. *Line 1* reaches a maximum loading of 55 % and *Trafo MS* 75 %.

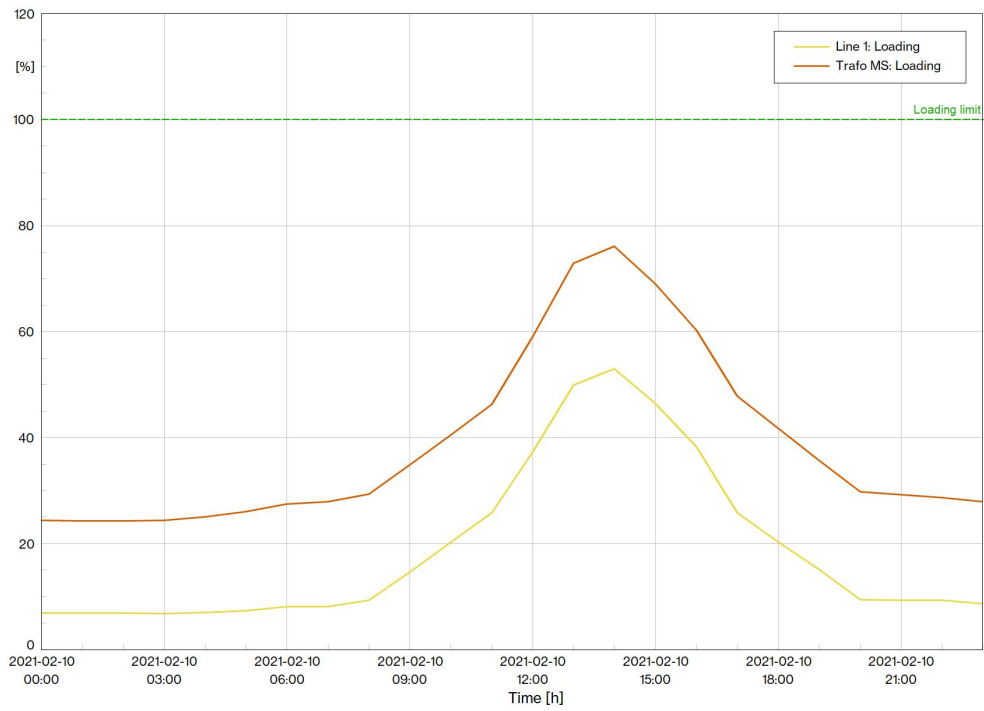

Figure 5.9: The loading of HV cables and transformers over 24 hours for 100% electrification in model 2.

6 Grid modification options

The existing grid is not able to handle more than a few percentages of electrification of heavy trucks at the logistics centres studied. Therefore, this chapter discusses different solutions to enable a more extensive electrification. Batteries to enable 50 % electrification are compared with grid reinforcement. The second part of the chapter contains a probabilistic analysis of the occurrence of the simulated peak power.

6.1 Analysis of solutions

When the power demand is higher than what the grid is dimensioned for, the traditional measure is to reinforce the grid. Implementations of solar or flexibility solutions could reduce the power demand from the grid and minimise or eliminate the need for grid reinforcement. However, all solutions are not suitable for this specific thesis. As can be seen in figure 2.6, the energy production from solar is close to non-existing in February, which is the simulated day in this study. Furthermore, hydrogen storage has such a low efficiency and is most commonly used to store excess production of energy rather than being an integrated part in the grid. Therefore, PV cells and hydrogen storage are not examined further in this study.

Flexibility in demand implies that the electricity consumption is shifted to other hours of the day through economic incentives. Logistics centres are optimising their use of time to minimise the time that the trucks are at standstill. For that reason the solutions regarding flexibility where they need to change their behaviours are likely a less attractive option. Flexibility could be an option if other customers within the grid would be willing to reduce their power consumption at times when the capacity in the grid is limiting. However, according to the simulation graphs the transformers are highly effected by the charging profiles. This indicates that the charging loads are much higher than other loads in the grid, which can be observed in figures 4.3 and 4.5 as well. Meaning flexibility from other customers would not be sufficient. Consequently, solutions regarding flexibility markets are not studied further in this thesis.

A stationary battery is charged when there is a surplus of electricity and available capacity. When there is a deficit of electricity, the battery will support the system and discharge. This type of battery usage enables peak shaving. Batteries are commonly used for short time storage due to their lack in ability to store energy over longer periods of time. The daily variations are quite large, therefore it is a suitable option for the models in this study and is examined further in this chapter. Since the efficiency is high for batteries it is not accounted for in the calculations.

6.1.1 Model 1

In figure 5.2 it can be seen that by taking the LV components into account, model 1 can only handle a 4 % electrification of its truck fleet. Therefore, measures need to be implemented to enable a higher degree of electrification of heavy trucks without overloaded components. It can be observed in the figure that the limiting factor are the cables. The cables from the distribution transformer to the customer are 240 mm² but more LV cables need to be installed. The length of each cable is 0.1 km and the cost for new cables is approximately 580 000 SEK/km according to Kraftringen standards. Since the power demand is exceeding 0.8 MW, the LV transformer is in need of reinforcement. The cost per new 0.8 MVA transformer is 148 000 SEK. The number of transformers needed depends on the degree of electrification, as mentioned above the size of the transformer should match the load.

As can be seen in figure 5.3, today's power transformer and the HV cables can endure a 15 % electrification. For further electrification the first step is to reinforce the grid by exchanging existing 10 kV cables at 120 mm² and 150 mm² with 240 mm². The cables that need to be exchanged are in total about 1.3 km. Multiple parallel cables need to be added as well. According to Kraftringen standards the cost for new 240 mm² cables is 760 000 SEK/km. In figure 5.5 it is observed that the HV transformer is overloaded between 7 am and 8.30 pm for a case of 100 % electrification. The area beneath the transformer line and above the 100 % loading limit can be translated into the amount of energy that needs to be handled to alleviate the grid. A battery to alleviate this overload in the transformer would need to be about 45 MWh/9 MW which would cost approximately 59 MSEK, according to the cost of lithium-ion batteries in chapter 2. This is more expensive than any corresponding transformer. Therefore, the solution of batteries is examined for the case of 50 % electrification. In figure 5.4 it is seen that for 50 % electrification the power transformer is overloaded for approximately one hour of the day, between 10 and 11 am.

Regardless if the measure to reach 50 % electrification is further grid reinforcement or battery storage it is inevitable to reinforce all of the cables and the LV transformer. Meaning the costs and measures for reinforcing the LV components and HV cables are the same for both cases. It is therefore most interesting to compare and evaluate the measures which follows. As mentioned above, the HV transformer is overloaded one hour per day. There are two options for solving this overload. Either an additional transformer can be added next to the existing one, or a battery can be inserted in the grid. The battery required is calculated to have to be 2.0 MWh/2.0 MW. This would result in a cost of 2.6 MSEK. The additional transformer needs to handle the same power excess. According to Kraftringen standards the cost for an additional transformer of this size in addition to the 30 MVA transformer is approximately 3.6 MSEK. The costs are presented in table 6.1 below. Note that the costs are only for the components, there will be additional costs such as foundations, protective buildings and additional electrical and control equipment.

Measure	Cost (MSEK)
HV transformer	3.4
Battery	2.6

Table 6.1: Table with a cost comparison for different measures to enable a 50 % electrification of heavy trucks in model 1.

6.1.2 Model 2

By observing the LV components in figure 5.6, it can be seen that the existing grid in model 2 can only handle an 7 % electrification. Therefore measures need to be implemented to be able to allow a higher degree of electrification of heavy trucks without overloading components. It can be observed in the figure that the limiting factor are the cables. As in model 1, the cables needs to be reinforced in this case. The existing LV cables are 240 mm², meaning more parallel cables needs to be implemented. The length of the cables are 60 m each and the cost is the same as above.

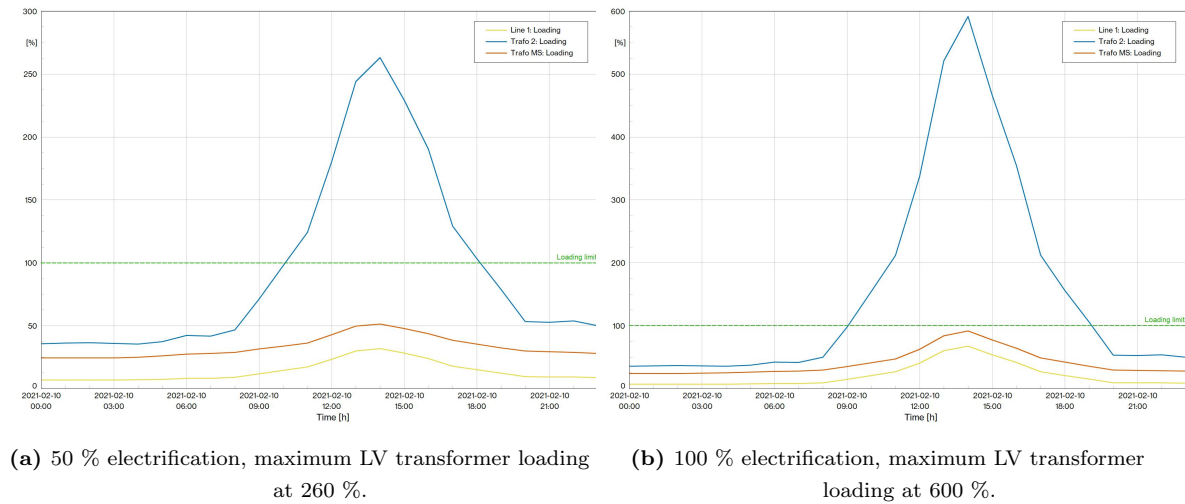

Figure 6.1: The loading for the transformers and LV cable for 50 % and 100 % electrification in model 2.

After the cables are reinforced the limiting component is the LV transformer, seen as the blue lines in figure 6.1. The red and yellow lines are the HV transformer and the HV cable. An option to prevent the transformer from overloading is to install several distribution transformers to match the power demand. To enable 100 % electrification four 0.8 MVA transformers are needed. A battery that handles the same loading would need to be 12.2 MWh / 2.5 MW. However, the available capacity is not enough to charge a battery large enough to shave the peaks. Therefore, the cost comparison focuses on 50 % electrification for this case as well.

To enable a 50 % electrification of the truck fleet, two 0.8 MVA transformers with a cost of 148 000 SEK each need to be installed. A battery that would be able to handle the same load would need to be 4.5 MWh/1 MW, this would cost around 5.9 MSEK. The cost comparison can be seen in table 6.2 below.

Measure	Cost (MSEK)
LV transformers	0.3
Battery	5.9

Table 6.2: Table showing the costs for different measures to enable a 50 % electrification of heavy trucks in model 2.

6.2 Probabilistic analysis

Since some parameters are varied to create the charging profiles it makes it a probabilistic model. This means that when the model is run multiple times with random inputs the outcomes vary. The grid simulations are based on the day with the highest power consumption of 2021 together with the corresponding weekday from the modelled planned charging profiles. This means that due to variations in the charging profiles, the worst peak for charging might not coincide with the day with the highest already existing strain on the grid. Subsequently it is possible for even higher peaks to occur during the year when aggregated with the baseloads. Therefore, it is of interest to make a probabilistic analysis. This is to examine the hourly power demand from the logistics centres over a year and investigate the probability for different loads to occur.

A graph is created through 52 different runs of weekly charging profiles. Together, these 52 runs represent a charging profile of a year. These yearly aggregated load profiles can be seen in figures 6.2 and 6.4 below. Resulting histograms of the hourly power demand are seen in figure 6.3 and 6.5 below and summarises the amount of times each power interval occurs. These figures illustrate the distribution of the power demand at the two logistics centres for 100 % electrification over a year. The probability (p) for different values to occur is calculated according to equation (6.1)

$$p = \frac{\text{frequency of specific data value}}{\text{total number of data values}} \quad (6.1)$$

6.2.1 Model 1

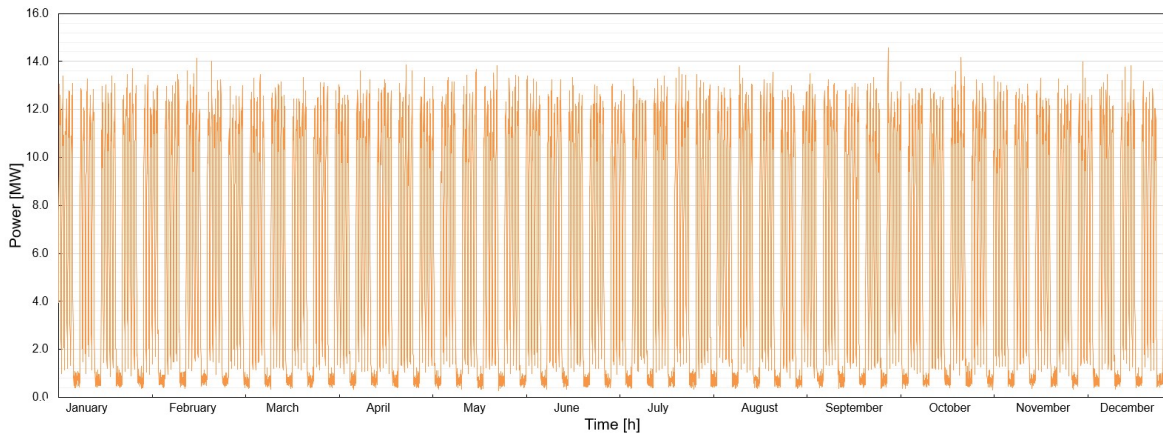

Figure 6.2: Yearly charging profile for model 1, baseload and charging profile (100 %) combined.

The aggregated peak power of 13.2 MW, which is used in the grid simulation for model 1, is marked as the green line in the histogram in figure 6.3. With an interval between 13.1 MW and 13.3 MW it can be seen that this peak appears 37 hours over a year. This means there is a 0.4 % chance that this peak occurs over a year. The probability that any peak above occurs is 0.6 %, meaning it occurs 53 hours over the year.

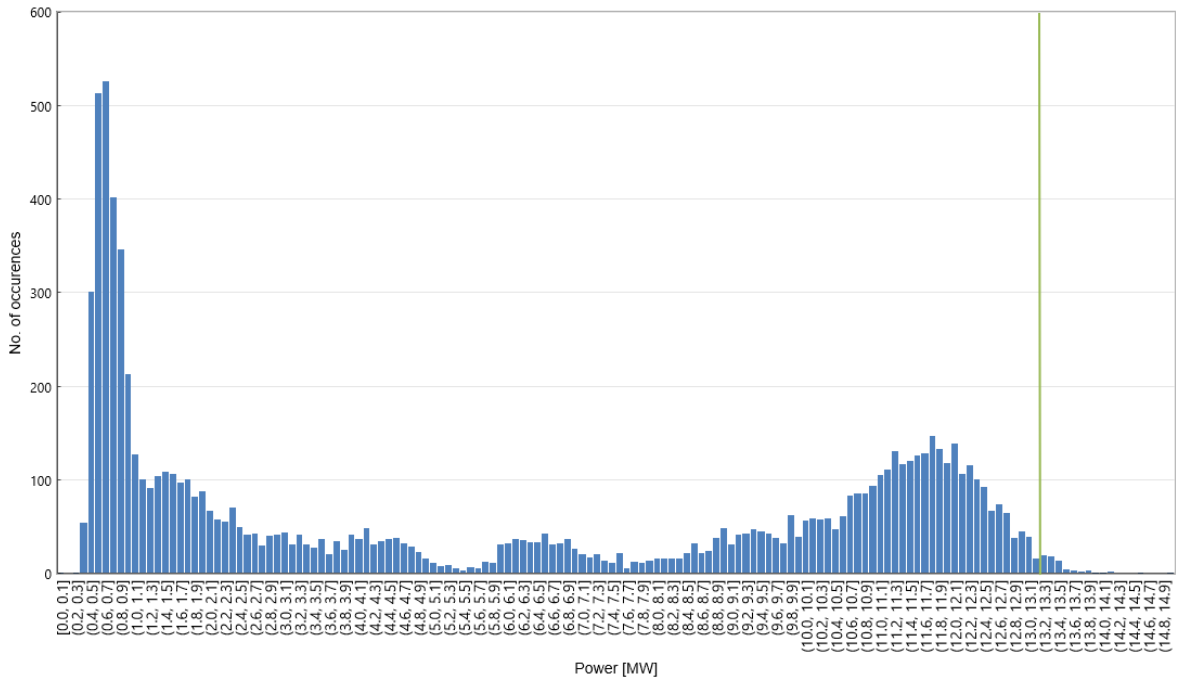

Figure 6.3: Histogram showing the distribution of the hourly power demand for 52 iterations in model 1.

6.2.2 Model 2

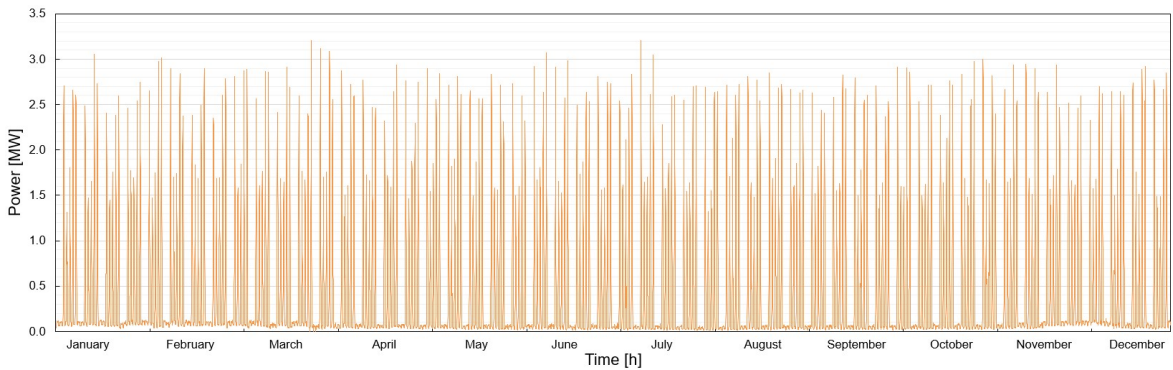

Figure 6.4: Yearly charging profile for model 2, baseload and charging profile (100 %) combined.

In model 2 the aggregated peak power used in the grid simulations is 2.96 MW. For more accurate probabilistic calculations two decimals are used. Figure 6.5 below shows that the peak power of an interval between 2.95 MW and 2.97 MW, which is marked by the green line, occurs 1 hour over the year. The probability that this peak occurs is 0.01 %. The probability that any peak above this power occurs is 0.1 %, which means that any peak above occurs for 12 hours over a year.

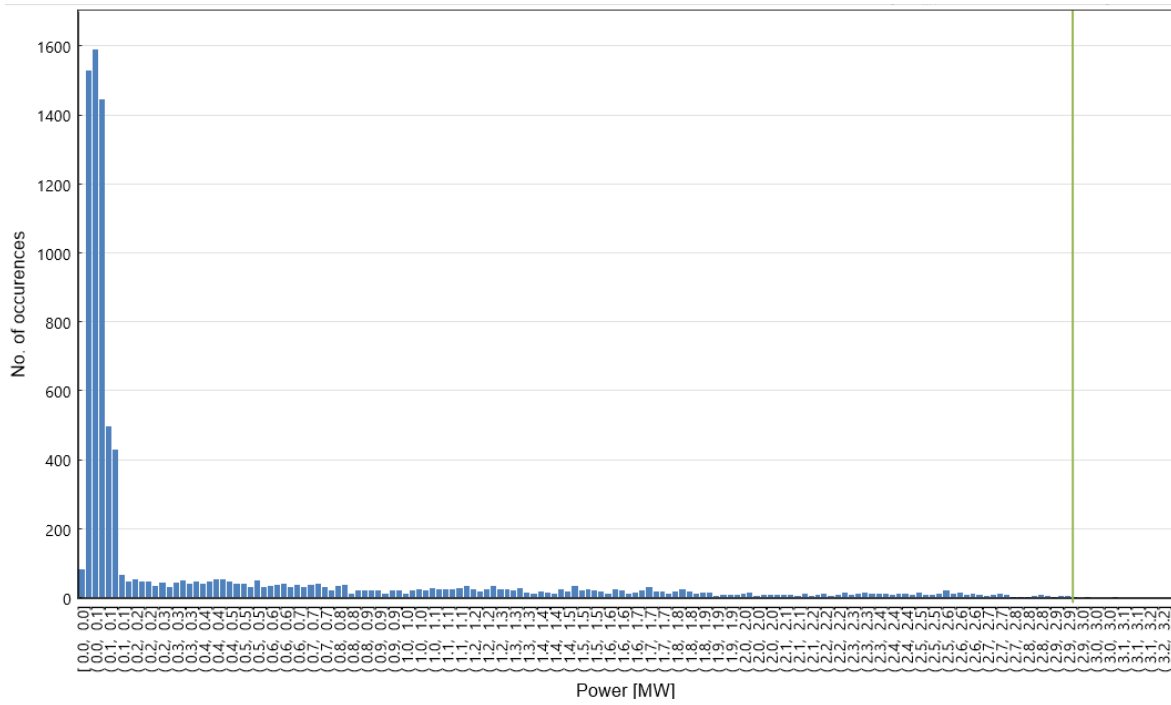

Figure 6.5: Histogram illustrating the distribution of the hourly power demand for 52 iterations in model 2.

7 Discussion

In this chapter the resulting charging profiles and the simulations of these on the existing grid are discussed. An evaluation regarding solutions and the probabilistic approach follows. In the end, suggested further studies are presented.

7.1 Charging profiles

By observing the graphs in chapter 4 it is seen that the peaks of power can be reduced by implementing planned charging instead of simple charging. For model 1, the peak power for a total electrification of the truck fleet is reduced from 19.5 MW to 13.2 MW. For model 2, the corresponding decrease is 5.0 MW to 3.0 MW. This indicates that for both models about a 35 % decrease is maintained by implementing planned charging. Today, simple charging is the most common way of charging. However, since the trucks at these logistics centres are driving after a schedule, planned charging should be possible to implement in the case of an electrification. The simple charging profiles are based on the usage of 1 MW chargers, which are not yet on the market. If the same calculations were to be done with lower charging capacity, the loads would not be as high but the charging and the subsequent parking time would be longer. 1 MW chargers are as mentioned above expected to be available by 2030.

The baseload for both logistics centres can be viewed in figure 4.3 and 4.5. It is observed that the baseload is small in both figures compared to the charging load. For model 1, the baseload is barely visible in the graph. During the simulated week, the baseload reaches a peak power of 0.2 MW for model 1 while the peak power for model 2 is 0.1 MW. When comparing the aggregated load with the baseload the power consumption increases substantially. It becomes 66 times larger than the baseload for model 1 and 30 times larger for model 2.

The charging profiles are modelled with a truck of 40 tonnes, in reality many of the trucks at these two logistics centres are heavier. This means that the trucks would probably need larger batteries and therefore demand more power. For planned charging this would result in the same curve shape of the charging profiles but with a higher demand of power. It would make the difference between the baseload and charging load even larger. For simple charging it would result in longer parking times. However, since there is not yet a heavier truck on the market with a satisfactory driving range the chosen truck was decided to be the best option and representative enough.

The driving patterns are different for the two logistics centres which is well represented in the charging profiles. Model 1 has approximately a 10 times larger truck fleet, and the business hours on weekdays

are the same every day. On weekends the activity is 10 % of that on the weekdays meaning it is closer in size to that in model 2. The difference is the constant flow of trucks arriving and departing throughout the day in model 1. In model 2 the business hours are only during daytime which results in the high peaks instead. Smaller loads most commonly occur during the weekends for industry customers. Two out of three of the busy days in model 2 are on weekends which could coincide with low activity for other industry customers nearby. This could make the total load on the power transformer more even.

7.2 Grid simulations

Firstly, it can be established that the voltage decreases further out in the grid in both models. It can also be said that the voltage is within reasonable and allowed limits. This indicates that the grid models are a reasonable representation of the real network.

Shortage in capacity is the main limitation in the grid due to insufficient components. According to figure 5.2 and 5.6 it can be seen that for only a few percentages of electrification, the LV components are overloaded in both models. Therefore, the focus shifted towards the HV components. From the graphs in section 5.1.2 it can be seen that the HV components in model 1 are able to endure 15 % electrification but not 50 %. It can be observed that the cables are the limiting factor. For model 2, it can be observed that the HV components can endure up to 100 % electrification, see section 5.2.2. The loading of the HV cables and the power transformer seems to be proportional with an increased degree of electrification.

It is noticeable, in the grid simulation results for both model 1 and 2 that the shape of the load curve for the power transformer is not very effected by a 15 % electrification (seen in figures 5.3 and 5.7). The curve shape of the transformer does not have the same shape as the charging load. However, at 50 % electrification it is visible that the loading of the transformer has the same shape as the load profile for the truck charging. It is even more clear in the 100 % electrification case. This indicates that the magnitude of the truck charging on the adjacent grid is larger than the other loads combined for these degrees of electrification.

The networks differ quite a lot in regards to the size of the power transformer which are 30 MVA and 6.3 MVA, respectively. The loads from the charging profiles are smaller in the later case but the fact that the smaller logistics centre happens to be located at the smaller transformer is a coincidence. If model 1, hence the larger logistics centre, would have been located there close to no electrification would be possible. Model 2 is able to be implemented at the present location if the LV components are replaced and consequently they become HV customers from a grid owner perspective. However, flexibility could help to shave the narrow power peaks here, such an installation would be more sustainable for the entire grid and its components.

The different degrees of electrification are scenarios for the future, as mentioned in section 2.1.2. However, it is important to keep in mind that the existing baseloads from QlikSense are not modified in any of the cases. It would have been reasonable to multiply these with a scaling factor since the base consumption will increase in the future as well. Therefore, it can be expected for the grid to be even more overloaded in some areas than it is from the calculations performed in this thesis.

7.3 Grid modification options

7.3.1 Analysis of solutions

As could be seen in figure 2.6, the amount of electricity produced from solar during the months with the highest electricity demand is not significant. Even though there are both economical and technical advantages with larger instalments, the construction of the roof would be a limiting factor. The available area for instalment of solar panels is not a problem in either of the two models. The roof surface for model 1 has an area of roughly 64 000 m² and for model 2 it is around 4 100 m². However, it is not realistic to utilise the whole surface due to construction stability. The seasonal variations are quite large and therefore it is not possible to become self sufficient during the whole year. Therefore, PV cells in itself is not considered to be a suitable solution for the kind of challenge that a logistics centre with electrified heavy trucks stand before. Instalment of PV cells would however decrease its dependency of electricity from the grid and is a way to contribute with renewable energy in the power system. When long term energy storage is possible it might be an option to combine with PV cells depending on the size of the solar instalment.

Another aspect that could decrease the demand of power is if the driving patterns would change at the logistics centres, i.e. implementing one type of flexibility in demand. This could reduce the power peaks in the charging profile. One way to implement this is if the logistics centres would allow their trucks to stand still for a longer period of time. This would allow for the trucks to charge at a lower power. Another possible way to decrease the power demand is if the centres had a more even distribution over the week of when the trucks arrive to charge and unload. For example, there is a smaller demand of power during nighttime or during the weekends. This seems to be a quite complex solution since the logistics centres operate with small margins and desire to stand still as little as possible. Flexibility in demand from surrounding customers is not a possible option. This is since the loads from the near customers are much smaller than the loads from the logistics centres, see appendix A.1 and A.2.

A type of storage seems like the most suitable option. Hydrogen is often mentioned as long term storage but is not yet implemented in large scale on the market. The low efficiency of hydrogen storage would mean that the volume of the storage would need to be quite large. Both these aspects is the reason why it is not examined further in this study. If hydrogen were to be utilised, it might be more suitable as a fuel rather than storage.

Batteries are a possible option to even out the demand of power from this grid as mentioned above. It could charge during hours with a lower power demand and shave peaks when the demand is high. As is seen in section 6.1, the measures for model 1 are comparable in price. The battery has a cost of 2.6 MSEK compared to the transformer which has a cost of 3.6 MSEK. The battery is dimensioned to shave the load for one hour on the 10th of February. This means the battery is dimensioned to alleviate the grid daily if needed. However, as mentioned above the charging profiles vary a little over the year. The additional HV transformer on the other hand enables increased power consumption for all hours of the year, given that the sub-transmission owner approves a larger outtake from their grid. If only one hour a day is utilised there is availability for new customers or it is possible for the logistics centre to further electrify its truck fleet. Which could be profitable for the grid owner.

For model 2, the measures are not as comparable in price. The required transformers has a cost of

0.3 MSEK while the battery has a cost of 5.9 MSEK. The transformers are much cheaper in this case since it is the LV transformers that needs to be reinforced. However, a battery could be a suitable option since it would even out the load on the grid. This would lead to a longer lifetime for the grid components and a more even distribution of available power during the day.

Grid reinforcement is the traditional way to handle capacity shortage. The cables need to be reinforced in all cases as mentioned above. Since the whole society is electrifying it can be assumed that the power demand in these networks will increase from other customers as well. Therefore, the transformers should be reinforced. But depending on delivery and construction time, as well as approval from the sub-transmission owner in model 1, it might be a lengthy process. Batteries could be installed as a quicker solution depending on the delivery time of the battery. However, according to present regulations, battery storage can not be owned by a network company. This means a third party would have to invest but could be used to postpone an investment for the grid company.

7.3.2 Probabilistic analysis

The lower values for model 1 in figure 6.3 seem to be in the shape of a Rayleigh distribution. The large number of values between 0.4 MW and 0.9 MW is a result of the low activity on weekends. The distribution of the higher power values resemble a normal distribution. The most reoccurring powers in this distribution is at 11.5 MW to 11.8 MW. For model 2, the distribution of the hourly power demand in figure 6.5 seem to be in the form of a Rayleigh distribution as well. The charging profile of model 2 has narrow peaks and a majority of zero values due to the driving pattern of the logistics centre. The fact that the baseload values are quite small but gathered results in a large number of values between 0.01 MW and 0.1 MW.

As mentioned above, the common way to dimension the grid is through a deterministic approach, which in this case would mean that simulations would be based on the worst value in the histograms. However, since these occur one hour per year it makes the probabilistic approach seem more reasonable. It is important to regard the fact that the the grid is a critical infrastructure which is why it is important to have margins.

As can be seen in the histograms, the peak powers used in the grid simulations does not occur very often in either of the cases. For model 1, power demands equal and above the simulated peak power occurs 90 hours of the year. For model 2, the power demands equal or above occur 13 hours. Both of these hours are reasonable since the logistics centres differ in size and driving pattern. The trucks in model 2 are only active at the logistics centre for 12 hours of the day, five days a week, while in model 1 there is activity during the entire day and all days a week. How often the peak power occurs indicates that the values used in the simulations in this study are rather conservative. In figure 6.3 for model 1, the peak power values in the right end of the graph resemble a normal distribution. This indicates that the peak of the normal distribution of around 11.7 MW is a more common peak power. An alternative would have been to make simulations based on this value. However, probabilistic approaches for grid simulations does not leave out the fact that in reality higher values occur. Therefore a plan for how to handle these values would still need to be in place. Instruments of flexibility could probably be one way to handle this.

7.4 Future work

This study has evaluated the expected power need for electrification of heavy trucks, how it affects the grid and possible solutions for enabling an electrification. However, since this is a case study for two logistics centres where the results turned out very differently it is hard to draw any general conclusions. Further work could focus on finding general trends in how logistics centres activities can be translated into charging patterns. This could be done by observing a larger number of logistics centres and try to find general patterns and/or key parameters when it comes to electrification.

Further case studies, such as in this thesis, could be done but with a larger perspective. For example it could be assumed that the charging infrastructure is developed and therefore the charging would not have to be as long at one location or it could include more possible charging points. Due to the geographical location of Sweden, the country is largely dependent on the freight from the continent. In order to successfully electrify the truck fleet, it is important to coordinate with other countries. Investigations on what battery and charging techniques would be suitable could be conducted. The coordination of the political decisions regarding enabling of large scale electrification could also be investigated.

There are more analysis to be done regarding solutions for challenges that stems from large scale truck electrification. The technical solutions mentioned in this study might be in need of reevaluation with the technical development. Some techniques are not mentioned in this study and might be of interest, especially in the future. Two examples are; vehicle-to-grid where trucks could act as battery storage when parked longer periods of time or electric road systems where the trucks are charging while driving, resulting in that the charging power is reduced and distributed both geographically and in time. Flexibility in demand could also be examined further and for example calculations could be done on how changed driving patterns would affect the economics of the logistics centre.

8 Conclusion

The aim of this thesis was to investigate two different logistics centres and see how the activity at the centres could be interpreted as a charging pattern. Furthermore the aim was to examine how the resulting load profiles would affect the existing electric grid, where investments are essential, and to evaluate different solutions for an increased electrification of heavy trucks.

Charging profiles can be created by observing the driving patterns of logistics centres and by making several assumptions for parameters regarding the vehicle battery. Depending on the type of charging, the power demand is somewhat different. Depending on different characteristics for the logistics centre studied, the charging profile varies as well. It is difficult to generalise a charging pattern from these two logistics centres only. Although the size of the truck fleet affects the power demand, it is such high loads that the baseloads are minuscule in comparison.

The grid today is not dimensioned for the magnitude of loads that a heavy truck electrification will result in. Even with very few trucks, components in the existing grid are overloaded. Based on the results from this study, the cables are the limiting component and the LV cables are always in need of reinforcement. With a higher degree of electrification, components on a higher voltage level are effected. Seen from a distribution grid owner perspective, logistics centres with electrified heavy trucks need to have a grid connection on a higher voltage level.

There are many potential solutions to alleviate the grid, both technical and business based ones. In this study, storage was decided to be the best option, specifically batteries. The batteries were in this study evaluated compared to reinforcing transformers. And according to the results for these two cases, the cost of batteries are more comparable when set against an HV transformer compared to an LV transformer. Batteries cannot always replace grid reinforcements, it is different for each case depending on the size and durability of the power peak. In this case study, the option of batteries was examined for 50 % electrification of the truck fleets since 100 % electrification would demand unreasonably large and expensive batteries. Short and high power peaks seem to be suitable to handle with batteries while longer overloads might not. This is since the cost of the battery is proportional to the energy rather than the power.

Conclusively, the electrification of the heavy truck fleet will imply challenges for both logistics centres and grid owners. In order to mitigate the power consumption the driving patterns would need to change towards longer standstill periods in order to charge at a lower rate. This is however complex and the driving patterns are well-established. The grid will be highly affected by the increased demand for power at certain times. The available and suitable solutions could rather be viewed as a temporary solution until grid reinforcement is in place. The focus in the study was to enable a 50 % electrification degree. According to the future predicted development this would meet the prediction at 2035, which

is further in the future than the national goal of emission reduction until 2030. Thereafter, there are hopefully successful infrastructure in place as well as preparations for further grid reinforcement to enable an even higher degree of electrification. As the electrification of the society proceeds, it is important to evaluate the prerequisites of the existing grid. Implementations of further solutions such as flexibility, energy production and energy efficient vehicles are necessary to maintain a sustainable electrical network.

Bibliography

- ACEA (2021a). *ACEA Position Paper. Heavy-duty vehicles: Charging and refuelling infrastructure requirements*. https://www.acea.auto/files/ACEA_Position_Paper-Heavy-duty_vehicles-Charging_and_refuelling_infrastructure.pdf.
- ACEA (2021b). *Interactive map - Electric trucks: regional stop locations fit for charging point deployment in Europe*. <https://www.acea.auto/figure/interactive-map-electric-trucks-regional-stop-locations-fit-for-charging-point-deployment-in-europe/> [2022-01-31].
- Axberg, E., Alkefjård, T., Grahn, P., Jigvall, C., Karlsson, J., Karlsson, T., Pandur, S., Sidén, J., Vendel-Nylander, C. and Wallnerström, C J. (2021). *Kapacitetsutmaningen i elnäten*. Ei R2020:06 Eskilstuna: Energimarknadsinspektionen. https://www.regeringen.se/4afc14/contentassets/8d350a3c57644a9faf9ffe7678743961/eir2020_06_kapacitetsutmaningen-i-elnaten.pdf.
- Battery University (2021a). *BU-409: Charging Lithium-ion*. <https://batteryuniversity.com/article/bu-409-charging-lithium-ion> [2022-05-04].
- Battery University (2021b). *BU-501: Basics about Discharging*. <https://batteryuniversity.com/article/bu-501-basics-about-discharging> [2022-05-04].
- BIL Sweden (2020). *Färdplan för fossilfri konkurenskraft: Fordonsindustrin - tunga fordon*.
- BloombergNEF (2021). *Battery Pack Prices Fall to an Average of 132 \$/kWh, But Rising Commodity Prices Start to Bite*. <https://about.bnef.com/blog/battery-pack-prices-fall-to-an-average-of-132-kwh-but-rising-commodity-prices-start-to-bite/> [2022-05-03].
- CIGRE (2020). *Power system development and economics - Optimal power system planning under growing uncertainty*. [Brochure].
- E.ON (2021a). *Anslut till lokalnätet*. <https://www.eon.se/foeretag/elnaet/anslut/lokalnaet#:~:text=Anslut%20till%20lokaln%C3%A4tet,%20och%20kilovolt>. [2022-04-13].
- E.ON (2021b). *Vad är elbrist, effektbrist och nätkapacitetsbrist?* <https://www.eon.se/om-e-on/kapacitetsbristen/elbrist-effektbrist-naetkapacitetsbrist> [2022-02-08].
- EV Safe Charge (n.d.). *What is DC fast charging?* <https://evsafecharge.com/dc-fast-charging-explained/> [2022-04-13].

- Jacobsson, K.A., Lidström, S. and Öhlén, C. (2016). *Elkraftshandboken: Elkraftsystem 1*. 3 uppl., Stockholm: Liber AB.
- Kraftringen (n.d.). *Anslut din fastighet eller produktionsanläggning till elnätet*. <https://www.kraftringen.se/privat/el/elnat/elanslutning-elnavtsavtal/> [2022-04-19].
- Leisse, Ingmar (2013). *Efficient Integration of Distributed Generation in Electricity Distribution Networks - Voltage Control and Network Design*. Diss. Lund: Lund University.
- Mimer (2021). *Produktionsstatistik*. <https://mimer.svk.se/ProductionConsumption/ProductionIndex> [2022-05-11].
- Ministry of Infrastructure (2022a). *550 miljoner kronor till elektrifiering av tunga transporter*. [Pressmeddelande], 10 februari.
- Ministry of Infrastructure (2022b). *Utsläpp av växthusgaser till år 2045*. <https://www.sverigesmiljomal.se/etappmalen/utslapp-av-vaxthusgaser-till-ar-2045/> [2022-05-11].
- Nordhammer, C. and Grankvist, J. (2021). *Truck electrification: Trends and impacts on the energy system*. Master thesis, Energy and Environment. Stockholm: KTH <http://kth.diva-portal.org/smash/get/diva2:1592007/FULLTEXT01.pdf>.
- PowerCircle (2020). *Batterilager i framtidens elsystem*. Stockholm: Power Circle AB. https://powercircle.org/wp-content/uploads/2020/11/Batterilager_i_framtidens_elsystem_SampEL.pdf.
- PowerCircle (2021). *Elektrifiering och laddning av tunga transporter*. Stockholm: Power Circle AB <https://powercircle.org/elektrifieradlastbilar.pdf>.
- Prusty, B. and Jena, D. (2017). *A critical review on probabilistic load flow studies in uncertainty constrained power systems with photovoltaic generation and a new approach*. Renewable and Sustainable Energy Reviews. <https://www.sciencedirect.com/science/article/pii/S1364032116311066>.
- Region Skåne (2021). *Skånes Elektrifieringslöfte*. <https://utveckling.skane.se/siteassets/kampanjsidor/effektkommissionen/skanskt-elektrifieringslofte.pdf>.
- Rosenlind, J., Broström, E. and Lahti, M. (2020). *Ei:s strategi för flexibilitet i elsystemet*. Eskilstuna: Energimarknadsinspektionen. <https://www.ei.se/om-oss/publikationer/publikationer/rapporter-och-pm/2020/eis-strategi-for-flexibilitet-i-elsystemet> [2022-02-08].
- Scania (2021). *Scania 64-tonne electric truck on the road with Wibax*. <https://www.scania.com/group/en/home/newsroom/press-releases/press-release-detail-page.html/4139928-scania-64-tonne-electric-truck-on-the-road-with-wibax> [2022-04-13].
- Scania (n.d.). *Battery Electric Trucks*. <https://www.scania.com/group/en/home/products-and-services/trucks/battery-electric-truck.html> [2022-04-13].

- SCB (2021a). *Elförsörjning 2021*. <https://www.scb.se/hitta-statistik/statistik-efter-amne/energi/tillforsel-och-anvandning-av-energi/manatlig-elstatistik-och-byten-av-elleverantor/pong/tabell-och-diagram/elforsorjning/> [2022-02-08].
- SCB (2021b). *Totala utsläpp och upptag av växthusgaser efter växthusgas och sektor. År 1990 - 2020*. https://www.statistikdatabasen.scb.se/pxweb/sv/ssd/START__MI__MI0107/TotaltUtslappN/# [2022-01-31].
- Sundén, B. (2019). *Hydrogen, Batteries and Fuel Cells*. Lund: Academic Press.
- SustainabilityExchange (n.d.). *What is Energy and How Much do You Use?* https://www.sustainabilityexchange.ac.uk/files/cambridge_regional_college_sus_how_much_energy_do_you_use_pdf.pdf [2022-05-11].
- Svenska Kraftnät (2021a). *CoordiNet*. <https://www.svk.se/utveckling-av-kraftsystemet/forskning-och-utveckling/pagaende-fou-projekt/coordinet> [2022-02-18].
- Svenska Kraftnät (2021b). *Sveriges elnät*. <https://www.svk.se/om-kraftsystemet/oversikt-av-kraftsystemet/sveriges-elnat/> [2022-01-31].
- Swenman, M., Wigenborg, G. and Bobadilla Robles, H. (2020). *Tjänster för efterfrågefleksibilitet*. Eskilstuna: Energimarknadsinspektionen <https://ei.se/download/18.6f9b6b2617714873b45f1194/1613487381373/Tj%C3%A4nster-f%C3%B6r-efterfr%C3%A5gefleksibilitet-Ei-R2020-10.pdf> [2022-02-18].
- Tesla (n.d.). *Semi*. <https://www.tesla.com/semi> [2022-04-13].
- Trafikanalys (2019). *Ny miljöpremie för lastbilar föreslås*. <https://www.trafa.se/vagtrafik/ny-miljopremie-for-lastbilar-foreslas-8175/> [2022-01-31].
- Uniper (n.d.). *Vätgas - en av nycklarna till klimatomställningen av Sverige*. <https://www.uniper.energy/sverige/vatgas> [2022-04-27].
- Volvo Trucks (2020). *Volvo FH with I-Save breaks Commercial Motor fuel test record*. <https://www.volvotrucks.com/en-en/news-stories/magazine-online/2020/feb/volvo-fh-with-i-save-breaks-fuel-record.html> [2022-05-11].
- Volvo Trucks (2022). *Volvo's heavy-duty electric truck put to the test: Excels in range and energy efficiency*. <https://www.volvotrucks.com/en-en/news-stories/magazine-online/2022/jan/volvo-fh-electric-excels-in-first-road-test.html> [2022-04-13].
- Volvo Trucks (n.d.). *Electric trucks*. <https://www.volvotrucks.com/en-en/trucks/alternative-fuels/electric-trucks.html> [2022-04-13].
- Wiesner, E., Schumacher, L., Bergerlind, J. and Cameron, D. (2019). *Elnätsutmaningen*. https://www.svensktnaringsliv.se/bilder_och_dokument/9gly8p_elnatsutmaningenpdf_1139044.html/Elntsutmaningen.pdf [2022-04-13].

A Appendix

A.1 Model 1 - Baseloads

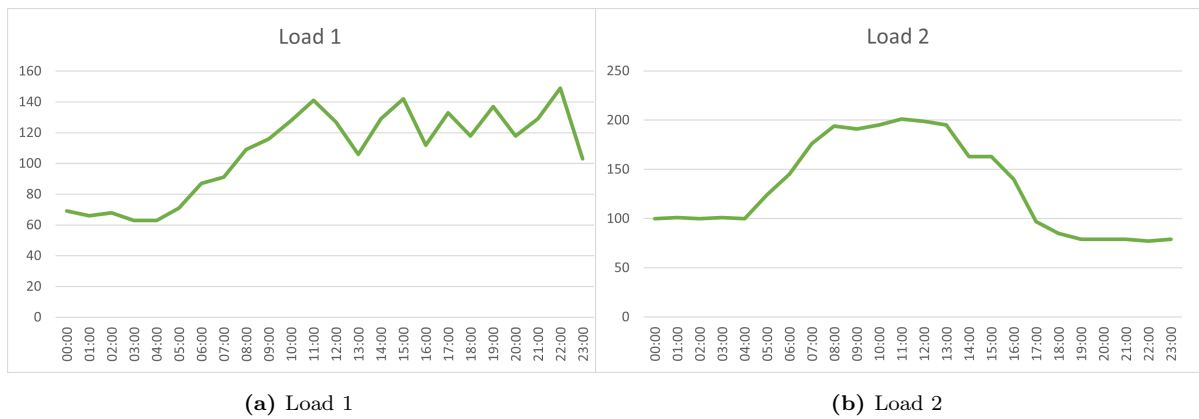
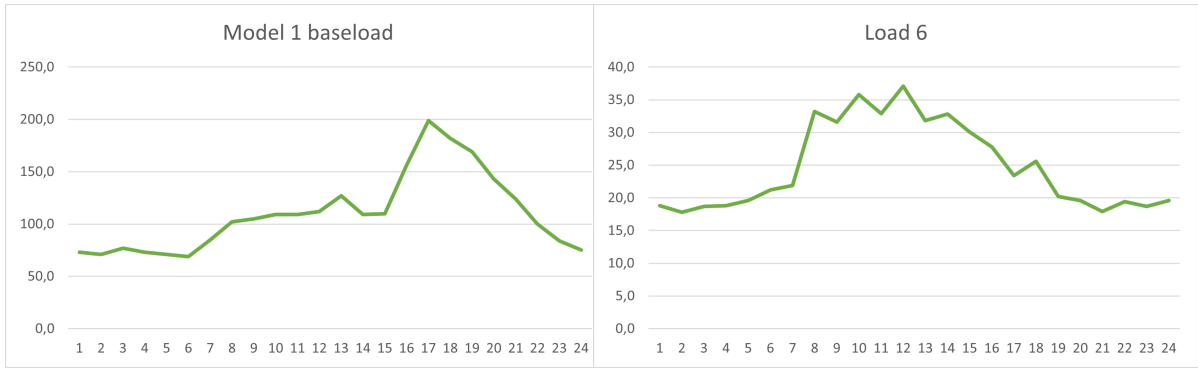

Figure A.1: Loads for different substations in the grid for the 10th of February



Figure A.2: Loads for different substations in the grid for the 10th of February



(a) Baseload Model 1

(b) Load 6

Figure A.3: Loads for different substations in the grid for the 10th of February

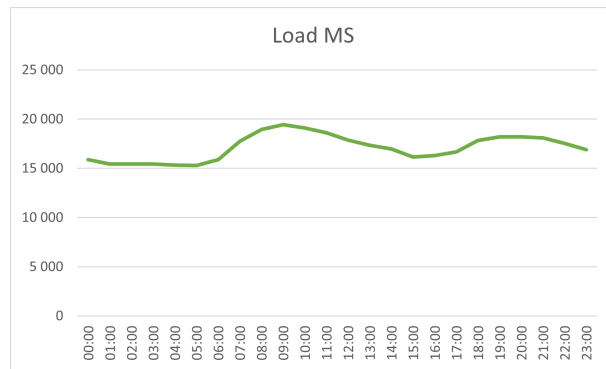
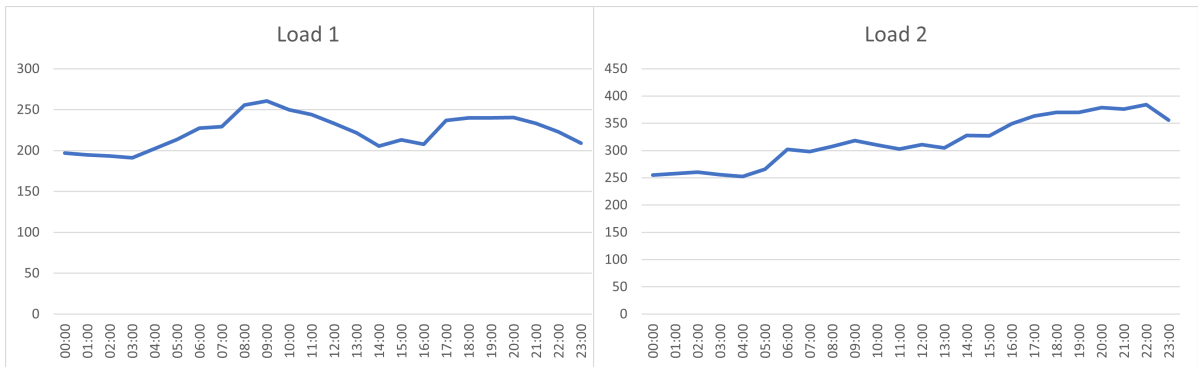

Figure A.4: Load at transformer MS for the 10th of February

A.2 Model 2 - Baseloads



(a) Load 1

(b) Load 2

Figure A.5: Loads for different substations in the grid for the 10th of February

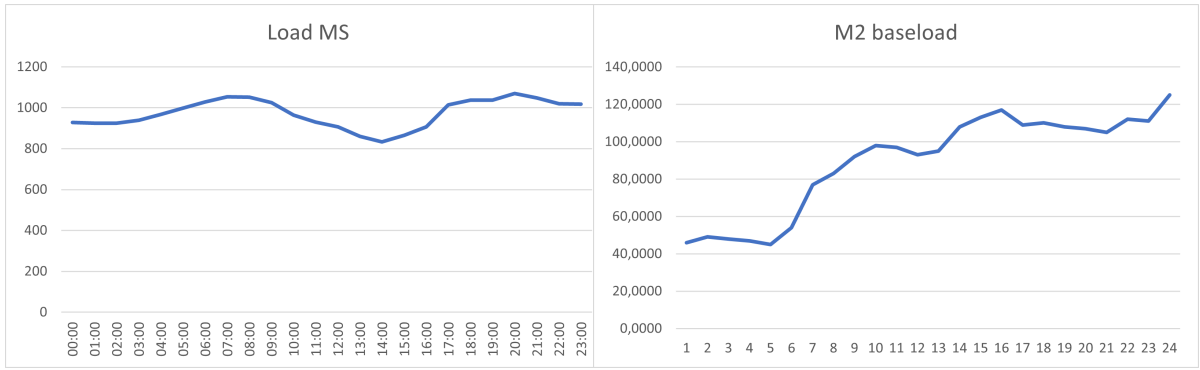

(a) Load at transformer MS

(b) Baseload model 2

Figure A.6: Loads for different substations in the grid for the 10th of February