



LUND UNIVERSITY

Robust Narrow-Band Disturbances Rejection Using Overparametrized Pole-Assignment Control

Savaresi, Sergio; Wittenmark, Björn

1995

Document Version:

Publisher's PDF, also known as Version of record

[Link to publication](#)

Citation for published version (APA):

Savaresi, S., & Wittenmark, B. (1995). *Robust Narrow-Band Disturbances Rejection Using Overparametrized Pole-Assignment Control*. (Technical Reports TFRT-7537). Department of Automatic Control, Lund Institute of Technology (LTH).

Total number of authors:

2

General rights

Unless other specific re-use rights are stated the following general rights apply:

Copyright and moral rights for the publications made accessible in the public portal are retained by the authors and/or other copyright owners and it is a condition of accessing publications that users recognise and abide by the legal requirements associated with these rights.

- Users may download and print one copy of any publication from the public portal for the purpose of private study or research.
- You may not further distribute the material or use it for any profit-making activity or commercial gain
- You may freely distribute the URL identifying the publication in the public portal

Read more about Creative commons licenses: <https://creativecommons.org/licenses/>

Take down policy

If you believe that this document breaches copyright please contact us providing details, and we will remove access to the work immediately and investigate your claim.

LUND UNIVERSITY

PO Box 117
221 00 Lund
+46 46-222 00 00

ISSN 0280-5316
ISRN LUTFD2/TFRT--7537--SE

Robust Narrow-Band Disturbances Rejection Using Overparametrized Pole-Assignment Control

Sergio Savaresi
Björn Wittenmark

Department of Automatic Control
Lund Institute of Technology
September 1995

Department of Automatic Control Lund Institute of Technology P.O. Box 118 S-221 00 Lund Sweden		<i>Document name</i> INTERNAL REPORT	
		<i>Date of issue</i> September 1995	
		<i>Document Number</i> ISRN LUTFD2/TFRT--7537--SE	
<i>Author(s)</i> Sergio Savaresi Björn Wittenmark		<i>Supervisor</i>	
		<i>Sponsoring organisation</i>	
<i>Title and subtitle</i> Robust Narrow-Band Disturbances Rejection Using Overparametrized Pole-Assignment Control			
<i>Abstract</i> <p>In this work, the problem of designing feedback controllers for the rejection of narrow-band disturbances is considered. The design technique proposed herein is based upon a well-suited overparametrization of standard controllers; the extra-degrees-of-freedom so introduced are used to improve the performances of the basic controller, in terms of output variance, and in terms of robustness with respect to uncertainties in the parameters. In particular, the problem of improving the robustness of the system, when the system time delay is subject to uncertainties, is considered, and an innovative solution proposed. Moreover, it is shown that the proposed overparametrizing technique can be straightforwardly used for the design of high-performance notch filters.</p>			
<i>Key words</i> Harmonic disturbances; overparametrization; robust control; minimum variance control; notch filters; pole placement.			
<i>Classification system and/or index terms (if any)</i>			
<i>Supplementary bibliographical information</i>			
<i>ISSN and key title</i> 0280-5316		<i>ISBN</i>	
<i>Language</i> English	<i>Number of pages</i> 50	<i>Recipient's notes</i>	
<i>Security classification</i>			

Department of Automatic Control Lund Institute of Technology P.O. Box 118 S-221 00 Lund Sweden	<i>Document name</i> INTERNAL REPORT	
	<i>Date of issue</i> September 1995	
	<i>Document Number</i> ISRN LUTFD2/TFRT--7537--SE	
<i>Author(s)</i> Sergio Savaresi Björn Wittenmark	<i>Supervisor</i>	
	<i>Sponsoring organisation</i>	
<i>Title and subtitle</i> Robust Narrow-Band Disturbances Rejection Using Overparametrized Pole-Assignment Control		
<i>Abstract</i> <p>In this work, the problem of designing feedback controllers for the rejection of narrow-band disturbances is considered. The design technique proposed herein is based upon a well-suited overparametrization of standard controllers; the extra-degrees-of-freedom so introduced are used to improve the performances of the basic controller, in terms of output variance, and in terms of robustness with respect to uncertainties in the parameters. In particular, the problem of improving the robustness of the system, when the system time delay is subject to uncertainties, is considered, and an innovative solution proposed. Moreover, it is shown that the proposed overparametrizing technique can be straightforwardly used for the design of high-performance notch filters.</p>		
<i>Key words</i> Harmonic disturbances; overparametrization; robust control; minimum variance control; notch filters; pole placement.		
<i>Classification system and/or index terms (if any)</i>		
<i>Supplementary bibliographical information</i>		
<i>ISSN and key title</i> 0280-5316		<i>ISBN</i>
<i>Language</i> English	<i>Number of pages</i> 50	<i>Recipient's notes</i>
<i>Security classification</i>		

The report may be ordered from the Department of Automatic Control or borrowed through the University Library 2, Box 1010, S-221 03 Lund, Sweden, Fax +46 46 110019, Telex: 33248 lubbis lund.

Robust Narrow-Band Disturbances Rejection Using Overparametrized Pole-Assignment Control[†]

SERGIO SAVARESI

Politecnico di Milano - Milano, ITALY

BJÖRN WITTENMARK

Lund Institute of Technology - Lund, SWEDEN

Abstract. In this work, the problem of designing feedback controllers for the rejection of narrow-band disturbances is considered. The design technique proposed herein is based upon a well-suited overparametrization of standard controllers; the extra-degrees-of-freedom so introduced are used to improve the performances of the basic controller, in terms of output variance, and in terms of robustness with respect to uncertainties in the parameters. In particular, the problem of improving the robustness of the system, when the system time delay is subject to uncertainties, is considered, and an innovative solution proposed. Moreover, it is shown that the proposed overparametrizing technique can be straightforwardly used for the design of high-performance notch filters.

Key Words. Harmonic disturbances; overparametrization; robust control; minimum variance control; notch filters; pole placement.

1. INTRODUCTION

This paper deals with the problem of designing feedback control systems, when the system is affected by harmonic (narrow-band) disturbances, the rejection of which is a non-trivial problem, which has received a great deal of interest both in the field of control system (see e.g. [25],[37]), and in the field of signal processing (see e.g. [5],[39]).

The importance of the problem is essentially due to the fact that harmonic (or quasi-harmonic) signals embedded in broad-band noise frequently appear in practice. As an example of harmonic disturbances, one can consider the case of acoustic noise or of mechanical vibrations induced on vehicles (cars, boats, aircrafts, helicopters, etc.) by the rotation of mechanical components (engines, gear boxes, etc.).

Several design techniques have been proposed during the last decades; among them, one of the most popular is based upon a biquadratic model of harmonic signals, and provides good performances over a wide range of conditions (see e.g. [31],[33],[37]).

[†] This work is supported within the Human Capital and Mobility Network: "Nonlinear and Adaptive Control: towards a Design Methodology for Physical Systems".

In this paper, a technique based on the overparametrization of a "standard" controller is proposed, having the aim of improving its performances, while keeping unchanged the number and the position of the poles of the closed-loop system; in this sense, such a technique, can be viewed as a pole-placement overparametrization technique (see [7],[41]). The extra-degrees-of-freedom are used to enhance the performances of the basic "overparametrized" controller, in terms of output variance, and in terms of robustness with respect to uncertainties in the parameters of the noise and of the system. In particular, an innovative method for dealing with the problem of improving the robustness of the control system, when the system time delay is subject to uncertainties, is developed.

Finally, it will be shown that the overparametrization technique developed for feedback control systems can be straightforwardly extended to the design of high-performances stop-band filters.

The paper is structured as follows: in Sect.2 the problem of narrow-band disturbances rejection is stated, while in Sect.3 a classical design technique for the cancellation of narrow-band signals is briefly presented. Sect.4 is entirely devoted to the presentation of the overparametrization technique, and it is complemented by several theoretical results and numerical examples. In Sect.5 the problem of stop-band filters design by using the overparametrization technique is considered. Some conclusive remarks end the paper.

2. PROBLEM STATEMENT

The scheme depicted in Fig.2.1 represents, in a synthetic way, a dynamical system with the output affected by an additive disturbance constituted by an harmonic signal embedded in white noise.

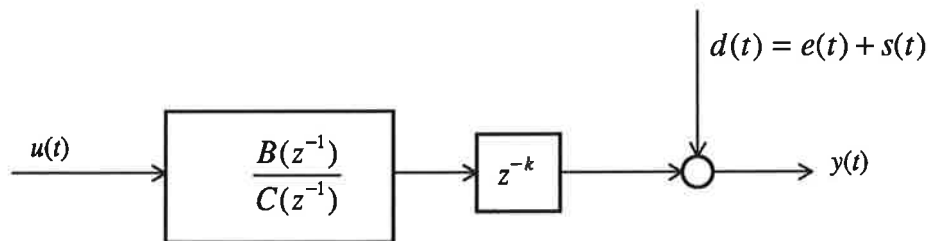

Fig.2.1. Dynamical system with narrow-band output disturbance.

The symbols used in the above scheme have the following meaning:

- $u(t)$ is the input of the system;
- $y(t)$ is the system output, and it is supposed to be measurable;
- $B(z^{-1})/C(z^{-1})$ is a known rational transfer function, and it is supposed that the roots of polynomials $B(z^{-1})$ and $C(z^{-1})$ are outside the unit circle (i.e.

$B(z^{-1})/C(z^{-1})$ has a stable inverse); $B(z^{-1})$ and $C(z^{-1})$ are supposed to have degree n_B and n_C respectively.

- z^{-k} is a k -steps pure time delay;
- $d(t) = e(t) + s(t)$ is an additive disturbance, constituted by a pure harmonic signal ($s(t) = M \sin(\Omega t + \phi)$) embedded in white noise (without loss of generality, in the rest of the paper, $e(t)$ will be supposed to be a zero-mean unitary-variance white noise). The parameters M and Ω of the harmonic signal are supposed to be known, possibly with some uncertainties (for more details on the problem of estimating such parameters, see e.g. [6],[12],[16],[18]).

The problem this work deals with is the design of a feedback control law (see Fig.2.2)

$$u(t) = -\frac{G(z^{-1})}{F(z^{-1})} y(t),$$

having the goal of minimising the output variance, in presence of uncertainties in the harmonic signal parameters, M and Ω , and in the system time delay, k .

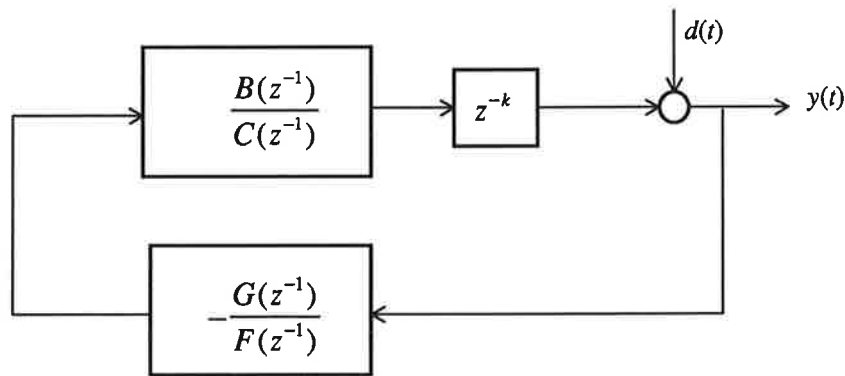

Fig.2.2 Closed-loop control system

As an example of a practical problem which can be schematised by means of the general scheme of Fig.2.2, consider the following:

Example 2.1

In Fig.2.3 the basic scheme of an Active Noise Cancelling (ANC) problem is depicted. The main elements which constitute such a scheme are the following (see [25],[31]):

- a noise source (e.g. an engine);
- a microphone, around which one would like to attenuate the noise level;
- a loudspeaker, which produces the cancelling signal;
- the system between the loudspeaker and the microphone (indicated with a dashed box in Fig.2.3); it can be, for instance, the cabin of a car, of a boat, of an helicopter, etc. Notice that the main dynamical phenomenon associated to such a system is usually the propagation delay of the pressure waves.

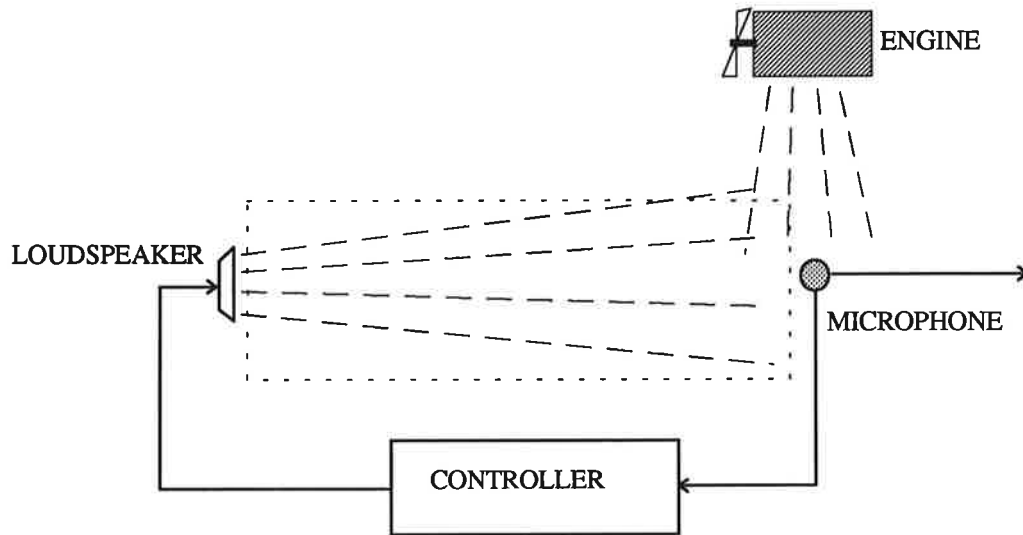

Fig.2.3. Active Noise Cancelling basic scheme.

The control problem is that of designing a feedback controller for the rejection of the harmonic signals which constitute the noise. It is apparent the strict similarities between the scheme in Fig.2.3 and the general scheme of Fig.2.1. ■

3. A CLASSICAL MODEL-BASED TECHNIQUE FOR THE DESIGN OF CONTROLLERS IN PRESENCE OF NARROW-BAND DISTURBANCES

In this section a standard technique, which is commonly used for the design of control systems in presence of narrow-band disturbances is described (see e.g. [13],[22],[29],[31],[33]). It is a minimum-variance technique, which makes reference to the classical concept of prediction error (see e.g. [1],[19],[34]), its main feature being that it is based on a rational ARMA approximation of the disturbance $d(t)$.

A standard way of approximating an harmonic signal embedded in white noise, as the output of an ARMA model fed by white noise is the following:

$$d(t) \approx \frac{1 - 2\rho_D \cos(\Omega)z^{-1} + \rho_D^2 z^{-2}}{1 - 2\rho_A \cos(\Omega)z^{-1} + \rho_A^2 z^{-2}} \varepsilon(t) = \frac{D(z^{-1})}{A(z^{-1})} \varepsilon(t), \quad (3.1)$$

where $\varepsilon(t)$ is a zero-mean unitary-variance white noise, $\rho_A, \rho_D \in [0;1)$ and $\rho_D < \rho_A$. Notice that $z^2 A(z^{-1})$ and $z^2 D(z^{-1})$ are both stable polynomials, having a pair of complex conjugate roots at $\rho_A e^{\pm i\Omega}$ and $\rho_D e^{\pm i\Omega}$ respectively (see Fig.3.1).

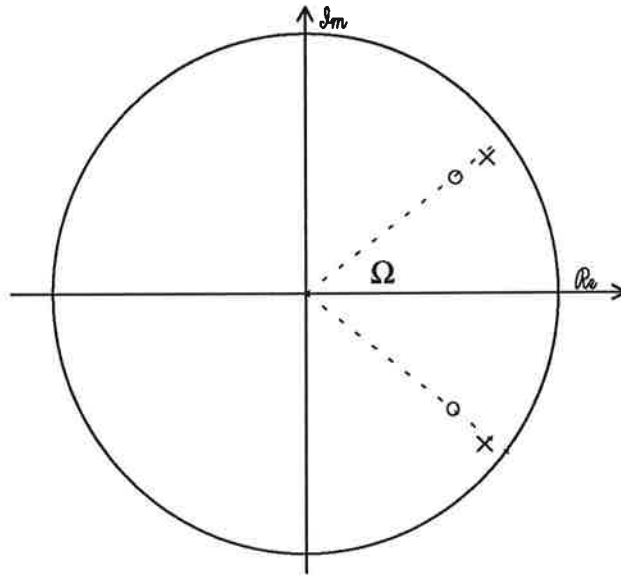

Fig.3.1. A typical configuration of the singularities of polynomials $z^2 D(z^{-1})$ (O), and $z^2 A(z^{-1})$ (X).

It can be easily seen that the model (3.1) represents a good approximation for $d(t)$ when ρ_A and ρ_D are both very close to 1. As a matter of fact the following hold (see e.g. [32]):

$$\left| \frac{D(e^{-i\omega})}{A(e^{-i\omega})} \right|^2 \xrightarrow[\substack{\rho_A \rightarrow 1 \\ \rho_D \rightarrow 1 \\ (\rho_D < \rho_A)}]{} 1 + \frac{m^2}{2} \left(\frac{1}{2} \delta(\omega - \Omega) + \frac{1}{2} \delta(\omega + \Omega) \right) \quad \omega \in [-\pi; +\pi], \quad (3.2)$$

m depending on the relative rate at which ρ_A and ρ_D tend to 1 (for instance, if $\rho_A = 1 - (1 - \rho_D)^2$ it can be easily seen that $m = \sqrt{2}$). Notice that (3.2) states that, as ρ_A and ρ_D tend to 1, $d(t)$ and $D(z^{-1})/A(z^{-1})\epsilon(t)$ tend to be equal *in the frequency domain*.

In practice, for the sake of simplicity, ρ_A is usually set to 1 (also in the rest of this paper, ρ_A will be always supposed to be set at 1); thus, ρ_D can be re-named simply as ρ , and it is usually called the "*debiasing parameter*" (notice that ρ is the only design parameter of model (3.1)).

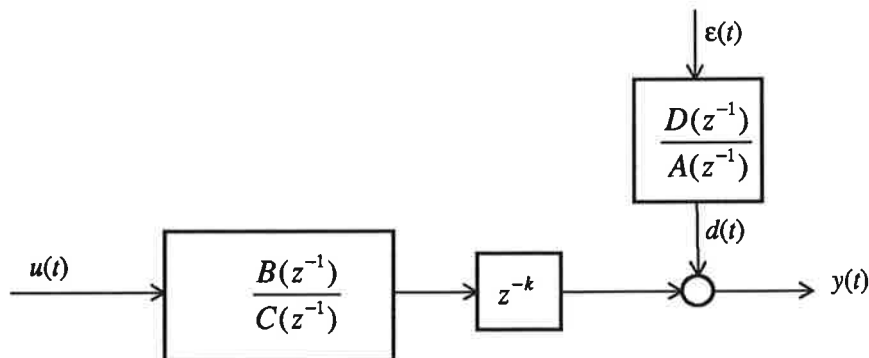

Fig.3.2. Dynamical system with ARMA approximation of the output disturbance.

By means of model (3.1), a minimum-variance controller for the stochastic system depicted in Fig.3.2 can be designed as follows:

(a) Find the k -steps ahead prediction for the system output, $y(t+k/k)$.

First remind that $y(t)$ can be written as:

$$y(t) = \frac{B(z^{-1})}{C(z^{-1})}u(t-k) + \frac{D(z^{-1})}{A(z^{-1})}\varepsilon(t) \quad (3.3)$$

In order to calculate the k -steps ahead prediction of $y(t)$, it is useful to re-write the model (3.1) as:

$$\frac{D(z^{-1})}{A(z^{-1})} = R(z^{-1}) + \frac{E(z^{-1})}{A(z^{-1})}z^{-k}, \quad (3.4)$$

or, equivalently:

$$D(z^{-1}) = A(z^{-1})R(z^{-1}) + z^{-k}E(z^{-1}), \quad (3.5)$$

where $R(z^{-1})$ and $z^{-k}E(z^{-1})$ are, respectively, the result and the remainder of the polynomial between $D(z^{-1})$ and $A(z^{-1})$ (the identity (3.5) is also known as the *Bezout identity*, or *Diophantine identity*). By use of (3.4), $y(t)$ can be rewritten as:

$$y(t) = \frac{B(z^{-1})}{C(z^{-1})}u(t-k) + R(z^{-1})\varepsilon(t) + \frac{E(z^{-1})}{A(z^{-1})}\varepsilon(t-k). \quad (3.6)$$

As is well known (see e.g. [1],[19]), in (3.6) the term $R(z^{-1})\varepsilon(t)$ is the so-called "innovation term" (i.e. it is the unpredictable part of $y(t)$ at time $t-k$). Thus, the k -steps ahead prediction of $y(t)$ is:

$$y(t+k/t) = \frac{B(z^{-1})}{C(z^{-1})}u(t) + \frac{E(z^{-1})}{A(z^{-1})}\varepsilon(t). \quad (3.7)$$

By explicating $\varepsilon(t)$ in the (3.3), and by substituting its expression in (3.7), the following expression of $y(t+k/t)$ as a function of "measurable" signals (notice that $\varepsilon(t)$ in the (3.7) is a "remote" signal), we obtain:

$$y(t+k/t) = \frac{B(z^{-1})(D(z^{-1}) - z^{-k}E(z^{-1}))}{C(z^{-1})D(z^{-1})}u(t) + \frac{E(z^{-1})}{D(z^{-1})}y(t).$$

(b) Impose $y(t+k/k) = 0$.

By imposing the condition $y(t+k/k) = 0$, the minimum variance controller can be straightforwardly obtained. It is given by:

$$u(t) = -\frac{C(z^{-1})E(z^{-1})}{B(z^{-1})A(z^{-1})R(z^{-1})}y(t). \quad (3.8)$$

Notice that the controller (3.8) has the polynomial $A(z^{-1})$ in the denominator, to be able to control the sinusoidal signal. This is the *internal model principle*.

In order to evaluate the performances of the controller (3.8), it is interesting to compute the transfer function from $\varepsilon(t)$ to $y(t)$, namely:

$$y(t) = R(z^{-1})\varepsilon(t) \quad (3.9)$$

Now remind that $R(z^{-1}) = 1 + r_1 z^{-1} + r_2 z^{-2} + \dots + r_{k-1} z^{-(k-1)}$ is the solution of the k -steps polynomial division of $D(z^{-1})$ by $A(z^{-1})$, and it depends on ρ . In particular, it is easy to show the following:

Proposition 3.1 Consider the result, $R(z^{-1})$, of the k -steps polynomial division between $D(z^{-1}) = 1 - 2\rho \cos(\Omega)z^{-1} + \rho^2 z^{-2}$ and $A(z^{-1}) = 1 - 2\cos(\Omega)z^{-1} + z^{-2}$:

$$R(z^{-1}) = 1 + r_1 z^{-1} + r_2 z^{-2} + \dots + r_{k-1} z^{-(k-1)} \quad (k < +\infty).$$

The following hold:

$$(a) \lim_{\rho \rightarrow 1} r_i(\rho) = 0, \quad i = 1, 2, \dots, k-1; \quad (3.10)$$

$$(b) \lim_{\rho \rightarrow 1} \text{cov}[y(t)] = 1. \quad (3.11)$$

(Notice that (3.11) represents the best possible solution - in terms of output variance -, 1 being the variance of the white, hence unpredictable, noise $\varepsilon(t)$).

Proof.

Statement (3.10) can be easily proved by direct inspection of the reminder of the first step of the k -steps polynomial division:

$$\begin{array}{r|l} \begin{array}{r} 1 \quad -2\rho \cos(\Omega)z^{-1} \quad + \rho^2 z^{-2} \\ -1 \quad +2\cos(\Omega)z^{-1} \quad -z^{-2} \\ \hline // \quad 2(1-\rho)\cos(\Omega)z^{-1} \quad + (\rho^2 - 1)z^{-2} \end{array} & \begin{array}{l} 1-2\cos(\Omega)z^{-1}+z^{-2} \\ \hline 1 \end{array} \end{array}$$

Notice that such a reminder (the polynomial in the shadowed box) has $(1 - \rho)$ as a multiplicative factor; hence, such a factor will appear in each term of $R(z^{-1})$, which can be rewritten as:

$$R(z^{-1}) = 1 + r_1 z^{-1} + r_2 z^{-2} + \dots + r_{k-1} z^{-(k-1)} = 1 + (1 - \rho)(\tilde{r}_1 z^{-1} + \tilde{r}_2 z^{-2} + \dots + \tilde{r}_{k-1} z^{-(k-1)}).$$

Thus:

$$\lim_{\rho \rightarrow 1} r_i(\rho) = \lim_{\rho \rightarrow 1} (1 - \rho)\tilde{r}_i(\rho) = 0, \quad i = 1, 2, \dots, k-1.$$

Statement (b) can now be easily proved by reminding that, from (3.9):

$$\text{cov}[y(t)] = \text{cov}[R(z^{-1})\varepsilon(t)] = 1 + r_1^2 + r_2^2 + \dots + r_{k-1}^2,$$

and, by virtue of (3.10), and of the fact that k is finite, (3.11) holds. ■

To get a feeling on the meaning of polynomial $R(z^{-1})$, Fig.3.3 shows the coefficients r_i , in the case $\Omega = \pi/4$, and for four different (increasing) values of ρ . Notice that the first coefficient is, obviously, always equal to 1, while the remaining coefficients look, as a function of the index i , like an undamped sinusoid of frequency Ω , the amplitude of which decreases as $\rho \rightarrow 1$.

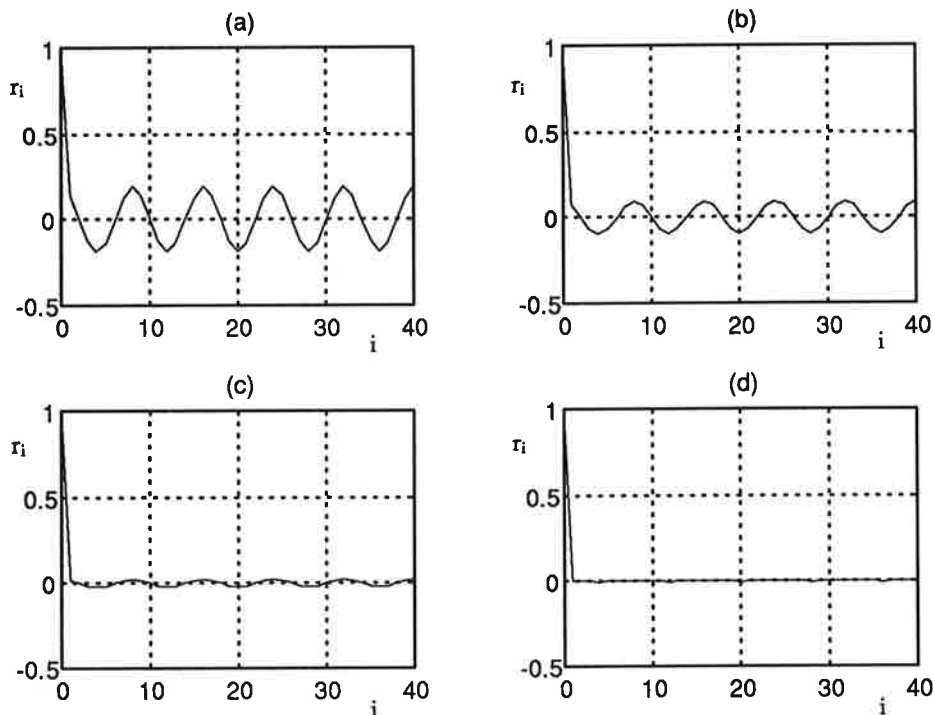

Fig.3.3. Coefficients r_i , as a function of i , when $\Omega = \pi/4$, and $\rho = 0.9$ (a), $\rho = 0.95$ (b), $\rho = 0.99$ (c), and $\rho = 0.999$ (d).

From (3.2) and (3.11) one might conclude that the best choice is to keep ρ as close as possible to 1; as a matter of fact, for $\rho \rightarrow 1$ the model approximation gets better and better, and the output variance tend to its minimum.

However, as is well known (see [11],[26]), $\rho \rightarrow 1$ is not, in general, the best choice for ρ . In order to make this apparent, compute, for instance, the transfer function, say $T(z^{-1})$, from $d(t)$ to $y(t)$ (which is more meaningful than (3.9), $d(t)$ being - so to say - the "real" disturbance):

$$y(t) = T(z^{-1})d(t) = \frac{A(z^{-1})R(z^{-1})}{D(z^{-1})}d(t). \quad (3.12)$$

From (3.12) it is evident that the roots of $D(z^{-1})$ are the internal poles of the system (which are not observable in the input-output representation from $\epsilon(t)$ to $y(t)$). Letting $\rho \rightarrow 1$ means to push such poles towards the instability region, or, in other words, it means to make the control system extremely poorly damped and "slow".

Thus, as is well-known, the choice of ρ must be a compromise between the two following extreme conditions:

- (a) If $\rho \rightarrow 1$ the rejection of the harmonic signal is very selective (in Fig.3.4a the typical shape of $T(z^{-1})$ in the frequency domain, as $\rho \rightarrow 1$, is depicted), but the system is extremely slow.

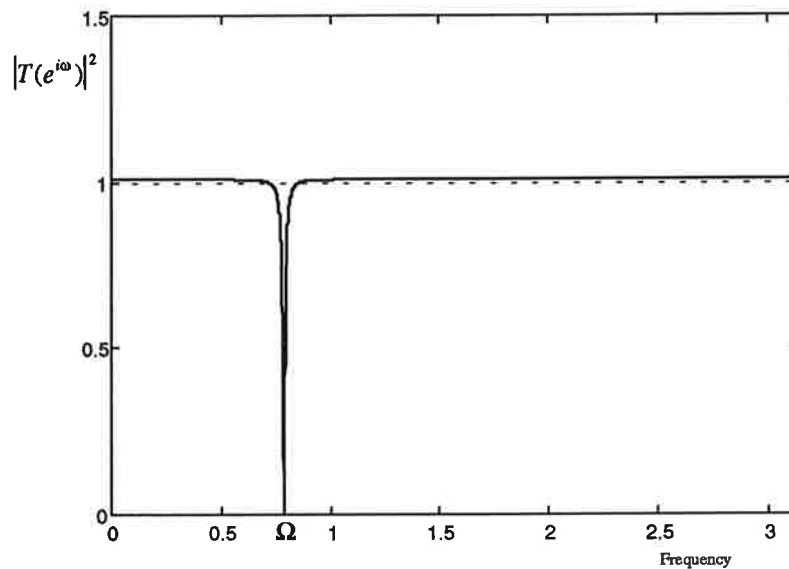

Fig.3.4a. Frequency-domain representation of $T(z^{-1})$, when $\rho=0.99$ ($\Omega=\pi/4$).

- (b) If $\rho \rightarrow 0$ the system is very "fast" (i.e. it is characterised by short transient periods), but the feedback loop introduces bad distortions over a wide frequency range around Ω (see Fig.3.4b), or, in other words, the variance of the broadband part of the disturbance is highly increased.

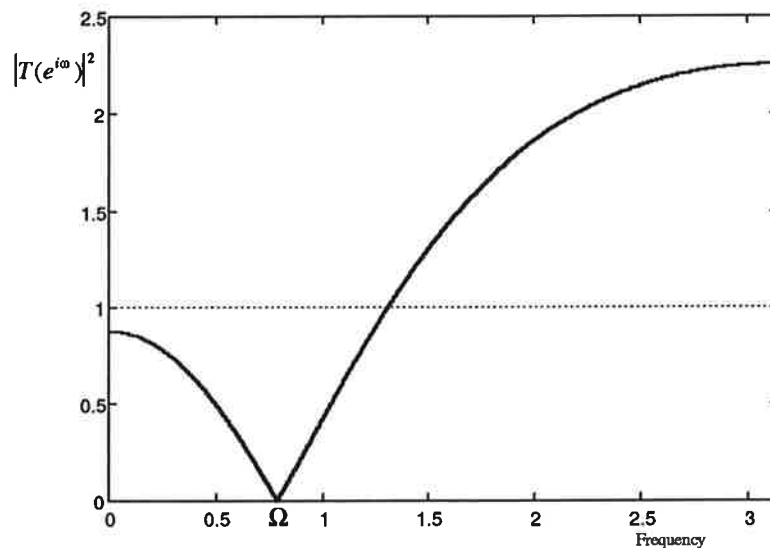

Fig.3.4b. Frequency-domain representation of $T(z^{-1})$, when $\rho=0.3$ ($\Omega=\pi/4$).

Depending on the need of a fast-reacting system, or on the need of an extremely selective rejection of the harmonic signal, the designer has to choose ρ accordingly. To this purpose, the rest of the paper is entirely devoted to the development of a new class of overparametrized controllers, having the aim of improving the selectiveness of the

harmonic disturbance cancellation, without deteriorating the dynamical properties (i.e. the collocation of the poles) of the system.

Remark 3.1

In the next section, the controller (3.8) will be "overparametrized", in order to improve its performance. To this purpose, it is worth noticing that usually (see e.g. [7],[41]), the "basic controller" (i.e. the controller used as a base for overparametrization) is the minimum-order controller which makes possible to place the poles of the closed-loop system at a desired location.

If we consider controllers having the following internal structure:

$$\frac{G(z^{-1})}{F(z^{-1})} = -\frac{C(z^{-1}) \tilde{G}(z^{-1})}{B(z^{-1}) \tilde{F}(z^{-1})} \quad (3.13)$$

(i.e. there is always a part of the controller which takes care of the inversion of the minimum-phase part of the system), $\tilde{G}(z^{-1})$ and $\tilde{F}(z^{-1})$ must satisfy the following polynomial identity:

$$\tilde{F}(z^{-1}) + z^{-k} \tilde{G}(z^{-1}) = D(z^{-1}), \quad (3.14)$$

in order to collocate the system poles at $\rho e^{±i\Omega}$.

The minimum order solution of (3.14) (which is unique, if the additional constraint $\tilde{g}_0 = 1$ is considered), when $k \geq 3$ is:

$$\begin{cases} \tilde{F}(z^{-1}) = 1 - 2\rho \cos(\Omega)z^{-1} + \rho^2 z^{-2} + 0z^{-3} + \dots + 0z^{-(k-1)} - z^{-k} \\ \tilde{G}(z^{-1}) = 1 \end{cases} \quad (3.15)$$

Notice that (except for the cases $k = 1, 2$) the order of polynomials (3.15) is 1 and k respectively, while the order of polynomials $\tilde{G}(z^{-1})$ and $\tilde{F}(z^{-1})$, which correspond to controller (3.8), is 2 (polynomial $E(z^{-1})$) and $k+1$ (polynomial $A(z^{-1})R(z^{-1})$) respectively.

The use of (3.8) as the basic controller, instead of controller (3.13)-(3.15) is simply motivated by the fact that the minimum-order pole-placement controller might have (and, in this case, *does have*) bad characteristics in terms of output variance and noise cancellation. Moreover, it can be shown that the choice (3.8) is equivalent to the choice (3.15) - in terms of performances achievable by the overparametrized controller - only when overparametrizing controllers of large degree are resorted to. Instead, when low-degree overparametrizing polynomials are used, the performance achievable by using (3.8) instead of (3.15) can be quite different (and quite better).

Being our aim that of improving the performances of the well-known (and well-working) controller (3.8), and not that of exploring the best performance achievable by overparametrizing a poor minimum-order controller, the choice of using (3.8) as the basic controller seemed to be natural. ■

4. ROBUST REDUCED-VARIANCE OVERPARAMETRIZED CONTROLLERS DESIGN

4.1. Introduction

This section is entirely devoted to the presentation of a technique which improves the performances of the classical notch-model-based controller (3.8), presented in Sect.3.

As already pointed out at the end of the last section, the main shortcoming of the classical controller for harmonic disturbances rejection is that there is a trade-off between the dynamical properties of the system and the selectiveness of the cancellation. The method we propose, in order to try to overcome this limitation, is that of searching for a suitable way of overparametrizing the classical controller (3.8), and using the extra degrees-of-freedom provided by the overparametrization, in order to:

- obtain a reduced variance of the system output,
- improve the robustness properties of the control system with respect to uncertainties in the harmonic signal parameters, M and Ω ,
- improve the robustness properties with respect to uncertainties in the system parameters (in particular, the major problem of uncertainties in the knowledge of the time delay z^{-k} will be considered),

without changing the dynamical properties of the system (i.e. without moving the position of the poles).

4.2. The overparametrized controller

To begin with, recall the structure of the "standard" controller (3.8):

$$u(t) = -\frac{C(z^{-1})E(z^{-1})}{B(z^{-1})A(z^{-1})R(z^{-1})}y(t).$$

A wise way of overparametrizing such a controller is the following:

$$u(t) = -\frac{C(z^{-1})}{B(z^{-1})} \frac{E(z^{-1}) - P_N(z^{-1})}{A(z^{-1})R(z^{-1}) + z^{-k}P_N(z^{-1})} y(t), \quad (4.2.1)$$

where $P_N(z^{-1})$ is a N th-order polynomial, characterised by a vector, say p_N , of $N+1$ parameters. This way of overparametrizing the controller is a variant of the method proposed in [7] and in [41].

The most important feature of the overparametrized controller (4.2.1) is shown in the following proposition.

Proposition 4.2.1 The internal poles of system (3.3), provided with controller (4.2.1) are the roots of polynomial $D(z^{-1})$, whatever $P_N(z^{-1})$ is.

Proof.

First remind that for closed-loop system having the structure of the system depicted in Fig.4.2.1, the characteristic polynomial is given by $H_D(z^{-1}) - H_N(z^{-1})$.

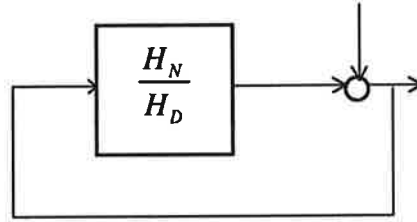

Fig.4.2.1. Feedback control system

In the case of system (3.3), complemented with controller (4.2.1), the loop transfer function is:

$$\frac{H_D(z)}{H_N(z)} = \frac{B(z^{-1})}{C(z^{-1})} z^{-k} \left[-\frac{C(z^{-1})}{B(z^{-1})} \frac{E(z^{-1}) - P_N(z^{-1})}{A(z^{-1})R(z^{-1}) + z^{-k}P_N(z^{-1})} \right]. \quad (4.2.2)$$

Thus, from (4.2.2) and (3.5), we obtain:

$$A(z^{-1}) + z^{-k}P_N(z^{-1}) + z^{-k}(E(z^{-1}) - P_N(z^{-1})) = A(z^{-1})R(z^{-1}) + z^{-k}E(z^{-1}) = D(z^{-1}). \blacksquare$$

Remark 4.2.1

In proposition 4.2.1 it is shown that the poles of the closed loop system, when (4.2.1) is used, do not change, whatever $P_N(z^{-1})$ is. As for the zeros of the control system, they obviously depend on the particular transfer function taken into account. In the rest of the paper, we'll focus on the transfer function $T(z^{-1})$ from signal $d(t)$ to signal $y(t)$, such a transfer function being the most meaningful one, when dealing with the disturbances rejection performances of the control system. It has the following expression:

$$T(z^{-1}) = \frac{A(z^{-1})R(z^{-1}) + z^{-k}P_N(z^{-1})}{D(z^{-1})}. \quad (4.2.3)$$

It is important to remind that (4.2.3) contains a simplification of the minimum-phase part of the system, $B(z^{-1})/C(z^{-1})$. However, both $B(z^{-1})$ and $C(z^{-1})$ being Hurwitz, this simplification does not lead to unstable non-observable dynamics.

From (4.2.3) it is apparent that the presence of the overparametrizing polynomial $P_N(z^{-1})$ increases the number of the zeros of the transfer function. Namely, the numerator of $T(z^{-1})$ is a polynomial having degree $k+N$ (N being the degree of polynomial $P_N(z^{-1})$). For the sake of completeness, notice that in (4.2.3) there are also $k+N-2$ poles in the origin of the axis. \blacksquare

The rest of this section is devoted to the presentation of several performance indices, the minimisation of which provides the "best" polynomial $P_N(z^{-1})$, with respect to the considered control goal. The presentation of such performance indices is complemented by some interesting theoretical results, some remarks, and some numerical examples, which give more insight in the performances obtainable via the proposed overparametrization technique.

4.3. Reduced-variance control system design

The performance index considered in this subsection is the most simple one; it is given by

$$J_{1N}(p_N) = \text{cov}[y(t, p_N)], \quad (4.3.1)$$

(p_N being the $N+1$ dimensional parameter column vector) which simply represents the variance of the system output.

Performance index (4.3.1) can be rewritten in a different form, by substituting (4.2.3) in (4.3.1):

$$J_{1N}(p_N) = \text{cov}\left[\frac{A(z^{-1})R(z^{-1}) + z^{-k}P_N(z^{-1})}{D(z^{-1})}d(t)\right]. \quad (4.3.2)$$

As it is well known (see e.g. [4],[11]), the following frequency-domain representation of (4.3.2) can be given:

$$J_{1N}(p_N) = \int_{-\pi}^{+\pi} \left| \frac{A(z^{-1})R(z^{-1}) + z^{-k}P_N(z^{-1})}{D(z^{-1})} \right|_{z=e^{j\omega}}^2 \Gamma_d(\omega) d\omega \quad (4.3.3)$$

Where $\Gamma_d(\omega)$ is the power spectrum of signal $d(t)$, and it is given by (notice that no ARMA representation of $d(t)$ is used):

$$\Gamma_d(\omega) = 1 + \frac{M^2}{2} \left(\frac{1}{2} \delta(\omega - \Omega) + \frac{1}{2} \delta(\omega + \Omega) \right) \quad \omega \in [-\pi; +\pi]. \quad (4.3.4)$$

Using (4.3.4), (4.3.3) can be splitted into two parts, the first due to the harmonic narrow-band signal, the second due to the white noise broad-band signal, namely:

$$J_{1N}(p_N) = J_{1Na}(p_N) + J_{1Nb}(p_N),$$

where:

$$J_{1Na}(p_N) = \frac{M^2}{2} \left| \frac{A(z^{-1})R(z^{-1}) + z^{-k}P_N(z^{-1})}{D(z^{-1})} \right|_{z=e^{j\Omega}}^2, \quad (4.3.5a)$$

$$J_{1Nb}(p_N) = \text{cov}\left[\frac{A(z^{-1})R(z^{-1}) + z^{-k}P_N(z^{-1})}{D(z^{-1})}e(t)\right]. \quad (4.3.5b)$$

It is easy to show that both (4.3.5a) and (4.3.5b) are quadratic functions of the parameter vector p_N ; thus, the minimisation of performance index (4.3.1) is straightforward, and only requires simple linear algebra computations (such as matrix

inversions). This, definitely, represents the other attractive feature of the overparametrization (4.2.1).

In the special case of harmonic disturbance embedded in white noise considered in this work, an explicit expression of (4.3.5a) and (4.3.5b) can be given, namely:

$$J_{1Na}(p_N) = p_N^T M_{1Na} p_N + p_N^T L_{1Na} + c_{1a} \quad (4.3.6a)$$

where:

$$M_{1Na} = S^2 \begin{bmatrix} 1 & \cos(\Omega) & \cos(2\Omega) & \cdots & \cos(N\Omega) \\ \cos(\Omega) & 1 & \cos(\Omega) & \cdots & \vdots \\ \cos(2\Omega) & \cos(\Omega) & 1 & \cdots & \vdots \\ \vdots & \vdots & \vdots & \ddots & \vdots \\ \cos(N\Omega) & \cdots & \cdots & \cdots & 1 \end{bmatrix}, \quad (4.3.6b)$$

$$L_{1Na}(p_N) = S^2 \begin{bmatrix} A(e^{i\Omega})R(e^{i\Omega})e^{-ik\Omega} + A(e^{-i\Omega})R(e^{-i\Omega})e^{+ik\Omega} \\ A(e^{i\Omega})R(e^{i\Omega})e^{-i(k+1)\Omega} + A(e^{-i\Omega})R(e^{-i\Omega})e^{+i(k+1)\Omega} \\ \vdots \\ \vdots \\ A(e^{i\Omega})R(e^{i\Omega})e^{-i(k+N)\Omega} + A(e^{-i\Omega})R(e^{-i\Omega})e^{+i(k+N)\Omega} \end{bmatrix} = 0, \quad (4.3.6c)$$

$$c_{1a} = S^2 A(e^{i\Omega})A(e^{-i\Omega})R(e^{i\Omega})R(e^{-i\Omega}) = 0 \quad (4.3.6d)$$

$$S^2 = \frac{M^2}{2((1-\rho^2)^2 + 4\rho \cos^2(\Omega)(1-\rho))}, \quad (4.3.6e)$$

and

$$J_{1Nb}(p_N) = p_N^T M_{1Nb} p_N + p_N^T L_{1Nb} + c_{1b}, \quad (4.3.7a)$$

where

$$M_{1Nb} = H^2 \begin{bmatrix} 1 & \eta(1) & \cdots & \cdots & \eta(N) \\ \eta(1) & 1 & \cdots & \cdots & \vdots \\ \vdots & \vdots & \ddots & \cdots & \vdots \\ \vdots & \vdots & \cdots & \ddots & \vdots \\ \eta(N) & \cdots & \cdots & \cdots & 1 \end{bmatrix}, \quad \eta(\tau) = \frac{1}{2H^2} E \left[\left(\frac{e(t)e(t-\tau)}{D(z^{-1})D(z^{-1})} \right) \right], \quad (4.3.7b)$$

$$L_{1Nb} = H^2 \begin{bmatrix} \mu(0) \\ \mu(1) \\ \vdots \\ \vdots \\ \mu(N) \end{bmatrix}, \quad \mu(\tau) = E \left[\frac{A(z^{-1})R(z^{-1})e(t)e(t-k-\tau)}{D(z^{-1})D(z^{-1})} \right], \quad (4.3.7c)$$

$$c_{1b} = H^2 \text{cov} \left[\frac{A(z^{-1})R(z^{-1})}{D(z^{-1})} e(t) \right], \quad (4.3.7d)$$

$$H^2 = \frac{1-\rho^4}{(1-\rho^4) - 4\rho^2 \cos^2(\Omega)(1-\rho^2)^2}. \quad (4.3.7e)$$

(M_{1Nb} , L_{1Nb} and c_{1b} can be easily calculated by means of recursive algebraic formulas which make use of the coefficients of polynomials $A(z^{-1})$, $R(z^{-1})$, and $D(z^{-1})$ - see [1],[2]).

Finally, performance index (4.3.1) can be written as:

$$J_{1N}(p_N) = \text{cov}[y(t, p_N)] = p_N^T M_{1N} p_N + p_N^T L_{1N} + c_1, \quad (4.3.8)$$

where:

$$M_{1N} = M_{1Na} + M_{1Nb}, \quad L_{1N} = L_{1Nb}, \quad c_1 = c_{1b}.$$

The parameter vector which minimise performance index (4.3.8), say \bar{p}_N , is given by:

$$\bar{p}_N = -\frac{1}{2} M_{1N}^{-1} L_{1N} \quad (4.3.9)$$

Notice that \bar{p}_N is unique, being M_{1N} a *definite positive symmetric Toeplitz matrix*.

Two interesting theoretical results can now be stated.

Proposition 4.3.1 Consider the performance indices $J_{1m}(p_m)$ and $J_{1n}(p_n)$, $m+1$ and $n+1$ being the number of parameters of polynomials $P_m(z)$ and $P_n(z)$ respectively. If $m \leq n$ the following holds:

$$J_{1m}(\bar{p}_m) \geq J_{1n}(\bar{p}_n),$$

\bar{p}_m and \bar{p}_n being the minimum vectors for $J_{1m}(p_m)$ and $J_{1n}(p_n)$ respectively.

Proof.

First consider performance index $J_{1m}(p_m) = p_m^T M_{1m} p_m + p_m^T L_{1m} + c_1$; being M_{1m} invertible, $J_{1m}(p_m)$ has a unique minimum, say \bar{p}_m , which can be computed as:

$$\bar{p}_m = -\frac{1}{2} M_{1m}^{-1} L_{1m}.$$

Now consider $J_{1n}(p_n) = p_n^T M_{1n} p_n + p_n^T L_{1n} + c_1$; being M_{1m} the sub-matrix of M_{1n} constituted by its first m rows and by its first m columns (see (4.3.6b) and (4.3.7b)), and being L_{1m} the sub-vector of L_{1n} constituted by its first m elements (see (4.3.6c) and (4.3.7c)), it is apparent that the following holds:

$$J_{1n}([\bar{p}_m^T \ 0 \ 0 \dots 0]^T) = [\bar{p}_m^T \ 0 \ 0 \dots 0] M_{1n} \begin{bmatrix} \bar{p}_m \\ 0 \\ 0 \\ \vdots \\ 0 \end{bmatrix} + [\bar{p}_m^T \ 0 \ 0 \dots 0] L_{1n} + c_1 = J_{1m}(\bar{p}_m).$$

Thus, only the two following situations can take place:

- $\bar{p}_n^T = [\bar{p}_m^T \ 0 \ 0 \dots 0] \Rightarrow J_{1m}(\bar{p}_m) = J_{1n}(\bar{p}_n)$;

- $\bar{p}_n^T \neq [\bar{p}_m^T \ 0 \ 0 \dots 0] \Rightarrow J_{1m}(\bar{p}_m) > J_{1n}(\bar{p}_n)$. ■

Proposition 4.3.1 essentially states that, by increasing the size of the overparametrizing controller, the variance of the output monotonically decreases. To this purpose, proposition (4.3.1) can be complemented with the following interesting result:

Proposition 4.3.2 Consider $J_{1N}(\bar{p}_N)$, which represents the minimum variance achievable when using $N+1$ over-parameters. The following holds:

$$\lim_{N \rightarrow +\infty} J_{1N}(\bar{p}_N) = 1.$$

Proof.

First, notice that, in any case, $\text{cov}[y(t, p_N)] = 1$ represents a lower bound for $J_{1N}(\bar{p}_N)$, 1 being the variance of the white noise (hence unpredictable) affecting the system.

Now consider expression (4.3.5) of performance index (4.3.1):

$$J_{1N}(p_N) = \frac{M^2}{2} \left| \frac{A(z^{-1})R(z^{-1}) + z^{-k}P_N(z^{-1})}{D(z^{-1})} \right|_{z=e^{i\Omega}}^2 + \text{cov} \left[\frac{A(z^{-1})R(z^{-1}) + z^{-k}P_N(z^{-1})}{D(z^{-1})} e(t) \right], \quad (4.3.10)$$

and consider a polynomial $P_N(z)$ having the following structure:

$$P_N(z^{-1}) = E(z^{-1}) + D(z^{-1})\tilde{P}_{N-2}(z^{-1}) \quad (4.3.11)$$

Thus, by substituting (4.3.11) into (4.3.10), and reminding (3.5), $J_{1N}(p_N)$ can be rewritten as:

$$J_{1N}(p_N) = \frac{M^2}{2} \left| 1 + e^{ki\Omega} \tilde{P}_{N-2}(e^{i\Omega}) \right|^2 + 1 + \text{cov}[\tilde{P}_{N-2}(z^{-1})e(t)] \quad (4.3.12)$$

From (4.3.12) it is apparent that the following hold:

$$\left. \begin{array}{l} \lim_{N \rightarrow +\infty} \left| \tilde{P}_{N-2}(e^{i\omega}) \right| = \begin{cases} 1 & \text{if } \omega = \pm\Omega \\ 0 & \text{if } \omega \in [-\pi; +\pi] \setminus \{-\Omega, +\Omega\} \end{cases} \\ \text{and} \\ \angle\{\tilde{P}_{N-2}(e^{i\Omega})\} = \pi + 2m\pi - k\Omega, m \in \mathbb{Z} \end{array} \right\} \Rightarrow \lim_{N \rightarrow +\infty} J_{1N}(\bar{p}_N) = 1 \quad (4.3.13)$$

(4.3.13) essentially moves the problem of proving that the lower bound $\text{cov}[y(t, p_N)] = 1$ can be reached by means of the overparametrized controller (4.2.1), to the problem of designing a FIR filter satisfying (4.3.13).

In order to prove that such a filter can be built, consider the following IIR filter:

$$F(z^{-1}, \rho) = \frac{z^{-k} (2 \cos(\Omega)(1 - \rho^2) + (\rho^2 - 1)z^{-1}) (\cos(\Omega) - z^{-1})^2}{1 - 2\rho \cos(\Omega)z^{-1} + \rho^2 z^{-2}} \quad (4.3.14)$$

It is easy to show that filter (4.3.14) has the following characteristics:

$$|F(e^{\pm i\Omega}, \rho)|^2 = 1, \quad \forall \rho \in (0,1), \quad (4.3.15a)$$

$$\lim_{\substack{\rho \rightarrow 1 \\ \omega \neq \pm \Omega}} |F(e^{i\omega}, \rho)|^2 = 0, \quad (4.3.15b)$$

$$\lim_{\rho \rightarrow +\infty} \angle\{F(e^{i\Omega}, \rho)\} = \pi + k\Omega \quad (4.3.15c)$$

Consider now the all-zeros infinitely long filter, associated to $F(z^{-1}, \rho)$:

$$F(z^{-1}, \rho) = \sum_{m=0}^{+\infty} f_m(\rho) z^{-m}; \quad (4.3.16)$$

if the overparametrizing polynomial is chosen as:

$$P_N(z) = E(z^{-1}) + D(z^{-1}) \left[\lim_{\rho \rightarrow +\infty} \sum_{m=0}^{N-2} f_m(\rho) z^{-m} \right], \quad (4.3.17)$$

from (4.3.11)-(4.3.16) one can conclude that $J_{1N}(\bar{p}_N)$ tends to 1 as $N \rightarrow +\infty$. ■

We end this subsection by presenting two illustrative numerical examples.

Numerical Example 4.3.1

Consider the following situation:

$$B(z^{-1}) = C(z^{-1}) = 1;$$

$$k = 2, M = \sqrt{2}, \Omega = \pi/4, \rho = 0.8.$$

The standard procedure for the design of the basic controller provides the following $T(z^{-1})$ (transfer function from $d(t)$ to $y(t)$):

$$T(z^{-1}) = \frac{1 - 1.1314z^{-1} + 0.6z^{-2} + 0.2828z^{-3}}{1 - 1.1314z^{-1} + 0.64z^{-2}}, \quad (4.3.18)$$

the frequency-domain behaviour of which is depicted in Fig.4.3.1(a).

By resorting to the overparametrization technique presented in this subsection, when using polynomials of order 2, 4, and 6 respectively, the following results have been obtained:

$$T_2(z^{-1}) = \frac{1 - 1.1314z^{-1} + 0.6422z^{-2} + 0.1831z^{-3} + 0.036z^{-4}}{1 - 1.1314z^{-1} + 0.64z^{-2}} \quad (4.3.19)$$

$$T_4(z^{-1}) = \frac{1 - 1.1314z^{-1} + 0.6284z^{-2} + 0.1069z^{-3} + 0.0307z^{-4} + 0.089z^{-5} - 0.1382z^{-6}}{1 - 1.1314z^{-1} + 0.64z^{-2}} \quad (4.3.20)$$

$$T_6(z^{-1}) = \frac{1 - 1.1314z^{-1} + 0.6413z^{-2} + 0.09z^{-3} + 0.025z^{-4} + 0.003z^{-5} - 0.0209z^{-6} - 0.078z^{-7} - 0.0271z^{-8}}{1 - 1.1314z^{-1} + 0.64z^{-2}}. \quad (4.3.21)$$

The frequency-domain behaviour of (4.3.19), (4.3.20), and (4.3.21) are depicted in Figs.4.3.1 (b), (c), and (d) respectively.

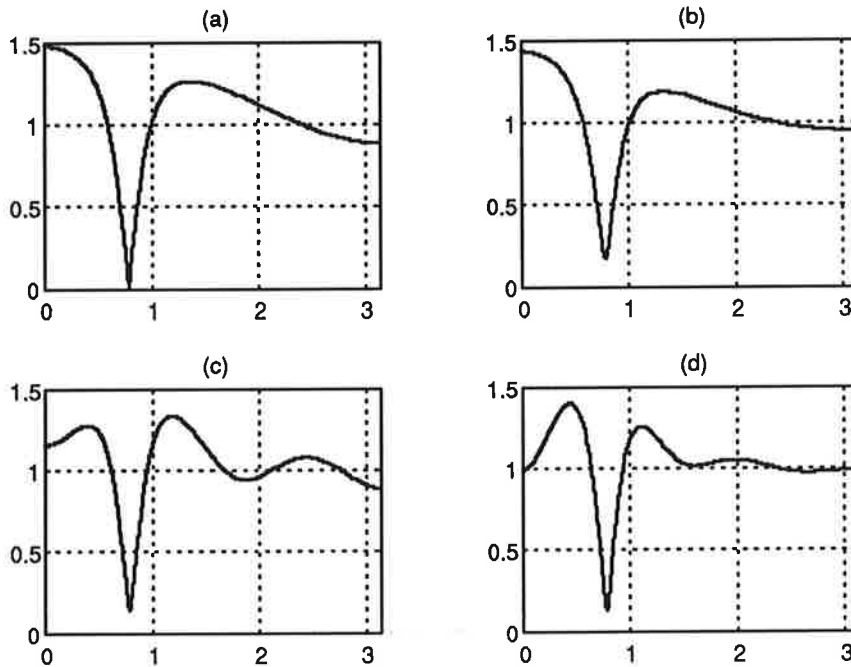

Fig.4.3.1. frequency-domain behaviour of $T(z^{-1})$ (a), $T_2(z^{-1})$ (b), $T_4(z^{-1})$ (c), and $T_6(z^{-1})$ (d).

In order to better understand the results achievable by means of the overparametrized controllers, in Fig.4.3.2 the output variance, as a function of the order N of the overparametrizing polynomial $P_N(z^{-1})$, is displayed.

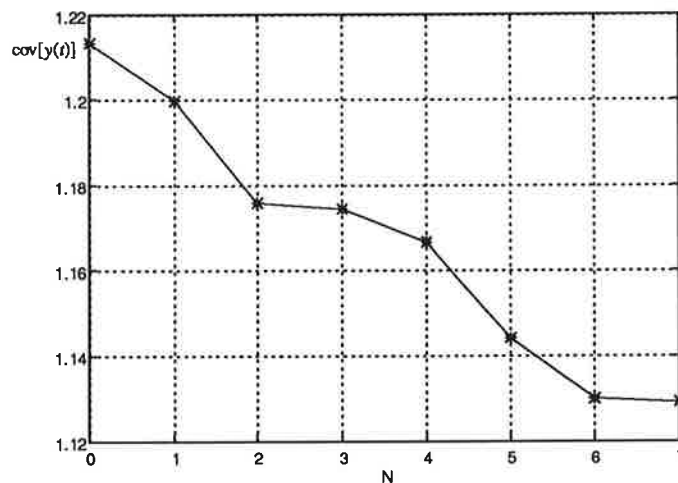

Fig.4.3.2. Output variance, as a function of the order of the overparametrizing polynomial.

From Fig.4.3.1 and Fig.4.3.2 one can notice that:

- By increasing the order of the overparametrizing polynomial, the output variance decreases monotonically. However, just as a curiosity, notice (see Fig.4.3.2) that the decreasing rate is quite irregular, and it does not seem to follow the behaviour of any "smooth" discrete function.
- By increasing the overparametrization order, the selectivity of the harmonic disturbance rejection increases accordingly; however, notice that by increasing the

number of the zeros, the frequency-domain behaviour of $T_N(z^{-1})$ become - so to say - "oscillating", in the frequency range away from the design frequency. This phenomenon will be better illustrated in the next numerical example. ■

Numerical Example 4.3.2

Consider the following situation:

$$B(z^{-1}) = C(z^{-1}) = 1;$$

$$k = 1, M = \sqrt{2}, \Omega = \pi/4, \rho = 0.8.$$

The standard procedure for the design of the basic controller (3.8) provides the following transfer function $T(z^{-1})$:

$$T(z^{-1}) = \frac{1 - 1.4142z^{-1} + z^{-2}}{1 - 1.1314z^{-1} + 0.64z^{-2}}; \quad (4.3.22)$$

correspondingly, the output variance is:

$$\text{cov}[y(t)] = 1.223.$$

The overparametrization of the basic controller, by means of polynomial $P_9(z^{-1})$, provides the following transfer function $T_9(z)$, from $d(t)$ to $y(t)$:

$$T_9(z^{-1}) = \frac{1 - 1.206z^{-1} + 0.724z^{-2} + 0.027z^{-3} + 0.021z^{-4} + 0.003z^{-5} - 0.016z^{-6} - 0.027z^{-7} - 0.021z^{-8} - 0.06z^{-9} + 0.1z^{-10}}{1 - 1.1314z^{-1} + 0.64z^{-2}}, \quad (4.3.23)$$

in correspondence of which the following output variance is obtained:

$$\text{cov}[y(t)] = 1.105.$$

In order to compare the output variance when the basic controller is used, and when the overparametrized controller is resorted to, in Fig.4.3.3 the accumulated output variance, as a function of the time, is depicted (see e.g. [14],[40]).

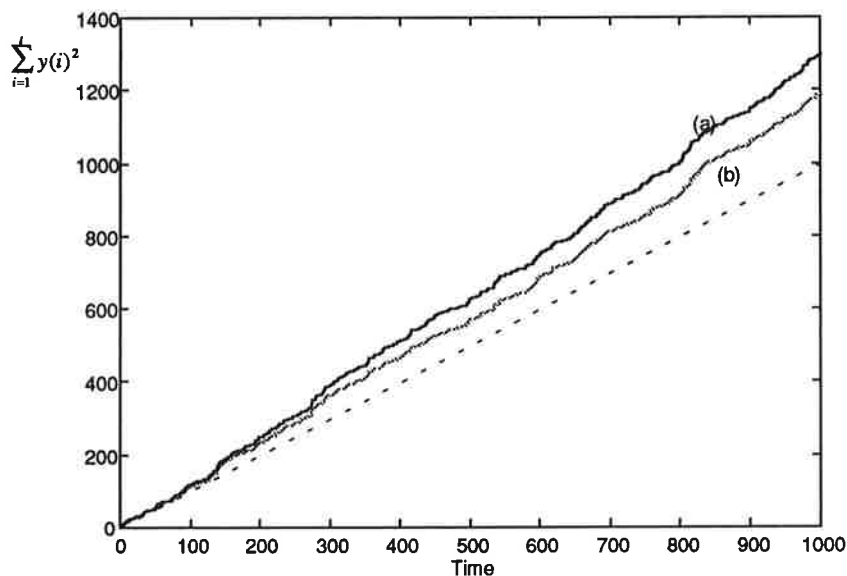

Fig.4.3.3. Accumulated output variance when the basic controller is used (line (a)), and when the overparametrized controller is used (line (b)). The dashed line is the accumulated output variance lower bound.

In Fig.4.3.4 the frequency-domain shape of (4.3.22) and (4.3.23) is depicted.

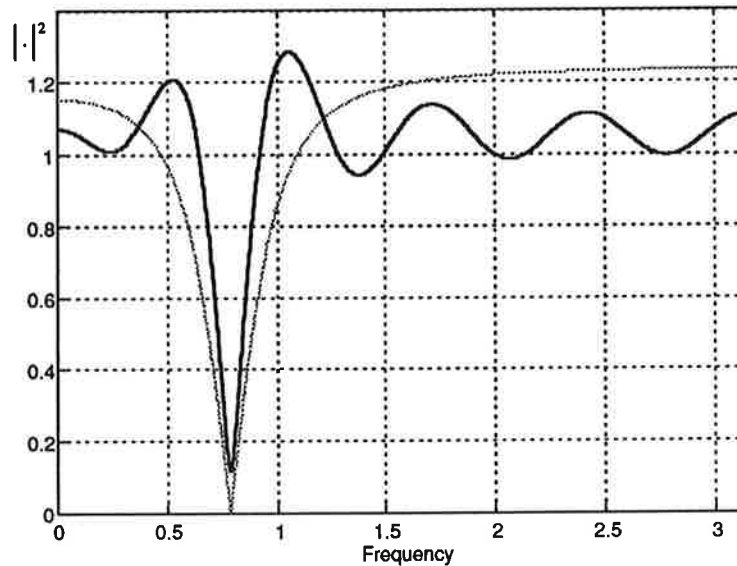

Fig.4.3.4. Frequency-domain shape of (4.3.22) (thin line), and of (4.3.23).

It is apparent that, even if (4.3.23) provides a remarkable reduction of the output variance, and improves the selectiveness of the basic controller, its behaviour, in the frequency domain, is quite "irregular": such a typical behaviour, characterised by a number of "ripples", is due to the presence of an high number of zeros. ■

At the end of this section, we can conclude that the simple reduced-variance approach (4.3.1) (which can be considered an extension, for the special case of harmonic disturbances, of the method proposed in [7] and [41]) does not provide a completely satisfactory result. As a matter of fact, even if the output variance can be remarkably decreased, this is obtained by paying the piper of the presence of undesired ripples in the frequency domain shape of $T(z^{-1})$.

Remark 4.3.1

A natural question can arise by inspecting the "oscillating" behaviour of the frequency-domain shape of $T_o(z^{-1})$, in the numerical example 4.3.2 (see Fig.4.3.4): why such a behaviour is a "bad" behaviour? More: which behaviour is a "good" one?

With reference to such questions, the following can be pointed out:

1. If the disturbance affecting the output of the system is only constituted by a white noise and by the harmonic signal to be rejected, the ripples which characterise the frequency domain shape of $T_N(z^{-1})$ have not to be considered as obnoxious: in such a case the reduction of the output variance is a suitable performance index, and it is not subject to any trade-off with other performance indices.
2. It frequently happens that the disturbance is not constituted only by $e(t)$ and $s(t)$, but there are other signals, which have to be kept as unchanged as possible (in the ANC problems, for instance, the microphone usually receives also the speech

signal). Even in such cases, for the sake of simplicity, the design of the control system is usually made with reference to the "basic" situation of $d(t)$ constituted only by a broad-band noise and by the sinusoid to be rejected, but the additional "performance index" of a "well-shaped" $T_N(z^{-1})$ in the frequency domain has to be taken into account. To this purpose, it is apparent that a well-shaped $T_N(z^{-1})$ is such that it is as close as possible to 1, away from the stopped-band around Ω , because such a shape guarantees the least possible distortion of the "additional" signals. ■

4.4. Analysis of the dynamical properties of the overparametrized controller

At the end of the last subsection, it has been shown that the overparametrization of the standard controller (3.8) makes possible the attainment of the lower bound of the output variance, without moving the poles position. At a first glance, this interesting result seems to state that the trade-off between dynamical properties and selectiveness in the harmonic disturbance rejection can be completely overcome by means of an overparametrized controller having the structure (4.2.1). However, such an unexpectedly attractive result must be correctly interpreted. A qualitative analysis of such a result is now proposed.

Consider the all-zeros infinitely long filter associated to the rational transfer function $T(z^{-1})$:

$$T(z^{-1}) = \sum_{i=0}^{+\infty} t_i z^{-i} \quad , \quad (4.4.1)$$

(where the coefficients t_i can be computed by means of the polynomial division between the numerator and the denominator of $T(z^{-1})$).

Being $T(z)$ a stable transfer function, it is well-known (see e.g. [1]) that:

$$\sum_{i=0}^{+\infty} t_i^2 < +\infty. \quad (4.4.2)$$

As a consequence of (4.4.2), the following holds:

$$\lim_{i \rightarrow +\infty} |t_i| = 0. \quad (4.4.3)$$

In other words, (4.4.3) states that the coefficients t_i tend to "vanish", as their index, i , increases. As a direct consequence of such a typical behaviour of the coefficients t_i , a simple way of getting an estimate of the settling time of the transfer function $T(z^{-1})$, say τ_T , is the following:

$$\tau_T = \min\{n / |t_i| < \varepsilon, \forall i \geq n\}, \quad (4.4.4)$$

where ε is a small number, typically chosen as the 1% of the first coefficient t_0 (notice that when a canonical representation of $T(z^{-1})$ is used, both its numerator and its denominator are monic, so resulting in $t_0 = 1$).

By means of (4.4.4), one can associate to $T(z^{-1})$ a FIR transfer function, say $\hat{T}(z^{-1})$, as follows:

$$\hat{T}(z^{-1}) = \sum_{i=0}^{\tau} t_i z^{-i} \quad (4.4.5)$$

It is now worth noticing that, even if, in general, the length of $\hat{T}(z^{-1})$ mainly depends on the position of the poles, the overparametrization of the numerator of $T(z^{-1})$ might result in a remarkable change in the settling time, if a large number of zeros is added.

To this purpose, it is apparent that when infinitely many zeros are added (see proposition 4.3.2), the settling time of the overparametrized transfer function $T_N(z^{-1})$ might be completely different from that of the basic transfer function, $T(z^{-1})$, even though the poles of $T_N(z^{-1})$ and of $T(z^{-1})$ are the same. With reference to the above remarks it can be stated that, when an overparametrization technique based on pole-placement is resorted to, the over-number of zeros must be chosen such that it does not lead to a large variation in the settling time of the system.

In order to better understand the qualitative discussion on the dynamical behaviour of an overparametrized controller, a numerical example is now provided.

Numerical Example 4.4.1

Consider the following situation:

$$B(z^{-1}) = C(z^{-1}) = 1;$$

$$k = 1, M = \sqrt{2}, \Omega = \pi/4, \rho = 0.8.$$

The design of the standard controller (3.8) results in the following transfer function from $d(t)$ to $y(t)$:

$$T(z^{-1}) = \frac{1 - 1.4142z^{-1} + z^{-2}}{1 - 1.1314z^{-1} + 0.64z^{-2}}, \quad (4.4.6)$$

while, by using an overparametrizing polynomial of order 9, the following transfer function is obtained:

$$T_9(z^{-1}) = \frac{1 - 1.206z^{-1} + 0.724z^{-2} + 0.027z^{-3} + 0.021z^{-4} + 0.003z^{-5} - 0.016z^{-6} - 0.027z^{-7} - 0.021z^{-8} - 0.06z^{-9} + 0.1z^{-10}}{1 - 1.1314z^{-1} + 0.64z^{-2}}. \quad (4.4.7)$$

In Fig.4.4.1 and Fig.4.4.2, the coefficients of the all-zeros transfer function associated to (4.4.6) and to (4.4.7) are displayed. It is apparent that such coefficients tend to vanish as their index increases.

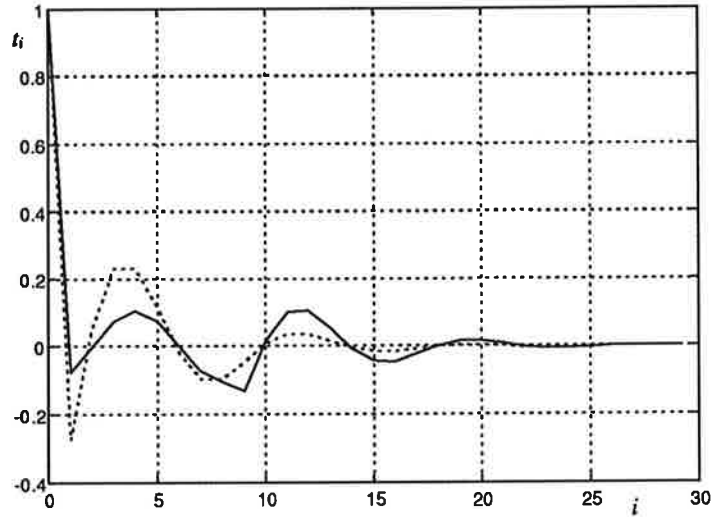

Fig.4.4.1 Coefficients of the all-zeros transfer functions associated to $T(z^{-1})$ (dashed line) and to $T_9(z^{-1})$ (continuous line).

In Fig.4.4.2, a zoom of Fig.4.4.1 is provided, in order to easier evaluate the settling time associated to (4.4.6) and to (4.4.7).

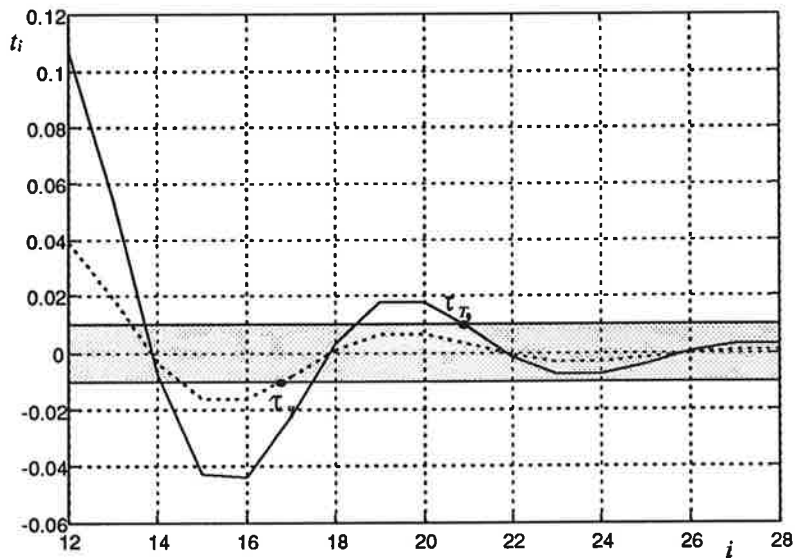

Fig.4.4.2. Zoom of Fig.4.4.1. The shadowed area indicates the interval $[-\epsilon; +\epsilon]$.

If $\epsilon = 0.01$ is chosen, it is apparent that $\tau_T = 17$, and $\tau_{T_9} = 21$. Such an approximate evaluation of the settling time of the two transfer functions reveals that $N=9$ can be considered as an upper limit for the order of the overparametrizing polynomial $P_N(z^{-1})$: as a matter of fact, a 25% variation of the settling time represents a non-negligible variation of the dynamical behaviour of the system. ■

4.5. Robust control design: the case of uncertainties in the frequency of the harmonic signal

In this subsection the problem of using the extra-degrees-of-freedom given by the overparametrization (4.2.1) of controller (3.8), in order to make the performances of the control system more robust with respect to uncertainties in the parameter Ω (the frequency of the harmonic part of the disturbance affecting the system), is considered. Notice that the problem of dealing with the uncertainties in the parameter Ω is a problem of major importance: as a matter of fact, in the practice, Ω is usually only approximately known; moreover, it frequently happens (see e.g. [11],[17],[28]) that Ω is a time varying parameter, which takes values over a well-defined frequency range.

In such cases, a probabilistic description of Ω is usually given. Suppose, for instance, that a probability density function (p.d.f.) of Ω , say $\gamma_\Omega(\Omega)$, is available; being $\gamma_\Omega(\Omega)$ a p.d.f., (which is supposed to be defined over the frequency range $[\Omega_0, \Omega_1]$) it must have the following properties:

$$\begin{cases} \int_{\Omega_0}^{\Omega_1} \gamma_\Omega(\Omega) d\Omega = 1 \\ \gamma_\Omega(\Omega) \geq 0, \forall \Omega \in [\Omega_0, \Omega_1] \end{cases} \quad (4.5.1)$$

By means of such a probabilistic description of Ω , the design of a robust controller, with respect to uncertainties in Ω , can be obtained by minimising the following performance index:

$$J_{2N}(p_N) = \int_{\Omega_0}^{\Omega_1} \gamma_\Omega(\Omega) J_{1N}(p_N, \Omega) d\Omega \quad (4.5.2)$$

(notice that in (4.5.2), and in the rest of the subsection, the poles of the system are supposed to be fixed at $\rho e^{\pm \bar{\Omega}i}$, $\bar{\Omega}$ being the "nominal" frequency of the sinusoid). By substituting in (4.5.2) expression (4.3.8) of $J_{1N}(p_N)$, we obtain:

$$\begin{aligned} J_{2N}(p_N) = p_N^T & \left(\int_{\Omega_0}^{\Omega_1} \gamma_\Omega(\Omega) (M_{1Na} + M_{1Nb}) d\Omega \right) p_N + p_N^T \left(\int_{\Omega_0}^{\Omega_1} \gamma_\Omega(\Omega) L_{1Nb} d\Omega \right) + \\ & + \left(\int_{\Omega_0}^{\Omega_1} \gamma_\Omega(\Omega) c_{1b} d\Omega \right) \end{aligned} \quad (4.5.3)$$

(where the integral operator applied to a matrix is supposed to be operate on each scalar element of the matrix). Remind now that M_{1Nb} , L_{1Nb} , c_{1b} do not depend on Ω (see (4.3.7)); thus, (4.5.3) can be finally rewritten as:

$$J_{2N}(p_N) = p_N^T \left(\int_{\Omega_0}^{\Omega_1} \gamma_\Omega(\Omega) M_{1Na} d\Omega + M_{1Nb} \right) p_N + p_N^T L_{1Nb} + c_{1b} \quad (4.5.4)$$

As for performance index (4.5.4), it is worth noticing that:

- $J_{2N}(p_N)$ is a quadratic form with respect to parameter vector p_N ;

- $\int_{\Omega_0}^{\Omega_1} \gamma_{\Omega}(\Omega) M_{1Na} d\Omega + M_{1Nb}$ is a definite positive symmetric Toeplitz matrix; this guarantees the existence and uniqueness of the minimum of $J_{2N}(p_N)$.

Remark 4.5.1

Using performance index (4.5.4) is a simple and effective way of dealing with the problem of designing a robust controller with respect to variations in Ω . Moreover, it is worth noticing that an unexpected and attractive feature of performance index (4.5.4) is that it usually provides a "smoothing" effect on the frequency domain shape of transfer function from $d(t)$ to $y(t)$. This interesting feature is illustrated in the following numerical example. ■

Numerical Example 4.5.1

Consider the following situation:

$$B(z^{-1}) = C(z^{-1}) = 1,$$

$$M = \sqrt{2}, \rho = 0.8, k = 1, N = 8.$$

The standard controller (3.8), when Ω is supposed exactly known ($\bar{\Omega} = \pi / 4$), provides the following transfer function, from $d(t)$ to $y(t)$:

$$T(z^{-1}) = \frac{1 - 1.4142z^{-1} + z^{-2}}{1 - 1.1314z^{-1} + z^{-2}}. \quad (4.5.5)$$

If Ω is not exactly known, a p.d.f., $\gamma_{\Omega}(\Omega)$, must be given. The following four different situations have been considered:

- Ω is uniformly distributed in $\left[\frac{\pi}{4} - 0.05; \frac{\pi}{4} + 0.05 \right]$;
- Ω is uniformly distributed in $\left[\frac{\pi}{4} - 0.1; \frac{\pi}{4} + 0.1 \right]$;
- Ω is uniformly distributed in $\left[\frac{\pi}{4} - 0.2; \frac{\pi}{4} + 0.2 \right]$;
- Ω is uniformly distributed in $\left[\frac{\pi}{4} - 0.3; \frac{\pi}{4} + 0.3 \right]$.

In Fig.4.5.1 the frequency-domain behaviour of the transfer function $T_8(z^{-1})$, provided by the minimisation of performance index (4.5.4), when situations (a)-(d) are considered, is displayed, and compared with (4.5.5).

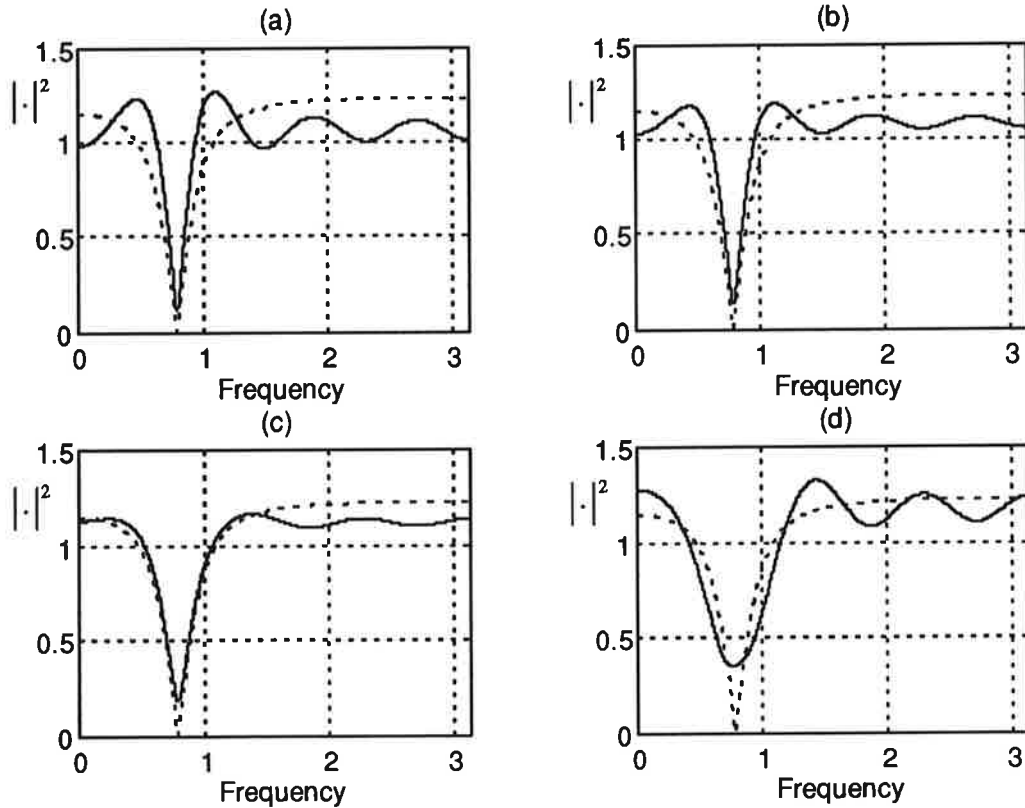

Fig.4.5.1. Frequency-domain shape of transfer function $T_g(z^{-1})$, obtained in correspondence of cases (a),(b),(c), and (d). As a comparison, the shape of (4.5.5) is always depicted with a dashed line.

Notice that, by increasing the width of the range $[\Omega_0, \Omega_1]$, the "notch" in correspondence to the nominal frequency $\Omega = \pi/4$ progressively enlarges, and the shape of $T_g(z)$ away from the nominal frequency becomes smoother and smoother. To this purpose, notice that the "best" shape is obtained for $[\Omega_0, \Omega_1] = [\frac{\pi}{4} - 0.2, \frac{\pi}{4} + 0.2]$; instead, when $[\Omega_0, \Omega_1] = [\frac{\pi}{4} - 0.3, \frac{\pi}{4} + 0.3]$ the oscillations appear again. This phenomenon can be interpreted as a symptom of the fact that the degree of overparametrization used is not enough to cope with the performances robustness over such a large frequency range, without deteriorating the performances in the complementary frequency range. ■

4.6. Robust control design: the case of uncertainties in the amplitude of the harmonic signal

In this subsection the problem of using the extra-degrees-of-freedom given by the overparametrization (4.2.1) of controller (3.8), in order to make the performances of the control system more robust with respect to uncertainties in the parameter M (the amplitude of the harmonic part of the disturbance affecting the system), is considered. The problem of dealing with the uncertainties in the parameter M is a major one, for, in the practice, usually one has only an approximate knowledge of M . To this purpose, it is worth reminding that the estimated value of M is commonly expressed by means of the so-called *signal-to-noise-ratio* (SNR); in the special case of a sinusoid embedded in

white noise, the harmonic signal is commonly considered as "signal", the broad-band signal as "noise", namely:

$$SNR = \frac{\text{cov}[M \sin(\Omega t + \phi)]}{\text{cov}[e(t)]} = \frac{M^2}{2}.$$

As usual, a probabilistic description of M is supposed to be given, by means of its probability density function, say $\gamma_M(M)$, $M \in [M_0; M_1]$; as usual, the following hold:

$$\begin{cases} \int_{M_0}^{M_1} \gamma_M(M) dM = 1 \\ \gamma_M(M) \geq 0, \forall M \in [M_0, M_1] \end{cases}$$

Similarly to the case of the Ω -robustness, a simple and effective way of designing a M -robust control system, is that of minimising the following performance index:

$$J_{3N}(p_N) = \int_{M_0}^{M_1} \gamma_M(M) J_{1N}(p_N, M) dM \quad (4.6.1)$$

By substituting in (4.6.1) the expression (4.3.8) of $J_{1N}(p_N)$, we obtain:

$$J_{3N}(p_N) = p_N^T \left(\int_{M_0}^{M_1} \gamma_M(M) (M_{1Na} + M_{1Nb}) dM \right) p_N + p_N^T L_{1Nb} + c_{1b} \quad (4.6.2)$$

(where the integral operator applied to a matrix is supposed to operate on each scalar element of the matrix). Remind now that M_{1Nb} does not depend on M (see (4.3.7)); thus, (4.6.2) can be finally rewritten as:

$$J_{3N}(p_N) = p_N^T \left(\int_{M_0}^{M_1} \gamma_M(M) M_{1Na} dM + M_{1Nb} \right) p_N + p_N^T L_{1Nb} + c_{1b} \quad (4.6.3)$$

As for performance index (4.6.3), it is worth noticing that:

- $J_{3N}(p_N)$ is a quadratic form with respect to parameter vector p_N ;
- $\int_{M_0}^{M_1} \gamma_M(M) M_{1Na} dM + M_{1Nb}$ is a definite positive symmetric Toeplitz matrix; this guarantees the existence and uniqueness of the minimum of $J_{3N}(p_N)$.

Remark 4.6.1

It is interesting to notice that the standard controller (3.8) is such that the corresponding transfer function from $d(t)$ to $y(t)$, $T(z^{-1})$, has two zeros at $e^{\pm i\Omega}$; hence, controller (3.8) provides a complete rejection of the harmonic signal, whatever its amplitude be. Instead, the minimum-variance overparametrized controller provided by (4.3.9) tries to minimise the overall output variance by searching for the best compromise between the rejection of the harmonic signal, and the enhancement of the broad-band signal; to this purpose, it is worth pointing out that the best compromise between these two opposite goals usually is characterised by a non-complete rejection of the harmonic signal. Indeed, such a optimal "balanced" solution can be obtained only

if a quite accurate knowledge of the SNR is available; more frequently, if such an information is not available, one would like to design a controller which guarantees the complete rejection of the harmonic signal, for every signal-to-noise-ratio, even though, in some sense, this way of operating is sub-optimal, and it is essentially due to an uncomplete knowledge of the system. ■

In the case mentioned in the above remark (i.e. when there is almost no knowledge on the amplitude of the harmonic disturbance affecting the system), the overparametrized controllers can be successfully used for enhancing the performances of standard controllers, by using the following performance index:

$$\hat{J}_{3N}(p_N) = \lim_{M \rightarrow +\infty} J_{1N}(p_N). \quad (4.6.4)$$

By plugging (4.3.5) into (4.6.4), one obtain:

$$\hat{J}_{3N}(p_N) = \lim_{M \rightarrow +\infty} \left(\frac{M^2}{2} \left| \frac{A(z^{-1})R(z^{-1}) + z^{-k}P_N(z^{-1})}{D(z^{-1})} \right|_{z=e^{i\Omega}}^2 \right) + \text{cov} \left[\frac{A(z^{-1})R(z^{-1}) + z^{-k}P_N(z^{-1})}{D(z^{-1})} e(t) \right]. \quad (4.6.5)$$

With reference to performance index (4.6.5), the following simple but interesting result can be stated:

Proposition 4.6.1 Performance index (4.6.5) has a unique minimum, \bar{p}_N , such that the correspondent polynomial $P_N(z^{-1})$ has two zeros at $e^{\pm i\Omega}$, i.e. $P_N(z^{-1})$ is such that:

$$P_N(z^{-1}) = A(z^{-1})\tilde{P}_{N-2}(z^{-1}).$$

Proof.

The proposition can be simply proved, by direct inspection of performance index (4.6.5). If one considers the first term of (4.6.5)

$$\lim_{M \rightarrow +\infty} \left(\frac{M^2}{2} \left| \frac{A(z^{-1})R(z^{-1}) + z^{-k}P_N(z^{-1})}{D(z^{-1})} \right|_{z=e^{i\Omega}}^2 \right), \quad (4.6.6)$$

it is apparent that, in order to keep (4.6.6) bounded,

$$\frac{1}{2} \left| \frac{A(z^{-1})R(z^{-1}) + z^{-k}P_N(z^{-1})}{D(z^{-1})} \right|_{z=e^{i\Omega}}^2$$

must be exactly equal to zero (notice that such a term does not depend on M). This can be true only when the polynomial $A(z^{-1})R(z^{-1}) + z^{-k}P_N(z^{-1})$ has a couple of zeros at $e^{\pm i\Omega}$, i.e. only when such a polynomial has the following structure:

$$A(z^{-1})R(z^{-1}) + z^{-k}P_N(z^{-1}) = A(z^{-1})(R(z^{-1}) + z^{-k}\tilde{P}_{N-2}(z^{-1})),$$

or, correspondingly,

$$P_N(z^{-1}) = A(z^{-1})\tilde{P}_{N-2}(z^{-1}).$$

Notice that, in general, the polynomial $P_N(z^{-1})$ having such a structure is not unique; the uniqueness of the minimum of (4.6.4) is guaranteed by the fact that the second term of (4.6.5),

$$\text{cov} \left[\frac{A(z^{-1})(R(z^{-1}) + z^{-k} \tilde{P}_N(z^{-1}))}{D(z^{-1})} e(t) \right]$$

is a definite positive quadratic form with respect to the parameter vector p_N .

A numerical example, related to proposition 4.6.1, is now provided.

Numerical Example 4.6.1

Consider the following situation:

$$B(z^{-1}) = C(z^{-1}) = 1;$$

$k = 1$, $\Omega = \pi/4$, $\rho = 0.8$, $N = 8$, and M unknown.

In this case, one has to resort to performance index (4.6.4), instead of (4.6.1), for completely no knowledge on M is available. In Fig.4.6.1, the positions of poles and zeros of the transfer function $T_8(z^{-1})$, obtained by use of (4.6.4), are displayed.

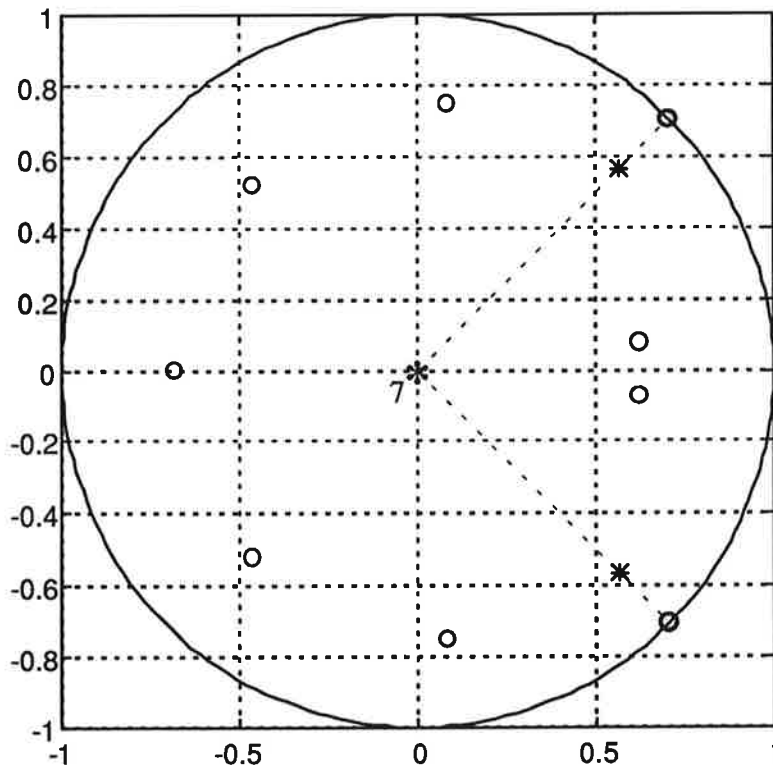

Fig.4.6.1. Positions of zeros (o), and poles (*) of $T_8(z^{-1})$. Notice the presence of 7 poles in the origin of the axes.

It is apparent that a couple of complex conjugate zeros at $e^{\pm i\frac{\pi}{4}}$ is present, which leads to a complete rejection of the harmonic disturbance, whatever its amplitude be. ■

Remark 4.6.2

Performance indices (4.2.5) and (4.6.1) can be - so to say - "combined", in order to take into account the robustness requirement on both M and Ω . The combination of such performance indices leads to the following performance index:

$$J_{2,3N}(p_N) = \int_{M_0}^{M_1} \int_{\Omega_0}^{\Omega_1} \gamma_{\Omega}(\Omega) \gamma_M(M) J_{1N}(p_N, \Omega) d\Omega dM, \quad (4.6.7)$$

which is, as usual, a weighted integral of the simple reduced-variance performance index (4.3.1). ■

Remark 4.6.3

The use of performance indices (4.5.2), (4.6.1), or (4.6.7) requires the knowledge of the probability density function associated to parameters M and Ω . However, such probability density functions, even when they are not exactly known, can be used as a design tool for the shaping of $T_N(z^{-1})$ in the frequency domain. This way of using the p.d.f. as a shaping tool is extremely useful, in the practice, because a well-shaped $T_N(z^{-1})$ is, perhaps, the most important requirement, for the improvement of the performances of controller (3.8). ■

4.7. Robust control design: the case of uncertainties in the system time delay

In this subsection the problem of using the degrees of freedom given by the overparametrization of the basic controller, in order to improve the robustness of the system with respect to the uncertainties in the time delay of the system, is considered. Needless to say, the robustness of the control system with respect to such an unknown parameter is a challenging problem which is of major importance in the design of the controller. As a matter of fact, the design of control systems for the rejection of narrow-band signals usually gives rise to poles which are very close to the instability region, and even small variations in the system time delay might lead to instability or to very poor performances.

Suppose that the time delay of the system is h , h belonging to a finite set of positive (the system is supposed to be casual) integers, say $h \in H$, and suppose to have some knowledge on the (discrete) probability density function associated to h , $\gamma_h(h)$, which, as usual, has to satisfy the following conditions:

$$\left\{ \begin{array}{l} \sum_{h \in H} \gamma_h(h) = 1 \\ \text{and} \\ \gamma_h(h) \geq 0, \quad \forall h \in H \end{array} \right.$$

Clearly, the "nominal" time delay k in correspondence of which the standard controller (3.8) is designed, is usually the value of H such that $\gamma_h(k) \geq \gamma_h(h)$, $\forall h \in H$.

When the overparametrized controller (4.2.1) is used, it is easy to show that the transfer function from $d(t)$ to $y(t)$ is:

$$y(t) = \frac{A(z^{-1})R(z^{-1}) + z^{-k}P_N(z^{-1})}{A(z^{-1})R(z^{-1}) + (z^{-k} - z^{-h})P_N(z^{-1}) + z^{-h}E(z^{-1})} d(t). \quad (4.7.1)$$

Notice that *in the case of uncertainties in the time delay of the system, the characteristic polynomial of the closed-loop system does change*. This represents a major difference with respect to the case of uncertainties in the disturbance parameters (M and Ω), and makes this robust control system design problem much more involved and challenging. However, it is interesting to notice that the zeros of transfer function (4.7.1) do not change, when the loop time delay varies.

As a consequence of the fact that, when $h \neq k$, $P_N(z^{-1})$ appears even at the denominator of (4.7.1), the output variance takes the following form:

$$\text{cov}[y(t, p_N, h)] = f_h(p_N) = \frac{f_{hn}(p_N)}{f_{hd}(p_N)}, \quad (4.7.2)$$

$f_h(p_N)$ being a rational function, i.e. both $f_{hn}(p_N)$ and $f_{hd}(p_N)$ being (high-order) polynomial functions of the parameter vector p_N , such functions depending on the value of the time delay h .

The most straightforward way of dealing with the design of a robust controller with respect to the uncertainties in the system time delay, is that of searching for the parameter vector which minimises the following performance index:

$$J_{4N}(p_N) = \sum_{h \in H} \gamma_h(h) f_h(p_N). \quad (4.7.3)$$

Unfortunately, performance index (4.7.3) is a non linear function (it is no longer a quadratic form as in the previous cases considered in this work!), the minimisation of which, with respect to p_N , is a non-trivial problem which has to be numerically solved by resorting to time-consuming iterative algorithms, which usually do not guarantee the attainment of the global minimum (see e.g. [20]).

In order to overcome this problem, we propose an innovative way of dealing with the problem of the robust design of a control system with respect to uncertainties in the loop time delay, via overparametrized pole-placement technique.

The method we propose can be presented as follows.

Consider the "nominal" (k -steps time delay) characteristic polynomial of the system:

$$\bar{W}(z^{-1}) = D(z^{-1}) = 1 - 2\rho \cos(\Omega)z^{-1} + \rho^2 z^{-2},$$

and the characteristic polynomial for a generic time delay $h \in H$:

$$W_h(z^{-1}, p_N) = A(z^{-1})R(z^{-1}) + (z^{-k} - z^{-h})P_N(z^{-1}) + z^{-h}E(z^{-1}) = w_0(p_N) + w_1(p_N)z^{-1} + \dots + w_{n_h}(p_N)z^{-n_h}, \quad (4.7.4)$$

n_h being the order of polynomial $W_h(z^{-1})$, which depends on the value of h , and w_0, \dots, w_{n_h} being its coefficients, which - it is worth noticing - are *linear* functions of the parameter vector p_N .

As previously noticed, the numerator of (4.7.1) does not depend on h ; hence, in order to force (4.7.1) to be as close as possible to the nominal transfer function (4.2.1), one has to minimise a "distance" of $W_h(z^{-1}, p_N)$ from $\bar{W}(z^{-1})$. A suitable synthetic measure of the distance between such polynomials is (see e.g. [3]):

$$\Delta_h^2(p_N) = (1 - w_0(p_N))^2 + (-2\rho \cos(\Omega) - w_1(p_N))^2 + (\rho^2 - w_2(p_N))^2 + \sum_{j=3}^{n_h} w_j(p_N)^2. \quad (4.7.5)$$

Clearly, the most attractive feature of such a distance is the fact that it is a quadratic form of the parameter vector p_N ; thus, (4.7.5) can be rewritten as:

$$\Delta_h^2(p_N) = p_N^T M_h p_N + p_N^T L_h + c_h. \quad (4.7.6)$$

With reference to the quadratic form (4.7.6), the following simple but interesting result holds:

Proposition 4.7.1 The quadratic form $\Delta_h^2(p_N)$ has a unique minimum in

$$\hat{p}_N = [e_0 \quad e_1 \quad 0 \quad \dots \quad 0]^T, \quad \forall h \in H \setminus \{k\}.$$

Proof.

By substituting $P_N(z^{-1}) = E(z^{-1})$ in the general expression of $W_h(z^{-1}, p_N)$ one obtain:

$$W_h(z^{-1}, p_N) = A(z^{-1})R(z^{-1}) + (z^{-k} - z^{-h})E(z^{-1}) + z^{-h}E(z^{-1}) = D(z^{-1}) = \bar{W}(z^{-1}),$$

for every value of h . Hence, when $p_N^T = \hat{p}_N^T = [e_0 \ e_1 \ 0 \ \dots \ 0]$, the distance between $W_h(z^{-1})$ and $\bar{W}(z^{-1})$ is zero; being $\Delta_h^2(p_N) \geq 0, \forall p_N, \hat{p}_N^T$ must be a minimum point for $\Delta_h^2(p_N)$. On the other hand, such a minimum point is unique, because $P_N(z^{-1}) = E(z^{-1})$ is the only solution of the polynomial equation $W_h(z^{-1}, p_N) = \bar{W}(z^{-1})$, when $h \neq k$. ■

Remark 4.7.1

Notice that the minimum parameter vector of $\Delta_h^2(p_N)$, $\hat{p}_N = [e_0 \ e_1 \ 0 \ \dots \ 0]^T$ (which corresponds to $P_N(z^{-1}) = E(z^{-1})$) is the parameter vector which opens the loop of the control system. In such a case, in fact, no feedback is present, $u(t)$ is set to zero, and $y(t) = d(t)$ whatever h be. This simple result is interesting because reveals that the chosen way of overparametrizing the standard controller (3.8) is - so to say - "able" to open the system loop. This feature is very important with respect to the stability properties of the overparametrized controller, as it will be shown in Proposition 4.7.3. ■

By using the quadratic form $\Delta_h^2(p_N)$, we propose the following procedure, for the design of the robust controller:

Procedure 4.7.1

(a) Consider the following performance index (which is quadratic in the parameter vector p_N):

$$\tilde{J}_{4N}(p_N) = J_{1N}(p_N) + \beta \left[\sum_{h \in H} \gamma_h(h) \Delta_h^2(p_N) \right], \quad \beta \in [0; +\infty) \quad (4.7.7)$$

(b) Find the minimum, say $\tilde{p}_N(\beta)$, of $\tilde{J}_{4N}(p_N)$. Notice that:

- such a minimum is unique and always exists, being $\tilde{J}_{4N}(p_N)$ definite positive;
- $\tilde{p}_N(\beta)$ is a vector of rational functions of parameter β .

(c) Substitute $\tilde{p}_N(\beta)$ into $J_{4N}(p_N)$ (4.7.3); notice that, after the substitution, $J_{4N}(\tilde{p}_N(\beta))$ is a non-linear rational function of the only parameter β .

(d) Minimise numerically $J_{4N}(\tilde{p}_N(\beta))$ with respect to β .

With reference to step (b) of procedure 4.7.1, the following result can be stated:

Proposition 4.7.2 $\tilde{p}_N(\beta)$, $\beta \in [0; +\infty)$ is a bounded non-linear continuous 1-dimensional line in \mathfrak{R}^{N+1} .

Proof.

By substituting (4.3.8) and (4.7.6) into (4.7.7), one obtains:

$$\begin{aligned} \tilde{J}_{4N}(p_N) = & p_N^T \left[M_{1N} + \beta \sum_{\substack{h \in H \\ h \neq k}} \gamma_h(h) M_{hN} \right] p_N + p_N^T \left[L_{1N} + \beta \sum_{\substack{h \in H \\ h \neq k}} \gamma_h(h) L_{hN} \right] + \\ & + \left[c_1 + \beta \sum_{\substack{h \in H \\ h \neq k}} \gamma_h(h) c_h \right] \end{aligned} \quad (4.7.8)$$

The minimum of (4.7.8), can be, as usual, obtained as:

$$\tilde{p}_N(\beta) = -\frac{1}{2} \left[M_{1N} + \beta \sum_{\substack{h \in H \\ h \neq k}} \gamma_h(h) M_{hN} \right]^{-1} \left[L_{1N} + \beta \sum_{\substack{h \in H \\ h \neq k}} \gamma_h(h) L_{hN} \right],$$

$\tilde{p}_N(\beta)$ being a $N+1$ dimensional column vector, each element of which is a rational function of β .

Now notice that the denominator of each element of $\tilde{p}_N(\beta)$ is the determinant of

$$\left[M_{1N} + \beta \sum_{\substack{h \in H \\ h \neq k}} \gamma_h(h) M_{hN} \right].$$

Being such a matrix a definite positive matrix, for $\beta \in [0; +\infty)$, its determinant always differs from zero. ■

With reference to procedure 4.7.1, the following fundamental result can now be stated:

Proposition 4.7.3 Consider performance index $J_{4N}(\tilde{p}_N(\beta))$, where $\tilde{p}_N(\beta)$ is the parametric minimum of performance index $\tilde{J}_{4N}(p_N)$. The following hold:

- 1) $\lim_{\beta \rightarrow +\infty} J_{4N}(\tilde{p}_N(\beta)) = 1 + \frac{M^2}{2}$;
- 2) $\exists B < +\infty: \tilde{p}_N(\beta) \in \Theta, \forall \beta > B$;

where:

$\Theta = \{p_N \in \mathfrak{R}^{N+1} / W_h(z^{-1}, p_N) \text{ is Hurwitz}, \forall h \in H\}$ (i.e. Θ is the whole set of parameter vectors p_N which guarantee the stability of the closed-loop system for every h belonging to H).

Proof.

Statement 1) can be easily proved by noticing that, as $\beta \rightarrow +\infty$, the minimum point of

performance index $\tilde{J}_{4N}(p_N)$ tends to the (unique) minimum point of $\Delta_h^2(p_N)$, which is given by $\tilde{p}_N^T = [e_0 \ e_1 \ 0 \ \dots \ 0]$, as shown in Proposition 4.7.1. As previously pointed out, in such a case $y(t) = d(t)$, whatever h be; hence,

$$\text{cov}[y(t, p_N, h)] = f_h(p_N) = \frac{f_{hn}(p_N)}{f_{hd}(p_N)} = \text{cov}[d(t)] = 1 + \frac{M^2}{2}, \forall h, p_N,$$

so resulting in:

$$J_{4N}(p_N) = \sum_{h \in H} \gamma_h(h) \left(1 + \frac{M^2}{2} \right) = 1 + \frac{M^2}{2}.$$

In order to demonstrate statement 2), remind that $J_{4N}(\tilde{p}_N(\beta))$ is a rational function of parameter β ; thus, it has at most a finite number of singular points, say $\{\bar{\beta}_1, \bar{\beta}_2, \dots, \bar{\beta}_{n_p}\}$, i.e. values of β where $J_{4N}(\tilde{p}_N(\beta))$ goes to infinite.

Consider now the largest singular value of $J_{4N}(\tilde{p}_N(\beta))$, say $\bar{\beta}_{\max}$; it is apparent that, in the range $[B, +\infty)$, $B > \bar{\beta}_{\max}$, $J_{4N}(\tilde{p}_N(\beta))$ never goes to infinite, by virtue of the fact that $\bar{\beta}_{\max}$ is its largest singular point, and by virtue of statement 1). This corresponds to the fact that any of the roots of $W_h(z^{-1}, \tilde{p}_N(\beta))$ ($\forall h \in H$) passes from the instability region to the stability one or vice-versa. Moreover, as previously remarked, $W_h(z^{-1}, \tilde{p}_N(\beta))$ tends to $D(z^{-1})$ for large values of β , $\forall h \in H$. Hence, being $W_h(z^{-1}, \tilde{p}_N(\beta))$ Hurwitz for large values of β , it maintains this property over the whole range $[B, +\infty)$. In other words, there exist finite values of β which guarantee that the correspondent overparametrized controller provides closed-loop stability, for each value of $h \in H$. ■

Remark 4.7.2

Notice that the method we propose is essentially that of transforming a $N+1$ -dimensional non-linear minimisation problem into a 1-dimensional non-linear minimisation problem. This is obtained by projecting the $N+1$ -dimensional manifold $J_{4N}(p_N)$ over the 1-dimensional smooth manifold represented by $\tilde{p}_N(\beta)$. A naive representation of this projection technique is depicted in Fig.4.7.1.

In Fig.4.7.1 $\tilde{p}_N(\beta)$ is depicted as a continuous one-dimensional line, which joins the nominal optimum parameter vector, \bar{p}_N (the parameter vector which minimise $J_{1N}(p_N)$), and the open-loop parameter vector, \hat{p}_N . The way $\tilde{p}_N(\beta)$ moves from \bar{p}_N to \hat{p}_N is such that it takes into account the problem of minimising the distance between the nominal characteristic polynomial, and the characteristic polynomial when $h \neq k$, even if it does not necessarily passes through the global minimum of $J_{4N}(p_N)$.

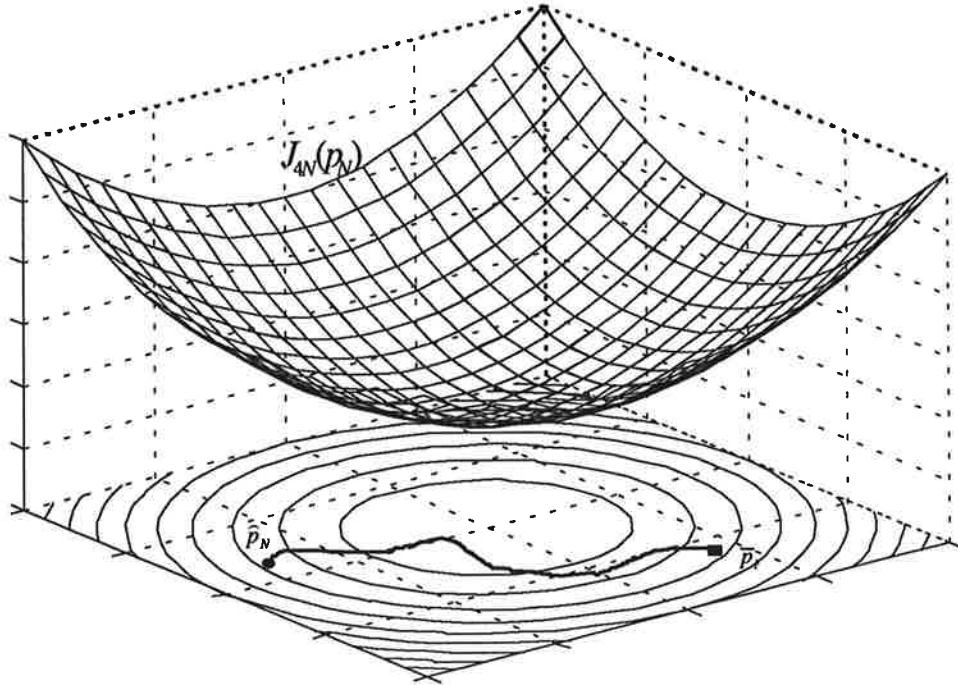

Fig.4.7.1. A naive representation of procedure 4.7.1

With reference to the problem of the stability of the solution "picked up" along line $\tilde{p}_N(\beta)$, in Fig.4.7.2 a typical shape of function $J_{4N}(\tilde{p}_N(\beta))$, as a function of β , is depicted.

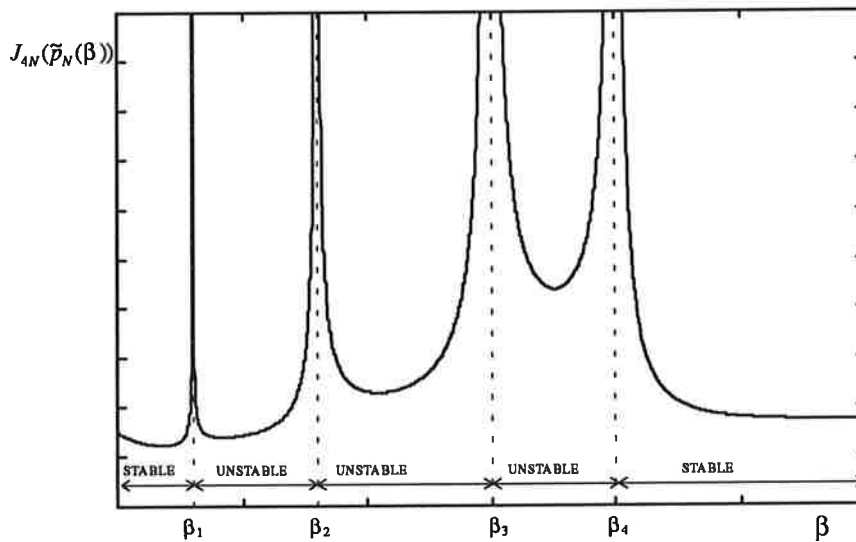

Fig.4.7.2. Typical shape of function $J_{4N}(\tilde{p}_N(\beta))$, as a function of β .

Being $J_{4N}(\tilde{p}_N(\beta))$ a rational function, it is characterised by a finite number of discontinuities, in correspondence to the values of β where the denominator of $J_{4N}(\tilde{p}_N(\beta))$ is zero. In each sub-range of $[0; +\infty)$ bounded by two discontinuities one must check the stability/instability of the characteristic polynomials $W_h(z^{-1}, \tilde{p}_N(\beta))$

($\forall h \in H$) in correspondence of a single value of β , randomly chosen in that sub-range: as a matter of fact, the stability/instability condition does not change within each sub-range. After each sub-range have been "labelled", the optimal solution must be searched for within the ranges labelled as "stable". The existence of (at least) one range of stability is guaranteed by proposition 4.7.3.

It is worth noticing that, in general, when such projection techniques are resorted to (see e.g. [26]), the optimality of the solution found by minimising the projection of the original manifold onto a low-dimension manifold cannot be guaranteed. Nonetheless, the proposed procedure seems to be a wise way of coping with the problem of designing a robust controller with respect to uncertainties in the system delay, not only because it dramatically reduces the computational complexity of the original minimisation problem, but also because some appealing stability properties can be guaranteed, as shown in the proposition 4.7.3. Moreover, when tested by means of numerical examples, it revealed to provide good results. Finally, the possibility of an easy check of the stability/instability of the solution along $\tilde{p}_N(\beta)$, makes the method we propose particularly attractive (see Numerical Example 4.7.1). ■

Numerical Example 4.7.1

Consider the following situation:

$$B(z^{-1}) = C(z^{-1}) = 1;$$

$$M = \sqrt{2}, \quad \Omega = \pi/4, \quad \rho = 0.8,$$

$$H = \{1,2\}, \quad \gamma_h(1) = 0.6, \gamma_h(2) = 0.4 \Rightarrow k = 1.$$

Three controller has been designed:

- (a) The standard controller, designed for the "nominal" case $k=1$; when using such a controller, the following performances are obtained (see Fig.4.7.4 and Fig.4.7.5):

$$\text{when } h = k = 1: T(z^{-1}) = \frac{1 - 1.414z^{-1} + z^{-2}}{1 - 1.131z^{-1} + 0.64z^{-2}} \Rightarrow \text{cov}[y(t)] = 1.223;$$

$$\text{when } h = 2: T(z^{-1}) = \frac{1 - 1.414z^{-1} + z^{-2}}{1 - 1.412z^{-1} + 1.282z^{-2} - 0.36z^{-3}} \Rightarrow \text{cov}[y(t)] = 1.755;$$

correspondingly, $J_{40} = 1.436$.

- (b) The overparametrized controller, designed for the nominal case $k=1$, using an overparametrizing polynomial of order two, $P_2(z^{-1})$; when using such a controller, the following performances are obtained (see Fig.4.7.4 and Fig.4.7.5):

$$\text{when } h = k = 1: T_2(z^{-1}) = \frac{1 - 1.239z^{-1} + 0.755z^{-2} + 0.131z^{-3}}{1 - 1.131z^{-1} + 0.64z^{-2}} \Rightarrow \text{cov}[y(t)] = 1.162;$$

$$\text{when } h = 2: T_2(z^{-1}) = \frac{1 - 1.239z^{-1} + 0.755z^{-2} + 0.131z^{-3}}{1 - 1.239z^{-1} + 0.863z^{-2} + 0.016z^{-3} - 0.132z^{-4}} \Rightarrow \text{cov}[y(t)] = 1.288;$$

correspondingly, $J_{42} = 1.213$.

(c) The controller designed with the procedure 4.7.1; the best controller has been obtained in correspondence of $\beta = 2.85$ (see Fig.4.7.3); when using such a controller, the following performances are obtained (see Fig.4.7.4 and Fig.4.7.5):

$$\text{when } h = k = 1: T_2(z^{-1}) = \frac{1 - 1.1941z^{-1} + 0.708z^{-2} + 0.149z^{-3}}{1 - 1.131z^{-1} + 0.64z^{-2}} \Rightarrow \text{cov}[y(t)] = 1.170;$$

$$\text{when } h = 2: T_2(z^{-1}) = \frac{1 - 1.1941z^{-1} + 0.708z^{-2} + 0.149z^{-3}}{1 - 1.194z^{-1} + 0.77z^{-2} + 0.08z^{-3} - 0.149z^{-4}} \Rightarrow \text{cov}[y(t)] = 1.240;$$

correspondingly, $J_{40} = 1.198$.

In Fig.4.7.3, $J_{4N}(\tilde{p}_N(\beta))$, as a function of β , has been plotted. It is apparent that it has a unique minimum, at $\beta = 2.85$. It is worth noticing that $J_{4N}(\tilde{p}_N(\beta))$, in this particular case, is a continuous function of β , $\beta \in [0; +\infty)$; hence, no stability check is, in principle, requested.

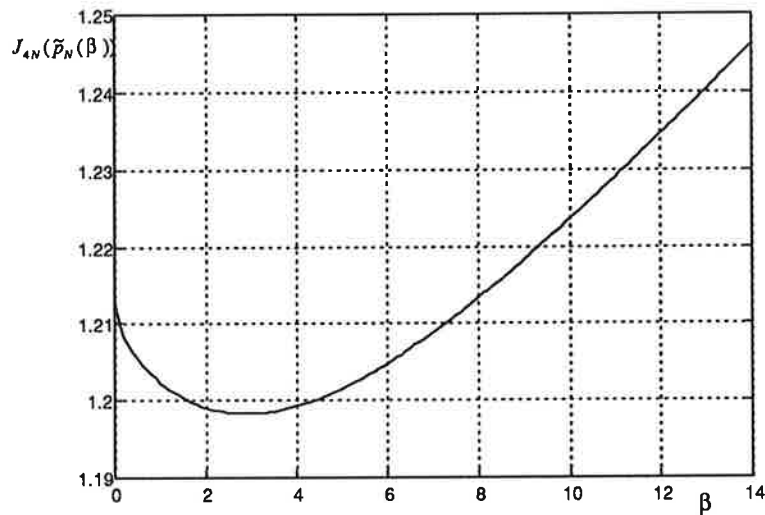

Fig.4.7.3 Function $J_{4N}(\tilde{p}_N(\beta))$.

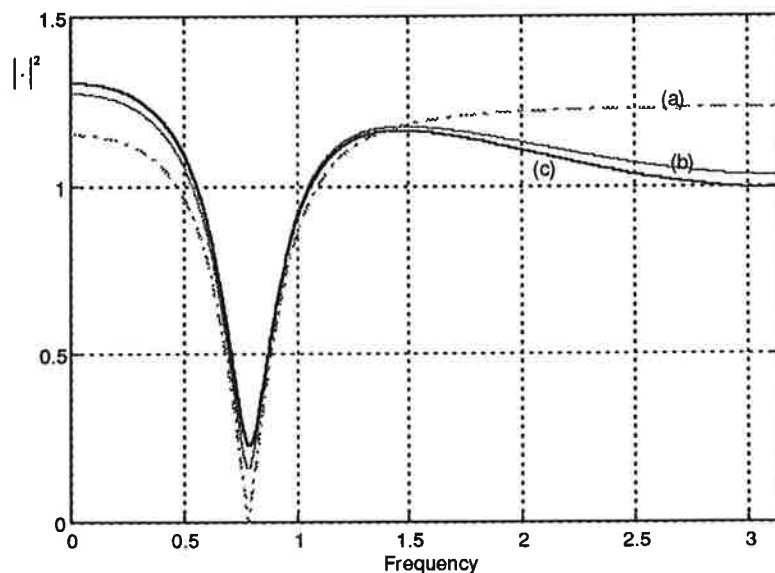

Fig.4.7.4 Frequency-domain shape of $T(z^{-1})$ (case (a), dashed line), $T_2(z^{-1})$ in case (b) (thin line), and $T_2(z^{-1})$ in case (c) (bold line), when the time delay of the system is $k=1$ (nominal time delay).

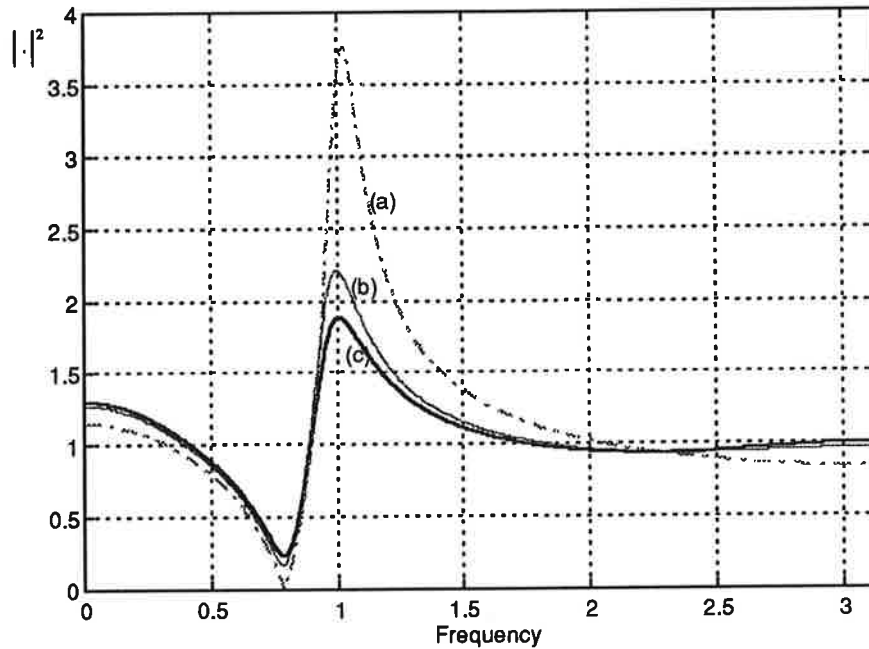

Fig.4.7.5 Frequency-domain shape of $T(z^{-1})$ (case (a), dashed line), $T_2(z^{-1})$ in case (b) (thin line), and $T_2(z^{-1})$ in case (c) (bold line), when the time delay of the system is $h=2$.

With reference to Fig.4.7.3, Fig.4.7.4, and Fig.4.7.5, one could notice that the standard controller (a) provides very bad performances, when $h=2$. Moreover, notice that the optimal overparametrized controller designed for the nominal case (controller (b)) provides comparatively good performances when $h=2$, even if it has been designed without taking into account that condition. As a matter of fact, Fig.4.7.4 and Fig.4.7.5 reveal that - roughly speaking - the "distance" (in terms of overall performances) between controller (a) and (b) is much higher than the distance between (b) and (c).

For the sake of completeness (and thanks to the low order of the overparametrizing polynomial), a direct numerical minimisation of performance index $J_{42}(p_2)$ has been made, in order to compare the sub-optimal solution provided by procedure 4.7.1 with the global minimum of $J_{42}(p_2)$. The results of such a minimisation are the following:

- the global minimum of $J_{42}(p_2)$ is $p_2 = [0.070 \quad -0.3520 \quad 0.2992]^T$;
- in correspondence to its minimum, the value of $J_{42}(p_2)$ is 1.166;
- when $h=2$, the correspondent characteristic polynomial is unstable.

Not surprisingly, the global minimum of $J_{42}(p_2)$ provides an unstable solution. Notice that this fact points out the need of an optimisation method which is capable to cope with the problem of easily checking the stability of the closed-loop system, as the method we've proposed does.

We conclude the numerical example by presenting a time-domain simulation, in order to get a feeling on the behaviour of control systems (a) and (c), even in the time domain. To this purpose, the disturbance

$$d(t) = \sqrt{2} \sin\left(\frac{\pi}{4} t\right) + \sqrt{2} \cos(t) \quad (4.7.9)$$

has been injected in the control system (a) and (c), and the output has been measured. In Fig.4.7.6 signal $d(t)$ is displayed. It is evident that it is constituted by two harmonic signals having different frequencies.

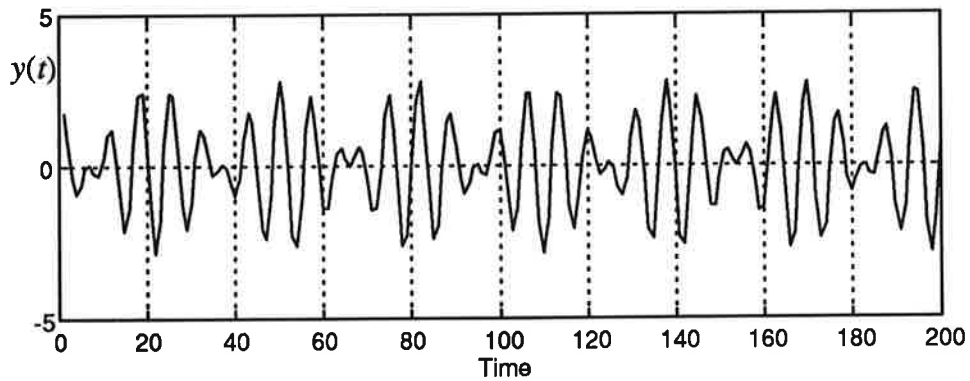

Fig.4.7.6. Signal $d(t)$ (4.7.9).

In Fig.4.7.7 and in Fig. 4.7.8, the difference between the output signals of control systems (a) and (c) respectively, and the harmonic signal at frequency 1, are plotted, when $h=2$, in order to compare the different distortions provided by the two control systems. It is apparent that there is a remarkable difference in the amount of the distortion.

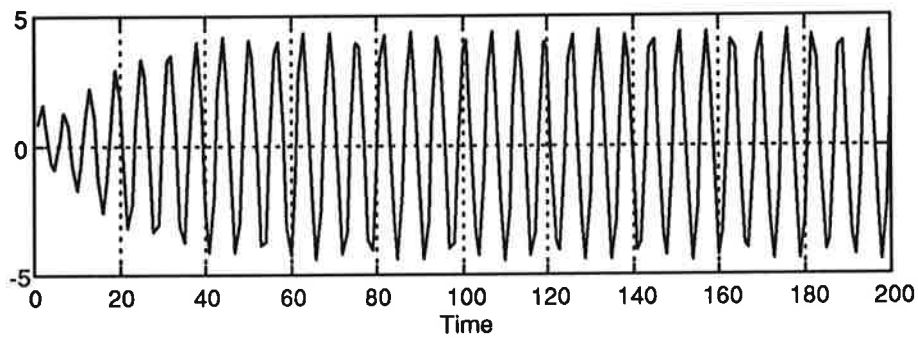

Fig.4.7.7. Difference between the output signal of system (a) and the harmonic signal $\sqrt{2} \cos(t)$, when affected by disturbance (4.7.9), and $h=2$.

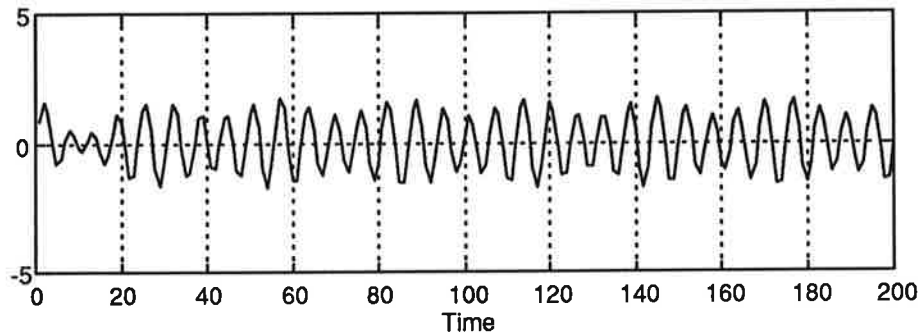

Fig.4.7.8. Difference between the output signal of system (c) and the harmonic signal $\sqrt{2} \cos(t)$, when affected by disturbance (4.7.9), and $h=2$.

To end with, it is worth pointing out that the case of multiple sinusoids, only one of which has to be cancelled, frequently happens in the practice; even in such a case, the controller designed for the special case of a sinusoid (the sinusoid to be rejected) embedded in white noise is usually resorted to (see remark 4.3.1). ■

4.8 Conclusions

In this section, an overparametrization technique of standard controllers has been presented, having the aim of improving their performances, in terms of variance reduction and robustness. The obtained results can be briefly summarised as follows:

- The controllers designed by resorting to the proposed technique are capable of outperforming the standard controllers, in terms of variance reduction; however, the use of a simple minimum-variance performance index usually provides questionable results, in terms of overall performances: as a matter of fact, bad distortions are usually introduced in the frequency-domain behaviour of the system.
- The performance indices proposed for the enhancement of the robustness of the system with respect to uncertainties in the frequency and in the amplitude of the sinusoid can be successfully used in order to re-shape the frequency-domain behaviour of the system.
- The most successful and effective way of using the extra-degrees-of-freedom introduced by the overparametrization seems to be that of enhancing the robustness of the system with respect to uncertainties in the system time delay.

5. DESIGN OF HIGH-PERFORMANCES NOTCH FILTERS VIA BIQUADRATIC FILTERS OVERPARAMETRIZATION TECHNIQUE

5.1 Introduction

In this section, the problem of improving the performances of standard biquadratic notch filters via overparametrization technique is considered.

A typical notch filter, frequently used in the practice (see e.g. [13],[17],[22],[24],[29]), is the so-called "biquadratic" IIR filter (also known as "biquad"):

$$T(z^{-1}) = \frac{A(z^{-1})}{D(z^{-1})} = \frac{1 - 2 \cos(\Omega)z^{-1} + z^{-2}}{1 - 2 \rho \cos(\Omega)z^{-1} + \rho^2 z^{-2}} \quad (5.1.1)$$

where ρ is a design parameter (the "debiasing parameter"), and Ω is the frequency of the harmonic signal to be rejected.

Now, notice that $T(z^{-1})$ is exactly the transfer function from $d(t)$ to $y(t)$ in the control system scheme depicted in Fig.2.2, when the "standard" controller (3.8) is used, and $k=1$ (without uncertainties). Interestingly enough, the design of notch filters can be viewed as a special case of control system design for the rejection of narrow-band disturbances, and one can resort to the overparametrization technique developed for the control system design, even for the notch filter design.

Thus, the problem of improving the performances of filter (5.1.1), via overparametrization of its numerator, can be formulated as follows:

"find the overparametrizing polynomial $P_N(z^{-1})$ which minimises the output variance

$$\text{cov}[y(t)] = \text{cov}\left[\frac{A(z^{-1}) + z^{-1}P_N(z^{-1})}{D(z^{-1})}d(t)\right],$$

when $d(t)$ is a signal constituted by an harmonic signal, and by a broad-band noise".

Clearly, such a problem can be straightforwardly solved, by resorting to the design techniques developed in Sect.4. In view of this fact, the rest of this section is mainly devoted to the presentation of a general result concerning with the design of the optimal "biquad" (Subsect.5.2), while the general case of high-order overparametrization is simply presented by use of a numerical illustrative example, complemented with some remarks.

5.2 The minimum-variance-optimal biquadratic filter

In this subsection the problem of designing the minimum-variance-optimal biquadratic filter is considered. To this purpose, the following optimisation problem has been first considered:

$$\bar{p}_1 = \arg \min_{p_1} \left\{ \text{cov} \left[\frac{A(z^{-1}) + z^{-1}P_1(z^{-1})}{D(z^{-1})} (e(t) + M \sin(\Omega t + \phi)) \right] \right\}. \quad (5.2.1)$$

Notice that \bar{p}_1 provides the optimal position of the two zeros of a biquadratic filter, when the denominator is $D(z^{-1})$. The expression of \bar{p}_1 , as a function of ρ , Ω , and M ,

can be explicitly found; it is quite long and involved and, for the sake of conciseness, is not here reported.

A much more interesting result has been obtained by considering the following optimisation problem:

$$[\hat{p}_1^T \hat{f}] = \arg \min_{p_1, f} \left\{ \text{cov} \left[\frac{A(z^{-1}) + z^{-1}P_1(z^{-1})}{1 - 2\rho f z^{-1} + \rho^2 z^{-2}} (e(t) + M \sin(\Omega t + \phi)) \right] \right\}. \quad (5.2.2)$$

Notice that the minimisation of (5.2.2) corresponds to search for the "global" optimum, within the class of biquadratic filters; as a matter of fact, it is apparent from (5.2.2) that the poles position is allowed to move from the standard position $\rho e^{\pm i\Omega}$; to this purpose, however, it is worth pointing out that the special parametrization chosen for the denominator of the filter is such that *the poles are forced to move along the circle having radius ρ* ; this constraint is needed in order to do not change the dynamical behaviour of the system.

The explicit expression of

$$\text{cov} \left[\frac{A(z^{-1}) + z^{-1}P_1(z^{-1})}{1 - 2\rho f z^{-1} + \rho^2 z^{-2}} (e(t) + M \sin(\Omega t + \phi)) \right], \quad (5.2.3)$$

as a function of ρ , Ω , M , f , and p_1 is extremely large and involved; needless to say, its minimisation with respect to parameters f and p_1 is even a more challenging problem, which can be solved only by means of a powerful symbolic manipulator tool ([21]). Nonetheless, surprisingly enough, the solution of this optimisation problem revealed to be extremely simple (and much more simple than the solution, \bar{p}_1 , of the optimisation problem (5.2.1)). To this purpose, the following result can be stated:

Proposition 5.2.1 Consider the optimisation problem (5.2.2). It has a unique solution given by:

$$- \hat{p}_1 = \frac{\left[\frac{2 \cos(\Omega)(\rho^2 - 1)^2}{(\rho^2 M^2 - 2\rho^2 + 2M^2)} \right]}{\left[(\rho^2 M^2 - 2\rho^2 + 2M^2) \right]}; \quad (5.2.4)$$

$$- \hat{f} = \frac{(1 + \rho^2)}{2\rho} \cos(\Omega). \quad (5.2.5)$$

(notice that the optimal position of the poles does not depend on M). In correspondence to (5.2.4) and (5.2.5), the output variance is given by:

$$- \text{cov}[y(t)] = \frac{-2(\rho^2 - 1 - M^2)}{(\rho^2 M^2 - 2\rho^2 + 2M^2)}. \quad (5.2.6)$$

Proof.

The result stated in the proposition can be obtained simply by computing the explicit algebraic expression of (5.2.3), and by minimising such an expression with respect to parameters f and p_1 . The whole computation has been made by means of a symbolic manipulator tool, such a computation being not feasible directly by hand. ■

Remark 5.2.1

Interestingly enough, the optimal denominator of $T(z^{-1})$, $1 - (1 + \rho^2)\cos(\Omega)z^{-1} + \rho^2z^{-2}$, is the same polynomial which solve a completely different problem, which can be briefly synthesised as follows:

when resorting to filter (5.1.1) for estimating the frequency Ω of an harmonic signal embedded in white noise, it can be shown that a biased estimated is provided (see e.g. [9]); with reference to this problem, one can search for the poles position which provides an unbiased estimate; it has been recently shown (see [4],[31]) that the polynomial which solves this problem is exactly $1 - (1 + \rho^2)\cos(\Omega)z^{-1} + \rho^2z^{-2}$.

Notice that the fact that the solutions of the abovementioned problem, and that of (5.2.2) coincide is particularly surprising; as a matter of fact, the optimal position of the zeros associated to vector (5.2.4) does not coincide with the roots of $A(z^{-1})$, and this makes the "duality" between the two problems hard to recognise. ■

5.3 Overparametrized biquadratic filters

As for the general case of overparametrized biquadratic filters, it is easy to show that, in general, the use of the "simple" performance index (4.3.1) leads to badly-shaped notch filters. As a matter of fact, the typical oscillations which characterise the frequency-domain shape of the filters provided by (4.3.1) (see Subsect.4.3) are considered an obnoxious feature for a stop-band filter. Hence, for the design of well-shaped high-performances filters, one has to resort to performance index (4.5.2): the probability density function, $\gamma_\Omega(\Omega)$ can be considered as a "smoothing" tool, which plays a similar role of that played by the so-called "windowing" techniques, commonly used in standard filter design methods (see e.g. [5]).

In order to show the effectiveness of the overparametrization technique proposed in this work for the design of high-performances notch filters, the following numerical example is proposed.

Numerical Example 5.2.1

Consider the following situation:

$$M = 2, N = 10,$$

$$A(z^{-1}) = 1 - 2\cos\left(\frac{\pi}{4}\right)z^{-1} + z^{-2},$$

$$D(z^{-1}) = 1 - 2 \cos\left(\frac{\pi}{4}\right) 0.8z^{-1} + 0.64z^{-2},$$

and

$$\gamma_{\Omega}(\Omega) = \begin{cases} 10 & \text{when } \Omega \in \left[\frac{\pi}{4} - 0.05; \frac{\pi}{4} + 0.05\right] \\ 0 & \text{when } \Omega \in \left(-\pi; \frac{\pi}{4} - 0.05\right) \cup \left(\frac{\pi}{4} + 0.05; \pi\right) \end{cases}$$

(uniformly distributed p.d.f).

By minimising the following performance index:

$$J(p_{11}) = \int_{\frac{\pi}{4}-0.05}^{\frac{\pi}{4}+0.05} \text{cov} \left[\frac{A(z^{-1}) + z^{-1}P_{10}(z^{-1})}{D(z^{-1})} (e(t) + 2 \sin(\Omega t + \phi)) \right] \gamma_{\Omega}(\Omega) d\Omega, \quad (5.2.7)$$

the following filter is obtained:

$$T_{10}(z^{-1}) = \frac{0.0905(1 - 1.27z^{-1} + 0.807z^{-2} + 0.037z^{-3} + 0.024z^{-4} + 0.0004z^{-5} - 0.019z^{-6} - 0.024z^{-7} - 0.015z^{-8} + 0.0004z^{-9} + 0.012z^{-10} + 0.0037z^{-11})}{1 - 1.1314z^{-1} + 0.64z^{-2}}. \quad (5.2.8)$$

In order to roughly evaluate the performances of filter (5.2.8), a comparison with the standard biquadratic filter (see Fig.5.2.1), and with a well-designed ([5],[23]) stop-band FIR filter of order 24 (see Fig.5.2.2) has been made (the length of the FIR equals the length of the FIR filter which approximates (5.2.8) - see Subject.4.4).

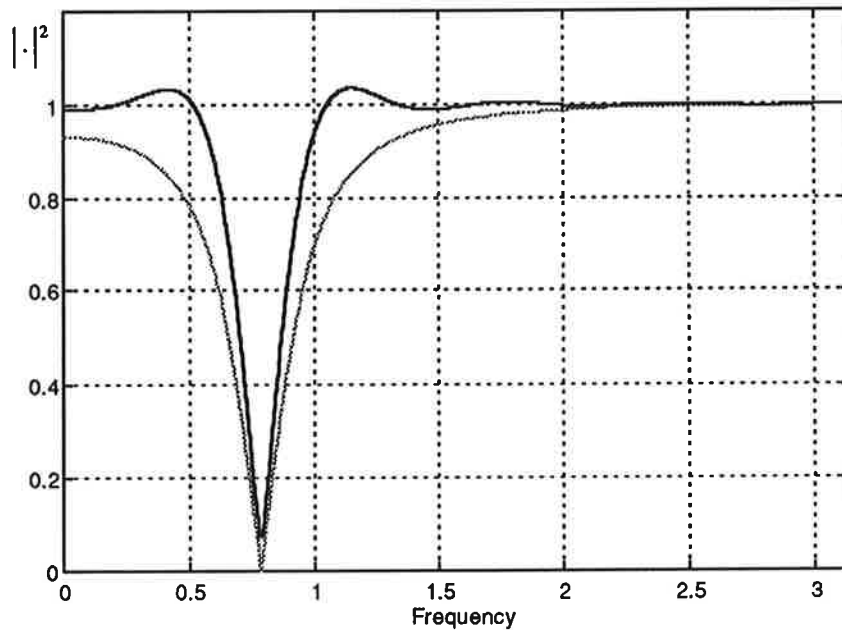

Fig.5.2.1. A comparison between the standard biquadratic filter (thin line), and $T_{10}(z^{-1})$ (bold line).

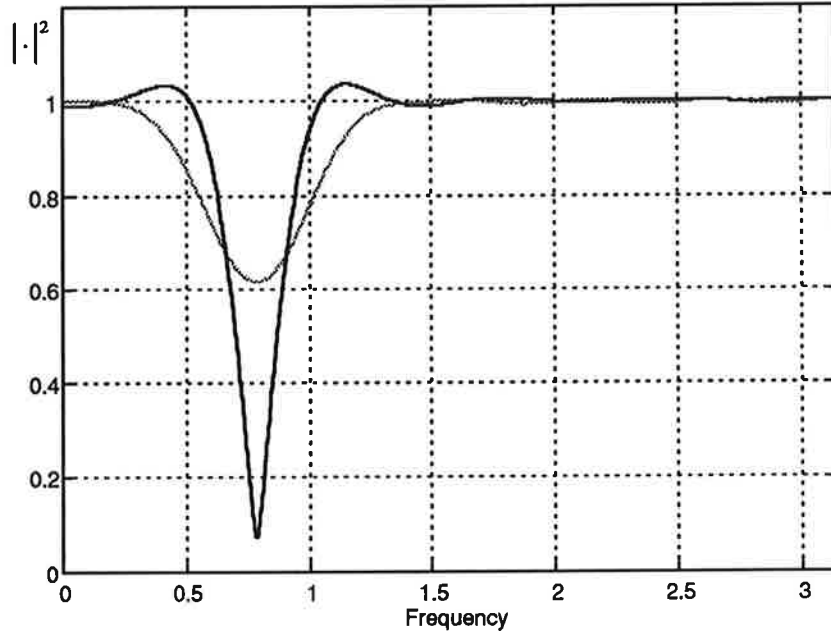

Fig.5.2.2. A comparison between a FIR(24)-based stop-band filter (thin line), and $T_{10}(z)$ (bold line).

As it is apparent from Fig.5.2.1 and Fig.5.2.2, the filter (5.2.8) is a well-shaped filter, which guarantees an high selectiveness in the rejection (see Fig.5.2.1), and an almost complete rejection of the harmonic disturbance (see Fig.5.2.2). ■

We conclude this section by remarking that the overparametrization technique proposed in this work represents an innovative and effective way of designing high-performance notch filters; by means of a wise use of the design parameters, namely N , ρ , and $\gamma_{\Omega}(\Omega)$, it is possible to improve the performances of standard biquadratic filters. To end with, notice that the overparametrization we propose might be viewed as a way of joining the best features of both IIR and FIR filters.

6. CONCLUSIONS

In this work an overparametrization technique of standard pole-placement controllers, for the rejection of harmonic disturbances, has been developed. Such a technique revealed to be an effective way of improving the performances of standard controllers, in terms of variance reduction at the output, and in terms of performance robustness with respect to uncertainties in the frequency and amplitude of the harmonic disturbance. Moreover, an innovative way of dealing with the problem of the robustness with respect to uncertainties in the time delay of the system has been developed: the proposed method revealed to be simple and effective, and it represents one of the most attractive ways of using the extra-degrees-of-freedom, which are made available by the overparametrization.

At the end of the paper, it has been shown that the proposed overparametrization technique can be extended, in a straightforward way, to the design of high-performance stop-band filters.

REFERENCES

- [1] Åström, K.J., and B. Wittenmark (1990). *Computer Controlled Systems, Theory and Design*, (2nd Edition). Prentice-Hall International.
- [2] Åström, K.J. (1970). *Introduction to stochastic control theory*. Academic Press.
- [3] Berger, C.S. (1984). "Robust Controller Design by Minimisation of the Variation of the Coefficients of the Closed-Loop Characteristic Equation". IEE Proc., Vol.131, Pt.D, No.3, pp.103-106.
- [4] Bittanti, S., Campi, M. and Savaresi, S. (1995). "Unbiased estimation of a sinusoid in noise via notch filters". Proceedings of IFAC Symposium ACASP. Budapest.
- [5] Bose, N.K. (1985). *DIGITAL FILTERS, Theory and Applications*, North Holland.
- [6] Chicharo, J.F. and Ng, T.S. (1990). "Gradient-Based Adaptive IIR Notch Filtering for Frequency Estimation," IEEE Trans. Acoust., Speech, Signal Processing, vol. ASSP-38, pp. 769-777.
- [7] Davies, R., and Zarrop, M.B. (1994). "On Reduced Variance Overparametrized Pole-Assignment Control". Submitted to Int. J. Control.
- [8] Doyle, J.C., Francis, B.A., and Tannenbaum, A.R. (1992). *Feedback Control Theory*. Macmillan Publishing Company.
- [9] Dragošević, M.V. and Stanković, S.S. (1989). "A generalized least squares method for frequency estimation," IEEE Trans. Acoust., Speech, Signal Processing, vol. ASSP-37, pp. 805-819.
- [10] Dragošević, M.V. (1993). "Stationary Points of the Recursive Generalized Least Squares Algorithm for Adaptive Notch Filtering," IEEE Trans. Signal Processing, vol. SP-41, pp. 1672-1675.
- [11] Friedlander, B. and Smith, J.O. (1984). "Analysis and performance evaluation of an adaptive notch filter," IEEE Trans. Inform. Theory, vol. IT-30, pp. 283-295.
- [12] Fuchs, J.J. (1994). "Multiscale Identification of Real Sinusoids in Noise". Automatica, Vol.30, No.1, pp.147-155.
- [13] Glover, J.R. (1977). "Adaptive noise cancelling applied to sinusoidal interferences," IEEE Trans. Acoust., Speech, Signal Processing, vol. ASSP-25, pp. 484-491.

- [14] Hagander, P., and Wittenmark, B. (1977). "A Self-Tuning Filter for Fixed-Lag Smoothing". IEEE Trans. on Information Theory, Vol.23, No.3, pp.377-384.
- [15] Halpern, M.E. (1988). "Modified Pole-Assignment Controller for Plant Models with Exact or Near Pole-Zero Cancellation". Proc. IEE, Vol.135, Pt.D, No.3, pp.189-195.
- [16] Händel, P. (1993). *Estimation Methods for Narrow-Band Signals*. PhD Thesis, Uppsala - Sweden.
- [17] Hush, D.R. et al. (1986). "An adaptive IIR structure for sinusoidal enhancement, frequency estimation, and detection," IEEE Trans. Acoust., Speech, Signal Processing, vol. ASSP-34, pp. 1380-1390.
- [18] Kay, S.M. and S.L. Marple, Jr. (1981). "Spectrum analysis - a modern perspective". Proc. IEEE, 69, 1380-1419.
- [19] Ljung, L. (1987). *System Identification: Theory for the user*. Englewood Cliffs, NJ:Prentice-Hall.
- [20] Lootsma, F.A. (1972). *Numerical Methods for Non-Linear Optimization*. Academic Press.
- [21] Maple Users' guide.
- [22] Martin, K.W. (1990). "The Isolation of Undistorted Sinusoids in Real Time," IEEE Trans. Acoust., Speech, Signal Processing, vol. ASSP-38, pp. 360-364.
- [23] Little, J.N., and Shure, N. (1992). *Signal Processing Toolbox for use with Matlab*. The MathWorks Inc..
- [24] Nehorai, A. (1985). "A minimal parameter adaptive notch filter with constrained poles and zeros," IEEE Trans. Acoust., Speech, Signal Processing, vol. ASSP-33, pp. 983-996.
- [25] Nelson, P.A. and Elliott, S.J. (1992). *Active Control of Sound*. Academic Press.
- [26] Nijmeijer, H., and A.J. van der Schaft (1990). *Nonlinear Dynamical Control Systems*, Springer-Verlag.
- [27] Ng, T.S (1987). "Some aspects of an adaptive digital notch filter with constrained poles and zeros," IEEE Trans. Acoust., Speech, Signal Processing, vol. ASSP-35, pp. 158-161.
- [28] Ng, T.S. (1988). "An IIR structure for digital tunable frequency response filter, adaptive notch filtering and line enhancers," in Proc. IFAC, Beijing (China).
- [29] Rao, D.V.B. and Kung, S.Y. (1984). "Adaptive notch filtering for the retrieval of sinusoids in noise," IEEE Trans. Acoust., Speech, Signal Processing, vol. ASSP-32, pp. 791-802.
- [30] Rao, B.D. and Peng, R. (1988). "Tracking Characteristics of the Constrained IIR Adaptive Notch Filter," IEEE Trans. Acoust., Speech, Signal Processing, vol. ASSP-36, pp. 1466-1479.

- [31] Savaresi, S., and Peroni, S. (1992). *Laurea dissertation*, Politecnico di Milano.
- [32] Savaresi, S. (1995). "*Identification of Hybrid Filters for Energy Estimation in Nuclear Spettroscopy*", Internal Report n.95.021, Politecnico di Milano.
- [33] Shoureshi, R., Brackney, L., Kubota, N. and Batta, G. (1993). "*A Modern Control Approach to Active Noise Control*". Trans. of ASME, Journal of Dynamic Systems, Measurement, and Control. Vol.115, Dec.1993, pp. 673-678.
- [34] Söderström, T. and Stoica, P. (1989). *System Identification*. Prentice Hall.
- [35] Stoica, P. and Nehorai, A. (1988). "*Performance analysis of an adaptive notch filter with constrained poles and zeros*," IEEE Trans. Acoust., Speech, Signal Processing, vol. ASSP-36, pp. 911-919.
- [36] Stoica, P., Moses, R.L., Friedlander, B. and Söderström, T. (1989). "*Maximum Likelihood Estimation of the Parameters of Multiple Sinusoids from Noisy Measurements*," IEEE Trans. Acoust., Speech, Signal Processing, vol. ASSP-37, pp. 378-392.
- [37] Strada, S. (1993). *Development and Analysis of Algorithms for the Active Control of Vibrations, with Reference to the Problem of the Vibrations Reduction in Helicopters (in Italian)*. PhD Thesis, Politecnico di Milano, Italy.
- [38] Wellstead, P.E., Prager, D., and Zanker, P. (1979). "*Pole-Assignment Self-Tuning Regulator*". Proc. IEE, Vol.126, No.8, pp.781-787.
- [39] Widrow, B. and Stearns, S.D. (1986). *Adaptive Signal Processing*. Englewood Cliffs, NJ:Prentice-Hall.
- [40] Wittenmark, B. (1974). "*A Self-Tuning Predictor*". IEEE Trans. On Automatic Control, Vol.19, No.6, pp.848-851.
- [41] Zarrop, M.B., and Fischer, M. (1985). "*Reduced-Variance Pole Assignment Self-Tuning Regulation*". International Journal of Control, Vol.42, No.5, pp.1013-1033.

