



LUND UNIVERSITY

Activity Report 2021

Automatic Control, Lund University

Rasmusson, Monika; Bernhardsson, Bo

2022

Document Version:

Publisher's PDF, also known as Version of record

[Link to publication](#)

Citation for published version (APA):

Rasmusson, M., & Bernhardsson, B. (Eds.) (2022). *Activity Report 2021: Automatic Control, Lund University*. (Annual Reports; No. TFRT-4049). Department of Automatic Control, Lund University.

Total number of authors:

2

General rights

Unless other specific re-use rights are stated the following general rights apply:

Copyright and moral rights for the publications made accessible in the public portal are retained by the authors and/or other copyright owners and it is a condition of accessing publications that users recognise and abide by the legal requirements associated with these rights.

- Users may download and print one copy of any publication from the public portal for the purpose of private study or research.
- You may not further distribute the material or use it for any profit-making activity or commercial gain
- You may freely distribute the URL identifying the publication in the public portal

Read more about Creative commons licenses: <https://creativecommons.org/licenses/>

Take down policy

If you believe that this document breaches copyright please contact us providing details, and we will remove access to the work immediately and investigate your claim.

LUND UNIVERSITY

PO Box 117
221 00 Lund
+46 46-222 00 00

Activity Report 2021

AUTOMATIC CONTROL | LUND UNIVERSITY





Department of Automatic Control
P O Box 118, 221 00 Lund, Sweden
www.control.lth.se

Annual Report TFRT--4049
ISSN 0280-5316

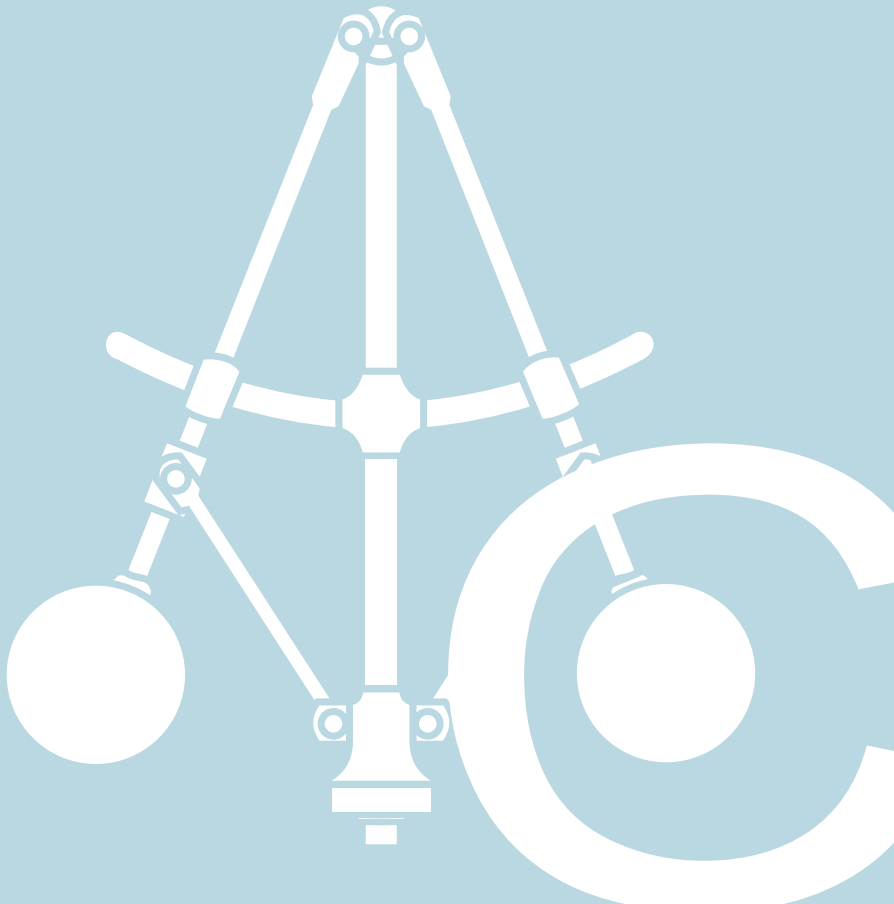

Activity Report 2021



LUND
UNIVERSITY

Department of Automatic Control

MAILING ADDRESS

Department of Automatic Control
Lund University
P O Box 118
SE-221 00 LUND, Sweden

VISITING ADDRESS 2020-2023

Reglerteknik, location KC4, 3rd floor
Naturvetarvägen 18
223 62 LUND

TELEPHONE

+46 46 222 87 87

WWW AND GENERIC E-MAIL ADDRESS

www.control.lth.se
control@control.lth.se

Edited by Monika Rasmusson and Bo Bernhardsson

Printed: Media-Tryck, Lund, Sweden, April 2022

ISSN 0280-5316

Annual Report TFRT-4049



Media-Tryck is a Nordic Swan Ecolabel certified provider of printed material. Read more about our environmental work at www.mediatryck.lu.se

MADE IN SWEDEN 

Content

Introduction	7
AUTOMATIC CONTROL HIGHLIGHTS OF 2021.....	9
Education	11
UNDERGRADUATE STUDIES	12
GRADUATE STUDIES	14
DOCTORAL DISSERTATION.....	15
Research	19
EXCELLENCE CENTERS AND NATIONAL PROJECTS.....	21
RESEARCH AREAS	27
LARGE SCALE SYSTEMS AND LEARNING	28
AUTONOMOUS REAL-TIME SYSTEMS.....	34
INNOVATIVE CONTROL APPLICATIONS	43
TOOLS AND SOFTWARE	56
Publications and seminars	59
PUBLICATIONS 2021.....	60
SEMINARS AT THE DEPARTMENT	67
External Contacts	71
Economy	77
ECONOMY.....	78
FUNDING.....	79
Staff	81
LONG-TERM VISITORS	84
BOARD OF THE DEPARTMENT.....	84
STAFF ACTIVITIES	84
AWARDS	101
ASSIGNMENTS.....	102
LECTURES BY STAFF OUTSIDE THE DEPARTMENT	106
POPULAR SCIENCE PRESENTATIONS.....	107

Introduction

A summary of the activities at the Department of Automatic Control, Lund University during the period January 1 to December 31, 2021

AUTOMATIC CONTROL HIGHLIGHTS OF 2021

This report covers the activities at the Department of Automatic Control during 2021. We can summarise the year in numbers as follows:

The economy showed a turnover for 2021 of 62,8 MSEK, an increase of 1,5 MSEK since last year. More about financial figures is found in the chapter *Economy*.

The department now has 61 members (excluding guests), divided into the following categories: 6 professors, 1 senior professor, 1 guest professor, 1 adjunct professor, 7 associate professors, 4 research engineers, 5 administrators, 4 post-docs, 3 researchers, 29 PhD students and 3 industrial PhD students (this includes part-time positions). This year five new PhD students were admitted to the department. Read more about this in the chapter *Staff*.

Karl Johan Åström, belonging to an exclusive group of excellent engineers, is now ranked as no 1 in Sweden of top scientists for Electronics and Electrical Engineering and, no 101 in the whole world! Read more in chapter *Staff*.

Charlotta Johnsson was elected Dean of Campus Helsingborg and started her new position in January 2021. She is also Director of X-Labs, LTH.

Rolf Johansson retired in August but is still working part-time for the department.

This year we welcomed our Lise Meitner professor to the department - Margret Bauer. Read more about her in the chapter *Staff*.

During 2021, the department gave 19 different courses to 1187 students at LTH, and 47 students presented their masters' theses at the department. Five PhD courses were also given. Following the restrictions for the pandemic both digital format and attended on site have taken place during 2021.

Four PhD theses by Gautham Nayak Seetanaidi, Mattias Fält, Marcus Greiff and Per Skarin, were defended during 2021. The total number of PhDs graduated from the department is now 132. No licentiate thesis was presented this year.

The number of WASP-funded PhDs at the department is now 13, including three industrial PhD students. Some of our other PhDs are also "WASP affiliated", which means that they can take courses offered within the WASP Graduate School programme. Read more about this in the chapter *Education*.

The department's involvement in WASP, the Wallenberg AI, Autonomous Systems and Software Program, has increased further during the year. New projects have started and we have been successful in getting more funding, as the WASP-DDLS (concerning data-driven life science) and WASP-NEST. Read more about our research in the chapter *Research*.

The euRobotics week is now well established and took place during three days in late November. Our latest investment *Spot*, an agile mobile robot, was this year's attraction. Fortunately, we were despite the pandemic able to invite the students to our RobotLab.

During the year our *Industry Club* started and launched a first newsletter in October 2021. The aim is to send out such a newsletter about four times a year containing updates about relevant activities, highlights from the field of control, invitations to meetings and events, and information about opportunities for collaboration. Today the club has 100+ members.

Even though we have been able to welcome several new colleagues, the pandemic has still impacted us the entire year and the number of guests visiting has been fewer than normal.

Looking into the future, the new funding and our newly started projects will open up new interesting challenges for the years to come. The field of Automatic Control is centrally placed in the rapidly developing field of AI, Machine Learning and its applications. We have an interesting time ahead of us!

Education

Education at undergraduate and graduate level including dissertations 2021

UNDERGRADUATE STUDIES

The engineering education at LTH, the engineering faculty of Lund University, follows the central European system with five-year programs leading up to the university degree *civilingenjör*, with the international title MSc.

Automatic control courses are taught as part of the engineering curriculum in Engineering Physics (F), Electrical Engineering (E), Computer Engineering (D), Mechanical Engineering (M), Information and Communication Engineering (C), Environmental Engineering (W), Engineering Mathematics (Pi), Industrial Management and Engineering (I), Biotechnology (B), Engineering Nanoscience (N), Chemical Engineering (K) and Biomedical Engineering (BME). Our advanced courses are included in more than fifteen of the master-level specializations in the various programs. During 2021, there were 1187 course registrations and 1036 passed grades were awarded. The number of registered students corresponds to 164 full-year equivalents. The table on the next page, lists our undergraduate courses, along with the number of students who passed each course. Some of our courses have become so popular that we unfortunately had to restrict the number of students, due to lack of staff resources.

The two year international master programme *Machine Learning Systems and Control* was started with 12 students in 2020 and a second batch of 18 students were admitted in 2021. The programme is managed by Mikael Nilsson at the mathematics department and Bo Bernhardtsson.

47 students completed their master's thesis projects, and a total of 31 theses were presented

during 2021. A list of the master's theses is given in the *Publications and Seminars* chapter.

In 2020, several courses had to swiftly transition to online teaching and virtual labs due to the pandemic. Hybrid mode of teaching continued during different parts of 2021; we had for example lab sessions with a reduced number of participants per occasion, and some exams were performed online under changed formats. This was made possible through a large extra effort by the PhD students and undergraduate TAs.

Frida Heskebeck was given the reward Teaching Assistant of the Year – twice. She gives exercises in a seminar format where the students discuss the theory from the courses with each other, a concept highly appreciated by the students.

In the fall, Tore Hägglund gave Automatic Control, Basic Course, for the last time. Throughout his career, he has lectured the course to somewhere between 15–20 000 students in total.

Richard Pates entered a maths exposition contest, where his contribution was featured in the wrap up video from the organisers. His youtube channel has quickly reached more than 1000 followers.

Most of our lectures have now been recorded and we have also developed new formats of teaching which are worthy to maintain also in the future, when we hopefully now return to a more normal post-pandemic situation.

Most of the courses now have course material available via a Canvas page open for the public. You can find these pages through our education web page.

TOTAL NUMBER OF STUDENTS WHO PASSED OUR COURSES 2021

Automatic Control, Basic Course (FRTF05 Reglerteknik)	551
Automatic Control, Basic Course (FRT010 Reglerteknik)	7
Systems Engineering (FRTF10 Systemteknik).....	40
Control Theory (FRTF15 Reglerteori).....	15
Applied Robotics (FRTF20 Tillämpad robotteknik).....	45
Introduction to Machine Learning, Systems and Control (FRTF25 Introduktion till maskininläring, system och reglering)	27
Physiological Models and Computations (FRTF01 Fysiologiska modeller och beräkningar)	38
Nonlinear Control and Servo Systems (FRTN05 Olinjär reglering och servosystem).....	29
Real-Time Systems (FRTN01 Realtidssystem)	27
Automatic Process Control (FRTN25 Processreglering).....	10
Network Dynamics (FRTN30 Nätverksdynamik)	30
Project in Automatic Control (FRTN40 Projekt i reglerteknik).....	24
Mathematical Modeling, Advanced Course (FRTN45 Matematisk modellering, fortsättningskurs)	30
Optimization for Learning (FRTN50 Optimering för maskininläring).....	18
Automatic Control, Advanced course (FRTN55 Reglerteknik, fortsättningskurs).....	45
Real-Time Systems (FRTN60 Realtidssystem)	29
Modeling and Learning from Data (FRTN65 Modellering och inläring från data)	55
Project in Systems, Control and Machine Learning NEW (FRTN70 Projekt i system, reglering och maskininläring)	16
Engineering Work Training (FRTF97 Ingenjörsinriktad yrkesträning).....	3
Degree Project in Automatic Control (FRTM01 Examensarbete i reglerteknik)	47

GRADUATE STUDIES

The PhD education consists of four years of studies, but since most students have 20% of department duties, the nominal time for the PhD education is 5 years. In the Swedish system there is also a possibility to do a half-time thesis called a "licentiate". The general syllabus for PhD studies in Automatic Control states that the course requirement for a PhD degree is 90 credits, while the thesis scope is 150 credits.

In 2021 four doctoral theses were defended by Gautham Nayaki Seentanadi, Mattias Fält, Marcus Greiff and Per Skarin but no licentiate thesis was presented. During the year we have admitted Fethi Bencherki, Martin Gemborn Nilsson, Zheng Jia, Max Nyberg Carlsson and David Ohlin as new PhD students.

The following PhD courses were given at the department in 2021:

- *Nonlinear Control*; Richard Pates, Anders Robertsson
- *Robust Control*; Carolina Bergeling
- *Adaptive Control*; Karl Johan Åström, Anders Rantzer
- *Introduction to Innovation in Computing Disciplines*; Anton Cervin, Charlotta Johnsson
- *Study circle in Deep Reinforcement learning*; Gautham Nayak Seentanadi, Karl-Erik Årzén

The PhD course *Introduction to Research Methodology, Ethics and Innovation for Computing Disciplines* is given by our department together with the Departments of Computer Science and Electro- and Information Technology. The course is divided into three parts. Charlotta is the course responsible for Part 3-[Innovation](#). This part was given in February 2021.

Charlotta was also involved as a Guest speaker in the PhD courses *Complex Automation* and *Innovation and Value Creation in Research*.

There are also several PhD courses organised within the WASP Graduate School programme, available for both WASP graduate and affiliated students, below are the courses offered in 2021:

- *Software Engineering and Cloud Computing*
- *Deep Learning and GANs (where Pontus Giselsson taught Module 2)*
- *Graphical Models, Bayesian Learning and Statistical Relational Learning*
- *WASP Project Course*
- *Topological Data Analysis*
- *Community Building Summer School 2021*
- *Summer School on "Hybrid Racing - Using Virtual Engineering for Real Miniature Cars" 2021*

DOCTORAL DISSERTATION

This year there were four PhD students defending their theses. The abstracts are presented below and are available by attached QR code.



Nayak Seetanadi,
Gautham

Fält, Mattias

Greiff, Marcus

Skarin, Per

IMPROVING PERFORMANCE OF FEEDBACK-BASED REAL-TIME NETWORKS USING MODEL CHECKING AND REINFORCEMENT LEARNING

Nayak Seetanadi, Gautham

ISBN 978-91-7895-720-0



Traditionally, automatic control techniques arose due to need for automation in mechanical systems. These techniques rely on robust mathematical modelling of physical systems with the goal to drive their behaviour to desired set-points. Decades of research have successfully automated, optimized, and ensured safety of a wide variety of mechanical systems.

Recent advancement in digital technology has made computers pervasive into every facet of life. As such, there have been many recent attempts to incorporate control techniques into digital technology. This thesis investigates the intersection and co-application of control theory and computer science to evaluate and improve performance of time-critical systems. The thesis applies two different research areas, namely, model checking and reinforcement learning to design and evaluate two unique real-time networks in conjunction with control technologies. The first is a camera surveillance system with the goal of constrained resource allocation to self-adaptive cameras. The second is a dual-delay real-time communication network with the goal of safe packet routing with minimal delays.

The camera surveillance system consists of self-adaptive cameras and a centralized manager, in which the cameras capture a stream of images and transmit them to a central manager over a shared constrained communication channel. The event-based manager allocates fractions of the shared bandwidth to all cameras in the network. The thesis provides guarantees on the behaviour of the camera surveillance network through model checking. Disturbances that arise during image capture due to variations in capture scenes are modelled using probabilistic and non-deterministic Markov Decision Processes (MDPs). The different properties of the camera network such as the number of frame drops and bandwidth reallocations are evaluated through formal verification.

The second part of the thesis explores packet routing for real-time networks constructed with nodes and directed edges. Each edge in the network consists of two different delays, a worst-case delay that captures high load characteristics, and a typical delay that captures the current network load. Each node in the network takes safe routing decisions by considering delays already encountered and the amount of remaining time.

The thesis applies reinforcement learning to route packets through the network with minimal delays while ensuring the total path delay from source to destination does not exceed the pre-determined deadline of the packet. The reinforcement learning algorithm explores new edges to find optimal routing paths while ensuring safety through a simple pre-processing algorithm. The thesis shows that it is possible to apply powerful reinforcement learning techniques to time-critical systems with expert knowledge about the system.

CONVERGENCE ANALYSIS AND IMPROVEMENTS FOR PROJECTION ALGORITHMS AND SPLITTING METHODS

Fält, Mattias

ISBN 978-91-7895-764-4



Non-smooth convex optimization problems occur in all fields of engineering. A common approach to solving this class of problems is proximal algorithms, or splitting methods. These first-order optimization algorithms are often simple, well suited to solve large-scale problems and have a low computational cost per iteration. Essentially, they encode the solution to an optimization problem as a fixed point of some operator, and iterating this operator eventually results in convergence to an optimal point. However, as for other first order methods, the convergence rate is heavily dependent on the conditioning of the problem. Even though the per-iteration cost is usually low, the number of iterations can become prohibitively large for ill-conditioned problems, especially if a high accuracy solution is sought.

In this thesis, a few methods for alleviating this slow convergence are studied, which can be divided into two main approaches. The first are heuristic methods that can be applied to a range of fixed-point algorithms. They are based on understanding typical behavior of these algorithms. While these methods are shown to converge, they come with no guarantees on improved convergence rates.

The other approach studies the theoretical rates of a class of projection methods that are used to solve convex feasibility problems. These are problems where the goal is to find a point in the intersection of two, or possibly more, convex sets. A study of how the parameters in the algorithm affect the theoretical convergence rate is presented, as well as how they can be chosen to optimize this rate.

NONLINEAR CONTROL OF UNMANNED AERIAL VEHICLES – SYSTEMS WITH AN ATTITUDE

Greiff, Marcus

ISBN 978-91-8039-048-4



This thesis deals with the general problem of controlling rigid-body systems through space, with a special focus on unmanned aerial vehicles (UAVs). Several promising UAV control algorithms have been developed over the past decades, enabling truly astounding feats of agility when combined with modern sensing technologies. However, these control algorithms typically come without global stability guarantees when implemented with estimation algorithms. Such control systems work well most of the time, but when introducing the UAVs more widely in society, it becomes paramount to prove that stability is ensured regardless of how the control system is initialized.

The main motivation of the research lies in providing such (almost) global stability guarantees for an entire UAV control system. We develop algorithms that are implementable in practice and for which (almost) all initial errors result in perfect tracking of a reference trajectory. In doing so, both the tracking and the estimation errors are shown to be bounded in time along (almost) all solutions of the closed-loop system. In other words, if the initialization is sound and the initial errors are small, they will remain small and decrease in time, and even if the initial errors are large, they will not increase with time.

As the field of UAV control is mature, this thesis starts by reviewing some of the most promising approaches to date in Part I. The ambition is to clarify how various controllers are related, provide intuition, and demonstrate how they work in practice. These ideas subsequently form the foundation on which a new result is derived, referred to as a nonlinear filtered output feedback. This represents a diametrically different approach to the control system synthesis. Instead of a disjoint controller/estimator design, the proposed method is comprised of two controller/estimator pairs, which when combined through a special interconnection term yields a system with favorable stability properties.

While the first part of the thesis deals with theoretical controller design, Part II concerns application examples, demonstrating how the theory can solve challenging problems in modern society. In particular, we consider the problem of circumnavigation for search and rescue missions and show how UAVs can gather data from radioactive sites to estimate radiation intensity.

CONTROL OVER THE CLOUD – OFFLOADING, ELASTIC COMPUTING, AND PREDICTIVE CONTROL

Skarin, Per

ISBN 978-91-8039-094-1



The thesis studies the use of cloud native software and platforms to implement critical closed loop control. It considers technologies that provide low latency and reliable wireless communication, in terms of edge clouds and massive MIMO, but also approaches industrial IoT and the services of a distributed cloud, as an extension of commercial-of-the-shelf software and systems.

First, the thesis defines the cloud control challenge, as control over the cloud and controller offloading. This is followed by a demonstration of closed loop control, using MPC, running on a testbed representing the distributed cloud. The testbed is implemented using an IoT device, clouds, next generation wireless technology, and a distributed execution platform. Platform details are

provided and feasibility of the approach is shown. Evaluation includes relocating an on-line MPC to various locations in the distributed cloud.

Offloaded control is examined next, through further evaluation of cloud native software and frameworks. This is followed by three controller designs, tailored for use with the cloud. The first controller solves MPC problems in parallel, to implement a variable horizon controller. The second is a hierarchical design, in which rate switching is used to implement constrained control, with a local and a remote mode. The third design focuses on reliability. Here, the MPC problem is extended to include recovery paths that represent a fallback mode. This is used by a control client if it experiences connectivity issues. An implementation is detailed and examined.

In the final part of the thesis, the focus is on latency and congestion. A cloud control client can experience long and variable delays, from network and computations, and used services can become overloaded. These problems are approached by using predicted control inputs, dynamically adjusting the control frequency, and using horizontal scaling of the cloud service. Several examples are shown through simulation and on real clouds, including admitting control clients into a cluster that becomes temporarily overloaded.

Research

This chapter presents our excellence centers and describes our three main research areas and their ongoing projects

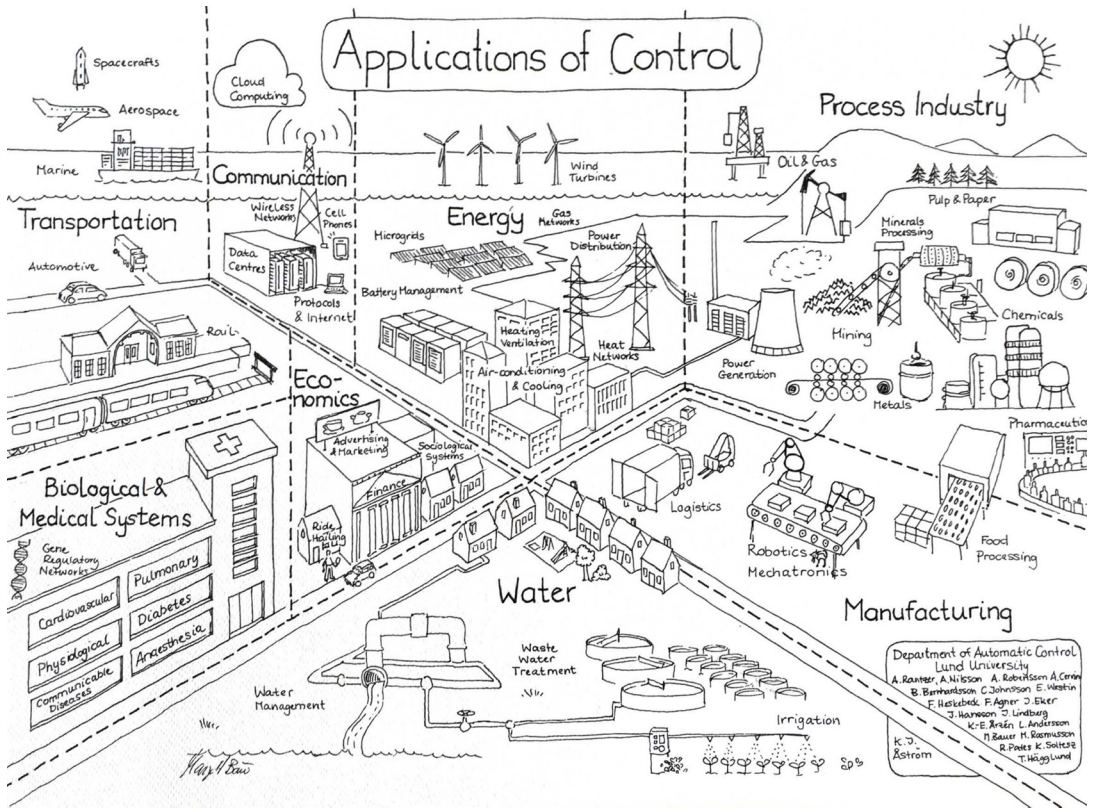

Above: Overall view of the Applications of Control by Margret Bauer

EXCELLENCE CENTERS AND NATIONAL PROJECTS

ERC – Scalable Control of Interconnected Systems
 ELLIIT – The Linköping–Lund Initiative on IT and mobile communication
 WASP – Wallenberg AI, Autonomous Systems and Software Program
 HI2OT – Nordic University Hub on Industrial Internet of Things

SCALABLE CONTROL OF INTERCONNECTED SYSTEMS



Funding: European Research Council - ERC Advanced Grant

Modern society is critically dependent on large-scale networks for services such as energy supply, transportation and communications. The design and control of such networks is becoming increasingly complex, due to their growing size, heterogeneity and autonomy. A systematic theory and methodology for control of large-scale interconnected systems is therefore needed. In an ambitious effort towards this goal, this project will address the following key aspects:

- Modeling by leveraging tools from learning and adaption
- Control design by utilizing structural properties of the system
- Verification of system performance using decomposable certificates

Energy networks (electricity and district heating*) will be used as a guiding example for the development of theory and methodology. Close collaboration with industrial partners will ensure that the research is relevant and useful in practice.



***Scalable Control for Increased Flexibility in District Heating Networks** - This project investigates the development and application of scalable control strategies to explore the flexibility of large scale district heating networks. In particular, we aim to leverage theoretical tools from the field of control theory with a specific focus on those developed for positive systems. The objective is improving the operation of district heating networks while taking into account their limited communication architecture and the need for scalability to large network structures. These control strategies will be employed in demand response and load control architectures that can allow heating networks explore increased flexibility through e.g. demand response and direct load control.

ELLIIT – THE LINKÖPING–LUND INITIATIVE ON IT AND MOBILE COMMUNICATION

Funding: Government-funded Strategic Research Area

ELLIIT is a strategic research environment funded by the Swedish government in 2010, as part of its initiative to support strong research in information technology and mobile communications.

ELLIIT has four partners: Linköping University, Lund University, Halmstad University and Blekinge Institute of Technology. ELLIIT constitutes a platform for both fundamental and applied research, and for cross-fertilization between disciplines and between academic researchers and industry experts. ELLIIT stands out by the quality and visibility of its publications, and its ability to attract and retain top talented researchers, and aims at being recognized as a top international research organization.

ELLIIT achieves its goals by a judicious choice of funded focus projects, a structured process for international recruitment, a balanced way of stimulating cooperation between research areas and between the sites involved (LiU, LU, BTH, HH), and a proactive approach towards fostering and maintaining cooperation with Swedish industry. The overarching objective of ELLIIT is to support scientific excellence in combination with industrial relevance and impact.

In the 2020 national budget bill for University Research and Education, an additional 72 MSEK/year were allocated to the strategic research area in IT and mobile communication with a focus on digitalization, i.e., an increase of the original

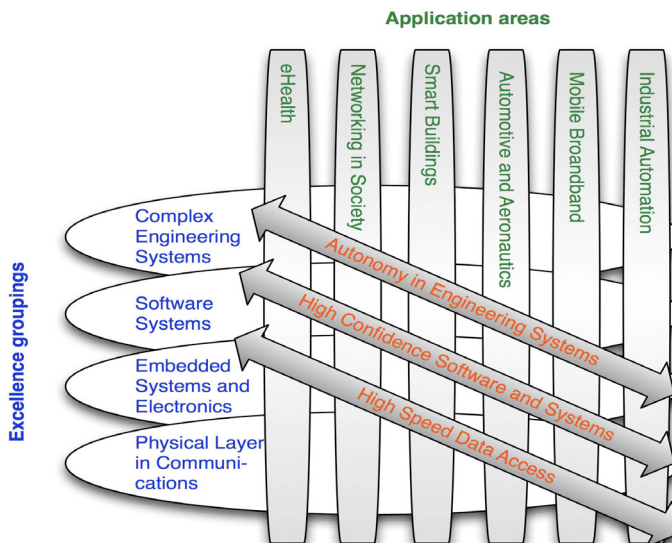

Illustration of the interaction between the themes, the application areas and the groupings (<http://www.liu.se/eLLIIT>)

budget with close to 200%. This initiated a major restart of ELLIIT including a new organization and restructuring of the research programme.

The following projects were started January 2021, in some cases as continuation of older project that formally were terminated. In each of the projects we have funding for one PhD student.

- Robust and Secure Control over the Cloud (Anton Cervin with Zebo Peng, Linköping University)
- Visual Feature-Based Data Reduction (Bo Bernhardsson with Ingrid Hotz, Linköping University)
- Scalable Optimization for Learning in Control (Anders Rantzer with Anders Hansson, Linköping University)
- Autonomous Force-Aware Swift Motion Control (Anders Robertsson with Lars Nielsen, Linköping University)
- Dynamics of Complex Socio-Technological Network Systems (Emma Tegling with Claudio Altafini, Linköping University)

Our department also received funding for three two-year postdoc projects from June 2020:

- Scalable Data Processing in Networked Systems (Anders Rantzer)
- Autonomous Radiation Mapping and Isotope Composition Identification by Mobile Gamma Spectroscopy (Anders Robertsson)
- Efficient and Reliable Training of Generative Adversarial Networks (Pontus Giselsson)

During 2021 we also received ELLIIT funding for recruitment of an Associate Professor in Robotics. The position is expected to be filled by September 2022.



Funding: Knut and Alice Wallenberg Foundation (KAW)

Wallenberg AI, Autonomous Systems and Software Program (WASP) is Sweden's largest individual research program ever, and provides a platform for academic research and education, fostering interaction with Sweden's leading technology companies. The program addresses research on autonomous systems acting in collaboration with humans, adapting to their environment through sensors, information and knowledge, and forming intelligent systems-of-systems. Software is the main enabler in autonomous systems, and is an integrated research theme of the program. WASP's key values are research excellence and industrial relevance.

WASP is funded by the Knut and Alice Wallenberg Foundation with co-funding from industry and the involved universities. The programme, which started in 2015, will continue until 2030 with a total budget of SEK 5.5 billion out of which the Knut and Alice Wallenberg Foundation (KAW) provides SEK 4.2 billion.

The graduate school within WASP is dedicated to provide the skills needed to analyze, develop, and contribute to the interdisciplinary area of AI, autonomous systems and software. The curriculum provides the foundations, perspectives, and state-of-the-art knowledge in the different disciplines taught by leading researchers in the field. Through an ambitious program with research visits, partner universities, and visiting lecturers, the graduate school actively supports forming a strong multi-disciplinary and international professional network between PhD-students, researchers and industry. The graduate school provides added value on top of the existing PhD programs at the partner universities, providing unique opportunities for students who are

dedicated to achieving international research excellence with industrial relevance.

WASP involves seven Swedish universities together with numerous Swedish industries. At Lund University the following four departments participate: Department of Automatic Control, Department of Computer Science, Department of Electrical and Information Technology, and the Mathematical Imaging Group at the Department of Mathematics.

During 2021 a new cluster model has been introduced. In the new model three types of clusters are supported. Core technical clusters are meeting points for WASP PhD students working with related research problems. The Application clusters gather students and WASP faculty that are active in the same application domain and, finally, the Area clusters gather students and WASP faculty that are active in the same technical area.

During 2021 a new funding instrument called NEST was introduced that encourages cross-disciplinary projects characterized by Novelty, Excellence, Synergy, and Teams. A NEST consists of 4 PIs (one PI and three co-PIs) and four PhD students or postdocs. In the first call nine NESTs were approved. Three faculty at the department (Anders Rantzer, Martina Maggio, and Emma Tegling) were involved as co-PIs in two of the NESTs. These will start in April 2022 and run for five years.

Furthermore a new initiative, WASP-DDLS, was initiated during 2021 where the two largest research programs in Sweden, the Wallenberg AI, Autonomous Systems and Software Program (WASP) and the SciLifeLab and Wallenberg National Program for Data-Driven Life Science (DDL),

will team up in a new collaborative effort, with the ultimate goal of solving groundbreaking research questions and to create synergies across disciplines. In the first call for projects the only faculty member from Lund University receiving funding was Bo Bernhardsson, who is co-PI in a project about pharmacometric modeling.

At the beginning of 2022 WASP funds the following positions at our department: 9 academic PhD students, 1 industrial PhD students

(with Saab Kockums), 6 affiliated PhD students (funded from other sources), 1 associate professor (Emma Tegling), and 1 postdoc. In December 2021 industrial PhD student Per Skarin from Ericsson defended his PhD thesis.

Karl-Erik Årzén (WASP Co-director for Research Program Coordination since beginning 2021) and Anders Rantzer are involved in the management of WASP and Monika Rasmusson is the WASP Financial Officer for Lund University.

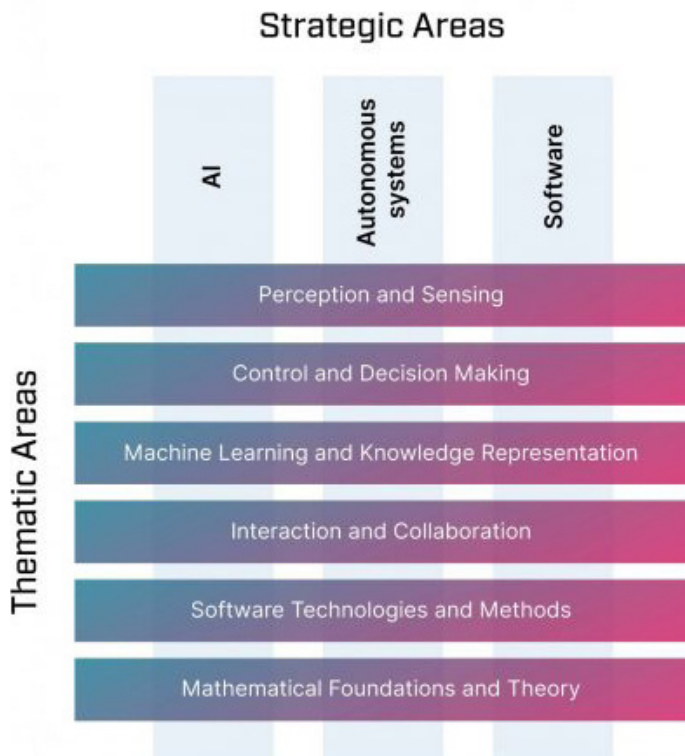

The research in WASP can be illustrated as a matrix with two dimensions, a strategic dimension and a thematic dimension. The strategic dimension emphasizes areas of impact on individuals, society, and industry, whereas the thematic areas represent the underlying scientific and technological challenges that are common to all types of autonomous systems.

The research is conducted at seven Swedish universities: Chalmers University of Technology, KTH Royal Institute of Technology, Linköping University, Lund University, Umeå University, Örebro University, and Uppsala University.

HI2OT – NORDIC UNIVERSITY HUB ON INDUSTRIAL INTERNET OF THINGS

Reseachers: Karl-Erik Årzén, Martina Maggio, Anders Robertsson, Anton Cervin, Johan Eker, Tommi Berner, Per Skarin, Alexandre Martins, Claudio Mandrioli, Nils Vreman, Albin Heimerson, Johan Ruuskanen, Marcus Greiff

Partners: DTU – Technical University of Denmark, Lund University, KTH – Royal Institute of Technology, NTNU – Norwegian University of Science and Technology, Aalto University

Funding: Nordforsk - Nordic University Hubs

The overall aim of HI2OT is to promote Nordic collaboration in Industrial Internet of Things (IIoT), which will increase the capacity of the participating organizations and create the critical mass needed to establish a world-leading Nordic research environment on IIoT.

There will soon be 50 billion “smart things” worldwide. When these become interconnected they form the Internet of Things, IoT. Industrial IoT (IIoT) is providing the infrastructure that underpins our Smart Society (Smart Energy Grid, Smart Cities, Smart and Green Mobility, Smart Manufacturing, etc.).

The proposal Nordic University (H)ub on (I)ndustrial (IoT) (HI2OT) is focused on Industrial IoT, a Nordic area of growth and a key technology enabler in solutions to several societal challenges. IIoT will only become a reality through the convergence of Operational and Information Technologies (OT & IT), which are currently separated. This will require multidisciplinary large-scale research effort. Hence, HI2OT brings together the strongest Nordic research groups in IIoT (8 groups at 5 universities) to form a long-term partnership for expanding IIoT cooperation in the Nordic region.

The overall aim of HI2OT is to promote Nordic collaboration in IIoT, which will increase the capacity of the participating organizations and create the critical mass needed to establish a

world-leading Nordic research environment on IIoT. HI2OT provides a unique integration of expertise, generating the synergies required to support the convergence of IT and OT. HI2OT will build a platform and a community to strengthen and structure the IIoT research and innovation. This will enhance strengthen national research and innovation systems by increasing their capacity, increase the ability of Nordic nations to address European and global cooperation and competition in IIoT, as well as increasing their competitiveness and growth via research and innovation.

The current Nordic IIoT research efforts are fragmented and address local national industries, lacking the necessary mass to become an international area of excellence. Research infrastructures are not cost-efficient, and will require the pooling of resources through increased coordination. HI2OT will build a platform and a community to strengthen and structure the IIoT research and innovation. HI2OT fits perfectly with the objectives of the participating universities, who have explicit IIoT strategies and strategies for Nordic cooperation. HI2OT will enhance the competitiveness of participating institutions, strengthen national research and innovation systems by increasing their capacity, and increase the ability of Nordic nations to address European and global cooperation and competition in IIoT.

RESEARCH AREAS

The goal of the department is to provide students with a solid theoretical foundation combined with a good engineering ability. This is reflected in the research program which covers both theory and applications. **Automatic control, mathematics, and computer science form the core of all our research.**

The research activities can roughly be divided into three thematic areas:



LARGE-SCALE SYSTEMS AND LEARNING

What do traffic networks, wind farms, Facebook and economic markets have in common? They are all large-scale networked systems, which can be analyzed and optimized using automatic control techniques.



AUTONOMOUS REAL-TIME SYSTEMS

Their vision? To create user-friendly, self-adaptive, resilient, high-performing systems, with low latency and jitter, while being cost-effective.



INNOVATIVE CONTROL APPLICATIONS

This is an area of application-driven research motivated by the desire to create a more sustainable society. It addresses several of the UN's 17 Sustainable Development Goals.

LARGE SCALE SYSTEMS AND LEARNING

What do traffic networks, wind farms, Facebook and economic markets have in common? They are all large-scale networked systems, which can be analyzed and optimized using automatic control techniques. By developing scalable methods for control and optimization, researchers at the Department of Automatic Control are contributing to solving one of the greatest challenges in modern engineering - the sustainable and safe operation of these large-scale systems.

A significant part of this field of research is directed towards developing theories and methodologies supporting the design and verification of distributed control structures. Other important parts focus on combining classical physics-based models with machine-learning tools, and combining models for traditional networks, for example, for electricity and heating, with learning algorithms for consumer behavior and decision-making. The aim is to improve efficiency and reliability, while at the same time reducing costs.

Ongoing projects:

- Dynamics, Information and Control in Networks
- Structured Controllers for Transportation
- Learning and Adaptation
- Large-Scale Convex Optimization
- Scalable Control Using Learning and Adaptation
- Statistical and Adversarial Learning in Continuous System Control
- AI4GNC - Artificial Intelligence Techniques for Guidance, Navigation and Control
- ICARUS - Intelligent Cell-Free Access for wiReless Ubiquitous Services
- Efficient Learning of Dynamical Systems
- Throughput Control in Autonomous Networks

DYNAMICS, INFORMATION AND CONTROL IN NETWORKS

Researchers: Martin Heyden, Richard Pates, Giacomo Como, Anders Rantzer, Emma Tegling

Funding: ERC, VR and SSF

Large-scale networks play a constantly increasing role in our modern society, e.g., affecting the access to essential services like mobility and energy, influencing the outcome of electoral polls, and determining the quality of the economic systems.

The Department hosts a research group on Dynamics, Information, and Control in Networks.

The focus of this group is on the mathematical foundations of large-scale network systems with particular emphasis on issues related to their resilience, centrality, and scalability. Applications include cyber-physical systems, transportation networks, as well as social and economic networks.

One project is focused on transportation networks, with publications about decentralized traffic signal control and distributed dynamic tolls.

Another project studies the interplay between economics and traffic flows in transport

networks. We will study exchange equilibria in traffic networks and network dynamics in presence of human decision makers. The goal is to gain deeper understanding of, and be able to exploit, the interaction between node demands and network flows.

STRUCTURED CONTROLLERS FOR TRANSPORTATION

Researchers: Martin Heyden, Richard Pates, Anders Rantzer

Funding: SSF

The goal of this project is to find structured controllers applicable to general transportation problems. The controllers should be structured in a way that facilitates an efficient implementation. Making them applicable for both large-scale systems, or for transportation systems with limited communication bandwidth.

The transportation systems will be modeled as a graph, where nodes correspond to a storage location for the quantity under transportation and the links to the possible transportation paths. For example, for a logistic system, the nodes correspond to the different warehouses and stores, while the links correspond to the different truck routes used to transport the goods.

We will study the behavior around a nominal solution. This nominal solution could be found on a more detailed model, taking effects such as saturation, quantization, and congestion into account.

Most control designs are either centralized, requiring full knowledge of the system in every part of the system, or decentralized, using none of the information available in other nodes.

The controllers designed in this project will be a middle ground between the centralized and decentralized structures. The goal is that this will result in an optimal trade-off between controller performance and implementation complexity. This will result in using as much information as possible, while still allowing the controller to be implemented for systems with many nodes, or systems with limited communication bandwidth.

In 2021 the derived controller was applied to a detailed model for water irrigation networks where it was shown to have better performance than PI controllers.

LEARNING AND ADAPTATION

Researchers: Johan Grönqvist, Christian Rosdahl, Olle Kjellqvist, Frida Heskebeck, Carolina Bergeling, Bo Bernhardsson, Anders Rantzer

Funding: WASP and ERC

There are many important applications where classical physics based models need to be combined with machine learning tools. A good example is in autonomous driving, where automotive industry have extensive experience of control technology such as ABS braking, cruise

control and ESP systems for vehicle stabilization. This technology now needs to be combined with machine learning methods to analyze traffic situations and human behavior. To do this in a safe and robust manner, it is essential to understand how learning algorithms for discrete sequential

decision-making can interact with continuous physics based dynamics. Many other applications can be found. In the energy sector, well established control solutions for power networks and generators are increasingly being combined with learning algorithms for consumer behavior and decision-making, to minimize costs and optimize efficiency. In medicine, standard practice for disease therapies is combined with expert systems and sequential decision-making for medical diagnosis.

In our collaboration project with Alexandre Proutiere at KTH the aim is to bridge the gap between machine learning and control engineering. These research fields have traditionally evolved more or less separately, but in recent years the intersections in terms of applications as well theoretical challenges have been gro-

wing. This project is concerned with sequential decision making in systems whose dynamics are initially unknown, i.e., with adaptive control or reinforcement learning. Statistical models are of fundamental importance in both areas, but while learning theory has been focused on sample complexity and regret, the corresponding control literature is discussing stability robustness and asymptotic performance. An important focus of our project is the tradeoff between exploration and exploitation, sometimes known as "dual control". The optimal tradeoff strategy can be formulated as the solution to a dynamic programming problem. We study properties of the solution as well as computational schemes. Optimal strategies are compared with common heuristics, both in control and reinforcement learning.

LARGE SCALE CONVEX OPTIMIZATION

Researchers: Pontus Giselsson, Sebastian Banert, Mattias Fält, Martin Morin, Hamed Sadeghi, Manu Upadhyaya

Funding: VR and WASP

Optimization is a modeling tool that has been used in many engineering fields for a long time. It can be used, e.g., for optimal control, financial decision making, signal reconstruction, route planning, statistical estimation, and training of supervised learning machines. Different optimization problems have different properties and fall into different categories. They can be coarsely divided into convex or nonconvex problems, smooth or nonsmooth problems, and small-scale or large-scale problems. Contemporary optimization problems in, e.g., machine learning, signal reconstruction, control, and statistical estimation are often large-scale. The research in this group is focused on understanding and developing efficient algorithms for solving such problems. We

focus on convex and nonsmooth problems with a primary focus is on so-called operator splitting methods and their stochastic variants. In particular, we develop frameworks for understanding a wide range of operator splitting methods that allow for a unified analysis and paves the way for design of new and improved algorithms. We also develop tools for automated algorithm analysis in which a so-called performance estimation optimization problem is formulated that exactly captures the worst possible performance of an optimization algorithm for some user-specified class of optimization problems. A solution to this, typically small-scale, performance estimation problem can give convergence guarantees for the analyzed algorithm.

SCALABLE CONTROL USING LEARNING AND ADAPTATION

Researchers: Olle Kjellqvist, Anders Rantzer, Bo Bernhardsson

Funding: ERC

At the United Nations Summit 2015, our world leaders adopted 17 Sustainable Development Goals. A necessary condition for the completion of these goals is efficient, reliable, and safe infrastructure. For example, Goal 7: Affordable and Clean Energy requires infrastructure robust to loss of the inertia prevalent in conventional power plants, such as coal, gas, and nuclear power. As the nature of consumption and production changes, the networks' structures and underlying control mechanisms must keep up. Unfortunately, many of the anticipated changes increase the load and introduce additional complexity. Examples are micro-producers of electricity, autonomous vehicles in transportation networks, and increased nodes in communication networks. As complexity can increase by orders of magnitude, controlling these networks

requires models at an entirely new scale. Manually sustaining accurate models of individual components becomes infeasible. A solution is to use adaptation and learning to automatically learn and sustain models, taking care to do so in a reliable and scalable way.

We address the fundamentals of scalable modeling's technical challenges using adaptation and learning. We study minimax control and graph realizability of controllers, meaning controllers that respect information exchange constraints in networks. The aim is to synthesize algorithms for scalable, robust adaptive control that automatically sustains accurate models of highly complex networks. Such algorithms can facilitate the complex technologies and infrastructures needed to reach the Sustainable Development Goals.

STATISTICAL AND ADVERSARIAL LEARNING IN CONTINUOUS SYSTEM CONTROL

Researchers: Johan Grönqvist, Olle Kjellqvist, Anders Rantzer

Funding: WASP, ERC

This project aims to bridge the gap between machine learning and control engineering. These research fields have traditionally evolved more or less separately, but in recent years the intersections in terms of applications as well theoretical challenges have been growing. This project is concerned with sequential decision making in systems whose dynamics are initially unknown, i.e., with adaptive control or Reinforcement Learning (RL) when using the control engineering and machine learning terminologies, respectively.

We will work on problems where disturbances are assumed to be of worst-case nature. In control theory, this assumption is the basis for H-infinity optimal control, which was introduced in the 1980s to counteract the fact that optimization in a statistical setting often gives poor robustness to unmodeled dynamics.

Inspired by the theory for robust control, based on worst-case assumptions, we would like to develop a theory to make RL or adaptive control algorithms robust to unmodeled dynamics.

AI4GNC - ARTIFICIAL INTELLIGENCE TECHNIQUES FOR GUIDANCE, NAVIGATION, AND CONTROL

Researchers: Anton Cervin, Anders Rantzer, Johan Grönqvist, Olle Kjellqvist, Venkatraman Renganathan, Emil Vladu, Manu Upadhyaya

Funding: ESA

The goal of this ESA-funded project is to investigate the feasibility of recent advances in control and AI for space missions. The first step is to review the state of the art in AI for the development and implementation of embedded guidance, navigation, and control (GNC) systems. The objective is to improve the GNC design process and manage system complexity through the vertical and horizontal integration of disciplines. Upon the outcome of the review, we will establish the functional and performance requirements applicable to an AI-assisted GNC design process and to an AI-augmented GNC system.

In the second phase of the project, we will perform a trade-off of suitable mathematical AI approaches compatible with the current GNC architectures and design processes (model-based approach), including complexity, effort,

and expected benefits assessment. This will allow us to establish the AI techniques suitable to the modeling, control, and verification needs in the view of robust and explainable AI-supported GNC architectures and functions.

In the last stage, we will develop a prototype set of benchmark problems for AI-assisted GNC design and AI-augmented GNC systems as well as for AI-supported autonomy (using an in-orbit assembly scenario or precision landing scenario including handling of failures and degradations). We will then perform a detailed design and coding of the established AI techniques applied to AI-assisted GNC design and to the AI-augmented GNC system. Finally, we will assess the performance and robustness of the AI-assisted GNC system and define the way forward for AI-GNC system deployment.

ICARUS - INTELLIGENT CELL-FREE ACCESS FOR WIRELESS UBIQUITOUS SERVICES

Researchers: Pontus Giselsson, Sebastian Banert, Mustafa Yetis

Funding: WASP

In this WASP expedition project, we lay the practical foundation for operating autonomous “cell-free” wireless networks. Instead of breaking down the network operation into independent cells, which is the cause of the inter-cell interference that drags down the performance of

cellular networks, all the access points in a cell-free network serve all users. Simply speaking, the interference is turned into desired signals. This project will take the first major leaps in achieving this using learning techniques.

EFFICIENT LEARNING OF DYNAMICAL SYSTEMS

Researchers: Christian Rosdahl, Bo Bernhardsson, Anton Cervin, Anders Rantzer

Funding: WASP

The research project focuses on efficient learning of dynamical systems. Some methods for controlling partially unknown systems are examined. We strive to find control policies that balance exploration and exploitation, in the sense that relevant uncertainties are diminished such that

the long-term control performance is improved. To this end, classical control methods, such as dual control, are combined with modern machine learning techniques. As a practical example of control of a complex dynamical system, we plan to examine a chiller process.

THROUGHPUT CONTROL IN AUTONOMOUS NETWORKS

Researchers: Emil Vladu, Anders Rantzer, Richard Pates, Carolina Bergeling

Funding: ERC

In many areas of application, it is important to suppress the impact of disturbances and model uncertainties on the desired output behavior. Large-scale systems in particular benefit additionally from transparent and sparse controllers. In this research, we are interested in sparse

controller structures which give rise to optimal or near-optimal worst-case disturbance attenuation. Our research output thus far considers linear as well as nonlinear systems, and positive systems in particular.

AUTONOMOUS REAL-TIME SYSTEMS

A significant part of the research in this field revolves around cyber-physical systems, clouds, and cloud control. Historically, control systems have been deployed as monolithic software implementations on carefully tuned hardware, adjacent to the plants they control. This has resulted in systems that are undesirably non-modular, not easily extensible and that have limited ability to self-adapt. In contrast, feedback-based cyber-physical systems and cloud-native applications offer the prospect of greater accessibility and flexibility, as well as higher reliability and lower latencies. Furthermore, when applications are implemented in a disaggregated manner, their execution can be distributed across the system's many nodes, migrated, and scaled to meet individual objectives as well as that of the system as a whole.

Ongoing projects:

- Autonomous Cloud
- Autonomous Datacenters – AutoDC
- Optimizing Radio Access Networks for Efficient Massive MIMO
- Robust and Secure Control over the Cloud
- Event-Based Control of Stochastic Systems with Application to Server Systems
- Event-Based Information Fusion for the Self-Adaptive Cloud
- Testing of Autonomous Systems
- Towards Adaptively Morphing Embedded Systems
- Mission-Critical Control over the Cloud
- Control-based Resource Management in the Distributed Cloud
- Autonomous Camera Systems in Resource Constrained Environments

AUTONOMOUS CLOUD

Researchers: Karl-Erik Årzén, Martina Maggio, Johan Eker, Tommi Berner, Per Skarin, Alexandre Martins, in collaboration with the Department of Electrical and Information Technology at LTH, Umeå University, and KTH.

Funding: WASP

Background

An increasing amount of computing and information services are moving to the cloud, where they execute on virtualized hardware in private or public data centers. Hence, the cloud can be viewed as an underlying computing infrastructure for all systems of systems. The architectural

complexity of the cloud is rapidly increasing. Modern data centers consist of tens of thousands of components, e.g., compute servers, storage servers, cache servers, routers, PDUs, UPSs, and air-conditioning units, with configuration and tuning parameters numbering in the hundreds of thousands. The same increasing trend holds

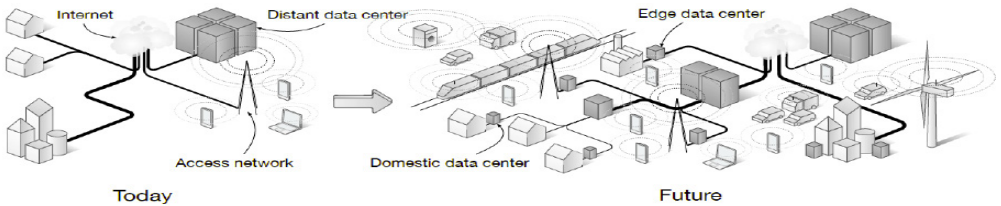

The following figure illustrates how the computations in the distributed cloud are migrating from back-end data centers out in the network.

for the operational complexity. The individual components are themselves increasingly difficult to maintain and operate. The strong connection between the components furthermore makes it necessary to tune the entire system, which is complicated by the fact that in many cases the behaviors, execution contexts, and interactions are not known a priori. The term autonomous computing or autonomic computing was coined by IBM in the beginning of the 2000s for self-managing computing systems with the focus on private enterprise IT systems. However, this approach is even more relevant for the cloud. The motivation is the current levels of scale, complexity, and dynamicity which make efficient human management infeasible. In the autonomous cloud control, AI, and machine learning/analytics techniques will be used to dynamically determine how applications should be best mapped onto the server network, how capacity should be automatically scaled when the load or the available resources vary, and how load should be balanced.

Currently there is also a growing interest in applying cloud techniques, such as virtualization and collocation, in the access telecommunication network itself. The unification of the telecom access network and the traditional cloud data centers, sometimes referred to as the distributed cloud, provide a single distributed computing platform. Here the boundary between the network and the data centers disappears, allowing application software to be dynamically deployed in all types of nodes, e.g., in base stations near

end-users, in remote large-scale datacenters, or anywhere in between. In these systems the need for autonomous operation and resource management becomes even more urgent as heterogeneity increases, when some of the nodes may be mobile with varying availability, and when new 5G-based mission-critical applications with harder requirements on latency, uptime, and availability are migrated to the cloud.

Project outline

In the project distributed control and real-time analytics will be used to dynamically solve resource management problems in the distributed cloud. The management problem consists of deciding the types and quantities of resources that should be allocated to each application, and when and where to deploy them. This also includes dynamic decisions such as automatic scaling of the resource amount when the load or the available resources vary, and on-line migration of application components between nodes. Major scientific challenges include dynamic modeling of cloud infrastructure resources and workloads, how to best integrate real-time analytics techniques with model-based feedback mechanisms, scalable distributed control approaches for these types of applications and scalability aspects of distributed computing.

In order to develop efficient methods for resource management, it is crucial to understand the performance aspects of the infrastructure, what the workloads look like, and how they vary over time. Hence, Infrastructure modeling and

Workload modeling for the distributed cloud are important topics. Due to user mobility and variations in usage and resource availability, applications using many instances are constantly subject to changes in the number of instances; the individual instances relocated or resized; the network capacity adjusted; etc. Capacity autoscaling is needed to determine how much capacity should be allocated for a complete application or any specific part of it; Dynamic component mapping to determine when, where, and how instances should be relocated, e.g., from a data center to a specific base station; and Optimized load mix management to determine how to “pack” different instances on individual servers or clusters. Since not all applications are equally important, e.g., due to differently priced service levels or due to some being critical to society (emergency, health care, etc.), the solutions to the three problems above must take into account Quality of Service differentiation. Finally,

we address Holistic management to perform full-system coordination.

The primary software infrastructure will be based on Calvin, an open source application environment developed by Ericsson and aimed at distributed clouds for IoT services. Calvin is based upon on the well-established actor model, it scales well, and it supports live migration of application components. We believe this infrastructure is suitable to investigate the application performance behavior of future commercial systems and validate our developed management solutions. It will enable accurate estimations of, for example, application latency and system loads.

The project results have the potential to be demonstrated in several WASP demonstrator arenas, including the Autonomous Research Arena (ARA), the Ericsson Research Data Center (ERDC); as well as in different university lab facilities.

AUTONOMOUS DATACENTERS – AUTODC

Researchers: Karl-Erik Årzén, Johan Eker and Albin Heimerson, in collaboration with KTH, Luleå University, Aalto University, Ericsson, RISE, and twelve other partners

Funding: Vinnova

With growth in the data center market expected to continue, the cost of operating and maintaining the data centre footprint will increase. The aim of AutoDC is to provide an innovative design framework for autonomous data centers to enable ongoing operation and self-healing indepen-

dent of contextual interference, e.g. intermittent power failure or overheating, without the need for any human intervention. Due to lower maintenance and operation costs, autonomous data centers can become key enablers of markets in developing countries.

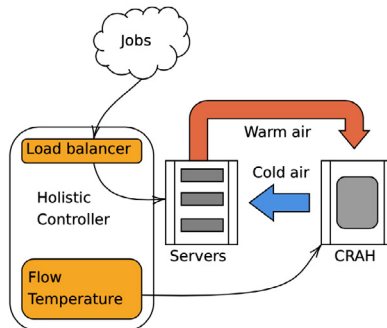

The ITEA3 project AutoDC successfully passed the final review in October 2021. It was a collaboration project lead by RISE with over 20 partners from Sweden, Canada, and Finland. Researchers from the control department contributed with expertise on feedback control and reinforcement learning. The initial result showed substantial power savings for data center energy management. A second piece of work on rein-

forcement learning for cloud resource scheduling resulted in a filed patent with Ericsson. The third leg of the engagement in the AutoDC project was a collaboration around anomaly detection and closed loop control of cloud services. We had a MsC project together with Ericsson where we designed and implemented a data collection and anomaly detection pipeline at Ericsson Research Datacenter.

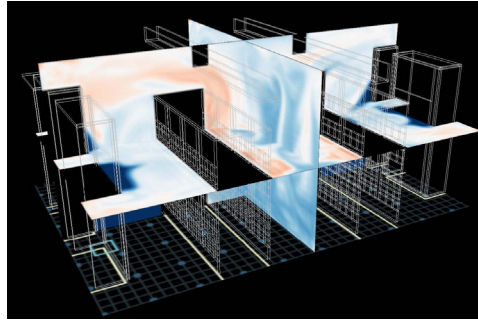

OPTIMIZING RADIO ACCESS NETWORKS FOR EFFICIENT MASSIVE MIMO

Researchers: Dino Pjanic, Fredrik Tufvesson, Bo Bernhardsson

Funding: SSF

Massive MIMO has today been incorporated as one of the main technologies in the standard to meet the requirements for 5G. While the core technology is in place, there are still many open topics with respect to the implementation and optimization of the cellular network using this technology. In this project, we aim for a machine learning approach for efficient operation of cellular networks based on massive MIMO. The many antennas in massive MIMO base stations give access to details in the radio channel and opens up for better prediction of both small scale behaviour such as user correlation as well as large scale behaviour such as mobility patterns. This in turn can lead to new opportunities with respect to scheduling approaches and handover strategies in order to provide low latency reliable user connection in mixed and dynamic environments.

The project is divided into four work packages

1. Long and short term channel prediction in massive MIMO
2. Mobility and traffic pattern estimation, handover prediction
3. Physical and virtual UE positioning based on network data, and
4. 5G user scheduling based on machine learning.

We will use a mix of experiments from the massive MIMO testbed at Lund University together with state of the art network simulators and real world traffic patterns to achieve our end goal: A machine learning enabled scheduling framework for mixed traffic in realistic 5G networks.

ROBUST AND SECURE CONTROL OVER THE CLOUD

Researchers: Anton Cervin, Max Nyberg Carlsson, Karl-Erik Årzén, Zebo Peng, Petru Eles, Yungang Pan in cooperation with Linköping University

Funding: ELLIIT

The ELLIIT-funded research project Robust and Secure Control over the Cloud runs between 2021 and 2025 and is a collaboration between the Department of Automatic Control and the Embedded Systems Laboratory at Linköping University, with one PhD student at each site. The project will develop theory and design methodology to explore the interplay between local and cloud-based control as well as the trade-offs between robustness, security, and adaptivity. The Lund team focuses on the control and autonomy aspects, while the Linköping team focuses on security and optimization. The results will be verified in real feedback control experiments over the cloud.

The cloud, with its virtually infinite storage and compute capacity, provides ample opportunities for applying advanced control and estimation algorithms in completely new settings. While local feedback is needed to ensure the stability of individual control applications regardless of the current status of the network, the cloud is ideal for running high-level control and optimization algorithms in large-scale networked systems. Compute-intensive algorithms such as model-predictive control (MPC), particle filtering, and reinforcement learning can exploit the massive amounts of data generated by local devices to

continuously adapt to the circumstances and optimize the overall system behavior. Fast-growing market demands, the need to reduce production cost, flexible product lines, and scalability issues are all driving forces towards shifting the control applications from being implemented on dedicated hardware to pieces of software running in the cloud.

Performing the control computations in the cloud, however, creates new challenges related to security and robustness. The main control-theoretical research challenge is how to ensure the stability and robustness of control loops closed over the cloud, despite the unpredictable capacity and timing overheads at all hardware and software layers and their impact on the control quality. In the literature on networked control systems, it is typically assumed that packet drops and network delays follow known probability distributions or have known upper bounds. This allows stability and control performance to be predicted through either analysis or simulation. However, if the design-time assumptions are violated at run-time, then the control system has to perform a safe shut-down. With cloud-based feedback control calculations, guarantees must be adaptive and generated on the fly, based on the current operating conditions.

EVENT-BASED CONTROL OF STOCHASTIC SYSTEMS WITH APPLICATION TO SERVER SYSTEMS

Researchers: Marcus Thelander Andrén, Anton Cervin, Bo Bernhardsson, Kristian Soltesz, Albin Heimerson

Funding: VR

With the current strong trend towards networked and autonomous systems, it becomes less realistic to demand that all elements of a control loop should operate in a synchronous, time-triggered fashion. Above the lowest level of feedback control, it is often more natural and efficient to communicate, decide, and act based on events. Previous work shows that event-triggered control can achieve both lower average sampling rates and better performance than standard, periodic control. There is however not yet a coherent theory for the analysis and synthesis of event-based controllers.

The aim of this project is to develop theory, tools, and design methodology for event-based

control of stochastic systems. The overall goals are more efficient resource usage and better performance compared to standard sampled-data control. At the same time, the methods are aimed at a wider class of control problems, including those that combine local feedback with higher-level decision-making. Such features are common in various applications such as autonomous vehicles, traffic routing, control of computing systems, supervisory plant control, and resource management in the cloud.

During the final phase of the project, we are investigating methods for combined identification and control of large server systems modeled as queueing networks.

EVENT-BASED INFORMATION FUSION FOR THE SELF-ADAPTIVE CLOUD

Researchers: Johan Ruuskanen, Anton Cervin, Karl-Erik Årzén

Funding: WASP

Successful self-adaptive resource provisioning in the cloud relies on accurate tracking of workload variations and timely detection of changes in the infrastructure. The general estimation problem is very challenging due to the massive number of observable events in various subsystems, each containing some useful information. In this project, we will develop novel, event-based estimation techniques for information fusion in cloud server systems. Our starting point will be the family of Monte Carlo-based inference

methods known as Particle Filters, which will be adapted to handle event-based measurements from different sources and with different time scales. The results will enable more responsive and exact decision making in the autonomous cloud.

In 2021 we focused on modeling and identification of networks of microservices using queueing models and measurements from Cloud applications.

TESTING OF AUTONOMOUS SYSTEMS

Researchers: Claudio Mandrioli, Martina Maggio, Karl-Erik Årzén

Funding: WASP

Many cyber-physical systems change their behaviour depending on environmental data and internal states. This is the case of control systems, that compute a control signal that depends on input values like a desired position, measured values like the current position, and internal states like the previous control action. This is also the case of systems embedding machine learning algorithms, that receive new samples and incorporate what they learnt using these new samples into a policy that determines how to behave in new conditions. All these systems are adaptive, in that their behaviour changes over time in a prescribed - but a priori unpredictable - way. This project is about testing and comparing systems that incorporate some adaptivity.

Testing systems whose behaviour varies over time is difficult. Think of a machine learning algorithm: how many and which samples should we give to the system before we can consider its behaviour testable? And what is the correct outcome? Of course we can apply unit testing to each function in the code, check for coverage, select a few cases in which the ideal behaviour of the code is known. But this does not give us any guarantee that the code is behaving correctly

for the task it has to complete in the physical environment.

We advocate that a formal and rigorous methodology is needed to test systems with adaptivity like self-adaptive software. This methodology should be used in conjunction with other forms of testing (e.g., unit testing) to provide guarantees on the cyber-physical system behaviour.

When learning is involved, it is impossible to provide any deterministic guarantees, since the function to be learnt may not have been explored. In such cases, drawing any general conclusion is impossible (and undesirable), unless probabilistic guarantees are targeted. We are convinced that this is true also for adaptive software and a paradigm shift is necessary for its testing: guarantees deriving from the tests' execution should be provided in the probabilistic space rather than in the deterministic one.

In the probabilistic space, we investigate three alternative methods to analyse testing data and provide guarantees:

- Monte Carlo experiments
- Extreme Value Theory
- Scenario Theory

TOWARDS ADAPTIVELY MORPHING EMBEDDED SYSTEMS - ADMORPH

Researchers: Martina Maggio, Nils Vreman, Anton Cervin

Funding: EU Horizon2020

Due to the increasing performance demands of mission- and safety-critical Cyber Physical Systems (of Systems) – CPS(oS) – these systems exhibit a rapidly growing complexity, manifested by an increasing number of (distributed) computational cores and application components connected via complex networks.

However, with the growing complexity and interconnectivity of these systems, the chances of hardware failures as well as disruptions due to cyber-attacks will also quickly increase. System adaptivity, foremost in terms of dynamically remapping of application components to processing cores, represents a promising technique to fuse fault- and intrusion tolerance with the increasing performance requirements of these mission- and safety-critical CPS(oS). In the ADMORPH project, we evaluate this hypothesis using a novel, holistic approach to the specification, design, analysis and runtime deployment of adaptive, i.e., dynamically morphing, mission- and safety-critical CPS(oS) that are robust against both component failures and

cyber-attacks. To this end, we will address four aspects that are instrumental for the realisation of these adaptively morphing systems:

- the formal specification of adaptive systems
- adaptivity methods like strategies for maintaining safe and secure control of CPS(oS)
- analysis techniques for adaptive systems to, e.g., perform timing verification of adaptive systems to avoid timing violations after system reconfigurations
- run-time systems for adaptive systems that realise the actual run-time system reconfigurations to achieve fault and intrusion tolerance

The developed methodologies, methods and tools will be evaluated using three industrial use cases taken from the radar surveillance systems, autonomous operations for aircrafts, and transport management systems domains.

MISSION-CRITICAL CONTROL OVER THE CLOUD

Researchers: Per Skarin, Karl-Erik Årzén, Maria Kihl, Martina Maggio, Johan Eker

Funding: WASP

Cloud technology has swiftly transformed the ICT industry and it is continuing to spread. Many ICT applications are suitable for cloud deployment in that they have relaxed timing or performance requirements. In order to take the cloud concepts beyond the ICT domain and apply it to mission critical use cases such as industrial automation, transport and health care we must provide guarantees and predictability. To this end we need new tools and new ways of working. This project attacks this problem

from two angles. We will work at developing a cloud infrastructure with a deterministic behaviour, thereby suitable for critical applications. Zero-touch configuration of the cloud based on feedback is a fundamental building block in our approach. Secondly we will showcase the viability of the hardened cloud through mission critical cloud application running in a real data center and operating real-world process, e.g. robotics, unmanned vehicles.

CONTROL-BASED RESOURCE MANAGEMENT IN THE DISTRIBUTED CLOUD

Researchers: Tommi Berner, Karl-Erik Årzén, Martina Maggio

Funding: WASP

In the project control and real-time analytics are used to dynamically solve resource management problems in the distributed cloud. The management problem consists of deciding the types and quantities of resources that should be allocated to each application, and when and where to deploy them. This also includes dynamic decisions such as automatic scaling of the resource amount when the load or the av-

ailable resources vary, and on-line migration of application components between nodes. Major scientific challenges include dynamic modeling of cloud infrastructure resources and workloads, how to best integrate real-time analytics techniques with model-based feedback mechanisms, scalable distributed control approaches for these types of applications and scalability aspects of distributed computing.

AUTONOMOUS CAMERA SYSTEMS IN RESOURCE CONSTRAINED ENVIRONMENTS

Researchers: Alexandre Martins, Karl-Erik Årzén, Martina Maggio, and Mikael Lindberg at Axis

Funding: WASP

The future networked society will contain a huge number of devices, many of them processing a very large amount of sensor data. One example of this is distributed video cameras in surveillance and supervision applications. Due to efficiency and price constraints the communication and computing platforms are often limited, hence dynamic resource management is required. This project aims to turn camera systems into a swarm of autonomous scene-learning devices that share the same resources, turning today's central server as a viewing-only client. The sys-

tems will make sure that available resources are dynamically and optimally allocated at all time. The swarm will be completely flexible allowing devices to be added or removed from it and re-allocating resources accordingly. Each of these devices will be communicating with its surroundings, and, will in the process learn situation specific parameters, such as resources availability and expenditure, scene properties etc, in order to predict future resource needs and allow for superior system wide resource management.

INNOVATIVE CONTROL APPLICATIONS

This is an area of application-driven research motivated by the desire to create a more sustainable society. It addresses several of the UN's 17 Sustainable Development Goals. It also has an impact on LTH's five core research areas, meaning that this field of research is important in digitalization, industry, the built environment, our climate, and life itself.

Numerous applications are being addressed, for example, within robotics, health care, the process industry, combustion engines, and smart manufacturing. A substantial part of the research takes place in the robotics lab. Apart from research on automatic control, this focus area also concentrates on teaching and learning methods, standards for smart industries, and innovation indexes.

Much of the research is performed in collaboration with, and is co-funded by, industrial partners.

Ongoing projects:

- Robotics Lab
- Construction Robotics of today and tomorrow
- Semantic Mapping and Visual Navigation for Smart Robots
- Autonomous Flight (UAS@Lund)
- The Future Drones
- Hemodynamic Stabilization
- On Humans for Humans
- Historical Female Influencers in Automatic Control
- DigIT Hub
- DSKM - Digitalisation and Standardisation for Customized Mass Production
- Strategies and Standards for Smart Swedish Industry - 4S
- Forum for Standardisation of Digitalisation in Production
- Real-Time Individualization of BCIs

ROBOTICS LAB

The Robotics Lab at LTH is an experimental arena shared by the Department of Automatic Control and the Department of Computer Science. Robotics is a multi-disciplinary topic, and we collaborate with both national and international robotics colleagues regarding different aspects of robotics and we also have a close cooperation with industrial partners. Our main research is in motion and compliance control, control system architectures and different sensor fusion problems with application mainly to industrial manipulators. We mainly use modified industrial robot control systems and UAVs as experimental platforms.

The purpose of past and present research projects is to show how to organize open robot control systems and to verify these ideas by means of experimental verification. As a part of this research, we have developed several experimental open robot control systems. The systems are built around industrially available robots that have been reconfigured for experimental purposes.

The developed specific robot interfaces and the integration of the robots into a complete system forms a unique environment for testing and development of algorithms for improvement of performance, sensor integration, programming automation and autonomous operation. New sensor interfaces with modification of hardware and realtime software architectures have been developed to accommodate the use of force control algorithms based on workspace sensing. The research in this area has been awarded with e.g., the EURON Technology Transfer award and an ICRA Best Automation paper.

Current robotics-related projects at the department include:

- Construction Robotics of Today and Tomorrow
- Semantic Mapping and Visual Navigation for Smart Robots
- Autonomous Flight

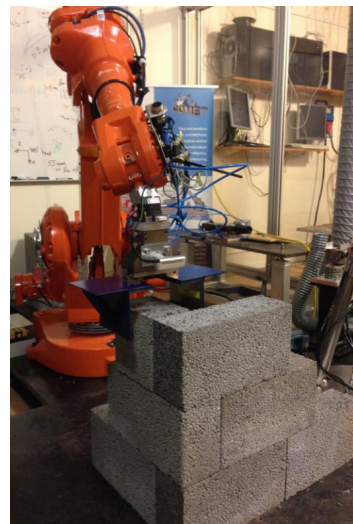
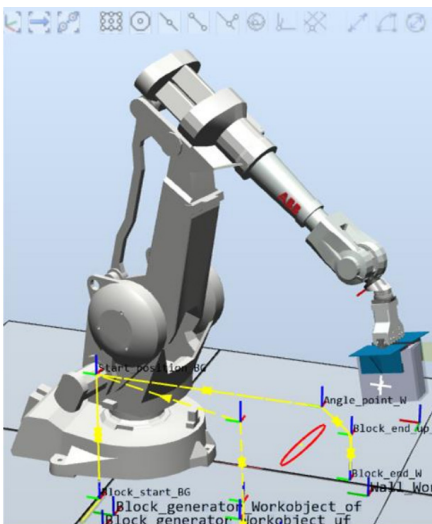

CONSTRUCTION ROBOTICS OF TODAY AND TOMORROW

Researchers: Anders Robertsson, Rolf Johansson; Manuel Korell and colleagues from the Department of Computer Science, Division of Structural Engineering, and Department of Architecture and Built Environment

Funding: Boverket, Formas, Vinnova, SBUF

Since a couple of years new activities within construction robotics have started at LTH and a new cross-disciplinary laboratory facility is under establishment in the V-buiding, LTH, with serial and parallel kinematic robots for use in building construction, large structure 3D-printing etc.

Ongoing collaboration projects are

- Innovative Construction with Flexible Robot-Human Interaction (Boverket)
- Innovative Agile Construction for Globally Improved Sustainability (ACon 4.0) (VINNOVA UDI-2)

Purpose and goal

The construction industry has major problems linked to productivity, building quality, gender equality & safe work environment and environmental impact. Today's tools are developed to support existing value chains and building systems, and can be seen as part of the sector's problems. The ACon project will develop and develop solutions in construction by (i) reducing the current fragmentation of the construction industry (ii) link digital design to production automation (iii) develop safer and more equal workplaces (iv) develop customized robotization for collaboration with workers at construction sites.

Planned presentation and action

Implementation of the ACon 4.0-project takes place in three work packages with underlying "tasks". There is a pronounced organization that ensures that deliveries and results are obtained.

- WP 1. Value chains & Business models - develop a traditional and new disruptive business model linked to small-scale robot production.
- WP 2. Technology development - digital information structure, building system, robot, rules and sensor technology
- WP 3. Communication & dissemination to Swedish construction industry and international collaboration - Initiate a construction robot lab at LTH with several stakeholders in academia and national construction industry, and there is also a dedicated international collaboration with the German INKOBABU-project.

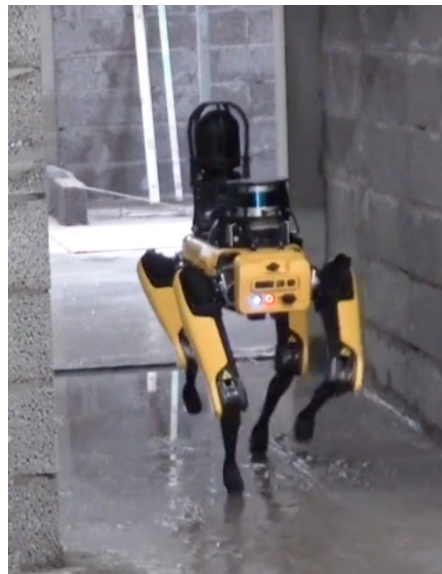

Boston Dynamics *SPOT* at construction site Vipan, Lund

SEMANTIC MAPPING AND VISUAL NAVIGATION FOR SMART ROBOTS

Researchers: Marcus Greiff, Bo Bernhardsson, Rolf Johansson, Boris Godoy, Anders Robertsson with colleagues from the Department of Mathematics, Lund, and Chalmers University of Technology.

Funding: SSF

Why is it that today's autonomous systems for visual inference tasks are often restricted to a narrow set of scene types and controlled lab settings? Examining the best performing perceptual systems reveals that each inference task is solved with a specialized methodology. For instance, object recognition and 3D scene reconstruction, despite being strongly connected problems, are treated independently and an integrated theory is lacking. We believe that in order to reach further, it is necessary to develop smart systems that are capable of integrating the different aspects of vision in a collaborative manner. We gather expertise from computer vision, machine learning, automatic control and optimization with the ambitious goal of establishing such an integrated framework.

The research is structured into four work packages:

- Scene modelling
- Visual recognition
- Visual navigation
- System integration to achieve a perceptual robotic system for exploration and learning in unknown environments.

As a demonstrator, we will construct an autonomous system for visual inspection of a supermarket using small-scale, low-cost quadcopters. The system goes well beyond the current state-of-the-art and will provide a complete solution for semantic mapping and visual navigation. The basic research outcomes are relevant to a wide range of industrial applications including self-driving cars, unmanned surface vehicles, street-view modelling and flexible inspection in general.

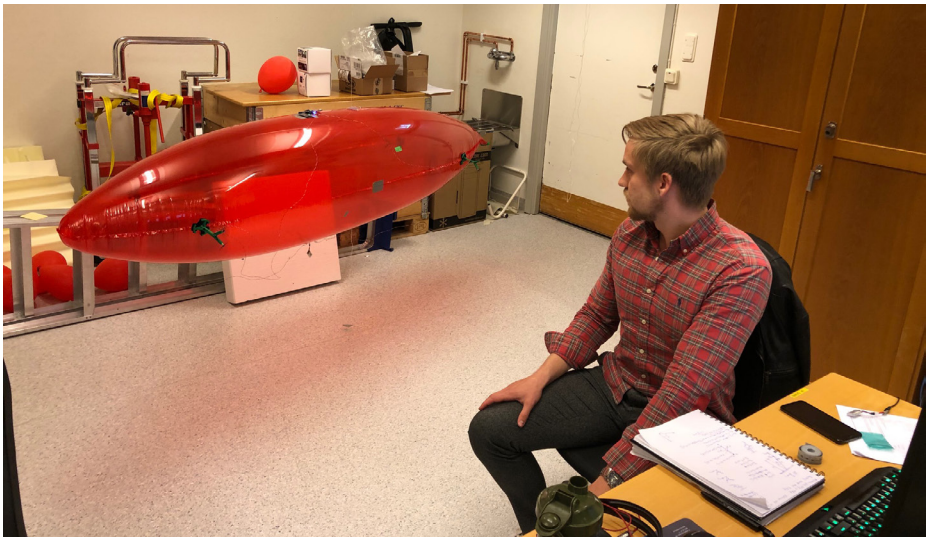

AUTONOMOUS FLIGHT (UAS@LUND)

Participants: Rolf Johansson, Johan Bergström, Anders Robertsson in cooperation with partners at other departments at Lund University

Funding: ELLIIT, Lund University cooperation grant *The future of drones*

This research project addresses and develops the technologies of unmanned flying systems (UAS or drones) in order to make such systems more suitable for addressing various social challenges. A current collaboration project (UAV@LU, currently changing name to UAS@LU) addresses the potential of UAS for addressing societal challenges including, but not limited to, more efficient and sustainable forestry and farming, urban planning and landscape modelling, monitoring of critical infrastructure system, smarter transport, as well as more efficient and safe emergency service operations. A problem shared across all sectors mentioned above is making the UAS autonomous; the transition from actively piloting a drone with continuous (human) control inputs from a remote ground station while having the drone within visual line of sight to an autonomous UAS solving complex problems without continuous human control inputs but as an autonomous agent beyond the visual line of sight in an airspace populated by unmanned as

well as manned aircraft. Consequently, the here proposed research project aims at developing and demonstrating autonomous flight missions in an airspace with mixed autonomous and manned aircraft under supervision and management of air traffic control. While the actors in the UAS@LU network represent a vast number of possible applications for autonomous UAS systems; this project will focus on two applications which are being developed with the purpose of enhancing societal safety: the cases of autonomous radiation detection and Sear-And-Rescue (SAR). The project serves the wider purposes of the collaboration UAS@LU and is conducted by Lund University School of Aviation and the Lund University Dept. Automatic Control in close collaboration with research conducted at the departments for Nuclear Physics and Medical Radiation Physics. External actors include those involved in Testbed Ljungbyhed as well as actors collaborating with LU researchers in UAS applications for societal safety.



In beginning of June 2021, Marcus Greiff, Emil Rofors, Rikard Tyllström and Rohith made field tests on UAV-based radiation measurements in the area around Gävle, which is the Swedish region which was most polluted after the Chernobyl accident in 1986. The research was made within the ELLIIT-project *Autonomous Radiation Mapping and Isotope Composition Identification by Mobile Gamma Spectroscopy*

THE FUTURE OF DRONES: TECHNOLOGIES, APPLICATIONS, RISKS AND ETHICS

Participants: Johan Bergström, Nicolo Dell’Unto, Anders Robertsson, Rikard Tyllström, Giacomo Landeschi, Johan Revstedt, Per-Ola Olsson, Anthony Smoker, Rolf Johansson

Unmanned Aerial Systems (UAS) are today considered a ‘disruptive technology’ which affects the way in which we address a variety of societal challenges, including agriculture and forest analysis, identifying property boundaries, surveying construction sites or corridors for roads and railroads, stockpile volume calculations, flooding and coastal erosion assessments, building information management, Search-And-Rescue, radiation detection, disaster planning and handling, surveys in remote or undeveloped areas, the delivery of goods, etc. The possibilities of digitalisation and technology development address societal challenges such as making societal sectors and domains more ecosystem friendly, efficient and competitive. This project will continue to work to connect academic actors with external stakeholders in their efforts to use UAS to identify and address such societal challenges. The project will also continue to study potential (unintended) consequences of such applications in terms of risks and ethical questions and also support internal as well as external stakeholders

in their efforts to be compliant with the recently enacted European regulatory framework for UAS.

In the last three years the collaboration project UAV@LU has served as an important opportunity to develop and combine cross-disciplinary research activities in several, for Lund University, strategic fields (see self-evaluation for more details). In doing so, the problem and opportunity of ‘system autonomy’ has been identified as a boundary problem shared by most actors in the collaboration network. Hence, increased system autonomy will be given a specific focus in the collaboration over the coming two years. Another additional challenge which has emerged just recently is how to adapt organisations (including Lund University) in order to be compliant with the recently enacted European regulatory frameworks for UAS.

In order to mark the increased focus on drone systems (rather than simply the drones themselves) the collaboration project will change its name from UAV@LU to UAS@LU.



DECENTRALIZED CONTROL STRUCTURES FOR PROCESS CONTROL

Researcher: Tore Hägglund

Funding: Vinnova

This project aims to revise, improve, and develop new, basic control structures for decentralized control used in the regulatory control layer in process control. However, the ideas to be investigated in this project are relevant in other application areas as well. In previous parts of the project, feedforward design methods, a new ratio control structure, and a new midranging control structure have been developed.

More information is given on the department's research web page.

Simple and efficient control loop decoupler for process control applications

In this project, a control loop decoupler suitable for process control applications has been developed and implemented in an industrial control system. A prerequisite was that the two SISO controllers should be retained, and that the decoupling should be obtained by connecting a decoupling block to the two controllers. The decoupling is based on the inverted decoupling technique. It has been shown that inverted decoupling using just static gains in the feedforward elements provides a significant reduction of the coupling. It has also been shown that gains obtained by just considering static rela-

tions give decouplings that often are similar to those obtained using optimal feedforward gains. The inverted decoupling changes the dynamics in the two loops, which means that different gains should be used in the two controllers depending on whether the decoupling is in use or not. A gain-scheduling function is therefore included in the decoupler to schedule the gains.

This project is performed in collaboration with ABB, and the control loop decoupler has been implemented in the ABB controller family AC 800M. Automatic tuning procedures are also developed so that the feedforward gains of the decoupler can be determined automatically.

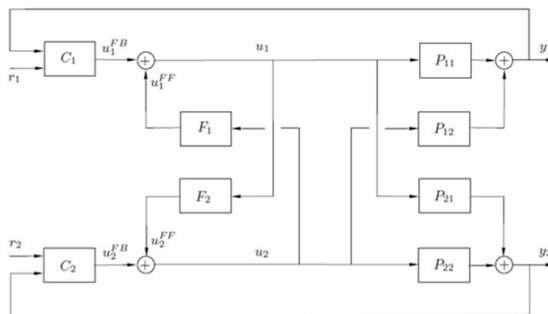

The control loop decoupler

HEMODYNAMIC STABILIZATION

Researchers: Kristian Soltesz, Henry Pigot, Ylva Wahlquist, Christopher Sturk, Trygve Sjöberg, Audrius Paskevicius (Heart and Lung transplantation), in collaboration with Igelösa Life Science

Funding: Vinnova

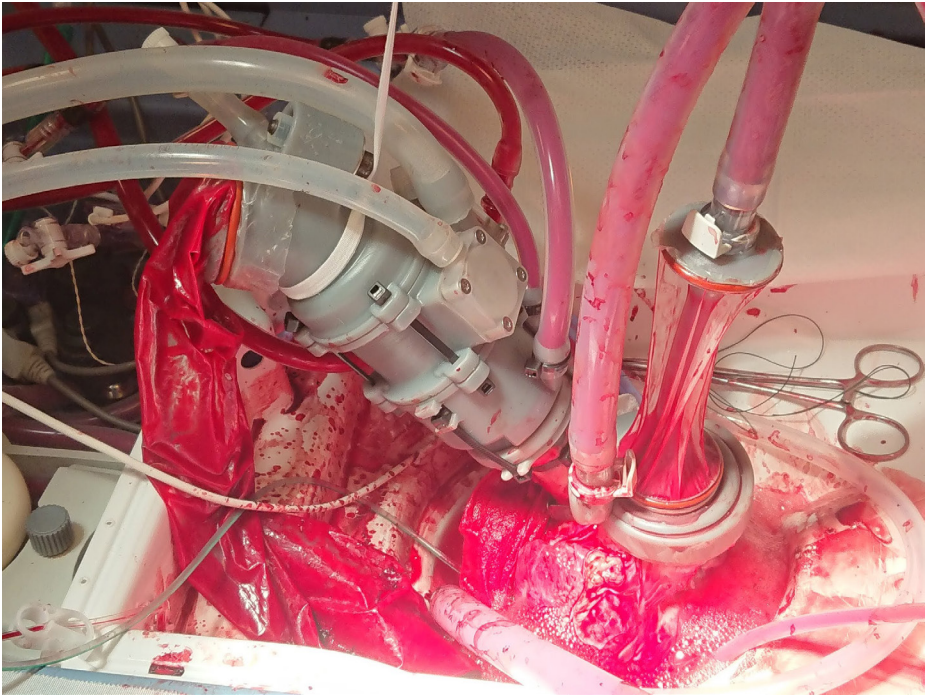

Testing of a device for functional heart evaluation, with an adjustable flow resistance (left) connected to a porcine heart, and blood being supplied to the organ via a compliant column (right). The device is designed to mimic the normal physiology of a prospective transplantation patient. The clinical application of this technology would help increase the number of available donor hearts that can safely be used in transplantation.

Intensive care patients often rely on a combination of drug, fluid, and other therapies to achieve and maintain stable hemodynamics. This project investigates how pharmacology, mathematical modeling, signal processing and closed-loop control can be combined to control hemodynamic entities such as blood pressure, heart rate, and vascular resistance, as well as related entities such as diuresis. The research relies on close inter-disciplinary collaboration

between medical and control systems researchers. It is conducted in a systems engineering framework and comprises the development of both methods and dedicated equipment for clinical verification.

The aim of the project is to develop methods for hemodynamic stabilization of intensive care patients. It comprises closed-loop control of readily measurable signals, including heart rate, arterial and venous blood pressure. Furthermore,

the project aims at optimizing hemodynamic parameters, which are not directly measurable, such as cardiac output and responsiveness to volume expansion.

The aim of the project is to develop a generic platform for closed-loop intravenous drug delivery. Apart from being used in research, such a platform can be adapted to a multitude of medical treatment scenarios, foremost in intensive care, where it has the potential to increase the availability of specialized physicians.

The aim of the project is to provide physicians with an 'auto pilot' for hemodynamic stabilization and optimization. The initially considered patient group are heart-beating braindead patients under intensive care (potential organ

donors). Due to the complete loss of vasomotor center function, hormonal and fluid therapy is required to establish hemodynamic stability within this group.

We combine automatic control methods with medical insight, to develop closed-loop controlled therapies. Developed methods are implemented on our in-house developed control system comprising sensors for invasive blood pressure measurement, and urination rate, as well as syringe and volumetric infusion, pumps for closed-loop controlled intravenous drug and fluid administration.

The methods are pre-clinically evaluated in collaboration with the project partner Igelösa Life Science AB.

ON HUMANS FOR HUMANS

Researcher: Charlotta Johnsson in collaboration with Skånes universitetssjukhus, Vävnadsbanken

Funding: Vinnova

By continuous development of new technology for surgical methods our healthcare is improved. Our vision of the project "On Humans for Humans" is to build a new testbed for groundbreaking robotics surgery, consisting of an operating theater with a nearby preparation and control room. The testbed will be located close to the

Tissue Bank (Vävnadsbanken) in Lund, which is the largest tissue bank in Scandinavia. Novel methods in collaborative robotics will be evaluated and could eventually, after careful testing, be scaled up and reach the development regions of the world.

DSKM- DIGITALISATION AND STANDARDISATION FOR CUSTOMIZED MASS PRODUCTION

Researchers: Charlotta Johnsson, Anders Robertsson, Anton Tetov Johansson, in collaboration with SWEP, IUC Syd.

Funding: Vinnova

The purpose of this project is to give Sweden a position as a successful country regarding "Industry 4.0" and "Smart industry" where the concept customized mass production is of great value. A production with high degree of automation and high compatibility with international

standards on sites in Sweden will support the perception of Sweden as a country that push the industry forward in a sustainable way. After finished project, the production lines will have a higher degree of automation based on a foundation of industrially accepted standards.

HISTORICAL FEMALE INFLUENCERS IN AUTOMATIC CONTROL

Researchers: Charlotta Johnsson, Eva Westin, Tore Hägglund, Kristian Soltesz, Margret Bauer, together with X-Lab and Campus Helsingborg

Funding: IFAC Activity Fund

It is interesting to look at the presence of role models in the automatic control community. The elder professionals in this field, influences the younger, and thereby shape the younger generation. There are many occasions where younger, potential future control professionals, could be influenced by elder professionals. One occasion is in the classroom e.g. when examples of pioneers in the field are highlighted. One other example is in the everyday working environment e.g. laboratories or offices, where histories and anecdotes from the passed are shared. Yet another example, are the award winners in the field, who just by getting the price raises their influence in the field.

Statistics from e.g. Department of Automatic Control, Lund University, Sweden shows that only 11 out of the 128 PhD theses, throughout its 60 years of history, are written by women. Statistics also show that only 14% of the PhD-students, and 9% of the professors are of female gender. These numbers are very low. Most probably the statistics from automatic control departments in other corners of the world, are very similar. Could it be that female role models are missing?

It is noted that the early pioneers that are highlighted in basic control courses often (or al-

ways) are men e.g. Bode, Nyquist, Kalman, etc. Also, award winners are to a very large degree men, e.g. Richard E Bellman Award was given to a man 40 years in a row. This has an explanation in the fact that there are no women in the field, but how could they enter if there are hardly no role models to identify with?

The intention in this project is to find out if there are some early female historical influencers. We believe that the best way to find out would be to identify a set of elder (retired or emeritus) female professionals, and by interviewing them get to know if they had any female role models? We also believe that the identified (retired or emeritus) female control professionals, act as role models themselves. The interviews with the identified (retired or emeritus) female control professionals will serve as material for a portrait-series of historical female influencers. The portrait-series of these women could be used in various outreach material such as e.g. lecture notes, and other inspirational material for young and potential future control professionals. By this project we hope to inspire more females to enter the community of Automatic Control.



**IRMGARD
FLÜGGE-LOTZ**

**Discontinuous
Automatic
Control**

Wikipedia: Irmgard Flügge-Lotz, née Lotz (16 July 1903 – 22 May 1974) was a German-American mathematician and aerospace engineer. She was a pioneer in the development of the theory of discontinuous automatic control, which has found wide application in hysteresis control systems; such applications include guidance systems, electronics, fire-control systems, and temperature regulation. She became the first female engineering professor at Stanford University in 1961 and the first female engineer elected a Fellow of the American Institute of Aeronautics and Astronautics.

DIGIT HUB

Researchers: Charlotta Johnsson and Erik Larsson at Integrated Electronic Systems LTH School of Engineering in Helsingborg, in collaboration with Mobile Heights, Media Evolution, IUC Syd, Malmö University

Funding: European Regional Development Fund, Region Skåne

DigIT Hub is an initiative that helps companies and the public sector in southern Sweden to digitalise. DigIT Hub has financial support from the European Regional Development Fund and Region Skåne.

Digitalisation is a broad term, and digitalisation needs vary within each organization. Through DigIT Hub, we are using digitalisation as an engine to create sustainable and efficient processes and working methods, strengthened competitiveness, and better tailored services in the region. We help organisations in Skåne and Blekinge stay relevant through digital transition; allowing them to meet expectations of customers, employees and citizens who are becoming increasingly digital.

DigIT Hub is specifically aimed at small and medium-sized companies in the manufacturing industry, as well as entities in the public sector. The initiatives we work with fall broadly within the areas "Smart Cities" and "Smart Industry". No digitalisation issue is too big or too small to share with us, and we offer both introductory and advanced digitalisation support.



FORUM FOR STANDARDISATION OF DIGITALISATION IN PRODUCTION

Researcher: Charlotta Johnsson in collaboration with KTH, RISE, Automation Region, Mälardalens högskola, SIS

Funding: Vinnova

The current increase of digitalisation in production provides many opportunities for Swedish manufacturing industry. An important challenge in this transition is how to relate to the large number of available standards and the standardization work within different groupings. Increased knowledge of this is important to be

able to take advantage of the opportunities in an increasingly digitalized business landscape. The goal is a network forum for Swedish industry that convey knowledge and support in understanding and navigating among standards for smart production.

STRATEGIES AND STANDARDS FOR SMART SWEDISH INDUSTRY

Researcher: Charlotta Johnsson, in collaboration with Blue Institute, SIS, SEK PiiA and Production2030

Funding: Vinnova

In order to realise the vision of Smart Industry (Smart manufacturing / Industry 4.0) collaboration, in two forms, is needed. First, between the technical applications involved in the value-chain that a product is related to which requires international standards that the technical solutions can be based on. Second, collaboration between people, at national and international level, in order to develop these standards. The 4S-project aim at igniting the Swedish engagement, and enable Swedish industry related research-results to become international standards. The project aims at intertwining, on one hand the Swedish industry research projects related to Smart

industry, and on the other hand the Swedish standardization organizations with their channels to the international arena. This collaboration and joint effort is needed in order to generate a Swedish engagement and take an international position as a leading nationality in the area of Smart Industry.



REALTIME INDIVIDUALIZATION OF BRAIN COMPUTER INTERFACES

Researcher: Frida Heskebeck, Pex Tufvesson, Martin Gemborn Nilsson, Carolina Bergeling, Bo Bernhardsson in collaboration with Maria Sandsten, Rachele Anderson at Mathematical Statistics, LTH and Mikael Johansson's group at the Department of Psychology, LU

Funding: WASP

Controlling the physical world with our mind only opens up for a vast number of exciting opportunities. This can be made possible through so called Brain Computer Interfaces (BCIs). In this project, we primarily focus on BCIs based on ElectroEncephaloGram (EEG) measurements, collected through the use of an EEG-cap. Although the technology behind BCIs have improved steadily over recent years, there is still much to be done. We investigate what the possibilities and limitations of BCIs are in terms of efficiency, reliability and individualizability.

The project is a collaboration between the Department of Automatic Control, the Department

of Mathematical Statistics and the Department of Psychology at Lund University. Bringing together cross-disciplinary expertise, we have identified several critical obstacles that prevent BCIs from becoming a truly life-changing technology, and methods to overcome them. We see several important areas of use such as communication and control for severely motor-impaired users, smart hearing aids, gaming-devices and forensics tools, as well as different health-related applications, such as rehabilitation, including restoration of motor control after stroke. This year our group was extended with two new PhD students, Martin Gemborn Nilsson and Pex Tufvesson.

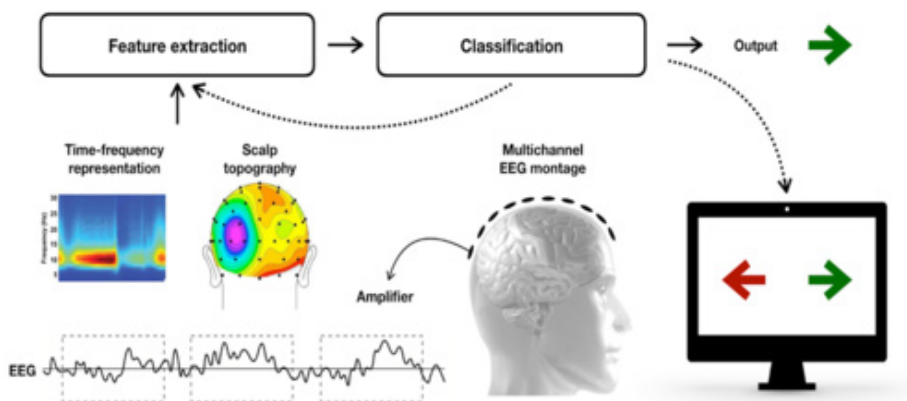

Our approach: Closed-loop design of the BCI with state-of-the-art time-frequency decomposition and feature extraction based on cognitive modeling.

TOOLS AND SOFTWARE

- Julia packages
- JGrafchart
- Jitterbug: A Matlab toolbox for real-time control performance analysis
- JITTERTIME: Real-time control performance simulation
- TrueTime: Simulation of Networked and Embedded Control Systems

JULIA PACKAGES

Researchers at the department, in particular Fredrik Bagge Carlson and Mattias Fält, have contributed to several registered packages for the Julia programming language:

- ControlSystems.jl – A control systems toolbox for Julia. (Several add-on packages are available.)
- BasisFunctionExpansions.jl – Basis function expansions for Julia.
- DeterministicPolicyGradient.jl – Reinforcement learning with deterministic policy gradient methods.
- DifferentialDynamicProgramming.jl – A package for solving differential dynamic

programming and trajectory optimization problems.

- DynamicMovementPrimitives.jl – Learning dynamic movement primitives in Julia.
- LPVSpectral.jl - A toolbox for least-squares spectral estimation and (sparse) LPV spectral decomposition.
- SingularSpectrumAnalysis.jl – A package for performing singular spectrum analysis.
- CholmodSolve2.jl – Package for solving linear systems given an LDLT factorization.
- FirstOrderSolvers.jl – Large scale convex optimization solvers in Julia.

JGRAFCHART

Grafchart is a language for supervisory level sequence control and procedure handling that has been developed at the department since 1991. Grafchart is based on ideas from Grafcet/Sequential Function Charts, Petri nets, Statecharts, and object-oriented programming.

The original implementation of Grafchart had the same name and was developed in G2 from Gensym Corporation. Using this platform

Grafchart was used for batch recipe control, diagnosis of mode-changing processes, alarm filtering, implementation of operator decision support systems, and implementation of robot cells. In 2001 an open implementation of Grafchart was made in Java. It is called JGrafchart and is used in our laboratory exercises on logical sequence control and batch control as well as in several research projects.

JITTERBUG: A MATLAB TOOLBOX FOR REAL-TIME CONTROL PERFORMANCE ANALYSIS

Jitterbug is a MATLAB-based toolbox that allows the computation of a quadratic performance criterion for a linear control system under various timing conditions. Using the toolbox, one can easily and quickly assert how sensitive a control system is to delay, jitter, lost samples, etc., without resorting to simulation. The tool is quite general and can also be used to investigate jitter-compensating controllers, a periodic

controllers, and multi-rate controllers. As an additional feature, it is also possible to compute the spectral density of the signals in the control system. The main contribution of the toolbox, which is built on well-known theory (LQG theory and jump linear systems), is to make it easy to apply this type of stochastic analysis to a wide range of problems.

JITTERTIME: REAL-TIME CONTROL PERFORMANCE SIMULATION

JitterTime is a spin-off from the Matlab toolbox Jitterbug and can be used for calculating the performance of a controller under non-ideal timing conditions. Examples of such conditions include delay and jitter due to CPU and network scheduling, lost samples or lost controls due to packet loss or execution overruns, and aperiodic behavior due to clock drift, asynchronous nodes, and random sampling. Both Jitterbug and JitterTime evaluate a quadratic cost function for a mixed continuous-time/discrete-time linear system driven by white noise. The main difference is

the timing model. In Jitterbug, the timing of the discrete systems are governed by random delays with specified probability density functions. This allows the total system to be treated as a jump-linear system, and covariance can be calculated by solving a set of linear equations. In JitterTime, however, the timing is arbitrary and completely driven by the user. This allows for more complex timing scenarios to be analyzed, including scheduling algorithms with long-term timing dependencies and asynchronous execution in distributed control systems.

TRUETIME: SIMULATION OF NETWORKED AND EMBEDDED CONTROL SYSTEMS

TrueTime is a Matlab/Simulink-based simulator for real-time control systems. Offering Simulink blocks that model real-time kernels and wired/wireless networks, TrueTime facilitates co-simulation of scheduling algorithms, control tasks, network protocols, and continuous plant dynamics.

TrueTime has been developed at the Department of Automatic Control since 1999. It is open source, written in C++, and can easily be extended with new functionality. TrueTime has been used in wide range of research projects and has also found use in university courses and in industry.

Publications and seminars

This chapter contains a list of publications and seminars during 2021

PUBLICATIONS 2021

You can find references to all the publications on www.control.lth.se/publications and almost all of them can be downloaded from this site. Any of the reports may, however, be borrowed through your library service or from the following libraries in Sweden:

- Göteborgs universitetsbibliotek
- Kungliga Biblioteket
- Linköpings universitetsbibliotek
- Lunds universitetsbibliotek
- Stockholms universitetsbibliotek
- Umeå universitetsbibliotek
- Uppsala universitetsbibliotek

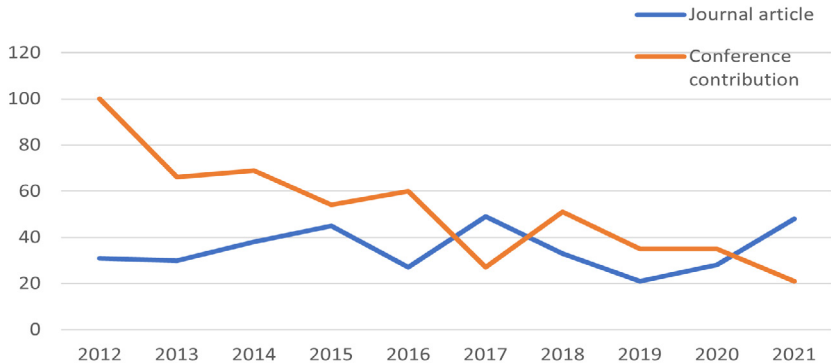
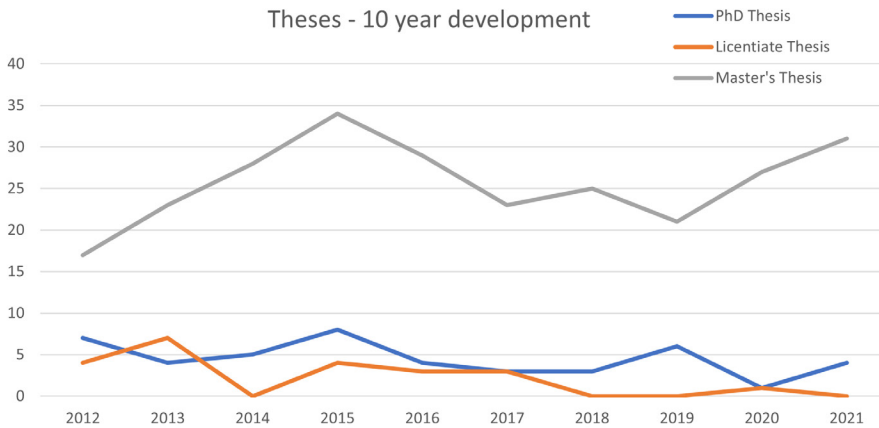

JOURNAL ARTICLES

- Anistratov, Pavel; Olofsson, Björn; Nielsen, Lars; *Analysis and design of recovery behaviour of autonomous-vehicle avoidance manoeuvres*. In *Vehicle System Dynamics*, (2021).
- Anistratov, Pavel; Olofsson, Björn; Nielsen, Lars; *Lane-deviation penalty formulation and analysis for autonomous vehicle avoidance maneuvers*. In *Proceedings of the Institution of Mechanical Engineers, Part D: Journal of Automobile Engineering* 235(12). p.3036-3050, (2021).
- Banert, Sebastian; Boț, Radu Ioan; Csetnek, Ernő Robert; *Fixing and extending some recent results on the ADMM algorithm*. In *Numerical Algorithms* 86(3). p.1303-1325, (2021).
- Bergeling, Carolina; Pates, Richard; Rantzer, Anders; *H-infinity Optimal Control for Systems with a Bottleneck Frequency*. In *IEEE Transactions on Automatic Control* 66(6). p.2732-2738, (2021).
- Cava, José Manuel Gonzáles; Bagge Carlson, Fredrik; Troeng, Olof; Cervin, Anton; van Heusden, Klaske; Dumont, Guy A.; Soltesz, Kristian; *Robust PID control of propofol anaesthesia: uncertainty limits performance, not PID structure*. In *Computer Methods and Programs in Biomedicine* 198, (2021).
- Como, Giacomo; Nilsson, Gustav; *On the well-posedness of deterministic queuing networks with feedback control*. In *Transportation Research. Part B: Methodological* 150. p.323-335, (2021).
- Fors, Victor; Olofsson, Björn; Nielsen, Lars; *Autonomous Wary Collision Avoidance*. In *IEEE Transactions on Intelligent Vehicles* 6(2). p.353-365, (2021).
- Fors, Victor; Anistratov, Pavel; Olofsson, Björn; Nielsen, Lars; *Predictive Force-Centric Emergency Collision Avoidance*. In *Journal of Dynamic Systems, Measurement, and Control, ASME* 143(8). p.081005-081005, (2021).
- Fransson, Per-Anders; Nilsson, Maria H; Rehn Crona, Stig; Tjernström, Fredrik; Magnusson, Måns; Johansson, Rolf; Patel, Mitesh; *Deep brain stimulation in the subthalamic nuclei alters postural alignment and adaptation in Parkinson's disease*. In *PLoS ONE* 16(12), (2021).
- Fransson, Per-Anders; Nilsson, Maria H; Rehn Crona, Stig; Tjernström, Fredrik; Magnusson, Måns; Johansson, Rolf; Patel, Mitesh; *Deep Brain Stimulation in the Subthalamic Nuclei Alters Postural Alignment and Adaptation in Parkinson's Disease*. In *PLoS ONE*, (2021).
- García-Mañas, F.; Guzmán, J. L.; Rodríguez, F.; Berenguel, M.; Häggglund, T.; *Experimental evaluation of feedforward tuning rules*. In *Control Engineering Practice* 114, (2021).
- Govaert, Alain; Ramazi, Pouria; Cao, Ming; *Rationality, Imitation and Rational Imitation in Spatial Public Goods Games*. In *IEEE Transactions on Control of Network Systems* 8(3). p.1324-1335, (2021).
- Greiff, Marcus; Robertsson, Anders; Sun, Zhiyong; *Attitude Control on SU(2): Stability, Robustness, and Similarities*. In *IEEE Control Systems Letters* 6. p.73-78, (2021).
- Grussler, Christian; Giselsson, Pontus; *Efficient Proximal Mapping Computation for Low-Rank Inducing Norms*. In *Journal of Optimization Theory and Applications*, (2021).
- Grussler, Christian; Rantzer, Anders; *On second-order cone positive systems*. In *SIAM Journal on Control and Optimization* 59(4). p.2717-2739, (2021).
- Gustafsson, Fredrik; Soltesz, Kristian; *NPI models explained and complained*. In *ISIF Perspectives on information fusion* 4(1). p.7-14, (2021).
- Gustafsson, Fredrik; Wacker, Andreas; Bernhardsson, Bo; Soltesz, Kristian; *Fler randomiserade tester hade lärt oss mer om pandemin*. In *Ny teknik*, (2021).
- Häggglund, T.; *A feedforward approach to mid-ranging control*. In *Control Engineering Practice* 108 (March). p.1-10, (2021).
- Heyden, Martin; Pates, Richard; Rantzer, Anders; *A Structured Optimal Controller With Feed-Forward for Transportation*. In *IEEE Control Systems Letters* 6. p.1130-1135, (2021).
- Jiang, Yan; Pates, Richard; Mallada, Enrique; *Dynamic Droop Control in Low-Inertia Power Systems* In *IEEE Transactions on Automatic Control* 66(8). p.3518-3533, (2021).

- Johnsson, Charlotta LU; Brandl, Dennis; *Beyond the Pyramid: Using ISA95 for Industry 4.0/Smart Manufacturing*. In InTech p.14-20, (2021).
- Jouini, Taouba; Rantzer, Anders; *On cost design in applications of optimal control*. In IEEE Control Systems Letters 6. p.452-457, (2021).
- Jouini, Taouba; Sun, Zhiyong; *Frequency synchronization of a high-order multi-converter system*. In IEEE Transactions on Control of Network Systems, (2021).
- Kergus, Pauline; *Data-driven control of infinite dimensional systems : Application to a continuous crystallizer*. In IEEE Control Systems Letters 5(6). p.2120-2125 (2021).
- Krüger, Kristin; Vreman, Nils; Pates, Richard; Maggio, Martina; Völz, Marcus; Fohler, Gerhard; *Randomization as Mitigation of Directed Timing Inference Based Attacks on Time-Triggered Real-Time Systems with Task Replication*. In Leibniz Transactions on Embedded Systems, (2021).
- Li, Yuling; Wang, Liping; Liu, Kun; He, Wei; Yin, Yixin; Johansson, Rolf; *Distributed Neural-Network-Based Cooperation Control for Teleoperation of Multiple Mobile Manipulators Under Round-Robin Protocol*. In IEEE Transactions on Neural Networks and Learning Systems, (2021).
- Li, Yuling; Zhang, Kai; Liu, Kun; Johansson, Rolf; Yin, Yixin; *Neural-network-based adaptive control for bilateral teleoperation with multiple slaves under Round-Robin scheduling protocol*. In International Journal of Control 94(6). p.1461-1474, (2021).
- Li, Xianwei; Sun, Zhiyong; Tang, Yang; Karimi, Hamid Reza; *Adaptive Event-Triggered Consensus of Multiagent Systems on Directed Graphs*. In IEEE Transactions on Automatic Control 66(4). p.1670-1685, (2021).
- Li, Xiaolei; Wen, Changyun; Chen, Ci; Xu, Qianwen; *Adaptive Resilient Secondary Control for Microgrids With Communication Faults*. In IEEE Transactions on Cybernetics, (2021).
- Li, Xiaolei; Chen, Ci; Xu, Qianwen; Wen, Changyun; *Resilience for Communication Faults in Reactive Power Sharing of Microgrids*. In IEEE Transactions on Smart Grid 12(4). p.2788-2799, (2021).
- Mandrioli, Claudio; Maggio, Martina; *Testing Self-Adaptive Software with Probabilistic Guarantees on Performance Metrics: Extended and Comparative Results*. IEEE Transactions on Software Engineering, (2021).
- Medvedev, Alexander; Soltész, Kristian; *Technical Committee on Health Care and Medical Systems*. In IEEE Control Systems 41(1). p.16-19, (2021).
- Olofsson, Bjorn; Nielsen, Lars; *Using Crash Databases to Predict Effectiveness of New Autonomous Vehicle Maneuvers for Lane-Departure Injury Reduction*. In IEEE Transactions on Intelligent Transportation Systems 22(6). p.3479-3490, (2021).
- Patel, Mitesh; Nilsson, Maria H; Rehncrona, Stig; Tjernström, Fredrik; Magnusson, Måns; Johansson, Rolf; Fransson, Per-Anders; *Strategic alterations of posture are delayed in Parkinson's disease patients during deep brain stimulation*. In Scientific Reports 11(1), (2021).
- Patel, Mitesh; Nilsson, Maria H.; Rehncrona, Stig; Tjernström, Fredrik; Magnusson, Måns; Johansson, Rolf; Fransson, Per Anders; *Spectral analysis of body movement during deep brain stimulation in Parkinson's disease*. In Gait and Posture 86. p.217-225, (2021).
- Pigot, Harry; Hansson, Jonas; Paskevicius, Audrius; Liao, Qiuming; Sjöberg, Trygve; Steen, Stig; Soltész, Kristian; *Identification of cardiac afterload dynamics from data*. 11th IFAC Symposium on Biological and Medical Systems In IFAC-PapersOnLine 54. p.508-513, (2021).
- Poussot-Vassal, C.; Kergus, P.; Kerherve, F.; Sipp, D.; Cordier, L.; *Interpolatory-Based Data-Driven Pulsed Fluidic Actuator Control Design and Experimental Validation*. In IEEE Transactions on Control Systems Technology, (2021).
- Salt Ducajú, Julián M.; Llobregat, Julián J.Salt; Cuenca, Ángel; Tomizuka, Masayoshi; *Autonomous ground vehicle lane-keeping LPV model-based control: Dual-rate state estimation and comparison of different real-time control strategies*. In Sensors 21(4), (2021).

- Ruuskanen, Johan; Berner, Tommi; Årzén, Karl-Erik; Cervin, Anton; *Improving the Mean-Field Fluid Model of Processor Sharing Queueing Networks for Dynamic Performance Models in Cloud Computing*. In Performance Evaluation 151, (2021).
- Sun, Zhiyong; Liu, Qingchen; Huang, Na; Yu, Changbin; Anderson, Brian D.O.; *Cooperative event-based rigid formation control*. In IEEE Transactions on Systems, Man, and Cybernetics: Systems 51(7). p.4308-4320, (2021).
- Sun, Zhiyong; Rantzer, Anders; Li, Zhongkui; Robertsson, Anders; *Distributed adaptive stabilization*. In Automatica 129, (2021).
- Troeng, Olof; *Five-Full-Block Structured Singular Values of Real Matrices Equal Their Upper Bounds*. In IEEE Control Systems Letters 5(2). p.583-586, (2021).
- Xia, Yuxuan; Wang, Pu; Berntorp, Karl Oskar Erik; Svensson, Lennart; Granstrom, Karl; Mansour, Hassan; Boufounos, Petros T.; Orlik, Philip; *Learning-based Extended Object Tracking Using Hierarchical Truncation Measurement Model with Automotive Radar*. In IEEE Journal on Selected Topics in Signal Processing 15(4). p.1013-1029, (2021).
- Yang, Qiyu; Lyu, Yi; Li, Xiaolei; Chen, Ci; Lewis, Frank L.; *Adaptive distributed synchronization of heterogeneous multi-Agent systems over directed graphs with time-varying edge weights*. In Journal of the Franklin Institute 358(4). p.2434-2452, (2021).
- Yin, Lianhao; Turesson, Gabriel; Tunestål, Per; Johansson, Rolf; *Sliding mode control on receding horizon : Practical control design and application*. In Control Engineering Practice 109, (2021).
- Wacker, Andreas; Jöud, Anna; Bernhardsson, Bo; Gerlee, Philip; Soltesz, Kristian; Gustafsson, Fredrik; *Estimating the SARS-CoV-2 infected population fraction and the infection-to-fatality ratio: A data-driven case study based on Swedish time series data*. In Scientific Reports 11(23963). p.1-1, (2021).
- Wahlquist, Ylva; Gojak, Amina; Soltesz, Kristian; *Identifiability of pharmacological models for online individualization*. 11th IFAC Symposium on Biological and Medical Systems In IFAC-PapersOnLine p.25-30, (2021).
- Wahlquist, Ylva; Soltesz, Kristian; Liao, Qiuming; Liu, Xiaofei; Sjöberg, Trygve; Steen, Stig; *Prevention of ischemic myocardial contracture through hemodynamically controlled DCD*. In Cardiovascular Engineering and Technology 12(5). p.485-493, (2021).

CONFERENCE CONTRIBUTIONS

- Agner, Felix; Kergus, Pauline; Pates, Richard; Rantzer, Anders; *Scalable Control of Heat Loads*. ELLIIT Workshop 2021.
- Greiff, Marcus; Rofors, Emil; Robertsson, Anders; Johansson, Rolf; Tyllström, Rikard; *Gamma-Ray Imaging with Spatially Continuous Intensity Statistics*. 2021 IEEE/RJS International Conference on Intelligent Robots and Systems p.5234-5239.
- Greiff, Marcus; Sun, Zhiyong; Robertsson, Anders; *Tuning and Analysis of Geometric Tracking Controllers on SO(3)*. 2021 American Control Conference, ACC 2021. In Proceedings of the American Control Conference 2021-May. p.1674-1680.
- Greiff, Marcus; Sun, Zhiyong; Robertsson, Anders; *Attitude Control on SU(2): Stability, Robustness, and Similarities*. 2021 American Control Conference, ACC 2021. In Proceedings of the American Control Conference 2021-May. p.1693-1699.
- Greiff, Marcus; Robertsson, Anders; Berntorp, Karl; *Exploiting linear substructure in linear regression Kalman filters*. 59th IEEE Annual Conference on Decision and Control p.2942-2948, (2021).
- Hansson, Jonas; Svensson, Magnus; Theorin, Alfred; Tegling, Emma; Soltesz, Kristian; Hägglund, Tore; Åström, Karl Johan; *Next generation relay autotuners—analysis and implementation*. IEEE Conference on Control Technologies and Applications p.1075-1982, (2021).

- Hansson, Jonas; Govaert, Alain; Pates, Richard; Tegling, Emma; Soltesz, Kristian; *Fundamental limitations of case isolation*. medRxiv (2021).
- Heimerson, Albin; Brännvall, Rickard; Sjölund, Johannes; Eker, Johan; Gustafsson, Jonas; *Towards a Holistic Controller: Reinforcement Learning for Data Center Control*. (2021) e-Energy '21: Proceedings of the Twelfth ACM International Conference on Future Energy Systems p.424-429..
- Heskebeck, Frida; Bergeling, Carolina; *An Adaptive Approach for Task-Driven BCI Calibration*. BCI meeting 2021.
- Jouini, Taouba; Rantzer, Anders; Tegling, Emma; *Inverse optimal control for angle stabilization in converter-based generation*. American Control Conference, (2021).
- Jouini, Taouba; Sun, Zhiyong; *Distributed learning for optimal allocation of synchronous and converter-based generation*. 29th Mediterranean Conference on Control and Automation (MED 2021) p.386-391
- Kergus, Pauline; *Data-driven control of infinite dimensional systems: Application to a continuous crystallizer*. 2021 American Control Conference, ACC 2021. In Proceedings of the American Control Conference 2021-May. p.1438-1443.
- Kjellqvist, Olle; Troeng, Olof; *Numerical Pitfalls in Q-Design*. 21st IFAC World Congress, (2021).
- Leal, Marta; Hoyo, Ángeles; Guzmán, José Luis; Hägglund, Tore; *Double back-calculation approach to deal with input saturation in cascade control problems*. 14th APCA International Conference on Automatic Control and Soft Computing, CONTROL0 2020. In Lecture Notes in Electrical Engineering 695 LNEE. p.200-209
- Lundh, Magnus; Theorin, Alfred; Hägglund, Tore; Hansson, Jonas; Svensson, Magnus; Åström, Karl Johan; Soltesz, Kristian; *Model optimization for autotuners in industrial control systems*. 26th IEEE International Conference on Emerging Technologies and Factory Automation (ETFA)
- Martins, Alexandre; Arzen, Karl Erik; *Dynamic Management of Multiple Resources in Camera Surveillance Systems*. 2021 American Control Conference, ACC 2021. In Proceedings of the American Control Conference 2021-May. p.2061-2068.
- Salt Ducaju, Julian M.; Olofsson, Bjorn; Robertsson, Anders; Johansson, Rolf; *Joint stiction avoidance with null-space motion in real-time model predictive control for redundant collaborative robots*. 30th IEEE International Conference on Robot and Human Interactive Communication, RO-MAN 2021 In IEEE International Conference on Robot and Human Interactive Communication, RO-MAN p.307-314.
- Sandsten, Maria; Anderson, Rachele; Reinhold, Isabella; Bernhardsson, Bo; Bergeling, Carolina; Johansson, Mikael; *A Novel Multitaper Reassignment Method for Estimation of Phase Synchrony*. 29th European Signal Processing Conference, EUSIPCO 2021. In European Signal Processing Conference 2021-August. p.2164-2168, (2021).
- Skarin, Per; Årzén, Karl-Erik; *Explicit MPC recovery for cloud control systems*. IEEE Conference on Decision and Control (CDC 2021).
- Tärneberg, William; Skarin, Per; Gehrman, Christian; Kihl, Maria; *Prototyping intrusion detection in an industrial cloud-native digital twin*. 2021 22nd IEEE International Conference on Industrial Technology (ICIT).
- Vreman, Nils; Cervin, Anton; Maggio, Martina; *Stability and Performance Analysis of Control Systems Subject to Bursts of Deadline Misses*. 33rd Euromicro Conference on Real-Time Systems (ECRTS 2021) 196.

PHD THESES

- Fält, Mattias; *Convergence Analysis and Improvements for Projection Algorithms and Splitting Methods*. PhD Thesis, Department of Automatic Control, Lund University, Sweden, February 2021.
- Greiff, Marcus; *Nonlinear Control of Unmanned Aerial Vehicles – Systems With an Attitude*. PhD Thesis, Department of Automatic Control, Lund University, Sweden, November 2021.
- Nayak Seetanadi, Gautham; *Improving Performance of Feedback-Based Real-Time Networks using Model Checking and Reinforcement Learning*. PhD Thesis, Department of Automatic Control, Lund University, Sweden, February 2021.
- Skarin, Per; *Control over the Cloud – Offloading, Elastic Computing, and Predictive Control*. PhD Thesis, Department of Automatic Control, Lund University, Sweden, December 2021.

TECHNICAL REPORTS

- Rasmusson, Monika; Pates, Richard (Eds); *Activity Report 2020: Automatic Control Lund University*, Technical Report, Department of Automatic Control, Lund University, Lund, Sweden, May 2021.

MISCELLANEOUS

- Johnsson, Charlotta; *Whitepaper on Smart Manufacturing*, August 2021.
- Wacker, Andreas; Jöud, Anna; Bernhardsson, Bo; Gerlee, Philip; Gustafsson, Fredrik; Soltesz, Kristian; *Estimating the SARS-CoV-2 infected population fraction and the infection-to-fatality ratio: A data-driven case study based on Swedish time series data*. In medRxiv: the preprint server for health sciences, (2021).

MASTER THESES

- Alumets, Martin; Evaldsson, Mattias; *Digital Control of a VCO for Radar Applications*. Master's Thesis TFRT-6148, Supervisors: Andersson, Lars; Glatz, Andreas Axis (external) and Cervin, Anton; Soltesz, Kristian, Department of Automatic Control, Lund University.
- Åman, Gustaf; *Indoor Blimp Control*. Master's Thesis TFRT-6134, Supervisors: Greiff, Marcus, Tyllström, Rikard; Robertsson, Anders; Johansson, Rolf, Department of Automatic Control, Lund University.
- Andersen, Tom; *Implementation of a Simple Asynchronous Pipeline Framework (SAPF) for construction of real-time BCI systems*. Master's Thesis TFRT-6141, Supervisors: Heskebeck, Frida; Bergeling, Carolina; Bernhardsson, Bo, Department of Automatic Control, Lund University.
- Broström, Gustaf; Carpenfelt, David; *Robust Perception for Formula Student Driverless Racing*. Master's Thesis TFRT-6152, Supervisors: Robertsson, Anders; Olofsson, Björn, Department of Automatic Control, Lund University.
- Cedergren, Joakim; Berglund, Jonathan; *Real-time Computer Vision in Industrial Automation*. Master's Thesis TFRT-6130, Supervisors: Jovanovski, Daniel, Beckhoff (external) and Robertsson, Anders; Johansson, Rolf, Department of Automatic Control, Lund University.
- Chouman, Oussama; *Compliance of a Robot Arm using Torque-Based Cartesian Impedance Control*. Master's Thesis TFRT-6147, Supervisors: Robertsson, Anders; Olofsson, Björn, Mayr, Matthias; Salt Decaju, Julian, Department of Automatic Control, Lund University.
- Fritzon, Christopher; Persson, Nils; *Modelling and Control of an Extruder Cooling System*. Master's Thesis TFRT-6132, Supervisors: Ottosson, Erik; Staudecker, Martin, B&R Automation (external), Hägglund, Tore; Robertsson, Anders, Department of Automatic Control, Lund University.
- Gojak, Amina; *Identifiability of pharmacological models from data*. Master's Thesis TFRT-6133, Supervisors: Soltesz, Kristian; Hägglund, Tore, Department of Automatic Control, Lund University.

- Gummesson Atroshi, Jacob; Le, Christian; *Automatic Log Based Anomaly Detection in Cloud Operations using Machine Learning*. Master's Thesis TFRT-6151, Supervisors: Iderup, Mats; Pedersen, Tobias; Hellman, Linus; Eker, Johan, Ericsson (external) and Como, Giacomo, Department of Automatic Control, Lund University.
- Gustafson, Niklas; *Shorten development time of Functional Testing (FCT) in electronic manufacturing with smart instruments*. Master's Thesis TFRT-6129, Supervisors: Marklund, Robert; Holmberg, Torgny; Eker, Johan, Ericsson (external) and Ärzén, Karl-Erik, Department of Automatic Control, Lund University.
- Haapamäki, Kim; Laurell, Jesper; *Playing Halite IV with Deep Reinforcement Learning*. Master's Thesis TFRT-6127, Supervisors: Eilert, Johan Sinch (external) and Grönqvist, Johan; Rantzer, Anders, Department of Automatic Control, Lund University.
- Hansen, Isabella; Wikström, Johanna; *Enhanced Detection of Minispare Usage*. Master's Thesis TFRT-6145, Supervisors: Nicklasson, Ola, Borg Warner (external) and Hägglund, Tore; Cervin, Anton, Department of Automatic Control, Lund University.
- Holmesson, Joel; *Accurate Simulation of a Collaborative Robot Arm with Cartesian Impedance Control*. Master's Thesis TFRT-6142, Supervisors: Mayr, Matthias; Olofsson, Björn; Robertsson, Anders; Johansson, Rolf, Department of Automatic Control, Lund University.
- Karlin, Andreas; *Slip Control for a Three-Wheeled Electric Motorcycle*. Master's Thesis TFRT-6128, Supervisors: Svensson, Ola, OMotion (external) and Olofsson, Björn; Robertsson, Anders, Department of Automatic Control, Lund University.
- Karlsson, Olof; Fredin, Erik; *Development of a controller to switch between relative and absolute path for target vehicles in simulation scenarios*. Master's Thesis TFRT-6139, Supervisors: Knabe, Emil; Andersson, Mikael; Molina Acosta, Angel, Volvo cars (external) and Cervin, Anton; Robertsson, Anders, Department of Automatic Control, Lund University.
- Klinghav, Lisa; *Mobile Floor-Marking Robot, utilizing Feedback from Laser Tracker*. Master's Thesis TFRT-6123, Supervisors: Andersson, Alina MAX IV (external); Robertsson, Anders; Hägglund, Tore, Department of Automatic Control, Lund University.
- Korsell, Lisa; Ydén, Tuva; *Control Design for an Energy-Sharing Module of Next-Generation Thermal Energy System ectogrid™*. Master's Thesis TFRT-6131, Supervisors: Kergus, Pauline; Agner, Felix; Rantzer, Anders, Department of Automatic Control, Lund University.
- Landelius, Jacob; Wallgren, Elsa; *Network analysis of delay propagation on Swedish railways*. Master's Thesis TFRT-6137, Supervisors: Como, Giacomo; Tegling, Emma; Palmqvist, Carl-William; Rantzer, Anders, Department of Automatic Control, Lund University.
- Larsson, Oskar; *Robustness, Stability and Performance of Optimization Algorithms for GAN Training*. Master's Thesis TFRT-6136, Supervisors: Morin, Martin; Giselsso, Pontus; Bernhardsson, Bo, Department of Automatic Control, Lund University.
- Lundh, Magnus; *A new, fast, and efficient automatic tuner for the ABB AC 800M family of controllers*. Master's Thesis TFRT-6146, Supervisors: Theorin, Alfred, ABB Process Automation (external) and Hägglund, Tore; Soltesz, Kristian, Department of Automatic Control, Lund University.
- Möllerström, Josefine; Nyberg Carlsson, Max; *Emulation of the Crazyflie 2.1 Hardware for Embedded Control System Testing*. Master's Thesis TFRT-6135, Supervisors: Eliasson, Marcus, Bitcraze AB (external) and Mandrioli, Claudio; Maggio, Martina, Department of Automatic Control, Lund University.
- Mora Carrión, Sergio; *Digitalization and Optimization of a Production Flow*. Master's Thesis TFRT-6144, Supervisors: Liegnell, Lennie SWEP (external) and Robertsson, Anders; Johnsson, Charlotta, Department of Automatic Control, Lund University.

- Nilsson, Emma; *Practical comparison of MPC Toolboxes*. Master's Thesis TFRT-6124, Supervisors: Kjellqvist, Olle; Cervin, Anton; Giselsson, Pontus, Department of Automatic Control, Lund University.
- Nilsson, Josef; Sandstedt, Henrik; *Traction Control of a Three-Wheeled Electric Motorcycle*. Master's Thesis TFRT-6138, Supervisors: Svensson, Ola, OMotion (external) and Olofsson, Björn; Robertsson, Anders, Department of Automatic Control, Lund University.
- Ohlin, David; Keding, Oskar; *Statistics and Machine Learning for Classification of Emotional and Semantic Content of EEG*. Master's Thesis TFRT-6125, Supervisors: Bernhardsson, Bo; Bergeling, Carolina; Johansson, Mikael; Jakobsson, Andreas, Department of Automatic Control, Lund University.
- Olhager, Philip; *Robust Reinforcement Learning Control of a Furuta Pendulum*. Master's Thesis TFRT-6150, Supervisors: Grönqvist, Johan; Pates, Richard; Rantzer, Anders, Department of Automatic Control, Lund University.
- Sedin, Anton; Wadmark, David; *Ghost target classification using scene models in radar*. Master's Thesis TFRT-6140, Supervisors: Heunisch, Sebastian; Papadelis, Aras, (external) and Olofsson, Björn; Johansson, Rolf, Department of Automatic Control, Lund University.
- Sondh, Axel; Johnsson, Björn; *Controlling a sliding contact on an electric vehicle with computer vision and AI*. Master's Thesis TFRT-6122, Supervisors: Zethraeus, Dan, Elonroad (external) and Grönqvist, Johan; Soltesz, Kristian, Department of Automatic Control, Lund University.
- Tarazona Ferrandis, Amparo; *Design and test of a robotic cell for stud bolt welding in heat exchangers for SWEP International AB*. Master's Thesis TFRT-6149, Supervisors: Robertsson, Anders; Johnson, Charlotta, Department of Automatic Control, Lund University.
- Trulsson, Patrik; *Dynamic Scheduling of Shared Resources using Reinforcement Learning*. Master's Thesis TFRT-6143, Supervisors: Tidelund, William; Korsell, Jonas, Ericsson (external); Bernhardsson, Bo; Årzén, Karl-Erik, Department of Automatic Control, Lund University.
- Wannebro, Linus; Ohlson, Victor; *Remote Positioning of a Multidirectional Camera*. Master's Thesis TFRT-6126, Supervisors: Klein, Malin; Axenram, Rasmus; Robertsson, Anders; Årzén, Karl-Erik, Department of Automatic Control, Lund University.

SEMINARS AT THE DEPARTMENT

January

- 28 Master's Thesis Presentation *Controlling a sliding contact on an electric vehicle with computer vision and AI*, Axel Sondh and Björn Johnsson, LTH.

February

- 05 Defence of Doctoral Dissertation: *Improving Performance of Feedback-Based Real-Time Networks using Model Checking and Reinforcement Learning*, Gautham Nayak Seetanadi, Department of Automatic Control, LTH.
- 25 *Integral action for nonlinear systems with an application to the control of a heat exchanger*, Daniele Astolfi, LAGEPP, Lyon
- 26 Defence of Doctoral Dissertation: *Convergence Analysis and Improvements for Projection Algorithms and Splitting Methods*, Mattias Fält, Department of Automatic Control, LTH.

March

- 02 *Causal inference in dynamical systems*, Søren Wengel Mogensen, Department of Automatic Control, LTH.
- 04 Master's Thesis Presentation: *Mobile Floor-Marking Robot, utilizing Feedback from Laser Tracker*, Lisa Klinghag, LTH.
- 24 Master's Thesis Presentation: *Statistics and Machine Learning for Classification of Emotional and Semantic Content of EEG*, Oskar Keding and David Ohlin, LTH.

April

- 23 Master's Thesis Presentation: *Automatic Log Based Anomaly Detection in Cloud Operations using Machine Learning*, Jacob Gummesson Atroshi and Christian Le, LTH.
- 26 Master's Thesis Presentation: *Remote Positioning of a Multidirectional Camera*, Linus Wannebro and Victor Ohlsson, LTH.
- 28 *Modeling and control of collective behavior*, Jordan Snyder, University of Washington.

May

- 24 Master's Thesis Presentation: *Modelling and Control of an Extruder Cooling System*, Christopher Fritzon and Nils Persson, LTH.
- 25 Master's Thesis Presentation: *Emulation of the Crazyflie 2.1 Hardware for Embedded Control System Testing*, Josefine Möllerström and Max Nyberg Carlsson, LTH.
- 25 Master's Thesis Presentation: *Enhanced Detection of Minispare Usage*, Isabella Hansen and Johanna Wikström, LTH.
- 26 Master's Thesis Presentation: *Identifiability of pharmacological models from data*, Amina Gojak, LTH.
- 26 Master's Thesis Presentation: *Control Design for Energy-Sharing Module of Next-Generation Thermal Energy System ectogrid™*, Tuva Ydén and Lisa Korsell, LTH.
- 26 Master's Thesis Presentation: *Slip Control for a Three-Wheeled Electric Motorcycle*, Andreas Karlin, LTH.

June

- 02 Master's Thesis Presentation: *A network analysis of delay propagation on Swedish railways*, J.Landelius and E. Wallgren, LTH.
- 08 Master's Thesis Presentation: *Real-time Computer Vision in Industrial Automation*, Jonathan Berglund and Joakim Cedergren, LTH.
- 09 Master's Thesis Presentation: *Playing Halite IV with Deep Reinforcement Learning*, Jesper Laurell and Kim Haapamäki, LTH.
- 11 Master's Thesis Presentation: *A new, fast, and efficient automatic tuner for the ABB AC 800M family of controllers*, Magnus Lundh, LTH.
- 14 Master's Thesis Presentation: *Dynamic Scheduling of Shared Resources using Reinforcement Learning*, Patrik Trulsson, LTH.
- 14 Master's Thesis Presentation: *Scenario Dose Calculation for Robust Optimization in Proton Therapy Treatment Planning*, Johan Sundström, LTH.
- 14 Master's Thesis Presentation: *Implementation of a Simple Asynchronous Pipeline Framework (SAPF) for construction of real-time BCI systems*, Tom Andersen, LTH.
- 14 Master's Thesis Presentation: *Robustness, Stability and Performance of Optimization Algorithms for GAN Training*, Oskar Larsson, LTH.

- 15 Master's Thesis Presentation: *Sound ranging using multilateration and Kalman filter*, Tobias Samuelsson, LTH.
- 16 Master's Thesis Presentation: *Digital Control of a VCO for Radar Applications*, Martin Alumets and Mattias Evaldsson, LTH.
- 16 Master's Thesis Presentation: *Traction Control of a Three-Wheeled Electric Motorcycle*, Josef Nilsson and Henrik Sandstedt, LTH.
- 17 Master's Thesis Presentation: *Development of a controller to switch between relative and absolute path for target vehicles in simulation scenarios*, Olof Karlsson and Erik Fredin, LTH.
- 17 Master's Thesis Presentation: *Domain Adaptation for Combined CT and CBCT Deep Learning Segmentation*, Jonas Berg, LTH.
- 17 Master's Thesis Presentation: *Ghost target classification using scene models in radar*, Anton Sedin and David Wadmark, LTH.
- 18 Master's Thesis Presentation: *Accurate Simulation of a Collaborative Robot Arm with Cartesian Impedance Control*, Joel Holmesson, LTH.
- 21 Master's Thesis Presentation: *Indoor Blimp Control*, Gustaf Åman, LTH.
- 21 Master's Thesis Presentation: *Shorten development time of Functional Testing (FCT) in electronic manufacturing with smart instruments*, Niklas Gustafson, LTH.
- 21 Master's Thesis Presentation: *Digitalization and Optimization of a Production Flow*, Sergio Mora Carrion, LTH.
- 21 Master's Thesis Presentation: *Design and test of a robotic cell for stud bolt welding in heat exchangers for SWEP International AB*, Amparo Tarazona Ferrandis, LTH.

August

- 23 Master's Thesis Presentation: *Compliance of a Robot Arm using Torque-Based Cartesian Impedance Control*, Oussama Choumans, LTH.

September

- 15 *Minimal Expected Regret for the Online LQR Problem*, Yassir Jedra, Division of Decision and Control Systems, KTH.

October

- 20 *Geometric Contraction Analysis with Applications*, Dongjun Wu.
- 20 Master's Thesis Presentation: *Automated construction supervision by Augmented Reality with a commercial robot (Spot from Boston Dynamics)*, Pablo Fernandez, LTH.
- 22 Master's Thesis Presentation: *Robust Reinforcement Learning Control of a Furuta Pendulum*, Philip Olhager, LTH.
- 28 *Collective decision-making on networked systems in presence of antagonistic interactions*, Angela Fontan, Department of Electrical Engineering, Linköping University.

November

- 02 Master's Thesis Presentation: *Robust Perception for Formula Student Driverless Racing*, Gustaf Broström and David Carpenfelt, LTH.
- 12 Defence of Doctoral Dissertation: *Nonlinear Control of Unmanned Aerial Vehicles – Systems With an Attitude*, Marcus Greiff, Department of Automatic Control, LTH.

- 30 *Designing controllers from data via approximate nonlinearity cancellation*, Professor Claudio De Persis, Engineering and Technology Institute Groningen and Jan C. Willems Center for Systems and Control.

December

- 17 Master's Thesis Presentation: *Advanced Teleoperation with Haptic Feedback*, Eric Ragnarsson, LTH.
- 20 Defence of Doctoral Dissertation: *Control over the Cloud - Offloading, Elastic Computing, and Predictive Control*, Per Skarin, Department of Automatic Control, LTH.
- 21 Master's Thesis Presentation: *A practical framework for the electric vehicle routing problem*, Johan Hellmark, LTH.



External Contacts

External contacts of importance to our projects, both academic and industrial

Together with external contacts and partners the goal is to solve real control problems. A mix of fundamental and applied work is a cornerstone of our activities. In these kind of projects the problems are approached with an open mind without glancing at particular methods. One purpose is to learn about real problems, another is to learn about new problems that are suitable for theoretical research. An important role for universities is to organize knowledge in such a way that the results can easily be digested by engineers in industry. The list below might be incomplete, and we ask for forgiveness if your organization is missing.

Lund / Academia

Lund University, AI Lund
Lund University, Dept of Architecture
Lund University, Dept of Clinical Sciences, Biomedical Engineering
Lund University, Dept of Chemical Engineering
Lund University, Dept of Computer Science
Lund University, Dept of Mathematics
Lund University, Dept of Electrical and Information Technology
Lund University, Dept of Heat and Power Engineering, Div. Combustion Engines
Lund University, Division of Thoracic Surgery
Skåne University Hospital, Medical Services

Lund / Industry & Society

Axis Communications AB
Business Region Skåne
Carrier
Cognibotics
Combine Systems
Energy Opticon
Ericsson, Lund
Igelösa Life Science AB
Max IV
Vävnadsbanken

Sweden / Academia

Chalmers University of Technology
KTH - Royal Institute of Technology
Linköping University
Luleå University of Technology
Umeå University
Uppsala University
Örebro University

Sweden / Industry & Society

5 High Innovations
ABB
ABB Corporate Research, Västerås

ABB Automation, Malmö
ABB Robotics
AChoice
Alfa Laval
Assa Abloy, Landskrona
Blue Institute
BorgWarner, Landskrona
Cementa
Clarister
Comsys
Corebon
E.ON, Malmö
Gustaf Fagerberg AB
Inventor
IUC Syd/IUC Lab - Industriellt utvecklingscentrum Syd
Noda Intelligent Systems AB, Blekinge
OP5
PEAB
Perstorp AB
PiiA
Prod2030
RISE
Saab AB, Linköping
Saab Bofors Dynamics, Linköping
Saab Kockums
Scania, Södertälje
Schneider Electric
Sectra Imtec
Sekvensa AB
SEK/IEC
SESAM-Sverige
Siemens
SIS/ISO
Swedish Energy Agency
Swedish Modules
Swegon Operations
SWEP International AB

Nordic countries / Academia

Aalto University, Finland
DTU - Technical University of Denmark
Jyväskylä University, Finland.
NordForsk - Nordic University of Hubs
NTNU - Norwegian University of Science and Technology, Dept of Engineering Cybernetics

Nordic countries / Industry & Society

Granlund OY, Finland
 kW-set OY, Finland
 Orbis OY, Finland
 UR, Denmark

Europe / Academia

ETH Zürich, Switzerland.
 European Innovation Academy, EU.
 Graz University of Technology - Institute of Computer Graphics and Vision, Austria
 KU Leuven, Belgium
 Lübeck University, Germany
 Oxford University, UK
 Max Planck Institute for Software Systems, Germany
 Politecnico di Milano, Italy
 Politecnico di Torino, Italy
 Sant'Anna School of Advance studies, Real-Time Systems Labs, Pisa, Italy
 Saarland University, Germany
 TU Chemnitz - Robotics and Human-Machine-Interaction Lab, Germany
 TU Darmstadt, Germany
 TU Delft, Netherlands
 TU Eindhoven, Netherlands
 TU Kaiserslautern, Germany
 TU Munich, Germany
 UNED, Spain
 Universidad de Almeria, Spain
 Universidad La Laguna, Spain
 Universidad Nacional de San Juan, Spain
 Università Luigi Bocconi, Milan, Italy
 University Groningen, Netherlands
 University of Brescia, Italy
 University of Cyprus, KIOS Research and Innovation Center of Excellence, Cyprus
 University of Cambridge, UK
 University of Ghent, Belgium
 University of Luxemburg
 University of Modena, Italy
 University of Rome Tor Vergata, Rome, Italy
 University of Salerno - Dept of Industrial Engineering, Italy

Europe / Industry & Society

AICo Software, Austria
 AlfaEvolution Technology, Italy
 Bosch Corporate Research, Germany
 Città dell Salute e della Scienza, Turin, Italy
 euRobotics
 Fluxguide, Austria

Machine Learning Reply, Italy
Robovision BVBA
SmartFactory, DFKI, Kaiserslautern, Germany
Tecnalia, Spain
Telecom Italia

World / Academia

Beihang University, BUA, Beijing, China
California Institute of Technology, USA.
Caltech, USA
Guangdong University of Technology, China
Hanyang University, Seoul, Korea
Massachusetts Institute of Technology, USA
McGill University, Canada
Nanyang Technological University, Singapore
Northeastern University, China
Saint Mary's University, Canada
Sydney University, Australia
Technion - Israel Institute of Technology, Haifa
Tel Aviv University, Israel
Tsinghua University, Dept Precision Instruments and Mechanology, Beijing, China
University of British Columbia (UBC), Vancouver, Canada
University of California, Sutardja Center for Entrepreneurship and Technology, Berkeley, USA
University of Maryland College Park, USA
University of Tennessee-Knoxville, USA
University of Texas at Arlington, USA
Zhejiang University, Control Science and Engineering, Hangzhou, China

World / Industry & Society

Lawrence Berkeley National Laboratory, USA
Mariner Partners, Canada
Missing Link Technologies, Canada
Mitsubishi Electric Research Laboratories - MERL, Boston, USA
United Technologies, Hartford, USA

Economy

This chapter contains an overall view of the economy and funding

ECONOMY

The turnover for 2021 was 62,8 MSEK, an increase of 1,5 MSEK compared to 2020. About half of the income comes from Lund University and the remaining half from external grants.

The activities and the number of employees are now in a growing phase since last year. The number of employees is currently 61 persons including part-time positions (51 full-time equivalents). Substantial support of our activities have been provided by The European Union, in Horizon 2020, the Swedish Foundation for Strategic Research (SSF), Swedish Research Council (VR), Knut and Alice Wallenberg Foundation (KAW) and Swedish Government Agency for Innovation Systems (Vinnova) . ELLIIT has grown and we have been succesful in receiving funding for both new PhD and Postdoc positions.

The block grants from VR, KAW, ELLIIT and some of the SSF projects are long range. Several projects do, however, have shorter duration such

as three years or less. To match these with the length of a PhD position, normally for 5 years, we have a long-term internal research planning, and we are careful to bid on projects that fit into our research plan. This has proven efficient to match short-term funding, research planning and personnel.

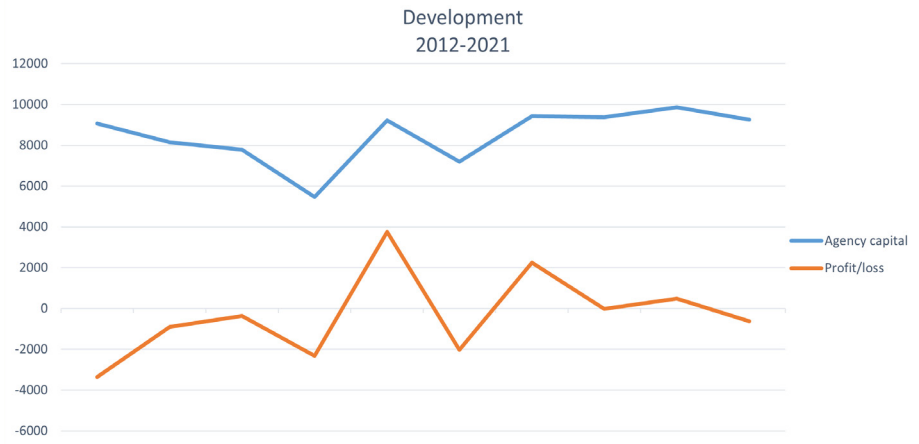
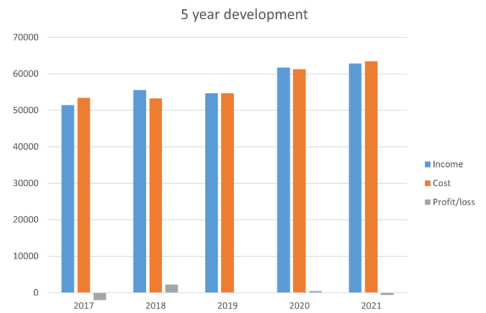

Above: Profit/loss and agency capital development over the last 10 years

FUNDING

2021 we had the following external grants:

VR – Control of Monotone Systems and Diffusions
VR – Large Scale Convex Optimization
VR – Hemodynamic Modeling and Control (Hemodynamisk modellering och reglering)
VR – Event-Based Control and Estimation with Application to Server Systems
VR – Fundamental mechanisms for scalable control of large networks
Vinnova – Strategies and Standards for Smart Swedish Industries, part 2
Vinnova – ITEA3, AutoDC
Vinnova – On Humans for Humans: Testbed for New Surgical Methods
Vinnova – Innovative Agile Construction for Globally Improved Sustainability (ACon4.0)
Vinnova – Digitalisation and Standardisation for Customized Mass Production (DSKM) *NEW*
Vinnova – Forum for Standardisation in Digitalisation of Production
Vinnova – SelectiCa (cofunding EU Horizon 2020)
Boverket – Innovative Construction with Flexible Robot-Human Interaction
SSF – Societal-Scale Cyber-Physical Transport Systems
SSF – Semantic Mapping and Visual Navigation for Smart Robots
EU Horizon 2020 – Scalable Control of Interconnected Systems - an ERC project
EU Horizon 2020 – Admorph Towards Adaptively Morphing Embedded Systems
KAW – Wallenberg AI, Autonomous Systems and Software Program (WASP)
ELLIIT – Scalable Data Processing in Networked Systems
ELLIIT – Autonomous Radiation Mapping and Isotope Composition Identification by Mobile Gamma Spectroscopy
ELLIIT – Efficient and Reliable Training of Generative Adversarial Networks
ELLIIT – Robust and Secure Control over the Cloud
ELLIIT – Autonomous Force-Aware Swift Motion Control
ELLIIT – Scalable Optimization for Learning in Control
ELLIIT – Visual Feature Based Data Reduction
ELLIIT – Dynamics of complex socio-technological network systems
Formas – SmartBuilt
NordForsk – Nordic University Hub on Industrial Internet of Things (HI2OT)
ESA – Artificial intelligence techniques for GNC design, implementation and verification - AI4GNC

Our major sources of funding for the research are currently;

- Lund University faculty funding
- EU - Horizon 2020
- VR – Swedish Research Council
- SSF – Swedish Foundation for Strategic Research
- Vinnova – Swedish Government Agency for Innovation Systems
- KAW – Knut and Alice Wallenberg Foundation

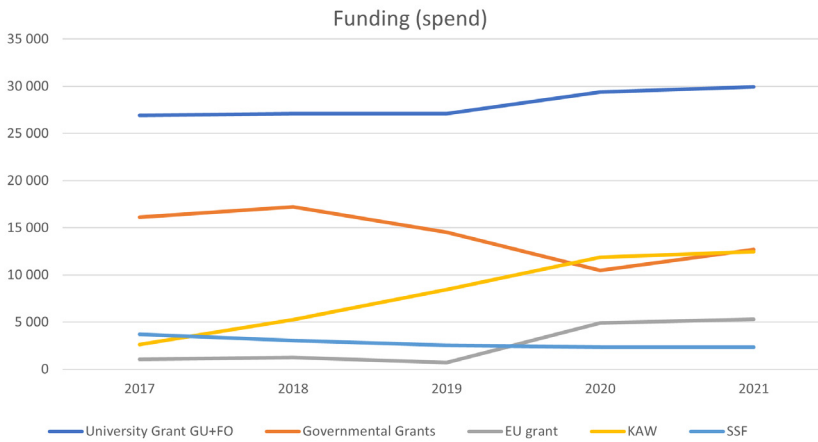

Staff

In this chapter the personnel and their activities are described



Kick off at Boklunden, October 2021

Personnel at Automatic Control

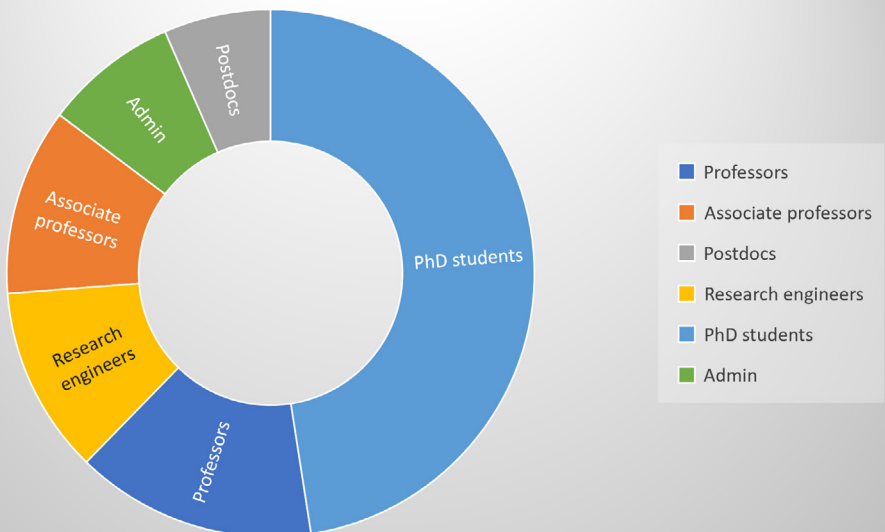

Professors

Årzén, Karl-Erik
 Åström, Karl Johan; senior professor (20%)
 Bauer, Margret; Lise Meitner professor (20%)
 Bernhardsson, Bo
 Eker, Johan; adjunct professor (20%)
 Hagander, Per; professor emeritus
 Hägglund, Tore, assistant head of department
 Johansson, Rolf; professor emeritus (from Sept)
 Johnsson, Charlotta
 Rantzer, Anders; head of department
 Robertsson, Anders
 Wittenmark, Björn; professor emeritus

Associate Professors

Cervin, Anton; deputy head of department, and
 director of undergraduate studies
 Como, Giacomo (25%)
 Giselsson, Pontus; director of graduate studies
 Maggio, Martina (20%)
 Pates, Richard
 Soltész, Kristian
 Tegling, Emma

Research engineers

Andersson, Leif (30%)
 Blomdell, Anders
 Korell, Manuel (until June)
 Nilsson, Anders
 Pisarevskiy, Alexander

Administrators

Edelborg, Cecilia
 Nishimura, Mika
 Rasmusson, Monika (70%)
 Westin, Eva

Project assistants

Tetov Johansson, Anton (from June)
 Zilic, Tihomir (internship from October)

Postdocs

Bergeling, Carolina (until December)
 Chen, Ci (until June)
 Govaert, Alain (from February)
 Kergus, Pauline (until December)

Renganathan, Venkatraman (from September)
 Yetis, Mustafa (until July)

Researchers

Banert, Sebastian (from September)
 Godoy, Boris (from October)
 Olofsson, Björn (20%)

PhD students

Agner, Felix
 Bencherki, Fethi (from September)
 Berner (Nylander), Tommi (until December)
 Fält, Mattias (until June)
 Gemborn Nilsson, Martin (from January)
 Greiff, Marcus (until December)
 Grönqvist, Johan
 Hansson, Jonas
 Heimerson, Albin
 Heskebeck, Frida
 Heyden, Martin
 Jia, Zheng (from August)
 Jouini, Taouba
 Kjellqvist, Olle
 Lindberg, Johan
 Mandrioli, Claudio
 Morin, Martin
 Nayak Seetanadi, Gautham (until February)
 Nyberg Carlsson, Max (from August)
 Ohlin, David (from August)
 Pigot, Henry
 Rosdahl, Christian
 Ruuskanen, Johan
 Sadeghi, Hamed
 Salt Ducaju, Julian
 Thelander Andrén, Marcus (until May)
 Upadhyaya, Manu
 Vladu, Emil
 Vreman, Nils
 Wahlquist, Ylva

Industrial PhD students

Martins, Alexandre; Axis
 Skarin, Per; Ericsson
 Tufvesson, Pex; Ericsson (from January)
 Wingqvist, Birgitta; Saab Kockums

LONG-TERM VISITORS

Magron, Victor; guest researcher, CNRS France (until December)

Wengel Mogensen, Søren, guest postdoc Copenhagen University

BOARD OF THE DEPARTMENT

Anders Rantzer
Anton Cervin
Kristian Soltesz
Pontus Giselsson
Monika Rasmusson
Carolina Bergeling
Martin Morin

Deputy members

Tore Häggglund
Karl-Erik Årzén
Richard Pates
Charlotta Johnsson
Mika Nishimura
Sebastian Banert
Frida Heskebeck

STAFF ACTIVITIES

Agner, Felix

MSc Engineering Physics, LTH, 2019. PhD student since January 2020.

His research interests are Scalable control for energy systems under Anders Rantzer's ERC-funded project in scalable control, focusing on load control and coordination. He is hoping to investigate and develop strategies that allow for system-level guarantees and benefits with minimal development in communication and measurements when utilizing load control to increase demand flexibility in energy systems.

His teaching assignments during spring as Lab assistant in the *Automatic Control, Basic Course* and *Mathematical Modeling*. During fall: Course development for our new course, *Learning Based Control*.

He has been responsible for the coordination of the Friday seminars, Marketing at the digital Farad fair and of course part of the the Party Committee.

Andersson, Leif

MSc, Research Engineer since 1970. Leif started at the department with responsibility for the teaching and research laboratory. After some years he drifted to computer maintenance and became computer manager. He retired formally in 2012, but was immediately rehired on 30%.

A large part of his time the past year has been spent as an internal LaTeX consultant, helping the PhD students to make their theses beautiful, and also helping the staff with general LaTeX problems.

As previous years he has worked a lot with the publication database LUCRIS, and also with adjusting some web trees to the new accessibility rules.

There is a general trend in computing to move applications from complete virtual machines to the more lightweight container model. Leif has taken part in building department competence in these matters.

Årzén, Karl-Erik

Professor (2000), PhD (1987), joined the department in 1981.

His research interests are real-time and embedded control, real-time systems, cloud control, feedback computing, autonomous systems, and programming languages for control.

Coordinator for the Lund part of WASP (Wallenberg AI, Autonomous Systems and Software Program). WASP co-director for research program coordination. Chair of the Research Management Group of WASP. Member of the WASP Executive Committee.

During the year he has primarily been involved with WASP, the VINNOVA/ITEA3 AutoDC project, and the Nordforsk University Network HI2OT.

He is partly or fully involved in the supervision of seven PhD students.

Åström, Karl Johan

Professor in Automatic Control since 1965 and founder of the department, emeritus from 2000, senior professor since 2008.

He worked on the second edition of the book *Feedback Systems* with Richard Murray, Caltech.

Banert, Sebastian

Sebastian obtained his diploma and PhD degrees in mathematics from Chemnitz University of Technology in 2012 and University of Vienna in 2017, respectively. After a postdoc position at KTH, he joined the department in September 2019.

His research interests are algorithms for convex and large-scale optimisation and monotone inclusions in connection with deep learning and inverse problems.

He is working in an ELLIIT project of Pontus Giselsson and co-supervises his PhD students.

Bauer, Margret

Margret received her undergraduate degree in electrical engineering from the University of Erlangen-Nuremberg in 2001. She is professor at Hamburg University of Applied Sciences in

Germany, and is one of few women in automatic control.

In 2021 she was nominated for the Lise Meitner Professorship at the Department of Automatic Control at LTH, and is now working part-time in Lund.

Her research interest is on data analytics and big data for process control.

Bergeling, Carolina

PhD (2019) and Lic. Tech. (2016) in Automatic Control, MSc in Engineering Physics (2013), from Lund University. Carolina has been with the department since 2013 and is currently a postdoc within the WASP Expedition Project *Realtime Individualization of Brain Computer Interfaces*, run by Professor Bo Bernhardsson.

Her research interests include Brain Computer Interfaces and control of large-scale systems.

She is the co-supervisor of PhD students Frida Heskebeck and Emil Vladu.

Carolina is also part of two working groups on gender equality and diversity.

Berner, Tommi

MSc in Engineering Physics. PhD student since January 2016.

He is part of the WASP Autonomous Clouds and Networks research cluster, focusing on control-based resource management.

Bernhardsson, Bo

PhD 1992, Professor since 1999, has also worked at Ericsson 2001-2010 as an Expert in Mobile System Optimization.

His research interests are in control of uncertain systems, learning-based control for Brain Computer Interfaces using EEG signals and applications of control, signal processing and communication systems.

During 2021 he worked as one of the Master Programme Directors for the program in *Machine Learning, Systems and Control* and gave the recently developed course *Modeling and Learning from Data*.

He was part of the examination committee for Alireza Javid at KTH in Feb 2021.

He is currently the main supervisor of 4 and co-supervisor of 6 PhD students, where 2 are with the EIT department and 1 with the mathematics department.

Blomdell, Anders

Research Engineer at the department since 1988. Heavily involved in almost all aspects of Robotics research at the department, also responsible for the department network and lab computers for teaching and research.

Still recuperating from the first phase of the big shuffle (renovation of the M-building), and trying to plan ahead for the next stage.

Cervin, Anton

Docent (2008), PhD (2003), MSc (1998). Anton joined the department in 1998 and has been employed as an Associate Professor since 2007.

His research interests include event-based and networked control, real-time systems, cloud control, and computer tools for analysis and simulation of controller timing.

He is the main supervisor of three PhD students and leads research projects within event-based control and estimation and co-design of real-time control systems.

During 2021 he was responsible for the new course *Project in Systems, Control and Learning* as well as the second edition of *Automatic Control, Advanced Course*. He was also supervisor or examiner of four master's theses. His administrative tasks included being deputy head of the department and director of studies for the first- and second-cycle education at the department.

Como, Giacomo

PhD (2008), Docent (2012). He has been with the faculty at the Department of Automatic Control since 2011 and was promoted Associate Professor in 2013.

His research interests are in Dynamics, Information, and Control in Networks, with applications to transport, infrastructure, as well as

social and economic systems.

During 2021, he has served as supervisor of Laura Arditti, Leonardo Cianfanelli, Martina Vanelli, Stephane Durand, and Mark Jeeninga, and co-supervisor of Luca Damonte, Leonardo Massai, Martina Alutto, and Roberta Raineri at Politecnico di Torino.

In Spring 2021, he taught the master level course *Network Dynamics* at Lund University.

During 2021, he has partly been on leave at Politecnico di Torino.

Since 2016, he has been an Associate Editor of the IEEE Transactions on Control of Network Systems and of the IEEE Transactions on Network Science and Engineering. Since 2019, he has been Chair of the IEEE-CSS Technical Committee on Networks and Communication. He co-organized the Workshop "Control for Autonomous Cities" at the 60th IEEE Control Decision Conference.

Edelborg, Cecilia

Financial Administrator at the department since 2017.

The responsibilities are primarily accounting regarding travel expenses, intermittent employments, reimbursements, invoices and projects. Also, administration of conferences and kick offs, committees and other administrative tasks.

She is also CPR trained as well as Fire protection trained and a member of the Equality group at the department and at LTH JäLM group to work with these questions. Also some responsibility regarding human resources issues.

Her background is from the Faculty of Law at Lund University.

Eker, Johan

Johan is adjunct Professor and Principal Researcher at Ericsson Research, Sweden. He received his PhD in Automatic Control from Lund University in 1999 and subsequently joined the Ptolemy group at UC Berkeley. He was appointed adjunct Professor in Automatic Control at Lund University in 2013.

His research interests range from program-

ming language design for parallel hardware, real-time control systems, mobile communications, adaptive resource management, IoT and cloud technology. He is the co-designer of the CAL Actor Language, which is part of the MPEG standard ISO/IEC 23001-4:2011. He holds over 60 granted patents in the areas of telecom, IoT and cloud computing.

He is participating in a range of program committees and research projects on topics such as real-systems, signal processing, software development, cloud technology, brain-computer interfaces, and AI.

He is involved in the operation of the Ericsson Research Data Center and works with industrial cloud applications and data-driven systems.

Johan is the main supervisor for Albin Heimer-son and the industrial supervisor for Per Skarin and Pex Tufvesson. He has also been master's thesis supervisor to Jacob Gummesson Atroshi and Christian Le, their thesis titled *Automatic Log Based Anomaly Detection in Cloud Operations using Machine Learning*.

Fält, Mattias

MSc, PhD student since August 2015.

His main research interest is methods for large-scale convex optimization. The focus has been on studying and improving convergence rates for first-order methods. In February he defended his thesis *Convergence Analysis and Improvements for Projection Algorithms and Splitting Methods*.

Gemborn Nilsson, Martin

MSc in Electrical Engineering 2020. PhD student at the department since January 2021.

Supervised by Bo Bernhardsson and funded by ELLIIT, Martin's research project is about representation and visualization of EEG signals for improved efficiency of Brain-Computer Interfaces.

During the year, Martin has been a TA in the following courses: *Basic Course in Automatic Control*, *Modeling and Learning from data*, *Project in Automatic Control*, and *Project in Systems, Control and Learning*.

Giselsson, Pontus

Pontus is currently an Associate Professor at the Department of Automatic Control. He received his MSc from Lund University in 2006, his PhD from the Department of Automatic Control, Lund University in 2012, and became Reader (Docent) in 2018.

His research interests are in optimization and its wide range of applications.

During 2021, Pontus was responsible for the undergraduate level course in *Optimization for Learning* and the *basic course*. He supervised three master projects, four PhD students, and two postdocs and is director of doctoral studies at the Department of Automatic Control.

Godoy, Boris

Boris received his PhD degree in 2008 from The University of Newcastle (AUS). Since November 2021, he has been a researcher with the Department of Automatic Control at Lund University.

He is involved in the ELLIIT-radiation mapping and SSF-projects, working with Professor Anders Robertsson, and alumni Dr. Marcus Greiff.

Govaert, Alain

Alain received his PhD degree in 2020 from the University of Groningen. Since 2021 he is a postdoc at the Department of Automatic Control, Lund University.

He is involved in research projects on Performance, Controllability, and Robustness of Large-Scale and Non-Normal Network Systems, and Dynamics of Complex Socio-Technological Network Systems. His research interests include modelling and control of large-scale decision-making processes and dynamical systems on networks.

Greiff, Marcus

Marcus received his MSc in 2017 at LTH.

His main research topic concerns nonlinear control and output feedback for drones, but he has also made contributions to motion planning and estimation theory more broadly. He is involved in an SSF-project concerning the visual

semantic mapping of indoor environments, as well as a recently started project concerning the mapping of radiation from drones.

In November he defended his thesis named *Nonlinear Control of Unmanned Aerial Vehicules - Systems With an Attitude*.

Grönqvist, Johan

PhD (Physics) from 2010, LTH and doctoral student at the department since 2019.

His general control interests are Learning and, Robustness. He is trying to obtain Guaranteed Stability with Neural Networks.

During 2021 he has been supervisor for several Master's Thesis projects: Supervisor for Kim Haapamäki and Jesper Laurell, working with Sinch, using Reinforcement Learning to play a game. He has been co-supervisor for Philip Olhager, using robustifying techniques for Reinforcement Learning in control.

In teaching he has supervised projects in *Mathematical Modelling*, using data from Covid pandemic. Developing Reinforcement Learning exercises for our new course *Learning Based Control*.

Hansson, Jonas

MSc in Engineering Physics, LTH, 2020. PhD student since August 2020.

Jonas is mainly interested in the fundamental mechanisms of networked control. Throughout the year he has been investigating the robustness and transient behavior of non-normal network dynamics.

He has been teaching assistant in the *Network Dynamics* course as well as the *Applied Robotics* course.

Heskebeck, Frida

Frida Heskebeck (M.Sc.Eng. in Biotechnology 2019, Lund University) started as a PhD student in 2019 and is working with Brain-Computer Interfaces (BCI).

During the year she has presented a poster at the international BCI-conference and supervised a master's thesis by Tom Andersen. She has

taught in two courses where she held seminars with the students. During a seminar the students discuss the theory from the course with each other. For both courses she was awarded *The Teaching Assistant of the Year* by the students. Frida and Prof. Margret Bauer held a *Workplace and equality workshop* in two courses at the department.

Finally, Frida is also one of the PhD student representatives in the Department board.

Hägglund, Tore

Professor, PhD (1984). Has been at the department since 1978 except for four years when he worked for ABB. He is responsible for two of the basic courses in Automatic Control in the engineering program.

Main research interests include process control, PID control, decentralized control, and monitoring and diagnosis.

Main research activities during the year have been feedforward control, mid-ranging control, and control loop decoupling. The research projects are presented on his personal web page at www.control.lth.se/personnel/.

Heimerson, Albin

PhD student since August 2018 with Johan Eker as supervisor.

Main project is a collaboration with Ericsson about automated datacenters. Research interests are towards ML/RL, and when this can be beneficial compared to classical control.

He has been a teaching assistant in the *Real-Time Systems* and also in the *Introduction to Machine Learning, Systems and Control* course for the Masters program.

Heyden, Martin

MSc, PhD student since October 2016.

His main research interest is control of large scale transportation networks.

During the year he has finalized his PhD thesis which will be defended in the beginning of 2022.

Jia, Zheng

Zheng Jia received the bachelor's degree in electronic engineering from The Hong Kong Polytechnic University, Hong Kong, in 2013, and the master's degree in robotics, systems, and control from ETH Zurich, Zurich, Switzerland, in 2017.

He started as a PhD student in September 2021, supervised by Anders Robertsson, Björn Olofsson and co-supervised by Lars Nielsen, Linköping University. He has been a teaching assistant in the courses: *Applied Robotics*, *Project in Automatic Control* and *Mathematical Modeling*.

He is now working on an ELLIIT project *Autonomous Force-aware Swift Motion Control* and his research interests include force control, motion control and robotics.

Johansson, Rolf

Professor, MD (1986), PhD (1983). Active at the department since 1979. In August 2021 he retired but is still supervising PhD students and engaged on part-time at the department.

Rolf Johansson's research interests are in system identification, robotics and nonlinear systems and automotive control.

Johnsson, Charlotta

Professor (2018), PhD (1999).

Charlotta's main research interest covers Automation, Control and Operations. However, Charlotta is also involved in the research domains of Innovation and Entrepreneurship, Teaching and Learning in Higher Education, as well as Technology Management and Engineering Leadership. She is the Chair of ISO TC184/SC5, hence actively working on standardisation activities for Smart Manufacturing and Industry 4.0. She is also the director for the makerspace X-Lab at LTH, an open innovation space for both students and colleagues at LTH.

During the year 2021, Charlotta has been a guest lecture in the course *Automation in Complex Systems* (given by the Department of Biomedical Engineering). Charlotta has also been

involved in the PhD-courses *Research Methodology*, *Ethics and Innovation* and *Innovation and Value Creation in Research*.

Charlotta has also given invited seminars to industry focusing on Industry 4.0/Smart Manufacturing.

Starting January 2021, Charlotta is the Dean of Campus Helsingborg, Lund University. She is also the Director of X-Lab, LTH as from January 2021.

Jouini, Taouba

MSc in Cybernetics Engineering from University of Stuttgart, Germany in 2016. Graduate research assistant at Automatic Control Laboratory (IfA) at ETH Zurich until January 2019. PhD student since August 2019.

Her research interests are related to the theory of modelling and control of networked systems with application to control of converters in power systems.

In January 2022 she will defend her thesis named *Network Synchronization and Control Based on Inverse Optimality - A Study of Inverter-Based Power Generation*.

Kergus, Pauline

Postdoctoral researcher at the Department of Automatic Control since January 2020 and until December 2021.

Her research interests are control, system theory, model order reduction and system identification. In particular, she works on modelling and control of district heating networks within the ERC project *Scalable Control of Interconnected Systems*. In addition, she is working in collaboration with NODA and Carrier on physics-informed learning for building thermal behaviour identification.

She is also the co-supervisor of Felix Agner and was the supervisor of the master thesis of Lisa Korsell and Tuva Yden, in collaboration with E.ON. She supervised Caroline Cognot for a 3-months research internship.

Kjellqvist, Olle

Olle obtained a MSc in 2018 from Lund University. He is a PhD student at the department since 2018.

His research interests are in learning from data and adaptation.

In 2021 he received a scholarship from the *ASEA Foundation of Scholarship Fund* through the *Sweden-America Foundation* for an extended research visit to California Institute of Technology with Richard Murray, where he is staying during the autumn 2021 and spring 2022.

Lindberg, Johan

Johan has a MSc in engineering Physics (2020) and started as a PhD student at the department in September 2020.

His supervisor is Richard Pates and he works with scalable, decentralized control.

Johan's research interests are towards how decentralized control can be used in the electrical power grid. Especially how to keep it in balance when more power production comes from renewables, that are less predictable than traditional power production, and where the power is injected to the power grid through power electronics, instead of traditional synchronous machines.

During 2021 Johan was a teaching assistant in the bachelor course *Systems Engineering/Process Control* and in the master course *Automatic Control, Advanced Course*.

Maggio, Martina

PhD, 2012, Politecnico di Milano and is now Associate Professor and has now been at the department for 9 years (employed January 1st, 2012).

Her research interests: Real-Time Control Systems. Martina has mainly two research interests. The first one has been the design of controllers for computing systems. Many components of a computing system can be designed as controllers: memory allocators, schedulers, and similar components. This is true also for distributed infrastructures like cloud computing facilities. The

second research interest concerns the implementation of control systems and their real-time properties. In that respect, she has been working on what happens when a controller designed with given proven characteristics is implemented and runs in a real computing environment, where unpredictable workloads can lead to missing computational deadlines. She is supervising two PhDs; Claudio Mandrioli and Nils Vreman.

Mandrioli, Claudio

Claudio received Bachelor (2015) and Master degree (2017) from Politecnico di Milano, both in Automation and Control engineering. At the end of his master he was a visitor at the department and worked on his final thesis. He has then been employed as a PhD student at the department since January 2018.

He is part of and funded by the WASP research program.

The main focus of his research work in 2021 was on the testing of software that implements control systems. More specifically, on how different testing setups can affect the effectiveness of the software tests. Another part of his work has been in the field of real-time aware controllers: the study of how the real-time implementation of a control algorithm can be made aware of faults in its execution timing.

In 2021 he was involved as teaching assistant in the *Real-Time Systems* course and the *Advanced Control* course. During spring 2021 he has been supervising the master thesis project of Josefine Möllerström and Max Nyberg Carlsson, with title *Department of Automatic Control Emulation of the Crazyflie 2.1 Hardware for Embedded Control System Testing*. From October 2021 to March 2022 he is visiting the Software Verification and Validation group at University of Luxembourg, headed by professor Lionel Briand.

Morin, Martin

MSc in Engineering Physics 2017, Lund University. PhD student at the department since 2017.

Research interests are within large scale optimization and monotone inclusion with previous

work focusing on variance reduced stochastic first order methods.

Current research revolve around modeling of general algorithms for solving monotone inclusions with the aim of deriving sufficient conditions for their convergence and examining their properties.

Nayak Seetanadi, Gautham

MSc in IC design from NTU-TUM. PhD student at the department since January 2016.

He defended his thesis titled *Improving Performance of Feedback-Based Real-Time Networks using Model Checking and Reinforcement Learning* in February.

Nishimura, Mika

Born in Japan. Administrator at the department since January 2014.

She handles Ladok (student administration system) for both students and PhD students. She has contact with the printing office about publications, and is responsible for purchase of office supplies, books and handles Lucat-catalogue system for the employees at the department. In addition, she reviews Lucris-research portal, updates LUP-student paper and parts of the web pages as well as other service-oriented tasks.

Nyberg Carlsson, Max

MSc Engineering Physics (2021) at LTH. PhD student since August 2021 as a part of an ELLIIT funded project.

Research interests include real-time systems and cloud computing.

Teaching duties were TA and lab responsible in *Automatic Control, Basic Course*.

Ohlin, David

MSc in Engineering Physics 2021, LTH. PhD student at the department since August, 2021.

Main research interest is currently the large-scale network dynamics of opinion modeling, within the ELLIIT project Dynamics of Complex Socio-Technological Network Systems.

Teaching responsibilities during 2021 included lab supervision in *Nonlinear Control and Servo Systems* as well as planning and development of course material for the new course *Learning-Based Control*.

Olofsson, Björn

He obtained the MSc in Engineering Physics in 2010 and the PhD in Automatic Control in 2015, both from Lund University, and was appointed Docent at Linköping University in 2020. He has been with the department since 2010. He is currently a part-time researcher at the department, with broad research interests in autonomous motion planning and control for robots and vehicles.

During the year, he has been involved in a research project within the ELLIIT Strategic Research Area called *Autonomous Force-Aware Swift Motion Control*. Moreover, he has participated in a pre-study within the Swedish Electromobility Centre on fuel cells in vehicles.

He has also taken active part in the teaching activities. He is the co-supervisor of three PhD students at the department. He is in addition the main supervisor of one PhD student and co-supervisor of one PhD student at the Division of Vehicular Systems, Linköping University. During the spring, he organized an online PhD course within ELLIIT on the topic *Advanced Motion Planning and Control*. He was also acting as supervisor of Master's Theses during the year.

Pates, Richard

Richard obtained the M.Eng degree in 2009 and PhD degree in 2014, both from the University of Cambridge. He is currently an Associate Professor at the Department of Automatic Control.

His research focus is on control system design for electrical power systems and autonomous vehicles. The vision is to build a modular theory of control system design that can be used to address the requirements of future large-scale interconnected systems.

He has been involved in teaching the *Non-linear Control and Servo Systems* course, and

the *Control Theory* course. He is involved in the supervision of 4 PhD students and 1 masters student.

Pigot, Henry

Henry (Harry) joined the department as a Project Assistant in 2018 and became a PhD student in 2019. He has an Electrical Engineering (Biomedical Option) degree from the University of British Columbia in Vancouver.

Harry's main interest is medical technology development. The focus of his thesis is applying control theory to improve the safety and efficacy of devices for evaluating heart organ function outside of the body. He works together with Kristian Soltesz and researchers at Igelösa Life Science AB.

In 2021, Harry conducted experiments to evaluate a heart evaluation system prototype, published work on commonly used models for cardiac afterload, and began a revised system design.

He also assisted in teaching *Physiological Modelling and Control*.

Harry is responsible for student engagement at X-Lab, an open co-creation and innovation space (makerspace) on campus, where he helps coordinate a group of student volunteers and holds workshops.

Pisarevskiy, Alexander

DipEng in Optoelectronics (2009). Research Engineer since 2020.

Mainly participates in upgrading of lab equipment for education processes.

During 2021 was involved in technical design for research projects, such as a real-time object detection system based on the Yolo algorithm, a Cardiac afterload system and several master thesis projects.

Rantzer, Anders

Professor of Automatic Control since 1999 and head of department.

Anders is the main supervisor for several PhD students and postdocs. In the spring 2021 he

was teaching the PhD course *Adaptive Control*. During the autumn, he developed a new masters level course named *Learning-based Control* to be taught in the spring 2022.

Anders Rantzer has broad interests in modeling, analysis and synthesis of control systems, with particular attention to uncertainty, optimization, scalability and adaptation.

Rasmusson, Monika

She joined the department in August 2011 and as from March 2017, she took over as finance officer and is now responsible for year-end closing, budget, forecast and reporting, both internally within the faculty and externally to sponsors.

As a part of the administrative team, her work includes backup function for her colleagues, editing the yearly Activity Report, among other administrative tasks.

She is a member at the Department Board.

She has a Bachelor's degree in Business administration, Lund University.

Renganathan, Venkatraman

Venkatraman is a Postdoctoral Researcher at the Department of Automatic Control since August 2021. He got his MSc in Electrical Engineering (Control Systems) from the Arizona State University, USA in 2016 and his PhD in Mechanical Engineering (Dynamics & Controls) from the University of Texas at Dallas in June 2021.

His research interests include Learning based control systems using deep reinforcement learning, robot motion planning, consensus dynamics and control of cyber-physical systems. He is currently working on analysing the minimax adaptive control algorithms through the project Scalable Control of Interconnected Systems.

Robertsson, Anders

Professor (2012), Associate Professor (2007), "Docent" (2005), Research Associate (May 2003), PhD (1999). Excellent Teaching Practitioner (ETP) in 2007.

His main interests are in nonlinear control, robotics and control of computing systems.

Currently, he is working on UAV-control within UAS@Lund, serial and parallel kinematic robots, sensor-data integration and force control of industrial robots in collaboration with ABB Robotics/ABB CRC and Cognibotics. The research has been conducted within the Robotics Lab, ELLIIT network, and the projects Smart Systems (SSF) and within a couple of projects related to construction robotics (VINNOVA and FORMAS).

He is manager for the RobotLab@LTH and the Center for Construction Robotics, Faculty of Engineering, Lund University.

He has been teaching in the courses on *Applied Robotics*, *Mathematical Modelling* and been supervisor for several project groups in automatic control, mechatronics, electronics and articulated in the teacher education at Vattenhallen, LTH. He has guest lectured on robotics at NTNU and University of Science and Technology "Sirius", Sochi, Russia.

He has acted as advisor/co-advisor for (4+3) PhD students and several Master's Thesis projects.

Rosdahl, Christian

MSc in Engineering Physics 2017, Lund University and PhD student at the department since September 2017.

He is part of the Wallenberg AI, Autonomous Systems and Software Program (WASP) and works on a project with focus on efficient learning of dynamical systems.

During the year, he has been a teaching assistant in the *Automatic Control, Basic Course* for several different engineering programs.

Ruuskanen, Johan

Graduated from Lund University with an MSc in Engineering Mathematics 2017, PhD student at the department since September 2017.

Johan is part of the WASP research program within the Autonomous Clouds and Networks cluster, and is supervised by Anton Cervin and co-supervised by Karl-Erik Årzén.

His research interest includes performance modeling and autonomic computing for cloud

application management, and further event-based estimation using the particle filter.

During the past year, Johan has been active in the research project *Event-Based Information Fusion for the Self-Adaptive Cloud*, and been a teaching assistant in the two master level courses *Network Dynamics* and *Modeling and Learning from Data*.

Sadeghi, Hamed

MSc (2013) in Mechanical Engineering, PhD student since August 2016.

His research interest is in Large-scale Optimization and its vast areas of application. His research is a part of Large-scale Optimization and Control cluster within WASP-AS branch.

Salt Ducaju, Julian

Julian has a MSc. in Aeronautical Engineering from Universidad Politecnica de Valencia (2018) and he did his master's thesis in the University of California, Berkeley with Professor Masayoshi Tomizuka as a visiting student researcher. Since February 2019 a PhD student at the department where he is an affiliated WASP-AS student.

The main focus of his research work has been in the fields of autonomous vehicles and robotics.

Soltesz, Kristian

Kristian Soltesz defended his PhD in Automatic Control at Lund University in 2013, based on research conducted at University of British Columbia; his masters thesis from the same department was the result of a undergraduate research visit to Caltech. Since 2019 Kristian Soltesz is Reader (Docent) in Automatic Control, with research focus on medical control systems.

He is the main supervisor of PhD students Ylva Wahlquist and Harry Pigot, both conducting experimental work within different areas of control systems for improved heart transplantation.

During 2021 Kristian Soltesz has been involved in teaching *systems engineering and process control*; *introduction to machine learning, systems and control*; *physiological models and computations*. Kristian Soltesz has also been

involved as supervisor or examiner in several master's thesis projects. One of them received the best work-in-progress paper awards at the 2021 IEEE EFTA conference.

Apart from his ordinary research, Kristian Soltesz has been involved in a COVID-modelling research, that has been disseminated through channels including a publication in *Nature*, a plenary talk at the International society of Information Fusion's annual conference and a feature piece in their annual magazine perspectives. Popular scientific aspects have been communicated through Vetenskapsradion P1 (Swedish national radio) and publication in *NyTeknik*.

Kristian Soltesz is a member of the department board at Automatic Control and holds a coordinating role amongst the research engineers at the department.

Tegling, Emma

PhD in Electrical Engineering, KTH, 2019. Senior Lecturer from Januari 2021. She is a WASP associate professor. Before joining Lund, she was a postdoc with the Institute for Data, Systems and Society (IDSS) at MIT.

Her research interests are within analysis and control of large-scale network systems, with a particular focus on challenges related to highly distributed power generation, epidemics, and social networks.

During 2021, she co-supervised *Network analysis of delay propagation on Swedish railways* by Jacob Landelius and Elsa Wallgren. She is also co-supervising the PhD students Jonas Hansson, Taouba Jouini, Fethi Bencherki and David Ohlin.

Tetov Johansson, Anton

Master of Architecture, 2021, LTH and Master of Advanced Studies in Architecture and Digital Fabrication, 2020, ETH Zürich.

Project assistant, since June 2021, in projects: DSKM, and Biomimetic fabrication through robotic 3D printing.

Anton has also been Technical Assistant in *Applied Robotics* and at the Robotics week.

Tufvesson, Pex

Pex graduated with a MSc in Electrical Engineering in 1997 from LTH, working as a chip designer on GPUs, supercomputing, communication systems, encryption and synthesizers.

He's founded startups doing wearables and child healthcare systems. Employed by Ericsson Research, and in 2021 he started as an industrial PhD student at the Department of Automatic Control.

He is part of the research group working with EEG-based Brain-Computer Interfaces led by Professor Bo Bernhardsson. His research is about real time online classification and signal analysis.

Vladu, Emil

MSc in Engineering Physics from Lund University, 2018. PhD student at the department since August 2019.

His supervisor is Anders Rantzer and his research project mainly concerns control in large-scale dynamic networks.

During the spring of 2021, he was a TA for the course *Control Theory* and was involved in the project *A14GNC* (see LUCRIS). During the autumn of 2021, he was a TA for the course *Nonlinear Control and Servo Systems*, in which he was also responsible for one of the three laboratory exercises as well as compiling the exam.

Upadhyaya, Manu

MSc in engineering physics, 2020, Lund University; MSc in finance, 2020, Lund University and BSc in mathematics, 2015, Lund University. PhD student since July 2020. PhD student since July 2020.

His research interests is in First-order optimization algorithms with a focus on worst-case performance estimation.

During the year he has been TA in *Optimization for Learning* and *WASP AI Deep Learning and GANs*. He has also taken part in developing both in *Optimization for Learning* and *WASP AI Deep Learning and GANs*. He has been project supervisor in the course *Project in Systems, Control and Learning*.

Vreman, Nils

Nils obtained a M.Sc (2018) from Lund University. He is now pursuing a PhD degree since August 2018.

The main focus of Nils' research has been on the analysis and synthesis of real-time control systems subject to computational faults, in particular systems where the computational faults follow a weakly-hard model.

During 2021, his research focus has been on designing tools and methodologies for analysing and improving the performance of real-time control systems subject to weakly-hard and consecutive fault models.

Additionally, he has been teaching: *Real-time Systems and Automatic Control, Advanced Course*.

Wahlquist, Ylva

MSc (2019) and PhD student at the department since May 2020.

Her research interests include pharmacometric modelling and control of hemodynamic parameters for intensive care and heart transplantation,

and identifiability in physiological models. She works together with Henry Pigot and Kristian Soltesz at Igelösa Life Science.

During the year, Ylva has been a teaching assistant for the *Physiological Models and Computation* course and the *Process Control and Systems Engineering* course and has also supervised one master thesis project.

Westin, Eva

PhD in French linguistics. Administrator at Automatic Control since 2008 and administrative manager from December 2017 for the administrators and research engineers at the department.

She handles the overall responsibility of human resources, guests and conferences. She also handles part of the process for research studies.

Eva is part of the steering group for AI Lund. She is also part of the steering group for gender and equality issues at the Faculty of Engineering. Eva is the health and safety representative substitute. From 2021 she is the administrative coordinator for ELLIIT Focus Programme.

JÄLM@REGLER - THE GENDER EQUALITY, EQUAL OPPORTUNITIES, AND DIVERSITY GROUP AT THE DEPARTMENT

The working group on gender equality and diversity was formed in early 2014. Since the start we have arranged more than twenty seminars and workshops by invited speakers on different subjects ranging from research to ergonomics, security and how to implement this at our department.

The seminars have made issues on gender equality and diversity a natural talking point during our coffee breaks, which we believe is crucial for improving and tackling upcoming questions in these areas. We also have a delegate from our department in the JäLM working group at LTH, Cecilia Edelborg.

During 2021, we arranged or co-arranged one seminar on the psychosocial work and study environment of the undergraduate students and another one on the challenge of remote work due to the pandemic. We also continued our tradition of inviting an even number of male and female students to our spring recruitment event, which was held online this year. The JäLM group also contributed to two department activities with the goal of integrating new employees into the work environment.



Karl Johan Åström, senior professor at the Department of Automatic Control, is approaching the respectable age of 88 years. But he has no intention of quitting work.

– For me, this is pleasure. It is not often I think of work as work. It is just a lot of fun, he says with a smile.

Text: Ulrika Jönsson Belyazid
Foto: Jacqueline Hellman

Karl Johan Åström - Senior Professor

Karl Johan Åström grew up in Östersund, in the northern part of Sweden. As a youngster he spent his time skiing, “because that is what the kids did there back then”. His dad was a painter and his mum a housewife. That he would continue studying and get an academic education was not at all given.

– I always had an easy time learning. My math teacher noticed and gave me university books and catalogues and inspired me to apply for a higher education.

Karl Johan Åström decided to go for engineering physics at the Royal Institute of Technology in Stockholm.

– Simply because it was an interesting program that seemed really difficult to get into. Then it had to be good, he chuckles.

After finishing his university education, Karl Johan Åström was hired by the Research Institute of National Defence in Stockholm.

– It was during the time when we were afraid of the Russians. I was hired to work on navigation systems for missiles. The group consisted of

several professors and senior engineers from the industry and we had very interesting meetings that gave me a great overview of technology. That is where my interest for automatic control was triggered, he says.

From there, the path has been straight as a die. Karl Johan Åström joined the IBM Nordic Laboratory in 1961 to work on theory and applications of computerized process control, and then went as a visiting scientist to IBM Research Laboratories in Yorktown Heights and San Jose in the US. Upon his return to Sweden, he became responsible for modelling and implementation of systems for computer control of paper mills and developed one of the first computerized models for the process industry. In 1965, he was appointed Professor of Automatic Control at Lund Institute of Technology, interestingly enough without having a PhD.

– I skipped that step, he says and laughs.

Today Karl Johan Åström is regarded as one of the leading control engineers of the world. His research interests cover a wide range of fields within theory and applications of control,

including stochastic control, system identification, adaptive control, event-based control, relay auto-tuning of simple controllers and computer-aided control engineering. One of the things he is most proud of is the development of automatic tuning of PID controllers, work that was done in collaboration with Tore Hägglund, now professor at the Department of Automatic Control and once PhD student of Karl Johan Åström. He has won numerous awards and prizes, the most prominent according to himself being the Institute of Electrical and Electronics Engineers (IEEE) Medal of Honor, which he received for his “fundamental contributions to theory and adaptive control technology”.

– It is the best prize I have ever received. Just look at the people who got it. It is an exclusive group of excellent engineers. I am very proud to belong to that group, he says.

Just the other day, Research.com published its 8th edition of top scientists ranking for Electronics and Electrical Engineering. Karl Johan Åström ranked #101 in the world and #1 in Sweden.

Building up the Department of Automatic Control from scratch, there were a few things that Karl Johan Åström found more important than others.

– I always made very thorough research plans, he says and continues:

– And I surrounded myself with great people. You cannot do much if you are alone.

Karl Johan Åström started building his network already during his time at IBM, and later when having visiting appointments at various universities in the US, Europe and Asia.

– I have taken advantage of the possibility of trips and sabbaticals. It was great for me personally, and I believe also for the department because they could benefit from my contacts, he says.

Karl Johan Åström also emphasizes the informal and open atmosphere and the focus on social activities at IBM, something that has inspired him in his own leadership. He has always paid attention to how successful company directors

act in order to achieve a positive attitude among employees.

– Cai Kinberg at IBM is the best boss I have ever had. He realized the value of social interaction and he has been a true inspiration to me.

Today, more than 20 years after Karl Johan Åström formally retired, the Department of Automatic Control is still known internationally not only for their top-notch research, but also for their informal and pleasant atmosphere.

Another interesting approach in the early days, which still persists, was to perform experiments in cooperation with the industry and Karl Johan Åström is known to have said that “Industry is my laboratory”.

During his 56 years at the Department, Karl Johan Åström has supervised more than 60 PhD students and over a hundred master students. If there is any advice he would like to give to young researchers of today, it is to get a broad knowledge of mathematics and engineering, to learn to use computers effectively and to make sure that the topic you choose to work on is intellectually challenging, interesting and can be applied in reality.

– Be curious and open-minded. Listen. And make sure you work for a person that you can really learn from. If not, move, he says firmly and continues:

– Go out in the world, have a look around and create networks. Great networks are essential for success.

When asked to describe himself, he laughs and says:

– I am a pretty healthy old guy. I have no worries. I have a great life, a fantastic family. I can do whatever I like, whenever I like. I am really privileged!

His secrets to a long and healthy life are very straightforward: Bike to work every day, surround yourself with interesting people, read a lot and eat a grapefruit for breakfast every morning. It is as simple as that!



Margret Bauer, professor at Hamburg University of Applied Sciences in Germany, is one of few women in automatic control. In 2021 she was nominated for the Lise Meitner Professorship at the Department of Automatic Control at LTH, and was appointed. One year has passed, and we took the opportunity to ask Margret Bauer about her experiences so far, and hear what she is planning for the two years to come.

Text: Ulrika Jönsson Belyazid
Photo: Jacqueline Hellman

Margret Bauer - Lise Meitner Professor

The Lise Meitner Professorship offers the possibility for female researchers to work part-time at LTH for a period of one to three years. It is part of the university's efforts to promote gender equality and diversity, and to set examples of women at leading positions at LTH. There are no specific requirements associated with the professorship. However, in the spirit of Lise Meitner, Margret Bauer initiated her professorship at the department by organizing a workshop on workplace equality together with PhD-student Frida Heskebeck. She is continuing her work to promote women in engineering by highlighting women in the history of control, something that has not been done frequently in the past.

– Most presentations on the history of control have no women in them, although they are present, says Margret Bauer and continues:

– We need female role models in control. Otherwise, women will not get the idea that they could work in control. I know I would not have, unless I had one.

Margret Bauer received her undergraduate degree in electrical engineering from the University of Erlangen-Nuremberg in 2001. Already as a child, Margret Bauer loved mathematics. However, she was discouraged to study physics by her teacher. Luckily her dad, who was a lawyer, took her with him to various industrial sites nurturing her interest for engineering and production processes.

– When in my third year at university, I went for an Erasmus exchange to London. That is what kick-started my career because I met Nina Thornhill, a control researcher, who later became my PhD supervisor. She was my female role model and incredibly important to me, says Margret Bauer.

Even later, when Margret Bauer returned to work in the industry for a few years, during her time as a postdoc at the University of Pretoria, and as an associate professor at the University of Johannesburg and extraordinary professor at the University of Pretoria, South Africa, Nina Thornhill continued to be an inspiration to her.

As a Lise Meitner Professor at the Department of Automatic Control, Margret Bauer is hoping to be for young researchers what Nina Thornhill was to her.

– I believe my most important purpose is to get to know people and create relations, she says.

But there are also other, more practical, engineering tasks ahead. Margret Bauer will, among other things, translate a book for applied engineers (originally written by Tore Hägglund, professor at the Department of Automatic Control) and initiate research on the architecture of control.

– People work with so many different applications of control here. I am interested in the similarities and differences in the design process and how all the different fields are interconnected.

Simultaneously, she will continue her research on data analytics and big data for process control. In the long term, she is hoping to take on a PhD student or two and create her own research group.

When speaking to Margret Bauer there are a few things that stand out – the love for control, the commitment to transfer her passion and knowledge to others and an optimistic approach. She lives her life by the mottos: Stay in control, take nothing for granted and seize the opportunities. The latter was what she did when being offered the position as Lise Meitner Professor.

– It is fantastic to have this kind of position. You can advance your work without having the pressure of teaching or of constantly publishing new articles. That is really what academia should be about. I am incredibly fortunate, she concludes.

FACTS Lise Meitner:

Lise Meitner was a leading Austrian-Swedish physicist and one of the pioneers of modern science. She discovered, together with her colleague Otto Hahn, nuclear fission as well as the element protactinium. Completing her doctoral research in 1905, Lise Meitner became the first woman from the University of Vienna and second in the world to earn a doctorate in physics. She spent most of her scientific career in Berlin, Germany, where she was a physics professor and department head at the Kaiser Wilhelm Institute. However, being of Jewish origin, she was forced to flee the Nazi regime in Germany in 1938. She ended up in Stockholm, and began working at Stockholm University, later becoming a visiting professor at the Catholic University in Washington DC. Meitner received many awards and honours in her life, but she did not share the 1944 Nobel Prize in chemistry for nuclear fission, which was awarded her long-time collaborator Otto Hahn.



Rolf Johansson - Professor Emeritus as from September 2021

In late August 2021, Rolf Johansson retired after a long career at the department, where he worked as Professor in Automatic Control and coordinating director of the Robotics Laboratory. He now continues working part-time as PhD supervisor.

During his academic career Rolf Johansson has worked in several fields, doing research in adaptive system theory, mathematical modeling, system identification, robotics and signal processing. Since 1987, he also participated in research and as a graduate advisor at the Faculty of Medicine, Lund University Hospital. He has had a wide range of visiting appointments all over the world, including Europe, USA, China, Singapore and Australia.

Rolf Johansson is an IEEE Fellow and Fellow of the Royal Physiographic Society, Section of Medicine. He was awarded the 1995 Ebeling Prize of the Swedish Society of Medicine for distinguished contribution to the study of human balance through application and development of system analysis and robotics. He was also corecipient of EURON Technology Transfer Award 2004, 2007, and ICRA2012 Best Automation Paper Award. He is Associate Editor of International Journal Adaptive Control & Signal Processing; Editor of Intelligent Service Robotics; Editorial Board Member of Robotics and Biomimetics; Editor of Mathematical Biosciences.

AWARDS

GRANTS

Travel Grant

Ylva Wahlquist was granted a travel grant from *Kungliga Fysiografiska sällskapet* for her planned visit at the University of British Columbia, Canada in Spring 2022.

Teaching Assistant of the Year

Frida Heskebeck was rewarded *Teaching Assistant of the Year* by the students – twice.

The first prize comes from the Environmental engineering guild at the Faculty of Engineering, Lund University.

The second prize comes from the Guild of Mechanical Engineering at the Faculty of Engineering, Lund University.

Best Paper Award

ECRTS 2021 Best Paper Award presented to Nils Vreman, Anton Cervin and Martina Maggio for the paper entitled *Stability and Control Analysis of Control Systems Subject to Bursts of Deadline Misses*.

Royal Swedish Academy of Engineering Sciences *100-list 2021*

Kristian Soltesz and his project *COVID-19: Dynamic modelling for estimation and prediction* was included in the academies list of 51 promising innovation/research projects.

Scholarship from ASEA Foundation

In 2021 Olle Kjellqvist received a scholarship from the ASEA Foundation of Scholarship fund through the Sweden-America Foundation for an extended research visit.

WASP grant

Claudio Mandrioli was granted financing through the WASP PhD student exchange program under the framework of WASPs Memorandum of Understanding for his 6-month stay at SnT Centre, University of Luxembourg.

ASSIGNMENTS

BOARD MEMBER

Årzén, Karl-Erik

Chair of the Research Management Group for the Wallenberg Autonomous Systems and Software Program (WASP).

Member of the WASP Executive Committee.

Member of Research Board for the Faculty of Engineering, Lund University.

Como, Giacomo

Board member of the Excellence Project of the Department of Mathematical Sciences, Politecnico di Torino.

Johnsson, Charlotta

Board member of CIRCLE (Centre of Innovation Research), Lund University, Sweden.

Board member of EFL (Executive Foundation Lund), Lund, Sweden.

Board member of Innovation Skåne, Sweden.

Board member of IUC Syd (Industriellt utvecklingscentrum Syd), Malmö, Sweden.

Board member of IUC Syd Lab, Lund, Sweden.

Other Board assignments in national and global companies.

Rantzer, Anders

Member of the steering committee for the International Symposium on Mathematical Theory of Networks and Systems.

Member of Editorial Board for the journal Annual Reviews in Control.

Member of WASP research management group for Mathematics in AI.

Chairman of the LTH RobotLab board .

Robertsson, Anders

Board member for Centre for Engineering Education (CEE), Faculty of Engineering, Lund University.

Member of work group for new master program in "Architecture and Digitalization" (lead by David Andreen), LTH, Lund University.

Westin, Eva

Member of the steering group for AI Lund.

Member of the steering group for gender and equality issues at the Faculty of Engineering.

MEMBER OF INTERNATIONAL PROGRAM COMMITTEE (IPC)

Hägglund, Tore

IEEE International Conference on Emerging Technologies and Factory Automation, ETFA'2021, Västerås, Sweden.

Rantzer, Anders

Member of the IPC for L4DC - Conference on Learning for Decision and Control, ETH Zürich, 2021.
 General Co-chair for the organization of European Control Conference 2024 in Stockholm.
 Member of organizing committee for IEEE CSS Workshop on Control for Societal Challenges 2021.

OPPONENT AND MEMBER OF EXAMINATION COMMITTEE**Årzén, Karl-Erik**

Member of the PhD examination committee of Pian Yu, Division of Decision and Control Systems, KTH, Feb 11.
 Member of the Licentiate examination committee of Nitin Desai, Division of Computer Science and Software Engineering, Mälardalen University, Nov 25.

Eker, Johan

External thesis review at the Budapest University of Technology and Economics, December 2021.
 PhD thesis opponent: *Quality of Experience in Industrial Internet of Things*, by Dimitar Minovski, at Luleå Technical University, October 2021.
 PhD thesis opponent: *Resource Management for Real-Time and Mixed-Critical Systems*, by Gautam Gaia at Technical University of Kaiserslautern, November 2021.
 Member of Licentiate committee, *Improving soft real-time performance of fog computing* by Vaclav Struhar at Mälardalen University, September 2021.

Giselsson, Pontus

Opponent of Licentiate thesis of Yuchao Li, KTH, Stockholm, December 20.
 Member of examination committee for PhD defence by Marcus Valtonen Örnhags, Lund University, Lund May 14.

Hägglund, Tore

PhD thesis opponent: *Novel Strategies to design Controllers and State Predictors based on Disturbance Observers*, by Alberto Castillo Frasquet, Universitat Politècnica de València, Valencia, Spain, February 25.
 PhD thesis opponent: *Modeling and Control of the Microalgae Biomass Production Process in Raceway Reactors*, by Enrique Rodríguez Miranda, University of Brescia, Italy, March 15.

Rantzer, Anders

Member of examination committee for habilitation by Victor Magron at Université Toulouse, May 25.
 Member of examination committee for PhD defence by Matias Müller, June 9.
 Member of examination committee for PhD defence by Julio Careaga, October 1.

Robertsson, Anders

Discussant for mid-time seminar for PhD student Albin Dahlin, Chalmers, March 1.
 Faculty opponent for PhD thesis *A Position Control-based Approach to Stiff Objects Haptic Rendering* by Yang Wang, KTH, Stockholm, Sweden, June 8.
 Deputy board member for PhD thesis *Improving DRX Performance for Emerging Use Cases in 5G* by Farnaz Moradi, LTH, Lund University, June 7.

ADVISORY COMMITTEES AND WORKING GROUPS

Årzén, Karl-Erik

Chair of the Signals and Systems panel, Swedish Research Council (VR).
Elected member of the Royal Swedish Academy of Engineering Sciences (IVA).

Bernhardsson, Bo

Member of the WASP-DDLS collaboration management group.

Como, Giacomo

Chair of the IEEE-CSS Technical Committee on Networks and Communications.
Co-Organizer of the Workshop *Control for Autonomous Cities* at the 60th IEEE Control Decision Conference.

Eker, Johan

Program committee member for International Joint Conference on Artificial Intelligence (IJCAI) 2021.

Johnsson, Charlotta

Chair of ISO TC184/SC5 (Industrial Automation / Interoperability, integration and architectures for enterprise systems and automation applications).
Member in ISO SMCC (Smart Manufacturing Coordination Committee), reporting directly to ISO Technical Management Board.
Voting member in the standardization committee ISA95 and ISA88, and an information member in the standardization committee ISA99.
Member in SIS and SEK. She serves as the Swedish expert in the international IEC 62264, IEC 61512, ISO 22400 and ISO 15746 standards, as well as in the groups IEC AhG3, IEC TC65E AhG1, as well as in the joint committee IEC/TC65-ISO TC184 JWG21 (Reference Architecture for Smart Manufacturing).
Member of several boards and working groups at Lund University.

Rantzer, Anders

Chairman of the IFAC Fellow Search Committee.
Member of the IEEE Control Systems Society Fellow Evaluating Committee.
Member Evaluation Committee for Wallenberg Academy Fellows.
Principal Investigator in the project "AI for Guidance Navigation and Control" funded by the European Space Agency.
Member of the Advisory Board for Lecture Notes in Control and Information Sciences at Springer Verlag Heidelberg.
Member of the IEEE Control System Society Technical Committee on Nonlinear Systems and Control.
Member of the IFAC Technical Committee on Nonlinear Systems.
Member of Advisory Board for Excellence Center DISMA at Politecnico di Torino.

Soltesz, Kristian

Member of the IEEE Technical Committee of Healthcare and Medical Systems.

Tegling, Emma

Organized and Chaired the workshop: Paths from Research to Impact: a year of collaborative research on Covid-19 at MIT on April 30th.

Co-organized at CDC 2021: *Covid-19 Focus Workshop*.

OTHER ASSIGNMENTS**Årzén, Karl-Erik**

Associate Editor for Real-Time Systems Journal.

Associate Editor for the Leibnitz Transactions on Embedded Systems (LITES).

Associate Editor for ACM Transactions of Cyber-Physical Systems.

Como, Giacomo

Associate Editor of the IEEE Transactions on Control of Network Systems and of the IEEE Transactions on Network Science and Engineering.

Guest Editor for Special Issue *Dynamics and Behaviors in Social Networks* for the IEEE Transactions on Control of Network Systems.

Guest Associate Editor for Special Section *Mathematical Modeling, Analysis, and Control of Epidemics* for the SIAM Journal on Control and Optimization.

Edelborg, Cecilia

Representative for Automatic Control in the Equality working group (JäLM) at the Faculty of Engineering.

Johnsson, Charlotta

Serving as the IFAC Liaison with IEC 65A.

Serving as a member in IEEE CSS industry Committee.

Westin, Eva

Member in project group for HR Excellence Onboarding, Section HR.

LONGER VISITS ABROAD**Maggio, Martina**

In April 2020, Martina Maggio started a double appointment as full professor at the Department of Computer Science of Saarland University in Germany. During 2021 she had only 20% duty at the Department of Automatic Control, Lund University.

LECTURES BY STAFF OUTSIDE THE DEPARTMENT

Årzén, Karl-Erik

Control over the edge cloud: Possibilities and Challenges, Tutorial on Fog computing and IoT, Embedded Systems Week (ESWEEK), virtual presentation, Oct 8.

Bernhardsson, Bo

Navigering och Radiokanalskattning, lecture recorded for the ELLIIT seminar series on societal challenges from an ICT perspective, Nov 21.

Reinforcement Learning, lecture in the external LUCE course "AI för civilingenjörer", Nov 9.

Como, Giacomo

Distributed flow control and dynamic pricing in traffic networks, CDC Workshop *Control for Autonomous Cities*, December 11.

Resilient control of dynamical flows in transportation network, University of California, USA, October 15, 2021.

Distributed flow control and mechanism design for infrastructure networks, ECC Workshop *Modeling and control of power grids, where do we go from here?* June 29.

Optimal targeting in super modular games, Uppsala University, Sweden, March 9.

Network games and interventions, University of California, USA, February 19.

Game Theory and Network Systems, Invited PhD course. Summer School SIDRA 2021, July 12-17.

Eker, Johan

Management in Complex Systems at Linköping University, June 2021. Guest lecture at PhD Course. The *WASP cloud course* by Umea University, April 2021. Keynote lecture.

AI for cloud and data center operations at Royal Swedish Academy on Engineering Science, September 2021 (AI och maskinläring inom IKT-branschen – vilka är möjligheterna?). Invited talk.

Johnsson, Charlotta

Introduction to Industry 4.0, presentation given to members of IUC Syd, April 27.

Introduction to Industry 4.0, presentation given to SWEF, April 27.

Production related performance metrics, presentation given to SWEF, December 27.

Vilka är pusselbitarna i smart industri?, presentation for ELLIIT.

Strategies and standards for Smart Swedish Industry, Forum for Standardisering, November 17.

Rantzer, Anders

Minimax Adaptive Control for a Finite Set of Linear Systems, Oral presentation at L4DC virtual conference, June 8.

On Thermal Networks and Distributed Control, MIT LIDS virtual seminar series on Changing Electric Energy Systems, November 3.

On Thermal Networks and Distributed Control, Invited virtual seminar at the Data Science & Systems Complexity Centre at University of Groningen.

Robertsson, Anders

Advanced Robotic (together with Volker Krueger), presentation at IUC Syd, May 10.
Construction Robotics, Presentation at Byggautomation-workshop, Stockholm, May 20.
 Inspirational Lecture *Introduction to Industry 4.0*, Guest lecture, Sept 7.
 ELLIIT-presentation on projects, arranging workshop on *Cyber-physical systems*, October 26-27.
Robotics presentation on force control, Sotji, Russia and NTNU, Norway, November 2.

Tegling, Emma

Performance aspects of frequency control in highly distributed grids, Invited conference presentation at: CoNDyNet2 Conference: Complexity in Power Grids – From Science to Practice, Potsdam Institute for Climate Impact Research, Potsdam, Germany. September 2021.
Scale fragilities and performance limitations in network systems, Invited research seminar: Hybrid Control Systems (HyConSys) Group seminar series, LMU Munich, Germany. January 2021.

POPULAR SCIENCE PRESENTATIONS**Johnsson, Charlotta**

Forskningen når inte ut i kommunernas praktiska verksamhet, debate article in Dagens Medicin, April 2021.
Miljonstöd till utveckling av digital dokumentation av hjärtoperationer, article in Insikt Medicin, August 23.

Robertsson, Anders

Vattenhallen lärarfortbildning / remote demo RobotLab, March 8.
 EUrobotics week 2021 - November 24-26 (about 16 visits/demos).
Intro to Automatic Control and Robotics, Teknicsommarskola för tjejer, Hässleholm, August 13.
 Workshop Presentation av Center för Byggrobotik, Studiebesök för SBUF, Smartbuilt och IQ Samhällsbyggnad, Lund, November 29.

Lundakarneval May 2022

