



LUND UNIVERSITY

Optically Stimulated Luminescence for Retrospective Radiation Dosimetry. The Use of Materials Close to Man in Emergency Situations

Geber-Bergstrand, Therése

2017

Document Version:

Publisher's PDF, also known as Version of record

[Link to publication](#)

Citation for published version (APA):

Geber-Bergstrand, T. (2017). *Optically Stimulated Luminescence for Retrospective Radiation Dosimetry. The Use of Materials Close to Man in Emergency Situations*. [Doctoral Thesis (compilation), Department of Translational Medicine]. Lund University: Faculty of Medicine.

Total number of authors:

1

General rights

Unless other specific re-use rights are stated the following general rights apply:

Copyright and moral rights for the publications made accessible in the public portal are retained by the authors and/or other copyright owners and it is a condition of accessing publications that users recognise and abide by the legal requirements associated with these rights.

- Users may download and print one copy of any publication from the public portal for the purpose of private study or research.
- You may not further distribute the material or use it for any profit-making activity or commercial gain
- You may freely distribute the URL identifying the publication in the public portal

Read more about Creative commons licenses: <https://creativecommons.org/licenses/>

Take down policy

If you believe that this document breaches copyright please contact us providing details, and we will remove access to the work immediately and investigate your claim.

LUND UNIVERSITY

PO Box 117
221 00 Lund
+46 46-222 00 00

Optically Stimulated Luminescence for Retrospective Radiation Dosimetry

The Use of Materials Close to Man in
Emergency Situations

Therése Geber-Bergstrand



LUND
UNIVERSITY

DOCTORAL DISSERTATION

by due permission of the Faculty of Medicine, Lund University, Sweden.

To be defended in Lilla Aulan, Jan Waldenströms gata 5, Malmö.

Friday May 26th 2017 at 9.00.

Faculty opponent

Professor emerita Eva Lund, Department of Medical and Health Sciences,
Linköping University

Organization LUND UNIVERSITY	Document name DOCTORAL DISSERTATION	
	Date of issue 2017-05-26	
Author(s) Therése Geber-Bergstrand	Sponsoring organization	
Title and subtitle Optically Stimulated Luminescence for Retrospective Radiation Dosimetry - The Use of Materials Close to Man in Emergency Situations		
Abstract <p>If an accident or attack involving radiological or nuclear material were to happen, people from the general public would be at risk of exposure to ionising radiation. Unlike people working with ionising radiation, for whom level of exposure to radiation is constantly monitored with dosimeters, people from the general population do not wear dosimeters; thus, the dose estimations for these individuals must be performed using alternative methods. This field of research is called retrospective dosimetry (or emergency dosimetry) and includes both biological and physical techniques. Following an accident or attack, dose estimations of potentially exposed individuals have to be performed as soon as possible, to give the proper medical care promptly and, especially in the case of a large-scale incident, to use the available resources in the best and most effective manner.</p> <p>In contrast to developing conventional dosimeter material, the approach for research into retrospective dosimeter materials is somewhat reversed. Instead of involving identification (or development) of a material that meets the set requirements, the work needs to conform to the properties of the materials found near or on people. This necessity often means that several materials/techniques are needed to fulfil the same requirements. In addition, exactly which materials will be present in a given situation is never certain, and the addition of new materials/methods that could be used for retrospective dosimetry thus is always a valuable contribution.</p> <p>In this thesis, a number of materials found in the immediate vicinity of people have been investigated with regard to their potential to act as retrospective radiation dosimeters using optically stimulated luminescence (OSL). The materials include human teeth and dental repair materials, components from electronic devices, desiccants, and common household salt (NaCl). The aim is both to increase the number of materials that could be used with OSL and to further develop methods for the materials already known to have some dosimetric properties.</p> <p>The overall conclusion of this work is that several materials found on or in the immediate vicinity of people can be used in retrospective dosimetry using OSL. Also, initial estimations of conversion factors for the transition between the dose to the retrospective dosimeter material and the dose to an individual have been obtained using an anthropomorphic phantom.</p>		
Key words: OSL, retrospective dosimetry, emergency dosimetry, tooth enamel, dental repair materials, resistors, mobile phone, NaCl, desiccants		
Classification system and/or index terms (if any)		
Supplementary bibliographical information		Language: English
ISSN and key title: 1652-8220		ISBN: 978-91-7619-460-7
Recipient's notes	Number of pages: 64	Price
	Security classification	

I, the undersigned, being the copyright owner of the abstract of the above-mentioned dissertation, hereby grant to all reference sources permission to publish and disseminate the abstract of the above-mentioned dissertation.

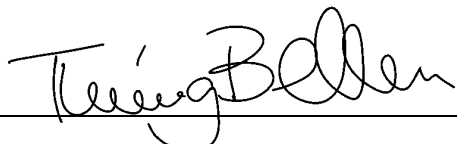
Signature  Date 2017-04-20

Optically Stimulated Luminescence for Retrospective Radiation Dosimetry

The Use of Materials Close to Man in
Emergency Situations

Therése Geber-Bergstrand



LUND
UNIVERSITY

Coverphoto: Circuit board of a laptop
taken by Magnus and Marie Sydoff

© Therése Geber-Bergstrand

Faculty of Medicine
Department of Translational Medicine

ISBN 978-91-7619-460-7
ISSN 1652-8220

Printed in Sweden by Media-Tryck, Lund University
Lund 2017



*“Not everything that can be counted counts,
and not everything that counts can be counted”*

-William Bruce Cameron

Contents

Summary	8
Summary in Swedish.....	9
Abbreviations	10
List of figures	11
List of tables.....	13
Original papers	14
Introduction	15
Objectives.....	15
Effects of ionising radiation on the human body.....	17
Late effects	17
Acute radiation syndrome	18
Retrospective dosimetry	19
Biological dosimetry techniques	20
The dicentric assay	20
The micronucleus assay.....	21
Fluorescence <i>in situ</i> hybridisation.....	21
γ -H2AX DNA damage assay	22
Physical dosimetry techniques	22
Electron paramagnetic resonance	22
Luminescence	25
Luminescence dosimetry	26
The band model	26
Thermoluminescence.....	28
Optically stimulated luminescence.....	29
OSL readers.....	33
The Risø TL/OSL equipment.....	33
Stimulation and detection	34
Irradiation source.....	35

Calibration of the internal source	35
External irradiation sources	36
OSL materials in retrospective dosimetry	37
Building materials	38
Household materials	39
Household salt, NaCl.....	40
Biological materials	41
Dental repair materials	42
Commonplace materials	42
Resistors	43
Dose estimates	47
Dose quantities	47
Fluence	48
Kerma	48
Absorbed dose and related protection quantities	49
Operational quantities.....	49
Dose conversion coefficients	50
Summary of papers.....	53
Paper I: Retrospective dosimetry using OSL of tooth enamel and dental repair materials irradiated under wet and dry conditions	53
Paper II: Optically stimulated luminescence (OSL) dosimetry in irradiated alumina substrates from mobile phone resistors	54
Paper III: Household salt for retrospective dose assessments using OSL: signal integrity and its dependence on containment, sample collection, and signal readout	54
Paper IV: Desiccants for retrospective dosimetry using optically stimulated luminescence (OSL).....	55
Paper V: Optically stimulated luminescence in NaCl and mobile phone components for personal dosimetry – correlating OSL response to operational radiation protection quantities using an anthropomorphic phantom.....	56
Conclusions	57
Concluding remarks	58
Acknowledgements	59
References	61

Summary

If an accident or attack involving radiological or nuclear material were to happen, people from the general public would be at risk of exposure to ionising radiation. Unlike people working with ionising radiation, for whom level of exposure to radiation is constantly monitored with dosimeters, people from the general population do not wear dosimeters; thus, the dose estimations for these individuals must be performed using alternative methods. This field of research is called retrospective dosimetry (or emergency dosimetry) and includes both biological and physical techniques. Following an accident or attack, dose estimations of potentially exposed individuals have to be performed as soon as possible, to give the proper medical care promptly and, especially in the case of a large-scale incident, to use the available resources in the best and most effective manner.

In contrast to developing conventional dosimeter material, the approach for research into retrospective dosimeter materials is somewhat reversed. Instead of involving identification (or development) of a material that meets the set requirements, the work needs to conform to the properties of the materials found near or on people. This necessity often means that several materials/techniques are needed to fulfil the same requirements. In addition, exactly which materials will be present in a given situation is never certain, and the addition of new materials/methods that could be used for retrospective dosimetry thus is always a valuable contribution.

In this thesis, a number of materials found in the immediate vicinity of people have been investigated with regard to their potential to act as retrospective radiation dosimeters using optically stimulated luminescence (OSL). The materials include human teeth and dental repair materials, components from electronic devices, desiccants, and common household salt (NaCl). The aim is both to increase the number of materials that could be used with OSL and to further develop methods for the materials already known to have some dosimetric properties.

The overall conclusion of this work is that several materials found on or in the immediate vicinity of people can be used in retrospective dosimetry using OSL. Also, initial estimations of conversion factors for the transition between the dose to the retrospective dosimeter material and the dose to an individual have been obtained using an anthropomorphic phantom.

Summary in Swedish

Katastroferna i Chernobyl och Fukushima påminner oss om att olyckor med joniserande strålning tyvärr inträffar. Även attentat med joniserande strålning är tänkbara, även om inga tack och lov ännu genomförts. Oavsett typ av katastrof, olycka eller attack, innebär en okontrollerad händelse med joniserande strålning att personer från allmänheten kan komma att exponeras för strålningen. Vill det sig riktigt illa kan det röra sig om så höga stråldoser att de ger direkt livshotande skador, så kallade akuta strålskador.

Vid en stor katastrofsituation med hundratals, eller tusentals, potentiellt drabbade individer kommer akutmottagningarna översvämmas av oroliga människor utav vilka troligen bara en bråkdel faktiskt har blivit exponerade för strålning. För att hushålla med de resurser sjukvården har, ge vård till de personer som behöver det mest och lugna icke-exponerade oroliga individer, måste man snabbt kunna avgöra vilka av alla personer som exponerats - ett förfarande som kallas för triage. Vid akuta strålskador uppträder symtomen dock först efter en viss tid (timmar till dagar) och de första symtom som uppvisas liknar de som kan visas vid stark oro, det vill säga kräkningar, huvudvärk, yrsel och diarré. Detta gör det svårt att endast från symptomen säkert kunna avgöra om en person har exponerats för en farlig stråldos.

Personal som arbetar med joniserande strålning bär alltid så kallade dosimetrar, från vilka stråldosen till personen kan avläsas. Även om personer från allmänheten naturligtvis inte bär denna typ av dosimetrar; skulle olika kroppsegna material eller föremål personen bär med sig potentiellt kunna användas som dosimeter. Genom att analysera dessa material skulle på så sätt exponerade personer kunna identifieras.

Det övergripande syftet med den här avhandlingen är att undersöka material som kan användas som dosimeter efter en olycka eller ett attentat med joniserande strålning genom utläsning med en metod som kallas optiskt stimulerad luminescens (OSL). Flera olika material har undersökts, däribland tänder och tandlagningar, hushållssalt och komponenter från mobiltelefoner.

Flera av materialen visar mycket lovande egenskaper för att kunna fungera som dosimeter och även om ytterligare studier är nödvändiga för samtliga material skulle flera av dem kunna användas redan nu om en olycka eller ett attentat med joniserande strålning inträffade.

Abbreviations

AP	Antero-posterior
ARS	Acute radiation syndrome
CW-OSL	Continuous wave optically stimulated luminescence
EPR	Electron paramagnetic resonance
FISH	Fluorescence <i>in situ</i> hybridisation
IR	Infrared
ISO	Isotropic
LAT	Lateral
LED	Light-emitting diode
LM-OSL	Linearly modulated optically stimulated luminescence
MDD	Minimum detectable dose
OSL	Optically stimulated luminescence
PA	Postero-anterior
POSL	Pulsed optically stimulated luminescence
PMT	Photomultiplier tube
ROT	Rotational
SAR	Single-aliquot regenerative-dose
SMR	Surface mount resistor
TL	Thermoluminescence
UV	Ultra violet

List of figures

1. Images showing the results of different biological dosimetry techniques. Left: the dicentric assay; middle: FISH; and right: γ -H2AX. Permission to print the pictures has been provided by L. Ainsbury and they were taken by J. Moquet and S. Barnard at Public Health England.
2. A Jablonski diagram illustrating the energy states of a particle in a molecule. The vibrational ground states are indicated by the thick lines and the higher vibrational states are indicated by the dashed lines. By courtesy of Mattias Jönsson.
3. Band model illustrating the process of stimulated luminescence. E_v is the energy level of the valence band and E_c is the energy level of the conduction band separated by the forbidden band gap, here containing two electron traps (T_s and T_t), one hole trap (H) and a recombination centre (R). By courtesy of Christian Bernhardsson.
4. Example of a TL glow-curve, obtained from irradiated household salt (NaCl).
5. Typical shape of the CW-OSL decay curves from irradiated surface mount resistors (SMR) and household salt (NaCl).
6. The Risø TL/OSL-DA-15 reader used for all OSL measurements in this thesis.
7. Schematic drawing of the Risø TL/OSL-DA-15 reader. Reprinted with permission from Guide to “The Risø TL/OSL Reader”, DTU Nutech, Denmark (www.nutech.dtu.dk).
8. Detection filters and stimulation light spectra in the Risø TL/OSL equipment. Reprinted with permission from Guide to “The Risø TL/OSL Reader”, DTU Nutech, Denmark (www.nutech.dtu.dk).
9. Different types of desiccants. “Silica gel” bags found in hand bags (left and middle) and cat litter (right).
10. Household salt (NaCl) in different packages commercially available.
11. Two types of dental repair materials and human tooth enamel (middle).
12. The circuit board of a mobile phone. Surface mount resistors with alumina underneath are pointed out by an ordinary ballpoint pen.

13. Photographs illustrating the procedure of dismantling a mobile phone. Top left: intact mobile phone, top right: circuit board of the mobile phone with metal sheets covering the components, bottom: all parts of the mobile phone after dismantling.
14. Different sizes (left) and the black upper side and white underside of the SMRs with dosimetric properties. Each gradation on the scale denotes one millimetre.
15. The OSL intensity as a function of the number of resistors on a measuring cup in the Risø equipment.
16. Relationship of quantities for radiological protection monitoring purposes (ICRP, 1996).
17. Schematic illustrations of the exposure geometries antero-posterior (AP), postero-anterior (PA) and rotational (ROT). Dashed lines indicates the direction of the radiation. By courtesy of Christian Bernhardsson.

List of tables

1. List of desired properties of an OSL dosemeter material (a similar list can be seen in Ainsbury et al. 2011 for dosemeter materials in general).
2. Summary of materials with dosimetric properties regarding OSL, their typical MDD values and type of dose estimates they would generate following an emergency situation (based on data shown in Bailiff et al. 2016; Ainsbury et al. 2011; Bernhardsson et al. 2009; Thomsen et al. 2002b; Bøtter-Jensen and McKeever 1996; **Paper I**; and **Paper IV**)

Original papers

This thesis is based on the following five publications, which will be referred to by their Roman numerals:

- I. Retrospective dosimetry using OSL of tooth enamel and dental repair materials irradiated under wet and dry conditions**
Therése Geber-Bergstrand, Christian Bernhardsson, Sören Mattsson, and Christopher L Rääf
Radiation and Environmental Biophysics, 2012. 51:443-449
- II. Optically stimulated luminescence (OSL) dosimetry in irradiated alumina substrates from mobile phone resistors**
Therése Geber-Bergstrand, Christian Bernhardsson, Maria Christiansson, Sören Mattsson, and Christopher L Rääf
Submitted to Radiation and Environmental Biophysics
- III. Household salt for retrospective dose assessments using OSL: signal integrity and its dependence on containment, sample collection, and signal readout**
Maria Christiansson, Christian Bernhardsson, Therése Geber-Bergstrand, Sören Mattsson, and Christopher L Rääf
Radiation and Environmental Biophysics, 2014. 53:559-569
- IV. Desiccants for retrospective dosimetry using optically stimulated luminescence (OSL)**
Therése Geber-Bergstrand, Christian Bernhardsson, Maria Christiansson, Sören Mattsson, and Christopher L Rääf
Radiation Measurements, 2015. 78:17-22
- V. Optically stimulated luminescence in NaCl and mobile phone components for personal dosimetry: correlating OSL response to operational radiation protection quantities using an anthropomorphic phantom**
Therése Geber-Bergstrand and Christian Bernhardsson
Manuscript

Published papers have been reproduced with permission from Springer (**Paper I** and **III**) and Elsevier (**Paper IV**). All rights reserved.

Introduction

Periodically, accidents or other incidents involving radiological devices or radioactive materials occur. When they do, there is an imminent risk that people are unexpectedly exposed to radiation. Radiation is used daily in medical care, and the doses to staff and patients are very carefully monitored. In other workplaces where staff might be exposed to radiation, e.g., at nuclear power plants, the workers are monitored. In other words, in situations where exposure to radiation is expected or a potential risk, the people working under such conditions wear dosimeters from which the received dose to the individual can be read out. However, when there is an unexpected radiation exposure, the people involved rarely are wearing dosimeters. In such cases, the dose received by each individual must be assessed by other means. Such an assessment can be done by using retrospective dosimetry, which employs materials or substances with properties that enable them to be used in a manner similar to commercial dosimeters. Retrospective dosimetry techniques can be physical or biological, and they all have strengths and weaknesses; thus, in a mass casualty event, the most likely scenario would be to use a multi-technique approach.

Obtaining a dose estimation requires that many aspects be taken into account, from the sampling procedure to the conversion from the dose to a material to the dose to an individual.

Objectives

The specific aims of this thesis were to

- investigate materials close to man with regard to their potential as dosimeters, using optically stimulated luminescence
- highlight practical aspects of importance for the dose estimation

Effects of ionising radiation on the human body

Exposure to ionising radiation may cause damage to cells in humans (UNSCEAR 1988). The degree of damage depends on the type and intensity of the radiation, and in the majority of cases, the damage is repaired. In fact, damage to the cells in the human body occurs many thousands of times per day per cell, even without exposure to ionising radiation (Bernstein et al. 2013). Cells have an excellent repair mechanism, and if the repair is unsuccessful, the cell will undergo apoptosis (a process of programmed cell death) or mitotic death (the cell dies of damaged chromosomes as it attempts to divide). In some cases, both the process of repair and apoptosis fail, and the damaged cell continues to exist and reproduce. A cell can also undergo necrosis, a traumatic, uncontrolled cell death (e.g. Hall and Giaccia 2006). Exposure to ionising radiation increases the risk for all kinds of cell damage although extensive, unreparable damage is a consequence mainly of high absorbed doses (delivered in a relatively short period of time).

Data on the human effects of ionising radiation come mainly from observations at relatively high doses (NCRP 2001). Little is known about the health effects of low radiation doses, and models are instead based on assumptions.

The effects of ionising radiation are normally divided into two categories: late and acute effects.

Late effects

The foremost late effect for ionising radiation is cancer. Cancer is considered a stochastic effect, i.e., the risk of getting cancer increases with increasing dose, but the cancer itself will not be more severe if the dose is higher. It is not possible to relate the cancer in an individual with the individual's exposure history in hindsight, i.e., it is impossible to decide what lead to the development of cancer for a specific individual. Studying the effect of ionising radiation on the cancer incidence is difficult for several reasons, including the long latency periods (up to several decades) and the many confounding factors involved (UNSCEAR 1988).

Cancer is thought to arise through accumulating defects in or damage to cells, making them incapable of undergoing apoptosis and instead continuing to divide uncontrollably. Different organs in the human body have different sensitivities to ionising radiation with respect to cancer development, as indicated by organ/tissue weighting factors (ICRP 2007). Some of the most radiosensitive organs are breast, lung, and colon.

The organ/tissue weighting factors for the gonads also include the risk for heritable effects, another late stochastic effect. The risk of heritable effects is low compared to that of cancer and has been estimated on basis of experiments on various animal species, because heritable effects as a consequence of radiation exposure have not been observed in humans.

According to the ICRP (2007) there is a risk of late stochastic effects of 5.7 % per Sv (5.5 % per Sv for cancer and 0.2 % per Sv for heritable effects) as a mean for the population.

Acute radiation syndrome

For whole body absorbed doses above ~ 1 Gy (delivered in a relatively short period of time) cells and tissues start to die which result in an acute radiation syndrome (ARS; UNSCEAR 1988). ARS is a deterministic effect (also termed *harmful tissue reaction*): once a certain threshold of the absorbed dose has been exceeded, the emergence is definitive (e.g., Martin et al. 2012). The severity of the damage increases with increasing dose, and ARS includes three subtypes: haematopoietic, gastrointestinal, and cerebrovascular syndromes. Each of these has four phases: prodromal, latent, manifest illness, and recovery or death (Waselenko et al. 2004). The onset of symptoms is related to the dose received, ranging from hours to weeks, which makes it necessary to base the decision about need for medical care on something besides ARS symptoms. In addition, early ARS symptoms (nausea, diarrhoea, fatigue) could also be symptoms of intense anxiety and fear and thus also present among unexposed individuals. The mean lethal whole body absorbed dose that would result in the death of 50 % of humans within 60 days, or $LD_{50/60}$, is around 3.25–4 Gy without medical care and around 6–7 Gy with advanced medical treatment (Anno et al. 2003; Waselenko et al. 2004). Thus, the ability to identify exposed people is crucial.

Retrospective dosimetry

Retrospective comes from the Latin word *retrospicere* which means “looking back,” and dosimetry related to how ionising radiation transfer energy in matter and how that energy is calculated, measured and converted to e.g. risk-related quantities. Thus, in retrospective dosimetry, the aim is to estimate the energy deposited in matter, usually human tissue, at some period (hours up to many years) after the exposure occurred. Bailiff et al. (2016) divide retrospective dose assessments into emergency dosimetry and retrospective dosimetry. This categorisation distinguishes the immediate phase following an exposure event from the long-term monitoring. In emergency dosimetry, the dose assessments are performed within hours or days following exposure to ionising radiation, and the objective is to separate the individuals who have genuinely been exposed to radiation from the “worried well”. This separation has to be achieved both for the sake of calming unaffected people and to use the available medical resources in the best possible way. Retrospective dosimetry in the long-term phase targets stochastic effects and epidemiology. The doses that are required for each category are quite different: in emergency dosimetry, the cutoff absorbed dose is ~2 Gy, and in retrospective dosimetry, the target dose is much lower: 100 mGy (ICRU 2002). The level of 2 Gy is commonly recommended for use in triage (e.g. JIWG 2005; Bailiff et al. 2016) because individuals exposed to absorbed whole body doses above this value would need medical follow-up and possible intervention. This cutoff is based on the data from Chernobyl victims, among whom no deaths were observed for doses below 2 Gy (Guskova et al. 1988).

Following a nuclear or radiological accident/attack, the exposure of people from the general public to ionising radiation is by definition not planned for; thus, exposed individuals do not wear dosimeters, unlike people working with radiation where exposure levels are constantly monitored. Other ways of estimating the dose received by these individuals are required. Several such techniques exist, all of which have their advantages and disadvantages. In a large-scale scenario, several of the techniques would have to be combined because no single method meets all of the requirements (e.g., time until first dose estimation and accuracy) and the workload would be too great for one method alone. For the latter reason, a number of networks (e.g., www.multibiodose.eu; www.reneb.eu) have been formed so that

laboratories in different countries can help share the workload following an emergency situation.

Biological dosimetry techniques

Biological retrospective dosimetry techniques use radiation-induced changes in the body to perform dose estimations. The changes studied could be cytogenetic, genetic, or haematological or based on protein biomarkers. Some of the available methods are described below.

The dicentric assay

The technique normally referred to as the gold standard – because it is generally accepted as the most specific and sensitive method currently available – is the dicentric assay (e.g., Alexander et al. 2007). Dicentric chromosomes, i.e., an abnormal chromosome with two centromeres, are in principle exclusively caused by ionising radiation, and thus the variation in the background level is small (ICRU 2002). The approach is to arrest peripheral lymphocytes in the metaphase, analyse the number of dicentrics per cell using a microscope, and compare the number with calibration curves obtained from blood samples irradiated *in vitro*. The time between receipt of the sample and dose estimation is at least 55 h because of the requirement for a culture time of 48 h. The assay can also be used in “triage mode”, where fewer cells are counted, and the time can then be reduced to 52 h (Ainsbury et al. 2011). The detection limit in full mode is in the order of 0.1 Gy and in triage mode, it is 0.5 Gy. An advantage of the dicentric assay is that it can determine whether the irradiation was homogeneous based on the intensity of changes per cell. The same absorbed dose given homogeneous over the whole body or inhomogeneous over a part of the body (depending on what part of the body that was exposed) could greatly affect the outcome for the individual in question. The presence of dicentrics diminishes with time because of the turnover of lymphocytes, so the technique is not applicable long after the exposure event (Romm et al. 2009). A microscopy image of dicentric chromosomes can be seen in Fig.1.

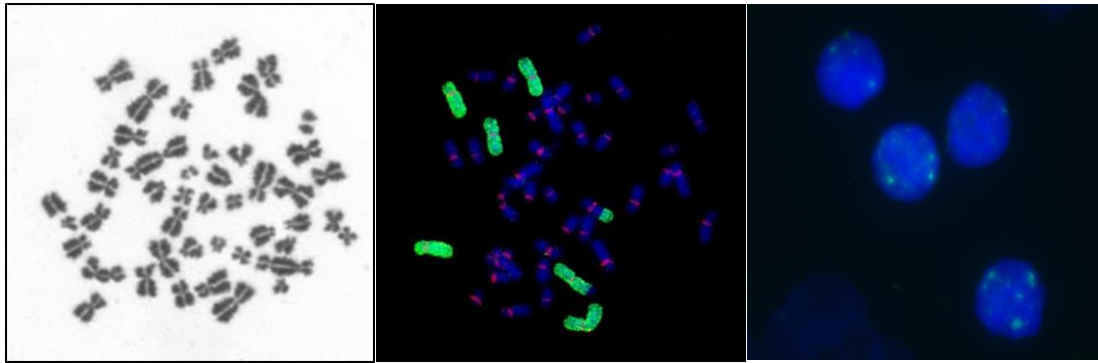

Figure 1. Images showing the results of different biological dosimetry techniques. Left: the dicentric assay; middle: FISH; and right: γ -H2AX. Permission to print the pictures has been provided by L. Ainsbury and they were taken by J. Moquet and S. Barnard at Public Health England.

The micronucleus assay

Micronuclei are created during cell division when a whole chromosome or acentric chromosome fragment does not integrate into the daughter nucleus. They can be seen by microscopy as distinct small spherical objects with the same morphology and staining properties as the binucleated daughter cell. The frequency of micronuclei decreases with time after exposure to ionising radiation (ICRU 2002). The lower detection limit is about 0.2 Gy (95 % confidence; Thierens and Vral 2009), and the time before the first dose estimation can be provided is 75 h. A disadvantage of the technique is that the variability in the background signal is relatively high and depends on lifestyle factors and age (Ainsbury et al. 2011). An advantage, however, is that the scoring is simple, does not require extensive experience in cytogenetics, and could even be automated, making high-throughput analysis possible (Alexander et al. 2007).

Fluorescence *in situ* hybridisation

Unlike the dicentric and micronucleus assays, fluorescence *in situ* hybridisation (FISH) is a method that measures more stable translocations (ICRU 2002). FISH is also called chromosome painting, which describes the process well. Chromosomes are painted in different colours, and any exchange between chromosomes (caused by incorrect repair following damage by ionising radiation) can be identified using a fluorescent microscope (Fig.1). The lower limit of detection is about 0.25 Gy, and the dose estimation is provided after 120 h (Ainsbury et al. 2011). FISH is used for protracted or historical exposures.

γ -H2AX DNA damage assay

A significantly more rapid biological dosimetry technique is γ -H2AX. When ionising radiation causes double-strand breaks in the DNA of a cell, the histone H2AX near the break is phosphorylated (a phosphoryl group, $(\text{PO}_3)^-$, is added) as a part of the cellular DNA damage response, producing the phosphorylated form γ -H2AX (Rothkamm and Horn 2009). γ -H2AX foci are generated minutes after exposure, and specific antibodies can be used to stain them (Fig. 1). The amount of γ -H2AX foci peaks less than an hour following exposure and then decreases rapidly; thus, this method is best used as a triage tool in the first days following irradiation. The lower detection limit is 0.5 Gy, and a dose estimation can be provided after approximately 3 h (Ainsbury et al. 2011).

Physical dosimetry techniques

A couple of different dosimetry techniques could be classified as physical; if overlooking computational techniques, e.g., those based on Monte Carlo calculations, however, only two methods are essentially in this category. The first involve luminescence techniques, and the second and historically most used in practise is electron paramagnetic resonance (EPR). The latter is described in a bit more detail just below whereas luminescence is described in the section that follows (Luminescence).

Electron paramagnetic resonance

Using EPR, dose estimations can be obtained by detecting paramagnetic centres, such as radicals, generated by ionising radiation. Paramagnetic systems have at least one unpaired electron, and with exposure to a magnetic field, the electron's energy levels split, an effect known as Zeeman splitting (e.g., Fattibene and Callens, 2010). If electromagnetic radiation corresponding to the energy difference between the energy levels, ΔE [J], is applied to the system, it will be absorbed according to:

$$\Delta E = h\nu$$

where h is Planck's constant [Js] and ν is the frequency [Hz] of the electromagnetic radiation. Furthermore,

$$h\nu = g\mu_B B$$

where g is a constant termed the g -factor (approximately 2 for spins of $\frac{1}{2}$), μ_B is the Bohr magneton (elementary electronic magnetic moment) [J/T], and B is the magnetic field induction [T].

In EPR dosimetry, the most frequently used electromagnetic radiation is microwaves, with a frequency in the order of 9.8 GHz (X-band; Alexander et al. 2007). Scanning the absorbed microwave energy while the magnetic induction field is swept yields an EPR spectrum.

The most used material in EPR retrospective dosimetry is tooth enamel (IAEA, 2002), which has a detection limit of about 100 mGy. Materials such as fingernails (e.g., Sholom and McKeever 2016), bone (e.g., Clairand et al. 2008), and chewing gum (Israelsson et al. 2013) also have been studied. *In vivo* EPR for measurements of teeth is under development, but because the frequency has to be lowered (for safety reasons), the sensitivity is decreased by a factor ~ 5 – 10 . On the other hand, to increase the sensitivity, EPR devices using higher frequencies (Q band) also are becoming more common. The use of Q band EPR enables measurements of smaller samples, i.e., biopsies of 4 mg for teeth (Ainsbury et al. 2011), making the method less invasive. The minimum detection limit for tooth enamel Q band EPR dosimetry was estimated by Trompier et al. (2009) to be about six times higher than for X band; thus, 600 mGy.

Luminescence

Two common pathways are available to produce light from another energy form: incandescence and luminescence. Incandescence is light produced from a material following heating; i.e., if a material is heated to a temperature high enough, it will start to glow. An example of incandescence is the stars, seen to glow in the night sky. Luminescence is often referred to as cold light because thermal excitation is not needed for light to be emitted. A variety of different phenomena may give rise to luminescence, such as chemical reactions, subatomic movements, or stress on the material in question. Below, some of the different types of luminescence are listed.

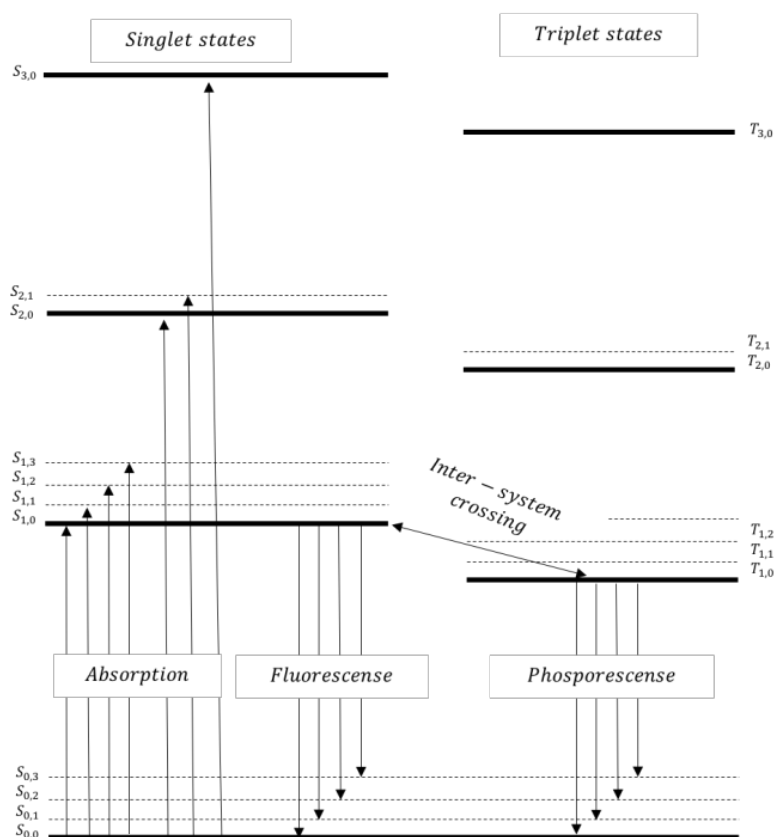

Figure 2. A Jablonski diagram illustrating the energy states of a particle in a molecule. The vibrational ground states are indicated by the thick lines and the higher vibrational states are indicated by the dashed lines. By courtesy of Mattias Jönsson.

Radioluminescence occurs when light is produced by a material during exposure to ionising radiation. The incoming radiation interacts with an orbital electron in the material, which gets excited to a higher energy level. When the electron returns to the ground state a photon is emitted. This effect may be seen in old watches with luminous needles.

Triboluminescence can be observed when a material is subjected to mechanical action, such as scratching. An example is the light that can be observed when two pieces of stone are rubbed together with force.

Fluorescence is the emission of light from a material that absorbs light or other electromagnetic radiation. In most cases, the emitted light has a longer wavelength than the absorbed light. The light emitted is a result of the relaxation of an electron in a molecule of the material from an excited state to the ground state (with the same multiplicity; Fig. 2). Fluorescence is often used in microscopes.

Phosphorescence is related to fluorescence, but here the re-emission of light is delayed by a transition from the excited state to a (forbidden) meta-stable state, i.e., a transition between levels of different multiplicity (Fig. 2). The meta-stable states work as traps for the electrons, and energy must be supplied for the electrons to be released back to the excited state, from which they can de-excite to the ground state. Often, the energy difference between the meta-stable state and the excited state is so small that lattice vibrations are enough to release the electrons. Sometimes, however, the energy difference is larger, and energy thus must be supplied externally. Thermoluminescence (TL) and optically stimulated luminescence (OSL) are examples of phosphorescence triggered by using heat or light, respectively. TL and OSL will be discussed in more detail in the following sections.

Luminescence dosimetry

In luminescence dosimetry, a transient light is observed, arising from the stimulation (with either heat for TL or light for OSL) of crystalline insulators or semiconductors previously exposed to ionising radiation.

The band model

In a solid material, the electrons form bands of allowed energy states, similar to the discrete energy levels allowed for electrons in a single atom. The space between the energy bands, called the band gap, is forbidden, and electrons thus may not occupy this space in a perfect crystal. For a crystal in its ground state, the

electrons are located in a band called the valence band, with an energy E_v , see Fig. 3. Provided that a sufficient amount of energy is absorbed by an electron in the valence band, it can excite to the upper energy band, called the conduction band, with energy E_c , i.e., an electron-hole pair is produced. The electron remains in the conduction band only for a short time and then loses its energy and de-excites back to the valence band. Materials may be classified according to the width of the band gap. For conductors, the valence band and conduction band overlap, making $E_v = E_c$, and thus the width of the band gap is zero. For insulators, the band gap is large, $E_v \ll E_c$, making the thermal energy of an individual electron insufficient to reach the conduction band. Semiconductors are intermediate between conductors and insulators: $E_v < E_c$. In reality, however, a crystal is never perfect and includes defects. These defects can be classified as either intrinsic, i.e., formed by displacements of atoms, or extrinsic, i.e., formed by foreign atoms. Thus, defects can be caused by missing atoms (vacancies), extra atoms at otherwise unoccupied positions (interstitials), foreign atoms replacing an “original” atom (impurities), or other dislocations. Defects create energy levels in the otherwise forbidden band gap. If the created energy level can capture a charge carrier (electron or hole), it is termed a trap centre (T and H, Fig. 3), and if the energy level can capture charges of opposite signs, i.e., electrons and holes can recombine, it is termed a recombination centre (R, Fig. 3). Therefore, in a crystal containing defects, an electron excited due to the materials absorption of ionising radiation could either de-excite to the valence band or be captured in a trap in the band gap. The trap is positioned at a forbidden location, so the electron cannot simply be de-trapped; energy has to be supplied to release the electron back to the conduction band. If the trap is shallow, i.e., close to the conduction band, the lattice vibrations in the crystal may be sufficient to release the electron. However, to use a material in dosimetry, the traps must be deep enough to hold the electrons captive until sufficient external energy (using heat or light) is supplied. (There are other ways in which charges may escape from traps, e.g., quantum mechanical tunnelling, but these will not be addressed in this thesis.) Following release back to the conduction band, some of the electrons may recombine with a hole at a radiative recombination centre, and luminescence is emitted. The luminescence can be detected by a photo multiplier tube (PMT), and the intensity of the luminescence is proportional to the number of trapped charges in the crystal, which in turn is proportional to the dose absorbed by the material. The fact that trapped charges may not escape unless energy is externally supplied creates a latency period in which energy is stored in the material, and because of that, the material could be used as a dosimeter.

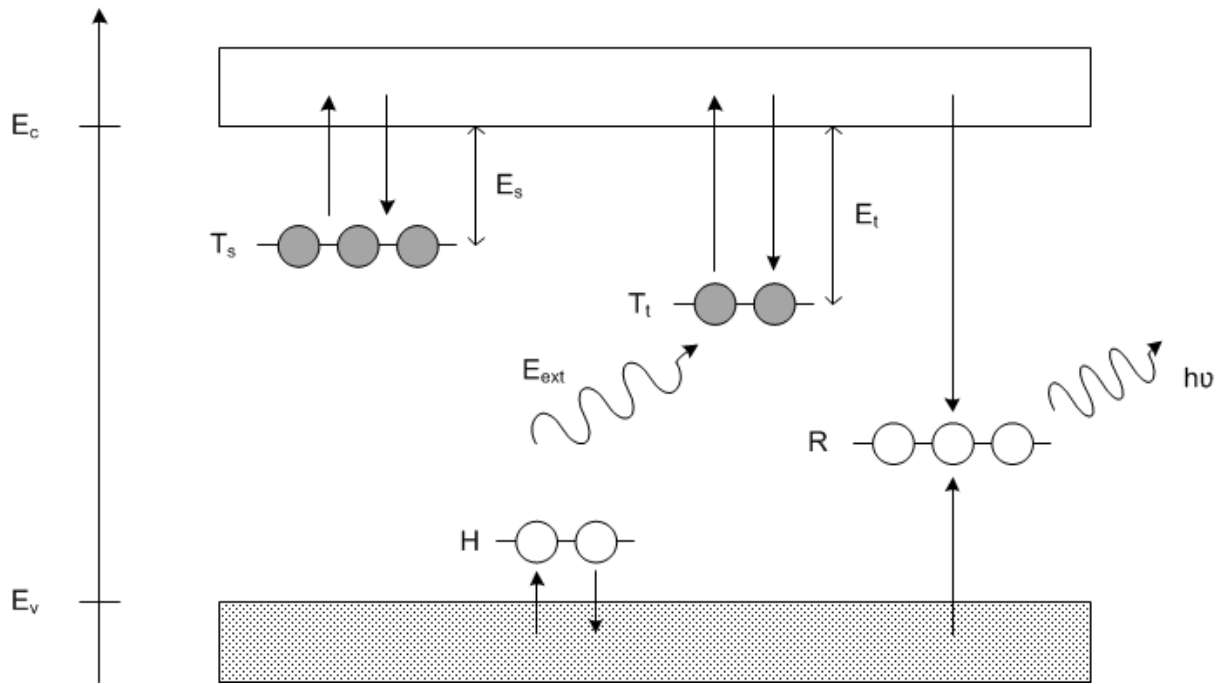

Figure 3. Band model illustrating the process of stimulated luminescence. E_v is the energy level of the valence band and E_c is the energy level of the conduction band separated by the forbidden band gap, here containing two electron traps (T_s and T_t), one hole trap (H) and a recombination centre (R). By courtesy of Christian Bernhardtsson.

Thermoluminescence

In TL, the electrons are stimulated back to the conduction band by gradually elevating the temperature, usually from room temperature to a couple of hundred degrees Celsius. The probability, p , of releasing an electron from a trap is described by the Boltzmann factor:

$$p = s \cdot e^{-\Delta E/kT}$$

where s is the frequency factor [Hz], ΔE [J] is the energy depth of the trap, k is the Boltzmann constant [J/K], and T is the absolute temperature [K]. Thus, when the temperature is elevated, the probability of emptying a trap increases, and the result is plotted in a luminescence vs. temperature plot called the TL glow-curve; see Fig. 4. The intensity is increased at first, then reaches a maximum and finally drops when the trap is depleted. If several traps are involved, a number of peaks may be seen, the location of which depends on the depth of the corresponding trap. A drawback with TL is that the signal may be thermally quenched, i.e., that the efficiency of the luminescence is decreased when the temperature is elevated. TL measurements were performed in **Papers III, IV, and V**.

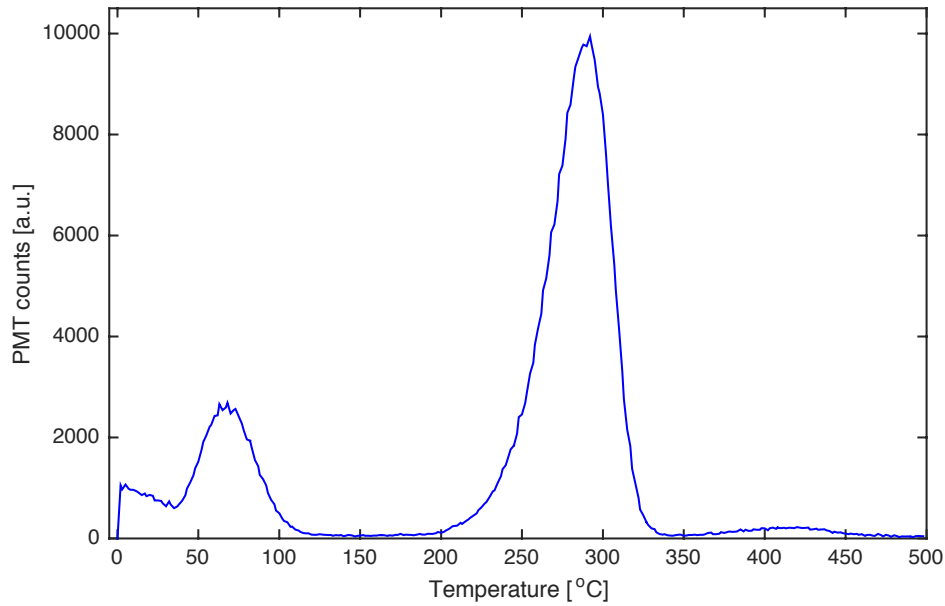

Figure 4. Example of a TL glow-curve, obtained from irradiated household salt (NaCl).

Optically stimulated luminescence

In OSL, the stimulation of trapped electrons is performed using light of a specific wavelength. Usually, the stimulation wavelength is longer than that of the observed luminescence, making OSL an anti-Stokes shift. The stimulation with light can be performed using different modes: continuous wave (CW-OSL), linearly modulated (LM-OSL), and pulsed (POSL). The CW-OSL mode is the most frequently used and means that the intensity of the stimulation light is kept constant and the luminescence is recorded during stimulation. Thus, filters are required to discriminate between the stimulation light and the luminescence (this is further described in the section *Stimulation and detection*). The stimulation light is about 10^{18} times more intense than the luminescence light (Thomsen 2004), so it is essential that the stimulation light do not reach the PMT. A typical CW-OSL curve, also referred to as a decay curve, can be seen in Fig. 5.

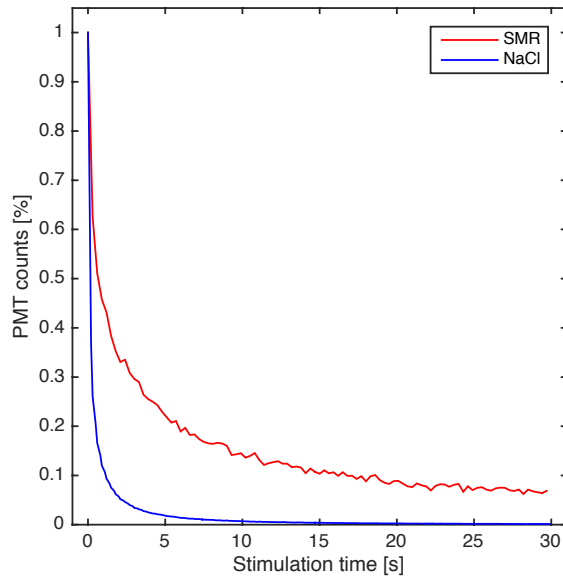

Figure 5. Typical shape of the CW-OSL decay curves from irradiated surface mount resistors (SMR) and household salt (NaCl).

In LM-OSL the intensity of the stimulation light is increased linearly, and traps with different photoionisation cross-sections appear at different times, similarly to a TL glow-curve. When using POSL, the stimulation light is pulsed and the luminescence recorded between the pulses, allowing measurements without optical filters. In the papers included in this thesis, only CW-OSL has been used; therefore LM-OSL and POSL will not be further explained.

A CW-OSL decay curve can take on a variety of different shapes and depends on the material, wavelength of the stimulation light, and sample temperature. Complex mathematical functions are often required to describe the shape of an OSL decay curve in detail (McKeever, 2001). In the following, a basic model including one trap and one radiative recombination centre is described (as described in McKeever, 2001). When a sample is stimulated using CW-mode, the luminescence is expected to decay with stimulation time as a result of the release of electrons to the conduction band and subsequent radiative recombination with a hole in a recombination centre. The probability, p , per unit time that an electron is de-trapped can be described by the stimulation intensity (photon fluence rate; ϕ [$\text{m}^{-2}\text{s}^{-1}$]) and the photoionisation cross-section, σ [m^2]:

$$p = \phi \cdot \sigma$$

Assuming that the number of trapped electrons and the number of trapped holes are the same at the start of stimulation, i.e., $n_0 = m_0$, then the flow of charge can be described by the rate equations

$$\frac{dn_c}{dt} = -\frac{dn}{dt} + \frac{dm}{dt}$$

$$I_{OSL} = -\frac{dm}{dt} = -\frac{dn}{dt} = np$$

where n_c represents the concentration of electrons in the conduction band and I_{OSL} is the intensity of the OSL. Assuming that the concentration of electrons in the conduction band is much smaller than the concentration of trapped electrons, $n_c \ll n, m$; that the changing rate of electrons in the conduction band is much smaller than the changing rate of trapped electrons, $dn_c/dt \ll dn/dt, dm/dt$; and that the probability of re-trapping is negligible, then

$$I_{OSL} = n_0 p \cdot e^{-tp} = I_0 \cdot e^{-t/\tau}$$

where I_0 is the OSL intensity at time $t = 0$, and $\tau = 1/p$ is the decay constant.

Considering more than one active trap ($i = 1, \dots, w$), the intensity of the OSL will be the sum of multiple exponentials

$$I_{OSL} = \sum_{i=1}^w I_{i0} \cdot e^{-t/\tau_i}$$

OSL readers

There are a number of different OSL readers available on the market, targeted against both research and occupational use. OSL readers of a simpler kind may also be relatively easy put together “in-house”. In this thesis, however, the commercial Risø TL/OSL reader (DTU Nutech, Technical University of Denmark, Risø campus, Roskilde, Denmark; Fig. 6) have been exclusively used and thus only this reader will be described.

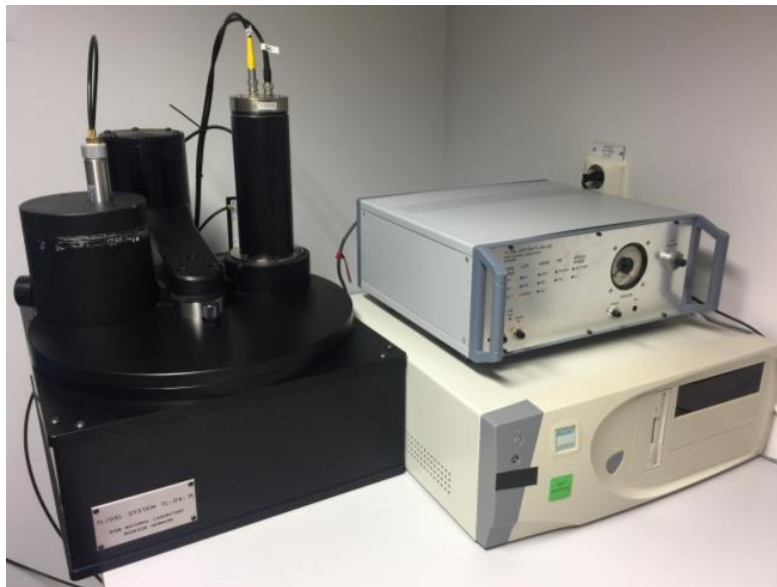

Figure 6. The Risø TL/OSL-DA-15 reader used for all OSL measurements in this thesis.

The Risø TL/OSL equipment

The basic elements needed for OSL measurements to be possible are stimulation light and a light detection system (e.g., a PMT). Preferably, also a heater (for pre-heat and/or OSL measurements at elevated temperatures) and an irradiation source are available. When non-commercial readers are used, it is not uncommon that the components are located at different sites, so that, for example, samples have to be tangibly moved between pre-heat and OSL read-out. For several reasons, it is more convenient to have all components in a single assembly. In Fig. 7, a

schematic drawing of the Risø TL/OSL-DA-15 reader which include all of these components is shown.

Samples are mounted on stainless steel cups (diameter 11.65 mm) and placed in the detachable sample carousel of the reader. The carousel accommodates up to 48 samples, also referred to as aliquots. When the carousel is placed in the sample chamber, individual irradiation and read-out parameters may be set for each aliquot using a sequence planning program. During read-out, the aliquot is lifted by a lift, which also works as a heater when desired, and may be stimulated using either light and/or heat; thus, the equipment functions both as an OSL and TL reader.

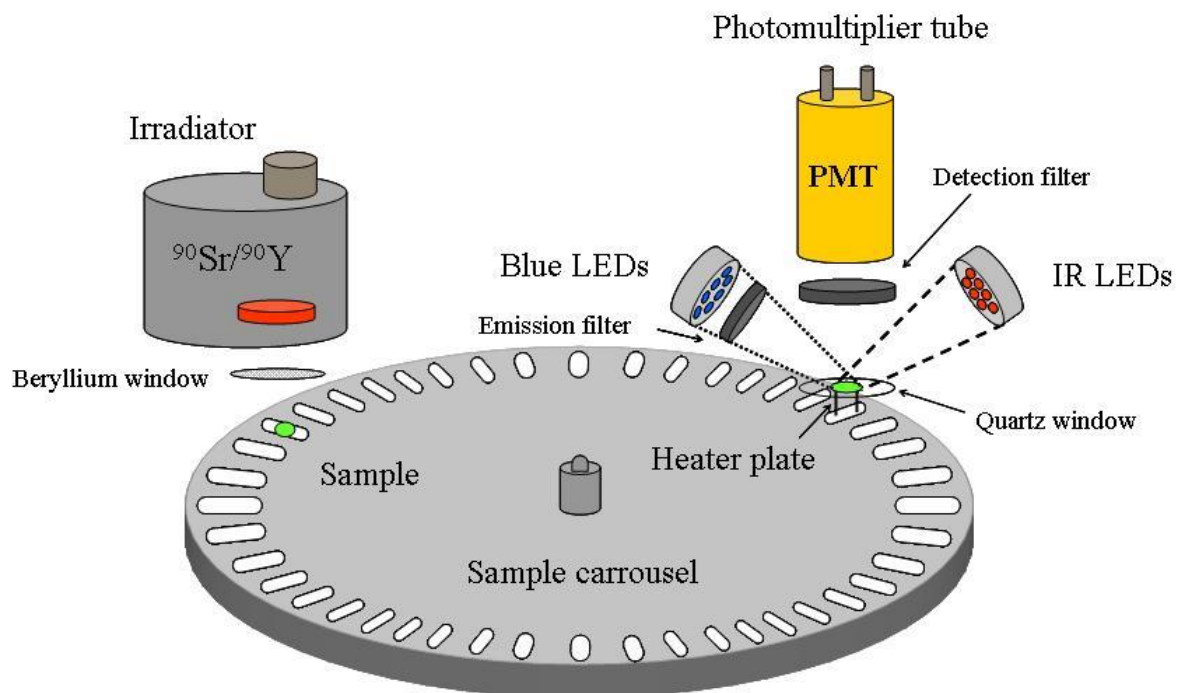

Figure 7. Schematic drawing of the Risø TL/OSL-DA-15 reader. Reprinted with permission from *Guide to "The Risø TL/OSL Reader"*, DTU Nutech, Denmark (www.nutech.dtu.dk).

Stimulation and detection

There are two luminescence stimulation systems in the Risø reader, a heating system for TL and a light system for OSL. The systems can be used individually or in combination. The heating element may be used to heat samples up to 700°C at rates from 0.1 to 10 K/s. The light stimulating systems consist of seven light-emitting diode (LED) clusters, of which three are with infrared (IR) LEDs and four with blue LEDs. The IR LEDs emit at ~875 nm and the blue LEDs at ~470 nm. Luminescence is detected with a PMT, which has a maximum detection efficiency between 200 and 400 nm, i.e., the ultraviolet (UV) region. To prevent

scattered stimulation light from reaching the PMT, detection filters are needed. Furthermore, the wavelength interval from the stimulation light and detection window must be well separated. In front of the PMT is a Hoya U-340 filter, with transmission approximately in the range 250–390 nm (www.hoyaoptics.com). The blue LEDs spectrum has a tail into the detection window (Fig. 8), so a transmission cutoff filter, GG-420, is positioned in front of each blue LED cluster to remove this tail.

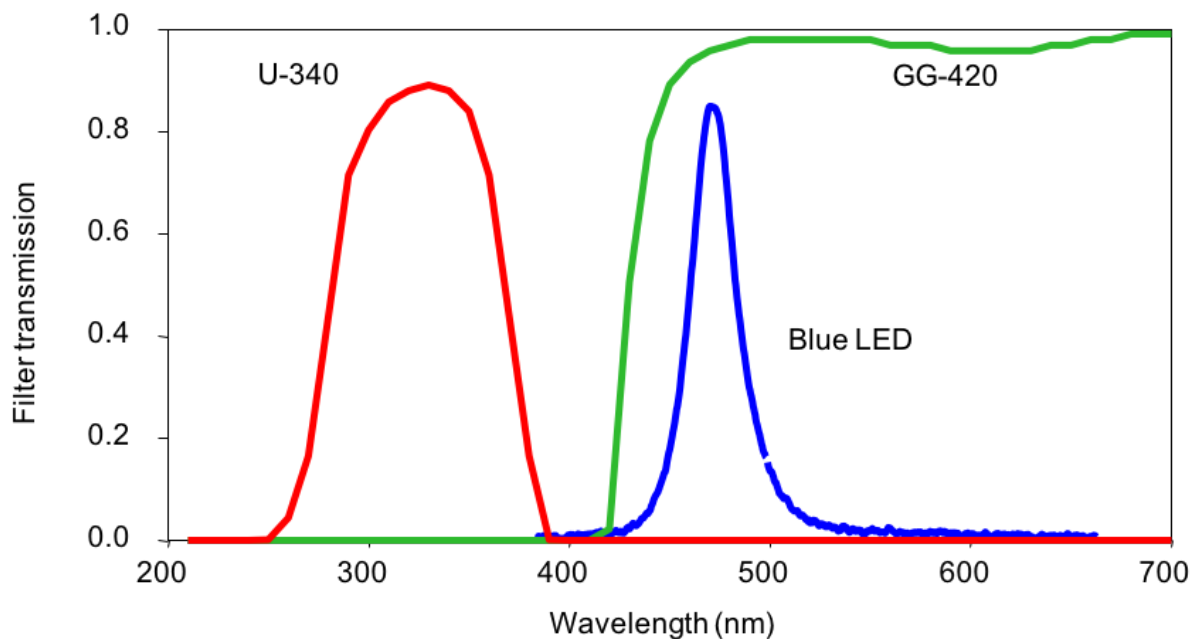

Figure 8. Detection filters and stimulation light spectra in the Risø TL/OSL equipment. Reprinted with permission from *Guide to "The Risø TL/OSL Reader"*, DTU Nutech, Denmark (www.nutech.dtu.dk).

Irradiation source

Incorporated into the reader is also an irradiation source, and it is possible to perform irradiations using either X-ray, alpha, or beta particles. As a standard, though, the reader comes with a $^{90}\text{Sr}/^{90}\text{Y}$ source, with an activity of approximately 1.48 GBq. $^{90}\text{Sr}/^{90}\text{Y}$ emits beta particles with a maximum energy of 2.27 MeV. A source with this activity was used for some of the measurements in **Paper II**. For all other irradiations in the Risø reader, the standard source was replaced by a $^{90}\text{Sr}/^{90}\text{Y}$ source with an activity of 20 MBq (2009-04-09).

Calibration of the internal source

Ensuring that the incorporated $^{90}\text{Sr}/^{90}\text{Y}$ source delivers the intended dose to the aliquot in the irradiation position requires that it be regularly calibrated. Because

the Risø reader was originally developed for archaeological dating, the calibration method recommended is to use quartz (one of the most commonly used materials in dating dosimetry). *Calibration quartz* may be ordered by the retailer and consists of pure quartz sieved to grain sizes of 180–250 μm and irradiated with 4.81 Gy (absorbed dose to quartz derived from the absorbed dose to water) in an external ^{137}Cs beam, calibrated at a secondary standard laboratory (Danish State Institute for Radiation Hygiene, SIS). The OSL signal corresponding to the 4.81 Gy of the calibration quartz, D_{cal} , is measured and then the single-aliquot regenerative-dose (SAR) protocol (described in more detail by Murray and Wintle, 2000) is used to determine the beta irradiation time needed to generate an OSL signal equal to that from D_{cal} . To calibrate against materials other than quartz, the same procedure may be performed by irradiating any material in a well-known beam and relating the corresponding OSL signal to a specific irradiation time of the $^{90}\text{Sr}/^{90}\text{Y}$ source. In **Paper II**, this process was performed with resistors from mobile phones (described in more detail in the section *Resistors*). Resistors were irradiated with 6 Gy (air kerma) in a ^{60}Co beam at IRSN (France). This kind of cross-calibration requires a well-known irradiation beam, i.e., a secondary standard laboratory, which, unfortunately, often results in this being postponed until later in the research process for a material. This delay of a proper cross-calibration generates a casual usage of the word *dose*. Often, but not always, the term dose then refers to the corresponding absorbed dose to quartz or to the absorbed dose to the surveyed material. However, as these quantities are not the ultimate concepts of interest, and since both cross-calibrations and conversion factors will later be applied to the signal of the surveyed material, the word *dose* is generally used for convenience.

External irradiation sources

Although not a part of the Risø TL/OSL equipment, external irradiation sources may be successfully used to deliver doses to samples later to be read out in the Risø reader. Obviously, this approach would be the case for accidental exposure of an individual. In **Paper I**, a linear accelerator (Clinac 2100C/D, Varian Medical Systems, www.varian.com) was used as well as the $^{90}\text{Sr}/^{90}\text{Y}$ source. The linear accelerator was, however, not calibrated against the internal source in any way because only relative measurements were performed. Four irradiation geometries were used in **Paper III**: *i*) the incorporated $^{90}\text{Sr}/^{90}\text{Y}$ source; *ii*) a ^{60}Co beam from a teletherapy unit (Gammatron 3, Siemens, Germany); *iii*) a ^{60}Co point source; and *iv*) authentic exposure in the Village of Svetilovichi, Belarus, which has a high ground deposition of ^{137}Cs after the Chernobyl accident. The same teletherapy unit (Gammatron 3, Siemens, Germany) was used for irradiations in **Paper V** and has been calibrated in terms of air kerma against the Swedish secondary standard laboratory (SSM).

OSL materials in retrospective dosimetry

For a material to be useful in OSL dosimetry for retrospective applications, it has to possess some essential qualities. A list over desirable properties for an OSL dosimeter material is given in Table 1. Ideally, all of these properties would be present; however, in reality, this is hardly ever the case. Furthermore, in retrospective/emergency dosimetry, the materials available are what they are, and further development is not possible (unlike the materials used in prospective dosimetry in a hospital, for example). The very first property a potential material for OSL emergency dosimetry must possess is availability in the immediate vicinity of the general public. Only when this availability is assured can additional investigations be of interest. Thus, the material in question should be available on or near as many people as possible. Although, it is also important to have alternative materials (or methods) in the case of a specific material not being accessible for some reason. Next, the material may not be exposed to light under normal conditions because the OSL signal is read out by light. This, requirement, together with the fact that the material must be an insulator or semiconductor with a crystal structure, limits the options.

Table 1. List of desired properties of an OSL dosimeter material (a similar list can be seen in Ainsbury et al. 2011 for dosimeter materials in general).

Property
Measured signal is specific for ionising radiation
Linear response to ionising radiation over a wide dose range (micro Gy to tens of Gy)
Well defined dose-response relations for different radiation qualities and dose rates
Measured signal is stable over time
The possibility of generating a universal calibration curve
Small individual variations between samples
No confounding factors
Ability to estimate uncertainties
Minimal invasive sampling (for endogenous materials)
Standardised, fast, automatic, and cheap sample processing and analysis

When using OSL in retrospective dosimetry, the materials can be classified into two groups: materials that generate individual dose estimations directly and

materials that generate a dose map from which individual dose estimations may be obtained by information on time and motion for each individual in the area. Even though direct individual dose estimations are preferable in most cases, this is not practically applicable in some instances, such as performing epidemiological studies on large populations. All OSL materials mentioned in the following sections and the kind of dose estimate they generate are listed in Table 2.

Table 2. Summary of materials with dosimetric properties regarding OSL, their typical MDD values and type of dose estimates they would generate following an emergency situation (based on data shown in Bailliff et al. 2016; Ainsbury et al. 2011; Bernhardsson et al. 2009; Thomsen et al. 2002b; Bøtter-Jensen and McKeever 1996; **Paper I**; and **Paper IV**)

Material	MDD	Type of dose estimation generated
Heated building materials	Tens of mGy	Map ^a
Unheated building materials	>100 mGy	Map ^a
Porcelain	50 mGy	Map ^a
Washing powder	5–100 mGy	Map ^a
Water softener	10 mGy	Map ^a
NaCl	<1 mGy	Map ^a
Desiccants	10–1800 mGy	Map ^a
Nails	0.1–5 Gy	Individual
Teeth	<1 Gy (in dry condition)	Individual
Dental repair materials	20–185 mGy	Individual
Clothes	45 mGy–1.2 Gy	Individual
Shoes	55–550 mGy	Individual
Money	30 mGy–2 Gy	Individual
Chip cards	<10 mGy	Individual
Resistors	<10 mGy	Individual
Integrated circuits	0.13–0.26 Gy	Individual

^aThese materials could also generate individual dose estimations given the additional information on time spent at different locations for each individual.

Building materials

Quartz and feldspar from heated ceramic materials (bricks and tiles) mainly have been used and studied for retrospective luminescence dosimetry (ICRU 2002). Unheated quartz in bricks, mortar, and concrete also may be used (e.g., Thomsen et al. 2002a); however, heating of the material (during manufacturing) works as a zeroing of the OSL signal (and also as a sensitisation process for quartz), thus making the dose estimation more straightforward. After manufacturing, the material accumulates dose from background radiation and later possibly also an

accident dose. The dose corresponding to the OSL read-out, D_{OSL} , therefore represents both the accident dose, D_a , and the accumulated background dose, D_b , so,

$$D_{OSL} = D_b + D_a$$

Generally, the dose in the material is then converted to dose or kerma in air and used together with residence time for each individual or population, as an intermediate step, before the dose to the organ or tissue of interest is estimated (Yukihara and McKeever 2011).

Household materials

A number of household materials have been studied for their potential use in OSL dosimetry. The materials include porcelain (e.g., Bøtter-Jensen and McKeever 1996), washing powder, water softener (Thomsen et al. 2002b), household salt (NaCl; e.g., Thomsen et al. 2002b; Bernhardsson et al. 2009), and desiccants (materials used to absorb moisture; **Paper IV**). The component thought to be responsible for the OSL in porcelain is Al_2O_3 (Bøtter-Jensen et al. 1996), which (although then carbon-doped, $Al_2O_3:C$) is a well-known OSL dosimeter material (e.g., Akselrod and McKeever 1999). For the same reason, but with regard to silica (SiO_2), the dosimetric properties of different desiccants were investigated in **Paper IV**. The most frequently used material generally in OSL, quartz, consists of silica; thus, the idea that other silica-rich materials might possess dosimetric properties seems promising. Various different kinds of desiccants (Fig. 9), with respect to their potential as OSL emergency dosimeters, are investigated in **Paper IV**. To add new materials to the list of potential dosimeters is always interesting and valuable, because it is never certain what materials will be available in an emergency situation.



Figure 9. Different types of desiccants. “Silica gel” bags found in hand bags (left and middle) and cat litter (right).

Household salt, NaCl

The fact that stimulation with light could generate luminescence in irradiated NaCl was first observed by Stoddard in 1960, though he did not call it OSL. The first study where NaCl was stated as a retrospective dosimeter material using OSL was performed by Bailey et al. (2000) and concluded that OSL of NaCl may be a useful dosimetric tool. Later, Bernhardsson et al. (2009) investigated a selection of household salts and stated that most salts have a very high specific luminescence (PMT counts per unit dose) and that the minimum detectable doses were below 1 mGy (0.2–1 mGy). They also mentioned that the OSL properties under normal household usage should be more thoroughly investigated. One aspect of daily usage that could affect the OSL signal is that the salt could be exposed to light between exposure and read-out, with the risk that the OSL signal would be quenched. In **Paper III**, the extent to which different NaCl packages found in supermarkets are light tight was investigated (Fig. 10).

Another advantage of NaCl is that it can be found virtually everywhere: in homes, workplaces, and restaurants all over the world. This means that it would be fairly simple to collect samples, and once in the lab, the sample preparation is minimal. Furthermore, the above-mentioned properties together with the fact that NaCl is very cheap (both regarding purchase and read-out) makes this material interesting also for prospective dosimetry, i.e., to use ready-made NaCl dosimeters in the same way as commercial LiF:Mg,Cu,P, and Al₂O₃:C dosimeters (Bernhardsson et al. 2012; Ekendahl et al. 2015). This option would be particularly useful in developing countries and amongst employers with limited budget for dosimetry, e.g., rescue service teams. The possibility of using NaCl as a prospective dosimeter in the future is evaluated in **Paper V**.



Figure 10. Household salt (NaCl) in different packages commercially available.

Biological materials

A material that perhaps is primarily associated with EPR, has been the subject of some considerable attention also using OSL: teeth. It was first suggested by Godfrey-Smith and Pass (1997) as a way to overcome the necessity at that time of extracting the tooth for using EPR. The same authors also mention the potential possibility of non-invasive, *in vivo* dosimetry, measuring the teeth directly in the mouth. Subsequent studies indicate minimal detectable doses (MDD) values of teeth in the order of a couple of grays (Yukihara et al. 2007; Godfrey-Smith 2008; DeWitt et al. 2010; Yüce et al. 2010; Sholom et al. 2011). However, the investigations performed in **Paper I** showed that when the teeth (Fig. 11) were irradiated in moist conditions (as they would be in the mouth), the OSL signal decreased significantly. Thus, the MDD would be substantially increased.

Another EPR-related material that been briefly investigated using OSL is fingernails and toenails (Sholom et al. 2011), materials that have great advantages primarily because of their extremely high availability and simple collection.

Dental repair materials

A positive conclusion from **Paper I** was that the OSL signal from dental repair materials (Fig. 11) did not decrease due to moisture, at least not to the same extent. Although dental repair materials are not biological, they are mentioned here because of the close link to teeth.

Paper I also shows that all repair materials evaluated in the study suffered from considerable fading, an observation consistent with previous work (Bailiff et al. 2002; Veronese et al. 2010; Ekendahl et al. 2013). A great challenge of using dental repair materials in retrospective dosimetry is that the materials are constantly being developed and improved in terms of clinical dental use. Furthermore, the exact composition is very difficult to establish because of trade secrets. A positive aspect of using dental repair materials, compared to teeth, is that there is no damage caused by extracting the repair material for measurements (for *ex vivo* measurements). Much more work remains before dental repair materials can be used in retrospective dosimetry, including an extensive survey of available materials on the market. However, a recent review article by Bailiff et al. (2016) states that “OSL from dental ceramics holds some promise for the development of an *in vivo* emergency dosimetry technique”.

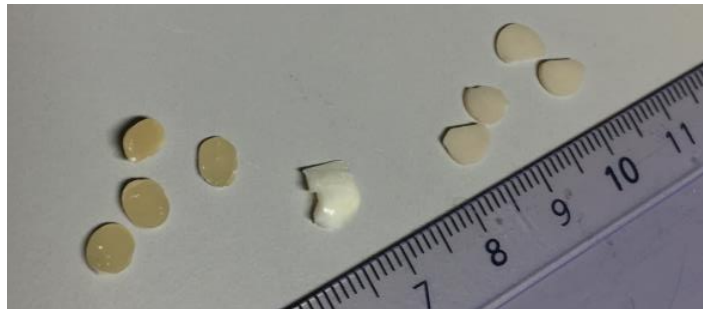

Figure 11. Two types of dental repair materials and human tooth enamel (middle).

Commonplace materials

By far the most research in retrospective OSL dosimetry has focused on so-called fortuitous or commonplace materials. These could be either materials worn on the body, such as clothes and shoes, or carried in a wallet or bag, such as money (both coins and bills; Sholom and McKeever 2014). Bortolin et al. (2010; 2011) also found that dust from these kinds of personal objects (keys, coins, jewellery) could be useful in retrospective dosimetry (using TL). The memory chip modules that may be found in telephone/ID/bank cards have also been investigated (e.g., Göksu 2003; Mathur et al. 2007; Woda and Spöttl 2009; Woda et al. 2012). All studies

have indicated that the epoxy cover found on the reverse side of the card and the silicate materials added to this epoxy are the main source of the OSL signal. Chip cards with these kinds of electronic chip modules are being increasingly used (Bailiff et al. 2016), and the availability in case of a radiological/nuclear emergency situation thus will be increased as well.

Another source of potential dosimeter materials carried by many people is mobile phones (or other electronic devices). Both the glass (although using TL; e.g., Bassinet et al. 2010a; Discher 2015) and components from the circuit board such as resistors and integrated circuits (e.g., Bassinet et al. 2010b) have shown promising properties. Of these, surface mount resistors (SMRs) have been studied the most (Fig. 12).

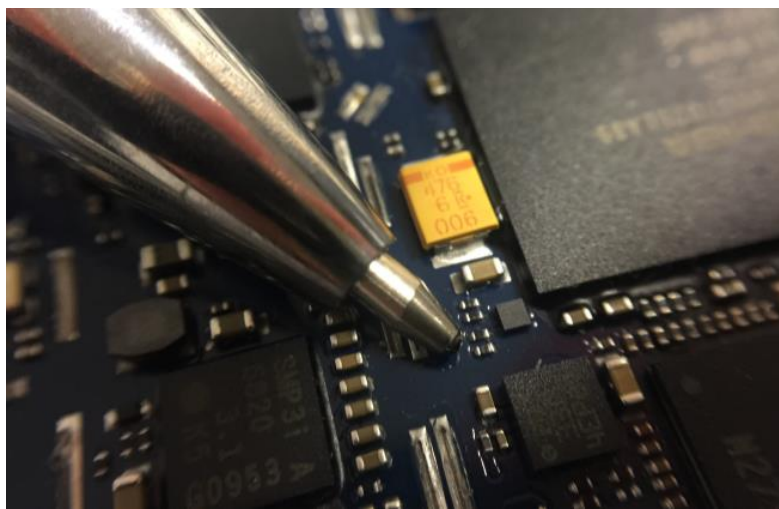

Figure 12. The circuit board of a mobile phone. Surface mount resistors with alumina underneath are pointed out by an ordinary ballpoint pen.

Resistors

Inrig et al. (2008) were the first to propose the use of SMRs in retrospective dosimetry. They also noted that the OSL signal of irradiated SMRs suffered from considerable fading and concluded that the fading is anomalous, i.e., not temperature dependent. The fading is instead believed to be the result of quantum-mechanical tunnelling. Generally, the fading of the OSL signal in SMRs has been looked on as a disadvantage and a limiting factor. In **Paper II**, however, it is discussed that the fading instead can be used in a positive manner, i.e., to estimate the time of exposure (if it is unknown) by comparing two subsequent measurements. Furthermore, as shown in **Paper II**, the OSL signal may be observed several years after exposure (for doses relevant in triage); for example, a dose of 0.5 Gy may be detected more than 6 years after exposure. Thus,

retrospective dosimetry using SMRs also could be useful also for epidemiological studies at least a couple of years following an emergency situation.

The biggest drawback in using SMRs following a large-scale emergency situation is that people might not be willing to give up their mobile phones (Eakins et al. 2016). These days, the mobile phone is the only communication tool for many people (the use of landline telephones is decreasing, at least for younger generations), and the decision to give up that connection in a situation of uncertainty and fear will not be made lightly. Thus, ways to provide people with an alternative communication tool and to secure the data stored in the phone must be established in advance.



Figure 13. Photographs illustrating the procedure of dismantling a mobile phone. Top left: intact mobile phone, top right: circuit board of the mobile phone with metal sheets covering the components, bottom: all parts of the mobile phone after dismantling.

Extraction of resistors

Another potential problem with using SMRs in retrospective dosimetry that must be overcome in advance is that enough people must be able to extract the resistors from the mobile phones. To open up a mobile phone and extract a sufficient number of resistors takes 10–30 minutes per phone. It is easy to imagine the workload that a large-scale emergency situation would generate, and several people working with extracting the resistors would be required. The withdrawal itself is not difficult, but some experience and a certain amount of skill are needed. First of all, the removal must be performed in a dark room, under red light conditions, to avoid quenching the OSL signal. To reach the SMRs on the circuit board the phone have to be dismantled, a process that have to be made carefully so that the resistors are not damaged but even so, a certain amount of violence is generally needed. The dismantling is performed in steps; first the outer shell and battery is removed, then the circuit board is loosened, and finally the metal sheets covering the components are removed, see Fig. 13. Second of all, the SMRs are small and only a certain type has the required properties, which makes it a bit tricky to recognise them. The SMRs with OSL properties comes in various sizes, of which the most commonly found in mobile phones are $0.6 \times 0.3 \times 0.2$ mm and $1.0 \times 0.5 \times 0.35$ mm, so that extraction of SMRs is preferably performed using a microscope. The SMRs that possess dosimetric properties are black on top and white underneath, which is the exposed ceramic consisting of alumina; see Fig. 14. Once identified, the resistor is loosened from the circuit board by gently pushing the soldered joint at the edges using a small screwdriver and then placing it, bottom side up, on a measuring cup (used to load samples in the Risø equipment; sprayed with oil to hold the resistors in place) using a fine tweezer. For reasons unspecified, generally 10 resistors per cup is the norm. However, the number of resistors is proportional to the OSL intensity (Fig. 15); thus, a greater number of resistors could be used if a higher accuracy is prioritised over time consumption or, conversely, a smaller number could be used if a fast but rough dose estimation is considered more important than precision.



Figure 14. Different sizes (left) and the black upper side and white underside of the SMRs with dosimetric properties. Each gradation on the scale denotes one millimetre.

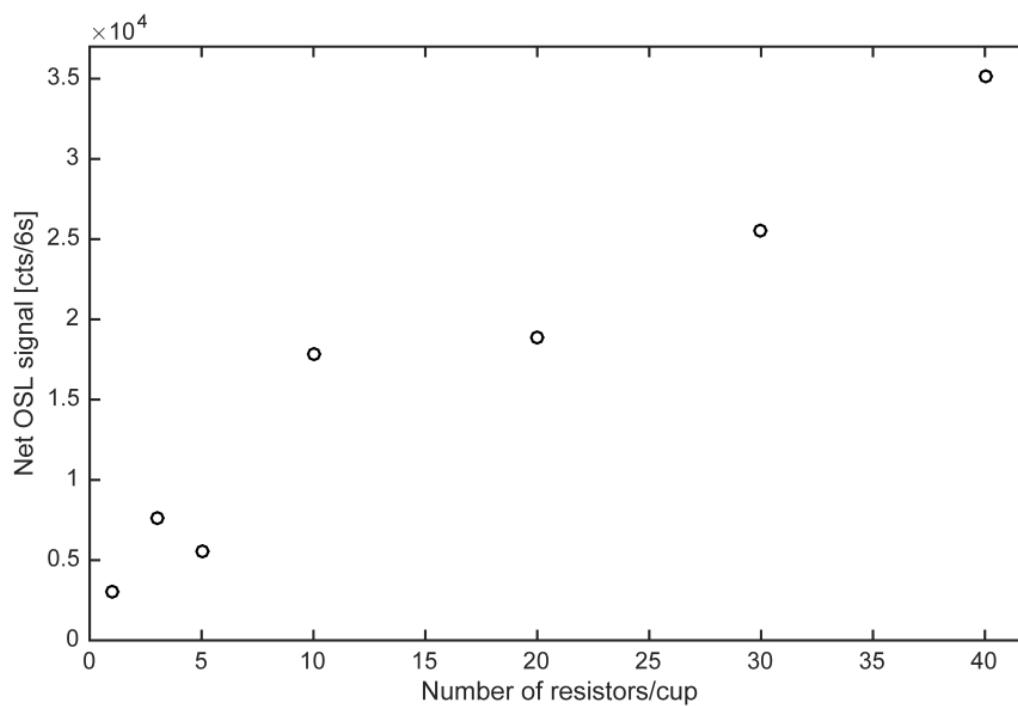

Figure 15. The OSL intensity as a function of the number of resistors on a measuring cup in the Risø equipment.

Dose estimates

The goal when using retrospective dosimetry techniques is to obtain the most accurate dose estimation possible for an individual. For emergency dosimetry, it is sufficient to distinguish a dose corresponding to a whole body absorbed dose of 2 Gy, so that the MDD of the technique should be at least in the order of 0.5 Gy. For biological dosimetry, achieving this target is somewhat easier than for physical techniques because the interaction with radiation used for the dose assessment is within the parts of the human body that are of interest from a risk point of view. For materials that are not endogenous and for teeth, the interaction with ionising radiation will be different than within the human body, which must be taken into account when the dose to an individual is being estimated. For retrospective dosimetry and e.g., epidemiological studies, the other quantities besides the absorbed dose is of interest as the investigations normally targets long term effects, such as cancer; thus, making the effective dose a more proper quantity. The minimum effective dose that the technique can distinguish should thus be as low as possible.

Dose quantities

Several quantities are used in radiation protection. There are physical quantities, such as fluence (Φ), kerma (K), and absorbed dose (D), that describe a property of a physical object or phenomenon (ICRU 1993). From the physical quantities, operational quantities, such as ambient dose equivalent ($H^*(d)$), directional dose equivalent ($H'(d, \Omega)$), and personal dose equivalent ($H_p(d)$), and protection quantities, such as organ absorbed dose (D_T), organ equivalent dose (H_T), and effective dose (E), may be calculated. Furthermore, the protection and operational quantities may be interlinked by measurements and calculations. How the different quantities are related can be seen in Fig. 16.

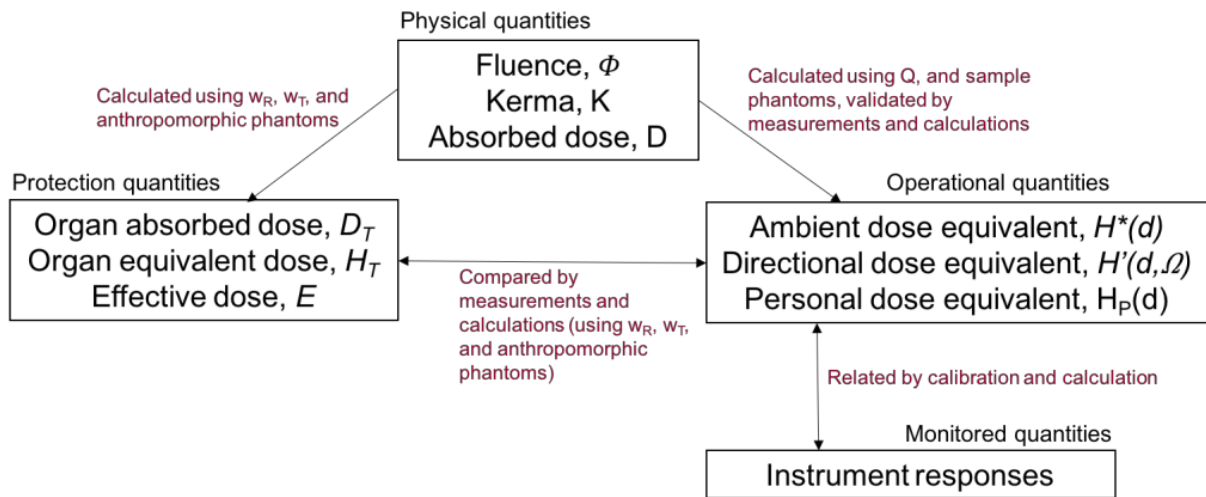

Figure 16. Relationship of quantities for radiological protection monitoring purposes (ICRP, 1996).

Fluence

A radiation field, independent of radiation type, can be described by its fluence (Φ), which is defined as the quotient of the number of particles, dN , incident on a sphere of cross-section area, da :

$$\Phi = \frac{dN}{da}$$

The fluence is usually expressed in the unit m^{-2} .

Kerma

Kerma, K , is the energy transferred by indirectly ionising radiation (photons and neutrons) to charged particles (Attix 2004). The energy transferred in a given volume is:

$$\epsilon_{tr} = (R_{in})_u - (R_{out})_u^{nonr} + \sum Q$$

where $(R_{in})_u$ is the radiant energy from uncharged particles that enters the volume, $(R_{out})_u^{nonr}$ is the radiant energy of uncharged particles that leaves the volume (except that which originated from the conversion of charged particle kinetic energy to photon energy), and $\sum Q$ is the net energy that is derived from rest mass in the volume. The kerma at a point of interest in the volume can now be defined as:

$$kerma = \frac{d\epsilon_{tr}}{dm}$$

The unit of kerma is J/kg, also called the gray [Gy].

Absorbed dose and related protection quantities

The absorbed dose is the quantity used when describing ARS and thus the quantity of interest for emergency retrospective dosimetry. It is defined as the quotient of $d\bar{\epsilon}$ by dm , where $d\bar{\epsilon}$ is the mean energy imparted and dm is the mass and given in the unit gray [Gy]:

$$D = \frac{d\bar{\epsilon}}{dm}$$

When Monte Carlo methods are used to calculate protection and operational quantities, the first step is to calculate the absorbed dose distribution in the model of the body. When the absorbed dose distribution is known, calculations of the organ absorbed doses are easily performed by dividing the absorbed dose in the mass element corresponding to the organ by the mass of the organ:

$$D_T = 1/m_T \int D dm$$

By multiplying the organ absorbed dose with a weighting factor, w_R , that accounts for the relative damage different types of radiation (ICRP 1996), the equivalent dose, H_T , can be calculated:

$$H_T = \sum_R w_R D_{T,R}$$

where $D_{T,R}$ is the average absorbed dose in tissue T from radiation R . In the next step, the effective dose (E) can be calculated by taking the risk of induced cancer in a specific organ into account. This is done by multiplying the equivalent dose, H_T , for an organ with the tissue weighting factor, w_T , of the same organ:

$$E = \sum_T w_T H_T$$

Both the equivalent dose and the effective dose are expressed in the unit Sievert [Sv=J/kg].

Operational quantities

The operational quantities are related to the protection quantities and are supposed to give reasonable estimates of the protection quantities. The operational quantities have been derived for use in practical areas and individual measurements and are based on the dose equivalent at a point in the body (or in a phantom). The dose equivalent, H [Sv], is obtained by multiplying the absorbed dose, D , at a point with a quality factor, Q , that weighs the biological effectiveness of the charged particles producing the absorbed dose:

$$H = QD$$

The ambient dose equivalent ($H^*(d)$) at a point in a radiation field is defined as the dose equivalent that would be produced at a depth, d , in the ICRU sphere by the corresponding field (ICRU 1993). The ICRU sphere is a tissue equivalent sphere with a diameter of 30 cm (ICRU 1980).

The directional dose equivalent ($H'(d,\Omega)$) at a point in a radiation field is defined as the dose equivalent that would be produced by the field at a depth, d , in the ICRU sphere, on a radius in a specified direction, Ω .

For individual monitoring, the personal dose equivalent ($H_p(d)$) is used. It is defined as the dose equivalent in soft tissue at a depth, d , in the body. A detector worn on the surface of the body, with appropriate build-up, can be used to measure the personal dose equivalent.

For all operational quantities, a depth of 10 mm is recommended for radiation that is strongly penetrating; a depth of 0.07 mm for the skin and 3 mm for the eye is recommended for weakly penetrating radiation.

Dose conversion coefficients

Dose conversion coefficients are used to make the transition between the physical quantities and the protection or operational quantities. In **Paper V**, novel conversion coefficients are derived for the transition between the absorbed dose or air kerma and personal dose equivalent or absorbed dose to the material (depending on material; as previously mentioned, before proper cross-calibrations have been performed different dose concepts are in use). In general, conversion coefficients are obtained by using either computer codes or phantoms. Conversion coefficients for SMRs have been calculated using Monte Carlo simulations (Eakins and Kouroukla, 2015). In **Paper V**, the first attempt to obtain conversion coefficients by using physical measurements on an anthropomorphic phantom was performed. Although conversion coefficients are necessary for proper dose estimations in all dosimetry applications, they are calculated for a finite number of exposure geometries and radiation energies. It is impossible to have conversion coefficients for all possible scenarios; thus, it has become conventional to limit the number of exposure geometries. The most common method is to use plane-parallel beams and assume whole body exposure (ICRP 1996), and the geometries antero-posterior (AP), postero-anterior (PA), lateral (LAT), rotational (ROT), and isotropic (ISO) are often used (Fig. 17).

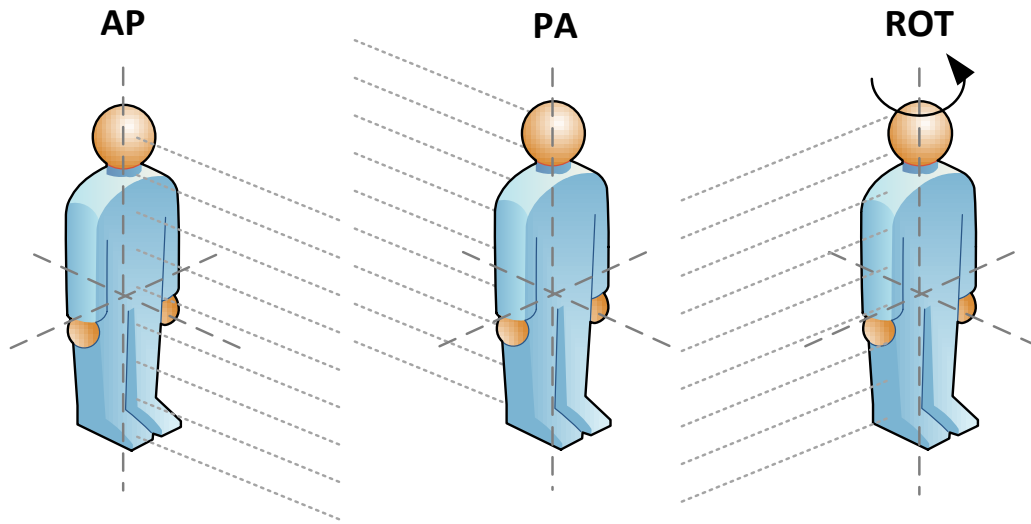

Figure 17. Schematic illustrations of the exposure geometries antero-posterior (AP), postero-anterior (PA) and rotational (ROT). Dashed lines indicates the direction of the radiation. By courtesy of Christian Bernhardsson.

Summary of papers

Here, a short summary of each paper included in this thesis is presented, together with thoughts about further work that should be done.

Paper I: Retrospective dosimetry using OSL of tooth enamel and dental repair materials irradiated under wet and dry conditions

In **Paper I**, the impact of a wet environment during irradiation on the OSL signal of tooth enamel and dental repair materials was investigated. It was found that a wet environment during irradiation decreases the OSL signal in tooth enamel at 40–95 %. Because teeth *in vivo* most definitely will be in a wet environment, this discovery greatly affects the MDD values of tooth enamel. The dental repair materials studied did not exhibit the same loss of signal when irradiated wet, which indicates that they could be potential materials for emergency dosimetry. Furthermore, the dental repair materials showed promising properties in terms of dose response and signal fading, i.e., the signal remained long enough to have time to perform measurements of interest for emergency dosimetry. The MDDs ranged from 20 to 185 mGy.

Further studies should include extensive investigations of the signal loss in tooth enamel when irradiated wet, including possible dose dependence and energy dependence. Different read-out protocols for the dental repair materials, i.e., TL and OSL at elevated temperatures, should be tried. A portable *in vivo* OSL reader is still an interesting development, but contemporary investigations of how dental repair materials could be extracted under dark-room conditions would be recommended. Also, the withdrawal itself could lead to a mechanically induced or reduced OSL signal.

Paper II: Optically stimulated luminescence (OSL) dosimetry in irradiated alumina substrates from mobile phone resistors

The use of resistors from electronic devices in OSL dosimetry has been in the spotlight recently. A property that has been considered a drawback of the technique is the significant fading of the OSL signal following exposure to ionising radiation. In **Paper II**, however, this fading was studied in more detail, and it was shown that the OSL signal remains for much longer than previously thought. In addition, the fading is independent of dose, and a dose of 0.5 Gy can be measured up to 6 years after exposure. **Paper II** also reveals that the size of the regenerative dose (calibration dose) does not affect the dose estimation.

Ideas for future studies are an extended fading curve, both prior to one hour (starting point for this study) and past 735 days (endpoint for this study), a more extensive dose-response curve, and MDD values calculated from a one dose only “dose-response curve” (because this is how the conversion from OSL signal to dose is performed in practise).

Paper III: Household salt for retrospective dose assessments using OSL: signal integrity and its dependence on containment, sample collection, and signal readout

It is not only the OSL properties of the material itself that affect the accuracy of dose estimation but also ambient factors, such as packaging and mixing of the grains. In **Paper III**, the impact of these factors on the estimated dose was investigated, in tandem with the impact of fractionation, storage time, and sensitivity changes. The results show that the OSL signal is preserved in cardboard boxes but not in plastic containers (included in the study). The estimated dose was in the same order whether the dose was fractionated or not. A depth dose curve in NaCl for ^{60}Co showed that the peak dose is found at a 15-mm depth and about 17 % higher than the entrance dose. Thus, the manner in which a sample is collected from the package would affect the dose estimation, and a thorough mixing is recommended. The OSL signal of NaCl does not fade (at least not over the time periods studied here, up to 300 days), but instead a so-called inverse fading is observed. Inverse fading means that the OSL signal increases with storage time;

the reason for the phenomenon is unknown but could be the result of a redistribution of trapped charges.

The phenomenon of inverse fading is interesting and requires further study for both its origin and more thorough characterisation (i.e., regarding possible impact of for example energy or size of the given dose) and thus the possibility of accounting for it in the dose estimations. Furthermore, the energy dependence of NaCl must be examined in more detail by performing measurements using other energies (work in progress). Regarding the packages that did not preserve the OSL signal, it would be interesting to keep a full salt package, previously irradiated, in a normal kitchen cabinet and investigate the degree of signal loss relative to the depth: Does the salt in the outermost parts shield the salt in the inner parts? The latter could also be simulated using Monte Carlo methods.

Paper IV: Desiccants for retrospective dosimetry using optically stimulated luminescence (OSL)

A new kind of materials, desiccants, were investigated in **Paper IV**. Desiccants is the generic name for materials used to remove humidity or liquids from unwanted places. They can, for instance, be found in bags, drug packages, and the vehicles of rescue service teams. No other studies on desiccants using OSL could be identified, so this study appears to be the first. Because the materials were completely unknown, the focus was to investigate the most basic OSL properties and if there was any response at all to ionising radiation. The main purpose of these materials is to absorb moisture, so the effect of moisture on the OSL signal was also investigated. All desiccants showed a response to ionising radiation in terms of OSL, but to varying degrees. Considering the results, the availability of the materials, and the limited information that is possible to obtain regarding the different materials (e.g., in terms of composition and manufacturing process), it is concluded that desiccants ought to be used together with other materials/methods or when no other materials are available.

Given that this report is the only known paper on desiccants in OSL, further studies are needed in all aspects, both to confirm these findings and also to further develop the technique.

Paper V: Optically stimulated luminescence in NaCl and mobile phone components for personal dosimetry – correlating OSL response to operational radiation protection quantities using an anthropomorphic phantom

When measuring the OSL signal in a material, the dose being estimated is actually the dose to the material in question, not to an individual. In **Paper V**, the transition from dose to a material to dose in the human body was studied. Conversion factors were obtained by attaching mobile phones and household salt to an anthropomorphic phantom containing dosimeters while irradiating the phantom in different exposure geometries. As expected, the results varied considerably with the exposure geometry, but the location of the dosimeter introduced bias to a lesser degree.

This study is the first to report measurements on conversion factors for materials used in retrospective dosimetry using OSL, so clearly, further studies are required. Preferably, these future studies should include simulations using Monte Carlo methods for comparisons and evaluations of the simulations. Other exposure geometries, radiation energies, and a larger number of resistors and salt packages are some aspects to consider for future research. Furthermore, a more complex phantom with pre-defined organs would give additional information about organ doses and a more accurate whole body dose estimation.

Conclusions

The papers that underlie this thesis have led to the following conclusions:

- Several materials found on, or in the immediate vicinity of man can be used for retrospective and/or emergency dosimetry using OSL.
- The OSL signal in tooth enamel is decreased if the tooth is wet during irradiation, as would be the case in the mouth, making it an inferior material for emergency dosimetry using current methods.
- Dental repair materials have great potential as retrospective/emergency dosimeters using OSL. The fact that removal of the repair material is simpler and less invasive than the removal of enamel is a great advantage.
- SMRs from electronic devices have a useable OSL signal for a much longer time period (years) than previously thought. Making them suitable for both retrospective and emergency dosimetry. For situations where the exposure time is unknown, the signal decay can be used to estimate the time of exposure by making to subsequent measurements with a well-known time gap.
- Some of the salt packages commercially available manage to retain the OSL signal of irradiated NaCl, enabling collection of salt packages for dose estimations following a radiological or nuclear emergency.
- NaCl does not exhibit direct fading of the OSL signal; rather, the OSL signal increases slightly with time after irradiation, a phenomenon called inverse fading.
- The way the sampling is performed when making dose estimations using NaCl is crucial for the outcome because the dose to the salt varies by almost 20 % depending on its depth in the package.
- Some types of desiccants found in or near homes and workplaces could be used as supplementary material in emergency OSL dosimetry.
- A first outcome of conversion factors for the transition between the dose to SMRs/NaCl and the effective dose to an individual has been obtained using an anthropomorphic phantom. The estimated dose varies considerably with exposure geometry.

Concluding remarks

All materials investigated in this thesis would benefit from further research with respect to the basic luminescence properties before they could be used for retrospective dosimetry with acceptable accuracies in any emergency situation. However, some of the materials already can facilitate eligible dose estimations provided that a few parameters are known. For example, to obtain dose estimations using SMRs, in the current situation, the exposure geometry and energy of the radiation would have to be known. The breakthrough for OSL in NaCl might be in prospective dosimetry. The robustness, excellent luminescence properties, and fact that it is very cheap are considerable advantages.

OSL using SMRs has the potential to become a key method for emergency dosimetry. A possible major problem, however, is the fact that the development in electronics is rapid, and in a few years, SMRs of this kind might not be as common. This problem is the same for dental repair materials and, in principle, all other materials that are not endogenous. Because there is no way to circumvent this problem, it cannot be seen as a reason not to investigate some types of materials. Emergency preparedness in itself means to be ready to act; thus, the materials currently available have to be subjects of interest as well as being under continuous re-evaluation in terms of usability. It is necessary to be prepared to reject a material and instead place emphasis on a new choice in order to keep up with technology. Also, the knowledge that is gained working with one material could be applied for new materials; thus, the time and effort spent on an obsolete material is not to be seen as wasted.

The transition from absorbed dose in a material to absorbed dose in the human body will probably be clarified using the Monte Carlo methods that are constantly improved, even though they will never completely transcend measurements that would be needed to verify calculations for various materials and configurations. If the geometry of an individual and the material chosen for OSL dosimetry could be simulated rapidly and with small constraints, conversion factors for each unique exposure situation would be derived with ease.

Acknowledgements

Det är många som på olika sätt hjälpt mig under arbetet fram till den här avhandlingen. Ni förtjänar alla en egen sida av tack, men jag ska försöka hålla mig lite mer kortfattat...

- Tack till mina handledare, som kompletterat varandra så fantastiskt bra.

Tack Christopher, för att du alltid är så engagerad. Från det att jag, rätt hastigt, hamnade som doktorand hos dig tills nu, har du alltid haft tid när jag knackat på din dörr.

Tack Christian, för att jag alltid kunnat ställa alla dumma frågor till dig. Utan alla diskussioner med dig hade jag inte förstått hälften så mycket av OSL som jag gör. Du är inte bara en självklar handledare utan också en självklar vän.

Tack Sören, för att du alltid trott på mig. Den självklara tillit och entusiasm du alltid visar är beundransvärd.

- Tack Maria, min medförfattare och vän, för alla roliga stunder vi haft ihop! Jag saknar dig i labbet (trots att du strösslar salt överallt 😊).
- Tack till alla nya och gamla doktorandkolleger, den här tiden hade varit så mycket tråkigare utan er! Tack Marie, du började som en trevlig kollega och blev en fantastisk vän! (Tack även till Magnus, eller Herr Dr. Marie Sydoff, för dina bidrag till min forskning 😊 och för alla trevliga middagar!) Tack Pernilla, att ha en så fin vän som rumskamrat gör det till en fröjd att gå till jobbet! Tack Kalle, för alla roliga och knäppa saker som alltid händer när man hänger med dig (jag ser fram emot flera)! Tack Marcus, Martin, Hanna, Peder, Jonas N, Mattias, Ünal, Mats, Jonas J, Daniel, Pontus, Magnus, Hannie, Tony, Lars, Maja, Simon, Lena, Carl, Andreas, Fredrik och Sofie.
- Tack till alla på avdelningen för Medicinsk Strålningsfysik/Strålningsfysik i Malmö för att ni gör det här till en fantastisk arbetsplats! Speciellt tack till Mikael, min gamle handledare, du fick mig att känna mig hemma här från dag ett! Extra tack också till Peter för att du alltid ställer upp och hjälper till med allt och inget!

- Tack till min familj (givetvis också den ingifta) för att ni alltid peppar mig och får mig att känna mig smart 😊. Tack för all hjälp med stort och smått under den här tiden.

Special thanks to Carmina, my very own proofreader!

Tack Nicholas, min ständige förebild, om inte du hade valt fysik så hade inte jag gjort det heller...

Tack mamma och pappa, för att ni alltid funnits där för mig. Tack pappa, för att du visade att matte och fysik var roligt. Vem av oss kunde ana att alla beräkningar på kollegieblocket hemma vid köksbordet skulle leda fram till det här? Tack mamma, för allt du gör för mig och för att du alltid så osjälviskt ställer upp. Du är min bästa vän.

- Tack Hampus & Ludwig, för att Ni finns. Jämfört med Er är allt annat oviktigt ♥
- Tack Marcus, för allt du gör för mig. Du gör mig hel.

References

- Ainsbury EA, Bakhanova E, Barquinero JF, Brai M, Chumak V, Correcher V, Darroudi F, Fattibene P, Gruel G, Guclu I, Horn S, Jaworska A, Kulka U, Lindholm C, Lloyd D, Longo A, Marrale M, Monteiro Gil O, Oestreicher U, Pajic J, Rakic B, Romm H, Trompier F, Veronese I, Voisin P, Vral A, Whitehouse CA, Wieser A, Woda C, Wojcik A, Rothkamm K (2011) Review of retrospective dosimetry techniques for external ionising radiation exposures. *Radiat Prot Dosim* 147(4): 573-592
- Akselrod MS, McKeever SWS (1999) A radiation dosimetry method using pulsed optically stimulated luminescence. *Radiat Prot Dosim* 81: 167-176
- Alexander GA, Swartz HM, Amundson SA, Blakely WF, Buddemeier B, Gallez B, Dainiak N, Goans RE, Hayes RB, Lowry PC (2007) BiodosEPR-2006 Meeting: Acute dosimetry consensus committee recommendations on biodosimetry applications in events involving uses of radiation by terrorists and radiation accidents. *Radiat Meas* 42(6-7): 972-996
- Anno GH, Young RW, Bloom RM, Mercier JR (2003) Dose response relationships for acute ionizing-radiation lethality. *Health Phys* 84: 565-575
- Attix FH (2004) Introduction to radiological physics and radiation dosimetry. Weinheim: WILEY-VCH
- Bailey RM, Adamiec G, Rhodes EJ (2000) OSL properties of NaCl relative to dating and dosimetry. *Radiat Meas* 32: 717-723
- Bailiff IK, Correcher V, Delgado A, Göksu Y, Hübner S (2002) Luminescence characteristics of dental ceramics for retrospective dosimetry: a preliminary study. *Radiat Prot Dosim* 101: 519-524
- Bailiff IK, Sholom S, McKeever SWS (2016) Retrospective and emergency dosimetry in response to radiological incidents and nuclear mass-casualty events: A review. *Radiat Meas* 94: 83-139
- Bassinat C, Trompier F, Clairand I (2010a) Radiation accident dosimetry on glass by TL and EPR spectrometry. *Health Phys* 98(2): 400-405
- Bassinat C, Trompier F, Clairand I (2010b) Radiation accident dosimetry on electronic components by OSL. *Health Phys* 98(2): 440-445
- Bernhardsson C, Christiansson M, Mattsson S, Rääf CL (2009) Household salt as a retrospective dosimeter using optically stimulated luminescence. *Radiat Environ Biophys* 48: 21-28
- Bernhardsson C, Matskevich S, Mattsson S, Rääf CL (2012) Comparative measurements of radiation exposure in a ¹³⁷Cs contaminated village in Belarus based on optically stimulated luminescence in NaCl and thermoluminescence in LiF. *Health Phys* 103(6): 740-749

- Bernstein C, Prasad AR, Nfonsam V, Bernstein H (2013). DNA Damage, DNA Repair and Cancer, New Research Directions in DNA Repair, Prof. Clark Chen (Ed.), InTech, DOI: 10.5772/53919. <https://www.intechopen.com/books/new-research-directions-in-dna-repair/dna-damage-dna-repair-and-cancer>
Accessed on 19 April 2017
- Bortolin E, Boniglia C, Della Monaca S, Gargiulo R, Onori S, Fattibene P (2010) Is dust a suitable material in retrospective personal dosimetry? *Radiat Meas* 45: 753-755
- Bortolin E, Boniglia C, Della Monaca S, Gargiulo R, Onori S, Fattibene P (2011) Silicates collected from personal objects as a potential fortuitous dosimeter in radiological emergency. *Radiat Meas* 46: 967-970
- Bøtter-Jensen L, Barkey BG, Poolton NRJ, Jungner H (1996) Luminescence Properties of Porcelain Ceramics Relevant to Retrospective Radiation Dosimetry. *Radiat Prot Dosim* 65: 369-372
- Bøtter-Jensen L, McKeever SWS (1996) Optically Stimulated Luminescence Dosimetry using Natural and Synthetic Materials. *Radiat Prot Dosim* 65: 273-280
- Clairand I, Huet C, Trompier F, Bottollier-Depois JF (2008) Physical dosimetric reconstruction of a radiological accident due to gammagraphy equipment that occurred in Dakar and Abidjan in summer 2006. *Radiat Meas* 43(2-6): 698-703
- DeWitt R, Klein DM, Yukihara EG, Simon SL, McKeever SWS (2010) Optically stimulated luminescence (OSL) of tooth enamel and its potential use in post-radiation exposure triage. *Health Phys* 98: 432-439
- Discher M (2015) Lumineszenzuntersuchungen an körpernah getragenen Gegenständen für die Notfalldosimetrie [dissertation]. Munich, Technical University of Munich (in German)
- Eakins JS, Kouroukla E (2015) Luminescence based retrospective dosimetry using Al₂O₃ from mobile phones: a simulation approach to determine the effects of position. *J Radiol Prot* 35: 343-381
- Eakins JS, Hager LG, Kouroukla E, Smith RW, Tanner RJ (2016) The PHE fortuitous dosimetry capability based on optically stimulated luminescence of mobile phones. *Radiat Prot Dosim* 170: 412-415
- Ekendahl D, Bulánek B, Judas L (2015) Comparative measurements of external radiation exposure using mobile phones, dental ceramic, household salt and conventional personal doseimeters. *Radiat Meas* 72: 60-65
- Fattibene P, Callens F (2010) EPR dosimetry with tooth enamel: A review. *Appl Radiat Isotopes* 68: 2033-2116
- Godfrey-Smith DI, Pass B (1997) A new method of retrospective radiation dosimetry: optically stimulated luminescence in dental enamel. *Health Phys* 72: 744-749
- Godfrey-Smith DI (2008) Toward *in vivo* OSL dosimetry of human tooth enamel. *Radiat Meas* 43: 854-858
- Guskova AK, Barabanova AV, Baranov AY, Gruszdev GP, Pyatkin YK, Nadezhina NM, Metlyaeva NA, Selidovkin GD, Moiseev AA, Gusef IA, Dorofeeva EM, Zykova IE (1988) Acute radiation effects in victims of the Chernobyl accident, in Appendix to Annex G of “Early effects in man of high radiation doses”. UNSCEAR 1988

- Göksu HY (2003) Telephone chip-cards as individual dosimeters. *Radiat Meas* 37: 617-620
- Hall EJ, Giaccia AJ (2006) *Radiobiology for the Radiologist*. Sixth edition. Lippincott Williams & Wilkins
- ICRP (1996) Conversion Coefficients for use in Radiological Protection against External Radiation. International Commission on Radiological Protection. ICRP Publication 74. Ann. ICRP 26 (3-4)
- ICRP (2007) The 2007 Recommendations of the International Commission on Radiological Protection. International Commission on Radiological Protection. ICRP Publication 103. Ann. ICRP 37 (2-4)
- ICRU (1980) Radiation Quantities and Units. International Commission on Radiation Units and Measurements, Bethesda, USA. ICRU Report 33
- ICRU (1993) Quantities and Units in Radiation Protection Dosimetry. International Commission on Radiation Units and Measurements, Bethesda, USA. ICRU Report 51
- ICRU (2002) Retrospective Assessment of Exposure to Ionising Radiation. International Commission on Radiation Units and Measurements, Bethesda, USA. ICRU Report 68
- Inrig EL, Godfrey-Smith DI, Khanna S (2008) Optically stimulated luminescence of electronic components for forensic, retrospective, and accident dosimetry. *Radiat Meas* 43: 726-730
- Israelsson A, Gustafsson H, Lund E (2013) Dose response of xylitol and sorbitol for EPR retrospective dosimetry with applications to chewing gum. *Radiat Prot Dosim* 154(2): 133-141
- JIWG (2005) Technology Assessment and Roadmap for Emergency Radiation Dose Assessment Program. Joint Interagency Working Group, US Department of Homeland Security, Washington DC. UCRL-TR-215887. https://www.dhs.gov/xlibrary/assets/S_T_TechAssess_ERDAP_June05.pdf Accessed 2 February 2017
- Martin A, Harbison S, Beach K, Cole P (2012) *An introduction to radiation protection*. Sixth edition. CRC Press
- Mathur VK, Barkyoumb JH, Yukihiro EG, Göksu HY (2007) Radiation sensitivity of memory chip module of an ID card. *Radiat Meas* 42: 43-48
- McKeever SWS (2001) Optically Stimulated Luminescence. *Nucl Instr and Meth in Phys Res B* 184: 29-54
- Murray AS, Wintle AG (2000) Luminescence dating of quartz using an improved single-aliquot regenerative-dose protocol. *Radiat Meas* 32: 57-73
- NCRP (2001) Evaluation of the Linear-Nonthreshold Dose-Response Model for Ionizing Radiation. National Council on Radiation Protection and Measurements, Bethesda, USA. NCRP Report No. 136
- Romm H, Oestreicher U, Kulka U (2009) Cytogenetic damage analysed by the dicentric assay. *Ann Ist Super Sanità* 45(3): 251-259

- Rothkamm K, Horn S (2009) γ -H2AX as protein biomarker for radiation exposure. *Ann Ist Super Sanità* 45(3): 265-271
- Sholom S, DeWitt R, Simon SL, Bouville A, McKeever SWS (2011) Emergency optically stimulated luminescence dosimetry using different materials. *Radiat Meas* 46: 1866-1869
- Sholom S, McKeever SWS (2014) Emergency OSL dosimetry with commonplace materials. *Radiat Meas* 61: 33-51
- Sholom S, McKeever SWS (2016) Emergency EPR dosimetry technique using vacuum-stored dry nails. *Radiat Meas* 88: 41-47
- Stoddard AE (1960) Effects of Illumination Upon Sodium Chloride Thermoluminescence. *Physical Review* 120(1): 114-117
- Thierens H, Vral A (2009) The micronucleus assay in radiation accidents. *Ann Ist Super Sanità* 45(3): 260-264
- Thomsen KJ, Bøtter-Jensen L, Murray AS, Solongo S (2002a) Retrospective dosimetry using unheated quartz: a feasibility study. *Radiat Prot Dosim* 101:345-348
- Thomsen KJ, Bøtter-Jensen L, Murray AS (2002b) Household and workplace chemicals as retrospective luminescence doseimeters. *Radiat Prot Dosim* 101: 345-348
- Thomsen KJ (2004) *Optically Stimulated Luminescence Techniques in Retrospective Dosimetry using Single Grains of Quartz extracted from Unheated Materials [dissertation]*. Roskilde: Risø National Laboratory
- Trompier F, Bassinet C, Wieser A, De Angelis C, Viscomi D, Fattibene P (2009) Radiation-induced signals analysed by EPR spectrometry applied to fortuitous dosimetry. *Ann Ist Super Sanità* 45(3): 287-296
- UNSCEAR (1988) Sources, effects and risks of ionizing radiation. United Nations Scientific Committee on the Effects of Atomic Radiation, New York, USA. UNSCEAR 1988 report
- Veronese I, Galli A, Cantone MC, Martini M, Vernizzi F, Guzzi G (2010) Study of TSL and OSL properties of dental ceramics for accidental dosimetry applications. *Radiat Meas* 45: 35-41
- Waselenko JK, MacVittie TJ, Blakely WF, Pesik N, Wiley AL, Dickerson WE, Tsu H, Confer DL, Coleman CN, Seed T, Lowry P, Armitage JO, Dainiak N (2004) Medical management of the acute radiation syndrome: recommendations of the Strategic National Stockpile Radiation Working Group. *Ann Intern Med* 140: 1037-1051
- Woda C, Spöttl T (2009) On the use of OSL of wire-bond chip card modules for retrospective and accident dosimetry. *Radiat Meas* 44: 548-553
- Woda C, Fiedler I, Spöttl T (2012) On the use of OSL of chip card modules with molding for retrospective and accident dosimetry. *Radiat Meas* 47: 1068-1073
- Yukihara EG, Mittani J, McKeever SWS, Simon SL (2007) Optically stimulated luminescence (OSL) of dental enamel for retrospective assessment of radiation exposure. *Radiat Meas* 42: 1256-1260
- Yukihara EG, McKeever SWS (2011) *Optically Stimulated Luminescence: Fundamentals and Applications*. John Wiley & Sons