



LUND UNIVERSITY

Comparison of hygrothermal measurements and calculations in a single-family wooden house on the west coast of Sweden

Mundt Petersen, Solof

2013

[Link to publication](#)

Citation for published version (APA):

Mundt Petersen, S. (2013). *Comparison of hygrothermal measurements and calculations in a single-family wooden house on the west coast of Sweden*. (Rapport TVBH; Vol. 3054). Byggnadsfysik LTH, Lunds Tekniska Högskola. <http://www.byfy.lth.se/publikationer/tvbh-3000/>

Total number of authors:

1

General rights

Unless other specific re-use rights are stated the following general rights apply:

Copyright and moral rights for the publications made accessible in the public portal are retained by the authors and/or other copyright owners and it is a condition of accessing publications that users recognise and abide by the legal requirements associated with these rights.

- Users may download and print one copy of any publication from the public portal for the purpose of private study or research.
- You may not further distribute the material or use it for any profit-making activity or commercial gain
- You may freely distribute the URL identifying the publication in the public portal

Read more about Creative commons licenses: <https://creativecommons.org/licenses/>

Take down policy

If you believe that this document breaches copyright please contact us providing details, and we will remove access to the work immediately and investigate your claim.

LUND UNIVERSITY

PO Box 117
221 00 Lund
+46 46-222 00 00

Comparison of hygrothermal measurements and calculations in a single-family wooden house on the west coast of Sweden

S. Olof Mundt-Petersen

Report TVBH-3054 Lund 2013

Building Physics, LTH



LUND
UNIVERSITY

Comparison of hygrothermal measurements and calculations in a single-family wooden house on the west coast of Sweden

S. Olof Mundt-Petersen
Licentiate thesis

Building Physics LTH
Lund University
P.O. Box 118
SE-221 00 Lund
Sweden

ISRN LUTVDG/TVBH--13/3054--SE(198)
ISSN 0349-4950
ISBN 978-91-88722-45-4
©2013 S. Olof Mundt-Petersen

Preface

This report was compiled at the Department of Building Physics, Lund University, Sweden, as part of the “Framtidens trähus” (Wood framed buildings of the future) project and my doctoral studies.

The study was carried out in cooperation with SP Technical Research Institute of Sweden and the Swedish wooden house company Myresjöhus. I would specially like to thank Lars Olsson and Simon Dahlquist at SP and Carl-Johan Sigfridsson at Myresjöhus for their valuable cooperation while carrying out the measurements. I would also like to thank my supervisor Jesper Arfvidsson and co-supervisors Lars-Erik Harderup and Petter Wallentén who have supported me while working on this project and for reviewing the report.

Lund 2012-05-31

S. Olof Mundt-Petersen

Summary

This report presents measurements of relative humidity, temperature and moisture content carried out in a wooden framed house on the west coast of Sweden during the period February 2009 to December 2011. The report also presents blind WUFI 5.0 calculations using the same measurement positions and carried out during the same period under as similar boundary conditions as possible.

Measurements and calculation results of relative humidity in the studied positions are also evaluated and compared to the risk conditions for mould growth by using the Folos 2D visual mould chart.

The measurement results, calculated results and comparisons between the measurements and calculations have been evaluated using Folos 2D visual mould charts which show the deviations between measured and calculated values. These are briefly discussed at the end of the report. The results from measurements, calculations and comparisons between measured and calculated values will be used and further evaluated in future studies and research projects.

Contents

Preface.....	3
Summary	5
1 Introduction.....	9
1.1 Background.....	9
1.2 Aim.....	9
1.3 Limitations	9
1.4 Intended readers	9
2 Method	10
2.1 Blind comparison between measured and calculated values	10
3 Materials.....	10
4 Measuring and calculation periods	11
5 Boundary and initial conditions for calculations	11
5.1 Outdoor climate boundary condition data.....	11
5.2 Indoor climate boundary condition data.....	16
5.3 Air change rate/ Ventilation in air gap behind the cladding	16
5.4 Attic boundary conditions	16
5.4.1 Basic attic information	17
5.4.2 Moisture security guard fan	17
5.4.3 Moisture security guard heating cable.....	17
6 Studied house and positions	18
7 Results	23
7.1 Position 1	23
7.2 Position 2	29
7.3 Position 3	35
7.4 Position 4	41
7.5 Position 5	47
7.6 Position 6	53
7.7 Position 7	59
7.8 Position 8	65
7.9 Position 9	71
7.10 Position 10	77
7.11 Position 11	81
7.12 Position 12	87

7.13 Position 13	93
7.14 Position 14	99
7.15 Position 15	105
7.16 A Position 16A.....	111
7.16 B Position 16B.....	117
7.17 Position 17	123
7.18 Position 18	131
7.19 Position 19	139
7.20 Position 20	147
7.21 Position 21	155
7.22 Position 22	163
7.23 Position 23	171
7.24 Position 24	177
7.25 Position 25	185
8 Discussion and analysis of the results	193
8.1 Walls	193
8.2 Attic.....	193
9 Conclusions.....	194
10 References.....	195

1 Introduction

This report presents measurements of relative humidity (RH), temperature (T) and moisture content (MC) in a number of positions in the studied house. Measurements of relative humidity and temperature are also compared with blind WUFI 5.0 calculations. Measured moisture contents have also been compared with blind WUFI 5.0 calculated values in positions where this was possible. The risk of mould growth has also been evaluated in the studied positions.

This study is part of the Swedish research project “Framtidens trähus” (Wood framed buildings of the future) and was mainly carried out in a cooperation between Lund University, SP Technical Research Institute of Sweden and the Swedish wooden house company Myresjöhus.

The report only includes a brief discussion based on the results. The results of measurements, calculations and comparisons between measured and calculated values will be used and further evaluated in future studies and research projects.

A separate report (Mundt-Petersen, S.O., 2013) has been compiled which includes a broad analysis, discussion and conclusions with regard to the comparisons between measured and blind WUFI 5.0 calculated values. This report also discusses the possibility of using WUFI 5.0 in the Swedish design process for Swedish constructions and Swedish climate conditions (Mundt-Petersen, S.O., 2013).

1.1 Background

The project “Wood framed buildings of the future” started in November 2007. In 2008 and 2009 several wireless sensors were installed in five differently designed wood framed houses during the construction process. The sensors measured temperature, RH and MC in order to make it possible to evaluate the climate conditions and risk of mould growth in different positions in different wood framed constructions (Framtidens trähus, 2012).

1.2 Aim

The aim of this report is to present the measurement results for temperature, RH and MC in the studied positions in the studied house. The report also aims to present comparisons between measurements and blind calculations of temperature and RH, and MC where possible, carried out using the transient heat and moisture calculation tool WUFI 5.0 (Mundt-Petersen, S.O., 2013). Furthermore, the report aims to evaluate the risk of mould growth in the studied positions.

1.3 Limitations

There are a number of limitations and sources of error with regard to the measurements, comparisons of measured and calculated values and evaluations of the mould growth risk. These limitations are described in a separate report (Mundt-Petersen, S.O., 2013).

1.4 Intended readers

This report has been written for the Swedish wooden house companies that participated in the “Wood framed buildings of the future” project and whose wooden framed constructions were studied.

2 Method

The comparisons between measured and calculated values were blind comparisons, i.e. they were verified without knowing the measurement results before the comparisons with the unadjusted calculated results were made. More detailed descriptions of the measurement method, the construction of the calculation model and the method of comparison between the measured and calculated values are provided in a separate report (Mundt-Petersen, S.O., 2013).

Measurements of temperature, RH and MC are presented in Folos 2D visual mould charts and additional charts together with comparisons with the blind WUFI 5.0 calculations and evaluations of the risk of mould growth. The Folos 2D visual mould chart is described in more detail in a separate report (Mundt-Petersen, S.O., 2012). Additional charts also show measured moisture content and, if it was possible, calculated moisture content. Vapour contents were calculated from measured and calculated values and compared. If there was a lack of measured values, the vapour content is shown as zero. There are also additional charts showing the magnitude of deviation between measured and calculated temperature and relative humidity.

Results from positions where the measuring sensor initially failed are not presented and consequently there are gaps in the numbering sequence of the measurement positions.

2.1 Blind comparison between measured and calculated values

Initially, measuring sensors for temperature, relative humidity and moisture content were mounted at different depths and locations in the walls during the construction phase. The construction phase was monitored to establish any possible deviations between the drawings and the real conditions in the built walls. Hourly measurements of temperature, relative humidity and moisture content for each specific position were then separately stored by a measurement collector, inaccessible to the persons involved in evaluating the calculation tool.

When the measurements were carried out, calculation models of each studied position were made. The calculation models were based on drawings and photos from the construction phase with the intention of reflecting as real conditions as possible. In 2012, blind calculations were carried out for each studied position without knowing the measured results. After the blind calculations had been completed and sent to the measurement collector, the previously inaccessible measurements were retrieved and compared to the calculated values.

Note that it was possible to make adjustments to the calculation models to achieve better correlation between the measured and calculated values in almost all the studied positions. However, this was not done since this was a blind verification.

3 Materials

The presented measurements, comparisons of measurements and calculations and evaluations of the risk of mould growth were carried out in a single-family house in Falkenberg on the west coast of Sweden built by the Swedish wooden house company Myresjöhus. The building was a one-floor single-family house with a living area of 144.4 m². The house was built on a concrete ground slab with wooden walls and a wooden roof frame. An underfloor heating system was installed in the concrete slab. The house was built in February 2009 when some of the measurements in the construction also started.

4 Measuring and calculation periods

Most of the measurements started on 3 February 2009. Due to the calculation structures in WUFI 5.0 when needed external transient files including heat and ventilation sources are used, the calculations have to start on 1 January 2009. Since comparisons were not possible during January 2009, the calculated results are given from 3 February 2009. The initial calculation period stabilizes the calculation and deals with possible influences of incorrect initial conditions. Indoor climate measurements started in March 2009.

Measuring sensors were mounted in cooperation with Lars Olsson at SP that have mounted in- and outdoor climate sensors and three sensors in the attic. Measuring data was collected by SP Trä Skellefteå. During some periods there were problems regarding local transmission of measuring data from the measuring sensors to the local measurement data collector (Sandberg, K., 2011). Some measuring positions therefore lack long periods of measured data.

5 Boundary and initial conditions for calculations

The climate boundary conditions and initial conditions aim to reflect as real conditions as possible during the measuring period. Specific parameters and initial set values are presented in a separate report (Mundt-Petersen, S.O., 2013). The materials used are also listed separately (Mundt-Petersen, S.O., 2013). However, the materials used are briefly presented in connection with the WUFI 5.0 model for each separate position.

The in- and outdoor climate boundary conditions used are presented below. This is done together with a comparison and check against other available climate data in the area. The methods for finding additional climate data during periods when this is lacking, in order to provide complete in- and outdoor climate boundary conditions, are described in a separate report (Mundt-Petersen, S.O., 2013). Comparisons and checks regarding other available climate are also described in the same report (Mundt-Petersen, S.O., 2013).

5.1 Outdoor climate boundary condition data

The boundary conditions data used for each parameter are presented below. The charts also include a comparison with other available climate data. The amount of supplemented data, which were the same amount of lack of data, is given in percent for each year for each climate parameter.

Outdoor short-wave radiation absorption, dependent on color, is assumed to be 0.2 (white) on walls and 0.7 on roofs (light grey).

Note that hourly climate data was used in the calculations and three-hourly data was used in order to check the hourly data. In some cases the three-hourly data was also used to supplement periods of lacking data, as described in a separate report (Mundt-Petersen, S.O., 2013). The lack of climate stations meant that hourly data and three-hourly data had to be captured from two different climate stations. Micro climate data available from own mounted sensors was only used in order to check possible deviations and defects in the hourly data.

The hourly outdoor climate used was captured from the climate station in Torup, which is located 37 km east of Falkenberg. Three-hourly data was used to check, and in some cases supplement, the hourly climate. Three-hourly data was captured from Efra-Broen, which is located 13 km southeast

of Falkenberg. There is a lack of air pressure and rain readings for the three-hourly data and no comparisons with hourly data were therefore made for those two parameters. Hourly global radiation data was captured from Gothenburg, which is located 108 km north of Falkenberg. Note that there is a great lack of radiation data while data from previous year have been repeated. Diffuse radiation readings were created from a model based on global radiation (Mundt-Petersen, S.O., 2013).

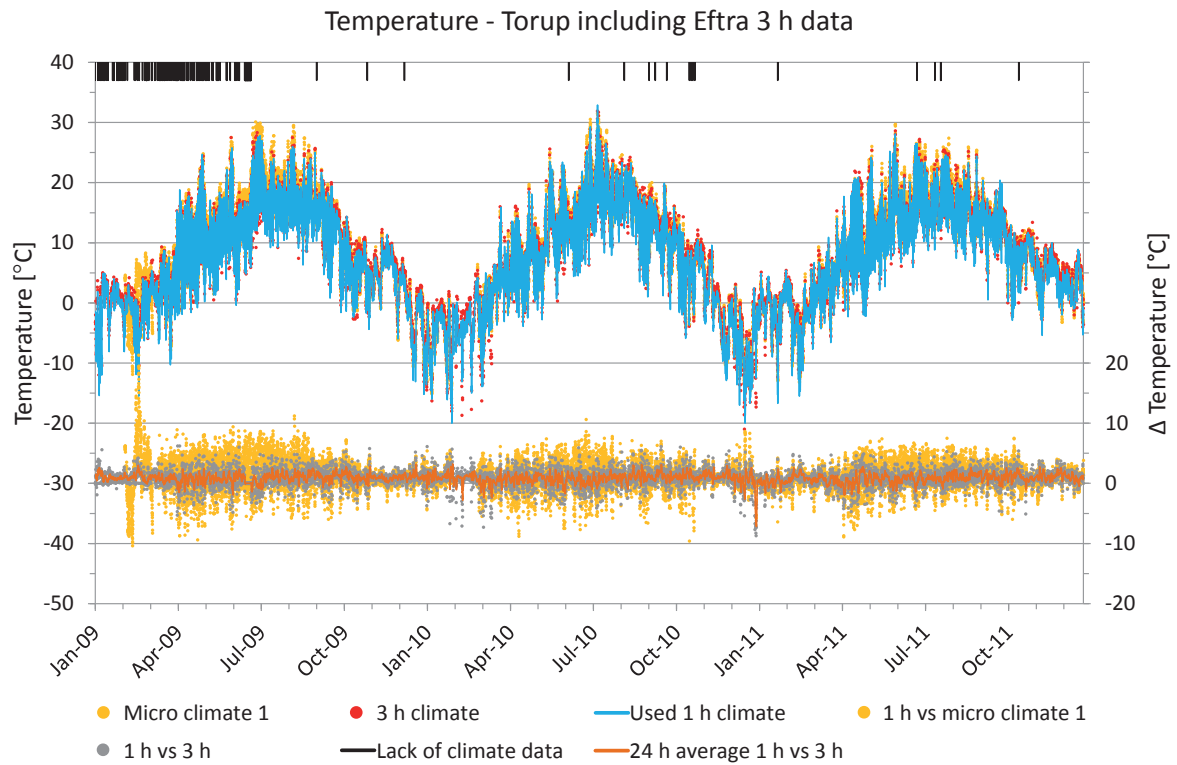

Figure 5.1.1. Used temperature data compared with other available climate data. Lack of data, in percent, that was supplemented: 2009 – 2.83 %, 2010 – 0.13 %, 2011 – 0.09 %.

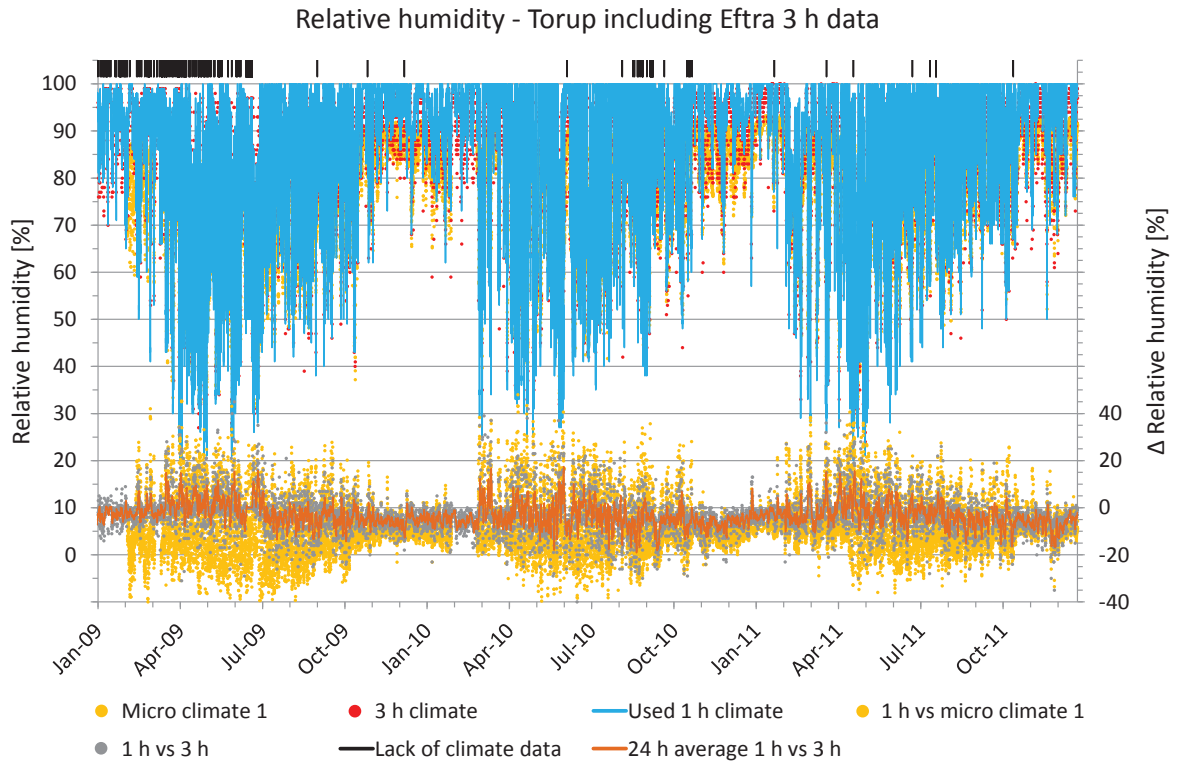

Figure 5.1.2. Used RH data compared with other available climate data. Lack of data, in percent, that was supplemented: 2009 – 2.88 %, 2010 – 0.63 %, 2011 – 0.11 %.

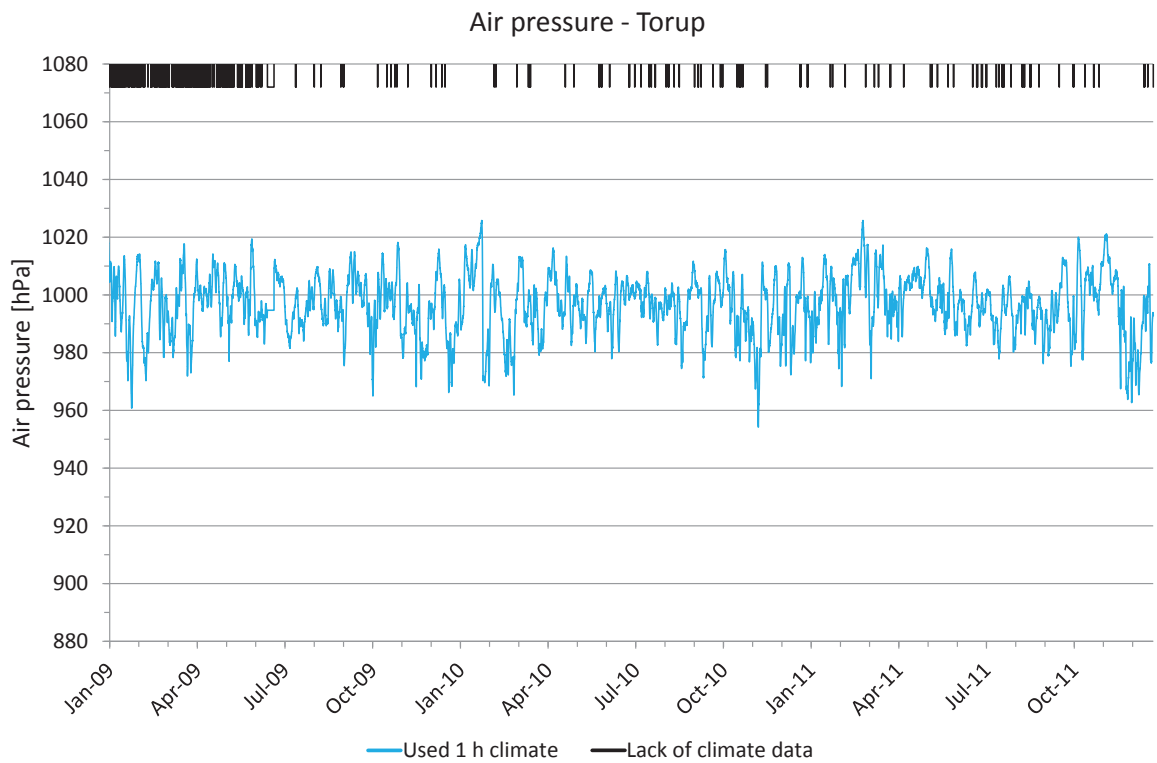

Figure 5.1.3. Used air pressure data at weather station height above sea level. Lack of data, in percent, that was supplemented: 2009 – 4.66 %, 2010 – 0.58 %, 2011 – 0.67 %.

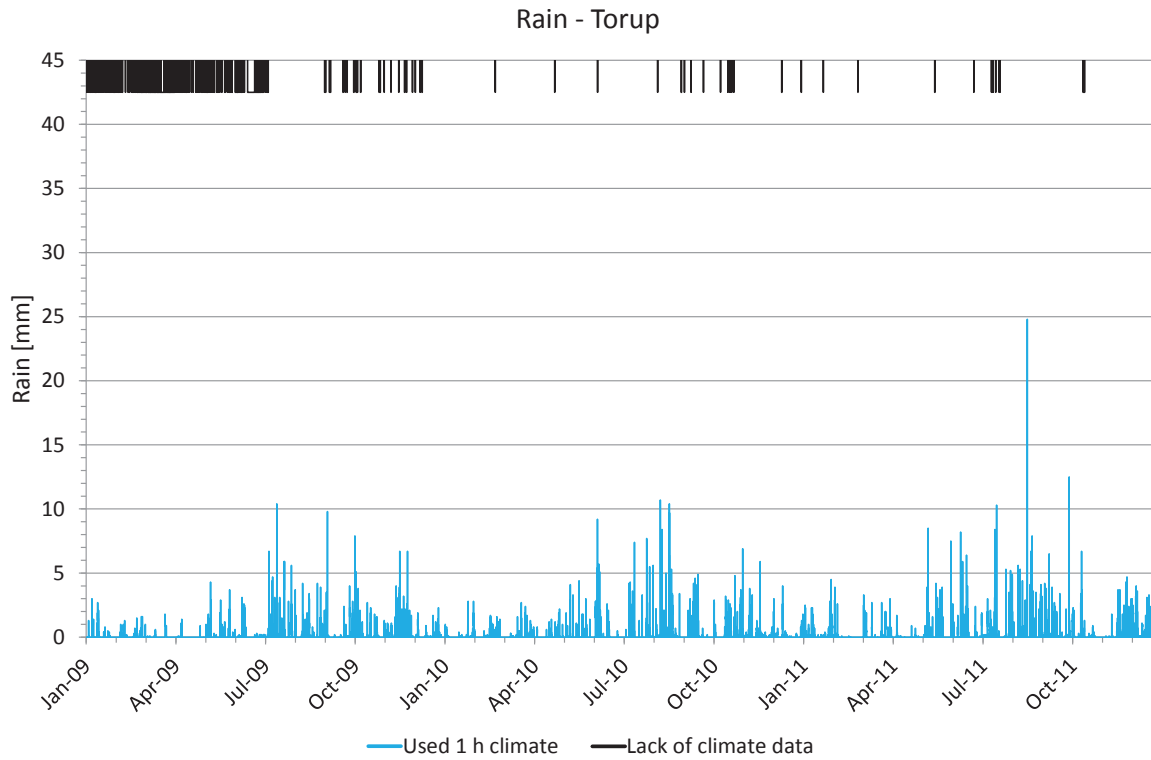

Figure 5.1.4. Used rainfall data. Lack of data, in percent, that was supplemented: 2009 – 17.58 %, 2010 – 0.53 %, 2011 – 0.61 %.

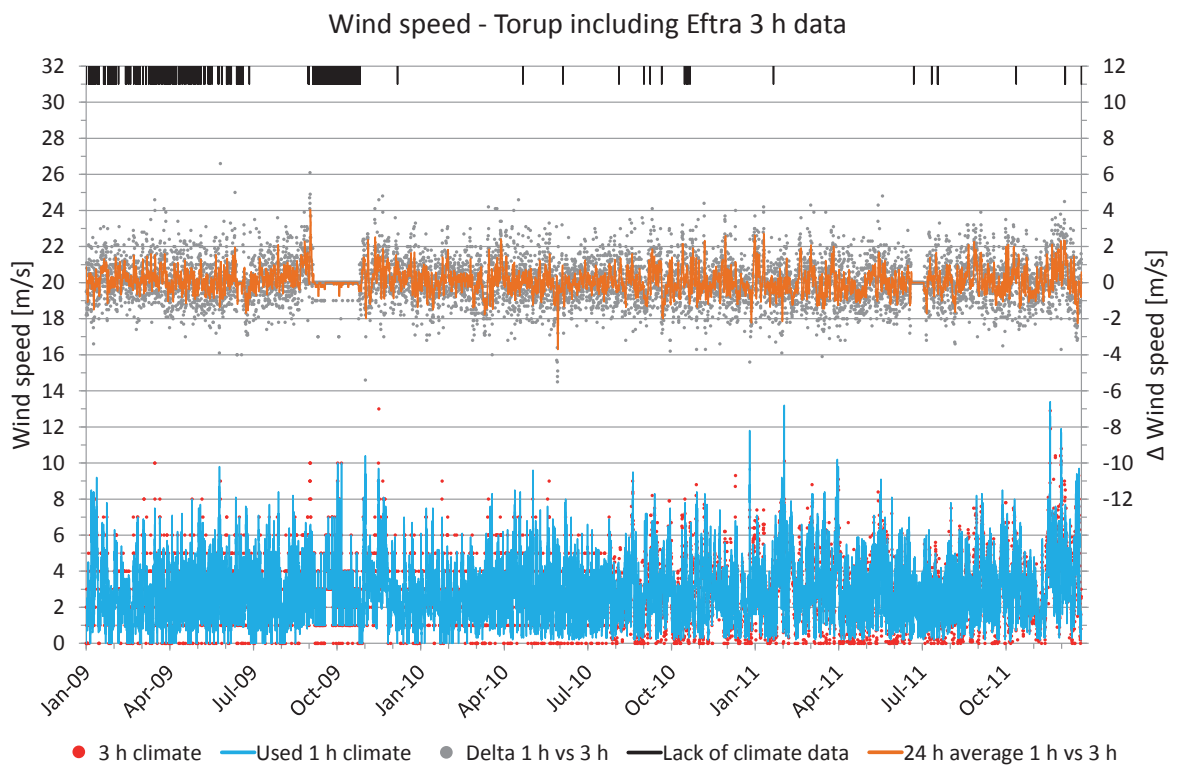

Figure 5.1.5. Used wind speed data compared with other available climate data. Lack of data, in percent, that was supplemented: 2009 – 12.85 %, 2010 – 0.14 %, 2011 – 0.13 %.

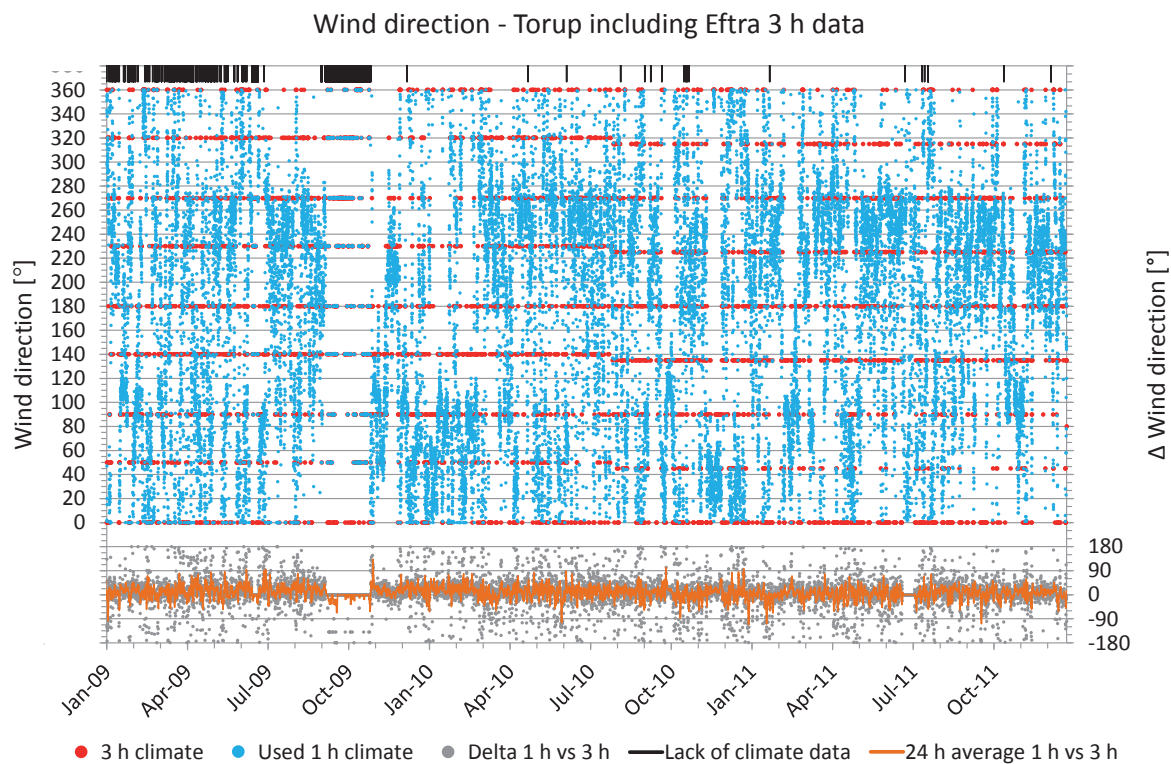

Figure 5.1.6. Used wind direction data compared with other available climate data. Lack of data, in percent, that was supplemented: 2009 – 12.85 %, 2010 – 0.14 %, 2011 – 0.14 %.

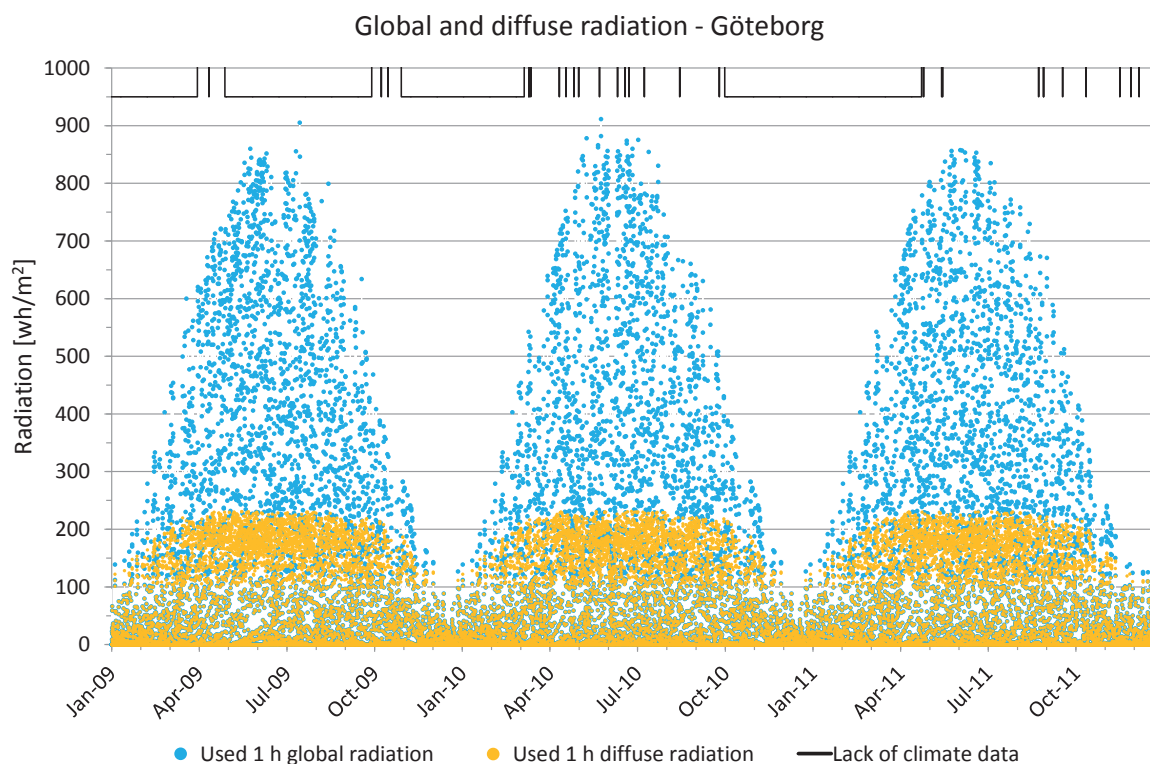

Figure 5.1.7. Used global and diffuse radiation data. Lack of global radiation data, in percent, that was supplemented: 2009 – 83.64 %, 2010 – 42.51 %, 2011 – 33.00 %. Diffuse radiation data was created from global radiation data (Mundt-Petersen, S.O., 2013).

5.2 Indoor climate boundary condition data

The boundary conditions data used is presented below. Periods with lack of data have been supplemented as described in a separate report (Mundt-Petersen, S.O., 2013).

Calculations in outdoor bathroom walls have assumed 99 % RH for the boundary conditions on the inside (Jansson, A., 2006).

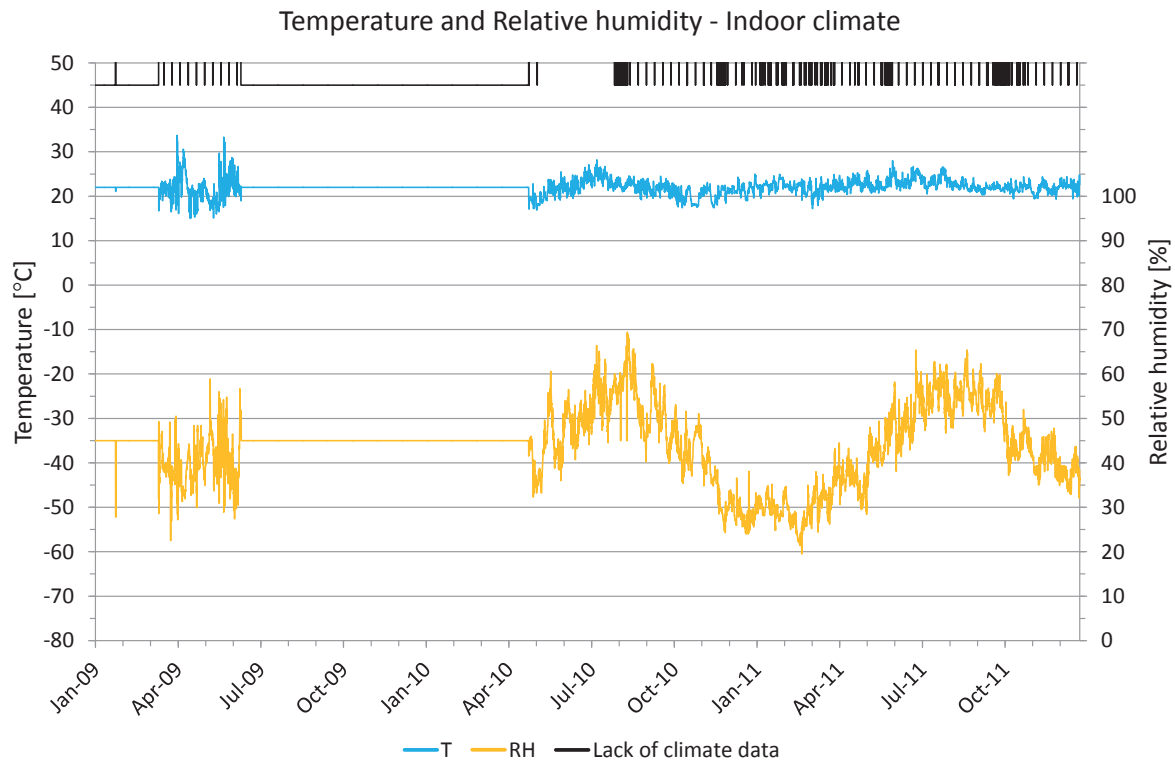

Figure 5.2.1. Used indoor temperature and relative humidity data. Lack of data, in percent, that was supplemented: 2009 – 75.01 %, 2010 – 33.26 %, 2011 – 1.43 %.

5.3 Air change rate/ Ventilation in air gap behind the cladding

Previous studies show that the air flow in the air gap varies depending on several of factors (Falk 2013). However, if the air change rate (ACH) in the air gap is high enough to handle all potential moisture in the gap, the influence of a higher ACH in the air gap is negligible (Hägerstedt 2010A, Hägerstedt 2011). Previous studies show that an air flow of 30 ACH in the air gap is reasonable in the case of ventilated air gaps behind the cladding. An air flow of 30 ACH has therefore been used in the walls studied in this report (Hägerstedt 2010A, Hägerstedt 2010B).

5.4 Attic boundary conditions

In the attic a separate moisture protection tool called "Trygghetsvakten" (Moisture security guard) was installed. The basic function of the moisture security guard was known but not the underlying algorithms that control the unit. The moisture security guard comprises a fan and a heating cable (Trygghetsvakten, 2012).

Furthermore, the WUFI 5.0 calculation model is a simplification as the height cold air space above the insulation varies and is larger than the available air layers in the WUFI 5.0 material data base. The air

space in the attic and the moisture security guard were therefore specially modeled, as described below.

5.4.1 Basic attic information

Total indoor living area is 144.4 m². The roof angle of 27 degrees in combination with the roof insulation layer makes the attic area smaller than the indoor living area. By studying the house and construction drawings it can be estimated that the attic area is approximately 10 % smaller than the indoor living area. This gives an attic area of approximately 130 m².

5.4.2 Moisture security guard fan

The output of the fan is 400 m³/h. The moisture security guard measures the vapour content in the attic and in the outdoor climate. If the outdoor vapour content is lower than the vapour content in the attic, the fan is switched on (Trygghetsvakten, 2012). Since it is not possible to handle functions like these in the WUFI 5.0 calculation, the outdoor air ventilation rate was set at a constant level in the attic air gap (WUFI, 2012). This means that both the ventilation created by the fan when it is running and the non-controlled air leakage between roof boards and other joints are taken into account. Even if the roof air gap is supposed to be closed, it has been assumed to be open because of respect to air leakage (Walker, I.S., 1995).

The height of the attic varies from 0 m close to the outer walls to approximately 2 m in the center of the attic. This means an average height of 1 m. The total ventilated volume is therefore approximately 130 m³. If the fan provides an air flow of 400 m³/h and the ventilated volume is 130 m³, this means that there is an air change rate of 3 ACH. An air change rate of 3 ACH also seems relevant with respect to other studies (Walker, I.S., 1995).

In the WUFI 5.0 calculation model the depth of the ventilated layer is usually set at 0.130 m in roof calculations. An attic area of 130 m² with a depth of 0.130 m gives a ventilated volume of 16.9 m³. This means that the actual air volume that could transport moisture corresponds to 23.6 ACH in a 0.130 m thick air layer. A constant air change rate of 20 ACH has therefore been used during the WUFI 5.0 calculation period.

5.4.3 Moisture security guard heating cable

The moisture security guard also includes a heating cable rated at 500 W. The cable is mounted in the attic. The heating cable is only switched on when the relative humidity has reached, or is close to reaching a critical level and the fan cannot provide ventilation with a sufficiently low moisture level (Trygghetsvakten, 2012).

In order to establish the periods during which the moisture security guard fan cannot provide ventilation with a sufficiently low moisture level with regard to the attic climate, a WUFI 5.0 calculation without any heating source was carried out. An initial calculation showed that critical limits occurred during the period September to March.

The attic area was approximately 130 m², as mentioned above. The heating cable was rated at 500 W. This provided approximately 4 W/m² and this was also used as a special heat source during the period September to March in the WUFI 5.0 calculations. The heat source was installed in a separate 0.130 m air layer, with additional moisture capacity, above the 0.130 m air layer with 20 ACH. The air change rates in smaller in non-draughty spaces in the attic were also estimated to be 20 ACH since the volume is smaller, which lead to a higher air change rate.

6 Studied house and positions

The locations of the studied positions are shown in the figures on the following pages. In connection with each studied position a more detailed specification and drawing of the position is also given. In some cases photos, showing the sensor, are provided in the results chapter in connection with the part in which each studied position is presented in detail.

The locations of the studied positions were mainly chosen for two reasons. One was to study the positions where previous knowledge and experience had shown a high frequency of damage. The second was to have a couple of positions in a row at different depths in the wall in order to obtain purer measurements and more reliable conditions in order to verify the WUFI 5.0 calculation tool.

The choice of the studied house and its location was governed by the potential for new-build houses from the housing company participating in the study.

stíðinnur íngar el í Myresjúhusa AB álagande

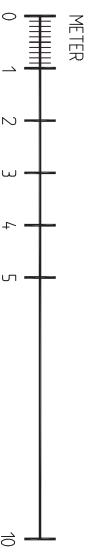
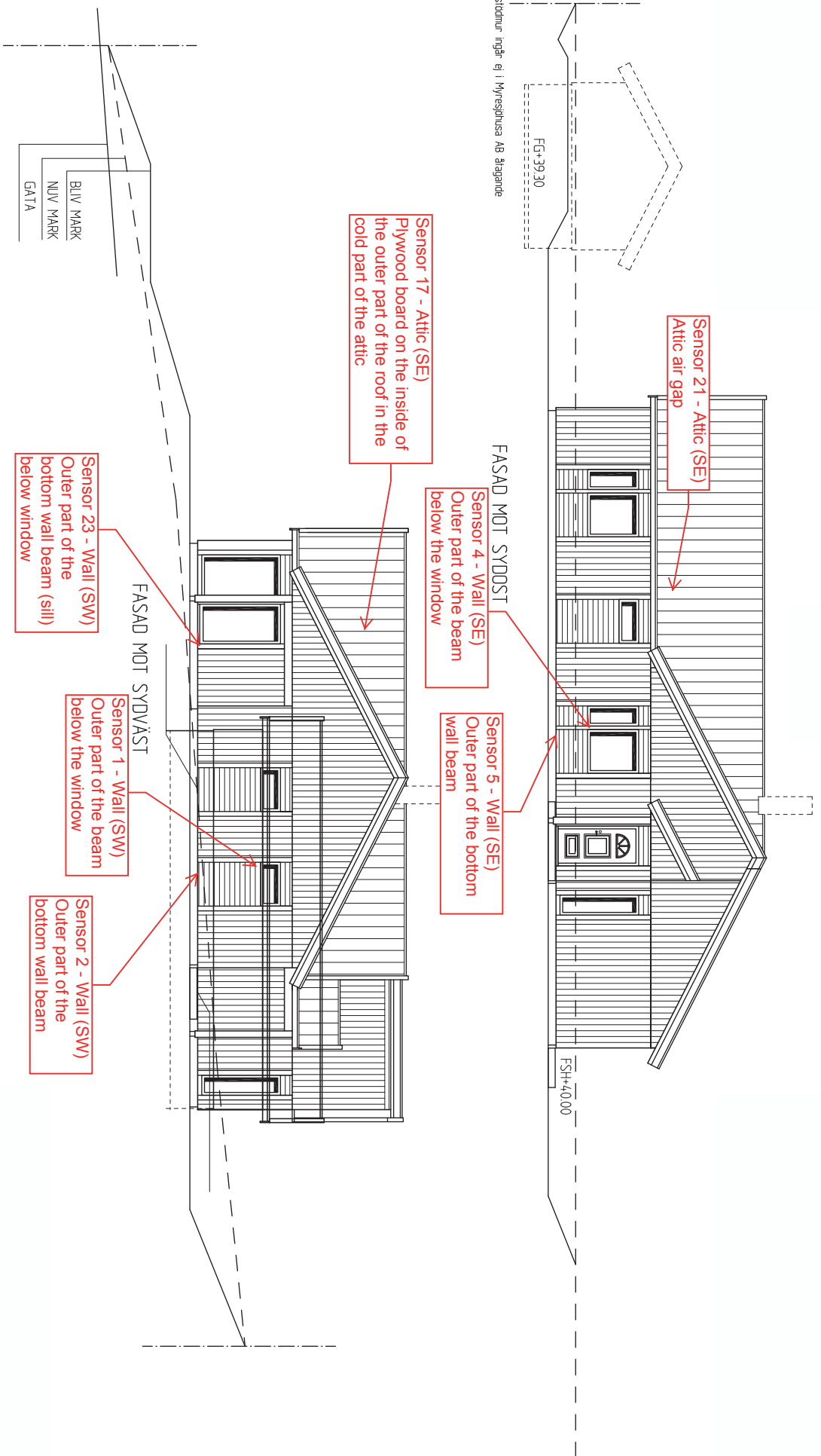

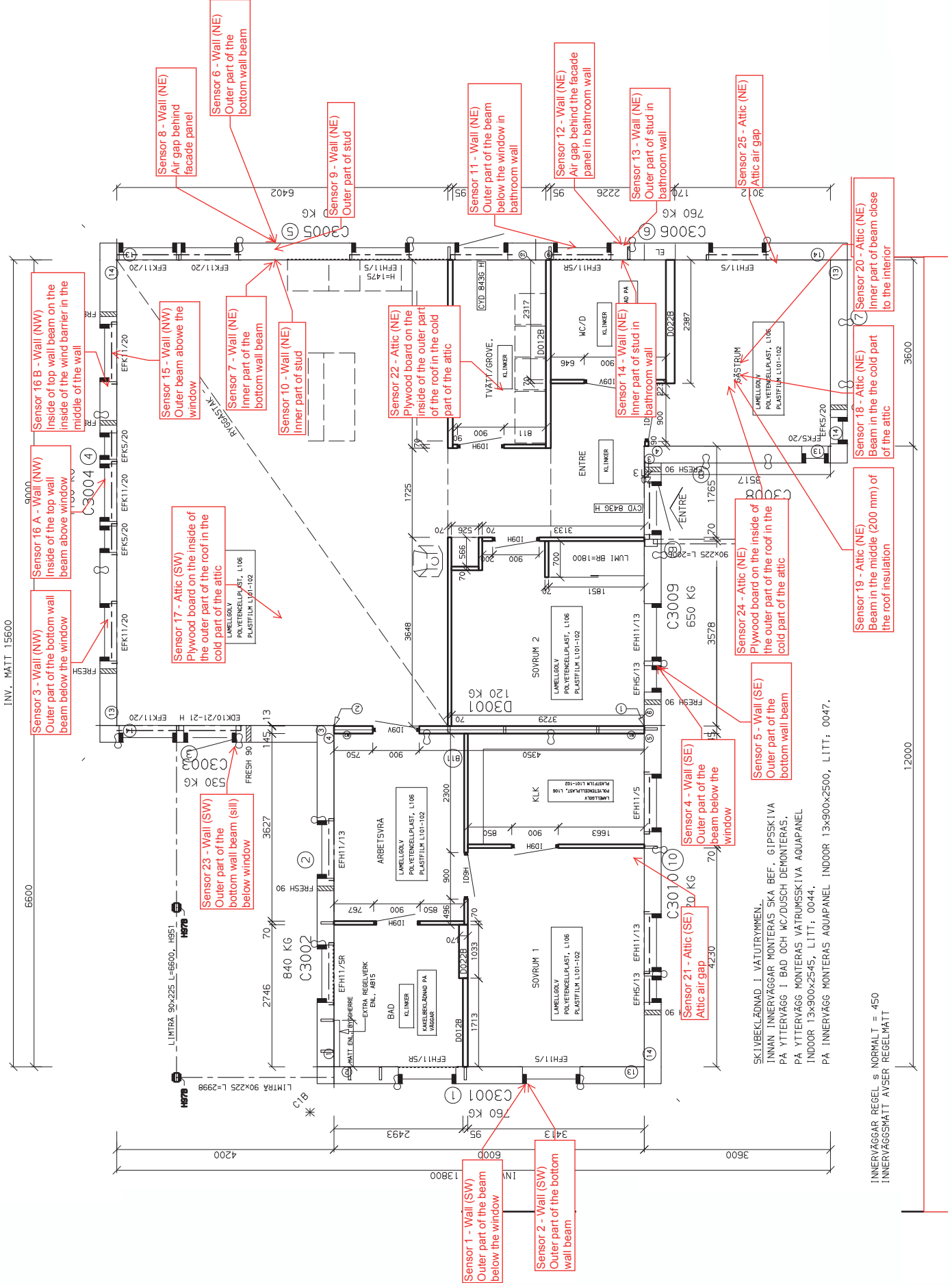

INV. MÅTT 15600

SKIVBEKLÄDNAD I VÄTTRYMMEN.
 INNAN INNERVÄGGAR MONTERAS SKA BEF. 6 I PPSKIVA
 PÅ YTTERVÄGG I BAD OCH MC/DUSCH DEMONTERAS.
 PÅ YTTERVÄGG MONTERAS VÄTRUMSSKIVA AQUAPANEL
 INDOOR 13x900x2545, LITTI: 0044.
 PÅ INNERVÄGG MONTERAS AQUAPANEL INDOOR 13x900x2500, LITTI: 0047.

INNERVÄGGAR REGLER s. NORMALT. = 450
 INNERVÄGGSMÅTT AVSER REGELMÅTT

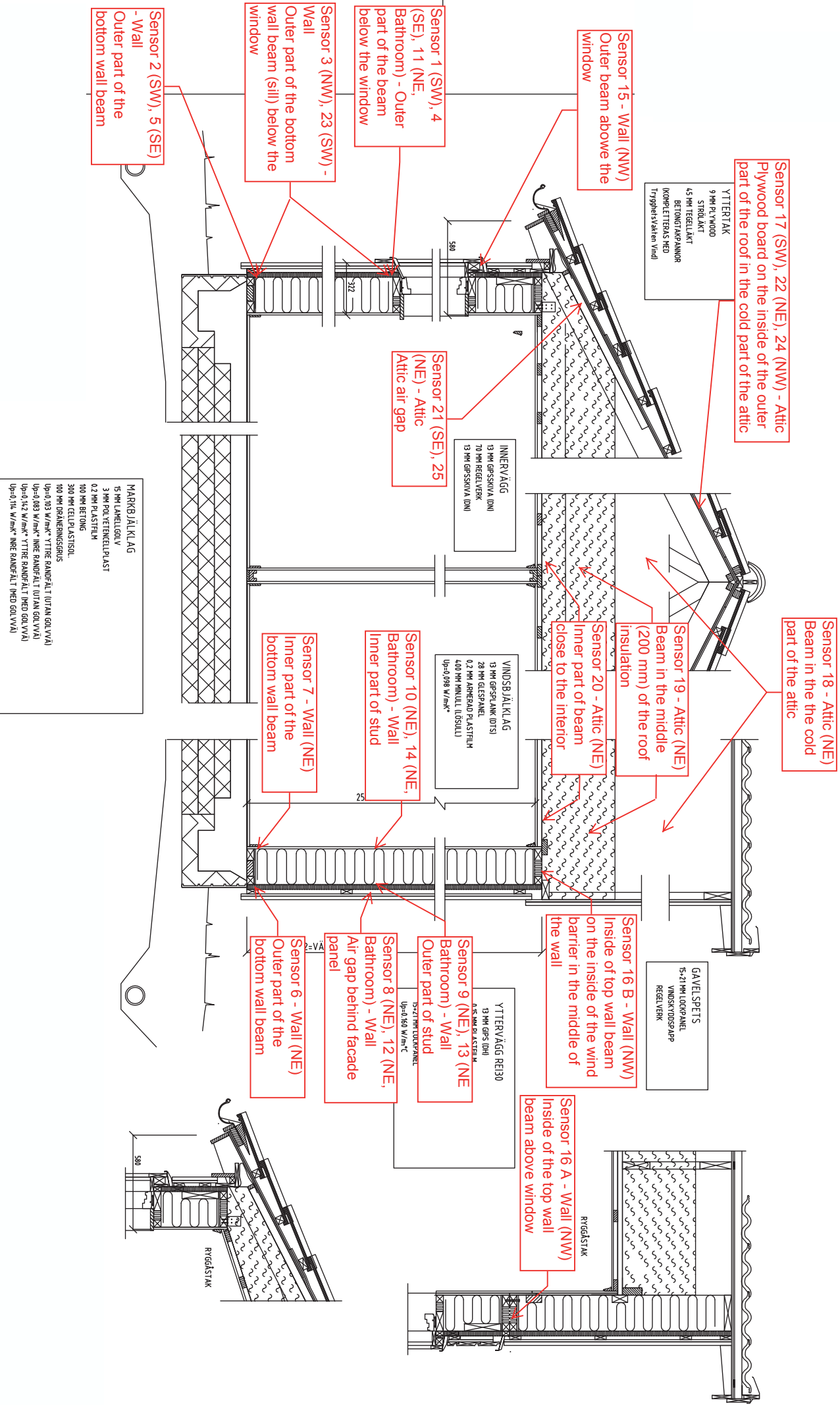

Sensor 17 (SW), 22 (NE), 24 (NW) - Attic Plywood board on the inside of the outer part of the roof in the cold part of the attic

YTTERTAK
9 MM PLYWOOD
STROLAKT
45 MM TEGELLAKT
BETONGTÄGGPÄNNOR
KOPPLETTAS MED
TrygghetsÅstaken Vindl

Sensor 18 - Attic (NE)
Beam in the the cold part of the attic

Sensor 19 - Attic (NE)
Beam in the middle (200 mm) of the roof insulation

Sensor 20 - Attic (NE)
Inner part of beam close to the interior

INNERVÄGG
13 MM GIPS SVÄVA (DN)
70 MM REGLVERK
13 MM GIPS SVÄVA (DN)

Sensor 21 (SE), 25 (NE) - Attic
Attic air gap

VINDSBJÄLKLAG
13 MM GIPSPLÅN (DTS)
28 MM GLESPÅNEL
0,2 MM ÅRBERÄD PLÅSTFILM
4,00 MM MINLULL (LÖSULL)
Up=0,098 W/m²K

Sensor 7 - Wall (NE)
Inner part of the bottom wall beam

Sensor 10 (NE), 14 (NE),
Bathroom) - Wall
Inner part of stud

Sensor 16 B - Wall (NW)
Inside of top wall beam on the inside of the wind barrier in the middle of the wall

GÄVELSPETS
5x21 MM LÖCKPÅNEL
VINDSTOPSAPP
REGLVERK

Sensor 16 A - Wall (NW)
Inside of the top wall beam above window

YTTERVÄGG REI30
13 MM GIPS (DN)
ÅRBERÄD SVÄVA
15x21 MM LÖCKPÅNEL
Up=0,160 W/m²K

Sensor 9 (NE), 13 (NE)
Bathroom) - Wall
Outer part of stud

Sensor 8 (NE), 12 (NE,
Bathroom) - Wall
Air gap behind facade panel

Sensor 6 - Wall (NE)
Outer part of the bottom wall beam

Sensor 2 (SW), 5 (SE)
- Wall
Outer part of the bottom wall beam

Sensor 3 (NW), 23 (SW) -
Wall
Outer part of the bottom wall beam (sill) below the window

Sensor 1 (SW), 4 (SE), 11 (NE,
Bathroom) - Outer part of the beam below the window

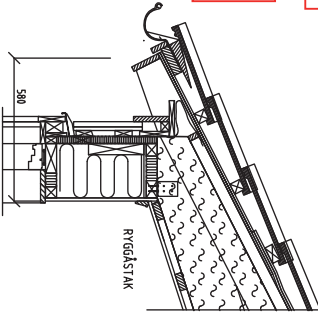

MARKBJÄLKLAG
15 MM LÄMELLGÅLV
3 MM POLYETYLENPLÅST
0,2 MM PLÅSTFILM
100 MM BETONG
300 MM GELPÅSTISOL
100 MM DRÄNERINGSGRUS
Up=0,103 W/m²K
YTTRE RÄNNEFÄLT UTÅN GÖLVÄY
Up=0,142 W/m²K
YTTERE RÄNNEFÄLT MED GÖLVÄY
Up=0,114 W/m²K
INNE RÄNNEFÄLT MED GÖLVÄY

7 Results

7.1 Position 1

The locations of the measured and calculated position are shown in the drawings and figures below. The studied position is located in a wall facing southwest.

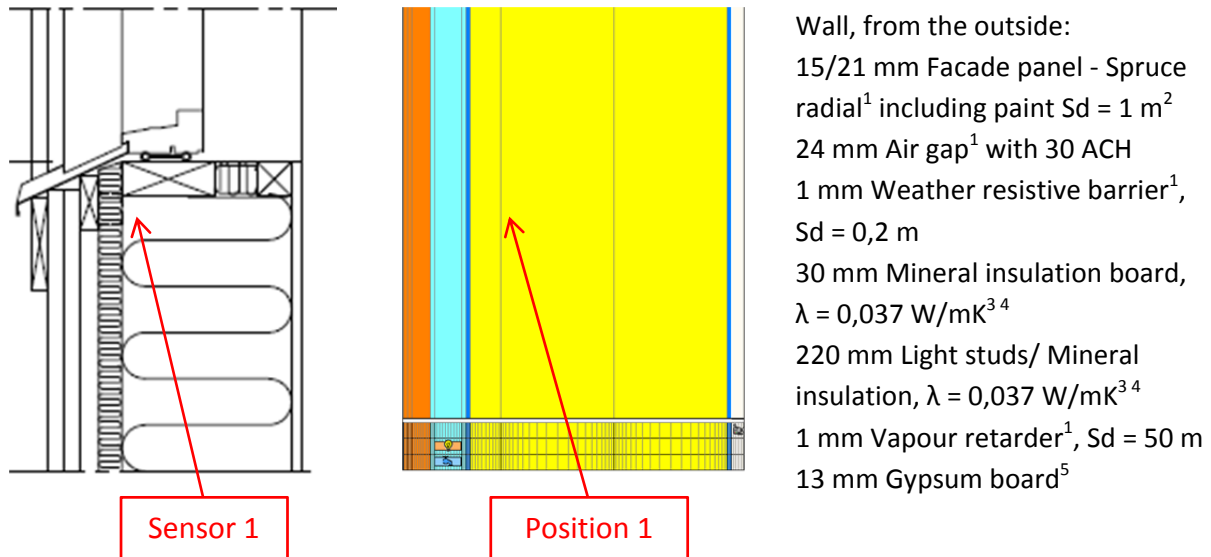

Figure 7.1.1. Vertical cross sectional drawing and WUFI calculation model showing the studied position. 1. IBP, 2012, 2. Nevander, L-E., 1994, 3. IEA Annex 24, 1996, 4. Paroc, 2002, 5. Krus, M., 1996.

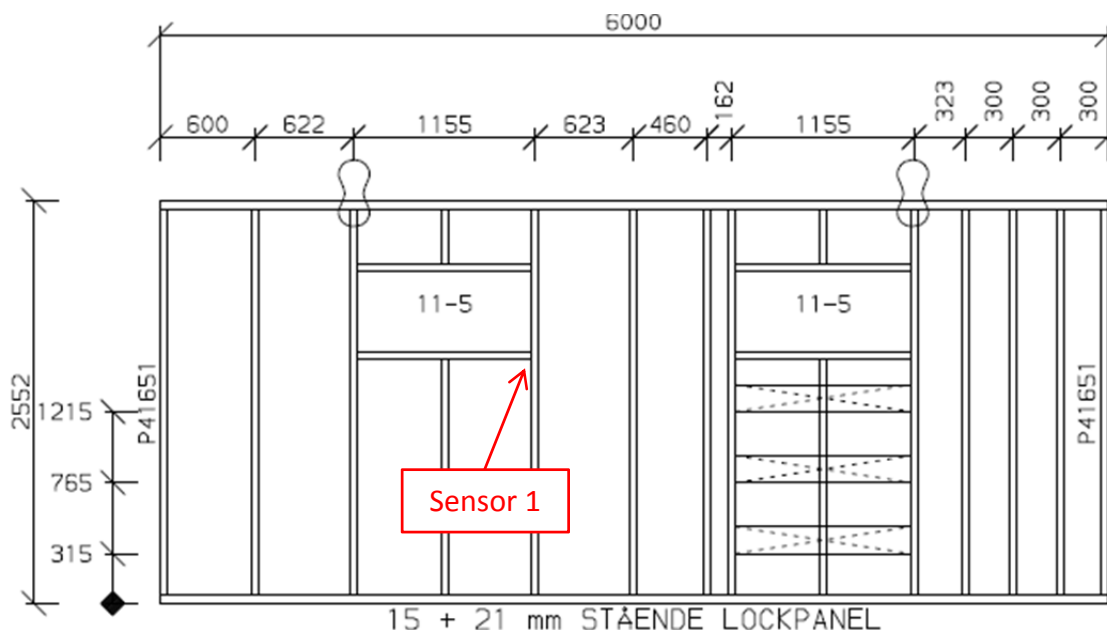

Figure 7.1.2. Location of the studied position.

A perfect match between the measured and calculated values cannot be expected due to e.g. the influence of two- and three-dimensional effects and the accuracy of the sensors.

Year 2009

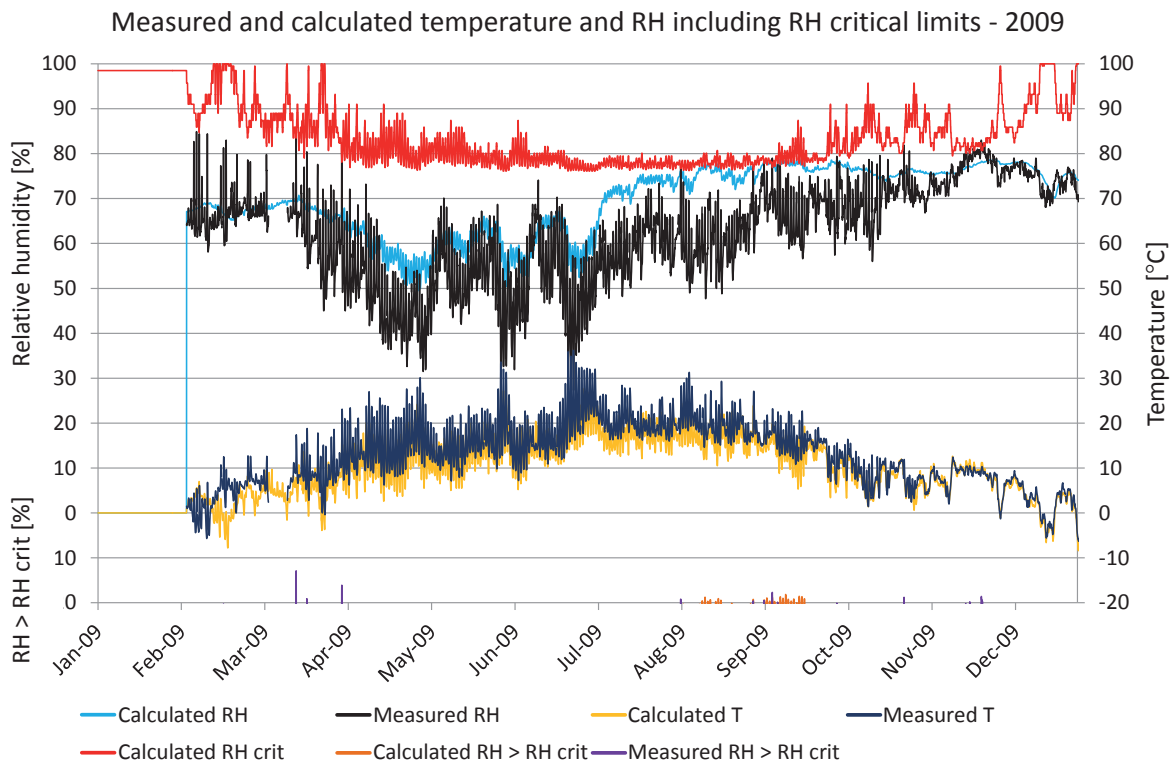

Figure 7.1.3. Comparisons between measured and calculated temperature and relative humidity. Calculated temperature (yellow), measured temperature (dark blue), calculated RH (turquoise), measured RH (black), RH_{crit} for calculated values (red), calculated $RH > RH_{crit}$ (light brown), measured $RH > RH_{crit}$ (purple).

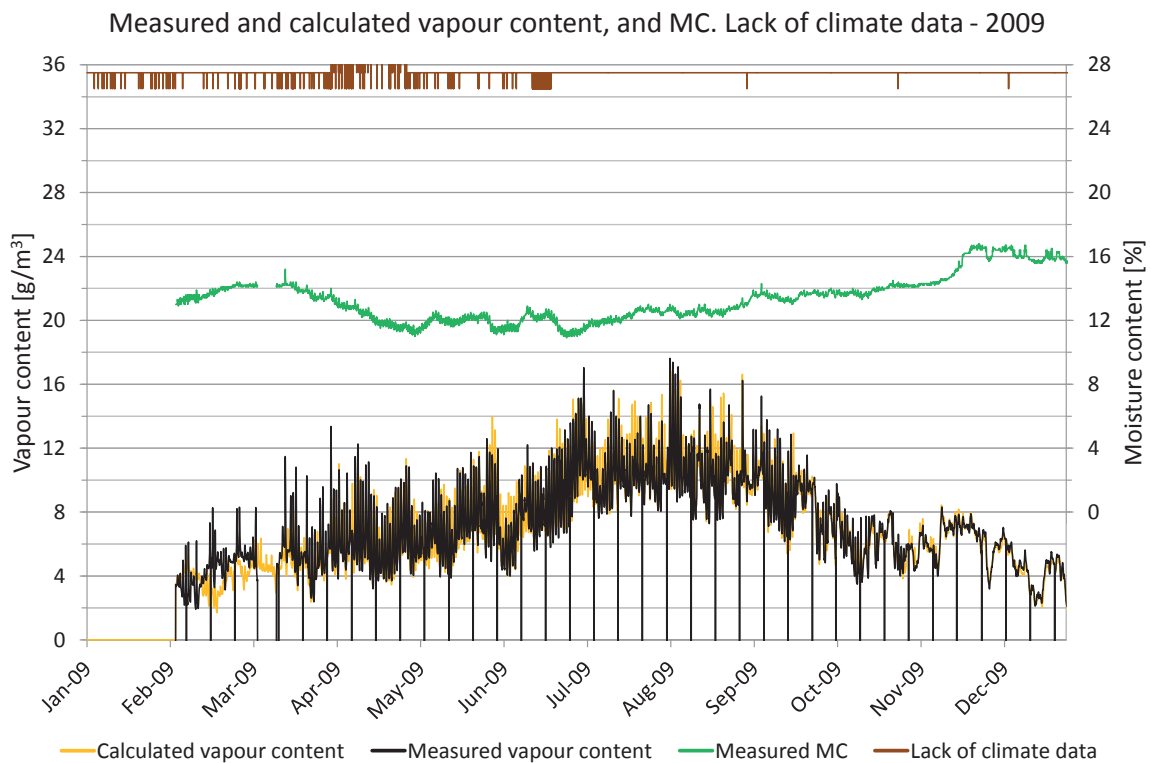

Figure 7.1.4. Measured moisture content, periods lacking climate data and comparisons of vapour content. Vapour content for calculated values (yellow) and measured values (black). Moisture content (green), periods with lack of climate data (brown).

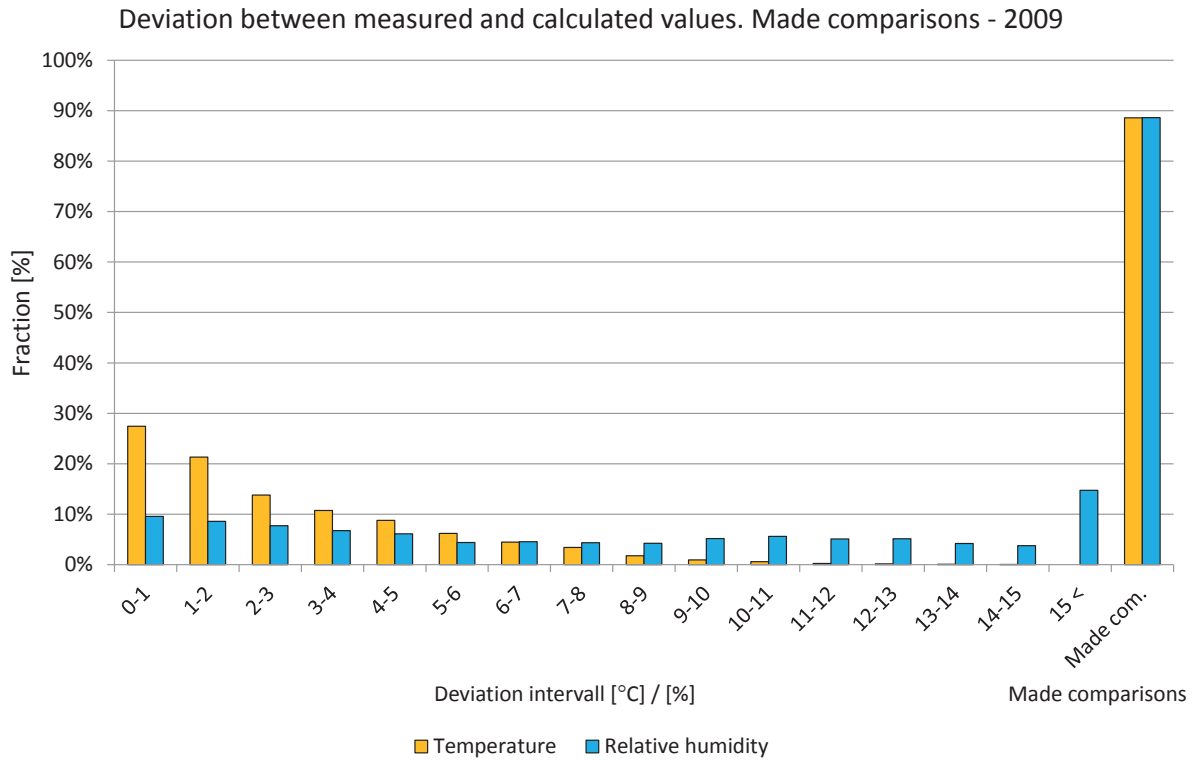

Figure 7.1.5. Deviations in comparisons shown in intervals from 0 to 15 °C or %. The two right-hand bars show the percentage of comparisons during the year. Temperature (yellow) and relative humidity (light blue).

Year 2010

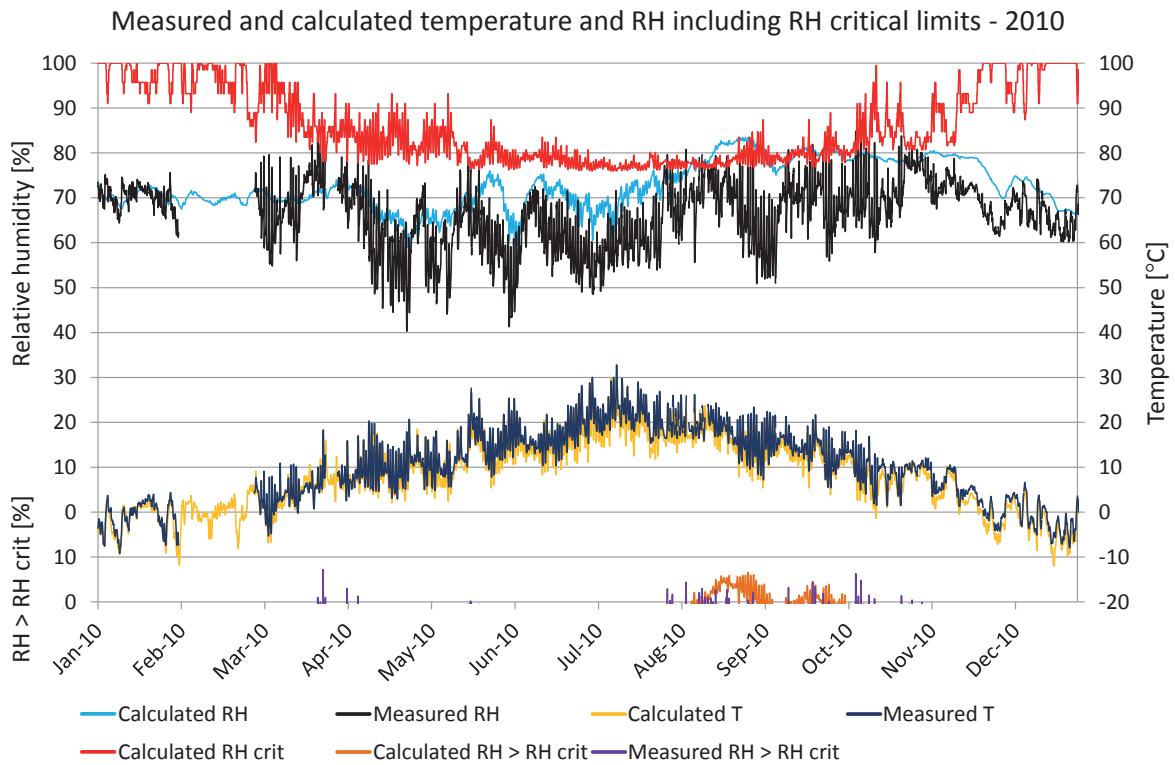

Figure 7.1.6. Comparisons between measured and calculated temperature and relative humidity. Calculated temperature (yellow), measured temperature (dark blue), calculated RH (turquoise), measured RH (black), RH_{crit} for calculated values (red), calculated RH > RH_{crit} (light brown), measured RH > RH_{crit} (purple).

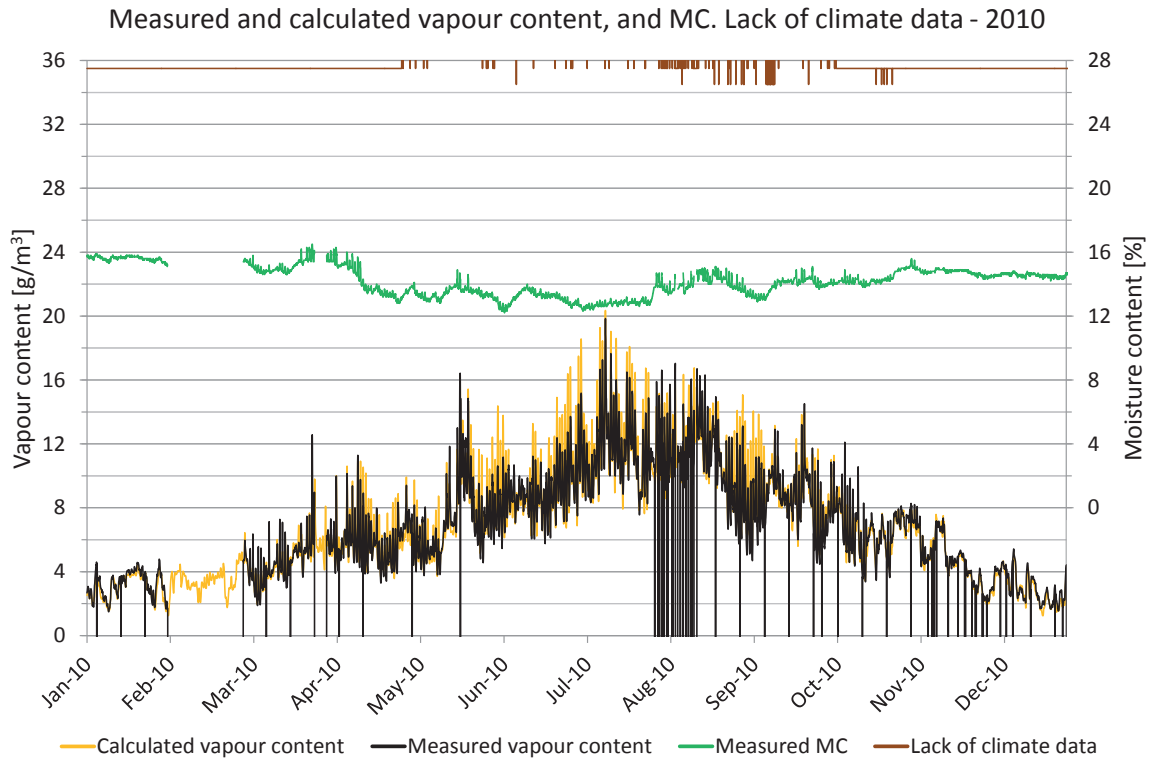

Figure 7.1.7. Measured moisture content, periods lacking climate data and comparisons of vapour content. Vapour content for calculated values (yellow) and measured values (black). Moisture content (green), periods with lack of climate data (brown).

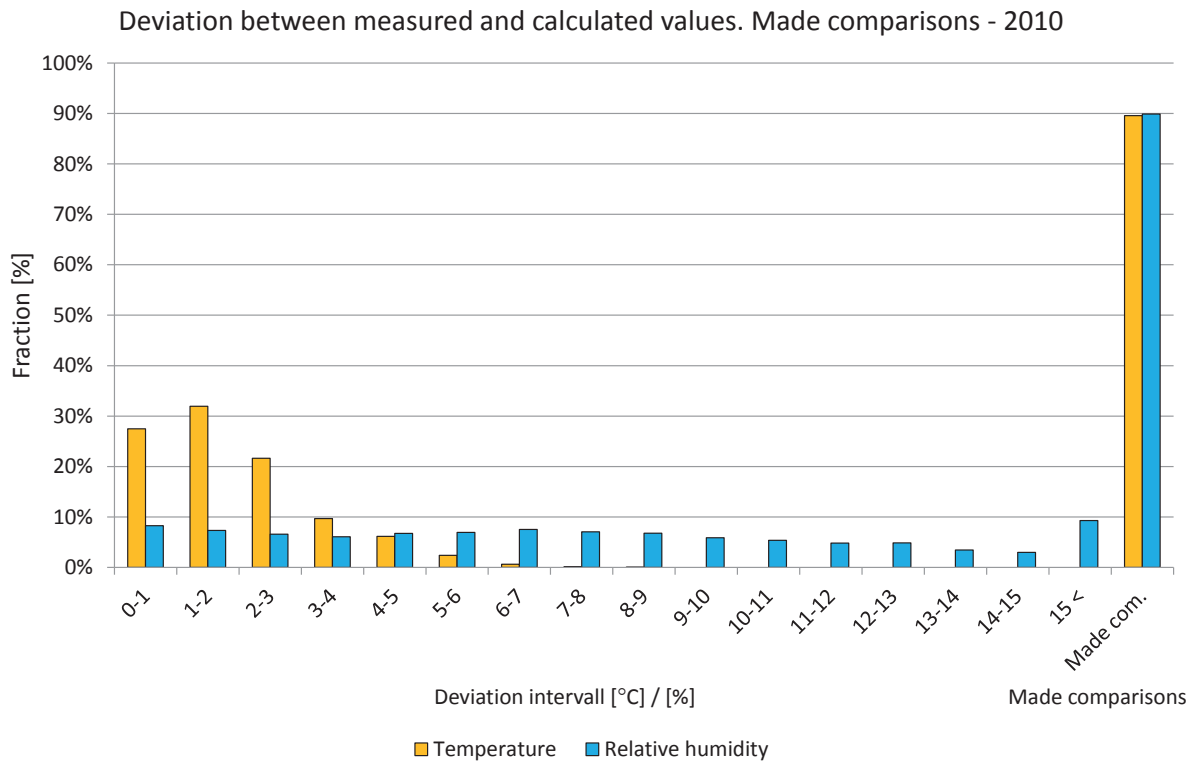

Figure 7.1.8. Deviations in comparisons shown in intervals from 0 to 15 °C or %. The two right-hand bars show the percentage of comparisons during the year. Temperature (yellow) and relative humidity (light blue).

Year 2011

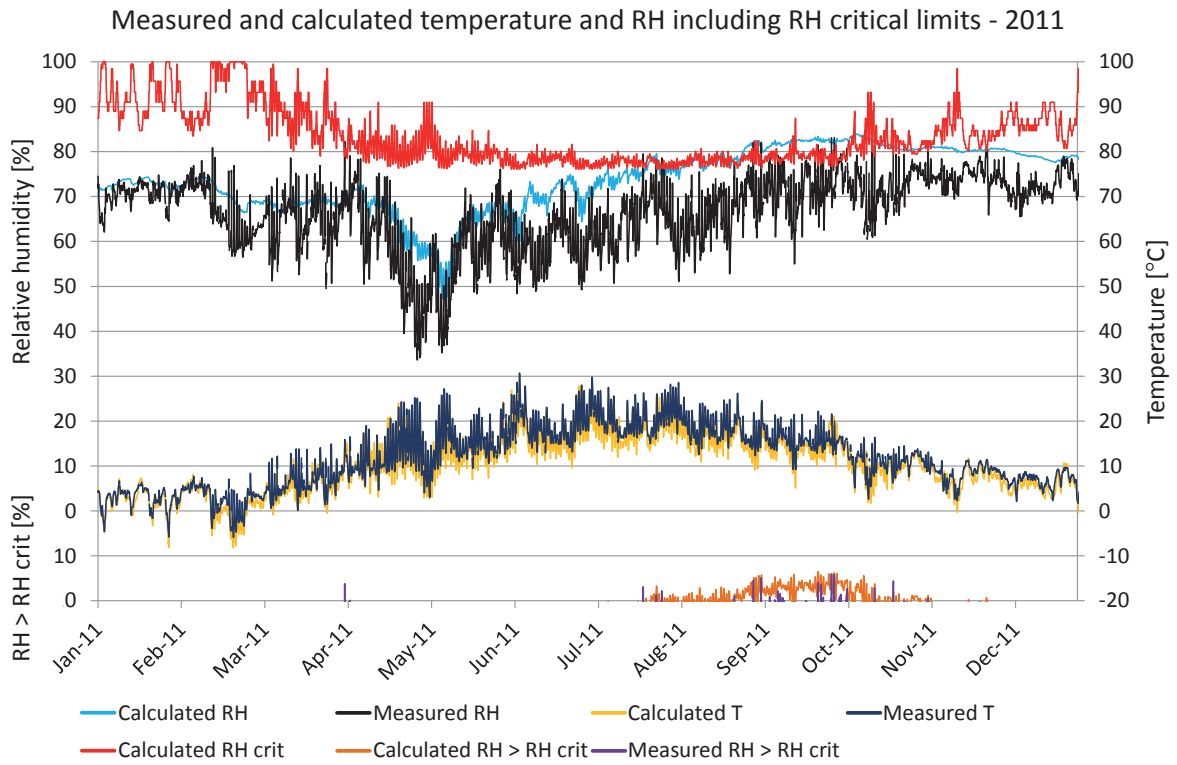

Figure 7.1.9. Comparisons between measured and calculated temperature and relative humidity. Calculated temperature (yellow), measured temperature (dark blue), calculated RH (turquoise), measured RH (black), RH_{crit} for calculated values (red), calculated $RH > RH_{crit}$ (light brown), measured $RH > RH_{crit}$ (purple).

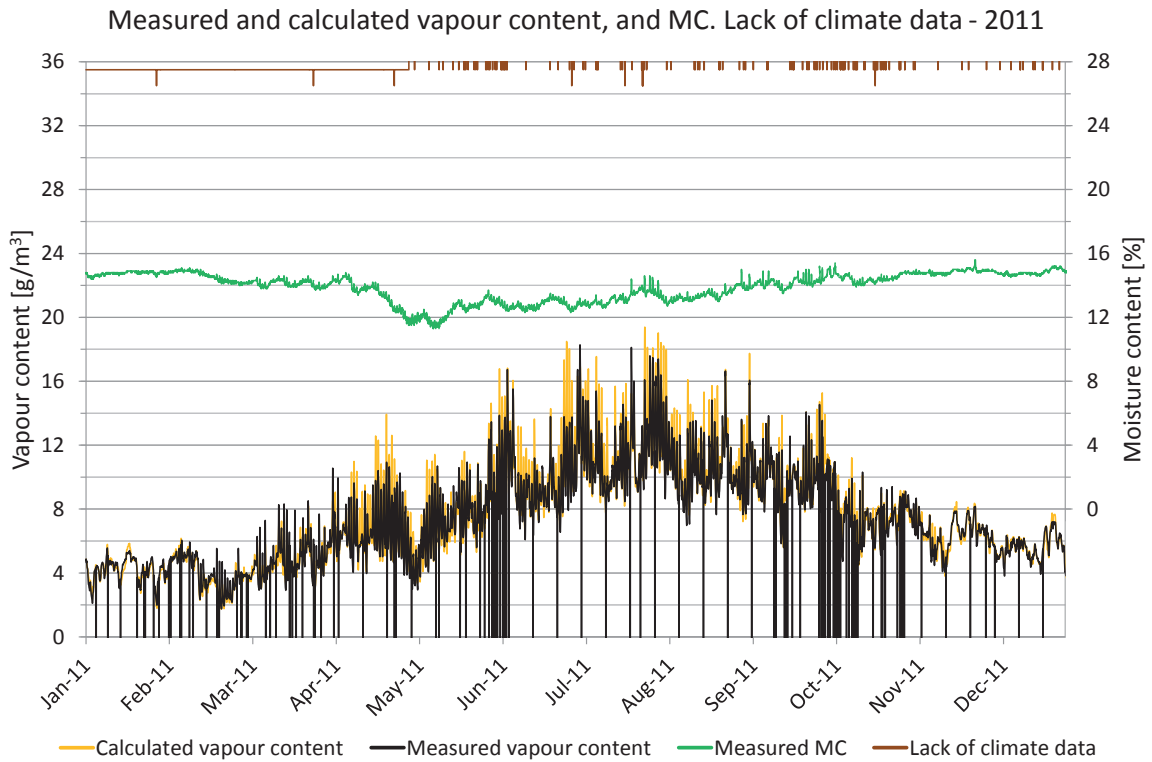

Figure 7.1.10. Measured moisture content, periods lacking climate data and comparisons of vapour content. Vapour content for calculated values (yellow) and measured values (black). Moisture content (green), periods with lack of climate data (brown).

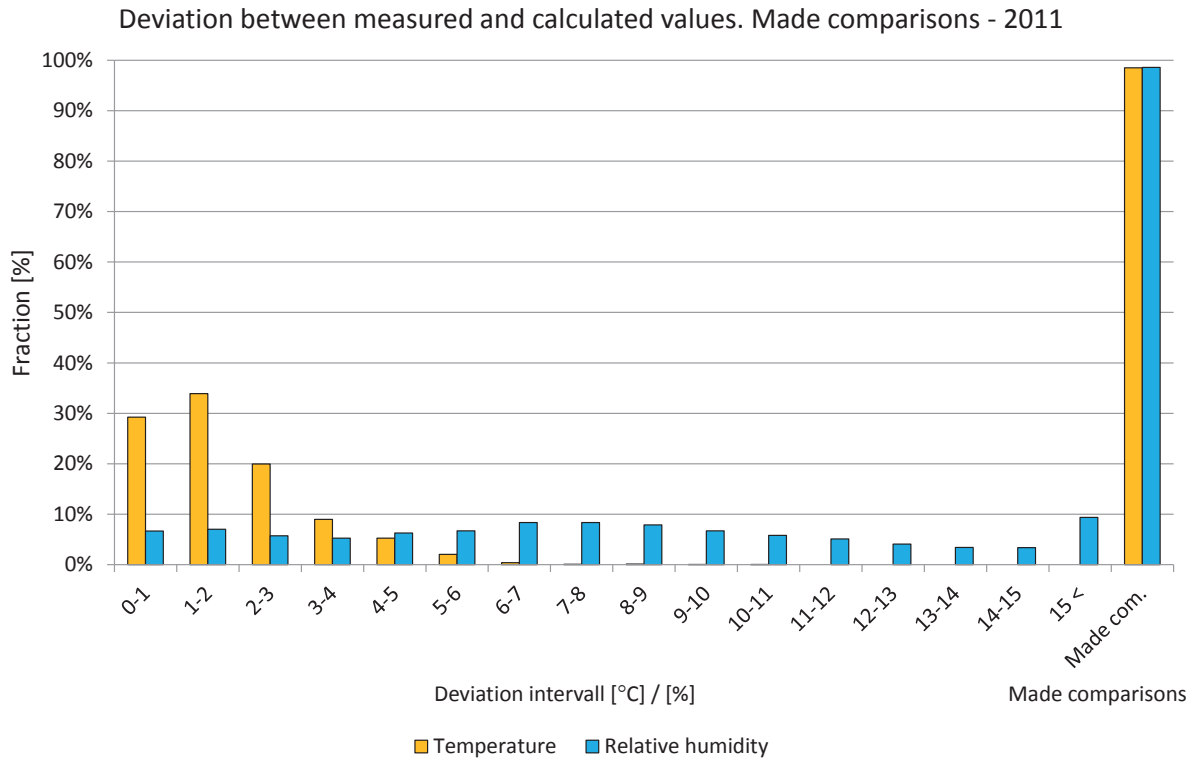

Figure 7.1.11. Deviations in comparisons shown in intervals from 0 to 15 °C or %. The two right-hand bars show the percentage of comparisons during the year. Temperature (yellow) and relative humidity (light blue).

7.2 Position 2

The locations of the measured and calculated position are shown in the drawings and figures below. The studied position is located in a wall facing southwest.

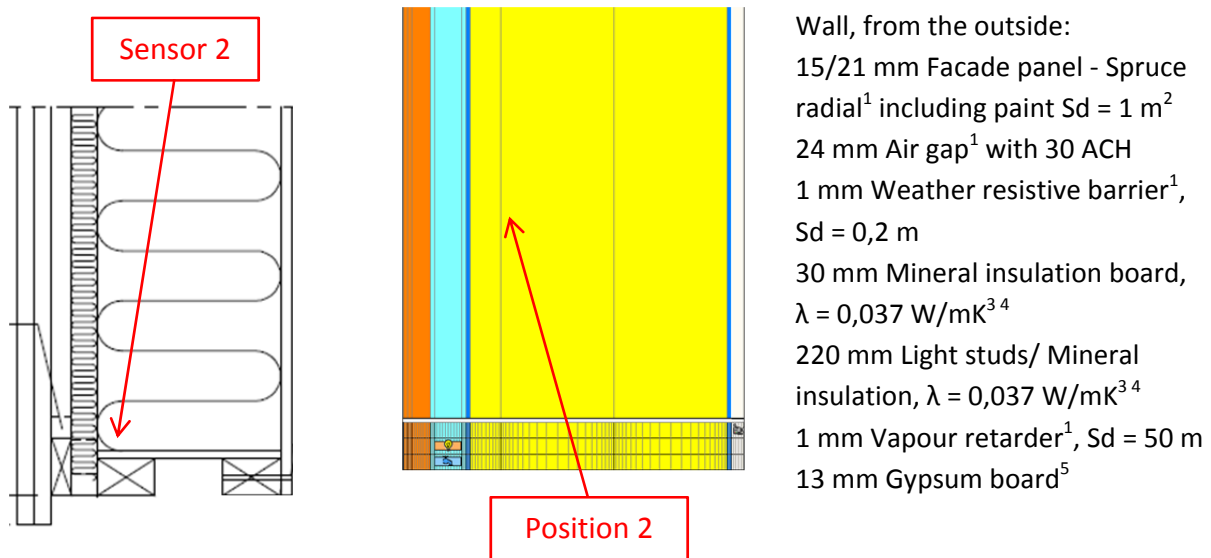

Figure 7.2.1. Vertical cross sectional drawing and WUFI calculation model showing the studied position. 1. IBP, 2012, 2. Nevander, L-E., 1994, 3. IEA Annex 24, 1996, 4. Paroc, 2002, 5. Krus, M., 1996.

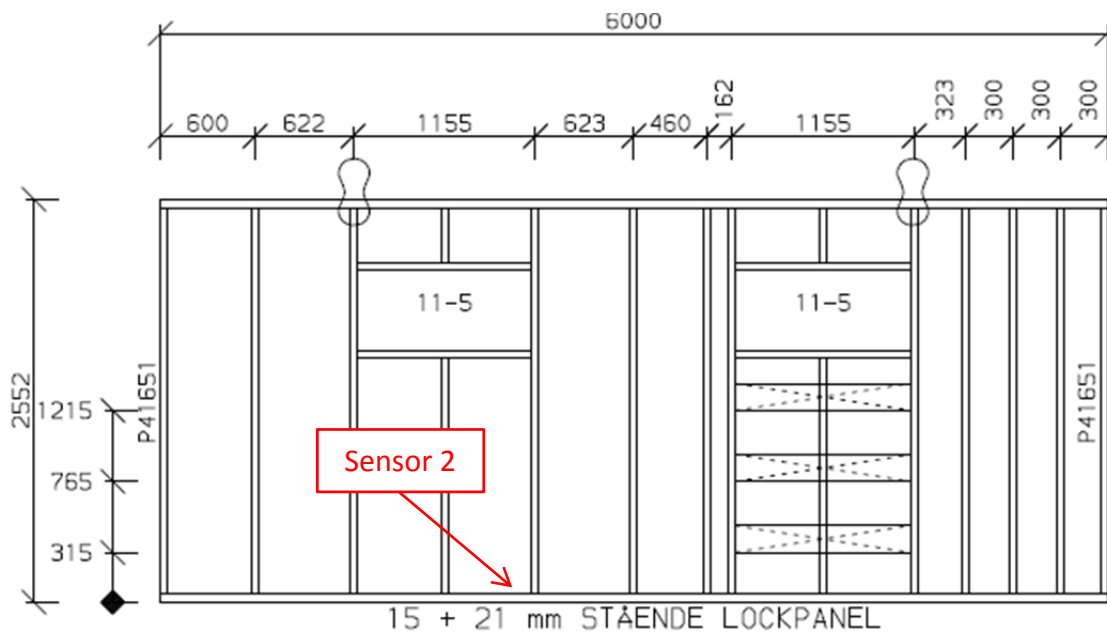

Figure 7.2.2. Location of the studied position.

A perfect match between the measured and calculated values cannot be expected due to e.g. the influence of two- and three-dimensional effects and the accuracy of the sensors.

Year 2009

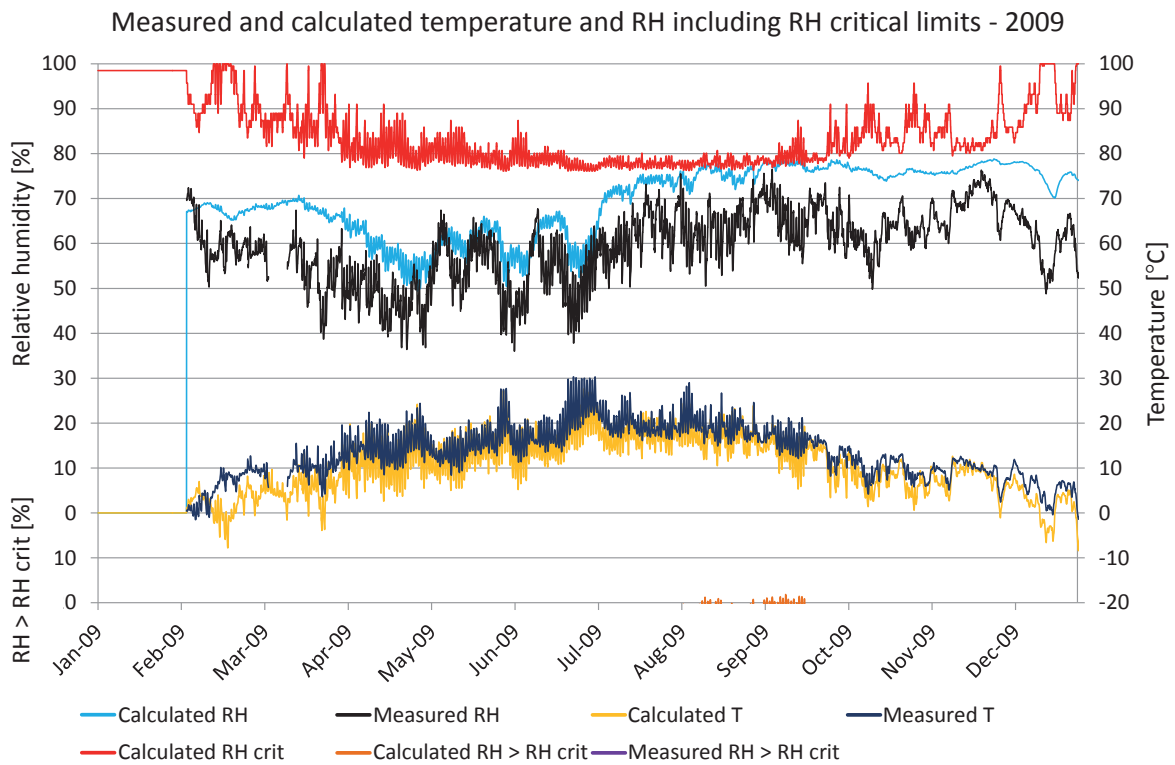

Figure 7.2.3. Comparisons between measured and calculated temperature and relative humidity. Calculated temperature (yellow), measured temperature (dark blue), calculated RH (turquoise), measured RH (black), RH_{crit} for calculated values (red), calculated RH > RH_{crit} (light brown), measured RH > RH_{crit} (purple).

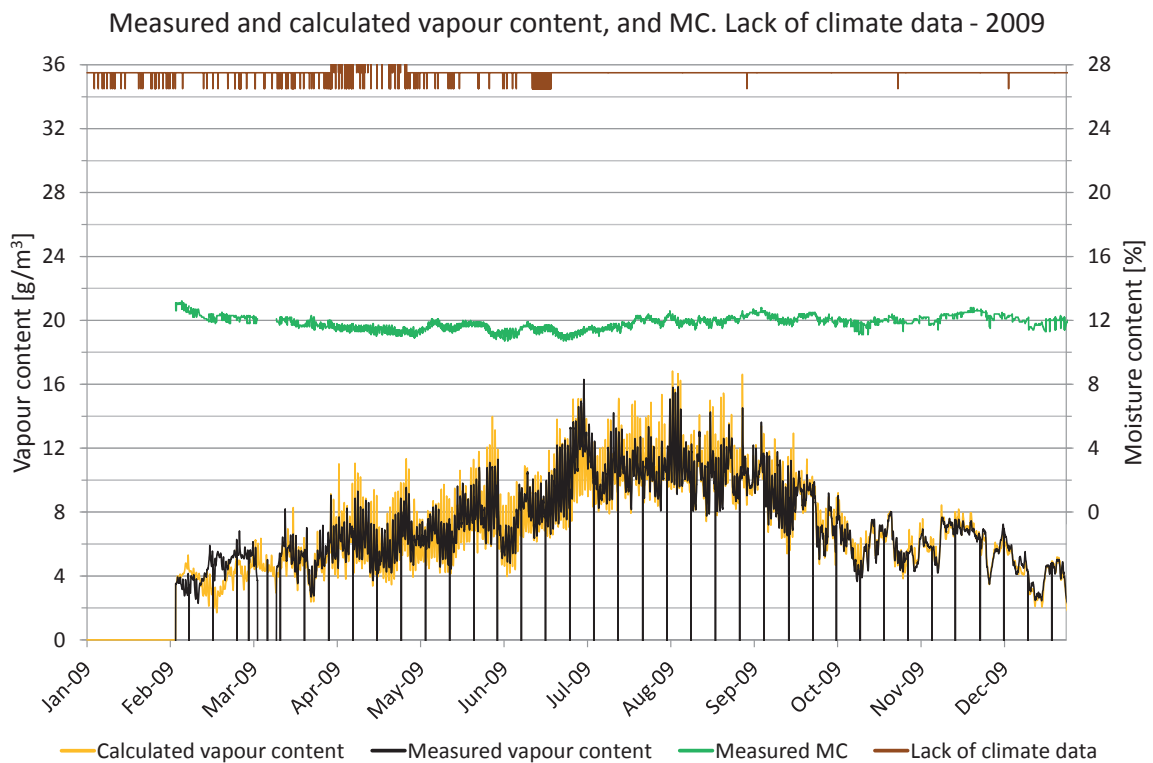

Figure 7.2.4. Measured moisture content, periods lacking climate data and comparisons of vapour content. Vapour content for calculated values (yellow) and measured values (black). Moisture content (green), periods with lack of climate data (brown).

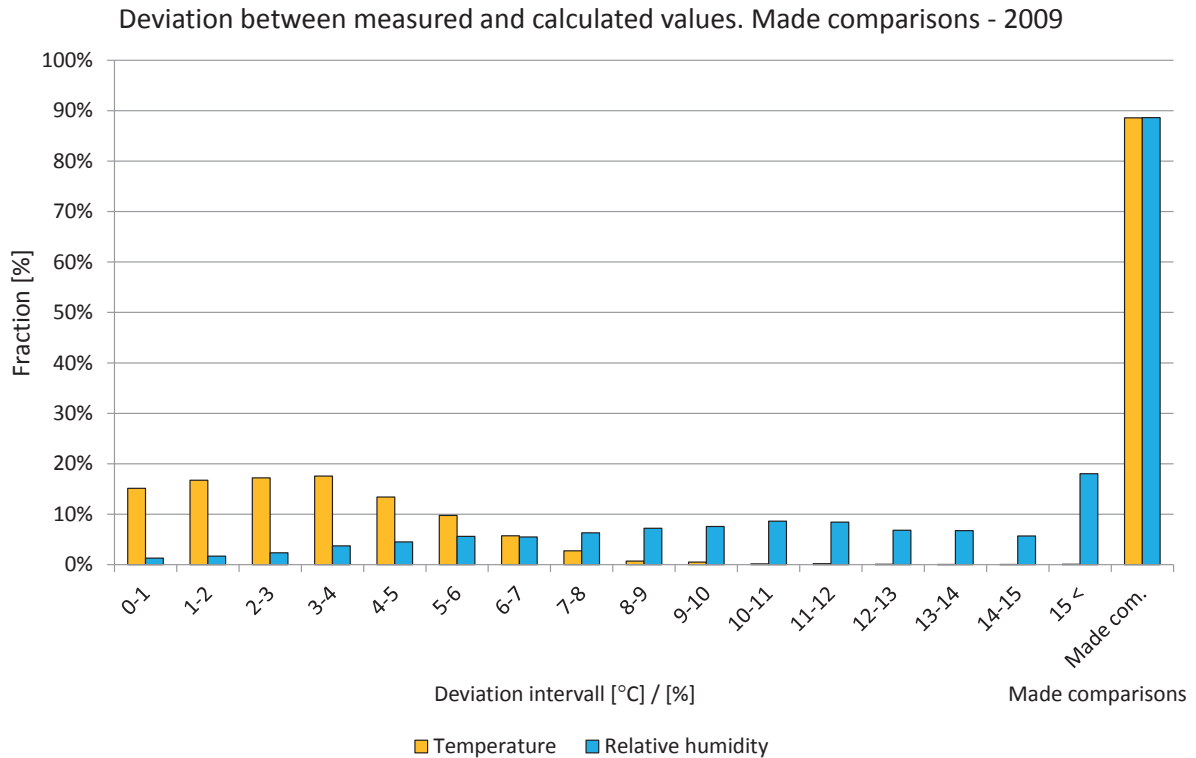

Figure 7.1.5. Deviations in comparisons shown in intervals from 0 to 15 °C or %. The two right-hand bars show the percentage of comparisons during the year. Temperature (yellow) and relative humidity (light blue).

Year 2010

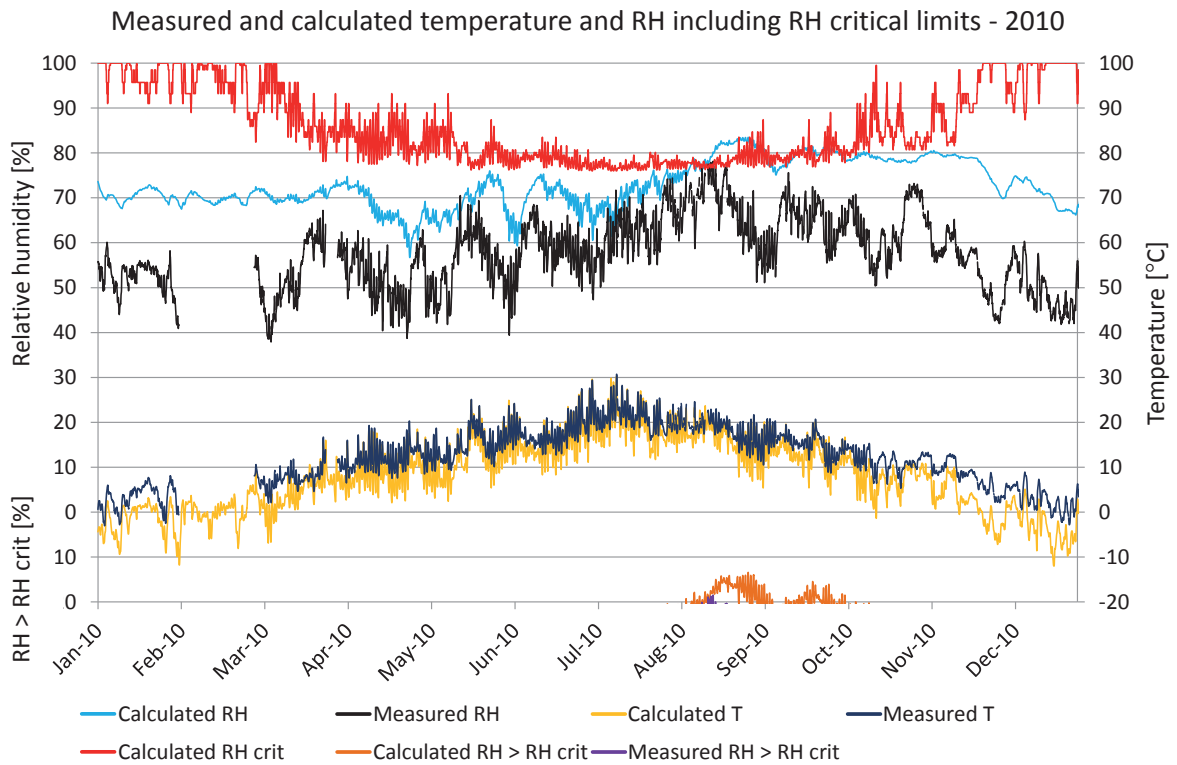

Figure 7.2.6. Comparisons between measured and calculated temperature and relative humidity. Calculated temperature (yellow), measured temperature (dark blue), calculated RH (turquoise), measured RH (black), RH_{crit} for calculated values (red), calculated $RH > RH_{crit}$ (light brown), measured $RH > RH_{crit}$ (purple).

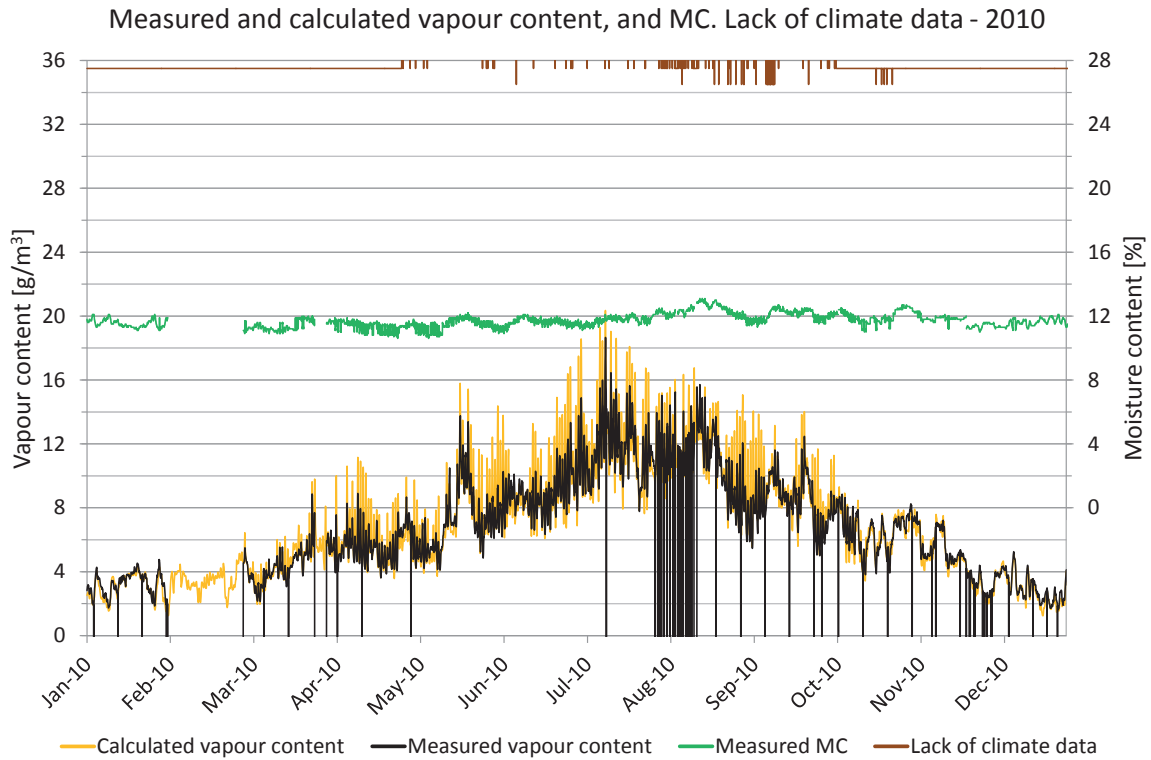

Figure 7.2.7. Measured moisture content, periods lacking climate data and comparisons of vapour content. Vapour content for calculated values (yellow) and measured values (black). Moisture content (green), periods with lack of climate data (brown).

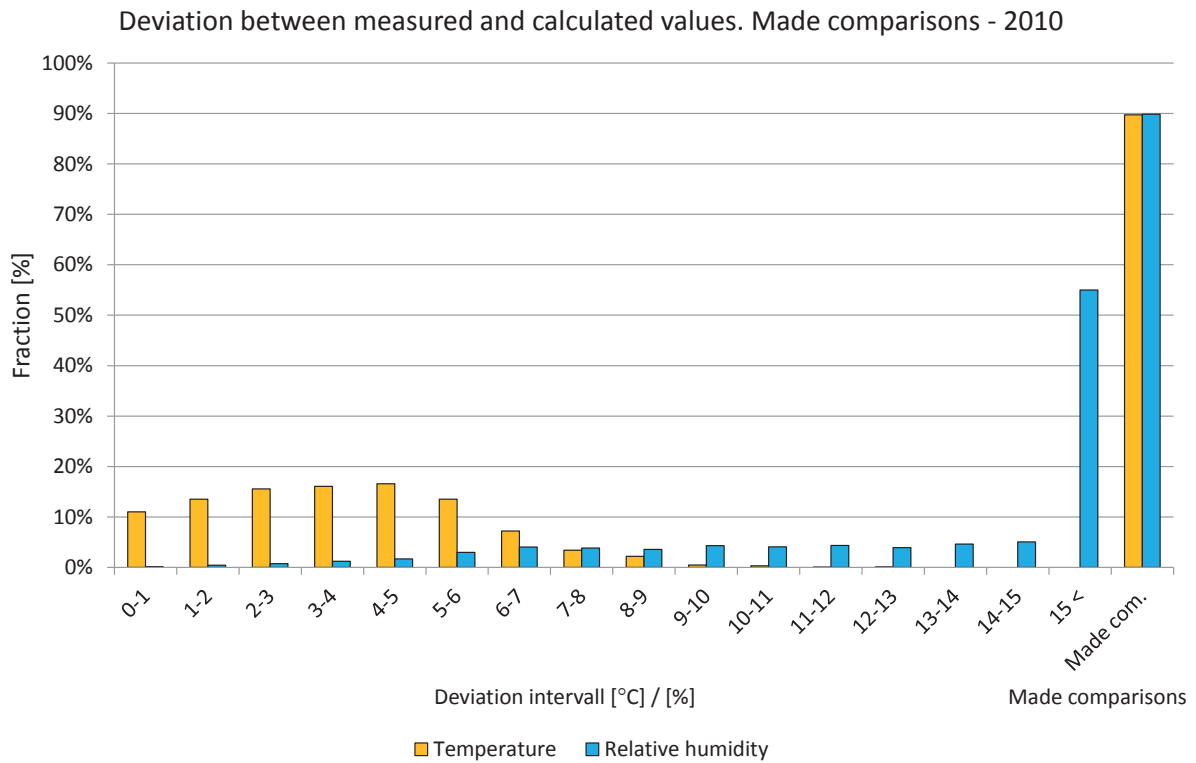

Figure 7.2.8. Deviations in comparisons shown in intervals from 0 to 15 °C or %. The two right-hand bars show the percentage of comparisons during the year. Temperature (yellow) and relative humidity (light blue).

Year 2011

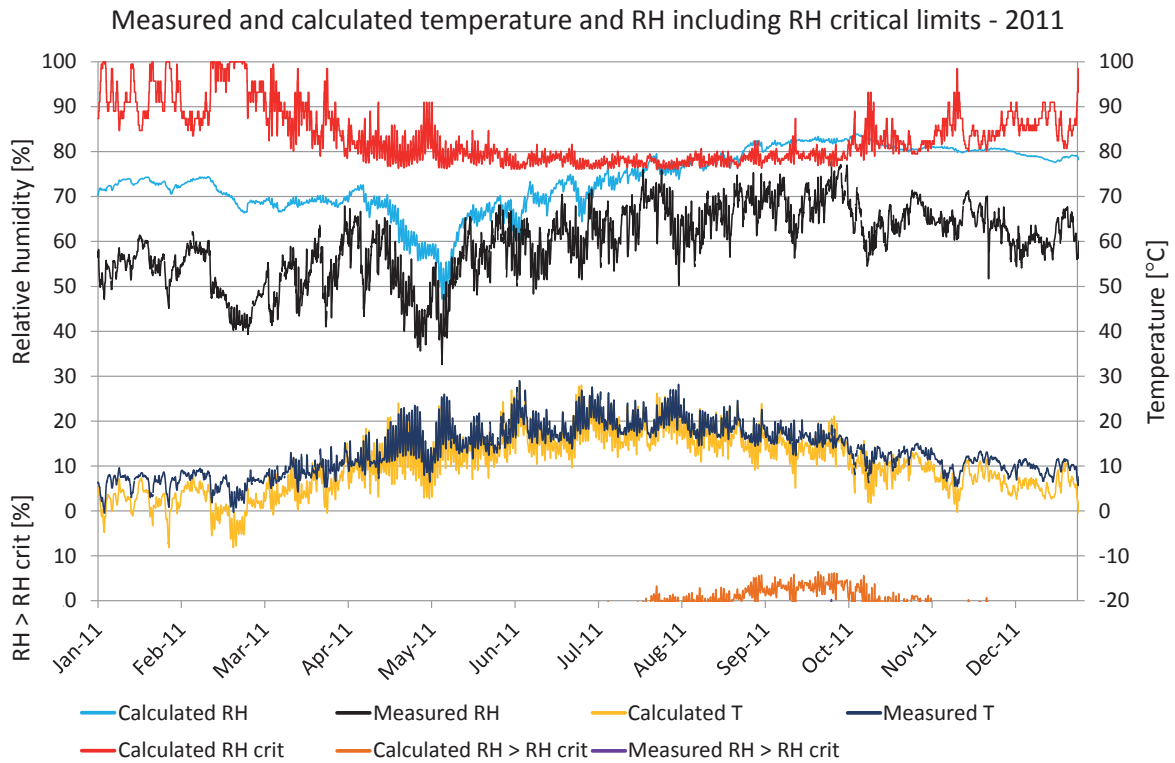

Figure 7.2.9. Comparisons between measured and calculated temperature and relative humidity. Calculated temperature (yellow), measured temperature (dark blue), calculated RH (turquoise), measured RH (black), RH_{crit} for calculated values (red), calculated $RH > RH_{crit}$ (light brown), measured $RH > RH_{crit}$ (purple).

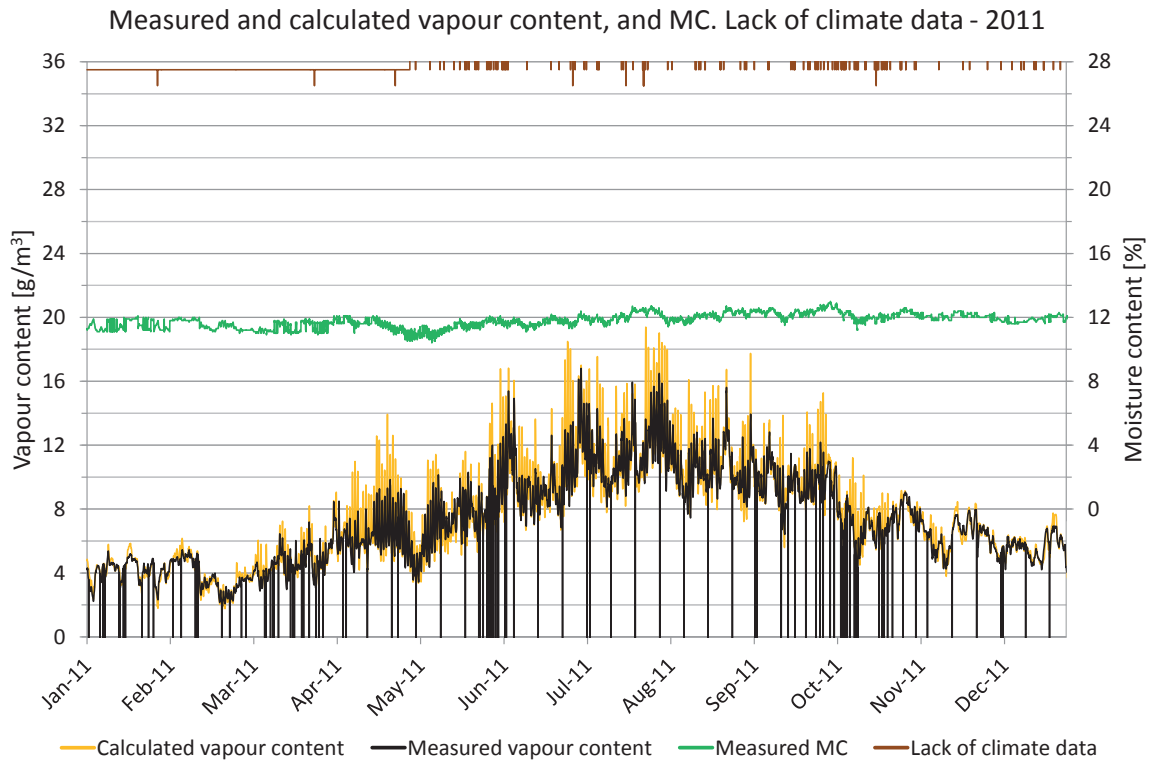

Figure 7.2.10. Measured moisture content, periods lacking climate data and comparisons of vapour content. Vapour content for calculated values (yellow) and measured values (black). Moisture content (green), periods with lack of climate data (brown).

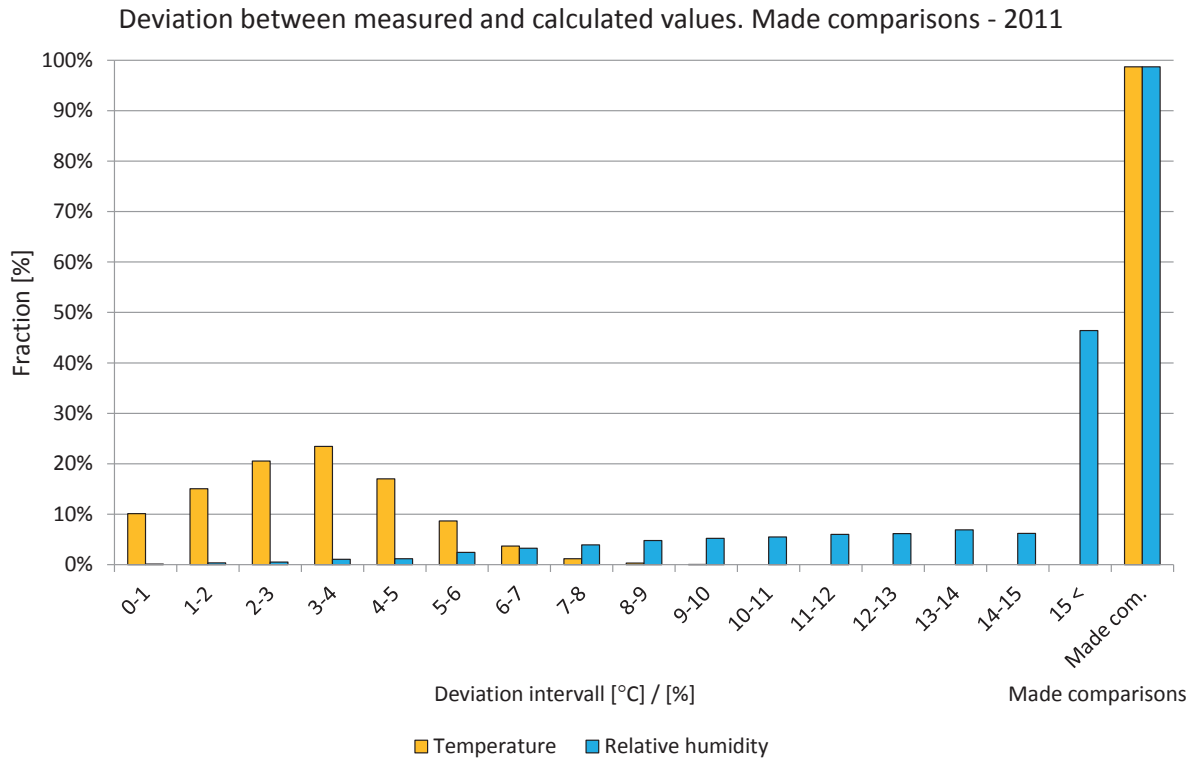

Figure 7.2.11. Deviations in comparisons shown in intervals from 0 to 15 °C or %. The two right-hand bars show the percentage of comparisons during the year. Temperature (yellow) and relative humidity (light blue).

7.3 Position 3

The locations of the measured and calculated position are shown in the drawings and figures below. The studied position is located in a wall facing northwest.

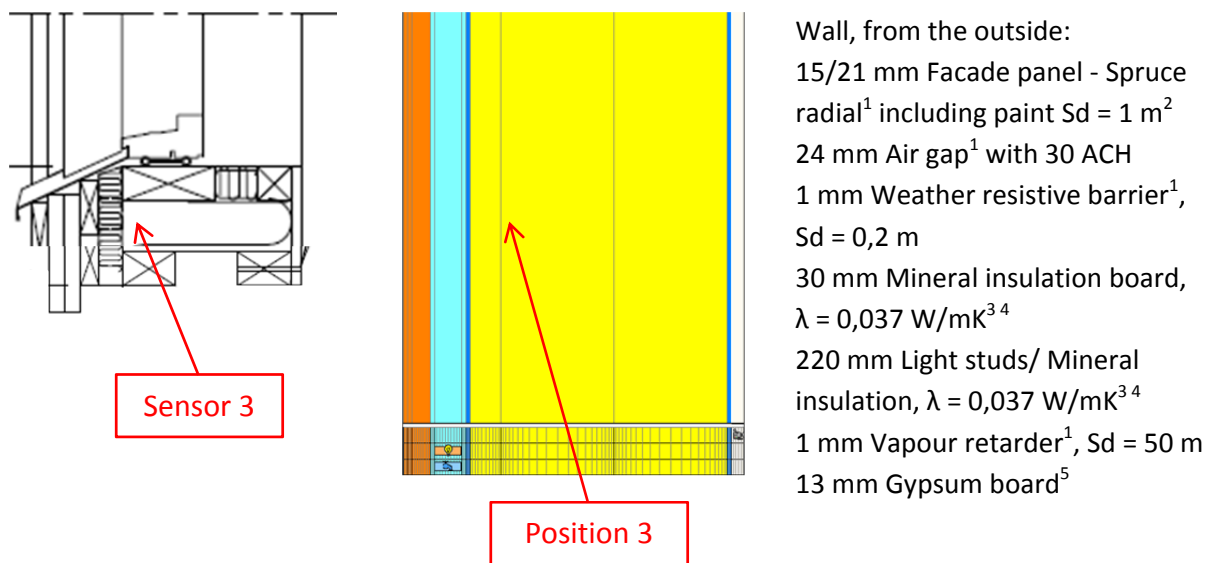

Figure 7.3.1. Vertical cross sectional drawing and WUFI calculation model showing the studied position. 1. IBP, 2012, 2. Nevander, L-E., 1994, 3. IEA Annex 24, 1996, 4. Paroc, 2002, 5. Krus, M., 1996.

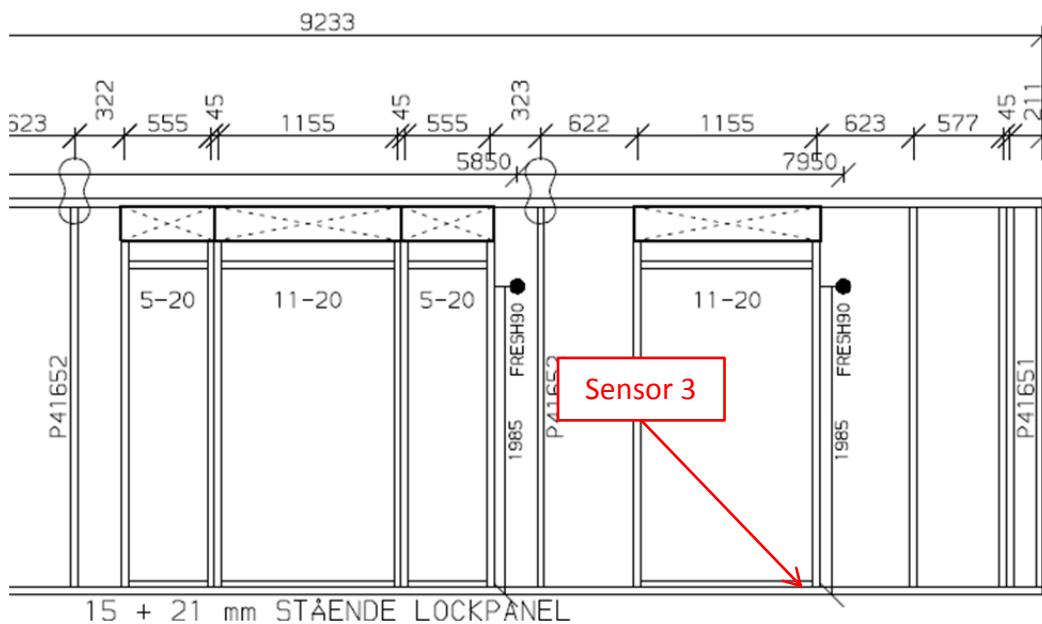

Figure 7.3.2. Location of the studied position.

A perfect match between the measured and calculated values cannot be expected due to e.g. the influence of two- and three-dimensional effects and the accuracy of the sensors.

Year 2009

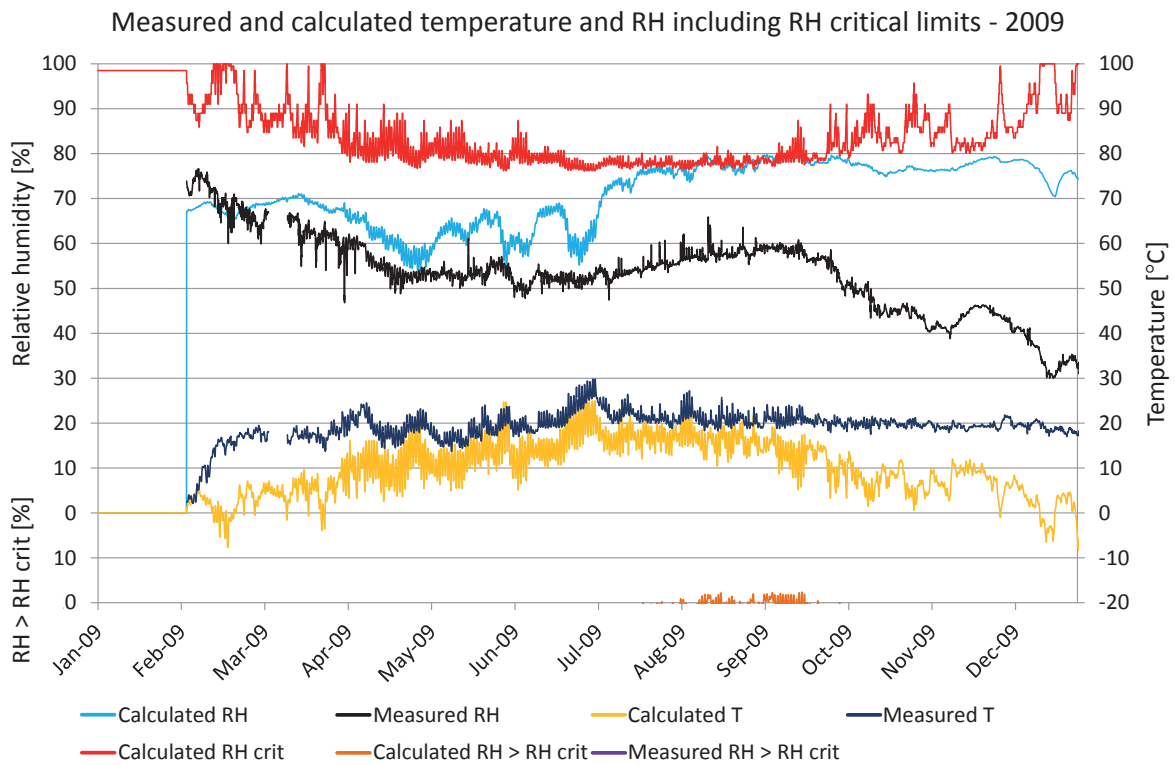

Figure 7.3.3. Comparisons between measured and calculated temperature and relative humidity. Calculated temperature (yellow), measured temperature (dark blue), calculated RH (turquoise), measured RH (black), RH_{crit} for calculated values (red), calculated $RH > RH_{crit}$ (light brown), measured $RH > RH_{crit}$ (purple).

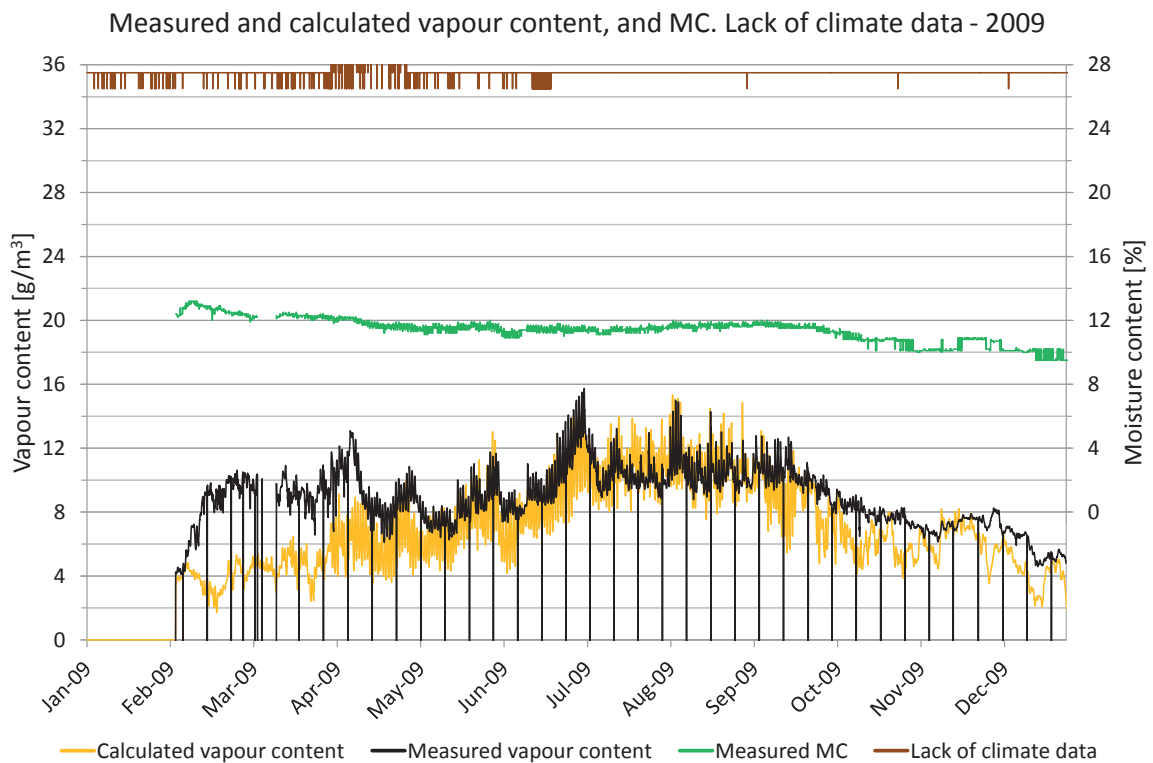

Figure 7.3.4. Measured moisture content, periods lacking climate data and comparisons of vapour content. Vapour content for calculated values (yellow) and measured values (black). Moisture content (green), periods with lack of climate data (brown).

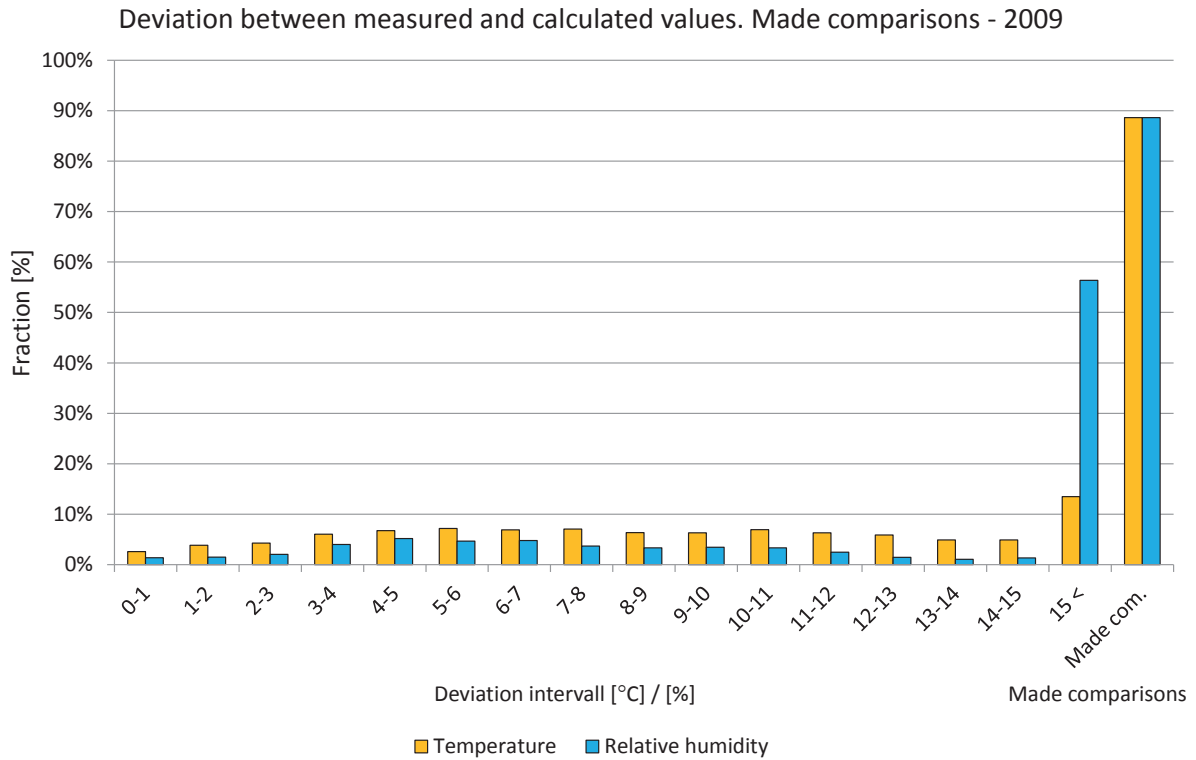

Figure 7.3.5. Deviations in comparisons shown in intervals from 0 to 15 °C or %. The two right-hand bars show the percentage of comparisons during the year. Temperature (yellow) and relative humidity (light blue).

Year 2010

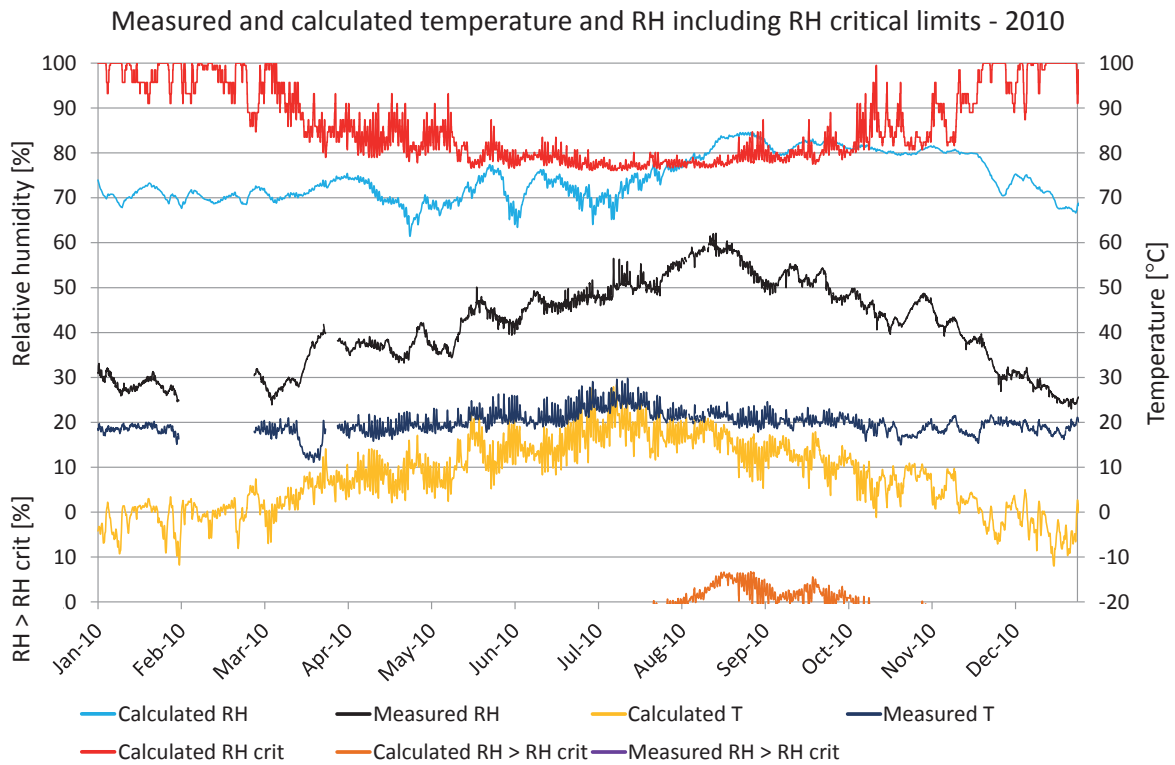

Figure 7.3.6. Comparisons between measured and calculated temperature and relative humidity. Calculated temperature (yellow), measured temperature (dark blue), calculated RH (turquoise), measured RH (black), RH_{crit} for calculated values (red), calculated $RH > RH_{crit}$ (light brown), measured $RH > RH_{crit}$ (purple).

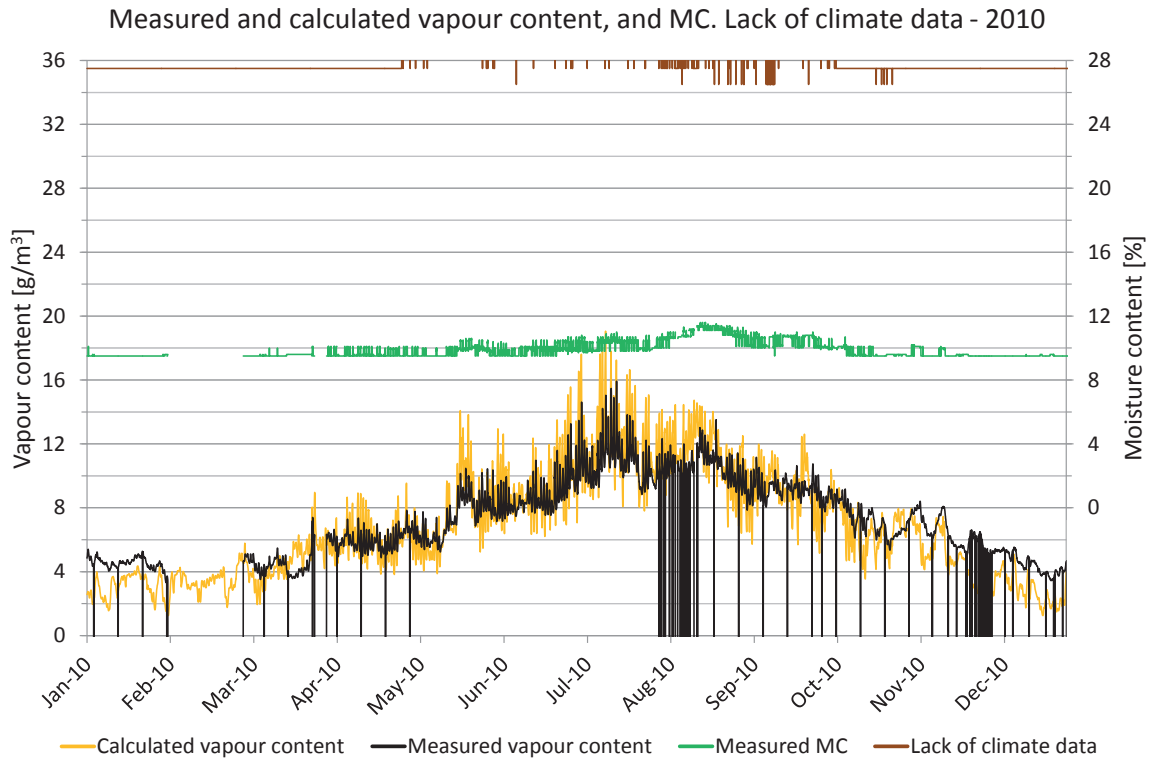

Figure 7.3.7. Measured moisture content, periods lacking climate data and comparisons of vapour content. Vapour content for calculated values (yellow) and measured values (black). Moisture content (green), periods with lack of climate data (brown).

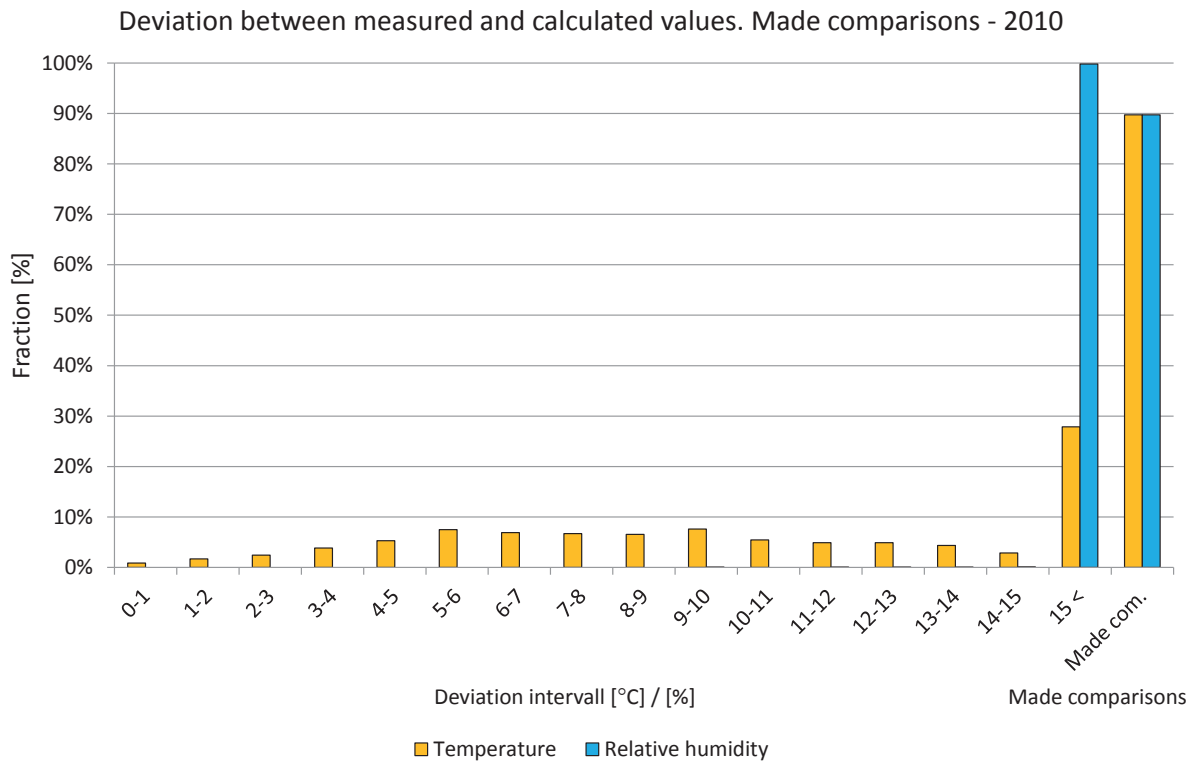

Figure 7.3.8. Deviations in comparisons shown in intervals from 0 to 15 °C or %. The two right-hand bars show the percentage of comparisons during the year. Temperature (yellow) and relative humidity (light blue).

Year 2011

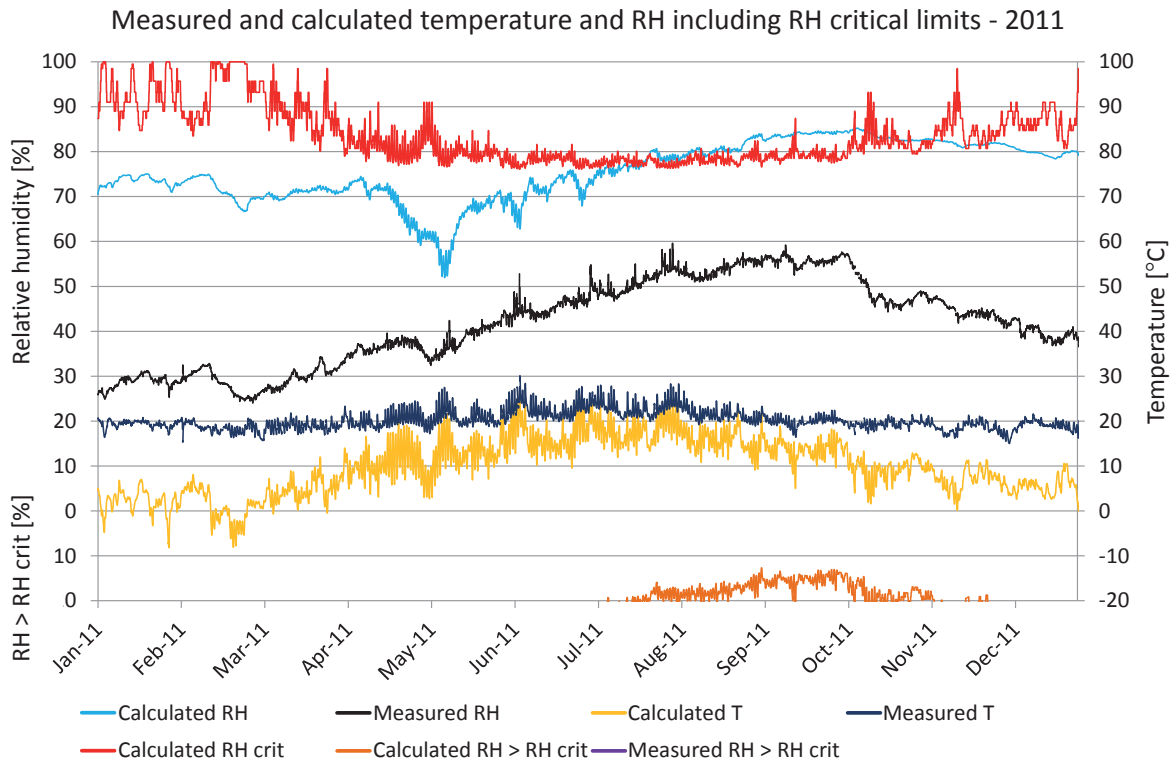

Figure 7.3.9. Comparisons between measured and calculated temperature and relative humidity. Calculated temperature (yellow), measured temperature (dark blue), calculated RH (turquoise), measured RH (black), RH_{crit} for calculated values (red), calculated $RH > RH_{crit}$ (light brown), measured $RH > RH_{crit}$ (purple).

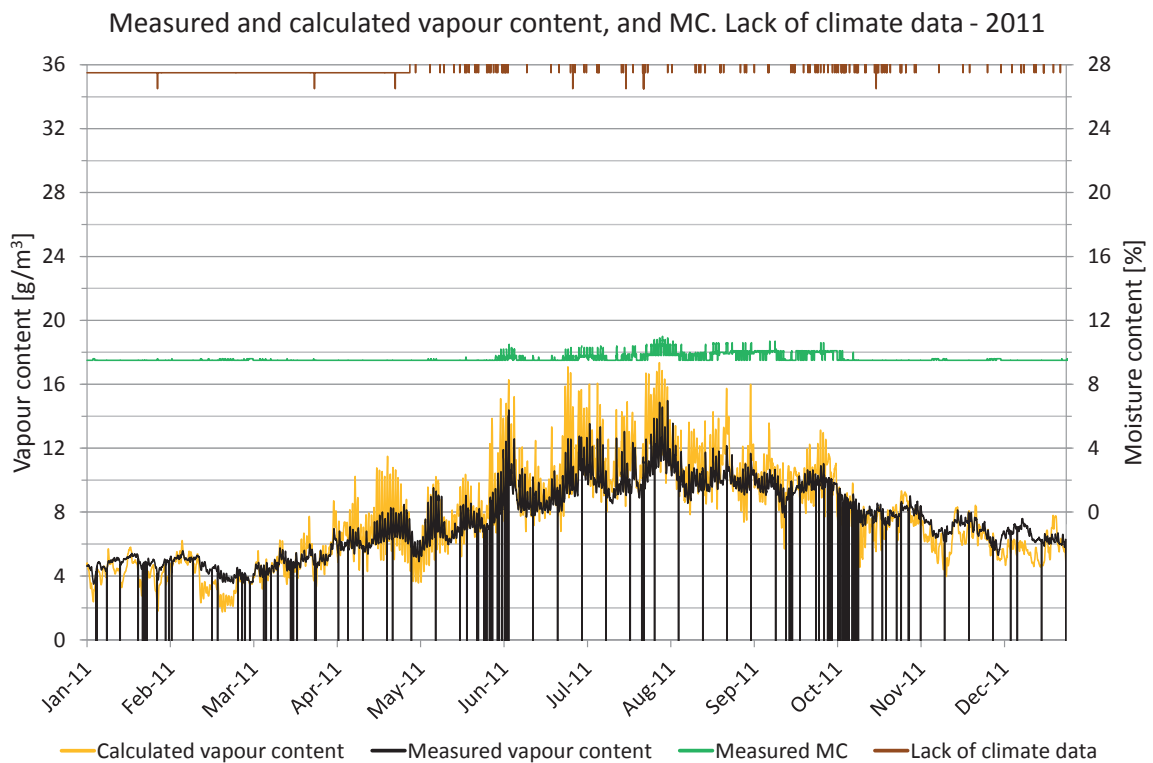

Figure 7.3.10. Measured moisture content, periods lacking climate data and comparisons of vapour content. Vapour content for calculated values (yellow) and measured values (black). Moisture content (green), periods with lack of climate data (brown).

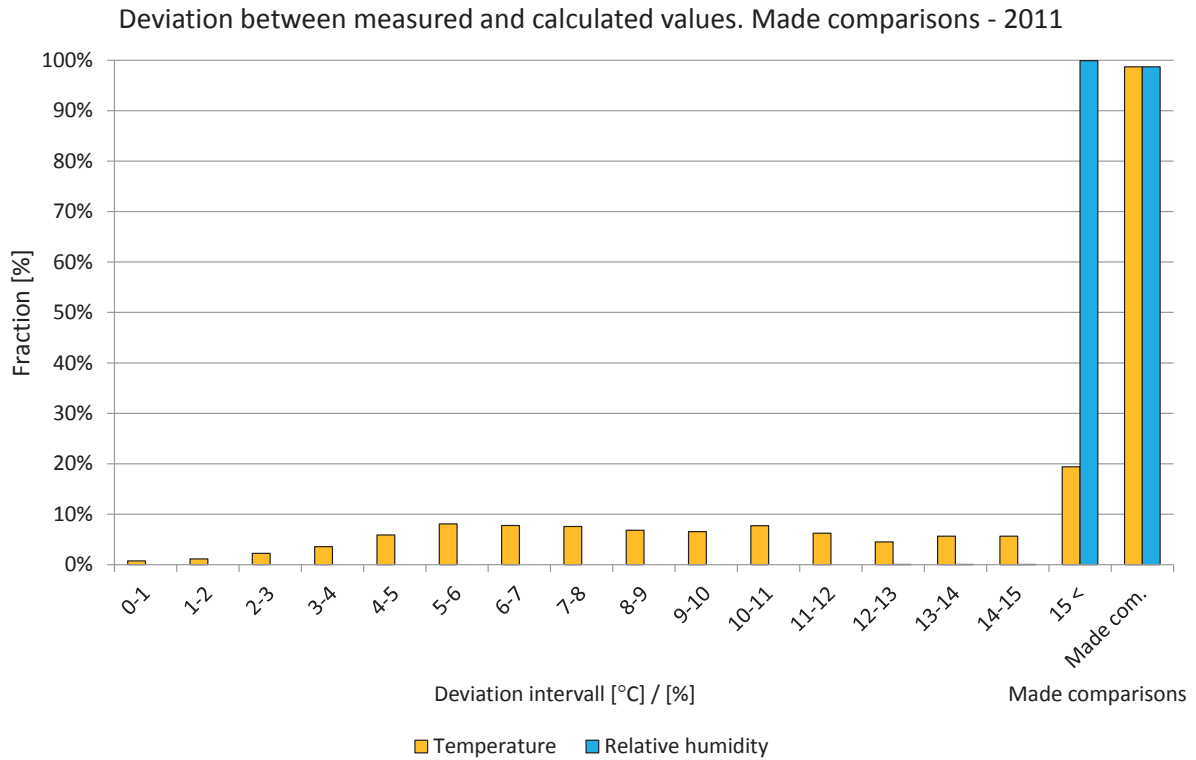

Figure 7.3.11. Deviations in comparisons shown in intervals from 0 to 15 °C or %. The two right-hand bars show the percentage of comparisons during the year. Temperature (yellow) and relative humidity (light blue).

7.4 Position 4

The locations of the measured and calculated position are shown in the drawings and figures below. The studied position is located in a wall facing southeast.

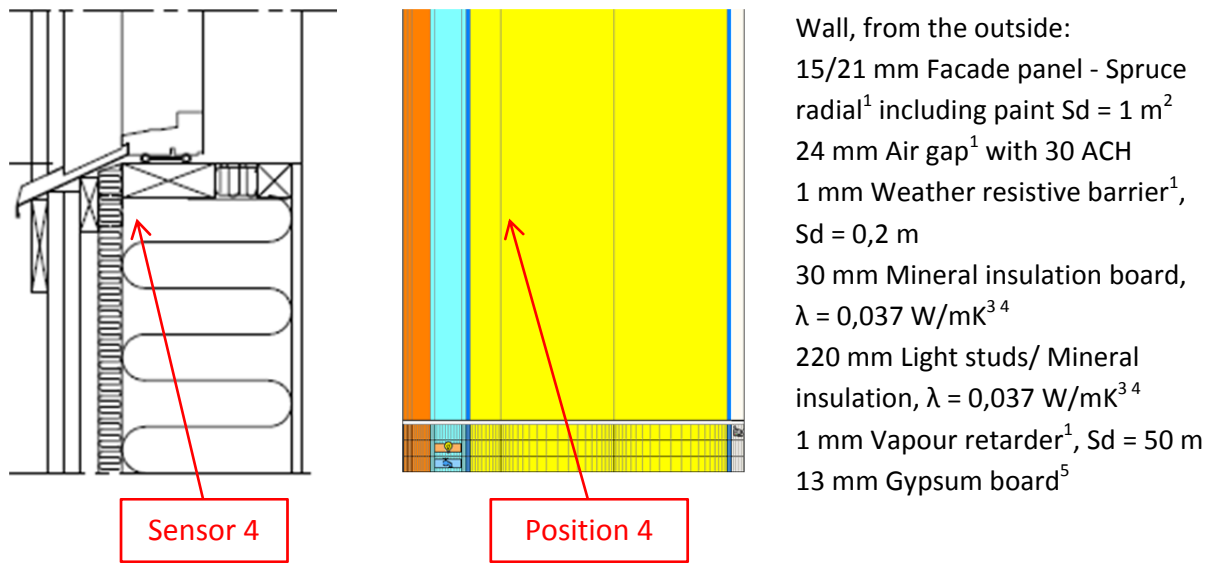

Figure 7.4.1. Vertical cross sectional drawing and WUFI calculation model showing the studied position. 1. IBP, 2012, 2. Nevander, L-E., 1994, 3. IEA Annex 24, 1996, 4. Paroc, 2002, 5. Krus, M., 1996.

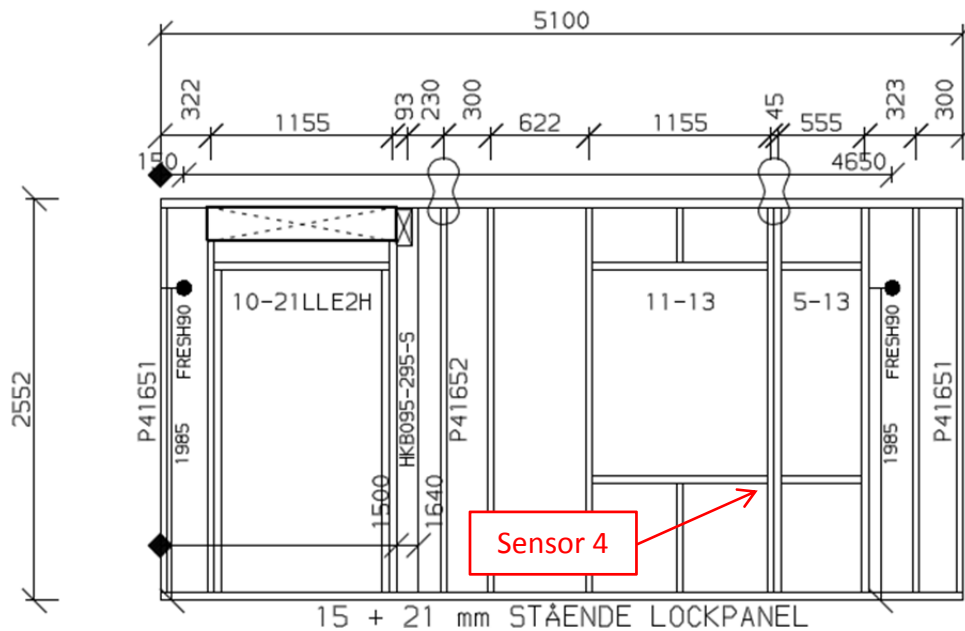

Figure 7.4.2. Location of the studied position.

A perfect match between the measured and calculated values cannot be expected due to e.g. the influence of two- and three-dimensional effects and the accuracy of the sensors.

Year 2009

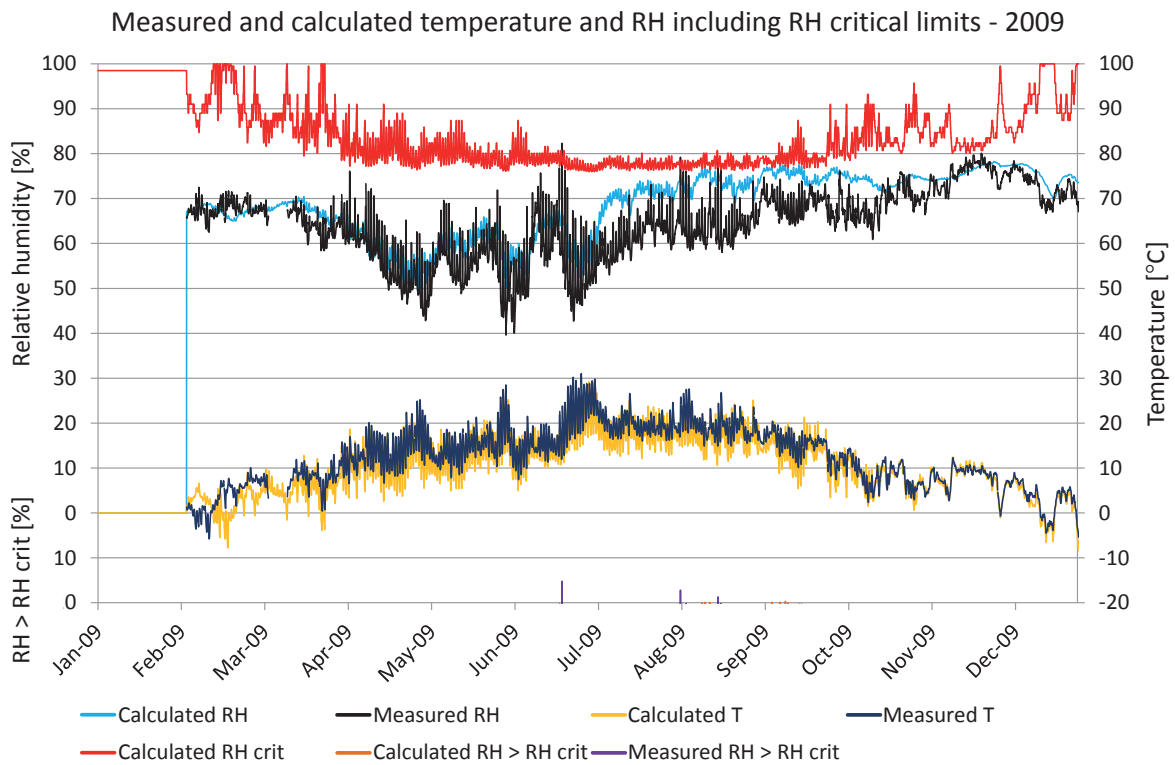

Figure 7.4.3. Comparisons between measured and calculated temperature and relative humidity. Calculated temperature (yellow), measured temperature (dark blue), calculated RH (turquoise), measured RH (black), RH_{crit} for calculated values (red), calculated $RH > RH_{crit}$ (light brown), measured $RH > RH_{crit}$ (purple).

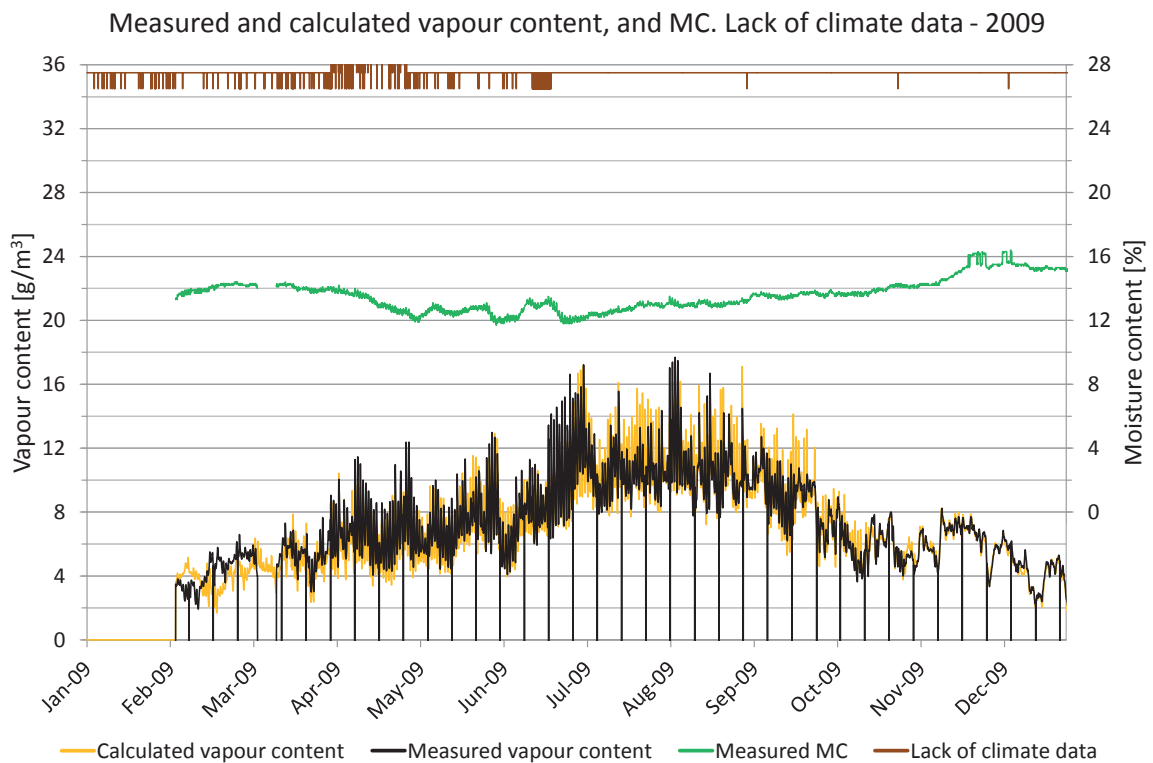

Figure 7.4.4. Measured moisture content, periods lacking climate data and comparisons of vapour content. Vapour content for calculated values (yellow) and measured values (black). Moisture content (green), periods with lack of climate data (brown).

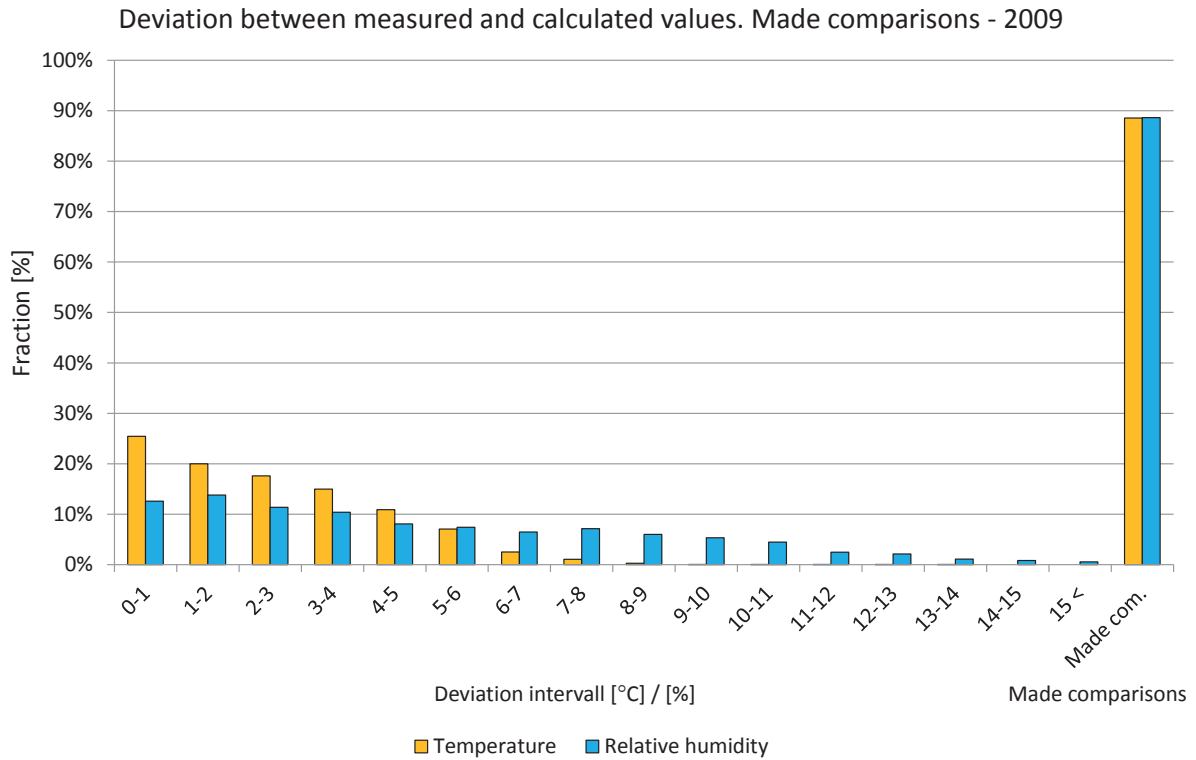

Figure 7.4.5. Deviations in comparisons shown in intervals from 0 to 15 °C or %. The two right-hand bars show the percentage of comparisons during the year. Temperature (yellow) and relative humidity (light blue).

Year 2010

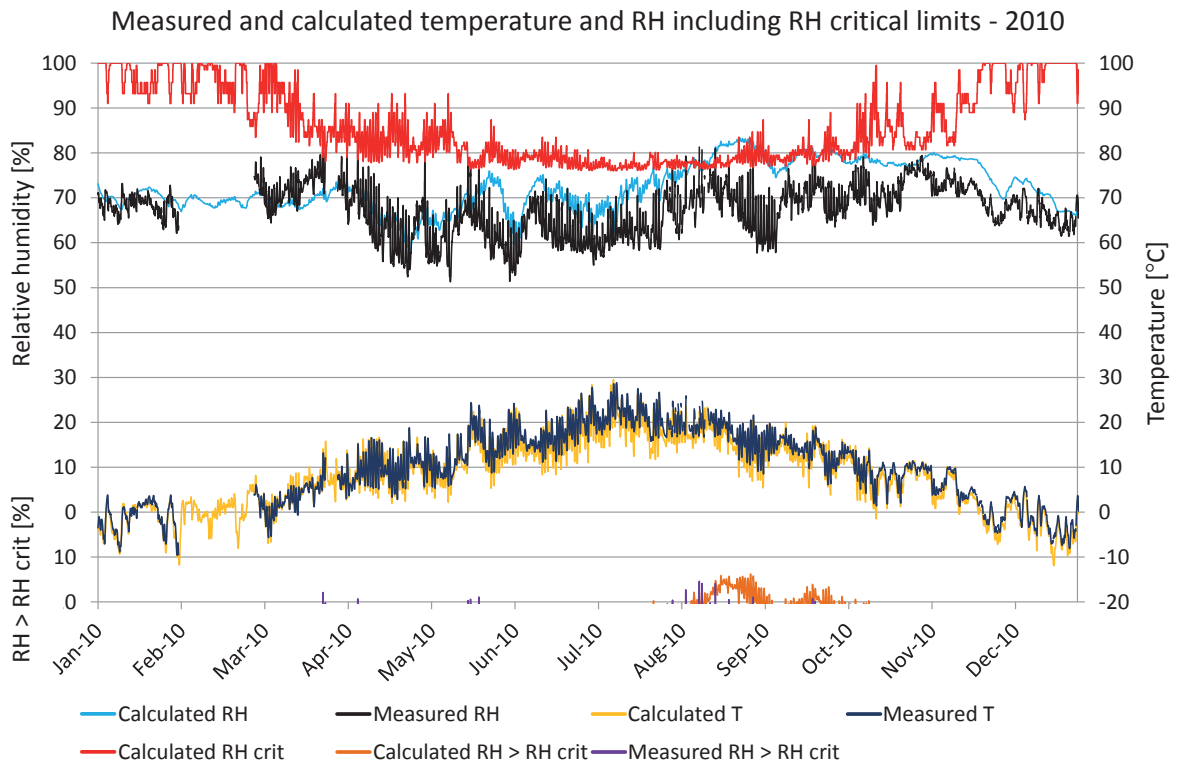

Figure 7.4.6. Comparisons between measured and calculated temperature and relative humidity. Calculated temperature (yellow), measured temperature (dark blue), calculated RH (turquoise), measured RH (black), RH_{crit} for calculated values (red), calculated $RH > RH_{crit}$ (light brown), measured $RH > RH_{crit}$ (purple).

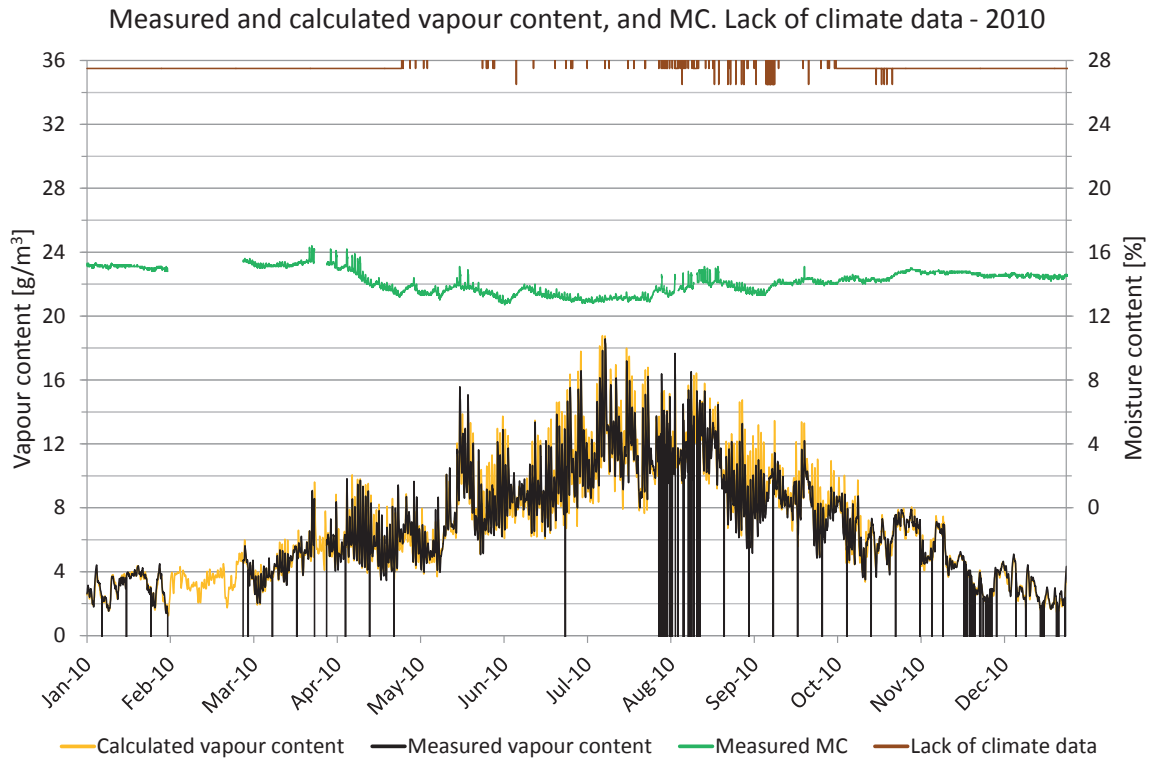

Figure 7.4.7. Measured moisture content, periods lacking climate data and comparisons of vapour content. Vapour content for calculated values (yellow) and measured values (black). Moisture content (green), periods with lack of climate data (brown).

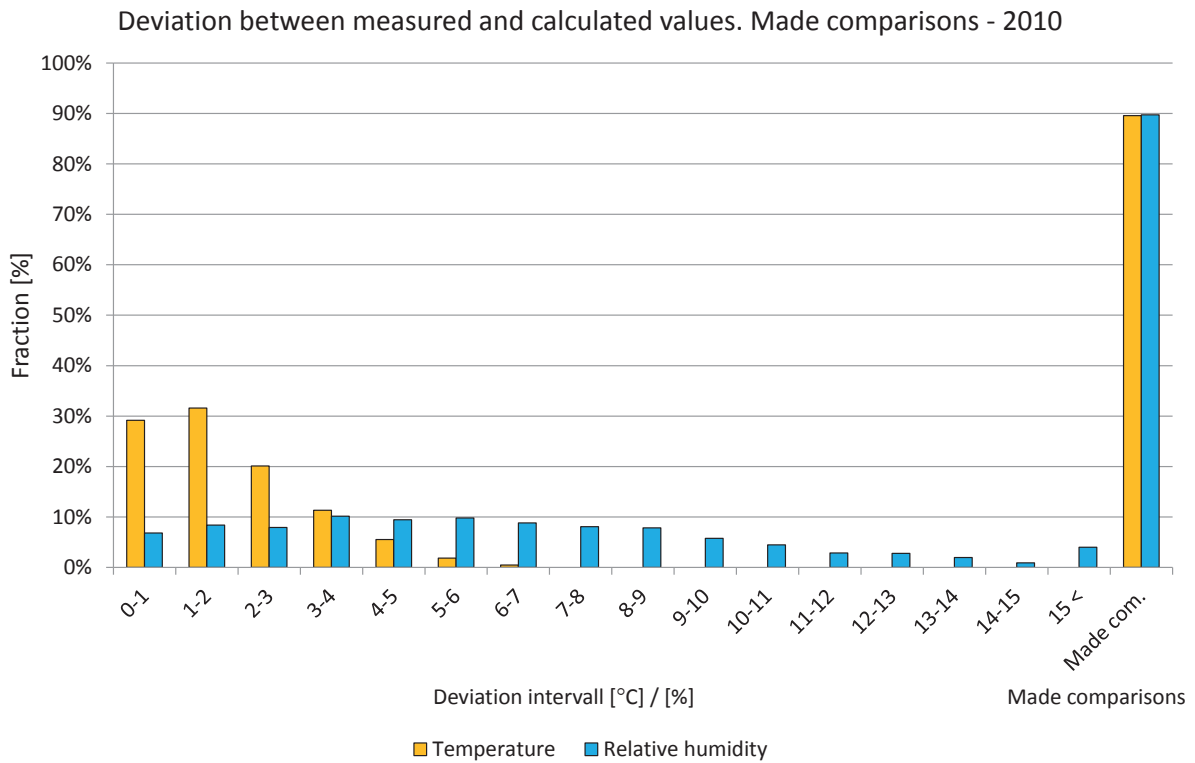

Figure 7.4.8. Deviations in comparisons shown in intervals from 0 to 15 °C or %. The two right-hand bars show the percentage of comparisons during the year. Temperature (yellow) and relative humidity (light blue).

Year 2011

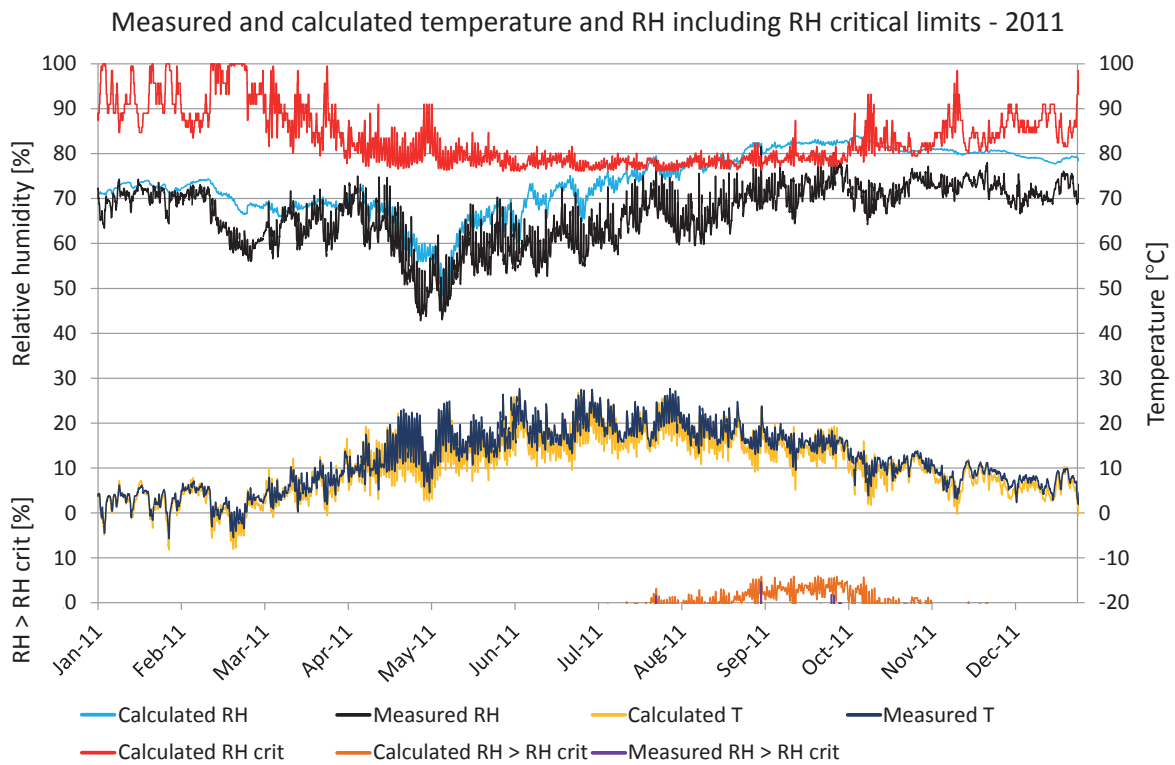

Figure 7.4.9. Comparisons between measured and calculated temperature and relative humidity. Calculated temperature (yellow), measured temperature (dark blue), calculated RH (turquoise), measured RH (black), RH_{crit} for calculated values (red), calculated $RH > RH_{crit}$ (light brown), measured $RH > RH_{crit}$ (purple).

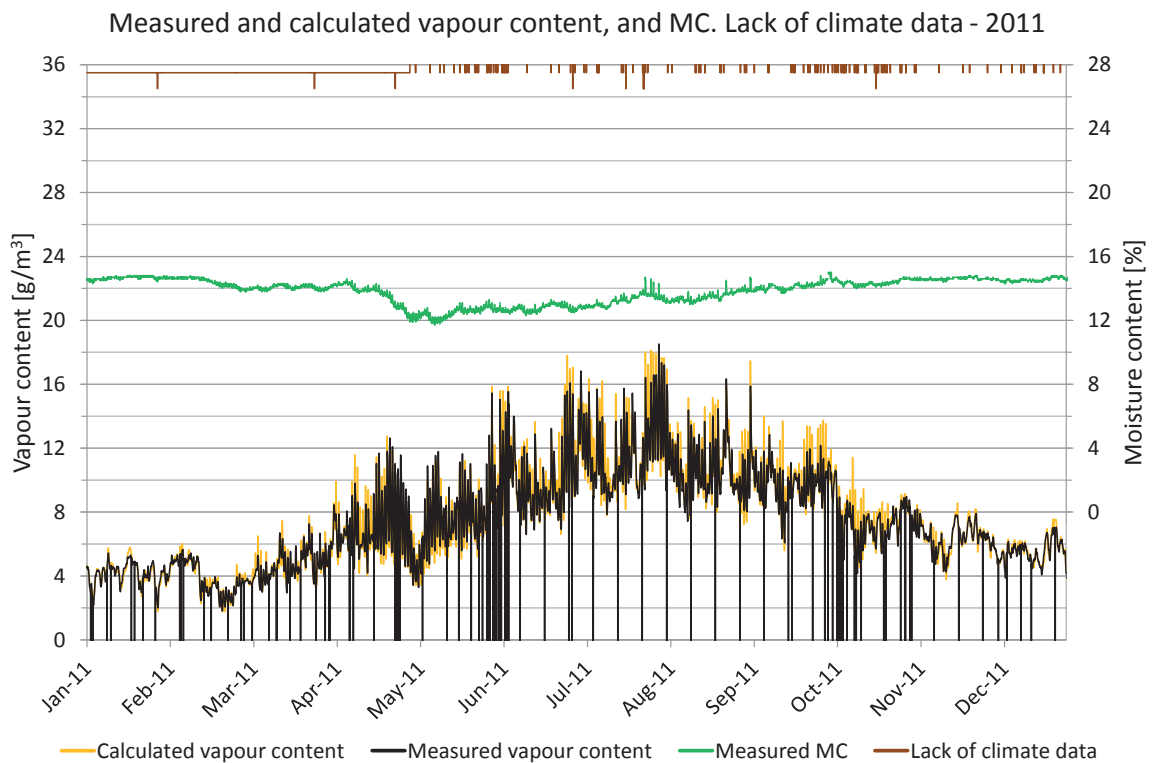

Figure 7.4.10. Measured moisture content, periods lacking climate data and comparisons of vapour content. Vapour content for calculated values (yellow) and measured values (black). Moisture content (green), periods with lack of climate data (brown).

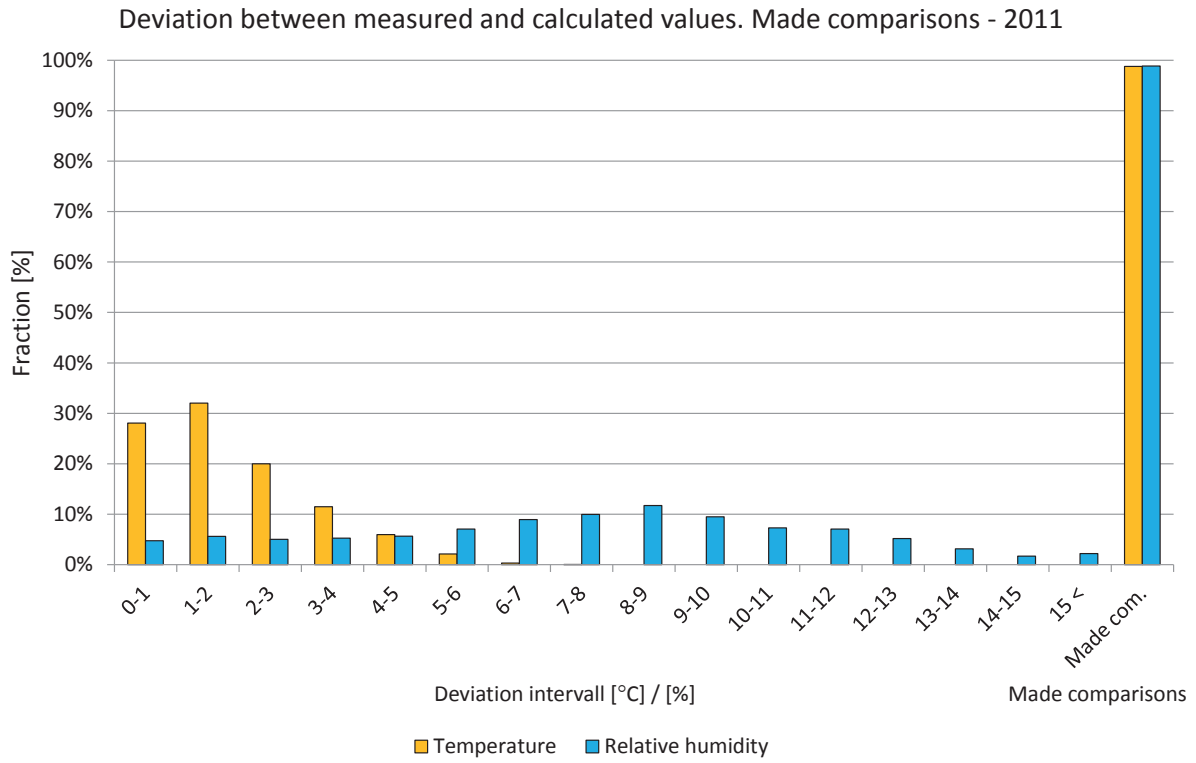

Figure 7.4.11. Deviations in comparisons shown in intervals from 0 to 15 °C or %. The two right-hand bars show the percentage of comparisons during the year. Temperature (yellow) and relative humidity (light blue).

7.5 Position 5

The locations of the measured and calculated position are shown in the drawings and figures below. The studied position is located in a wall facing southeast.

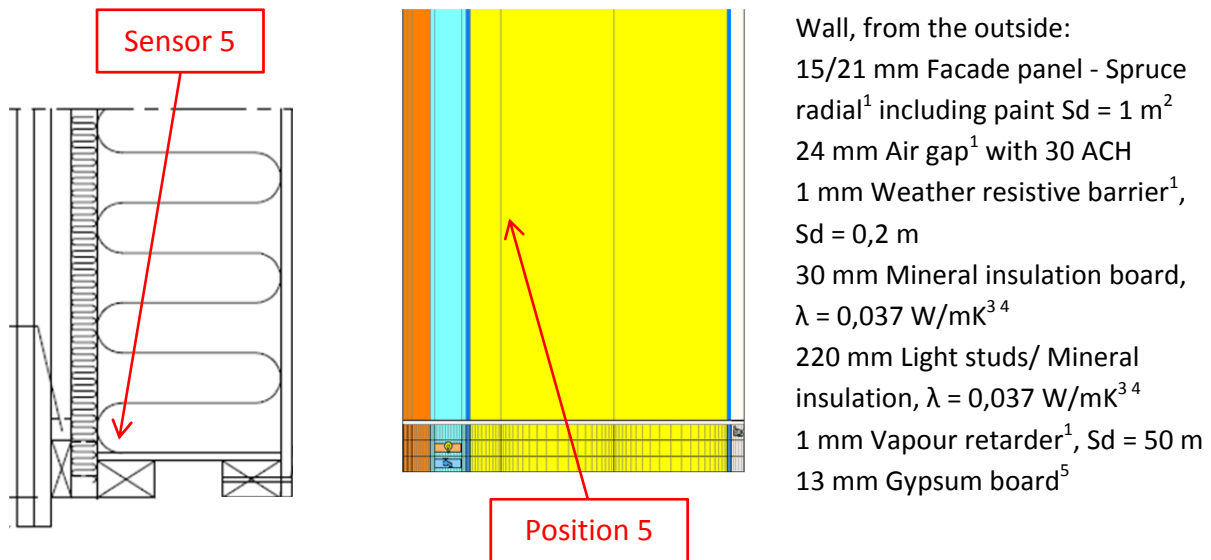

Figure 7.5.1. Vertical cross sectional drawing and WUFI calculation model showing the studied position. 1. IBP, 2012, 2. Nevander, L-E., 1994, 3. IEA Annex 24, 1996, 4. Paroc, 2002, 5. Krus, M., 1996.

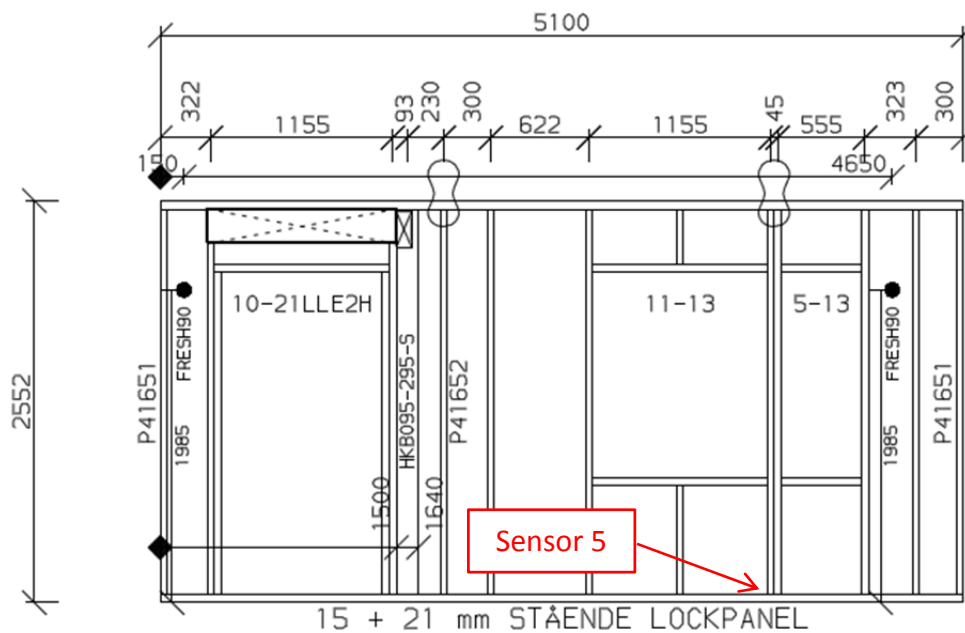

Figure 7.5.2. Location of the studied position.

A perfect match between the measured and calculated values cannot be expected due to e.g. the influence of two- and three-dimensional effects and the accuracy of the sensors.

Year 2009

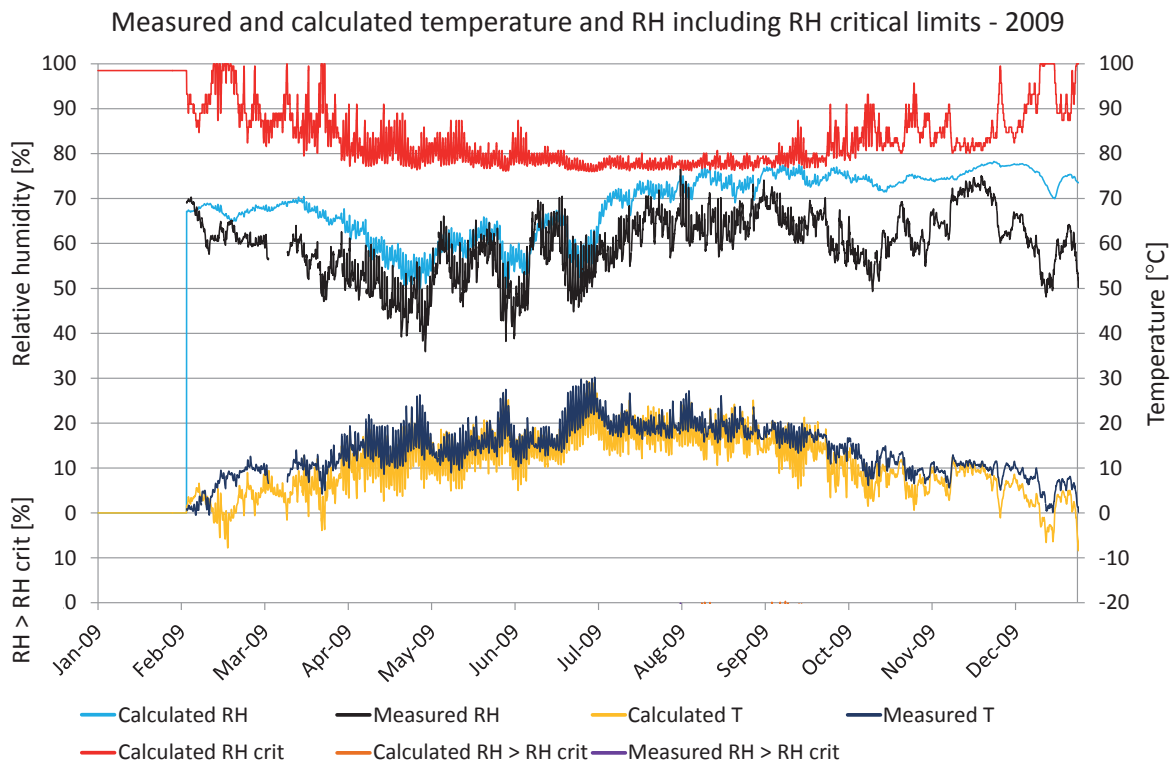

Figure 7.5.3. Comparisons between measured and calculated temperature and relative humidity. Calculated temperature (yellow), measured temperature (dark blue), calculated RH (turquoise), measured RH (black), RH_{crit} for calculated values (red), calculated $RH > RH_{crit}$ (light brown), measured $RH > RH_{crit}$ (purple).

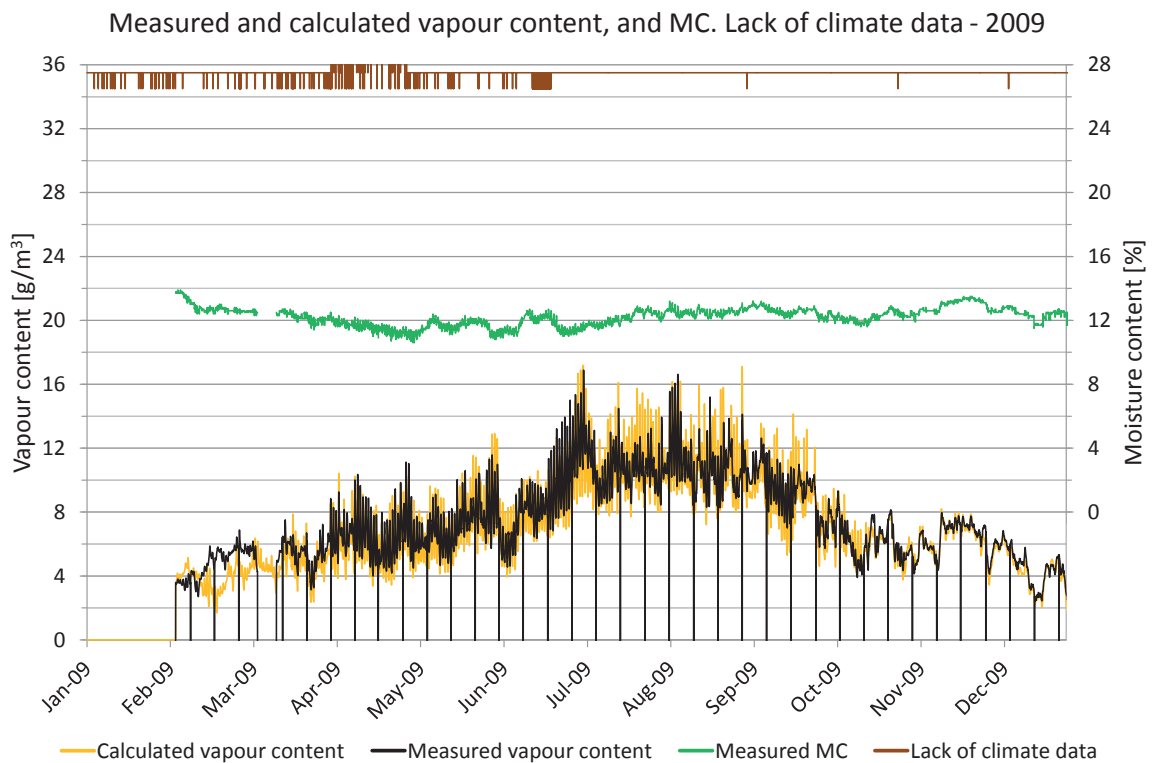

Figure 7.5.4. Measured moisture content, periods lacking climate data and comparisons of vapour content. Vapour content for calculated values (yellow) and measured values (black). Moisture content (green), periods with lack of climate data (brown).

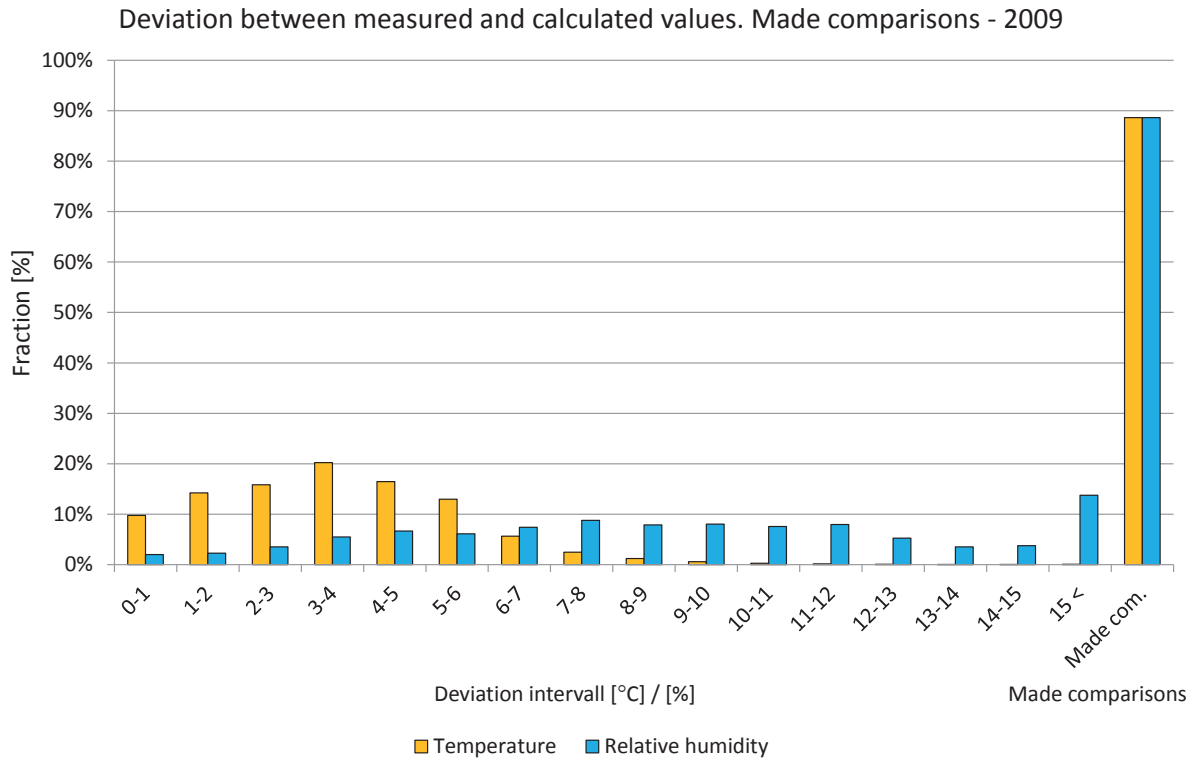

Figure 7.5.5. Deviations in comparisons shown in intervals from 0 to 15 °C or %. The two right-hand bars show the percentage of comparisons during the year. Temperature (yellow) and relative humidity (light blue).

Year 2010

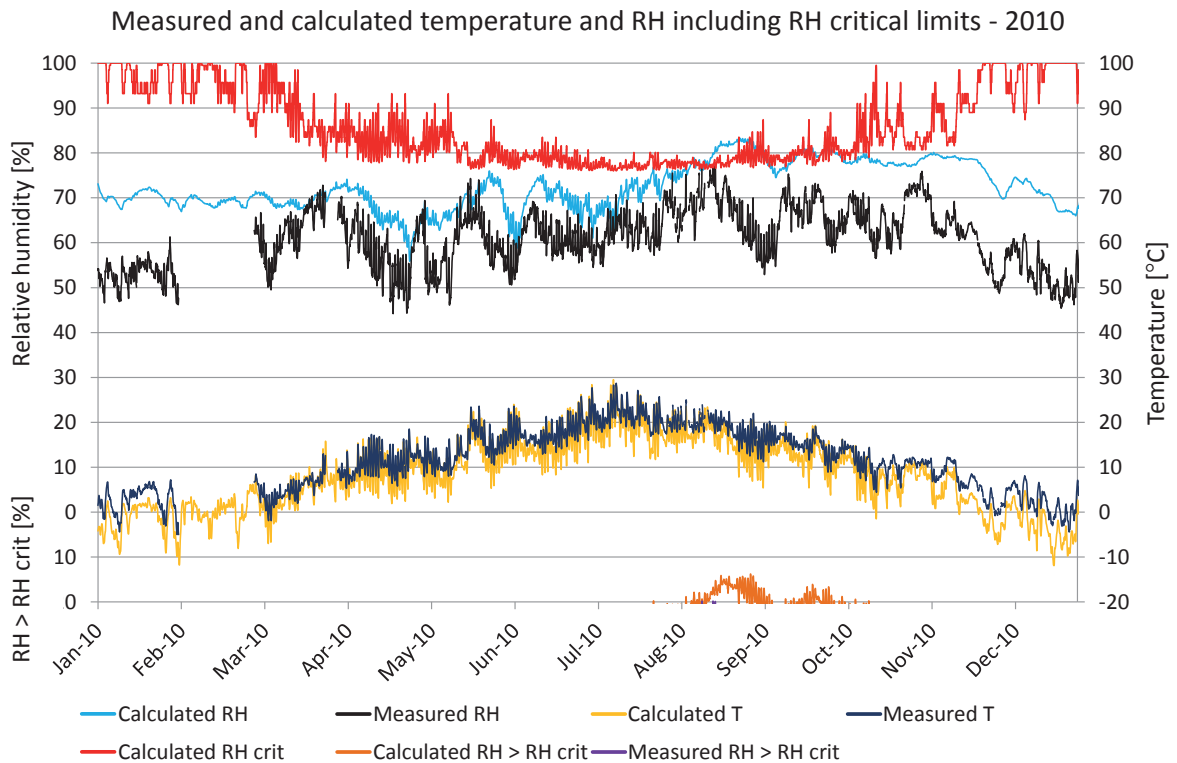

Figure 7.5.6. Comparisons between measured and calculated temperature and relative humidity. Calculated temperature (yellow), measured temperature (dark blue), calculated RH (turquoise), measured RH (black), RH_{crit} for calculated values (red), calculated $RH > RH_{crit}$ (light brown), measured $RH > RH_{crit}$ (purple).

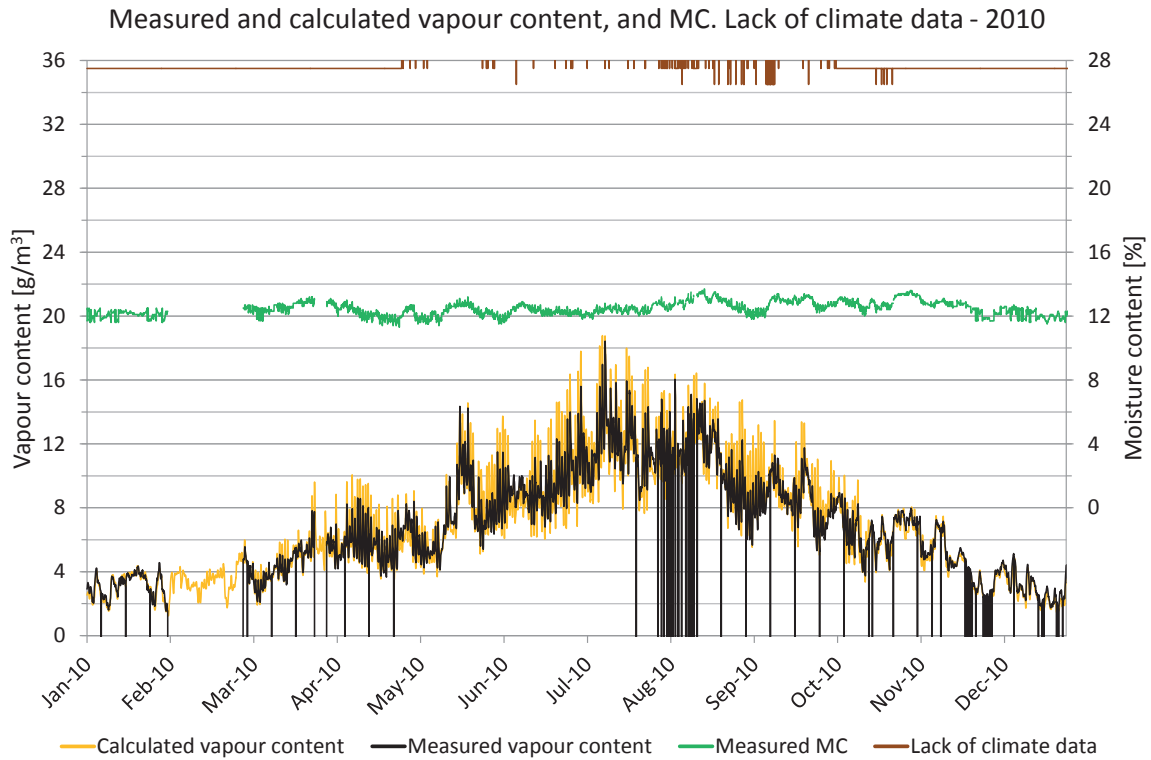

Figure 7.5.7. Measured moisture content, periods lacking climate data and comparisons of vapour content. Vapour content for calculated values (yellow) and measured values (black). Moisture content (green), periods with lack of climate data (brown).

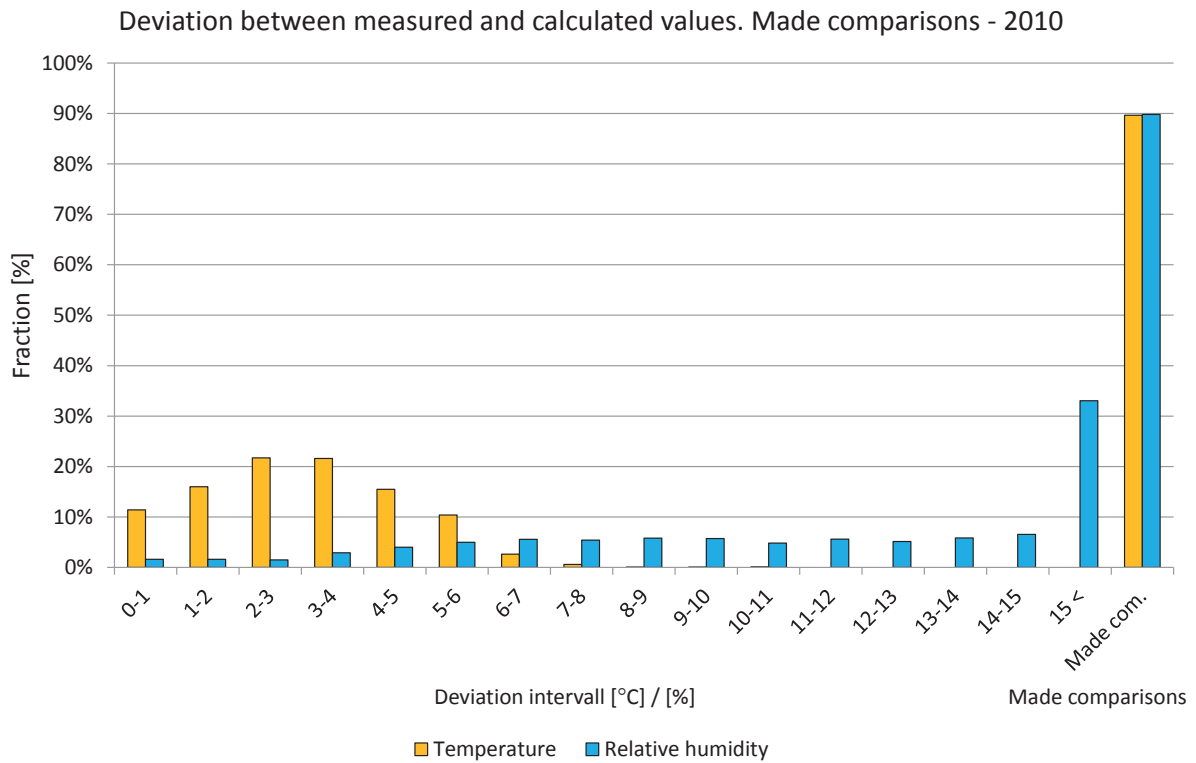

Figure 7.5.8. Deviations in comparisons shown in intervals from 0 to 15 °C or %. The two right-hand bars show the percentage of comparisons during the year. Temperature (yellow) and relative humidity (light blue).

Year 2011

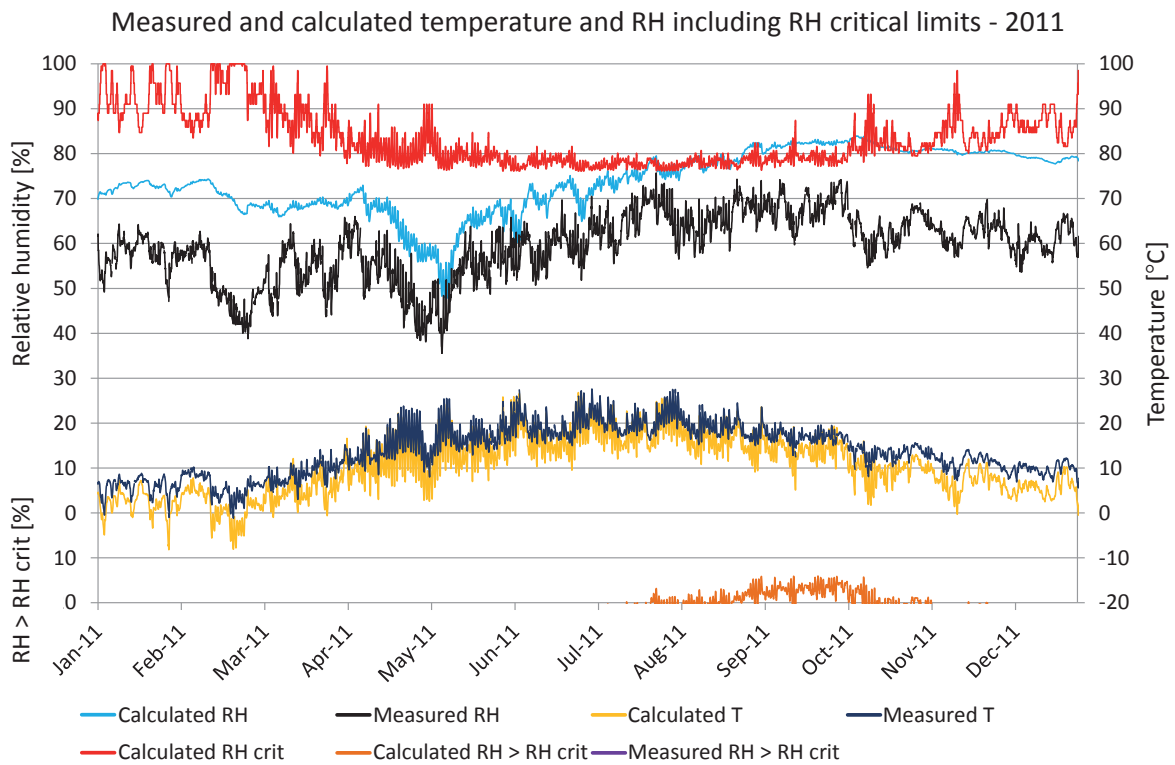

Figure 7.5.9. Comparisons between measured and calculated temperature and relative humidity. Calculated temperature (yellow), measured temperature (dark blue), calculated RH (turquoise), measured RH (black), RH_{crit} for calculated values (red), calculated $RH > RH_{crit}$ (light brown), measured $RH > RH_{crit}$ (purple).

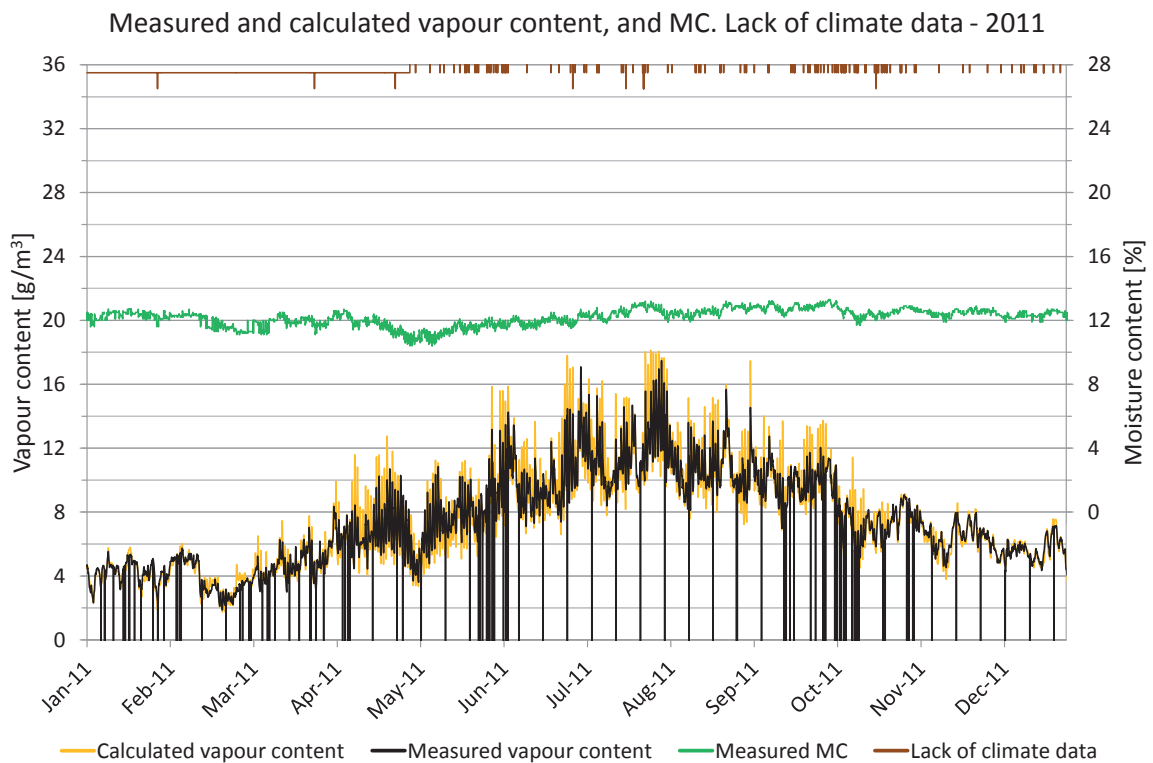

Figure 7.5.10. Measured moisture content, periods lacking climate data and comparisons of vapour content. Vapour content for calculated values (yellow) and measured values (black). Moisture content (green), periods with lack of climate data (brown).

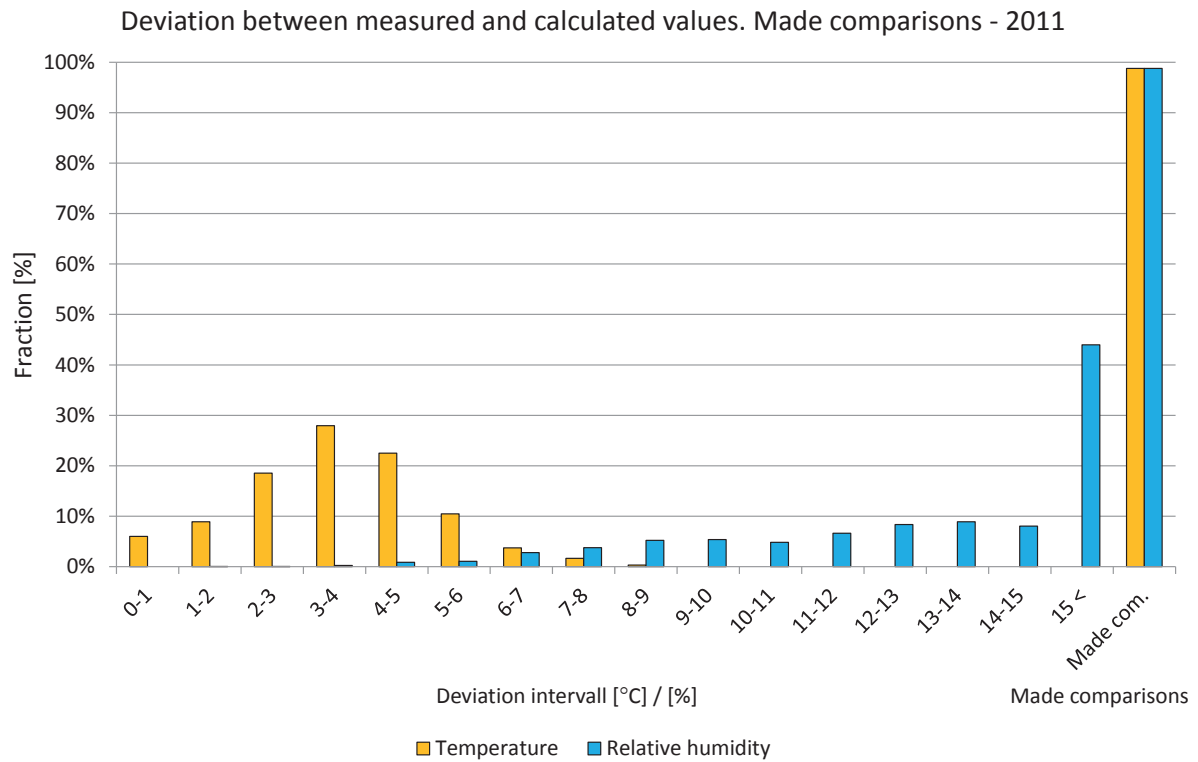

Figure 7.5.11. Deviations in comparisons shown in intervals from 0 to 15 °C or %. The two right-hand bars show the percentage of comparisons during the year. Temperature (yellow) and relative humidity (light blue).

7.6 Position 6

The locations of the measured and calculated position are shown in the drawings and figures below. The studied position is located in a wall facing northeast.

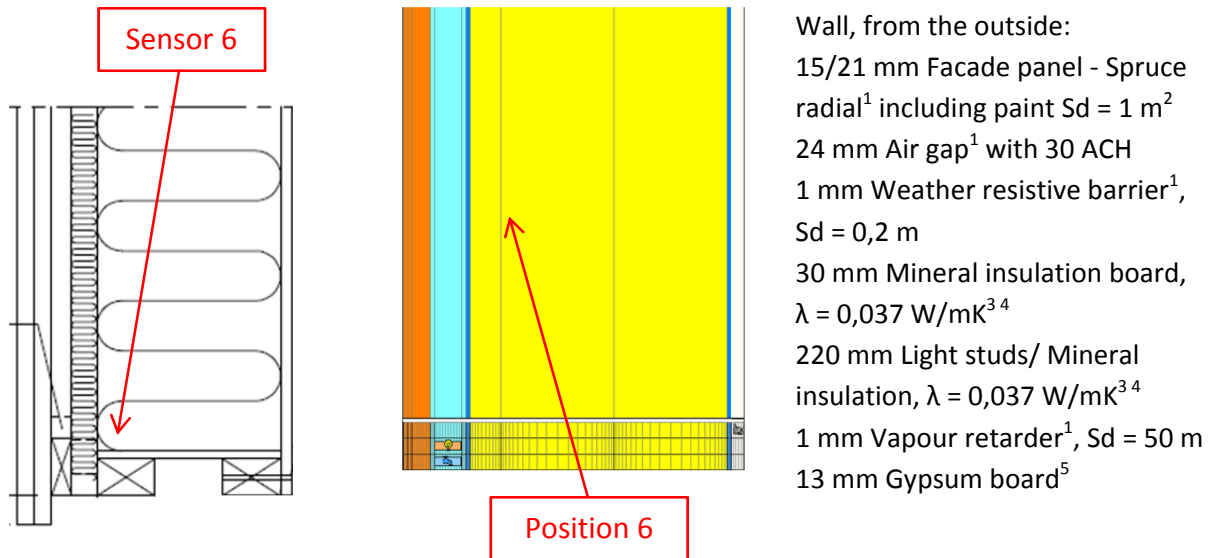

Figure 7.6.1. Vertical cross sectional drawing and WUFI calculation model showing the studied position. 1. IBP, 2012, 2. Nevander, L-E., 1994, 3. IEA Annex 24, 1996, 4. Paroc, 2002, 5. Krus, M., 1996.

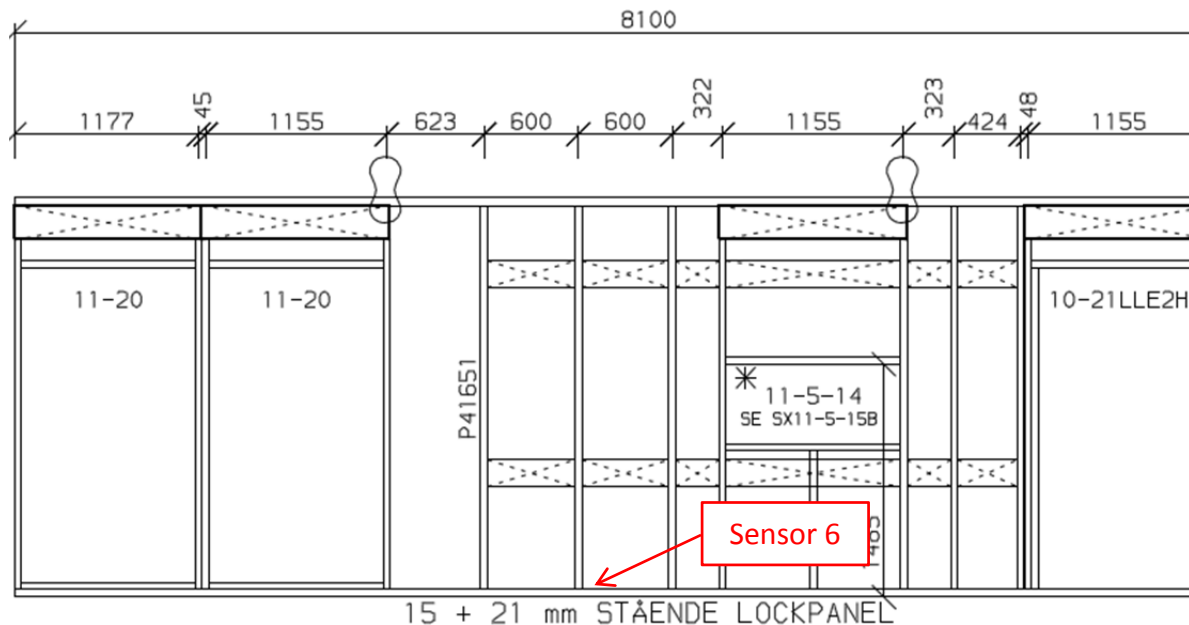

Figure 7.6.2. Location of the studied position.

A perfect match between the measured and calculated values cannot be expected due to e.g. the influence of two- and three-dimensional effects and the accuracy of the sensors.

Year 2009

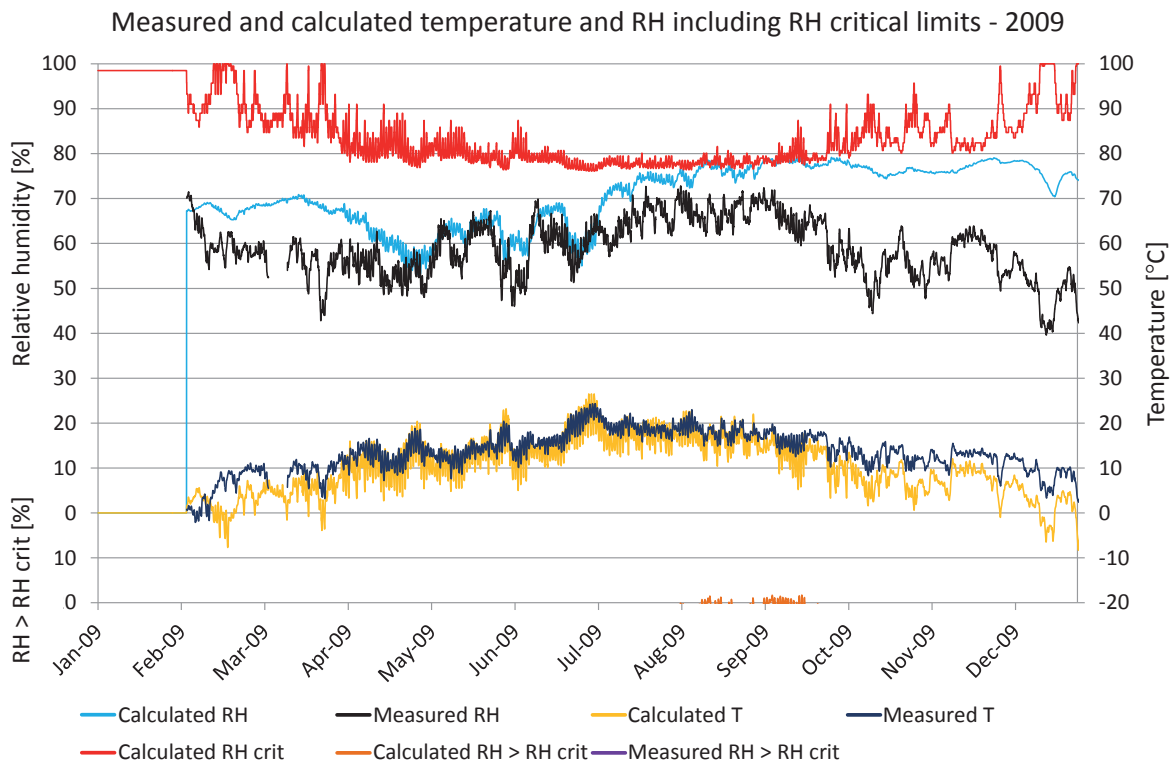

Figure 7.6.3. Comparisons between measured and calculated temperature and relative humidity. Calculated temperature (yellow), measured temperature (dark blue), calculated RH (turquoise), measured RH (black), RH_{crit} for calculated values (red), calculated $RH > RH_{crit}$ (light brown), measured $RH > RH_{crit}$ (purple).

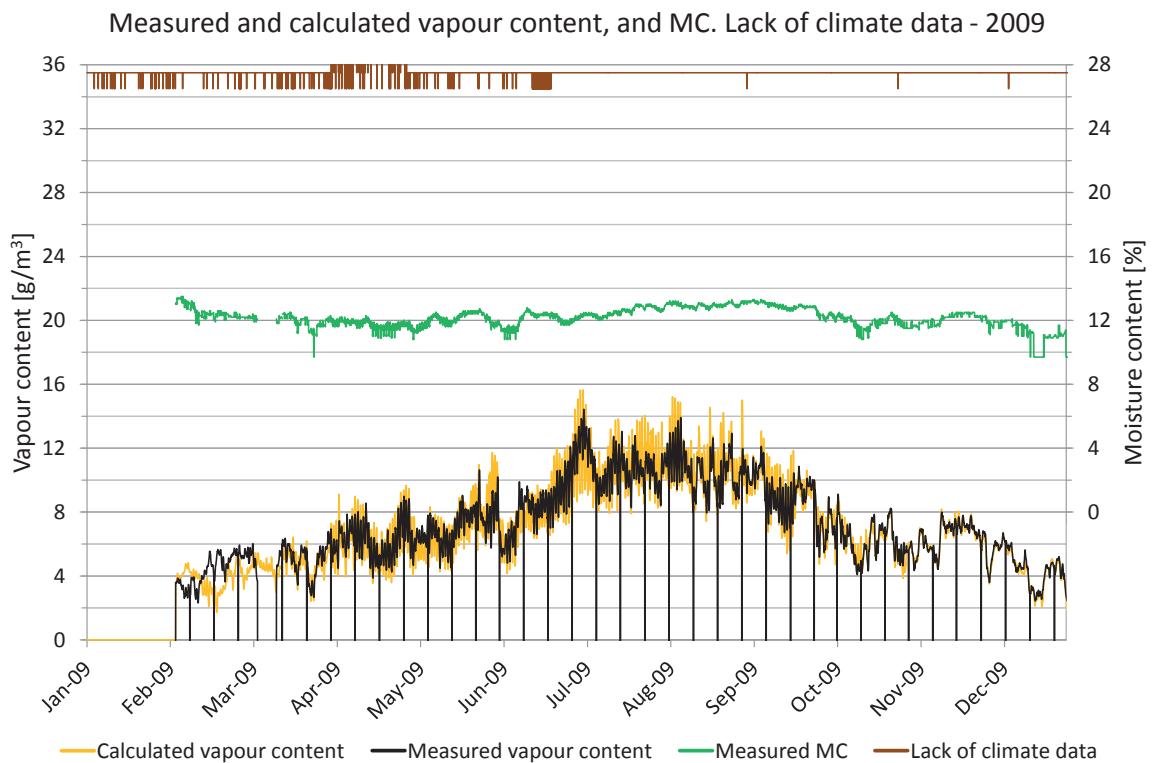

Figure 7.6.4. Measured moisture content, periods lacking climate data and comparisons of vapour content. Vapour content for calculated values (yellow) and measured values (black). Moisture content (green), periods with lack of climate data (brown).

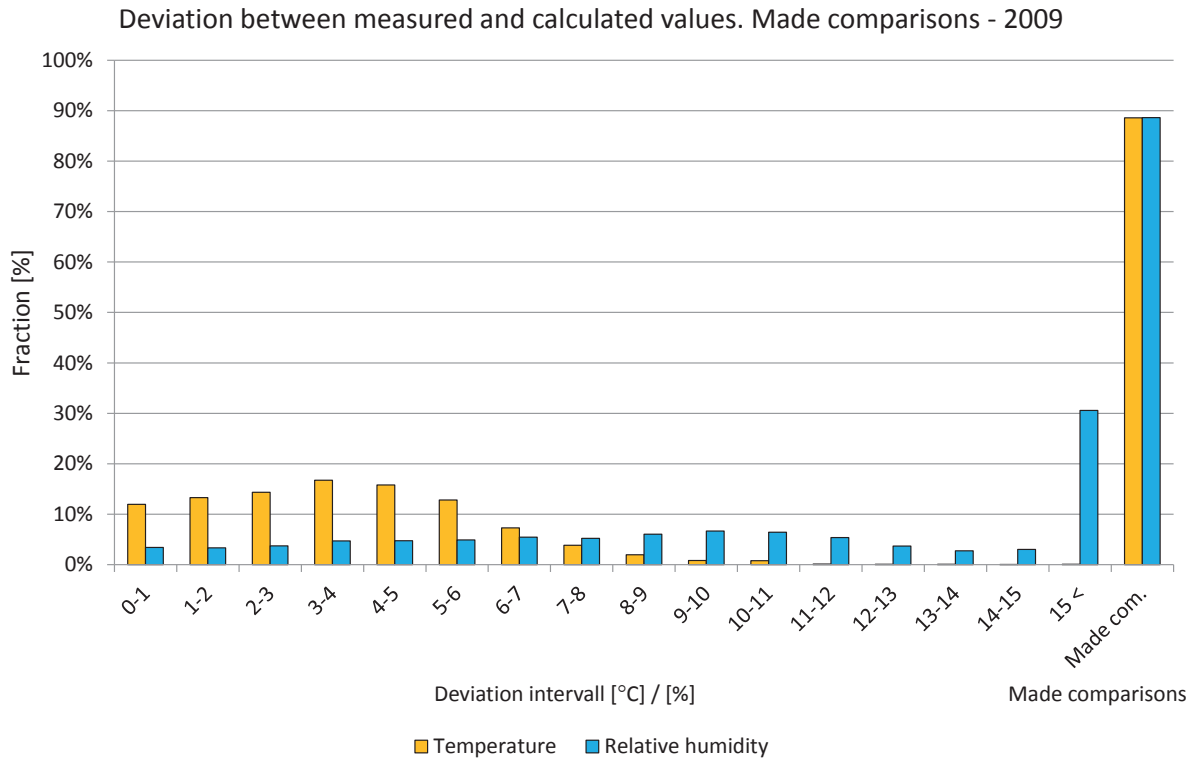

Figure 7.6.5. Deviations in comparisons shown in intervals from 0 to 15 °C or %. The two right-hand bars show the percentage of comparisons during the year. Temperature (yellow) and relative humidity (light blue).

Year 2010

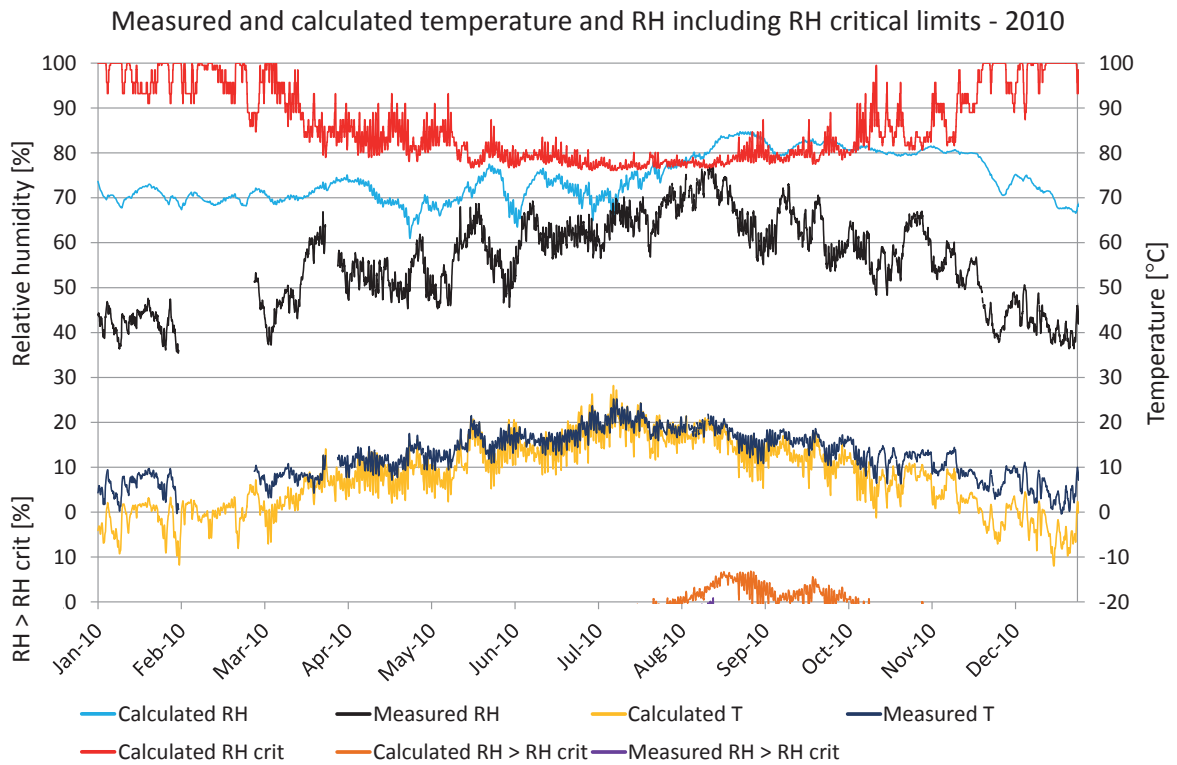

Figure 7.6.6. Comparisons between measured and calculated temperature and relative humidity. Calculated temperature (yellow), measured temperature (dark blue), calculated RH (turquoise), measured RH (black), RH_{crit} for calculated values (red), calculated $RH > RH_{crit}$ (light brown), measured $RH > RH_{crit}$ (purple).

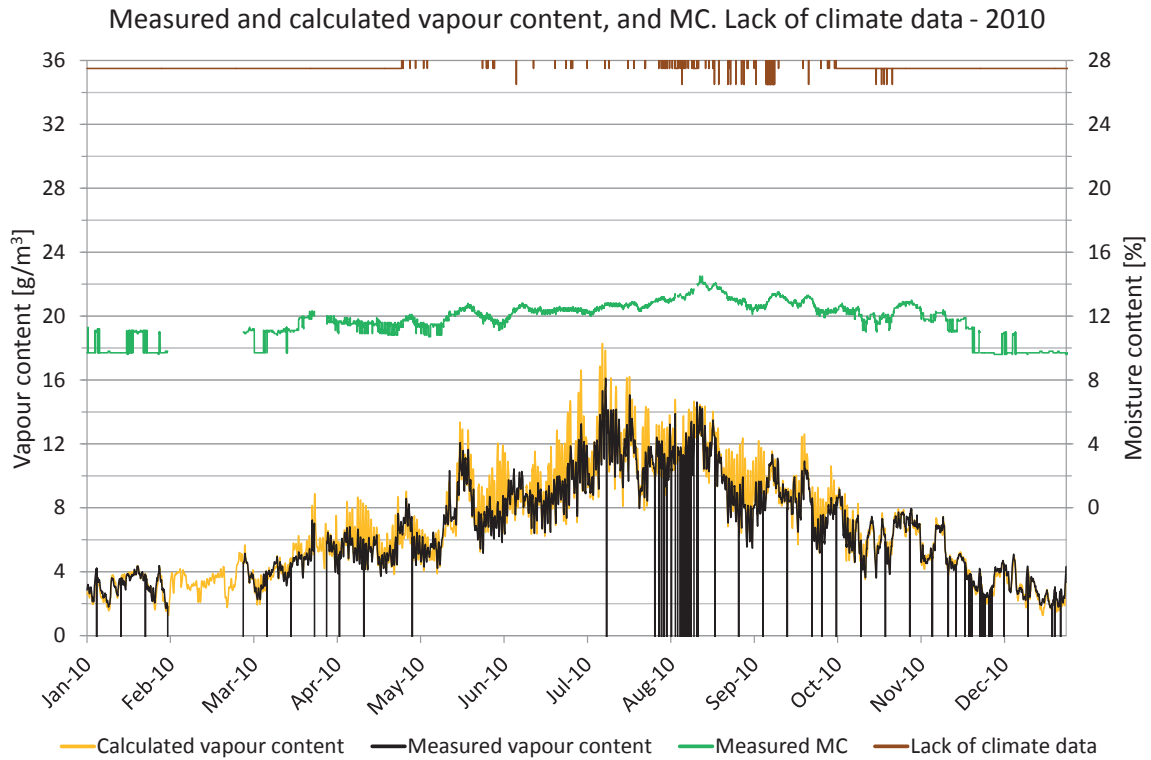

Figure 7.6.7. Measured moisture content, periods lacking climate data and comparisons of vapour content. Vapour content for calculated values (yellow) and measured values (black). Moisture content (green), periods with lack of climate data (brown).

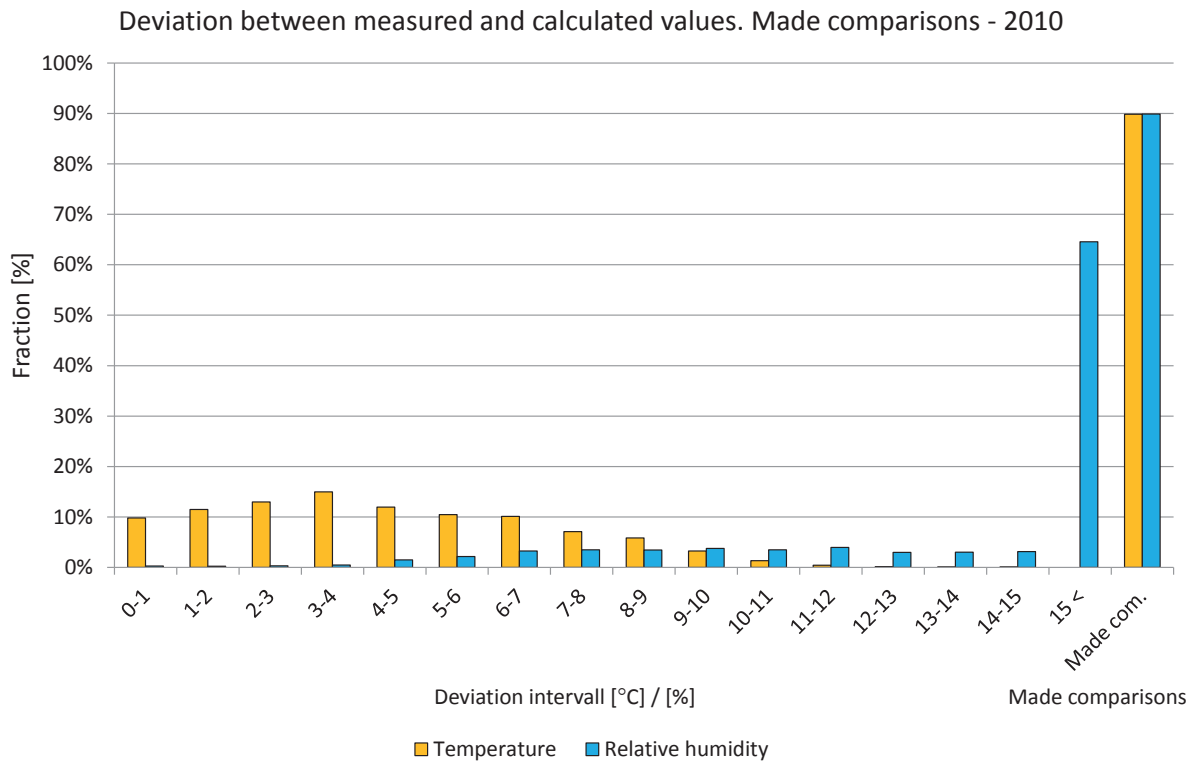

Figure 7.6.8. Deviations in comparisons shown in intervals from 0 to 15 °C or %. The two right-hand bars show the percentage of comparisons during the year. Temperature (yellow) and relative humidity (light blue).

Year 2011

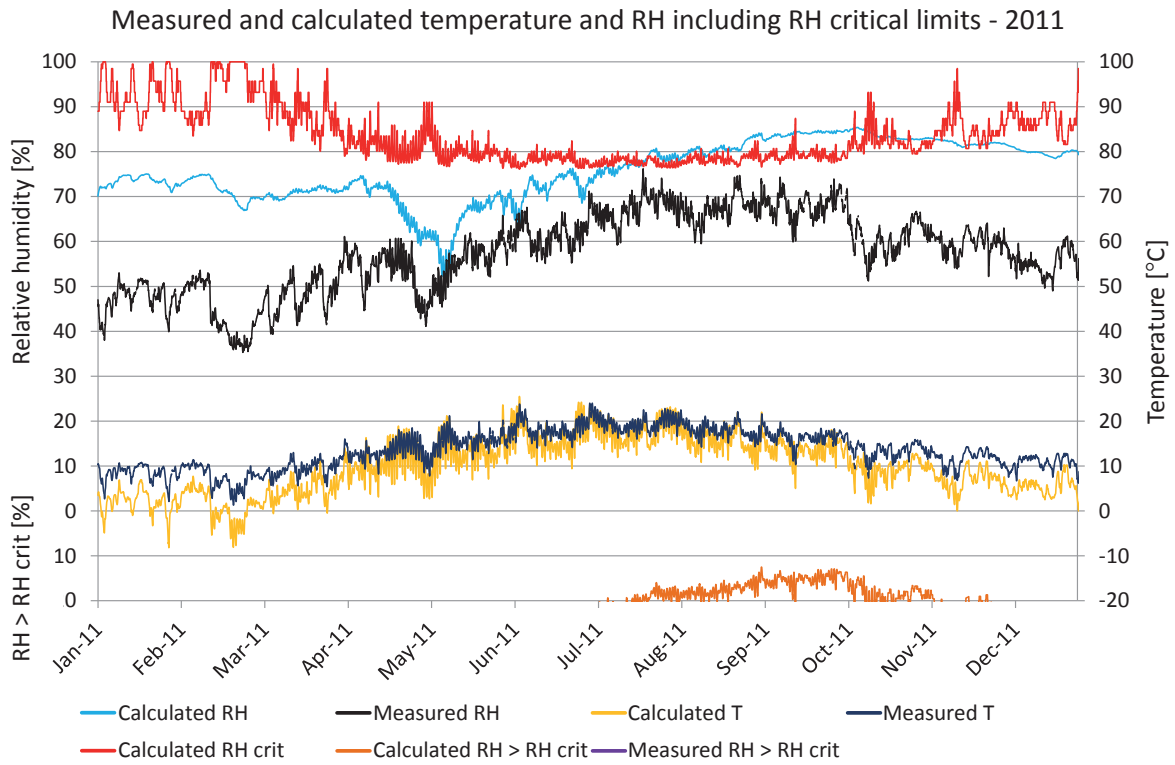

Figure 7.6.9. Comparisons between measured and calculated temperature and relative humidity. Calculated temperature (yellow), measured temperature (dark blue), calculated RH (turquoise), measured RH (black), RH_{crit} for calculated values (red), calculated $RH > RH_{crit}$ (light brown), measured $RH > RH_{crit}$ (purple).

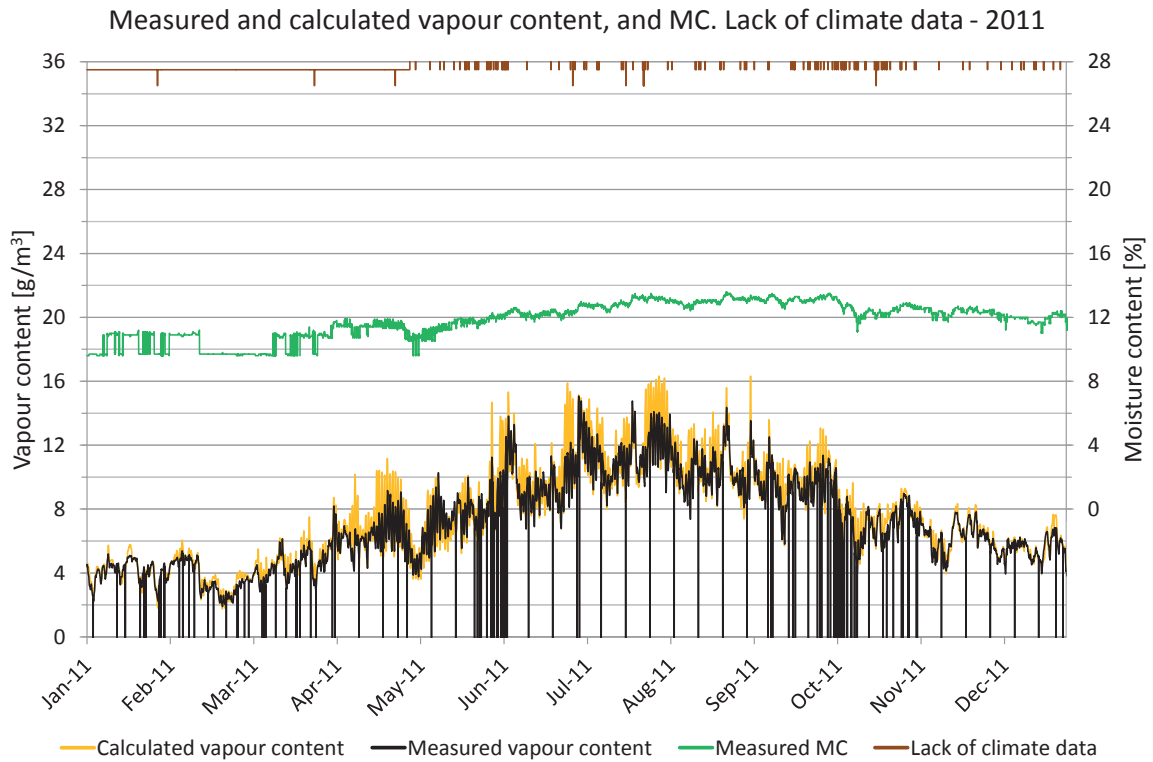

Figure 7.6.10. Measured moisture content, periods lacking climate data and comparisons of vapour content. Vapour content for calculated values (yellow) and measured values (black). Moisture content (green), periods with lack of climate data (brown).

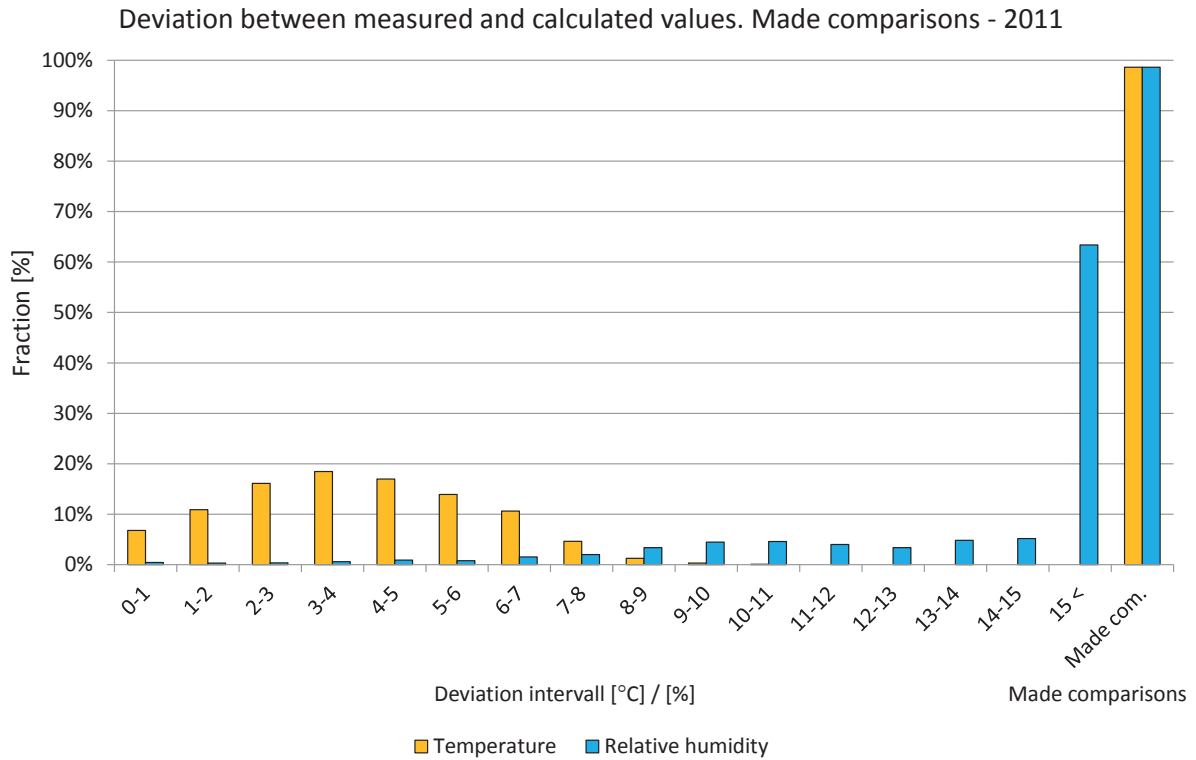

Figure 7.6.11. Deviations in comparisons shown in intervals from 0 to 15 °C or %. The two right-hand bars show the percentage of comparisons during the year. Temperature (yellow) and relative humidity (light blue).

7.7 Position 7

The locations of the measured and calculated position are shown in the drawings and figures below. The studied position is located in a wall facing northeast.

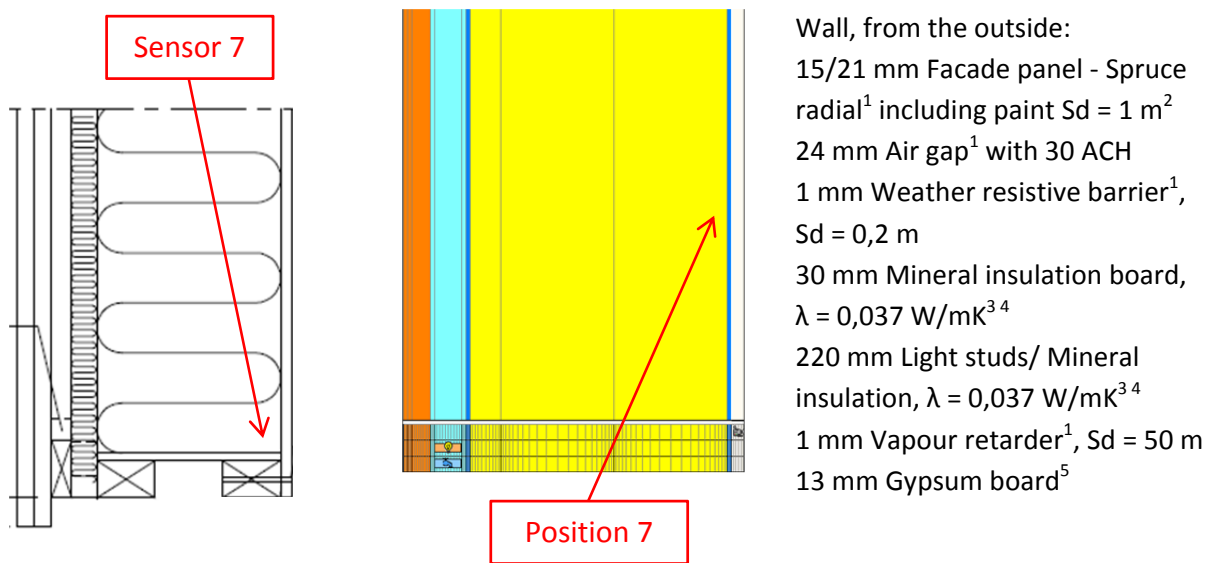

Figure 7.7.1. Vertical cross sectional drawing and WUFI calculation model showing the studied position. 1. IBP, 2012, 2. Nevander, L-E., 1994, 3. IEA Annex 24, 1996, 4. Paroc, 2002, 5. Krus, M., 1996.

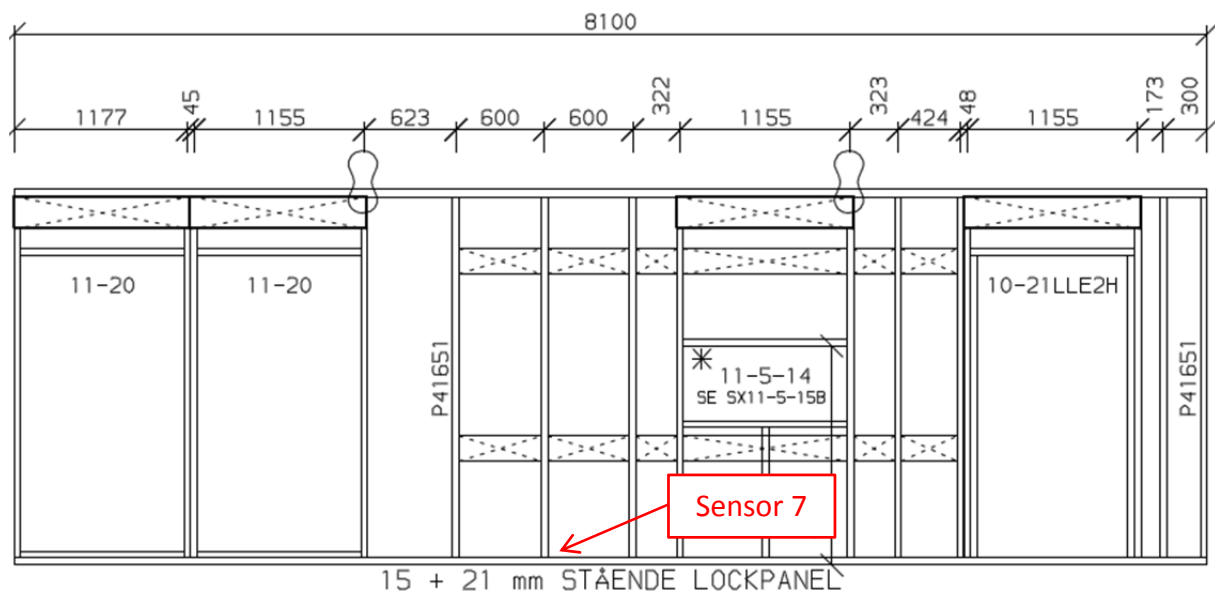

Figure 7.7.2. Location of the studied position.

A perfect match between the measured and calculated values cannot be expected due to e.g. the influence of two- and three-dimensional effects and the accuracy of the sensors.

Year 2009

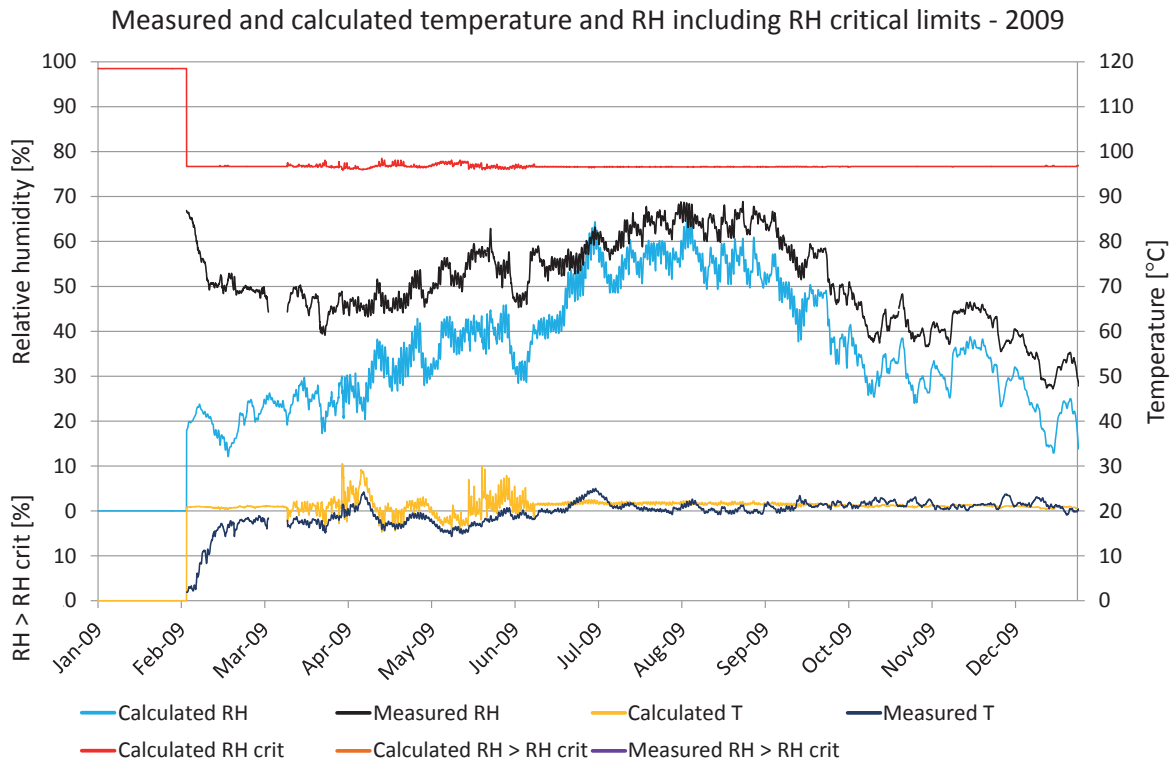

Figure 7.7.3. Comparisons between measured and calculated temperature and relative humidity. Calculated temperature (yellow), measured temperature (dark blue), calculated RH (turquoise), measured RH (black), RH_{crit} for calculated values (red), calculated $RH > RH_{crit}$ (light brown), measured $RH > RH_{crit}$ (purple).

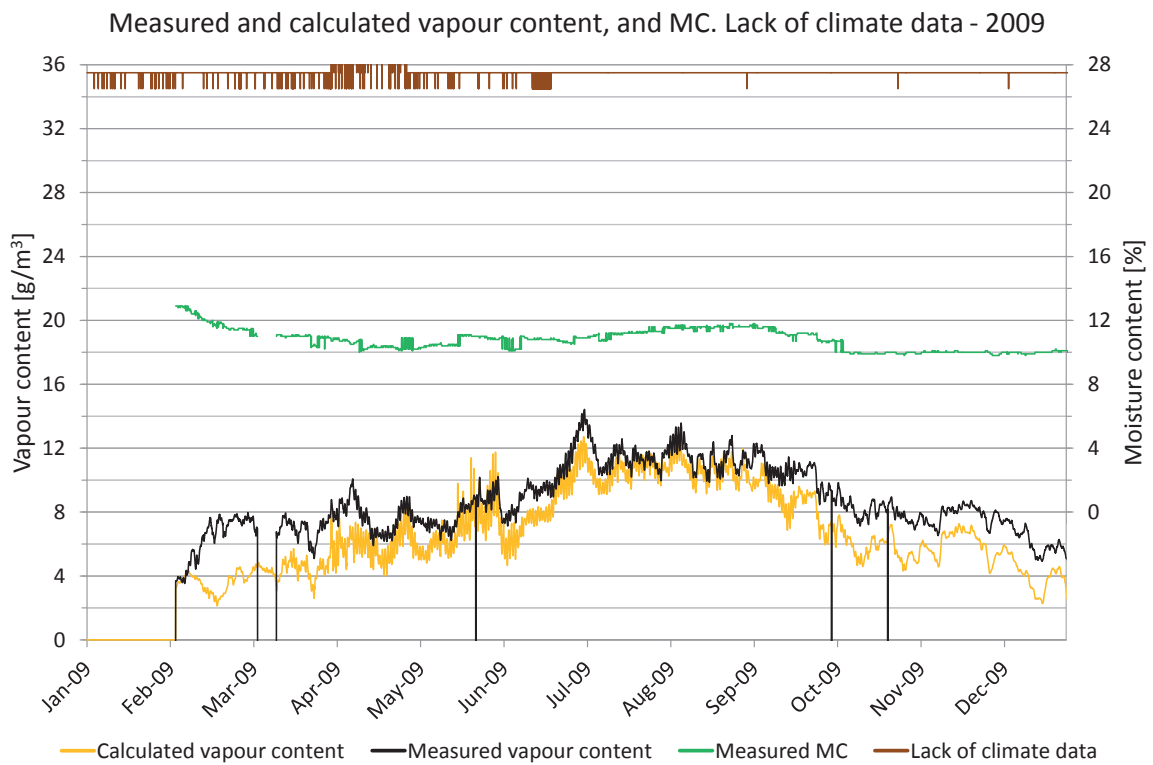

Figure 7.7.4. Measured moisture content, periods lacking climate data and comparisons of vapour content. Vapour content for calculated values (yellow) and measured values (black). Moisture content (green), periods with lack of climate data (brown).

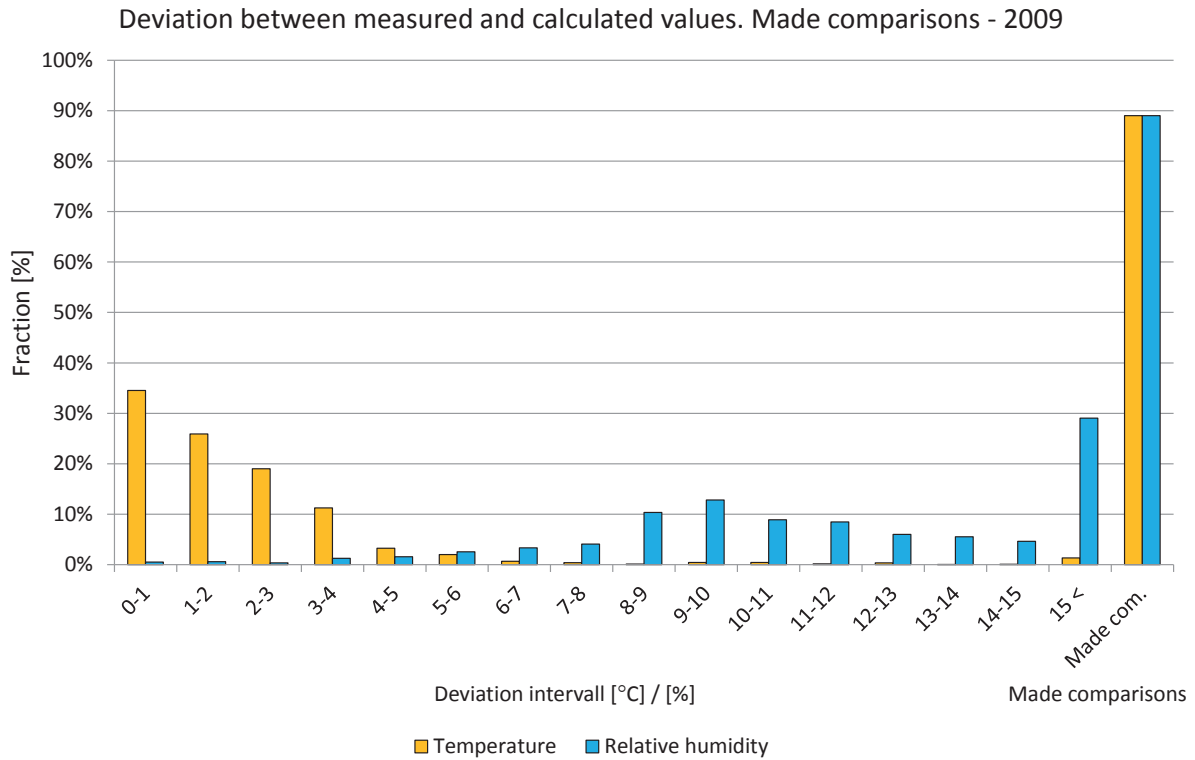

Figure 7.7.5. Deviations in comparisons shown in intervals from 0 to 15 °C or %. The two right-hand bars show the percentage of comparisons during the year. Temperature (yellow) and relative humidity (light blue).

Year 2010

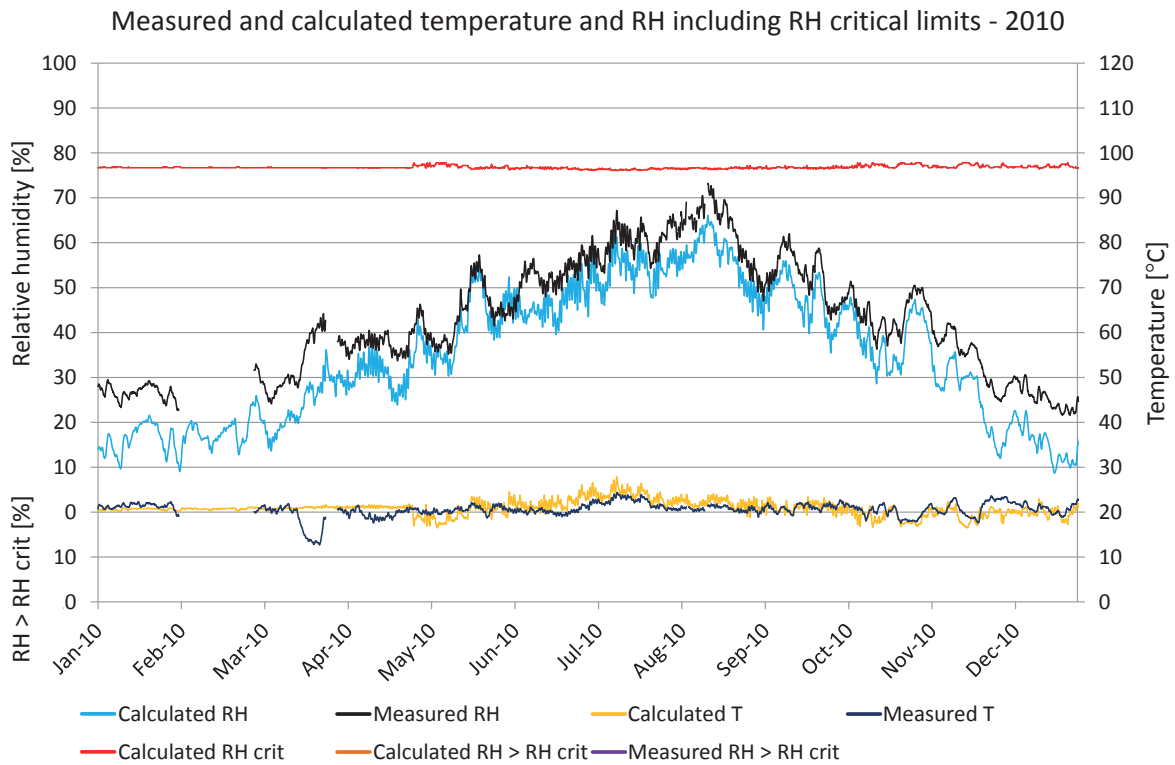

Figure 7.7.6. Comparisons between measured and calculated temperature and relative humidity. Calculated temperature (yellow), measured temperature (dark blue), calculated RH (turquoise), measured RH (black), RH_{crit} for calculated values (red), calculated RH > RH_{crit} (light brown), measured RH > RH_{crit} (purple).

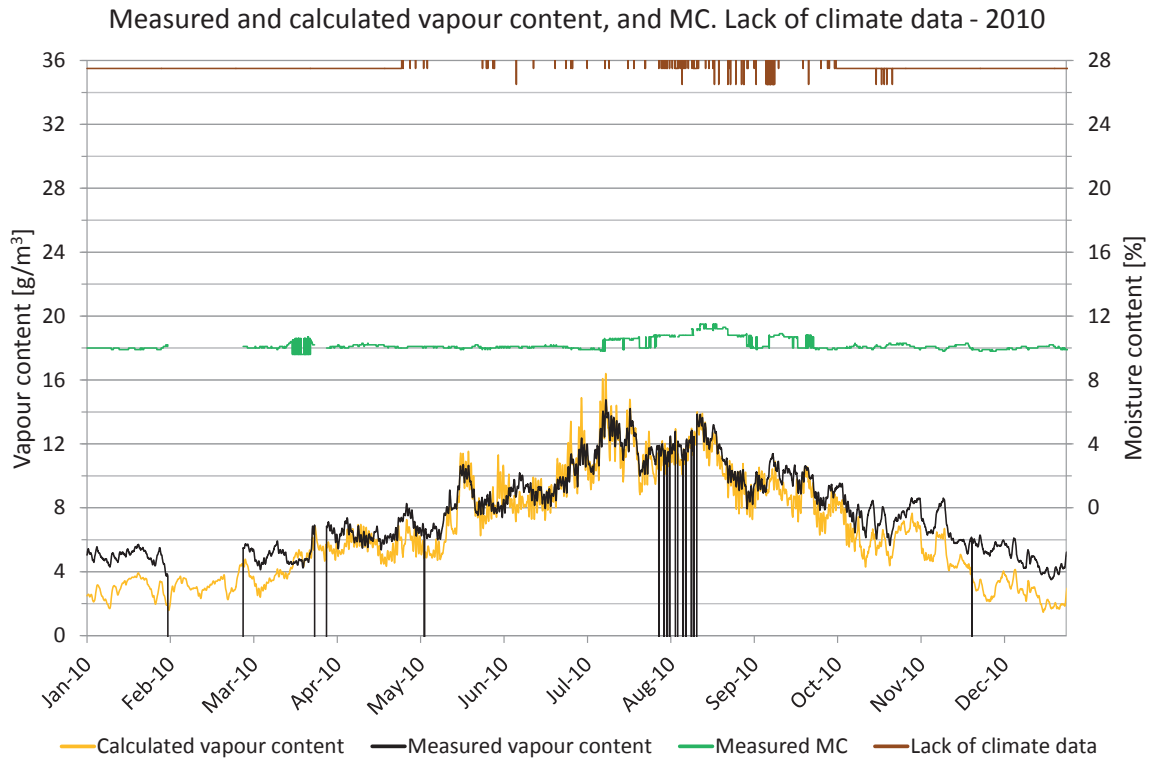

Figure 7.7.7. Measured moisture content, periods lacking climate data and comparisons of vapour content. Vapour content for calculated values (yellow) and measured values (black). Moisture content (green), periods with lack of climate data (brown).

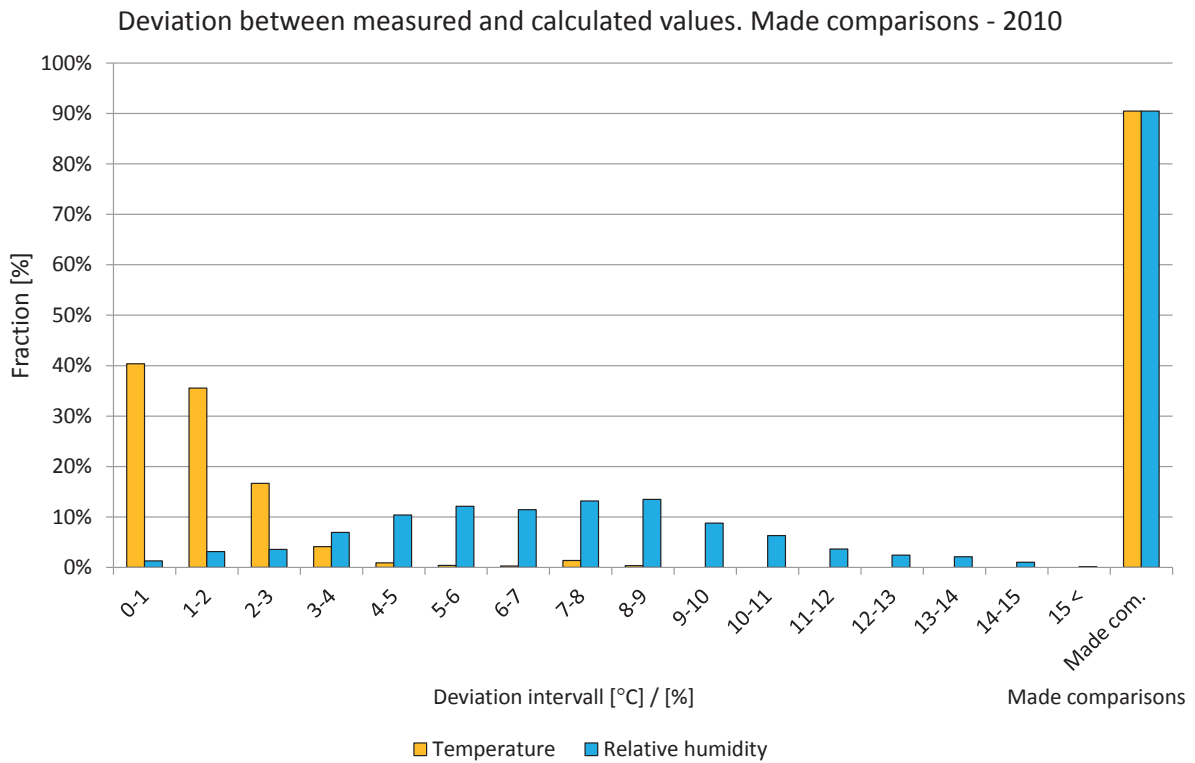

Figure 7.7.8. Deviations in comparisons shown in intervals from 0 to 15 °C or %. The two right-hand bars show the percentage of comparisons during the year. Temperature (yellow) and relative humidity (light blue).

Year 2011

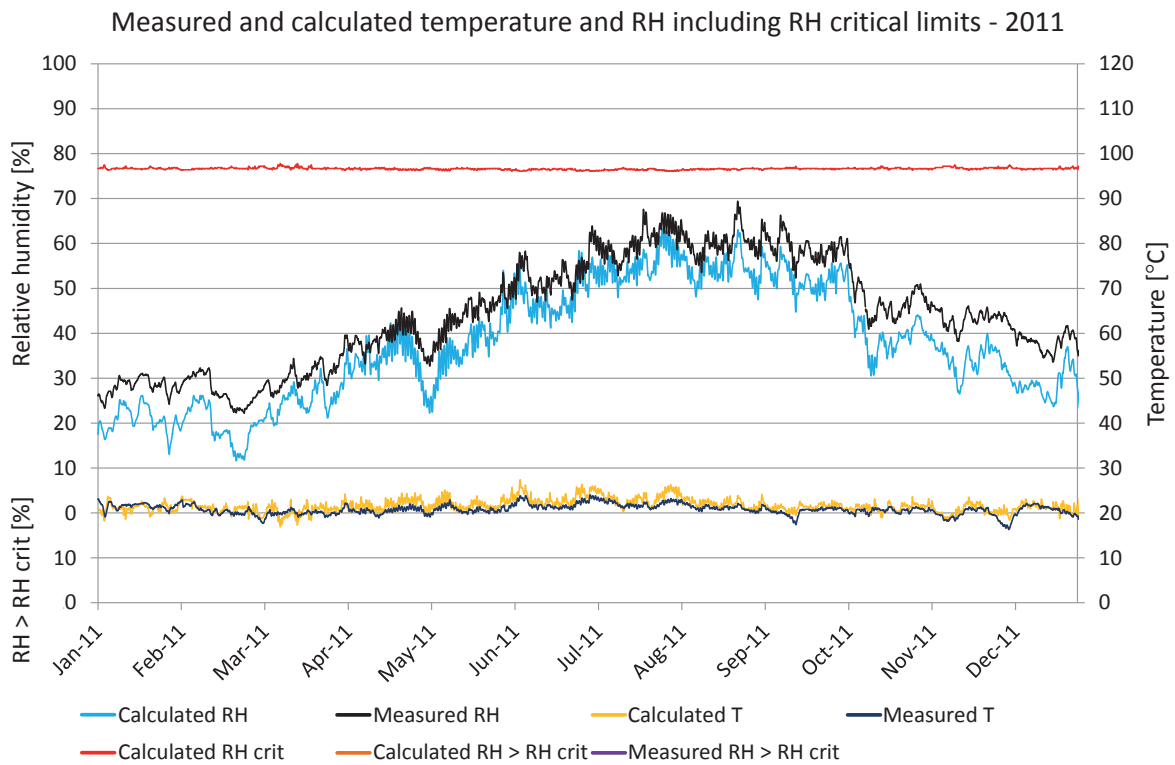

Figure 7.7.9. Comparisons between measured and calculated temperature and relative humidity. Calculated temperature (yellow), measured temperature (dark blue), calculated RH (turquoise), measured RH (black), RH_{crit} for calculated values (red), calculated $RH > RH_{crit}$ (light brown), measured $RH > RH_{crit}$ (purple).

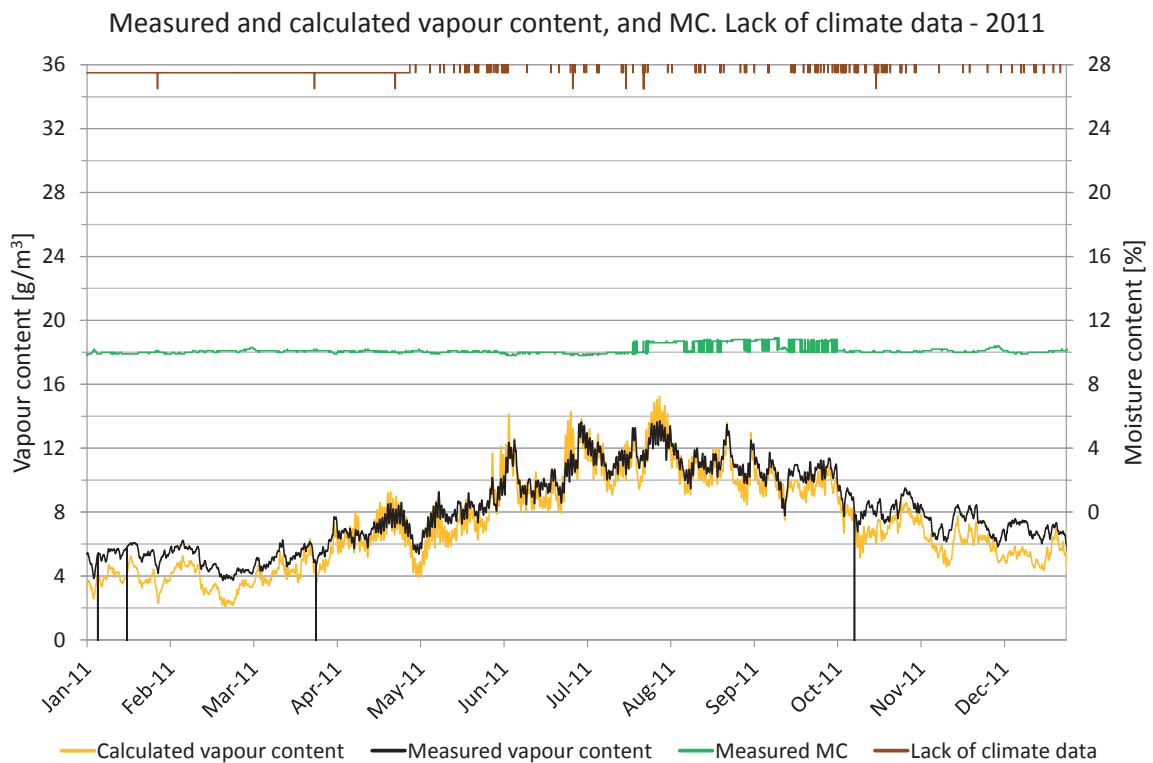

Figure 7.7.10. Measured moisture content, periods lacking climate data and comparisons of vapour content. Vapour content for calculated values (yellow) and measured values (black). Moisture content (green), periods with lack of climate data (brown).

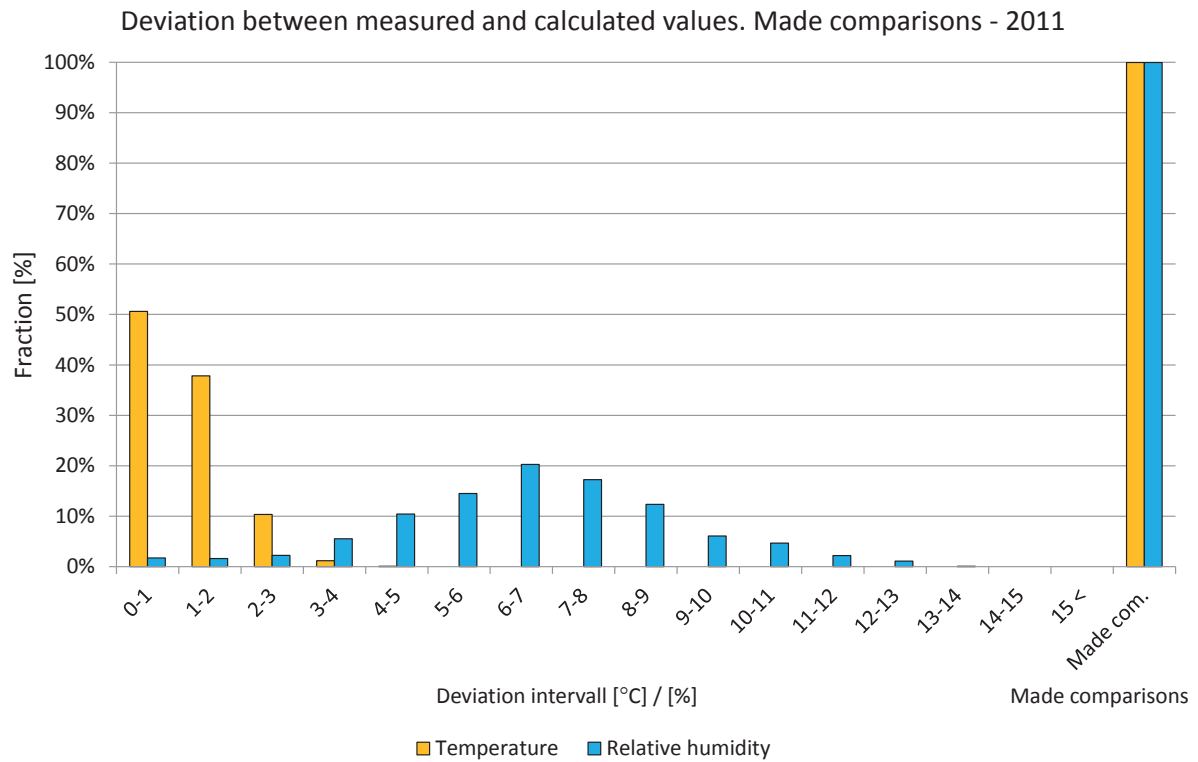

Figure 7.7.11. Deviations in comparisons shown in intervals from 0 to 15 °C or %. The two right-hand bars show the percentage of comparisons during the year. Temperature (yellow) and relative humidity (light blue).

7.8 Position 8

The locations of the measured and calculated position are shown in the drawings and figures below. The studied position is located in a wall facing northeast.

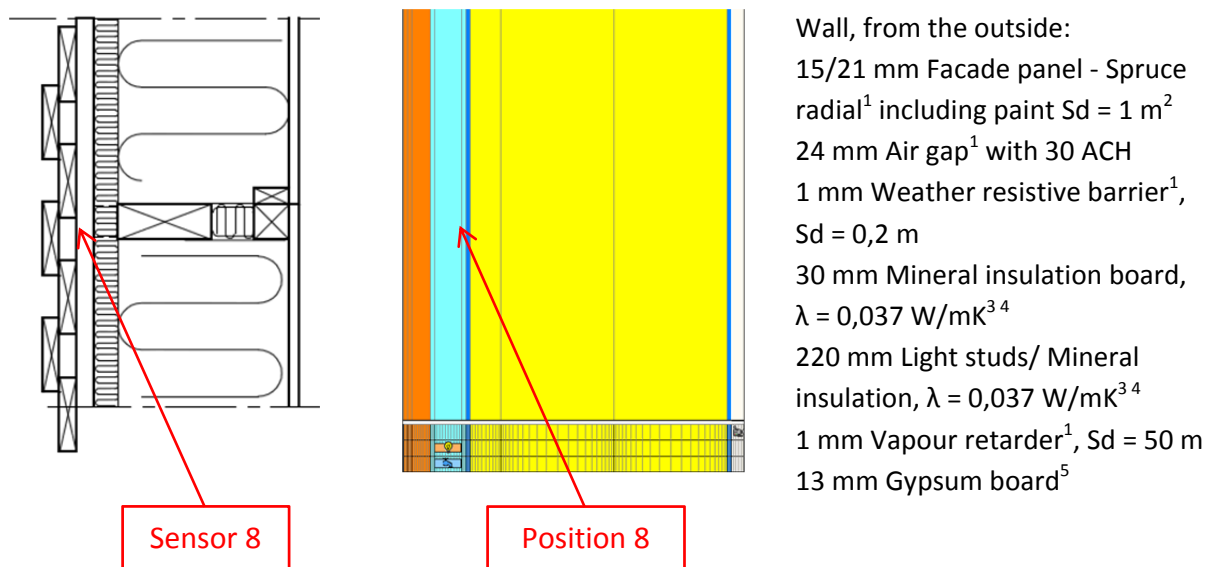

Figure 7.8.1. Vertical cross sectional drawing and WUFI calculation model showing the studied position. 1. IBP, 2012, 2. Nevander, L-E., 1994, 3. IEA Annex 24, 1996, 4. Paroc, 2002, 5. Krus, M., 1996.

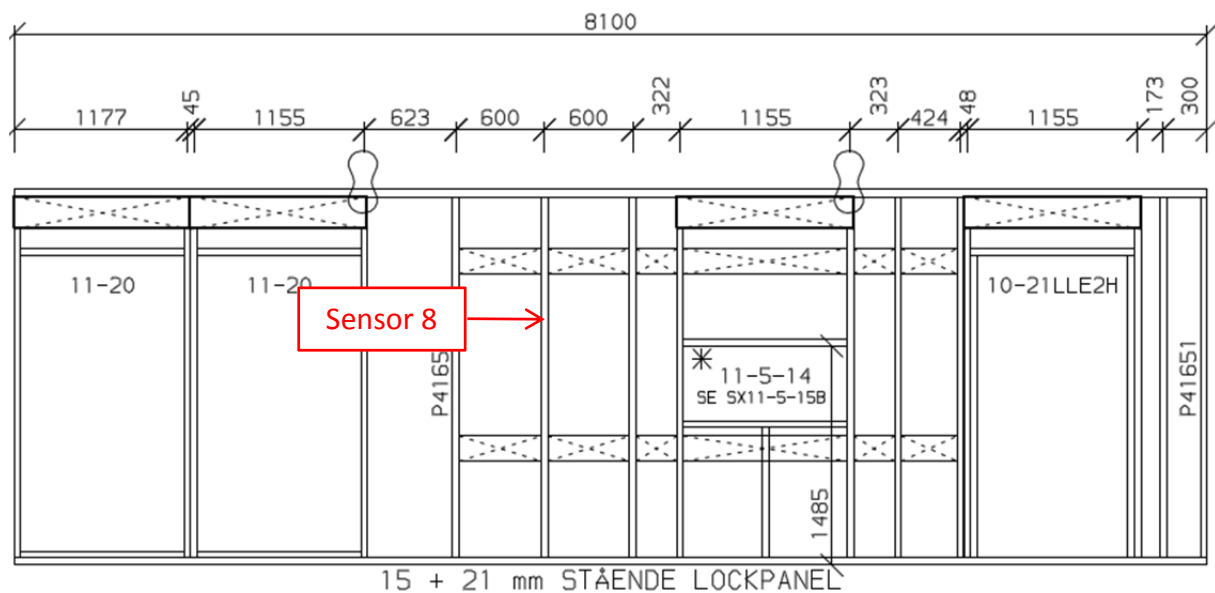

Figure 7.8.2. Location of the studied position.

A perfect match between the measured and calculated values cannot be expected due to e.g. the influence of two- and three-dimensional effects and the accuracy of the sensors.

Year 2009

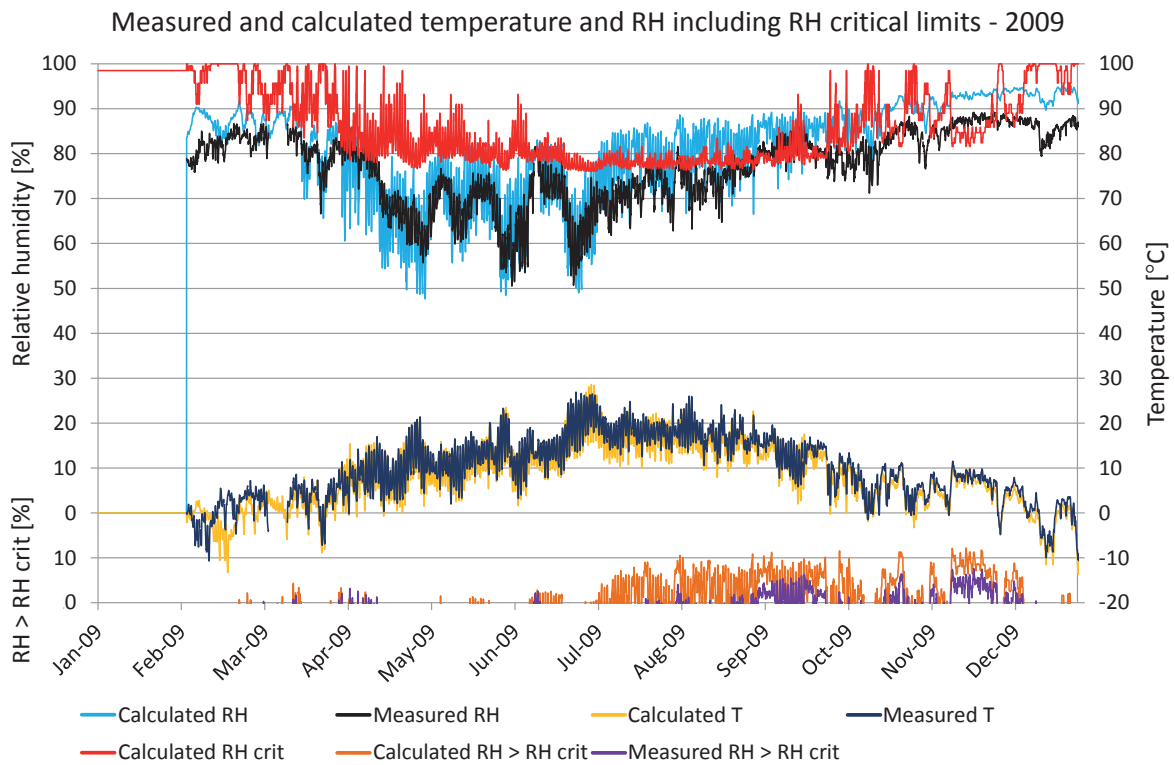

Figure 7.8.3. Comparisons between measured and calculated temperature and relative humidity. Calculated temperature (yellow), measured temperature (dark blue), calculated RH (turquoise), measured RH (black), RH_{crit} for calculated values (red), calculated $RH > RH_{crit}$ (light brown), measured $RH > RH_{crit}$ (purple).

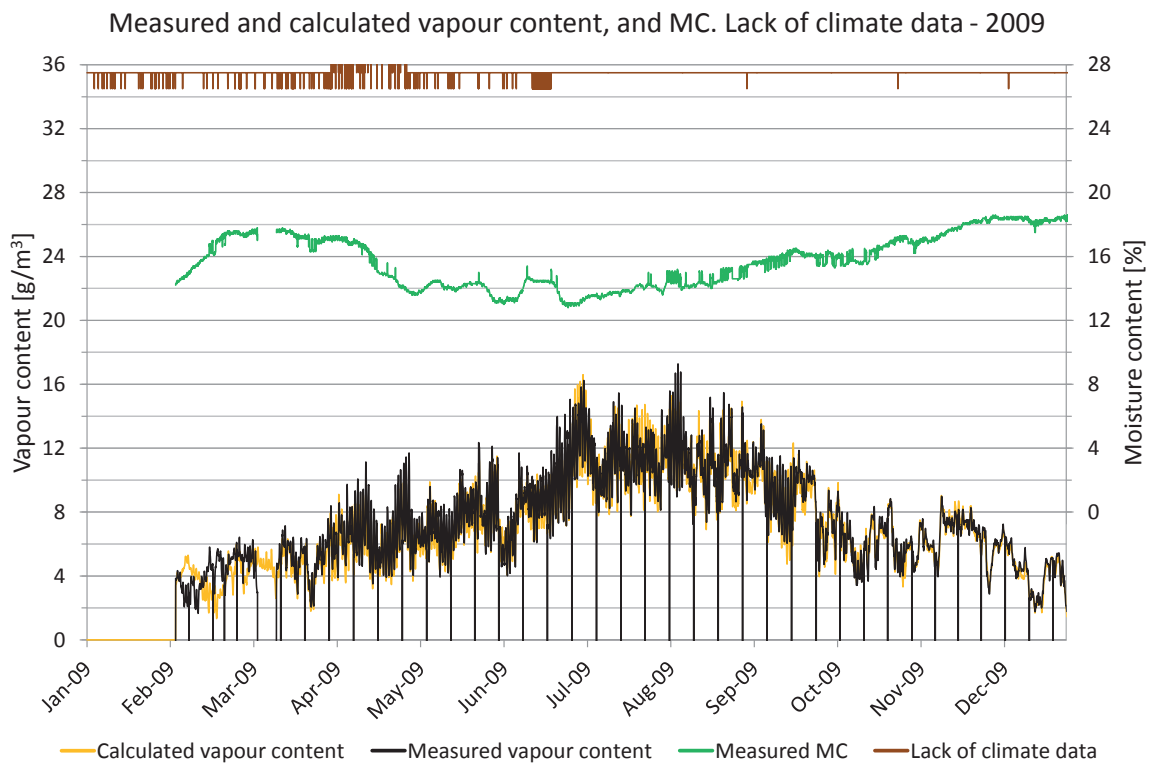

Figure 7.8.4. Measured moisture content, periods lacking climate data and comparisons of vapour content. Vapour content for calculated values (yellow) and measured values (black). Moisture content (green), periods with lack of climate data (brown).

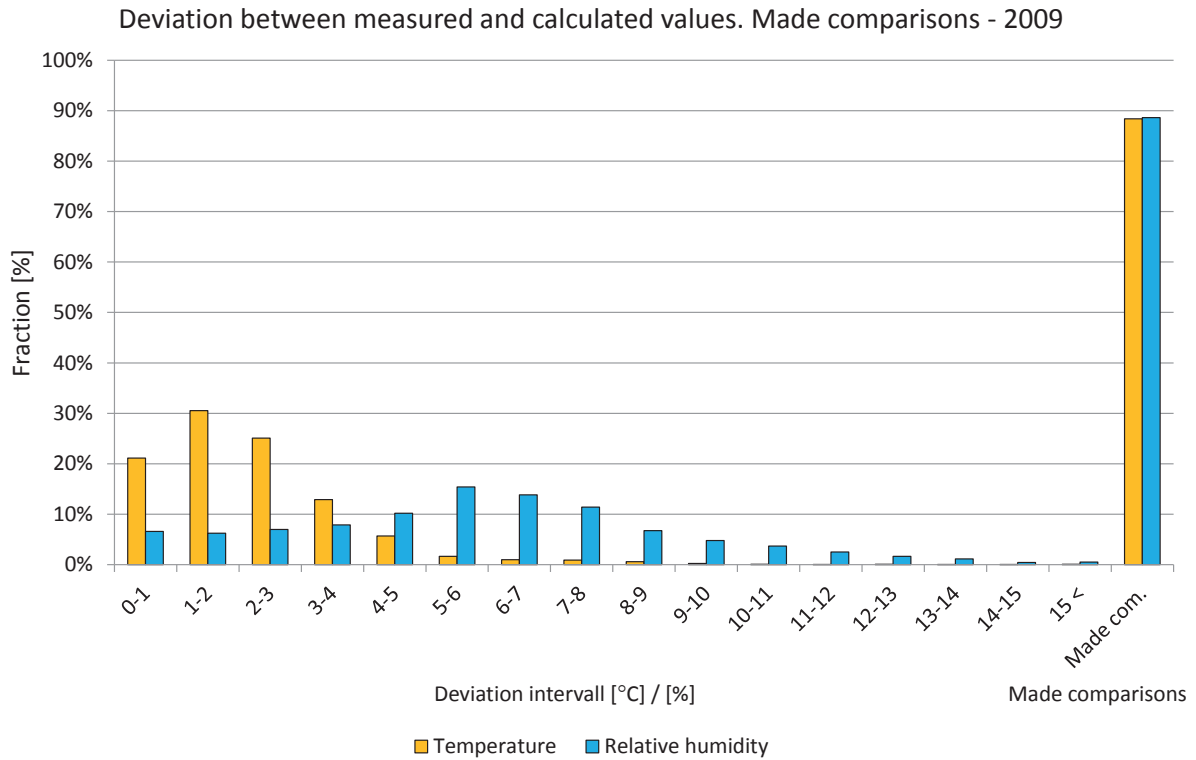

Figure 7.8.5. Deviations in comparisons shown in intervals from 0 to 15 °C or %. The two right-hand bars show the percentage of comparisons during the year. Temperature (yellow) and relative humidity (light blue).

Year 2010

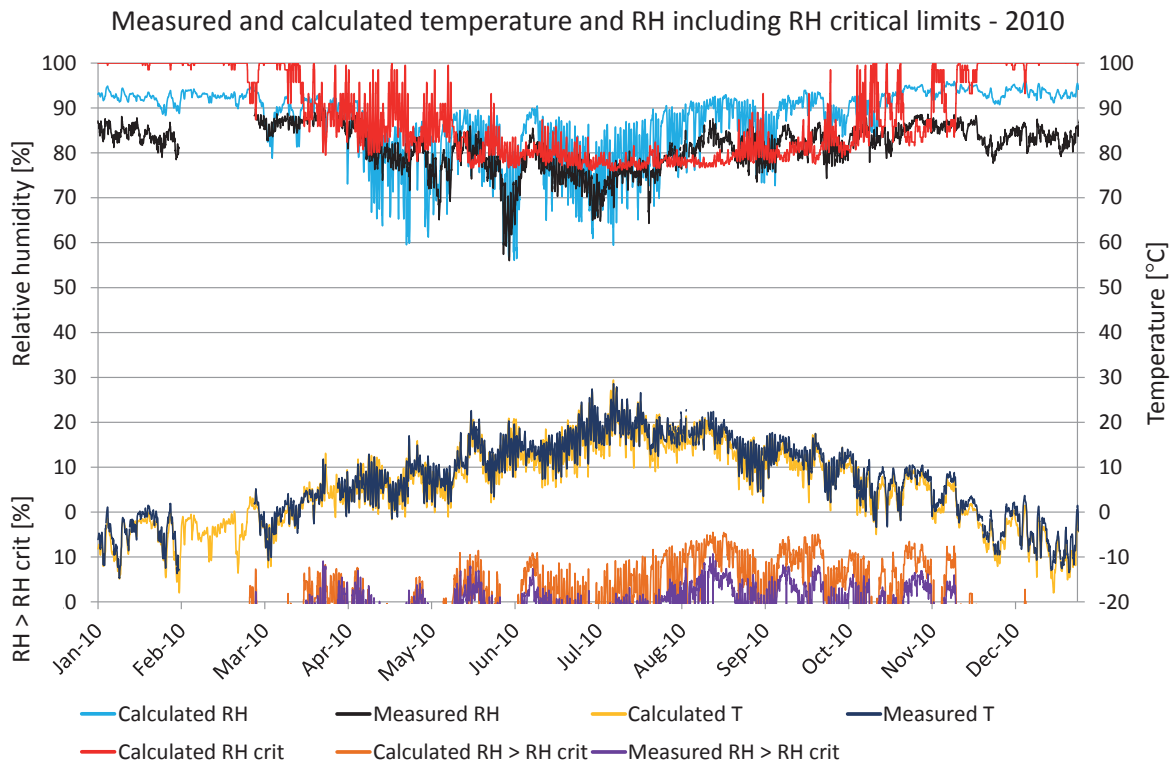

Figure 7.8.6. Comparisons between measured and calculated temperature and relative humidity. Calculated temperature (yellow), measured temperature (dark blue), calculated RH (turquoise), measured RH (black), RH_{crit} for calculated values (red), calculated $RH > RH_{crit}$ (light brown), measured $RH > RH_{crit}$ (purple).

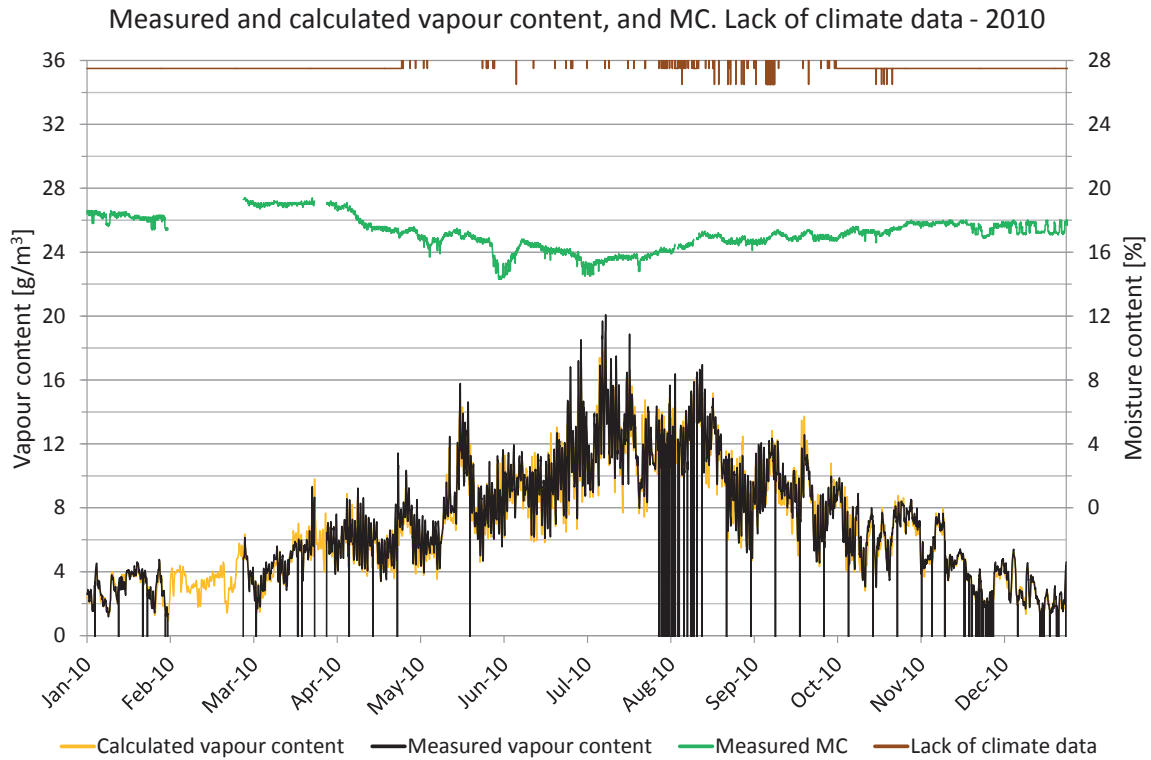

Figure 7.8.7. Measured moisture content, periods lacking climate data and comparisons of vapour content. Vapour content for calculated values (yellow) and measured values (black). Moisture content (green), periods with lack of climate data (brown).

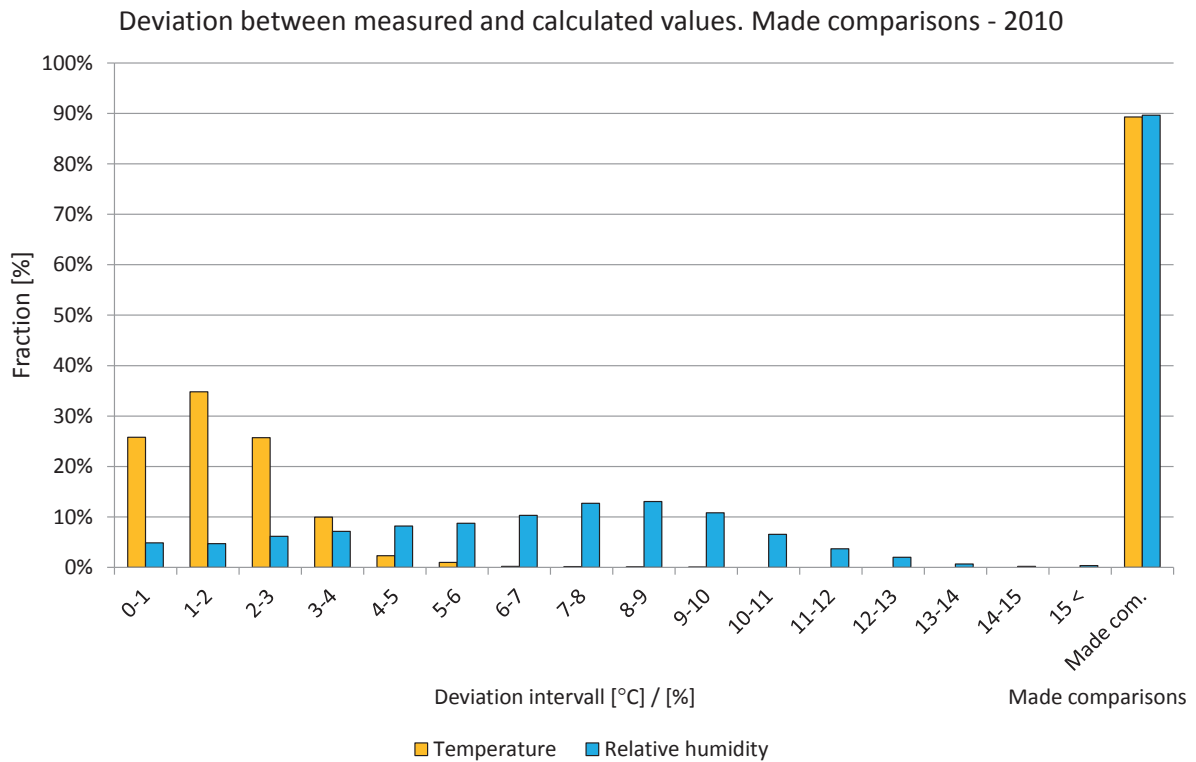

Figure 7.8.8. Deviations in comparisons shown in intervals from 0 to 15 °C or %. The two right-hand bars show the percentage of comparisons during the year. Temperature (yellow) and relative humidity (light blue).

Year 2011

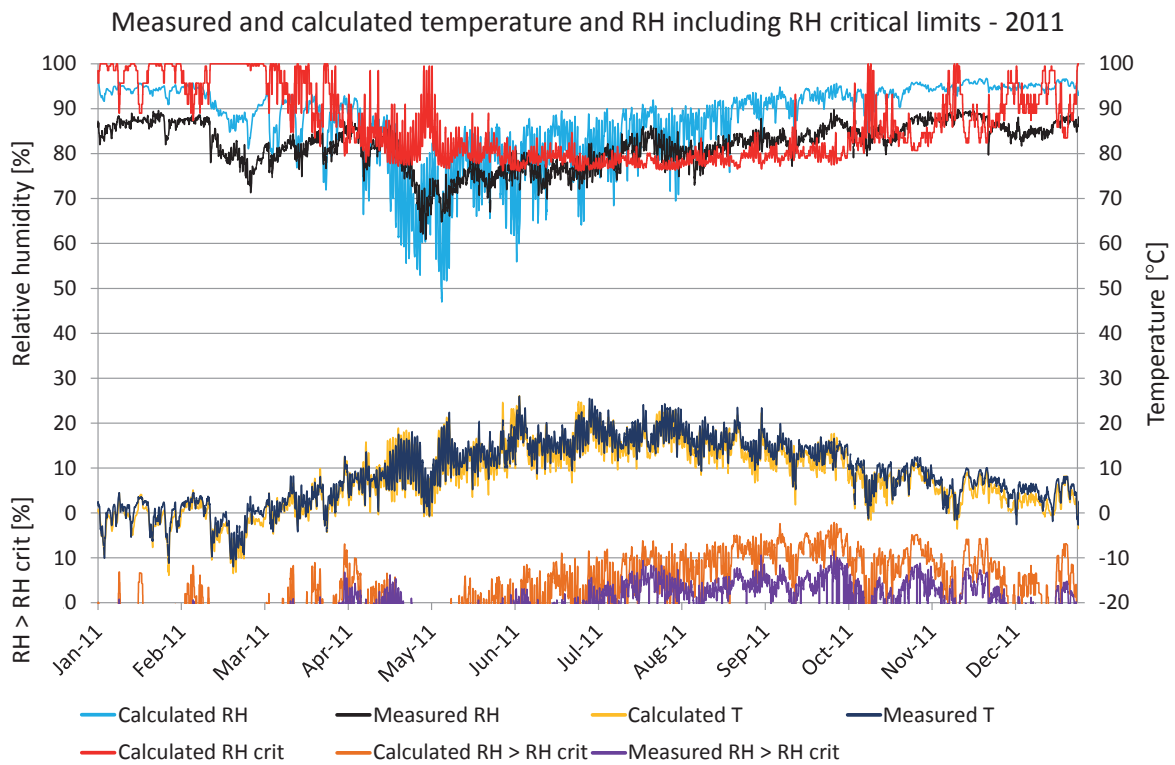

Figure 7.8.9. Comparisons between measured and calculated temperature and relative humidity. Calculated temperature (yellow), measured temperature (dark blue), calculated RH (turquoise), measured RH (black), RH_{crit} for calculated values (red), calculated $RH > RH_{crit}$ (light brown), measured $RH > RH_{crit}$ (purple).

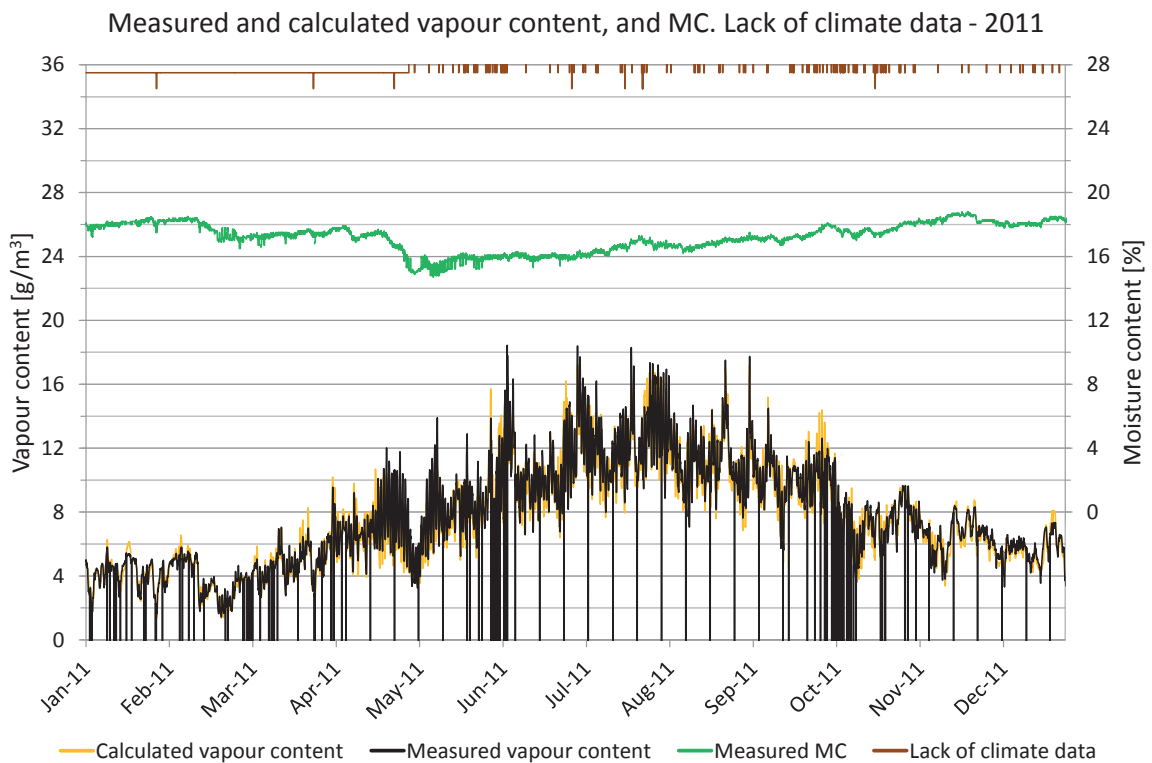

Figure 7.8.10. Measured moisture content, periods lacking climate data and comparisons of vapour content. Vapour content for calculated values (yellow) and measured values (black). Moisture content (green), periods with lack of climate data (brown).

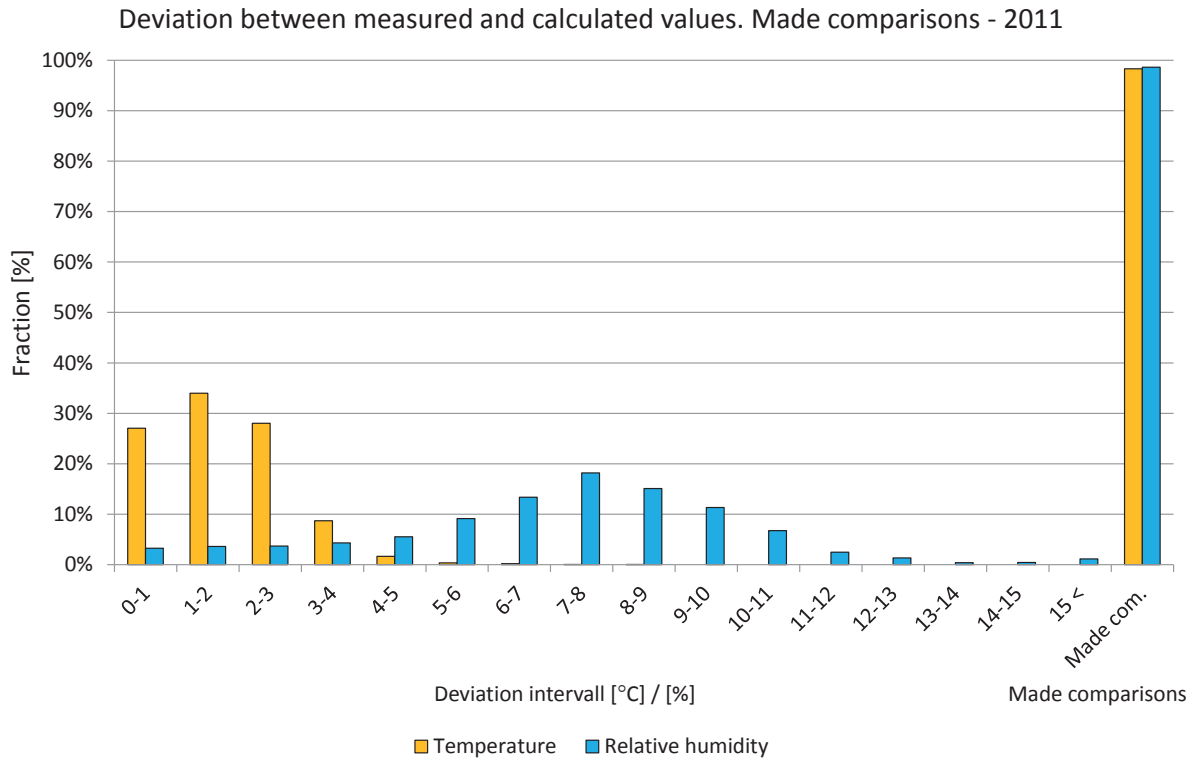

Figure 7.8.11. Deviations in comparisons shown in intervals from 0 to 15 °C or %. The two right-hand bars show the percentage of comparisons during the year. Temperature (yellow) and relative humidity (light blue).

7.9 Position 9

The locations of the measured and calculated position are shown in the drawings and figures below. The studied position is located in a wall facing northeast.

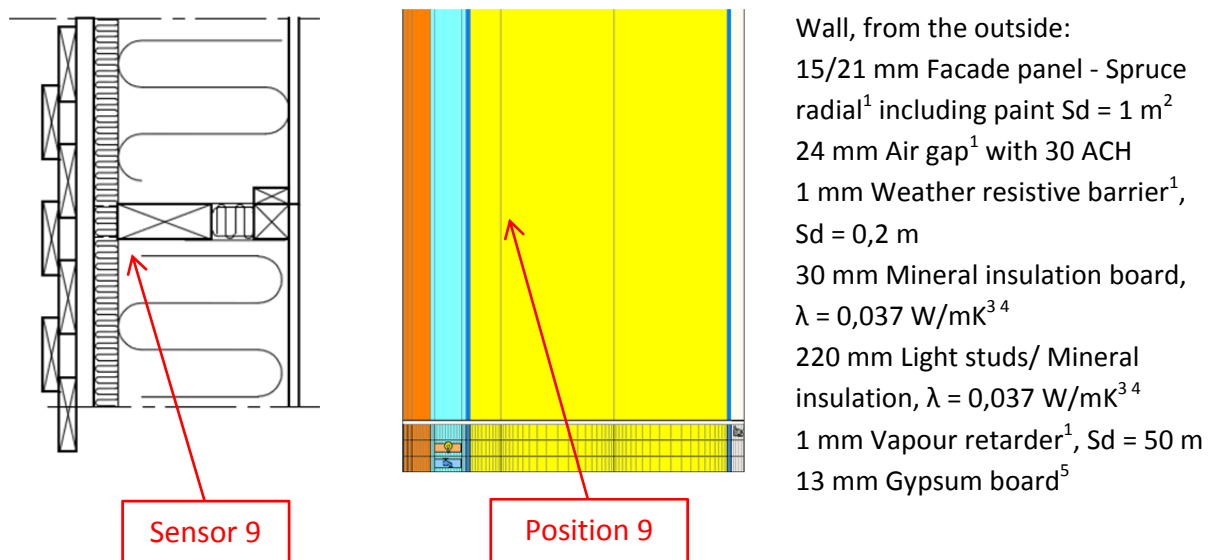

Figure 7.9.1. Vertical cross sectional drawing and WUFI calculation model showing the studied position. 1. IBP, 2012, 2. Nevander, L-E., 1994, 3. IEA Annex 24, 1996, 4. Paroc, 2002, 5. Krus, M., 1996.

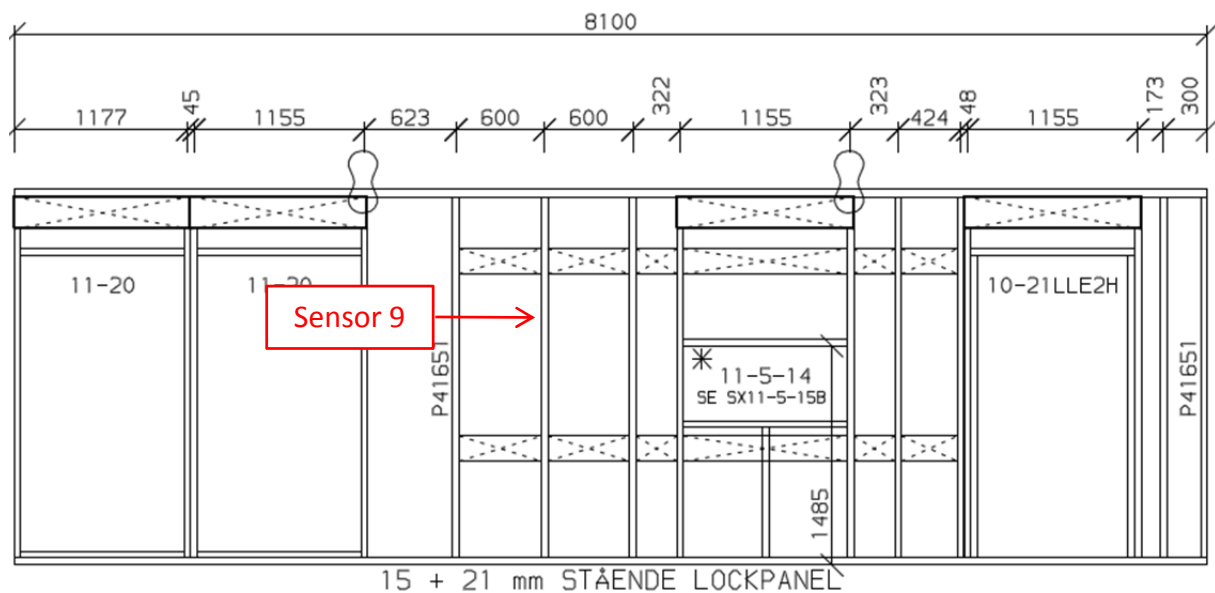

Figure 7.9.2. Location of the studied position.

A perfect match between the measured and calculated values cannot be expected due to e.g. the influence of two- and three-dimensional effects and the accuracy of the sensors.

Year 2009

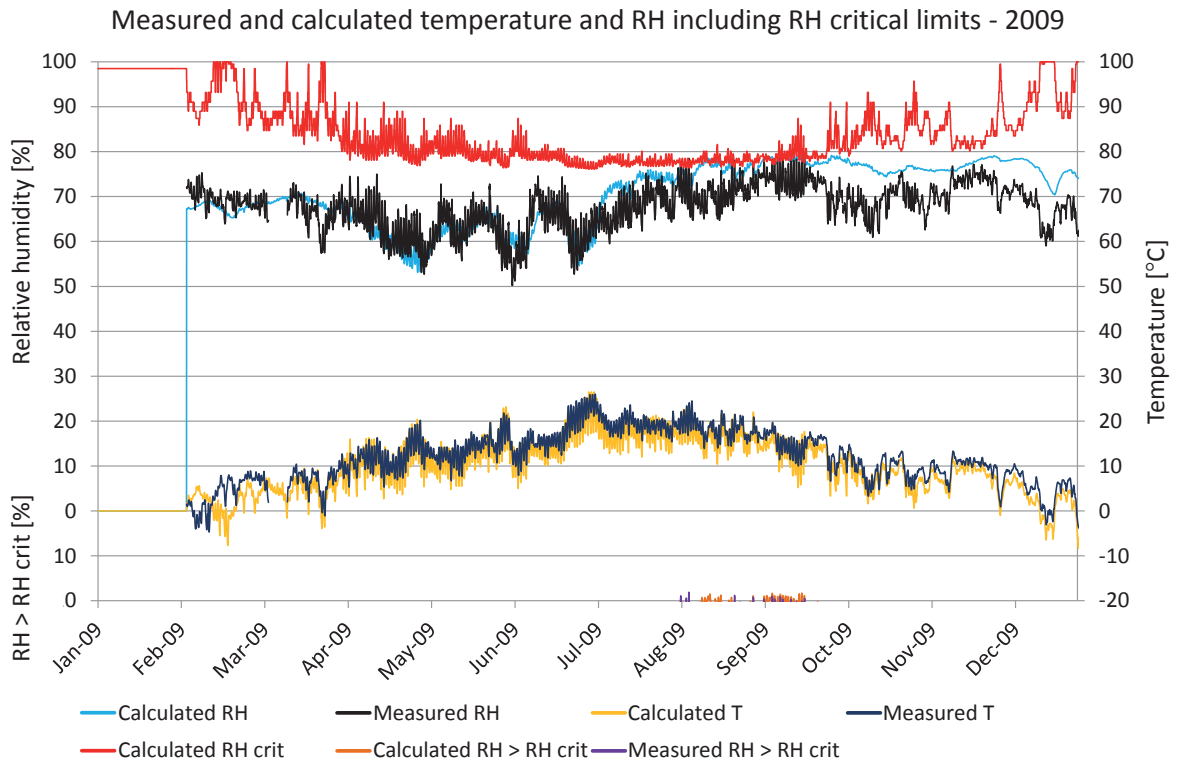

Figure 7.9.3. Comparisons between measured and calculated temperature and relative humidity. Calculated temperature (yellow), measured temperature (dark blue), calculated RH (turquoise), measured RH (black), RH_{crit} for calculated values (red), calculated $RH > RH_{crit}$ (light brown), measured $RH > RH_{crit}$ (purple).

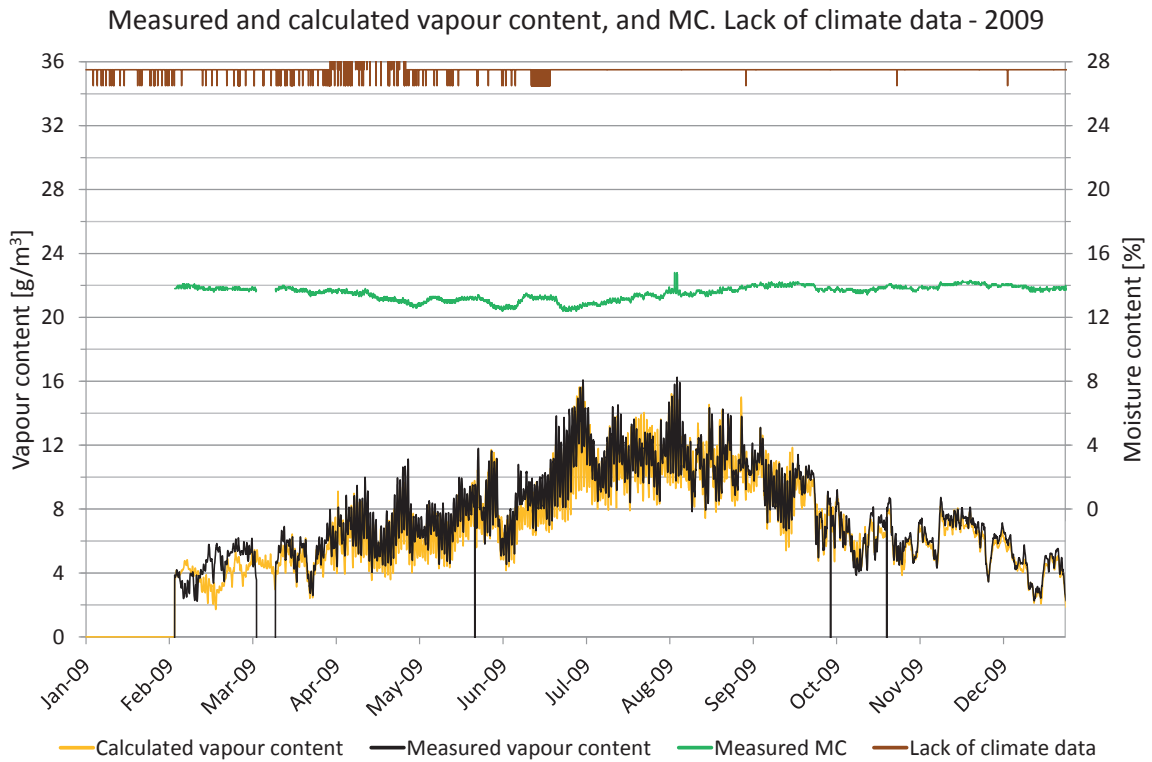

Figure 7.9.4. Measured moisture content, periods lacking climate data and comparisons of vapour content. Vapour content for calculated values (yellow) and measured values (black). Moisture content (green), periods with lack of climate data (brown).

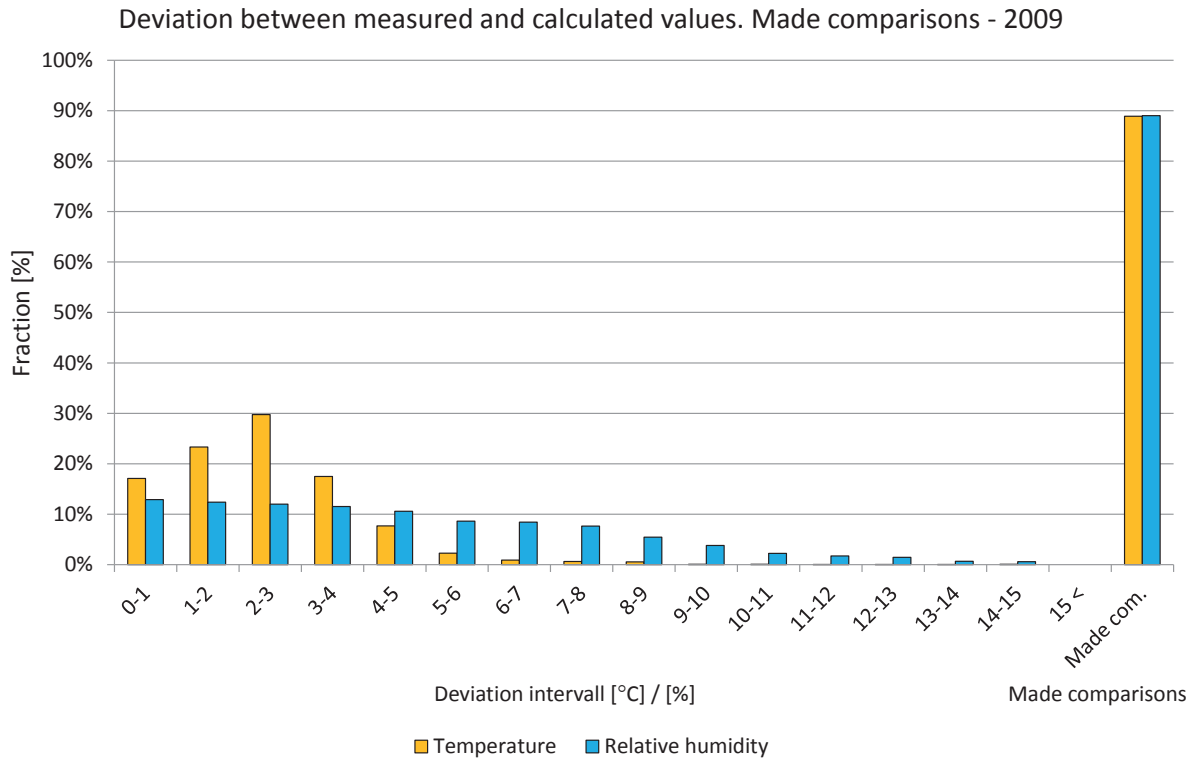

Figure 7.9.5. Deviations in comparisons shown in intervals from 0 to 15 °C or %. The two right-hand bars show the percentage of comparisons during the year. Temperature (yellow) and relative humidity (light blue).

Year 2010

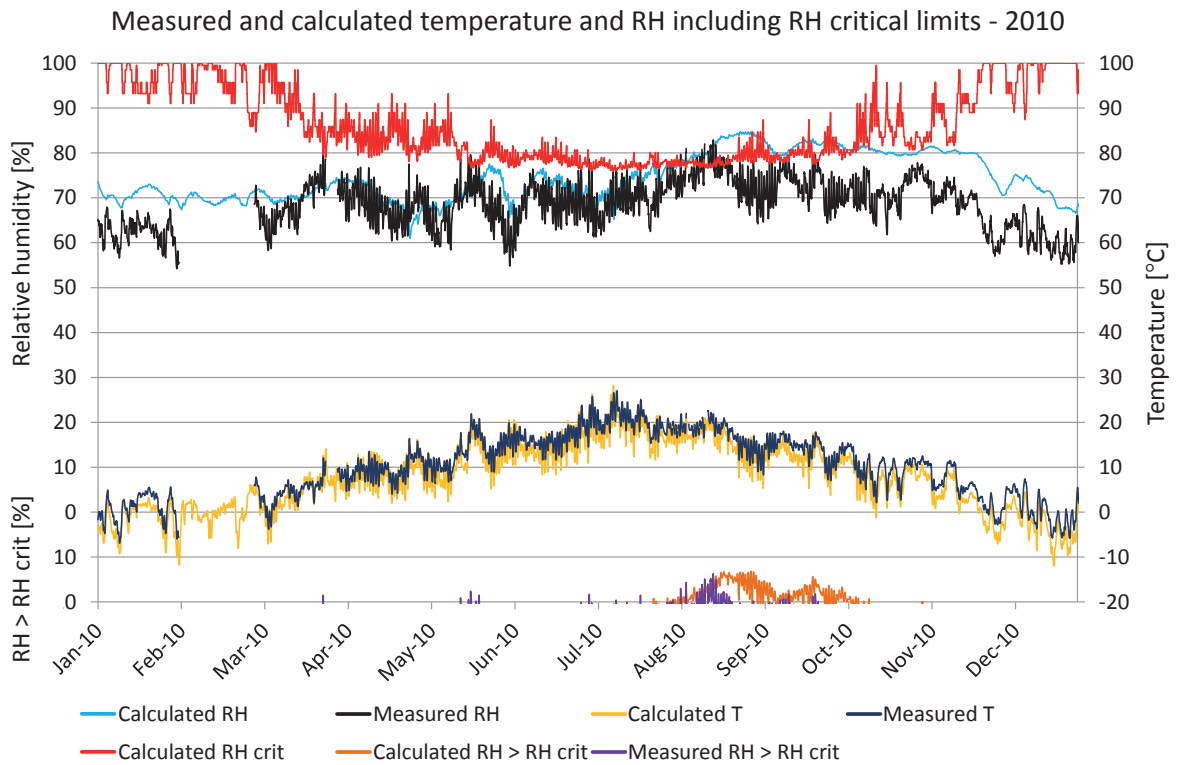

Figure 7.9.6. Comparisons between measured and calculated temperature and relative humidity. Calculated temperature (yellow), measured temperature (dark blue), calculated RH (turquoise), measured RH (black), RH_{crit} for calculated values (red), calculated $RH > RH_{crit}$ (light brown), measured $RH > RH_{crit}$ (purple).

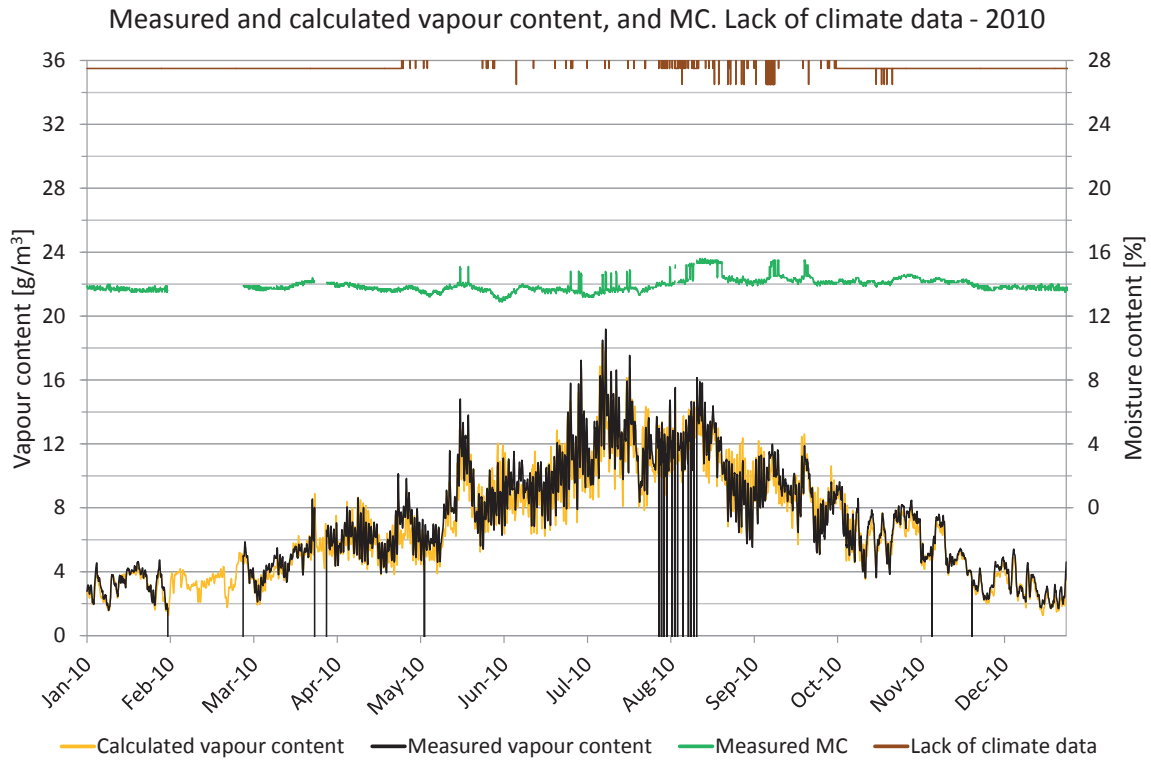

Figure 7.9.7. Measured moisture content, periods lacking climate data and comparisons of vapour content. Vapour content for calculated values (yellow) and measured values (black). Moisture content (green), periods with lack of climate data (brown).

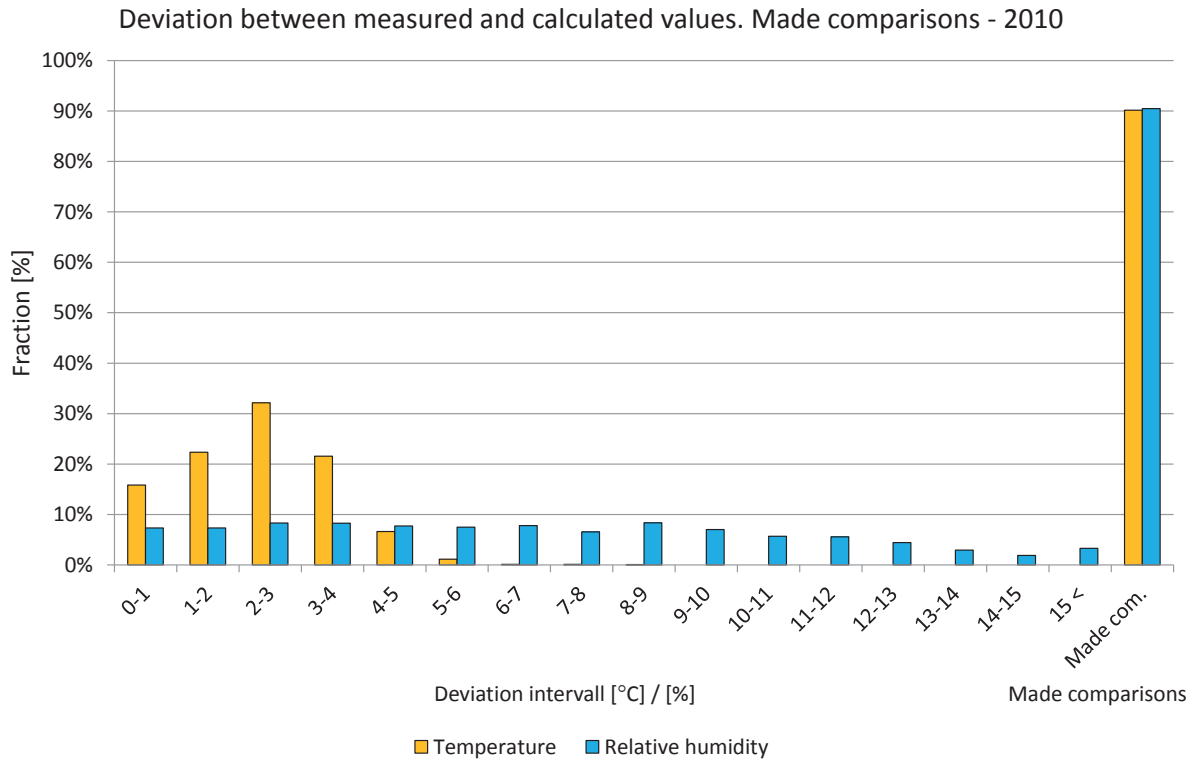

Figure 7.9.8. Deviations in comparisons shown in intervals from 0 to 15 °C or %. The two right-hand bars show the percentage of comparisons during the year. Temperature (yellow) and relative humidity (light blue).

Year 2011

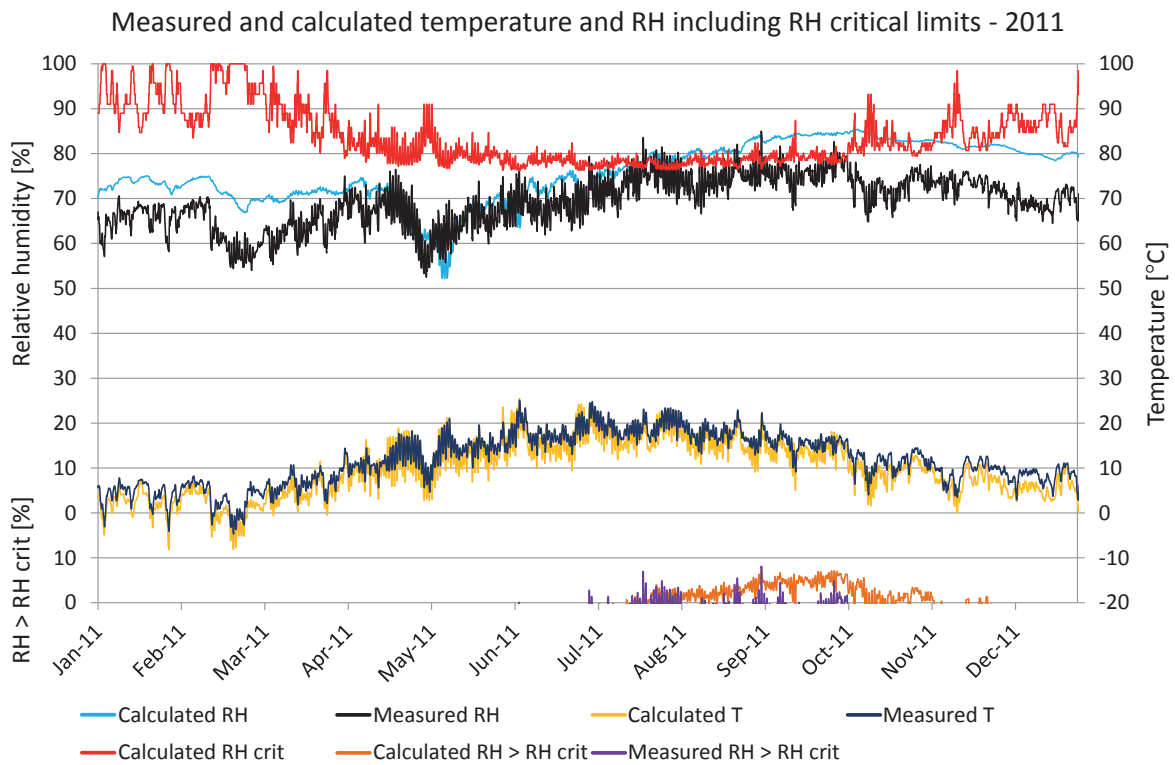

Figure 7.9.9. Comparisons between measured and calculated temperature and relative humidity. Calculated temperature (yellow), measured temperature (dark blue), calculated RH (turquoise), measured RH (black), RHcrit for calculated values (red), calculated RH > RHcrit (light brown), measured RH > RHcrit (purple).

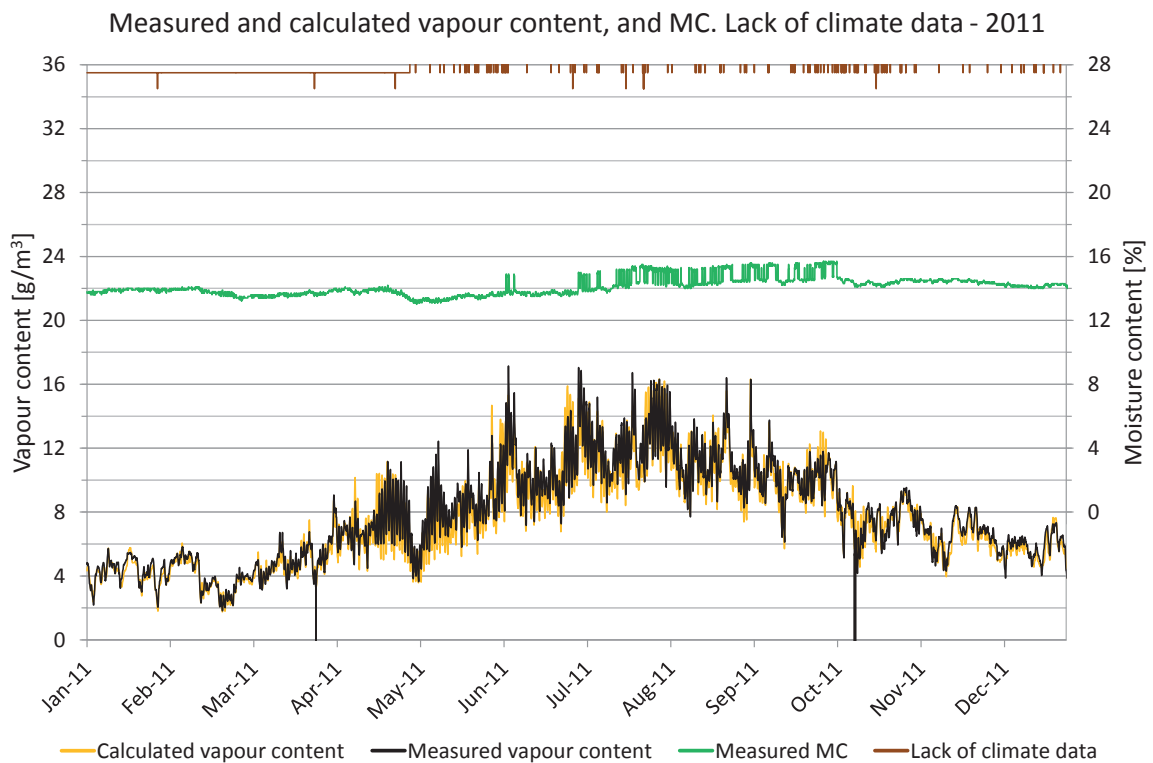

Figure 7.9.10. Measured moisture content, periods lacking climate data and comparisons of vapour content. Vapour content for calculated values (yellow) and measured values (black). Moisture content (green), periods with lack of climate data (brown).

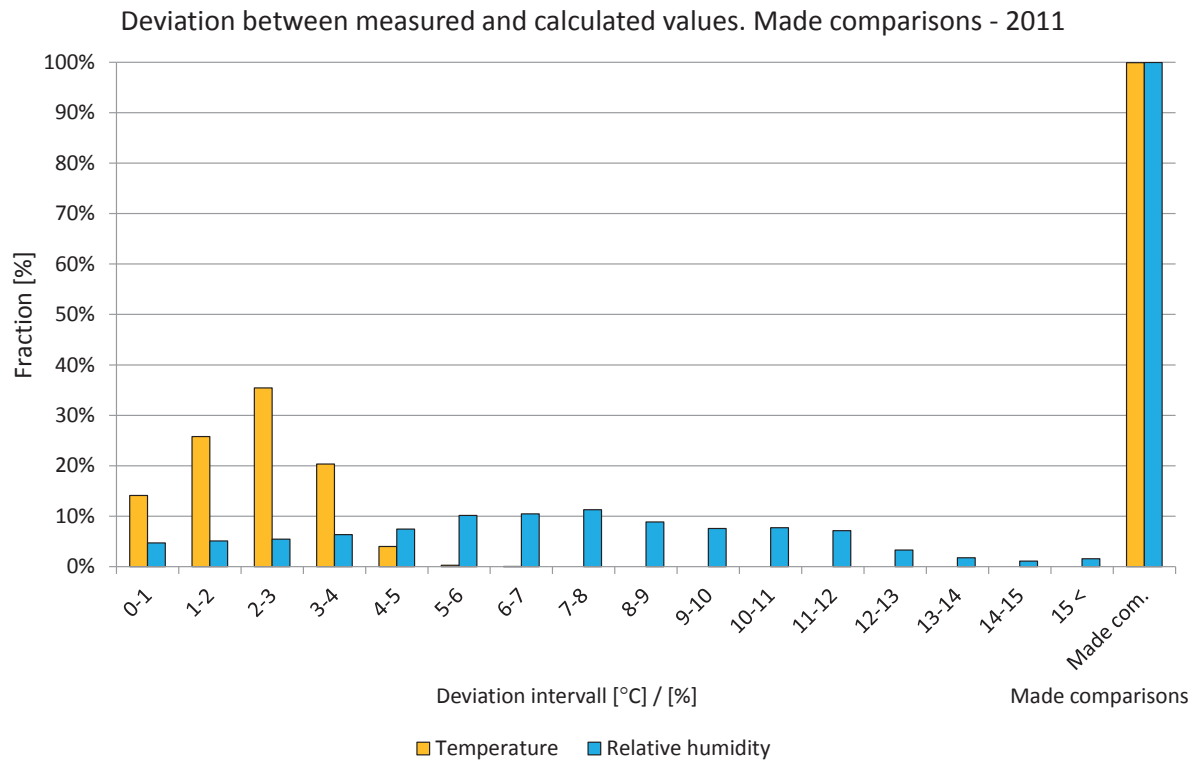

Figure 7.9.11. Deviations in comparisons shown in intervals from 0 to 15 °C or %. The two right-hand bars show the percentage of comparisons during the year. Temperature (yellow) and relative humidity (light blue).

7.10 Position 10

The locations of the measured and calculated position are shown in the drawings and figures below. The studied position is located in a wall facing northeast. Unfortunately sensor 10 was broken and no measured data is therefore available. This means that only calculated data is shown and no charts presenting deviations between measured and calculated values are presented.

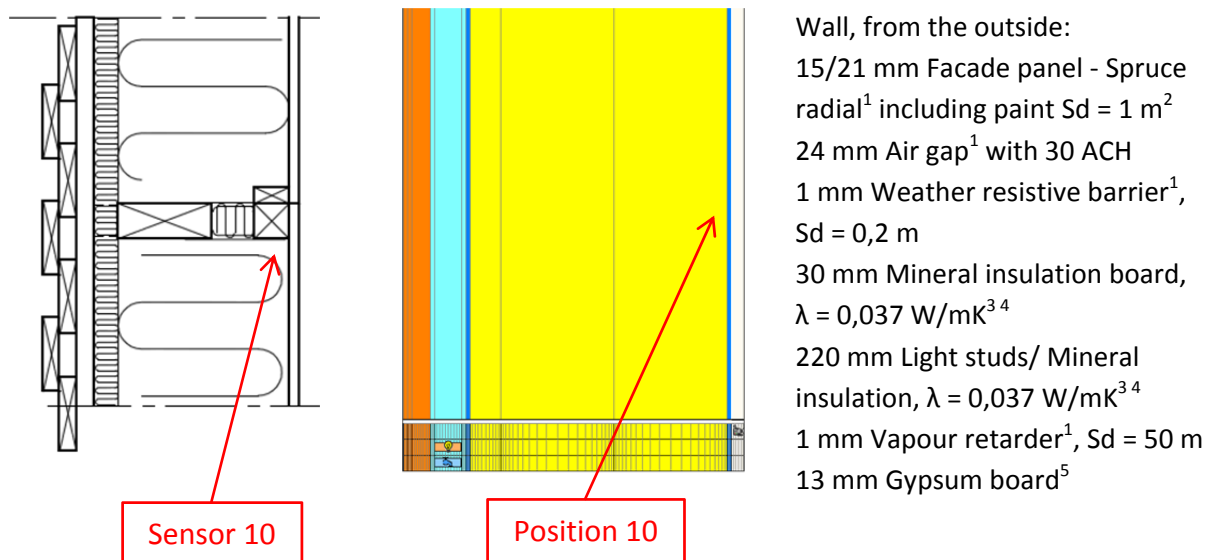

Figure 7.10.1. Vertical cross sectional drawing and WUFI calculation model showing the studied position. 1. IBP, 2012, 2. Nevander, L-E., 1994, 3. IEA Annex 24, 1996, 4. Paroc, 2002, 5. Krus, M., 1996.

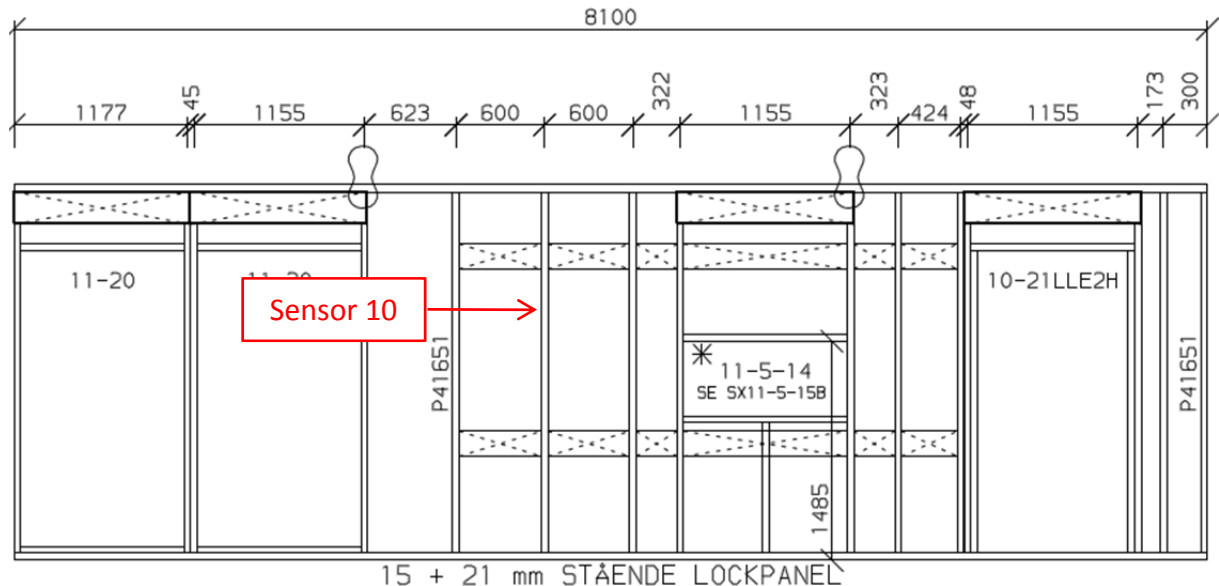

Figure 7.10.2. Location of the studied position.

A perfect match between the measured and calculated values cannot be expected due to e.g. the influence of two- and three-dimensional effects and the accuracy of the sensors.

Year 2009

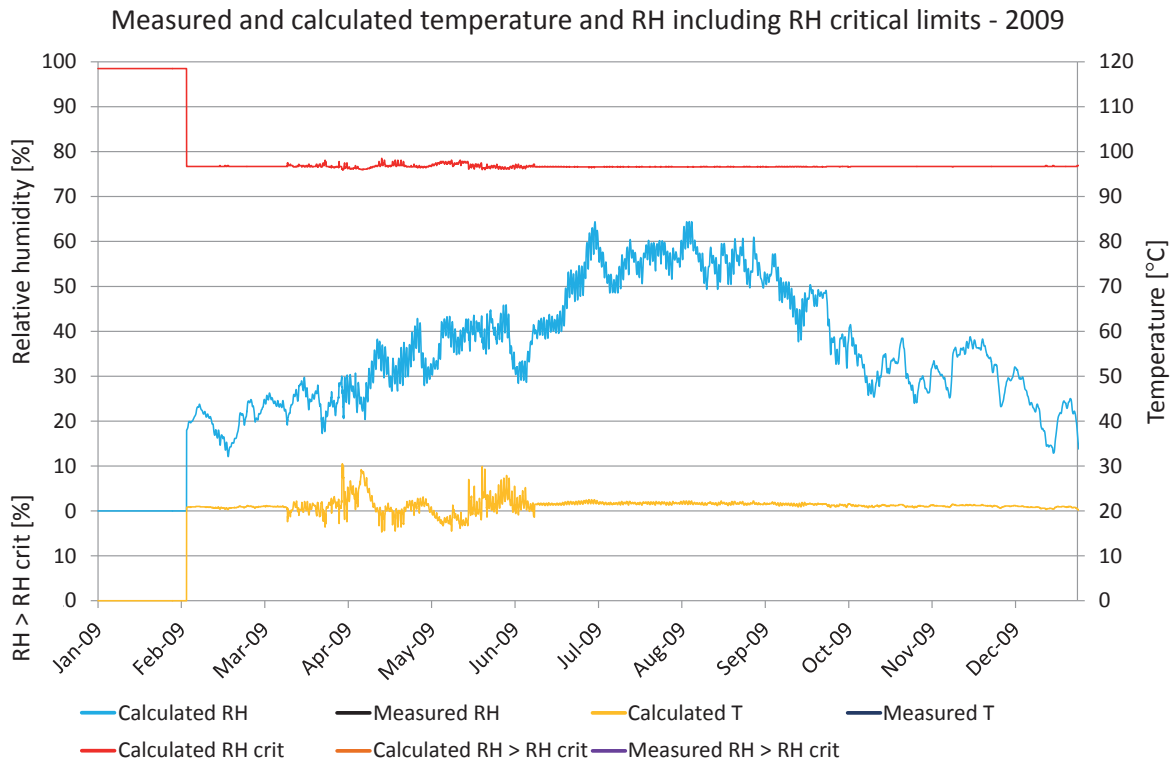

Figure 7.10.3. Comparisons between measured and calculated temperature and relative humidity. Calculated temperature (yellow), measured temperature (dark blue), calculated RH (turquoise), measured RH (black), RH_{crit} for calculated values (red), calculated $RH > RH_{crit}$ (light brown), measured $RH > RH_{crit}$ (purple).

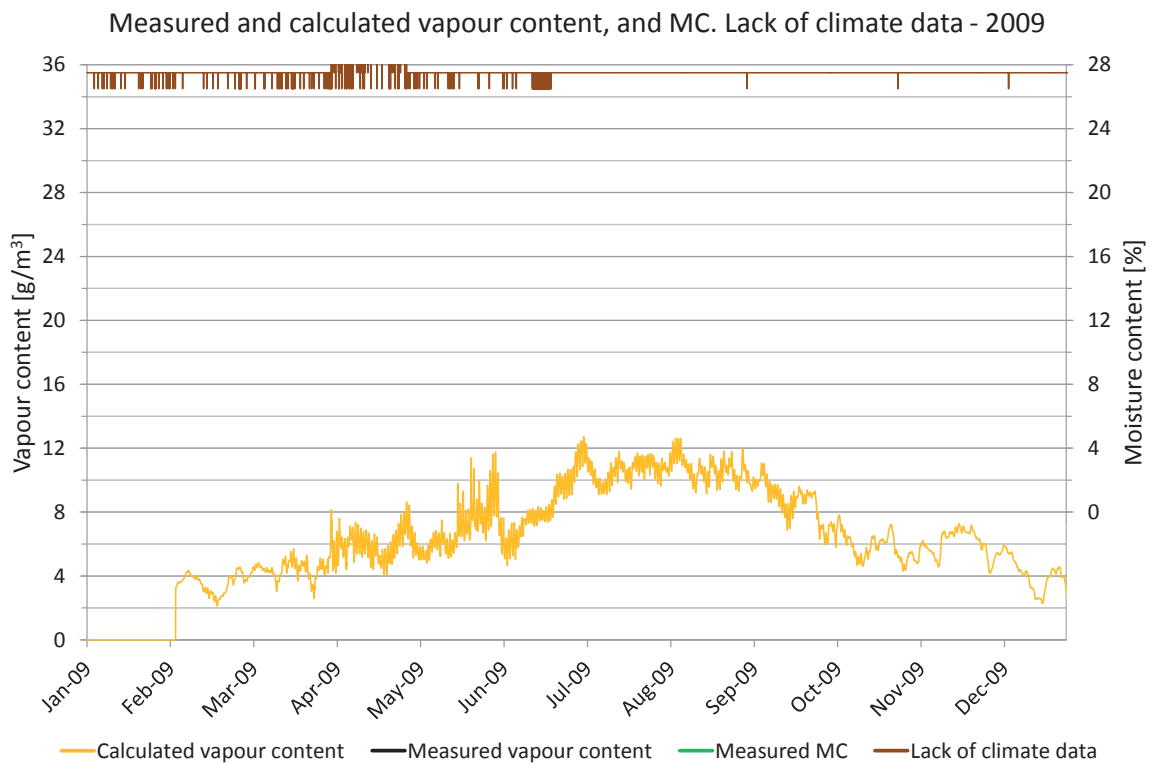

Figure 7.10.4. Measured moisture content, periods lacking climate data and comparisons of vapour content. Vapour content for calculated values (yellow) and measured values (black). Moisture content (green), periods with lack of climate data (brown).

Year 2010

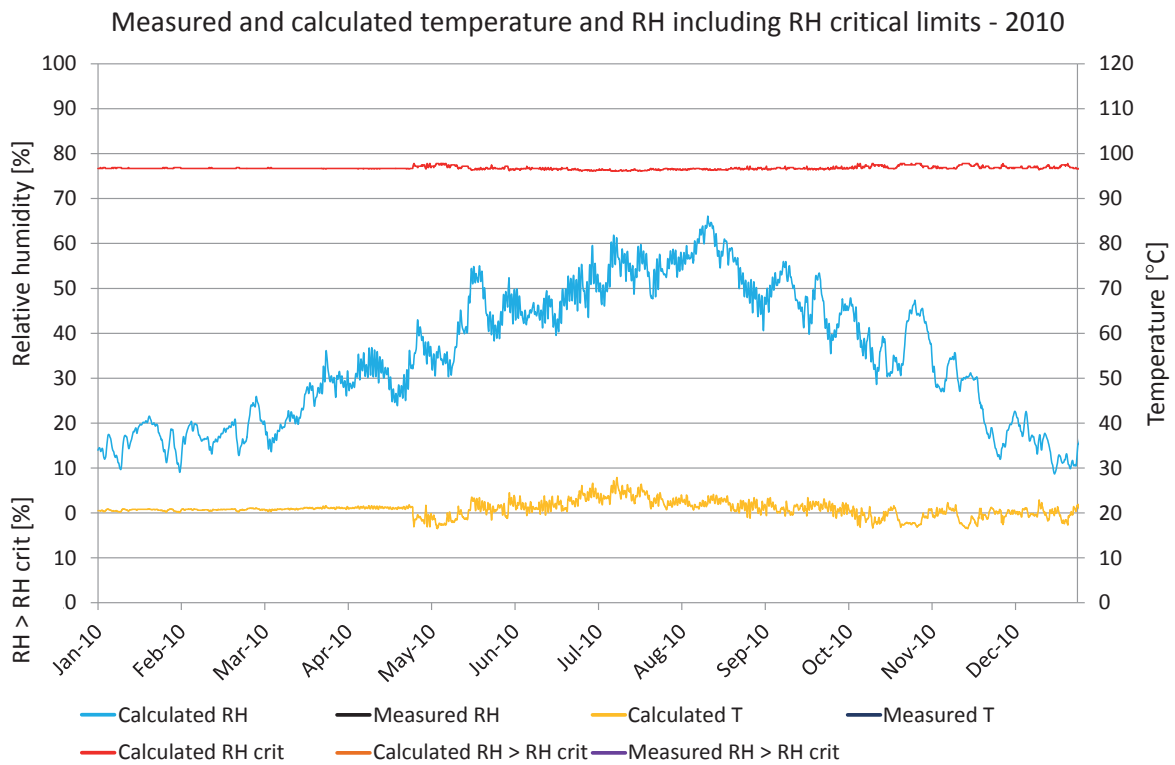

Figure 7.10.5. Comparisons between measured and calculated temperature and relative humidity. Calculated temperature (yellow), measured temperature (dark blue), calculated RH (turquoise), measured RH (black), RH_{crit} for calculated values (red), calculated $RH > RH_{crit}$ (light brown), measured $RH > RH_{crit}$ (purple).

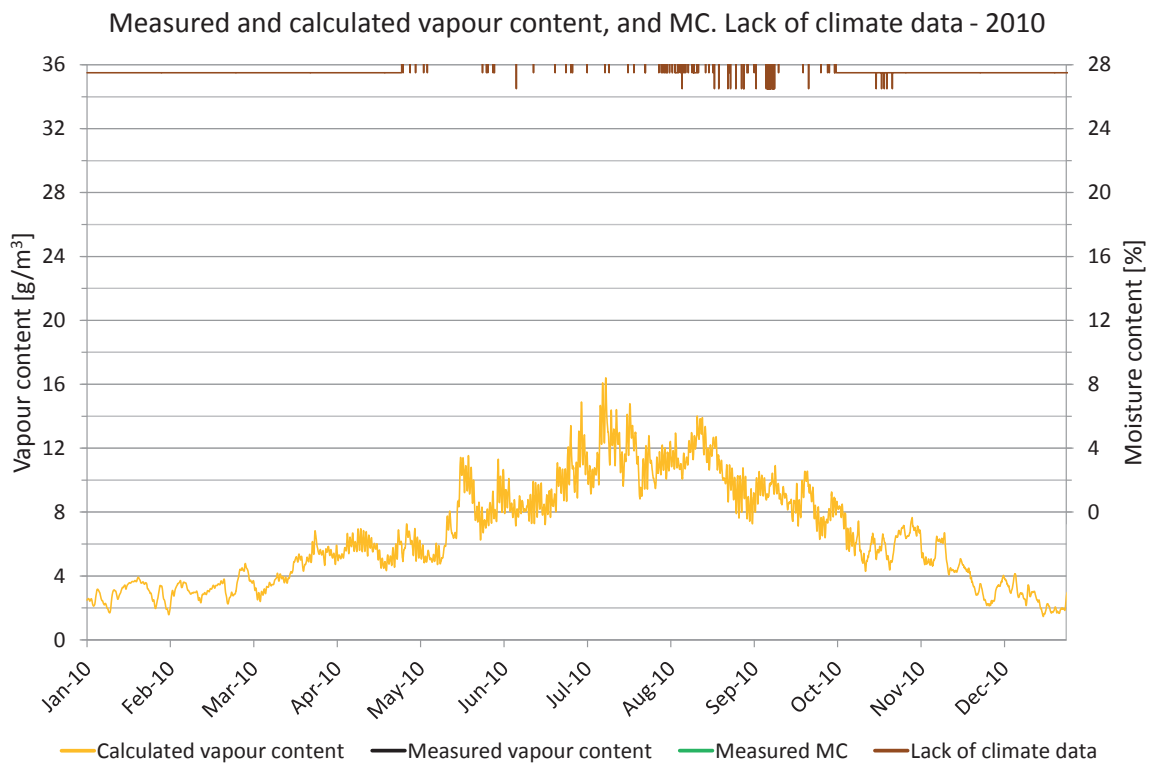

Figure 7.10.6. Measured moisture content, periods lacking climate data and comparisons of vapour content. Vapour content for calculated values (yellow) and measured values (black). Moisture content (green), periods with lack of climate data (brown).

Year 2011

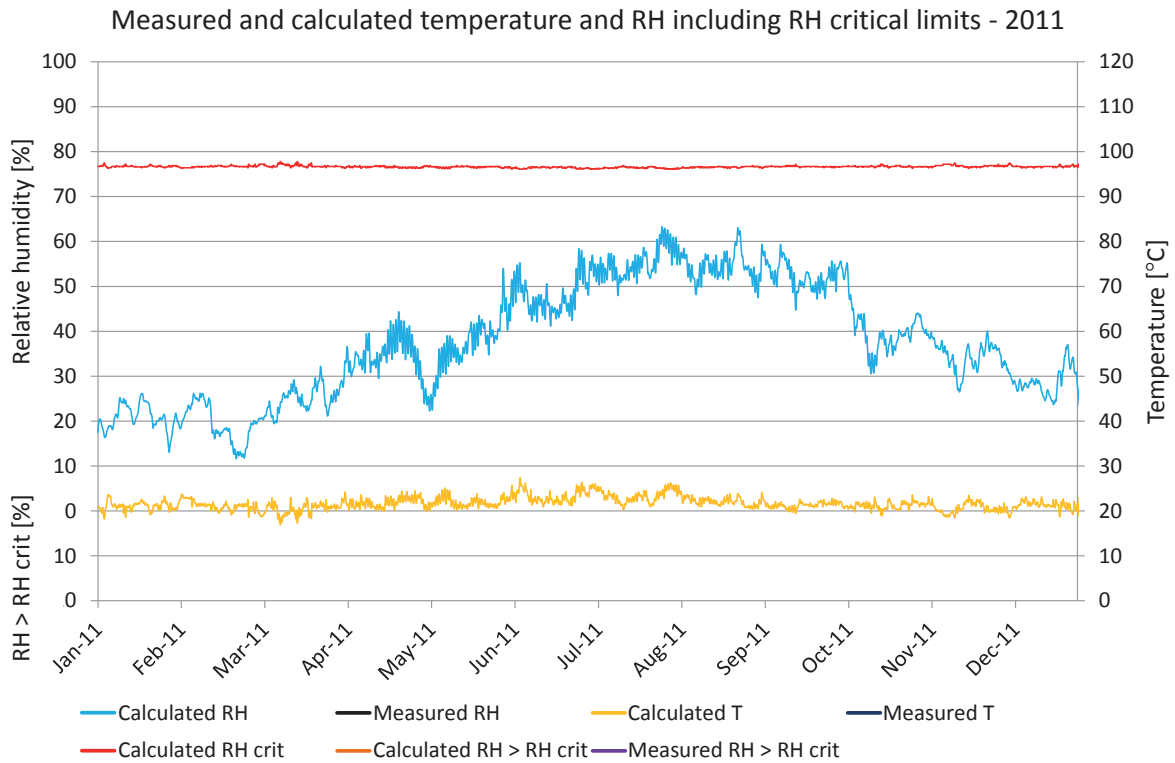

Figure 7.10.7. Comparisons between measured and calculated temperature and relative humidity. Calculated temperature (yellow), measured temperature (dark blue), calculated RH (turquoise), measured RH (black), RH_{crit} for calculated values (red), calculated $RH > RH_{crit}$ (light brown), measured $RH > RH_{crit}$ (purple).

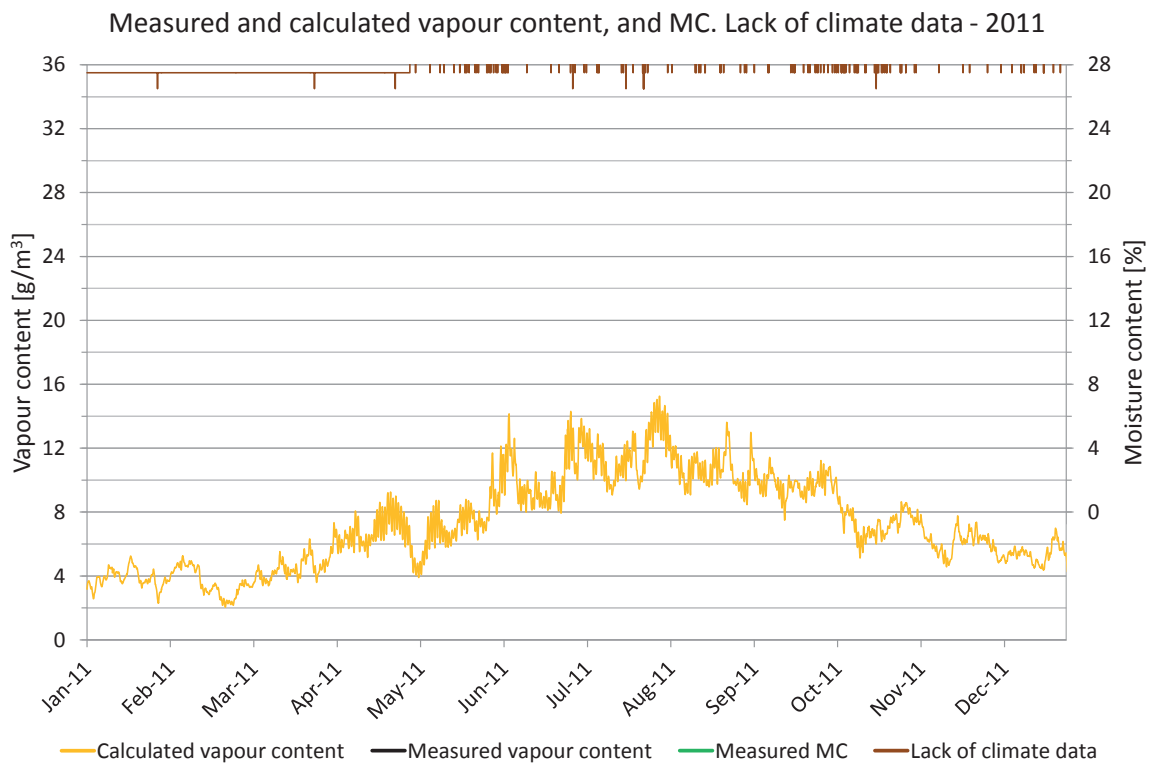

Figure 7.10.8. Measured moisture content, periods lacking climate data and comparisons of vapour content. Vapour content for calculated values (yellow) and measured values (black). Moisture content (green), periods with lack of climate data (brown).

7.11 Position 11

The locations of the measured and calculated position are shown in the drawings and figures below. The studied position is located in the exterior bathroom wall facing northeast.

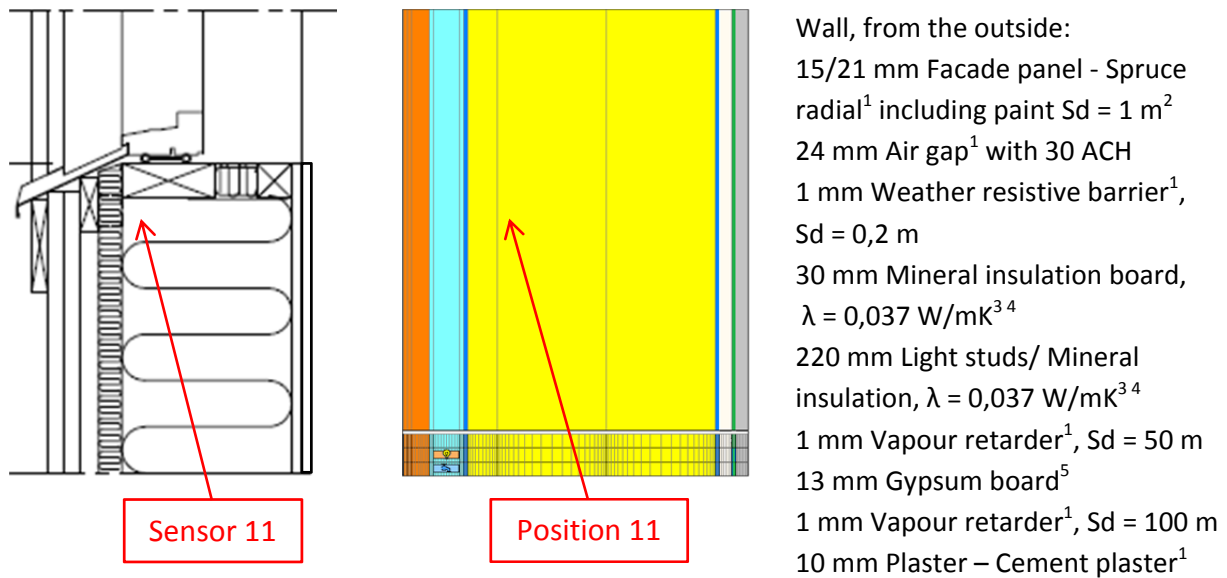

Figure 7.11.1. Vertical cross sectional drawing and WUFI calculation model showing the studied position. 1. IBP, 2012, 2. Nevander, L-E., 1994, 3. IEA Annex 24, 1996, 4. Paroc, 2002, 5. Krus, M., 1996.

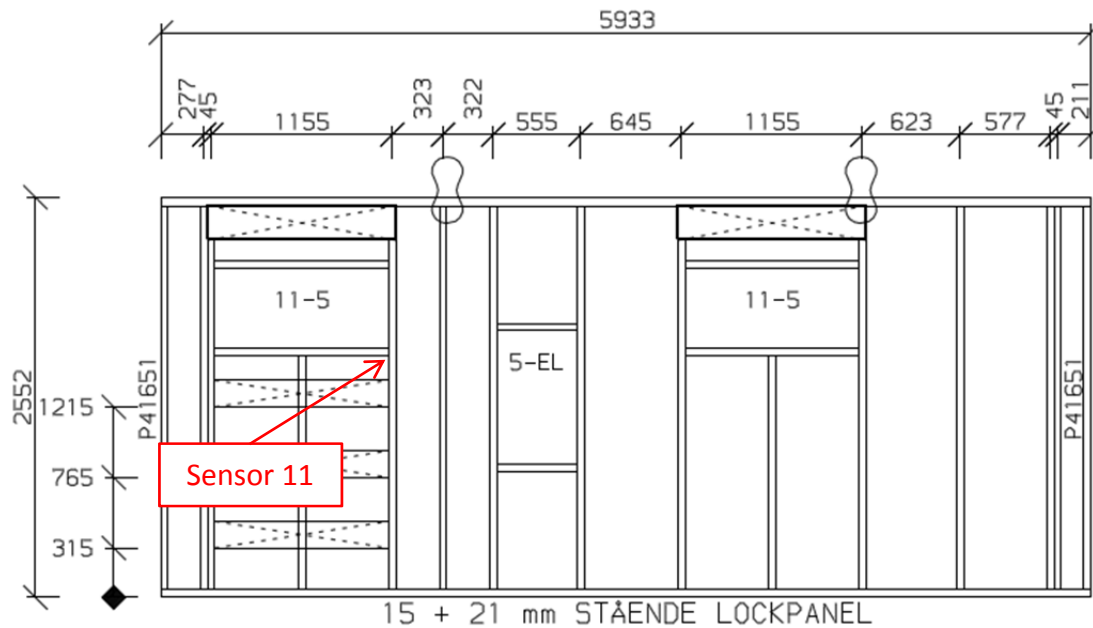

Figure 7.11.2. Location of the studied position.

A perfect match between the measured and calculated values cannot be expected due to e.g. the influence of two- and three-dimensional effects and the accuracy of the sensors.

Year 2009

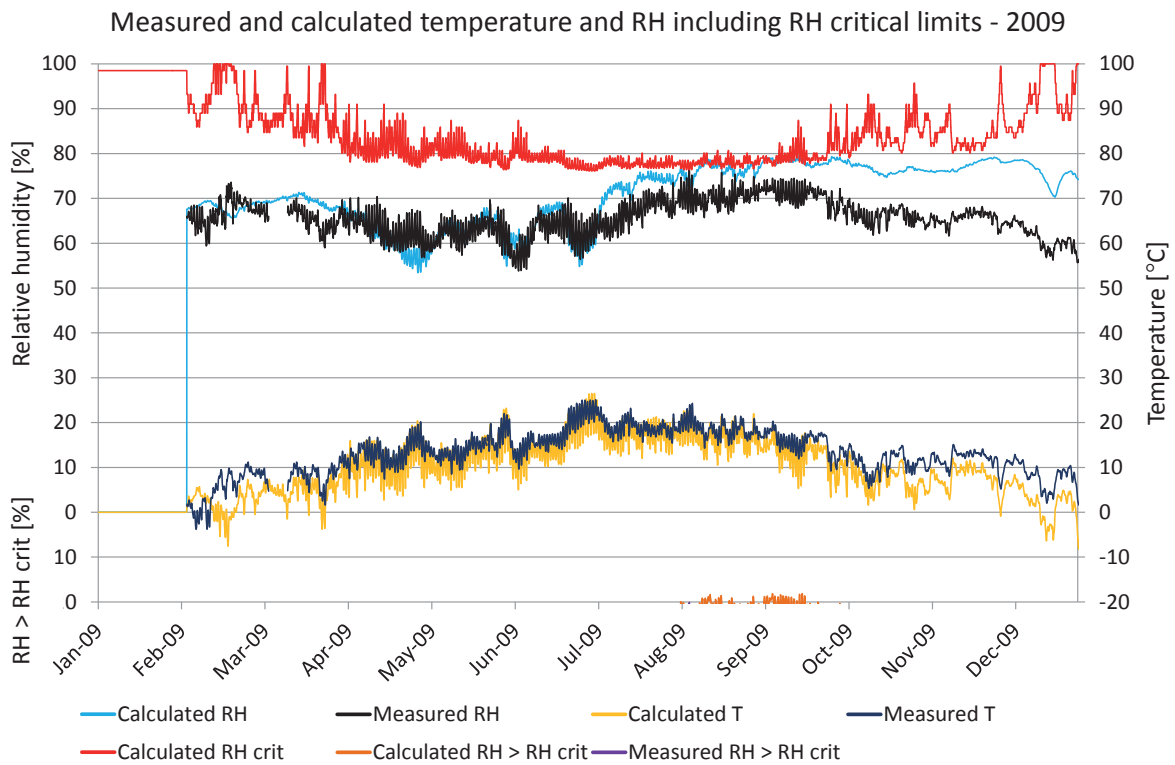

Figure 7.11.3. Comparisons between measured and calculated temperature and relative humidity. Calculated temperature (yellow), measured temperature (dark blue), calculated RH (turquoise), measured RH (black), RH_{crit} for calculated values (red), calculated RH > RH_{crit} (light brown), measured RH > RH_{crit} (purple).

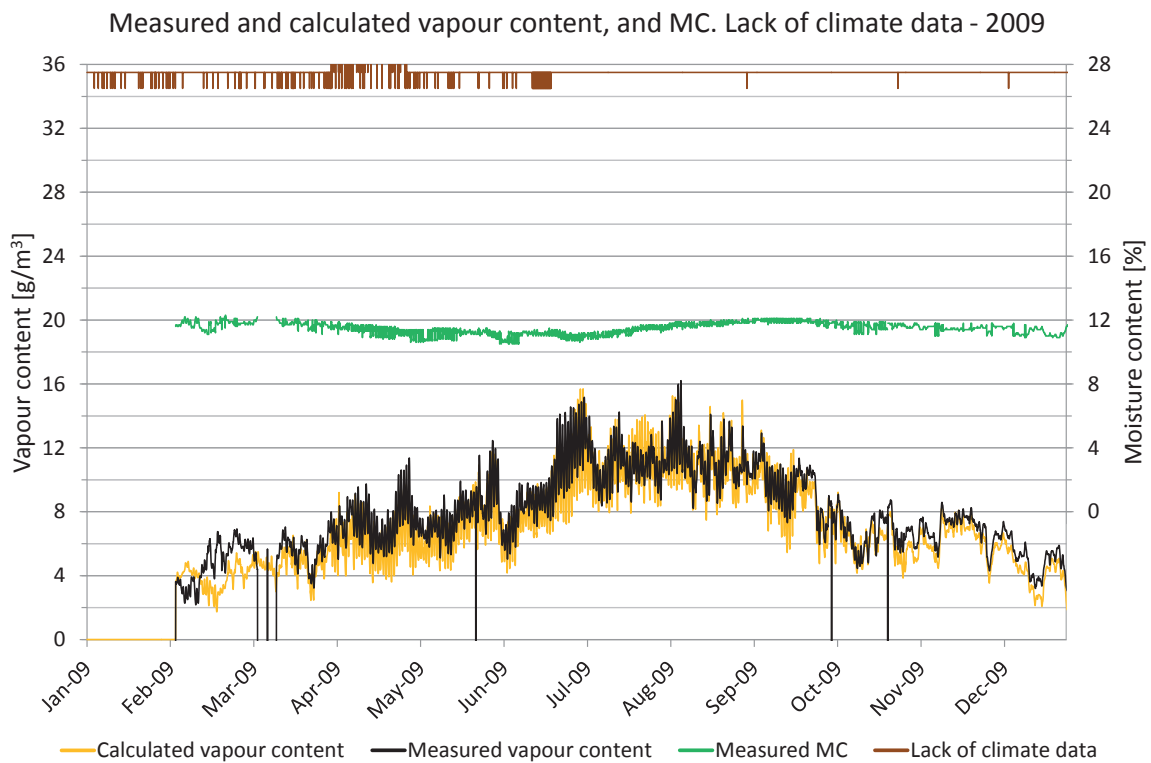

Figure 7.11.4. Measured moisture content, periods lacking climate data and comparisons of vapour content. Vapour content for calculated values (yellow) and measured values (black). Moisture content (green), periods with lack of climate data (brown).

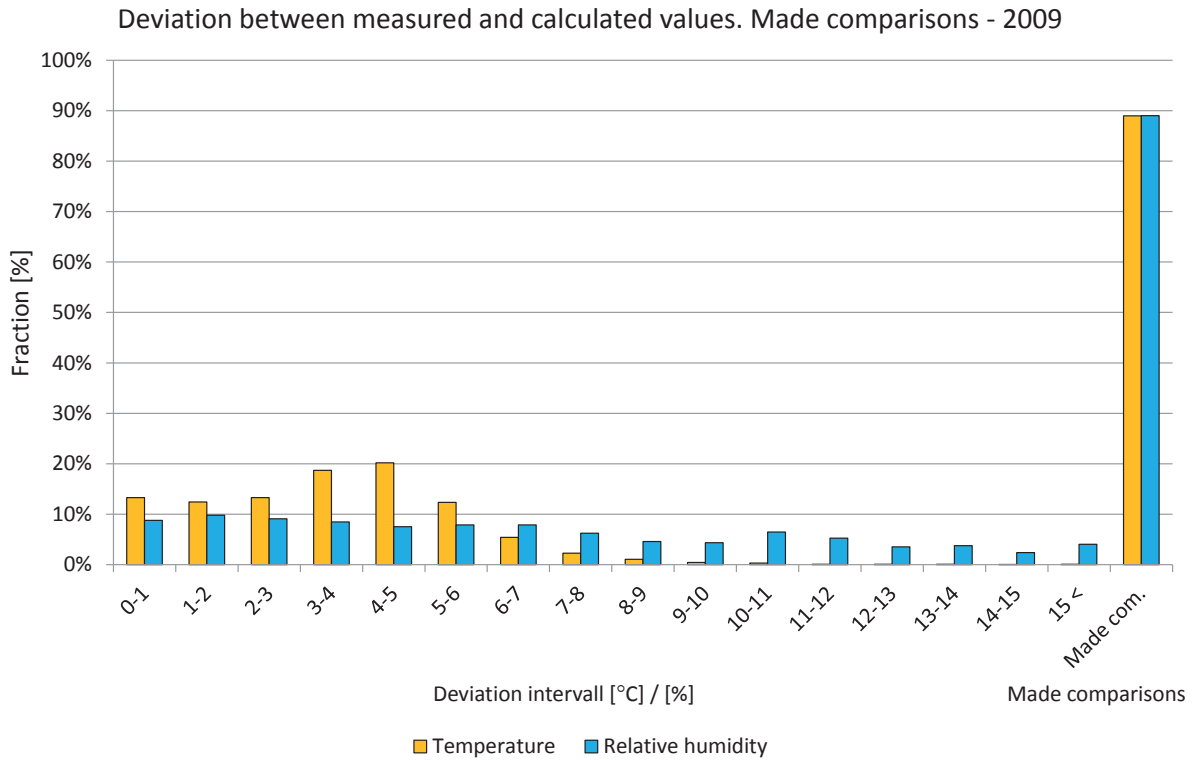

Figure 7.11.5. Deviations in comparisons shown in intervals from 0 to 15 °C or %. The two right-hand bars show the percentage of comparisons during the year. Temperature (yellow) and relative humidity (light blue).

Year 2010

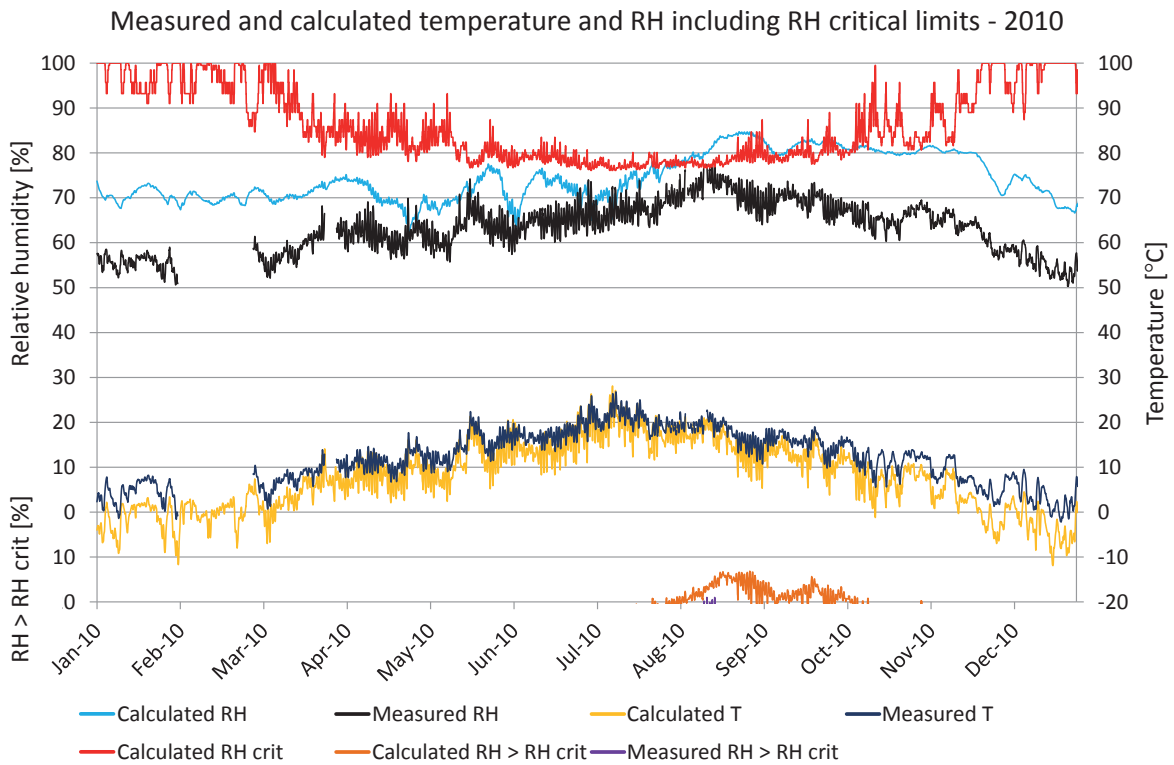

Figure 7.11.6. Comparisons between measured and calculated temperature and relative humidity. Calculated temperature (yellow), measured temperature (dark blue), calculated RH (turquoise), measured RH (black), RH_{crit} for calculated values (red), calculated RH > RH_{crit} (light brown), measured RH > RH_{crit} (purple).

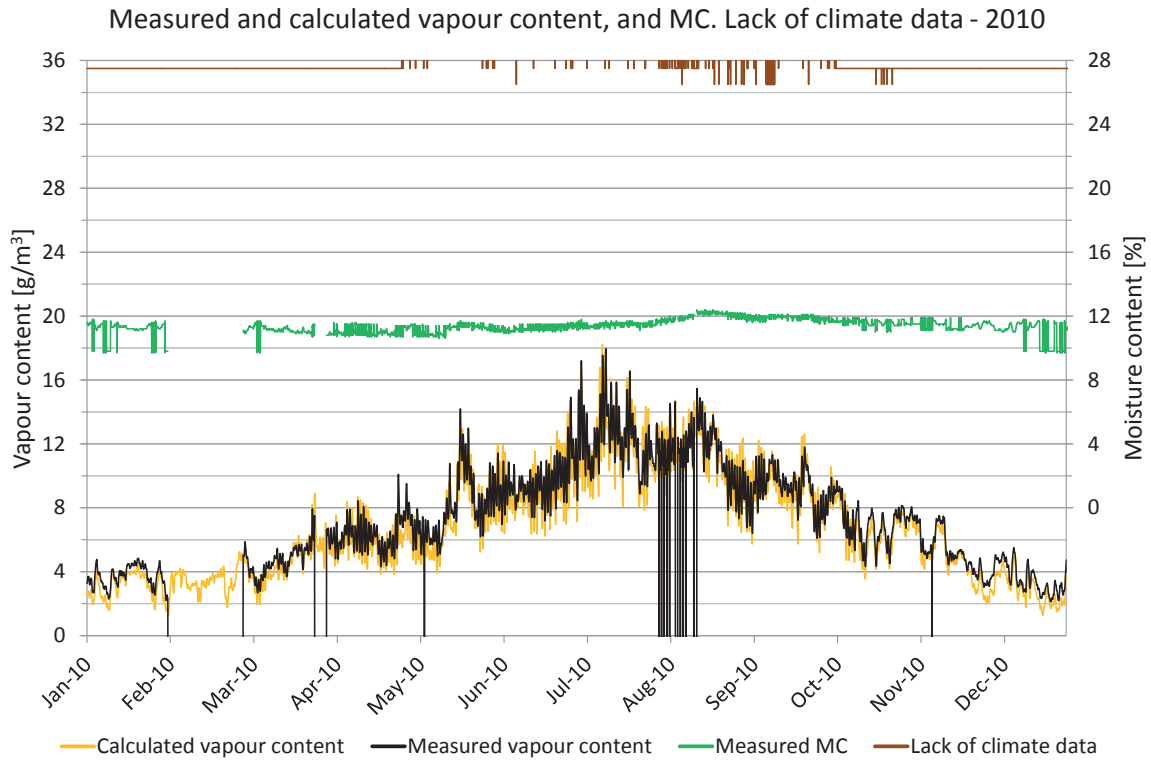

Figure 7.11.7. Measured moisture content, periods lacking climate data and comparisons of vapour content. Vapour content for calculated values (yellow) and measured values (black). Moisture content (green), periods with lack of climate data (brown).

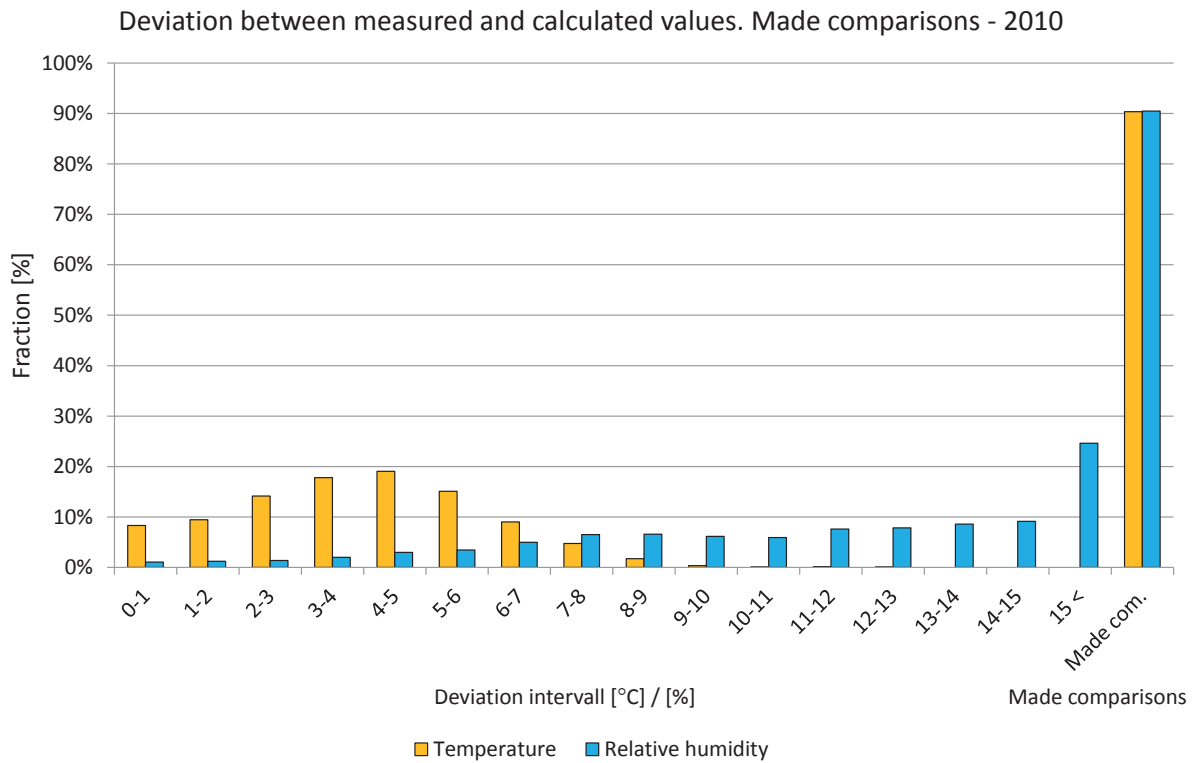

Figure 7.11.8. Deviations in comparisons shown in intervals from 0 to 15 °C or %. The two right-hand bars show the percentage of comparisons during the year. Temperature (yellow) and relative humidity (light blue).

Year 2011

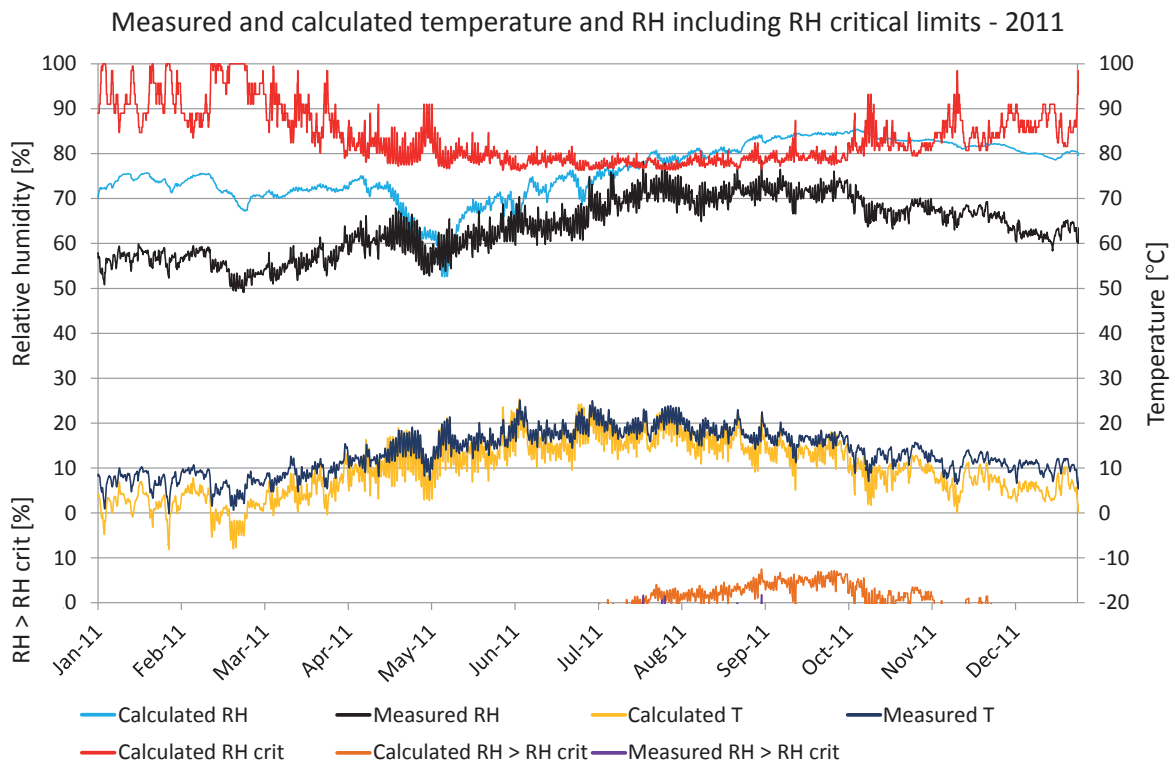

Figure 7.11.9. Comparisons between measured and calculated temperature and relative humidity. Calculated temperature (yellow), measured temperature (dark blue), calculated RH (turquoise), measured RH (black), RH_{crit} for calculated values (red), calculated RH > RH_{crit} (light brown), measured RH > RH_{crit} (purple).

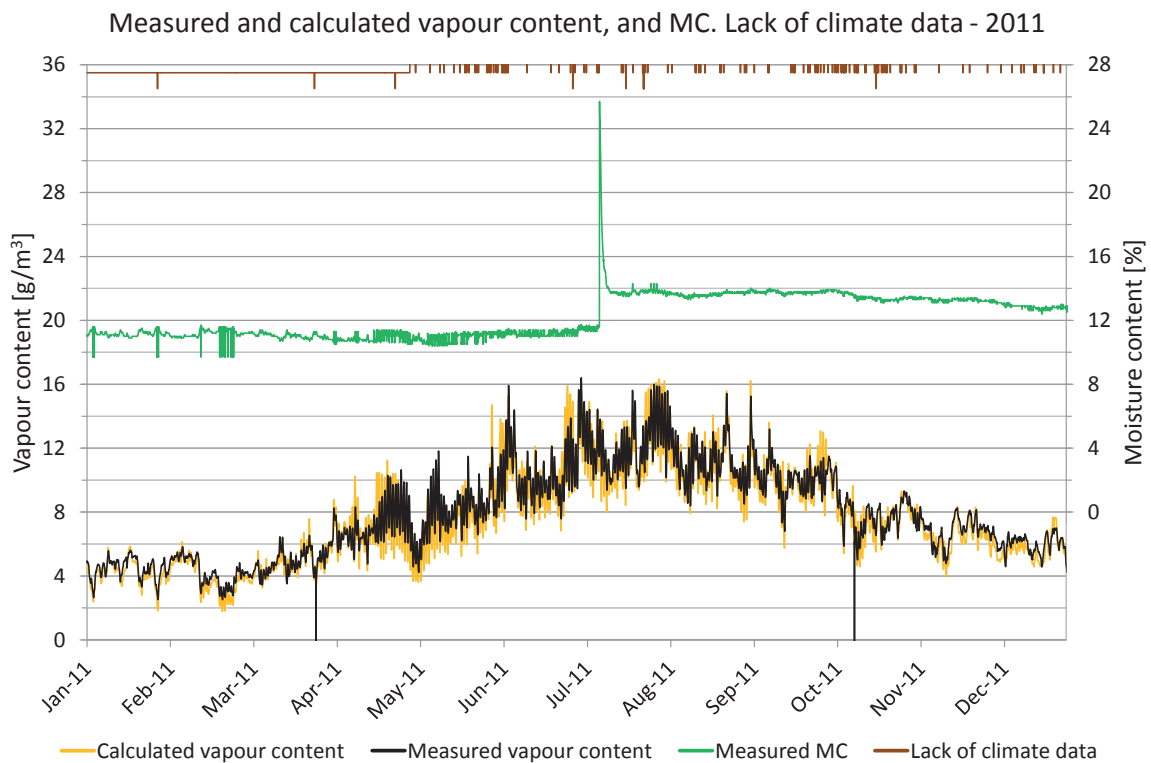

Figure 7.11.10. Measured moisture content, periods lacking climate data and comparisons of vapour content. Vapour content for calculated values (yellow) and measured values (black). Moisture content (green), periods with lack of climate data (brown).

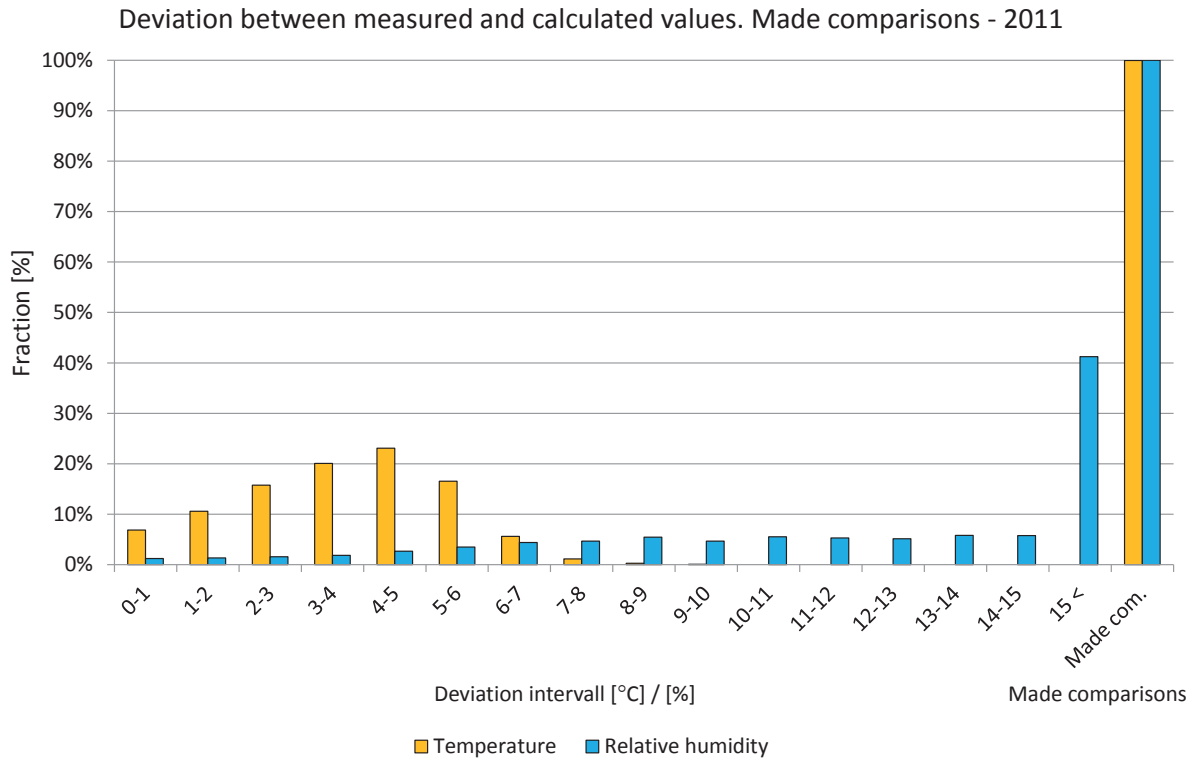

Figure 7.11.11. Deviations in comparisons shown in intervals from 0 to 15 °C or %. The two right-hand bars show the percentage of comparisons during the year. Temperature (yellow) and relative humidity (light blue).

7.12 Position 12

The locations of the measured and calculated position are shown in the drawings and figures below. The studied position is located in the exterior bathroom wall facing northeast.

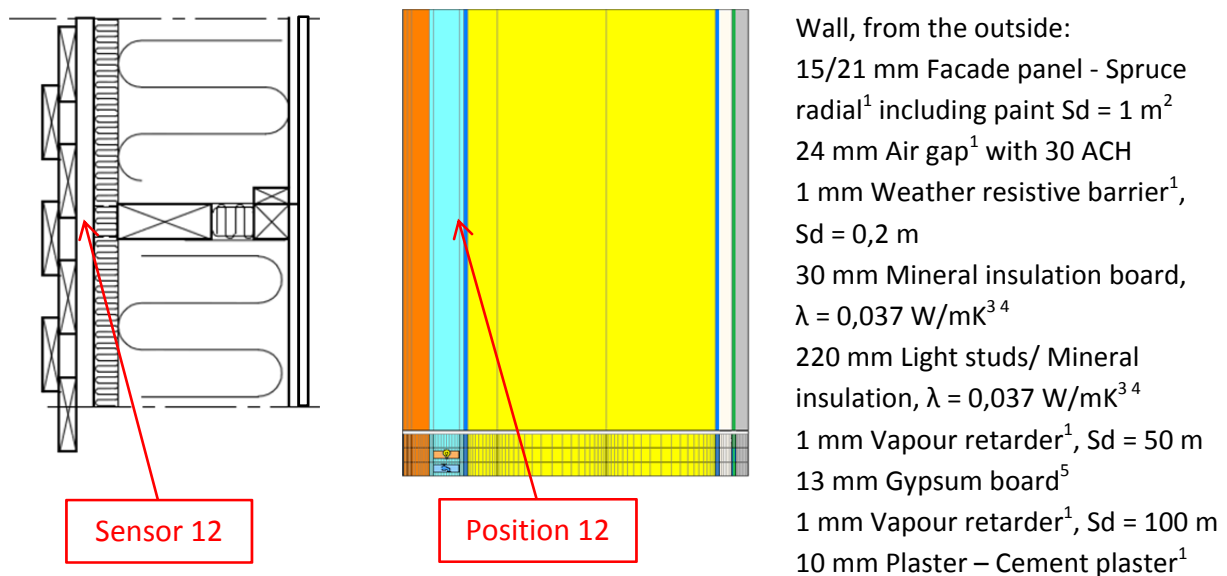

Figure 7.12.1. Vertical cross sectional drawing and WUFI calculation model showing the studied position. 1. IBP, 2012, 2. Nevander, L-E., 1994, 3. IEA Annex 24, 1996, 4. Paroc, 2002, 5. Krus, M., 1996.

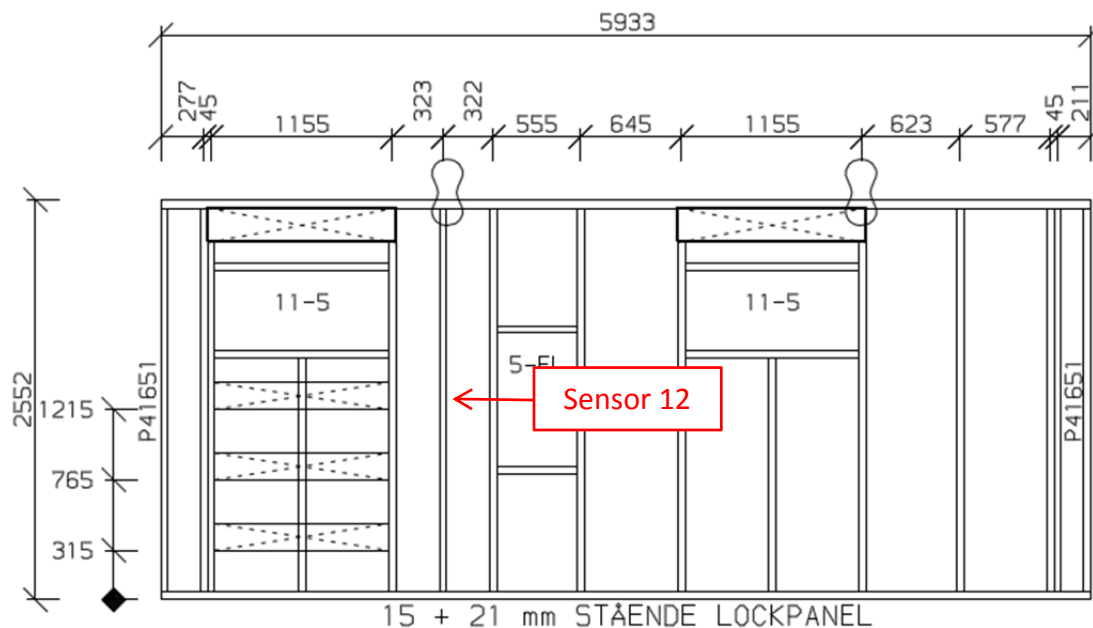

Figure 7.12.2. Location of the studied position.

A perfect match between the measured and calculated values cannot be expected due to e.g. the influence of two- and three-dimensional effects and the accuracy of the sensors.

Year 2009

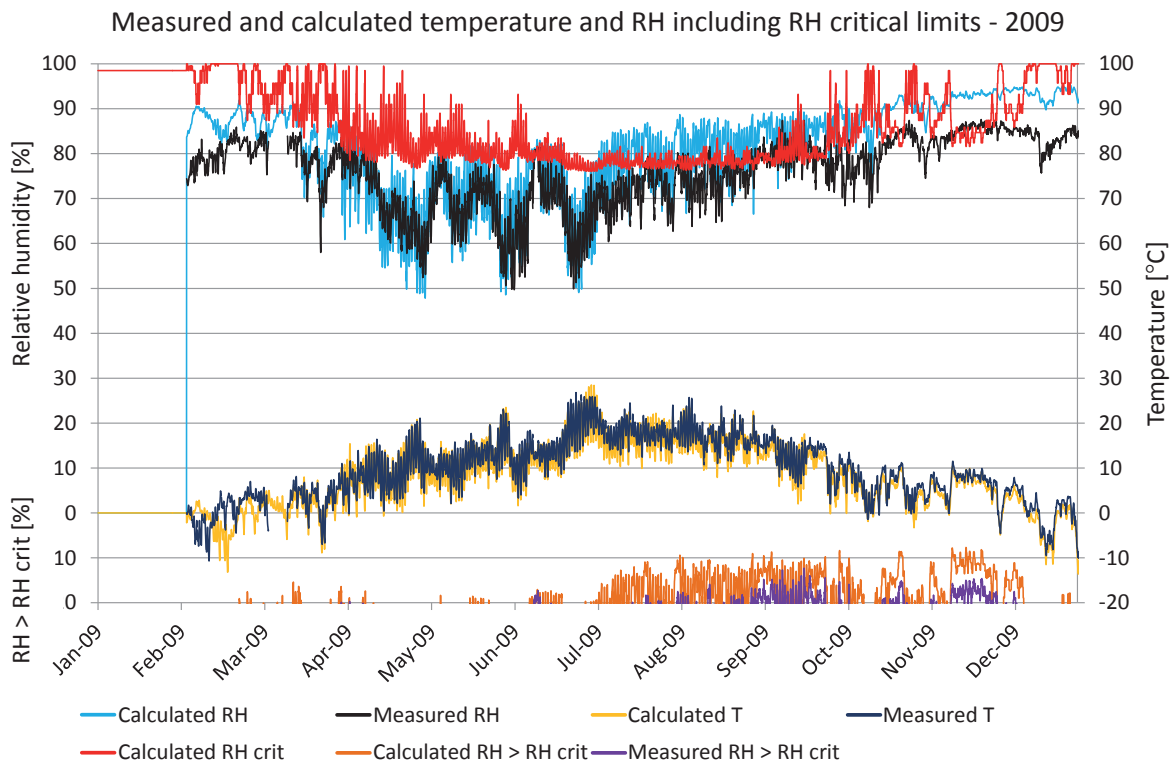

Figure 7.12.3. Comparisons between measured and calculated temperature and relative humidity. Calculated temperature (yellow), measured temperature (dark blue), calculated RH (turquoise), measured RH (black), RH_{crit} for calculated values (red), calculated $RH > RH_{crit}$ (light brown), measured $RH > RH_{crit}$ (purple).

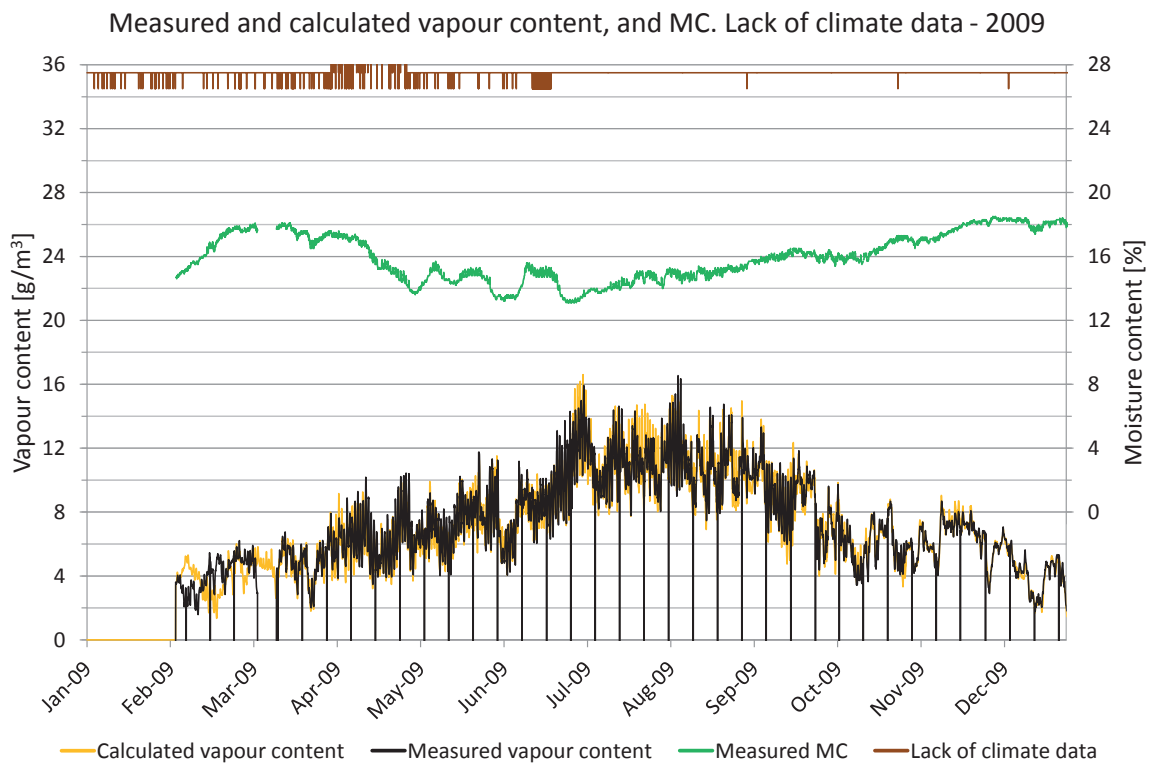

Figure 7.12.4. Measured moisture content, periods lacking climate data and comparisons of vapour content. Vapour content for calculated values (yellow) and measured values (black). Moisture content (green), periods with lack of climate data (brown).

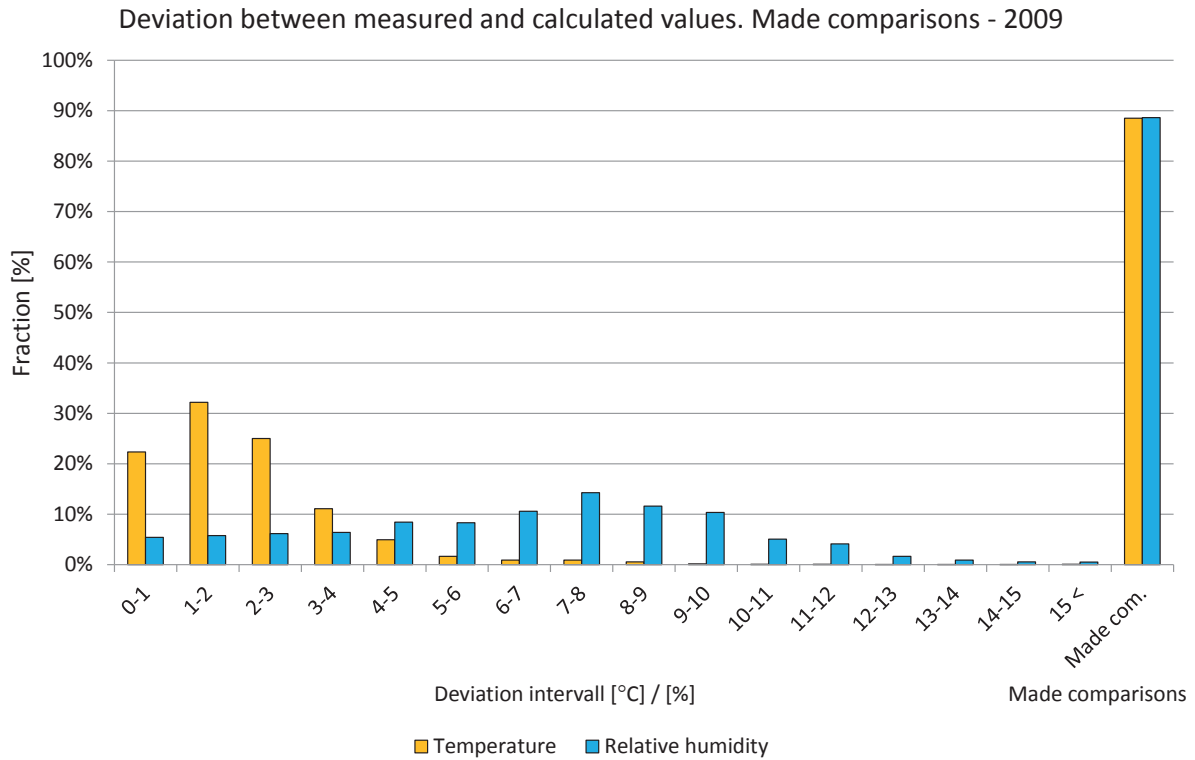

Figure 7.12.5. Deviations in comparisons shown in intervals from 0 to 15 °C or %. The two right-hand bars show the percentage of comparisons during the year. Temperature (yellow) and relative humidity (light blue).

Year 2010

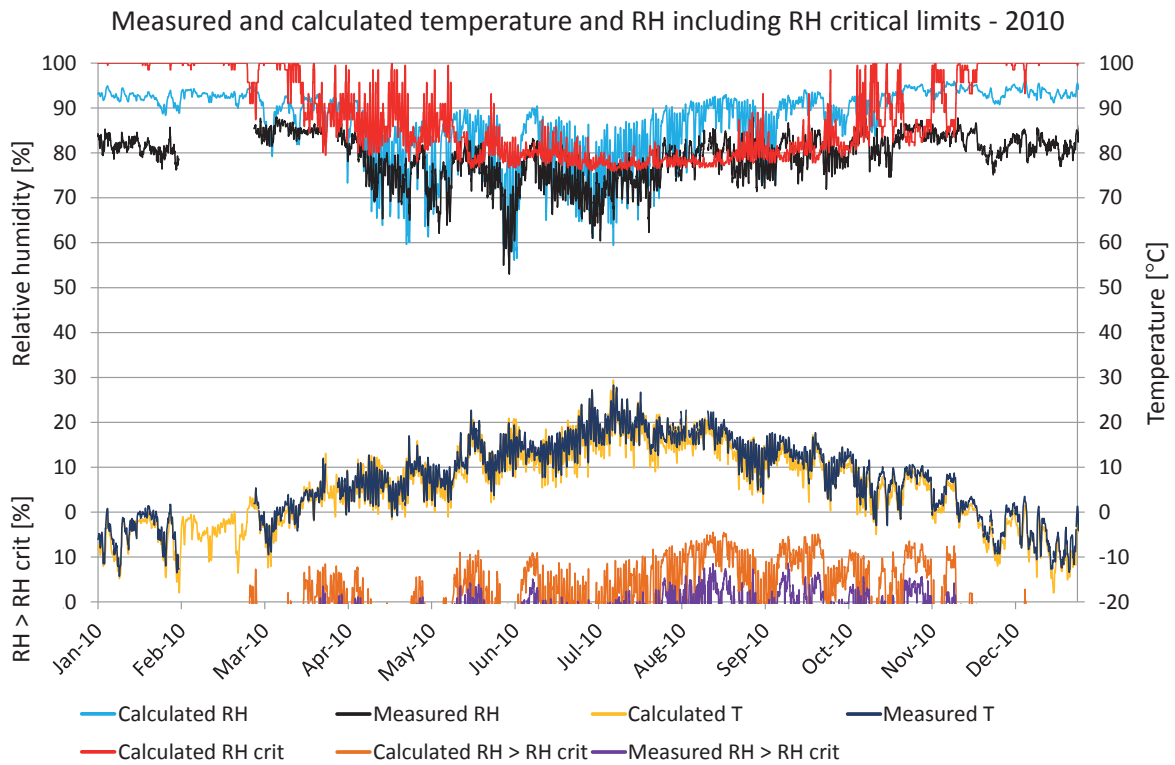

Figure 7.12.6. Comparisons between measured and calculated temperature and relative humidity. Calculated temperature (yellow), measured temperature (dark blue), calculated RH (turquoise), measured RH (black), RH_{crit} for calculated values (red), calculated $RH > RH_{crit}$ (light brown), measured $RH > RH_{crit}$ (purple).

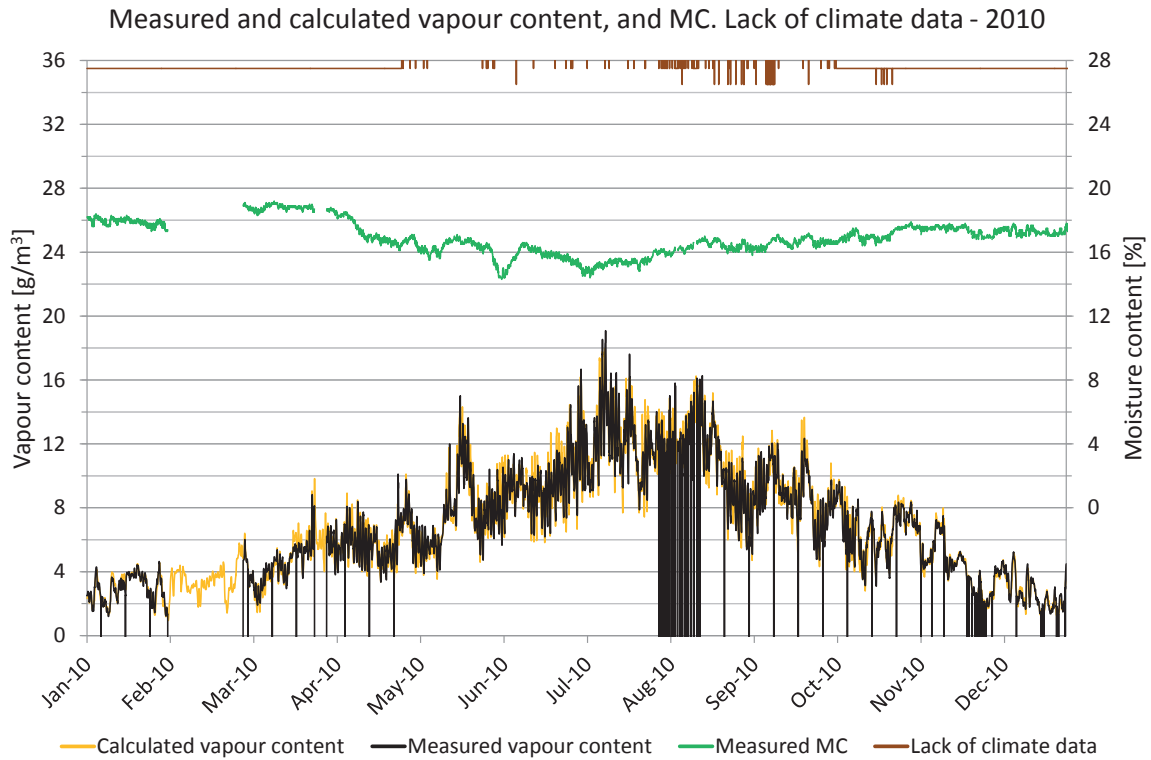

Figure 7.12.7. Measured moisture content, periods lacking climate data and comparisons of vapour content. Vapour content for calculated values (yellow) and measured values (black). Moisture content (green), periods with lack of climate data (brown).

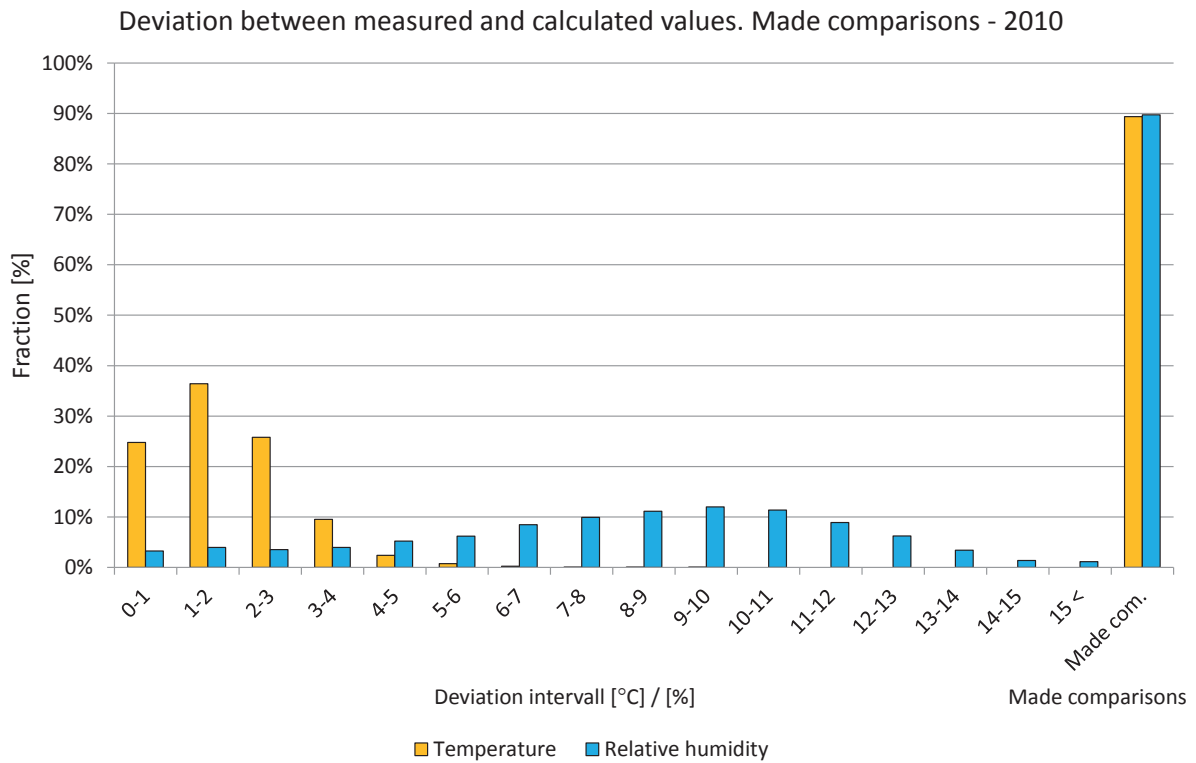

Figure 7.12.8. Deviations in comparisons shown in intervals from 0 to 15 °C or %. The two right-hand bars show the percentage of comparisons during the year. Temperature (yellow) and relative humidity (light blue).

Year 2011

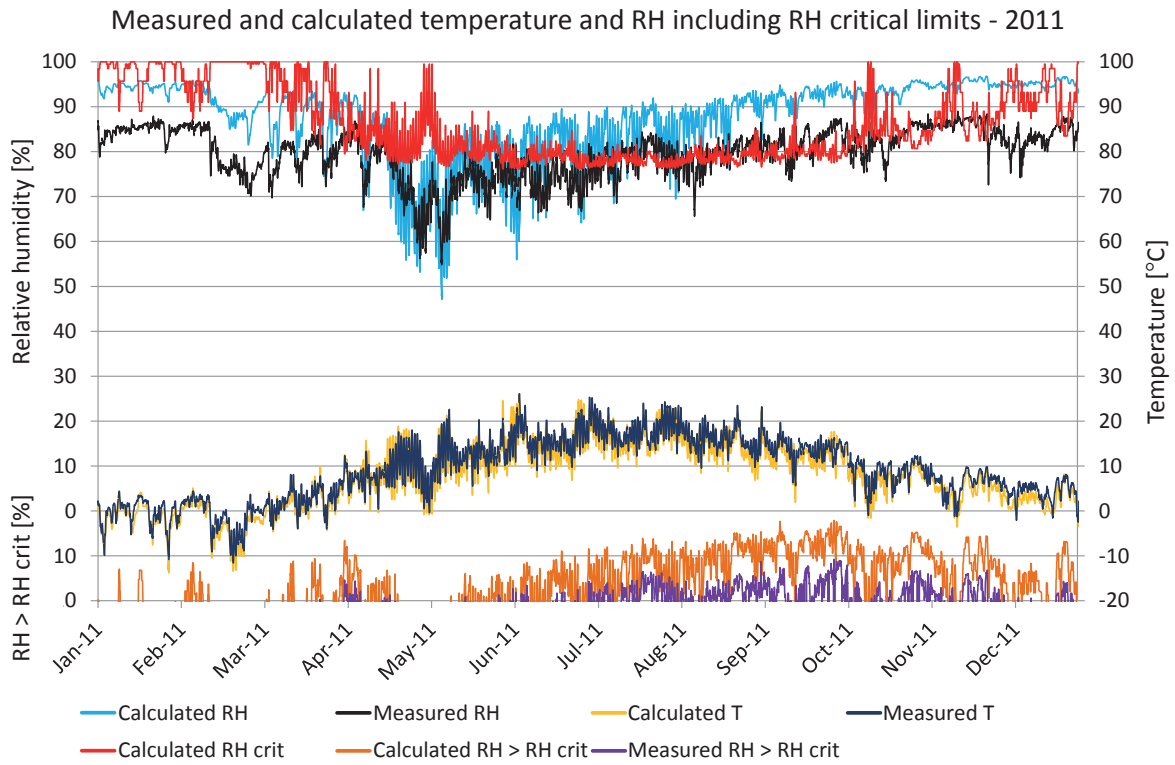

Figure 7.12.9. Comparisons between measured and calculated temperature and relative humidity. Calculated temperature (yellow), measured temperature (dark blue), calculated RH (turquoise), measured RH (black), RH_{crit} for calculated values (red), calculated $RH > RH_{crit}$ (light brown), measured $RH > RH_{crit}$ (purple).

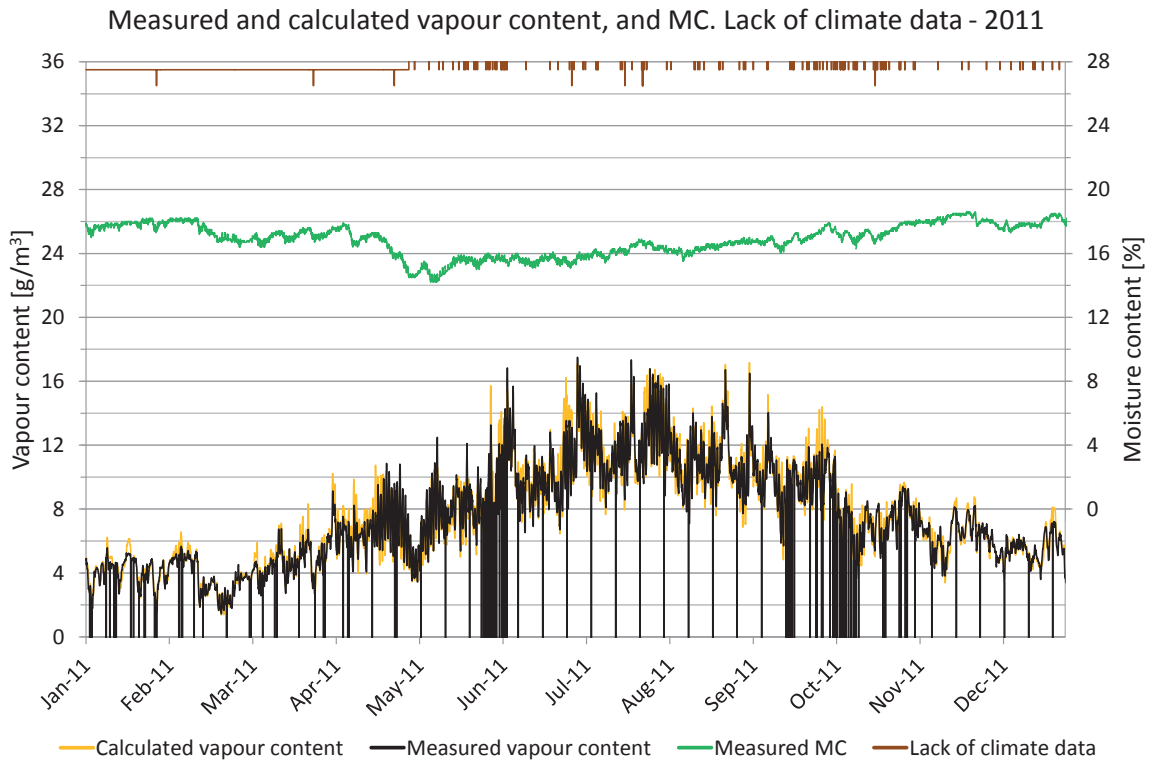

Figure 7.12.10. Measured moisture content, periods lacking climate data and comparisons of vapour content. Vapour content for calculated values (yellow) and measured values (black). Moisture content (green), periods with lack of climate data (brown).

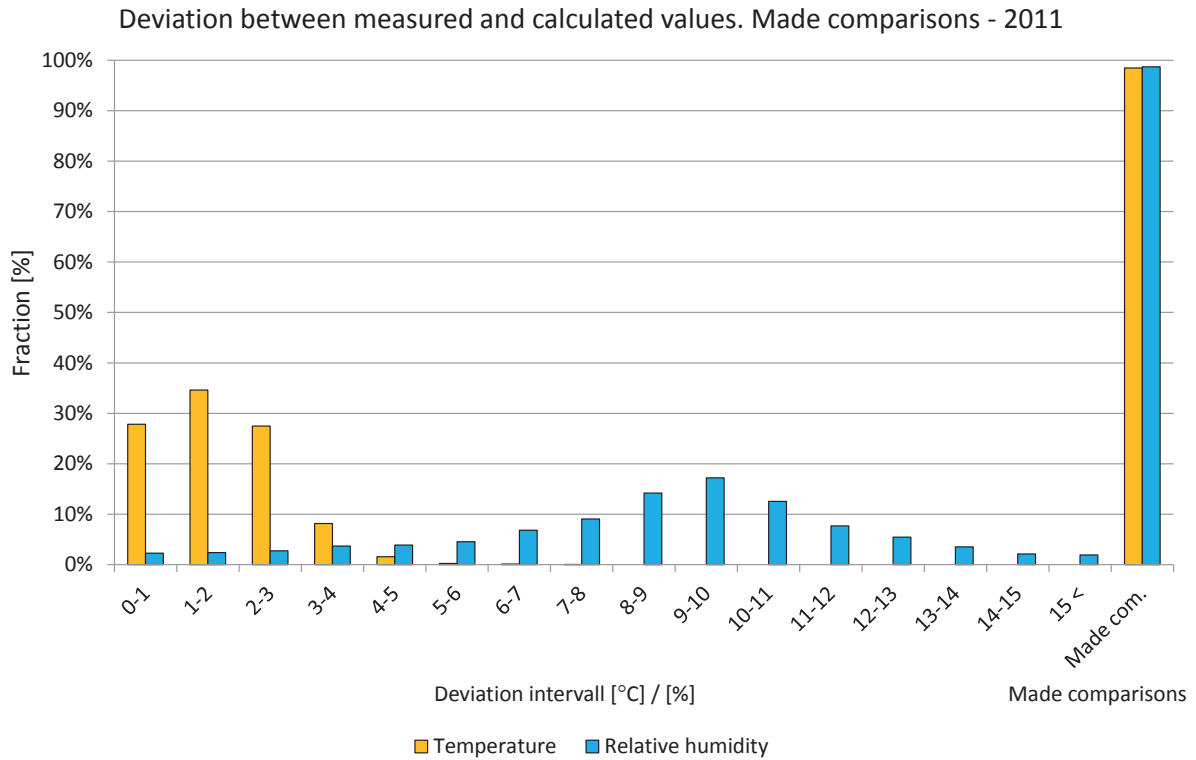

Figure 7.12.11. Deviations in comparisons shown in intervals from 0 to 15 °C or %. The two right-hand bars show the percentage of comparisons during the year. Temperature (yellow) and relative humidity (light blue).

7.13 Position 13

The locations of the measured and calculated position are shown in the drawings and figures below. The studied position is located in the exterior bathroom wall facing northeast.

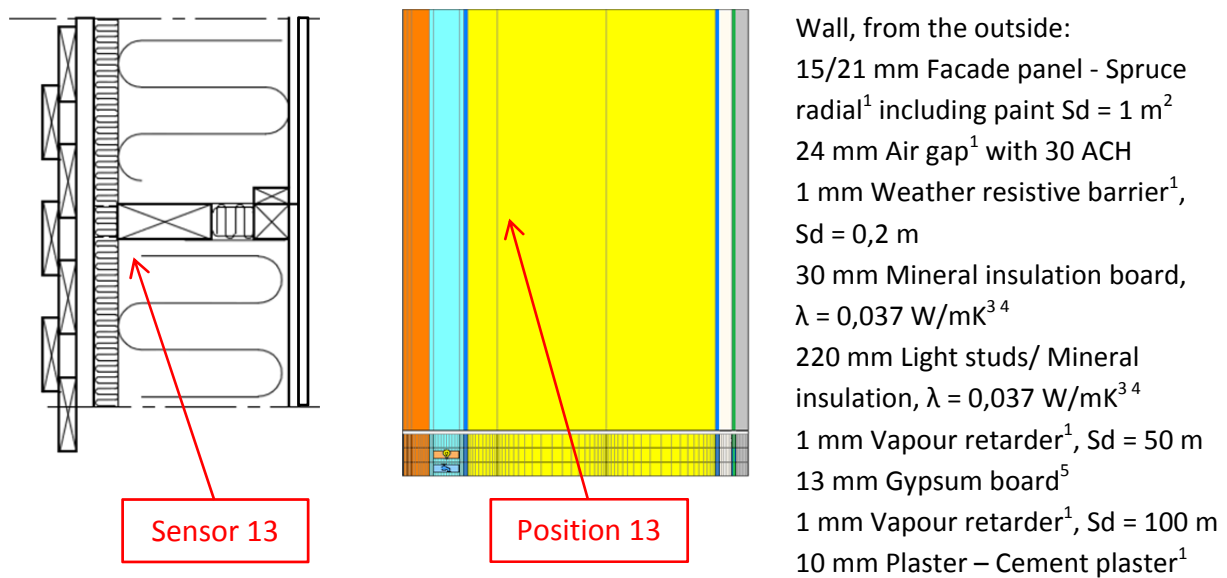

Figure 7.13.1. Vertical cross sectional drawing and WUFI calculation model showing the studied position. 1. IBP, 2012, 2. Nevander, L-E., 1994, 3. IEA Annex 24, 1996, 4. Paroc, 2002, 5. Krus, M., 1996.

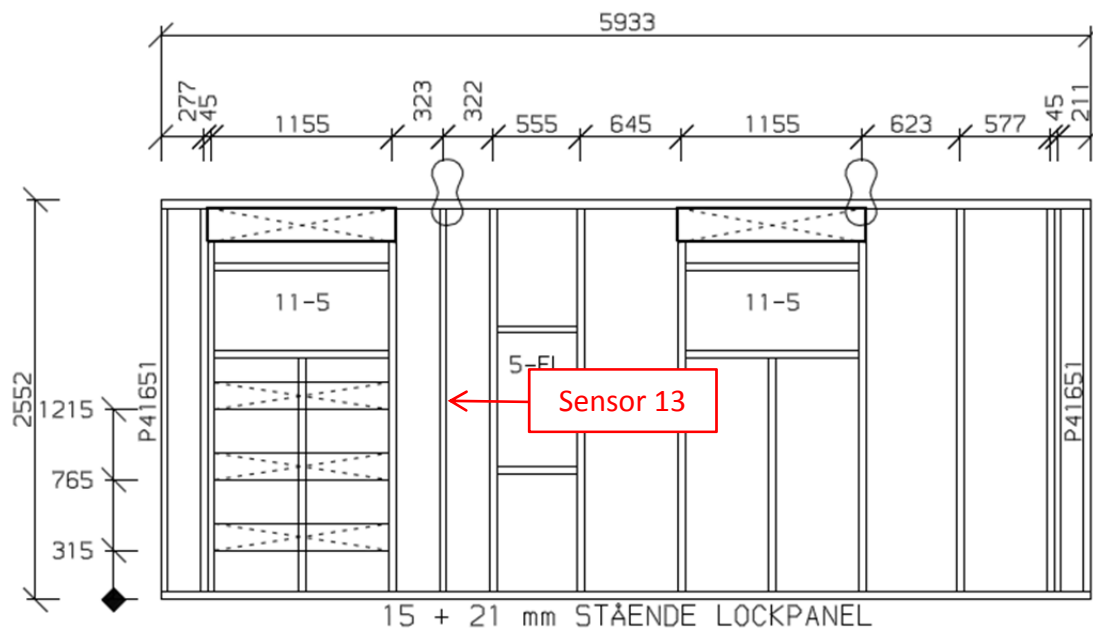

Figure 7.13.2. Location of the studied position.

A perfect match between the measured and calculated values cannot be expected due to e.g. the influence of two- and three-dimensional effects and the accuracy of the sensors.

Year 2009

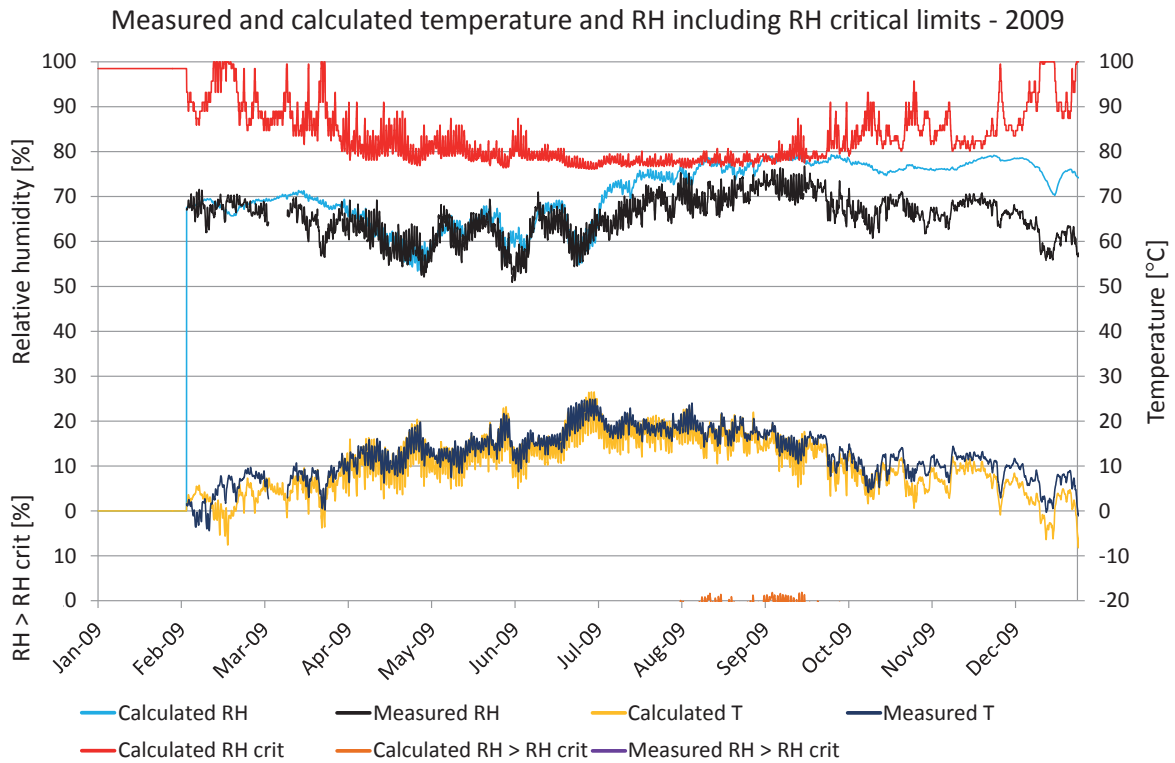

Figure 7.13.3. Comparisons between measured and calculated temperature and relative humidity. Calculated temperature (yellow), measured temperature (dark blue), calculated RH (turquoise), measured RH (black), RH_{crit} for calculated values (red), calculated $RH > RH_{crit}$ (light brown), measured $RH > RH_{crit}$ (purple).

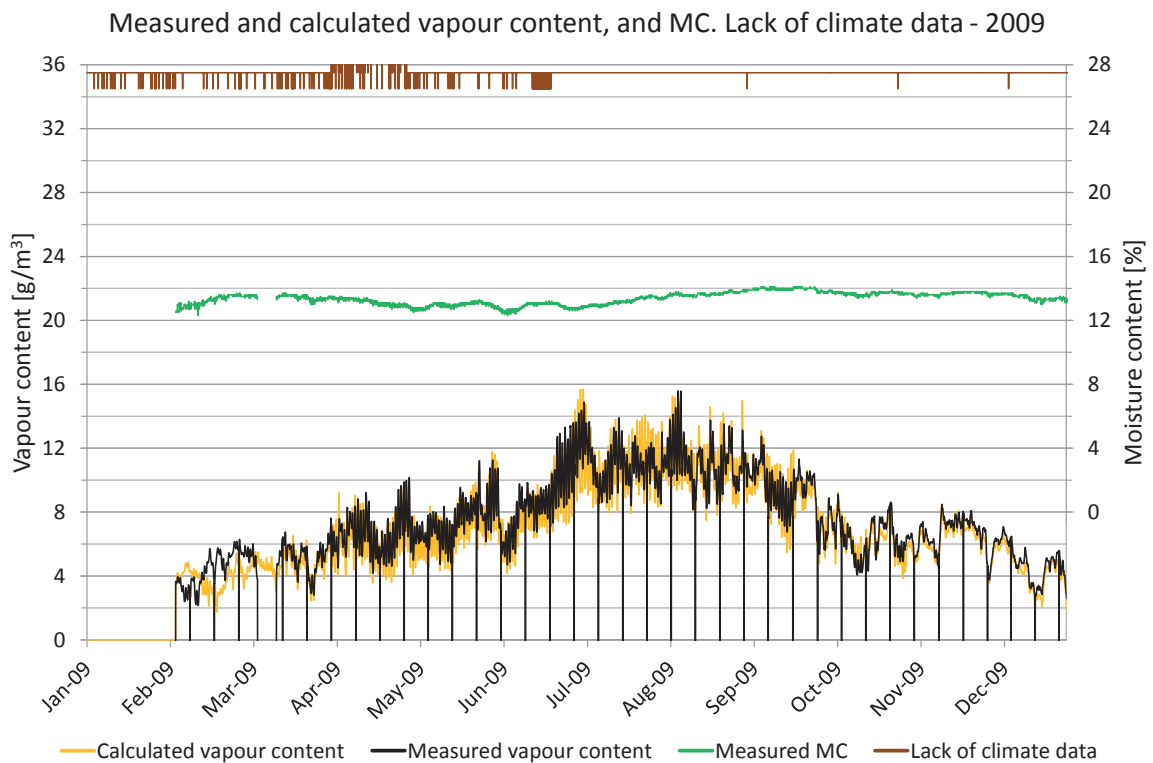

Figure 7.13.4. Measured moisture content, periods lacking climate data and comparisons of vapour content. Vapour content for calculated values (yellow) and measured values (black). Moisture content (green), periods with lack of climate data (brown).

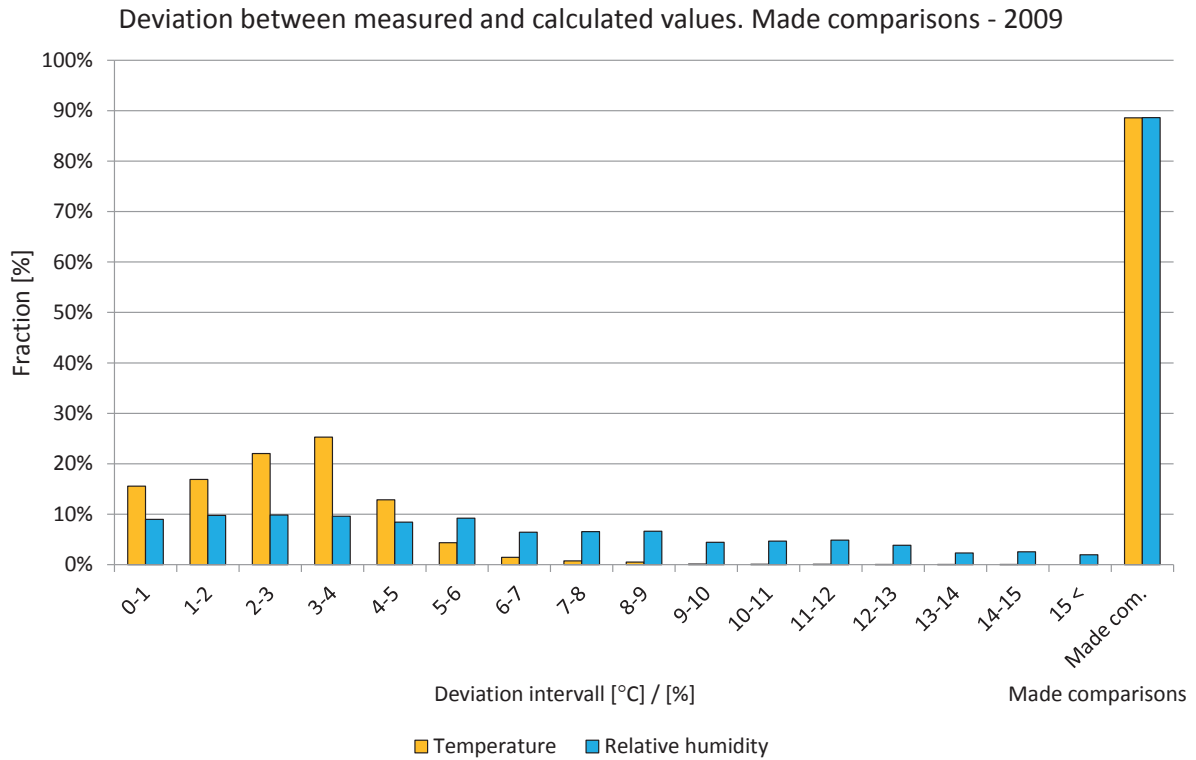

Figure 7.13.5. Deviations in comparisons shown in intervals from 0 to 15 °C or %. The two right-hand bars show the percentage of comparisons during the year. Temperature (yellow) and relative humidity (light blue).

Year 2010

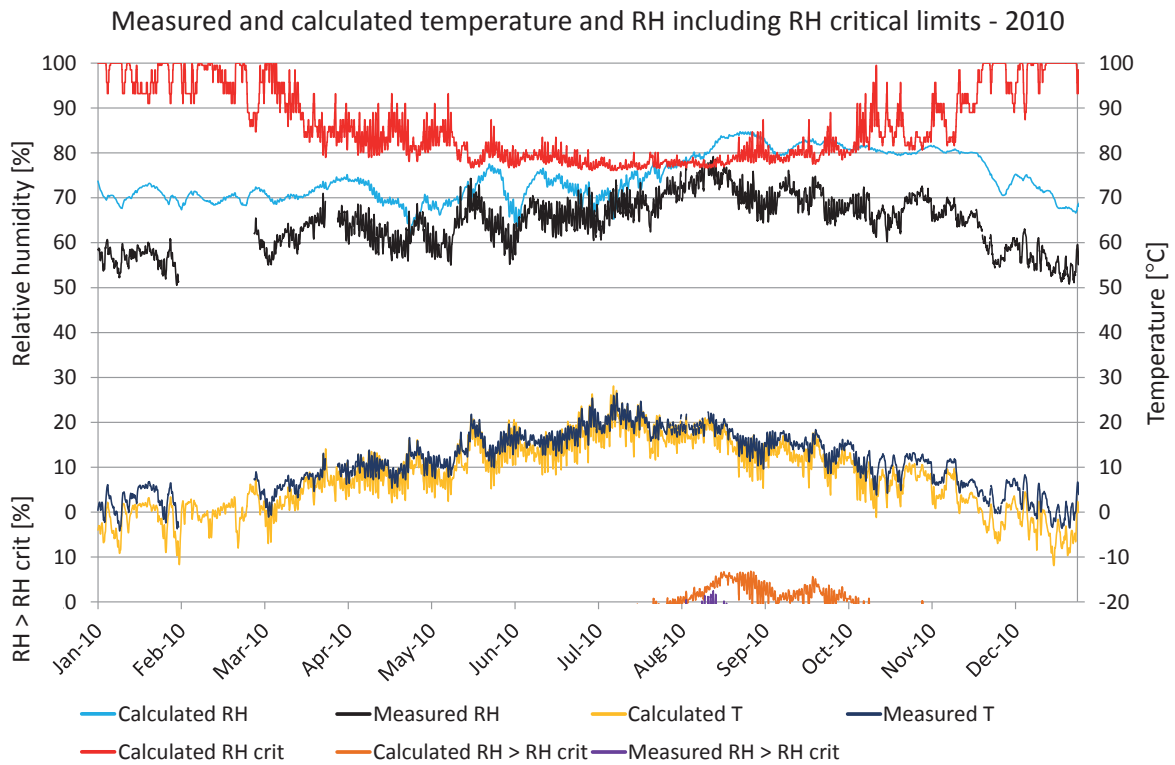

Figure 7.13.6. Comparisons between measured and calculated temperature and relative humidity. Calculated temperature (yellow), measured temperature (dark blue), calculated RH (turquoise), measured RH (black), RH_{crit} for calculated values (red), calculated RH > RH_{crit} (light brown), measured RH > RH_{crit} (purple).

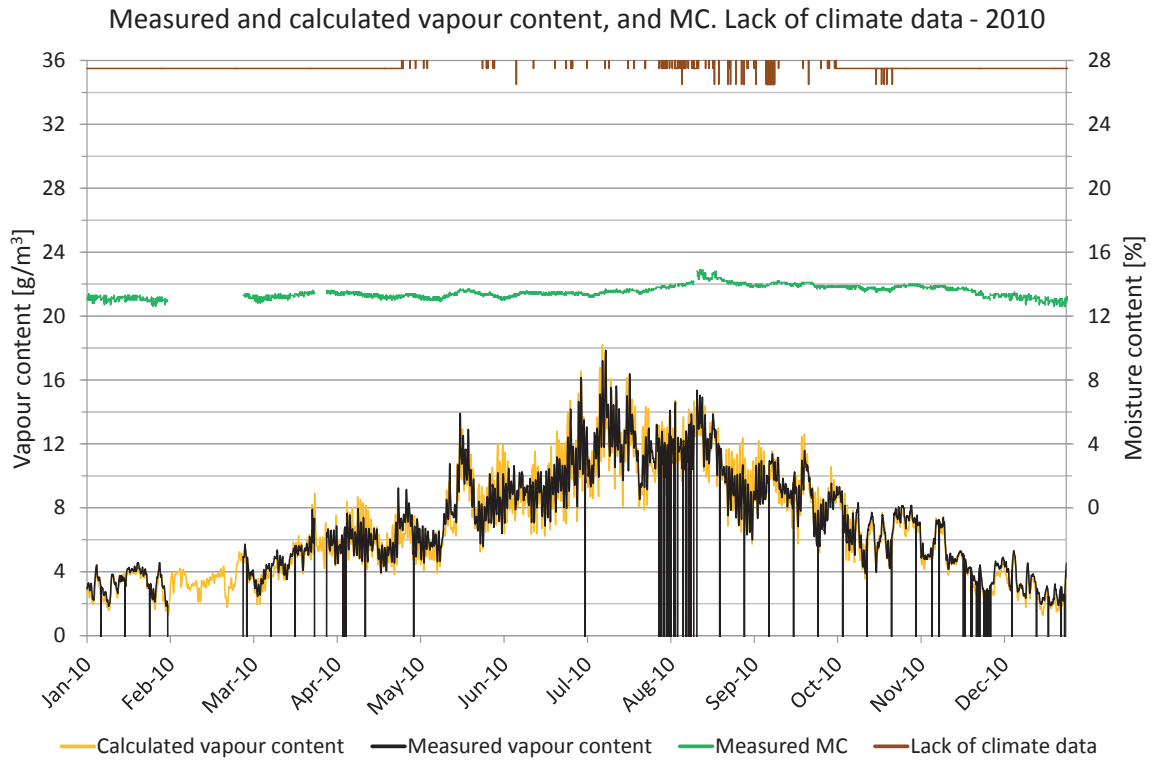

Figure 7.13.7. Measured moisture content, periods lacking climate data and comparisons of vapour content. Vapour content for calculated values (yellow) and measured values (black). Moisture content (green), periods with lack of climate data (brown).

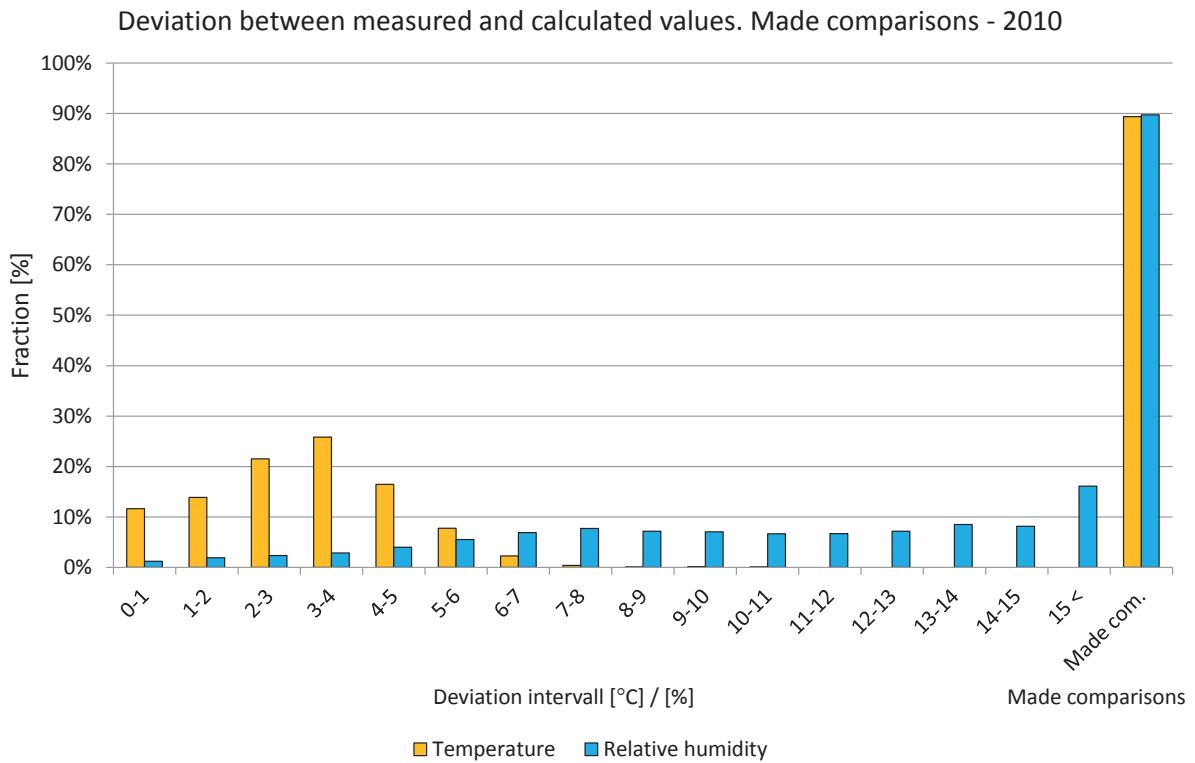

Figure 7.13.8. Deviations in comparisons shown in intervals from 0 to 15 °C or %. The two right-hand bars show the percentage of comparisons during the year. Temperature (yellow) and relative humidity (light blue).

Year 2011

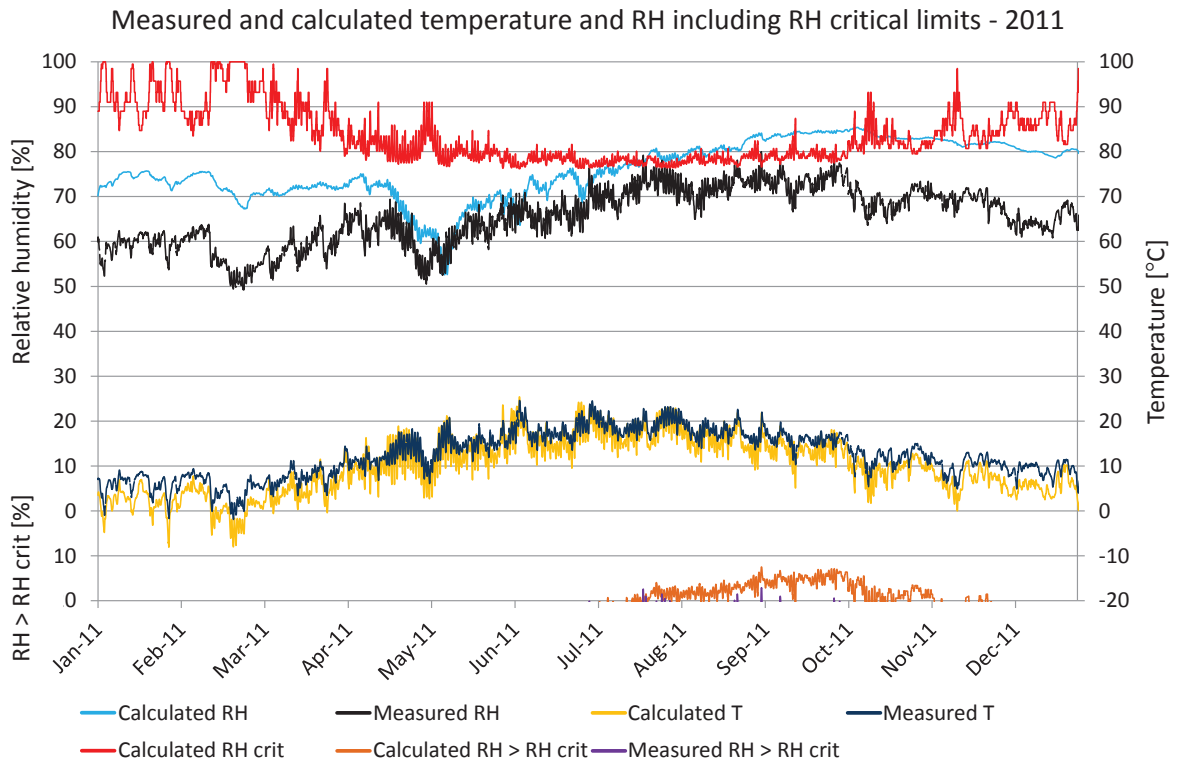

Figure 7.13.9. Comparisons between measured and calculated temperature and relative humidity. Calculated temperature (yellow), measured temperature (dark blue), calculated RH (turquoise), measured RH (black), RH_{crit} for calculated values (red), calculated RH > RH_{crit} (light brown), measured RH > RH_{crit} (purple).

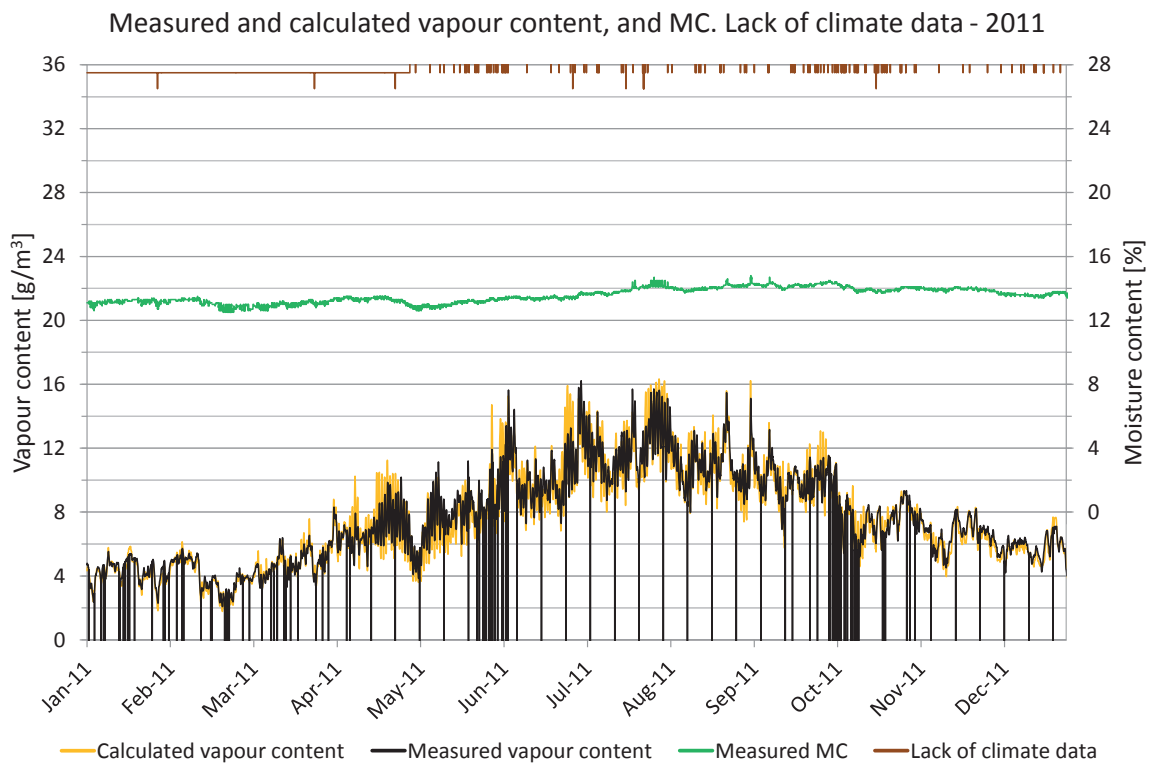

Figure 7.13.10. Measured moisture content, periods lacking climate data and comparisons of vapour content. Vapour content for calculated values (yellow) and measured values (black). Moisture content (green), periods with lack of climate data (brown).

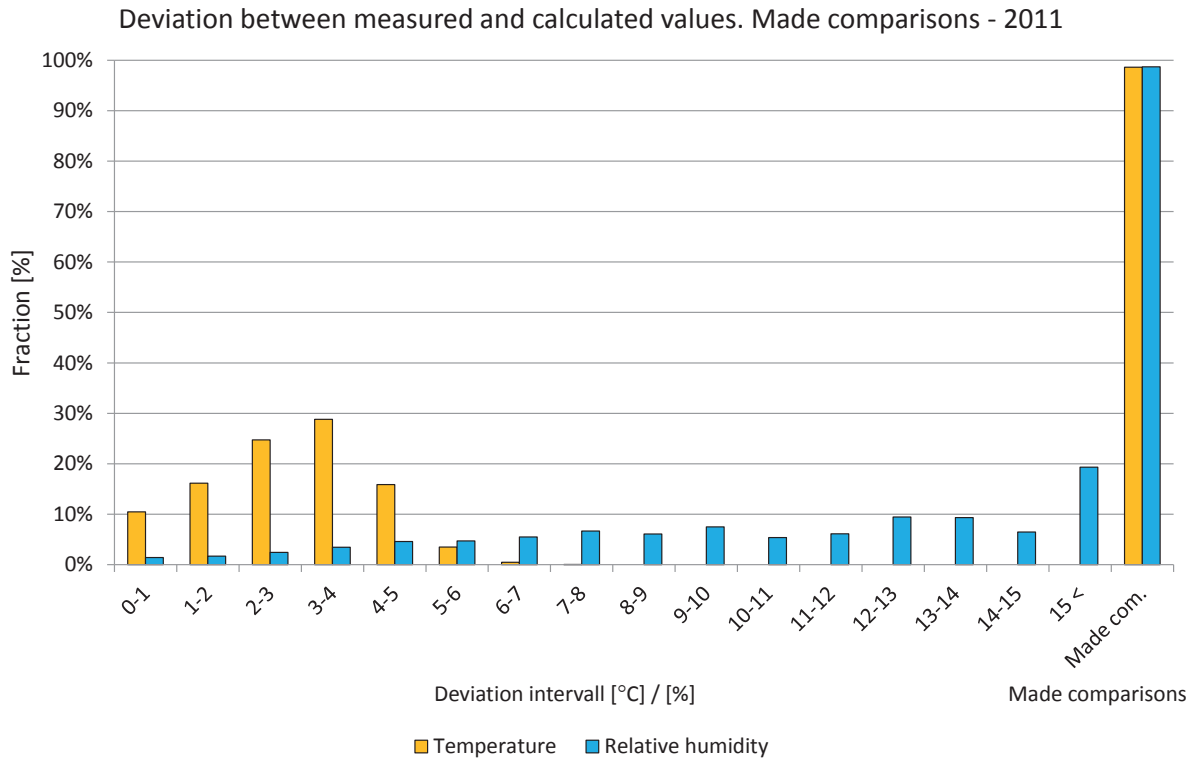

Figure 7.13.11. Deviations in comparisons shown in intervals from 0 to 15 °C or %. The two right-hand bars show the percentage of comparisons during the year. Temperature (yellow) and relative humidity (light blue).

7.14 Position 14

The locations of the measured and calculated position are shown in the drawings and figures below. The studied position is located in the exterior bathroom wall facing northeast.

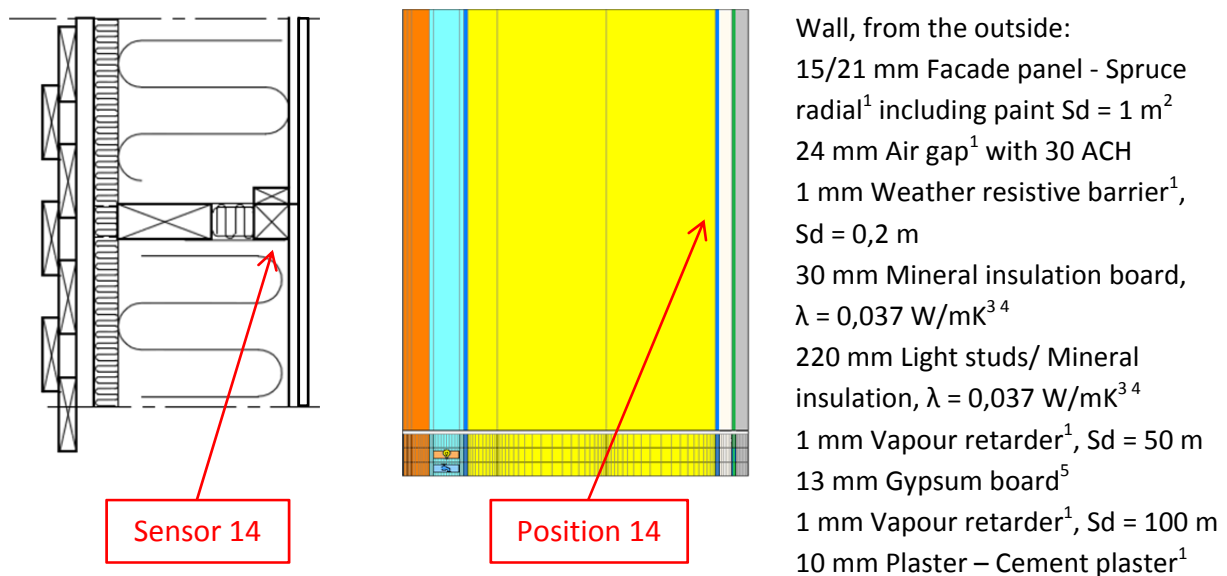

Figure 7.14.1. Vertical cross sectional drawing and WUFI calculation model showing the studied position. 1. IBP, 2012, 2. Nevander, L-E., 1994, 3. IEA Annex 24, 1996, 4. Paroc, 2002, 5. Krus, M., 1996.

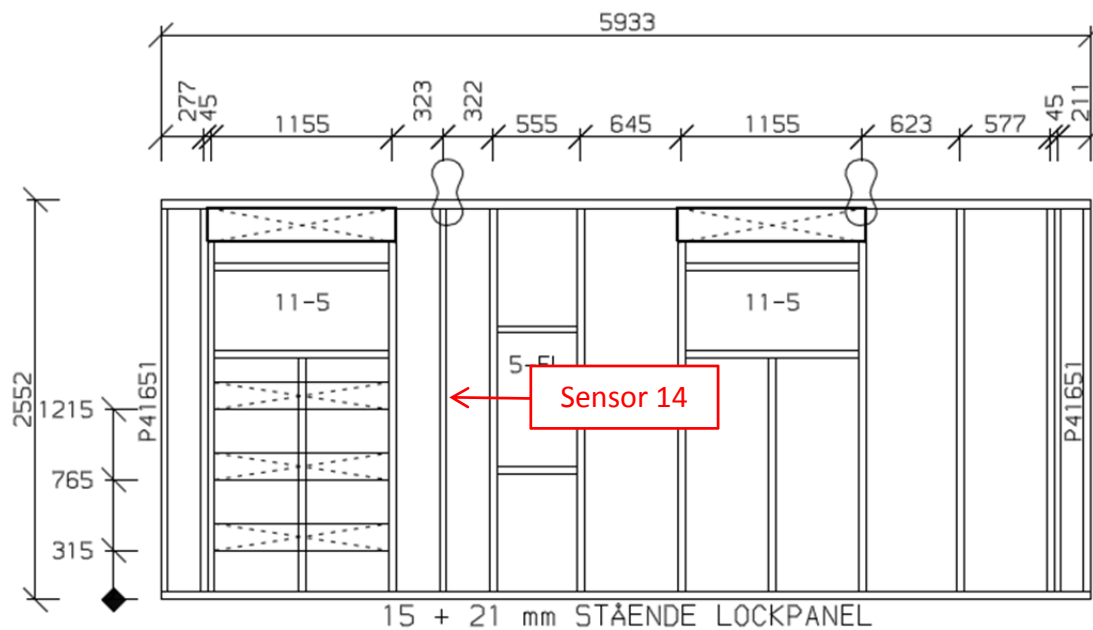

Figure 7.14.2. Location of the studied position.

A perfect match between the measured and calculated values cannot be expected due to e.g. the influence of two- and three-dimensional effects and the accuracy of the sensors.

Year 2009

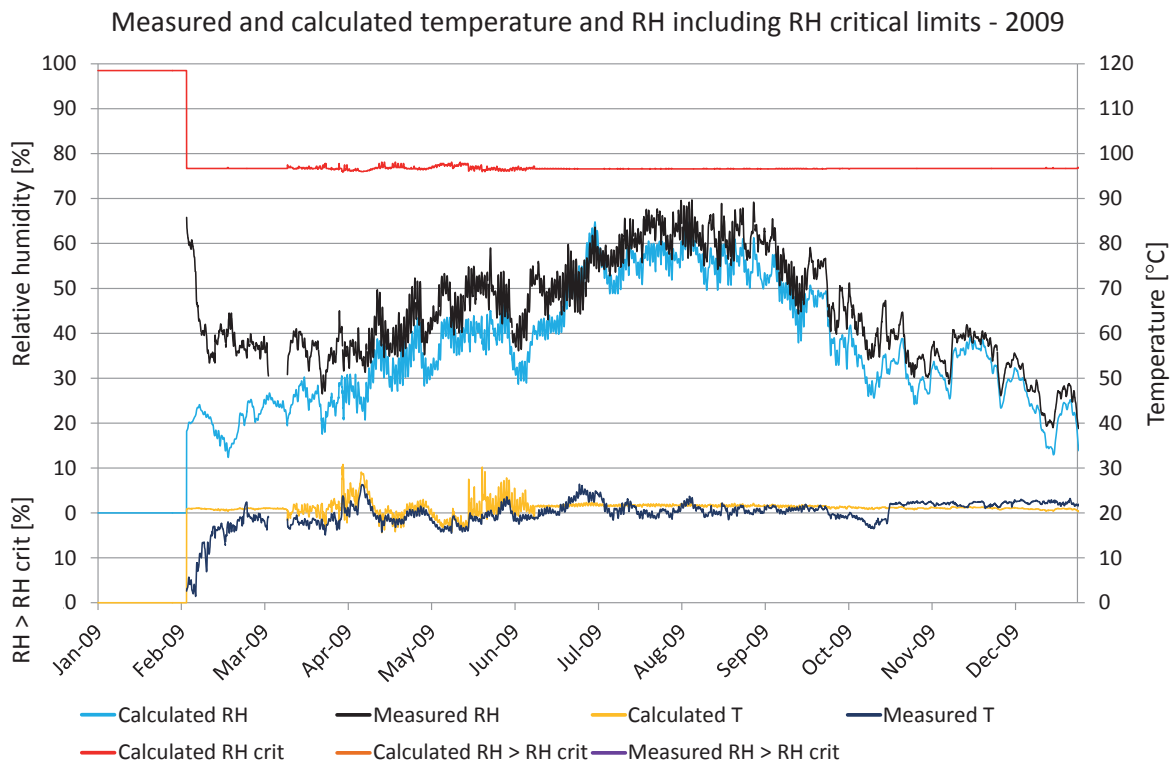

Figure 7.14.3. Comparisons between measured and calculated temperature and relative humidity. Calculated temperature (yellow), measured temperature (dark blue), calculated RH (turquoise), measured RH (black), RH_{crit} for calculated values (red), calculated $RH > RH_{crit}$ (light brown), measured $RH > RH_{crit}$ (purple).

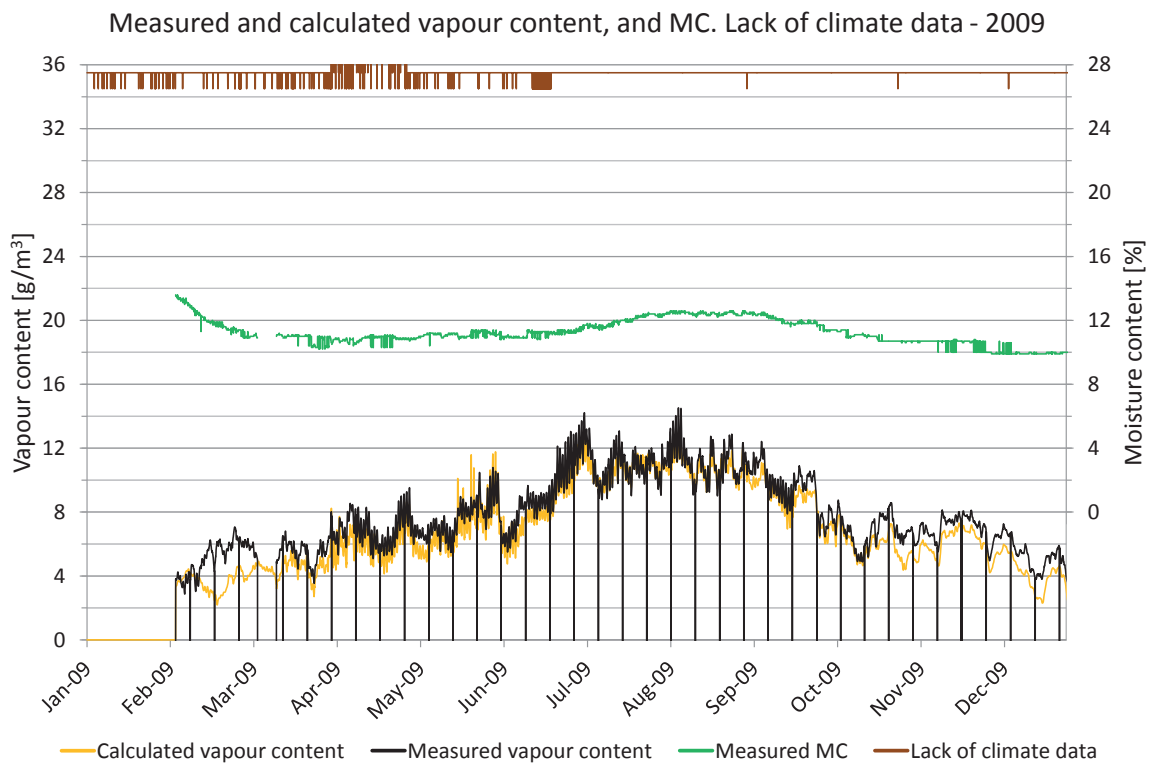

Figure 7.12.4. Measured moisture content, periods lacking climate data and comparisons of vapour content. Vapour content for calculated values (yellow) and measured values (black). Moisture content (green), periods with lack of climate data (brown).

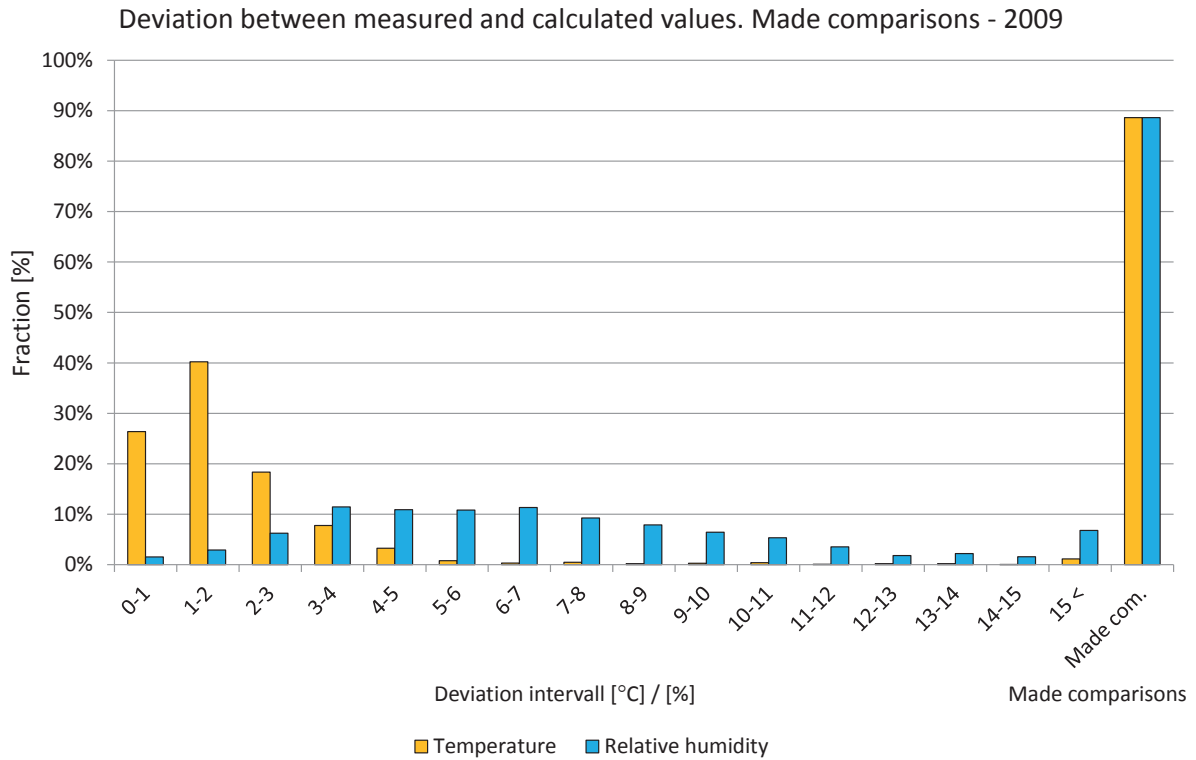

Figure 7.14.4. Deviations in comparisons shown in intervals from 0 to 15 °C or %. The two right-hand bars show the percentage of comparisons during the year. Temperature (yellow) and relative humidity (light blue).

Year 2010

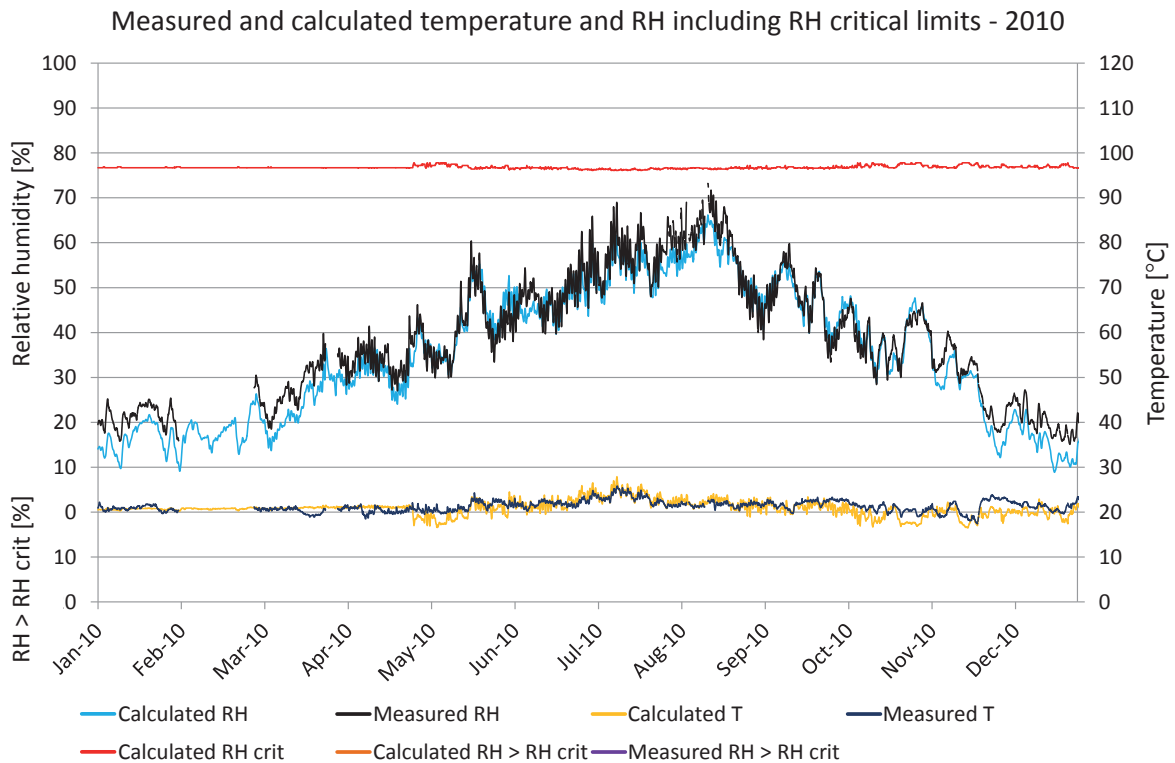

Figure 7.14.6. Comparisons between measured and calculated temperature and relative humidity. Calculated temperature (yellow), measured temperature (dark blue), calculated RH (turquoise), measured RH (black), RH_{crit} for calculated values (red), calculated RH > RH_{crit} (light brown), measured RH > RH_{crit} (purple).

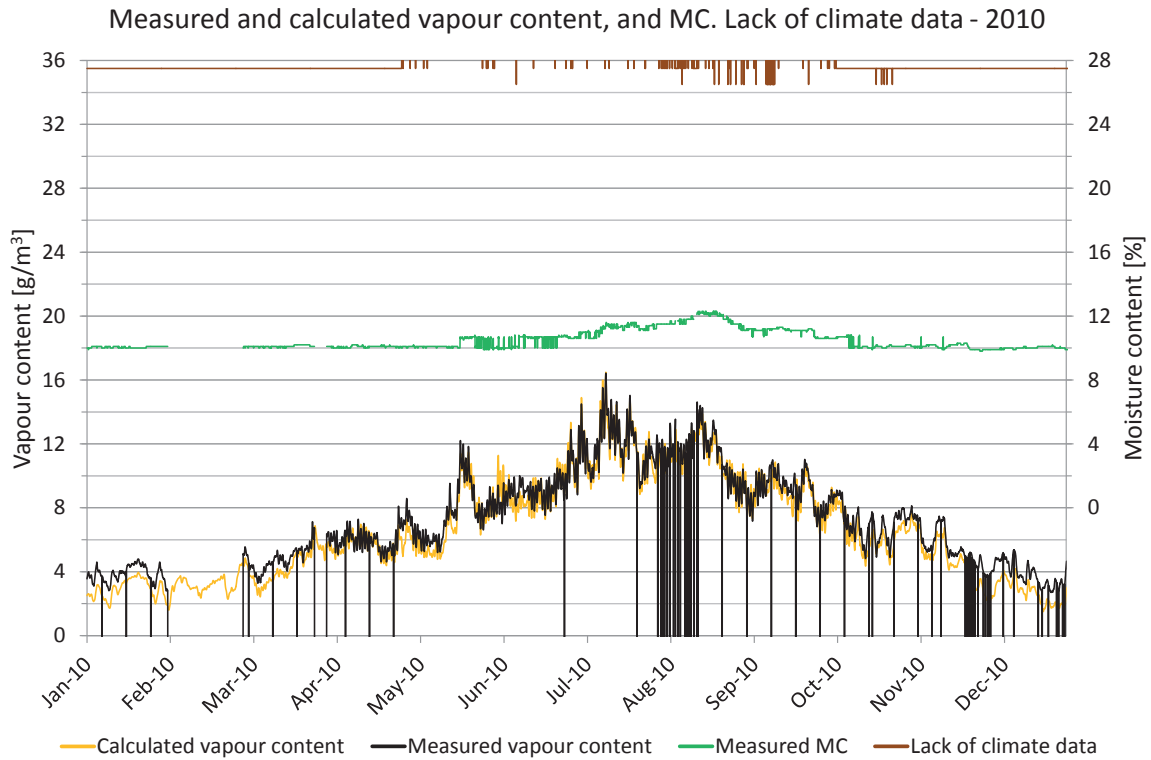

Figure 7.14.7. Measured moisture content, periods lacking climate data and comparisons of vapour content. Vapour content for calculated values (yellow) and measured values (black). Moisture content (green), periods with lack of climate data (brown).

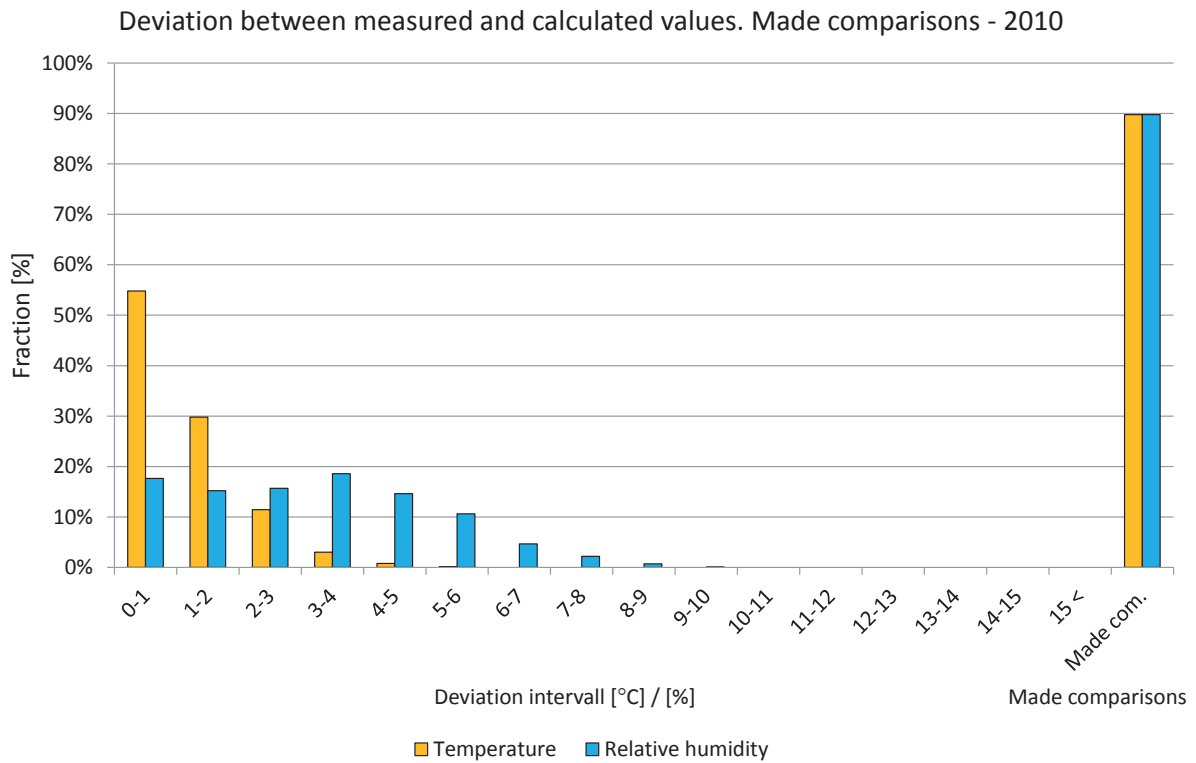

Figure 7.14.8. Deviations in comparisons shown in intervals from 0 to 15 °C or %. The two right-hand bars show the percentage of comparisons during the year. Temperature (yellow) and relative humidity (light blue).

Year 2011

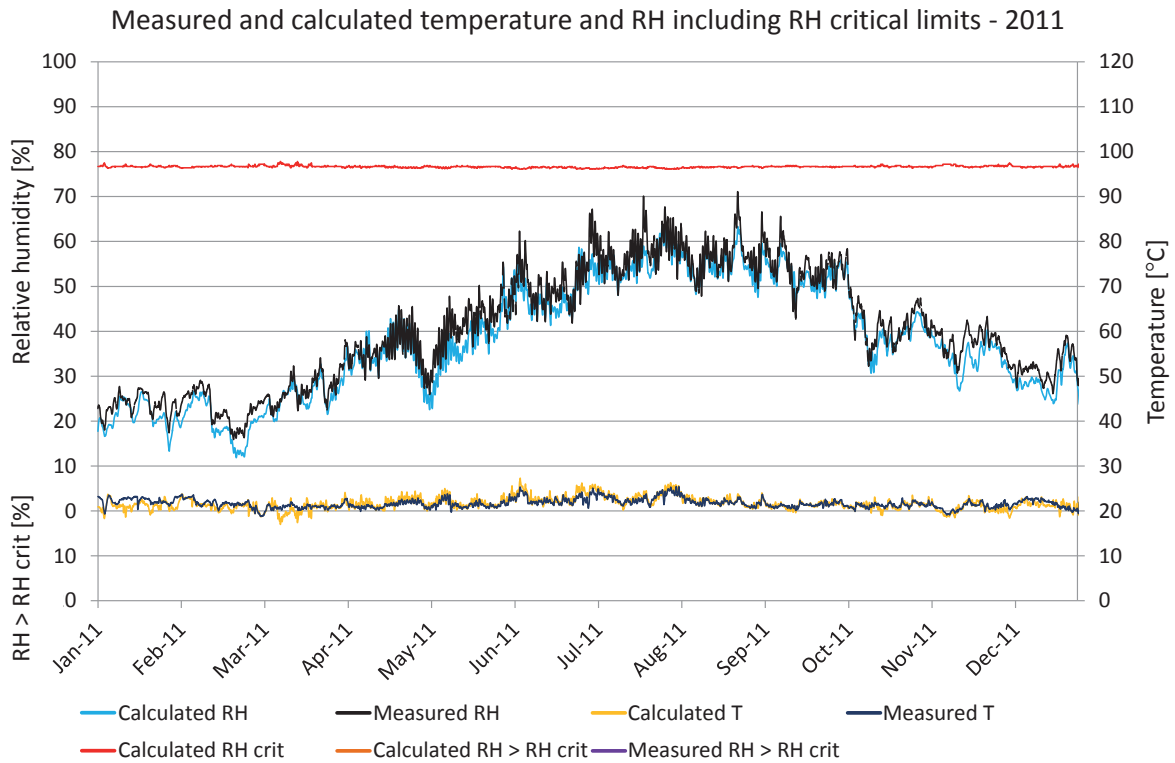

Figure 7.14.9. Comparisons between measured and calculated temperature and relative humidity. Calculated temperature (yellow), measured temperature (dark blue), calculated RH (turquoise), measured RH (black), RH_{crit} for calculated values (red), calculated $RH > RH_{crit}$ (light brown), measured $RH > RH_{crit}$ (purple).

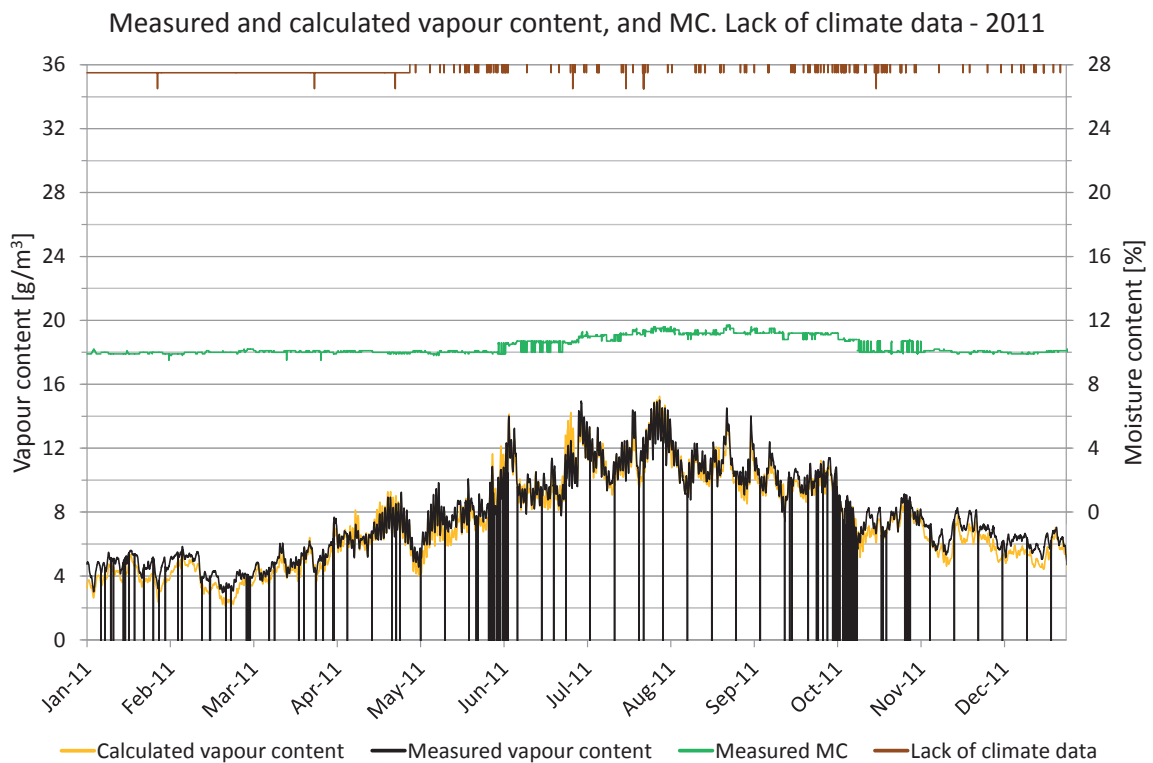

Figure 7.14.10. Measured moisture content, periods lacking climate data and comparisons of vapour content. Vapour content for calculated values (yellow) and measured values (black). Moisture content (green), periods with lack of climate data (brown).

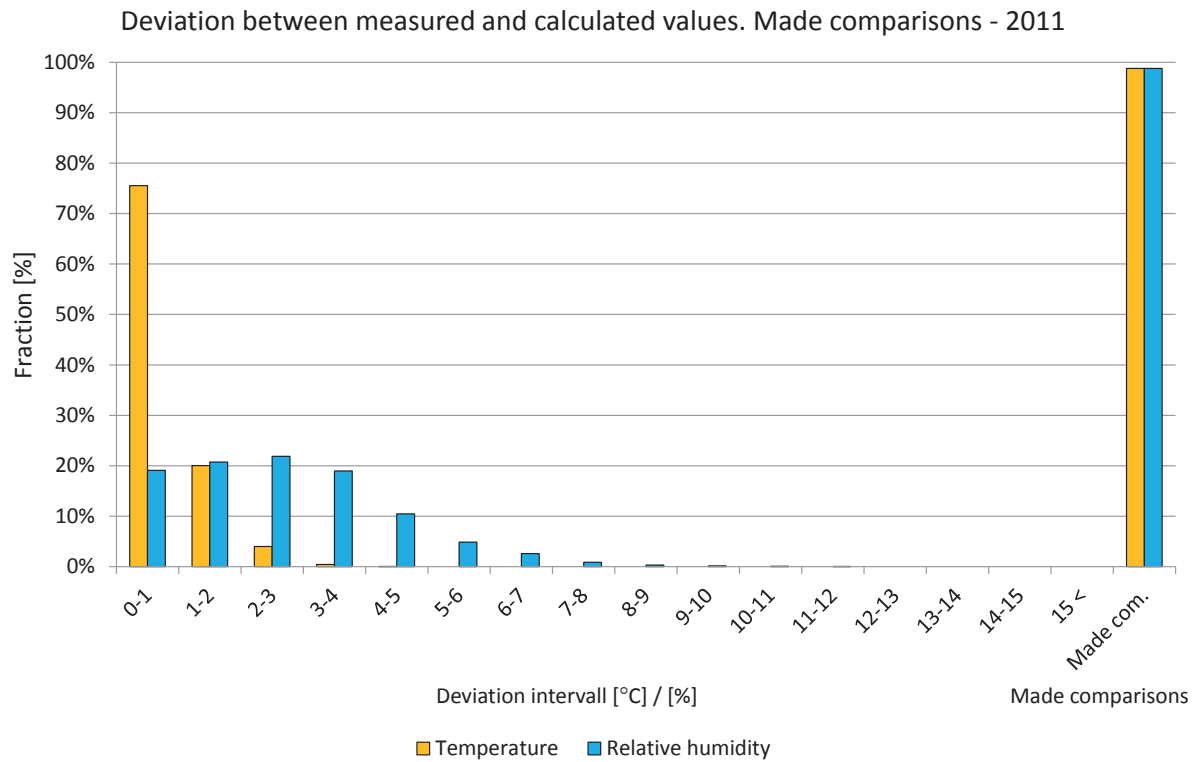

Figure 7.14.11. Deviations in comparisons shown in intervals from 0 to 15 °C or %. The two right-hand bars show the percentage of comparisons during the year. Temperature (yellow) and relative humidity (light blue).