



# LUND UNIVERSITY

## High-performance and self-compacting concrete in house building. Field tests and theoretical studies of possibilities and difficulties

Peterson, Markus

2008

[Link to publication](#)

*Citation for published version (APA):*

Peterson, M. (2008). *High-performance and self-compacting concrete in house building. Field tests and theoretical studies of possibilities and difficulties*. [Doctoral Thesis (monograph), Division of Building Materials]. Division of Building Materials, LTH, Lund University.

*Total number of authors:*

1

### General rights

Unless other specific re-use rights are stated the following general rights apply:

Copyright and moral rights for the publications made accessible in the public portal are retained by the authors and/or other copyright owners and it is a condition of accessing publications that users recognise and abide by the legal requirements associated with these rights.

- Users may download and print one copy of any publication from the public portal for the purpose of private study or research.
- You may not further distribute the material or use it for any profit-making activity or commercial gain
- You may freely distribute the URL identifying the publication in the public portal

Read more about Creative commons licenses: <https://creativecommons.org/licenses/>

### Take down policy

If you believe that this document breaches copyright please contact us providing details, and we will remove access to the work immediately and investigate your claim.

LUND UNIVERSITY

PO Box 117  
221 00 Lund  
+46 46-222 00 00

LUND INSTITUTE OF TECHNOLOGY  
LUND UNIVERSITY

---

Division of Building Materials

# **HIGH-PERFORMANCE AND SELF-COMPACTING CONCRETE IN HOUSE BUILDING**

**Field tests and theoretical studies of  
possibilities and difficulties**

Markus Peterson

Report TVBM-1027

Doctoral thesis

---

Lund 2008

ISRN LUTVDG/TVBM--08/1027--SE(1-224)  
ISSN 0348-7911 TVBM  
ISBN 978-91-628-7494-0

Lund Institute of Technology  
Division of Building Materials  
Box 118  
SE-221 00 Lund, Sweden

Telephone: 46-46-2227415  
Telefax: 46-46-2224427  
[www.byggnadsmaterial.lth.se](http://www.byggnadsmaterial.lth.se)

# Abstract

Cast in-situ concrete is the most frequently used materials technology worldwide within production of structural frames in multi-storey residential buildings. In Sweden, this technology dominates the market but is challenged by other competitive production methods. The criticism concerns issues as for instance short slab spans (limited flexibility for future refurbishment), long production times, unhealthy work environment and indoor air problems. Many of these disadvantages are due to the fact that by tradition ordinary low-grade concrete is used in house building. Extensive concrete materials research on high-performance concrete (HPC) and self-compacting concrete (SCC) has revealed opportunities to counter the criticism, but the technologies are not yet utilised in house building to large extent. The research project aims at investigating the potential of HPC and SCC for competitive production, structural design and function of structural frames of cast in-situ concrete in house building.

The first part of the research project is dominated by production studies performed in field with the aim of investigating the '*real*' potential of SCC addressing technical/practical and economical issues. These case studies consist of observations and measurements of the consequences when normal concrete is replaced by SCC. The result shows that SCC has a large potential for both increasing the production efficiency and improving the work environment.

In the second part of the project, the *theoretical* potential of HPC is investigated by several parameter studies where HPC is compared with ordinary concrete as well as an interview study focusing on building process issues. The main conclusions from these studies are that use of HPC can reduce the production time strongly (by rapid drying and strength development), increase the slab span significantly (through utilisation of increased tensile strength and E-modulus) and also increase the building function (increased flexibility, acoustic and indoor air quality).

When it comes to technical and building process related obstacles for the implementation of HPC and SCC, these are analysed and described together with proposed solutions.



# Preface

The work for this thesis has been carried out at the Department of Building Materials at Lund University, in collaboration with Skanska Sweden. The project has formed a part of the Swedish research programme Competitive Building. The project has been financially supported by Skanska Sweden -Skanska Asphalt and Concrete, The Swedish Foundation for Strategic Research 'SSF' and the Development Fund of the Swedish Construction Industry 'SBUF', who all are gratefully acknowledged.

I am grateful to my supervisor, Professor emeritus Göran Fagerlund, for his inspiration and valuable discussions throughout the work. I would also like to express my gratitude to Professor Lars-Olof Nilsson, Head of the Department of Building Materials and to both Professor Kyösti Tuutti at Skanska and University of Lund and Per-Ola Jönsson at Skanska Sweden -Skanska Teknik for initiating the project.

There are many colleagues and friends at Skanska, the Department of Building Materials at Lund University and within Competitive Building, whom all I would like to thank for interesting discussions and valuable support.

In particular, I would like to thank my former group managers at Skanska, Lise Langseth and Karin Pettersson as well as my present boss Hans Hedlund, not only for keeping the work distribution balanced between research work and other work but also for all encouraging words. Thanks to Thomas Johansson (Skanska) and Jörgen Falk (Skanska) for a valuable dialogue. Thanks also to Mats Öberg for former co-operative research work as PhD students at the Department of Building Materials.

Most especially, I want to thank my parents for your incessant encouragement.

To my beloved Maria, my daily reviewer, I thank you for all wise support, inspiration and patience during these years. Finally, I also want to thank our wonderful little daughter Ebba for refreshing interruptions of my writing.

Stockholm, March 2008

Markus Peterson



# List of contents

Abstract	i
Preface	iii
List of contents	iv
Summary	1
Sammanfattning	5
<b>1. Introduction</b>	<b>9</b>
1.1 Background	9
1.2 Aim	9
1.3 Division of the work	10
1.4 Methods	10
1.5 Outline of the thesis	11
<b>2. Structural frame production – technology and process</b>	<b>15</b>
2.1 Introduction	15
2.2 Production methods for structural frames in multi-storey residential buildings	17
2.2.1 Historical development and utilisation of concrete materials technology within structural frame building	17
2.2.2 Production methods of structural frames today	18
2.2.3 Potential of new concrete materials technology	21
2.3 The choice of structural frame – building process related issues	22
2.3.1 Introduction	22
2.3.2 Influence of the form of contract on the choice of structural frame	22
2.3.3 Influence of actors on the choice of structural frame materials	23
2.3.4 Obstacles for implementation of new concrete materials technology	30
2.4 Structural frame production with cast in-situ concrete – summary of technical and building process related aspects	33
<b>PART 1, Self-compacting concrete (SCC):</b>	<b>35</b>
<b>3. Self-compacting concrete – materials properties and effects on production</b>	<b>37</b>
3.1 Introduction	37
3.1.1 Self-compacting concrete – general	37
3.1.2 Fresh and hardened SCC – brief description of main properties	37
3.1.3 Aim of the chapter	38
3.2 Materials properties of fresh SCC	39
3.2.1 Fundamental/basic materials characteristics of fresh SCC regarding its self-compacting properties	39
3.2.2 Properties of fresh SCC – effects on production	50
3.3 Materials characteristics of hardened SCC – relevant properties for structural frames	54
3.3.1 Introduction	54
3.3.2 Compressive strength	54
3.3.3 Tensile strength	55
3.3.4 Modulus of elasticity	56
3.3.5 Creep	56
3.3.6 Shrinkage	56
3.3.7 Drying	58
3.3.8 Bond to reinforcement	59
3.3.9 Durability	60
3.4 Potential of SCC for improved work environment	61
3.4.1 Introduction	61
3.4.2 Disadvantages of normal concrete – risk of vibration related injuries	61
3.4.3 Disadvantages of normal concrete – risk of injuries related to ergonomics	64
3.4.4 Disadvantages of normal concrete – risk of injuries related to noise	64
3.4.5 Discussion	64
3.5 Potential of SCC for competitive production of structural frames	66
3.5.1 Potential benefits and incentives regarding SCC	66
3.5.2 Potential disadvantages and obstacles for the implementation of SCC	67



3.6 Research, development and utilisation of SCC	68
3.6.1 International R&D and utilisation of SCC	68
3.6.2 Swedish R&D and utilisation of SCC	70
<b>4. Field tests of structural frame production with cast in-situ SCC</b>	<b>73</b>
4.1 Introduction	73
4.1.1 Background	73
4.1.2 Aim and goals	73
4.1.3 Methods	73
4.2 Characteristics of the cases	76
4.2.1 Case study 1	76
4.2.2 Case study 2	78
4.2.3 Case study 3	80
4.2.4 Case study 4	82
4.3 Concrete characteristics	85
4.3.1 Mix proportions	86
4.3.2 Mixing	86
4.3.3 Transport	86
4.3.4 Properties	86
4.4 Observations	94
4.4.1 Mixing	94
4.4.2 Transport	95
4.4.3 Casting	95
4.4.4 Surface quality	102
4.4.5 Drying	106
4.4.6 Production economy	107
4.4.7 Work environment	110
4.5 Discussion and conclusions	112
4.5.1 Characteristics of the field studies	112
4.5.2 Observed consequences of SCC – comments and main conclusions	114
<b>5. Full-scale tests of SCC top layers as replacement for self-levelling screed cast on precast hollow core slabs</b>	<b>125</b>
5.1 Introduction	125
5.1.1 Background	125
5.1.2 Aim and goals	127
5.1.3 Layout of the test programme	128
5.2 Full-scale test 1	130
5.2.1 Introduction	130
5.2.2 Method	130
5.2.3 Result	131
5.2.4 Discussion/conclusions	131
5.3 Full-scale test 2	132
5.3.1 Pre-study to Full-scale test 2	132
5.3.2 Full-scale test 2	133
5.4 Full-scale test 3	140
5.4.1 Introduction	140
5.4.2 Method	140
5.4.3 Result	142
5.4.4 Discussion/conclusions	143
5.5 Full-scale test 4	145
5.5.1 Introduction	145
5.5.2 Method	145
5.5.3 Result	146
5.5.4 Conclusions	146
5.6 Summarising discussion and conclusions	147
5.6.1 General	147
5.6.2 Test 1	147
5.6.3 Test 2	147
5.6.4 Test 3	148

5.6.5 Test 4	148
5.6.6 Summary	148
<b>PART 2, High-performance concrete (HPC):</b>	<b>151</b>
<b>6 High-performance concrete for competitive structural frame production of cast in-situ concrete</b>	<b>153</b>
6.1 Introduction	153
6.1.1 General	153
6.1.2 International research and experience of HPC	153
6.1.3 Swedish research and experience of HPC	154
6.1.4 HPC – some important properties compared to NC	155
6.1.5 Potential beneficial synergy effects of utilisation of HPC in house building	160
6.1.6 Obstacles to implementation of HPC	163
6.2 Theoretical study of drying of HPC structures	165
6.2.1 Introduction	165
6.2.2 Calculation for Climate 1 – summer conditions and controlled drying directly from start of concrete casting	167
6.2.3 Calculation for Climate 2 – summer conditions and controlled drying 1 month after start of concrete casting	171
6.2.4 Calculation for Climate 3 – winter conditions, default data and controlled drying 1 month after start of concrete casting	173
6.2.5 Calculation for Climate 4 – winter conditions, concrete temperature constantly 10°C during the first 7 days after casting, controlled drying 1 month after start of concrete casting	175
6.2.6 Calculation for Climate 5 – winter conditions, concrete temperature calculated by Hett97 during the first 4 days, controlled drying 1 month after start of concrete casting	176
6.2.7 Effect of concrete temperature	179
6.2.8 Effect of outer climate conditions	180
6.2.9 Discussion	182
6.2.10 Conclusions	184
6.3 Utilisation of HPC for rapid strength development – a theoretical study	185
6.3.1 Introduction	185
6.3.2 Early stripping of formwork	186
6.3.3 Freezing of concrete	191
6.3.4 Early post-tensioning	195
6.3.5 Summary of results and conclusions	196
6.4 Utilisation of HPC for improved structural design – a theoretical analysis	199
6.4.1 Introduction	199
6.4.2 Background	199
6.4.3 Method	199
6.4.4 Result	200
6.4.5 Summary of results and conclusions	200
6.5 Technical obstacles for the implementation of HPC	202
6.5.1 General	202
6.5.2 Technical obstacles related to the concrete production	202
6.5.3 Technical obstacles related to the fresh concrete on site	203
6.5.4 Technical obstacles related to the function of the hardened concrete	204
6.6 Use of HPC – summary and main conclusions	205
<b>7. Conclusions</b>	<b>207</b>
7.1 Use of SCC	207
7.1.1 Possibilities	207
7.1.2 Difficulties	209
7.1.3 Future research	209
7.2 Use of HPC	210
7.2.1 Possibilities	210
7.2.2 Difficulties	211
7.2.3 Future research	212
7.3 General conclusions	213

**Appendices**

**Appendix A Structural design potential of HPC within house building**

- Slab constructions -general conditions, structural calculations, material properties etc
- Results, analysis and conclusions

**Appendix B Drying of HPC**

- Results

**Appendix C Synergy effects of HPC on the building function**

# Summary

Cast in-situ concrete is the most used materials technology in structural frames worldwide, addressing the production of multi-storey residential buildings. Although cast in-situ concrete is challenged by competing materials techniques, the usage of cast in-situ concrete in house building is in general based on average 'house-building concrete', which is not optimal from neither technical nor non-technical points of view.

However, intense international concrete research has led to new concrete materials technologies, as for instance high performance concrete (HPC) and self-compacting concrete (SCC). Although the use are still limited, these technologies may solve many of the problems related to the use of traditional concrete, e.g. long production times, short slab spans, unhealthy work environment and indoor air problems. Today, HPC is in comparison to production of civil engineering structures and prestigious high-rise buildings seldom utilised within the production of multi-storey residential buildings. When it comes to SCC utilisation, the delivered volumes are still very limited in as well as outside Sweden both within the civil engineering and building sector.

The research project aims at estimating the potential for improved structural design, cost-efficient production and increased function of multi-storey residential buildings through utilisation of HPC and SCC.

The project is divided into two main parts of which the *first part* focuses on the 'real' potential of SCC for competitive production of structural frames in multi-storey residential buildings. Technical as well as non-technical consequences are estimated through both case studies in field, where SCC has been implemented, and through laboratory studies of SCC applications.

Within the *second part* of the research project, the main focus is set on the structural design and production related potential of HPC.

The potential of HPC and SCC is analysed from a total perspective with respect to both technical and building process related issues. Presumptive benefits as well as disadvantages/obstacles with regard to implementation of new concrete materials technology are included. In general, the result shows that it is of great importance that regard is taken to both positive and negative presumptive consequences of HPC and SCC already within the early planning phase of building projects if the total potential is to be fully exploited and negative consequences avoided/managed.

Below, main results of the research project are presented briefly:

## *State-of-the-art of technology and process regarding structural frame building*

Structural frame building using cast in-situ concrete is technically described mainly addressing the limitations of conventional 'house-building concrete' versus the opportunities of HPC and SCC.

Interviews and surveys are carried out in order to describe the structural frame building process. Decision criteria for the choice of building materials for structural frames are dependent on the actors involved, which further depend on the form of contract.

Technical as well as building process related obstacles for the implementation of new concrete materials technologies within house building are discussed. The main technical obstacles for the use of HPC are workability issues and difficulties of managing high quality requirements for the mix ingredients. When it comes to SCC, the main technical obstacle concern the risk of non-robust fresh concrete due to improper mix design, which may be based on insufficient control of the influence of the mix ingredients on the self-compacting properties. Furthermore, hardened SCC may incorporate disadvantages as for instance non-homogenous structure (if segregation has occurred) and increased shrinkage cracking in comparison to normal concrete.

Non-technical barriers for the exploitation of new technologies within the building sector are commonly based on economy. The added direct materials costs may seemingly exceed the cost-savings if not the *total* potential is taken into regard. Other building process related obstacles are related to traditions concerning the choice of materials, improper cooperation between the actors, lack of information, insufficient feedback, limiting norms, unclear responsibility, lack of technical knowledge of the new materials etc.

#### *State-of-the-art of technical properties, research and experiences of HPC and SCC*

Literature review is carried out with respect to technical properties of HPC and SCC in comparison to normal concrete. Especially with respect to SCC there are areas of research that need to be further investigated, e.g. effects of mix ingredients on the rheological behaviour, drying properties and cracking behaviour. Various incentives to implementation and experiences are compared. Consequences of the use of SCC from a work-environmental perspective are described separately.

#### *Potential of SCC*

With the aim of estimating the ‘real’ potential of SCC, field studies are conducted on building projects where SCC are implemented and replacing conventional concrete in ordinary cast in-situ reinforced slabs and walls. In addition, laboratory studies are carried out regarding another type of application, i.e. unreinforced ‘thin’ overlay of SCC cast in-situ on precast hollow core slabs, used as replacement for self-levelling screed.

Observations and measurements are carried out in order to estimate the positive and negative technical as well as non-technical consequences of SCC implementation. A total analysis is performed where a total concept is adopted. Positive as well as negative consequences of SCC use are presented. The consequences are divided into: (1) direct consequences of self-compaction, (2) indirect effects of SCC, of which both types are economically quantifiable and (3) other non-economically quantifiable effects of SCC.

The results of the field studies show that utilisation of SCC enables several opportunities to increase the cost-efficiency from a total-economy perspective. As for instance, the costs for finishing work of slabs and materials (self-levelling screed) may be reduced or eliminated when the self-levelling effect of SCC is utilised. This advantage enables cost-savings of up to

50% of the price of normal concrete (NC). Another observed benefit concern the increased productivity, e.g. the possibility to reduce manpower during casting, which may save production costs of up to 20% of NC price. There are also other advantages such as improved work environment that is difficult to relate to direct economical earnings. Another advantageous area of SCC use, which is difficult to quantify economically, concerns the ability to cast advanced designed and heavily reinforced structures.

However, there are presumptive negative effects of SCC as well, e.g. increased risk of plastic shrinkage cracking and high formwork pressure -effects that may set requirements for precautious production methods. Furthermore, due to the increased sensitivity of fresh SCC, to as for instance segregation, it is of higher importance (in comparison with NC) to control mix ingredients and to handle fresh SCC properly during transport as well as on site.

If economical earnings through SCC use are to be achieved, it is important that potentially beneficial effects (e.g. improved productivity and reduced costs for finishing work) as well as negative SCC consequences (e.g. increased direct materials costs and presumptive added costs for protection against formwork leakage and cracking) are regarded already within the early planning of building projects.

#### *Production potential of HPC*

HPC for increased structural design performance also leads to opportunities for shortening the production time and further for reducing the production costs provided that synergy effects, as rapid strength development and reduced drying time are utilised. The HPC production study that is based on theoretical parameter studies, using various PC simulation/calculation tools, results in analyses of influencing parameters on the concrete drying and strength development. The impact from concrete properties, formwork systems, surrounding climate conditions etc is quantified. Concerning the potential of HPC for rapid drying, the result shows as for instance a reduction from 16 months of drying to less than 2 months to reach acceptable moisture level when comparing HPC with NC. Furthermore, the formwork stripping time may be reduced from 5 days to less than 1 day (under summer conditions) and from more than 28 days to 5 days (during winter conditions and covering of the concrete surface is used as winter protection method) according to the presented result when NC is replaced by HPC.

#### *Structural design potential of HPC*

The design study is based on theoretical parameter studies where effects on the structural performance of various concrete properties are estimated by using finite element methods. Performance of normal concrete (NC) is compared to HPC. The result presents a significant potential of HPC for increasing the slab spans or reducing the dimensions provided that increased tensile strength and/or increased elastic modulus are utilised. As for instance, the slab span of slab/wall structures may be increased by up to 40% and for slab/column structures by 50% if tensile strength of 5 MPa and elastic modulus of 50 GPa are utilised. The design study also describes a more competitive method of utilising the reinforcement when the placement of the reinforcement is based on the real distribution of bending moment instead of the maximum bending moment in the slab.

### *Building function potential of HPC*

The third aspect of the potential of HPC lies in its effects on the finished building function. Benefits, such as increased flexibility for future refurbishment (through increased slab spans), improved indoor air quality (reduced moisture related problems by utilising the more rapid drying of HPC), higher acoustic quality (by utilising the opportunities for producing thicker constructions without extended production times) and future energy savings (due to the high level of heat capacity of concrete) are described. Some of these are not only connected to HPC though, but to concrete structural frames in common.

# Sammanfattning

Platsgjuten betong är globalt sett den mest använda stombyggnadstekniken vid produktion av flerbostadshus. Trots att denna teknik möter konkurrens från annan stombyggnadsteknik baseras användandet av den till största del på konventionell ”husbyggnadsbetong” som varken är optimal ur teknisk eller icke-teknisk synvinkel.

Ny och omfattande internationell betongforskning har lett till nya betongtekniker, såsom högpresterande betong (HPB) och självkompakterande betong (SKB). Trots att användandet fortfarande är begränsat, skulle dessa tekniker kunna lösa flera av de problem som traditionell betong ofta förknippas med, t.ex. långa produktionstider, begränsade spännvidder, bristande arbetsmiljö och inomhusmiljöproblem. I jämförelse med anläggningsbyggande och prestigefyllda skyskrapsbyggen används HPB idag sällan inom flerbostadsbyggande. Vad gäller SKB är de levererade volymerna i och utanför Sverige fortfarande mycket begränsade både inom hus- och anläggningsbyggande.

Forskningsprojektet syftar till att undersöka potentialen hos HPB och SKB för förbättrad konstruktion, kostnadseffektiv produktion och ökad funktion av stommar till flerbostadshus.

Projektet är uppdelat i två huvuddelar av vilka den första fokuserar på den ”verkliga” potentialen hos SKB avseende rationell produktion av stommar till flerbostadshus. Både genom fältstudier utförda på byggprojekt där SKB har implementerats och genom laboratoriestudier av SKB-applikationer har tekniska och icke-tekniska konsekvenser undersökts.

Projektets andra del fokuserar huvudsakligen på konstruktions- och produktionsteknisk potential hos HPB.

Potentialen hos HPB och SKB analyseras ur ett helhetsperspektiv avseende både tekniska och byggprocessorienterade aspekter. Potentiella fördelar såväl som nackdelar/hinder avseende användande av ny betongteknik är inkluderade. Resultatet visar allmänt på att hänsyn måste tas till eventuella för- och nackdelar redan i ett tidigt projektskede om den fulla potentialen hos HPB och SKB ska kunna utnyttjas och negativa konsekvenser undvikas.

Nedan presenteras resultatet av forskningsprojektet kortfattat:

## *State-of-the art studie kring teknik och process avseende stombyggande*

Ur ett tekniskt perspektiv är stombyggande med plastgjuten betong beskrivet avseende begränsningar med konventionell ”husbyggnadsbetong” jämfört med möjligheter med HPB och SKB.

För att kunna beskriva stombyggnadsprocessen har intervjuer och enkäter använts. Beslutsriterier för val av stommateriäl beror på involverade aktörer, vilka i sin tur beror på kontraktsform.

Tekniska såväl som byggprocessbaserade hinder för implementering av ny betongtekniker diskuteras. Eventuella hinder för HPB-användande består huvudsakligen av begränsad arbetbarhet hos färsk betong och svårigheter angående kvalitetskrav på ingående material.



Vad gäller SKB utgörs de tekniska hindren främst av ökad risk för icke-robust färsk betong pga av bristande kontroll avseende de ingående materialens påverkan på de självkompakterande egenskaperna. Hårdnad SKB kan leda till nackdelar såsom inhomogen struktur (om betongseparation uppstår) och ökad krympsprickbildning jämfört med vanlig betong.

Icke-tekniska hinder för utnyttjande av ny betongteknik inom husbyggnadssektorn är ofta ekonomiskt relaterade. Direkta materialmerkostnader kan överstiga kostnadsbesparingar om det inte tas hänsyn till den totala potentialen. Andra byggprocessororienterade hinder är relaterade till tradition avseende stomval, bristande samarbete mellan aktörer, kunskapsbrist, begränsande normer, oklara ansvarsfrågor, begränsad kunskap kring ny materialteknik etc.

### *State-of-the-art studie av tekniska egenskaper, forskning och erfarenheter avseende HPB och SKB*

Litteraturstudier har utförts vad gäller tekniska egenskaper hos HPB och SKB jämfört med vanlig betong. Speciellt vad gäller SKB finns det forskningsområden som behöver undersökas ytterligare, t.ex delmaterials betydelse för reologiska egenskaper, uttorkningsegenskaper och sprickbenägenhet. Incitament för SKB jämförs med olika erfarenheter. SKB-användande ur ett arbetsmiljöperspektiv beskrivs separat.

### *Potential hos SKB*

Med syfte att undersöka den "verkliga" potentialen hos SKB, har fältstudier genomförts på husbyggnadsprojekt där SKB har implementerats och ersatt vanlig betong i platsgjutna bjälklag och väggar. Dessutom har ytterligare en applikation undersökts som består av tunn oarmerad SKB-påggjutning på håldäck som ersättningsalternativ till avjämningsmassa.

Observationer och mätningar har gjorts för att kunna undersöka positiva och negativa tekniska såväl som icke-tekniska konsekvenser från implementering av SKB. En totalanalys har gjorts med ansats ur ett helhetsperspektiv. Positiva såväl som negativa konsekvenser av SKB-användande presenteras. Dessutom är konsekvenserna uppdelade i direkta konsekvenser (effekter direkt relaterade till färsk SKB) och indirekta (synergieffekter av hårdnad SKB). Både ekonomiskt och icke-ekonomiskt kvantifierbara konsekvenser är behandlade.

Resultaten av fältstudierna visar att användande av SKB leder till flera möjligheter att öka kostnadseffektiviteten ur ett totalekonomiskt perspektiv. Exempelvis kan kostnaderna reduceras eller elimineras för efterarbete inkl. materialkostnader (avjämningsmassa) om den självnivellerande effekten hos SKB utnyttjas. Denna fördel möjliggör kostnadsbesparing som motsvarar upp till 50 % av priset för normalpresterande betong (NPB). En ytterligare fördel som observerats är möjligheten till ökad produktivitet, t.ex. möjligheten att minska personal under gjutningen, vilket kan leda till minskad produktionskostnad motsvarande upp till 20 % av priset för NPB. Det finns även andra fördelar såsom förbättrad arbetsmiljö men som är svåra att översätta till ekonomiska vinningar. Ett ytterligare fördelaktigt område för SKB som är svårt att ekonomiskt kvantifiera berör möjligheten att gjuta konstruktionsmässigt avancerade och tätarmerade konstruktioner.

Det finns även negativa effekter av SKB i jämförelse med NPB, t.ex ökad risk för plastisk krympsprickbildning och högre formtryck -effekter som kan kräva förebyggande åtgärder.

Dessutom innebär den ökade känsligheten hos SKB jämfört med NPB, mot t.ex betongseparation, att det är viktigt med kontroll över delmaterial och att hantera SKB korrekt under såväl transport som under användandet på byggarbetsplatsen.

Om produktionsekonomiska besparingar ska erhållas är det viktigt att hänsyn tidigt tas till potentiella fördelar (t.ex förbättrad produktivitet och reducerade kostnader för efterarbete) men även till negativa konsekvenser från SKB-användande (t.ex ökade direkta direkta materialkostnader och eventuella extrakostnader för undvikande av formläckage och sprickbildning

### *Produktionspotential hos HPB*

HPB för ökade konstruktionstekniska prestanda innebär även möjligheter att minska produktionstiden och därmed att minska produktionskostnaderna om synergieffekter såsom snabb hållfasthetstillväxt minskad erforderlig uttorkningstid utnyttjas. Produktionsstudien avseende HPB bygger på teoretiska parameterstudier där olika PC-baserade simulerings/beräknings-program har använts för att kunna analysera påverkande parametrar på uttorkning och hållfasthetsutveckling. Påverkan av betongegenskaper, formsystem, omgivande klimat etc är kvantifierad. Vad gäller möjligheterna hos HPB för reducerad erforderlig uttorkningstid, visar resultatet på en minskning från 16 månader till mindre än 2 månader för att komma ner till acceptabel fuktnivå när HPB jämförs med NPB. Resultatet visar ytterligare att formrivningstiden eventuellt kan minskas från 5 dygn till 1 dygn (sommarklimat) och från mer än 28 dygn till 5 dygn (vinterklimat och då högvärdig täckning av betongytan används som vinterbetongmetod) vid jämförelse mellan NPB och HPB.

### *Konstruktionsteknisk potential hos HPB*

Konstruktionsstudien är baserad på teoretiska parameterstudier i vilka effekterna av olika betongegenskaper på konstruktionstekniska prestanda är undersökta genom användande av finita element metoder. Resultat avseende NPB jämförs med HPB och visar på en tydlig potential hos HPB för ökade spännvidder eller minskade dimensioner under förutsättning att ökad draghållfasthet och/eller ökad elasticitetsmodul utnyttjas. T.ex kan spännvidden för platta/vägg-konstruktioner öka med upp till 40 % och för platta/pelare-konstruktioner med upp till 50 % om draghållfasthet på 5 MPa och elasticitetsmodul på 50 GPa utnyttjas. Konstruktionsstudien beskriver även en metod för rationellt utnyttjande av armering, baserat på utnyttjande av det verkliga och varierande böjmomentet istället för det maximala böjmomentet.

### *Potential avseende byggnadsfunktion hos HPB*

En tredje aspekt av potentialen hos HPB berör dess effekt på den färdiga byggnadens funktion. Fördelar beskrivs, t.ex ökad flexibilitet för framtida ombyggnation (genom ökade spännvidder), förbättrad innemiljö (minskade fuktproblem tack vare snabbare uttorkning hos HPB), högre akustisk kvalitet (möjlighet att producera tjockare konstruktioner utan förlängd produktionstid) och framtida energibesparing (genom högre värmekapacitet hos betong). En del av dessa fördelar gäller inte enbart för HPB utan betong i allmänhet.



# 1. INTRODUCTION

## 1.1 Background

There are several concepts for structural frames in multi-storey residential buildings, e.g. cast in-situ concrete, prefabricated concrete elements, steel and wood. Since many decades, cast in-situ concrete has been the dominant material both in Sweden and on the international market. However, in Sweden, cast in-situ concrete frames are criticised for short slab spans (limited flexibility for future refurbishment), long production times, unhealthy work environment, indoor air problems (due to the long time needed for moisture to dry out) etc. Although novel concrete research presents technical solutions to the described problems and the market shares of competing materials are increasing, cast in-situ concrete within house building is still based on almost the same technology as decades ago.

During the 80s and 90s, intense international concrete materials research has resulted in two novel concrete technologies, high performance concrete (HPC) and self-compacting concrete (SCC). These technologies may solve many of the problems cast in-situ concrete structural frames are criticised for. Still today though, HPC is mainly utilised within civil engineering construction and the delivered volumes of SCC are significantly limited. If HPC and SCC are to be further utilised within the construction of structural cast in-situ concrete frames in multi-storey residential buildings, a wide range of aspects probably must be considered, with regard to benefits as well as disadvantages.

From a chronological perspective, the first conducted part of the project (Peterson, 2003) addresses primarily the *theoretical* potential of HPC for exploiting and improving the performance of cast in-situ concrete structural frames with regard to structural design, production and future function. The secondly conducted and main part of the project is to large extent based on field studies conducted on building projects where SCC has been implemented and laboratory studies including full-scale testing of SCC applications. These studies address the '*real*' potential of SCC within house building with respect to technical/practical and economical aspects. The result of the field studies are analysed and compared with the theoretical potential.

## 1.2 Aim

The research project aims at investigating the potential of new concrete materials technology (HPC and SCC) for competitive construction of cast in-situ concrete structural frames in multi-storey residential buildings. To avoid sub-optimisation during production and end use of the building, several aspects are included, i.e. structural design, production and building function. Regard is taken to both technical and building process related obstacles.

## 1.3 Division of the work

The work presented in this thesis was divided into two main parts:

- Part 1: Field and laboratory studies of SCC

The potential advantages and difficulties of using self-compacting concrete were studied both in field and in laboratory conditions. The work is presented in the main part of this thesis in Chapters 3-5.

- Part 2: Exploratory study of HPC

The potential advantages and difficulties of applying mainly high-performance concrete in construction of building frames were analysed purely theoretically. The work is presented in Chapter 6 and appendices A, B, C and D

## 1.4 Methods

Briefly, the studies below have been conducted within the project. For further descriptions, see the method section for each study.

In the *first part* of the research project, the following methods have been used:

- **State-of-the-art studies – building technology and building process today**  
State-of-the-art studies have been conducted with the aim of describing building technology and building process in Sweden today. Both quantitative and qualitative aspects have been included. Interviews have been arranged with actors within the building sector in order to describe building process related issues with respect to the choice of materials for structural frames. Furthermore, a review of the today most used structural frame types has been included.
- **State-of-the-art analysis of SCC – properties, research and experiences**  
Literature studies (and to some extent surveys) have been conducted for describing SCC with regard to properties, international research and experiences.
- **Field studies – production potential of SCC**  
Field studies have been carried out on four different Swedish building projects. Technical/practical and economical consequences when replacing ordinary concrete by SCC have been estimated on site during the production of structural frames.
- **Full-scale testing of SCC applications under laboratory conditions**  
Full-scale tests have been conducted to verify the applicability and competitiveness of SCC in thin non-reinforced top layers cast in-situ on prefabricated hollow core slabs.

- **Concluding analysis – ‘real’ potential of SCC**  
The ‘real’ potential of SCC has been analysed, based on conducted field and laboratory studies in comparison to the theoretical potential.

Within the *second part* of the project, the following studies have been performed:

- **State-of-the-art studies – properties, research and experiences of new concrete materials technology**  
Literature studies have been conducted aiming at describing properties, international research and implementation experiences of mainly HPC and to some extent SCC.
- **Parameter studies – structural design aspects of HPC**  
To estimate the design related potential of HPC, parameter studies using the PC-program FEM-Design Plate (FEM-Design Plate, 2000) has been conducted.
- **Parameter studies – production related aspects of HPC**  
To analyse production related aspects of HPC, two PC-tools have been used:
  - TorkaS 1.0, for estimating/simulating influencing parameters on the concrete drying (TorkaS 1.0, 1998)
  - Hett97, for estimating/simulating the effects relevant for the concrete strength development (Hett97, 1997)
- **Concluding analysis – theoretical potential of HPC**  
Summarising analysis has been performed including both technical and non-technical potential benefits as well as obstacles of HPC for implementation.

## 1.5 Outline of the thesis

### Chapter 1 Introduction

According to the background, aim, methods and outline of the thesis, which are described within the first chapter, this research project differs from the main part of research into concrete materials technology. By adopting a total perspective, the potential of new concrete materials technology, i.e. HPC and SCC, are studied theoretically, in field and in laboratory. Both potential technical and non-technical benefits as well as presumptive negative consequences concerning implementation are included.

### Chapter 2 Structural frame production – technology and process

The production methods of cast in-situ structural frames in multi-storey residential buildings including historical development are described. Special focus is set on presumptive disadvantages of average ‘house-building concrete’ in comparison with the potential of new concrete materials technologies.

Also the building process today is described, where special attention is paid to the different actors' influence on the choice of structural frame materials. The study is based on interviews and surveys carried out with various actors in the building sector.

### **Chapter 3 Self-compacting concrete – materials properties and effects on production**

Self-compacting concrete (SCC) is described and analysed from a state-of-the-art perspective with respect to technical properties (in relation to various constituent materials of SCC, e.g. filler types and chemical admixtures), international research and experiences of implementation. The described technical properties are divided into fundamental/basic properties of fresh SCC regarding self-compacting ability (from a rheological perspective and including description of various test methods), properties of fresh SCC regarding concreting/production/casting (issues related to ready-mix concrete production, transport, placing, finishing etc) and properties of hardened SCC (e.g. strength, creep, shrinkage, drying and durability).

Potentially beneficial synergy effects and presumptive negative consequences (which may act as obstacles for implementation) regarding SCC use in structural frame production, are briefly described as well. Comparisons with normal concrete (NC) are conducted.

### **Chapter 4 Field studies of structural frame production with cast in-situ SCC**

This chapter presents field studies conducted on four Swedish building projects, addressing the consequences when replacing traditional concrete for SCC in structural frames, i.e. slabs and walls.

The focus of the field studies is set on technical/practical (e.g. risk of segregation, improper surface-quality and cracking) as well as economical issues (e.g. increased direct materials costs). Both advantages and disadvantages of SCC use in comparison with experiences from use of normal concrete are estimated through rheological testing of the fresh concrete, estimations/observations of the fresh concrete during casting and measurements of the properties of the hardened SCC.

Both beneficial and non-beneficial consequences from SCC use are divided into *direct* (and economically quantifiable) consequences of self-compacting properties of fresh SCC (e.g. potentially more rapid casting process of SCC compared with NC casting process) and *indirect* (and economically quantifiable) consequences, i.e. secondary effects of hardened SCC (e.g. increased strength through the 'filler effect'). Furthermore, the consequences are divided into a third group, i.e. non-economically quantifiable effects (e.g. improved work environment).

Finally, the observations, measurements and estimations of the total potential of SCC use, are analysed from a total point of view. Incentives in relation to the result of the implementation are compared from both the contractors' and the concrete suppliers' perspective.

## **Chapter 5 Full-scale tests of thin ready-mix SCC top layers as replacement for screed cast in-situ on precast hollow core slabs**

The studies in the fifth chapter concentrate on one specific type of application that is developed and tested into full scale under laboratory conditions. The actual application consists of ‘thin’ (thickness 55-70 mm) unreinforced SCC top layer, cast in-situ on precast hollow core slabs -an application that may lead to increased risk of technical disadvantages (e.g. edge lifting due to shrinkage effects and improper bond) in comparison to ‘traditional’ ‘thick’ reinforced slabs (thickness typically 180-220 mm).

Several full-scale tests have been carried out where measurements of both the fresh properties (e.g. flow ability measured by rheological testing) and hardened properties (e.g. relative humidity, strength and bond) are performed.

To control presumptive risks, typical for the type of investigated application, development work has been performed gradually. The results of the study are summarised in an analysis where total-concept thinking is adopted. Practical/technical and economical issues are included.

## **Chapter 6 High-performance concrete for competitive structural frame production of cast in-situ concrete**

Initially in the chapter, high-performance concrete (HPC) is described focusing on technical properties, international research and experiences of implementation. Also the potential of HPC for competitive construction of concrete structural frames in multi-storey residential buildings is *briefly* described, as well as the technical obstacles for implementation.

To analyse the production related potential of HPC, two parameter studies concerning concrete drying times and strength development of concrete slabs are carried out. In the first study, the effects of concrete properties (water/cement ratio, cement content, silica fume content etc) and surrounding conditions (drying climate conditions, type of formwork, slab thickness etc) on the required time for reaching specific RH levels in the slabs are estimated. Used tool is the PC-program ‘TorkaS 1.0’ (TorkaS, 1998), which simulates the drying process of concrete for various outer climate conditions and different concrete variables.

The second parameter study aims at estimating the strength development which affects, for instance, the formwork removal times and technical problems connected to casting wintertime. The PC-tool ‘Hett97’ is utilised for estimating the effects of concrete properties (concrete quality, cement content etc) and surrounding conditions (outer air temperature, type of formwork etc) on the required time for reaching specific strength levels (Hett97, 1997). Special attention is paid on how various winter casting methods (covering, insulating and heating of concrete) affect the strength development.

The two studies are also combined for simulating the effects on the drying time of cold climate conditions during casting.

Furthermore, a theoretical study was made on the possibility HPC might give for a more rational structural design of concrete frames. This study is summarised briefly in Chapter 6 and presented entirely in Appendix A.



## **Chapter 7 Conclusions**

Conclusions are summarised from all sub-studies of the research project regarding the potential of HPC and SCC for competitive production of concrete structural frames in multi-storey residential buildings. Also the need of further research and development is discussed.

## **Appendices**

### **Appendix A Structural design potential of HPC within house building (extract from Peterson, 2003)**

Appendix A is a structural design analysis of HPC based on parameter studies where finite element methods (FEM) have been used. The studies are based on calculations by using the PC- tool 'FEM-design Plate' (FEM-Design Plate, 2000), where the influence of concrete parameters (compressive and tensile strength, elastic modulus, concrete slab thickness etc), amount of reinforcement and type of structure (various slab/wall and slab/column structures) are simulated. The effects on the structural design performance of various concrete properties for normal performance concrete (NC) are compared with HPC. The study primarily investigates the opportunity for increasing concrete slab spans through utilisation of HPC. Secondly, an alternative method of utilising the reinforcement when the required reinforcement is based on the varying moment instead of the maximum moment of the slab is analysed.

### **Appendix B Drying of HPC**

The results of the study on drying of HPC (within Chapter 6) are presented.

### **Appendix C Synergy effects of HPC on the building function**

Synergy effects of using HPC on the function of the building are described, e.g. increased flexibility regarding future refurbishment, reduced moisture problems, increased acoustic quality and reduced energy consumption. The two latter effects can be seen as advantages for concrete structural frames in general, but HPC generates further opportunities for trouble-free building due to the short drying time that for NC affects thick concrete structures in a negative way by extended drying/production times.

## 2. STRUCTURAL FRAME PRODUCTION – TECHNOLOGY AND PROCESS

### 2.1 Introduction

Over the years, there has been a development of various structural frame building production methods based on concrete. Efforts have been made to continuously improve the technology as well as the building process by increasing the production cost efficiency and improving work environment and technical performance of the final product. Structural frame production for multi-storey residential buildings is dominated by the use of traditional ‘average-grade’ ready-mix concrete. This has been criticised from both technical and non-technical perspectives, e.g. limitation to short floor spans, long production time, moisture related problems and high manpower need on site, low grade of standardisation, as well as insufficient co-operation between actors. Despite intense research on new concrete materials that might potentially solve these criticised problems, the types of concrete materials and the structure of organisation used today are still often the same as decades ago.

Within the building sector, there is a focus on production methods that include increased degree of industrialisation. With influences from other industry sectors, e.g. car production, shipping and aeroplane production there are efforts made to decrease manual work on site, reduce non-value adding activities and standardise various structure parts included. According to Stintzing (2003), the development trend within house building is characterised by cost-efficient methods, flexibility, high precision, high technical quality and environmental and work-environmental requirements. The requirements for industrialised production may be fulfilled easier if ‘system-thinking’ and/or prefabrication is adopted.

Industrialised building systems include several typical terms, e.g:

- Elements  
Prefabricated elements (walls, floors, formwork system for permanent use) are ‘industrially’ produced in factories and transported to building sites for mounting.
- Volume elements  
Elements are in element factory put together to volumes including finished surfaces, furniture installations etc and delivered to the building site.
- Modules  
Standardised components with respect to dimensions and properties, which are produced in large series.
- ‘Type houses’  
Complete building systems with standardised components and elements that are put together on site. Most commonly used regarding single-family houses.

Furthermore, there are methods that concern non-technical issues within the industrialised building, e.g:

- Partnering  
Partnering is a form of co-operation between two or more actors during longer than one project and includes sub-actors. By partnering there are potential opportunities to develop competitive concepts and efficient and 'well-working' organisation.
- Proper organisation on site (e.g. through 'lean construction')  
In a 'lean' building project, the personnel on site may be dimensioned according to fit the 'real' need, which reduces the risk of unwanted waiting time and/or mistakes.

Concerning the use of cast in-situ concrete the industrialisation degree is increased if concrete cast in-situ is combined to utilisation of prefabricated formwork systems and volume elements (e.g. wet rooms). For further increased industrialisation the organisation needs to fulfil requirements regarding co-operation, efficiency etc. The grade of industrialisation may be further increased if (new concrete materials technology) HPC and/or SCC are utilised, which might bring about increased productivity, less manpower need on site and higher technical quality.

This chapter presents production techniques for structural frames in multi-storey residential buildings. Principally production based on ready-mix concrete cast in-situ is described. Performance limitations and disadvantages are exemplified and comparisons are made with potential opportunities achieved if new concrete materials technology are utilised.

Furthermore, this chapter presents non-technical aspects concerning structural frame building. Results from interviews conducted within the research project with the aim of investigating factors related to the building process (e.g. type of contracts and roles of actors) influencing the choice of structural frame materials are presented. A survey aiming at investigating the ability of various actors to influence the implementation of self-compacting concrete (SCC) versus the interest for SCC of each actor is presented as well. Finally, various non-technical obstacles to implementation of high-performance concrete (HPC) and SCC are described.

## **2.2 Production methods for structural frames in multi-storey residential buildings**

### **2.2.1 Historical development and utilisation of concrete materials technology within structural frame building**

Concrete is one of the oldest man-made building materials used in structural frames. This is exemplified by the 'Pantheon' building that was built around the year 180 in Rome. The method for concrete production was described by the Roman architect 'Vitruvius' in the book series 'Ten books about architecture', which was rediscovered as late as during the 15<sup>th</sup> century. The concrete that the Romans had used was based on burnt limestone and volcanic ash. When the Roman era ended, the knowledge of concrete materials faded away though. First during the 18<sup>th</sup> and 19<sup>th</sup> century, concrete technology was rediscovered. In the year of 1759, the Englishman Smeaton invented the hydraulic limestone and built the foundation for the lighthouse 'Eddystone'. In the year of 1796, the Englishman Parker developed what he called 'roman cement' by burning ground limestone containing clay. In 1824 the Frenchman Aspdin started to produce what he called 'Portland cement' in large scale. Portland cement was based on a mixture of limestone and silicious materials that was burnt in a kiln at high temperature. Principally, Aspdin's Portland cement is the same as the cement we use today.

Concrete was then used as replacement material for stone and brick and was designed to only carry compressive stress. First when concrete was utilised in combination with reinforcing steel it was possible to design for tensile and shear stresses. According to Johansson (2002), intense design development led to that various concrete floor systems were implemented on the Swedish market for multi-storey residential buildings, e.g. the 'Monier floor system' during 1890s and the 'floor system of Koenen' at the end of 1890s, which both consisted of concrete including steel girders. With the 'floor system of Hennebique' in the early beginning of the 20<sup>th</sup> century it was possible to produce 'slim' floors in large scale by utilisation of reinforcement bars cast in the concrete. Some years later, another system was introduced, i.e. the floor system of 'Kahn' (Johansson, 2002).

Parallel to the development of structural design using concrete materials, new production techniques were introduced, see Johansson (2002). At the beginning, the fresh concrete was compacted layer-by-layer using special wooden 'stamps'. Low amount of water led to low shrinkage and relatively high strength. The consistency was very stiff though, which led to heavy casting work. Alternatively, more flowable concrete was used but then the risk of segregation and large shrinkage increased dramatically. During the 1930s mechanical concrete vibrators were introduced, which led to improvement of compaction and of work environment. Furthermore, the development of new transport methods was important; viz. when it became possible to transport fresh concrete with trucks to the building site, the quality was improved due to the fact that it was then possible to produce concrete on ready-mix concrete plants instead of directly on the site.

Structural design methods were continuously improved during the 20<sup>th</sup> century. New production techniques were introduced on the market, e.g. high-flow concrete and pumps, which have improved the efficiency of concrete casting and work environment. During the last decades new concrete materials technology has been developed, e.g. high-performance,

self-compacting and fibre-reinforced concrete. These materials are however not very much used in house building.

## **2.2.2 Production methods of structural frames today**

### **2.2.2.1 Structural frames in multi-storey residential buildings**

Various structural frame concepts are used for multi-storey residential buildings. Within the production of single-family houses in Sweden, prefabricated wooden frames are the most frequently used material. When it comes to multi-storey residential buildings in Sweden though, concrete is the most used material, either as cast in-situ (fresh ready-mix concrete transported to and cast on the building site) or as prefabricated/precast elements (e.g. hollow-core slab elements transported to the building site and mounted on bearing walls before screed or over-floor system is placed on before floor covering). Other structural frame concepts on the market for multi-storey buildings are concrete-steel composites and timber. According to a survey of market shares of materials in structural frames produced in 1998 in Sweden, by Mångda (1999), cast in-situ concrete is used to 65%, precast elements to 15%, concrete-steel composites to 10% and others, e.g. timber, to 10%. Furthermore, Bygginstrin (2004) describes this market share of cast in-situ concrete as having been constantly about 60% for several years. Due to the fact that there are possibilities for different combinations of material types in structural frames, the result of the survey should be seen as somewhat uncertain.

### **2.2.2.2 Structural frames of cast in-situ concrete**

In Sweden, cast in-situ concrete has been the dominant material for producing structural frames in multi-storey residential buildings. However, the method has been criticised for not being as industrialised as competing materials concepts, e.g. precast concrete elements. From a technical point of view, this criticism has been focused on structural design (limitation to short spans), production (low cost efficiency, long production times, non-rational production methods, improper work environment, as well as on aspects related to building function (moisture problems and non-flexible solutions for future refurbishment). Many of these problem areas are related to that the same methods and technologies as used during the last decades still are used within the building sector. In order to follow the increasing industrialisation within the construction sector, the use of cast in-situ concrete must be developed further in order to survive (Byfors, 1999). Below, a brief technical description of the cast in-situ concept used today in Sweden for structural frames in multi-storey residential buildings is presented.

From a design perspective, cast in-situ concrete structural frames for multi-storey residential buildings have to large extent, during the last decades, been produced by using steel tunnel-formwork system for slab or wall casting (see Figure 2.1). During the last 5-10 years these formwork systems have to major extent been replaced by precast concrete formwork floor system for permanent use, so called Filigran type of formwork. This reinforced (pre-stressed as well) Filigran formwork system has a thickness of typically 45 mm and include lattice girders for proper bond with the cast in-situ slab (see Figure 2.2). The thickness of the cast slab is typically 200 mm (sometimes up to 250 mm). Concerning walls there are both precast concrete formwork system for permanent use (i.e. of shell mould type) and dismountable formwork systems of wood or steel. Typically thickness of walls is 160 to 200 mm (in inner

walls). There are also competing materials for permanent formwork systems introduced on the market, e.g. cement-bonded particleboards (CBPB). The building is often furnished with curtain wall facades, which are prefabricated or built on site with studs of sheet steel or wood and cladding of bricks or rendering on mineral wool.

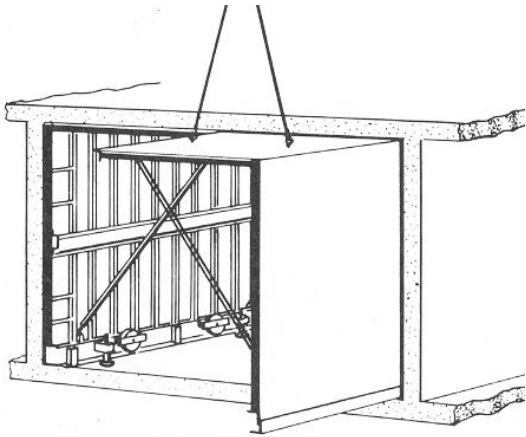

*Figure 2.1 Use of tunnel-form leads to the opportunity for casting both slab and wall at the same time. Figure according to Nilsson (1992).*

The most frequently used concrete type is an ordinary ‘house building concrete’, defined as a mix with a high water/cement ratio (w/c ratio) of approximately 0.60 to 0.70 and cube concrete compressive strength ( $f_{cc}$ ) of about 30 MPa. Generally, the reinforcement is non-tensioned. The relatively low structural capacity due to the average concrete quality, member thickness and minimum reinforcement only permits floor spans up to approximately 5 m.



*Figure 2.2 Precast formwork system for permanent use, i.e. Filigran type of formwork, is a common method in combination with ready-mix concrete cast in-situ. Photo taken from ‘Betongbanken’, ( see SFF, 2007), a planning tool including experience from use of ready-mix concrete.*

Cast in-situ concrete partition walls normally support the slabs to form a solid cell system, which is illustrated in Figure 2.3. This limits flexibility for the customer and the opportunity for future adaptation, compared to other layouts, which are common within the construction of multi-storey office buildings, such as column-slab structures and post-tensioned

reinforcement. To some extent though, the latter concepts are today introduced also to the production of multi-storey residential buildings.

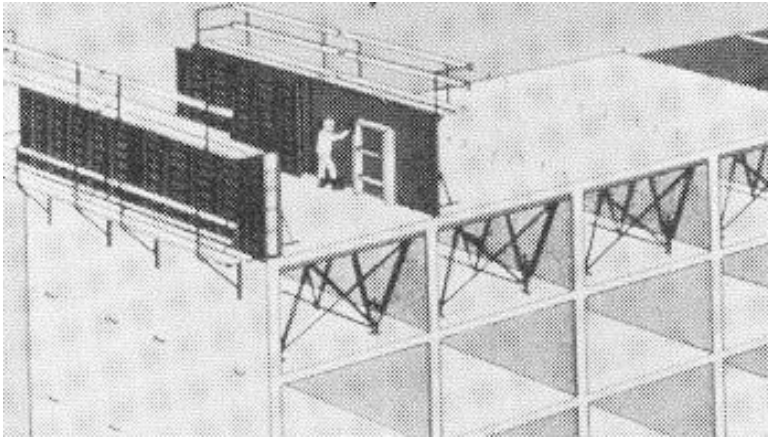

*Figure 2.3 Commonly used type of cast in-situ concrete structural frame where the partition walls, supporting the slab, form a solid cell system, which reduces the future flexibility. Figure according to Nilsson (1992).*

With regard to production, the high w/c ratio of a traditional low-grade house-building concrete, leads to long drying times before floor coverings can be applied. This is needed in order to avoid moisture related problems caused by emission from screeds, glue or carpets. Another example of how such average concrete might affect the production in a negative way, is when cold air temperatures wintertime either extends the time for reaching the required strength for formwork removal, or requires external concrete protection methods (e.g. covering, insulation and/or heating of concrete) for reducing the required formwork stripping time or avoiding early freezing of concrete. Also, during normal outer air temperatures, the fairly slow strength development of low-grade concrete may lead to non-cost efficient production due to long required times until formwork stripping and/or before post-tensioning of reinforcement can be performed. Ordinary cast in-situ concrete has to be vibrated and compacted with vibrators. The method is manpower-intensive and may lead to hearing impairment and/or vibration injuries, i.e. 'hand-arm vibration syndrome' (HAVS).

Both the design and the production properties mentioned concerning cast in-situ structural frames made with ordinary low-grade concrete furthermore affect the function of the finished building. As mentioned, short floor spans combined with concrete partition walls limit future flexibility and refurbishment. With regard to presumptive future moisture problems, e.g. emissions from carpets or adhesives and mould growth in organic material, Swedish building regulations stipulate maximum allowable values for relative humidity, measured on a certain depth from the surface, the so-called equivalent depth (Swedish Building Centre, 1998). These values depend on the type of material used to cover the concrete floor. For most materials the maximum values are between 85% and 90% relative humidity, which usually requires a drying time of several months for average concrete. For acoustical purposes, a thick concrete slab is highly advantageous (Ljunggren, 1995). However, in practice, the thickness of the concrete slab is limited because of the long drying times of normal concrete. Partly for this reason, the sound insulation class 'A', which in accordance with Swedish building regulations corresponds to the highest acoustic quality, is seldom reached.

## 2.2.3 Potential of new concrete materials technology

During the past decade, considerable research effort has been put into both high performance concrete (HPC) and self-compacting concrete (SCC). HPC has been implemented especially within civil engineering work (e.g. bridges, roads and offshore construction) and in the construction of prestigious high-rise buildings. Within Swedish multi-storey residential buildings, HPC has been implemented to some extent with the aim of reducing the concrete drying times and/or formwork removal time. SCC has been used in a few attempts to obtain more competitive structural frame production. However, most cast in-situ concrete is used in the same way and by the same kind of building process organisation as in past decades, despite the increasing competitiveness of other structural frame methods, e.g. precast concrete elements, wood or steel.

Research into concrete materials technology is mainly concentrated on technical aspects. Research on non-technical aspects concerning, e.g. obstacles to implementation or incentives such as economic benefits are often limited. Some research though, has shown that rationalisation is possible when using new concrete technology. In Sweden, research results show practical advantages and cost savings from the use of HPC -see, for example, Hallgren (1993) and Persson (1996) who describe some of the economic benefits. Commonly though, just one or two aspects are examined in this type of research. A total concept that would highlight the range of opportunities available from using novel technology is lacking. In addition, concerning SCC there is some research that presents opportunities for increased cost efficiency from a wider point of view, e.g. the latest ACBM Symposium on SCC (ACBM, 2005).

By utilising novel concrete materials technology, such as SCC and HPC, the technical disadvantages of ordinary low-grade house-building concrete for the construction of cast in-situ concrete structural frames, according to section 2.2.2.2 'Structural frames of cast in-situ concrete' can be countered. This is a fundamental issue for building process improvement and forms the primary aim of the research project. Briefly, the potential benefits of HPC and SCC are as follows. HPC leads to opportunities to improve the structural design performance, i.e. increased spans and/or more slim structures. Furthermore, use of HPC creates possibilities to reduce the production time through more rapid drying and faster strength development. These advantages lead to improved function of the structural frame as well as increased flexibility with respect to future use of the building, and improved indoor air quality with respect to problems caused by moisture. Another positive synergy effect is the ability to produce structural frames with higher acoustic qualities due to that thick and sound insulating floors are possible to produce without extended drying time.

When it comes to SCC, there are several opportunities for more competitive in-situ production, e.g. increased productivity during casting, less need of finishing costs (work and materials) and significantly improved work environment. A potential application area for SCC concerns the ability to replace screed by SCC in thin top layers on precast elements due to the self-levelling effect of SCC. See Chapter 5 for further details.



## **2.3 The choice of structural frame – building process related issues**

### **2.3.1 Introduction**

The building sector has been criticised for the low level of co-operation between actors, lack of knowledge, poor inclination to innovate, unclear responsibility, inflexible roles and conservative decision-making etc. In Sweden, the Government's Building Cost Commission (BKD, 2000) has criticised the building sector for lack of customer orientation, lack of technical innovation, lack of holistic consideration (i.e. integration) regarding design, production and use, and lack of co-operation between the actors.

As described in section 2.2 'Production methods for structural frames in multi-storey residential buildings' many of the technical problems within the building sector caused by traditional use of low-grade cast in-situ concrete may be solved if new concrete materials technologies are utilised. However, there are both technical and non-technical obstacles for the implementation of such new materials technologies within house-building. See section 2.3.4 'Building process related obstacles for the implementation of new concrete materials technology' for further details. For technical obstacles, see each section concerning technical obstacles within Chapter 3 'SCC Self-compacting concrete for competitive production of cast in-situ structural frames in multi-storey residential buildings' and Chapter 6 'High performance / high strength concrete for competitive cast in-situ production'.

Section 2.3 aims at describing building process related aspects of house building today, focusing on influencing parameters regarding the choice of materials for the structural frame, addressing for instance the form of contract and role of actors. The result of the analysis is largely based on interviews with persons representing various actors within the building sector (Öberg and Peterson, 2001). The persons interviewed have by their expert knowledge been selected with the aim of covering relevant areas within the sector regarding planning and production of multi-storey residential buildings. Important to notice is that section 2.3 consists of a summary of personal opinions. The section also presents results from a survey conducted with the aim of investigating the interest in SCC implementation versus the ability and power to implement SCC (Peterson and Simonsson, 2005).

### **2.3.2 Influence of the form of contract on the choice of structural frame**

The opportunities for different actors to influence the choice of structural frame, is to a large extent dependent on the form of contract used in the particular project. In the *general contract* model the investor in co-operation with the appointed consultants are the decision makers, and they produce the production documents. Thus the possibilities with regard to the influence on design of the building, are very limited for the general contractor inclusive subcontractors and suppliers, see Figure 2.4.

A contract model with some similarities with the general contract is the *divided contract*. The difference is that by the general contract, the general contractor is responsible for production co-ordination while by the divided contract, the investor or the appointed construction management consultant takes this responsibility.

In the case of a *design and build contract* model, there are greater possibilities for the contractor to influence the decision of structural frame and other aspects of the building. The investor provides only principal documents and the contractor is responsible for the production documents, according to Figure 1.1. A design and build contract model also tends to give more opportunity to subcontractors and suppliers, like the ready mix concrete producer, to influence the design.

A special concept closely related to the design and build model is the *own development model*, whereby the investor and the main contractor are within the same company.

**General contract**

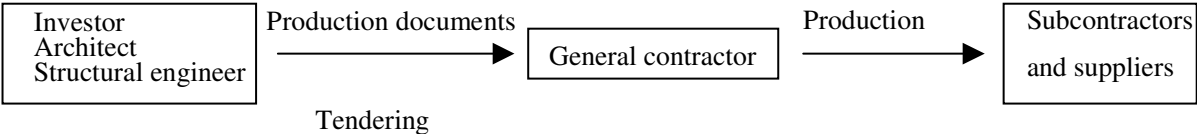

The structural frame is decided

**Design and build contract**

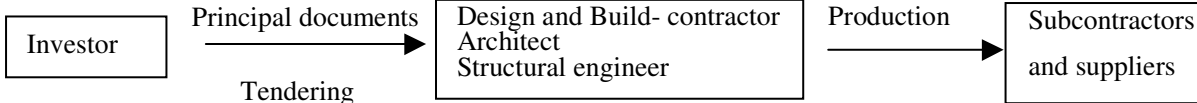

The structural frame is decided

Figure 2.4 The influence of the type of contract model on the design decisions (Öberg and Peterson, 2001).

**2.3.3 Influence of actors on the choice of structural frame materials**

**2.3.3.1 Introduction**

The building sector has been criticised for being not as industrialised as the manufacturing industry from an organisational and process oriented point of view. The major arguments concern the co-operation between the, in many cases, large number of actors which are involved in house-building projects. Especially the co-operation between the actors in the early stage of projects, the planning process, is criticised for being less developed compared to the manufacturing industry.

Some state that the house-building sector is conservative and traditional which makes innovations difficult to implement. This can to some extent be referred to the fact that buildings have to be safe and functional for a very long period of time and that malfunction often causes dangerous and expensive consequences.

This section aims at describing the role of the major actors within the building of concrete structural frames, addressing the actors' influence on the choice of structural frame material. The investigated actors within the study are the architect, the structural engineer, the contractor, the ready mix concrete producer and the concrete element producer. The focus is set on these actors regarding co-operation, competence and tradition.

Within the house-building sector, there are some actors in the production process who seldom are involved in the planning process. For example, subcontractors or material suppliers, such as the ready mix concrete producer, do in most cases not co-operate with neither the architect nor the structural engineer. The reasons behind this tradition, its effects and the possibilities for change will be discussed below.

Today, in Sweden the contract type 'own development projects' dominates the production of multi-storey residential buildings. Many persons within the house-building sector believe that this concept promotes a higher grade of co-operation and feedback compared to traditional project forms, especially the general contract. On the other hand, the concept is criticised for being too much focused on the production phase and based on company standards, and that the influence of some important actors, especially the architect, may be too small. Many believe that these participants have to break their own traditions if they want to be more active during the whole building process.

Some trends influenced by the manufacturing industry can be seen in the house-building sector today. It is increasingly common that the contractor uses 'system thinking' as a strategy, which means that a total concept is taken where different parts of the process are integrated. For example, with regard to single-family houses, the productivity increased with 45% between 1968 and 1997 by integrating the process of design and production, while the corresponding increase for multi-storey residential buildings was only 15%, (BKD, 2000). It is unclear if the 'system thinking' trend will increase in the future and what consequences this will have for building process.

Below, the possibilities of the studied actors for influencing the choice of structural frame will be discussed. As already mentioned, the result is based on personal interviews and therefore will contain subjective points of views.

### **2.2.3.2 The architect**

Traditionally, the architect has the key role in the planning of house-building projects and thus the responsibility, with the assistance of structural and technical supply engineers, for the overall functional and esthetical quality and for the adaptation of the new building into the local environment.

In Sweden, the architect is primarily involved in the early stages of the building process, a situation different from that in many other countries, where the architect is involved in the whole building process. In Denmark, for instance about 1/3 of the architect's work is related to the production phase. Further, an obvious advantage of the architect's increased learning through improved feedback from the production is the safeguarding of the realisation of the overall building quality.

Regarding multi-storey buildings, it is increasingly common in Sweden that large construction companies produce multi-storey residential buildings as own development projects. See Figure 2.5. With the aim of increasing the productivity, standardised building concepts are being introduced. It is generally acknowledged that the productivity issue is important and pressure has been put on the building industry to address this, (BKD, 2000).

Consequently, it is necessary that the standardised concepts are sufficiently flexible and open not to obstruct the freedom of the architect. Furthermore, attention should be paid to the risk that the architect's role could be limited in the context of own-development projects including company based, standardised technical solutions.

### **2.3.3.3 The structural engineer**

Similar to the architect, the Swedish structural engineer has a rather limited dialogue with the contractor and the material suppliers, such as the ready-mix concrete producer, both in the planning and the execution phase.

There are probably differences in the quality of the dialogue, depending on whether the structural engineer is hired as a consultant or employed in-house by the contractor. The competence in production technique and materials technology is often limited, maybe due to ambiguity of responsibility.

The co-operation between the structural engineer and the contractor on the one hand and the ready mix concrete producer on the other, differs when comparing house building to civil engineering construction. The average structural engineer in civil engineering often practises significantly more advanced concrete technology compared to the structural engineer within house building. In civil engineering construction, there is normally also a frequent dialogue between the actors concerning the possible use of advanced concrete technology. Many of the persons interviewed mean that this dialogue very often is missing within such parts of the house-building sector, where the utilisation of new concrete technology is less valued.

### **2.3.3.4 The contractor**

As shown in Figure 2.5, the contractor's role as a general contractor within house building in Sweden has more and more been changed into the role of own development contractor.

By some of the interviewed persons, the own development and the design and build contract models are considered to encourage more production-oriented design and choice of materials. The competence and knowledge of each actor may more easily be shared if there are open dialogues.

It is believed by many of the persons interviewed, that in the previously often used general contract models, the contractor is not able to influence the planning process, which leads the investor together with the hired consultants to be decision makers within the early stages of house-building projects.

In the design and build contract form though, there are probably increased opportunities for the contractor to influence the planning process. But some of the interviewed persons state

that even for this contract form, ‘system thinking’ including feedback and open dialogues with the subcontractors, e.g. the concrete producer, is seldom established.

As said in the previous paragraph the interest for and utilisation of new concrete materials technologies, or advanced structural design, has often been low in the ordinary house-building sector, compared to the civil engineering sector. However, with regard to new concepts created within own development contract models, the opportunities for usage of new design, new production and novel materials techniques may be clearer, if the actors are able to have open dialogues during the planning process and feedback in the production phase. These concepts may further increase the utilisation of new technology without focusing on questions concerning, for instance, responsibility, which often is described as a main obstacle today in the implementation of novel concrete materials technology.

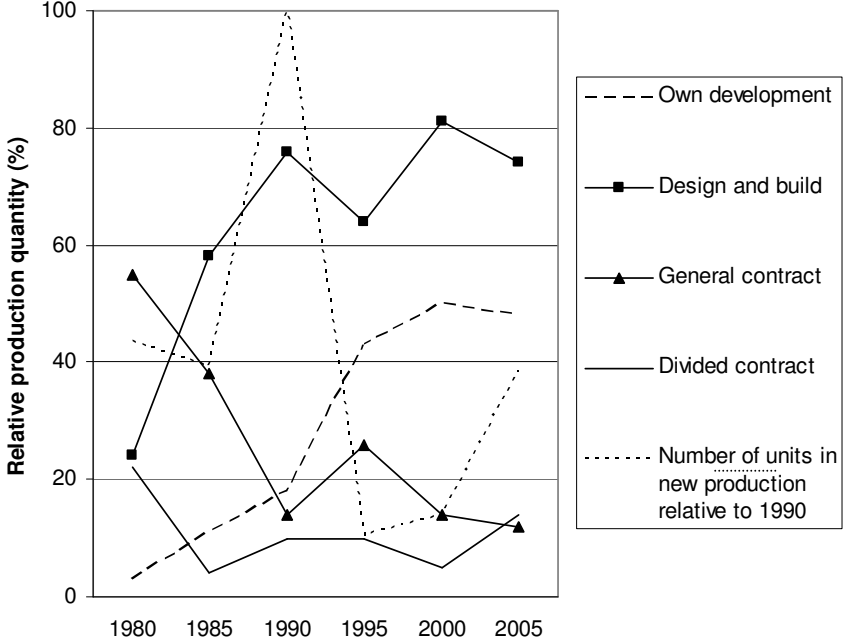

Figure 2.5 Production of multi-family dwellings in Sweden. Contract models’ proportion and relative production quantity according to SCB (2007).

### 2.3.3.5 The concrete supplier

Due to the aim of the research project, special attention is paid to the roles of the ready-mix concrete and concrete element suppliers.

During the so-called ‘Million Programme’ in Sweden 1965-1975, more than 1 million dwellings were produced. Some persons interviewed believe that the huge amount of ready-mix concrete and prefabricated concrete elements that was needed further influenced the attitude of the concrete producers; the ready mix concrete producer did not have to make any big efforts in marketing the product. It was selling itself. The precast concrete industry developed systems adapted to fit large-scale projects with great repetitiveness, and large precast plants were in operation in the vicinity of the larger cities.

During the time after termination of the ‘Million Programme’ until today, the production of ready mix concrete for the house-building sector, as well as the production of multi-storey

residential buildings, has decreased. However, the way of thinking and traditions, created during the 'Million Programme' are still very strong, especially in parts of Sweden remote from the big city areas, and in areas where there is a lower grade of competition between the concrete producers.

The ready mix concrete producers are seldom engaged in the early stages of the building process. Due to this fact, it is almost impossible for the concrete producer to influence the planning of house-building projects. In several cases, especially in the low competition markets, the concrete producer is described as being "only a supplier of concrete to the building site".

The co-operation of the concrete supplier with the architect and structural engineer is almost none. However, during the last years a fairly close co-operation concerning the question of how to control the drying of concrete in order to secure a healthy building has been established. This question often forms a decision criterion for the choice of concrete quality because of the close link to both production time and production costs. Another example of increased co-operation is the implementation of self-compacting concrete (SCC), which has set requirements for a clear dialogue between the ready-mix concrete producer and the contractor.

The collaboration between the ready-mix concrete producer and other actors in the building process is normally limited to the contractor and in most cases co-operation starts after the planning process. The potential advantage of interaction in the early stages can be illustrated by the example of the structural engineer making structural use of a high concrete strength, selected in order to meet the concrete drying criteria. The technical knowledge of the other actors is often considered inadequate by the concrete producer, which limits the possibilities to reduce production cost and to increase the technical performance of the building. Spreading knowledge of novel concrete materials technology may be difficult within the house-building sector due to the generally low interest in new concrete technique and due to the varying and occasionally also limited technical competence within the concrete ready-mix industry, especially in low competition markets.

The marketing arguments for the concrete element producer, in comparison to the ready mix concrete producer, partly consist of that the element producer is able to offer a total concept including structural design, which is seldom the case in the concrete cast in-situ alternative. The precast concrete producers can offer more or less complete packages of structural frames including the design and building production phases. Some producers in Sweden have developed complete systems for multi-storey residential buildings incorporating not only the structural frame but also finished facades including windows and technical systems for heating and ventilation. To exploit the precast technology properly it is deemed necessary that the precast producer should be engaged early in the project planning process.

One way for the ready-mix concrete industry to increase the co-operation between the involved actors in building of structural frames is to establish organisations, acting both as materials producer, structural engineer and contractor. In the city of Gothenburg one ready-mix concrete producer has started co-operation with contractors by forming a structural frame company, and in Stockholm a big construction company has introduced a special structural frame organisation. This seems to be one way to get more 'system thinking' and feedback and clearer definitions of the responsibilities of the different partners involved in the production of structural frames.

### 2.3.3.6 Implementation of SCC – actors’ view

Incentives to the use of SCC (as well as the interest in SCC in common) differ between actors. Furthermore, the ability (and ‘power’) differs between the actors to influence the implementation of SCC. In general, the interest in SCC is based on potential production economical benefits and to less extent work environmental arguments. For some actors the advantages of SCC are direct and for other actors the advantages are indirect. In addition, the possibilities for the actors to affect the implementation of SCC and the interest in SCC differ between the civil engineering sector and the house-building sector. With the aim of investigating these issues, a survey was carried out (Peterson and Simonsson, 2005). Below, the analysis and result of the survey is briefly presented.

A survey according to the ‘Actor model’ (Johnson and Scholes, 1999) was conducted. In general, actors according to Figure 2.6 have the possibility to influence and/or are influenced by the implementation of SCC. Within the survey, the contractor, owner of the building and the ready-mix concrete supplier were asked to place the interest of each actor in implementing SCC versus the ability of each actor to influence the implementation of SCC in a 10-degree scale with x and y direction respectively, see Figure 2.7 and Figure 2.8.

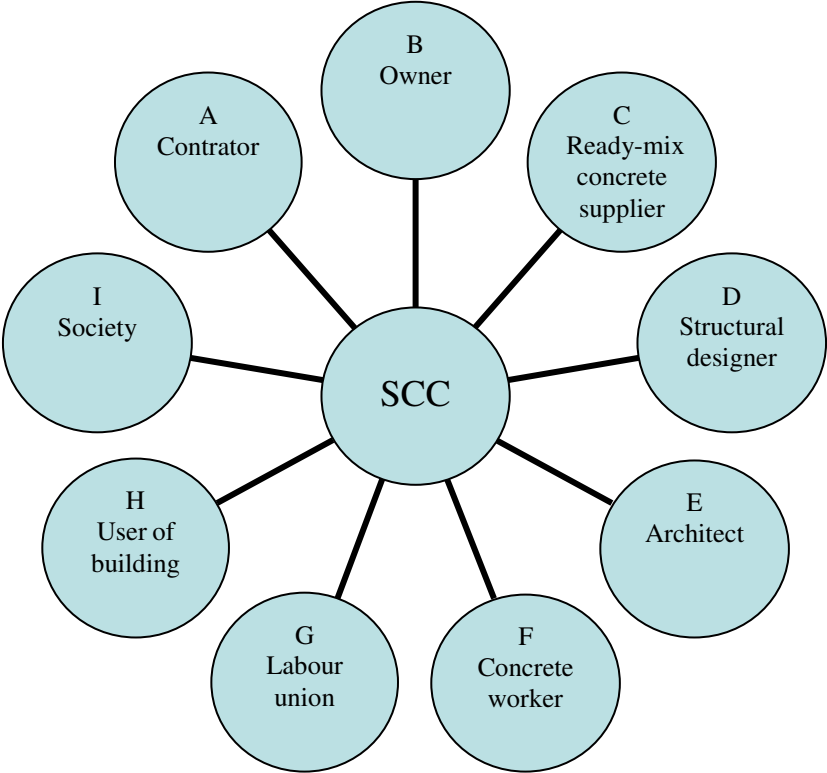

Figure 2.6 Main actors that may be influenced by SCC implementation and by the ability to influence the implementation of SCC.

The result of the survey conducted within the house-building sector was based on response from 3 contractors, 8 ready-mix concrete suppliers and 3 structural designers. According to Figure 2.7, the spread of the result was limited. The ready-mix concrete supplier was seen as having the largest interest in SCC, followed by the contractor and thereafter the designer and owner. The ability to influence the implementation was seen as somewhat lower for the concrete supplier.

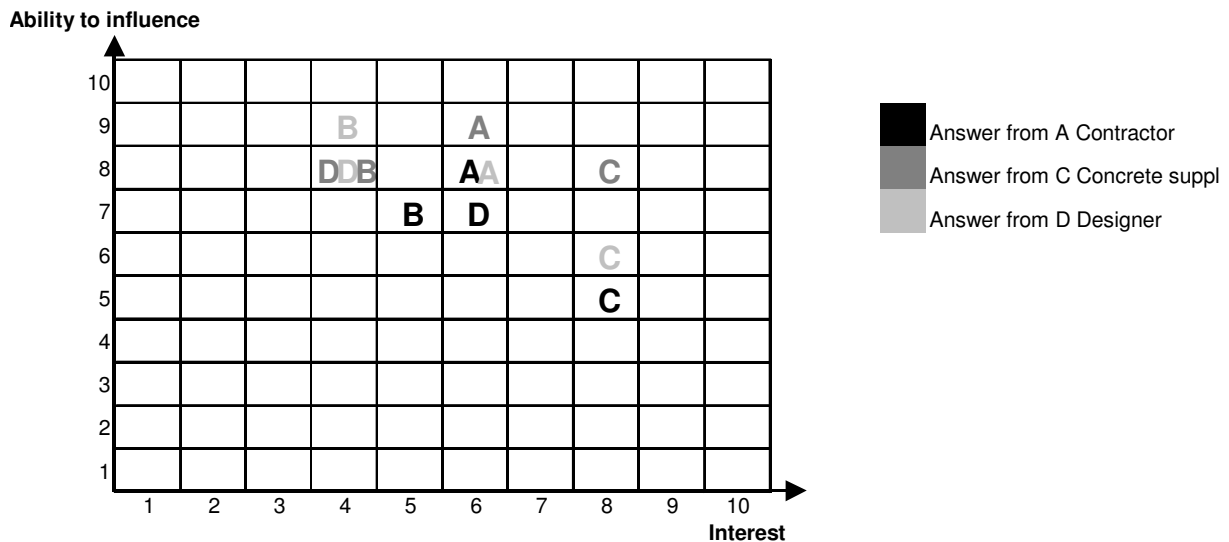

Figure 2.7 Result of the survey carried out within the house-building sector concerning the interest in SCC.

For the civil engineering sector, the responses represented answers from 5 contractors, 3 ready-mix concrete suppliers and 2 structural designers. According to Figure 2.8 the answers (average values) concerning the civil engineering sector, were more spread in comparison to the answers from the house-building sector. In addition there were other differences, as for instance that the contractor considers the interest in SCC from the concrete supplier as low and that the ability of the concrete supplier to influence the implementation is seen as low especially of the designer. From the concrete suppliers perspective they are very interested in SCC but have very limited ability to affect the implementation of the material. This may be based on large knowledge about the potential benefits of SCC of the concrete supplier but difficulties concerning communication with other actors.

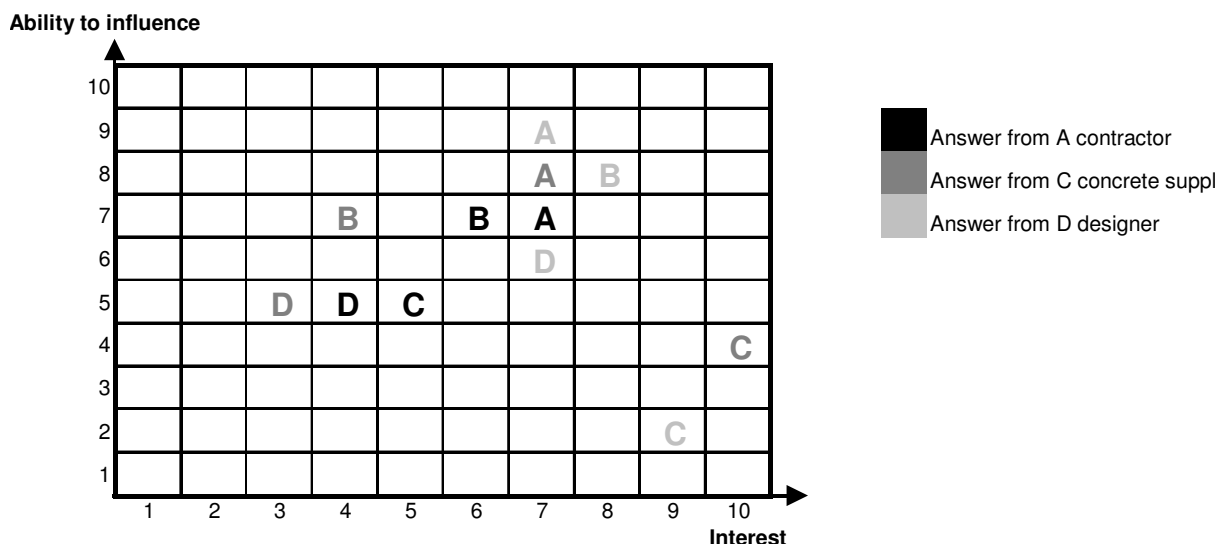

Figure 2.8 Result of the survey conducted within the civil engineering sector.



The differences of result between house-building and civil engineering may be based on that it is probably easier to utilise SCC within house-building due to less preparation time between castings, i.e. higher grade of casting time in relation to total structural frame production time. In general, there is a more clear focus on cost-efficient production cycles in house-building in comparison with civil engineering where the focus is primarily set on fulfilling advanced technical requirements. Due to the fact that SCC may lead to improper fulfilment of technical requirements, this is probably one of the strongest obstacles for implementation of SCC within civil engineering.

The ‘Actor model’, as used above, is probably as most representative if it is carried out within one single project. Then it may be possible to see significant differences between interests and possibilities of various actors. Despite the fact that the number of respondents is limited within the survey presented and that SCC implementation in general is regarded, differences between the actors interest and ability to affect the implementation are indicated, as well as between the house-building and civil engineering sector.

## **2.3.4 Obstacles for implementation of new concrete materials technology**

### **2.3.4.1 Introduction**

There are both technical and non-technical obstacles for implementation of new concrete materials technology within house building. For description of technical obstacles, see each chapter on HPC and SCC respectively (chapters 6.4 ‘Technical obstacles for the implementation of HPC’ and 3.5.2 ‘Potential disadvantages and obstacles for the implementation of SCC’)

Non-technical obstacles can be divided as follows:

- Organisation
- Economy
- Building codes

### **2.3.4.2 Organisation**

Like other innovations to be implemented within the house-building sector, the introduction of new concrete materials technologies meets barriers related to how the house-building sector is organised. Below, the most significant barriers are presented, of which the last two are connected to new concrete materials technology and not to innovation in general.

- Conservatism among the actors
- Lack of knowledge and low interest in innovation
- Missing spread of information and feed-back between and within the actors

- Unclear responsibility  
(Example: It is not always clear who is responsible for compaction of SCC. Is it the ready-mix producer delivering the mix or the constructor casting the mix? When problems with compaction occur, the responsibility of the two participants might be a matter of controversy.)
- Risks for concrete workers losing their jobs due to less need for personnel when utilising SCC

### 2.3.4.3 Economy

Often, the economical issues within house building are focused on production economy and not on the whole life cycle of buildings. This fact and its negative effects is discussed and exemplified in Öberg (2005). To predict future costs and benefits of new concrete materials in comparison to other materials can be difficult. Some factors are also hard to quantify in economical terms, as in the case of different types of “quality” such as serviceability, durability, functionality, aesthetics etc. However, such factors are seldom affected by the choice of type of concrete in the structural frame. Another aspect is that the multi-benefits of new materials technologies are seldom analysed. When discussing new concrete materials technology, it is common that the discussion addresses one single production economical benefit, which may lead to sub-optimisation. The full range of the potential of new technology is therefore seldom utilised.

Another aspect of the economical barriers for utilisation of new concrete materials technology is that of the direct costs. Often, the supplier of concrete set a higher price level for new concrete types, compared to the direct materials costs and ready-mix concrete production costs. The reason is often the increased risk for failure, which is connected to the low production volume of new types of concrete. With SCC, the set price is also affected by the increased responsibility for the supplier due to the elimination of traditional vibration work that for normal concrete was included within the responsibility of the contractor. As for HPC, the increased concrete quality often requires extra tests on site, which leads to added costs. Below the discussed economical barriers are summarised:

- Economy questions often focus on direct materials costs and not on the total production cost or on the total life cycle cost for the building
- Sub-optimisation. Regard is seldom taken to possible multi-benefits of new materials.
- Pricing of HPC (product cost criticised for being set too high if regard is taken to the real materials costs)
- Pricing of SCC (price of SCC criticised for being set too high compared to real materials costs)
- Added costs (due to presumptive extra required testing of HPC and SCC)

### 2.3.4.4 Building codes

The Swedish building code 'BKR 03' (Boverket, 2003) includes concrete qualities with a maximum cube compressive strength of 75 MPa (C60/75). If higher levels of the concrete strength class are to be used, special investigations have to be conducted. However, the new Swedish HPC Design Handbook (Swedish Building Centre, 2000b) treats strength classes up to 120 MPa (cube strength).

In the planning phase of house-building projects, the norms might discourage from use of HPC, due to presumptive added costs for concrete testing and/or for uncertainties regarding risks for technical problems. International codes differ regarding the maximum allowed strength level. See further Table 2.1 below (FIP/CEB, 1994). Building codes have therefore been criticised for not being updated with regard to new types of concrete materials. For example, the Swedish building regulations stipulate specific design values not only for compressive strength, but also for tensile strength and elastic modulus (E-modulus). In the concrete standard, the latter values are both coupled to the compressive strength class. These values are based on standard values addressing the correlation between testing on cast concrete cubes or cylinders and not real values valid for the finished construction. If higher levels of tensile strength and E-modulus are to be utilised, special investigations have to be conducted.

*Table 2.1 Examples of various international codes, which cover HPC according to FIP/CEB (1994). Note that the former Swedish building code 'BBK 94' is presented.*

Country	Building code	Max. comp. strength (MPa)	Test specimen
Sweden	BBK 94	80	Dry cube 150 mm
Sweden	HPC Design Handbook	120	Dry cube 150 mm
International	CEB-FIP MC-90	80	Wet cylinder 150/300mm
International ext	CEB-FIP MC-90	100	Wet cylinder 150/300mm
US	ACI 318-89	no maximum specified	Wet cylinder 152/304 mm
Germany	Suppl. to DIN 1045, 488 and 1055	115	Dry cube 200mm
Norway	NS 3473	105	Dry cube 100 mm
		94	Wet cylinder 150/300 mm
Japan	Specification for HPC	80	Wet cylinder 100/200

Contrary to HPC, SCC is within the Swedish building regulations today not separated from normal concrete. Therefore the codes are not seen as barriers for SCC. However, the strength of SCC is often higher than of normal concrete with the same w/c ratio and amount of cement. Thus a certain strength class can often be achieved with higher w/c ratio and lower amount of cement. This will have an effect on durability, which however is of less importance for indoor concrete.

## **2.4 Structural frame production with cast in-situ concrete – summary of technical and building process related aspects**

Besides conventional and novel technology for structural frame production (especially in-situ concrete production), this chapter describes issues related to the building process, e.g. influence of actors and various requirements. The chapter acts as a basis to other studies of the research project where the theoretical potential of HPC and the ‘real’ potential of SCC are investigated.

Ready-mix concrete cast in-situ is the dominating materials technology within structural frame production for multi-storey residential buildings in Sweden. Despite criticism with regard to technical performance, average-grade ‘house-building concrete’ with cube strength 25 to 30 MPa is still the most commonly used type of concrete, which limits the possibilities to increase the competitiveness of ready-mix concrete. During the last decade though, new concrete materials technologies such as self-compacting concrete (SCC) and high performance concrete (HPC) have been developed. The potential of these materials in structural frame production is not exploited. A more frequent use of these techniques would probably result in advantages in design, production and function of the buildings. In general the interest in novel technology is low and the grade of co-operation between actors is low. If new concrete materials technology is to be integrated into house-building, the traditional low degree of co-operation between the actors, as well as the low interest in developing the structural frame, has to be broken.

Within the building sector, some actors are seldom involved in the planning phases of projects. For example, in most cases subcontractors and material suppliers do not co-operate with either the architect or the structural engineer. The opportunity for different actors to influence the choice of structural frame is largely dependent on the form of contract adopted for the project. In Sweden, the production of multi-storey residential buildings is dominated by self-development projects. This form of contract often embodies total concepts, which would promote a higher level of ‘industrialisation’, e.g. increased standardisation and utilisation of finished modules, improved co-operation and feedback, compared to the more traditional general form of contract. With regard to the possibility for implementation of novel concrete materials technology, self-development projects may decrease the uncertainties regarding responsibility and lead to opportunities for increased competence and feedback. On the other hand, the concepts can be criticised for being too focused on the production phase and based on ‘company standards’ whilst reducing the influence of some actors such as the architect. Another presumptive way to increase the industrialisation grade is exemplified by that efforts have been made to establish special frame-building companies, addressing the potential for increasing the market shares by offering complete structural frames. These companies include the roles of both structural designer, concrete supplier and contractor.

However, there are several methods to increase the grade of industrialisation within structural frame building. Implementation of new concrete materials technology is one way that may lead to increased competitiveness and solve several problems. If an increased implementation is to be conducted though, several obstacles have to be solved, of which some are automatically solved when an industrialised point of view is increased.



## PART 1, Self-compacting concrete (SCC)



# **3. SELF-COMPACTING CONCRETE – MATERIALS PROPERTIES AND EFFECTS ON PRODUCTION**

## **3.1 Introduction**

### **3.1.1 Self-compacting concrete – general**

Self-compacting concrete (SCC), or self-consolidating concrete that is the most common term in North America, is described worldwide as one of the most important development steps in concrete materials technology during the last decades. SCC is based on new types of highly efficient water-reducing admixtures (superplasticisers) combined with high powder contents, e.g. limestone filler or special fine-grained sand. Alternatively, a viscosity-modifying agent (VMA) can be added to the concrete mix when no or limited filler amount is used. The main advantage of SCC is that the traditionally needed compaction work can be eliminated. This opportunity means that several potential benefits may be exploited. These benefits cover various important areas, e.g. improved structural design, increased production efficiency and improved building function. However, since the introduction during the second half of the 1990s, the utilisation in Sweden of SCC is still strongly limited. The obstacles for increased implementation of SCC include both technical and non-technical issues. Concerning the latter, direct economical aspects, e.g. direct materials costs, still is the dominating influence on the choice of concrete in many house-building projects. Probably, if a more total-economy related or a more work-environmental perspective is adopted in combination with further technical development of SCC, the utilisation of SCC will be influenced in a positive way.

### **3.1.2 Fresh and hardened SCC – brief description of main properties**

The idea of SCC is the opportunity to cast without compaction by vibration, which is always needed for traditional concrete. In order to achieve a homogenous hardened structure with high-quality surfaces and proper filling of the form, fresh SCC without segregation is needed. To manage this, special requirements are set concerning the type and proportions of constituent materials in relation to normal concrete (NC). The risk of segregation increases for SCC with high flow, low viscosity and/or during improper placing conditions. If segregation occurs after placing this may lead to surface defects (e.g. cracking and weak surface layer) and segregation during placing may lead to inhomogeneous structure of the hardened concrete. Briefly, the main methods to achieve self-compacting performance (in comparison with NC) consist of:

- Increasing the flow by usage of:
  - Superplasticiser (SP)
  - Reduced coarse aggregate content (to avoid blocking of particles)
  
- Maintaining the viscosity to achieve robustness and avoiding segregation by:
  - Increasing the content of fines
  - Alternatively, adding viscosity increasing agents



By applying these methods, there will automatically be positive as well as negative consequences on the technical properties of *fresh* SCC in comparison with fresh NC, e.g:

- Potential advantages:
  - High passing ability (i.e. ability of the concrete to pass narrow openings)
  - High form filling ability
  - High self-levelling ability
- Presumptive disadvantages:
  - Sensitivity to segregation
  - High flow with high form pressure and/or form leach as result
  - Increased sensitivity to plastic shrinkage and early cracking

In addition, there will be consequences on the technical properties of *hardened* SCC, e.g:

- Potential advantages:
  - Automatically high strength at constant w/c-ratio caused by the filler ('filler effect')
  - Level and smooth horizontal surfaces
  - High-quality vertical surfaces
- Presumptive disadvantages:
  - Increased cracking due to increased shrinkage caused by filler
  - Improper vertical surface quality when the self-compacting ability is unsatisfactory
  - Unwanted high strength due to the 'filler effect' (e.g. increased need of cracking reinforcement)

Due to the fact that some of the consequences are contradicting and that the result may differ, e.g. that the opportunity to achieve high-quality surfaces may change to improper surface quality, it is of large importance to have control of the properties of the fresh concrete. This may be difficult.

### **3.1.3 Aim of the chapter**

The chapter aims at describing materials properties of both fresh and hardened SCC. Furthermore, the potential of SCC is summarised from a structural frame production perspective. Special attention is set on work-environmental issues. Swedish as well as international SCC research and experience from SCC implementation are presented.

## 3.2 Material properties of fresh SCC

### 3.2.1 Basic materials characteristics of fresh SCC regarding its self-compacting properties

#### 3.2.1.1 Introduction

Ordinary concrete requires external compaction work by internal or external vibrators for proper compaction, filling of the formwork and covering of the reinforcement. Proper SCC fulfils at least the same quality level but with no vibration work. SCC compacts itself automatically by its own weight. In order to create the self-compacting effect of SCC, the friction between the particles has to be reduced at the same time as satisfying stability of the fresh concrete has to be maintained.

The basic/fundamental properties of SCC concern the rheological characteristics in the fresh state and can be divided into the following main areas of self-compacting ability according to Bonen and Shah (2005):

- Deformability
- Flow
- Segregation resistance
- Passing ability

In comparison with conventional concrete, SCC is characterised by increased levels of these properties. To reduce the friction between particles and thereby increase the deformability, high-range water reducer (HRWR), or so-called superplasticiser (SP) is utilised. The risk of blockage between aggregate particles can be reduced if both the volume of coarse and fine aggregate is limited and thereby achieving an 'excess layer' of paste around each particle, which will minimise the friction between particles (Walraaven, 2005). Thereby, it is possible to increase the retention of the kinetic energy of the particles. To control the stability and avoid concrete segregation, a high content of powder or filler (i.e. particles < 0,125 mm) can be used. High filler contents, e.g. lime stone or glass filler, increase the viscosity of the fresh concrete, which makes the coarse aggregate particles being suspended in the mortar phase avoiding concrete segregation. Alternatively, chemical additive, i.e. viscosity-modifying agent (VMA), can be used to increase the viscosity. Fig 3.1 displays how the constituent materials and their proportions typically differ between SCC and conventional concrete (Okamura and Ouchi, 2003). The main difference is that the amount of gravel (G) in SCC is reduced due to the required increased amount of powder (i.e. cement and for instance limestone filler). The ratio between paste (i.e. water, W, cement, C and powder) and aggregate (i.e. sand, S and gravel, G) is smaller for conventional concrete in comparison to SCC.

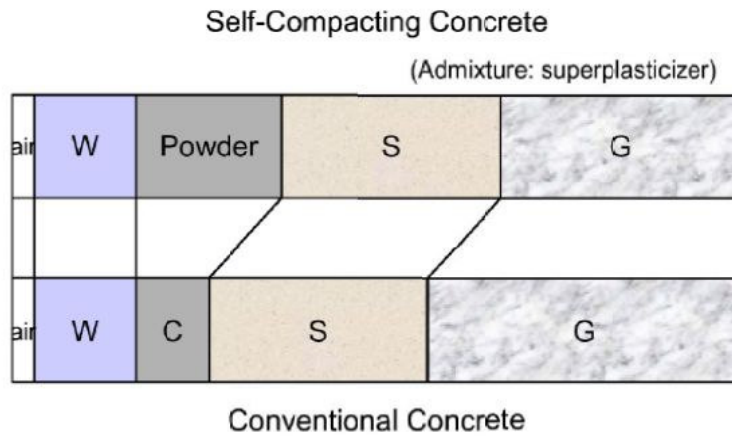

Figure 3.1 Proportions of constituent materials of SCC versus conventional concrete (Okamura and Ouchi, 2003). S=sand, G=gravel, C=cement and W=water.

For SCC mixes of VMA type, the coarse aggregate volume can be higher than in powder types of SCC but lower than in normal concrete. See Figure 3.2. Note that the presented concrete types have the same level of compressive strength.

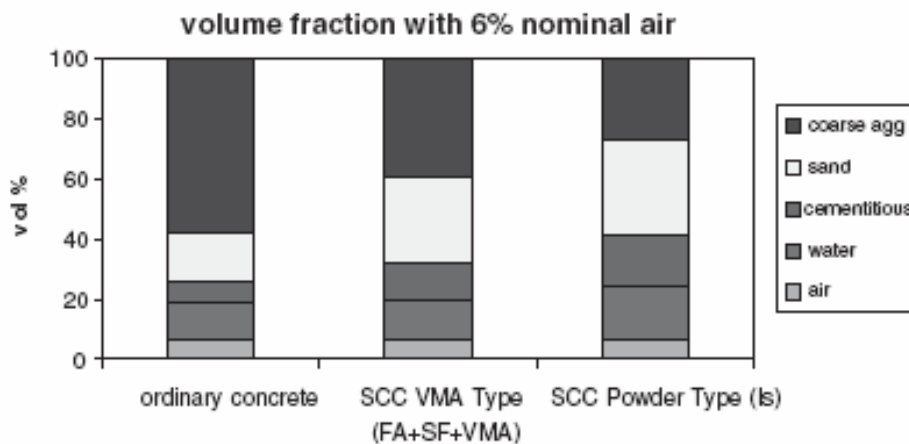

Figure 3.2 Proportions of constituent materials of SCC including VMA, SCC including powder and ordinary concrete. Note similar strength. (Bonen and Shah, 2005)

There are several concepts for producing SCC. For all concepts, some kind of high-efficient water reducing and dispersing superplasticiser is used. Superplasticisers aim at increasing the dispersing effect and furthermore decreasing the friction between the particles. There has been an intense development of superplasticisers during the last decades making both SCC and HPC feasible. Conventional types of SP, e.g. sulphonated naphthalene formaldehyde condensates (SNFC) and sulphonated melamine formaldehyde condensates (SMFC) disperse cement particles by electrostatic repulsing mechanisms. In comparison, the last version of SP that is based on polycarboxylate ether (PCE), also called the ‘third generation’ of SP and ‘hyperplasticisers’, also include a strong steric hindrance effect by polymer chains. To further prevent cement particles from flocculating, multi-ion polymer may be used in combination with PCE, which increases the dispersing effect even more (Fletcher, 2004).

The parameter that varies most between different mix concepts for SCC concerns the viscosity-controlling ability that aims at achieving robust non-segregating SCC. There are, in main, three methods for controlling the viscosity, i.e. increased powder content, usage of viscosity-modifying agent and a combination of the two methods.

Below, three main concepts for SCC regarding constituent materials and their effects are presented:

### **1. SCC based on increased powder content**

Powder-SCC incorporating limestone filler is the dominating SCC-concept in Sweden, Netherlands and Japan. In Norway and Switzerland, added powder is often not needed due to the high quality of the aggregate that in general includes natural fines. See Figure 3.3 for an overview of various SCC concepts in relation to flow and viscosity. There are also alternative powder concepts that contain other types of filler i.e. glass filler, fly ash, ground granulated blast furnace slag and/or silica fume. Another method to achieve powder-SCC is to increase the cement content itself. However, a proper mixed powder-SCC may result into a robust SCC with satisfying stability, viscosity and flow. The balance between flow and stability is however very important for the behaviour of fresh concrete. The filler properties as well as the filler amount affect the stability and viscosity. Increased fineness of the filler normally including increased specific area leads to increased viscosity and improved stability of the fresh concrete. The flow performance is mainly affected by the superplasticiser, but also the filler type has an influence. Coarser filler generally gives increased flow compared to finer filler (Nordkalk, 2007). Filler characteristics are shown in Table 3.1.

An increased amount of powder affects the hardened concrete properties, which is referred to as the ‘filler effect’. For concretes with increased amounts of filler but similar w/c ratios the strength normally significantly increases although the filler is supposed not to be chemically reactive. The reason might be that the filler acts as an accelerator to the cement reaction, i.e. it increases the amount of reacted cement. Furthermore, use of filler may improve the microstructure by reducing the risk of micro-defects. It is also possible that limestone filler has certain reactivity. See Bonaretti et.al (2001).

Provided strength is the only important property, the ‘filler effect’ may be utilised for decreasing the amount of cement and thereby it creates possibilities for the concrete producer to reduce the direct materials costs of the concrete. On the other hand, investments in extra silo capacity for filler have to be made by the concrete producer.

Table 3.1 Properties of common limestone fillers on the Swedish market according to Nordkalk (2007).

Product name	Max. size (mm)	Specific surface (m <sup>2</sup> /kg)	Type of filler
Limus 15	0.2	556	Fossil limestone, CaCO <sub>3</sub> age 70 million years, Geographical area of Ignaberga
Limus 25	0.1	526	Metamorphic limestone, CaCO <sub>3</sub> age 1.8-2.0 billion years, Geographical area of Köping
Limus 40	0.5	330	Metamorphic limestone, CaCO <sub>3</sub> age 1.8-2.0 billion years, Geographical area of Köping
Limus 190	1.0	270	Fossil limestone, CaCO <sub>3</sub> age 70 million years, Geographical area of Ignaberga

## 2. SCC based on viscosity-modifying agent (VMA)

Viscosity-modifying agents (VMAs) are normally water-soluble polymers. Addition of VMA to SCC-mixes enhances the stability of SCC and thereby prevents the concrete from segregation without usage of any filler. Similar to the utilisation of powder in SCC, addition of VMA increases the concrete robustness against variations in the amount of mixing water, which further may depend on moisture variations in fines, e.g. sand. There are contradicting results concerning the robustness of VMA-SCC versus powder-SCC. For instance, Sakata et.al (2003) means that powder-SCC is less robust. On the other hand the Swedish Concrete Association (2002) means that the balance of the mix composition of VMA-SCC is very important and hard to manage in practice. Shindoh and Matsuoka (2003) further argue for a synergistic effect of VMA-SCC based on the fact that VMA leads to the possibility of increasing the amount of SP. This can further increase the self-compactability without causing segregation. From an economical point of view, most VMAs are expensive and in general more expensive than powder, e.g. limestone filler. However, when analysing the total cost and presumptive benefits of powder versus VMA, regard must also be taken to that powder requires extra silo capacity. On the other hand, the 'filler effect' may lead to cost savings, e.g. reduction of cement content and faster strength development. Research is ongoing with the aim of creating more cost-efficient VMA. As for instance, Lachemi et. al. (2003) describes the positive economical potential of VMA based on new types of polysaccharide in comparison with the normally used VMA based on welan gum. A newly introduced VMA-concept on the market is called 'Smart Dynamic Construction' (SDC). According to the supplier 'BASF', SDC leads to several opportunities when compared to powder-SCC, e.g. lower price, easier ready-mix production and high robustness against segregation (Byggindustrin, 2008).

### 3. SCC based on both VMA and powder

In reality, the difference between powder-SCC and VMA-SCC may be hard to distinguish due to the fact that small amounts of VMA or powder may be added to the both types of SCC. For that reason, the third main concept of SCC is based on both concept 1 ‘SCC based on increased powder content’ and concept 2 ‘SCC based on VMA use’. Addition of VMA reduces the powder need and vice versa.

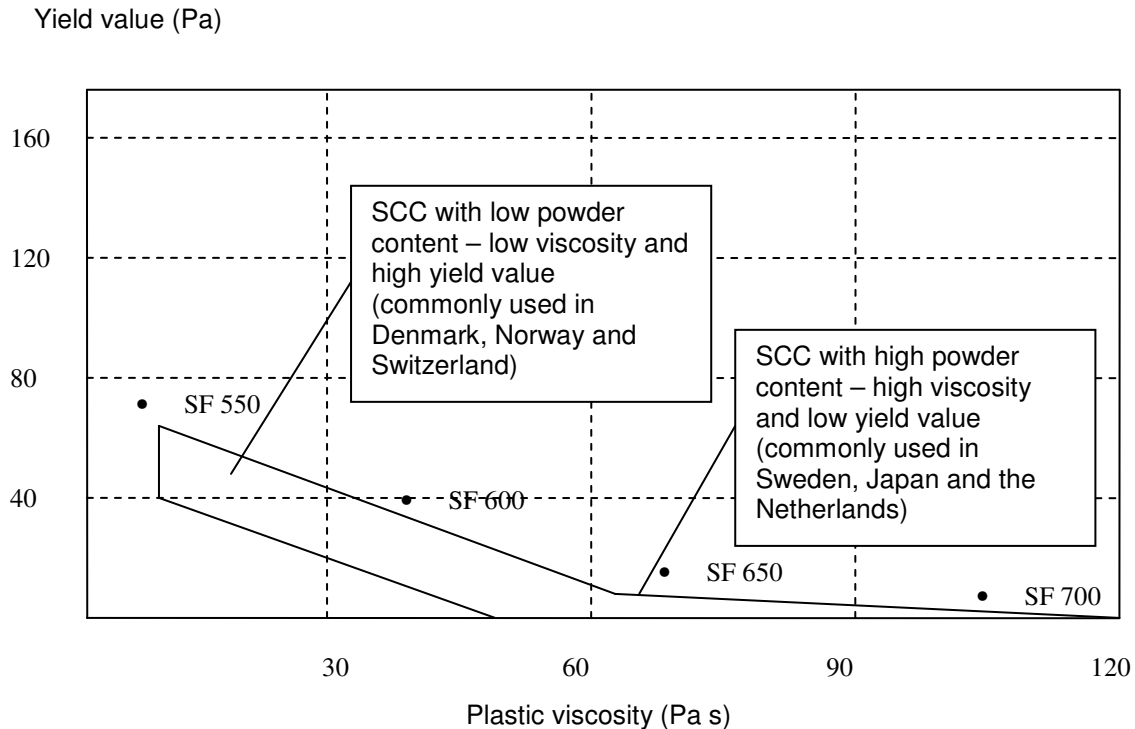

Figure 3.3 Overview of the range of fluidity (yield value) and viscosity for various SCC concepts with respect to constituent materials and geographical markets according to (Wallevik, 2003). Yield value and plastic viscosity are defined in Fig. 3.4.

#### 3.2.1.2 Rheology

Rheology can be defined as “the science of deformation and flow of matter”. Rheological methods are used in various sectors and with various aims. Most rheological methods aim at understanding the interactions between different ingredients in a product or sample, e.g. the relation between the size/shape of particles in a solvent and the cohesion and viscosity of the solution. Further, the result of rheological measurements can be utilised for quality control of raw materials and final products and/or for the design of process equipment as for instance pumps and pipelines.

Within the area of concrete materials technology, various rheological methods are used to examine the properties of the fresh concrete that also affect the properties of the hardened concrete. Historically the most frequently used rheological method has been to measure the ‘slump’. This is used for quantification of the ‘consistency’ of the concrete. The ‘slump method’ is a simple testing method that is well suited to field conditions on building sites. Other rheological methods that have been used within concrete materials technology are for example the ‘remoulding test’ to measure the ‘workability’ of the fresh concrete. Since the

introduction of SCC, the requirements of proper rheological control of the fresh concrete have increased due to the fact that SCC is more sensitive to variations of ingredients affecting for instance the self-compacting ability and the segregation tendency. Another incentive to increased focus on rheology methods is that they are needed for optimised mix design regarding flow capacity, stability/robustness and passing ability.

For the testing of self-compacting properties, as for instance deformability, passing ability and segregation resistance on site, “simple” rheological test methods are used, e.g. ‘slump flow’ and ‘L-box’. More scientific rheological methods i.e. rheometers and viscometers have been developed and are used but mostly within research. They are seldom used within the ready-mix concrete production.

### Definitions

Figure 3.4 illustrates the difference between Bingham flow and Newtonian flow in terms of shear stress in relation to rate of shear. Newtonian flow is the simplest type of flow, valid for instance for water. For a Newtonian flow, the viscosity (i.e. the slope of the line) is constant and independent of the rate of shear. If a fluid is not flowing until a specific level of shear stress is applied, the ‘yield level’, the fluid belongs to the group of viscoplastic fluids, which as for instance include concrete. This type of flow is described as a ‘Bingham flow’. The viscosity of a Bingham fluid is named as plastic viscosity and is independent of the shear rate.

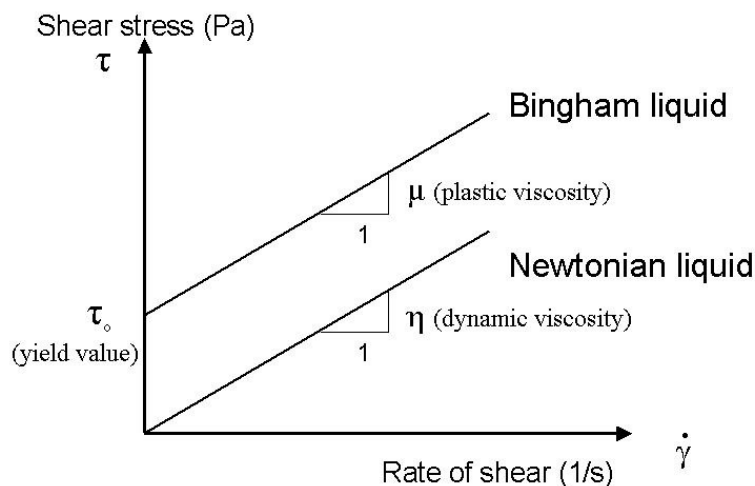

Figure 3.4 Comparison between Newtonian liquid (e.g. water) and Bingham fluid (e.g. concrete) with respect to rate of shear in relation to shear stress. See Skarendahl and Petersson (2000).

Thixotropy is a term that is commonly used for describing one important aspect of the rheology of concrete, especially SCC. If a material shows thixotropic behaviour, the flow characteristics are dependent on the history of shear stress, e.g. the viscosity increases if the shear stress is set to zero during a time period. When a shear stress is once again applied on the material the viscosity will recover and decrease to its original level. In Figure 3.5, thixotropy is illustrated as a hysteresis effect between increasing and decreasing the rate of shear. The area between the curves can be described as the ‘energy’ required to break down the thixotropic structure (Wallevik and Nielsson, 1998).

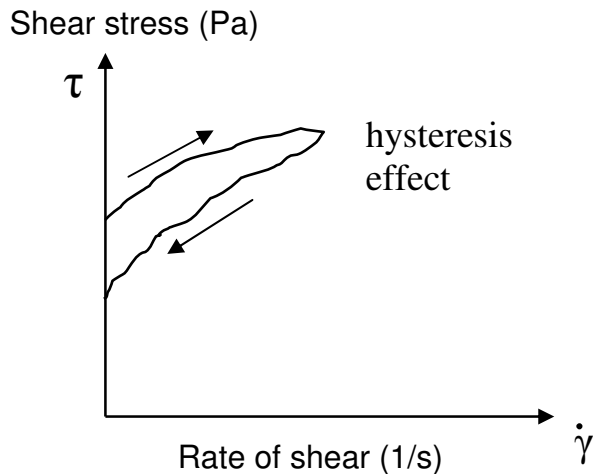

Figure 3.5 By thixotropic behaviour of a material is meant that the flow characteristics are dependent on the history of shear stress.

### 3.2.1.3 Test methods for fresh SCC

In order to verify that proper self-compacting ability and stability are achieved, increased testing of fresh SCC (in comparison with NC) is required both at the ready-mix concrete plant and on the building site. Various new types of test methods are developed in order to verify important properties of the fresh SCC during mix optimisation and for control during daily production and delivery on the site. None of these test methods for SCC are included within the European standards today. However, test methods for fresh SCC were investigated within the major research project ‘Testing SCC’ that was funded by the European Union during the years 2001 to 2004. See the final report of the project (Testing SCC, 2005). The result of ‘Testing SCC’ has been important for ‘The European guidelines for self-compacting concrete’ (ERMCO et. al, 2005) as well as the adaptation work of EN 206-1 with regard to SCC, which is ongoing. In Table 3.2, test methods for fresh SCC according to ERMCO et. al (2005) are listed together with corresponding characteristics, specification classes and typical application areas.

Briefly, the test methods and their interpreted result can be described as follows:

- Slump flow
  - Estimation of the flowability
  - The most frequently used test method for fresh SCC
  - Test equipment similar to slump testing (cone and plate)
  - Can additionally be used for estimating the risk of segregation through ocular observation of the spreading of the concrete front



- T500 and V-funnel
  - Estimation of the viscosity
  - T500 uses the same equipment as slump flow
  - V-funnel uses new equipment developed especially for SCC testing
  - By measuring the rate of flow (the time required until the concrete flow stops), the viscosity can be assessed, e.g. quick initial flow and then stop means low viscosity. Continuous flow over an extended time indicates high viscosity
  
- L-box
  - Estimation of the passing ability, i.e. the ability to flow through narrow openings without segregation, loss of uniformity or causing blocking
  - Equipment is unique for testing of SCC only
  
- Sieve segregation
  - Estimation of the segregation resistance
  - Equipment is developed with regard to SCC testing

*Table 3.2 Test methods for fresh SCC according to ERMCO et. al (2005) with corresponding characteristics, specification classes and typical application areas.*

<b>Testing method</b>	<b>Characteristics</b>	<b>Class</b>	<b>Measurement unit</b>	<b>Typical application area</b>
Slump flow	Flowability	SF1	550 to 650 mm	Slabs
		SF2	660 to 750 mm	Walls and columns
		SF3	760 to 850 mm	Densely reinforced and/or complex designed structures
T500 V-funnel	Viscosity	VS1 VF1	≤ 2 s ≤ 8 s	Densely reinforced structures and high-quality surface needed
T500 V-funnel		VS2 VF2	> 2 s 9 to 25 s	Reduced formwork pressure needed
L-box	Passing ability	PA1	≥ 0.80 with 2 rebars	House building
		PA2	≥ 0.80 with 3 rebars	Civil engineering
Sieve segregation resistance	Segregation	SR1	≤ 20%	Flow distance <5 metres
		SR2	≤ 15%	Flow distance >5 metres High-quality surface needed

The proposed specification system of the European SCC guidelines, aims to make it possible to fulfil the requirements set on SCC on site for various applications, i.e. it is a tool for increased communication between the contractor and the concrete supplier. Figure 3.6 illustrates the specification system with respect to required properties for different applications.

Viscosity				Segregation resistance/ passing ability
VS 2 VF 2	Ramps			Specify passing ability for SF1& 2
VS 1 or 2 VF 1 or 2 or a target value.		Walls and piles	Tall and slender	Specify SR for SF 3
VS 1 VF 1	Floors and slabs			Specify SR for SF 2 & 3
	SF 1	SF 2	SF 3	
	Slump-flow			

Figure 3.6 Various SCC specifications with respect to required properties for different applications according to ERMCO et. al (2005).

There are also other methods that are used for testing fresh SCC but not included within the specification presented in ERMCO et. al (2005), as for instance the ‘Orimet’ and ‘J-ring’ for estimation of flowability and passing ability respectively. For more scientific purpose and to some extent for mix development and optimisation, rheometers, e.g. coaxial viscometers of ‘BML type’ are used. By using such a viscometer it is possible to estimate rheological properties such as yield value and plastic viscosity. As for instance, Esping (2007) presents results from a large number of rheological tests of SCC. However, due to high investment costs and measurement complexity in relation to traditional SCC test methods, rheometers are seldom used by ready-mix concrete producers.

### 3.2.1.4 Main rheological differences between SCC and normal concrete (NC)

In Figure 3.7 rheological properties of SCC are compared with those of NC and high-strength concrete (HSC). In general, the yield value of normal concrete is high enough to prevent the fresh concrete from segregation. However, in SCC, the maximum level of the yield value has to be restricted in order to achieve proper flowability. Normally, the yield value is not high enough in itself to prevent the concrete from segregation. Therefore, in order to avoid segregation, high viscosity of the matrix (paste and fines) is needed in SCC.

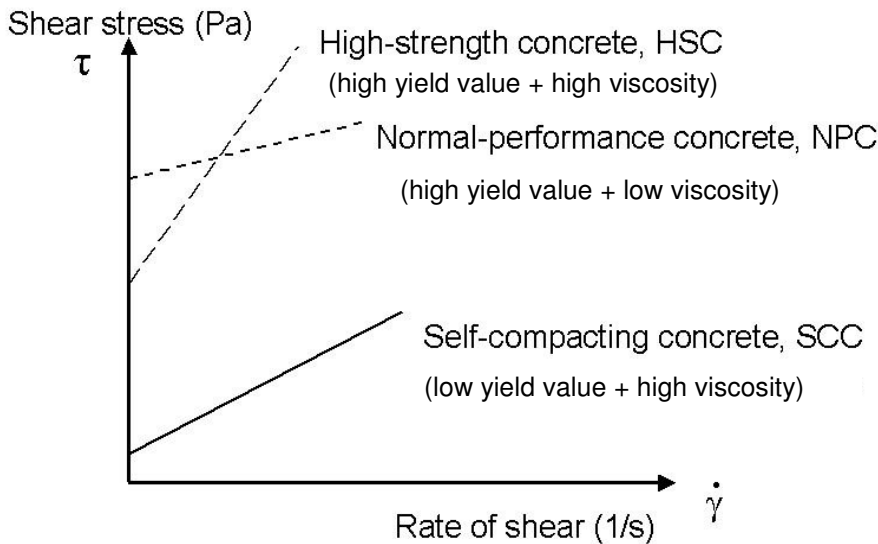

Figure 3.7 Comparison between various concrete types with respect to typical rheological properties according to Wallevik (2003).

The relationship between yield value and plastic viscosity varies between different geographical markets due to what type of SCC mix is used (based on available and ‘traditionally’ used ingredients). If mixes incorporating high yield values are used as ‘standard concept’ on one market, lower viscosity may be acceptable than is commonly used on other markets; the lower the yield value, the higher viscosity is normally required. HSC that is not self-compacting has a plastic viscosity that is normally higher than that of SCC. This depends on the low w/c ratio. As seen in Figure 3.8, the yield value does not affect the viscosity but practical terms as the ‘stiffness’ and ‘wetness’ of the fresh concrete. In practice, high viscosity leads to increased need of vibration work and since viscosity increases with reduced w/c-ratio there is sometimes a practical limit of the w/c ratio that is possible to manage -a problem that not exists for SCC due to the fact that the concrete is compacted by itself.

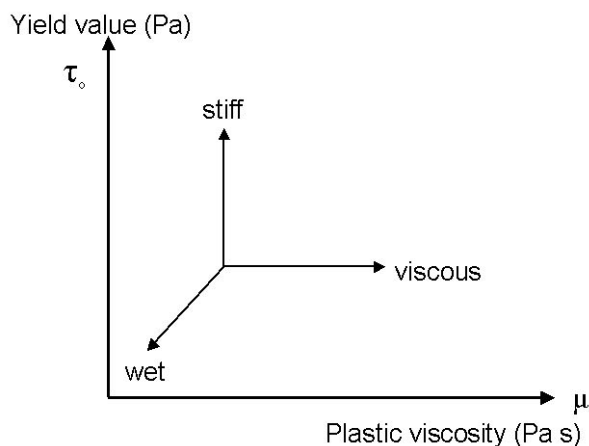

Figure 3.8 In contradiction to viscosity, properties as ‘stiffness’ and ‘wetness’ are affected by the yield value according to Wallevik (2003).

### 3.2.1.5 Important mix design parameters of SCC with regard to rheology

#### *Rheological testing and modelling – examples of international research*

In Japan, according to Okamura and Ouchi (2003), the most used mix-design method is to limit the coarse aggregate to 50% of the solid volume as well as to limit the fine aggregate to 40% of the mortar volume. This will lead to an 'excess layer' of paste around each particle, which minimises the friction between particles, provided that the volume of powder in relation to the volume of water is between 0.8 and 0.9. Increased thickness (through decreasing the water content) of the inter-particle layer may lead to segregation whereas decreased thickness may lead to increased friction. To ensure self-compacting ability, the SP dosage and water/powder ratio (powder = particles < 0.125 mm) is finally determined.

Several rheological models for SCC have been developed. For instance, Bui et. al. (Bui et.al, 2002) have developed a model based on paste rheology criteria, aiming at achieving SCC with satisfying segregation resistance and flow performance. In this model, the criteria mainly concern the aggregate diameter and aggregate spacing. This model is a development of the earlier model (Saak et.al, 2001) that introduced the concept of the rheological self-flow zone (SFZ) in order to avoid segregation.

Khayat et.al has conducted several field-oriented test methods for evaluating SCC (Khayat, 1999). Various SCC mixes have been evaluated regarding deformability, filling capacity and stability. Both SCC of powder type and of VMA type are tested and the performance compared with ordinary concrete.

In Ghezal and Khayat (2002), the results of a large experimental program is presented where several SCC mixes including limestone filler are evaluated with regard to 8 performance criteria that mainly cover rheological issues but also the hardened properties and to some extent also economical (due to the beneficial filler effect).

In Khayat et.al (2004), test methods for estimating SCC properties, especially stability in field are investigated addressing the correlation with various rheological rheometers and viscometers. The influence of measuring procedure on the result of rheological testing is addressed in Geiker et.al (2002). Non-steady state viscometer tests with lack of relaxation time may cause an overestimation of the plastic viscosity and an underestimation of the yield value, which may explain shear-thickening behaviour of SCC observed elsewhere.

The rheological effect of filler is investigated in Yahia et. al (2004). An increased viscosity can be achieved by reduced w/c-ratio, addition of VMA and/or addition of filler. When adding filler, the water demand increases due to the higher specific area, caused by the filler. Another effect is that the inter-particle contact increases, which may decrease the deformability and passing ability.

### *Rheological testing and mix design – summary*

In order to achieve proper self-compacting ability, the following rheological parameters must be fulfilled:

- High deformability – by low yield value
- High flow ability – by low yield value, low viscosity and retention of the kinetic energy (to prevent particles from blocking by decreasing the coarse aggregate content and thereby increasing the particle distance)
- High segregation resistance – by maintaining moderate viscosity
- High passing ability – by decreased shear stress in the matrix and maintaining moderate viscosity

Further, concerning mix design of SCC that fulfils the above requirements the following mix ingredients are needed:

- Low yield value – by addition of superplasticiser (SP)
- Retention of the kinetic energy – by addition of SP
- Maintenance of moderate viscosity – by increasing the content of fine particles, i.e. adding filler, e.g limestone. Alternatively, a viscosity-modifying agent (VMA) can be added.
- High passing ability – by limiting the coarse aggregate content the shear stress of the matrix can be decreased and a moderate viscosity maintained.

For estimation of the above properties, the following test methods are recommended according to the European Guidelines of self-compacting concrete (ERMCO et. al, 2005):

- Deformability – Slump flow
- Flow ability – Slump flow and T500
- Segregation resistance – Sieve segregation test
- Passing ability – L-box

## **3.2.2 Properties of fresh SCC – effects on production**

### **3.2.2.1 General**

In comparison with conventional concrete, SCC is normally more sensitive to variations in constituent materials with respect to quantity as well as quality. Not only the ready-mix production in concrete plants needs increased control, also the transportation as well as the casting process on site is less tolerant to variations in the fresh concrete than conventional concrete. To achieve SCC with satisfying properties of the hardened concrete, not only material composition has to be optimised, the whole process requires proper management, skills and training.

### **3.2.2.2 Mixing**

It is important that the equipment, constituent materials as well as the process for production of ready-mix SCC in concrete plants are accurately controlled. Quality control systems, e.g. ISO 9001 are recommended and in some countries required. However, if any conditions are changed, there may be large differences between performance of the initially developed and optimised recipe versus the later on daily produced SCC. For instance, uncontrolled increase of the total water content of the mix may lead to problems such as increased flow and concrete segregation on site. Therefore, not only well-controlled scale weighing machines on concrete plants play an important role but also measurement system for moisture content in aggregate plays an important role. There may be significant performance variations if additives are changed or replaced by new ones. Further, the type of mixer and mixing order affect the SCC properties. Accordingly, testing of the fresh SCC on the concrete plant of as many batches as possible is important. After testing, addition of more superplasticiser may be needed to achieve proper self-compacting properties. Consequently, a renewed testing may then be required before the transport.

### **3.2.2.3 Transport**

Truck transport of SCC needs to be properly executed in order to maintain the required fresh properties on the site. The time factor is of large importance. Direct negative consequences, e.g. consistency loss and segregation may occur if the SCC-delivery is delayed. In addition, extended waiting time between the deliveries may result in thixotropic thickening behaviour of the already cast concrete, which may result into inhomogeneous structure due to 'layer tendency' between separate deliveries.

Accordingly, the production capacity on plant and transport time must be balanced to the casting capacity and time schedule on the building site. Also the instructions to the concrete truck drivers must be clear regarding rotator speed, addition of superplasticiser on site etc. When delivered to the site, the fresh concrete in general has to be tested once more regarding its self-compacting ability. Normally, this test is performed before pumping, but in some cases also testing after pumping is conducted.

### **3.2.2.4 Placing and finishing**

The casting process of SCC differs from traditional casting of normal concrete, where the vibration work is an essential part. SCC casting without vibration leads to several presumptive opportunities e.g. more rapid, less noisy and less complicated casting process. However, there are also difficulties connected to the fresh properties of SCC, which must be considered. As for instance, attention must be paid to the risk of segregation, entrapped air and form leakage. In practice this means that regular observations have to be conducted. For example, the segregation tendency can be indicated by checking that coarse aggregate remain near the upper concrete surface. Depending on the type of structure, the placing and finishing methods have to be optimised and proper planned if the potential of SCC is going to be fully exploited. For instance, proper skip floating technique is often required in order to achieve smooth and level concrete surfaces by effectively utilising the self-levelling effect of SCC. Another example concerns the opportunity to achieve more rapid casting. This requires on-time delivery of concrete as well as continuous placing technique without interruptions. The latter

is exemplified by the practical difference between use of pump and use of skip, where skip may be more time demanding due to the fact that unwanted waiting between the skips is necessary.

Typical presumptive technical problems connected to SCC such as increased risk of cracking due high rate of plastic shrinkage mean that preventive cautions have to be correctly conducted, e.g. early water curing, membrane curing and/or covering. Also setting cracks parallel to reinforcement may occur as a result of SCC that has more or less segregated due to as for instance low amount of fines.

It is important to train personnel on site for increased skills and relevant competence of SCC. Spreading of knowledge concerning practical differences between SCC and traditional concrete is important. Increased co-operation between contractor and concrete supplier may be necessary also for this reason.

### **3.2.2.5 Formwork pressure, formwork design and thixotropy**

There are several factors influencing the formwork lateral pressure, e.g. height and rate of placement, placing method, rheological properties of fresh concrete, shape and size of aggregate, setting time, type and amount of admixtures as well as formwork design. In normal concrete there is a 'silo effect' meaning that there is a certain depth, below which the lateral formwork pressure remains constant. SCC is generally expected to act as a pure fluid, which means that full hydrostatic pressure from the top to the bottom of the formwork is assumed. Hydrostatic pressure is expressed as:  $P_{max} = \rho gH$ , where  $\rho$ ,  $g$ , and  $H$  correspond to the concrete unit weight, coefficient of gravity, and concrete height in the formwork, respectively. See Figure 3.9 where examples of the lateral pressure of SCC are presented. Pumping of concrete from the bottom of the formwork may lead to high levels of pressure, also above hydrostatic. There are field investigations showing that SCC means decreased formwork pressure. The explanation may be related to a potential reduction of the hydraulic head due to the friction between the rising concrete during placing and the surface of the formwork, the 'silo effect' (Assaad et. al, 2003). Another explanation is coupled to the thixotropic behaviour of SCC, i.e. the ability of SCC to recover its original viscosity and cohesiveness soon after placement and thereby also decreasing the lateral pressure. The type of SCC may influence the thixotropic behaviour, e.g. SCC with high powder content and high original viscosity leads in general to higher thixotropy and therefore presumptively to lower formwork pressure. According to Billberg (2006), SCC for house building (with w/c ratio of 0.58) cannot be regarded as sufficiently thixotropic as to reduce the formwork pressure below hydrostatic.

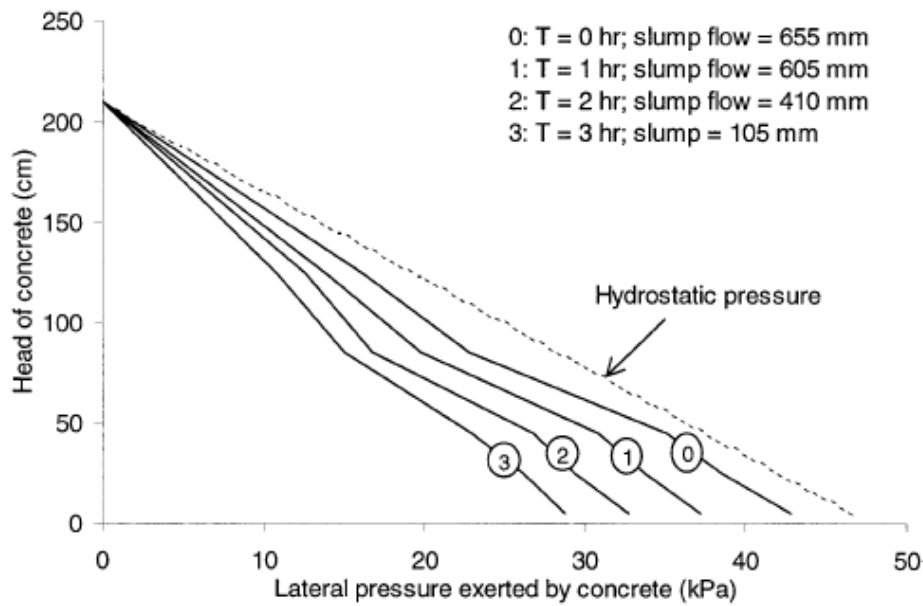

Figure 3.9 Examples from Assaad et. al (2003) regarding lateral pressure measured on SCC incorporating silica fume (4% of binder), fly ash (22% of binder) and accelerator (1000 ml/100 kg of CM) with various slump flow reached after different times after mixing.

Increase of the lateral pressure above the maximum allowed, means risk of formwork failure, which must of course to be avoided. Increased lateral pressure therefore affects the design of formwork, which increases the cost for formwork. Another negative effect is that the potential of SCC for more rapid casting may be strongly limited due to the requirements for limited rate of rise of concrete in the formwork. The effect of SCC on formwork pressure is still not very well clarified. Therefore, more research has to be performed.



## **3.3 Materials characteristics of hardened SCC – relevant properties for structural frames**

### **3.3.1 Introduction**

In comparison with NC, the hardened properties of SCC, especially if limestone filler is included, may differ despite the same w/c ratio in the two types of concrete. Examples are improved microstructure with less micro-defects, increased strength and higher risk of early plastic shrinkage. Although the differences, compared with NC, are small with respect to practical consequences within production, special attention has to be paid in order to utilise SCC fully and/or to avoid presumptive technical problems.

### **3.3.2 Compressive strength**

#### **3.3.2.1 Introduction**

Of all concrete properties, the compressive strength is the most tested. Requirements regarding strength class are normally set for each structure. World wide, there are standardised routines for compressive strength testing both on cubes and cylinders. Concerning cubes, fresh concrete is poured into special cube moulds directly after the production process on the ready-mix concrete plant and/or after the transportation to the building site. After a fixed time, normally 28 days, the specimens are tested. The result of the compressive strength testing forms a basis for various concrete quality classes, e.g. C25/30, where the first number (25) correlates to minimum cylinder strength (28 days) and the second number (30) to minimum cube strength (28 days) required for the quality class. In official norms and standards there are stipulated empirical relations between compressive and tensile strength and between compressive strength and E-modulus. Consequently, according to these norms and standards the compressive strength class indirectly also indicates the tensile strength and elastic modulus. Therefore, these properties are usually not determined experimentally. A method for judging the concrete strength in cast structure is to estimate the maturity age. Then the temperature development during the concrete hydration is measured whereupon the strength development can be estimated. Incentives to measuring the strength development are for example to control and/or optimise the strength development with regard to formwork-stripping time.

#### **3.3.2.2 Comparison between SCC and NC**

Usually, SCC leads to somewhat increased compressive strength compared to NC when the same water/cement ratio is used. This effect may be related to improved quality of the interface between aggregate and paste. Furthermore, for SCC with added powder, e.g. limestone filler, the strength normally is significantly higher compared with SCC with less or no powder content. This strength-gain effect is generally named the ‘filler effect’. Concerning estimation of the strength on site, measurement of maturity is a useful method also for SCC with limestone filler, provided the activation energy of the mix is known together with the strength-maturity curve of the actual mix. One can expect that these properties differ from those of NC with the same strength class. Due to the ‘filler effect’, it is possible to produce

SCC of the same strength as normal concrete using less amount of cement. However, the use of VMA instead of filler may decrease the strength of SCC to 25% due to the increased entrapped air (2-3% more air) depending on the sort of VMA (i.e. welan gum or methylcellulose based) according to Bonen and Shah (2005).

### 3.3.2.3 The ‘filler effect’

Mechanisms that might explain the ‘filler effect’ are:

- LS filler improves the particle packing

According to Bosiljkov (2003), limestone filler leads not only to increased stability of the fresh SCC but also to increased density of the paste matrix and improved interfacial transition zone (ITZ) in the hardened concrete. Increased fineness of the lime stone filler further improves the packing and thereby the cement paste density increases.

In Bonen and Shah (2005), the relation between porosity and compressive strength is discussed in terms of the ‘binder-space ratio’ (defined as the binder volume including filler over the volume of the binder). They mean that this ratio is more suitable for SCC than the Powers’ and Brownyard’s gel-space ratio in which only cement is included in the definition of solid binding phase. Using this approach the strength can be calculated.

- LS filler act as nucleation sites that improve the micro-structure of cement paste reducing the size of micro-defects.

Bosiljkov (2003) and Isaia et. al (2003) describe the ‘filler effect’ mechanism as that the limestone filler grains act as nucleation sites for CH and C-S-H reaction and thereby also accelerate the hydration of clinker minerals, especially  $C_3S$ , which results in improved early strength.

- LS filler is reactive producing more hydration products

Rahhal and Talero (2005) mean that crystalline non-hydraulic fillers increase the hydration degree through not only acting as nucleation sites of the CH crystals, but also through reacting with the aluminate phase of cement. This was also suggested by Bosiljkov (2003).

### 3.3.3 Tensile strength

According to European guidelines for SCC (ERMCO et. al, 2005), the volume of paste (cement+finer+water) has no significant effect on the concrete tensile strength. Further, ERMCO et. al (2005) assumes that the tensile strength of SCC may be safely assumed to be the same as the one for normal concrete for a given strength class and maturity. This means that there is a ‘filler effect’ also for tensile strength so that the tensile strength of SCC

including limestone filler may be significantly higher compared to normal concrete without limestone filler and the same water/cement ratio. As for instance, Zhu and Gibbs (2005) have estimated the 'filler effect' on both the compressive and tensile strength and reports significant strength gains. Compared to the 'filler effect' on the compressive strength though, the fineness and type of limestone seem to have less impact on the tensile strength. However, regard should be taken to the presumptive increase of the tensile strength either if the effect is negative, e.g. increased requirements for reinforcement to control the crack width, or if the tensile strength gain effect is positive, e.g. increased potential for reduced deflections in slabs due to increased stiffness. Therefore it is recommended that the real tensile strength is measured for each mix.

### **3.3.4 Modulus of elasticity**

The elastic modulus (E-modulus) of concrete is to larger extent influenced by the volume of aggregate and by the aggregate properties than by the paste properties. In comparison with normal concrete the aggregate content of SCC is smaller and the paste content of SCC is larger. Therefore the elastic modulus of SCC is expected to be somewhat lower than in normal concrete of the same strength class, which also is presented in several reports. However, the differences are small and covered by the safe assumptions included in the formulas within the norms. In cases where the E-modulus is of special importance, its real value ought to be determined.

### **3.3.5 Creep**

The basic creep ought to be somewhat bigger in SCC containing limestone filler compared to NC. The reason is the somewhat reduced amount of coarse aggregate in SCC (including filler). The effect can however be expected to be small.

The drying creep depends mainly on the climate conditions. Since these are the same for concrete used in the same condition, the difference in creep between SCC and NC of the same strength class ought to be about the same as for basic creep.

Creep of SCC has been studied experimentally but the result varies quite much. More research is needed.

### **3.3.6 Shrinkage**

There are three types of shrinkage in cementitious porous materials, i.e. plastic shrinkage (early drying shrinkage), autogenous shrinkage and drying shrinkage. The mechanism and effect of each type can be explained briefly as follows:

- Plastic shrinkage (early drying shrinkage)

During the early drying after casting (i.e. within approximately 12 hours) shrinkage stresses may occur especially in the surface layer where the drying due to evaporation is most rapid. If the loss of water due to drying outwards exceeds the bleeding, a negative capillary pore water pressure caused by the curved menisci between particles develops. This capillary pressure causes plastic shrinkage that may lead to 'wild'

cracking initiated at the surface of the structure. The cracks may be continuous through the section. The risk of plastic-shrinkage cracking increases with reduced bleeding. Therefore, SCC containing big amount of LS filler is more sensitive than NC.

Early surrounding air conditions (e.g. temperature, relative humidity, wind, sunlight and air exchange) affect the extent of plastic shrinkage cracking. Main methods used for prevention against plastic cracking are for instance covering, water curing and membrane curing. There are also 'direct' mix related factors that may lead to an increased plastic shrinkage, e.g. increased content of fines.

- Autogenous shrinkage

Due to the fact that the volume of hydration products is smaller than that of unhydrated cement and water before hydration, a certain internal drying of the concrete takes place as a result of hydration. This drying causes a reduction in the relative humidity (RH) in the concrete. Therefore tensile stresses develop that may lead to shrinkage despite the concrete is unable to dry outwards. This shrinkage is called 'autogenous'. Autogenous shrinkage is as largest during the early phase and may result in cracking evenly through the section. Low w/c ratio, addition of silica fume and large extent of fines are factors that increase the risk of autogenous cracking. The reason is that these factors make the pore-structure finer, causing a certain drying and a larger reduction in RH.

- Drying shrinkage

When moisture gradually dries out from the structure, shrinkage stresses will occur due to negative pore water pressure caused by drying. Due to that the drying is larger in the surface part of the structure, thin structures might curve. One example is non-adhesive overlays cast on top of concrete. If free shrinkage is not possible due to constraint such as bond between reinforced slabs cast on elements, cracking may occur perpendicular to the constraint. In general, 'cracking reinforcement' is used to limit the crack size.

There are several factors influencing shrinkage, e.g. paste content versus aggregate content, pore structure of cement paste and elastic modulus of aggregate. Especially with concern to early plastic shrinkage, surrounding conditions have large importance, e.g. weather and curing conditions.

Due to the fact that SCC in general contains less aggregate and more paste than NC, the shrinkage therefore may be higher in SCC than in comparable NC. If the w/c ratio is decreased though, the drying shrinkage will often decrease while the autogenous and plastic shrinkage will increase, of which the latter depends on decreased bleeding. Results according to Persson (2003) show significantly smaller plastic shrinkage cracking in SCC if the w/b ratio is increased and the maximum aggregate size is increased. Löfgren and Esping (2005) recommend SCC with w/c 0.55 or higher in order to limit the autogenous as well as the plastic shrinkage. Furthermore, Löfgren and Esping (2005) mean that w/c lower than 0.55 may lead to increased autogenous shrinkage cracking and that higher w/c may lead to increased plastic shrinkage cracking due to increased grade of evaporation.

SCC containing filler (powder) may lead to larger drying shrinkage compared with the VMA type of SCC due to the decreased amount of coarse aggregate. This effect can also be seen if segregation has occurred leading to increased content of paste in the surface layer of a structure. Substitution of cement for limestone filler has shown a reducing effect on the shrinkage, which might depend on a reduced w/c ratio for the same strength (Bonen and Shah, 2005).

There are chemical additives introduced on the market with the aim of minimising shrinkage cracking, i.e. shrinkage reducing additive (SRA). Through reducing the surface tension of the pore water, the shrinkage stresses can be reduced. Up to 45% reduction of the free drying shrinkage has been reported (e.g. Rongbin and Jian, 2004). Reduced drying shrinkage cracking have also been experienced through usage of SRA (e.g. Petersson, 2007). A negative effect of SRA is that the frost resistance might be severely reduced (Barthelson, 2006).

### 3.3.7 Drying

The drying properties of SCC may differ in comparison with normal concrete due to the presumptive refinement of the pore system in hardened SCC. Especially for SCC including high level of powder content, e.g. limestone filler, the drying properties may be different in comparison to NC (Bosiljkov, 2003).

The reason why drying is important is that a certain drying is required if deterioration of materials placed in contact with the concrete, like organic flooring materials, shall be avoided. Normally RH-levels of the order 80 to 90% are required before such materials can be applied. Besides, drying causes shrinkage.

The drying process depends on two factors:

1. The moisture diffusivity  
This depends on the fineness of the pore system. If filler makes the concrete more fine porous, the drying rate outwards will be reduced, prolonging the drying time.
2. The shape of the sorption isotherm, especially at high RH-levels, 80 – 100% RH

A more horizontal isotherm in this RH-range brings about a lower RH, a larger reduction in RH, for the same loss of water by drying outwards. Furthermore, even if no drying outwards is possible, the drying caused by cement reaction ('autogenous drying') will cause a reduction in RH. The shape of the isotherm depends on the fineness of the pore system; the finer the pore system the more horizontal the isotherm, and the bigger the reduction in RH for a given drying outwards, or a given degree of hydration.

According to the second factor, SCC may lead to the opportunity to reduce the drying time required for reaching a specific relative humidity inside the concrete. Mjörnell (2003) presents results of RH-measurement of various SCC and NC mixes. Sorption isotherms according to Figure 3.10 for various concrete mixes shows significant decrease of RH in relation to reduction of moisture content (i.e. more flattened slope of the sorption isotherm) for SCC with limestone filler. The effect seems larger for SCC incorporating LS filler of type 'KÖ 500' than 'IB 200'. KÖ 500 correlates to 'Limus 40' and 'IB 200' to 'Limus 15', which are

described in '3.2 Materials properties of fresh SCC'. Furthermore, the effect was larger for SCC with higher w/c ratio. Also measurements of the diffusion coefficient of several concrete mixes are presented, which indicate the same tendency, i.e. SCC including LS filler may lead to a more dense structure with finer pore system than normal concrete. This also explains the more horizontal isotherm at high RH-levels since a finer pore corresponds to a lower RH-level.

#### Moisture ratio (%)

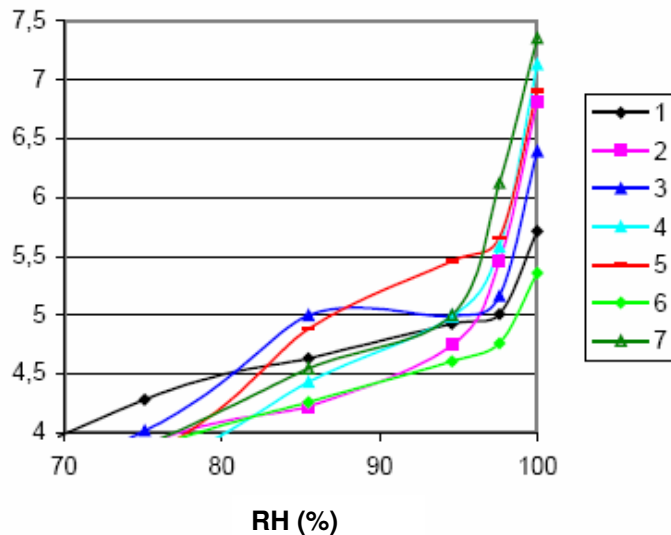

- |  |   |
|--|---|
| 1 SCC w/c 0.38, LS filler 'KÖ 500' 150 kg/m <sup>3</sup> | 2 SCC w/c 0.59, LS filler 'KÖ 500' 75 kg/m <sup>3</sup> |
| 3 SCC w/c 0.59, LS filler 'KÖ 500' 150 kg/m <sup>3</sup> | 4 SCC w/c 0.59, LS filler 'IG 200' 75 kg/m <sup>3</sup> |
| 5 SCC w/c 0.59, LS filler 'IG 200' 150 kg/m <sup>3</sup> | 6 NC w/c 0.38   |
| 7 NC w/c 0.6   |   |

Figure 3.10 Sorption isotherms for NC versus SCC incorporating various w/c ratios, filler contents and filler types (Mjörnell, 2003).

### 3.3.8 Bond to reinforcement

In comparison to normal concrete, SCC seems to lead to increased bond to reinforcement bars (REF). The most common reasons to poor bond when normal concrete is used are insufficient vibration, concrete segregation and/or bleeding, which lead to decreased quality of the hardened concrete especially below the top reinforcement bars. A potential but not clarified problem concerns settlement before SCC hardens, which might cause weak bond to the lower part of top reinforcement. According to Soylev and Francois (2003), however, the presumptive risk is reduced when using SCC.

### 3.3.9 Durability

The durability of SCC is probably about the same as for normal concrete provided the same w/c ratio and cement type are used. Some potential problems have however been pointed out:

1. Concrete containing limestone filler might be attacked by sulphate in soil or water. The attack consists of formation of thaumasite, which might cause complete destruction of the concrete (Trädgårdh, 2002). The phenomenon has also been studied in Sweden, see Persson (2003).
2. The effective diffusivity of chloride ions might be increased in SCC with limestone filler compared with normal concrete with the same w/c ratio (Persson, 2004). The reason is unclear but might depend on a reduced chloride binding capacity in SCC containing limestone filler.
3. If self-compaction is not perfect it might be that the reinforcement bars are not completely covered by cement paste. The same will be the case if the concrete settles due to early hydration while the reinforcement cage is “locked” and unable to follow the sinking concrete. If this happens, the resistance to reinforcement corrosion will be impaired.
4. The more fluid concrete and the high dosage of superplasticiser might cause an unstable air-pore system, which will reduce the frost resistance of the concrete.

No doubt, much more research must be made on the durability of different types of SCC before it can be safely used in exposed structures.

## **3.4 Potential of SCC for improved work environment**

### **3.4.1 Introduction**

The building process based on traditional in-situ cast concrete is criticised for work-environmental disadvantages caused by the required vibration work. Statistics exemplifies that handling with concrete vibrators may lead to work-related injuries on concrete workers, e.g. so called ‘white-fingers-syndrome’. Besides, vibration work might cause harmful ergonomics (i.e. heavy work) and/or noise related hearing impairment. Another aspect is the decreased safety with respect to uneasy verbal communication on site due to the high noise levels of concrete vibrators. However, use of SCC may be a solution to these problems.

When it comes to stipulations of maximum allowed vibration per time unit, the earlier Swedish recommendations with respect to vibration are replaced by a new directive of the European Union, i.e. the ‘Directive 2002/44/EC’ (see EUHVD, 2002). This directive clearly defines allowed vibration levels and further set requirements for precaution and/or health surveillance plan if these values are exceeded. Whether the directive will affect the implementation of SCC is still unclear.

### **3.4.2 Disadvantages of normal concrete – risk of vibration related injuries**

#### **3.4.2.1 Hand-arm-vibration-syndrome (HAVS)**

Long-time use of hand-held concrete vibrators may cause the type of injuries called ‘HAVS’ that means Hand-Arm-Vibration-Syndrome. According to the ‘Human Vibration Directive’ of EU (EUHVD, 2002) ‘Hand Arm Vibration’ is defined as ”The mechanical vibration that, when transmitted to the human hand-arm system, entails risks to the health and safety of workers, in particular vascular, bone or joint, neurological, or muscular disorders”.

Large focus has been set on HAVS and several major reports have been published, e.g. (BOMEL, 2003) and Hägg (2001). Internationally, very little has been written about SCC as a possibility to reduce HAVS. However, there are some examples, e.g. (BOMEL, 2003) and McMillan and Scott (2002).

A large percentage of concrete workers are pre-retired due to this reason. Table 3.3 shows the total number of HAVS cases reported in Sweden during 2004 according to AV (2005). As seen, concrete workers are placed as number three.



Table 3.3 Reported HAVS cases in Sweden during 2004 according to AV (2005).

Type of profession	Type of HAVS-related injury			
	Circulation org.	Nerve system	Muscles	Summary
Car fitter	4	12	34	50
Joiner	7	10	29	46
Concrete worker	4	5	19	28
Mechanician	12	7	8	27
Machine driver	2	5	16	23
Vehicle driver	2	3	15	20
Plater	4	5	10	19

### 3.4.2.2 Vibration levels

Vibration levels of concrete vibrators differ between various types and sizes. Old vibrators used also for plastic and stiff mixes normally give higher levels than new, which are designed for more flowing concrete. Furthermore, handles of pistol type on the vibrators reduce the vibration impact strongly. Vibrators used in house building are in general smaller than vibrators used for compaction of civil engineering concrete structures. According to one survey (Burström, 2000), measured vibration levels for 10 different types of vibrators are as showed in Table 3.4. However, significantly higher vibration levels have been estimated, which may be based on that the distance to the vibration poker has a significant impact on the measured vibration level (Nielsen, 2006).

Table 3.4 Measured vibration levels of various concrete vibrators according to Burström (2000).

Vibration level	Level
Mean value	1.1 m/s <sup>2</sup>
Standard deviation	0.6 m/s <sup>2</sup>
Minimum value	0.5 m/s <sup>2</sup>
Maximum value	2.0 m/s <sup>2</sup>

### 3.4.2.3 New and old stipulations regarding allowed vibration levels

The earlier recommended vibration levels in Sweden, according to (AFS, 1986), where divided into three risk classes, where each class included maximum allowed exposure time with respect to vibration level (see Table 3.5). As for instance, a concrete vibrator that gives a vibration level of maximum 3 m/s<sup>2</sup> was classified into the highest class and led to no risk of HAVS if the maximum exposure time was less than 4 hours.

Table 3.5 Old Swedish vibration recommendations according to AFS (1986).

Vibration class	Vibration level (m/s <sup>2</sup> )	Risk	Max allowed exp. time (h)
Class I	< 3	none	4
Class II	3-10	some	4- 0.4
Class III	> 10	large	< 0.4

The new vibration directive of EU (EUHVD, 2002) was introduced in Sweden in June 2005 and differs from the old Swedish stipulations with respect to several aspects. According to Figure 3.11, two limits are used, i.e. 2.5 m/s<sup>2</sup> and 5.0 m/s<sup>2</sup>, which are both standardised to an 8-hour reference exposure time. Vibration measurements on concrete vibrators shall be conducted in accordance to the procedures specified in ISO (2001). The region between the top and bottom curve is referred to as the caution zone. If the vibration action limit is reached, special precautions have to be introduced by the employer, i.e. to institute a program to reduce the vibration exposure. The vibration exposure limit value is not allowed to exceed. If exceeded though, a special health surveillance program shall be implemented.

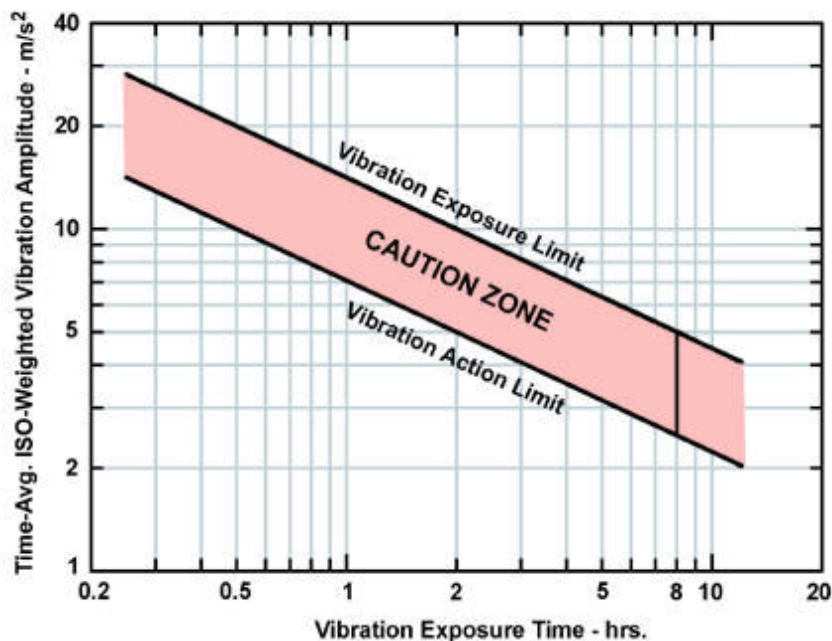

Figure 3.11 Allowed vibration levels in relation to vibration exposure time according to the Human Vibration Directive of European Union (ErgoAir, 2002).

Furthermore, always when workers are exposed to vibration work, even if the levels are limited, the EU Human Vibration Directive requires measuring of vibration and estimation of the risk for vibration-work related disorders.

Another aspect is that according to the new directive, working methods and equipment that are advantageous from a work-environmental perspective should be used in the first case if they are available for utilisation. This may lead to natural arguments for SCC despite that vibration equipment used has vibration levels below the allowed according to Figure 3.11.

In general, the major part of concrete vibrators used today within concrete work has vibration levels that are allowed according to the directive. On the other hand, when workers are

exposed to hand-arm vibration, the directive requires the employer to determine the risk for vibration-work related disorders. Consequently, there will be discussions whether there are risks for HAVS even if the vibration levels according to the vibration equipment supplier are below the allowed.

### **3.4.3 Disadvantages of normal concrete – risk of injuries related to ergonomics**

Another work-environmental disadvantage of normal concrete is that somewhat injurious working methods occasionally are required. Examples according to AFS (1998) are heavy lifts and forced operating positions. Within the construction sector, concrete workers are the most sick-reported category of all professionals with regard to ergonomics according to statistics from (AV, 2006). SCC in combination with pumping creates opportunities for work methods including improved ergonomics. The role of the concrete worker will then mainly be to control the casting process.

### **3.4.4 Disadvantages of normal concrete – risk of injuries related to noise**

#### **3.4.4.1 Noise – hearing impairment**

The noise level of concrete vibration on site, using conventional concrete vibrators, is between 85 and 93 dB(A). An equivalent noise level of 85 dB(A) or higher may lead to hearing impairment according to (AFS, 1992). By eliminating concrete vibrators, the noise level on the building site may be significantly decreased. According to (Nygren and Waller, 2002), the noise level potentially decreases with 10 dB(A) when normal concrete is replaced by SCC.

#### **3.4.4.2 Noise – safety on site**

Noise level is not only a question of reducing the risks for hearing impairment, but is also a potential for reducing the general safety risk. Lower noise level creates possibilities for easier communication on site during concrete casting. Perhaps the work environment will therefore be considered as more comfortable. Besides, people living or working close to the building site might probably appreciate quieter building sites.

### **3.4.5 Discussion**

#### **3.4.5.1 Costs of vibration-work related disorders**

The costs for vibration-work related disorders of concrete workers can be divided into several groups of sources, as for instance:

- Sick leaves and rehabilitation

- Investigations of vibration including measurements (according to the EU Human Vibration Directive, see EUHVD, 2002)
- Vibration reduction programs (according EUHVD, 2002)
- Health surveillance programs including rehabilitation plan (according to EUHVD, 2002)

The methods of financing the costs differ in relation to the type of costs and organisation. As for instance, there is a trend in Sweden (especially concerning large companies) to finance costs for sick leave within each house-building project. However, after 14 days, the costs of sick leave as well as long-time rehabilitation are paid for by the society ('The Swedish Social Insurance Agency').

There might be an incentive to each house-building project to use SCC and thereby to reduce presumptive costs for sick leave etc. However, due to the fact that HAVS in general is a result of the total history of vibration exposure for each concrete worker and that the total reason for sick leave may consist of several sub reasons not connected to the vibration work, there are seldom any obvious argument for increasing the materials costs through SCC and in the end make cost savings through less costs for work-related disorders.

Maybe the most 'natural' way to see use of SCC as a possibility to decrease costs for work-related disorders is if organisations high-lightens SCC from a more central point of view. Thereby, SCC can be utilised in a more long-term perspective as well as increase the work-environmental image of the organisation.

A third presumptive 'investor' for SCC use with the primary aim to decrease the costs for work environmental disorders is the state and/or the house-building/construction sector. The incentives as well as obstacles are however to large extent the same as for each organisation/contractor.

### **3.4.5.2 Work environmental incentives to SCC versus other incentives to SCC**

Despite that use of SCC potentially improves the work environment, i.e. eliminates the risk of HAVS, reducing the risk of hearing impairment and improves the ergonomics on site, it is uncertain if ordinary concrete will be replaced by SCC to larger extent only addressing the potential for improved work environment. Probably, more direct economical benefits, e.g. increased productivity and less materials/labour costs for finishing, are needed to balance the increased direct materials costs of SCC. If not a long-time perspective is adopted, the work environmental benefits of SCC probably are seen more as secondary synergy effects. Probably this perspective can be changed if the incentives are high lightened by central parts of organisations and/or the state/community. Maybe the labour unions can be an effective actor leading to more widespread use of SCC.

## 3.5 Potential of SCC for competitive production of structural frames

### 3.5.1 Potential benefits and incentives regarding SCC

Mizobuchi et. al. (1999) have described SCC as one of the most innovative developments in the field of concrete technology. Byfors (1999) discusses the use of SCC in the context of industrialisation of cast in-situ concrete. With SCC that eliminates vibration work there are various kinds of new opportunities for improving the function of the structural frame as well as the building process.

#### *Improved work environment*

There are many advantages in using SCC, not least the improved work environment. Injuries related to ‘hand-arm-vibration-syndrome’ (HAVS), i.e. ‘white fingers’ on concrete workers, will be more or less totally eliminated in the future. The proportion of heavy work is reduced and job sites can be significantly quieter since concrete vibrators are not needed. This is an advantage both for safety on site and for the neighbourhood.

#### *Cost-efficient production*

The elimination of vibration work accelerates the production process and improves quality of concrete structures, all of which generate cost savings (Grauers, 1999). The elimination of vibration means rationalised casting technique with less need of personnel and/or more rapid production cycles and thereby presumptively reduced production costs. Smooth and level high-quality surfaces can be produced directly, without neither finishing work nor added materials costs for self-levelling flooring compounds (e.g. screed), which often is needed when concrete is cast traditionally. In addition, there is some research indicating a more rapid drying of SCC compared with normal concrete with the same w/c ratio (Norling-Mjörnell, 2003). These results could however not be confirmed in a recent study (Barthelsson, 2006).

#### *New opportunities with respect to structural design*

There are also opportunities for structural designers. For instance, densely reinforced structures, which are difficult or even impossible to construct using traditional methods, can be cast with SCC. One example is the design of the Millennium Tower in Vienna, which is described by Pichler (1999) as it had been impossible to build without SCC.

#### *Summarised benefits*

Consequently, the three main beneficial areas of SCC within house building can be summarised as follows:

- Improved work environment
- Cost-efficient production (also from the perspective of total production cost)
- Fulfilling of special structural design related requirements, e.g. proper filling of densely reinforced and complicated formwork

### 3.5.2 Potential disadvantages and obstacles for the implementation of SCC

Despite the potential advantages of SCC compared to normal concrete, the implementation is still strongly limited. The obstacles for increased implementation of SCC are both technical and non-technical. In comparison with ordinary concrete, SCC requires extended control of both the mix design and the concrete casting conditions. Small differences in mix proportions or in in-situ conditions may result in a number of technical quality problems that may act as obstacles for further use of SCC. Despite the intense research on SCC and development of SCC, there are still unsolved technical problems and a wide range of *technical* difficulties connected to SCC, which can be generally described as follows:

- Problems related to the ready-mix production process of SCC (e.g. more extensive control of mix ingredients)
- On-site problems related to the fresh SCC (e.g. increased formwork pressure and thixotropical effects causing reduced flow)
- Problems related to the hardened SCC (e.g. low surface quality, reduced fire resistance due to spalling, increased cracking due to early shrinkage and increased drying shrinkage)

Non-technical obstacles for SCC implementation concern both economical and non-economical issues, e.g:

- Economical obstacles (e.g. focus on added direct materials costs for SCC in relation to direct potential cost-savings, instead of total economy perspective)
- Non-economical obstacles (e.g. lack of knowledge on SCC and unclear responsibility of the ready-mix producer versus the contractor)

## 3.6 Research, development and utilisation of SCC

### 3.6.1 International R&D and utilisation of SCC

Research into SCC started in Japan in the 1980s. The intention was to manage durability problems caused by insufficient compacting of concrete (Okamura & Ouchi, 1999). The first prototype mixes became available in 1988 making concrete casting possible without vibration. This material was, in fact, named high performance concrete (HPC). Since in Japan, the definition HPC includes self-compacting concrete. Over the past few years, SCC has been introduced progressively around the world but the amount of delivered volumes of SCC is still only a fraction of the total concrete production. In 1997, SCC amounted to a mere 0.1% of the total production of ready-mix concrete in Japan (Ouchi, 1999). Production statistics concerning European SCC volumes according to European Ready Mix Concrete Organisation, 'ERMCO' (ERMCO, 2006) show that few European countries exceeded levels of 2% during the year of 2005. One exception is Denmark that showed the highest SCC production level in Europe during 2005, i.e. 25%, which partly can be explained by a positive effect of a major Danish R&D programme 'The SCC Consortium', which has the goal of increasing the use of ready-mix SCC to at least 50% in 2008 (Danish SCC Consortium, 2004). Sweden and Poland had the second highest level, i.e. 5%. In UK, the SCC volume of 2005 increased from nearly 0% (2004) to 2%. For the rest of the ready-mix concrete sector in Europe, the volume was significantly lower than 2%. For the precast industry the volumes according to (Danish SCC Consortium, 2004) are significantly larger, e.g. 60% in the Netherlands, 50% in Sweden and 30% in Denmark.

The obstacles as well as the incentives to increased implementation of ready-mix SCC vary between countries. The obstacles are often production-economy related, e.g. added direct materials costs, but may alternatively be technically related, e.g. increased risks of concrete segregation and insufficient compaction. In some countries, the access to concrete plants that deliver SCC is restricted. Another type of barrier for SCC use considers the construction codes. In some countries SCC is nearly impossible to use due to that SCC is not included in the national codes.

The mix design has an effect on the economical and technical properties of the delivered SCC. The mix design furthermore differs from country to country. For instance, the use of limestone filler is still restricted in some countries in comparison to Sweden where the majority of delivered SCC contains this type of filler.

Furthermore, the incentives to SCC utilisation differ, e.g. improved production economy and ability to realise casting of advanced structural design. The benefit to improve the work environment is often seen as a secondary synergy effect. In addition, the pricing of SCC differs, which affect the possibilities to change SCC to be a standard product instead of being a 'special product'. However, the time for SCC experience after the introduction varies between countries as well, which further affect the experience of SCC use until today.

SCC research is performed intensely worldwide. One major European research project, was the Brite EuRam project 'SCC' (Brite Euram SCC, 2000) that included research areas as for instance:

- Mix design
- Transport
- Casting on site
- Test methods
- Hardened properties of SCC

Several RILEM symposiums on SCC have been held since 2001. These covered a wide range of research from a large number of countries. See for instance (RILEM SCC, 2003). Furthermore, the major topics included in the ACBM-conference on SCC in 2005 (ACBM, 2005) are summarised below:

- Mix design
- Chemical admixtures
- Powder materials
- Aggregates
- Fibres
- Structural performance
- Fresh state properties
- Test methods

As seen, these topics are oriented towards concrete technology. In addition, there were also result presented that included other issues, e.g:

- Case studies
- Applications
- Economics

Within the latter three topics, the majority of the studies concerned precast applications or special applications of cast in-situ concrete within the civil-engineering sector, e.g. bridges, tunnels and pavements. This strengthens the general tendency that SCC research is still fairly low when it comes to the house-building process and house-building applications. To some extent there are examples though of SCC research within house building, but in the most cases this research concerns high-rise buildings or densely reinforced and advanced building structures.

Another aspect is that SCC research, focusing on work environmental issues is lacking. Often, potential work environmental benefits are mentioned generally when describing SCC but seldom analysed in detail. Furthermore, economical issues are seldom included within the discussion of work environment.

However, as the application areas increase and new incentives to SCC are discovered and experienced, research in these issues might increase as well.



There are still no unique product standards incorporating SCC. There is, however, on-going work with modifying the European standard for concrete, EN 206-1, with respect to as for instance test methods for SCC. Until a new version of the standard is published, it is in many European countries allowed to use SCC as conventional concrete using the standards today. In Europe, recommendations and guidelines for SCC have been published (ERMCO et. al, 2005). The covered topics are:

- Engineering properties
- Specifying SCC for ready-mix and site mixed concrete
- Constituent materials
- Mix composition
- Production for ready-mixed and site mixed concrete
- Site requirements and preparation
- Placing and finishing on site
- Precast concrete products
- Appearance and surface finish

As seen, both ready-mix and precast concrete are included.

One of the most important aims of the European guidelines is probably the proposal for specifying SCC in the fresh state, i.e. its rheological properties estimated using specially developed test methods, e.g. slump flow, T 500 and L-box. Consequently, the specifying guidelines probably make the standardisation work more rapid.

### **3.6.2 Swedish R&D and utilisation of SCC**

No major Swedish national research programme like that performed on HPC (see Elfgren et. al, 1996) has been conducted on SCC. However, Swedish research on SCC has been carried out since the middle of the 1990s. The first full-scale project including SCC consisted of a road bridge that was carried out by the Swedish National Road Administration in 1998. Incentives to utilising SCC within this project consisted mainly of potentially improved strength, assumed increased service life, better aesthetic quality and higher cost-efficiency (Skarendahl, 2001). The project was successful and resulted in a number of projects where SCC was used with the aim of eliminating vibration work since this was seen as personnel demanding and leading to disadvantages in work environment. To balance for the increased direct materials costs of SCC, direct benefits of SCC were set into focus, e.g. the opportunity to achieve high-quality concrete surfaces with less finishing-work as result. However, this potential benefit was mainly utilised in vertical structures as for instance walls and columns.

During the last years though, special focus has been set on the ability to achieve proper *horizontal* surfaces of slabs by utilising the self-levelling properties of SCC. By this, the need of special self-levelling flooring compounds (e.g. screeds) is decreased or eliminated and large direct cost-savings may be possible.

During the first five years after the introduction of SCC in Sweden, the delivered amounts increased to a level of 5 to 10% of the total ready-mix production within both the civil engineering and house-building sector. Within the house-building and construction sector many expected a larger increase. Still today the total volume of ready-mix SCC is strongly

limited, especially within the civil-engineering sector. In the house-building sector though, the trend during the last two years seems to be increasing. There are in fact examples of house-building projects where 100% of the delivered concrete has been SCC. In contradiction there are also geographical areas where in principal no house-building projects have included SCC. For the Swedish precast concrete industry the produced volumes of SCC differ between production factories. There are several examples that show high amounts of SCC in comparison with normal concrete, e.g. more than 90% (Skanska Stomsystem, 2006). The explanation to this difference in the volumes of produced SCC between ready-mix and precast is probably that the incentives to SCC within the precast industry are presumptively more obvious, e.g. reduced noise and shorter production cycles. There are also the possibilities for increased material and production control in a factory environment.

Despite that SCC has been regarded as one of the most important technical innovations for a more rational way of building with cast in-situ concrete there are also projects where SCC has led to technical problems, as for instance concrete segregation with non-satisfying surfaces as result, concrete cracking due to plastic shrinkage, and formwork failure due to high form pressure. An extensive development and utilisation of new concrete additives has taken place and on the Swedish market several SCC-concepts are practiced. It is believed that further research on SCC is required to secure a robust and fully satisfying product, especially within the civil-engineering sector where the requirements regarding for instance durability of the structures in general are higher compared to the majority of the structures within house building. In a report on SCC, published by the Swedish Concrete Association (2002), properties, research, recommendations etc, are presented. Required research areas and the organising of a presumptive national SCC research programme are also described by Emborg (2002).



## **4. FIELD TESTS OF STRUCTURAL FRAME PRODUCTION WITH CAST IN-SITU SCC**

### **4.1 Introduction**

#### **4.1.1 Background**

International research into SCC focuses mainly on properties of the material. In general, SCC research is conducted under laboratory conditions with the aim of investigating specific technical properties, e.g. influence of mix design on rheological behaviour of fresh SCC and properties of hardened SCC, as for instance cracking, permeability, shrinkage and strength development. In the same way as for concrete materials research in general, research into SCC focuses to a notable extent on issues that may have an impact on durability, e.g. fire resistance, chloride ingress, thaumasite attack and cracking behaviour. SCC research also includes studies on production related aspects, such as formwork pressure, thixotropic behaviour and evaluation of new additives for improvement of the rheological properties. However, SCC research with a clear focus on practical/technical and economical issues aiming at exploiting the presumptive beneficial potential for increasing the competitiveness of the building process is still lacking. Considering the big potential of SCC, not at least because of the great potential for improving the work environment, future SCC research may probably have a more direct focus on these questions.

The studies presented in this chapter differ from conventional studies of SCC. They are performed in field on real house-building projects and have focus on technical/practical as well as economical issues. Furthermore, appropriate case studies for SCC implementation have been difficult and time-demanding to find. Both advantages and disadvantages of SCC use are observed and analysed from a total point of view. Comparisons are made with experiences from use of normal concrete in other similar projects.

#### **4.1.2 Aim and goals**

The aim and goal of the field studies are to observe and quantify both beneficial and non-beneficial consequences when replacing ordinary concrete by SCC. Furthermore, the field studies aim to verify whether the theoretical potential of SCC can be exploited or not.

#### **4.1.3 Methods**

The majority of the field studies presented in this chapter was carried out on four residential multi-storey house-building projects in Sweden, where ordinary concrete was replaced by SCC. The structural frames of the studied cases, in which SCC was utilised, differed as follows:

- **Case study 1**
  - SCC slabs cast in-situ on precast concrete formwork elements for permanent use, i.e. 'Filigran-elements'
  - SCC walls cast in-situ, using precast shell-mould system of concrete for permanent use
- **Case study 2**
  - SCC slabs cast in-situ on Filigran-elements
- **Case study 3**
  - SCC slabs cast in-situ on prefabricated cement-bonded particle boards (CBPB) for permanent use
  - SCC walls cast in-situ, using prefabricated shell-mould system of CBPB for permanent use
- **Case study 4**
  - SCC slabs cast in-situ on Filigran-elements
  - SCC walls cast in-situ (using conventional dismountable formwork system of steel)

Except the type of structural frame and the type of SCC application, another important aspect that differed between the cases concerned the point of time when the decision took place regarding replacement of normal concrete by SCC. This might have affected the result with respect to the possibilities for exploiting the full potential of SCC.

Several methods were used within the cases in order to estimate positive as well as negative consequences of the use of SCC. To quantify technical properties of SCC, various test methods were conducted. Thereby it was possible to verify whether the theoretical technical potential of SCC could be exploited in reality. Measurements were carried out on both the fresh and hardened concrete. Concerning testing of the fresh SCC, rheological test methods, i.e. slump flow, T500 and L-box were conducted at the ready-mix concrete factory and at the building site as well. The aim of the latter tests was to follow up presumptive effects of transport and placing of the concrete. Properties of hardened concrete, e.g. strength, relative humidity and surface quality (e.g. cracking and level quality) were measured as well.

For estimation of the consequences on work environment and requirement for time and personnel when replacing normal concrete by SCC, observations were performed of the building process regarding ready-mix concrete production, concrete transport and on-site activities such as placing, finishing and curing.

Economical effects of SCC use were estimated and comparisons with normal concrete were made. Direct extra materials costs for SCC were compared with observed economical advantages obtained during production. To some extent, the effect on the service life of the building was analysed as well.

In the summarising analyses, the economically quantifiable consequences of SCC use were divided into direct and indirect effects, of which the direct effects are related to the self-compacting properties of fresh SCC and the indirect consequences address secondary effects of hardened SCC. Furthermore, non-economically quantifiable effects were analysed.

The main methods conducted within the case studies are presented briefly as follows:

- **Rheological measurements of fresh SCC**
  - Slump flow
  - T 500
  - L-box
  
- **Estimations/observations during SCC casting**
  - Rheological properties (flow ability, robustness, segregation tendency etc)
  - Production efficiency (production time demand and manpower need)
  - Work-environmental aspects
  - Other practical issues (formwork leach, skip floating etc)
  
- **Measurements of hardened SCC properties**
  - Compressive strength (cube testing and maturity measurement on site)
  - Relative humidity (RH)
  - Surface level quality
  - Cracking (type, amount and width of cracks)
  - Structure homogeneity (of drilled cylinders)
  - Other practical issues (need of finishing work, curing methods etc)
  
- **Concluding analysis**
  - Grouping of consequences from SCC use
  - Comparison between expected incentives to SCC and results obtained
  - Estimation of production cost increase and reduction (time, manpower, materials etc)
  - Discussion of qualitative aspects (e.g. work environment, safety on site)
  - Characterization of future work

## **4.2 Characteristics of the cases**

### **4.2.1 Case study 1**

#### **4.2.1.1 General**

Case study 1 was conducted on a house-building project located in the outer part of Stockholm during the years 2003 to 2005. The project consists of totally 8 multi-storey residential buildings, 4-6 floors each and 153 apartments. The structural frame consists of concrete cast in-situ in combination with precast concrete formwork system for permanent use both for slabs and walls. The concrete type used in the beginning of the project was, as planned, ordinary concrete that needed traditional vibration. Normal requirements were set on the concrete quality with regard to needed strength and on the w/c ratio with regard to relative humidity before floor covering. After an initiation part of the house-building project, it was decided that SCC should be tested primarily in walls. The main reason for the change was to evaluate whether utilisation of SCC could reduce the experienced difficulties connected to vibration work in narrow parts of the wall formwork. Later on, SCC was tested in slabs as well, and finally, SCC was utilised to nearly 100% of cast in-situ concrete within the project. The results of the studies present a variety of experiences from utilisation of SCC in house-building applications. Both beneficial and non-beneficial consequences of replacing normal concrete by SCC, as well as obstacles for further utilisation of SCC, were analysed and quantified.

#### **4.2.1.2 Technical facts related to production of the structural frame**

The project is described in Table 4.1. The structural frame of this house-building project consists of steel columns (in the facade) in combination with non-removable precast concrete formwork system. Slabs with a thickness of 190 mm were cast in-situ on precast formwork elements for permanent use, Filigran-elements with a thickness of 45 mm. The chosen floor covering system varied between wooden floor (parquet) and ceramic clinker, where the latter was used only in wet rooms. The requirements for maximum allowed level of relative humidity before floor covering (according to 'AMA 98', see Swedish Building Centre, 1998) varied in relation to the floor materials. For wooden floor with a thick PE-foil as moisture barrier against the concrete slab the required level of RH in the concrete slab is 95% (measured on the specific depth according to Swedish Building Centre, 1998) and for ceramic clinker the required value is 90%. These RH requirements in relation to the available drying time led to no special requirements for use of rapid-drying concrete with low w/c-ratio. To achieve plane and high-quality level surfaces before floor covering according to the requirements in 'AMA 98' (Swedish Building Centre, 1998), the use of screed with 10 mm thickness was planned. To be able to achieve proper slopes for drainage gutters in wet rooms the surface height of wet rooms was made lower (30 mm) than in living room and kitchen. Thereby it was possible to use clinker and sloping screed locally in wet rooms. All slabs were cast by pump and finished by skip floating. No curing method was used, neither spraying of water nor membrane curing or covering with PE-foil. Reinforcement bars were placed and fixed to the cast-in reinforcement in the slab formwork system.

Bearing wall structures were cast in-situ using a precast shell-mould concrete system for permanent use. The precast shell-mould wall system included reinforcement when delivered to the building site. Both pump and skip were used as placing methods.

During the initial castings, both slabs and walls were cast using conventional concrete. After the slab casting of each floor, the wall formwork was mounted on the existing floor. Thereafter the slab formwork of next floor was mounted. Before casting of the next slab the walls were cast. After several casting cycles, the planned and therefore used concrete type, i.e. traditional concrete (non-SCC), was replaced by SCC.

*Table 4.1 Technical facts related to the concrete structural frame of Case 1*

**General building facts**

Type of building	Multi-storey residential buildings
Project time period	2003-2005
Number of buildings	8
Number of floors/building	4-6
Total number of flats	153

**Relevant building parts**

Floor structure	Slab (thickness of 190 mm) cast in-situ on precast permanent formwork system (thickness 45 mm) of Filigran type
Bearing walls	Precast shell mould system filled with cast in-situ concrete
Floor covering materials	Screed (thickness of 10 mm) on all concrete slabs Clinker in wet room (RH-requirement 90%), wooden floor on PE-foil in other rooms (RH-requirement 95%)

**Concrete facts**

Placing method	Pump used for slab casting and either skip or pump used for wall casting
Finishing method of floors	Level control by laser measurement + skip floating
Curing method	None
Planned and initially used concrete type	Conventional concrete C25/30 and C32/40
Mainly used concrete type	SCC
SCC mix	w/c-ratio 0.55, cement type CEM II with 13% limestone filler, glass filler in the beginning and the main part of the project, limestone filler at the end of the project) superplasticiser of type polycarboxylate, slump flow 650 mm target value, concrete temperature at delivery approximately 15°C



## 4.2.2 Case study 2

### 4.2.2.1 General

This case study consists of three separate multi-storey residential buildings containing up to 6 floors each. It was built from 2004 to 2005 in the city of Karlstad in Sweden. The total number of flats is 80.

The aim of the second field study was to further estimate the ‘real’ potential of SCC and verify the observations made in the first case study. The main goal was to estimate the effects when SCC replaces ordinary concrete already in the early planning of a house-building project in comparison to ‘Case 2’ where SCC was introduced when the project already had started. Another difference between ‘Case 1’ and ‘Case 2’ is that only slabs were cast in-situ in ‘Case 2’ due to the fact that the walls were precast homogenous concrete elements.

Decision was taken early in the project by both the contractor and the owner that SCC was to be utilised with the aim of improving the work environment as well as generating presumptive cost savings. Therefore, SCC was implemented already when casting the first slab of the project. A satisfying result led to that 100% of the rest of castings were conducted with SCC. Efforts were made continuously to improve the production efficiency of the slab castings. As for instance, special top formwork was utilised in order to facilitate various thickness of the slabs, in wet rooms versus living rooms.

SCC usage within the project led to multiple advantages. A few disadvantages (although less than experienced in Case 1) were however observed, which are included in the total analysis.

### 4.2.2.2 Technical facts related to production of the structural frame

Similar to the house-building project studied within the first case study, the structural frame of the present case study (see Table 4.2 for further description) included formwork of precast concrete elements for permanent use, i.e. Filigran-elements. There were discussions whether plastic carpet or ceramic clinker was to be used in the wet rooms -a question that has considerable importance regarding the ability to place one and the same concrete type for the entire slab. If plastic carpet had been chosen the w/c ratio have had to be reduced in the concrete for the wet rooms in order to meet the requirements regarding maximum allowed RH before floor covering. However, ceramic clinker was chosen and therefore SCC with the same w/c ratio could be used in the entire slab. Upper formwork was utilised locally to solve the problem with differing thickness in wet rooms compared to other parts of the flats, i.e. thickness of 210 mm in general except in the shower area of the wet rooms where the thickness was reduced to 190 mm. In the other parts of the flats the slab floor was carpeted with wooden floor of parquet type on PE-foil. The w/c ratio was 0.50 in all concrete except in the ground floor concrete where the w/c ratio 0.45 was used due to the increased thickness, and in the top floors where 0.45 was also used due to the required shorter drying time before planned floor covering.

All SCC was placed using pump after transportation with truck from the ready-mix concrete plant. To level and smooth the surfaces of the fresh SCC, laser and skip floating was utilised in conventional way. No special precautions were undertaken regarding curing. All surfaces were 'lightly' ground (using floor grinding machine) before floor covering in order to eliminate local defects (tops).

*Table 4.2 Technical facts mainly related to the concrete structural frame of Case 2.*

**General building facts**

Type of building	Multi-storey residential buildings
Project time period	2004-2005
Number of buildings	3
Number of floors per building	6
Total number of flats	80

**Relevant building parts**

Floor structure	Slab cast in-situ 200 mm on precast formwork system for permanent use, Filigran-element (45 mm)
Bearing walls	Precast walls
Floor covering materials	No screed needed on concrete slabs Clinker (plastic carpets planned in the early stage) in wet room (RH-requirements 85%), wooden floor (parquet) + PE-foil in other rooms (RH-requirements 90% set by the owner)

**Concrete facts**

Placing method	Pump
Finishing method	Laser + skip floating
Curing method	None
Planned concrete type	SCC
Mainly used concrete type	SCC
SCC mix	w/c-ratio 0.49 and 0.45, cement type CEM II without limestone filler, additional limestone filler, superplasticiser of polycarboxylate type, slump flow 680-710 mm, concrete temperature at delivery appr. 15 °C

## 4.2.3 Case study 3

### 4.2.3.1 General

The third case study was conducted on a house-building project located near the central parts of Stockholm during the years 2004 to 2006. The project consists of 1 building with 6 floors where the ground floor is a shopping area, and the other 5 floors containing 153 residential apartments. The structural frame is made of concrete cast in-situ in combination with a prefabricated formwork system for permanent use in both slabs and walls. The project is the first in Sweden where this formwork system was used. It consists of cement-bonded particle boards (CBPB), which due to the relatively low weight, enables more rapid assembly and denser joints compared to traditional permanent formwork elements of concrete. Figure 4.1 shows wall elements of CBPB. The CBPB-system further enables easy making of holes during the production time and easy nailing on walls for the user.



*Figure 4.1 Formwork wall elements of CBPB-type used within the case study 3.*

From the building start of the project, SCC was used in all structures except wet room slabs (to enable lower heights for making of slopes) despite the fact that ordinary concrete was planned initially. High requirements were set on the concrete w/c ratio, 0.45, considering the low required relative humidity before floor covering, i.e. 85% RH.

The third case study mainly differs from the earlier conducted case studies regarding the consequences of the new type of formwork system (CBPB) used in both slabs and walls plus that SCC with low w/c ratio was extensively used.

### 4.2.3.2 Technical facts related to production of the structural frame

The third case, which is described in Table 4.3, included utilisation of a formwork system, the 'VST-System' that had never before been tried on the Swedish market before. The system consists of non-removable cement-bonded particle boards (CBPB) for permanent use. The system has been widely exploited in Central Europe, e.g. Austria and Czech Republic,

especially within the hotel-building sector. Generally, the potential advantages of the system consist of the reduced weight, rapid montage and improved possibilities for hole making, sawing and painting, and/or easy nailing directly on the wall surface. Utilisation of the system was planned for slabs as well as walls. Concerning walls, these were designed as shell-mould system that was to be filled with concrete to a homogeneous structure. The formwork elements are possible to ‘click’ into each other using a special lock-system. The VST-system requires decreased spacing of formwork props in comparison to traditional permanent formwork system of concrete due to the lower bearing capacity and stiffness of the VST-system. 1100 mm is required as maximum spacing compared with 1200 mm that normally is used.

Concerning wet rooms, the slab cast in-situ was approximately 20 mm thinner than other parts of the slab in order to achieve equal height levels after application of the screed that was required for achieving proper slopes for drainage gutters in shower areas. With regard to practical reasons traditional concrete was chosen in wet rooms in order to limit the spread of concrete through the temporary wooden formwork that was placed around the wet room. Floor-covering materials were wooden floor on PE-foil and ceramic clinker in wet rooms. To limited extent linoleum carpets were used. The owner set the required RH-values lower than the requirements according to ‘AMA 98’ Swedish Building Centre (1998). Therefore, 85% RH measured on the equivalent depth was required as maximum RH-level concerning all slabs before floor covering. Further, the set RH-demands in combination with that the most castings were conducted during winter conditions required high concrete quality with low w/c ratio. Concrete with w/c ratio of 0.45 was therefore used in order to fulfil the RH-requirements with regard to the maximum allowed production time. During spring and summer, the w/c ratio was increased to 0.55 due to the warmer surrounding climate, which makes the drying process more rapid. The VST-system gave possibility to double-sided drying.

The wall formwork was filled in-situ by SCC using skip as main placing method, according to regulations from the producer of the formwork system. The wall thickness varied between 100 and 200 mm. The wall formwork contained narrow sections due to pre-mounted reinforcement, formwork ties, electrical cables/boxes and limited width etc. Therefore, the maximum aggregate size of the wall concrete mix was changed from 16 to 11mm and later on the need of 8 mm aggregate maximum size was discussed. Walls were cast in 2-3 levels/parts due to the presumptive risk of formwork collapse due to high formwork pressure.

*Table 4.3 Technical facts mainly related to the concrete structural frame of Case 3.*

<b>General building facts</b>	
Type of building	Multi-storey residential building
Project time period	2004-2006
Number of buildings	1
Total number of floors	6
Number of flats	80
<b>Relevant building parts</b>	
Ground construction	Insulated slab on ground founded on rock + piling
Floor structure	Slab cast in-situ (235 mm) on prefabricated formwork system (22 mm) of cement-bonded particleboards (CBPB) for permanent use

Bearing walls	Walls cast in-situ in prefabricated CBPB shell mould system (thickness of mm)
Floor covering materials	Clinker in wet room, wooden floor + PE-foil on other rooms (RH-requirements 85% in all rooms. No screed needed on concrete slabs (except in wet rooms for achieving proper slopes)

### **Concrete facts**

Placing method	Pump on slabs and skip in walls
Finishing method	Laser + skip floating
Curing method	Membrane curing, water curing and covering
Planned concrete type	SCC
Mainly used concrete type	SCC
SCC mix	W/c-ratio 0.45 and 0.55, cement type CEM II with 13% limestone filler, additional limestone filler, superplasticiser of polycarboxylate type, slump flow 540-600 mm, concrete temperature at delivery appr. 15°C 11 mm maximum aggregate size in walls later

## **4.2.4 Case study 4**

### **4.2.4.1 General**

The fourth house-building project studied is located in Linköping, about 200 km south of Stockholm. See Table 4.4 that describes the project. The study was made during the years 2004 to 2005. The project consists of 3 buildings, each with 5 floors and 100 residential apartments. The structural frame was made of SCC cast in-situ in slabs and to some extent in walls as well. The formwork consisted of precast concrete elements for permanent use in slabs (of Filigran type) and dismountable steel elements for walls.

This case study mainly differs from the others regarding the higher adaptation grade to SCC. Another difference is that the SCC mix used in this house-building project not incorporated any limestone filler.

The contractor of the house-building project has been using SCC during the previous five years both in cast in-situ slabs and to some extent in cast in-situ walls (using traditional dismountable formwork system). Positive as well as negative experiences have been gained concerning SCC utilisation.

In this house-building project, SCC was used in all slabs with satisfying result from economical as well as practical points of view. In walls though, SCC was later replaced by ordinary concrete due to less positive economical benefits as those experienced in slabs. Another reason was the increased risk of poor surface quality.

Ordinary w/c ratio, i.e. 0.55 was used. High grade of adaptation to SCC enabled utilisation of several SCC-related benefits, e.g. faster placing process and self-levelling effect as well as precautions against presumptive negative effects, e.g. formwork leakage. In comparison to the other field studies conducted, the SCC mix of this study was not containing any limestone filler. Optimisation of the mix design was conducted, aiming at improving the robustness of the mix.

#### **4.2.4.2 Technical facts related to production of the structural frame**

Casting of slabs started with placing a bottom layer of SCC with reduced slump flow (i.e. from 690 mm to 610 mm) on all formwork elements joints in order to avoid leach of the fresh concrete. This was performed rapidly by moving the pump mast parallel to the joints.

Thereafter, the slab was cast with SCC of w/c ratio 0.55 and slump flow of 690 mm. Due to the fact that the SCC not incorporated any limestone filler, the mix was optimised in order to achieve satisfying robustness by utilising an aggregate curve containing high amount of fine materials, alternatively by increasing the cement content (see Peterson and Saleh, 2003). The contractor perceived the SCC used within this project as more homogenous and robust compared with earlier experiences of SCC. The high flow of the SCC used showed high self-levelling ability. To rationalise the castings, the goal was to eliminate different height levels and recesses of the slab. As for instance, specially designed top formwork of steel therefore was utilised in the wet rooms to directly achieve proper slopes for drainage gutters. Due to the fact that SCC requires no vibration it was possible to cast beneath the top formwork. Furthermore, no screed was required at all in the wet rooms -an important difference in comparison to the earlier conducted field studies. One and the same height level was possible to cast for each floor. In order to avoid uncontrolled SCC spreading over the entire slab, mesh of expanded metal was used.

The selected flooring materials required 90% RH or lower before covering the slabs according to Swedish Building Centre (1998). The w/c ratio 0.55 was enough with respect to the drying time available between casting and floor covering.

The incentives to use of SCC in walls were not as strong as in slabs. The contractor had tested SCC in walls in several earlier projects (see Peterson and Saleh, 2003). The experience of the projects was that it was higher risk of improper concrete surface quality (e.g. increased amount of pores) when using SCC instead of ordinary concrete. As a result of the conducted optimisation of the SCC regarding robustness, the surface quality increased but not to a fully satisfying level. Another explanation to the lack of incentive to SCC use in walls was that the economical benefit, in terms of reduction of time, was not judged big enough to compensate for the added direct materials costs. For walls, SCC had been placed by skip, which reduces the placing speed. Moreover, the casting rate was further reduced with respect to the risk of increased formwork pressure.

*Table 4.4 Technical facts mainly related to the concrete structural frame of Case 4.*

**General building facts**

Type of building	Multi-storey residential buildings
Project turnover	
Project time period	2004-2006
Number of buildings	4
Total number of floors	5
Number of flats	80

**Relevant building parts**

Ground construction	Insulated slab on ground founded on rock + piling
Floor structure	Slab 235 mm on precast concrete formwork system (Filigran type, thickness 45 mm)
Bearing walls	Cast in-situ DOKA formwork system
Floor covering materials	No screed needed on concrete slabs Clinker in wet room, wooden floor + PE-foil on other rooms (RH-requirements 90% in all rooms)

**Concrete facts**

Placing method	Pump on slabs and skip in walls
Finishing method	Laser + skip floating
Curing method	-
Planned concrete type	SCC
Mainly used concrete type	SCC
SCC mix	w/c ratio 0.55, cement type CEM II with 13% limestone filler, superplasticiser of polycarboxylate type, VMA, slump flow 610-690 mm, concrete temperature at delivery appr. 15°C

## 4.3 Concrete characteristics

### 4.3.1 Mix proportions

The SCC mixes used in the cases varied with respect to the type of constituent materials and their proportions. In Table 4.5, the main characteristics of the mixes are summarised. Each w/c ratio was designed with respect to the required level of relative humidity in concrete before floor covering. The most frequently used w/c ratio was 0.55. In Case 2 though, w/c ratio of 0.49 was used in slabs and 0.45 in ground slabs. In Case 3, the used w/c ratio was 0.45 in the first part of the project and changed to 0.49 in the second part.

In all cases, the cement was of type CEM II and included 13% limestone filler.

Filler was added to all SCC mixes except in Case 4 where VMA in combination with aggregate including large content of natural fines was used instead. Used filler consisted of limestone (LS) in all cases except in Case 1 where glass filler was used at the major part of Case 1 but replaced by LS filler at the end of the project.

Concerning chemical additives, polycarboxylate-based superplasticisers were used in all cases.

The fresh SCC varied in terms of rheological behaviour between the cases. The SCC mix used in Case 3 had the lowest flowability with an average slump flow of 580 mm and the SCC mix in Case 2 had the highest flowability with an average slump flow of 700 mm.

*Table 4.5 SCC mixes used in the different case studies.*

<b>Property</b>	<b>Case 1</b>	<b>Case 2</b>	<b>Case 3</b>	<b>Case 4</b>
<b>w/c ratio</b>	0.55	0.49 (0.45 in ground slabs)	0.45 (0.55 in the second part of the project)	0.55
<b>Cement type</b>	CEM II incl. 13% lime stone (LS) filler	CEM II incl. 13% (LS) filler	CEM II incl. 13% LS filler	CEM II incl. 13% LS filler
<b>Type of filler</b>	Glass filler exchanged to limestone filler (LS)	LS	LS	No filler
<b>Type of superplasticiser</b>	Polycarboxylate (PC)	PC	PC	PC
<b>Measured slump flow (mm)</b>	610-690	680-710	540-600	610-690
<b>Others</b>			Maximum aggregate size in walls 11 mm	VMA used



## 4.3.2 Mixing

When comparing the different cases, the mixing process varied to some extent between the SCC mix recipes used and the ready-mix concrete suppliers involved. In Table 4.6 the most relevant characteristics are presented. The most important difference considers whether an extra silo for LS filler was available or not.

*Table 4.6 Variations in the SCC mixing process.*

<b>Characteristics</b>	<b>Case 1</b>	<b>Case 2</b>	<b>Case 3</b>	<b>Case 4</b>
Type of concrete mixer	Free-fall mixer	Free-fall mixer	Free-fall mixer	Free-fall mixer
Mixing time (s)	180	240	180	120
Mixing order	(1) water+add, (2) cem+ls+agg	(1) water+add, (2) cem+ls+aggr	(1) water+add, (2) cem+ls+aggr	(1) water+add (2) cem+agg
Mix volume (m <sup>3</sup> )	5	5.5-6	5	5.5-6
Silo capacity	Extra silo for LS filler used	Extra silo for LS filler used	Extra silo for LS filler used	No extra silo for LS filler available
Testing on plant (before transport to site)	Performed both after basic and added SP dosage for each delivery	Performed only once for each delivery	Performed both after basic and added SP dosage for each delivery	Performed only once for each delivery

## 4.3.3 Transport

In all the cases, transport of SCC from the concrete plant to the building site was performed using conventional concrete trucks with mixing drum. The transport time varied both between the cases due to different transport distances and within the cases due to delays caused by traffic stockings etc. The procedures for truck mixing of the concrete during transport and at the arrivals to the sites varied between the cases to some extent. The most common procedures were to keep the mixing drum of the truck rotating slowly during transport and to rotate the mixing drum rapidly during approximately 2 minutes before emptying the drum.

## 4.3.4 Properties

### 4.3.4.1 Rheological properties

In Case 1, testing of the fresh SCC was carried out regularly at the ready-mix concrete plant and to some extent also on the building site. See Table 4.7 and 4.8 where measurements on

deliveries to one and the same slab casting are displayed. Used methods were slump flow (SF), T500 and L-box. Note that the three first deliveries contained SCC with lower consistency (for use in wet rooms and corridors with lower height). An increase of slump flow can be seen when comparing the result from plant with the result from site, e.g. slump flow of 610 mm versus 690 mm, T500 of 4.4 sec versus 2.2 sec for delivery 5. This effect may depend on a delayed effect of the used superplasticiser.

*Table 4.7 Result from rheological testing of fresh SCC on concrete plant in Case 1.*

SCC Rheological testing (performance control)								
Case study 1								
2004-05-06								
Testing <b>on ready-mix concrete plant</b>								
Delivery	T500 1 (sec)	SF 1 (mm)	SP added (litres)	T500 2 (sec)	SF 2 (mm)	L-box (mm)	Ttotal (sec)	Concrete strength Class
1	9.5	520	1.3	4.3	620	80	-	C32/40
2	-	520	1.3	7.3	580	75	-	C32/40
3	13	520	1.3	6.3	600	85	9	C32/40
4	5	590	-	-	-	75	6.9	C28/35 w/c 0.52
5	9.5	520	1.3	4.4	610	80	5.7	C28/35 w/c 0.52

*Table 4.8 Result from rheological testing of fresh SCC on site in Case 1.*

SCC Rheological testing (performance control)								
Case study 1								
2004-05-06								
Testing <b>on site</b>								
Delivery	Slump flow			L-box			Ttotal (sec)	Concrete strength class
	SF (mm)	T500 (sec)	H1 (mm)	H2 (mm)	H2/H1			
1	615	4,5	115	70	0.61	10.8	C32/40	
2	615	3,6	-	-	-	6.6	C32/40	
3	615	3,1	105	75	0.71	-	C32/40	
4 (after pump)	675	2,1	100	90	0.90	3.6	C28/35 w/c 0.52	
5	680	2,2	95	85	0.89	4.0	C28/35 w/c 0.52	
5 (after pump)	690	2,2	100	90	0.90	2.7	C28/35 w/c 0.52	

In Case 2, slump flow and T500 measurements were conducted regularly on site. See Table 4.9.

*Table 4.9 Result of testing of fresh SCC on site in Case 2.*

<b>Case 2</b>						
<b>Rheological testing on site</b>						
<b>West Building</b>					<b>Slump flow T500</b>	
Part of building	Date of casting	Strength class	W/c ratio	(mm)	(sec)	
Floor 4	2004-11-24	C32/40	0.45	670		
Floor 3	2004-11-08	C32/40	0.50	650		
Floor 2	2004-10-19	C32/40	0.50	620	6	
Floor 1	2004-10-04	C32/40	0.50	710	4	
Ground floor	2004-08-26	C32/40	0.45	680	5	
<b>North Building</b>					<b>Slump flow T500</b>	
Part of building	Date of casting	Strength class	W/c ratio	(mm)	(sec)	
Floor 4	2004-12-01	C32/40	0.45	630		
Floor 3	2004-11-15	C32/40	0.50	620		
Floor 2	2004-10-25	C32/40	0.50	700		
Floor 1	2004-10-07	C32/40	0.50	670	5	
Ground floor	2004-09-16	C32/40	0.45	660	5	
<b>East Building</b>					<b>Slump flow T500</b>	
Part of building	Date of casting	Strength class	W/c ratio	(mm)	(sec)	
Floor 5	2004-12-16	C32/40	0.45	610		
Floor 4	2004-12-03	C32/40	0.45	610		
Floor 3	2004-11-17	C32/40	0.50	620		
Floor 2	2004-10-28	C32/40	0.50	680		
Floor 1	2004-10-15	C32/40	0.50	660	5	
Ground floor	2004-09-22	C32/40	0.45	580	4	

Slump flow values measured on plant regarding Case 3 are presented in Table 4.10.

*Table 4.10 Measured slump flow values on plant in Case 3.*

Case	Date of casting	Building part	Required strength class	W/c ratio	Type of filler	Slump flow (mm) measured on concrete plant
3	2005-01-10	wall	C35/45	0.45	limestone	600
	2005-01-12	slab	C35/45	0.45	limestone	600
	2005-01-17	wall	C35/45	0.45	limestone	580
	2005-02-08	slab	C35/45	0.45	limestone	560
	2005-03-04	slab	C35/45	0.45	limestone	600
	2005-03-08	wall	C35/45	0.45	limestone	600
	2005-04-12	wall	C35/45	0.45	limestone	620
	2005-04-29	wall	C35/45	0.45	limestone	580
	2005-05-18	wall	C35/45	0.52	limestone	620
	2005-05-24	wall	C35/45	0.52	limestone	610

#### 4.3.4.2 Strength

Measured final strength, i.e. compressive strength of 28 days old cubes, of the SCC used in Case 1 and 3 are shown in Table 4.11. In these two projects, SCC was produced at the same ready-mix concrete plant. The measured strength was significantly larger than the strength class required from a structural design related perspective. The reason partly depends on that lower w/c ratio was used than what was necessary with respect to the minimum required strength class. This was based on that increased requirements were set on the w/c ratio with the aim of achieving more rapid drying. In addition, the added filler increased the strength further due to the ‘filler effect’.

*Table 4.11 Measured strength (cube values, 28 days old) of SCC used within Case 1 and 3 that concern SCC produced at the same ready-mix concrete plant.*

Case	Date of casting	Building part	Required strength class	W/c ratio	Type of filler	Average cube strength 28d (MPa)
1	2004-03-02	slab	C28/35	0.55	glass	56
	2004-04-01	slab	C28/35	0.55	glass	54
	2005-01-03	slab	C28/35	0.55	limestone	55
	2005-01-11	slab	C28/35	0.55	limestone	53
3	2005-01-10	wall	C35/45	0.45	limestone	64
	2005-01-12	slab	C35/45	0.45	limestone	65
	2005-01-17	wall	C35/45	0.45	limestone	64
	2005-02-08	slab	C35/45	0.45	limestone	64
	2005-03-04	slab	C35/45	0.45	limestone	62
	2005-03-08	wall	C35/45	0.45	limestone	65
	2005-04-12	wall	C35/45	0.45	limestone	61
	2005-04-29	wall	C35/45	0.45	limestone	65
	2005-05-18	wall	C35/45	0.52	limestone	55
	2005-05-24	wall	C35/45	0.52	limestone	50

In Table 4.12, strength measurement from Case 2 is presented. In addition to cube testing on plant, strength development was estimated on site using maturity meters.

*Table 4.12 Result of compressive strength of used SCC in Case 2, estimated by ordinary cube testing on plant and calculated from maturity measurement on site.*

<b>Case 2</b>								
<b>Compressive strength</b>								
<b>West Building</b>					Cube strength (MPa)		Strength on site (MPa)	
Building part	Date of casting	Strength class	W/c ratio	1 d	7 d	28 d	7 d	28 d
Floor 4	2004-11-24	C32/40	0.45		47,0	59,5		
Floor 3	2004-11-08	C32/40	0.50			58,5		62,0
Floor 2	2004-10-19	C32/40	0.50			56,0		
Floor 1	2004-10-04	C32/40	0.50		43,5	56,0		
Ground floor	2004-08-26	C32/40	0.45			58,5	48,5	60,0

<b>North Building</b>					Cube strength (MPa)		Strength on site (MPa)	
Building part	Date of casting	Strength class	W/c ratio	1 d	7 d	28 d	7 d	28 d
Floor 4	2004-12-01	C32/40	0.45			60,0		
Floor 3	2004-11-15	C32/40	0.50			58,5		
Floor 2	2004-10-25	C32/40	0.50					62,0
Floor 1	2004-10-07	C32/40	0.50			58,5		
Ground floor	2004-09-16	C32/40	0.45	30,5	55,0	64,5		

<b>East Building</b>					Cube strength (MPa)		Strength on site (MPa)	
Building part	Date of casting	Strength class	W/c ratio	1 d	7 d	28 d	7 d	28 d
Floor 5	2004-12-16	C32/40	0.45			60,5		
Floor 4	2004-12-03	C32/40	0.45			60,5		
Floor 3	2004-11-17	C32/40	0.50			58,5		
Floor 2	2004-10-28	C32/40	0.50					60,5
Floor 1	2004-10-15	C32/40	0.50				44,0	57,5
Ground floor	2004-09-22	C32/40	0.45		48,0	61,5		

The strength development of concrete in the structure was also estimated on site in Case 3, using the same type of maturity measurement system as was used in Case 2. Data from logging of concrete temperature and corresponding strength in Case 3 are exemplified in Figure 4.2a and 4.2b respectively. Both in Case 2 and 3, retardation tendencies regarding early strength development were observed during surrounding air temperatures lower than approximately 10°C. The effect is explained by increased sensitivity to retardation of the early hydration of concrete that contains high dosages of superplasticisers, which is the case for SCC (compared with NC). Early freezing of the concrete did however not occur before the concrete reached 5 MPa, which fulfils the requirements of the Swedish building codes (BKR, 2004).

### Temperature (C)

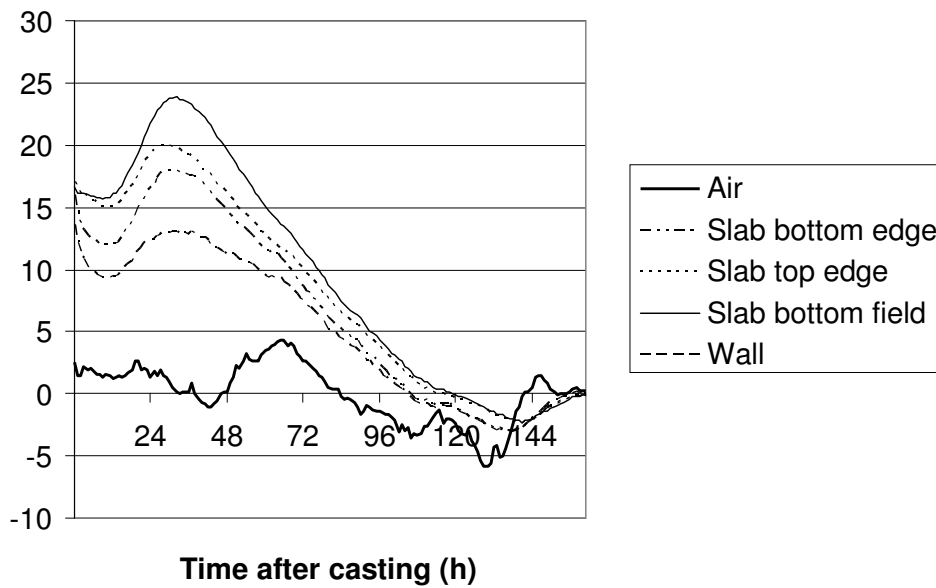

Figure 4.2a Example of measured temperature development in SCC on site in Case 3 using maturity meters.

### Strength (MPa)

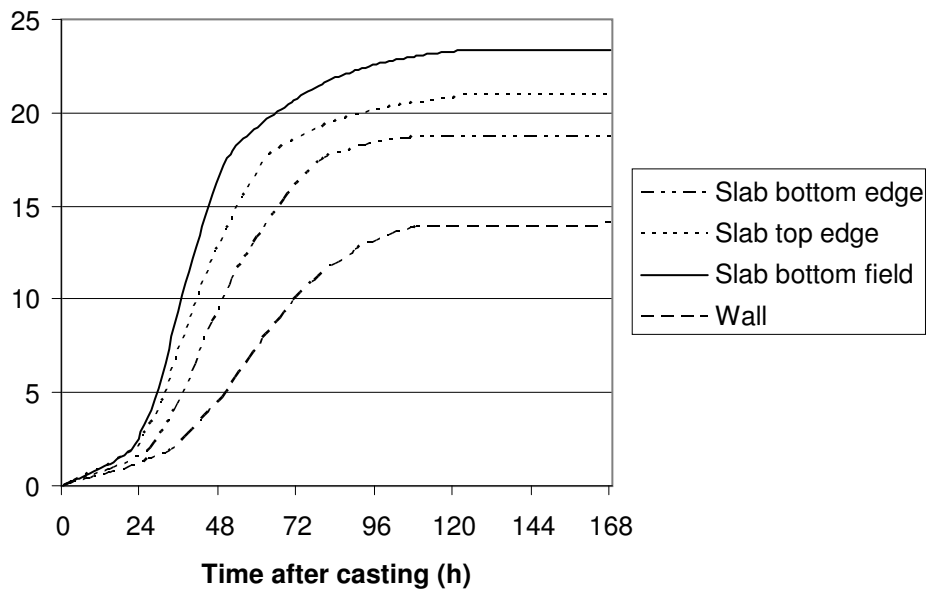

Figure 4.2b Examples of estimated strength development on site in Case 3 using maturity meters.

### 4.3.4.3 Drying of the concrete

In all studied cases, the relative humidity was measured on the equivalent depth of the slabs with respect to the stipulated requirements in 'AMA 98' (Swedish Building Centre, 1998) before floor covering. In Case 1, where screed was used, the RH of the concrete slab increased after the placing of screed, which occurred approximately 1 month before the planned carpeting. First when the screed itself dried out to lower RH level than the concrete, the slab continued to dry out.

Results from RH measurement in Case 2 are presented in Table 4.13. The drying was more rapid in higher storeys despite that these were cast later. The effect may be explained by that the surrounding climate was both warmer and dryer where these stories were produced.

*Table 4.13 Result of RH measurement from Case 2. Strength class C32/40 used in all floors. Measurement depth 42 mm from surface (i.e. equivalent depth = 20% of total thickness), w/c ratio 0.50 in all floors except in ground floors where w/c 0.45 was used, slab thickness 210 mm on precast formwork of 'Filigran' type 45 mm in all floors except ground floors where slab on ground was used.*

<b>Case 2</b>				
<b>RH measurement on site</b>				
<b>West Building</b>				
Building part	Month when casting	Measured RH (%)	months after casting	Comments
Floor 3	Nov	87	5	
Floor 2	Oct	86	6	
Floor 1	Oct	89	6	
Ground floor	Aug	91	8	Equivalent depth 200 mm (measured in haunches)
<b>North Building</b>				
Building part	Month when casting	Measured RH (%)	months after casting	Comments
Floor 3	Nov	82	6	
Floor 2	Oct	86	7	
Floor 1	Oct	90	7	
Ground floor	Sep	-	8	Equivalent depth 280 mm (measured in haunches)
<b>East Building</b>				
Building part	Month when casting	Measured RH (%)	months after casting	Comments
Floor 4	Dec	84	6	
Floor 3	Nov	85	7	
Floor 2	Oct	84	8	
Floor 1	Oct	87	8	
Ground floor	Sep	91	9	Equivalent depth 220 mm (measured in haunches)

As shown in Table 4.14, the RH development measured in Case 3, was approximately 20% more rapid in SCC than in NC (used in wet rooms) with the same w/c ratio despite that the slab thickness of SCC was 7% larger. The castings of both SCC and NC were performed during the same days and on same floors. The surrounding drying conditions correlated well between NC and SCC during the time until the date of measurement.

*Table 4.14 RH measured on site in Case 3 showing result regarding both SCC and NC. Controlled drying climate started in April.*

<b>Case 2</b>						
<b>RH measurement on site</b>						
<b>SCC versus NC</b>						
<b>Type of concrete</b>	<b>Measurement place</b>	<b>Thickness of concrete layer</b>	<b>Equivalent depth (measurement depth)</b>	<b>Month of casting</b>	<b>Drying time (months)</b>	<b>Measured RH (%)</b>
NC w/c 0.45	Flat 129 Wet room	220	49	Dec	7	86
SCC w/c 0.45	Flat 129	235	52	Dec	7	82
NC w/c 0.45	Flat 123 Wet room	220	49	Mar	4	87
SCC w/c 0.45	Flat 123	235	52	Mar	4	85



## 4.4 Observations

### 4.4.1 Mixing

In general, if the SCC-mix is not properly balanced, there are risks of several unwanted problems on site -both with respect to the fresh and the hardened concrete properties. SCC is, in comparison to normal concrete, significantly more sensitive to variations in the mix proportions. Even small differences in quality and amount of constituent materials can result into troublesome variations of the SCC properties and performance on site. As for instance, quantity as well as quality variations with respect to filler, mixing water, cement, aggregate and additives might lead to consistency variations, concrete segregation and early loss of self-compacting ability. To achieve satisfying robustness of the fresh SCC delivered, it is essential to have control also of small variations that might be of less importance for traditional concrete.

Consequently, proper production process control at the ready-concrete plant was required in all studied cases. It was particularly important to have control of variations of moisture content in the aggregate and water in trucks left after cleaning. Furthermore, the type, order and time with respect to mixing may affect the fresh SCC properties. Therefore it was essential to make renewed tests of the SCC not only after modifications of the recipe but also after changes in the production process.

Due to the high risk of performance variations of SCC, rheological testing (slump flow, T500 and to some extent for example L-box) was carried out when developing new recipes and optimising already existing SCC recipes. When it comes to delivered SCC within the Cases, the quantity of tests differed but slump-flow testing on plant were often performed at least for the first SCC deliveries of the day. In Case 1 and 3, one method was used with the aim of achieving improved rheological result by testing the SCC twice at the ready-mix concrete plant, i.e. one after addition of the intended amount of SP and then after a presumptive addition of SP. By this method, the risk of too high flow, due to too much SP added, was reduced. On the other hand, it was believed that the test procedures in combination with the extended mixing times of SCC led to decreased delivering capacities for the concrete plant of Case 1 and 3. Probably, this issue becomes more relevant for suppliers of ready-mix concrete in markets where the time schedule for deliveries is tight, which often is the case in big city areas. Testing on site was not performed to the same grade as on plant. However, the first deliveries of SCC (from a total point of view) to each project included on-site testing as well.

The mixing procedures were mainly the same for all the studied cases except that Case 4 not included any glass or limestone filler (due to that no extra filler silo was available on the plant). See 4.3 'Concrete characteristics' for further details considering mixing related issues of the Cases.

The general conclusion of all cases especially cases 1-3 including filler in the mix, was that it was quite possible to produce SCC over long period without disturbing variations in the self-compacting ability.

## 4.4.2 Transport

Also when it comes to transportation, SCC is in general more sensitive to variations compared to normal concrete. During long-time transports, which may be caused not only by long distances but also by traffic stockings, it was observed that the self-compacting ability might be impaired or lost, especially when the mix contained large amounts of superplasticiser and when the surrounding air temperature was high. One observed solution to this problem was to add SP at the building site, by using truck mixing on site. Consequently, a dialogue had to be held between the truck driver and the ready-mix concrete producer in order to minimise the risk of adding too much SP. Furthermore, special transport instructions were required, regarding as for instance the way of using the truck mixer (rotation speed and rotation time) and cleaning the truck mixer between different deliveries.

See 4.3 'Concrete characteristics' for further details considering transport of SCC in the Cases.

## 4.4.3 Casting

### 4.4.3.1 Slabs

#### **Varying consistency**

In all studied cases, the consistency of the fresh SCC was varying to some extent. This effect may be the result of that SCC, in comparison with traditional concrete, in general is more sensitive to moisture variations of the aggregate. In addition, increased slump flow was measured on site in Case 1 and 3, which might have been caused by a delayed effect of the superplasticiser. However, the increase of slump flow was limited and no noteworthy concrete segregation occurred.

#### **Castings with reduced need of man-hours**

Pump was used as placing method in all studied slab castings. The opportunity to reduce the production time required for slab casting when SCC was used was frequently observed. As for instance, the casting time, when using SCC in the slabs of Case 1, corresponded to nearly half of the time required for normal concrete that was used initially in the case (i.e. 3.5 hours in comparison with 6 hours for each slab casting).

The required amount of personnel during the SCC casting moments was reduced. Figure 4.3 exemplifies casting of normal concrete with three concrete workers. In comparison, Figure 4.4 displays casting of SCC with two concrete workers. Both pictures are taken from Case 1. It is also common that four concrete workers are used when casting slabs with normal concrete and three when using SCC. However, due to that the vibration-work moment is eliminated when using SCC, one concrete worker less is needed.

Furthermore, the possibility to reduce personnel from the entire project and not only from the casting moment is to large extent dependent on the adaptation grade of SCC in each project. In all case studies, the ability to reduce man-hours were utilised for reducing the casting time and temporarily for reducing manpower during casting and not for reducing personnel from the project.

See '4.4.6 Production economy' for quantified economical effects of SCC with respect to the ability to reduce required man-hours.



*Figure 4.3 Casting of slab using traditional concrete.*



*Figure 4.4 Casting of slab using SCC.*

### **High flowability – risk of leach**

One commonly observed disadvantage of SCC occurred when concrete surface levels were lowered locally in wet rooms (typically by 30 mm) in order to be able to make slopes for drainage gutters. The high grade of flow of the used SCC (in comparison to NC) consequently led to practical problems with preventing the fresh concrete from spreading to the surrounding parts of the slab. In Case 1, SCC with a higher viscosity was therefore used in wet rooms locally together with using of simple wooden formwork. In Case 3, ordinary concrete was used in wet rooms for the same reason. See Figure 4.5.

To solve the issue dealing with slopes required for drainage gutters, special top formwork was used locally in wet rooms for the slabs in Case 2 and 4 (see Figure 4.6, Case 4). Thereby, lower height was achieved, which led to the possibility to making proper slopes (see Figure 4.7). This method enabled that one and the same type of SCC could be used for the whole slab, which is illustrated in Figure 4.8, Case 2.



*Figure 4.5 Ordinary concrete that limits the spread through the temporary wooden formwork was chosen in the wet rooms of Case 2 in order to achieve lower surface than for the rest of the slab. All other parts of the slabs were cast using SCC.*



*Figure 4.6 Utilisation of specially designed top formwork during casting in Case 4 led to the ability of achieving proper slopes for drainage gutters directly.*



*Figure 4.7 Example from Case 4 showing slope for drainage gutter in wet room directly achieved by SCC and top formwork.*



*Figure 4.8 In Case 2 specially made top formwork was utilised in combination with SCC in order to achieve lower heights for slopes for drainage gutter. Note that the major part of the slab area was possible to cast with one and the same type of SCC based on increased adaptation grade to SCC compared to Case 1.*

A similar aspect of the high flow performance of SCC is that problems may occur when SCC with different w/c ratios are required within the same slab, which may be needed if different floor covering materials are used, e.g. wooden floor in living room and plastic carpets in wet rooms. In the beginning of Case 2, plastic carpets were planned for wet rooms. Later, decision was taken to use clinker instead, which enabled use of SCC with one and the same w/c ratio for all parts of the slab with respect to the different RH requirements for various floor-covering materials prescribed in 'AMA 98' (Swedish Building Centre, 1998).

#### **Leach between formwork elements**

Due to the high fluidity of fresh SCC, there were also the risks of leach between the horizontal formwork elements. Different methods were used in the cases. In Case 1 and 2

were joint compounds used, which worked well. Furthermore, in Case 4, each slab casting started with placing of SCC with reduced slump flow (from 690 mm to 610 mm) over all interfaces between the concrete formwork elements in order to avoid leach of the fresh concrete. See Figure 4.9. This was performed rapidly by moving the pump mast parallel with the joints.



*Figure 4.9 In order to avoid leach of high flowable SCC between formwork joints, the first concrete delivery for each slab casting consisted of SCC with reduced slump flow, which was placed by moving the pump mast over the interfaces.*

In Case 3 where the VST-formwork system was used, the element joints were enough dense to avoid leach.

With regard to the increased flowability of SCC, further observations could be made. In Case 1, there were difficulties using SCC in comparison to traditional concrete, addressing the possibility to estimate the really required placed volume versus the theoretical total volume. The reason is based on the different flow performance. As for instance, a height difference of 10 mm on an area of 100 m<sup>2</sup>, correlates to a concrete volume of 1 m<sup>3</sup>. In order to limit the flow of concrete, thereby diminishing the flow of concrete, the transportation must be on time. Long waiting time on site may lead to a flow of concrete that is difficult to control.

#### **Retardation effect versus filler effect**

To various extents, retardation effects wintertime with respect to initial cement hydration were observed in all cases. The effect is explained by that the increased content of superplasticiser that is common for SCC, may delay the cement hydration, especially when the air temperature is low. After the initiation of the cement hydration, the rate of hydration increased rapidly and led to a high final strength. The latter effect, sometimes referred to as a ‘filler effect’ that automatically leads to ‘over-strength’ was not set into focus in any cases, neither with respect to structural design nor to production. Due to the rapid strength growth, no early freezing of the concrete was experienced wintertime. In case 1, 2 and 4 no external freezing protection methods were used, e.g. covering, heating and insulation of the concrete structure/formwork. In Case 3 though, heating from beneath was used during the coldest castings. Furthermore, in Case 3, one experienced disadvantage concerning the retardation effect of early hydration was that early covering of the surface with the aim of avoiding plastic shrinkage and/or avoiding early freezing of the concrete was difficult due to not hard enough surfaces plus that high-quality surfaces may be deteriorated.

### 4.4.3.2 Walls

Wall casting in-situ with SCC was performed to various extents in all case studies, except in Case 2 where precast concrete walls were used instead. In the initiation part of Case 1, NC was exchanged for SCC. Case 3 was the only project where all walls were cast with SCC. Pump and shell-moulds (for permanent use) of concrete and CBPB were utilised in Case 1 and 3 respectively. See Figure 4.10 and 4.11 showing wall castings in Case 1. In Case 4, traditional dismountable formwork and skip were used. Furthermore, in Case 4, SCC was exchanged to NC later on.



*Figure 4.10 Placing of SCC in walls.*



*Figure 4.11 Placing of SCC in walls by using pump (close-up).*

#### **Rational wall castings**

In Case 1, the need of manpower during placing of SCC in walls was reduced with one person. Another observed advantage was that the risk of unwanted delays, due to difficulties related to vibration work was eliminated. In comparison with experiences from traditional NC castings including skip use, placing with pump further reduced the required time due to the fact that no waiting cycles (when filling the skip) was required.

In Case 1, total wall lengths of approximately 65 metres were placed at each casting. In comparison to normal concrete, half the number of vibration points were needed, i.e. approximately 10-15 points per casting. The upper parts of the walls were easier and faster to cast, due to less door and window openings, which led to that a smaller number of vibration points were required. The height of concrete drop was normally 2 metres and the filling speed depended on the variations of consistency. Setting effects were not observed despite the big casting height. However, as compensation for presumptive concrete setting in walls, this could be compensated for when casting the slabs.

#### **Opportunity to cast narrow structures**

The total wall thickness of the shell-mould walls of CBPB in Case 3, i.e. the VST-system, was smaller in comparison to the shell-mould walls of concrete used in Case 1. Furthermore,

the amount of reinforcement was larger in the VST-system due to smaller stability of the VST-system itself. If normal concrete had been used within Case 3, large difficulties due to the narrow spaces would probably have occurred with respect to the ability to vibrate the fresh concrete properly. SCC use within Case 3 led to the opportunity to cast the narrow and densely reinforced wall structures.

### **Increased formwork pressure**

There may be a risk of increased lateral formwork pressure if SCC is used due to presumptive full hydrostatic pressure. In Case 1, minor collapses were experienced two times but if the reason was related to SCC use or not was not clarified. However, to avoid further collapse of formwork, the casting height of walls was limited into two separate steps (half of the total wall height each) with one day's break.

Also in Case 3, the casting rate of the VST-walls was limited. Concerning the first walls, which were up to 4 metres in height, the wall supplier recommended casting of minimum four separately parts (heights) in order to limit the formwork pressure. The first walls also included various heights due to different ground heights, which further delayed the casting speed. Later on in the project, the wall heights were limited to 2.60 m and did not differ, which restricted the casting parts into three.

### **Leach between formwork elements**

Due to the high flow of SCC, there was also the presumptive risk of leaching formwork. To minimise this effect at the bottom horizontal joints, the formwork were placed on mortar in Case 1, which increased the tightness of the interface between wall and slab to a satisfying level.

In comparison, the dense joints between VST-elements of Case 3 in combination with the ability of achieving plane surfaces directly led to that no joint mortar was needed in order to achieve tight interfaces between wall formwork and slabs.

### **Difficulties regarding filling of dense wall formwork system**

In Case 3, the wall sections became narrow due to limited wall thickness in combination with electrical installation cables and boxes, distance boxes and reinforcement. See Figure 4.12. This led to difficulties regarding proper filling of the formwork system. The possibilities for ocular inspection regarding proper filling, were limited. Thereby, risks existed of getting inhomogeneous parts of hardened concrete, for example in column sections at the side of windows. Further, this risk could lead to that wall parts were loosened during slab castings. Below openings for windows, there were difficulties as well for filling the formwork properly because of large parts of entrapped air when placing the concrete from above using skip.





*Figure 4.12 Example of narrow wall sections, Case 3.*

To minimise the observed filling problems, the SCC recipe was changed with respect to maximum aggregate size. Aggregate of 16 mm were replaced by 11 mm. Further reduction of the maximum aggregate size led to problems regarding the self-compacting properties of the concrete tested on the concrete plant. Another method that was tried was to change the placing of the electrical boxes from the inside of walls to the outside.

## **4.4.4 Surface quality**

### **4.4.4.1 Slabs**

#### **Surface level quality, smoothness and pores**

In Case 1, where SCC neither was planned nor used in the initiation part of the project, the hardened slab surfaces were of high quality after SCC introduction were. In comparison to earlier experienced result of normal concrete, the difference was remarkable. This started the discussions of the need of additional screed. However, due to the fact that final levels had to be cast directly if this beneficial effect of SCC was to be exploited at the same time as large variations of final height levels were detected, decision was taken to use screed.

In Case 2, 3 and 4, SCC was included within the early project planning phase, which led to increased possibilities to utilise the self-levelling effect of SCC to avoid extra surface finishing. In these Cases, the self-levelling effect was one of the major incentives to SCC, addressing not only the possibilities to balance for the extra direct materials cost of SCC (in comparison to NC) but also the opportunities for production economical savings from a total economy perspective. With the aim of achieving high-quality surfaces of the hardened slabs, proper skip floating was conducted in the cases. Early in the projects, the hardened concrete surfaces were measured with respect to level quality and the result fulfilled the requirements of smoothness and level quality according to ‘AMA 98’ (Swedish Building Centre, 1998). Thereby, significant cost-savings were possible to achieve based on that no screed was

required. A secondary effect of that no screed had to be used was that cleaning and preparation of the concrete surface before placing of a screed could be eliminated.

There were also other aspects to take into regard considering the quality of hardened concrete surfaces. Air voids released from the fresh concrete may result in large pores or so-called blowholes in the hardened concrete surface. This effect was observed to various extents within the cases. See Figure 4.13 and 4.14 showing top surfaces of fresh and hardened concrete respectively from Case 1. In comparison to normal concrete, the air release of SCC may occur later (after the skip-floating moment) due to that no vibration is performed. Alternatively, the air release was larger than for normal concrete due to segregation tendency and/or high content of superplasticiser, which in itself might introduce air into the mix. If screed is utilised, blowholes have no practical importance. However, 'light' grinding (using floor grinding machine) of the hardened concrete was carried out in Case 2, 3 and 4. Risks of not fulfilling the requirements regarding smoothness due effects of blowholes were thereby eliminated.

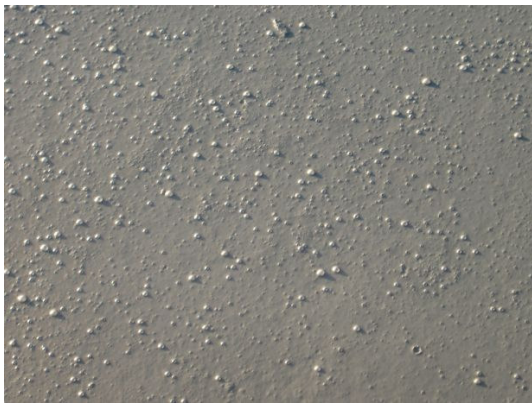

*Figure 4.13 Air release from fresh SCC.*

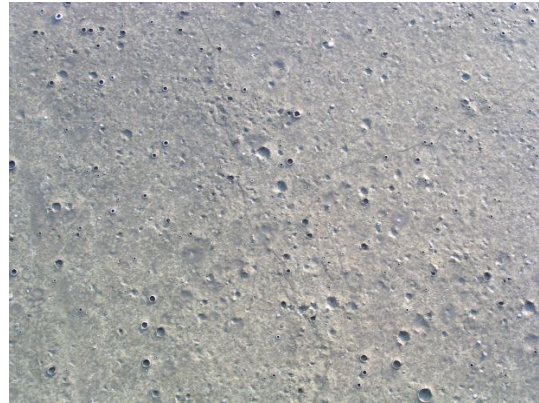

*Figure 4.14 Blowholes in hardened concrete caused by air release from the fresh concrete.*

### **Cracking**

The amount of cracking of the hardened SCC slabs varied between the case studies. In all studied cases, except Case 3, the extent of cracks was limited. In Case 1, setting cracks above the reinforcement bars were dominating and in Case 3, cracking to largest extent was based on plastic shrinkage. In Case 2 and 4, the observed cracking was very limited.

In Case 1, early cracks were observed to some extent in the slab surface, parallel to and above the reinforcement bars. See Figure 4.15. Probably, the reason to these cracks was related to setting effects due to that SCC was not vibrated. Similar type of cracking was also observed in Case 4. This effect was probably based on segregation and setting effects caused by the relatively high w/c ratio and limited content of fines.

Also wild cracks, i.e. less symmetric oriented cracks, based on plastic shrinkage, were observed to limited extent in Case 1, 2 and 4. In general, efficient methods for protection against early shrinkage cracking consist of preventing surface drying by spraying of water, membrane-curing agent and covering with PE-foil. However, none of these methods was

conducted in Case 1 due to practical difficulties of using water close to moisture sensitive facade elements. However, observed cracking was assumed to have no negative effects of importance with regard to requirements on structural performance and/or acoustic performance. In Case 2 and 4 the plastic shrinkage cracks occurred to such limited extent that no precaution methods were needed.



*Figure 4.15 Setting cracks parallel with and above top reinforcement bars.*

In Case 3 the major experienced disadvantages of SCC only concerned plastic shrinkage cracking. In comparison to Case 1 that included ready-mix SCC delivered from the same plant as Case 3, this negative effect occurred to a significantly larger extent within Case 3. Figure 4.16 exemplifies heavy plastic shrinkage cracking experienced within the project.



*Figure 4.16 Example of heavy plastic shrinkage on slab cast with SCC.*

Several factors may explain the severe plastic shrinkage cracking in Case 3. One reason may be that SCC used in Case 3 had lower water/cement ratio than in Case 1, i.e. 0.45 instead of 0.55. Another presumptive reason is that the SCC used in Case 3 contained limestone filler instead of glass filler. Both these factors may have led to decreased bleeding of SCC in Case 3. Furthermore, factors related to the surrounding climate, as for instance wind, rain/snow, sunlight and surrounding temperature affect the risk of plastic shrinkage as well. In many of the case studies, the result of the hardened concrete surfaces showed reduced amount of plastic shrinkage cracking when the cast concrete surface was covered by rain or snow. During winter castings gas and electrical heaters were used to protect the concrete from early freezing. Differences in plastic shrinkage with regard to the efficiency of the heaters could be observed. Electrical heaters increased the temperature of the slab more than gas heater (e.g. 15°C versus 5°C), which also led to increased amount of plastic shrinkage.

Different precautions were tried in Case 3, e.g. membrane curing, covering of the surface and addition of PE fibres and cellulose fibres in the mix. In general, water curing leads to satisfying result regarding plastic shrinkage cracking. In the first part of Case 3, water curing was avoided with the aim of minimising the risk of early freezing. However, the used membrane-curing agent was not recommended of the supplier for surrounding temperatures below 0. Therefore, the effect could not be verified. Later in the project, the w/c ratio was increased from 0.45 to 0.55 due to the fact that w/c 0.55 was estimated to be low enough with regard to the required level of RH before floor covering due to improved surrounding drying climate. Plastic shrinkage cracking was then reduced to some extent but not to a satisfying level. During the same time, the same type of SCC was delivered (from the same concrete supplier) to another house-building project and no plastic shrinkage cracking was observed. In that project, proper water curing was conducted. However, the consequences of the plastic shrinkage cracks were discussed concerning the structural and acoustic performance of the cast slabs. Cylinders were drilled out, which showed the depth and width of the cracks. See Figure 4.17. No extra precautions had to be taken, according to the technical investigation, carried out by the structural engineer.



*Figure 4.17 Drilled cylinders taken out from slabs cast with SCC showed the depth of cracks due to plastic shrinkage.*

#### **4.4.4.2 Walls**

In comparison to the shell-mould wall systems used in Case 1 and 3, the traditional dismountable wall formwork system, used in Case 4, led to visible surfaces of the hardened concrete. Due to varying surface quality, added finishing work was occasionally needed. Presumptively, this negative effect might have been smaller if the SCC mix had contained more fines, e.g. limestone filler.

Another parameter that might have influenced the surface quality is the raising speed. Wall castings with SCC in general require restricted raising speed, not only due to the increased risk of high formwork pressure but also due to the risk of poor surface quality caused by entrapped air that is not released through vibration, a situation that occurs when NC is used. Due to that SCC in walls was placed by skip in Case 4, restricted raising speed addressing the risk of release of entrapped air was ‘automatically’ solved.

SCC has the potential to produce high-quality wall surfaces. This was exemplified in Case 1 where traditional type of formwork was used for one support wall with a length of 7 metres and a height of 1.8 m. The result showed high-quality surfaces with almost no required finishing work.

#### **4.4.5 Drying**

In all studied cases, the drying rate of SCC used was more rapid than expected, compared to earlier experiences with normal concrete with similar w/c ratio. In Case 3, both SCC and NC (in wet rooms) were used in the same floors that were cast during the same day and dried under the same drying conditions. The result from RH measurement showed significantly more rapid drying when SCC was used. See ‘4.4.2 concrete characteristics’ for further quantified result regarding drying.

Another observed benefit of SCC in Case 2, 3 and 4 was that the presumptive elimination of screed also reduced the required drying time. In general, when using screed, the drying time of the concrete is extended due that the screed has to dry out itself and to some extent to that the moisture content in the surrounding air increases after placing and drying of the screed. When the screed is eliminated these negative effects are eliminated.

## 4.4.6 Production economy

### 4.4.6.1 Slabs

Various economical consequences of SCC used in slabs were observed in the cases studied. Due to fundamental differences between the projects with respect to influencing factors, as for instance type of structure and degree of SCC adaptation, the effects on production economy varied. In Table 4.15 the economical effects are summarised. Below, observed economical effects are presented and discussed.

#### **More expensive concrete**

The price for SCC, charged by the ready-mix producer, varied between the cases due to different concrete classes, market places, ingredients etc. However, the price increase for SCC varied between 15 and 20% in relation to NC of consistency class S5 (slump >210 mm).

#### **Increased production efficiency**

In all case studies, slab castings with SCC were observed to be more rapid and/or less manpower requiring in comparison to experiences from corresponding NC castings.

When it comes to *manpower reduction* measured as costs for personnel (man hours/m<sup>3</sup>), SCC was in the case studies observed to enable slab castings of 0.1 to 0.2 man hours/m<sup>3</sup> when pump was used as placing method. These values are based on a casting rate of 20 m<sup>3</sup>/h using three concrete workers (i.e. approximately 15 minutes per truck of 5 m<sup>3</sup>).

Thus, in comparison to slab casting using NC that in common corresponds to 10 to 15 m<sup>3</sup>/h using four concrete workers, which corresponds to 0.3 to 0.4 man hours/m<sup>3</sup> according to 'Betongbanken' (see SFF, 2007), that is based on experiences from Swedish building sites, SCC use enables a reduction of approximately 0.2 man hours/m<sup>3</sup>. Theoretically, this reduction corresponds to 5-10% of the NC cost. To utilise this opportunity in reality, however, proper planning of personnel and high adaptation grade of SCC is required. Furthermore, SCC theoretically enables possibilities for personnel reduction within the projects and not only during the casting moment. In practice, however, it was observed that this saved personnel was required for preparation work that increased when SCC was used.

Concerning the *casting time* required for SCC slabs, reductions of up to 50%, in comparison to corresponding NC castings, were achieved. This advantage was, in the same way as for reduced man hours, difficult to utilise in reality for reduced production costs. One direct benefit of a more rapid casting process though, utilised especially in Case 2 and 4, was the ability to have more time left for preparation work before casting, due to that the casting could start at a later time of the day. Alternatively, possibilities to avoid delayed work (i.e. expensive hours) could be utilised. Both these advantages are difficult to quantify economically.

Furthermore, it was possible to reduce costs for pump rental in all case studies, but due to that a fixed price dominates the rent, independent on the amount of rental hours, the cost reduction related to reduced time was very restricted.

Costs for vibration equipment rental were eliminated in Case 2 and 4. However, these cost savings corresponded to only minor total cost reductions -four days rental of vibration equipment corresponded to approximately the price for 1 m<sup>3</sup> of NC. In Case 1 this potential reduction in rental costs was not possible to utilise due to that NC was used initially and in Case 3 due to that NC was used in wet rooms.

In Case 1, the added costs for SCC (the increased material cost) in slabs were considered as higher than the economical benefit that was limited to the opportunity to reduce manpower and equipment during the casting moment (e.g. reduced placing time by 40%, 4 man-hours, 1 hour of pump rental and costs for vibration equipment rental). There might have been larger direct economical benefits of SCC regarding the slabs of Case 1 if the self-levelling effect could have been utilised and thereby screed avoided, (which was found to be possible in the other cases). However, due to the planned variations of slab level heights between living rooms, wet rooms and corridors, one single SCC casting over the whole slab was not possible in Case 1.

### **No screed needed due to the self-levelling effect of SCC**

In comparison with Case 1, potential economical incentives to SCC use were taken into regard already in the planning of Case 2, 3 and 4. The main economical incentive to SCC use in these cases was to avoid costs for screed by utilisation of the self-levelling effect of SCC. The observed cost reduction based on reduced/eliminated need of screed (conventional thickness 10 mm) was approximately 10% (of NC price) per m<sup>2</sup>, which corresponds to 50% cost reduction of NC price per m<sup>3</sup> for 200 mm thick slabs. Added materials costs for SCC was as mentioned about 15-20% of NC price. Thereby, the economical benefits were larger than the added direct materials costs for the delivered SCC. The total cost reduction due to the self-levelling effect when using SCC was about 30-35%.

In order to optimise the utilisation of SCC, practical regard had to be taken to the high flow of SCC. Such an optimisation was made in Case 2 and 4 where the same height levels and RH requirements were designed for the whole slab (including wet rooms).

There were also other observed positive consequences of that screed could be avoided, e.g. that cleaning before floor covering only had to be conducted once. Furthermore, screed in general may extend the concrete drying time due to that the screed itself has to dry before the drying of the concrete can continue. This effect is difficult to quantify economically since the cost saving varies from case to case depending on outer climate and construction rate.

### **Rapid drying**

The drying of SCC was in general experienced as more rapid within all Cases in comparison to experiences of normal concrete with the same w/c ratio. In Case 3, in which the adaptation degree to SCC was lower compared with Case 2 and 4, NC was used in wet rooms to achieve lower height locally. Thereby it was possible to compare the drying between NC and SCC during the same conditions. Despite the larger thickness of SCC, the drying was significantly more rapid of SCC, which if utilised during the planning phase may lead to cost savings such as the possibility of using decreased concrete quality, avoidance of heating and drying, and reduced number of production days.

### **Rapid strength development**

The high strength and rapid strength development of SCC used in the cases were not utilised for more rapid production cycles, reduced strength class and/or less winter concrete methods. One reason was that mainly formwork for permanent use was used. To some extent the positive effects of strength mentioned were counteracted by retardation effects on early hydration wintertime.

### **Work environment vs economy**

The benefits of SCC with respect to improved work environment were obvious in all cases. No economical benefits with regard to improved work environment could be quantified though. SCC may lead to lower costs for sick leaves and thereby also enable the possibility of creating direct economical incentives based on improved work environment. However, there were discussions in all cases whether added material costs for SCC could be seen as investment from a wider perspective for increased health and safety and whether extra costs for SCC should be paid for within the contractors' central organisations and not within each house-building project that is the case today.

*Table 4.15 Summary of observed economical consequences from replacement of NC by SCC.*

<b>Type of economical consequence of SCC</b>	<b>Observed estimation</b>
Added materials costs for the buyer/user (increased product price)	15-20% of NC price (in relation to consistency class of NC)
Reduced/eliminated costs for screed use if the self-Levelling effect of SCC is utilised	Up to 50% of NC price
Increased efficiency for <i>slab</i> casting (less man hours required)	5-10% of NC price (potentially)
Increased efficiency for <i>wall</i> casting (less man hours required)	10-20% of NC price (potentially)
More rapid strength development and higher final strength (less winter protection methods required, more rapid casting cycles, reduced concrete quality)	Not economically estimated
More rapid drying (reduced drying time - saved production costs, lower price if reduced concrete quality)	Not economically estimated
Reduced/eliminated equipment rental costs	Very restricted
Reduced pump rental	Very restricted
More time to preparation	Difficult to economically estimate
Safe castings	Difficult to economically estimate
Work environment	Difficult to economically estimate



#### 4.4.6.2 Walls

In the wall castings in Case 1, where concrete shell-mould system was used, SCC was considered as beneficial, primarily due to easier casting process without the risk of unwanted delays (due to eliminated difficulties regarding vibration work in narrow sections) and secondarily due to that the need of personnel was reduced with one person during each wall casting.

The shell-mould system of Case 3 was densely reinforced. Furthermore, the wall sections were narrow. Therefore, the high filling capacity of SCC was considered as more or less necessary in order to fill the form properly. Sufficient vibration work was considered as very difficult to manage if NC had been used.

Compared with the shell-mould systems used in Case 1 and 3, the walls of Case 4 were cast using ordinary dismountable formwork system. This was less congested, which enabled vibration work of NC without practical difficulties. In addition, reduced surface quality and added extra costs for finishing work were experienced when using SCC. Furthermore, no production time was saved when using SCC partly because skip instead of pump was used, which lead to unavoidable waiting times. Consequently, there were no incentives to SCC and as a result, SCC was replaced by ordinary concrete.

In order to increase the wall casting rate when SCC is used, several aspects have to be optimised and adapted for SCC. As for instance, skip use leads to non-rational waiting time (that otherwise is utilised for vibration work if NC is used). Furthermore, if traditional removable formwork is used, high casting rate of walls may lead to poor surface quality (air bubbles, pores) due to restricted time for air loss. For NC though, air will be released through vibration work.

When it comes to quantification of SCC effects on production costs for walls, which is included in Table 4.15, reductions of 10 to 20% of the NC price were potentially possible. This estimation corresponds to increased casting efficiency of 0.15 to 0.3 man hours/m<sup>3</sup>. These values were based on a casting rate of 7 m<sup>3</sup>/h using one concrete worker and two concrete workers respectively. As comparison, a common casting rate for NC walls is 0.6 man hours/m<sup>3</sup> according to 'Betongbanken' (see SFF, 2007). For other economical effects of SCC, see Table 4.15.

#### 4.4.7 Work environment

Several work-environmental improvements due to SCC use (addressing the eliminated vibration work) were observed in the case studies. For both slabs and walls, the following main advantages were noted:

- Eliminated risk of hands-arm vibration syndrome (HAVS)
- Strongly reduced heavy work (improved ergonomics)
- Less noisy castings (increased safety and comfort)

In the cases where SCC was planned early, another advantage was observed, i.e. reduced experienced stress. This was related to that more time became available for preparation work before castings due to that casting could start later on the day because of more rapid casting.

As mentioned in 4.4.6.1, in several cases, there were discussions about the influence of SCC on presumptive future costs for injuries (due to HAVS or poor ergonomics) and rehabilitation. Whether this is an incentive to the company or society, needs however, to be more investigated.

## 4.5 Discussion and conclusions

### 4.5.1 Characteristics of the field studies

The field studies, carried out within the research project, differ from SCC research in common with respect to various aspects. The main differences are:

- The presented studies have been conducted in field on real house-building projects where SCC has been implemented in full-scale and where the volumes of SCC have reached nearly 100% of the delivered ready-mix concrete
- A total perspective has been adopted, which includes analysis of practical/technical as well as production economy related consequences

Due to various practical reasons, limitations have had to be made with regard to SCC mix types, types of applications, number of measurements, quantification level of consequences etc. Below, variations of the most important parameters of the studied cases are listed:

- Formwork system
  - Precast concrete slab elements for permanent use (i.e. Filigran type)
  - Precast concrete shell-mould system for permanent use in walls
  - Cement-bonded particle boards, CBPB-system for permanent use in slabs and as shell-mould system for walls
  - Traditional removable wall system of steel
- w/c ratio
  - 0.45 to 0.60
- Mix additives
  - Limestone filler
  - Glass filler
  - No filler
- Adaptation level to SCC
  - SCC included within the early planning
  - NC replaced by SCC after project start
  - Contractor's earlier experience of SCC/ no experience of SCC
- Placing method
  - Pump
  - Skip
- Weather conditions
  - All seasons
  - Rain, wind
- Flooring materials (affecting RH required in concrete before floor covering)
  - Wooden floor of parquet type (on PE foil)
  - Ceramic clinker
  - Carpets of linoleum

In Table 4.16, the main differences between the four field studies performed are summarised with respect to the type of application where SCC was used, main properties of SCC and adaptation grade to SCC within the building projects.

*Table 4.16 Main differences between conducted field studies concerning type of application, main properties of SCC and adaptation grade to SCC.*

<b>Case study/ type of application</b>	<b>Main properties of SCC</b>	<b>Grade of adaptation to SCC</b>
<p><b>Case 1</b>            SCC slabs cast in-situ on precast concrete formwork elements for permanent use</p> <p>SCC walls cast in-situ in shell-mould wall system of precast concrete for permanent use</p>	<p>Powder type SCC (glass filler used mainly, which in the of the project was exchanged to limestone filler)</p> <p>w/c ratio 0.55</p> <p>Slump flow 610-690 mm</p>	<p>Project not adapted to SCC (e.g. varying slab heights and varying RH requirements over the slabs)</p>
<p><b>Case 2</b>            SCC slabs cast in-situ on precast concrete formwork elements for permanent use</p> <p>Precast homogenous concrete walls</p>	<p>Powder type SCC (limestone filler)</p> <p>w/c ratio 0.45 in ground slab w/c ratio 0.49 in other slabs</p> <p>Slump flow 680-710 mm</p>	<p>High adaptation grade to SCC (early planning and proper adaptation to SCC, e.g. not-varying requirements for slabs regarding heights and RH levels)</p>
<p><b>Case 3</b>            SCC slabs cast in-situ on formwork elements of CBPB (VST-system) for permanent use</p> <p>SCC walls cast in-situ in shell-mould wall system of CBPB (VST-system) for permanent use</p>	<p>Powder SCC (of limestone filler)</p> <p>w/c ratio 0.45</p> <p>Slump flow 540-600 mm</p>	<p>Moderate adaptation grade to SCC (partly apadapted to SCC regarding slab heights and RH-levels)</p>
<p><b>Case 4</b>            SCC slabs cast in-situ on precast concrete formwork elements for permanent use</p> <p>SCC walls cast in-situ in traditional dismountable wall formwork system</p>	<p>VMA SCC (no filler used)</p> <p>w/c ratio 0.55</p> <p>Slump flow 610-690 mm</p>	<p>High adaptation grade to SCC (early planning and proper adaptation to SCC, e.g. non-varying requirements for slabs regarding heights and RH levels) and high grade of experience of SCC</p>

## **4.5.2 Observed consequences of SCC – comments and main conclusions**

Below, effects of using SCC within the conducted field studies are presented. The effects are divided into the groups presented in 4.5.2.1.

The effects presented in sections 4.5.2.2 to 4.5.2.4 regard the contractor's point of view. Comments on each consequence are presented together with main conclusions, which focus on practical and production economical aspects.

Effects of SCC from the ready-mix concrete supplier's view are presented in 4.5.2.5.

### **4.5.2.1 Identification of observed main incentives and consequences regarding SCC use**

The results of the case studies showed both beneficial and negative consequences of replacing normal concrete by SCC. In order to sort out and distinguish various types of consequences, it was first important to identify *the type of incentive* to use of SCC. These can be divided into the following main groups:

1. Incentives based on SCC as a valuable 'special product'

SCC is used as a 'special product' for fulfilling special technical requirements, e.g. proper filling of densely reinforced and/or advanced designed structures, or silent castings with regard to protection of the neighbourhood. Both these factors are difficult to manage with ordinary concrete. Due to that the main aim of SCC utilisation is to fulfil such special technical requirements, economical consequences as for instance increased direct materials costs, are in general not high-lightened. Furthermore, it may also be difficult to economically quantify these types of incentives.

2. Incentives based on SCC as a cost-efficient 'standard product'

Then, SCC is used as a competitive 'standard product' with the aim of increasing the cost-efficiency of the building process. Economical consequences are set into focus, which means that cost-savings have to be larger than the direct materials costs -a requirement that probably is most efficiently solved if a total-economy perspective is adopted.

The majority of the incentives to SCC in the four cases studied belonged to the second type. For instance, they included incentives as for instance to achieve cost-savings since no screed was required due to the beneficial self-levelling effect of SCC. Examples of the first type of incentives were the use of SCC in walls using shell mould formwork systems in Case 1 and 3.

Furthermore, the following three *main types of consequences* from SCC use were observed:

1. Direct consequences of self-compaction (economically quantifiable)
2. Indirect effects of SCC (economically quantifiable)
3. Other consequences of SCC (non-economically quantifiable)

The first and second types of consequences were both possible to quantify economically but differed from each other depending on whether they were directly based on the self-compacting property of fresh SCC or indirectly through secondary effects of SCC (e.g. increased final strength).

The third type of consequence was primarily the opportunity for work-environment improvements, which was however not a primary incentive to SCC use in any of the cases. Instead, the improved work environment was seen as a ‘bonus effect’. If there had been a focus on the ability of achieving presumptive economical earnings concerning work environment (e.g. less costs for sick leaves and rehabilitation of concrete workers) the economical scenario might have been different and even more positive for the use of SCC.

In order to realise the potential positive effects of SCC, negative consequences caused by technical problems, have to be reduced/avoided. One way to reduce presumptive technical risks is to use well-developed ‘company-standardised’ concepts, which also may lead to maximum cost-efficiency. No such concepts were implemented in the cases.

#### **4.5.2.2 Direct consequences of self-compaction**

##### **Direct advantages**

- **Less need of finishing work and finishing materials (e.g. screeds) for slabs due to the self-levelling effect**

By utilising the more or less automatically achieved self-levelling effect of SCC, the requirements for high-quality levels may be fulfilled directly without the common costs for self-levelling flooring compounds, e.g. screeds. Presumptively, grinding has however to be performed to limited extent in order to avoid blowholes etc. Furthermore, elimination of screed may also lead to reduced costs concerning more rapid drying and reduced need for cleaning and ‘closing’ of floor areas.

*Conclusion: Due to the reduced or eliminated need of finishing materials/work when utilising the self-levelling effect of SCC, cost reductions of up to 50% of NC price were estimated.*

- **Rapid slab casting**

There are discussions whether SCC can generate direct cost savings due to the opportunity to decrease the need of manpower and/or to reduce the required time for casting. The amount of personnel during the casting moment obviously decreases since no vibration has to be done. Alternatively, the casting rate can be increased with the same amount of personnel and the casting time consequently reduced. The latter alternative enables further cost savings, e.g. reduced costs for pump rental.

In addition, SCC may lead to the need of more manpower for preparation of formwork (making this more strong and tight). It is clear that the possibility to reduce manpower to a large extent depends on the type of building project.

No direct economical benefit, based on reduced manpower need, was experienced in any of the cases, despite that reduction of casting time of up to 50% in comparison with NC was measured. However, when the castings started later in the day more time was achieved for preparation work etc, which led to reduced stress for the concrete workers.

*Conclusion: Potentially, cost savings of 5 to 10% of NC price were within reach when casting SCC slabs due to the reduced need of man hours per m<sup>3</sup>. However, to exploit this opportunity in practice, early planning of manpower has to be conducted.*

- **Less need of finishing work and materials of walls due to high-quality surface**

Well-designed SCC may lead to smooth vertical concrete surfaces with low amount of surface pores. Compared to an average concrete, SCC creates potential cost savings by reducing the often-needed finishing work of concrete surfaces. Worth to be mentioned is that the surface quality of vertical structures also depends on other factors (e.g. type of formwork and vertical raise), which may result in large variations in practice.

In Case 4 where SCC was used with removable wall formwork, increased need of finishing work was experienced, compared to when NC was used.

*Conclusion: In walls, the potential of SCC could not be exploited for high surface quality and thereby not for decreased costs for finishing work.*

- **Efficient wall casting**

Regarding vertical structures, e.g. walls, casting with SCC may enable increased concrete volumes cast per time unit. Much of the time spent on vibration work for traditional concrete may through SCC instead be utilised for placing of concrete. However, this potential advantage is somewhat dependent on the type of structure. For instance, casting of wall structures may be time demanding also for SCC due to the demand for slow rise of the concrete level in order to avoid concrete segregation, low-quality surfaces and/or high formwork pressure. It has turned out by practical experiences that SCC can be used with success for vertical structures but that more solid formwork may be required.

SCC is also beneficial with regard to the casting of advanced and geometrically complicated vertical structures. For instance, in cases where the structure is densely reinforced, traditional concrete in combination with vibration work is very time demanding and nearly impossible to manage in practice. In these cases, SCC can be utilised as a competitive method, and for some cases, as the only possible practical solution. One specific technical solution to advanced designed and vertical concrete structures (e.g. walls), is to pump SCC from below through special valves in the formwork and further letting the rising SCC automatically compact itself and fill the form.

Experiences from Case 1 and Case 3, where SCC was utilised in shell-mould systems for walls, showed efficient casting process, e.g with respect to time demand, need of manpower and risk of delays.

*Conclusion: In the same way as for slabs, there was a 'theoretical' possibility to reduce costs for manpower, i.e. 10 to 20% of NC price, when using SCC in walls.*

- **No/reduced costs for compaction equipment**

SCC use eliminates and/or reduces costs on site for compaction equipment. However, the cost savings are very restricted. Four days rental of vibration equipment corresponds to approximately the price for 1 m<sup>3</sup> of NC. Another opportunity is that SCC enables casting without need of electricity on site. Due to that NC was used partly in Case 1 and 3, costs for vibration equipment were not affected. In Case 2 and 4, where only SCC was used, cost savings could be observed.

*Conclusion: By avoiding rental of vibration equipment when using SCC, minor cost savings were generated.*

### **Direct disadvantages**

- **Increased concrete price**

The price for SCC was between 15 and 20% higher than the NC price. When making fair price comparisons between SCC and NC, it is important that concrete quality and w/c ratio correspond to each other and that regard is taken to what consistency class the compared NC has.

- **Increased costs for jointing materials and jointing work**

Due to the high fluidity of SCC, leach through formwork element joints may occur. The risk depends on the formwork system used and the consistency of SCC. Various methods was utilised in the cases in order to prevent leach. In Case 1 and 2, jointing compounds and/or mortar were placed on top of the joints between Filigran slab elements. In Case 4, SCC with reduced fluid was placed locally on Filigran slab joints. In Case 3, the tightness of the CMPB formwork system led to no disturbing leach.

*Conclusion: When SCC with high fluidity was cast on formwork elements of concrete, dense joints were needed but solved, however, through simple and cost-efficient methods.*



- **Difficulties when casting different slab heights**

Another experienced negative consequence of the high fluidity of SCC was the risk of leach under vertical formwork used for casting slabs with different heights, e.g. between wet rooms and other rooms. Due to that wooden formwork used traditionally for NC for this type of application lead to leach if SCC is used, NC was used in wet rooms in Case 1 and 3. In Case 2 and 4, SCC was possible to utilise in all slabs due to that special formwork was used locally in wet rooms.

*Conclusion: If NC not was used locally for low slab sections (e.g. wet rooms), special 'top' formwork had to be utilised in order to control the flow of SCC.*

- **Increased formwork pressure – decreased casting rate of walls**

The lateral formwork pressure of SCC might be considerably higher than that of normal concrete. Therefore, stronger formwork will normally be needed for vertical structures (walls, columns). Influencing factors on the formwork pressure are consistency, placing method, thixotropy effects and casting rate. The relation between these parameters and pressure has to be further investigated.

As a consequence of the potentially increased formwork pressure, the wall castings were divided into 2 parts (heights) for Case 1 and 3 parts for Case 3.

*Conclusion: In order to manage the presumptive risk of formwork collapse when casting SCC walls using formwork not designed for full hydrostatic pressure, the castings were divided into several parts (heights), which furthermore might have generated added costs.*

- **Poor surface quality of walls – increased need of finishing work and materials**

One potential benefit of SCC is the opportunity to achieve high-quality concrete surfaces of vertical structures, which reduces the costs for finishing work and surface repair materials. However, there are many examples of poor surface quality reported. Several factors may affect the quality of the concrete surface in a negative way. For instance, if the rise of the concrete front is too fast, entrapped air in concrete may not be released properly upwards but instead assemble at the surfaces, which may cause an unacceptably porous concrete surface. The type of formwork system and placing method may also affect the surface quality.

Case study 4 was the only study that included traditional dismountable formwork system. Due to that various surface qualities, some very unsatisfactory, were observed, SCC was exchanged to NC.

*Conclusion: When removable wall formwork was used with SCC, unsatisfactory surface quality occurred, which resulted in unwanted costs for finishing work. Concerning formwork system for permanent use, however, the problem is irrelevant.*

- **Increased requirements for on-time delivery**

SCC includes higher risk of layer tendency between castings due to that no vibration is made. Especially if fibres are used, there may be risk of non-homogenously dispersed fibres between the layers. Therefore, it is important that the deliveries are on time. However, there were no problems of this type observed.

*Conclusion: Due to that SCC was not vibrated, there were risks for that unwanted layers between cast SCC-deliveries could occur, which made it often more important to avoid delayed deliveries than if NC is used.*

- **Increased need of testing**

Although it is not required by the codes, SCC-testing is occasionally performed both at plant and on site, at least for the first deliveries of each casting. When implementing a new recipe though, rheological testing of fresh SCC is conducted frequently, at least at plant. SCC-testing may lead to delayed deliveries and thereby there are risks of affecting the casting process negatively.

#### 4.5.2.3 Indirect effects of SCC

##### Indirect advantages

- **The ‘filler effect’**

SCC including increased amount of powder, e.g. limestone filler, normally leads to improved strength in comparison with NC with the same cement content and w/c ratio. Both more rapid strength development and increased final strength are normally achieved. Increased strength development may affect the production economy positively through potential earlier formwork stripping and smaller costs for winter protection methods. An increased final strength may be beneficial with regard to bearing capacity. Alternatively, an increased strength class based on the ‘filler effect’ enables a reduction of the cement content.

In all studied cases, SCC gave higher strength than was required with respect to structural design. This was an effect of requirements of maximum w/c ratio (especially in Case 3) combined with the ‘filler effect’. This ‘over strength’ was not planned to be exploited for more rational production in any of the Cases. However, the effect was advantageous under winter conditions.

*Conclusion: The ‘over strength’ of SCC, generated from the ‘filler effect’, enabled potential for reduced production cost, which was mainly exploited wintertime.*

- **Rapid drying**

There are in general several examples showing that SCC might lead to more rapid drying than NC with corresponding w/c ratio. Some research of drying of SCC has been made that strengthens this effect especially for SCC including limestone filler. Other research, however, does not show any difference between drying of SCC and NC. More research on drying of SCC is needed.

At constant strength, SCC containing limestone filler may cause longer drying times than for normal concrete, which depends on the fact that the w/c ratio can be increased in SCC.

In all studied cases the drying rate of SCC was interpreted as more rapid or equal to NC. RH measurements in both NC and SCC slabs were conducted in Case 2, which showed 20% more rapid drying of SCC despite 7% thicker slab.

*Conclusion: Use of SCC enabled more rapid drying than NC used, which furthermore generated possibilities for reduced production time.*

### **Indirect disadvantages**

- **Increased need of curing (increased plastic shrinkage cracking)**

SCC may lead to increased early plastic shrinkage cracking in comparison with NC. Especially SCC with large amount of fines, e.g. limestone filler, and/or low w/c ratio leads to less bleeding, which increases the risk of early cracking. Besides, the surrounding climate conditions influences the plastic shrinkage cracking to large extent. The dryer the conditions are, the larger the risk of cracking. Therefore, efficient methods for avoiding plastic shrinkage cracking are to cover the fresh concrete with PE-foil, to use water curing or to use membrane curing. Alternatively, PP fibres mixed into the concrete, can be used in order to reduce the crack width. However, these methods are only occasionally utilised for ordinary slabs in residential multi-storey buildings, where requirements regarding crack width seldom are set.

Of the studied cases, Case 3 showed significantly higher grade of plastic shrinkage cracking (due to lower grade of bleeding), especially when low w/c ratio was used.

*Conclusion: There were examples of that SCC (especially with low w/c ratio) resulted into increased plastic shrinkage cracking, which not necessary must lead to added costs due to that requirements for crack width seldom is actual within house-building applications.*

- **Increased need of cracking reinforcement**

The need of cracking reinforcement may increase since SCC may lead to higher long-term shrinkage cracking caused by the somewhat increased drying shrinkage, especially when the filler content is high. Another reason for increased reinforcement is the increased tensile strength due to the 'filler effect'. However, as mentioned with

respect to plastic shrinkage cracking, there are seldom requirements set for maximum allowed crack width in house building.

*Conclusion: When SCC was used, the need of cracking reinforcement might increase, which for applications in house-building has minor practical and/or minor economical importance.*

- **Retardation effects regarding strength development in cold climate conditions**

The strength development of SCC may be retarded under cold climate conditions in comparison with NC with the same cement content. The main reason is related to higher amount of superplasticisers in SCC. Retardation may lead to increased need of winter protection and extended formwork stripping time.

Another disadvantage of the retardation effect is that it is difficult to utilise the self-levelling effect on concrete that not has hardened.

Heating from beneath and utilising the ‘filler effect’ and/or using a low w/c ratio may solve the retardation problem, which was demonstrated in as for example Case 3.

*Conclusion: SCC casting under cold climate may lead to increased production costs in cold climate conditions due to risk of retardation of the early hydration.*

- **Setting cracks**

In comparison to plastic shrinkage cracks, which are ‘wild’, setting cracks often are located parallel with and above reinforcement bars. Normally, this type of cracks occurs due to concrete segregation (or settlement), which is most common for higher w/c ratios and/or SCC without high content of fines. Setting cracks were observed in Case 1. Another reason is the chemical shrinkage due to early cement reaction.

*Conclusion: In the same way as for plastic shrinkage cracks, setting cracks (that may be a result of SCC use) had strongly limited practical and/or economical importance due to that requirements regarding maximum allowed crack width seldom is set within house-building.*

#### **4.5.2.4 Other effects of SCC (non-economically quantifiable)**

##### **Other non-economically quantifiable *advantages***

- Improved work environment

SCC use leads to several work-environmental advantages, e.g. eliminated risk of hand-arm vibration syndrome (HAVS), decreased noise, improved ergonomics, increased safety by improved communication and increased work satisfaction. Despite the potential for reducing costs for sick leaves, it is difficult to economically quantify the effects.

In all case studies, the work-environmental improvements were obvious for both the concrete workers and the project managers. Any measurable economical benefits addressing the work environmental potential of SCC could however not be obtained. If the ability to improve the work-environment is to be utilised as an economical benefit, a total-economy view including a longer perspective probably is needed and the following steps recommended to be taken:

- Exchange from project economy to contractor economy
- Exchange from contractor economy to society economy

*Conclusion: The work environment was significantly improved when SCC was used, addressing the potential for no risk of HAVS, decreased noise and improved ergonomics -benefits that were impossible/difficult to economically quantify.*

- New possibilities to cast narrow and densely reinforced sections

SCC use enables opportunities to cast structures that are impossible or difficult to cast properly with NC. Due to the high filling capacity of SCC, also for congested structures, proper quality of the hardened concrete and easier scheduling of castings are achieved.

This advantage was experienced especially when placing SCC in the shell mould wall systems used in Case 1 and 3.

*Conclusion: SCC enabled casting of congested structures (e.g. shell-mould walls) that would have been difficult/impossible to cast with NC.*

- Less noise for surrounding neighbourhood

There are also advantages for the nearest surroundings to the building site when SCC is used. Due to the eliminated noise of concrete vibrators, significantly more silent castings are enabled when comparing to NC castings. Furthermore, this advantage creates competitive opportunities to cast at evenings/nights in city areas.

*Conclusion: Use of SCC had less negative impact (than NC) on the acoustical environment of the neighbourhood to the building site.*

### **Other non-economically quantifiable disadvantages**

- Risk of improper performance in the fresh state

SCC may lead to consistency variations, concrete segregation, loss of self-compacting ability etc. The most common explanation to these effects is based on the increased sensitiveness to moisture variations of the mix ingredients of SCC in comparison with NC.

Despite minor consistency variations, no serious complications were experienced in any of the case studies. However, the type of application is important regarding presumptive consequences from improper consistency. As for instance, civil

engineering structures are in general more densely reinforced and higher technical requirements are often set with regard to the properties of the hardened concrete.

*Conclusion: Although SCC in common is more sensitive than NC to improper performance in the fresh state no important negative consequences were observed.*

- Increased building process related requirements

Proper planning and high adaptation grade is essential both for utilisation of the full potential of SCC and for avoiding presumptive technical problems. If potential synergy effects, like reduced finishing costs and more rapid drying, are utilised, the possibility increases for SCC to be a standard product instead of a special product.

The grade of SCC utilisation differed between the case studies. The observed variations between the cases regarding utilisation were mainly based on when SCC was introduced into the projects. However, the dialogue between the contractor and ready-mix supplier was appeared to be more frequent than when NC is used, both before and during the castings.

*Conclusion: In order to exploit the full potential of SCC and reduce the risk of unwanted negative consequences, proper planning and high adaptation grade with regard to SCC was favourable.*

#### **4.5.2.5 Consequences of SCC for the concrete supplier**

The SCC consequences discussed above consider mainly the contractor. In addition, other actors may be affected as well. Below, presumptive consequences of SCC production for the ready-mix concrete supplier are listed:

##### **Advantages of SCC for the concrete supplier**

For the ready-mix concrete supplier, SCC may be a beneficial product in several ways. As for instance, the following opportunities may be created:

- Ability to avoid loss of market shares to competing materials, by:
  - Offering a cost-efficient product
  - Managing lack of concrete workers
  - Improving the work environment on site
- Increased income (due to higher price of product)
- Increased customer knowledge and interest of concrete materials technology in common

*Conclusion: SCC may be a beneficial product for the ready-mix concrete supplier by retention/increase of market shares, improved customer contact and increased profits.*

## **Disadvantages of SCC for the concrete supplier**

There are also presumptive negative economical consequences of SCC production for the concrete producer:

- Increased costs for constituent materials of SCC (e.g. admixtures and LS filler)
- Increased costs for SCC production (e.g. requirements for extra silos)
- Decreased productivity (longer mixing times and added testing needed in comparison to NC)
- Increased risk taking (extended responsibility 'in practice' for the product performance on site)

*Conclusion: For the ready-mix concrete producer, SCC may also lead to added production costs, decreased productivity and increased risks.*

# 5. FULL-SCALE TESTS OF SCC TOP LAYERS AS REPLACEMENT FOR SELF-LEVELLING SCREED CAST ON PRECAST HOLLOW CORE SLABS

## 5.1 Introduction

### 5.1.1 Background

In Chapter 4 ‘Field tests of structural frame production with cast in-situ SCC’, the investigated structural frames were conventional slabs with a thickness of typically 180 to 220 mm cast in-situ on formwork for permanent use, e.g. precast concrete elements of Filigran type (thickness of typically 45 mm) or cement-bonded particle boards (CBPB) with a thickness of typically 22 mm.

In this chapter, the investigated type of structural frame includes significantly thinner layers of SCC, i.e. slabs with a thickness of 55 to 70 mm. These ‘thin’ SCC slabs act as replacement for screed and are cast on precast and pre-stressed hollow core slabs (HD/F elements) that are typically 265 mm thick. Figure 5.1 shows a cross-section of the investigated type of structure.

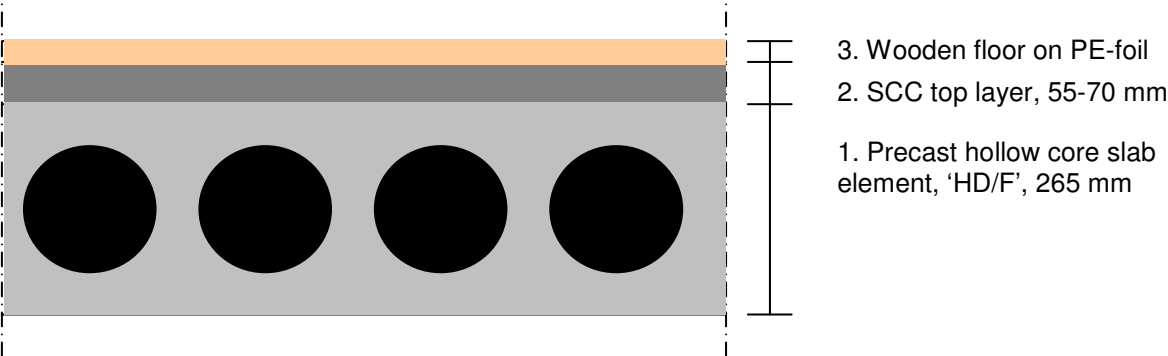

Figure 5.1 Cross-section of the investigated type of structure, i.e. top-layer of SCC cast in-situ on precast hollow-core slab.

When comparing the requirements of structural frames in multi-storey office buildings with multi-storey residential buildings, there are important differences regarding as for instance requirements considering acoustics, slab spans, installation aspects, floor covering materials etc. For example, in multi-storey office buildings it is common that a self-levelling screed with a thickness between 10 and 15 mm is placed on the HD/F elements to level and balance the ‘over-height’ of the slab field caused by the pre-stressed reinforcement. Electrical runs are normally concealed above the inner roof panels. In multi-storey residential buildings however, the cast layer normally has to be thicker due to the required acoustic quality class and due to that installations normally are cast and concealed within the top layer inner roof panels are seldom used for aesthetic reasons. Alternatively, some type of ‘sub-floor system’ on girders can be used, see Figure 5.2.





*Figure 5.2 As alternative to top layer of concrete cast in-situ or self-levelling screed, some type of sub-floor system on steel girders can be used.*

When comparing thin un-reinforced concrete overlays (thinner than 100 mm) cast on bearing elements with homogenous thicker conventional and reinforced concrete slabs (i.e. 180 -280 mm), there are important differences concerning the risks of defects. Improper bond between a top layer and an element lead to that the top layer tends to curve during drying. Tensile stresses occur in the overlay, and the risk of cracking in this increases. If the cracks are continuous to the element beneath, there is risk of edge lifting. See Figure 5.3. Extensive studies of bond between concrete overlays and old concrete have been performed by Silfwerbrand. See as for instance Silfwerbrand (1987, 1996). Edge lifting has been studied by Buö and is reported in, as for instance, Buö (1973).

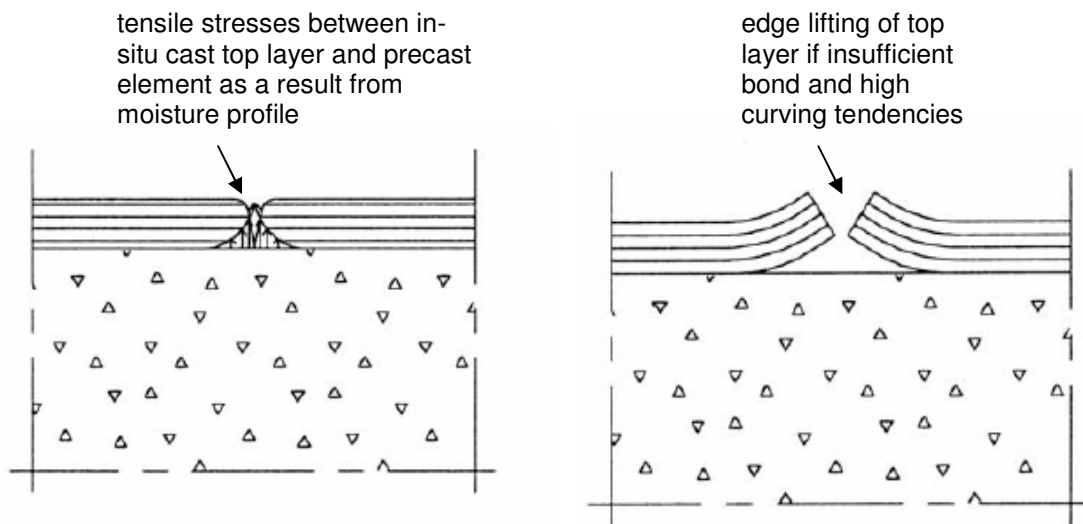

*Figure 5.3 Edge lifting of an overlay cast on a stiff element (figure according to Betongvaruindustrin, 2005).*

For practical reasons, loss of bond and edge-lifting effects are not wanted mainly due to presumptive reduction of acoustic performance. The quality of the floor surface may be affected negatively as well.

Precast concrete formwork systems (e.g. of Filigran type) include an anchorage system for the slab cast on top. The reinforcement of cast slabs on formwork elements is thereby anchored in

the formwork element. Besides, the formwork element is much thinner than the slab cast on top. These factors make edge lifting impossible. However, for hollow core elements there are no such anchoring system. This, together with the significant moisture profile of thin slabs lead to that the risk of edge lifting is larger in thin slabs.

When using a self-levelling screed, the risk of edge lifting is less than when using a concrete overlay. This depends on that such a screed normally leads to proper bond due to that screed has lower strength and higher ductility, and therefore less cracking tendency compared with traditional concrete. For very thin layers (i.e. 10 to 30 mm), self-levelling screed has become a standard product in Sweden in order to achieve proper level and surface quality before floor covering (using e.g. linoleum carpets, ceramic or wooden floor).

However, screed layers with thickness of typically more than 50 mm may cause problems. It is sometimes difficult to predict the moisture performance of thick screed layers. There are many examples where the required drying time has been strongly increased in comparison to the estimated. Another disadvantage of thick layers of screed is the high cost in comparison to ready-mix concrete. Consequently, there is a potential for use of ready-mix concrete in un-reinforced top layers on concrete elements as for instance hollow core slabs, based on presumptive lower direct materials costs and faster/safer drying. In addition, there are, as described in Chapter 4, potential cost savings if SCC is utilised instead of traditional concrete. Except the potentially more rapid casting process that may reduce the manpower need, there is also the opportunity to achieve high-quality surfaces directly. Conventionally, a 10-20 mm thick layer of self-levelling screed on the concrete is needed in order to fulfil the requirements regarding surface level quality. If the self-levelling effect of SCC can be utilised, the need of screed is eliminated. Furthermore, SCC may lead to more rapid drying due to the dense structure that affects the sorption isotherm positively. See paragraph 3.3.7.

However, the increased risk of cracking and edge lifting, when SCC is used instead of normal screed, must be controlled. Otherwise, there are risks of strongly increased costs due to repair work. The risks of poor bond and edge lifting may be more imminent for SCC than for NC due to the increased shrinkage and increased strength of SCC. There are however several methods to decrease the risks, e.g. use of shrinkage reducing additive and increasing the bond by increasing the roughness of the element surface, e.g. by brushing the fresh concrete surface or exposing the aggregate.

The chapter describes four conducted full-scale tests where thin top layers of SCC are cast on hollow core elements. The result is analysed with regard to the applicability of SCC in these types of structures as a competitive alternative to the traditionally used self-levelling screed that is used in common. Technical, practical as well as economical aspects are regarded.

## **5.1.2 Aim and goals**

The aim of the study is to estimate the practical/technical as well as the economical potential of 'thin' un-reinforced top layers of SCC as replacement for expensive self-levelling screed cast in-situ on precast and pre-stressed hollow core slab elements. As sub goals, the effects of shrinkage-reducing additive and increased element surface roughness on several technical factors (e.g. shrinkage cracking, poor bond and edge lifting) are investigated in the full-scale tests.

### **5.1.3 Layout of the test programme**

Full-scale tests have been conducted where SCC in ‘thin’ top-layers with thickness between 55 and 70 mm have been cast in-situ under ‘real’ conditions as regards ready-mix concrete production, transport, placing and finishing methods. In Table 5.1, main characteristics of the conducted full-scale tests are presented. The tests have been performed under various climate conditions regarding temperature and relative humidity of the surrounding air. Specimens with areas of approximately 10 x 3.6 metres have been used in all full-scale tests except in Test 1. Many different measurements have been made; shrinkage cracking, bond between top layer and under-laying element and RH development have been studied in order to estimate the effect of different procedures on risk of edge lifting. In addition, the surface quality/level of the slabs has been measured to verify that no extra screed is needed to fulfil the requirements with regard to level and evenness. Furthermore, various methods regarding the risk of edge lifting have been applied and their influence estimated, e.g. the effects of shrinkage reducing additive, increased element surface roughness and optimised mix-design with regard to shrinkage and strength properties. Also economical aspects of different procedures have been considered. Costs for SCC versus traditional concrete and/or screed have been compared. Both direct materials and synergy effects from a total point of view have been included.

In order to achieve realistic levels of shrinkage cracking, stress and edge lifting, the tests have been conducted in full-scale. Due to practical reasons, e.g. amount of available test local space, the number of tests have had to be limited.

Table 5.1 Main characteristics of full-scale tests of 55-70 mm thick SCC-overlays.

Test	Specimen	Concrete	Climate	Measurements /estimations
	Number of specimens and type of element surface	Size of each element		
1	6 (totally) 2 smooth 2 'lightly' brushed 2 brushed	6 m <sup>2</sup>  1.2 x 5	SCC with/without steel fibres, w/c 0.60, LS filler, CEM I 52.5 R, max aggr. size 8 mm, slump flow 650-710 mm,	Average RH 60% Average temp. 15 °C Ocular observations: cracking, edge lifting, surface quality
2	1 brushed	36 m <sup>2</sup>  3.6x10m	SCC, w/c 0.55, LS filler, CEM I 52.5 R, max aggr. size 11 mm, slump flow 600-650 mm	Average RH 30% Average temp. 22 °C Ocular observations: cracking, edge lifting, surface quality  Measurements: RH in top-layer concrete, bond, compressive strength, surface level quality, manpower need, production economy
3	2 (totally) 1 brushed (and anchored) 1 exposed aggregate	36 m <sup>2</sup>  3.6 x 10	SCC, with/without Shrinkage – reducing additive (SRA) w/c 0.55, LS filler, CEM II/A-L 42.5 with 13% LS-filler, max aggr. size 11 mm, slump flow 600-660 mm	Average RH 65%, Average temp. 22 °C Similar to Test 2
4	2 (totally) 1 brushed 1 exposed aggregate	36 m <sup>2</sup>  3.6 x 10	SCC, SRA, w/c 0.55, LS filler, CEM II/A-L 42.5 with 13% LS-filler, max aggr. size 11 mm, slump flow 600-650 mm	Average RH (same as Test 2) 65%, Average temp. 15 °C

## 5.2 Full-scale test 1

### 5.2.1 Introduction

The main aim of the first test was to investigate the risk of edge lifting and insufficient bond, as influenced by the quality of the surface of the substrate element. Therefore, three types of HD/F element surface structures with varying roughness were used.

In order to simulate ‘real conditions’, the test was conducted with ready-mix SCC transported by truck and placed on prefabricated and cured HD/F elements in a test local. The specimens were stored indoors for continuous observation regarding shrinkage cracking and edge lifting effects.

### 5.2.2 Method

The full-scale test included 6 different specimens consisting of 70 mm thick top layer of SCC cast on six different HD/F elements. See Figure 5.4. Each element was 5 meters long and 1.2 m wide. With the aim to examine the influence of surface roughness on the bond, three types of element surface were used, i.e. original (smooth), ‘lightly’ brushed and ‘heavy’ brushed. Formwork of plywood was used. Ready-mix SCC, transported by truck, was used in order to simulate ‘real’ conditions. Furthermore, concrete were placed by chute. Before placing of SCC, the HD/F elements were ‘lightly’ pre-moistened.

The SCC mix was designed to fit the type of application, i.e. thin layer (thickness 55-70 mm). Therefore, the maximum aggregate size was reduced to 8 mm instead of the normally used maximum size, 16 mm. To achieve proper robustness, limestone filler was added to the SCC-mix. The w/c ratio was chosen to 0.60 in order to reduce the strength of the hardened layer as well as to limit the plastic shrinkage cracking. In addition, the cement used was of type rapid-hardening in order to reduce the risk of plastic shrinkage cracking (see Friberg, 2002). Furthermore, SCC both with and without steel fibres was used. The test specimens were stored in surrounding temperature of approximately 15°C and at rather dry climate, 60% RH (indoors in a hall used for storage of precast elements) for 5 weeks. See Figure 5.4.

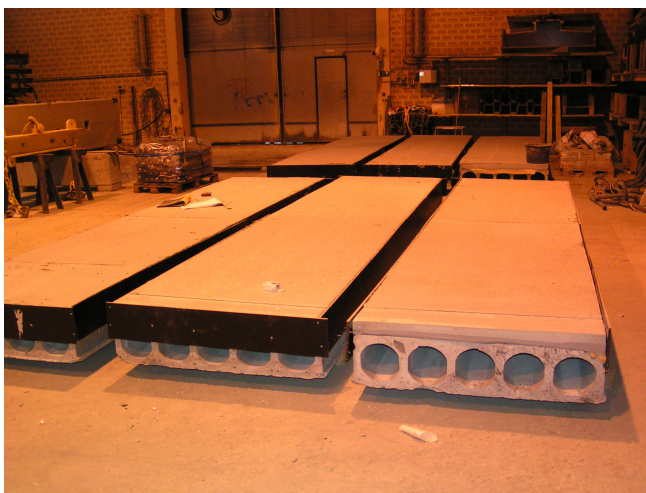

*Figure 5.4 The test specimens incorporating SCC top layer cast on HD/F elements were stored in a hall also used for storage of elements from normal production.*

### 5.2.3 Result

One day after casting, plastic shrinkage cracking was observed to a very limited extent. During the test period lasting for two months, no new drying shrinkage cracks were observed. The climate conditions could be described as 'medium warm' and 'medium humid'. Still after four months, no edge lifting effects were observed on any of the specimens. With regard to cracking tendencies, only small differences were observed between the different element surface types and between SCC with and without steel fibres.

### 5.2.4 Discussion/conclusions

There were no significant differences observed concerning the effects of the methods used in order to reduce the plastic and drying shrinkage cracking and to eliminate the risk of edge lifting. There are several presumptive explanations to the result, e.g:

- The specimens may have been too small (even though they were 5 x 1 m) for leading to enough high shrinkage stresses to cause bond fracture and edge lifting
- The chosen SCC mix (including rapid cement and high w/c ratio) together with the favourable indoor climate (no wind, no direct sun light, moderate temperature and humidity) may have led to low risk of plastic shrinkage cracking
- The favourable surrounding climate conditions may have led to slow drying of the concrete, which led to slow drying shrinkage and possibility to relax bond stresses.

As mentioned, the primarily aim of the first full-scale test was to investigate the risk of edge lifting due to presumptive insufficient bond in combination with drying shrinkage stresses. Also the effect of steel fibres on drying shrinkage cracking and edge lifting was to be studied. The result showed that it was possible to avoid disturbing shrinkage cracking and edge lifting irrespectively of how the element surface was prepared or fibres were used or not -a result that was not expected. Due to practical limitations, no reference concrete (i.e. ordinary house-building concrete) was included in the tests. Furthermore, no RH measurement in the top layer concrete was.

In order to further study presumptive negative shrinkage and bond effects, it was decided that in Test series 2, warmer and dryer climate conditions, more representative for normal conditions in the building during its use, were going to be tested together with larger specimen size. See 5.3 'Full-scale test 2'.

## 5.3 Full-scale test 2

### 5.3.1 Pre-study to Full-scale test 2

#### 5.3.1.1 Introduction

Before the start of Full-scale test 2, laboratory studies were conducted with the aim of investigating the drying performance of SCC with various w/c ratios containing limestone filler. The main reason was that there were contradicting requirements of the SCC-mix regarding drying and shrinkage performance. Firstly, the SCC mix had to fulfil the requirements regarding disadvantageous shrinkage and bond effects. As for instance, SCC with high w/c ratio may lead to less plastic shrinkage as well as less rapid drying shrinkage due to the decreased cement content. Secondly, the chosen SCC had to fulfil the requirements on reaching required moisture level before floor covering. SCC with low enough w/c ratio was needed for the latter reason. One way to solve the problem is to utilise the presumptive beneficial effect of limestone filler on the drying performance of SCC. It has been reported (Norling-Mjörnell, 2003) that SCC containing limestone filler may accelerate the RH-decrease for normal mixes with the same w/c ratios during the same drying conditions. One explanation may be that the presumptive finer structure of SCC that contains limestone filler leads to that more water is physically bonded in comparison to the case of normal concrete.

With the aim to optimise the SCC for Full-scale test 2, SCC with relatively high w/c ratio was tested with regard to the possibility to avoid plastic shrinkage and bond problems but to fulfil requirements on rapid drying. This was done as a pre-study where the presumptively beneficial effect of limestone filler was investigated under laboratory conditions.

#### 5.3.1.2 Test method

In the first lab series, three SCC mixes were tested with w/c ratios 0.50, 0.55 and 0.60. Limestone filler was included in all mixes. In comparison to the mix recipe used in Full-scale test 1, the maximum aggregate size of Full-scale test 2 (where the aggregate was taken from a different geographical area) had to be increased from 8 to 11 mm in order to avoid unsatisfactory rheological performance of the fresh SCC. To simulate single-sided drying, plastic buckets were filled with SCC. The thickness of the concrete layer was 70 mm in all buckets. The buckets were stored in a surrounding climate of 18°C air temperature and 30% air RH with the aim of simulating the predicted climate conditions in the following full-scale tests. The RH-development on the equivalent depth (40% of the total thickness measured from the top surface), which is approximately 3 cm from the top surface (according to AMA 98' (Swedish Building Centre, 1998) was measured continuously by using loggers and RH sensors placed in drilled holes. See figure 5.5.

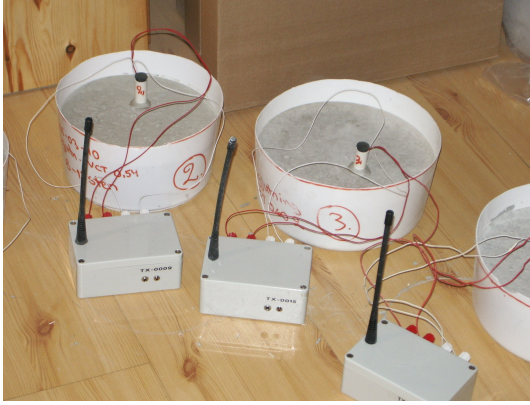

Figure 5.5 RH-measurement of specimens in laboratory conditions.

### 5.3.1.3 Result

After four weeks, RH on the equivalent depth decreased to 88% or lower in all three samples. The result of the pre-study showed significantly faster drying in comparison with calculations (using TorkaS 1.0, 1998) performed for ordinary concrete with the same w/c ratio, the same thickness, the same single-sided drying and correlating climate conditions but without limestone filler.

### 5.3.1.4 Discussion/conclusions

The main goal of the pre-study was to find a SCC mix with as high w/c ratio as possible (in order to minimise the risk of edge-lifting effects) but that despite this fulfilled the drying requirements, i.e. RH 90% or lower within five weeks after casting. This became a target value for all next-coming full-scale tests. The result of the pre-study showed that the goal was possible to fulfil climate conditions that were assumed to correlate well with the climate conditions in the next-coming full-scale test. Furthermore, the result of the laboratory tests indicated a more rapid drying than predicted for ordinary concrete without limestone filler. In fact, the w/c ratio 0.60 should be low enough to fulfil the drying requirements but due to unacceptable performance of the fresh SCC, 0.55 was judged to be more suitable. There was also the risk of that real climate conditions in a building could be less beneficial regarding drying.

Worth to be mentioned is that if the requirements of reaching 90% RH within five weeks are set, the presumptive waiting time until proper drying climate conditions are reached, must be considered. As for instance, climate conditions outdoor including low temperatures and rain may delay the total drying time significantly.

## 5.3.2 Full-scale test 2

### 5.3.2.1 Introduction

‘Full-scale test 1’ illustrated that there was a potential of un-reinforced SCC top layers cast on HD/F elements for achieving limited shrinkage cracking and no edge lifting. However, the positive result of the first full-scale study might depend on the fact that too small specimens



were used and the climate conditions were too favourable (too cold, too humid). With the aim of more safely evaluate the risk of achieving heavy shrinkage cracking, improper bond and edge lifting, it was decided to change the conditions by making efforts to accelerate drying shrinkage and its speed. Therefore, in comparison with 'Full-scale test 1', the second full-scale test was conducted under warmer and dryer climate conditions. Moreover, potentially more realistic conditions were evaluated in the second test, e.g. increased specimen size and specimens that included joints and electrical installation tubes.

In order to examine the influence of shrinkage and bond on the risk of edge lifting, RH development of the cast top layer and the bond between the HD/F element and the top layer were measured. The surrounding RH and temperature in air were measured as well.

### 5.3.2.2 Method

Due to practical restrictions, e.g. available testing area, only one specimen was evaluated containing non-reinforced top layer of SCC cast on a hollow core slab. On the other hand, this specimen was of major size (10 x 3.6 metres) and included both element joints filled with mortar and electrical installation tubes (see Figure 5.6).

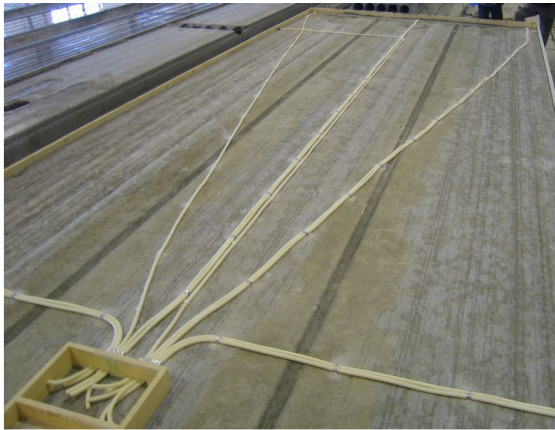

*Figure 5.6 Specimens used within the full-scale test 2 incorporated cast joints and installation tubes with the aim of achieving proper simulation of 'real' conditions.*

To simulate as 'real' conditions as possible, the concrete was transported from the ready-mix concrete plant by truck to the testing hall. The concrete was placed by skip and finished by professional concrete workers using laser and skip floating. See Figure 5.7.



*Figure 5.7 SCC full-scale casting simulating 'real' conditions.*

The SCC used was of the same type as the SCC mix with w/c ratio of 0.55 described in section 5.3.1. Briefly, this SCC can be characterised as a mix containing LS filler (with the aim to achieve a robust mix in the fresh state as well as rapid drying properties without needed w/c decrease), maximum aggregate of 11 mm (with regard to the thin structure) and rapid hardening type of cement (aiming at reducing the risk of plastic shrinkage cracking).

In order to achieve potentially increased bond between the elements and the top layer, brushed surfaces of the elements were used. The production method for these surfaces was developed to suit the ordinary production process of hollow core slabs. By using a special brush on the hollow core element production machine, the rough surfaces were achieved automatically. In addition, the element surfaces were cleaned properly before the casting of the top layer. Thereafter a primer was applied on the elements. To minimise the risk of early shrinkage cracks, a wax-based membrane-curing agent was applied on the cast top layers (approximately 30 minutes after casting).

The day after casting, the surfaces were lightly grinded (using floor grinding machine) in order to eliminate presumptive tops and achieving a high-quality surface with respect to smoothness.

During the test, several measurement methods were used. In order to estimate the properties of the fresh SCC, rheological methods were conducted, e.g. slump flow and T 500. Hardened concrete properties of SCC, as for instance cube strength, development of average RH of the total top layer thickness of drilled cores plus RH logging at the equivalent depth 30 mm from the top surface and bond between the top layer and element were measured (using pull-out test). Shrinkage cracking behaviour was followed by ocular observations and cracking width measurements were made by crack microscope. During the testing period, the surrounding climate conditions, i.e. air RH and air temperature were logged. Finally, tendencies to edge-lifting were estimated acoustically by mechanical knocking and by direct ocular observations. For estimation of the total economical potential of SCC used in top layers, the surface level quality was measured. Also practical aspects were observed, e.g. production time required and work environmental aspects.

### 5.3.2.3 Result

In comparison to the first test, early shrinkage cracking was observed to larger extent within 12 hours. The cracking was not evenly spread over the whole slab. There was a tendency to increased cracking in the part of the overlay that was cast latest. This may to some extent be explained by concrete segregation (which was observed on the drilled cores) that led to increased paste fraction in the surface layer. The segregation might depend on that the concrete was placed by skip with an inbuilt vibrator.

Concerning the surfaces, the level quality was estimated by measuring the distance between the concrete surface and a straight steel ruler (see Figure 5.8). The requirements before floor covering due to 'AMA 98' (Swedish Building Centre, 1998) were fulfilled. However, despite this, the concrete surface was lightly ground (using floor grinding machine) in order to eliminate presumptive tops and blow holes.



*Figure 5.8 The potential of the self-levelling effect of SCC was verified by estimating the level quality of the hardened concrete surface, which directly, i.e. without additional self-levelling screed, fulfilled the requirements according to 'AMA 98' (Swedish Building Centre, 1998).*

After 14 days, few but large drying shrinkage cracks were observed. The maximum crack width was approximately 0.7 mm. See Figure 5.9. The RH-measurement showed very rapid drying due to the rather high w/c ratio. After 14 days, RH on the equivalent depth decreased to 86%. Any edge-lifting tendency was not observed though. When casting the top layer, the RH of the hollow core elements was measured to 79%. The elements had been pre-stored for 4 weeks at the same climate conditions during the test.

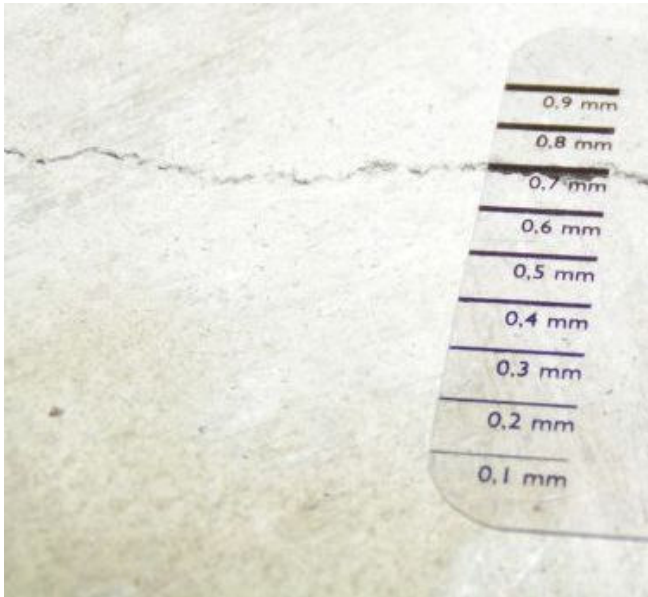

Figure 5.9 Drying shrinkage crack observed after 14 days.

One week later, i.e. totally three weeks after casting, same tendencies to edge lifting could be observed acoustically by mechanical knocking. Finally, five weeks after the casting, significant edge lifting was observed after dismantling the formwork. See Figure 5.10 that shows a section with both a continuous drying shrinkage crack and edge lifting.

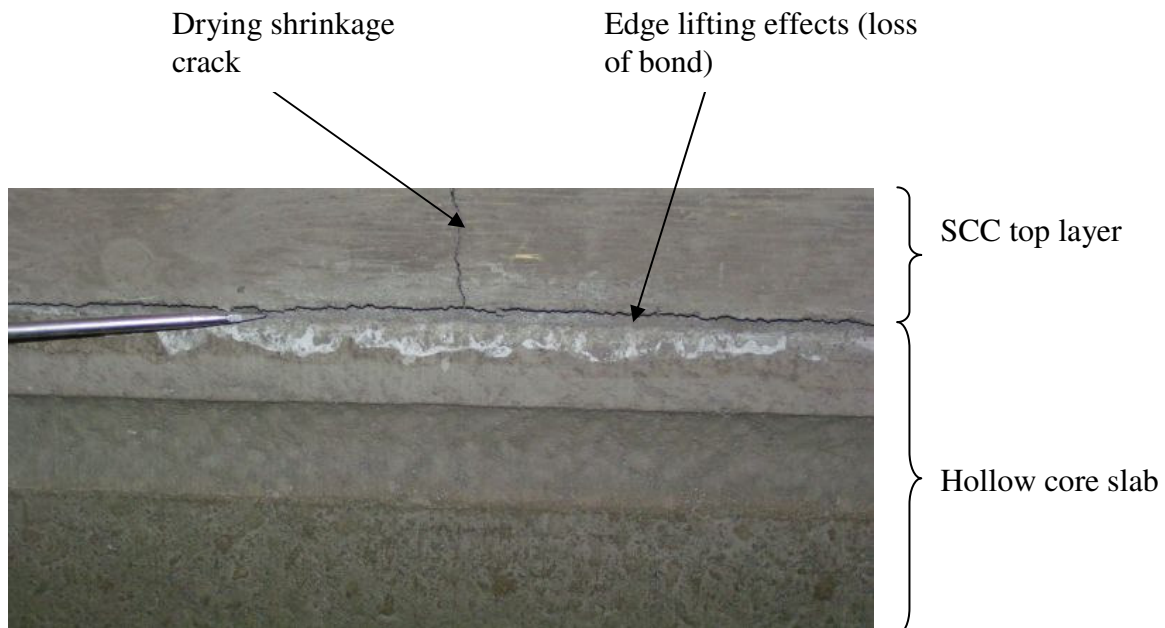

Figure 5.10 After dismantling the formwork, heavy edge lifting could be observed five weeks after casting.

The bond between the HD/F element and the top layer was measured using pull-out test. Bond was shown to be low. For several cores, total fracture occurred within the interface between the top layer and the element. See Figure 5.11 that also shows that the filling beneath the electrical tubes was proper.



*Figure 5.11 Fracture of cylinders when bond testing occurred totally within the interface between the HD/F element and the cast top layer. Note the proper filling beneath the installation tube though.*

The result of the second full-scale test can be summarised as follows:

- The casting process of the top layer was rapid due to eliminated vibration moment
- Plastic shrinkage cracking did occur to a limited extent
- The surface level quality of the hardened top layer correlated well with requirements according 'AMA 98' (Swedish Building Centre, 1998) *before* edge lifting occurred
- Significantly rapid drying of the top layer led to a RH level of 86% (average value measured on drilled cores), 14 days after the casting
- Few but relatively large drying shrinkage cracks did occur after 14 days
- Edge lifting was observed at both the original edges of the slab and along the drying shrinkage cracks. Thereby, the surface level quality was negatively affected.
- No, or very low bond was measured

#### **5.3.2.4 Discussion/conclusions**

The positive result concerning the efficient casting process and the high quality of the hardened surfaces was counteracted by the negative effects of shrinkage cracking and edge lifting occurred. The presumptive explanation to these negative effects are based on that the SCC mix had high shrinkage caused by high paste volume and small aggregate volume compared to ordinary concrete and that the climate conditions were very dry and warm. The very rapid drying of the concrete led to rapid and big shrinkage. The shrinkage stresses had no

time to relax. Further, the chosen SCC mix led to high strength that combined with big shrinkage give high bond stresses that may affect the bond negatively. High strength of the concrete requires high bond levels if bond failure and edge lifting shall not occur. The use of primer may have contributed to reduced bond.

Based on the second full-scale test, the following main conclusions were made:

- SCC single top layer may lead to high-quality surface level directly without any need of additional screed
- SCC including LS filler may lead to rapid drying also when the w/c ratio is normal
- Despite precautions, e.g. increased roughness of the HD/F-element surface (brushed surfaces), use of membrane curing agent and primer, there are risks for considerable shrinkage cracking, improper bond and edge lifting for the type of structure investigated under warm and dry surrounding climate conditions.
- Evaluation of alternative solutions in order to reduce shrinkage cracking, increase bond and eliminate the risk of edge lifting is recommended in order to further verify the potential of using a SCC top layer as replacement of the traditional self-levelling screed.

## 5.4 Full-scale test 3

### 5.4.1 Introduction

In order to investigate the possibility to manage the negative effects that the second full-scale test resulted in, a third full-scale test was planned. This test included several presumptive solutions to the observed problems. The proposed main solution included the following sub solutions:

- Increased bond between the cast top layer and the underlying element should be obtained by further increasing the surface roughness and surface strength
- Reduced shrinkage of the SCC mix should be obtained by using a shrinkage-reducing additive (SRA)
- Less strength and less rapid shrinkage of the SCC mix should be obtained by optimisation of the mix recipe

In addition, an alternative solution including the following sub-solutions were evaluated:

- Anchored top layer to the element by using anchor bolt and reinforcement along the element sides
- Controlled drying shrinkage cracking using steel fibres

The hot and dry surrounding climate conditions of the second full-scale test led to big and rapid drying, which led to rapid drying shrinkage and reduced possibility to relaxation stresses. In the third full-scale test, it was decided to have surrounding climate conditions that are less hot and dry to simulate more realistic conditions during the drying phase of concrete slabs before floor covering. However, it was also decided to avoid too cold and humid conditions that may lead to too slow drying shrinkage.

### 5.4.2 Method

In order to avoid the problems observed within the second full-scale test, two alternatives were tested. Alternative 1 was supposed to be the most rational and cost-efficient solution of the two alternatives. The sub-solutions of *alternative 1* consisted of:

- Use of *exposed aggregate* of the HD/F element surface in order to achieve surfaces with high roughness and strength. By this procedure, the bond may increase not only through increased roughness but also through increased strength of the surface layer of the element, i.e. reduced risk of having weak and/or loose parts. The process of achieving exposed aggregate was developed and integrated to the normal production process of hollow core slabs. A retarding agent was sprayed on the element surface and after a waiting period, the surface was washed with high-pressure equipment in a sealed room. Figure 5.12 shows the exposed aggregate surface.



*Figure 5.12 Increased roughness and presumptively increased strength as well of the concrete surface of the first specimen through utilisation of exposed aggregates.*

- *SRA-utilisation* aiming at minimising negative shrinkage effects, i.e. plastic, autogenous and drying shrinkage cracking. In addition, it was assumed that edge lifting was assumed to be reduced due to the reduced shrinkage. SRA may reduce shrinkage by up to 45% (Rongbin and Jian, 2004). The mechanism is based on reduced surface tension of the pore water, decreasing the shrinkage and therefore reducing the shrinkage stress. Presumptively, the required drying time of concrete may increase when using SRA. Therefore, laboratory studies on drying were conducted in addition to the earlier performed (and described in section 5.3.1). The result showed that SRA did not increase the drying time in comparison to the same SCC mix but without SRA.
- *Mix optimisation* in general aiming at reducing shrinkage and strength. By changing the use of rapid cement to normal cement and decreasing the cement content it was possible to reduce the shrinkage a bit.

*Alternative 2* differed from the first alternative mainly by anchoring the top layer to the element through anchor bolts and reinforcement, see Figure 5.13. In order to control shrinkage cracking, steel fibres were added to the mix. It had been shown earlier in real building projects that it was possible by these procedures to avoid heavy shrinkage cracking and edge lifting.





*Figure 5.13 The second specimen incorporated reinforcement net, anchored to the HD/F-elements.*

In both alternatives, three HD/F-elements each with a length of 10 metres were used. The elements were jointed to each other by joint mortar. Before casting, each specimen was properly cleaned by vacuum cleaner. The SCC was produced in a ready-mix concrete plant and truck transported to the test local. The fresh concrete was tested with regard to slump flow and poured by concrete chute on to the elements that had been pre-wetted by moderate amount of water. No primer was used. After the placing, the cast SCC of both specimens was skip-floated (to achieve high-quality level surface) and a wax-based membrane-curing agent was sprayed on the surface after approximately 30 minutes. The surrounding climate conditions during the test were for both specimens somewhat more humid and colder than in Full-scale test 1 (average values of 22 °C and 65% RH of the surrounding air).

In order to quantify the result, the following measurements were made during the test period: logging surrounding RH and temperature, ocular observations of presumptive cracking and edge lifting (also acoustic knocking), RH measurement of the top layer by measuring the average value of drilled cores, and bond testing.

### **5.4.3 Result**

In comparison to the second full-scale test, the third test gave more satisfying results regarding the technical requirements, i.e. no bond failure and no harmful edge lifting and drying to at least 90% RH within five weeks. The result of the two specimens were correlating well with each other, e.g. very limited plastic shrinkage cracking with regard to both amount and width, no drying shrinkage cracking and no edge-lifting observed during a period of three months from casting.

The bond between the top layer and the HD/F element was proper and fulfilled the bond requirements well for both specimens and was measured by pull-out tests. The majority of bond fracture occurred at the interface between the glued metal cylinder used for applying the tensile force and the top of the concrete. The tensile strength of the bond to the steel cylinder was approximately 2 MPa, which thereby indicates the minimum bond strength between the top layer and the HD/F element. Some fracture however occurred in the HD/F element, which is seen in Figure 5.14. This also indicates a high value of the bond between the top layer and the HD/F element.



*Figure 5.14 For some cores, the fracture when pull-out testing occurred in the HD/F element (the darker part at the bottom of the cylinder), which indicates on proper bond between the SCC top layer and the HD/F element.*

The RH development was observed by measurement of the average RH level of samples from drilled core cylinders. RH fulfilled the set requirements, i.e. 90% RH five weeks after casting. For the specimen with SCC including steel fibres, the RH level was 90% and for the other 89%.

The first alternative of producing the overlay was considerably less time-demanding than the second alternative that included time-demanding moments as drilling and placing of anchor bolts and reinforcement. On the other hand, the second alternative required less time in the production process of the precast elements due to that no work was required for exposing the aggregate.

#### **5.4.4 Discussion/conclusions**

The result of the third full-scale test showed that it was possible to avoid edge lifting and fulfil drying requirements (i.e. maximum 90% RH allowed five weeks after casting) for Alternative 1 as well as for Alternative 2. Alternative 2 was however not considered as rational from neither a production economical nor a practical perspective due to the increased direct costs for materials as well as increased labour needed.

One obvious explanation for the more positive effect of Test 3 compared with Test 2 is that the climate was much more favourable (65% RH instead of 30% RH). Another explanation may be the improvement of the SCC mix recipe of the third test, e.g. usage of SRA and slower as well as reduced cement content with the aim of decreasing the amount and rate of shrinkage. Another explanation may be the increased potential for proper bond through exposed aggregate surface or (as tried in Alternative 2) anchored reinforcement net by anchor bolts. Further, the steel fibres used in Alternative 2 may have decreased the risk of achieving few and large shrinkage cracks. Concerning the effect of steel fibres for the type of structure, it may be most beneficial to utilise fibres when proper bond is achieved. Otherwise, there may

be risk of getting heavy edge lifting and loss of bond for the whole top layer. In addition, no primer on the hollow core element surface was used in the third test.

Due to practical limitations concerning the number of specimens, it was difficult to quantify the influence of each parameter.

## 5.5 Full-scale test 4

### 5.5.1 Introduction

Despite the satisfying result of the third full-scale study it was decided to carry out another full-scale test with the aim of verifying the positive result of the third test and to optimise the concept further. The aim of this concept optimisation was to increase the total cost-efficiency, which meant efforts to avoid presumptive expensive technical sub-solutions that also may lead to practical difficulties, e.g. exposed aggregate of HD/F element surface and membrane curing of the SCC-layer.

As for the earlier full-scale tests, the number of specimens included in the fourth test had to be limited due to practical conditions, e.g. available test local area. With respect to the large specimen size required to achieve typical shrinkage effects and to that the specimens had to be stored indoors under controlled climate conditions to achieve proper drying and shrinkage the total number of specimens was limited to two of which the first was a verification-test of the third full-scale test and the second was an further optimised test specimen regarding cost-efficiency and suitability regarding practical aspects.

### 5.5.2 Method

The fourth full-scale test comprised two specimens with an area of 10 x 3.6 metres each. Each test specimen consisted of three HD/F-elements that were jointed together using joint mortar. The surface of the joint mortar was brushed in order to achieve proper roughness for increased bond to the SCC-layer. The HD/F-element surface of the first specimen had exposed coarse aggregate. The surface of the second specimen was brushed. Furthermore, the specimens differed from each other concerning that the use of membrane curing of the SCC-surface was eliminated in the second specimen.

SCC was produced in a ready-mix concrete plant and transported to the test local by truck. Concrete from the same delivery were used for both specimens. The mix recipe correlated well to the SCC recipe used in full-scale test 3, specimen 1, i.e. SCC without steel fibres except that some modification/optimisation of the recipe had to be done because the aggregate were taken from another source. SRA was used for both specimens. The HD/F surfaces were both cleaned and pre-wetted before casting of SCC. The fresh SCC was placed as 55 to 70 mm thick un-reinforced top layer directly on the HD/F elements using concrete chute. It was finished through skip floating.

The surrounding climate had an average temperature of 15°C and an average RH of 65%, which was considered to correspond well to air temperature and RH during drying of concrete slabs before floor covering in real building projects. In order to avoid too low temperatures, electrical heating fans were utilised.

During the test period, the following measurements were made: RH of the cast SCC top layer, RH and temperature logging of the surrounding air and bond testing. In addition, ocular observations of shrinkage cracking and mechanical knocking (for identification of edge lifting tendency) were carried out.

### 5.5.3 Result

The fourth full-scale test showed that no edge lifting had occurred after five weeks, neither regarding the specimen with exposed aggregate surface nor regarding the specimen with brushed surface. In addition, bond testing showed proper bond for both specimens, i.e. approximately 2.0 MPa.

The measured RH levels after five weeks in specimen 1 and 2 were 89.4% and 86.2% respectively, which indicates that the requirement with respect to RH (90% RH after 5 weeks) was fulfilled. The RH level of specimen 1 (i.e. the verification test) that included usage of membrane-curing agent, correlated well with the RH level, measured in the third full-scale test. The RH-level of specimen 2 (i.e. without membrane curing), indicated significantly more rapid drying.

Considerable more plastic shrinkage cracking could be observed on the second specimen (the specimen without membrane curing). During the test period of five weeks, these cracks grew further due to drying shrinkage. Regarding the first specimen, plastic shrinkage cracking was small and no further crack growth could be measured.

### 5.5.4 Conclusions

*Specimen 1 used for verification of the result in Test 3*

The result of alternative 1 in full-scale test 3 was completely verified; no edge lifting occurred, bond strength was satisfactory, drying was rapid, the surface was satisfactory and no need of screed required

*Specimen 2 (extended test regarding cost-efficiency)*

The same satisfactory results as for specimen 1 were obtained despite the fact that the element surface was only brushed and that no membrane curing of SCC was made.

## 5.6 Summarising discussion and conclusions

### 5.6.1 General

The risk of edge lifting is high for ‘thin’ concrete layers placed on top of a more massive concrete slab and the explanation is:

- Drying of the thin layer may lead to curving of the layer due to drying shrinkage stresses are largest in the surface of the top layer
- Shrinkage stresses may lead to shrinkage cracking, which may lead to new free edges of the thin layer where edge lifting may occur
- In general, thin top layers are unreinforced and non-anchored to the element
- Precast elements, e.g. hollow core slabs normally have smooth surfaces (with low roughness) which may lead to insufficient bond between the top layer and the element

In addition, SCC in the thin layer may lead both to increased plastic shrinkage and to increased drying shrinkage, which may increase the risk of edge lifting. On the other hand, there are strong incentives to SCC based on its self-levelling property, its rapid drying and the rational production process, which may lead to increased competitiveness and cost-efficiency in comparison to the use of self-levelling screed on the element.

In order to investigate the potential of ‘thin’ top layers of SCC cast in-situ on hollow core elements, as replacement for expensive self-levelling screed, several full-scale tests were conducted. The aim of these tests was to investigate the possibility of the concept to fulfil the following requirements:

- Surface level quality according to ‘AMA 98’ (Swedish Building Centre, 1998)
- 90% RH within five weeks
- No edge lifting
- Competitive and cost-efficient production method from a practical and total-economy perspective

### 5.6.2 Test 1

The *first* full-scale test focused on the risk of edge lifting, i.e. whether the type of structure was possible to use without edge lifting at all. Three types of element surface roughness, as well as SCC with and without steel fibres were tested at 60% RH and 15°C in the surrounding air. The result indicated that it was possible to use all alternatives without edge lifting and loss of bond. The test was however limited with respect to surrounding climate conditions (that was ‘medium’ cold and ‘medium’ humid) and specimen size.

### 5.6.3 Test 2

In order to test the effect of more realistic circumstances, the *second* full-scale test was conducted using increased specimen size and installations (electricity tubes), and in warmer as

well as dryer surrounding climate conditions, 30% RH and 22°C. Furthermore, professional concrete workers carried out the casting in order to achieve realistic placing and finishing moments for improved quantification of the hardened surface level quality. The result showed heavy shrinkage cracking, insufficient bond and severe edge lifting. Drying was, however, satisfactory.

### 5.6.4 Test 3

In the *third* test, two alternatives were tested at 65% RH and 22°C:

- Alternative 1
  - Utilisation of shrinkage-reducing additive (SRA) in SCC and exposed aggregate surface on the element
- Alternative 2
  - Utilisation of SRA in SCC, reinforcement in the SCC anchored by bolts to the element and steel fibres in SCC

Both alternatives showed that it was possible to avoid shrinkage cracking and edge lifting as well as achieving sufficient bond and drying. Alternative 2, however, was regarded as too expensive.

### 5.6.5 Test 4

Finally, a *fourth* test was conducted in order to:

- verify the result of alternative 1 of the third test
  - Utilisation of SRA and exposed aggregate surface
- further optimise the concept regarding cost efficiency
  - Exposed aggregate element surface changed to brushed and no membrane curing

The fourth test led to satisfying result for both specimens since no edge lifting occurred and the bond was sufficiently high. The shrinkage cracking of the specimen without membrane curing was more intense.

### 5.6.6 Summary

To summarise, the following conclusions can be made regarding the potential of unreinforced single SCC top layer (with a thickness of 55 to 70 mm) cast on precast concrete elements:

- It is possible to achieve high-quality surface without need of any additional screed, which depends on the self-levelling effect of SCC

- It is possible to achieve rapid drying of the cast SCC layer using w/c ratio commonly used in Swedish house building, approximately 0.55, and under normal climate conditions
- The production is cost efficient, which depends on rapid production process including less manpower need, improved work-environment and less expensive direct materials costs in comparison with conventional concrete in combination with self-levelling screed, alternatively only self-levelling screed
- It is possible to achieve sufficient bond as well as to avoid edge lifting if SRA and brushed element surface are utilised
- It is possible to achieve sufficient bond, strongly limited shrinkage cracking and to avoid edge lifting, if SRA, exposed aggregate element surface and membrane curing are utilised
- Elimination of membrane curing may lead to increased plastic and drying shrinkage cracking as well as more rapid RH decrease





# PART 2, High-performance concrete (HPC)



# 6 HIGH-PERFORMANCE CONCRETE FOR COMPETITIVE PRODUCTION OF CAST IN-SITU CONCRETE

## 6.1 Introduction

### 6.1.1 General

Several years of intense concrete materials research and development worldwide has led to that it is possible to use high-performance concrete (HPC) in practice. By increasing the cement content and lowering the water/cement ratio, the properties of hardened HPC are improved with respect to as for instance strength, drying and denseness. According to the Swedish nomenclature, HPC might be defined as concrete with cube compression strength of more than 80 MPa or more and a water/cement ratio (w/c ratio) of 0.40 or less. The definitions concerning HPC differ around the world. The most common incentive to use of HPC within civil engineering is to utilise increased strength for higher bearing capacity and/or to utilise increased denseness for improved durability. Within conventional house building, though, increased strength and bearing capacity seldom has to be utilised except for columns in high-rise buildings. Within Swedish production of structural frames in multi-storey residential buildings rapid drying of HPC is however utilised for decreased production time. Despite the mentioned advantages implementation of HPC is still limited. There are several barriers for HPC implementation, which may be managed if an increased total concept view is adopted including proper production control as well as utilisation of synergy effects.

This chapter mainly aims at estimating the potential of HPC for house building with special regard to production aspects. The main potential benefit is the possibility to *reduce the production time*, either by decreasing the concrete drying time, or by utilising the rapid strength development. The study consists of two separate studies where drying times and strength development are estimated with regard to various kinds of concrete qualities. Used tools are the PC-programs TorkaS 1.0 (1998) and Hett97 (1997) that simulate the concrete drying process and the concrete strength development respectively. For both drying time and strength development, the surrounding conditions affect the result to large extent. With the aim of simulating realistic conditions on building sites, regard has been taken to various weather conditions, e.g. cold temperature and rain, as well as practical production methods, e.g. insulating, covering, and heating of concrete.

In addition, based on literature review, the chapter describes properties, experience and research of HPC. Furthermore, presumptive technical risks and obstacles for implementation are analysed.

### 6.1.2 International research and experience of HPC

In the 1980s, concrete with silica fume in combination with superplasticisers was developed to give increased strength, thereby creating new possibilities for concrete structures such as columns in high-rise buildings (Walraven, 1999). This new material was termed high strength concrete (HSC). However, the concrete had other properties such as high durability, and was

used in other kinds of construction, for instance in offshore. These new properties led to the name being changed to that of high performance concrete (HPC). The benefits of HPC lead to opportunities for its utilisation within a range of applications. During the 1990s, research and applications of HPC have increased dramatically (Helland, 1996). Over the past few years, HPC has been common in offshore construction, bridges, tunnels, roads and high-rise buildings worldwide. Helland (1999) argues that the concrete sector has changed from a low-tech to a high-tech sector and must continue to develop and implement novel concrete materials technology in order to compete with other materials. According to Walraven (1993), the conservative construction sector has to extend international building codes and get accustomed to the idea of using HPC. Increased knowledge in new materials technology may be necessary for designers, if the new materials are to be fully exploited and their potential risks are to be properly handled (Walraven, 2000). Helland (1996) further argues that international codes must follow technical development in order to avoid major step changes.

Regarding house building, international research on HPC concentrates mainly on high-rise buildings. In the US, HSC was at first used in columns in high-rise buildings to achieve greater height and stiffness and to reduce column sizes (Russel & Fiorato 1994). Hoff (1993) gives an overview of HPC in high-rise buildings constructed in the US before 1992. In Asia, the use of HPC in Japan is described by Ikeda (1993), in Singapore by Chew (1993) and in China by Chen & Wang (1996). Incentive to using HPC in high-rise buildings in Asia has been its high degree of earthquake resistance (Jinnai, 1999). In summarising the use of HPC in high-rise buildings, the incentive in most cases has been the increased strength of concrete columns, allowing greater height and larger floor area.

### **6.1.3 Swedish research and experience of HPC**

A major Swedish research programme on HPC was during the years 1991-1997 conducted by Swedish companies, institutes and universities. The programme was financed both through an industry consortium and through governmental funding. The main result is presented in two handbooks, one on material performance and one on the design of HPC (Swedish Building Centre, 2000a, 2000b). The results cover a wide range of research areas but also give detailed information regarding technical aspects. The most relevant research concerns concrete production, material properties (strength, deformation, durability) and structural analysis. Hardly, any of the result covers aspects related to its practical utilisation.

In Sweden, like the rest of world, HPC has been implemented mainly within civil engineering works. There are many examples of how the increased durability of HPC (due to the increased denseness of the material structure) has been utilised within the construction of bridges, tunnels etc. Another incentive to using HPC within the civil engineering area is the possibility to reduce dead load and the possibilities for reduced material volume and/or increased bearing capacity. Also, from a production related point of view, HPC has been utilised for earlier formwork stripping, early post-tensioning of reinforcement and reduction of problems connected to winter casting.

However, within the Swedish building sector, HPC has been utilised mainly for reasons related to moisture-related problems, viz. it was found that HPC with low water/cement ratio has remarkable self-desiccation properties. However, the automatically increased bearing capacity of concrete with low water/cement ratio is seldom utilised. To a small extent HPC

has also been chosen for more rapid production cycles, especially during wintertime. Compared to the international utilisation of HPC in high-rise buildings, Sweden has very few examples, due to the fact that these types of buildings historically are very rare in Sweden, even in the big city areas. During the last years though, a small number of high-rise building projects have been executed and some presumptive projects are in the planning phase. Whether HPC will be utilised for these types of building is somewhat uncertain.

### 6.1.4 HPC – some important properties compared to NC

#### 6.1.4.1 General

The most commonly required function of HPC is the increased compressive strength and, as already mentioned, the former name was also high strength concrete (HSC). However, concrete with a high level of compressive strength often includes a number of other properties with increased performance, e.g. more rapid strength development, higher tensile strength and elastic modulus, increased self-desiccation and a more dense structure. These properties create opportunities for further increased functions with regard to other aspects than pure compressive strength.

#### 6.1.4.2 Compressive strength

The compressive strength, as well as many other properties of HPC, derives mainly from the low w/c ratio, which is reached by reducing the water content by water reducing admixtures at the same time as the cement content often is increased. Figure 6.1 shows the relation between equivalent w/c ratio (regard is taken to that 1 kg of silica fume is supposed to correspond to 2 kg of cement) and compressive strength, determined on 100 mm cubes at 28 days age. The reason for the spread in the result is that different types of aggregate were used in different mixes and that the compaction degree varied.

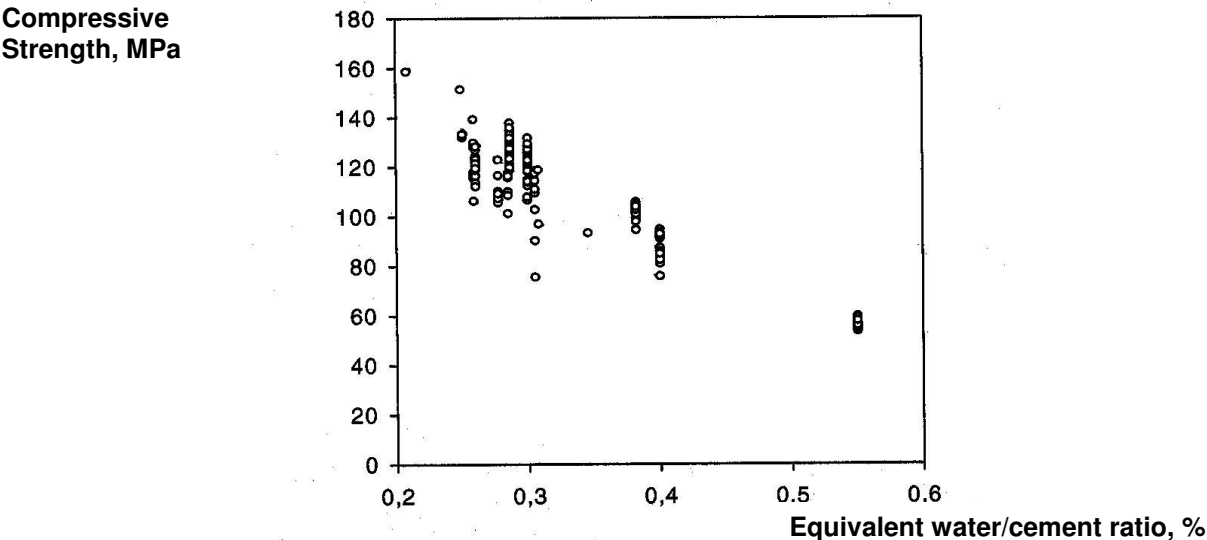

Figure 6.1 Concrete cube compression strength at 28 days age as function of the equivalent water/cement ratio (Hassanzadeh, 2000), based on work by Hassanzadeh, Gabrielsson and Claesson.

### 6.1.4.3 Tensile strength

The tensile strength is not increasing linearly with the compressive strength. According to the Swedish building regulations 'BKR', see (Boverket, 2003), an increase of the compressive strength from 30 to 75 MPa only corresponds to an increase of the characteristic tensile strength from 1.7 to 2.95 MPa, if special investigations are not able to verify a higher value. Several laboratory studies show that the tensile strength may be increased to as high value as 7 MPa. See Figure 6.2, which displays the relation between split tensile and compressive strength (100 mm cubes, 28 days age). The spread of the result is probably based on the variety of used aggregate and differing types of concrete samples (Hassanzadeh's data corresponds to 100x200 mm cylinders, Gabrielsson's data to 100 mm cubes and Claesson's data to 150x300 mm cylinders).

Splitting tensile strength, MPa

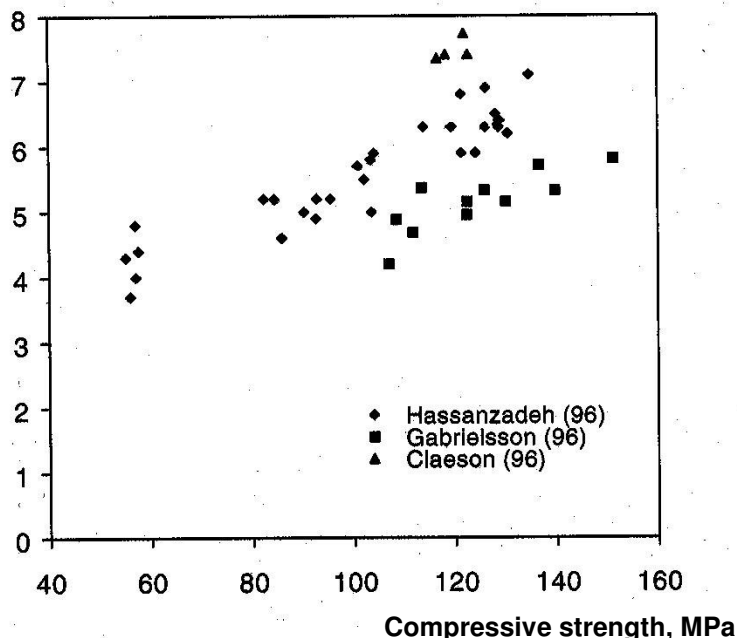

Figure 6.2 Concrete cube and cylinder splitting tensile strength as function of cube compression strength (data from Hassanzadeh, 2000).

### 6.1.4.4 Elastic modulus

Similar to the tensile strength, the elastic modulus (E-modulus) of concrete does not increase linearly with the compressive strength. Increased compressive strength leads to a rather limited increase of the elastic modulus. According to the Swedish building norms 'BKR 03' (Boverket, 2003), it is allowed to utilise a characteristic E-modulus of 31 GPa for concrete corresponding to a strength class of C25/30. For the maximum allowed concrete strength class of C60/75 the allowed E-modulus is limited to 39 GPa. As for tensile strength, the Swedish norm allows the use of higher value of the E-modulus if this can be verified experimentally. A method for increasing the E-modulus is utilisation of aggregate with high E-modulus. Several laboratory studies show that a value of approximately 50 GPa can be used if aggregate of type

diabase is used. See Figure 6.3 below, which presents the elastic modulus of concrete as function of the concrete cylinder compression strength (Hassanzadeh, 1998).

**Modulus of elasticity, GPa**

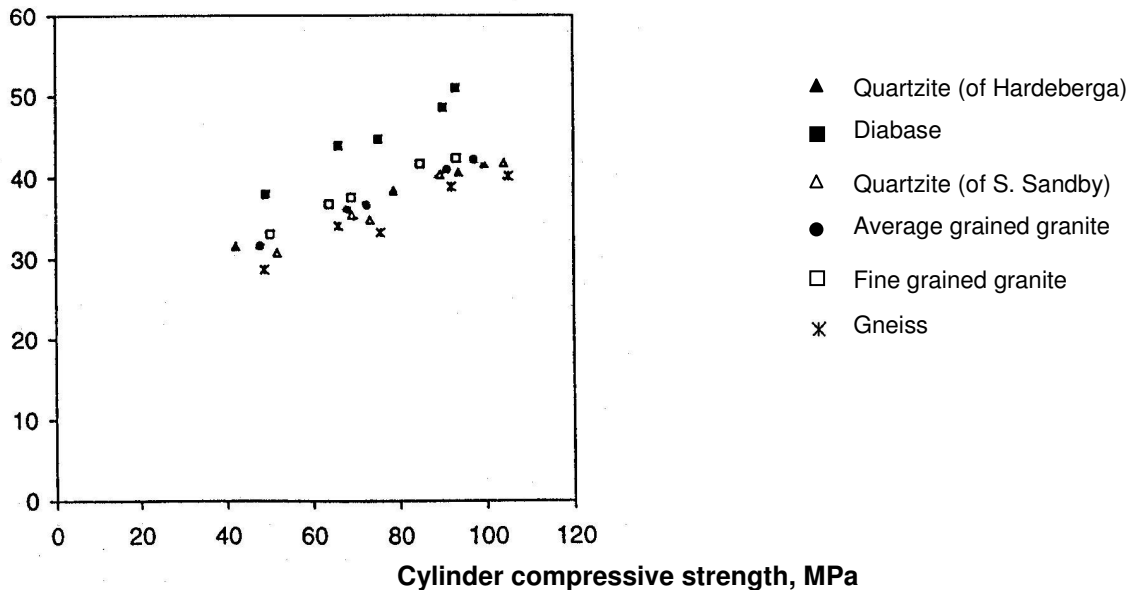

Figure 6.3 Elastic modulus of concrete as function of cylinder compressive strength for various qualities of aggregate (Hassanzadeh, 1998).

**6.1.4.5 Autogenous shrinkage**

According to Figure 6.4, HPC with low w/c-ratio leads to large autogenous shrinkage (shrinkage without moisture loss). This depends on the self-desiccation occurring in concrete with low w/c ratio.

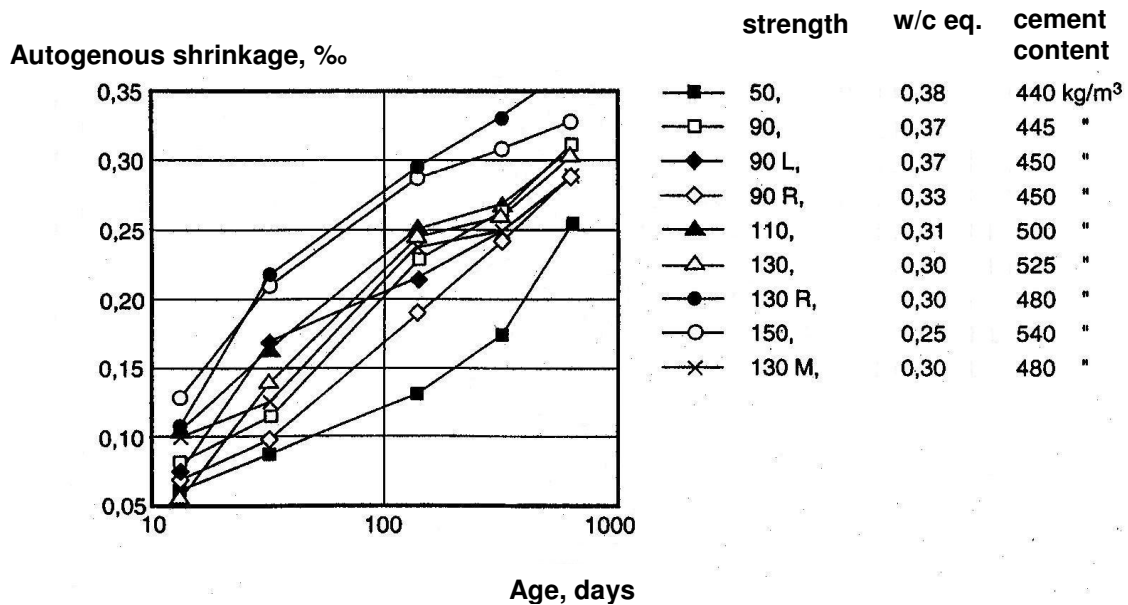

Figure 6.4 Autogenous shrinkage as function of maturity age.  $f_{cc}(28)=50-150$  MPa (Persson, 2000).



### 6.1.4.6 Drying, self-desiccation effect

The drying process for HPC differs remarkably from that of ordinary concrete (e.g. Persson, 1998). In HPC there is a significant effect of self-desiccation caused by cement hydration. Self-desiccation also occurs in NC, but in HPC it also causes a lowering of the w/c ratio. This depends on the shape of the sorption isotherm curve at high RH, which for HPC is significantly more flattened than for NC, see Figure 6.5.

Moisture content, kg/m<sup>3</sup>

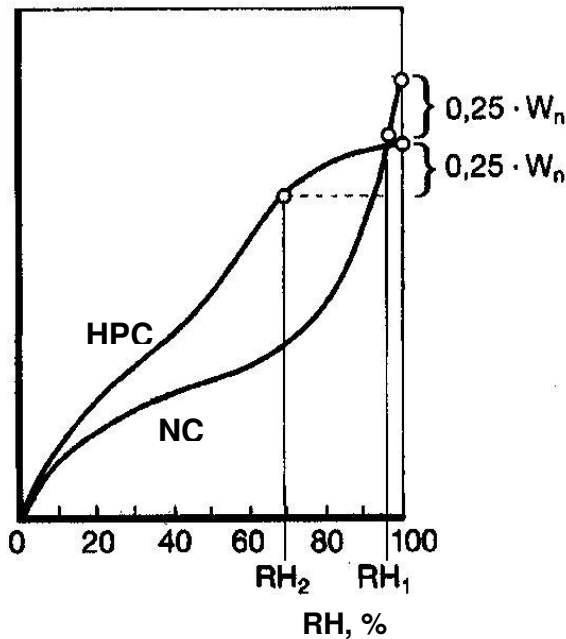

Figure 6.5 Sorption isotherm of HPC compared to NC-principles (Fagerlund, 1994).  $0.25 W_n$  is the amount of self-desiccated pores where  $W_n$  is the amount of chemically bound water ( $\text{kg/m}^3$ ).

Self-desiccation of HPC reduces the required time for reaching the desired RH level. Figure 6.6 shows examples of the correlation between w/c ratio and the required drying time for reaching 85 and 90% RH on 36 mm depth from the surface in a 180 mm concrete slab with two-sided drying. Note that two of the concrete types include 5% of silica fume (market with 'Si'), which further increases the self-drying effect. The cement is a Swedish high-alkali OPC (Slite Std).

**Approximately drying times to reach 85 and 90% RH**

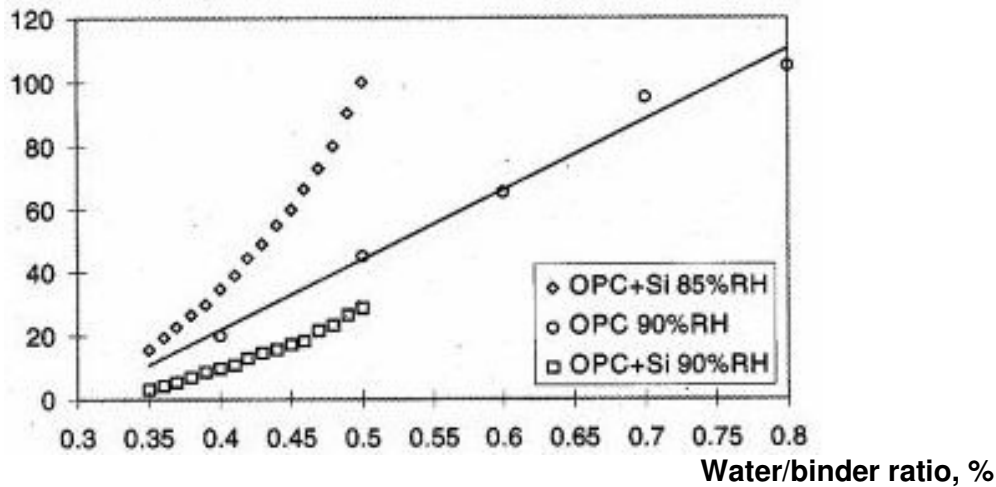

Figure 6.6 Drying time as function of w/b ratio (Hedenblad, 1996). At definition of w/b it is assumed that 1 kg silica fume corresponds to 1 kg cement.

**6.1.4.7 Rapid strength development**

Compared to NC, HPC gives significantly more rapid strength development, due to the low w/c ratio and high amount of cement. Figure 6.7 shows strength development curves for different concrete strength classes. Time is expressed in terms of maturity time at +20°C. The curves are valid for the Swedish cement type ‘Std Degerhamn’, which is a low-alkali sulphate resistant cement. The strength development of concrete with Swedish OPC is more rapid. For a C32/40 concrete, approximately 180 hours is required to reach compressive strength of 30 MPa, compared to a C100/115 concrete, which requires approximately 30 hours.

**Compressive strength, MPa**

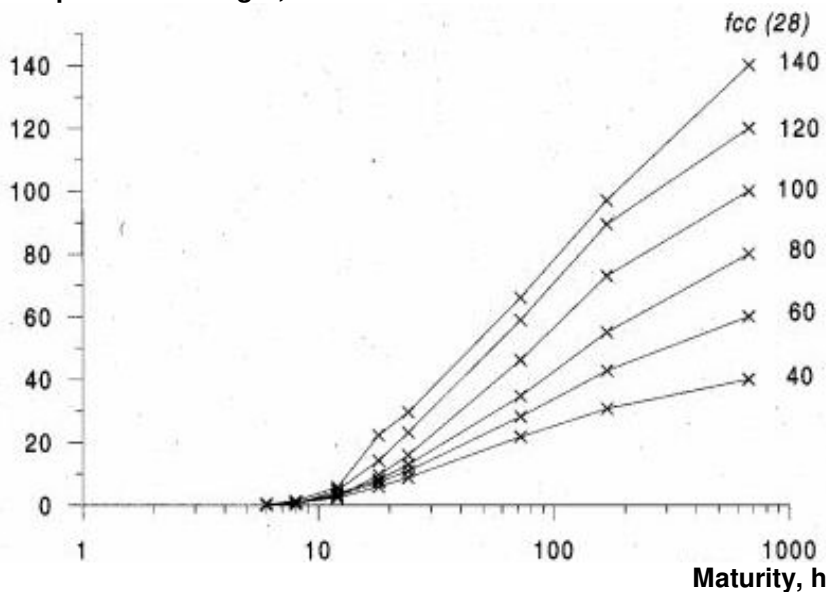

Figure 6.7 Concrete compressive strength as function of the age of maturity for various concrete strength classes (Emborg, 2000). Maturity is defined as the curing time at +20 °C.

#### 6.1.4.8 Other important properties of HPC

- Service life (durability)  
The dense structure of HPC creates opportunities for increased service life of concrete structures by reducing the diffusion coefficient of aggressive media and reducing the amount of freezable water.
- Environmental aspects  
When it comes to energy consumption, the negative effects of increased cement content of HPC may be partly balanced by decreased volume of concrete when the increased load- carrying capacity is considered. When estimating the energy consumption of buildings, it is important to consider the total service life consumption, which is assumed to consist of 85% during the usage phase and 15% within the production phase (also including the manufacturing of building materials) Adalberth (2000). HPC creates opportunities for further increased energy savings during the use of the building, see Appendix C 'Synergy effects of HPC on the building function'.

The described properties of HPC, derived largely from its low w/c ratio, allow increased function and more efficient production of concrete structures. The list below briefly displays correlations between technical properties and main potential function areas of HPC. Further descriptions of the various beneficial functions are presented in the next sub section, 6.1.5.

- High compressive strength (28 days) – improved design
- High tensile strength (28 days) – improved design
- High elastic modulus – improved design
- Dense structure – improved serviceability (durability)
- Self-desiccation – more efficient production
- Rapid strength development – more efficient production

### 6.1.5 Potential beneficial synergy effects of utilisation of HPC in house building

#### 6.1.5.1 General

As mentioned, within the international building sector, HPC is to the largest extent utilised for the production of vertical load-bearing parts in high-rise buildings. The high compressive strength of HPC provides opportunities for HPC-columns to increase the building height and/or reducing materials costs. Occasionally, the fast strength development of HPC is utilised for rapid production cycles.

There are also some potential benefits of HPC in low- medium rise multi-storey residential buildings. They are described below. The section is divided into three parts: structural design, production and building function related benefits of HPC for house building.

### 6.1.5.2 Potential of HPC with regard to structural design

For low- medium rise buildings, HPC enables three main benefits compared to NC, from a structural design related perspective:

- Increase of slab spans
- Reduction of amount of concrete material
- Reduction of amount of reinforcement

To increase slab spans by using HPC, it is necessary to utilise the potentially higher tensile strength and/or E-modulus of HPC. A high value of the concrete compressive strength itself does not significantly affect the possibilities for increased slab spans to large extent, neither with regard to the ultimate nor to the serviceability limit state. The conducted structural design study (see Appendix A ‘Structural design potential of HPC within house building’) using increased values of tensile strength and E-modulus, presents a significant potential of HPC for increasing slab spans, both for slab/wall and slab/column structures. For instance, the span for slab/wall structures can be increased by 20% and slab/column structures by 50% when the tensile strength is increased from 2.5 to 5.0 MPa without increase in slab thickness. The same comparison but with regard to an increase of the E-modulus from 30 to 50 GPa results in increase of 15 and 15%. These possibilities of increasing the span are based on non-stressed reinforcement. If post-stressed concrete is used, the span can be further increased due to the high compressive strength. This possibility has not been investigated in the project.

The potential for increased slab span also creates opportunities for reducing the slab thickness and/or reducing the amount of reinforcement if the slab span is not increased. Especially concerning slab/column structures there is a significant potential if regard is taken to the risk for concrete punching, which often is managed by increase of concrete thickness and/or increase of reinforcement.

Another advantage of HPC, both from perspectives of structural design and production, is the self-desiccation effect. This enables a significantly faster drying process for HPC than NC. Furthermore, in HPC the drying time becomes more independent of the concrete thickness, which for NC may be a critical factor, due to the heavy extended drying and production time. In other words, it is possible to produce thicker structures without any extended drying times if HPC is utilised.

To summarise, HPC has potential for producing larger spans or slimmer constructions for multi-storey residential buildings, as well as reducing the amount of reinforcement and/or concrete material amount.

### 6.1.5.3 Potential of HPC with regard to production

#### *Rapid drying*

The reduced drying time of HPC, caused by its self-desiccation effect, allows floor coverings to be applied earlier. According to Swedish praxis, a relative humidity (RH) level of 85 or 90%, measured on the equivalent depth in the concrete structure, is required for many often-used floor-covering materials. Equivalent depth is the depth from the drying surface of which RH has the same value as will appear after long time on the bottom side of a flooring material that is 100% impermeable to moisture. In Section 6.2 results showing the possibility to utilise

the rapid drying of HPC are given. The results present large differences in drying time required for reaching 85 and 90% RH for different concrete qualities, formwork-systems, slab thickness, surrounding climate conditions etc. For instance, the results show that a concrete slab needs 15 months of drying time for reaching a RH-level of 85% when NC is used, compared to 3 months if a certain type of HPC is utilised, for the same conditions, see Figure 6.8 below. This advantage of HPC gives opportunities for both shorter total production time and lower production cost.

**Drying time  
(months)**

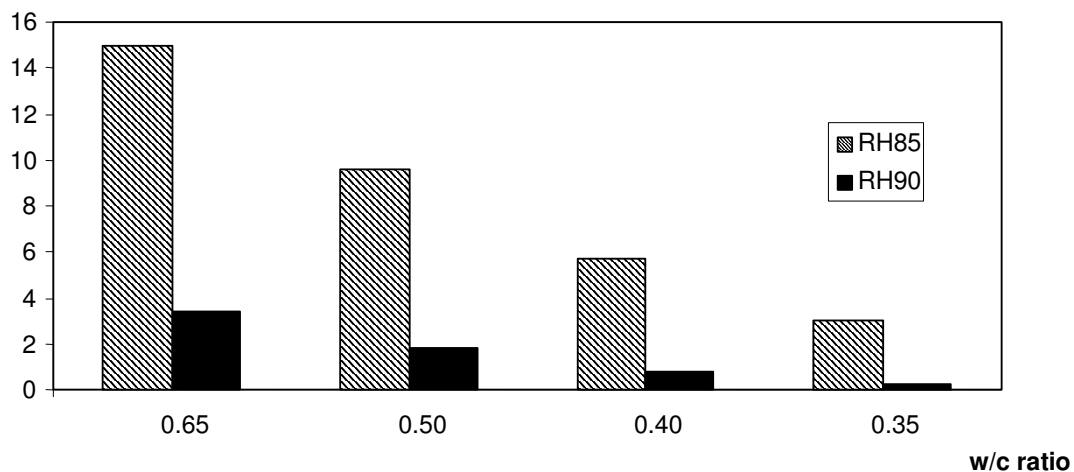

*Figure 6.8 Required drying time for reaching 85 and 90% RH at the equivalent depth (for definition, see above) as function of w/c ratio. Data are taken from section 6.2. The result is based on calculations based on the PC-program TorkaS 1.0 (1998). Conditions are slab thickness 0.20 m, double-sided drying and controlled drying climate (air RH 60% and air temperature 18 °C) from the start of casting.*

#### *Rapid strength development*

The fast development of strength of HPC can be utilised for reduced production time and cost, through decreased time for reaching the minimum strength value required for formwork removal etc. This enables rational use of formwork systems and shorter production cycles. Also, for post-tensioning of reinforcement, the time for reaching the required minimum strength level can be reduced. Especially during wintertime the rapid heat and strength development of HPC can be used for reduction of problems with early freezing and long form-skipping time. According to section 6.3 that presents the result of a study aiming at estimating the benefits of HPC regarding rapid strength development, an increase of the cement content also significantly reduces the risk of early freezing of the concrete structure, (Fagerlund *et al.*, 1999).

Not only can the costs for reduced production time be decreased. There are also the opportunities for cost-savings by reduction or elimination of winter concrete protection methods such as covering, insulating and heating of the concrete. Figure 6.9, below, presents result from the production study of section 6.3 and displays the estimated time for reaching compressive strength of 20 MPa in a slab as function of various concrete qualities, with regard taken to three kinds of surrounding climate.

## Required time (days)

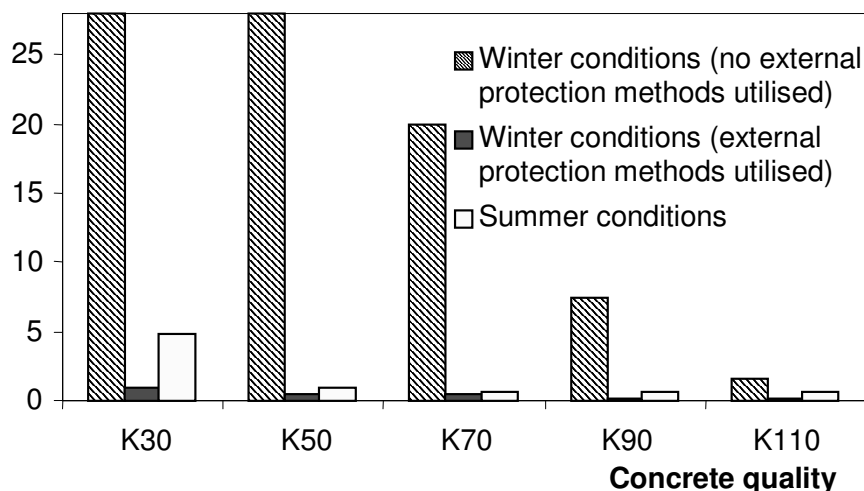

Figure 6.9 Required time to reach a concrete compressive strength of 20 MPa in a slab as function of various concrete qualities, with regard taken to three kinds of surrounding climate. The result is based on calculations according to the study in section 6.3 based on the PC-program Hett 97 (1997), which estimates the heat and strength development of concrete structures with regard to various climate conditions and production methods. By winter conditions means  $-5\text{ }^{\circ}\text{C}$  air temperature and summer conditions  $+15\text{ }^{\circ}\text{C}$  air temperature. Studied winter protection methods are covering, heat insulation of form and heating of concrete by infra heaters. Slab thickness 0.20 m. Plywood form 19 mm. Concrete temperature at casting during winter is  $+15\text{ }^{\circ}\text{C}$ . See section 6.3 for further details.

### 6.1.5.4 Potential of HPC with regard to building function

HPC also provides advantages concerning the function and use of the building. Larger spans in combination with light, easy dismantable, partition walls allows a higher grade of flexibility through increased rebuilding possibilities. Concerning the fast drying process, an advantage may also be the possibility to, in a rational way, avoid moisture related health problems that sometimes have been blamed on inadequate drying time before floor covering. The self-drying effect can also be used to improve acoustic qualities by allowing thicker slabs without any extended production time. Thicker slabs also allows for increasing the free span between walls and columns.

Appendix C further describes the building function related benefit of HPC.

### 6.1.6 Obstacles to implementation of HPC

#### 6.1.6.1 General

There have been obstacles for utilising HPC, from technical as well as organisational and economical perspectives. Many of the impediments for exploitation of HPC have been

managed, through research and development of the technology, in combination with feedback from successful projects. However, there are still implementation problems to solve, especially within the low- medium rise building area. This section briefly describes the obstacles for HPC within house building in Sweden. See section 6.4 for further detailed descriptions concerning technical obstacles for utilisation.

### **6.1.6.2 Technical obstacles**

Technical obstacles for the implementation of HPC are rather few since the relations between concrete composition and the properties of fresh and hardened concrete are fairly well-known. However, it is important that the norms and standards are changed so that the use of HPC is not hindered or the benefits of HPC cannot be fully exploited.

### **6.1.6.3 Obstacles with regard to the building process**

In comparison to the technical obstacles, many of the building process related problems for utilisation of HPC are still unsolved. The main obstacles for increased utilisation of HPC within house building are:

- Conservatism
- Lack of knowledge and low interest for innovations
- Missing feedback between the actors
- Unclear responsibility with regard to presumptive technical problems
- Limits within the building codes
- Economy issues focused on direct materials costs and not the total life cycle for buildings
- Sub-optimisation because no regard taken to synergy effects
- Pricing of HPC (product costs not corresponding to the 'true' materials costs)
- Added costs to HPC due to increased control of mix ingredients

## **6.2 Theoretical study of drying of HPC-structures**

### **6.2.1 Introduction**

#### **6.2.1.1 Background**

A frequently discussed problem with cast in-situ concrete is the long drying times needed to avoid future moisture problems caused by deterioration of floor covering materials applied on concrete slabs before a satisfying level of the concrete humidity was reached. These problems are related to ordinary house-building concrete with fairly high w/c-ratio. RH 85 or 90% is often required according to the Swedish building norms. For a concrete quality of C25/30 (required cube compressive strength level of 30 MPa), the required drying time can be as long as one year if the concrete is not protected from rain and/or cool surrounding temperatures and if a permanent formwork system as for example steel is used. This type of formwork leads to slow drying in only one direction. In many cases, forced drying methods or impermeable materials applied on the concrete must be utilised in order to keep the production time within acceptable limits and/or avoiding potential future moisture problems. If HPC with low water/cement ratio is utilised, many of the described problems may be avoided. There are a number of field studies that indicate the efficiency of HPC for rapid drying during various climate conditions. For example, Persson (1999) has conducted field studies where the moisture levels in concrete slabs (of both NC and HPC) have been measured whereby it was shown that HPC gave considerably more rapid drying.

#### **6.2.1.2 Aim of the study**

There are various parameters affecting the concrete drying time. The study aims at estimating the potential for reduction of drying time by changing the composition of the concrete mix at different outer climate.

#### **6.2.1.1 Method of the study**

Calculations of drying times in concrete slabs have been carried out using the PC-program TorkaS 1.0 (1998). The PC-program is based on a theoretical analysis of moisture transport in concrete and is calibrated against laboratory studies of drying a large number of concrete specimens of various qualities. TorkaS 1.0 simulates the concrete drying process by using the time development of degree of hydration and the effect of this on the internal RH. The degree of hydration is based on measurements of chemically bound water at varying hydration temperature and relative humidity in the surrounding air.

The parameters in Table 6.1 were used in the calculations of drying.



Table 6.1 Parameters included within the production study of concrete drying.

Parameters	Levels
Water/cement ratio	0.65, 0.50, 0.40 and 0.35
Cement content	300, 400, 450 and 500 kg/m <sup>3</sup>
Silica fume content	0 and 5%
Slab thickness	0.15, 0.20, 0.25 and 0.30 m
Type of form	50 mm Filigran element of concrete and steel
Air temperature and rain frequency	Average weather data from SMHI (The Swedish Metrology and Hydrology Institute) valid for Bromma airport. Stockholm
Casting weather conditions	Summer and winter
Covering (protected from rain)	Directly after casting and after 10 days
Controlled drying climate	Directly after casting and after 1 month
Concrete temperature wintertime	Alt 1: the same as the air temperature. default data from SMHI Alt 2: calculated by the PC-program Hett 97 (considering heat of hydration, heat insulation etc)

As shown in Table 6.2, the calculations of the study have been conducted for five different types of surrounding climate conditions, of which the first corresponds to controlled drying from casting (season independent), the second to summer conditions where controlled drying starts a month after casting and the last three to winter conditions. Concerning the first three simulated climate conditions, the default weather data within the PC-program are used directly, which means that the outdoor air temperature is used as concrete temperature data. This leads to an underrating of the concrete hydration during wintertime, since the concrete temperature is significantly higher than the air temperature during the first days after casting. The fourth and fifth climate conditions aim at investigating the effects of utilising the early heat development of concrete. Therefore, in Climate 4, the surrounding air temperature during the first 10 days after casting is supposed to be 10°C, which within the PC-program simulates a concrete temperature of the same value. For the fifth climate condition, concrete heat development calculated by the PC-program Hett97 (1997) were used as input data in the calculation. Hett97 (1997) calculates the heat and strength development of concrete constructions with regard taken to multiple surrounding factors, as for instance air temperature, formwork system and winter concrete protection methods, e.g. covering, insulation and heating of concrete. The fifth climate condition is the most correct, especially in winter climate, due to the fact that it uses the real hydration. Below, the differences between the simulated climate conditions are briefly displayed. Detailed descriptions for each climate condition are presented in the further sections. Concerning the result of the influence of climates on drying, some selected diagrams are presented for each climate. See further Appendix B for all result diagrams concerning the effects of climate condition on concrete drying times.

Table 6.2 Brief description of the five studied climates.

Climate	Casting date	Covering	Controlled drying	Season	Notes
1	1 July	1 July	1 July	-	Controlled drying directly
2	1 July	11 July	1 August	Summer	
3	1 January	11 January	1 February	Winter	Default temp data
4	1 January	11 January	1 February	Winter	Temp 10°C first 10 days
5	1 January	11 January	1 February	Winter	Temp data from Hett97 first 4 days

Calculations have been made for two levels of relative humidity on the ‘equivalent depth’ in the concrete slab, 85% and 90%. ‘Equivalent depth’ is defined as the depth from the concrete top surface, on which the relative humidity during drying equals the final relative humidity that is reached under a 100% impermeable flooring material put on top of the slab. For a slab drying in two directions, the ‘equivalent depth’ is about 20% of the slab thickness. For one-sided drying it is about 40%.

## **6.2.2 Calculation for Climate 1 – summer conditions and controlled drying directly from start of concrete casting**

### **6.2.2.1 Introduction**

The first simulated climate condition simulates a surrounding environment where the construction directly from the start of casting is protected against rain, and where both the relative humidity in the air and the air temperature are controlled and constantly set to 60% and 18 °C respectively. This fairly well simulates concreting under indoor conditions such as within a sheltering tent. The use of weather protecting methods in the form of heated tents is increasing within house building in Sweden, see Figure 6.1, which exemplifies a weather protection tent. This method does not only protect the building materials from rain and speed up the drying of concrete through dryer and warmer drying climate, it also creates an advantageous work-environment, especially during the winter season.



*Figure 6.1 Commonly utilised type of weather protecting tent (Jonsereds, 2002).*

The aim of the calculations for Climate 1 is to estimate the difference in required drying time between different concrete qualities for a climate condition where controlled drying is used one month after casting by utilising the built structural frame as the main weather protection, which often is common practise. As with the other simulated climates, the effects on required concrete drying time for reaching relative humidity of 85 and 90% respectively, with regard to

variables as slab thickness, silica content and form type, are studied and presented in the separate diagrams.

### 6.2.2.2 Conditions

In Figure 6.2 the simulated climate conditions during the first 40 days after concrete casting are presented. Also during the remaining time of the simulation, the surrounding climate is constantly set to 18°C surrounding air temperature and 60% relative humidity of the surrounding air.

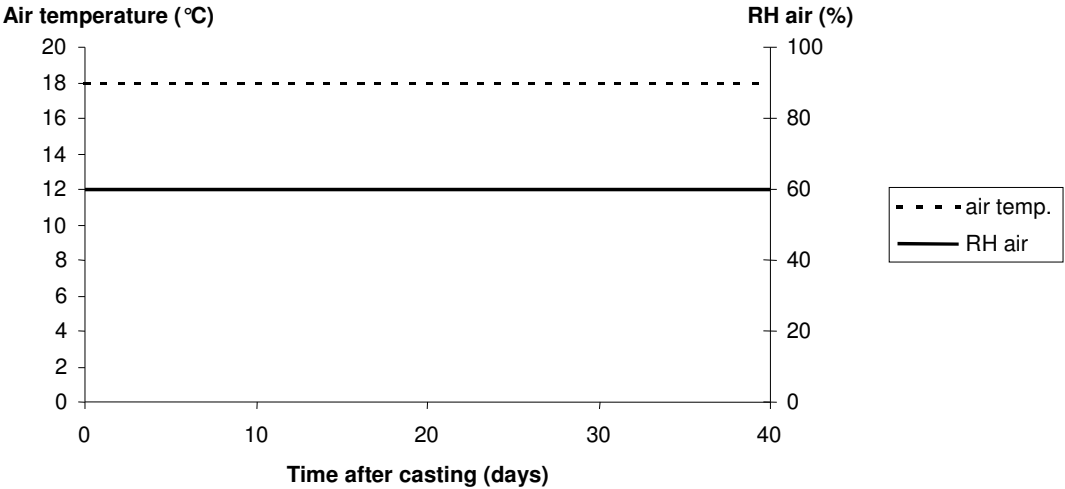

Figure 6.2 Surrounding climate conditions for Climate 1 during the first 40 days after concrete casting.

### 6.2.2.3 Results

Five types of results are presented. See the figures 6.3 to 6.7, displaying the difference in required drying time with regard to:

- Water/cement ratio
- Type of formwork
- Slab thickness
- Silica fume content

**Drying time (months)**

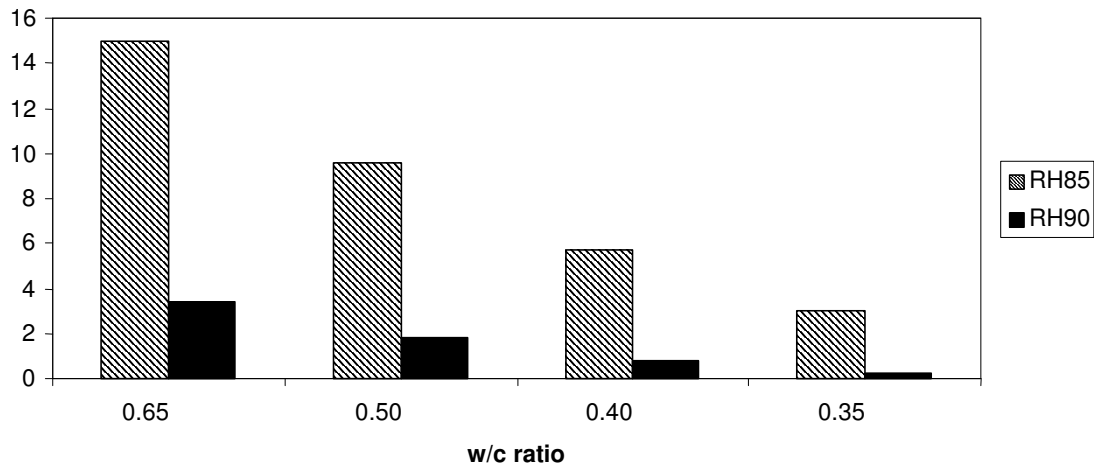

Figure 6.3 Calculated effect of the w/c ratio on the concrete drying time in Climate 1 for reaching a relative humidity of 85% or 90% on the equivalent depth. 50 mm thick Filigran element as formwork and 20 cm slab thickness exclusive formwork are constantly used within the calculations.

Figure 6.3 indicates that the drying time significantly decreases for concrete with reduced w/c ratio. The calculations are made for the same type of formwork (permanent concrete elements, Filigran), as well as for the same slab thickness (0.20 m). None of these calculations includes silica fume in the concrete.

**Drying time (months)**

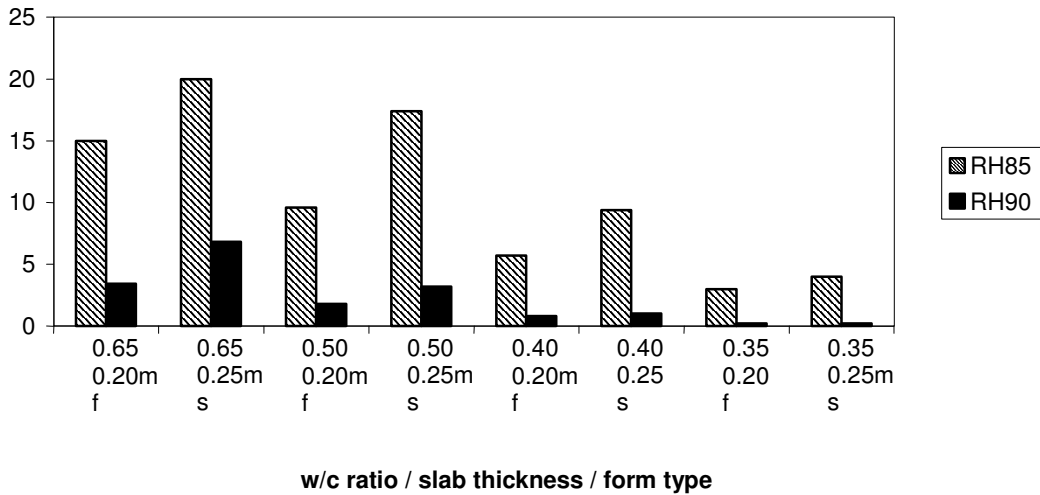

Figure 6.4 Calculated effect of the type of formwork on the concrete drying time for different concrete qualities (w/c ratios) for reaching 85% or 90% relative humidity on the equivalent depth. The letter 'f' indicates that permanent concrete elements, so called 'Filigran' are used as formwork and 's' that permanent formwork of steel is used. Concerning the result of the Figure, all calculations are based on no utilisation of silica fume. The total concrete slab thickness including formwork is constantly set to 0.25 (Filigran-formwork has a thickness of 5 cm).

The effect of type of formwork (precast permanent concrete formwork element, so called 'Filigran' and permanent formwork of steel), on the required drying time for various w/c ratio is shown in Figure 6.4. The total concrete slab thickness for both types of formwork systems is 0.25 meter. A 0.20 m concrete slab on 'Filigran' formwork corresponds to a 0.25 m concrete slab on steel formwork regarding total concrete thickness. The main reasons to the differences in required drying time for the two formwork systems is partly the difference in the cast concrete thickness but mainly that a 'Filigran' formwork allows drying in two directions.

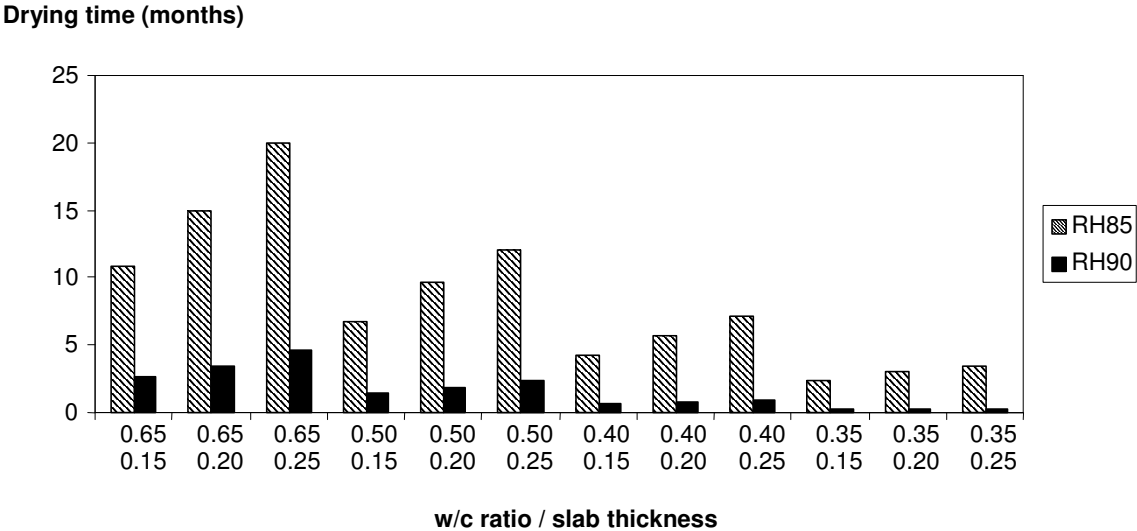

Figure 6.5 Estimated effects of the slab thickness on the required drying time for reaching 85 and 90% RH on the equivalent depth. For the calculations, permanent concrete formwork 'Filigran' is used. No silica fume is used.

As shown in Figure 6.5, an increase in slab thickness leads to an increase in required drying time. For concrete with low w/c ratios, the self-desiccation effect makes the difference in drying time caused by slab thickness smaller. The self-desiccation in low w/c-concrete occurs homogenously over the entire concrete thickness. For high w/c ratio, drying is almost entirely caused by physical drying through moisture transport to the surroundings. In this case the effect of slab thickness is strong.

### Drying time (months)

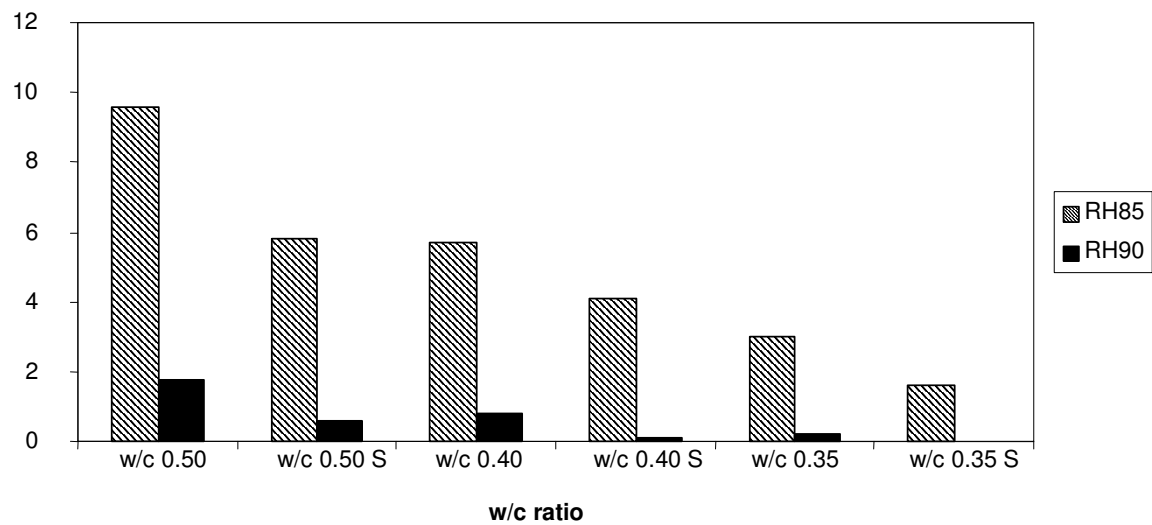

Figure 6.6 Estimated effects of silica fume content (marked as 'S') on the concrete drying time. Calculations are based on use of permanent concrete elements, 'Filigran' as formwork and a cast concrete slab thickness of 0.20 m.

In Figure 6.6, the effect of 5% silica fume (fraction of cement) on drying is shown. For reaching the RH level 85%, concrete including silica fume needs approximately about 2/3 of the required drying time of concrete including no silica fume. This is valid for all w/c-ratios.

## 6.2.3 Calculation for Climate 2

### – summer conditions and controlled drying 1 month after start of concrete casting

#### 6.2.3.1 Introduction

When a weather-protecting tent is not used, a common and traditional alternative is to only use the concrete structural frame as a tool both for protection against rain (when next floor above the actual is built) and for controlled drying climate, provided that openings for windows, doors, etc. are covered and heating systems are utilised for getting an effective drying climate. The advantage of this method is that it is not as expensive as an external tent. However, there are risks for extended drying times if the coverings are not properly done and/or the production of next floor above is delayed. This production method is called Climate 2.

#### 6.2.3.2 Conditions

In comparison to the calculations on Climate 1 where controlled drying is applied directly from the start of casting, Climate 2 simulates surrounding conditions where controlled drying starts one month after the casting during summertime. During the first 10 days the concrete

construction is simulated as unprotected, which, based on statistical weather included within TorkaS 1.0, leads to 1 day of rain.

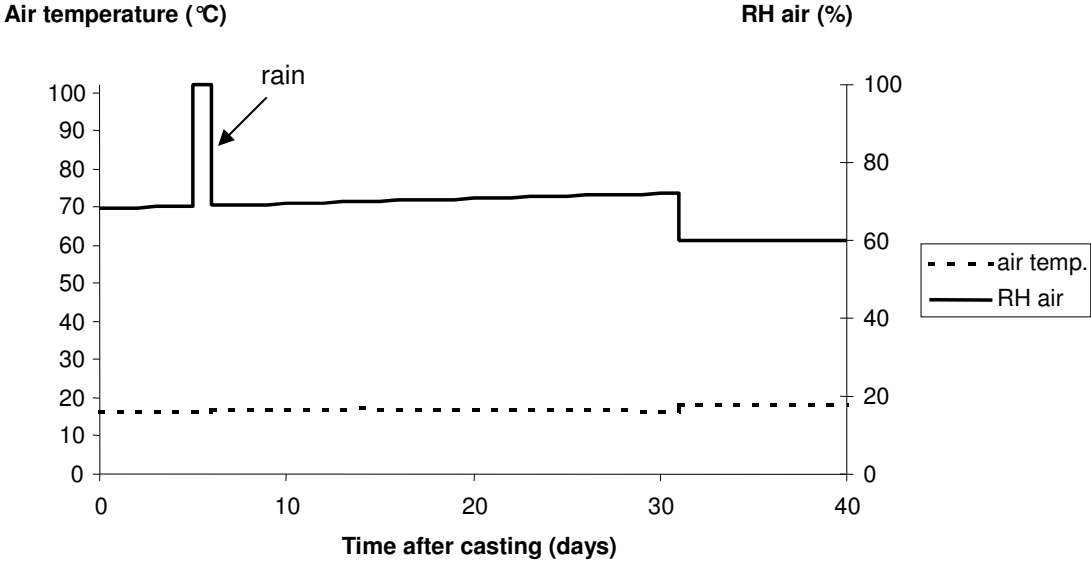

Figure 6.7 Surrounding climate conditions for Climate 2 during the first 40 days after concrete casting.

### 6.2.3.3 Results

In Appendix B all result diagrams concerning Climate 2, displaying effects of formwork type, concrete slab thickness and silica fume content on the required drying time for reaching RH levels of 85% and 90% are shown. One diagram showing the effect of w/c ratio on the drying time is presented below.

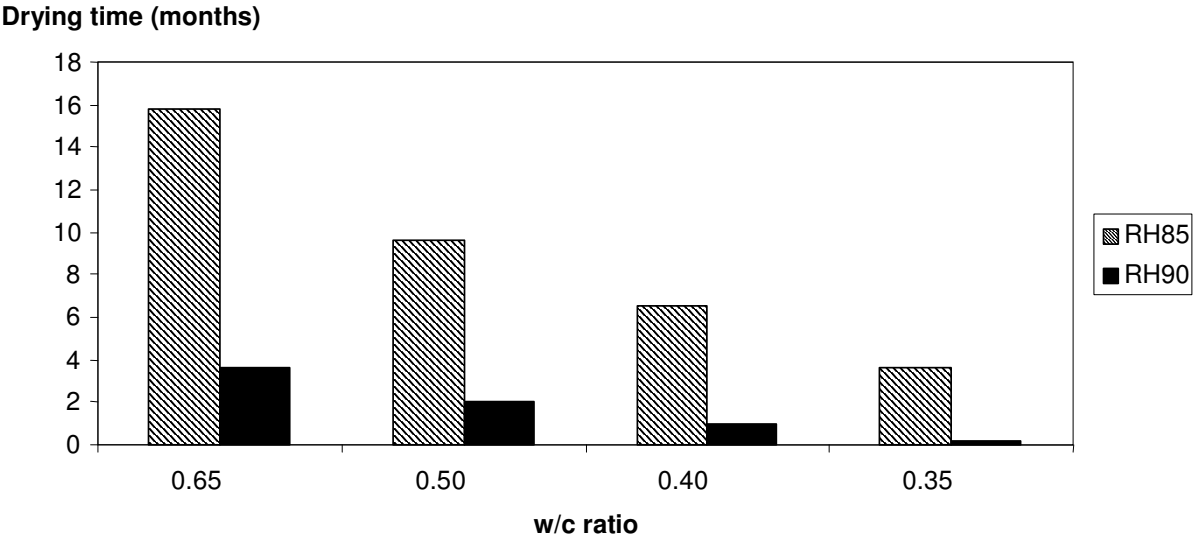

Figure 6.8 Estimated effects of various w/c ratios on the concrete drying time for Climate 2. Constant type of formwork (permanent concrete elements, 'Filigran') and cast slab thickness (0.20 m) is used within the calculations. No silica fume.

As for Climate 1, the effect of a lowered w/c ratio gives a considerable reduction in drying time. The difference between Climate 1 (fig. 4.3) and Climate 2 is not very big. Climate 2 leads to only a couple of weeks longer drying time. Thus, a 24 h rain a few days after casting is not as negative for drying as one might have expected. This was also confirmed experimentally by Johansson (2005).

## **6.2.4 Calculation for Climate 3 – winter conditions, default data, controlled drying 1 month after start of concrete casting**

### **6.2.4.1 Introduction**

The third climate condition represents winter climate conditions based on the default surrounding air temperatures within TorkaS 1.0, using statistical weather data. The PC-program assumes that the concrete temperature is equal to the surrounding air temperature but protected from early freezing of concrete, i.e. no consideration is taken to the fact that warmed concrete is delivered wintertime and to the heat development during cement hydration.

### **6.2.4.1 Conditions**

No heat insulation of the formwork or on the concrete surface was applied. According to Figure 6.9, the controlled drying starts one month after casting. During the first ten days, 1 day of rain (or snow) will occur, based on the statistical weather data used by TorkaS 1.0. After ten days, the concrete will be covered and protected from further rain.



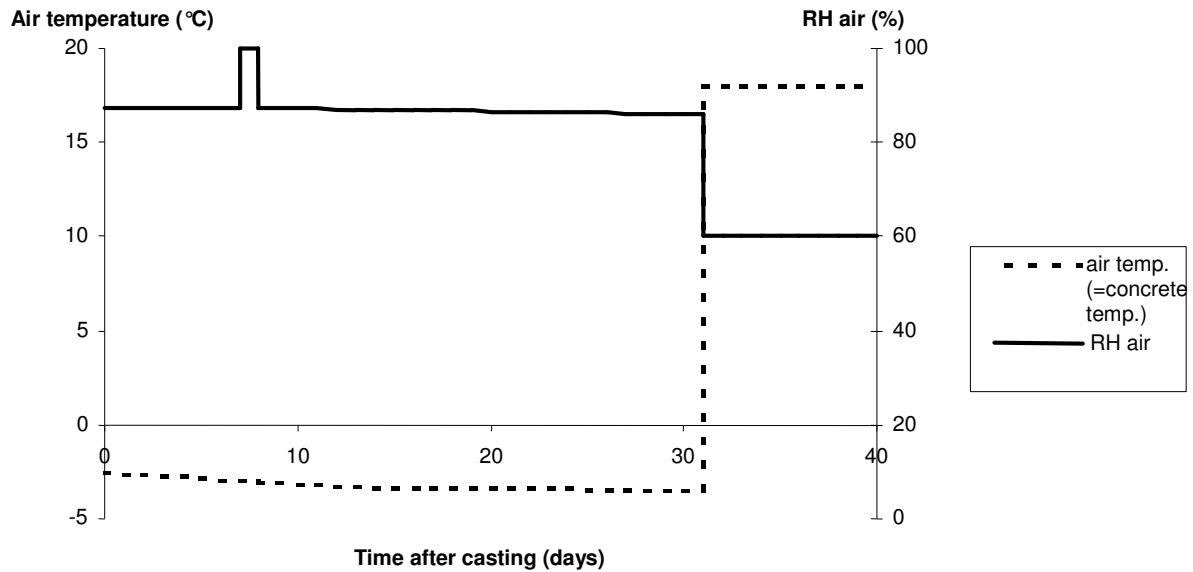

Figure 6.9 Surrounding climate conditions for Climate 3 during the first 40 days after concrete casting.

### 6.2.4.1 Result

Figure 6.10 shows that there is a considerable increase in drying time, compared to summer conditions represented by Climate 1 and 2. This is an effect of the very slow cement hydration occurring at the very low concrete temperature used in the calculations (concrete temperature equals outer temperature). HPC with w/c-ratio as low as 0.35 requires a drying time of more than half a year for reaching 85% RH.

#### Drying time (months)

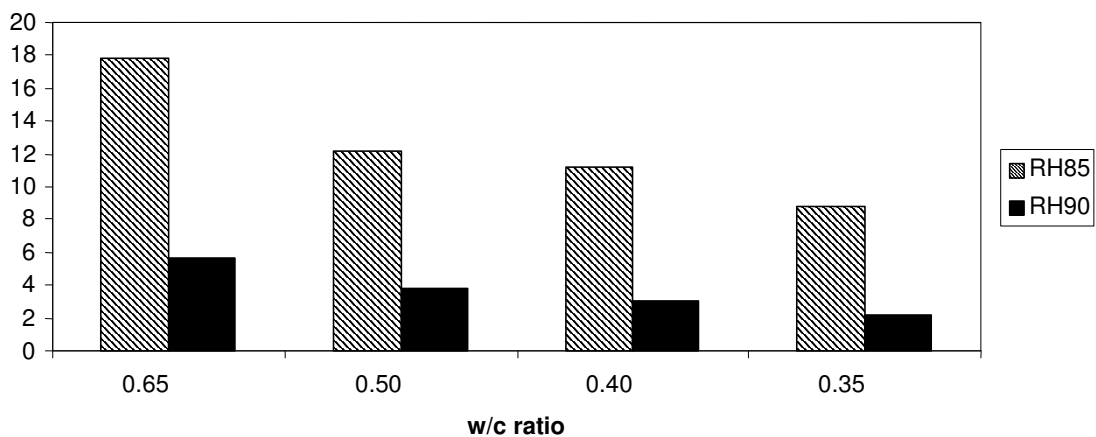

Figure 6.10 Estimated effects of various w/c ratios on the concrete drying time for Climate 3. Constant type of formwork (permanent concrete elements, 'Filigran') and cast slab thickness (0.20 m). No silica fume.

### 6.2.5 Calculation for Climate 4

– winter conditions, concrete temperature constantly 10°C during the first 7 days after casting, controlled drying 1 month after start of concrete casting

#### 6.2.5.1 Introduction

The increased temperature of the concrete during the first days after casting due to heat development caused by hydration, leads to faster strength development in cold surrounding temperatures and a reduced risk for early freezing of the concrete. A high concrete temperature is also positive for the drying process since the degree of hydration is accelerated. In order to calculate the effects of a higher concrete temperature level, than that of Climate 3. Climate 4 simulates the real temperature conditions by using fixed concrete temperature of +10°C during the first week.

#### 6.2.5.2 Conditions

As shown in Figure 6.11, the climate condition 4 simulates a concrete temperature of +10°C during the first 7 days after concrete casting. Thereafter and until controlled drying is taking place (from 8 until 30 days after casting), the concrete temperature is set to be equal to the surrounding air temperature. During this time the concrete will be unprotected from rain, which due to the statistical weather data leads to that one day of rain will occur. No heat insulation of the formwork or on the concrete surface was applied.

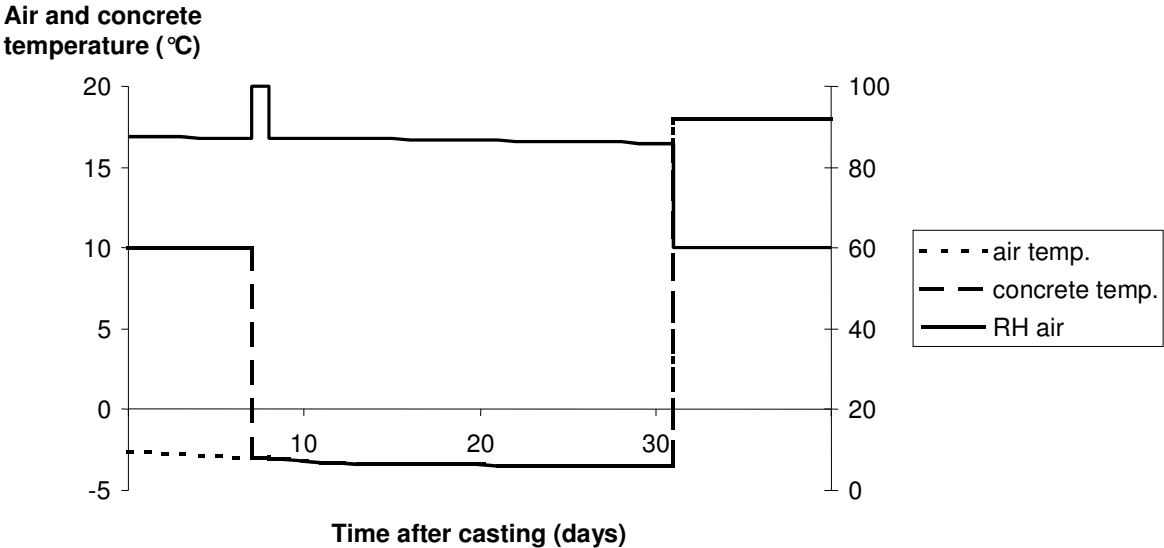

Figure 6.11 Surrounding climate conditions for Climate 4 during the first 40 days after concrete casting.

### 6.2.5.3 Result

The result for varying w/c ratio is shown in Figure 6.12. It displays a certain decrease of the required drying time for reaching a RH level of 85 and 90%, compared to the climate condition 3 (Figure 6.10). Thus, the fact that the concrete is warmer during the first week has a certain positive effect on drying. The drying time to 85% or 90% can be reduced by about 1 month for all w/c-ratios.

Drying time (months)

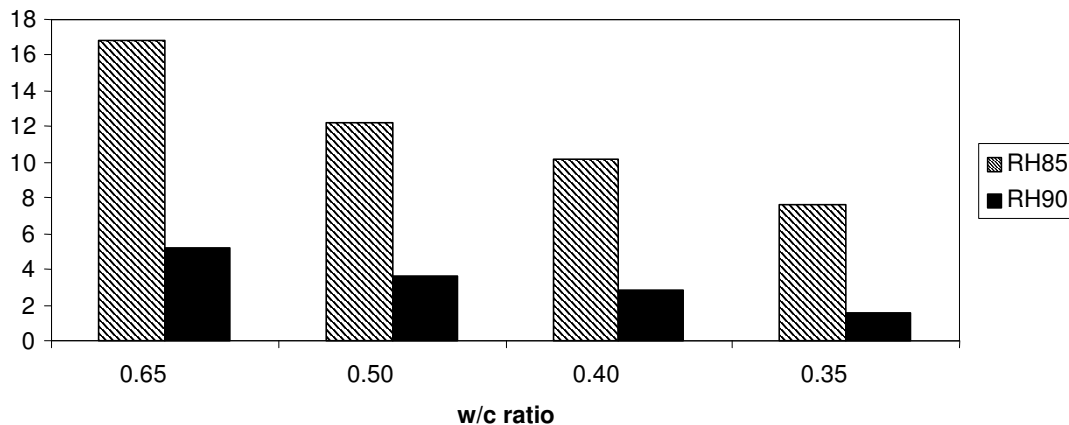

Figure 6.12 Estimated effects of various w/c ratios on the concrete drying time for Climate 4. Constant type of formwork (permanent concrete elements, 'Filigran') and cast slab thickness (0.20 m) is used in the calculations. No silica fume.

## 6.2.6 Calculation for Climate 5

– winter conditions, concrete temperature calculated by Hett97 during the first 4 days, controlled drying 1 month after start of concrete casting

### 6.2.6.1 Introduction

Methods for protecting concrete from early freezing and/or from obtaining slow rate of hydration during cold surrounding air temperatures are, for instance, covering of the concrete surface, insulation of the formwork and heating the concrete. This can be done in combination with utilisation of the larger heat development in concrete with high cement content compared to ordinary house-building concrete. As mentioned, the early hydration of the concrete affects the drying process, especially the self-desiccation in concrete with low w/c ratio. The calculations using Climate 5 aims at simulating larger but probably more realistic heat development and hydration, in comparison to the other winter climate conditions studied (Climate 3 and 4).

### 6.2.6.2 Conditions

For Climate 5, realistic concrete temperature development data have been utilised by importing result from the PC-program Hett97 (1997), which calculates temperature, maturity and strength development in concrete constructions for various concrete qualities, types of constructions, weather conditions etc. Figure 6.13 shows the average concrete temperature according to Hett97, during the first 4 days after casting. The calculations with Hett97 are based on outer climate conditions, similar to the climate conditions for Climate 5 (see Figure 6.14). The diagram shows the result regarding various w/c ratios when uninsulated formwork system of ‘Filigran’ is used, cast slab thickness 0.20 m, concrete temperature at casting 20°C, infra heating (350 W/m<sup>2</sup>) during the first 24 hours, and ‘high-quality’ covering (definition according to Hett97).

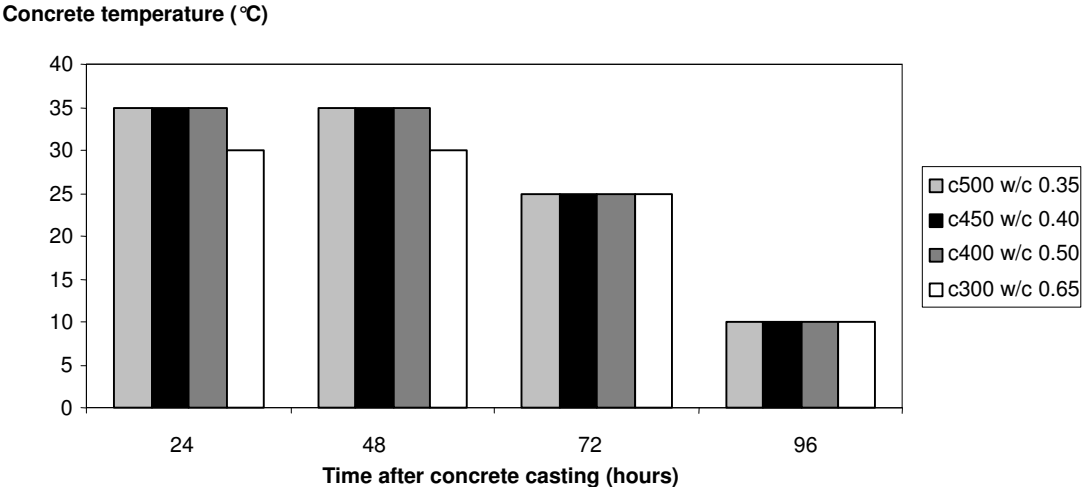

Figure 6.13 Used concrete temperature data during the first four days, based on calculations through the PC-program Hett97 (1997) for the surrounding air temperature of Climate 5. Used cement content between 300 kg/m<sup>3</sup> (c300) and 500 kg/m<sup>3</sup> (c500). Cast slab thickness 0.20 m, Filigran-form, concrete temperature at casting 20°C, infra heating (350 W/m<sup>2</sup>) during the first 24 hours and ‘high-quality’ covering (definition according to Hett97).

As shown in Figure 6.14, the concrete is supposed to, as in the case of other winter climate conditions (Climate 3 and 4), have a temperature equal to the surrounding air temperature (based on statistical weather data) from the 4<sup>th</sup> day until the 30<sup>th</sup> day after casting. After the fourth day the concrete is supposed to be non-covered and therefore be affected by one day of rain (due to the statistical weather data) until the tenth day, when covering (protection from rain) will take place.

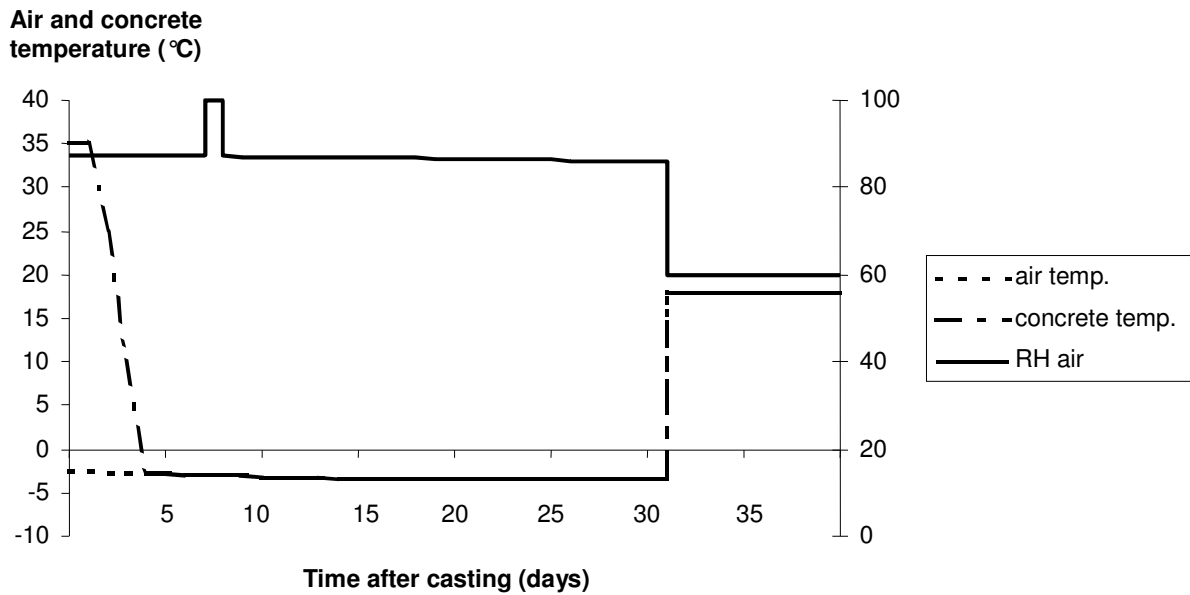

Figure 6.14 Surrounding climate conditions and concrete temperature for Climate 5 during the first 40 days after casting.

### 6.2.6.3 Result

The calculated required concrete drying time for Climate 5 can be seen in Figure 6.15. Additional information is given in paragraph 6.2.7. A comparison of the results in Figure 6.15 with the results for Climate 4 in Figure 6.12 shows that the calculated drying time is shortened by about 1 ½ to 2 months for concrete with low w/c-ratio when realistic concrete temperature is used. For concrete with higher w/c-ratio, the effect is smaller. This indicates that concrete temperatures mostly affect the self-desiccation, which in turn is more favourable in Climate 5 than Climate 3. For normal concrete, physical drying is more important. The rate of physical drying is less dependent on concrete hydration. It is even bigger the lower the degree of hydration since then the moisture permeability is higher. Therefore, for NC the Climates 3, 4, and 5 give almost the same drying time.

#### Drying time (months)

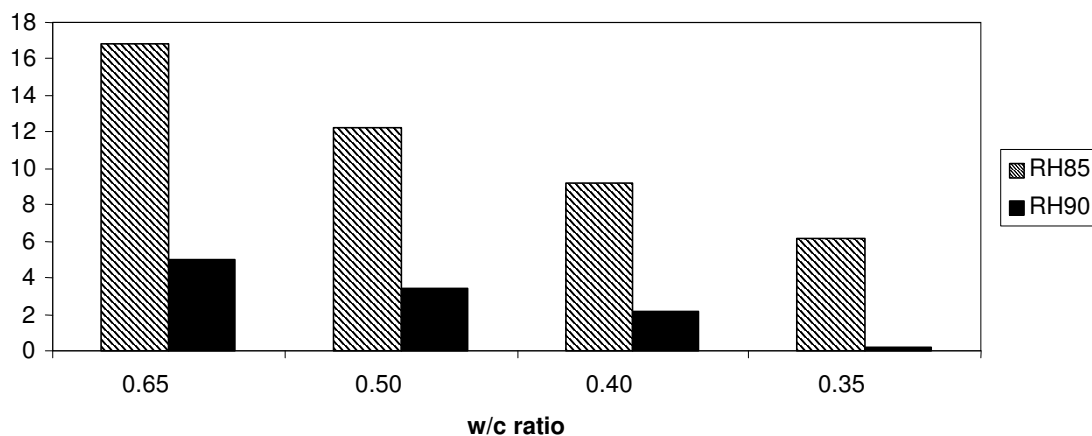

Figure 6.15 Estimated effects of various w/c ratios on the concrete drying time for Climate 5. Constant type of formwork (permanent concrete elements 'Filigran') and cast slab thickness (0.20 m) is used within the calculations. No silica fume.

## 6.2.7 Effect of concrete temperature

### 6.2.7.1 Result

A comparison of results regarding winter climate conditions (Climate 3-5) for different w/c ratio is presented in the Figure 6.16 'a' and 'b'.

Drying time (months)

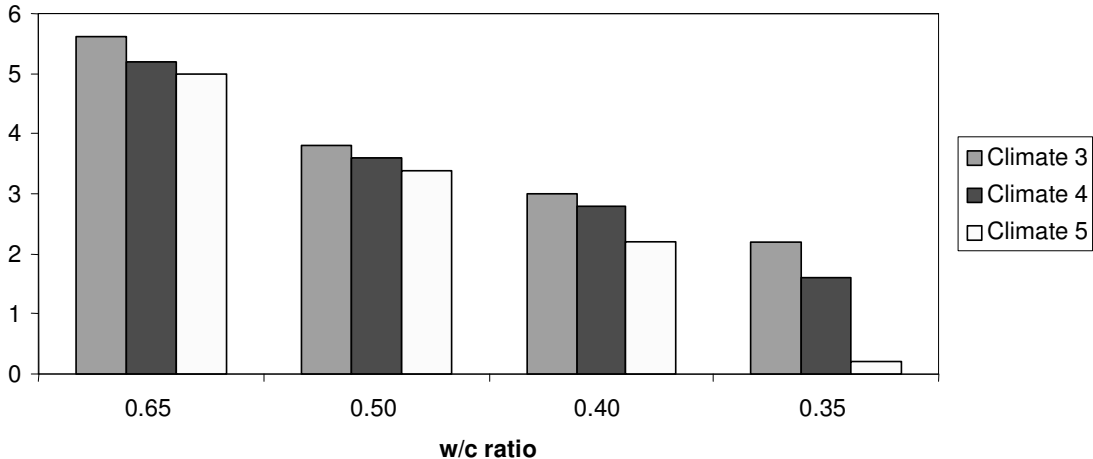

a

Drying time (months)

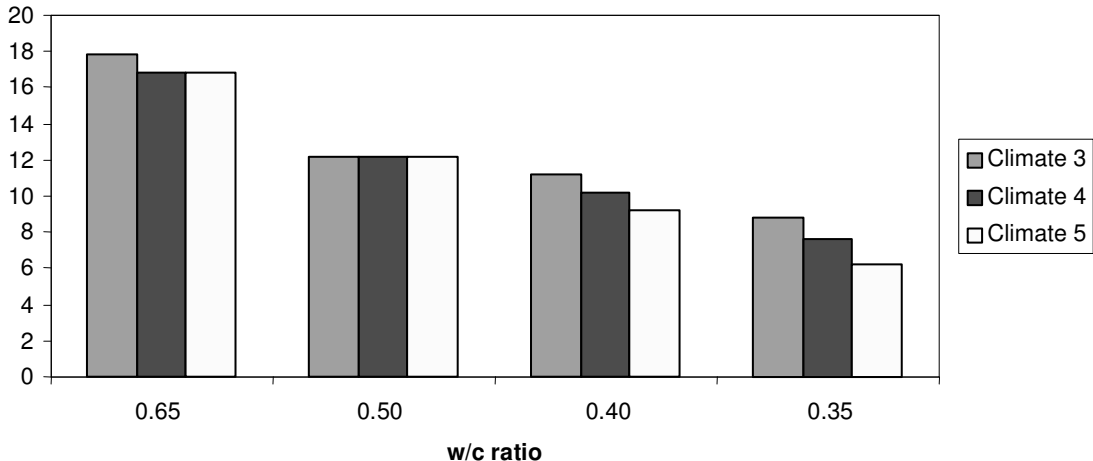

b

Figure 6.16 Effect of different early concrete temperatures on the calculated required drying time for reaching RH 90% (a) and 85% (b). Constant type of formwork (permanent concrete elements, 'Filigran') and cast slab thickness (0.20 m) is used within the calculations. No silica fume.

### **6.2.7.2 Analysis/conclusions**

As seen in Figure 6.16, the difference in required drying time between different simulated concrete temperatures during the first days are larger for HPC than for NC. The effect can be explained as follows.

Drying depends on the mechanisms: (1) self-desiccation caused by volume reduction of chemically bound water, (2) physical drying caused by moisture transport to the surface. For HPC, self-desiccation is the dominant mechanism. It is very much affected by the rate of cement hydration. This increases with increased concrete temperature. Therefore, Climate 5 is more favourable than Climate 4.

Two conclusions can be drawn concerning the effect of concrete temperature on drying and on the use of TorkaS 1.0 for estimating the drying time:

1. Calculations by TorkaS 1.0 show that the concrete temperature has very big effect on the calculated drying time, especially for concrete with low w/c-ratio. Thus, it is recommended that as precise values as possible for concrete temperature are used as input parameter in TorkaS 1.0, and not the outdoor temperature. The concrete temperature can be calculated by the PC-program Hett97.
2. The results show the importance of using winter concreting methods that give rapid hydration when efficient drying process and rapid drying times are required. Thus, the use of warm concrete, high cement content, rapid cement, heat-insulated formwork, heating of concrete by infra-heaters and early covering of the concrete surface are essential.

## **6.2.8 Effect of outer climate conditions**

### **6.2.8.1 Result**

Figure 6.17 'a' and 'b' present the effect of the five climate conditions studied on the required drying time for reaching 90% and 85% RH.

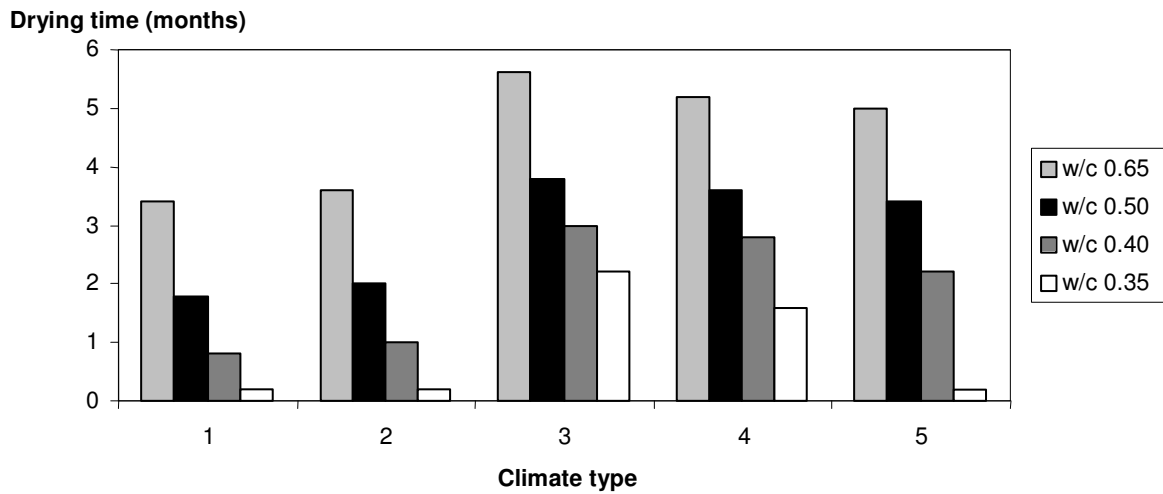

a

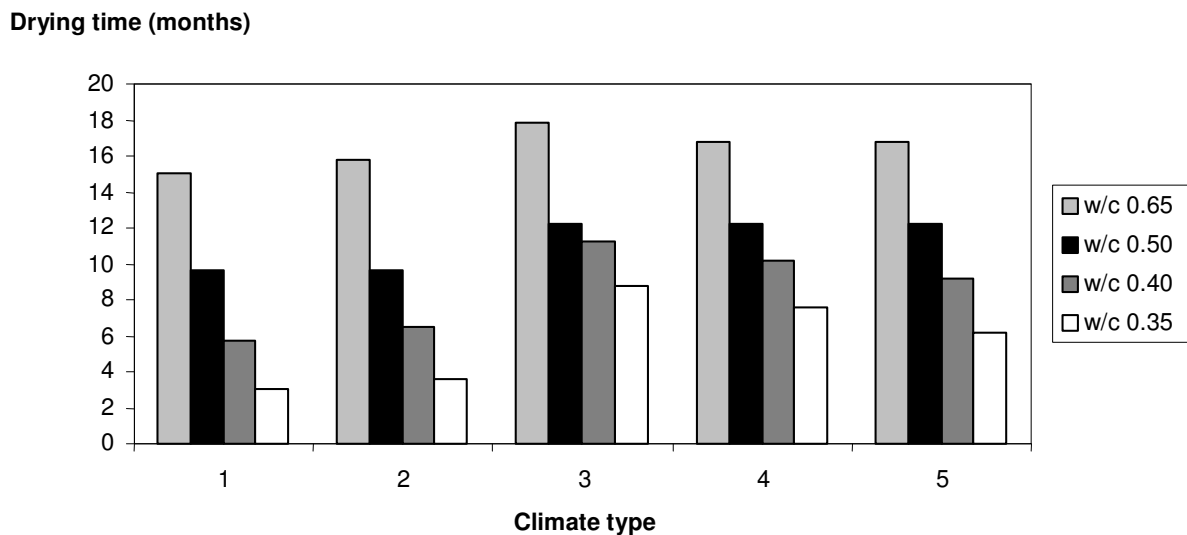

b

Figure 6.17 Comparison of results from all studied climates on the required drying time for reaching RH 90% (a) and 85% (b) for various w/c ratio. Constant type of formwork (permanent concrete elements, 'Filigran') and cast slab thickness (0.20 m) is used within the calculations. No silica fume.

### 6.2.8.2 Analysis

The difference in required drying time for different climate conditions is considerably smaller for NC than for HPC, especially when the required RH level is set to 85%. Several conclusions can be made. For instance, according to Figure 4.17 b (required RH of 85%), utilisation of controlled drying from the start of casting through weather-protecting tents,



which is an expensive method, only reduces the drying time of NC (w/c 0.65) from 16 (Climate 2) to 15 months (Climate 1) during summer conditions, and from 18 (Climate 3) to 15 months (Climate 1) during winter conditions. The same comparison but considering HPC (w/c 0.35) also indicates a small difference during summer conditions. During winter conditions though, the difference in drying time is significantly larger, 6 months (Climate 5) compared to 3 months (Climate 1).

When 90% is used as required RH level, a clear difference in drying time with regard to surrounding climate conditions can also be seen for NC (w/c 0.65), 3.5 months (Climate 1) compared to 5 months (Climate 5).

Thus, the high importance of providing for good conditions for early rapid hydration, causing rapid self-desiccation is most pronounced for HPC during wintertime.

Another conclusion is, that for all studied climates HPC leads to significantly reduced drying time. For Climate 1, the drying time can be reduced from 15 to 3 months and for Climate 5, from 17 to 6 months, when HPC is utilised instead of NC.

## **6.2.9 Discussion**

### **6.2.9.1 General**

The results of the study reveal in what degree the parameters water/cement ratio, silica fume content, slab thickness and type of formwork affect the concrete drying time for different types of surrounding climate conditions. Limitations of the parameters and climate conditions have had to be made. However, values of the variables are intended to correspond to realistic conditions.

There are also limitations in the used calculation tool, the PC-program TorkaS 1.0. In order to simulate the drying time for constructions cast in winter, real concrete heat development data during the first days after casting have been used instead of the default data used in the original version of program. These changes are assumed to be more correct compared to the original data, especially for HPC.

Another aspect of the use of TorkaS 1.0 is that the required drying time in reality may be different from the calculated. Probably the calculated values are too big for HPC. However, the calculations aim at presenting the potential for shorter drying times using HPC, and there are small risks for that calculated drying times are shorter than the real.

Generally, decreased w/c ratio and reduced slab thickness together with the use of silica fume reduces the drying time considerably for all studied climates. Another result is that Filigran-formwork leads to shorter drying times compared to steel forms, due to that double sided drying is enabled instead of single direction drying. Comparing ordinary concrete with w/c ratio of 0.65, steel form and without silica fume to HPC containing silica fume, with w/c ratio of 0.35 and Filigran-form, shows that there is a very big difference in required drying time. To reach a relative humidity of 85%, the first concrete concept requires a drying time of more than 20 months and the latter about two months.

### **6.2.9.2 Effects of self-desiccation**

A low w/c ratio reduces the drying time due to the self-desiccation effect. Besides, concrete with a high degree of self-desiccation is less sensitive to variations such as slab thickness, use of steel form etc. The self-desiccation effect can in other words be utilised for a more versatile way of building, since aspects that normally affect the drying time can be more or less ignored. The advantages of using self-desiccating HPC for obtaining good acoustic indoor quality are obvious. Good acoustic quality requires thick concrete slabs, but this will give unacceptable long drying time if NC is used. By using HPC, thick slabs can be produced with short drying times.

In order to utilise the self-desiccation effect of HPC when casting in winter, it is important to use winter concrete protection methods, in order to create favourable conditions for concrete hydration.

### **6.2.9.3 Effect of silica fume**

The result of the calculation displays an obvious effect of silica fume on the drying time. For instance, a reduction of drying time of about 35% is possible when a silica fume content of 5% is used during Climate 1. The reason for the positive effect of silica fume is that it increases self-desiccation.

### **6.2.9.4 Winter-concreting**

Three types of winter temperature data valid for outdoor air have been used. The first climate condition uses the default values within the PC-program TorkaS 1.0. For the second condition the concrete temperature has been set to constantly 10 °C during first week. For the third climate condition, more realistic concrete temperature data from the PC-program Hett 97 have been used. The difference between the three types of climate is relatively big. Especially for HPC, the differences in drying time are significant. According to earlier mentioned explanations, the reason for this is that HPC to a larger extent is dependent on rapid hydration for the self-desiccation effect to be efficient.

### **6.2.9.5 Effects of controlled drying**

The most efficient climate for a reduced drying time is of course Climate 1, where controlled drying starts immediately after the concrete is cast. For the other climates, the controlled drying is assumed to start after one month. As shown in figure 4.17, the difference between the summer climates 1 and 2, where the latter simulates controlled drying after one month, is much smaller than the difference between Climate 1 and 3-5, where the concrete is cast wintertime and protected by various winter concrete methods.

## 6.2.10 Conclusions

According to the analysis, the main positive effects of HPC, compared to NC, concerning drying time are as follows:

- HPC leads to significantly shorter drying times for all studied climate conditions (20-50% of drying time required for NC)
- Drying of HPC is nearly independent of the concrete slab thickness
- HPC creates possibilities for short drying times even when impermeable formwork systems as steel (leading to drying in one single direction) are used

Other conclusions concerning concrete drying are:

- Formwork  
For NC, formwork that does not allow drying in two directions (e.g. steel) leads to approximately 70% increase in drying time for a 20 cm slab, compared to Filigran-formwork, which enables drying in two directions.
- Silica fume  
Concrete (w/c ratio of 0.35 to 0.50) including silica fume needs approximately about 2/3 of the required drying time, compared to concrete without silica fume, for reaching 85% RH on the equivalent depth.
- Concrete slab thickness  
If the concrete slab thickness is increased from 0.15 to 0.25 meters, the required drying time for NC for reaching 85% RH will be extended by 100% when Filigran-formwork is used.
- Concrete temperature during the first days after casting during wintertime  
In order to utilise the self-desiccation effect of HPC, rapid hydration during the first days after casting is important. Therefore it is important to use high quality protection of the concrete during the first days.
- Surrounding climate conditions  
For HPC, the drying time for reaching RH 85% when controlled drying is used from casting (Climate 1) is 50% of the time required for the realistic Winter climate 5. Similar comparisons regarding NC though, result in smaller differences. For NC to reach RH 85%, the required drying time in Climate 1 is 90% of the drying time required for Climate 5.

## **6.3 Utilisation of HPC for rapid strength development – a theoretical study**

### **6.3.1 Introduction**

#### **6.3.1.1 Background**

The production cycle for cast in-situ concrete is strongly dependent on the required time until stripping the formwork and/or the time before post-tensioning of reinforcement can be made. The time depends on the rate of strength development of the concrete, which in turn, to a large extent depends on the concrete quality and surrounding air temperature. Winter conditions with cold air temperature significantly decrease the rate of strength development and thereby also increase the required formwork stripping time. There are also the risks for early freezing of the concrete that may lead to risks for serious damage of the concrete. To increase the strength development, the cement content is often increased and during winter conditions, external protection methods as insulating the formwork, covering the concrete surface and heating of the concrete (by using infra-heaters) often has to be utilised in order to increase the strength development and protect the concrete from early freezing.

#### **6.3.1.2 Aim**

The study aims at estimating the potential for reduction of the production time, by utilising the rapid strength development of HPC caused by the high cement content and low water/cement ratio. Studied areas concentrate on presumptive beneficial effects of HPC, as for instance the decreased time required until formwork stripping and post-tensioning of reinforcement can be made, and the reduced risk for early freezing of the concrete. Required time to reach specific strength levels and risk for early freezing with regard to various climate conditions and production methods are estimated and comparisons between NC and HPC are made.

The study is divided into the following main parts: (1) strength development for formwork stripping, (2) strength for post-tensioning of reinforcement and (3) the risk for freezing.

#### **6.3.1.3 Method**

Parameter studies of variables influencing the strength development in concrete slabs are carried out by use of the PC-program Hett97 (1997). By this PC-tool the development and gradients within the cross-section of temperature, maturity age and compressive strength in various types of concrete structures can be estimated. Further, Hett97 uses tendency curves for the strength development of different concrete types made with different cements produced in Sweden. The tendency curve gives the strength development for a constant reference temperature (+20°C). A number of construction types can be analysed (e.g. walls, columns, slabs on ground and slabs including various formwork systems). The input data concerning surrounding conditions are, for example, temperature of concrete at casting, air temperature, wind conditions, covering, insulation and heating of concrete.

In the present work the influence of various concrete qualities in combination with different outer conditions has been simulated with the aim of estimating the difference between HPC and NC concerning time required for reaching a minimum concrete strength of 20 MPa at the slab top surface and also the risk of early freezing of the concrete based on that the required strength level is 5 MPa before freezing. The results of the calculations are presented as diagrams.

## **6.3.2 Early stripping of formwork**

### **6.3.2.1 Introduction**

Construction codes include requirements for concrete compressive strength when stripping the formwork, in order to eliminate the risk for collapse. Concerning concrete slabs, the Swedish Building norm requires a minimum strength of 70% of the strength class required for the concrete construction. The required concrete compressive strength regarding vertical formwork needed for walls is set to 6 MPa in the Swedish building norm. On the market there are a number of measurement systems to estimate the strength level of concrete. For all systems it is important to conduct the measurement in relevant parts of the structure. In concrete slabs, measurement should be conducted in zones with the highest compressive stress and in walls at the outer surface of the lower parts, where stresses are highest and temperature (hydration) lowest.

Stripping of slab formwork during summertime can normally be made a few days after casting but can nevertheless be a critical parameter with regard to the total production time when demands on rapid production are high, especially during the colder parts of the year. For walls, the normal stripping time is less than 24 hours, and this time should preferably be kept also during cold weather. There are a number of solutions for reducing the required time for removal of formwork. One often-used method is to increase the amount of cement, which means a decrease of the w/c ratio. Summertime, a moderate increase in strength class considerably reduces the formwork stripping time. During the cold part of the year though, when the air temperature falls to levels around or below zero, increased concrete quality often is supplemented by external winter concrete methods, as for instance heat insulation, covering of the surface and heating of the concrete. However, utilisation of concrete strength classes corresponding to HPC, which according to the Swedish tradition requires concrete compressive strength of at least 80 MPa, with the main aim of decreasing the formwork removal time is seldom practised, neither in summer nor in winter.

Within the study, formwork-stripping time is calculated by simulating important parameters. The calculations aim at comparing HPC with NC, assessing different winter concrete methods and different kinds of climate and formwork. Only slabs are considered.

### **6.3.2.2 Calculations**

Table 6.3 displays the parameters investigated. The values of these have been varied, in order to investigate the effect of the early strength development of concrete.

Within all calculations, the used concrete strength classes, so called ‘K-values’, are according to the former Swedish concrete norm (Boverket, 1994). Each ‘K-value’ represents the

required compressive strength value for 150 mm dry *cubes*. Due to the fact that the concrete types considered within the PC-program are limited to a maximum strength level of 70 MPa, the two highest concrete qualities (K90 and K110) have been manually introduced in the PC-program by increasing the cement content with 30 kg/m<sup>3</sup> per strength class together with increasing the strength of 28 days maturity to the actual K-values. Used type of cement is in all simulated cases of type CEM I, Swedish Std Portland. Used superplasticiser is of melamine type. The slab thickness is permanently set to 0.20 meters. Studied form types are plywood with a thickness of 19 mm and prefabricated concrete Filigran formwork with a thickness of 50 mm. For summertime simulations, the surrounding air temperature is constantly set to +15 °C and during winter time, three levels of air temperature are simulated, 0, -5 and -10 °C. Concerning external winter concrete methods, aiming at utilising the internal concrete heat development during the first couple of days after casting, three types are simulated: heating the form/concrete from below using infra heaters (350 W/m<sup>2</sup> during the first 24 hours), ‘well-insulating’ heat insulation of the formwork (definition according to Hett97) and ‘high-quality’ covering of the concrete from above (definition according to Hett97). The concrete temperature at casting has for simulations during summer climate been set to +15 °C and during winter to +20 °C, which means that during winter, the concrete has been heated in the concrete factory to a level that can be regarded as a standard value for Swedish winter conditions. Also +25 °C has been considered.

The required minimum level of strength at stripping of formwork has, for all simulations within the study, been set to 20 MPa at the top surface of the slab, which is a commonly used level in practice. The Swedish norm requires a minimum level of 70% of the total strength required with regard to design aspects when stripping the formwork. This value (70%) is, however, in most cases much too high for HPC.

*Table 6.3 Studied parameters within the production related study of early strength development.*

<b>Parameters</b>	<b>Levels</b>
Concrete strength class (K-value)	30, 50, 70, 90 and 110
Cement content for each K-value (Std Portland)	270, 420, 450, 570 and 690 kg/m <sup>3</sup>
Additive	Superplasticiser of melamine type
Slab thickness	0,20 m
Types of forms	Plywood (P) 19 mm and Filigran (F) 50 mm
Air temperature (no wind)	Summer (+15 °C) and Winter (0, -5 and -10 °C)
Heating of concrete by infra heaters	Yes (350W/m <sup>2</sup> 24hours) and no (none)
Heat insulation of formwork	Yes (‘well-insulated’) and no (none)
Covering	Yes (‘high-quality’ 672 hours) and no (none)
Concrete casting temperature	Summer (+15 °C) and Winter (+20 and +25 °C)

### 6.3.2.3 Result

The time required for reaching 20 MPa for various concrete strength classes, from NC (K30) to HPC (K110), during summer conditions with outer air temperature of 15 °C is shown in Figure 6.18. An increase to K50 from K30 leads, independently of formwork type, to a large reduction of time required (1 day in relation to 5 days) for reaching the strength level of 20 MPa in the slab. When using an even higher concrete quality (e.g. K110), the time required can be reduced to approximately 0.5 day. However, in practice special attention must be paid

on that the early strength growth may be retarded for HPC with high amount of superplasticiser. This retardation effect increases when the surrounding air temperature decreases.

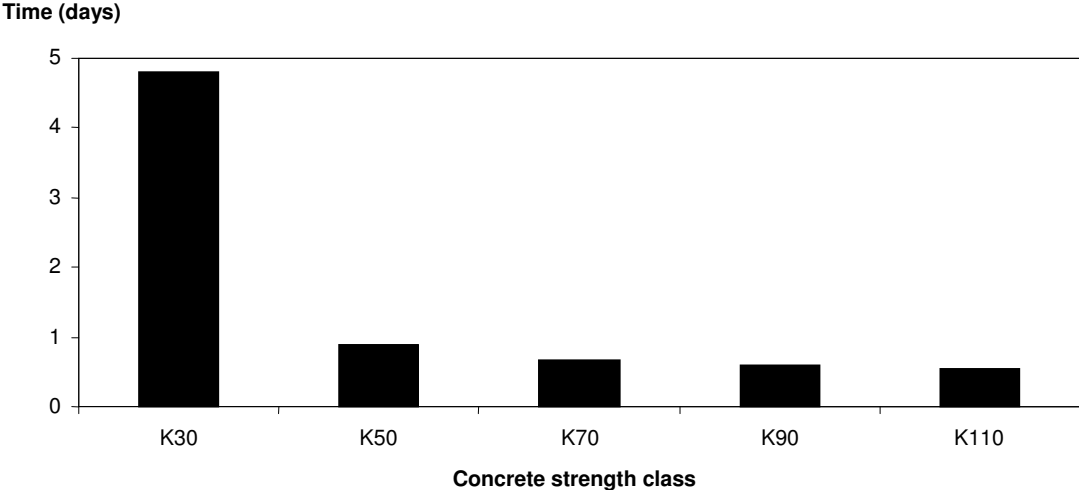

Figure 6.18 Calculated time required for reaching 20 MPa minimum strength at the slab top surface for various concrete strength classes during summer conditions, (+15 °C). 19 mm plywood form.

The effect of cold winter climate is clearly displayed in Figure 6.19. With a surrounding air temperature of 0 °C an increase from K30 to K50 leads to a significant reduction of the stripping time required, but with an outer air temperature of -5 °C, an even higher strength class is required if short time is wanted. Only when using a strength class as high as K90, the time required is less than 10 days. The table also shows that when the outer air temperature is as low as -10°C, a high strength class is not enough if an acceptable stripping time is wanted. The concrete is not allowed (according the Swedish Building stipulations) to freeze before it has reached minimum strength of 5 MPa. This requirement was not fulfilled for all presented strength classes in Figure 6.19 when the outer temperature was -5 °C or lower and the concrete was unprotected, see Table 6.4. Note that none of the analysed structures include any winter concrete methods. The result is based on simulations where only plywood is used as formwork system and the concrete is not heated by infra-heaters, heat insulated, or covered.

Time (days)

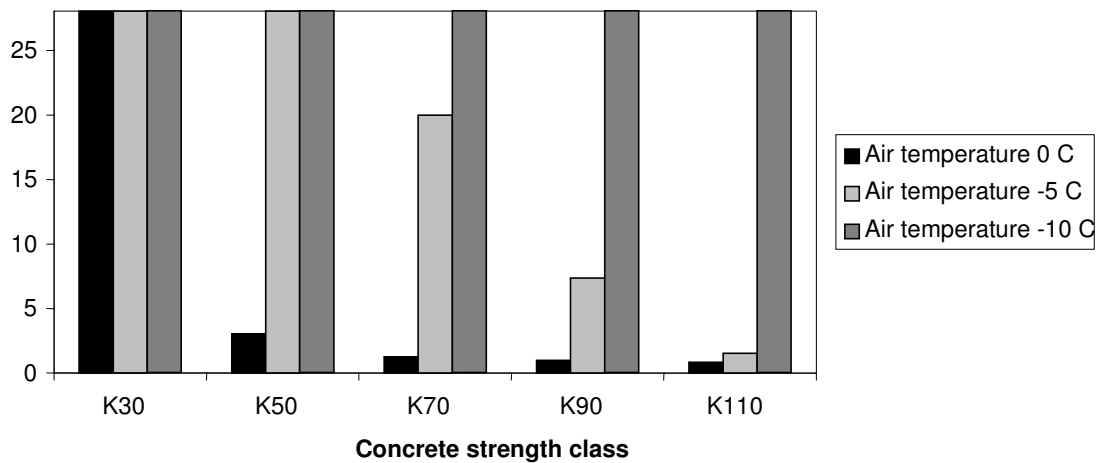

Figure 6.19 Calculated time for reaching minimum strength of 20 MPa at the top surface of concrete slabs for different strength classes and different outer air temperatures. No winter precautions. Only 19 mm plywood form. Concrete temperature at casting +20 °C.

Results of calculations of the effect of type of uninsulated formwork on the time for reaching minimum 20 MPa at outer temperature -5°C are shown in Figure 6.20. The highly negative effect of using uninsulated concrete Filigran-elements is obvious. The high difference between plywood and Filigran-formwork reflects the much lower heat conduction coefficient of wood.

Time (days)

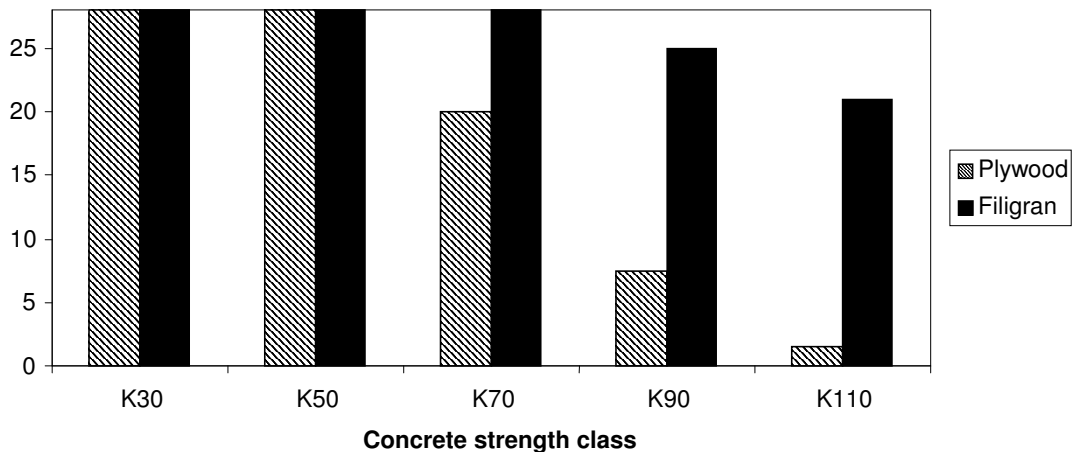

Figure 6.20 Calculated time to reach 20 MPa at an outer temperature of -5 °C and use of non-insulated form and no winter precautions. Concrete temperature at casting +20 °C.

The effect of utilising all winter concrete methods simultaneously (heat insulated formwork, covered concrete surfaces and heated concrete by infra-heaters) is shown in Figure 6.21. The result is based on a surrounding air temperature of -5°C and that plywood has been used as formwork. The diagram shows a significant reduction of time required for reaching the strength level of 20 MPa for all studied concrete strength classes. The time required to reach



20 MPa for K30 and K110, when both are *including* winter concrete methods are approximately 1 day and 0.2 days respectively. In comparison, a K110 concrete *without* winter concrete methods needs 1.5 days for reaching 20 MPa. However, as said above, a K110 concrete often contains so much superplasticiser that the strength development is retarded, which probably leads to that 0.2 day is too short.

**Time (days)**

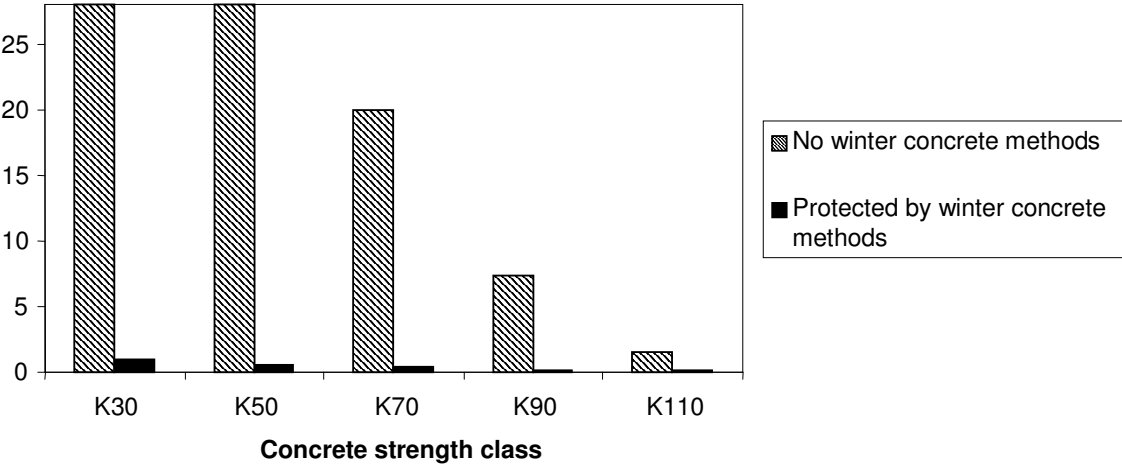

Figure 6.21 Calculated time to reach 20 MPa at outer temperature of -5°C. Effect of winter precaution activities is regarded. 19 mm plywood form. Concrete temperature at casting +20°C.

The effect of different winter concrete precaution activities used separately and in various combinations, is presented in Figure 6.22. An insulated K70 leads to nearly the same form stripping time as a K30 that is protected by insulation, covering and heating. The result is based on an outer air temperature of -5°C.

**Time (days)**

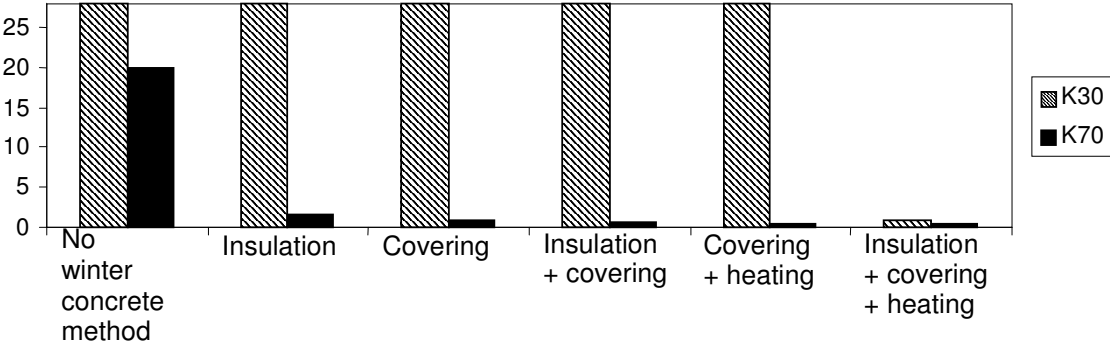

Figure 6.22 Example of the effect of different winter precaution activities on the time needed to reach 20 MPa at an outer temperature of -5°C. 19mm plywood form. Concrete temperature at casting +20°C.

### 6.3.2.4 Early formwork stripping – Conclusions

There are a number of procedures that can be used alone or in combination to minimise the time required for reaching a specific strength level required for stripping of the formwork. An increase of the concrete quality, causing more rapid early strength development, can significantly reduce the time required. This is valid during summer as well as during winter. Depending on surrounding air temperature, there are various combinations of concrete strength classes and winter concrete methods that can be used in order to reach a specific strength value at a specific time.

According to Figure 6.19, the use of an ordinary house-building concrete without use of any winter concrete protective methods is not enough to get a normal form stripping time. For an outer air temperature of 0°C, an increase in concrete quality from K30 to K50 leads to a significant improvement in terms of reduced stripping time. For lower air temperatures like -5°C, HPC (K90 or higher) is needed in order to get a satisfying strength development when no winter concrete methods are used. With an air temperature of -10°C, even a K110 concrete is not enough, unless winter protective methods are used.

It is quite clear from the result that concrete has to be protected during wintertime castings. Figure 4.21 shows that an ordinary K30 concrete including all winter concrete methods used together (insulation, covering and heating), leads to approximately the same strength development time required as a K110 concrete without any winter concrete protective methods. When various winter concrete methods are used separately (Figure 6.22), a K110 concrete including only insulation and/or covering leads to approximately the same strength development time required as a K30 concrete including both insulation, covering and heating.

## 6.3.3 Freezing of concrete

### 6.3.3.1 Introduction

Concrete casting when the surrounding air temperature is below 0°C may lead to early freezing of water in the concrete, which causes a severe risk for frost damage in this. To prevent such damage, the Swedish building code includes requirements for a compressive strength of minimum 5 MPa before the concrete temperature is allowed to fall below 0°C. When measuring the compressive strength of concrete, which has started to freeze, there might be risks for false overestimations of the strength as a result of that the strength of ice is included. When the ice melts in a concrete frozen already, the real strength of the concrete will be reduced dramatically, which in worst case may result in serious safety problems and low quality. The reason to that 5 MPa is used as criterion is not that 5 MPa is high enough to sustain the stresses occurring at freezing, but that 5 MPa corresponds to an internal drying caused by hydration that is big enough to take care of the 9% volume increase, when water is transformed to ice, Fagerlund (1980).

The internal concrete temperature increases during the first days after casting even when the outer air temperature is low. However, at an air temperature below 0°C, the risk of freezing is high also in the surface parts of concrete of high quality, if no external winter casting concrete methods are utilised. The most common methods to increase the strength development of concrete during cold outer temperatures are, as already mentioned insulation, covering and

heating of concrete. As an alternative to the external methods, an increase of the concrete quality may be enough with regard to early strength development and elimination of the freezing risk, provided that the temperature is not too low.

The aim of this part of the study is to estimate the potential of HPC for reducing or eliminating the risk of early freezing concrete. The freezing risk of HPC combined with/without external winter concrete methods are calculated and compared to NC with/without external winter concrete methods.

### 6.3.3.2 Calculations

Similar calculations as performed in the previous section of the chapter, regarding early strength development, are conducted with the aim of calculating the strength level in the surface of the concrete slab when the minimum internal concrete temperature passes below 0°C. The PC-program Hett97 has been used. With the aim of estimating the differences regarding freezing, protecting methods for HPC and NC, various external winter concrete methods and surrounding air temperatures are simulated. The cement type is CEM I, Swedish Std Portland. Only 20 cm thick slabs are considered.

### 6.3.3.3 Result

The first results concern the effects of surrounding air temperature on the freezing risk of concrete, i.e. freezing at the surface before the strength has reached 5 MPa, see Table 6.4. Other parameters are concrete quality and winter protective methods.

Note that the result is based on a concrete temperature at casting of +20 °C, formwork of plywood and that winter casting methods consist of heat insulation, covering and heating by infra-heaters of concrete. The details of these methods are described in 6.3.2.2.

The table shows that no studied concrete will freeze if all winter concrete methods are used simultaneously. Further, if no winter concrete precaution methods are used, a concrete quality of at least K90 is required when the surrounding air temperature is -5°C.

*Table 6.4 Estimated risk of early concrete freezing with regard to the surrounding air temperature, concrete quality and utilisation of winter concrete methods. Plywood 19 mm is used as formwork. Temperature of concrete at casting 20 °C. Winter concrete methods consist of a combination of insulation, covering and heating of concrete. Swedish Std Portland cement.*

<b>Air temp</b>	<b>K30</b> (c=270kg/m <sup>3</sup> )	<b>K50</b> c=450kg/m <sup>3</sup> )	<b>K70</b> c=470kg/m <sup>3</sup> )	<b>K90</b> c=590kg/m <sup>3</sup> )	<b>K110</b> c=690kg/m <sup>3</sup> )
Not protected by winter concrete methods					
-5	r	r	r	nr	nr
-10	r	r	r	r	r
protected by winter concrete methods					
-5	nr	nr	nr	nr	nr
-10	nr	nr	nr	nr	nr

r = risk for frost damage    nr = no risk for frost damage

Table 6.5 presents the effects of each studied winter concrete method, used separately or in combination with other methods, on the freeze risk for various concrete strength classes (K30 – K110) and different internal concrete casting temperatures (+20°C and +25°C). The potential of HPC is clear. For example a K70 concrete does not need to be protected against early freezing by external winter concrete methods if the concrete temperature at casting is 25°C. An ordinary K30 concrete requires both covering and insulation irrespectively of the casting temperature.

Another result is that heating of concrete is not required. However, as described above, heating of concrete is still an efficient method in order to reach a specific strength level with regard to formwork stripping.

Table 6.5 Estimated risk of early freezing of a 20 cm thick concrete slab depending on various winter concrete methods. The outer air temperature is constantly set to -10 °C. Plywood 19 mm is used for all calculations.

K-value	Cement (kg/m <sup>3</sup> )	Insulated form	Covering	Heating	Freeze risk Concrete temperature at casting = 20 °C	Freeze risk Concrete temperature at casting = 25 °C
30	270				<b>yes</b>	<b>yes</b>
		<b>x</b>			<b>yes</b>	<b>yes</b>
			<b>x</b>		<b>yes</b>	<b>yes</b>
		<b>x</b>	<b>x</b>		no	no
		<b>x</b>	<b>x</b>	<b>x</b>	no	no
50	450				<b>yes</b>	<b>yes</b>
		<b>x</b>			<b>yes</b>	no
			<b>x</b>		no	no
		<b>x</b>	<b>x</b>		no	no
		<b>x</b>	<b>x</b>	<b>x</b>	no	no
70	470				<b>yes</b>	no
		<b>x</b>			<b>yes</b>	no
			<b>x</b>		no	no
		<b>x</b>	<b>x</b>		no	no
		<b>x</b>	<b>x</b>	<b>x</b>	no	no
90	570				<b>yes</b>	no
		<b>x</b>			no	no
			<b>x</b>		no	no
		<b>x</b>	<b>x</b>		no	no
		<b>x</b>	<b>x</b>	<b>x</b>	no	no
110	690				<b>yes</b>	no
		<b>x</b>			no	no
			<b>x</b>		no	no
		<b>x</b>	<b>x</b>		no	no
		<b>x</b>	<b>x</b>	<b>x</b>	no	no

### 6.3.3.4 Conclusions

If the temperature of the concrete passes below 0°C before the strength of the concrete has reached a level of 5 MPa, there are risks for freezing damages in the concrete structure. Different types of methods to protect against early freezing of concrete have been investigated. These methods consist of increased cement content (and strength), various external winter concrete methods (insulation, covering and heating of concrete) and various combinations of these variables. By using the PC-program Hett97, the effects of the methods are simulated for various types of formwork and surrounding air temperature. The study

results in tables presenting the risks of early freezing of concrete with regard taken to protection methods and surrounding conditions.

Main conclusions are:

- When simultaneously utilising all studied winter concrete methods, there are no risks for early freezing in any parts of the concrete slab, independent of the concrete strength level, even if the surrounding air temperature is as low as  $-10^{\circ}\text{C}$  and the concrete temperature at casting is  $20^{\circ}\text{C}$ .
- A concrete quality of at least K90 is required for eliminating the risks for early freezing when no winter protecting methods are used at the same time as the outer air temperature is  $-5^{\circ}\text{C}$  and the temperature of the fresh concrete is  $+20^{\circ}\text{C}$ .
- If the concrete temperature at the start of casting is  $+25^{\circ}\text{C}$ , no external winter concrete methods have to be used regarding the risk for early freezing for concrete qualities of K70 or more, even if the surrounding air temperature is as low as  $-10^{\circ}\text{C}$ . For the same conditions, a K50 concrete needs heat insulation of the formwork and a K30 must be both insulated (of the formwork) and covered (of the concrete surface) to avoid early freezing of the concrete.

## 6.3.4 Early post-tensioning

### 6.3.4.1 Introduction

In order to produce post-tensioned elements in a rational way, it is important that the concrete has a rapid strength growth and rapid growth of E-modulus. The strength required when post-tensioning can be made, depends on the type of element and is often more than 20 MPa. The same requirement for rapid strength growth is valid for in-situ casting, like 'Freivor-Bau' of bridges. One can seldom wait more than 3 days until post-tensioning has to be made, in order that one shall be able to move the mould outwards.

### 6.3.4.2 Calculations

The calculations are similar to the ones performed before regarding stripping time of formwork. The value of required strength regarding post-tensioning of reinforcement is therefore set to 20 MPa, which is equal to the value set for stripping of formwork. As for the earlier calculations, the PC-program Hett97 is used as calculation tool, where the effects of various concrete qualities, surrounding air temperatures and winter concrete methods, on the strength development are estimated. Only the cast in-situ condition is considered. The cement type is of type Swedish Std Portland.

### 6.3.4.3 Result

Figure 6.23 shows the time theoretically required for reaching a concrete strength level of minimum 20 MPa during summer conditions ( $+15^{\circ}\text{C}$ ) as well as during winter conditions ( $-5^{\circ}\text{C}$ ). In practice, the time until post-tensioning probably is chosen to be extended. The

member thickness is 0,20 m and the mould is 19 mm plywood. The result concerning winter conditions is further divided into two groups, based on whether external protecting winter concrete methods (insulation, covering and heating of concrete) are used or not.

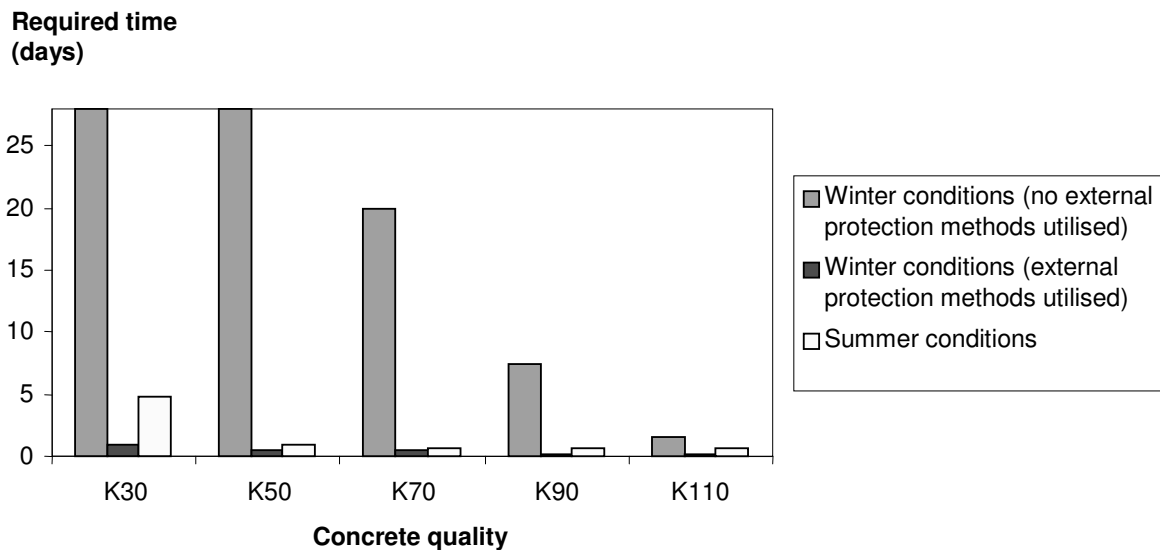

Figure 6.23 Time needed to reach a minimum compressive strength of 20 MPa in a 0.2 m thick member cast in 19 mm Plywood form. Effects of concrete quality and winter precautions are shown. Swedish Standard Portland Cement.

## 6.3.5 Summary of results and conclusions

### 6.3.5.1 Concreting during summer conditions

The result of the study concerning summer conditions shows that the time required for reaching a strength level of 20 MPa may be reduced by 80%, i.e. from 5 days to 1 day, when utilising a K50 concrete instead of a conventional house-building concrete K30. Furthermore a K110 concrete needs 0.5 day to reach the same strength level. This effect is caused by the lower w/c ratio in concrete with high strength and can be utilised for rapid form removal and/or early post-tensioning of reinforcement.

### 6.3.5.2 Concreting during winter conditions

The largest potential for utilising the rapid strength development of HPC is valid for winter conditions, especially when the surrounding air temperature passes below 0°C. Concrete qualities with different strength levels (K30 – K110) and various kinds of external winter protecting methods are analysed in the study, e.g. the use of form insulation, infra-heating of concrete, covering of the concrete surface and increased concrete casting temperature.

The analysis shows that there is a large potential for reducing the production time when utilising the fast strength development of HPC or in combination with winter protection method/methods. For an example the time required to reach 20 MPa can be reduced from more than 28 days to only 1 day, by using a K70 instead of K30, when only covering is used

as winter concrete protection method and the concrete temperature at casting is 20°C and the outer air temperature is -5°C. Further a HPC (K110) without any winter protection methods, requires approximately the same time for reaching 20 MPa as a NC (K30) furnished with heat insulation of formwork, covering of the concrete surface and heating of the concrete, for the same casting temperature and outer temperature as above.

#### *Freezing of concrete*

HPC has considerable potential for eliminating the risk of early freezing of concrete that otherwise may lead to serious damages on the concrete structure. The calculations show that there is no frost damage risk for a K70 concrete without use of any winter protection methods, compared to a K30 concrete that needs both covering and insulation of the concrete for the same conditions (outer air temperature of -10°C and concrete temperature of 25°C at casting).

#### *Concrete temperature at casting*

There is a significant effect on the strength development during winter conditions by the temperature of concrete at casting. For instance, an increase from 20°C to 25°C leads to that a K70 concrete does not need the use of any winter protection methods, in comparison with a starting temperature of 20°C, which requires covering to avoid early freezing damages.

### **6.3.5.3 Economical aspects**

The study shows that there are multi-interactions between different parameters affecting the concrete strength development. When summarising the results of the study, it becomes clear that there is a potential, utilising the rapid strength development of HPC, for reducing the production costs by decreasing the required production time, both for summer and winter conditions. However, the study does not aim at making a detailed assessment of the difference between HPC and NC considering added materials costs and reduced production costs. The interaction between these costs is complex and also to a large extent dependent on specific conditions of various building projects. Therefore, only a brief description of the potential based on the result of the study is presented below.

- For summer conditions, utilisation of HPC instead of NC includes a potential for reducing the production time through early stripping of formwork and/or early tensioning of post-tensioned reinforcement
- During winter conditions, HPC significantly reduces the production time by the same reasons as for summer conditions mentioned above, but also through the potential for reducing or eliminating the added costs connected to external winter protection concrete methods, which may be needed for early stripping of formwork in order to avoid early freezing of concrete

When analysing economical aspects it is also important to consider practical matters. With the aim of reducing the building costs during wintertime, it is important to predict the climate conditions during production in order to optimise the concrete quality (strength level) in relation to required external winter protection concrete methods. For example missing parts of external protection methods can lead to local freezing damage. It can also be time-consuming, expensive and create logistical problems if necessary changes have to be made of the planned methods, due to unexpected difference in surrounding air temperatures in relation to the predicted. However, a HPC of which the rapid heat and strength growth are utilised probably



is also the most flexible and safe solution regarding unexpected problems and hard-predictable factors such as unexpectedly low outer temperature after casting. A large increase of the concrete quality, with the aim of only reducing the strength development time when winter casting, may however lead to economical sub-optimisation. In a more detailed economical analysis of the benefit of using HPC, consideration should be taken also to other aspects, as for instance shorter drying time and possibilities for improved structural design.

## 6.4 Utilisation of HPC for improved structural design – a theoretical analysis

### 6.4.1 Introduction

The main aim of the research project is to investigate the effect of new concrete materials technology on *production* of structural frames. However, some studies were also carried out addressing the use of HPC for improved structural design.

The high final strength of HPC makes possible a more rational design of structural frames for house building. The possibilities of HPC for improvement of the structural design performance within house building have been theoretically analysed and presented. The analysis is presented in Appendix A that is an extract from Peterson (2003).

Below, the background to the study, the method of performing the study and the main results of the study are summarised:

### 6.4.2 Background

Increased concrete quality is traditionally characterised as concrete with increased compressive strength, but as shown in this study, increased compressive strength is not a potential for increased slab spans. It is necessary to utilise other properties of HPC, e.g. high tensile strength and high elastic modulus.

The aim of the structural design study was to investigate the potential of HPC in house building for increased slab spans and/or decreased slab thickness. Besides, the amount of reinforcement in HPC-structures was analysed. By input of ‘real’ measured concrete materials data (compressive and tensile strength, elastic modulus and creep ratio), different kinds of slab types were analysed without paying attention to economical or production related effects (e.g. large amounts of reinforcement and high aggregate quality requirements). The results of the calculations were aimed to show the pure structural design potential of HPC. This forms the basis for further analysis of synergy effects with regard to the production and the function of the building.

### 6.4.3 Method

Calculations were performed by using the PC-program FEM Design Plate (2000) developed by ‘Skanska IT Solutions’. For calculations in the *ultimate limit state*, different kinds of spans were simulated, and the required reinforcement with regard to maximum moment for each kind of slab type was calculated. Regard was taken to punching when column/slab structures were used. Variables in these calculations were: (1) the characteristic compressive strength (21.5 and 56.5 MPa, corresponding to the Swedish K30 and K80 respectively), (2) the characteristic tensile strength (1.60, 2.50 and 5.0 MPa corresponding to K30, K80 and HPC with increased tensile strength) and (3) the slab thickness (0.20 and 0.24 meters). The

theoretical amount of reinforcement based on the real varying moment of entire slab sections was also calculated by summing up the calculated amount of reinforcement in each FEM node and thereafter calculating the average value.

In the *serviceability limit state*, maximum deflection was calculated and compared to the maximum allowed according to normal principles. By this, the maximum allowed spans with regard to deformation were obtained. The variables were: (1) the characteristic compressive strength (same values as defined above), (2) the characteristic tensile strength (same values as defined above), (3) the slab thickness (same values as defined above), (4) the elastic modulus (30, 40 and 50 GPa) and (5) the creep ratio (0 and 2).

## 6.4.4 Result

All results are presented in Peterson (2003), see Appendix A.

## 6.4.5 Summary of results and conclusions

For the studied slab/wall structures, the maximum allowed slab span was to a large extent dependent on the maximum deflection allowed. The presented result was based on deflection limits defined as  $L/400$ , where  $L$  is the slab span. The concrete parameters most influential on maximum slab span were tensile strength and E-modulus. The results showed that high levels of these concrete properties (tensile strength of 5.0 MPa and E-modulus of 50 GPa) enabled opportunities to increase the slab span considerably for slab/wall structures (with regard to deflections in the serviceability limit state). See Table 6.6 below. Alternatively, the slab thickness or the amount of reinforcement could be reduced.

Concerning studied slab/column structures, the punching effect of the ultimate limit state considerably reduced the possibilities for larger spans. The most potential concrete property to optimise in order to reduce the punching effect was, according to the conducted calculations, the tensile strength. If this was set twice as high as the normally used level for HPC (5.0 MPa instead of 2.5 MPa), large opportunities were created for increased spans of slab/column structures (with regard to reduced risk for punching in the ultimate limit state). See Table 6.6. However, to manage the deflection limit, it was also important to increase the E-modulus. The slab thickness affected the span in both ultimate and serviceability limit state.

Furthermore, the result showed that extensive reduction of reinforcement could be made if the reinforcement was designed based on the actual moment curve instead of on the maximum moment in field or over support.

Table 6.6 Summarised approximate quantification of the studied parameters' influence on the possibility for increasing the maximum slab span allowed when regard is taken both ultimate and serviceability limit state. When the effects of each parameter was estimated, all other concrete parameters were constantly set to the lowest studied value, i.e. slab thickness 0.20 m, characteristic compressive strength 21.5 MPa, characteristic tensile strength 1.6 MPa and E-modulus 30 GPa.

Parameter	Slab 1-3 (slab/wall structures)		Slab 4-6 (slab/column structures)	
	Ultimate limit state	Serviceability limit state	Ultimate limit state	Serviceability limit state
Increased slab thickness (from 0.20 to 0.24 m)	25%	15%	20%	15%
Increased characteristic compressive strength (from 21.5 to 56.5 MPa)	<5%	<5%	0%	<5%
Increased characteristic tensile strength (from 2.5 to 5.0 MPa)	0%	20%	50%	20%
Increased elastic modulus (from 30 to 50 GPa)	0%	15%	0%	15%
Increased amount of reinforcement (from 0.1% to 0.2%)	35%	<8%	20%	<8%

Based on the structural analyses, the following main conclusions were made:

- For slab/wall structures, slab spans were possible to be increased by up to 40% (with regard to reduced deflection in the serviceability limit state) when concrete tensile strength of 5.0 MPa and increased elastic modulus of 50 GPa were utilised.
- For slab/column structures, increase of the slab spans by up to 50% was reachable (with regard to reduced risk of punching in the ultimate limit state) when concrete tensile strength of 5.0 MPa was utilised.
- The following reductions of reinforcement could be made if the structural design of the reinforcement was based on the actual moment curve instead of the maximum moment in field or over support:
  - 25 to 80% for slab/wall structures
  - 50 to 80% for slab/column structures

## 6.5 Technical obstacles for the implementation of HPC

### 6.5.1 General

Technical obstacles for the implementation of cast in-situ HPC relate to difficulties in production of ready-mix HPC, to technical performance problems of the fresh and hardening concrete on site and to uncertainties concerning the function of the hardened concrete. Below, the main issues regarding technical obstacles and uncertainties for the implementation of HPC within house building are briefly presented. Note that many technical barriers have been managed by means of solutions based on research.

### 6.5.2 Technical obstacles related to concrete production

Generally, the requirements are higher for all ingredients used in HPC, compared to NC. Increased control of properties and variations in ingredients, as well as proper mix proportioning is necessary to achieve the desired performance.

- Mix proportions (Petersons and Åberg, 2000)  
Mix proportioning of HPC is more complicated than for NC, because of the contradicting requirements for good workability and low amount of water. Often, these parameters have to be compromised and balanced to create an acceptable level of the workability in relation to the low water content. Compared to NC, HPC is significantly more dependent on proper mix proportioning where regard is taken to all included sub materials, to achieve the desired performance. As for instance, the strength of the cement paste determines the strength of NC. For HPC though, all ingredients (as cement and aggregate) and the interaction between these (as the interface between cement paste and aggregate) strongly influence the strength of HPC. Mix proportioning of HPC can be summarised as a process that requires increased control of the quality of ingredients as well as controlling the amount of all ingredients.
- Cement (Sandberg, 2000a)  
For HPC used for civil engineering constructions, coarse-ground, sulphate resistant and low alkali cement is normally used in order to achieve low heat development (to avoid cracks), high final strength and low water need. The latter increases the workability of HPC and further makes the mix less sensitive to variations in ingredients. However, within house building, the requirements often include fast strength development and rapid drying. Therefore fine-ground cement is often used. This cement type often has higher alkali content, which increases the need for mixing water, and also affects the workability in a negative way. This can however be balanced by means of water reducing additives.
- Additives (Sandberg, 2000b)  
Super plasticisers, water reducers and air entrainment are the main types of additives for HPC. Super plasticisers are always required for managing the low w/c ratio of HPC, but the content must be limited in order to avoid retarded hydration, concrete

separation and plastic cracking. There are also risks for increased air content when water reducers are used. This will decrease the strength of the concrete. Often, strength is no problem. Then the use of air entrainment may affect HPC positively by increasing the workability.

- Pozzolans (Sandberg, 2000a)  
HPC including silica fume affects the stability and strength in a positive way. Further, within house building, silica fume is often added with the aim of increasing the self-desiccation effect and reducing the drying time. The amount of silica fume in HPC is set to 5% of the cement content in order to limit the increased stickiness of the fresh concrete caused by silica fume.
- Aggregates (Fagerlund, 2000)  
For HPC, the type, amount and gradation of aggregate significantly affect the workability of the fresh concrete as well as the performance of the hardened concrete. Therefore it is even more important to control and test the effects of aggregate on HPC even regarding small variations in aggregate properties.  
The cement paste in HPC is very strong. Therefore the aggregate can be the weak link if precautions are not taken to avoid inferior aggregate. Also other properties of HPC (E-modulus, tensile strength) are to a high degree dependent on the properties of the aggregate. By selecting suitable aggregate, the stiffness and tensile strength can be increased above normal values. This is very important for efficient use of HPC as structural material, see Chapter 3.  
The control of the performance of aggregates is for that reason also important regarding the hardened concrete. Unusually high quality aggregate may be required, which can be problematic since such aggregate (like diabase) is scarce.

### **6.5.3 Technical obstacles related to the fresh concrete on site**

- Casting conditions, e.g. workability (Byfors, 2000 and Nykvist, 2000)  
The increased cement content and decreased water content of HPC (the low w/c ratio), together with silica fume, may make the concrete 'sticky', due to the increased cohesion. This might cause trouble with compaction and with finishing of surfaces. Special attention should also be paid to the more rapid stiffening (e.g. slump loss) of HPC. One positive effect of casting HPC is the reduced risk for concrete separation, which depends on the decreased water content and increased fines content. An open dialogue between the concrete supplier and the contractor is recommended on information about workability, vibration efforts etc.

## 6.5.4 Technical obstacles related to the function of the hardened concrete

- Cracking (Emborg, 2000)  
Due to the high cement content of HPC, the risks for temperature cracks increase. Also, the plastic and autogenous shrinkage in HPC may lead to increased risk of early cracking of HPC structures.  
As with NC, it is also for HPC recommended to limit the early heat development of the concrete structure, in order to reduce the temperature difference within the structure and between the structure and surrounding structures or rock.
- Emission (Nilsson et. al., 2000)  
The dense structure of concrete surfaces in combination with the increased alkali content of HPC might lead to potentially increased risks for emissions from water-based adhesives and flooring materials. It is not known though if this possible risk is real or not. The possible problems might be avoided by using alkali-resistant adhesives and low-emitting flooring materials.
- Fire resistance (Anderberg, 2000)  
Due to the dense structure of HPC, the possibilities for vapour and moisture transport are limited. In the case of fire, high vapour pressures may appear, which may lead to risks of surface spalling of HPC. The interaction between affecting parameters is complex. To prevent from surface spalling, polypropen fibres can be added. In the case of fire, the fibres will melt and create a fine pore system, which reduces the vapour pressure and thereby decreases or eliminates the risk for surface spalling.

## 6.6 Use of HPC- summary and main conclusions

In comparison to Chapter 4 and 5, which are based on case studies and full-scale laboratory tests of SCC, the studies of HPC within this chapter are carried out from a theoretical point of view. In brief, the following main conclusions are made:

1. Low water/cement ratio enables rapid drying
2. High concrete quality enables rapid strength development that leads to opportunities for reduced risk of early freezing, early form stripping and reduced need of winter concrete protection methods
3. Increased level of concrete tensile strength and elastic module enables opportunities for increased slab span

The chapter is summarised below, where the main conclusions of each section are presented. For further conclusions, see each paragraph respectively.

### **Investigation of the potential for rapid drying**

According to the analysis of drying performed by the PC-program TorkaS, the main positive effects of HPC concerning drying time in comparison with NC are as follows:

- HPC leads to significantly shorter drying times for all studied climate conditions (20-50% of drying time required for NC)
- Drying of HPC is nearly independent of the concrete slab thickness
- HPC creates possibilities for short drying times even when impermeable formwork systems as steel (leading to drying in one single direction) are used

### **Investigation of potential for rapid strength development**

Parameter studies of variables (e.g. concrete quality, surrounding weather conditions and effects of winter concrete methods) influencing the strength development in concrete slabs are carried out by use of the PC-program Hett97 (1997). Comparisons between NC and HPC are made. The study includes the following main parts: (1) strength development for formwork stripping, (2) strength for post-tensioning of reinforcement and (3) the risk for freezing.

Main conclusions of the study are:

- For summer conditions, utilisation of HPC instead of NC includes a potential for reducing the production time through early stripping of formwork and/or early tensioning of post-tensioned reinforcement



- During winter conditions, HPC significantly reduces the production time by the same reasons as for summer conditions mentioned above, but also through the potential for reducing or eliminating the added costs connected to external winter protection concrete methods, which may be needed for early stripping of formwork in order to avoid early freezing of concrete

### **Investigation of structural potential**

The chapter only briefly presents the results of the structural design study of HPC due to that the chapter mainly addresses production oriented aspects. For further results and analysis, see Appendix A, where the structural design study is presented as an extract from Peterson, 2003).

The main conclusions from the structural design study were that:

- High levels of tensile strength (5.0 MPa) and E-modulus (50 GPa) enabled opportunities to increase the slab span by up to 40% for slab/wall structures (with regard to deflections in the serviceability limit state) and by up to 50% for slab/column structures (with regard to reduced risk for punching in the ultimate limit state).
- Furthermore, the result showed that reduction of reinforcement (25 - 80% for slab/wall structures and 50 - 80% for slab/column structures) could be made if the reinforcement was designed based on the actual moment curve instead of on the maximum moment in field or over support.

### **Investigation of potential for improved building function**

From a long-time perspective, production using HPC is furthermore advantageous for the function of the building. As for instance, possibilities are increased for more flexible future refurbishment (by larger slab spans allowed), improved indoor air quality (through improved drying and reduced moisture problems) and increased sound insulation (by rapid drying also for thick structures).

See Appendix C, for further details.

### **Technical obstacles**

There are not only advantages of HPC but also some technical obstacles for implementation. They are divided into the following areas: (1) ready-mix production, (2) fresh concrete on site and (3) function of the hardened concrete. Each area is further described in 6.5.

## 7. CONCLUSIONS

The aim of this research project was to investigate the potential of SCC and HPC for competitive production, more efficient structural design and improved building function of structural frames in multi-storey residential buildings.

Conclusions from observations and calculations within the research project are presented below. For each type of concrete (SCC and HPC) the conclusions are divided under three headings:

1. Possibilities
2. Difficulties
3. Future research

### 7.1 Use of SCC

The observed main consequences from use of SCC in the studied cases are divided into:

- Direct consequences of self-compaction (economically quantifiable)
- Indirect effects of SCC (economically quantifiable)
- Other consequences of SCC (non-economically quantifiable)

In addition, the effects of SCC for the ready-mix concrete supplier and the applicability of SCC in ‘thin’ overlays on precast elements are summarised.

#### 7.1.1 Possibilities

##### 7.1.1.1 Production

###### Direct advantages of self-compaction

- Reduced need of finishing work and finishing materials (e.g. screeds) for slabs due to the self-levelling effect of SCC enabled cost reductions of up to 50% of NC price.
- Potentially, cost savings of 5 to 10% of NC price were possible when casting SCC slabs and 10 to 20% of NC price when using SCC in walls, due to the reduced need of man hours per m<sup>3</sup>. However, to exploit these opportunities in practice, early planning of manpower has to be conducted.
- By avoiding rental of vibration equipment when using SCC, minor cost savings were generated.

### **Indirect advantages of SCC**

- Due to the 'filler effect', both the final strength and strength development increased for SCC including limestone filler but the effect was not exploited.
- RH measurements in both NC and SCC with the same w/c ratios resulted in approximately 20% more rapid drying of SCC compared with NC.

### **Other advantages of SCC**

- Strongly improved work environment (e.g. eliminated risk of HAVS, improved ergonomics and reduced noise)
- Innovative possibilities to cast tight and densely reinforced sections
- Less noise for the surrounding neighbourhood (which furthermore enables opportunity to cast during late evenings in residential areas)

### **Advantages of SCC for the ready-mix concrete producer**

- SCC may be a beneficial product for the ready-mix concrete supplier by retention/increase of market shares, improved customer contact and increased profits.

### **SCC in thin overlays**

- SCC showed to be a cost-efficient and rational alternative to self-levelling screed in overlays (thickness 55-70 mm) on precast elements addressing the following potential aspects:
  - High-quality surface levels could be achieved directly without any use of screed due to the self-levelling effect of SCC
  - Rapid drying was possible, using conventional w/c ratio under normal climate conditions
  - The investigated concept enabled competitive and cost-efficient production process addressing less expensive direct materials costs, reduced manpower need and improved work-environment in comparison with conventional concrete in combination with screed, alternatively only screed
  - It was possible to achieve sufficient bond as well as to avoid edge lifting if SRA and brushed element surface were utilised
  - It was possible to achieve sufficient bond, to avoid edge lifting and to limit shrinkage cracking strongly if SRA, exposed aggregate element surface and membrane curing were utilised

## 7.1.2 Difficulties

### Direct disadvantages of self-compaction

- Increased product price (i.e. between 15 and 20% higher than the NC price)
- Dense joints between formwork elements were needed for SCC with high fluidity but solved, however, through simple and cost-efficient methods
- If NC not was used locally for low slab sections (e.g. wet rooms), special ‘top’ formwork had to be utilised in order to control the flow of SCC
- Risk of increased formwork pressure led to decreased casting rate of walls
- Presumptive poor surface quality of walls led to increased costs for finishing work when removable formwork was used
- On-time delivery was required in order to avoid unwanted layers between newly cast SCC-delivers

### Indirect disadvantages of SCC

- SCC, especially with low w/c ratio could result into increased plastic shrinkage cracking, which further increased the need of curing. However, the consequence in general is of minor importance due to that requirement seldom is set regarding maximum allowed crack width within house building. The same is the case for setting cracks that also was observed to increase for SCC.
- Tendency to retardation effects regarding strength development in cold climate conditions were observed but not leading to serious consequences with regard to early freezing.

### Other disadvantages of SCC (non-economically quantifiable)

- Variations of rheological performance were observed regarding fresh SCC but no important negative consequences were experienced
- Early planning and high adaptation grade to SCC was required in order to exploit the full potential and to reduce the risk of unwanted negative consequences

### Disadvantages of SCC for the *concrete producer*

- For the ready-mix concrete producer, SCC could also lead to added production costs, decreased productivity and increased responsibility for technical performance problems on site.

## 7.1.3 Future research

- More research ought to be conducted (in field under various real conditions) into presumptive obstacles of SCC use, e.g. risk of rheological variations, high formwork pressure and early shrinkage cracking.
- Furthermore, secondary advantages of SCC, as for instance rapid drying, ought to be more investigated in order to fully exploit the potential.

## 7.2 Use of HPC

The potential effects of HPC use, presented below, are divided into possibilities and difficulties, of which the latter are further divided into technical and non-technical.

### 7.2.1 Possibilities

#### 7.2.1.1 Production

- The required drying time for reaching 85 and 90% RH on the equivalent depth in concrete slabs is significantly reduced in HPC with low w/c-ratio, especially when silica fume is included. In comparison with normal house-building concrete, the use of HPC during summer conditions can, for instance cause a reduction from 16 months to less than 2 months to reach RH 85%. For cold surrounding air temperatures though, the study indicates the importance of achieving rapid concrete temperature development also in HPC during the first days after casting, in order to utilise the significant self-desiccation effect and thereby enable rapid drying.
- The results of the study indicate significantly faster strength development of HPC compared to NC, especially during cold surrounding air temperatures. As for instance, the formwork stripping time may be reduced from 5 days to less than 1 day (under summer conditions) and from more than 28 days to 5 days (during winter conditions and covering of the concrete surface is used as winter protection method) when NC is replaced by HPC. This creates beneficial potential for earlier formwork stripping, earlier post-tensioning of reinforcement and reduction of the risks of early concrete freezing. Another aspect of the result is the ability for eliminating or reducing the requirements for external winter concrete methods (e.g. insulating, covering and heating of the concrete) for HPC compared to NC.

#### 7.2.1.2 Structural design

- Utilisation of HPC with increased concrete tensile strength (to 5.0 MPa) and/or increased elastic modulus (to 50 GPa) enables increased slab spans by approximately 40% for slab/wall structures (with regard to reduced deflection in the serviceability limit state) and by approximately 50% for slab/column structures (with regard to reduced risk for punching in the ultimate limit state). Alternatively, the slab thickness or the amount of reinforcement can be reduced.
- The amount of reinforcement can be reduced by 25 to 80% for slab/wall structures and by 50 to 80% for slab/column structures if the reinforcement is designed based on the actual moment curve instead of the maximum moment curve in field or over support.

### 7.2.1.3 Building function

To largest extent the possibilities below are based on HPC with low w/c ratio. However, the ‘filler effect’ of SCC with respect to strength development and drying may lead to the effects as well.

- Increased flexibility of future refurbishment (based on the opportunity for increased slab spans in combination with dismountable inner walls)
- Improved indoor environment (due to less moisture problems according to more rapid drying)
- Increased acoustic quality (addressing the opportunity for building heavier, and thereby also more sound insulating concrete structures without any extended drying/production time)
- Reduced energy consumption of the owner of the building (addressing the opportunity for building heavier, and thereby also more heat buffering concrete structures without any extended drying/production times)

## 7.2.2 Difficulties

### 7.2.2.1 Technical

- Problems related to the *ready-mix concrete production process* (e.g. more complex mix design, increased sensibility to variations, increased quality control of ingredients needed)
- Problems related to *handling of fresh concrete on site* (e.g. risk of decreased workability)
- Problems related to the *function of the hardened concrete* (e.g. increased cracking tendency, increased risk of emissions from adjacent materials and decreased fire resistance)

### 7.2.2.2 Non-technical

The non-technical difficulties, presented below, cover new concrete materials technology in general. Therefore, also SCC is included.

- Problems related to *organisational issues* (e.g. improper co-operation between actors, lack of competence and interest with respect to novel technology, tradition related decision criteria for the choice of materials and unclear responsibility for negative consequences)

- Problems related to *economical issues* (e.g. sub optimisation concerning direct materials costs versus total economical benefits, pricing of new types of concrete etc, not updated information data regarding economical effects of new concrete materials technology)
- Problems related to *building codes* (e.g. limitations regarding adaptation to new types of concrete and requirements for added testing and standardised test methods for SCC are lacking today)

### **7.2.3 Future research**

- The theoretically investigated production potential of HPC (regarding rapid strength development and rapid drying) ought to be verified through full-scale tests and field studies.
- The result of the structural design study of HPC ought to be verified through full-scale tests addressing the ‘real’ potential to utilise increased tensile strength and elastic modulus.

## 7.3 General conclusions

- Use of SCC (instead of normal concrete) for production of structural frames of cast in-situ concrete in house building enables large possibilities to decrease the production cost mainly through reduced need of finishing work for slabs and by efficient castings.
- When normal concrete is replaced by SCC, the work environment is strongly improved.
- SCC is furthermore a cost-efficient and rational solution in thin overlays on prefabricated elements if regard is taken to presumptive technical problem areas.
- HPC with low w/c ratio enables rapid drying.
- High concrete quality enables rapid strength development that leads to possibilities for reduced risk of early freezing, early form stripping and reduced need of winter concrete protection methods.
- Use of HPC may improve the structural performance if increased level of concrete tensile strength and elastic module is used, the maximum allowed slab span is significantly increased.
- Use of HPC may improve the function of the building.
- There are both technical and non-technical obstacles for the implementation of HPC and SCC. However, early planning and high grade of adaptation to SCC (and HPC to some extent) are required in order to fully exploit the potential and to avoid presumptive negative consequences.





## References

- ACBM (2005), *Proceedings of ACBM Symposium on SCC*, Evanston: Center for advanced cement-based materials, Northwestern University McCormick School of Engineering & Applied Science
- Adalberth, K. (2000), Energy Use and Environmental Impact of new Residential Buildings, *Report TVBH-1012*, Lund: University of Lund, Dep. Of Building Physics.
- AFS (1986), Arbetarskyddsstyrelsens kungörelse med föreskrifter om vibrationer från handhållna maskiner, *Arbetarskyddsstyrelsens författningssamling AFS 1986:7*, Solna: Swedish Labour Inspectorate (in Swedish).
- AFS (1998), Arbetarskyddsstyrelsens kungörelse med föreskrifter om belastningsergonomi, *Arbetarskyddsstyrelsens författningssamling AFS 1998:1*, Solna: Swedish Labour Inspectorate (in Swedish).
- AFS (1992), Arbetarskyddsstyrelsens kungörelse med föreskrifter om buller, *Arbetarskyddsstyrelsens författningssamling AFS 1992:10*, Solna: Swedish Labour Inspectorate (in Swedish).
- Anderberg, Y. (2000), Chapter 16 Fire, *Handbook of High Performance Concrete*, Stockholm: Swedish Building Centre (in Swedish).
- Assaad, J., Khayat, K. and Mesbah, H. (2003), Variation of formwork pressure with thixotropy of self-consolidating concrete, *ACI Materials Journal No 1*, Farmington Hills: American Concrete Institute, pp 29-37.
- AV (2005), Vibrationer, *Korta sifferfakta Nr.3*, Solna: Swedish Work Environment Authority (in Swedish).
- AV (2006), Belastningsergonomi i byggverksamhet, *Korta sifferfakta Nr.5*, Solna: Swedish Work Environment Authority (in Swedish).
- Barthelson, C. (2006), Drying and shrinkage of concrete with limestone filler, *Report TVBM-5063*, Lund: Department of Building Materials, University of Lund, (in Swedish).
- Betongvaruindustrin (2005), Planning tool for precast construction 'Bygga med Prefab', Stockholm: The Swedish Precast Concrete Federation (in Swedish).
- Billberg, P. (2006), Form pressure generated by self-compacting concrete -influence of thixotropy and structural behaviour at rest, *Doctoral thesis*, Stockholm: Royal Institute of Technology, School of Architecture and Build environment, Division of Concrete structures.
- BKD, Byggekostnadsdelegationen (2000), Betänkande från Byggekostnadsdelegationen, *SOU 2000:44*, Stockholm: The Swedish Building Cost Commission (in Swedish).

- BOMEL (2003), Hand arm vibration syndrome – underlying causes and risk control in the construction industry, *Research Report ref 114*, Slough: Bomel Limited.
- Bonaretti, V.L., Rahhal, V.F. and Irassar, E.F (2001), Studies on the carboaluminate formation in limestone filler blended cement, *Journal of Cement and Concrete Research No 31*, Amsterdam: Elsevier Science Ltd, pp 853-859.
- Bonen, D. and Shah, S. (2005), Fresh and hardened properties of self-consolidating concrete, *Journal of Progress in Structural Engineering and Materials No 7*, New Jersey: John Wiley & Sons Ltd, pp 14-26.
- Bosiljkov, V.B. (2003), SCC mixes with poorly graded aggregate and high volume of limestone filler, *Journal of Cement and Concrete Research No 33*, Amsterdam: Elsevier Science Ltd, pp 1279-1286.
- Boverket (1994), *BBK 94 Boverkets Handbok om Betongkonstruktioner*, Karlskrona: The Swedish Board of Housing, Building and Planning (in Swedish).
- Boverket (2003), *BKR 03 Boverkets konstruktionsregler*, Karlskrona: The Swedish Board of Housing, Building and Planning (in Swedish).
- Brite Euram SCC (2000), Rational production and improved working environment through using self compacting concrete, *Brite-EuRam project BRPR-CT96-0366*.
- Bui, V., Akkaya, Y. and Shah, S. (2002), Rheological model for self-consolidating concrete, *ACI Material Journal No 6*, Farmington Hills: American Concrete Institute, pp 549-559.
- Burström, L. (2000), Summary of vibration levels of concrete vibrators, Umeå: Swedish Institute for working life.
- Buö, F.O. (1973), Resilient floors and concrete floors on ground, *Journal of the Nordic Concrete Federation No 3*, Stockholm: Nordic Concrete Federation pp 3-12 (in Swedish).
- Byggindustrin (2004), No time difference between precast and in-situ casting, *Byggindustrin No. 12/2004*, Stockholm: The Swedish Construction Federation (in Swedish).
- Byggindustrin (2008) SDC -new concrete that flows out by itself, *Byggindustrin No. 01/2008*, Stockholm: The Swedish Construction Federation (in Swedish).
- Byfors, J. (1999), SCC is an important step towards industrialisation of the building industry, *Proceedings of the First International RILEM Symposium on Self-compacting Concrete*, Stockholm: RILEM Publications S.A.R.L, pp.15-21.
- Byfors, J. (2000), Chapter 6 Fresh concrete, *Handbook of High Performance Concrete*, Stockholm: Swedish Building Centre (in Swedish).
- Chen, Z. & Wang, D. (1996), Utilization of high-strength concrete in China, *Proceedings from the Fourth International Symposium on Utilization of High Strength/High Performance concrete*, Paris: Presses de l'ENPC, pp.1571-1580.

- Chew, M.Y. (1993), Utilisation of high strength concrete in Singapore, *Proceedings of the Third International Symposium on Utilization of High-Strength Concrete*, Lillehammer: Norwegian Concrete Association, pp.678-690.
- Claesson, C. (1999), *Praktisk tillämpning av högpresterande betong*, Göteborg: Byggmästareföreningen Väst/FoU-Väst (in Swedish).
- Danish SCC Consortium (2004), *Newsletter No 1 from the Danish SCC Consortium*, Taastrup: Danish Technological Institute.
- Elfgrén, L., Fagerlund, G. & Skarendahl, Å. (1994), Swedish R&D Program on High-Performance Concrete, *Proceedings of the International Workshop on High Performance Concrete in Bangkok*, Michigan: American Concrete Institute, pp.247-262.
- Emborg, M. (2000), Chapter 12, Temperature and moisture influenced stresses and cracking, *Handbook of High Performance Concrete*, Stockholm: Swedish Building Centre (in Swedish).
- Emborg, M. (2000), Chapter 7 Young concrete, *Handbook of High Performance Concrete*, Stockholm: Swedish Building Centre (in Swedish).
- Emborg, M. (2002) Framtida forskning och samverkan, *CBI:s Informationsdag 2002 – Sammanfattningar*, Stockholm: Cement- och Betonginstitutet, pp.45-49 (in Swedish).
- ErgoAir (2002), *Hand-Arm vibration technical information*, Las Vegas: ErgoAir Inc.
- ERMCO (2006), *European ready-mixed concrete industry statistics year 2005*, Brussels: European Ready-mixed Concrete Organisation.
- ERMCO BIBM, CEMBUREAU, EFCA and EFNARC (2005), *The European Guidelines for self-compacting concrete -specification, production and use*, Warrington: SCC European project group.
- Esping, O. (2007), Early-age properties of self-compacting concrete. Effects of fine aggregate and limestone filler, *Doctoral thesis 2571*, Gothenburg: Chalmers University of technology, Dep. of Civil and Environmental Engineering.
- Esping, O. and Löfgren, I. (2005), Cracking due to plastic and autogenous shrinkage - investigation of early age deformation of self-compacting concrete, *Report 2005:11*, Gothenburg: Chalmers University of technology, Dep. of Civil and Environmental Engineering.
- EUHVD (2002) European Union Human Vibration Directive 2002/44/EC, *Official Journal of the European Union*, Luxembourg: Office for Official Publications of the European Communities.
- Fagerlund, G. (1980), Influence of slag cement on the frost resistance of concrete- a theoretical analysis. *Research Fo 1:80*. Stockholm: Swedish Cement and Concrete Research Institute.

- Fagerlund, G. (1994), Chapter 28 High performance concrete, *Handbook of concrete-Materials*, Stockholm: Swedish Building Centre (in Swedish).
- Fagerlund, G. (2000), Chapter 4 Aggregate, *Handbook of High Performance Concrete*, Stockholm: Swedish Building Centre (in Swedish).
- Fagerlund, G., Gillberg, B., Jönsson, Å. & Tillman, A-M. (1999), *Betong och Miljö*, Stockholm: Swedish Building Centre, pp.14-48 (in Swedish).
- FEM- Design Plate 3.50, (2000), PC-based computer program, Malmö: Skanska IT Solutions.
- FIP/CEB (1994), Application of High Performance Concrete, *Bulletin d'Information 222*, Lausanne: CEB.
- Fletcher, K. and D'Souza, B. (2004), New generation hyperplasticisers for the new millennium, Degussa Construction Chemicals Australia Pty Ltd.
- Friberg, P. (2002), Plastic shrinkage of self-compacting concrete, *Report TVBM-5051*, Lund: Department of Building Materials, University of Lund, (in Swedish).
- Fundia Armering AB (2002), The BAMTEC-system, Photo taken by Fundia.
- Geiker, M., Brandl, M., Thrane, L., Bager, D. and Wallevik, O.(2002), The effect of measuring procedure on the apparent rheological properties of self-compacting concrete, *Journal of Cement and Concrete Research No 32*, Amsterdam: Elsevier Science Ltd, pp 1791-1795.
- Ghezal, A. and Khayat, K. (2002), Optimising self-consolidating concrete with limestone filler by using statistical factorial design methods, *ACI Materials Journal No 3*, Farmington Hills: American Concrete Institute, pp 264-272.
- Grauers, M. (1999), Self compacting concrete – industrialised site cast concrete, *Proceedings of the First International RILEM Symposium on Self-compacting Concrete*, Stockholm: RILEM Publications S.A.R.L, pp.651-658.
- Hägg, G. (2001), Handintensivt arbete, *Arbetslivsinstitutets expertgrupp för ergonomisk dokumentation -dokument 3*, Stockholm: Arbetslivsinstitutet, (in Swedish).
- Hallgren, M. (1993), *Use of high performance concrete in load bearing structures - Does high strength bring cost savings?* Stockholm: Royal Institute of Technology, Department of Structural Engineering.
- Hassanzadeh, M. (1998), Brottsighet hos högpresterande betong, *Report M4:06*, Lund: University of Lund, Dep. of Building materials (in Swedish).
- Hassanzadeh, M. (2000), Chapter 9 Strength, *Handbook of High Performance Concrete*, Stockholm: Swedish Building Centre (in Swedish).
- Hassanzadeh, M. (2000), Chapter 9 Strength, *Handbook of High Performance Concrete*, Stockholm: Swedish Building Centre (in Swedish).

- Hedenblad, G. (1996), Fuktmätning i högpresterande betong, *Intern rapport M8:4*, University of Lund, Dep. of Building materials, (in Swedish).
- Helland, S. (1996), Utilization of HPC, *Proceedings from the Fourth International Symposium on Utilization of High Strength/High Performance concrete*, Paris: Presses de l'ENPC, pp.67-73.
- Helland, S. (1999), Introduction of HSC/HPC in the market, A Contractors view, *Proceedings from the 5<sup>th</sup> International Symposium on Utilization of High Strength/High Performance Concrete*, Sandefjord: Norwegian Concrete Association, pp.14-17.
- Hett 97 (1997), PC-based computer program, Stockholm: SBUF, Cementa AB, NCC AB, Svenska Fabriksbetongföreningen.
- Hoff, G.C. (1993), Utilization of high strength concrete in North America, *Proceedings of the Third International Symposium on Utilization of High-Strength Concrete in Lillehammer*, Oslo: Norwegian Concrete Association, pp.28-36.
- Ikeda, S. (1993), Utilization of high strength concrete in Japan, *Proceedings of the Third International Symposium on Utilization of High-Strength Concrete in Lillehammer*, Oslo: Norwegian Concrete Association, pp.37-44.
- Isaia G.C., Gastaldini, A.L.G. and Moraes R. (2003), Physical and pozzolanic action of mineral additions on the mechanical strength of high-performance concrete, *Journal of Cement & Concrete Composites No 25*, Amsterdam: Elsevier Science Ltd, pp 69-76.
- ISO (2001), Mechanical vibration – measurement and evaluation of human exposure to hand-transmitted vibration, *ISO 5349-1:2001*, Geneva: International Organization for Standardisation.
- Jinnai, H., Namiki, S., Kuroha, K., Kawabata, I. & Hara, T. (1999), Construction and design of high-rise buildings using 100 MPa high strength concrete, *Proceedings from the 5<sup>th</sup> International Symposium on Utilization of High Strength/High Performance Concrete in Sandefjord*, Oslo: Norwegian Concrete Association, pp. 809-818.
- Johnson, G. and Scholes, K. (1999), *Exploring corporate strategy, Text and cases*, London: Prentice Hall Europe.
- Johansson, B. (2002), Concrete and architecture, *Licentiate thesis*, Gothenburg: Chalmers University, Department of Design and Technology (in Swedish).
- Johansson, N. (2005), Drying of concrete. Effects of cement type, concrete quality and surrounding moisture conditions, *Report TVBM-3124*, Department of Building Materials, University of Lund (in Swedish).
- Jonsereds Miljösystem AB (2002), Weather protection system 'Torra Byggen', Photo taken by Jonsereds.
- Khayat, K. (1999), Workability, testing, and performance of self-consolidating concrete, *ACI Materials Journal No 3*, Farmington Hills: American Concrete Institute, pp 346-354.

- Khayat, K., Assaad, J. and Daczko, J. (2004), Comparison of field-oriented test methods to assess dynamic stability of self-consolidating concrete, *ACI Materials Journal No 2*, Farmington Hills: American Concrete Institute, pp 168-176.
- Lachemi, M., Hossain, K.M.A., Lambros, V., Nkinamubanzi, P.-C. and Bouzoubaa, B. (2004), Performance of new viscosity modifying admixtures in enhancing the rheological performance of cement paste, *Journal of Cement and Concrete Research No 34*, Amsterdam: Elsevier, pp 185-193.
- Ljunggren, S. (1995), Tysta huset klart för inflyttning, *Fastighetsnytt nr 16 1995*, Stockholm: Fastighetsnytt Förlags AB (in Swedish).
- Mängda (1999), *Marknadsanalys husbyggnad*, Stockholm: Mängda AB.
- McMillan and Scott (2002), EU safety laws - equipment vibration, *Construction Industry Times*.
- Mizobuchi, T., Yanai, S., Takada, K., Sakata, N. & Nobuta Y. (1999), Field applications of self-compacting concrete with advantageous performances, *Proceedings of the First International RILEM Symposium on Self-compacting Concrete*. Stockholm: RILEM Publications S.A.R.L, pp.605-616.
- Nielsen, C. (2006) SCC and the working environment, *Presentation at the Nordic SCC Network Workshop 2006*, Copenhagen: DTI Concrete Centre.
- Nilsson, L-O, Hedenblad, G., Norling-Mjörnell, K. (2000), Chapter 11 Moisture properties, *Handbook of High Performance Concrete*, Stockholm: Swedish Building Centre (in Swedish).
- Nilsson, M. (1992), Chapter 8 Formwork for cast in-situ concrete, *Handbook of Concrete-Workmanship*, Solna: Swedish Building Centre (in Swedish).
- Nordkalk, 2007, Product information on limestone filler, Stockholm: Nordkalk.
- Norling Mjörnell, K. (2003), Drying of construction moisture in self-compacting concrete, *SBUF Report project 10041*, Stockholm: Development Fund of the Swedish Construction Industry, SBUF (in Swedish).
- Nygren A. and Waller, E. (2002), Aspects of costs by using self-compacting concrete for house constructions, *Report Oru-Te-Exa096-B105/02*, Örebro: Örebro University, Department of technology, (in Swedish).
- Nykvist, H. (2000), Chapter 20 Casting, *Handbook of High Performance Concrete*, Stockholm: Swedish Building Centre (in Swedish).
- Okamura, H. & Ouchi, M. (1999), Self-compacting concrete. Development, present use and future, *Proceedings of the First International RILEM Symposium on Self-compacting Concrete*, Stockholm: RILEM Publications S.A.R.L, pp.3-14.

- Okamura, H. and Ouchi, M. (2003), Self-compacting concrete, *Journal of advanced concrete technology*, Tokyo: Japan Concrete Institute.
- Ouchi, M. (1999), Self-compacting concrete development, applications and investigations, *Proceedings of the Nordic Concrete Research Meeting in Reykjavik*, Oslo: Norwegian Concrete Association, pp.29-34.
- Persson, B. (1996), Betong anpassad för ett effektivt byggande, *Bygg & Teknik 7/96*. Stockholm: Förlags AB Bygg & Teknik (in Swedish).
- Persson, B. (1996), Långtidsdeformationer- grundkrypning hos högpresterande betong, *Intern rapport M06:14*, Lund: University of Lund, Dep. of Building materials (in Swedish).
- Persson, B. (1998), Self-desiccation and its' importance in concrete technology, *Nordic Concrete Research 21*, Oslo: Norwegian Concrete Association.
- Persson, B. (1999), Modern betong och filigranform förutsättningar för ett rekordbygge I Malmö, *Reprint/Särtryck Sä 99.44*, Lund: University of Lund, Dep. of Building Materials (in Swedish).
- Persson, B. (2003), Plastic shrinkage of self-compacting concrete without construction moisture, *Report TVBM 7176*, Lund: University of Lund, Dep. of Building Materials (in Swedish).
- Persson, B. (2003), Self-compacting concrete at fire temperatures, *Report TVBM-3110*, Lund: University of Lund, Dep. of Building Materials.
- Persson, B. (2003), Sulphate resistance of self-compacting concrete, *Journal of Cement and Concrete Research No 33*, Amsterdam: Elsevier Science Ltd, pp 1933-1938.
- Persson, B. (2004), Chloride migration coefficient of self-compacting concrete, *Materials and structures Vol. 37, No 2*, Dordrecht: Springer, pp 82-91.
- Peterson, M. (2003), New concrete materials technology for competitive house building, *Licentiate thesis, Report TVBM 3111*, Lund: University of Lund, Department of Building Materials.
- Peterson, M. and Saleh, I. (2003), Self-compacting concrete for rational house building, *SBUF-report project 0106*, Stockholm: Development Fund of the Swedish Construction Industry, SBUF (in Swedish).
- Peterson, M. and Simonsson, P. (2005), Industrialised cast-in-situ production of structural frames using self-compacting concrete, *Report within the Competitive Building course 'Industrialised building'*, Lund: University of Lund, Department of Physics (in Swedish).
- Petersons, N., Åberg, L. (2000), Chapter 18 Proportioning, *Handbook of High Performance Concrete*, Stockholm: Swedish Building Centre (in Swedish).



- Petersson, Ö. (2007), Jointless concrete floors and Shrinkage-reducing additive at repair of concrete structures, *SBUF report of the projects 11529 and 11683*, Stockholm: Development Fund of the Swedish Construction Industry, SBUF (in Swedish).
- Pichler, R. (1999), The use of SCC for building the Millennium Tower in Vienna, *Proceedings of the First International RILEM Symposium on Self-compacting Concrete*. Stockholm: RILEM Publications S.A.R.L, pp.729-732.
- Rahhal, V., Talero, R. (2005), Early hydration of Portland cement with crystalline mineral additions, *Journal of Cement and Concrete Research No 35*, Amsterdam: Elsevier Science Ltd, pp 1285-1291.
- RILEM SCC (2003), *Proceedings RILEM Symposium on SCC in Reykjavik*, Cachan Cedex: RILEM Publications s.a.r.l.
- Rongbin, B. and Jian, S. (2004), Synthesis and evaluation of shrinkage-reducing admixture for cementitious materials, *Journal of Cement and Concrete Research No 35*, Amsterdam: Elsevier Science Ltd, pp 445-448.
- Russel, H.G. & Fiorato, A.E. (1994), High-strength concrete research for buildings and bridges, *Proceedings of the International Workshop on High Performance Concrete in Bangkok*, Michigan: American Concrete Institute, pp.375-392.
- SFF (2007), Planning tool for cast in-situ concrete 'Betongbanken', Stockholm: Swedish ready-mix concrete association (in Swedish).
- Saak, A., Jennings, H. and Shah S. (2001), New methodology for designing self-compacting concrete, *ACI Materials Journal No 6*, Farmington Hills: American Concrete Institute, pp 429-439.
- Sakata, N., Yanai, S., Yokozeki, K. and Maruyama, K. (2003), Study on new viscosity agent for combination use type of self-compacting concrete, *Journal of advanced concrete technology*, Vol 1, No1, Tokyo: Japan Concrete Institute, pp 37-41.
- Sandberg, P. (2000a), Chapter 2 Cement and pozzolans, *Handbook of High Performance Concrete*, Stockholm: Swedish Building Centre (in Swedish).
- Sandberg, P. (2000b), Chapter 3 Additives, *Handbook of High Performance Concrete*, Stockholm: Swedish Building Centre (in Swedish).
- SCB (2007), Statistics on form of contracts for produced multi-storey residential buildings in Sweden 1980-2005, Stockholm: Statistics Sweden.
- Shindoh, T. and Matsuoka, Y. (2003), Development of combination-type self-compacting concrete and evaluation test methods, *Journal of advanced concrete technology*, Tokyo: Japan Concrete Institute, pp 26-36.

- Silfwerbrand, J. (1987) Effects of Differential Shrinkage, Creep and Properties of the Contact Surface on the Strength of Composite Concrete Slabs of Old and New Concrete, *Bulletin No 147*, Department of Structural Engineering, Royal Institute of Technology, Stockholm: 131 pp. (in Swedish).
- Silfwerbrand, J. (1996) Concrete overlays, *Report No 10, 2nd edition*, Department of Structural Engineering, Royal Institute of Technology, Stockholm: Sweden, pp. 41. (in Swedish).
- Skarendahl, Å. (2001), Market acceptance of self-compacting concrete, the Swedish experience, *Proceedings of the Second International Symposium on Self-Compacting Concrete in Tokyo*, Kochi: COMS Engineering Corporation, pp 1-12.
- Skarendahl, Å. and Petersson, Ö. (2000), Self-compacting concrete: State-of-the-art report of RILEM technical committee 174-SCC, *RILEM report 23*, Cachan Cedex: RILEM Publications s.a.r.l.
- Soylev, T. A. and Francois, R. (2003), Quality of steel-concrete interface and corrosion of reinforcing steel, *Journal of Cement and Concrete Research No 33*, Amsterdam: Elsevier Science Ltd, pp 1407-1415.
- Stintzing, R. (2003), Rodel reder ut, *Arkitekten nr 11*, Stockholm: Swedish Association of architects (in Swedish).
- Swedish Building Centre (1990), *Handbook of Concrete – Design*, Solna: AB Swedish Building Centre.
- Swedish Building Centre (1998), *Hus-AMA 98*, Solna: Swedish Building Centre (in Swedish).
- Swedish Building Centre (2000a), *Handbook of High Performance Concrete*, Stockholm: Swedish Building Centre (in Swedish).
- Swedish Building Centre (2000b), *High Performance Concrete Structures - Design Examples*, Stockholm: Swedish Building Centre (in Swedish).
- Swedish Concrete Association (2002), Self-compacting concrete -recommendations for use, *Report no. 10*, Stockholm: Swedish Concrete Association (in Swedish).
- Testing SCC (2007), Measurement of properties of fresh self-compacting concrete, *Final report European Union Growth Contract No. G6RD-CT-2001-00580*, Paisly: ACM Centre, University of Paisley.
- TorkaS 1.0 (1998), PC-based computer program, Lund: University of Lund, Institution of BuildingTechnology.
- Trädgårdh, J. (2002), The risk of a TSA in Sweden SCC -ongoing research, *Proceedings from NCR meeting*, Oslo: Nordic Concrete Research, pp 298-300.

- Wallevik, O. (2003), Rheology -a scientific approach to develop self-compacting concrete, *Proceedings of Third International RILEM Symposium on Self-Compacting Concrete in Reykjavik*, Cachan Cedex: RILEM Publications s.a.r.l.
- Wallevik, O. and Nielsson, I. (1998), Self-Compacting Concrete -a rheological approach, *Proceedings of the International Workshop on Self-compacting Concrete*, Kochi: Kochi University of Technology
- Walraaven, J. (2005), Self-compacting concrete: Challenge for designer and researcher, *Proceedings of ACBM Symposium in Chicago*, Evanston: Center for advanced cement-based materials, Northwestern University McCormick School of Engineering & Applied Science.
- Walraven, J. (1993), High strength concrete: a material for the future? *Proceedings of the Third International Symposium on Utilization of High-Strength Concrete in Lillehammer*, Oslo: Norwegian Concrete Association, pp.17-27.
- Walraven, J. (1999), The future of high strength/high performance concrete, *Proceedings of the 5<sup>th</sup> International Symposium on Utilization of High Strength/High Performance Concrete in Sandefjord*, Oslo: Norwegian Concrete Association, pp.25-36.
- Walraven, J. (2000), How can we shorten the bridge between design and material engineers, *Proceedings of the Nordic Concrete Research Meeting in Reykjavik*, Oslo: Norwegian Concrete Association, pp.1-3.
- Yahia, A., Tanimura, M., Shimoyama, Y. (2004), Rheological properties of highly flowable mortar containing limestone filler -effect of powder content and w/c ratio, *Journal of Cement and Concrete Research No 35*, Amsterdam: Elsevier Science Ltd, pp 532-539.
- Zhu, W. and Gibbs, J. (2005), Use of different limestone and chalk powders in self-compacting concrete, *Journal of Cement and Concrete Research No 35*, Amsterdam: Elsevier Science Ltd, pp 1457-1462.
- Öberg, M. & Peterson, M. (2001), Multi-dwelling concrete buildings in Sweden: a review of present technology, design criteria and decision making, *Report TVBM-7158*, Lund: University of Lund, Department of Building Materials.
- Öberg, M. (2005), Integrated life cycle design, *Doctoral thesis, Report TVBM 1022*, Lund: University of Lund: Department of Building materials.

## **Appendix A**

Structural design potential of HPC within house building  
(extract from Peterson, 2003)



## **A.1 Introduction**

### **A.1.1 Background**

Concrete structural frames are sometimes criticised for leading to short slab spans and limited grade of flexibility concerning future adaptation. The criticism is based on the fact that the frame is built of traditional low-grade, cast in-situ house-building concrete, in combination with supporting concrete partition walls. Other criticism concerns the long drying times that lead to extended production times, moisture problems, and specific complications and costs when casting during winter conditions.

The low w/c-ratio of HPC gives higher and more rapid strength development, but also increased elastic modulus and self-desiccation effect. These properties create advantages in structural frames from design, production and building function related point of views.

HPC has been utilised internationally in high-rise buildings during the 90s. The incentives have been higher bearing capacity that leads to taller buildings and slimmer constructions. Within the Swedish house-building sector, HPC has to some extent been used with the aim of shortening the concrete drying times, by utilising the self-desiccation effect. To a minor extent, HPC is used in Sweden because of its' rapid form removal times and/or less winter casting problems. But the incentive for using HPC in house building in Sweden has seldom been its' larger bearing capacity.

If the described benefits of HPC are to be gained, various obstacles have to be managed. There are technical, economical and building-process related obstacles for a higher grade of utilisation of HPC in the production of multi-dwelling buildings in Sweden. Benefits from many points of view probably must be taken into account if disadvantages, as for example higher materials costs, are to be accepted. Therefore it is motivated to focus on the *structural design related* advantages of HPC, which is an often forgotten area in the house-building sector.

### **A.1.2 Aim**

The aim of the study is to investigate the potential of HPC in house building with regard to *structural design*, e.g. increased spans and decreased slab thickness. Besides, the amount of reinforcement in HPC is analysed.

By input of "real" measured concrete materials data (compression and tensile strength, elastic modulus and creep ratio), different kinds of slab types are calculated without paying attention to economical or production related effects (e.g. large amounts of reinforcement and high aggregate quality requirements).

The result of the calculations is aimed to show the structural design potential of HPC. This forms the basis for further analysis of synergy effects with regard to the production and the function of the building.

### A.1.3 Method

Finite element methods (FEM) are conducted by using the PC-program FEM Design Plate (2000) developed by “Skanska IT Solutions”. For calculations in the *ultimate limit state*, different kinds of spans are simulated, and the required reinforcement with regard to maximum moment for each kind of slab type is calculated. Regard is taken to punching when column/slab structures are used. Variables in these calculations are: the characteristic compression strength (21.5 and 56.5 MPa, corresponding to the Swedish K30 and K80 respectively), the characteristic tensile strength (1.60, 2.50 and 5.0 MPa corresponding to K30, K80 and HPC with increased tensile strength) and the slab thickness (0.20 and 0.24 meters). The theoretical amount of reinforcement based on the real varying moment of entire slab sections has also been calculated by summing up the calculated amount of reinforcement in each FEM node and thereafter calculating the average value.

In the *serviceability limit state*, maximum displacement has been calculated and compared to the maximum allowed deformation criteria. This method provides the maximum allowed spans with regard to deformation. The variables are: the characteristic compression strength (same values as defined above), the characteristic tensile strength (same values as defined above), the slab thickness (same values as defined above) *and* the elastic modulus (30, 40 and 50 GPa) and creep ratio (0 and 2). For further description of the method of calculation, see section A.3 “Structural calculations”.

## A.2 Slab constructions – general conditions

### A.2.1 Concrete parameters

With the aim of estimating the structural design related *potential* for HPC in house building, the effects of a number of concrete parameters are theoretically estimated through finite element calculations. As mentioned in the introduction of the chapter, the structural potential mainly means the opportunity for increasing the slab spans.

#### *Concrete compression strength*

To define significant concrete parameters for the opportunities for increasing the slab spans, a *pre-study* was conducted. Examples of the result, see Figure A.1, display that high levels of concrete compression strength, as compared to low, generally do not affect the possibilities for increasing the slab spans, *unless* the reinforcement amounts exceed the limits for balanced reinforcement. Balanced reinforcement is the amount of reinforcement when yield in reinforcement occurs at the same time as compression failure in the concrete. The levels for balanced reinforcement (reinforcement quality KS 500) are 1.89% for K30 and 4.55% for K80, which strongly exceeds normal amounts used in house building. The concrete compression strength does not influence the opportunities for increasing the slab spans when using within house building commonly used reinforcement amounts (approximately 0.1-0.3%). Further, for amounts of 0.5- 1.0%, the differences are significantly less than for other parameters like the concrete slab thickness.

However, the pre-study also indicates that deformations within the serviceability limit state strongly limit the slab spans with regard to the in practice often used maximally allowed deflection (as for instance span divided with 400,  $L/400$ ). The pre-study shows that the influence of concrete compression strength on the deformations is of minor importance, when comparing to other concrete parameters as the elastic modulus (creep ratio) and the tensile

strength. On the basis of the pre-study result, the levels of compression strength for the main structural design study are limited to K30 and K80. According to the Swedish building regulations, the K-value defines the minimum level allowed of concrete cube compression strength corresponding to the statistic level of the lowest 5%-fractile. Further, the *characteristic* compression strength defines the level that corresponds to 85% of the concrete cylinder compression strength. This leads to the characteristic levels of 21.5 and 56.5 MPa for K30 and K80 respectively.

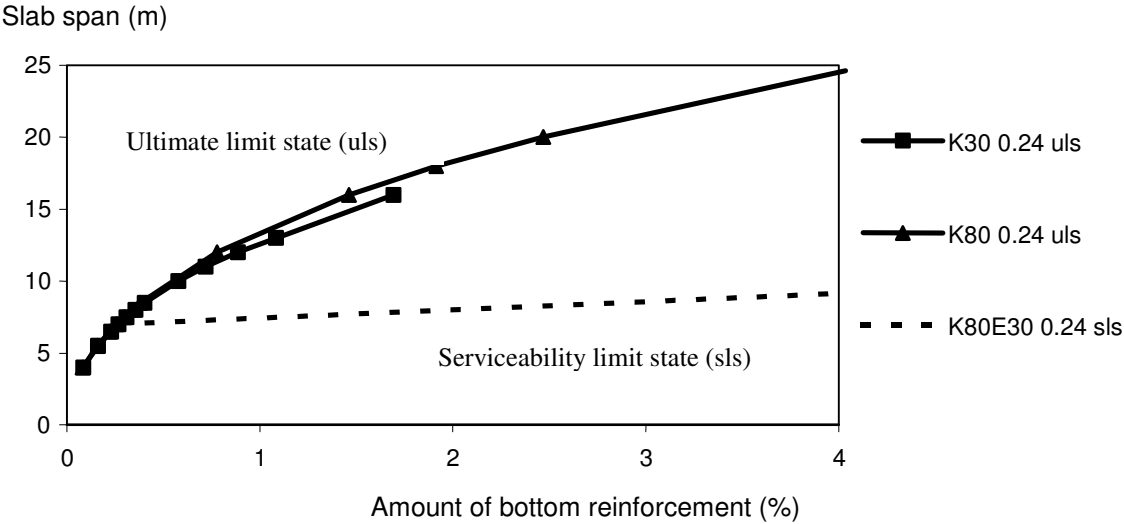

Figure A.1: Result of the pre-study displaying the influence of concrete compression strength on the maximum slab span allowed for a one-way reinforced slab. Regard is taken to the ultimate limit state and the possible slab span within the serviceability limit state (maximum deflection allowed = span/400).

*Concrete tensile strength, elastic modulus and creep ratio*

For each K-value, the Swedish building regulations allow utilisation of specific characteristic levels of the tensile strength as well as the elastic modulus. Therefore the values of the characteristic concrete tensile strength used in the calculation are set to 1.6 and 2.5 MPa corresponding to K30 and K80 respectively. However, if special investigations verify higher levels, the Swedish norm allows exploitation of increased levels. Therefore, also the effects of characteristic tensile strength of 5.0 MPa are calculated. Though high, this value is assumed to be realistic for a well-designed HPC.

Further, the Swedish building regulations allow usage of characteristic E-modulus levels of 30 GPa for K30 and 38.5 GPa for K80. As in the case of the tensile strength, it is allowed to utilise higher values if investigations verify this. Therefore the effect is calculated for three levels of characteristic elastic modulus, 30, 40 and 50 GPa. These values are assumed to be realistic if high quality aggregate is used. By using different values of E-modulus, the creep ratio is considered. Therefore the creep ratio is set to 0. For some calculations however, the creep ratio is set to 2 in order to only display the effect of increased creep ratio, and not varying the elastic modulus. For potential exploitation of increased tensile strength and elastic modulus, see further Chapter 6.1.4.



### Summary of used concrete parameters

In Table A.1, the concrete parameters used within the study are displayed. The characteristic values are further reduced to design levels using partial coefficients, see further section A.3.3 ‘Material data’.

Table A.1: K-values, characteristic strength, elastic modulus and creep ratio of the concrete parameters used within the study.

Concrete parameter	Level	Unit
K-value (Swedish Building Standards)	30 and 80	-
Characteristic concrete compression strength, $f_{ck}$	21.5 and 56.5	MPa
Characteristic concrete tensile strength, $f_{ctk}$	1.6, 2.5 and 5.0	MPa
Characteristic concrete elastic modulus, $E_{ctk}$	30, 40 and 50	GPa
Concrete creep ratio, $\varphi$	0 and 2	-

### A.2.2 Loads

Loads are set in accordance with the Swedish building norm, BKR99 Chapter 2:321 and 3:4 (Boverket, 1999), for multi-family residential buildings. The load values and partial coefficients, with regard to the ultimate and serviceability limit state for each load type, are shown in Table A.2.

Table A.2: Characteristic load values used, together with partial coefficients ( $\gamma$ ) for both the ultimate and serviceability limit state and load reduction coefficients ( $\psi$ ).

Load type	Value	Partial coeff. $\gamma_f$ (ultim.)	Partial coeff. $\gamma_f$ (serv.)	Load red. coeff. $\psi$
$G_k$ Dead load	2.4 kN/m <sup>2</sup>	1.0	1.0	-
$Q_k$ Variable bound	0.5 kN/m <sup>2</sup>	1.3	1.0	1.0
$Q_k$ Variable free	1.5 kN/m <sup>2</sup>	1.3	1.0	0.33

### A.2.3 Deflection

The maximum deflection allowed is in the study set to  $L/400$ , where  $L$  is the slab span (in meters). As a comparison, the effects of the criterion  $L/300$  also have been estimated. See A.5.3 ‘Additional results’.

### A.2.4 Reinforcement

The reinforcement used in the study is ribbed bars of quality Ks 500, in accordance with the Swedish building norms.

## A.2.5 Studied slab types – general properties

Six types of reinforced concrete slabs have been analysed. They represent the most frequently used structural frames in multi-dwelling buildings. Each slab type including characteristic basic data are presented below.

### Slab type 1: One-way reinforced slab (slab/wall-structure)

#### Conditions

- Slab span,  $L$ , varies between 5.0 and 15 m
- Slab width is set to 1.0 m
- Slab thickness 0.20 and 0.24 m
  
- Wall thickness 0.3 m
- Wall height 3.0 m
  
- Hinged connections
- Uplift of slab end not allowed
- Safety class 2

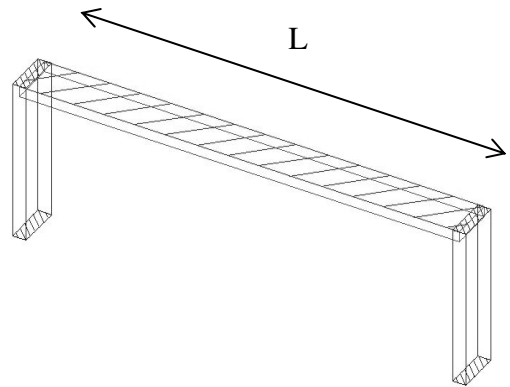

Figure A.2 Slab type 1, one-way reinforced slab

### Slab type 2: Single, two-way reinforced slab (slab/wall-structure)

#### Conditions

- Slab span,  $L$  varies between 5.0 and 15 m
- Slab thickness 0.20 and 0.24 m
  
- Wall thickness 0.3 m
- Wall height 3.0 m
  
- Hinged connections
- Uplift of slab end not allowed
- Safety class 2

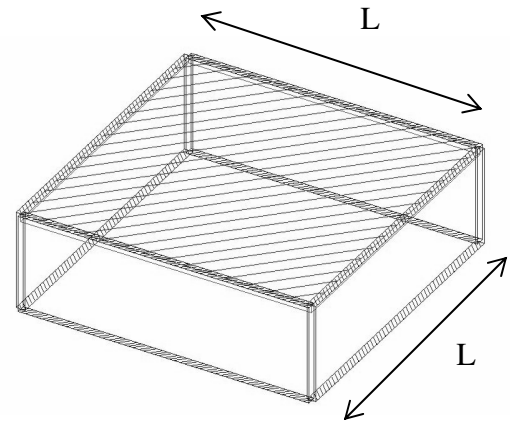

Figure A.3 Slab type 2, single two-way reinforced slab.

### Slab type 3: Two-way reinforced inner field (slab/wall- structure)

#### Conditions

- Slab span,  $L$  varies between 5.0 m and 15 m
- Slab thickness 0.20 and 0.24 m
- Wall thickness 0.3 m
- Wall height 3.0 m
- Hinged connections
- Uplift of slab end not allowed
- Safety class 2

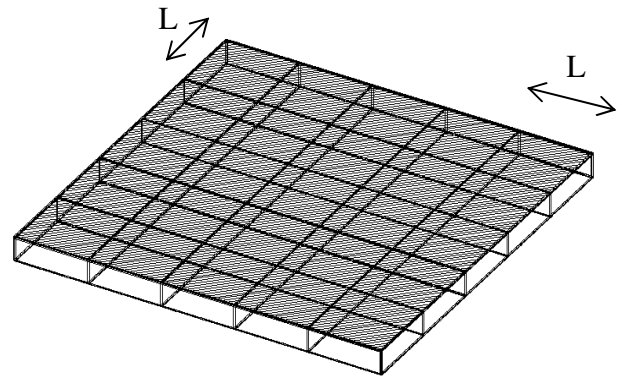

Figure A.4 Slab type 3, Two-way reinforced inner field.

### Slab type 4: Indefinite long girderless floor (slab/column- structure) on facade walls

#### Conditions

- Slab span between columns,  $L$  varies between 5.0 and 15 m
- Slab thickness 0.20 and 0.24 m
- Column width 0.3 m
- Column height 3.0 m
- Hinged connections
- Uplift of slab end not allowed
- Safety class 2

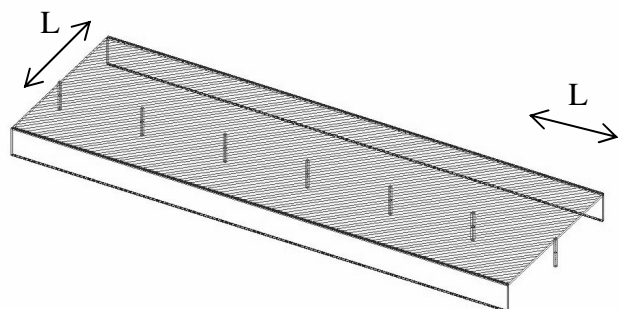

Figure A.5 Indefinite long girderless floor on facade walls.

### Slab type 5: Indefinite long girderless floor (slab/column- structure) on facade columns

#### Conditions

- Slab span between columns,  $L$  varies between 5.0 and 15 m
- Slab thickness 0.20 and 0.24 m
- Column width 0.3 m
- Column height 3.0 m
- Hinged connections
- Uplift of slab end not allowed
- Safety class 2

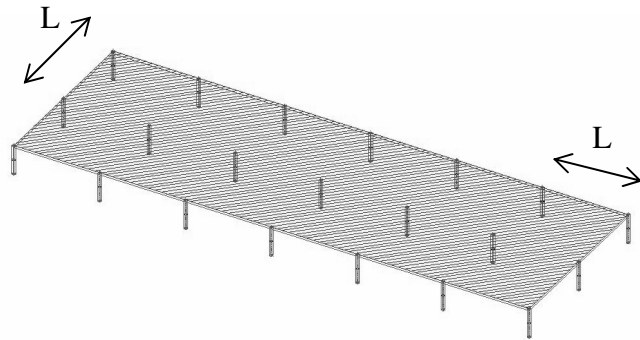

Figure A.6 Indefinite long girderless floor on facade columns

### Slab type 6: Inner field of indefinite girderless floor (slab/column- structure)

#### Conditions

- Slab span between columns,  $L$  varies between 5.0 and 15 m
- Slab thickness varies between 0.20 and 0.24 m
- Column width 0.3 m
- Column height 3.0 m
- Hinged connections
- Uplift of slab end not allowed
- Safety class 2

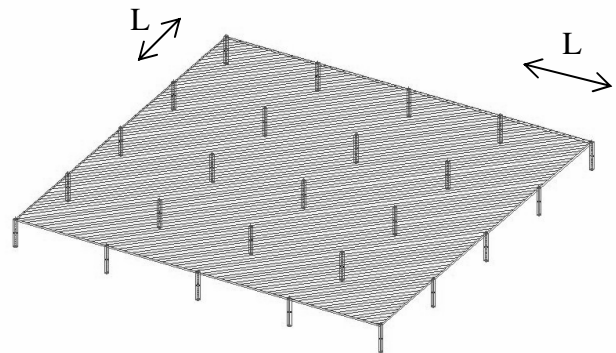

Figure A.7 Slab type 6, Inner field of indefinite girderless floor.

## **A.3 Structural calculations**

### **A.3.1 Calculations performed**

For each of the 6 slab types described above, calculation of the ultimate and serviceability limit state was performed using the FEM-program FEM-Design Plate 3.50 (2000). The calculation was made according to the following steps.

#### **Step 1 Choice of slab**

- Type of slab
- Dimensions

#### **Step 2 Choice of material parameters**

- Concrete parameters
  - Compression strength
  - Tensile strength
  - Elastic modulus
  - Creep ratio
- Reinforcement parameters
  - Reinforcement quality (only one type used, KS 500)
  - Amount of reinforcement (to simulate effects within the serviceability limit state)

#### **Step 3 Consideration to cracking and load conditions**

- No regard to cracking of concrete in the ultimate limit state
- Regard to cracking of concrete in the serviceability limit state
- Regard to different load combinations

#### **Step 4 Results**

- Required bottom and top reinforcement amounts in x- and y-direction (ultimate limit state)
  - With regard to maximum moment
  - With regard to varying moments over the slab
- Punching effects if slab/column structure (ultimate limit state)
- Displacements (serviceability limit state)
  - Comparison between estimated and maximum allowed displacement

#### **Step 5 Repetition of calculation cycles**

- For each type of slab, the calculation cycles are repeated with other slab spans and materials parameters

#### **Step 6 Presentation of results**

- All results are exported to Excel sheets and presented both as tables and diagrams

### **A.3.2 Method of calculation – norms and equations (Swedish Building Code BBK94)**

For more detailed description of the method of calculation, see further Peterson (2003), where equations according to the following literature are presented:

- The Swedish Building Code BBK94 (Boverket, 1994)
- Handbook of Concrete-Design, “BHK” (Swedish Building Centre, 1990)

A brief description of the method of calculation is given below.

#### **Ultimate limit state**

##### *Main reinforcement*

Section forces and design moments in the slabs are calculated by elastic theory, according to the Swedish Building code BBK94 Chapter 6.5.3.2 and “BHK”, Chapter 3.2:125. Required bending reinforcement is designed according to “BHK” 3.6:43, Figure 3.6:12b.

##### *Shear capacity*

Shear capacity of the concrete is calculated according to BBK94 3.7.3.2.

##### *Punching*

The slab capacity with regard to punching is calculated according to BBK94 6.5.4-5 and BHK 6.5:34.

#### **Serviceability limit state**

##### *Method of solution*

Calculations of deflections and cracks within the serviceability limit state are performed for all load combinations in accordance with BHK 4:5 and 4:6.

The decrease in slab stiffness due to cracking has been considered in the calculations. In the calculations, slabs are first assumed to be uncracked and cross-section forces are calculated. In the next step, the calculated moments are controlled and compared to the crack moments to estimate whether sections are belonging to “Stadium I” (uncracked condition) or “Stadium II” (cracked condition). Required bending reinforcement is calculated for each element as the maximum value for all load combinations.

### **A.3.3 Material data**

According to BBK94 2.3, the characteristic values described within section A.2.3 of this chapter have to be reduced to the design values as follows:

#### **Ultimate limit state**

Concrete compression strength,  $f_{cc}=f_{ck}/1.5\gamma_n$

Concrete tensile strength,  $f_{ct}=f_{ctk}/1.5\gamma_n$

Concrete elastic modulus,  $E_c=E_{ck}/1.2\gamma_n$

Steel tensile strength,  $f_{st}=f_{yk}/1.1\gamma_n$

Steel elastic modulus,  $E_s=E_{sk}/1.05\gamma_n$

The values of  $\gamma_n$  are, according to “BHK”, Table 2.3:2 (Swedish Building Centre, 1990), dependent on safety class, as follows:

$\gamma_n=1.0$  for safety class 1 (low)

$\gamma_n=1.1$  for safety class 2 (normal)

$\gamma_n=1.2$  for safety class 3 (high)

#### **Serviceability limit state**

Concrete tensile strength,  $f_{ct}=f_{ctk}/1.0$

Concrete elastic modulus,  $E_c=E_{ck}$

### **A.4 Result**

#### **A.4.1 Comparison between NPC and HPC regarding maximum slab span**

The study has resulted in a large number of diagrams that are presented in Peterson (2003), displaying the slab span as function of required amount of reinforcement. Regard has been taken to both ultimate and serviceability limit state and effects of concrete compression strength, tensile strength and elastic modulus. The effects of concrete slab thickness, creep ratio and alternative deformation criteria are also presented.

Table A.3 below summarises the result of the design study by presenting the maximum span with regard to ultimate and serviceability limit state for HPC and NPC respectively. To clearly display the differences in effects of the studied concrete types, the chosen HPC represents the most optimised HPC, or in other words, both tensile strength and elastic modulus are increased although within a range, assumed to be realistic with regard to practical production. The result is based on calculations where slab thickness and maximum displacement allowed are set to 0.2 meter and  $L/400$  respectively. The creep ratio is

constantly set to 0. In order to simulate creep effects, various levels of E-modulus are used in the calculations.

Concerning the reinforcement amounts presented, the required amount of bottom reinforcement is calculated for the *maximum* slab moment for one single axis (x). The *average required* bottom reinforcement is estimated as the mean value of the required reinforcement, with regard taken to the varying moments in the finite elements of the slab section. The required reinforcement is based on the ultimate limit state.

The most significant parameters when addressing the possibility for increasing the slab spans are the amount of reinforcement (ultimate limit state), slab thickness (ultimate and serviceability limit state), concrete tensile strength (ultimate and serviceability limit state) and concrete elastic modulus (serviceability limit state). For slab types 1, 2 and 3 (slab/wall structures), the most important factor that reduces the maximum slab span is the deflection criterion with regard to the serviceability limit state. High levels of concrete tensile strength and/or E-modulus, however, increase the maximum slab span allowed with regard to the serviceability limit state. For slab types 4, 5 and 6, (slab/column structures), the punching effect strongly reduces the maximum slab span with regard to the ultimate limit state. A large increase in slab span is however possible if an increased level of concrete tensile strength is utilised.

*Table A.3 Comparison between HPC and NPC regarding the maximum span allowed for all studied slab types (1-6).*

Slab type	Concrete type	Characteristic compression strength (MPa)	Characteristic tensile strength (MPa)	Characteristic E-modulus (GPa)	Maximum span ultimate limit state (m)	Maximum span serviceability limit state (m)	Maximum bottom reinforcement amount (%)	Mean reinforcement amount (%)
1	NPC	21.5	1.6	30		6.0	0.259	0.171
1	HPC	56.5	5.0	50		8.5	0.344	0.277
2	NPC	21.5	1.6	30		9.5	0.229	0.174
2	HPC	56.5	5.0	50		13.0	0.329	0.25
3	NPC	21.5	1.6	30		14.0	0.245	0.074
3	HPC	56.5	5.0	50		20.0	0.354	0.106
4	NPC	21.5	1.6	30	6.0		0.137	0.025
4	HPC	56.5	5.0	50	9.0		0.327	0.055
5	NPC	21.5	1.6	30	5.0		0.121	0.035
5	HPC	56.5	5.0	50	8.5		0.299	0.087
6	NPC	21.5	1.6	30	5.0		0.06	0.02
6	HPC	56.5	5.0	50	11.0		0.294	0.1



Figure A.8 presents the main result of Table A.3 visualised in the form of a diagram.

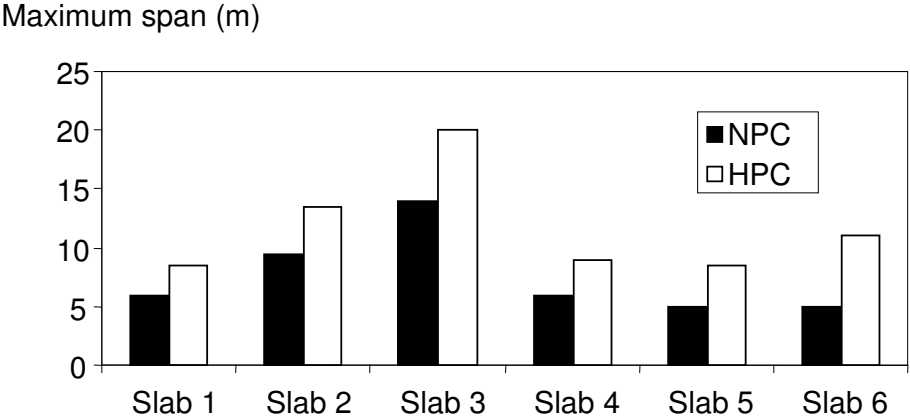

Figure A.8. Comparison between normal house-building concrete (NPC) and high performance concrete (HPC) with regard to maximum slab span allowed in all studied slab types.

**A.4.2 Effects of concrete properties on maximum slab span for slab/wall structures**

The effects of the studied parameters on the maximum slab span for slab/wall structures for slab type 1 are shown in Figure A.9. The parameters are explained in Table 2. For NPC, the maximum span for slab type 1 is limited to 6 metres, even when increasing the reinforcement. This limit is based on the fact that the maximum span is determined by deflection. An increase in the amount of reinforcement allows for larger slab spans, provided that the displacement criterion ( $L/400$ ) regarding the serviceability limit state is not exceeded. Concerning HPC though, both the maximum slab span and the reinforcement amount are possible to increase further, if increased values of concrete E-modulus and/or tensile strength are utilised.

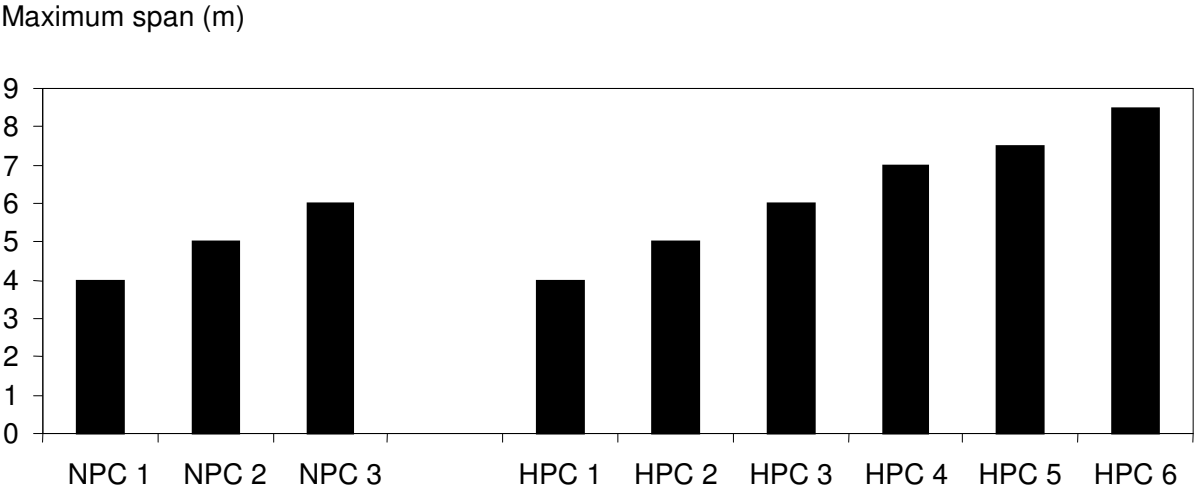

Figure A.9 Effects of various concrete and slab parameters on maximum slab span. Slab type 1.

Table A.4 Definition of the parameters used in Figure A.9.

Concrete type	Description
NPC 1	NC, reinforcement amount 0.1%, thickness 0.20 m
NPC 2	NC, thickness 0.24 m
NPC 3	NC, reinforcement amount 0.25%, thickness 0.20 m
HPC 1	HPC, reinforcement amount 0.1%, thickness 0.20 m
HPC 2	HPC, thickness 0.24 m
HPC 3	HPC, reinforcement amount 0.25%, thickness 0.20 m
HPC 4	HPC, E-modulus 50 GPa (reinforcement amount 0.34%)
HPC 5	HPC, tensile strength 5.0 MPa (reinforcement amount 0.4%)
HPC 6	HPC, tensile strength 5.0 MPa, E-modulus 50 GPa, (reinforcement amount 0.5%)

#### A.4.3 Effects of concrete and slab parameters on maximum slab span for slab/column structures

Figure A.10, which corresponds to Figure A.9, presents slab/column structures (slab type 4). Here, *punching* with regard to the ultimate limit state is the most significant reduction effect on the maximum slab span. The result indicates that concrete tensile strength is the most important property for increasing the maximum slab span, when regard is taken to punching. A high value of concrete tensile strength and an increased slab thickness will permit the use of larger spans in the ultimate limit state. Increased tensile strength and/or increased E-modulus must be used in order to decrease deflections. The diagram displays large differences between NPC and HPC in their respective potential for utilisation of increased tensile strength and elastic modulus in order to increase the span.

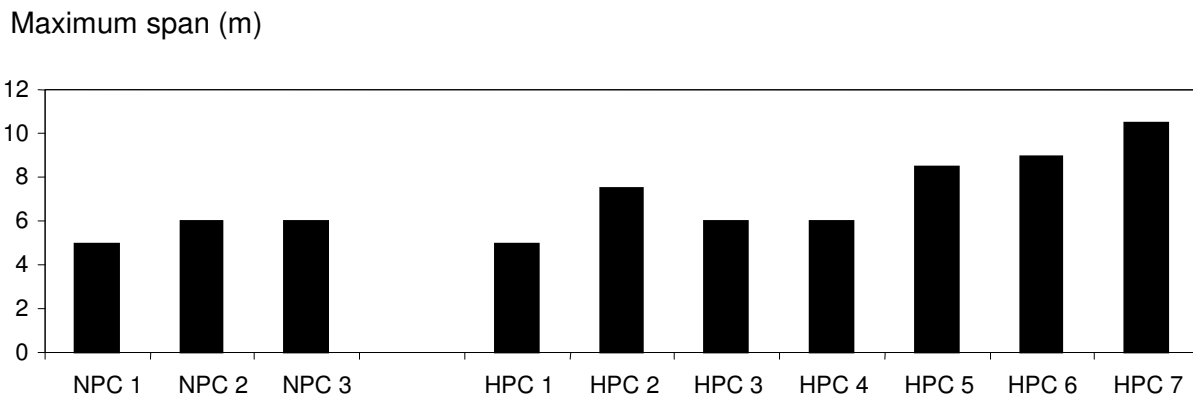

Figure A.10 Effects of different concrete and slab parameters on maximum slab span for slab type 4.

Table A.5 Explanation to parameters used in Figure A.10.

Concrete type	Description
NPC 1	NC reinforcement amount 0.09%, thickness 0.20 m
NPC 2	NC thickness 0.24 m
NPC 3	NC reinforcement amount 0.14%, thickness 0.20 m
HPC 1	HPC reinforcement amount 0.09%, thickness 0.20 m
HPC 2	HPC thickness 0.24 m
HPC 3	HPC reinforcement amount 0.14%, thickness 0.20 m
HPC 4	HPC E-modulus 50 GPa (reinforcement amount 0.14%)
HPC 5	HPC tensile strength 5.0 MPa (reinforcement amount 0.29%)
HPC 6	HPC tensile strength 5.0 MPa, E-modulus 50 GPa, (reinforcement amount 0.33%)
HPC 7	HPC tensile strength 5.0 MPa, E-modulus 50 GPa, thickness 0.24 m (reinforcement amount 0.33%)

#### A.4.4 Summary

For the studied slab/wall structures (slab types 1-3), the maximum allowed slab span is to a large extent dependent on the maximum deflection allowed. The presented result is based on displacement limits defined as  $L/400$ , where  $L$  is the slab span. The concrete parameters most influential on maximum slab span are tensile strength and E-modulus. High levels of these concrete properties and increased slab thickness also allow utilisation of high amount of reinforcement.

Concerning studied slab/column structures (slab types 4-6), the punching effect of the ultimate limit state considerably reduces the possibilities for larger spans. The most potential concrete property to optimise in order to reduce the punching effect is, according to the conducted calculations, the tensile strength. If this is set twice as high as the normally used level (5.0 MPa), opportunities are created for largely increased spans. However, to manage the displacement limit, it is also important to increase the E-modulus. The slab thickness affects the span in both ultimate and serviceability limit state.

Approximate effects of studied parameters on the maximum slab span are displayed in Table A.6.

Table A.6 Summarised approximate quantification of the studied parameters' influence on the possibility for increasing the maximum slab span allowed when regard is taken both ultimate and serviceability limit state. When the effects of each parameter was estimated, all other concrete parameters were constantly set to the lowest studied value, i.e. slab thickness 0.20 m, compression strength 21.5 MPa, tensile strength 1.6 MPa and E-modulus 30 GPa.

Parameter	Slab 1-3 (slab/wall structures)		Slab 4-6 (slab/column structures)	
	Ultimate limit state	Serviceability limit state	Ultimate limit state	Serviceability limit state
Concrete slab thickness (increase from 0.20 to 0.24 m)	25%	15%	20%	15%
Concrete compression strength (increase from 21.5 to 56.5 MPa)	<5%	<5%	0%	<5%
Concrete tensile strength (increase from 2.5 to 5.0 MPa)	0%	20%	50%	20%
Concrete elastic modulus (increase from 30 to 50 GPa)	0%	15%	0%	15%
Amount of reinforcement (increase from 0.1% to 0.2%)	35%	<8%	20%	<8%

## **A.5 Additional discussion of result**

### **A.5.1 Ultimate limit state**

#### **Amount of reinforcement versus concrete quality**

With regard taken to the ultimate limit state, the most significant parameter affecting maximum slab allowed span is the amount of reinforcement. For instance, if the amount of reinforcement in a slab of type 1 is increased from 0.1% to 0.35%, the theoretical maximum span is increased from 4 to 8 metres, with slab thickness constantly set to 0.24 m and concrete quality to K30. If even larger amount of 1.6% is used, which is just less than the amount of balanced reinforcement for K30 concrete, the maximum span in the ultimate limit state can be increased up to 16 m. If the amount of reinforcement ever is larger than the balanced, the reinforcement starts to yield before the concrete breaks in compression. Since higher concrete qualities increase the level for balanced reinforcement, the possibilities for constructing larger spans can only be increased when extremely large amounts of reinforcement is used, amounts which are above the level of balanced reinforcement. However, when normal amount of reinforcement is used, the concrete compression strength does not affect the opportunity for building larger spans if only the ultimate limit state is considered.

#### **Required reinforcement due to maximum moment versus average moments**

The calculations for estimating the required reinforcement are based on the maximum moment of the slabs. Further, in practise, the most used method for ordinary one-way reinforced slabs (type 1) is to design all reinforcement with regard to the maximum moment, which can be described as an easy design and production method in practice but not as an optimal method, considering the materials costs of reinforcement.

However, the total amount of reinforcement required, based on the maximum moment, is significantly larger than the theoretical amount, based on the varying moment in the slab. With the aim of estimating the differences in required amounts of reinforcement, the mean reinforcement amount has also been calculated. These calculations are based on the theoretically required reinforcement in every FEM-node. When summarising and dividing with the number of nodes within the slab, a mean value is calculated. The difference between the mean and maximum value is in some cases large. For instance, theoretically, the reinforcement can be reduced by approximately 30% for one-way reinforced slabs like type 1. However, to further utilise this benefit in reality, CAD/CAM- produced reinforcement nets are required. See further A.5.3 “Additional results’ and A.5.4 “Concluding remarks – additional results’.

#### **Punching**

For the slab/column structures (slab type 4 to 6), the dominating limitation for increase of slab spans is punching. The calculations show that when ordinary concrete is used, the maximum span is heavily reduced due to punching, even if reinforcement or the slab thickness is increased. The calculations further show that the concrete tensile strength significantly reduces the risk of punching. For many of the calculated slab types, the maximum span might be increased by approximately 50% when the characteristic concrete tensile strength is increased to 5 MPa.

### Examples of diagrams of calculation result

In Peterson (2003) all results from the calculations are presented in the form of diagrams for each type of slab, for both the ultimate and serviceability limit state. Explanations to the diagrams regarding the ultimate limit state are presented in the following figures (A.11-A.13), where the different curves show the possible slab spans as function of the amounts of reinforcement regarding the *ultimate limit state*. Each curve represents a specific concrete quality (K-value) and slab thickness. The first diagram (Figure A.11) represents slab type 1 and the two next following figures represent slab type 4 (slab/column structure). When comparing the two latter with each other, the effect of punching clearly shows that possible spans are heavily reduced when standard values of tensile strength are used. The grey curves show the possible span in the serviceability limit state.

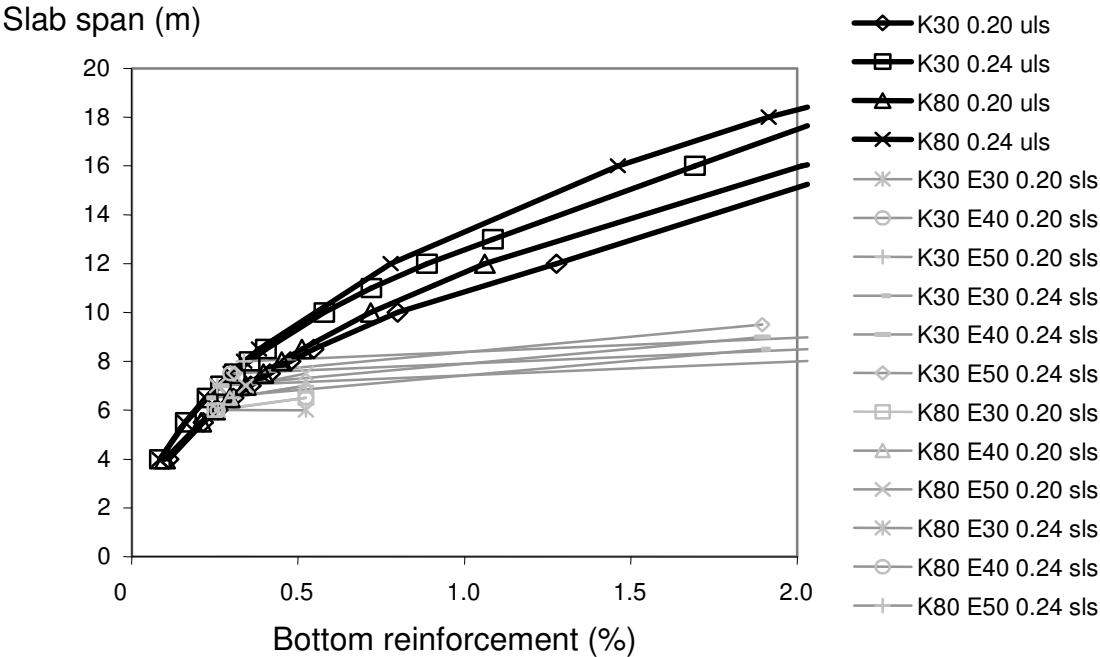

Figure A.11 Example of diagrams for slab type 1. The bold curves indicate the maximum slab span regarding the ultimate limit state (uls). Reinforcement is calculated on basis of the maximum moment.

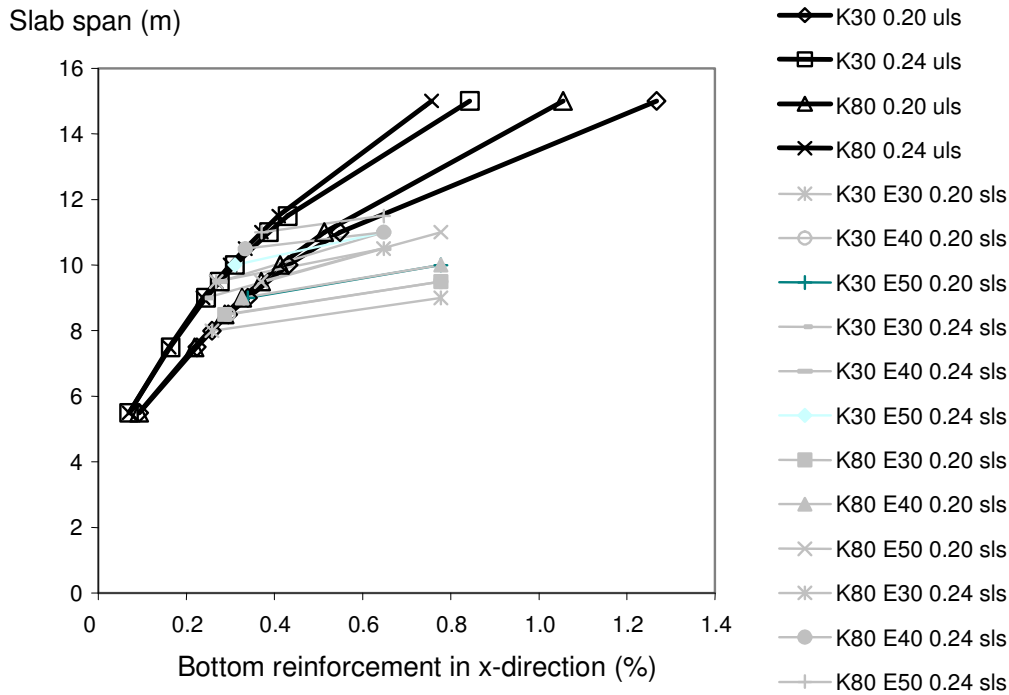

Figure A.12 Example of diagrams for slab type 4 (slab/column structure), where the bold curves indicate the maximum slab span regarding the ultimate limit state (uls) but not including the punching effects. Reinforcement is calculated on basis of the maximum moment.

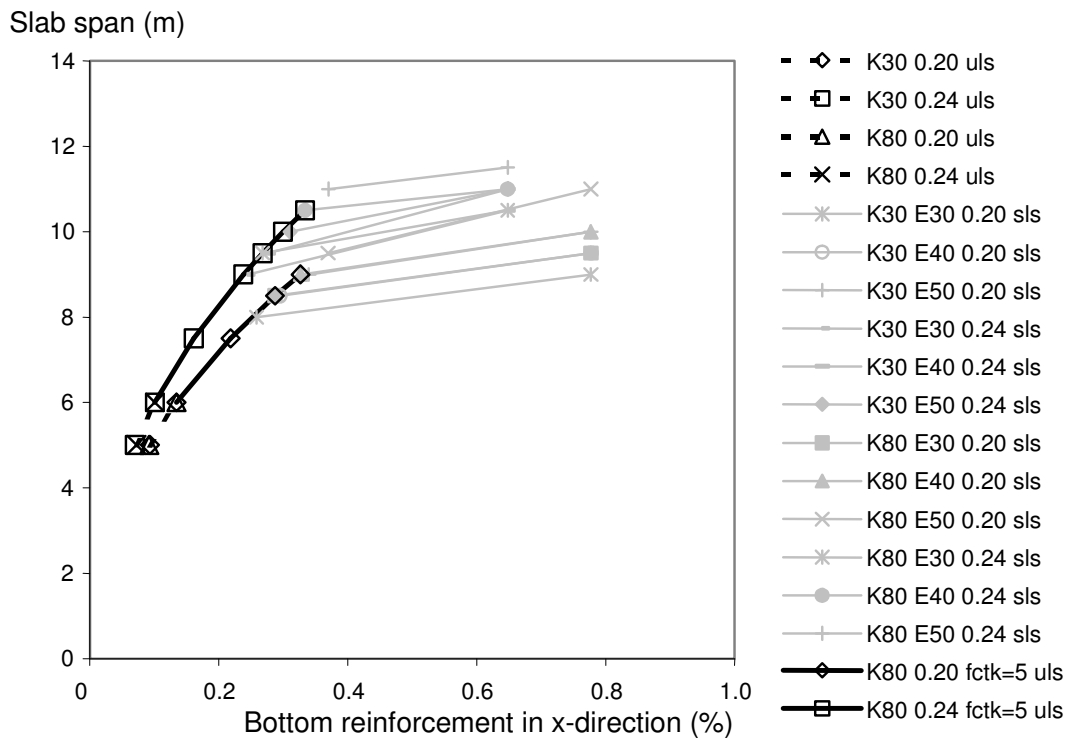

Figure A.13 Example of diagrams concerning slab type 4 (slab/column structure), where the bold curves indicate the maximum slab span regarding the ultimate limit state (uls) and including the punching effects. Reinforcement is calculated on basis of the maximum moment.

**Summary of significant parameters in the ultimate limit state**

In the ultimate limit state, the most significant parameters determining the opportunity for increasing the slab span are the amount of reinforcement and slab thickness. Concerning the concrete properties, the tensile strength is the most important parameter for increased slab span in such slab/column structures for which punching is the determining factor. The compression strength has marginal effect. The elastic modulus though, only affects the maximum slab span considering to deformations in the serviceability limit state (see next section).

**A.5.2 Serviceability limit state**

**Amounts of reinforcement**

The amount of reinforcement does not affect the possibilities for increased slab spans in the serviceability limit state, as much as in the ultimate limit state. To some extent though, a higher grade of slab stiffness is created if the amount of reinforcement is hugely increased. This gives a certain possibility for larger spans.

**Example diagrams**

In Figure A.14 below, the bold curves display possible spans as function of the amount of reinforcement for the *serviceability limit state*. Each curve represents a specific concrete quality (K-value), E-modulus and slab thickness. The maximum deflection allowed, is limited to the slab span divided by 400 (L/400). The grey curves show the possible span in the ultimate limit state. All result diagrams for each type of slab considering both ultimate and serviceability limit state are further presented in Peterson (2003).

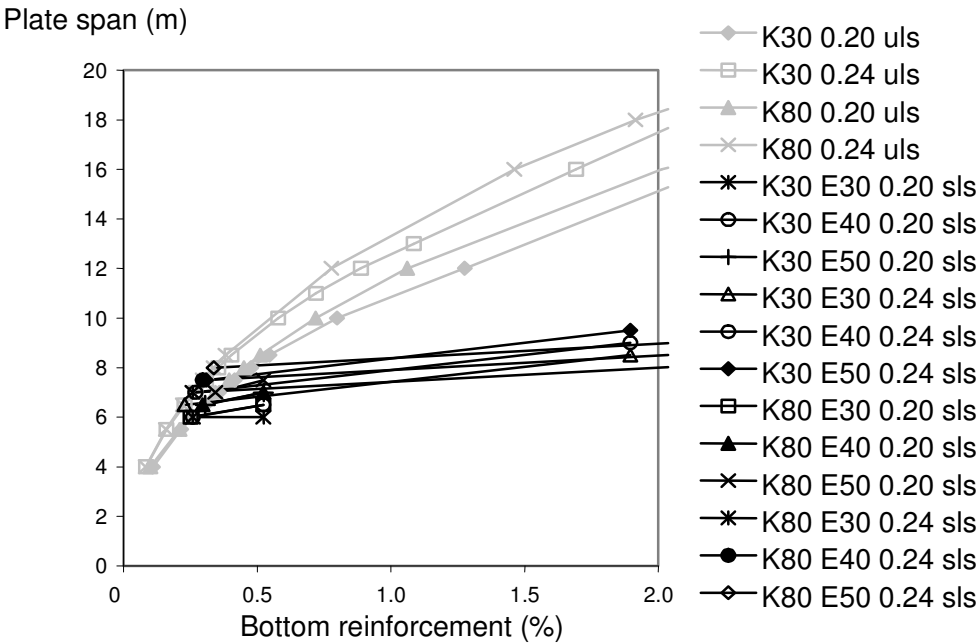

Figure A.14 Example of result diagram concerning slab type 1, where the bold curves indicate the maximum slab span with regard to the serviceability limit state (sls). Maximum deflection allowed is L/400. Reinforcement is calculated on basis of the maximum moment.

**Summary of significant parameters in the serviceability limit state**

The most significant parameters concerning increased slab span, with regard to deformation of the slab within the serviceability limit state, are the E-modulus, the slab thickness, and the concrete tensile strength. Besides, the criterion for maximum displacement has great importance.

**A.5.3 Additional results**

**Required reinforcement based on the average moment in the slab**

As shown in Figure A.16, there is a significant difference between the required amount of reinforcement based on the maximum moment and the mean required amount of reinforcement based on the average moment for the slab. For instance, the reduction of reinforcement concerning slab 3 is approximately 70%. This indicates the potential of a more rational method for utilisation of reinforcement, where the reinforcement is based on the real moment curve and not only dimensioned with regard to the maximum moment in the slabs.

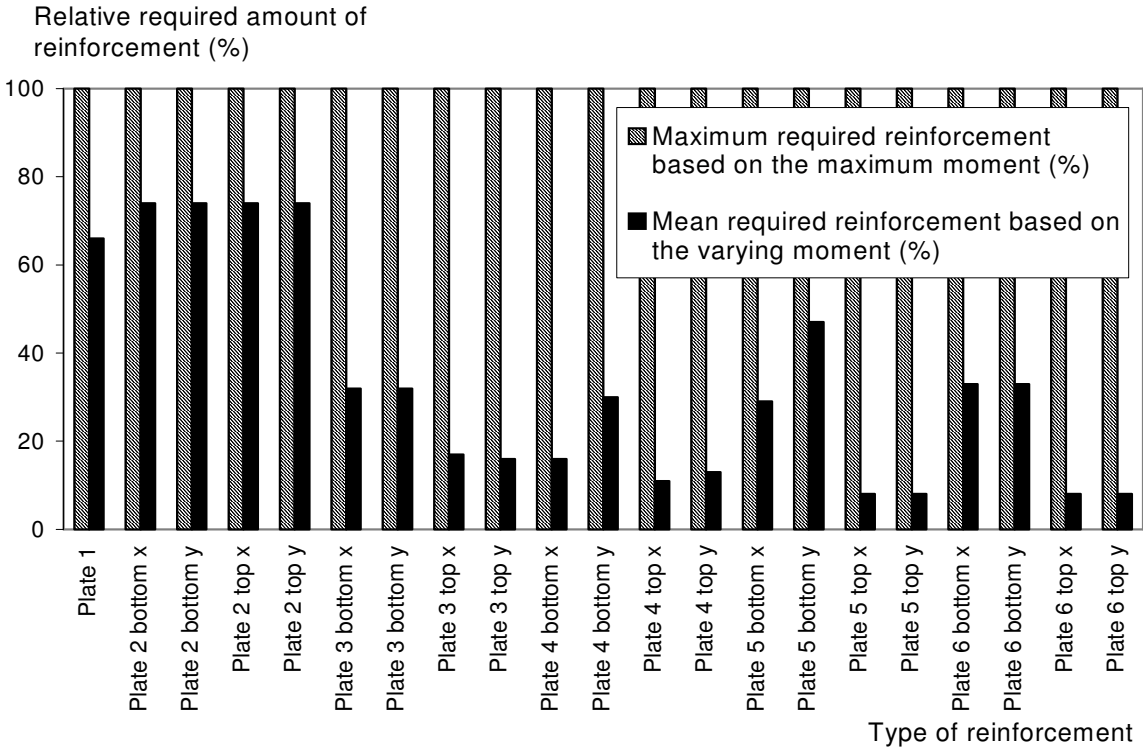

Figure A.16 Comparison between required reinforcement based on the maximum and the average slab moment.

**Effects of creep ratio and deflection requirements on the maximum allowed slab span**

Figure A.17 illustrates the effect of an increase in the creep ratio from 0 to 2 on the deflections. The maximum slab span is reduced by approximately 15%. However, instead of varying the creep ratio in the FEM-calculations, the E-modulus has been varied and the creep ratio constantly been set to 0.



The diagram also shows the effects of an alternative maximum deflection limit allowed. When reducing this from L/400 to L/300 (L= slab span), the maximum allowed slab span is increased by approximately 15%.

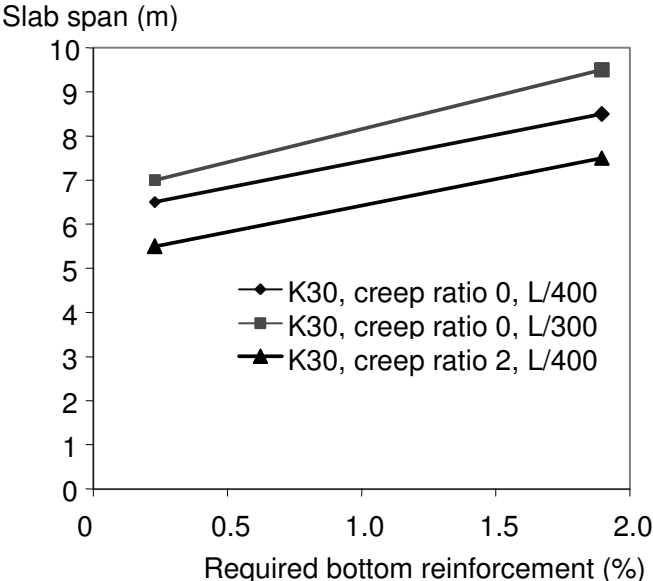

Figure A.17 Estimated influence of increased concrete creep ratio (from 0 to 2) and decrease of the deformation criteria (from L/400 to L/300) on the maximum slab span allowed for slab type 1. Concrete quality K30.

**Effects of the concrete tensile strength on the deflections within the serviceability limit state**

According to Figure A.18 below, the maximum span with regard to deflections increases by 20% when increasing the characteristic concrete tensile strength,  $f_{ctk}$ , from 2.5 MPa (which corresponds to K80 according to the Swedish building norm) to 5.0 MPa. The figure also displays the effect of increased amount of reinforcement on slab stiffness. However, as already mentioned, extremely large amount of reinforcement is required to increase the slab stiffness by the reinforcement itself.

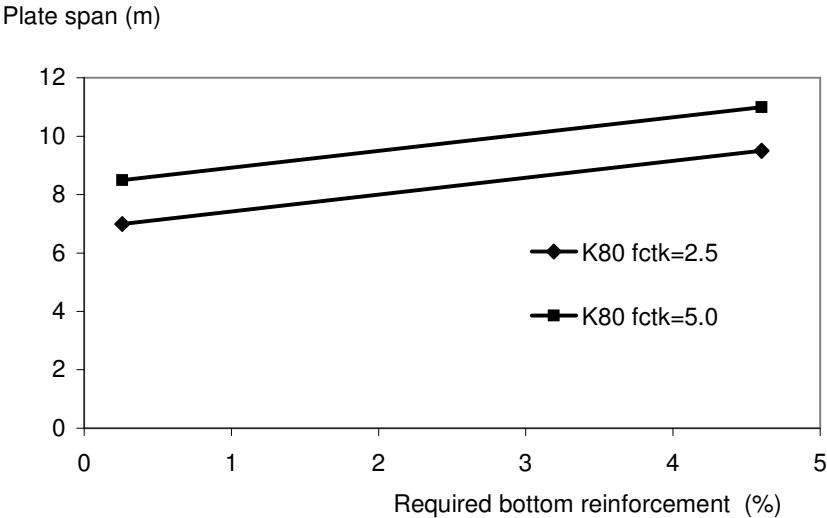

Figure A.18 Estimated influence of increased concrete tensile strength (from 2.5 to 5.0 MPa) on the maximum slab span allowed for slab type 1 considering the serviceability limit state.

#### **A.5.4 Concluding remarks**

Increased concrete quality is traditionally characterised as concrete with increased compression strength, but as shown in this study, increased compressive strength is not a potential for increased slab spans. It is necessary to utilise other properties of HPC, e.g. high tensile strength and high elastic modulus.

#### **Main results**

##### *Effects of concrete properties on maximum slab spans allowed regarding to the ultimate limit state*

When summarising the effects of parameters concerning the potential for increased slab spans in structural frames, there are various aspects to take into regard. For slab/wall structures (slab type 1-3) without columns, where punching is not relevant, the significant parameters for increase of spans are mainly amount of reinforcement and slab thickness. If there is no punching effect, the concrete quality does not affect the potential for increased spans when regard is only taken to the ultimate limit state, and unless extremely high amount of reinforcement (above balanced reinforcement) is used. For slab/column structures though, the concrete tensile strength is a significant parameter for the increase of slab spans, since increased tensile strength increases the punching capacity. When summarising the effects of HPC on the maximum slab span regarding the ultimate limit state, it creates possibilities for increased spans only for slabs supported by columns.

##### *Effects of concrete properties on maximum slab spans regarding the serviceability limit state*

Concerning the *serviceability limit state* though, the concrete properties affect the possibilities for increasing the slab spans to larger extent than is the case with the ultimate limit state. If HPC with increased levels of elastic modulus and/or tensile strength is utilised, the maximum span for all studied slabs (slab type 1-6) may be significantly increased. Other parameters affecting deflections are slab thickness and to some extent the amount of reinforcement.

#### **Additional results**

##### *Effect of the creep ratio on deflections*

The main result of the study is based on calculations where the creep ratio has been set to 0, while three levels of the elastic modulus (30, 40 and 50 GPa) have been used. In paragraph A.5.3 some results of the calculation of the effects of the creep ratio are briefly presented. When increasing the creep ratio from 0 to 2, the maximum slab span regarding the serviceability limit state is reduced by approximately 15%.

##### *Effects of the concrete tensile strength on deflections*

The study is mainly based on a tensile strength of concrete in accordance with the Swedish building regulations. It is 2.65 MPa for concrete with a quality of K80, except from the slab/column structures (slab type 4-6) where also tensile strength of 5 MPa is used in order to cope with punching. An increased level of tensile strength will result in increased stiffness due to increased cracking load. The result shows a significant potential for increasing the maximum slab span with regard to deflections, e.g. 20% for slab type 1 when the tensile strength is increased to 5 MPa. This level is not unrealistically high for HPC but requires

high-quality ingredients and proportion. In reality, another problem is the limitations within the building codes. For utilising higher values than 2.65 MPa, the Swedish codes state that special investigations are required. See further Chapter 6.5 ‘Technical obstacles for the implementation of HPC’.

#### *Effects of various regulations of the maximum allowed deflection*

The Swedish building regulations do not stipulate any maximum levels regarding the allowed deflection for concrete slabs in house-buildings. The value is dependent on the requirements valid for the specific building project. However, the general deformation criterion in practise is often a maximum deflection, equal to slab span divided with 400 ( $L/400$ ). To estimate the effects of alternative deflection criteria,  $L/300$  has been studied. It was shown that the maximum allowed slab span regarding deflections could be increased by 15% for slab type 1.

#### *Potential for utilisation of rational reinforcement*

The structural design study points out the possibility of using significantly decreased amount of total reinforcement if it is designed with regard to the real varying moment of the slab and not to the maximum moment. The difference between maximum and average amounts is large for all types of studied slabs. For some slabs the difference is 70%, which may lead to significant cost savings. Today the usage of reinforcement is often based on the maximum moment. If methods based on the average amount are practiced, as for instance through utilisation of CAD/CAM-methods, opportunities for large cost savings may be created. Another way of rationalising the usage of reinforcement is to combine nets designed for either maximum or average moment. Further, rational reinforcement methods already exist on the market place today, as for instance the BAMTEC-method (see Figure A.19), which consists of prefabricated reinforcement nets, able to be rolled on the concrete slabs by only two persons (Fundia, 2002).



Figure A.19 The BAMTEC-system is an example of competitive reinforcement solution (Fundia, 2002).

## Utilisation of the result

The study indicates a number of structural design benefits by utilisation of HPC for building structural frames in low- medium rise house-buildings. Economic effects are not analysed but the result can be used for an economical analysis, in which higher material cost of HPC can be compared with cost savings during production and economical benefit of a more flexible building. *Direct* economical benefits, according to the result are the presumptive reduction of concrete and/or reinforcement amounts by utilisation of HPC. There are also presumptive *secondary* economical benefits, as for instance reduced production costs by rapid production cycles through HPC (see Chapter 6) and further future cost savings with regard to the function of the building, e.g. flexibility (see further Appendix C).

However, there are also technical, economical and building process related obstacles for the implementation of HPC. These obstacles are not discussed within this Appendix but further described in sections 2.3.4 and 6.5.



## **Appendix B**

### **Drying of HPC**

**(extract from Peterson, 2003)**

In this Appendix, results of calculation of drying time to 85 % RH and 90 % are presented. Variables for each climate are w/c-ratio, slab thickness, form type and use of silica fume.



**Climate 1 Controlled drying directly after casting (summer conditions); see Figure 6.2**

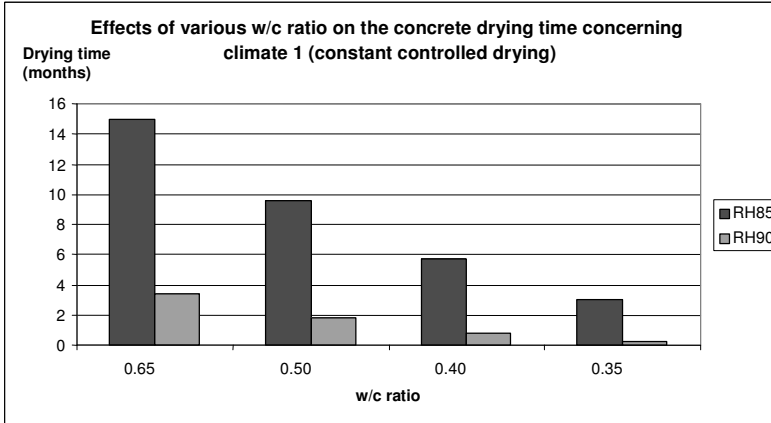

Filigran-form  
20 cm slab thickness

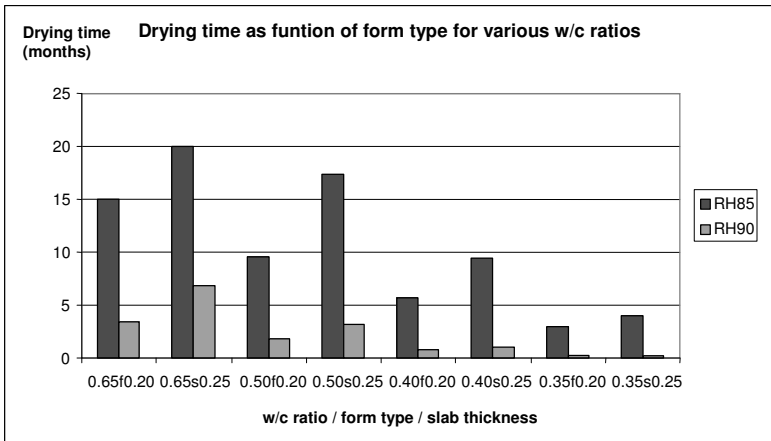

f= Filigran-form  
s= steel form

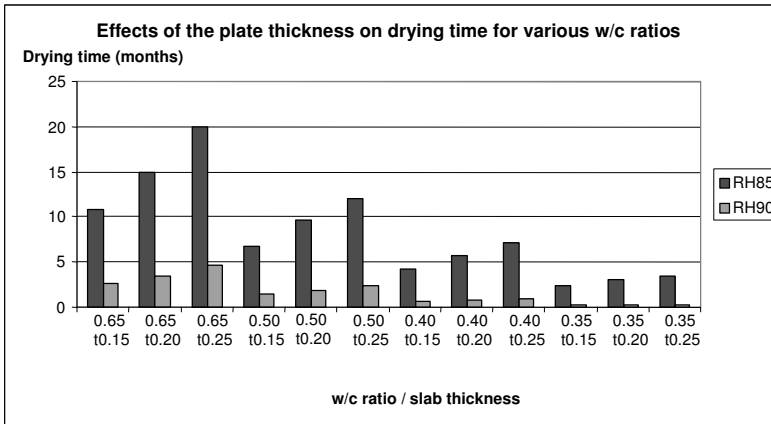

Filigran-form

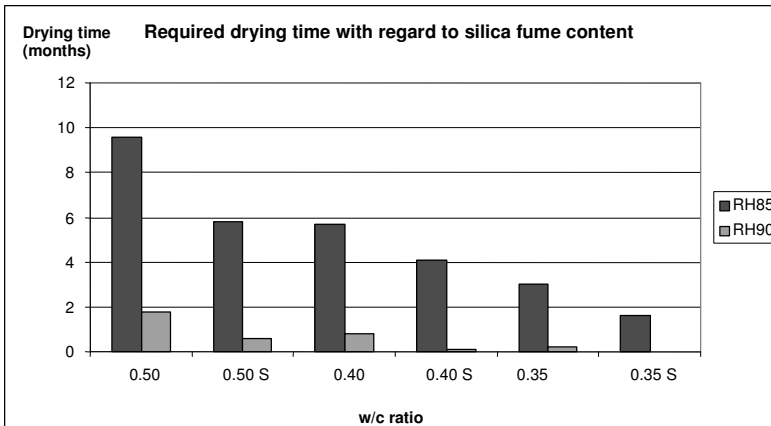

20 cm slab thickness  
S= 5 % silica fume  
Filigran-form  
w/c=water/Portland cement



**Climate 2 Controlled drying after one month (summer conditions); see Figure 6.7**

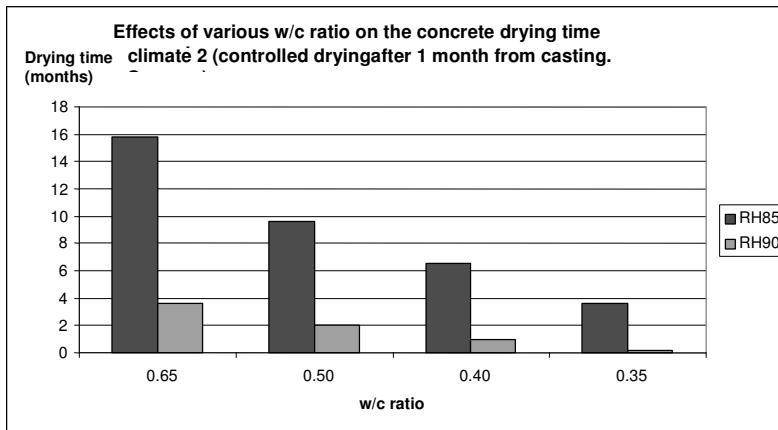

Filigran-form  
 20 cm slab thickness

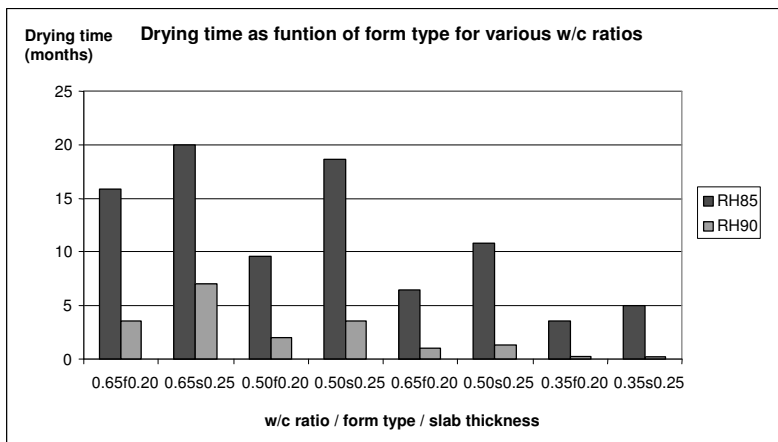

f= Filigran-form  
 s= steel form

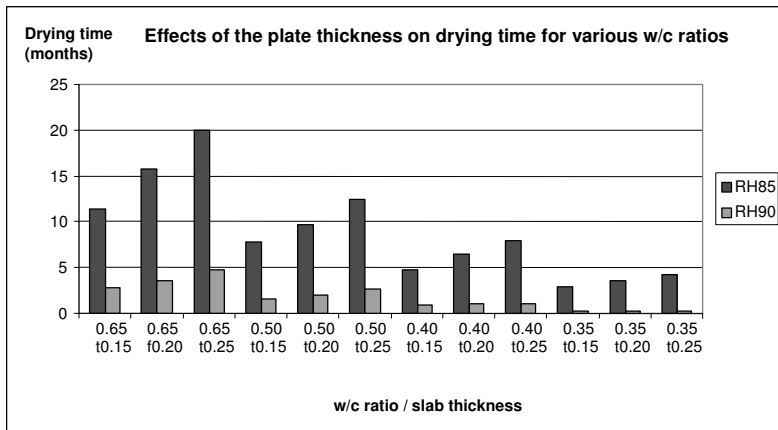

Filigran-form

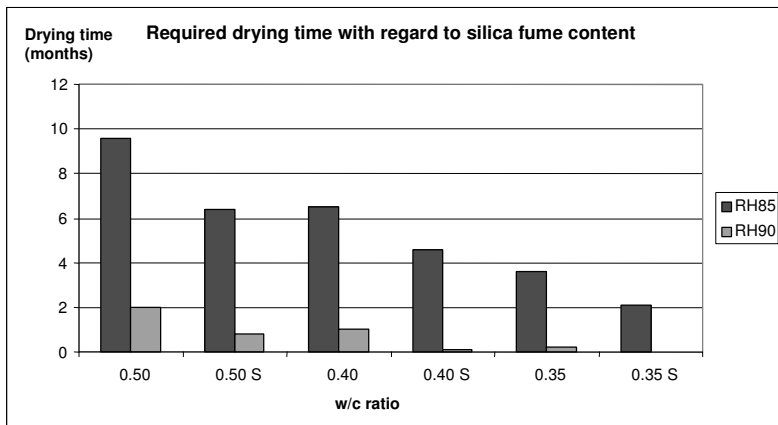

20 cm slab thickness  
 S= 5 % silica fume  
 Filigran-form  
 w/c=water/Portland cement

**Climate 3 controlled drying after 1 month (winter conditions, default temperature data); see Figure 6.9**

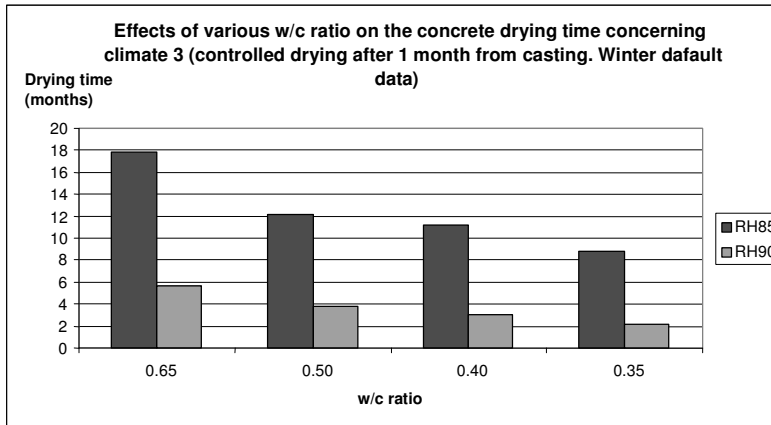

Filigran-form  
20 cm slab thickness

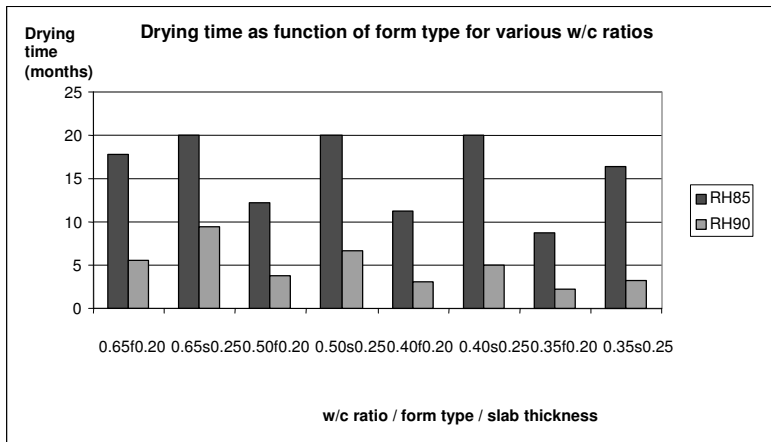

f= Filigran-form  
s= steel form

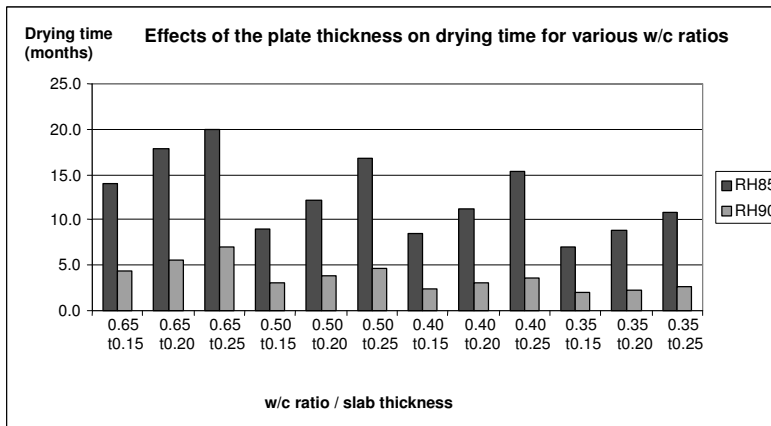

Filigran-form

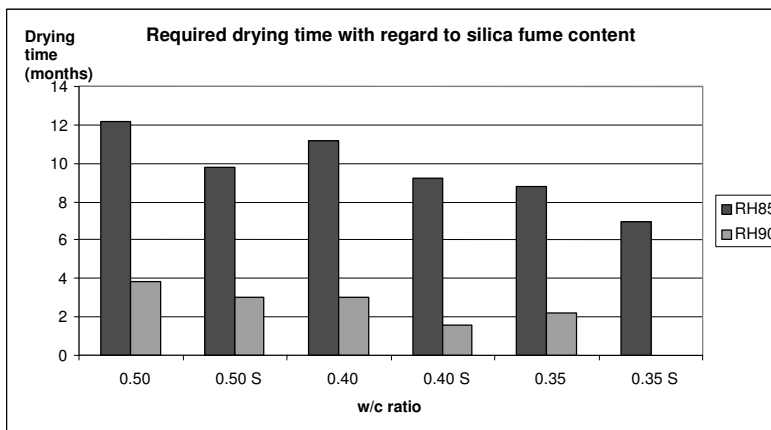

20 cm slab thickness  
S= 5 % silica fume  
Filigran-form  
w/c=water/Portland cement

**Climate 4 controlled drying after 1 month (winter conditions, modified temperature data, 10 °C during the first week after casting); see Figure 6.11**

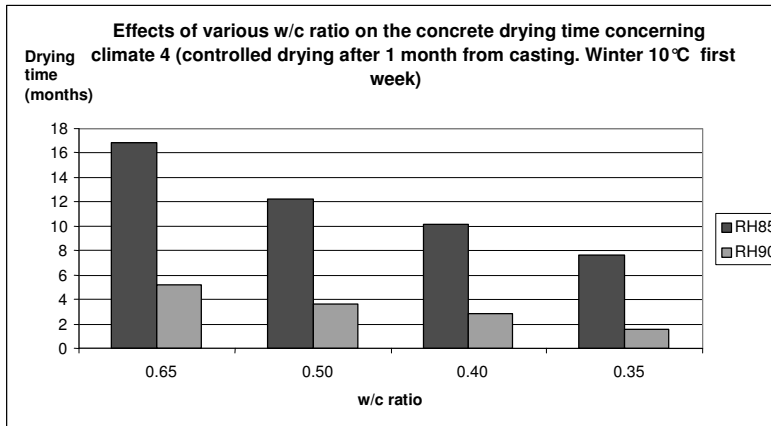

Filigran-form  
20 cm slab thickness

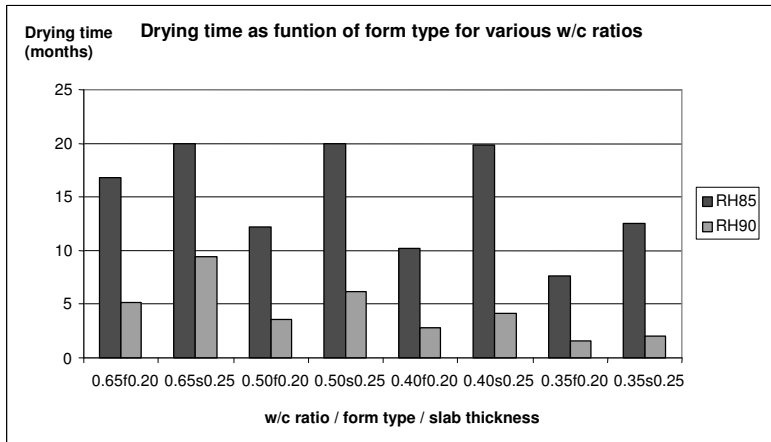

f= Filigran-form  
s= steel form

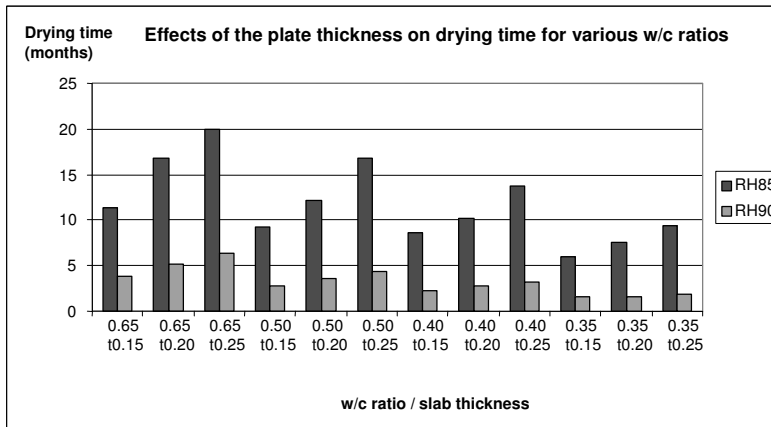

Filigran-form

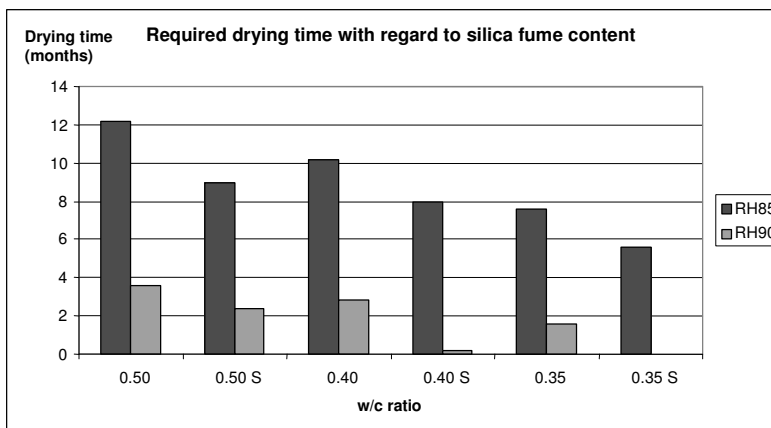

20 cm slab thickness  
S= 5 % silica fume  
Filigran-form  
w/c=water/Portland cement

**Climate 5 controlled drying after 1 month (winter conditions, used concrete temperature data from Hett97 during the first four days after casting); see Figure 6.14**

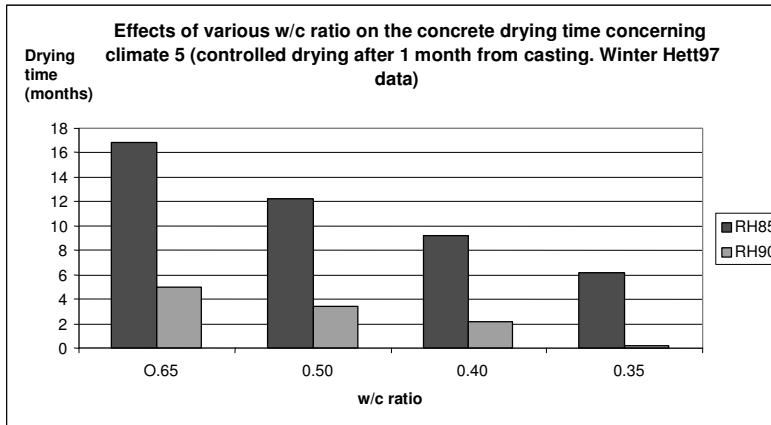

Filigran-form  
20 cm slab thickness

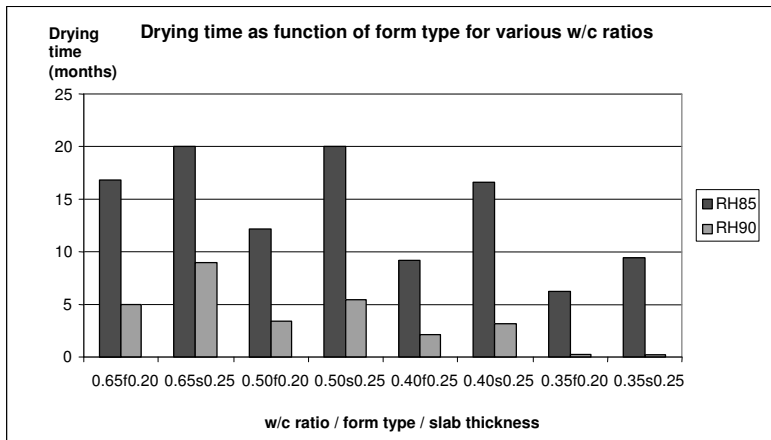

f= Filigran-form  
s= steel form

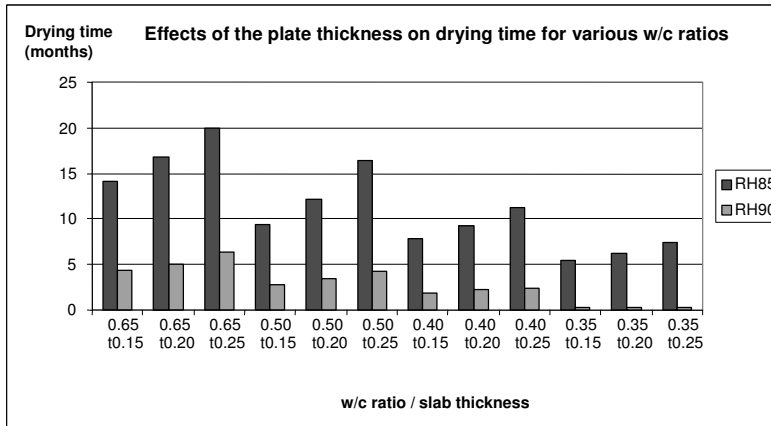

Filigran-form

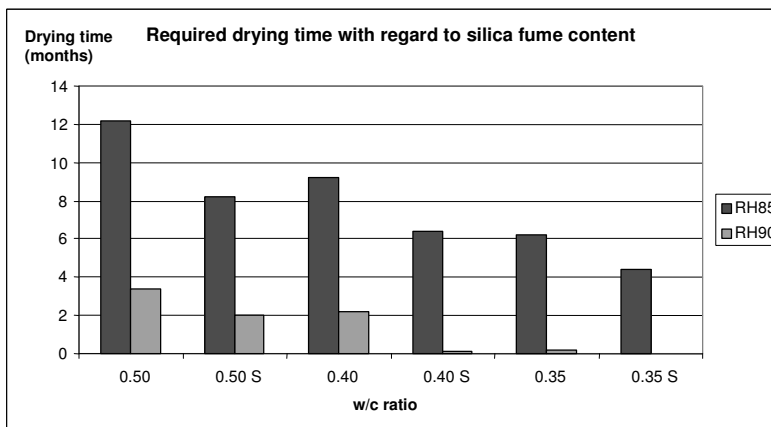

20 cm slab thickness  
S= 5 % silica fume  
Filigran-form  
w/c=water/Portland cement



## **Appendix C**

### **Synergy effects of HPC on the building function**

**(extract from Peterson, 2003)**



### C.1 Increased flexibility/future refurbishment by utilisation of HPC

Structural frames produced of average concrete and designed as solid slab/wall structures often limit the flexibility for future changes and adaptation to new use of the building. The low bearing capacity of average house-building concrete reduces the maximum allowed slab spans. Bearing walls of solid concrete, limits the possibilities for future refurbishment in comparison with slab/column structures including easily dismantlable walls. Chapter 3 “Structural potential of HPC within house building” indicates possibilities for increased flexibility, such as increased possibilities for the user to change the function of the rooms to meet future requirements. Increased floor spans and/or dismantling or mounting of light walls create possibilities not only for further arranging of furniture but also for new functions of the rooms. To meet the presumptive increased requirements for working at home in the future, residential functions more frequently have to be rebuilt into office functions.

Below, Figure 5.1 illustrates the potential of HPC and slab/column structures for increased flexibility. “A” illustrates a solid concrete slab/wall structure of NPC and “B” of HPC. The span is significantly increased for “B” but future requirements for refurbishment is however limited compared to “C” and “D”, which illustrate slab/wall structure supported by column, including two alternatives for placing the internal dismantlable walls. Another possibility is to use bigger slab/column structures with large span between the columns.

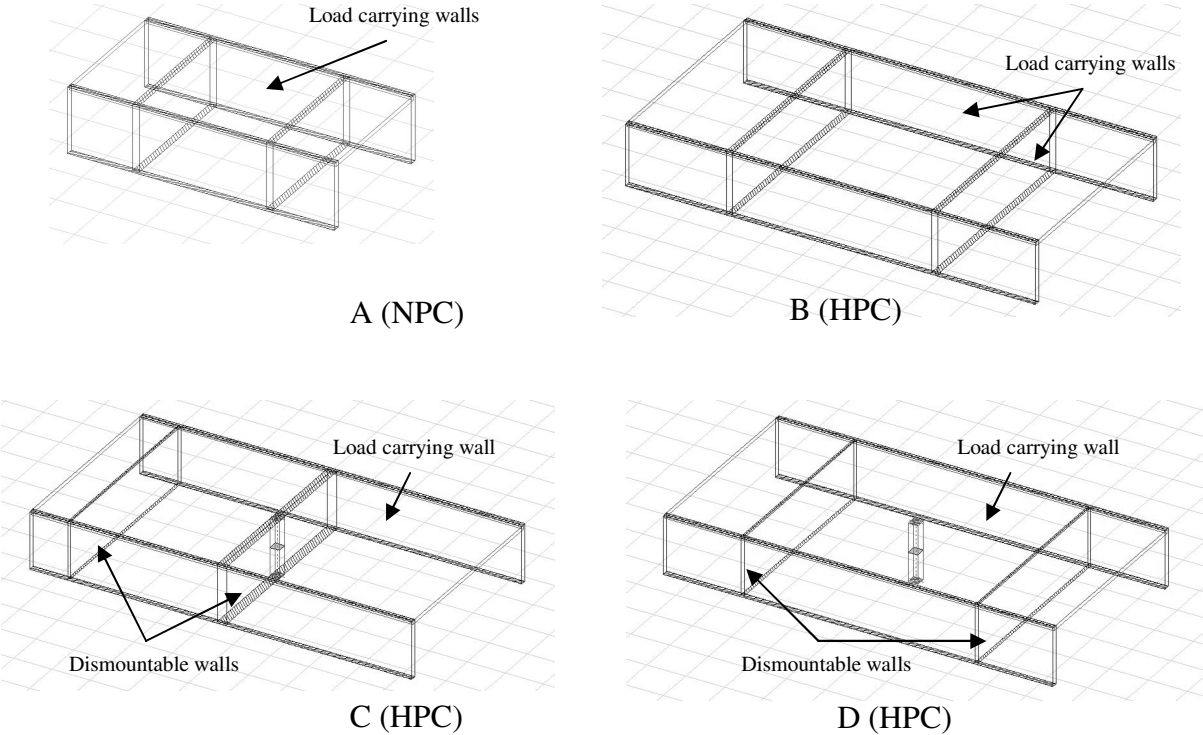

Figure C.1 Examples of increased flexibility regarding future refurbishment by the use of HPC.



## C.2 Reduced moisture problems by utilisation of HPC

Insufficiently dried concrete may indirectly contribute to moisture related health problems in the finished building, the so called “sick building syndrome”. The reason is that organic flooring material or other organic materials in contact with moist alkaline concrete emits unpleasant gases to the room. These are measured as VOC (volume of organic compounds) or TVOC (total volume of organic compounds). The concrete itself has negligible emission, even when regard is taken to chemical additives. Another problem is mould growth, which may occur if concrete with high moisture content is in direct contact with wood or other organic materials. Therefore it is important to dry out concrete before sensitive materials are placed in contact with it. Generally accepted values in Sweden on the maximum concrete humidity with regard to various floor-covering materials are presented in Table 5.1 below.

*Table C.1 Allowed maximum levels of concrete relative humidity (RH) according to Swedish rules, measured on the equivalent depth, for different type of floor-covering materials.*

<b>Materials</b>	<b>RH requirements (%)</b>
Textile	≤ 90%
Cork	≤ 85%
Linoleum	≤ 90%
Rubber	≤ 85%
PVC (> 50% filling material)	≤ 90%
PVC (≤ 50% filling material)	≤ 85%

To reach a relative humidity of 90%, an average house-building concrete needs approximately 6 months, which in the worst case may extend the total production time by the same time. For RH levels of 85%, the required drying time can be nearly impossible to manage in practice. If permanent steel formwork and no controlled drying are used, drying times of over 20 months are often required. However, if HPC with low w/c ratios and self-desiccation, is utilised instead of NPC, the required drying time can be significantly reduced. RH levels of 85% are then possible to reach within a couple of months. Local moisture problems related to various dimensions of the constructions are also easier to avoid if HPC is used, since the self-desiccation effect makes the drying time of HPC nearly independent of the construction thickness. See Chapter 6.1.

There are ongoing discussions on whether HPC, because of its’ dense structure, may cause emissions due to the smaller permeability. Also a pre-dried HPC has to absorb water from water-based adhesives used for bonding flooring materials. This effect, together with the high alkali content of HPC, are claimed to lead to increased emissions from the floor adhesives. As a preventing method, alkali-resistant screeds can be used.

## C.3 Increased acoustic quality by utilisation of HPC

Concrete structural frames normally result in high levels of acoustic insulation. There are two main types of sound transmission within a building, (1) impact sound caused by impact (like steps) directly on the concrete and (2) airborne sound (talk or music) transmitted from air to the building frame. Airborne sound can be transmitted in two ways, through direct transmission (directly crossing a slab or wall) or flank transmission (crossing via connected walls or slabs). One of the most significant affecting parameter on the acoustic quality is the

concrete thickness, especially for isolation against low frequency sound. However, there are many other factors affecting the sound insulation, e.g. the type of structural frame, partial wall properties, installation systems, floor covering materials and proportions of the rooms.

According to the Swedish building regulations (Boverket, 1999), there are four recommended acoustic quality classes; A (the highest class), B, C and D, of which C is the minimum required for production of new house-buildings (D is required for renovation projects). The classes are set with regard to two types of acoustic aspects, airborne sound insulation and impact sound level.

For concrete slabs, a thickness of approximately 0.28 m is required for Class A and 0.22 m for B, with regard to vertical airborne sound insulation. Regarding impact sound level, the required concrete slab thickness for the two acoustic classes is approximately 0.25 and 0,19 m.

An obstacle for utilising the high sound insulation properties of concrete structural frames has been the extended drying time for increased thickness of concrete constructions. Reaching high-quality sound insulation has generally been impossible if short production times are required and conventional house-building concrete is used. But if HPC with low w/c ratio is used, the effects of self-desiccation can be utilised, which gives reduced drying time, even for concrete members with big thickness, see the figures C.2 a and b below. The result is based on the calculations of required drying times made in Chapter 6. Constant parameters for the calculations are formwork of permanent steel and the climate condition (18°C, 60% RH) from the start of casting. In HPC (w/c ratio of 0.35) a silica fume content of 5% is used.

**Required drying time (months)**

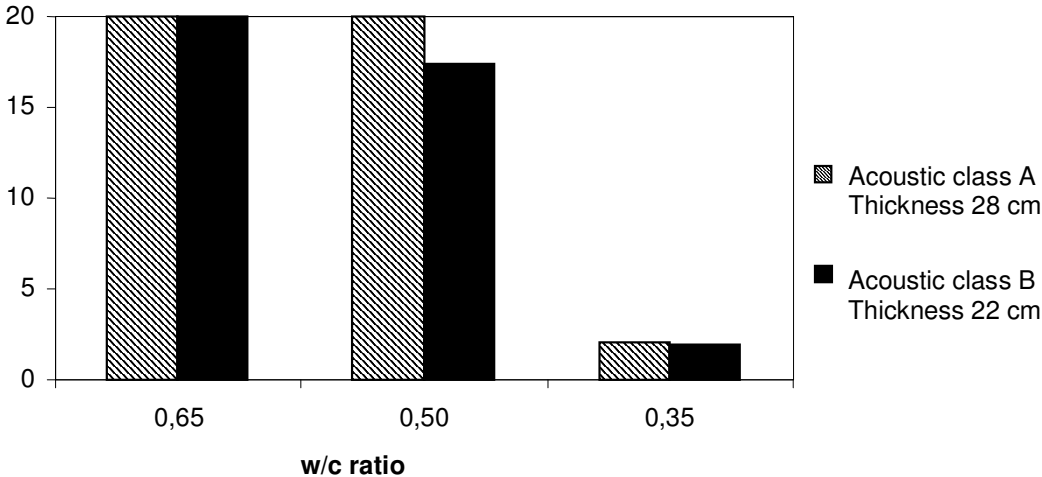

a

### Required drying time (months)

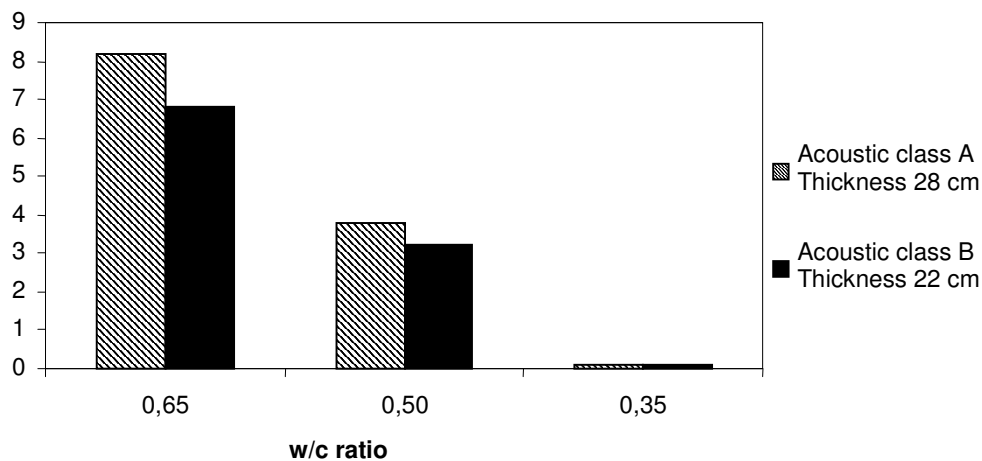

b

Figure C.2 Drying times for various concrete qualities according to the result of the production study in Chapter 6, recalculated with regard to acoustic classes according to the Swedish Building norm. Figure “a” presents the required drying time for reaching 85% RH and “b” for reaching 90% RH, with regard to criteria for acoustic sound class A versus B.

According to Figure C.2, when HPC is utilised, high acoustic quality is possible to manage even if short production time is required.

### C.4 Decreased energy-consumption by utilisation of HPC

Many studies of the energy consumption related to house-buildings, indicate that approximately 85% of the total energy consumption is connected to the usage phase and only 15% to materials production, building erection, renovation, demolition etc. (Adalberth, 2000). In Sweden, the energy consumption related to the building sector is about 40% of the total energy consumption in Sweden. The concrete house-building sector is sometimes criticised for being more energy demanding than competing materials for the building of structural frames, such as wood or steel, but considering the entire life cycle, concrete is probably not more energy demanding than other materials.

The major advantage of concrete structural frames, when it comes to indoor thermal comfort, is the high weight. A structural frame of concrete is able to buffer and store heat to larger extent than wooden or light building structural frame systems, depending on the high heat capacity. As a result, the heat capacity of concrete affects both the indoor air quality and the costs during the total usage phase. One important prerequisite though, is that day-related variations of the indoor air temperature can be accepted by the resident and tolerated by the heating and ventilation system. Otherwise, the opportunity for buffering heat within the concrete construction will be eliminated.

The thickness of the concrete structural frame is important not only for acoustic aspects, but also for the thermal aspects. The thickness of a concrete wall has to be at least 10 to 15 cm for having maximum capacity of storing heat. An even thicker wall does not increase the capacity. Because of the extended production time associated with increased concrete thickness using ordinary house-building concrete, there is a potential for HPC also with regard to thermal aspects. When summarising the life cycle heating and cooling costs for house buildings, the added materials costs for HPC may be easier defended.