



LUND UNIVERSITY

Activity Report: Automatic Control 2012

Rasmusson, Monika; Robertsson, Anders

2013

Document Version:

Publisher's PDF, also known as Version of record

[Link to publication](#)

Citation for published version (APA):

Rasmusson, M., & Robertsson, A. (Eds.) (2013). *Activity Report: Automatic Control 2012*. (Annual Reports TFRT-4040). Department of Automatic Control, Lund Institute of Technology, Lund University.

Total number of authors:

2

General rights

Unless other specific re-use rights are stated the following general rights apply:

Copyright and moral rights for the publications made accessible in the public portal are retained by the authors and/or other copyright owners and it is a condition of accessing publications that users recognise and abide by the legal requirements associated with these rights.

- Users may download and print one copy of any publication from the public portal for the purpose of private study or research.
- You may not further distribute the material or use it for any profit-making activity or commercial gain
- You may freely distribute the URL identifying the publication in the public portal

Read more about Creative commons licenses: <https://creativecommons.org/licenses/>

Take down policy

If you believe that this document breaches copyright please contact us providing details, and we will remove access to the work immediately and investigate your claim.

LUND UNIVERSITY

PO Box 117
221 00 Lund
+46 46-222 00 00

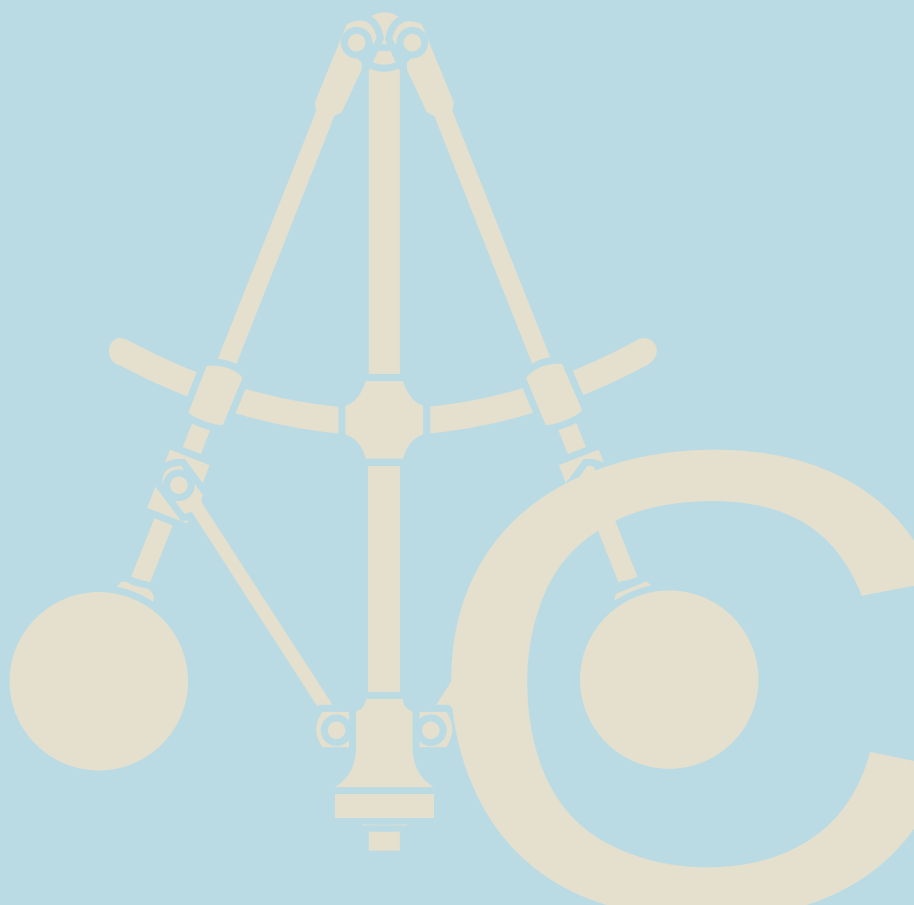



Activity Report 2012



LUND
UNIVERSITY

Department of Automatic Control
Sweden

MAILING ADDRESS

Department of Automatic Control
Lund University
Box 118
SE-221 00 LUND, Sweden

VISITING ADDRESS

Institutionen för Reglerteknik
Ole Römers väg 1
232 63 LUND

TELEPHONE

+46 46 222 87 87

FAX

+46 46 13 81 18

GENERIC E-MAIL ADDRESS

control@control.lth.se

WWW AND ANONYMOUS FTP

www.control.lth.se
<ftp://ftp.control.lth.se/pub>

Edited by Monika Rasmusson och Anders Robertsson

Printed: Media-Tryck, Lund, Sweden, June 2013

ISSN 0280-5316
ISBN LUTFD2/TFRT--4040--SE

Content

Introduction	7
Education 2012.....	11
BASIC LEVEL.....	12
PHD STUDIES	14
LICENTIATE DISSERTATIONS.....	15
DOCTORAL DISSERTATIONS.....	18
Research 2012.....	27
EXCELLENCE CENTERS	28
MODELLING AND CONTROL OF COMPLEX SYSTEMS.....	37
CONTROL AND REAL-TIME COMPUTING.....	46
PROCESS CONTROL	51
ROBOTICS.....	58
AUTOMOTIVE SYSTEMS	67
BIOMEDICAL PROJECTS	69
TOOLS	72
External Contacts	77
ACADEMIC CONTACTS.....	78
INDUSTRIAL CONTACTS.....	78
EUROPEAN COLLABORATION	79
Staff.....	81
PERSONNEL AND VISITORS	82
STAFF ACTIVITIES	84
AWARDS	99
ASSIGNMENTS.....	100
Economy and General Information	107
ECONOMY.....	108
FUNDING	109
INTERNET SERVICES	110
Appendix.....	111
PUBLICATIONS 2012.....	112



Introduction

This report describes the main activities at the Department of Automatic Control at Lund University during the period January 1 to December 31, 2012

AUTOMATIC CONTROL 2012

The department has now stabilized in size. The turnover for 2012 was 53,9 MSEK and we are 59 persons working at the department (guests not included). More about the financial figures is found in the chapter *Economy and General Information*.

Today (year 2012) the department has 6 full time professors, 3 senior professors, 2 associate professors, 3 assistant professors, 5 research engineers, 4 administrators, 29 PhD students, including one industrial PhD student, and 7 post-docs. Some of these numbers include part-time positions. During the year 6 new PhD students were admitted to the department. Moreover, Lizette Borgeram joined the department as administrator and Pontus Andersson as research engineer. Eva Schildt and Britt-Marie Mårtensson have both retired after serving the department for more than 40 years. At the end of the year Giacomo Como was appointed to "Docent" (Associate Professor).

Seven PhD theses by Aivar Sootla, Anders Widd, Karl Mårtensson, Maria Henningsson, Isolde Dressler, Pontus Giselsson and Toivo Henningsson, were published during 2012. Aivar is now working at Imperial College in London, Maria and Toivo at Modelon, Anders at Haldor Topsoe in Denmark, Karl at Combitech, Stockholm, Isolde has returned to Switzerland and Pontus has decided to stay at the department as post-doc. The total number of PhDs graduating from the department is now up to 95. There were also four licentiate theses presented: by Kristian Soltesz, Fredrik Ståhl, Philip Reuterswård and Andreas Stolt.

During 2012 we gave 16 courses to 980 students at LTH and 47 students presented their master's thesis at the department. We also arranged 7 PhD courses. More about this in the chapters *Education* and *Research*.

In March, a new Marie-Curie Intra-European Fellowship project (ViCyPhySys: Virtual Cyber-Physical Systems) started. Thanks to this project a new Marie-Curie fellow, Enrico Bini, was engaged to study the relationship between the dynamics of systems and the computing elements. The supervisor of the project is Karl-Erik Årzén.

In August, Leonid Mirkin from Technion, Israel, joined the department as guest professor.

The Linnaeus center LCCC organized a series of events during 2012. In April there was a symposium on robotic skill learning and cognition. In September a workshop was organized around system design and equation-based languages. Finally, in October, a 5-week focus period was devoted to information and control in networks.

As part of the European robotics week over 770 visitors ranging from pupils at primary schools to university students, faculty staff and visitors from local industry attended presentations and guided tours in the RobotLab, LTH, during the period November 28th to December 5th.

Monika Rasmusson and Anders Robertsson

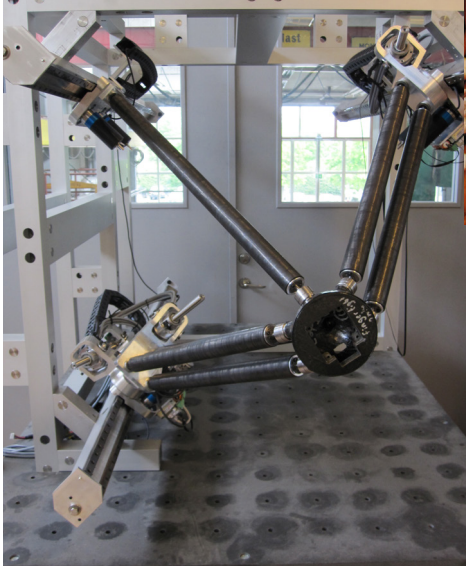



Education 2012

Education on basic level, PhD studies, and Licentiate and Doctoral dissertations



BASIC LEVEL

The engineering education follows the central European systems with a five year program leading up to the university degree “civilingenjör” (civ.ing.), with the international title MSc.

Automatic control courses are taught as part of the engineering curriculum in Engineering Physics (F), Electrical Engineering (E), Computer Engineering (D), Mechanical Engineering (M), Information and Communication Engineering (C), Environmental Engineering (W), Engineering Mathematics (Pi), Industrial Management and Engineering (I), Biotechnology (B), Engineering Nanoscience (N) and Chemical Engineering (K).

During 2012 the department has been involved in courses given together with Lund University School of Economics and Management. Within this interdisciplinary cooperation called Technology Management, 21 future engineers have completed a master’s thesis in pair with a future economist. These students have also completed different courses on the subject.

This year, in total 980 students passed our courses and 47 students completed their master’s thesis projects. A list of the master’s theses is given in the Appendix *Master’s Theses*. The number of registered students correspond to 149 fullyear equivalents during the year. The numbers for 2011 were 952, 37 and 135 respectively.

In the table, our courses are listed along with the number of students who passed each course. Each course in the engineering program has its own homepage, documentation, manuals, old exams, etc. We also have information sheets about the engineering courses, the master’s thesis and the doctorate program. You will find the links at www.control.lth.se/education/

TOTAL NUMBER OF STUDENTS WHO PASSED OUR COURSES 2012

Reglerteknik AK FRT010 (Automatic Control, Basic Course).....	569
Realtidssystem FRTN01 (Real-Time Systems)	73
Prediktiv reglering FRTN15 (Predictive Control)	35
Processreglering FRTN25 (Process Control).....	21
Reglerteori FRT130 (Control Theory).....	22
Flervariabel reglering FRTN10 (Multivariable Control)	53
Systemidentifiering FRT041 (System Identification).....	9
Systemteknik FRT110 (Systems Engineering)	54
Olinjär reglering och servosystem FRTN05 (Nonlinear Control and Servo Systems).....	31
Projekt i reglerteknik FRT090 (Projects in Automatic Control)	23
Internationell projektkurs i Reglerteknik (International Project Course in Automatic Control).....	2
Matematisk modellering FK FRT095 (Mathematical Modeling, Advanced Course)	27
Marknadsstyrda system (Market Driven Systems)	24
Examensarbete FRT820 (Master's Thesis Project).....	26
Examensarbete TMA820 (Master's Thesis Project within Technology Management)	21
TMA-kurser (Technology Management Courses) (TMA035, TMA037, TMA010)	37

PHD STUDIES

The PhD education consists of four years of studies: 120hp of courses and 120hp of thesis work. Since most students have 20% of department duties, the nominal time for the PhD education is 5 years. In the Swedish system there is also a possibility to do a half-time thesis called a "Licentiate".

Four licentiate theses were presented during 2012, by Kristian Soltesz, Fredrik Ståhl, Philip Reuterswård and Andreas Stolt.

Seven doctoral theses were also defended during the year by Aivar Sootla, Anders Widd, Maria Henningson, Karl Mårtensson, Isolde Dressler, Pontus Giselsson och Toivo Henningson.

We have admitted Christian Grussler, Fredrik Magnusson, Josefin Berner, Manfred Dellkrantz, Olof Garpinger and Yang Xu as PhD students during 2012.

The following PhD Courses were given in 2012:

- Convex Optimization
- Advanced Real-time Systems
- Information Theory
- Introduction to Time-Delay Systems
- History of Control
- Convex Optimization II
- Nonlinear Control

4.2 Instrumentation

4.3 Influence of Modeling Errors on Positioning Accuracy

Figure 4.8 End-effector accuracy in a 2D-workspace section. Level plot of maximum possible positioning error [μm] for case 1. The black squares indicate the actuator positions. The area examined is very roughly limited by the robot frame-work (left and upper edge of the figure).

Figure 4.8 shows the maximum possible Cartesian error

Contents

Preface 11

Nonlinearities 15

1. Introduction and Background 17

1.1 Systems Theory Background 19

1.2 Basic Model Order Reduction Techniques 24

1.3 Transfer Function Factorizations 28

1.4 Convex Optimization 31

1.5 Quasi-Convex Optimization Approach to Model Reduction 35

2. Semidefinite Hankel-type Model Order Reduction 38

2.1 Hankel-type Formulation of Model Reduction Problem 40

2.2 Semidefinite Hankel-type Model Reduction 42

2.3 Iterative Approach to Hankel-type Formulation 48

2.4 Model Reduction Extensions 49

2.5 Examples 56

2.6 Conclusion and Discussion 60

3. Parameterized Model Order Reduction 62

3.1 Preliminaries and Problem Formulation 63

3.2 Parameterized Semidefinite Hankel-type Model Reduction 65

3.3 Computation of Explicit Parameter Dependent Models 69

3.4 Implementation and Examples 72

3.5 Conclusion and Discussion 77

4. Model Order Reduction in the system matrix 79

80

82

89

90

Chapter 5. HCCI Control using FTM and VVA

5.1 Control Design

As only control of β was the objective, there was no penalty on IMEP_{opt}, but it was used as a measurement signal. The considered cost function was

$$J(\beta) = \sum_{i=1}^{N_c} \gamma(i|\beta) + \sum_{i=0}^{N_c-1} \alpha(i|\beta) \quad (5.1)$$

91

98

99

3. Lagrange Multiplier Norm Bounds

LEMMA 2

For every $\bar{x} \in \beta \mathbb{X}_N$ with $\beta \in (0, 1)$, a Slater vector to the optimization problem (2) is given by $\mathbf{y}(\bar{x}) = \beta \mathbf{y}^*(\bar{x}|\beta)$. Further, $\gamma(\bar{x}(\beta)) \geq (1 - \beta) d_{\min}$.

PROOF

We first note that

$$\mathbf{A}\bar{\mathbf{y}}(\bar{x}) = \beta \mathbf{A}\mathbf{y}^*(\frac{\bar{x}}{\beta}) = \beta \mathbf{b} \frac{\bar{x}}{\beta} = \mathbf{b}\bar{\mathbf{x}}$$

which implies that the equality constraints are satisfied. Further

$$\mathbf{C}\bar{\mathbf{y}}(\bar{x}) = \beta \mathbf{C}\mathbf{y}^*(\frac{\bar{x}}{\beta}) \leq \beta \mathbf{d} = \mathbf{d} - (1 - \beta)\mathbf{d}$$

Hence $-(\mathbf{C}\bar{\mathbf{y}}(\bar{x}) - \mathbf{d}) \geq (1 - \beta)\mathbf{d}$ which by definition of the function γ and d_{\min} gives the result. □

Next, we present a theorem that, using Lemma 1 and Lemma 2, shows how a bound on the norm of the optimal dual variables can be computed.

1.3 Event-Based Control over Data Networks

Figure 1.3 Event-based control over a shared network. Solid lines represent continuous signal transmission, while dashed lines represent event-based transmission.

attached to the process in different places, orchestrated by the controller.

Paper II. Synthesis of Structured Output Feedback Controllers

where \bar{x} satisfies (17). The following theorem determines the suboptimality by looking at the dual function to the constrained problem.

THEOREM 1

Let $\beta \in (0, 1)$ and \bar{x} that for a given sequence of adjoint

$$\leq \beta \min_{\substack{\lambda \geq 0 \\ \bar{x}(0) = \bar{x}} \sum_{t=0}^{t_{\max}} \begin{bmatrix} \bar{x}(t) \\ \xi(t) \end{bmatrix}^T R \begin{bmatrix} \bar{x}(t) \\ \xi(t) \end{bmatrix} + 2\lambda(t)^T (\bar{x}(t+1) - \mathbf{A}^T \bar{x}(t))$$

ing bound can be verified

$$J_{\beta}(L, \alpha, t_{\max}) \leq \beta J_{\beta}(L, \alpha, t_{\max})$$

$$L_{opt} = \arg \min_L \bar{J}_{\beta}(L, \alpha, t_{\max}).$$

LICENTIATE DISSERTATIONS

The licentiate theses, of which the abstracts are presented below, are available in their entirety at www.control.lth.se/publications

TOWARDS PSEUDOSPECTRAL CONTROL AND ESTIMATION

Reuterswård, Philip

This thesis covers different topics related to the application of pseudospectral optimization methods in the field of automatic control. Pseudospectral optimization methods solve dynamic optimization problems by discretizing the state-space, creating a discretized version of a continuous problem. The resulting discretized optimization problems are solved by standard software for nonlinear optimization.

An evaluation of pseudospectral optimal control in a model predictive control (MPC) setting is presented, as a double-tank process is controlled from one set point to another. The method quite often experiences divergence, which makes its use in a real setting limited.

The thesis proposes a way to use pseudospectral optimization as a nonlinear state estimator together with Out-Of-Sequence-Measurements (OOSM). The main idea is outlined; however, it represents future work as a lot remains to be done.

The thesis also evaluates possible performance gains when solving optimization problems governed by ODE system dynamics in parallel. For large systems, with very many discretization points, substantial speedups are possible. However, the application is shown only on randomly generated systems, as real world examples of such large sizes are elusive.



ON AUTOMATION OF THE PID TUNING PROCEDURE

Soltész, Kristian

Within process industry, and in many other areas, the PID controller is responsible for handling regulatory control. An educated guess is that the number of executing PID control loops lies in the billions (2011) and there are no signs indicating a decrease of this number.

Properly tuning the PID controller, i.e., setting its parameter values based on characteristics of the process it controls together with robustness criteria, is commonly both timely and costly. Hence, the tuning is often overseen, resulting in numerous poorly tuned loops. These result in unnecessary lack of performance, which might be both hazardous and uneconomic.



If a linear time invariant model of the process is given, there exists numerous feasible tuning methods. However, automatically obtaining even a low complexity model is far from trivial in the absence of a priori process information.

This thesis addresses system identification to be used in the automatic PID tuning procedure. A method for generating the identification input signal is proposed. Its objective is to yield higher model accuracy in the frequency range where it is most needed for robust tuning.

Subsequently, methods for obtaining process models from input and output data pairs are proposed and discussed. All methods are presented using numerous simulations and laboratory experiments.

Finally, a simulation study of closed-loop anesthesia in human patients, based on clinically obtained model parameters, is presented. The novelty lies in that the depth of hypnosis PID controller is individualized based on data collected during the induction phase of anesthesia. It is demonstrated that updating the controller, using a herein proposed method, significantly improves performance.



DIABETES MELLITUS GLUCOSE PREDICTION BY LINEAR AND BAYESIAN ENSEMBLE MODELING **Ståhl, Fredrik**

Diabetes Mellitus is a chronic disease of impaired blood glucose control due to degraded or absent bodily-specific insulin production, or utilization. To the affected, this in many cases implies relying on insulin injections and blood glucose measurements, in order to keep the blood glucose level within acceptable limits. Risks of developing short- and long-term complications, due to both too high and too low blood glucose concentrations are severalfold, and, generally, the glucose dynamics are not easy to fully comprehend for the affected individual—resulting in poor glucose control. To reduce the burden this implies to the patient and society, in terms of physiological and monetary costs, different technical solutions, based on closed or semi-closed loop blood glucose control, have been suggested.

To this end, this thesis investigates simplified linear and merged models of glucose dynamics for the purpose of short-term prediction, developed within the EU FP7 DIAdvisor project. These models could, e.g., be used, in a decision support system, to alert the user of future low and high glucose levels, and, when implemented in a control framework, to suggest proactive actions.

The simplified models were evaluated on 47 patient data records from the first DIAdvisor trial. Qualitatively physiological

correct responses were imposed, and model-based prediction, up to two hours ahead, and specifically for low blood glucose detection, was evaluated. The glucose raising, and lowering effect of meals and insulin were estimated, together with the clinically relevant carbohydrate-to-insulin ratio. The model was further expanded to include the blood-to-interstitial lag, and tested for one patient data set. Finally, a novel algorithm for merging of multiple prediction models was developed and validated on both artificial data and 12 datasets from the second DIAdvisor trial.

ROBOTIC ASSEMBLY AND CONTACT FORCE CONTROL

Stolt, Andreas

Modern industrial robots are traditionally programmed to follow desired trajectories, with the only feedback coming from the internal position/angle sensors in the joints. The robots are in general very accurate in tracking the desired motion, and they have become indispensable in many applications, such as spot welding and painting in the automotive industry. In more complex tasks, such as physical interaction with the environment, position control of the robot might be insufficient due to the fact that it is hard, or too costly, to achieve an environment that is structured enough. This is due to inherent uncertainties, such as part variations and inexact gripping.

One example of a challenging application is assembly, which is hard to accomplish using only position controlled robots. By adding a force sensor to the system, it gives the robot ability to correct for uncertainties by measuring contacts. This thesis presents a framework for force controlled robotic assembly. Assembly tasks are specified as sequences of constrained motions, where transitions are triggered by sensor events, coming either from thresholds or from more advanced classifiers. The framework is also able to explicitly deal with uncertainties, which can be estimated during execution to improve the performance. Further, a method for adaptation of force control parameters is presented, and how a singularity-free orientation representation can be used within the assembly framework. The case when no force sensor is available is also considered, and a method for estimating the external forces based on the joint control errors is presented. All methods presented are validated in experiments.

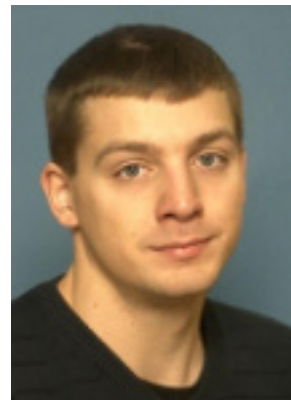

DOCTORAL DISSERTATIONS

The doctoral theses, of which the abstracts are presented below, are available in their entirety at www.control.lth.se/publications



MODELING AND CONTROL OF STIFF ROBOTS FOR FLEXIBLE MANUFACTURING

Dressler, Isolde

To survive on a global market, small and medium size enterprises (SMEs) require affordable and competitive industrial automation for high quality flexible manufacturing. This thesis contributes to the development of robot concepts that fit the needs of SMEs. A major part of the thesis deals with the modeling of the three degree-of-freedom (DOF) Gantry-Tau parallel kinematic robot, which has the potential to fulfill the requirements on accuracy, mechanical stiffness and conceptual flexibility of a robot for SMEs. Additionally, concepts that aid the SMEs to achieve the required accuracy and a more intuitive robot operation were developed and evaluated.

The modeling of the Gantry-Tau robot includes both kinematic and dynamic modeling. Based on the nominal kinematic model, kinematic error models were developed, as well as kinematics for the F1-type Gantry-Tau, a Gantry-Tau architecture extended to 6DOFs. The modeling was evaluated in kinematic calibration experiments. A rigid body model was derived and identified, including friction in the actuators. As noticeable flexible behaviour was observed, the compliance dynamics were identified by black box modeling.

Kinematic calibration was not only considered for evaluation of the kinematic models developed, but it was also studied how to automatize the kinematic calibration procedure, so that it can be executed by non-expert SME staff after a possible geometric reconfiguration of the robot. In the search of affordable, accurate and reusable measurement devices for kinematic calibration in SMEs, the usage of camera vision for kinematic calibration was evaluated.

To make the programming of a robot trajectory fast and intuitive, lead-through programming was recently introduced. A new concept for lead-through programming in contact situations is proposed in this thesis, where two force sensors are used. While the first sensor is used for guiding the robot, the second force sensor measures the tool force, which can prevent damage of the tool or workpiece and can help to keep a steady contact between

tool and surface. The concept was demonstrated in two example applications.

A possibility to improve the performance for a repeatedly executed motion is iterative learning control (ILC). An ILC algorithm is evaluated on the Gantry-Tau robot, which uses an estimate of the tool motion, based on measurements from an accelerometer mounted at the end-effector plate and in addition to measurements on the motor side. The performance of the tool motion was shown to be considerably improved compared to the case when only motor side measurements are used.

GRADIENT-BASED DISTRIBUTED MODEL PREDICTIVE CONTROL

Giselsson, Pontus

The thesis covers different topics related to model predictive control (MPC) and particularly distributed model predictive control (DMPC). One topic of the thesis is gradient-based optimization algorithms for solving the optimization problem arising in DMPC in a distributed manner. The underlying idea is to solve the optimization problem in distributed fashion using dual decomposition, which is a well-known method. Dual decomposition is traditionally used in conjunction with (sub)gradient methods which are known to have bad convergence rate properties, especially for ill-conditioned problem. In this thesis it is shown how to use accelerated gradient methods with dual decomposition, and how to choose the step size parameter optimally in the algorithm. A method to bound the number of iterations needed to guarantee a prespecified accuracy of the solution is also provided. Based on the iteration bound, it is shown how to precondition the problem data optimally to improve conditioning of the problem. These contributions significantly improve the performance of the distributed optimization algorithm compared to dual decomposition with a (sub)gradient method.

Another topic of the thesis is to guarantee feasibility and stability when using the developed distributed optimization algorithm in a DMPC context. Traditional methods of proving stability in MPC usually involve terminal cost functions and terminal constraints that are non-separable. These methods are not directly applicable in DMPC based on dual decomposition because of the non-separable terms. Further, dual decomposition does not provide feasible iterations but is guaranteed to be primal feasible only in the limit. These issues have been addressed in the thesis. The stability issue is addressed by showing that for problems without a terminal cost or terminal constraints and if a certain controllability

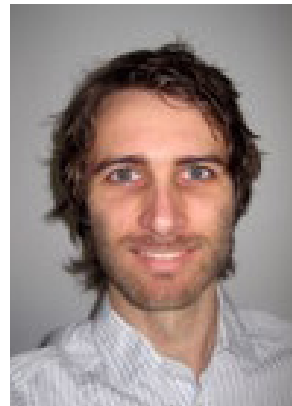

assumption on the stage costs is satisfied, the optimal value function is decreasing in every time step by a prespecified amount. It is also shown how the controllability assumption can be verified by solving a mixed integer linear program. The feasibility issue is addressed by a novel adaptive constraint tightening approach. The adaptive constraint tightening guarantees that a primal feasible solution can be constructed with finite number of algorithm iterations without compromising the stability guarantee.

The developed distributed optimization algorithm is evaluated on a hydro power valley benchmark problem. The hydro power valley consists of several dams connected in series where each dam is equipped with a turbine to extract power from the water. The objective is to control the water flow between the dams such that the total power from the turbines matches a power reference while respecting constraints on water levels and water flows. The control problem is formulated as an optimization problem, which is solved in receding horizon fashion using the distributed optimization algorithm presented in the thesis. The performance of the proposed distributed controller is compared to the performance of a centralized controller.

DATA-RICH MULTIVARIABLE CONTROL OF HEAVY-DUTY ENGINES

Henningsson, Maria

The combustion engine is today the dominant technology for transportation of goods and people world-wide. Concerns for global warming, toxic exhaust emissions, as well as cost and availability of fuel have in recent years created incentives for technological evolution of combustion engines. More sophisticated engine instrumentation with additional degrees of freedom has been added to the engine design to reduce emissions and fuel consumption. But, as engines become more complex, the task of calibration and control becomes more challenging.

This thesis investigates approaches to utilize rich sensor information for multivariable engine control. Different combustion modes, and different combinations of sensors and actuators have been studied and evaluated experimentally on a full-scale six-cylinder heavy-duty engine. The work is divided into four areas: virtual emissions sensing, dynamic emissions models, optimal engine control, and control of sensitive combustion modes. The theme of the thesis is to show how feedback control based on rich sensor information can be exploited to improve the engine operation and reduce the off-line calibration effort.

The virtual sensing work presents a data-mining method for predicting exhaust emissions from cylinder pressure data. Princi-

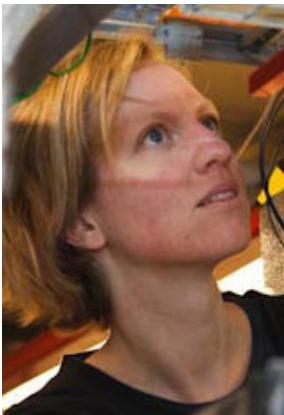

pal component analysis was used to reduce the dimensionality of the high-resolution data, and a neural network model was trained to predict emissions on a cycle-to-cycle, cylinder-individual basis.

The work on dynamic models investigates how system identification can be used to find multivariable dynamic models from a set of engine actuators to a set of variables related to high-level engine specifications, namely emissions, work output, combustion phasing, and peak pressure derivative. It was shown how fairly simple Wiener models can capture the main dynamics of the engine at a grid of operating points.

One of the identified multivariable models was used for optimal control of the engine. In contrast to most previous work in the field, integration of fuel- and gas-path control into a single framework was pursued. A model predictive controller was designed based on a cost function expressed in terms of high-level engine control objectives, and feedback was based on measured emissions as well as cylinder pressure data.

The final part of the thesis presents work on two sensitive combustion modes, HCCI and dual-fuel operation. Here, feedback control is necessary to achieve robust operation. For both types of combustion, it was shown how a combination of two actuators can be used to successfully control the combustion process.

STOCHASTIC EVENT-BASED CONTROL AND ESTIMATION **Henningsson, Toivo**

Digital controllers are traditionally implemented using periodic sampling, computation, and actuation events. As more control systems are implemented to share limited network and CPU bandwidth with other tasks, it is becoming increasingly attractive to use some form of event-based control instead, where precious events are used only when needed.

Forms of event-based control have been used in practice for a very long time, but mostly in an ad-hoc way. Though optimal solutions to most event-based control problems are unknown, it should still be viable to compare performance between suggested approaches in a reasonable manner.

This thesis investigates an event-based variation on the stochastic linear-quadratic (LQ) control problem, with a fixed cost per control event. The sporadic constraint of an enforced minimum inter-event time is introduced, yielding a mixed continuous-/discrete-time formulation. The quantitative trade-off between event rate and control performance is compared between periodic and sporadic control. Example problems for first-order plants are investigated, for a single control loop and for multiple loops closed over a shared medium.

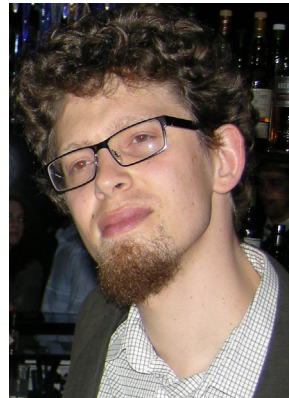

Path constraints are introduced to model and analyze higher-order event-based control systems. This component-based approach to stochastic hybrid systems allows to express continuous- and discrete-time dynamics, state and switching constraints, control laws, and stochastic disturbances in the same model. Sum-of-squares techniques are then used to find bounds on control objectives using convex semidefinite programming.

The thesis also considers state estimation for discrete time linear stochastic systems from measurements with convex set uncertainty. The Bayesian observer is considered given log-concave process disturbances and measurement likelihoods. Strong log-concavity is introduced, and it is shown that the observer preserves log-concavity, and propagates strong log-concavity like inverse covariance in a Kalman filter. A recursive state estimator is developed for systems with both stochastic and set-bounded process and measurement noise terms. A time-varying linear filter gain is optimized using convex semidefinite programming and ellipsoidal over-approximation, given a relative weight on the two kinds of error.



GRADIENT METHODS FOR LARGE-SCALE AND DISTRIBUTED LINEAR QUADRATIC CONTROL **Mårtensson, Karl**

This thesis considers methods for synthesis of linear quadratic controllers for large-scale, interconnected systems. Conventional methods that solve the linear quadratic control problem are only applicable to systems with moderate size, due to the rapid increase in both computational time and memory requirements as the system size increases. The methods presented in this thesis show a much slower increase in these requirements when faced with system matrices with a sparse structure. Hence, they are useful for control design for systems of large order, since they usually have sparse systems matrices. An equally important feature of the methods is that the controllers are restricted to have a distributed nature, meaning that they respect a potential interconnection structure of the system.

The controllers considered in the thesis have the same structure as the centralized LQG solution, that is, they are consisting of a state predictor and feedback from the estimated states. Strategies for determining the feedback matrix and predictor matrix separately, are suggested. The strategies use gradient directions of the cost function to iteratively approach a locally optimal solution in either problem. A scheme to determine bounds on the degree of suboptimality of the partial solution in every iteration,

is presented. It is also shown that these bounds can be combined to give a bound on the degree of suboptimality of the full output feedback controller. Another method that treats the synthesis of the feedback matrix and predictor matrix simultaneously is also presented.

The functionality of the developed methods is illustrated by an application, where the methods are used to compute controllers for a large deformable mirror, found in a telescope to compensate for atmospheric disturbances. The model of the mirror is obtained by discretizing a partial differential equation. This gives a linear, sparse representation of the mirror with a very large state space, which is suitable for the methods presented in the thesis. The performance of the controllers is evaluated using performance measures from the adaptive optics community.

MODEL ORDER REDUCTION BASED ON SEMIDEFINITE PROGRAMMING

Sootla, Aivar

The main topic of this PhD thesis is complexity reduction of linear time-invariant models. The complexity in such systems is measured by the number of differential equations forming the dynamical system. This number is called the order of the system. Order reduction is typically used as a tool to model complex systems, the simulation of which takes considerable time and/or has overwhelming memory requirements. Any model reflects an approximation of a real world system. Therefore, it is reasonable to sacrifice some model accuracy in order to obtain a simpler representation. Once a low-order model is obtained, the simulation becomes computationally cheaper, which saves time and resources. A low-order model still has to be “similar” to the full order one in some sense. There are many ways of measuring “similarity” and, typically, such a measure is chosen depending on the application. Three different settings of model order reduction were investigated in the thesis.

The first one is H infinity model order reduction, i.e., the distance between two models is measured by the H infinity norm. Although, the problem has been tackled by many researchers, all the optimal solutions are yet to be found. However, there are a large number of methods, which solve suboptimal problems and deliver accurate approximations. Recently, research community has devoted more attention to large-scale systems and computationally scalable extensions of existing model reduction techniques. The algorithm developed in the thesis is based on the frequency response samples matching. For a large class of systems the computation of the frequency response samples can be done very efficiently. Therefore,



the developed algorithm is relatively computationally cheap. The proposed algorithm can be seen as a computationally scalable extension to the well-known Hankel model reduction, which is known to deliver very accurate solutions. One of the reasons for such an assessment is that the relaxation employed in the proposed algorithm is tightly related to the one used in Hankel model reduction. Numerical simulations also show that the accuracy of the method is comparable to the Hankel model reduction one.

The second part of the thesis is devoted to parameterized model order reduction. A parameterized model is essentially a family of models which depend on certain design parameters. The model reduction goal in this setting is to approximate the whole family of models for all values of parameters. The main motivation for such a model reduction setting is design of a model with an appropriate set of parameters. In order to make a good choice of parameters, the models need to be simulated for a large set of parameters. After inspecting the simulation results a model can be picked with suitable frequency or step responses. Parameterized model reduction significantly simplifies this procedure. The proposed algorithm for parameterized model reduction is a straightforward extension of the one described above. The proposed algorithm is applicable to linear parameter-varying systems modeling as well.

Finally, the third topic is modeling interconnections of systems. In this thesis an interconnection is a collection of systems (or subsystems) connected in a typical block-diagram. In order to avoid confusion, throughout the thesis the entire model is called a supersystem, as opposed to subsystems, which a supersystem consists of. One of the specific cases of structured model reduction is controller reduction. In this problem there are two subsystems: the plant and the controller. Two directions of model reduction of interconnected systems are considered: model reduction in the nu-gap metric and structured model reduction. To some extent, using the nu-gap metric makes it possible to model subsystems without considering the supersystem at all. This property can be exploited for extremely large supersystems for which some forms of analysis (evaluating stability, computing step response, etc.) are intractable. However, a more systematic way of modeling is structured model reduction. There, the objective is to approximate certain subsystems in such a way that crucial characteristics of the given supersystem, such as stability, structure of interconnections, frequency response, are preserved. In structured model reduction all subsystems are taken into account, not only the approximated ones. In order to address structured model reduction, the supersystem is represented in a coprime factor form, where its structure also appears in coprime factors. Using this representation the problem is reduced to H infinity model reduction, which is addressed by the presented framework.

All the presented methods are validated on academic or known benchmark problems. Since all the methods are based on semidefinite programming, adding new constraints is a matter of formulating a constraint as a semidefinite one. A number of extensions are presented, which illustrate the power of the approach. Properties of the methods are discussed throughout the thesis while some remaining problems conclude the manuscript.

PHYSICAL MODELING AND CONTROL OF LOW TEMPERATURE COMBUSTION IN ENGINES

Widd, Anders

The topic of this thesis is model-based control of two combustion engine concepts, Homogeneous Charge Compression Ignition (HCCI) and Partially Premixed Combustion (PPC), using physics-based models. The studied combustion concepts hold promise of reducing the emission levels and fuel consumption of internal combustion engines.

A cycle-to-cycle model of HCCI, including heat losses to the cylinder wall, was derived. The continuous heat transfer between the cylinder wall and the gas in the cylinder was approximated by three heat transfer events during each cycle. This allowed the model to capture the main dynamics of the cylinder wall temperature while keeping the complexity of the resulting model at a tractable level.

The model was used to derive model predictive controllers for the combustion phasing using the inlet air temperature and inlet valve closing timing as control signals. The resulting controllers were evaluated experimentally and achieved promising results in terms of set-point tracking and disturbance rejection.

Additionally, the differences in performance between using a switched state feedback controller and a hybrid model predictive controller for controlling exhaust recompression HCCI were investigated. The dynamics of exhaust recompression HCCI vary significantly between certain operating points, and the model predictive controller produced smoother transients in both simulations and experiments.

A continuous-time model of PPC was derived and implemented in the Modelica language. The model structure, a single-zone model, and implementation platform, JModelica.org, were chosen in order to allow for numerical optimization based on the model equations. The resulting framework allowed the calibration of the model parameters to be formulated as an optimization problem penalizing deviations between a measured pressure trace and that of the model. The calibrated model predicted the effects of variations in the injection timing with satisfactory accuracy.





Research 2012

This chapter contains the different projects that were ongoing during 2012

EXCELLENCE CENTERS

LCCC - LUND CENTER FOR CONTROL OF COMPLEX ENGINEERING SYSTEMS

Within LCCC the following programs were held during 2012

Autonomous skill learning is a highly desirable feature in task-oriented robotics. Still, there are currently few examples of truly autonomous robotic capacity of robots to control behaviors to changing work-space condition based on perception and skills acquired during run-time operation. The purpose of this symposium is to investigate and bring forward the interaction between exteroception (perception) and task-oriented sequential motion planning and coordination in contexts of robotics, biomimetics and human cognition. In this symposium, distinguished scientists from control, computer science, robotics, neuroscience, cognitive science will be brought together to highlight the state of the art and current issues on skills, learning and cognition.

Speakers: Il Hong Suh, Hanyang Univ.; Henrik Jörntell, Lund University; Kevin Warwick, University of Reading; Patrick van der Smagt, DLR; Sylvain Calinon, IIT, Genova; Herman Bruyninckx, K. U. Leuven; Peter Gärdenfors, Lund University; Il Hong Suh, Hanyang University; Carl Henrik Ek, KTH; Michael Beetz, TU München; Dongheui Lee, TU München; Christian Balkenius, Lund University; Aude Billard, EPFL, Lausanne; Jacek Malec, Lund University; Hiroshi Ishiguro, Osaka University; Germund Hesslow, Lund University; Frank L. Lewis, The University of Texas at Arlington; Gordon Cheng, TU München; Thomas Schön, Linköping University; Mahdi Ghazaei, Lund University; Volker Krüger, Aalborg University.

Second LCCC Industrial Workshop, May 2012

The LCCC Linnaeus center arranged its second industrial workshop on May 16. The workshop gathered industrial partners and research contacts with a common interest in complex control systems, including IT systems (Ericsson, Spotify),

energy systems (General Electric, Vestas), and industrial automation systems (Siemens, Honeywell). There was also a discussion about open-source software in industry led by Modelon.



Participants at LCCC Robot Skill Learning and Cognition workshop in April

Workshop in System Design meets Equation-based Languages, September 2012

Equation-based languages, often designed for modeling and simulation of physical systems, are increasingly used in systems design. The aim of the workshop is to gather outstanding researchers and industrial practitioners from different communities with a common interest in modeling languages for systems design, including language design and extension, algorithms for systems design and verification, and industrial applications. Challenges in this area are cross disciplinary, and we therefore aim to bring together researchers and industrial practitioners from related fields during the workshop to stimulate exchange of ideas and inspire new research directions.

Speakers: Bernhard Bachmann, Bielefeld University, Germany; Albert Benveniste, IRISA/INRIA, France; Torsten Blochwitz, ITI GmbH, Germany; Francesco Casella, Politecnico di Milano, Italy; Fernando D'Amato, General Electric Global Research, USA; Moritz Diehl, KU Leuven,

Belgium; Hilding Elmqvist, Dassault Systèmes, Sweden; Sebastian Engell, University of Dortmund, Germany; Alberto Ferrari, ALES, Italy; Peter Fritzson, Linköping University, Sweden; Claus Führer, Lund University, Sweden; Klaus Havelund, JPL-NASA, USA; Görel Hedin, Lund University, Sweden; Clas Jacobson, United Technologies Research Center, USA; Krzysztof Kuchcinski, Lund University, Sweden; Carl Laird, Texas A&M University, USA; Edward Lee, University of California, Berkeley, USA; Pieter Mosterman, McGill University/Mathworks, Canada; Stefan-Alexander Schneider, BMW, Germany; Johan Sjöberg, ABB Corporate Research, Sweden; Eric van Wyk, University of Minnesota, USA; Andrea Walther, Universität Paderborn, Germany; Mike Whalen, University of Minnesota, USA; Johan Åkesson, Lund University/Modelon, Sweden; Karl Johan Åström, Lund University.

Focus Period and Workshop in Information and Control in Networks, October 2012

In control of complex networked systems, a central role is played by information. The system dynamics and the information flows evolve in an intertwined way. While control theory and information theory have traditionally developed independently from each other, the need for a convergence of the two has strongly emerged in the last years, and is now a very active research field. In addition to efforts in control and information theory, strong research is witnessed in computer science, mathematics, mathematical statistics. The aim of this focus period is to bring together leading researchers from some of these communities to create exciting cross-fertilization and new ideas. At any particular time, there will be room for up to 10 invited researchers. A typical visit will be 2-5 weeks. Interested visitors are encouraged to contact Giacomo Como <giacomo.como@control.lth.se> or Bo Bernhardsson <bob@control.lth.se>.

Workshop speakers: Prof. Murat Arcak, UC Berkeley; Prof. Peter Caines, Mc Gill University; Prof. Carlos Canudas-de-Wit, CNRS; Prof. Michelle Effros, CalTech; Prof. Nicola Elia, IOWA State University; Prof. Fabio Fagnani, Politecnico di Torino; Prof. Massimo Franceschetti, UC San Diego; Prof. Edmond Johnckheere, University of Southern California; Prof. Gerhard Kramer, Technische Universität München; Prof. Amos Lapidoth, ETH Zurich; Prof. Nuno Martins, University of Maryland; Prof. Sanjoy Mitter, Massachusetts Institute of Technology; Prof. Girish Nair, University of Melbourne; Dr. Dragan Obradovic, Siemens; Prof. Lars Rasmussen, Kungliga Tekniska Högskolan; Prof. Anant Sahai, UC Berkeley; Prof. Mikael Skoglund, Kungliga Tekniska Högskolan; Prof. Sekhar Tatikonda, Yale University; Prof. Demostenis Teneketzis, University of Michigan; Prof. Tsachy Weissman, Stanford University; Prof. Serdar Yüksel, Queen's University; Prof. Sandro Zampieri, Università di Padova.

ELLIIT - THE LINKÖPING–LUND INITIATIVE ON IT AND MOBILE COMMUNICATION

Researchers: Karl-Erik Årzén, Bo Bernhardsson, Anton Cervin, Anders Rantzer, Karl, Berntorp, Isolde Dressler, Magnus Lindroth, Jerker Nordh, Anders Mannesson, Björn Olofsson, Anders Robertsson, Olof Sörnmo, Andreas Stolt in collaboration with researchers at the Departments of Computer Science, Electrical and Information Technology, and Mathematics, Lund University, and Linköping University, Halmstad University, and Blekinge University.

Funding: VINNOVA/VR (National Strategic Research Area)

Duration: 2010 - 2014

Home page: <http://www.liu.se/elliit>

ELLIIT is a network organization for Information and Communication Technology (ICT) research at Linköping, Lund, Halmstad and Blekinge, which has been created to support and enhance an internationally acknowledged research envi-

ronment in these areas. The objective is scientific excellence in combination with industrial relevance and impact. It is organized within the Swedish government's strategic research support initiative.

Parallel Architectures for Sampling Based Nonlinear Filters

Researchers: Anders Mannesson, Bo Bernhardsson

Funding: ELLIIT

Performed in cooperation with Linköping University.

Sampling based filters are used today in industrial settings. In many applications, there is a need for increased computational power, and while a pure software implementation may give flexibility and portability, it is in many cases not fulfilling the requirements for computational power. Further, sampling based filters are nontrivial to implement, many algorithmic versions exist, and there are many new potential applications around the corner today hindered by available processing power.

The project aims at development of methodology and architecture for parallel implementation in hardware of sampling based filters, as a means for enabling more applications than what is possible today. We consider parallel custom hardware, as implemented in FPGA or in an ASIC, but also different multicore architectures are considered, e.g. GPUs, standard multicore

processors, and multicore DSP architectures. We study how algorithmic aspects of sampling based filters relate to possibilities and constraints, in parallelization and in approximation during an implementation.

For a successful implementation it is necessary to develop methods to translate user requirements to architectural and algorithmic parameters used in the implementation. It is also important to investigate deployment related parameters, e.g. when there are varying degrees of nonlinearities among the state variables. In this case, it may be possible to use ordinary Kalman filters for some state variables while a particle filter is required for other state variables.

The project has participants from automatic control, computer engineering, electronics systems, and computer science, which gives possibilities to develop methods for optimization

of the resulting system not only from a control performance perspective, but also from a HW utilization perspective, e.g., with respect to area, speed and power consumption. When performing optimization for parallelization, it is also of interest to investigate the usage of different tools and languages. For this purpose, languages

such as CAL are of interest, for design space exploration and as a means to get more insight on how to translate from user requirements to architecture and filter parameters, and how parameters influence different performance criteria, e.g., size and power consumption.

Cooperative Cyber-Physical Systems

Researcher: Karl-Erik Årzén

Performed in cooperation with Linköping University

Cooperative Localization and Mapping for UAVs and UGVs - Indoor localization and mapping with UGVs has been an active research area and has led to very useful theoretical and pragmatic results. Indoor localization and mapping with micro-UAV's is a relatively new area with less

mature results. The same can be said in regard to cooperative localization and mapping with several UAVs, or with combinations of UGVs and UAVs. The focus of this sub-project will be to develop cutting edge theory and usable systems for collaborative indoor localization and mapping.

Advanced Navigation and Localization

Researchers: Anders Mannesson, Jerker Nordh, Karl Berntorp, Bo Bernhardsson

Funding: ELLIIT

Performed in cooperation with departments of EIT and Mathematics in Lund and with Linköping University

Navigation - Navigation, localization and map making are interesting research areas with many interesting applications. Indoor navigation is much more challenging compared to outdoor navigation since there is usually no GPS coverage, electronic compasses do not work that well, and the radio environment is complicated. Visual localization with respect to landmarks has the potential to overcome many of these problems, but needs considerable development to be robust and to be able to scale to large image collections. In this sub-project we will work on several aspects of navigation, localization and map making and investigate the use

of combining several different sensor modalities such as multiple cameras, inertial sensors (accelerometers and gyroscopes), Ultra-wideband (UWB) measurements, field strength measurements. The research at AC is focusing on a platform for radio-aided positioning using virtual antenna arrays. Algorithms for tightly coupled radio channel estimation and IMU positioning have been developed. Also new algorithms for simultaneous localization and mapping (SLAM) using particle smoothers have been studied, and different versions of occupancy grids especially developed to fit particle smoothing have been developed.

Process Learning

Researchers: Anders Robertsson, Isolde Dressler, Andreas Stolt, Olof Sörnmo, Magnus Lindroth

Funding: ELLIIT

Performed in cooperation with Linköping University and Dept of Computer Science, LTH

The project consists of two subprojects having slightly different emphasis, but with several common aspects. One common theme is the aim to model, or with an alternative terminology, to learn the properties of a system. Another common aspect is related to the sensor inputs where multi dimensional sensors are used in both subprojects and where the information has to be fused into a lower dimensional space.

In the first subproject the aim is to study how learning can be used for control of industrial robots to compensate for various types of errors and to reach accuracy close to the repeatability level of the robot mechanics. The goal of the subproject is to develop the automatic learning using sensors on the manipulator and to include also measurements from the process result. The sensors measuring the process results can include sensors like, 6 Degrees of Freedom force/torque sensors, 3D scanners and stereo vision systems. The aim of the project is to span the entire range from theoretical aspects of algorithm design, via utilization of control system hardware for implementation and experimental evaluation, and the project will encompass several important research topics. One example, including additional sensors such as force sensors, vision systems,

or IMUs, is to make it necessary to integrate information from different sensors in order to get estimates of position, orientation and various types of performance related quantities.

The second subproject is focused on system identification, which is an approach to process learning where mathematical models are estimated from measured input and output signals from a system. The objective is to investigate the possibilities and difficulties that arise when the output signals are measured using a computer vision system. Normal sensors will typically yield measurements clustered symmetrically around the correct value, such that the effects of noise can be averaged out in a straightforward way. In contrast, measurements coming from a computer vision system are often plagued by outliers or missing data. To exemplify, a camera monitoring a robot might lose track during fast motions or be occluded by other objects. Questions about robust estimation methods, conflicting vision measurements, and choice of model structures will be studied. A class of outlier detection problems arising in vision has recently been shown to be solvable in polynomial time and we want to explore the possibilities of extending these results to problems in system identification.

Optimal Maneuvers

Researchers: Björn Olofsson, Karl Berntorp, Bo Bernhardsson, Anders Robertsson

Funding: ELLIIT

Performed in cooperation with Linköping University

Construction of efficient maneuvers is critical for both vehicle control and robotics. The goal of the project is to obtain techniques to handle situations with complicated nonlinear dynamics and significant model uncertainty to be solved in time-critical situations. The intention is to go beyond the classical approaches consisting of offline optimization of reference trajectories combined with online local feedback. From a modelling perspective preparation needs to be made for efficient handling of online replanning, where simpler models are needed for reasons of speed. The models still need to capture relevant phenomena, and it is also necessary to handle cases with sensor outages and sudden model discrepancies. A complicating factor is being close to safety limits, leading to an intricate

interplay between model complexity and expressiveness together with control and optimization.

The two subprojects considered are "Optimizing Vehicle Maneuvers" and "Narrow Lane Robotics". The former focuses on investigating and develop models for optimal control in critical situations (e.g., evasive maneuvers), as well as studying the maneuvering strategies that are obtained from these optimizations and how they can be utilized in future advanced safety systems. The second subproject is subject to similar problems, applied to robotics for industrial production purposes, focusing on the optimal control task for traversing a "narrow lane" (defined by tolerated path deviations) subject to e.g., actuator saturation.

Large-scale Optimization for Systems Analysis

Researcher: Anders Rantzer

Funding: ELLIIT

Performed in cooperation with Linköping University

Many control applications involve dynamics of a complexity that cannot be handled in standard optimization algorithms. This situation is common for example in process industry, in electricity networks, and in many other areas. Typically the controllers are tuned or designed locally with local objectives in mind. This is of course seldom optimal from a global perspective and can even cause instabilities. In this project we study how to assess global robustness and stability using tailor-made algorithms with limited information exchange. This is specifically relevant when parallel processors are used to reduce computational

time. This has specific applications for robustness analysis of models coming from spatial discretization of partial differential equations, e.g. robustness analysis of flexible structures. A similar approach can also sometimes be used when the models of the local objects are private, and the owners of the models do not want to share detailed information about the models. We are focusing our efforts in robustness analysis of dynamical systems which are interconnected. In particular, we study interconnected systems that can be described with a chordal graph.

Enabling End-User-Centered Energy Management Systems

Researchers: Bo Bernhardsson, Anders Rantzer

Funding: ELLIIT

Performed in cooperation with Linköping University

Today there exists a large number of different solutions for small-scale energy production using, e.g., solar and wind energy. Such environmentally friendly solutions have not yet been fully integrated at the end consumer. A key component for minimizing the need for external power supply is to introduce energy storage devices in the system, for example a dedicated battery system or a plug-in hybrid/electrical vehicle. A main vision is then that an end user easily can

plug in local energy producing storage, and consuming devices, and reliably obtain optimal external energy consumption. The project studies adaptive management of the different energy sources which involves design of new power electronics, overall control, and supervision. This includes energy storage dimensioning based on predicted wind/solar availability and predicted consumption.

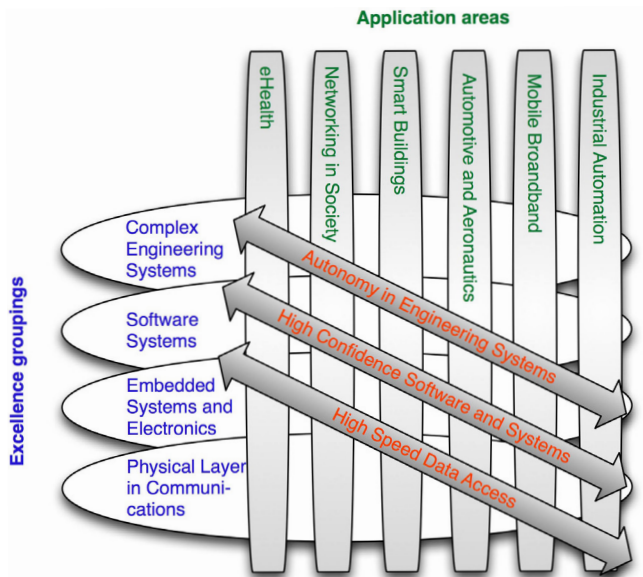

Illustration of the interaction between the themes, the application areas and the groupings [<http://www.liu.se/elliit>]

PICLU - Process Industrial Center

Researchers: Olof Garpinger, Tore Hägglund, Martin Hast, Charlotta Johnsson, Ola Johnsson, Anna Lindholm, Vanessa Romero Segovia, Kristian Soltesz

Funding: SSF (Swedish Foundation for Strategic Research)

Duration: 2008-2013

Home page: <http://www.processindustrycentre.se>



With support from the Swedish Foundation for Strategic Research (SSF), the process industrial centre PIC-LU has been established in collaboration with the department of Chemical Engineering.

The overall goal of PIC-LU is to establish, in cooperation with Swedish process industry, an internationally leading centre for research and professional training in process optimization and control.

In the research program, methodology and tools for modelling, optimization, and control of industrial processes are developed, in order to improve production systems with respect to flexibility, controllability, and availability. The methodology and the tools are developed from

specific solutions to process control problems suggested by the industrial partners. The goal is to make the results from PIC-LU industrially relevant, not only for the participating industries, but on a wide scale in process operation and automation. The industrial partners are Borealis, K A Rasmussen, Modelon, Novo Nordisk, Novo-Zymes, Perstorp, and Pfizer.

In the competence development program, the main goal is to increase the competence level of process optimization and control in industry as well as in academy. The goal will be reached in two ways; through an educational program at different levels for staff in process industry, and by directed efforts in MSc and PhD programs at the university.

MODELLING AND CONTROL OF COMPLEX SYSTEMS

ACTIVE CONTROL OF COMPRESSOR SYSTEMS

Researchers: Rolf Johansson, Anders Robertsson, Alina Rubanova in cooperation with Prof. Anton Shiriaev, Umeå University & NTNU, Trondheim, Leonid Freidovich, Umeå University. Swedish Research Council 2007-2009, Ref. 2006-5243; VR 2007-2009, VR 2009-3178

This project deals with a number of facts related to the output feedback stabilization of the Moore-Greitzer compressor model. We show that quadratic feedback stabilization of the surge subsystem of the three-state Moore-Greitzer compressor model, which ensures an absence of additional equilibria in the augmented with stall dynamics closed loop system, implies convergence of all solutions to the unique equilibrium at

the origin. Then some steps in developing such output feedback controller for surge subsystem are discussed, and a family of controllers is presented. Based on our new theoretical results on integrability, stability, nonlinear dynamic output feedback control, we wish to pursue active control application to compressor systems and experimental verification.

ADAPTIVE CONTROL IN FLYING VEHICLES

Researchers: Anders Pettersson, Rolf Johansson, Anders Robertsson, Karl Johan Åström Project NFFP5 "2009-01333 Adaptive Control in Airborne Vehicles" financed by Vinnova

The goal of this project is to address the question whether adaptive control can be used in products that SAAB are developing today or in the future.

There are two fundamentally different ways of controlling systems with dynamics that change over time: adaptive or robust control. The industrial baseline for flying applications today is to use robust control, which caters for the effect of parametric uncertainties, but this baseline comes with an associated loss of performance. On the other hand, with an adaptive controller it is possible to boost the performance of the closed-loop system, but then the inherent robustness may be insufficient.

Questions to be addressed:

- Can better performance be achieved for a fully/partly adaptive controller compared to a robust controller, especially with uncertain dynamics in the plant and its subsystems?
- When in product development cycle, can adaptive steering be used? In what applications can adaptive techniques be used? Subsystems such as actuators perhaps, as well as at the top level?

For the use of adaptive control in these systems, aspects such as product safety, control law clearance and certification should be taken into account.

CONTROL OF WIND FARMS

Researchers: Daria Madjidian, Maxim Kristalny, Anders Rantzer in collaboration with project partners from Aalborg University, Industrial Systems and Control Ltd in Glasgow, University of Zagreb, Energy Research Centre of the Netherlands and Vestas Wind Systems A/S.

Funding: EU/IST/FP7

Aeolus is an European research project funded by the European Commission under the IST framework programme 7 for Information and Communication Technology, ICT. The main goal of Aeolus is to research and develop models that allow real-time predictions of flows and incorporate measurements from a set of spatially

distributed sensor devices. In Aeolus we will use the flow information as a basis for new control paradigms that acknowledge the uncertainty in the modelling and dynamically manage the flow resource in order to optimise specific control objectives

CONTROL OF HETEROGENEOUS AUTOMATION SYSTEMS

Researchers: Pontus Giselsson, Erik Johannesson, Mikael Lindberg, José Maestre, Karl Mårtensson, Anders Rantzer, Karl-Erik Årzén in collaboration with project partners from University of Pisa, Siemens AG, University of Trento, University College London, Eltag Datamat, Sofidel and University of Salento .

Funding: EU/IST/FP7

Scalability, reconfigurability, and security are three aspects of paramount importance in developing efficient, predictable, and safe control architectures for large-scale networked industrial automation. At present, the state of control systems technology is such that the supervision and control of larger and more complex plants cannot be achieved without considerable costs in terms of hard infrastructure and software development.

CHAT is a research project exploring the research and engineering challenges inherent in the development of algorithms, protocols and procedures for next generation distributed

control systems, in order to drastically reducing infrastructure, maintenance and reconfiguration costs.

Involvement

The Department of Automatic Control is involved in developing price mechanisms for distributed control as well as consensus and distributed estimation algorithms. Currently the focus is on using such methods for mobile robot task allocation. We have also provided simulation environments, extended to incorporate industrial network standards to our partners (FlexRay and PROFINET in Truetime).

CONTROL WITH COMMUNICATION CONSTRAINTS

Researchers: Erik Johannesson, Anders Rantzer, Bo Bernhardsson, Andrey Ghulchak

Funding: Swedish Research Council through LCCC and EU/IST/FP7 through CHAT

Classical control theory assumes perfect communication, without limitations, between different parts of the control system and the process. A current trend in control systems is, however, for the systems to become more distributed and more dependent on communication over different types of networks. This makes it necessary to study the implications of the resulting communication constraints. In the control community this has spurred interest in the research of the interplay between communication and control. The results have mainly concerned fundamental limitations of control performance that arise from communication constraints.

In this project, the goal is to design optimal controllers and estimators for some specific problems with limited communication. We model the communication constraints by analog communication channels with limited SNR (signal to noise ratio). These channels give an incentive to perform coding and decoding of the transmitted signal, in addition to the usual filtering and computation of control signals. The problem of designing the controller, coder and decoder simultaneously is a distributed control problem, which can be solved using tools from convex optimization. Currently, we are focusing on two specific problem structures, which represent an estimation problem and a control problem respectively.

Estimation over Channel with SNR Constraint

The objective is to design the coder and the decoder so that the estimation error is minimized. This can be interpreted as a real-time coding problem (if P is replaced by a time delay) with

input noise. Another interpretation is that this concerns the design of a disturbance feedforward compensator, where the sensor and the actuator are geographically separated.

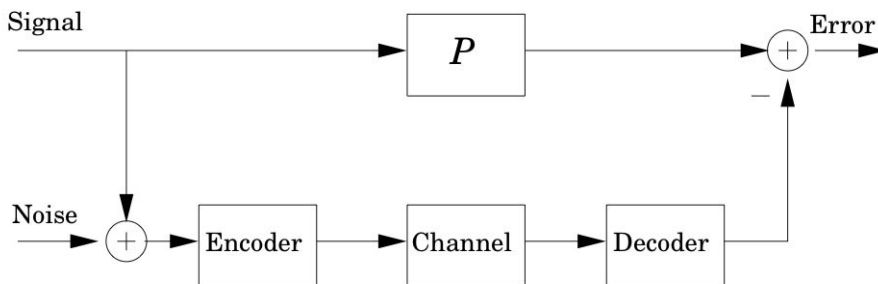

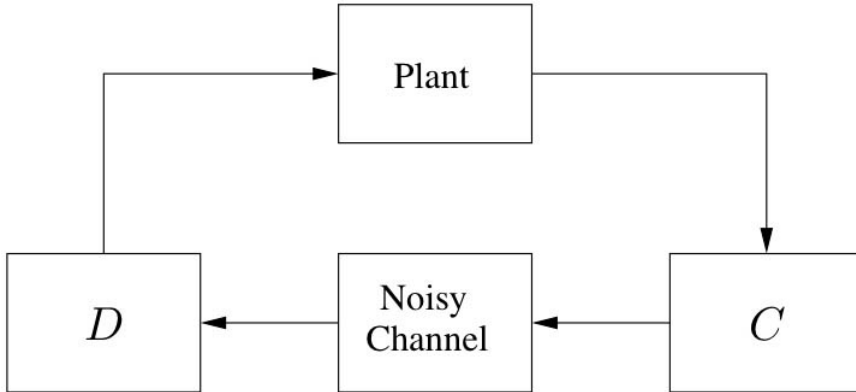

Control over Channel with SNR Constraint

In this problem, the objective is to design an observer/coder C and decoder/controller D that stabilize the plant and minimize the effect caused by a plant disturbance (not shown).

MODELLING AND VALIDATION OF COMPLEX SYSTEMS

Researchers: Anders Rantzer, Kin Cheong Sou and Aivar Sootla

Funding: Swedish Control Council and Toyota Motor Corporation

Large complex mathematical models are regularly used for simulation and prediction. However, in control design it is a common practice to work with as simple process models as possible. This makes it easier to analyze and evaluate the model, or to use it as a component for efficient system-wise evaluation. On the other hand, models are typically dependent on some adjustable parameters, which allow system design. Therefore, the capability of simplifying parameter dependent models is important from an efficient design point of view. One objective of this project is to develop methods for parameterized model reduction, where a single parameter dependent reduced model is an accurate simplification of the original complex model for all the parameter values of interest. In this project, a semidefinite programming based parameterized model reduction method is being developed.

Another aspect of this project is to develop model reduction tools that take into account the properties and restrictions of large scale distributed networked systems. Model reduction schemes guaranteeing overall system stability is being developed. In addition, structure preserving model reduction and network topology simplification methods are also being investigated.

LANGUAGE SUPPORT FOR DYNAMIC OPTIMIZATION

**Researchers: Johan Åkesson, Fredrik Magnusson, Karl-Erik Årzén and Görel Hedin
(Department of Computer Science, LTH)**

Overview

Efficient development and operation of control systems is essential in industry today. Optimization is increasingly used as a standard tool to improve operation, both in on-line and off-line applications. Examples are calculation of operating points, grade change trajectories and production schedules that maximize production while minimizing raw material, energy and other resources. Similar issues arise in the design of embedded control systems for e.g., the automotive, avionics, and mobile telecom areas, where efficient utilization of computing, communication, and/or battery resources is required in order to meet market demands. This can also often be formulated as optimization problems.

Due to the ever increasing complexity of plants, a model-driven approach is required. At the heart of this project is a language-based approach for developing a high-level description framework targeted at unified modeling of physical systems and associated optimization problems. This also includes development of prototype software, which transforms a high-level description into a canonical mathematical model representation. This canonical representation may then be used as a basis for code generation for the above mentioned applications. The main topic of the project is the formulation of large-scale optimization problems. Associated with this topic is also code generation for numerical solvers.

Optimica

A key issue is the definition of syntax and semantics of the Modelica extension, Optimica. Optimica provides the user with language constructs that enable formulation of a wide range of optimization problems, such as parameter estimation, optimal control and state estimation based on Modelica models.

At the core of Optimica are the basic optimization elements such as cost functions and constraints. It is also possible to specify bounds on variables in the Modelica model as well as to mark variables and parameters as optimization quantities, i.e., to express what to optimize over. While this type of information represents a canonical optimization formulation, the user is often required to supply additional information, related to the numerical method which is used to solve the problem. In this category we have e.g., specification of transcription method, discretization of control variables and initial guesses. Optimica also enables convenient specification of these quantities.

Software Tools - the JModelica.org platform

One of the results of the research project is an open source project entitled JModelica.org. JModelica.org is an extensible Modelica-based open source platform for optimization, simulation and analysis of complex dynamic systems. The main objective of the project is to create an industrially viable open source platform for optimization of Modelica models, while offering a flexible platform serving as a virtual lab for algorithm development and research. As such, JModelica.org is intended to provide a platform for technology transfer where industrially relevant problems can inspire new research and where state of the art algorithms can be propagated from academia into industrial use. JModelica.org is currently managed by the Lund-based company Modelon AB and continues to evolve in close collaboration with several departments at Lund University, including Automatic Control, Mathematics and Computer Science.

Applications and related projects

JModelica.org, and prototypes thereof, have been used in a number of industrial size applications. These include start-up optimization of a plate reactor, lap time optimization for racing cars and optimal robot control. In a recent project, JModelica.org is used to compute optimal

grade change profiles in collaboration with plastics manufacturer Borealis. For details, see the corresponding research home page, <http://www.control.lth.se/Research/ProcessControl/gradechanges.html> The project is also related research on parallel methods for dynamic optimization.

PARALLEL METHODS FOR DYNAMIC OPTIMIZATION

Researchers: Johan Åkesson, Carl Laird (Texas A&M University, TX, USA)

Optimization is used extensively in many contexts in control engineering. Applications include design optimization to develop optimal processes, set-point optimization to minimize raw material and energy consumption, and on-line optimal control strategies such as Model Predictive Control (MPC). As systems are becoming increasingly complex, the need for efficient computational methods is put into focus.

The proposed research project is motivated by Moore's law, which states that the maximum number of transistors that be fit into an Integrated Circuit to a reasonable cost is doubled every other year. For decades, Moore's law has been closely related to important performance measures, for example the computational power of processors found in desktop computers. During the last 3-4 years this situation has changed, however. While the number of transistors on an Integrated Circuit continues to increase rapidly, many software applications does not run at correspondingly higher execution speeds. The explanation is that modern processors are equipped with multiple cores. Also, the clock frequency, which directly affect execution speed,

is increasing only moderately. Many applications are capable of utilizing only one core, and cannot benefit from the availability of multi-core architectures.

In order to utilize more than one core, new methods and/or application of known methods in new contexts are needed. Such methods are typically specific for different application areas. In the field of dynamic optimization, development of parallel and distributed methods is essential in order to efficiently meet the challenges outlined above. In principle, there are two different scenarios that require attention. In the first scenario, the main challenge is the complexity of the problem. In this case, decomposition and parallelization is important in order to obtain manageable subproblems to distribute amongst the available cores. In the second scenario, the complexity of the problem may be moderate, but the computation time is critical. For example, MPC falls into this category. In this case, parallel algorithms are needed in order to fully explore the computational power of multi-core architectures and thereby reduce computation times.

ICT PLATFORM FOR SUSTAINABLE INFRASTRUCTURES

Researchers: Anders Rantzer, Bo Bernhardsson, Georgios Chasparis, partners at IEA, LTH and KTH

Funding: Swedish Foundation for Strategic Research

Resource-efficient infrastructures are critical for sustainable societies that want to maintain and improve today's standard of living. National and international climate goals imply large increases in renewable electricity production. This variable generation together with the increasing international trading of electricity affects the power flows in the electricity networks, which needs to be managed by system operators on local, regional and national levels. This development is in addition to the continuously increasing demand on reliable electricity supply. Traditionally this double challenge would be met by the building of new power lines. This is a simple and effective solution, but due to public reluctance to new power lines and the lengthy permission process alternatives are sought for. One general alternative is the use of automation for optimizing

the use of the available network capacity. This concept - currently referred to as Smart Grids - involves investment in and installation of ICT equipment rather than physical capacity. While having been applied locally before, the situation now calls for application on a system-wide scale. Similar trends can be observed in other infrastructures.

This project aims to design the decision-layer of an ICT platform for controlling large-scale infrastructures to operate reliably, economically, and with minimum resource waste. Special attention is given to functionality for detecting, clearing and recovering from critical operating conditions. A key component is the ARISTO real-time power system simulator, which will be used as demonstrator to illustrate the results.

NUMERICAL AND SYMBOLIC ALGORITHMS FOR DYNAMIC OPTIMIZATION

Researchers: Fredrik Magnusson and Johan Åkesson

The target of this project is the development of collocation methods for numerical solution of large-scale, DAE-constrained, non-convex dynamic optimization problems. The project targets both optimal control and parameter estimation. Applications include minimization of material and energy consumption during set-point transitions in power plants and chemical processes, minimizing lap times for vehicle systems, trajectory optimization in robotics and identifying unknown parameter values of models using measurement data.

The first step of the project has been to implement state-of-the-art algorithms based on

collocation methods and integrate them with the high-level, object-oriented modelling language Modelica and its extension Optimica. This allows basic users to conveniently formulate and solve problems of moderate difficulty without worrying about the details of the solution algorithms, while still allowing advanced users to tailor the algorithm as needed for complex problems. This implementation is a part of the open-source JModelica.org project. One of the important benchmarks has been based on a model of a combined cycle power plant, whose diagram is shown to the right. Two important third-party tools used within the project is CasADi, for au-

tomatic differentiation, and IPOPT, for solution of non-linear programs.

Future activities include investigating the possibilities of improving robustness and execution

times of collocation methods using symbolic algorithms to exploit model structure.

ESTIMATION AND OPTIMAL CONTROL OF CONTINUED CYCLE POWER-PLANTS

Researchers: Johan Åkesson, Niklas Andersson (Department of Chemical Engineering) , Bernt Nilsson (Department of Chemical Engineering)

In the electricity market of today, characterized by an increasing demand for electricity production on short notice, the combined cycle power plant stands high regarding fast start-ups and efficiency. In this project, modeling, parameter and state estimation, and optimal control for efficient operation, in particular fast start-ups of combined power-plants are explored.

The basis for the work is a Modelica library containing optimization-friendly components, from which plant models are constructed. Measurement data from real plants is exploited in order to select an efficient combination of pa-

rameters to calibrate, with the goal of deriving a model with a good match between model response and data.

A critically limiting factor during start-up optimization is the stress of important components, e.g., the evaporator. In order to take this aspect into account, constraints on the stress levels of such components are explored in the start-up optimization formulation.

Control and estimation problems are solved in the project using the OSS platform JModelica.org.



LISA - LINE INFORMATION SYSTEM ARCHITECTURE

Researchers: Charlotta Johnsson and Alfred Theorin with partners from KTH, Chalmers, Siemens, Rockwell Automation, Leax, Scania and Volvo Cars.

This project is funded by VINNOVA FFI Sustainable Production Engineering.

Duration: 2011-2013

Future sustainable competitive production systems need to be productive and flexible, as well as environmentally friendly and safe for the personnel. There are today few system solutions that assist production management with a coherent information model and a modular system architecture that facilitates for data gathering

regarding products and processes throughout the entire plant. To solve this problem the aim of this project is to develop a line information system architecture – LISA that can be used in industrial production systems in general and in automotive discrete manufacturing specifically.

Involvement: The department of Automatic

Control is involved in the LISA-work- package that assures development of new relevant standards, in order to guarantee that the automotive manufacturer's perspective is taken into account. The workpack- age makes it possible to obtain

feedback and interaction between the industries invol- ved in LISA and corresponding standard committees. Examples of relevant standards currently developed are: IEC 62264 and ISO 22400.

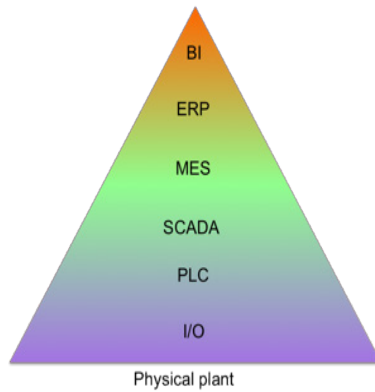

Figure : Functional levels of software products and information systems.

CONTROL AND REAL-TIME COMPUTING

In the Control and Real-Time Computing area we work in two main directions: Implementation of control systems on resource-constrained implementation platforms, e.g., small embedded processors or networked controllers with limited communication bandwidth. This also includes event-based control.; Applications of control to computing and communication systems. This includes control of server and cloud systems and adaptive resource management of embedded systems.

CONTROL OF COMPUTER SERVER SYSTEMS

Researchers: Anders Robertsson, Manfred Dellkrantz, Karl-Erik Årzén, Karl Johan Åström, Martina Maggio, Enrico Bini and Björn Wittenmark in collaboration with Maria Kihl and Payam Amani at Dept. of Electrical and Information Technology, LTH, Lund University

Funding:

Lund Center for Control of Complex Engineering Systems (LCCC)
The Swedish Research Council / Vetenskapsrådet

In the last couple of years "Communication and Control" has gained large attention and a lot of new research has focused on control of and over networks. However, the admission control problem, which is important for the utilization and the robustness of the network still remains as a rather unexplored area. Here, we believe the interaction of queuing theory and nonlinear control play a major role. The research is aimed at advancing the state of the art in control oriented modeling and control design of server systems by combining the scientific expertise from the telecommunication and the control communities. Important components in this research field are queuing theory, system identification, real-time systems and non-linear control theory. These fields have since long been well established research areas. However, the integration of this research with application to control of server systems gives raise to fundamental and challenging

questions on how to e.g., combine and analyse discrete-event and continuous time flow models. The problems are of large theoretical as well as practical relevance in control of computing systems.

The main objectives of the research are:

- To use system identification and control theoretic methods to find good stochastic models and reliable state estimators for traffic and server systems
- Analyse the fundamental mechanisms in the combination of discrete-event based server systems and real-time control algorithms.
- To develop an experimental platform for experimental evaluation of control mechanisms

EVENT-BASED CONTROL

Researchers: Anton Cervin, Toivo Henningsson, Erik Johannesson, Bo Bernhardsson, Karl Johan Åström

Funding: Swedish Research Council, LCCC

The vast majority of all feedback controllers today are implemented using digital computers, relying on periodic sampling, computation, and actuation. For linear systems, sampled-data control theory provides powerful tools for direct digital design, while implementations of nonlinear control designs tend to rely on discretization combined with fast periodic sampling. In recent years, there has been a growing research interest in event-based control, in particular in connection to distributed and networked control systems. The basic idea is to communicate, compute, or control only when something significant has occurred in the system. The motivation for abandoning the time-triggered paradigm is to better cope with various constraints or bottlenecks in the system, such as sensors with

limited resolution, limited communication or computation bandwidth, energy constraints, or constraints on the number of actuators.

In this project we are currently

- developing theory and design methodology for suboptimal event-based state feedback and comparing the achievable performance to the linear time-invariant case.
- developing theory and design methodology for suboptimal event-based observers and comparing the achievable performance to the linear time-invariant case.
- investigating scheduling policies for multiple event-based controllers or observers on a shared local network.

INTEGRATED SCHEDULING AND SYNTHESIS

Researchers: Anton Cervin, Yang Xu, Enrico Bini and Karl-Erik Årzén, in collaboration with the Embedded Systems Lab at Linköping University

Funding: ELLIIT, LCCC

Modern embedded control systems comprise periodic and sporadic software tasks that control several physical processes and execute on platforms with multiple computation and communication components. The project will focus on the complex system timing induced by resource sharing among the tasks, which is one of the main characterizations of the control quality. This control quality, which is affected negatively by long and varying computation and communication delays in the control loop, will be considered during system-level scheduling and optimization, as well as during controller synthesis by delay-compensation techniques.

Many control systems have time-varying resource demands, implying that scheduling policies and control strategies must be adapted at runtime to provide high control quality and efficient resource usage. Such variations are inherent in event-based control, which is an emerging technology in resource-constrained systems, but also occur depending on the states of the controlled processes or as a result of process disturbances and mode changes. The project will therefore also consider runtime optimization techniques to address such variations.

The project aims to push the state of the art of integrated control and computer systems design

in several directions. We shall develop design methods for control-quality optimization of embedded control applications running on distributed execution platforms, which, for example, are very common in the automotive systems domain. Our subsequent aim is to develop design-time and runtime optimization methods that trade off control quality with the varying resource

requirements present in multi-mode and event-based control systems. The long-term objective of the project is to develop an optimization and resource-management framework to be used for the design and implementation of future resource-constrained and adaptive embedded control systems.

LUCAS

Researchers: Karl-Erik Årzén, Rolf Johansson, Anders Robertsson, Anton Cervin, Anders Blomdell and Anders Nilsson in collaboration with Department of Computer Science, Lund University

Home page: <http://www.lth.se/programvaruportalen/>

The Center for Applied Software Research (LUCAS) is a collaboration between the software-oriented parts of the Departments of Automatic Control and Computer Science at LTH. In total around 15 faculty members and 20 PhD students are involved in LUCAS. The focus of LUCAS is industrially-oriented and motivated software research. This includes research on software

engineering, software technology, and software applications. Special focus is put on real-time systems, in particular embedded systems, networked systems, and control systems.

LUCAS started in 1999 and its status has changed over the years. Currently its main role is to act as an umbrella organization. The main activity is the annual LUCAS workshop.

CLOUD CONTROL

Researchers: Martina Maggio, Enrico Bini, Anders Rantzer, Bo Bernhardsson, Karl-Erik Årzén, Anders Robertsson, Anton Cervin, Manfred Dellkrantz in collaboration with Maria Kihl's group at the Department of Electrical and Information Technology, Lund University and Erik Elmroth's (project leader) group at Umeå University.

Funding: VR (Framework Grant)

Duration: 2013 - 2016

We take a control theoretic approach to a range of cloud management problems, aiming to transform today's static and energy consuming cloud data centers into self-managed, dynamic, and dependable infrastructures, constantly delivering expected quality of service with acceptable operation costs and carbon footprint for large-scale services with varying capacity demands.

Such data centers will form the backbone of the digitalized society by providing unparalleled information storage and processing capabilities.

Today's explosive growth of the Internet and mobile connectivity hints at a digitized society where information is created, stored, processed, and distributed at a previously unparalleled rate, already today including, e.g., multimedia

services as online TV and music, social networks, scientific applications, and business services such as e-commerce, online banking, enterprise applications, etc. Whereas the Internet is becoming ubiquitous and provides reasonably mature communication abilities, significant advancements are required to create the future cloud data centers that will form a backbone for information processing and storage, and thus be a key enabler of the digitized society.

However, with a continued extreme growth in capacity demands, today's cloud data center infrastructures are literally jeopardizing the continued development of the digitized society by simply being too static, providing too low Quality-of-Service (QoS), and by consuming ridiculous amounts of energy. Today's data center infrastructures are not even near being able to cope with the enormous and rapidly varying capacity demands that will be reality in a near future. So far, very little is understood about how to transform today's data centers (being large, power-hungry facilities, and operated through heroic efforts by numerous administrators) into a self-managed, dynamic, and dependable infrastructure, constantly delivering expected QoS with reasonable operation costs and acceptable

carbon footprint for large-scale services with sometimes dramatic variations in capacity demands.

To meet these challenges, the project addresses a set of fundamental and inter-twined auto-management challenges assuming that there during execution are stochastic variations in capacity needs and resource availability, as well as changes in system response and operation costs (in monetary and energy terms). The challenges include how much capacity to allocate at any time for an elastic application, where to allocate that capacity including optimizing complete data center energy efficiency, if to admit an elastic service with unknown lifetime and future capacity demands, as well as how holistic management can be performed to optimize the various management tools' concerted actions.

This cross-disciplinary project builds on a collaboration between Umeå University and Lund University with complementing expertise on cloud management and control of computing systems. The collaboration addresses fundamental algorithmic challenges that in industrial collaborations have been identified as crucial. The project is funded by a 20 million SEK framework grant from the Swedish research council (VR).

FEEDBACK-BASED RESOURCE MANAGEMENT

Researchers: Karl-Erik Årzén, Martina Maggio, Enrico Bini, Georgios Chasparis

Funding: VR

Duration: 2012 - 2015

This project is aimed at advancing the state of the art in dynamic resource management for embedded multicore computing platforms by applying control theory. Efficient resources usage is becoming one of the most important design criteria for all types of computer systems from large data centers, laptops, cellular smart phones, and embedded computing devices down to sensor network nodes. The overall goal of the

resource management can be to minimize power consumption or generated heat, or to have better means for differentiating applications against each other, e.g., ensure that a safety-critical application is guaranteed sufficient resources also in the presence of less important applications.

In embedded systems there are many resources that need to be managed, e.g., memory, buses, and power. The most important resource,

however, is the CPU. By controlling how much and where different applications may execute, it is also possible to control the power consump-

tion and the heat generation. Hence, the focus of this project is control of CPU resources.

VIRTUAL CYBER-PHYSICAL SYSTEMS

Researchers: Enrico Bini, Karl-Erik Årzén

Funding: Marie Curie Actions—Intra-European Fellowships (IEF)

Duration: 2012-2013

In Cyber-Physical Systems (CPS), a physical process is controlled by a pervasive network of embedded computers. In this environment, computation, communication, and the physical environment are so tightly coupled that process dynamics blends into the behavior of computa-

tion. A proper design of such systems requires understanding the joint dynamics of computers, software, networks, and physical processes. The project investigates the creation of a foundational theory and a design methodology for Cyber-Physical Systems.

PROCESS CONTROL

The department has always had an active collaboration with the process industry as well as suppliers of process control instrumentation. Most of the research projects are formed together with the process industry, and several of them are performed with active participation by staff from industry. Many of the research results are also transferred to instrument and system suppliers, and implemented and used in process industry. Most of the process control research is today performed within the Process Industrial Center at Lund University, PICLU (www.pic.lu.se) and the Process Industry Center, PIC (www.processindustrycentre.se).

PID CONTROL

Researchers: Karl Johan Åström, Olof Garpinger, Tore Hägglund, Martin Hast, and Vanessa Romero Segovia

This project has been in progress since the beginning of the eighties, and resulted in industrial products as well as several PhD theses. Three monographs on PID control that are based on experiences obtained in the project have also been published. The last is "Advanced PID Control", published in 2005. It is also translated to Spanish 2009: "Control PID avanzado". During 2012, the research has focused on the following topics:

Measurement noise filtering for PI and PID controllers

Measurement signals are always corrupted with noise. This will be reflected in the control signal behaviour in e.g. high variance or large inter-sample jumps if considering a discrete time setting. Previous work on PI and PID controllers often focus on proportional-, integral- and derivative gains at design but the filter action is added afterwards such that a reasonable sensitivity to noise is given. However, the filter changes phase and gain of the controller and the initial tuning may not give satisfying results. In this project, we investigate the trade-offs between load disturbance attenuation, robustness and the undesired control activity generated by measurement noise. The goal is to find design

rules that take all this aspects into account in the PID design, where the measurement noise filter is included.

Software tools for design of PID controllers

An interactive and easily modifiable software tool for robust PID design has been developed at the department. The tool has been programmed in Matlab and the goal is to find the controller that minimizes the IAE value during a load disturbance, while applying robustness constraints in terms of M-circles. The figure on this page shows a plot from the program, depicting the IAE cost as a function of the integral time and the derivative time in a PID controller. The minimum is shown by the yellow mark in the figure.

The software is free to download at <http://www.control.lth.se/media/Research/PID/design-pid.zip>. The Matlab files contained in the zip-file will make it possible to design a robust, optimal PID (or PI) controller. It has shown to work well on several industrial plants.

The tool has also shown able to tune PID controllers with measurement noise filters, i.e. four parameter control. By adjusting the lowpass filter time constant, one can plot the trade-off relationship between performance and noise

sensitivity and thus select a controller that amplifies measurement noise less than a factor \sqrt{k} to the control signal. This way one can also judge whether a PI or a PID controller is preferable for the control problem at hand, which should also enable tuning of more PID controllers in industry.

PID design by convex-concave procedure

Convex optimization has grown to become a mature and powerful tool in a vast number of research fields. Design of PID controllers subject

to robustness constraint is not a convex optimization problem, however, it fits well into the framework of the convex-concave procedure. Although globally optimal controllers cannot be guaranteed, the method produces robust controllers with good performance. The work is done in collaboration with Stephen Boyd, Stanford University.

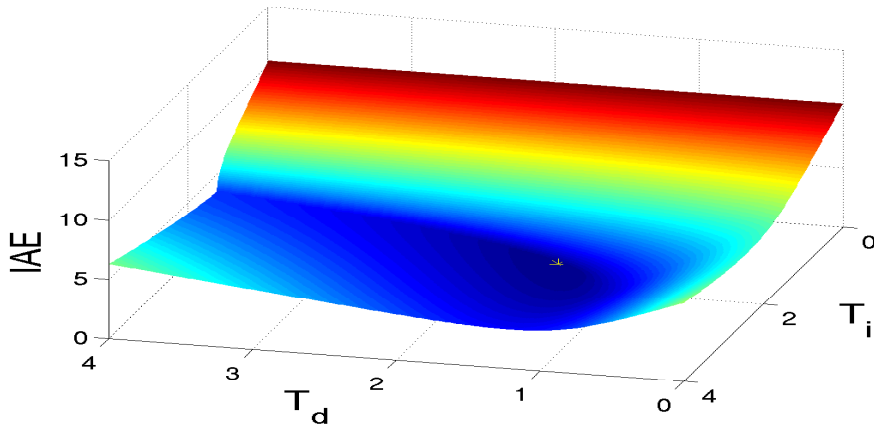

Surface plot from the PID design tool

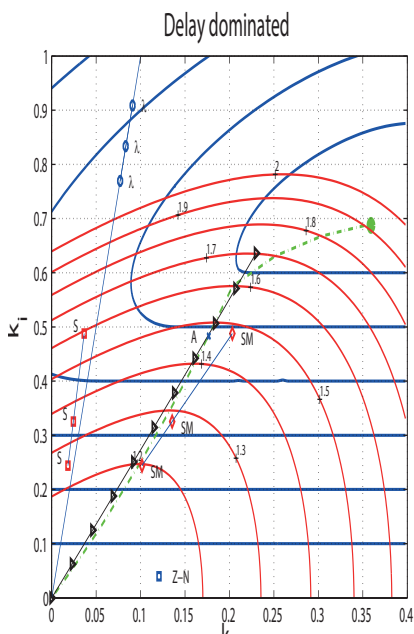
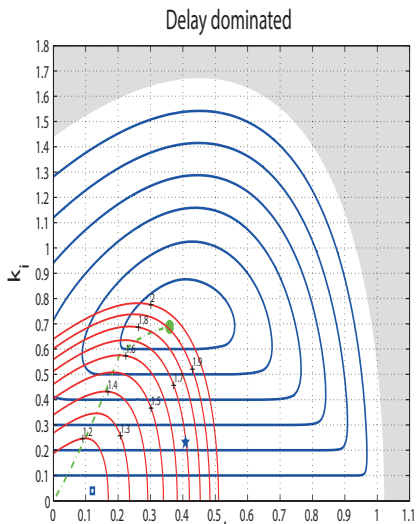

Criteria and Trade-offs in PID Design

Control design is a rich problem which requires that many issues such as load disturbances and set-point tracking, model uncertainty, and measurement noise are taken into account. In this work we introduce trade-off plots for PI and PID controllers, which give insight into the design methods, criteria and design compromises.

The trade-off plot above is drawn for PI control of a second order delay-dominant process. The lower plot is a magnification of the lower-left part of the upper plot. The blue level curves show constant values of Integrated Absolute Error (IAE), equal to $1/k_i$ (k_p is proportional gain and k_i is integral gain), during a unit step load disturbance on the process input. The red level curves show constant values of $\max(M_s, M_t)$, where M_s is the max norm of the sensitivity function and M_t is the max norm of complementary sensitivity. The green, dash-dotted, line shows the loci of IAE optimal controllers for different values of $\max(M_s, M_t)$ and the green dot shows the absolute minimum. Five different tuning methods are shown in the plot, namely: Ziegler-Nichols step response method (Z-N), Lambda tuning, Skogestad's two SIMC methods (S and SM) and AMIGO tuning. The black line marked with triangles is a parametrization of the optimal controllers.

Interacting learning modules for PID control

We are also developing interactive learning modules for PID control. The modules are designed to speed up learning and to enhance understanding of the behaviour of loops with PID controllers. The modules are implemented in SysQuake, and the work is done in collaboration with professor Sebastián Dormido at UNED, Madrid, and José Luis Guzmán at Universidad de Almería.

AUTOMATIC TUNING

Researchers: Kristian Soltesz, Tore Hägglund, Karl Johan Åström

Within process industry, a large number of processes can be accurately modeled using simple models, i.e., SISO FOTD or SOTD.

In order to control FOTD or SOTD processes, it is often sufficient to use the PID controller. It is desired to choose PID parameters yielding a closed loop system with robustness towards load and measurement disturbances.

We aim at developing a methodology for automatic tuning of PID controllers, using nonlinear feedback for identification input generation and optimization based methods for both process parameter identification and controller synthesis.

The main components of the auto-tuning algorithm are the following:

1. Generate identification input with little or none a priori system information
2. Transfer function parameter identification through optimization
3. Model verification
4. PID synthesis
5. Performance evaluation

As a case study, a modified version of the method has been applied in closed-loop controlled anesthesia.

HIERARCHICAL SCHEDULING AND UTILITY DISTURBANCE MANAGEMENT

Researchers: Anna Lindholm, Charlotta Johnsson, Pontus Giselsson

The research is part of the Process Industrial Centre at Lund University, PIC-LU, and done within the project PIC-opic. The research is performed in collaboration with Perstorp AB and researchers from the Department of Mathematics and the Department of Management and Engineering at Linköping University.



Site Stenungsund

The chemical industry has during the past decades become a global marketplace with strong competition between manufacturers, which requires a more agile plant operation to increase flexibility and decrease production costs. Planning, scheduling, and control are some key features that have large economic impact on process industry operations. In this research project, a hierarchical approach to integrate scheduling (on a timescale of days) with production control (on a timescale of hours) is suggested. The approach focuses on sites with several interconnected production areas with continuous production.

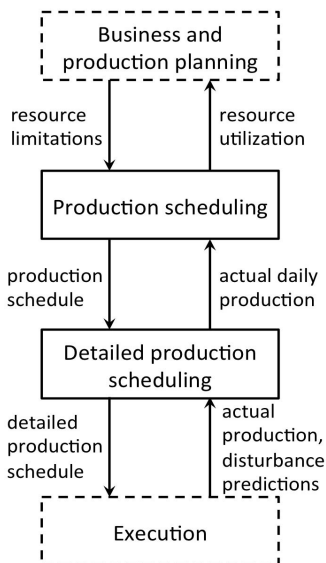

The scheduling level is denoted production scheduling (PS) and the production control level detailed production scheduling (DPS), in agreement with the ISA-95 terminology. The production scheduling takes orders, forecasted orders, and the actual production per day as inputs to make a production schedule for a month ahead divided into daily time periods. The objective of the production scheduling is to make a production schedule that serves as an input to the lower level in the hierarchy, the detailed production

scheduling. The production schedule is updated every day in receding horizon. The objective of the detailed production scheduling is to handle daily disturbances at the site in order to minimize the economical influence of these disturbances. Reference values for the sales of products are given by the production schedule, and predicted disturbance trajectories are also given as input for the detailed production scheduling. The detailed production schedule has a timescale of hours and is updated every hour in receding horizon.

The focus for the detailed production scheduling is currently disturbances in the supply of utilities, such as steam and cooling water. Utilities are often shared between the production areas at a site, and management of these disturbances thus becomes an interesting topic when production areas are also connected by the flow of products. A generic method for minimizing the effects of disturbances in utilities has been developed, which requires a model of the site. Different modeling approaches have been suggested and the objective has been to start with simple and quickly obtained models, and step by step move towards more elaborate models. The current model for utilities assumes a linear relation between the supply of a utility to an area and the production in the area.



DECENTRALIZED CONTROL STRUCTURES

Researchers: Martin Hast and Tore Hägglund

There is an unfortunate gap between the centralized computational approaches of multi-variable control theory and the common practice to design local control loops disregarding couplings and interaction. Today it appears that both approaches has reached a point of refinement where the gap can be reduced from both sides. This project aims to revise and improve the basic modules for decentralized control, and to develop new. The ideas to be investigated in this project are relevant not only for process control but is also of interest for general classes of multi-variable systems.

Feedforward from load disturbances

Feedforward is a powerful method to improve the performance of feedback loops. Feedforward can be made both from setpoint and measurable load disturbances. In this project, the goal is to improve both structures and design methods for feedforward control from load disturbances.

The basic idea for design of feedforward compensators is simple. The ideal compensator is formed as the dynamics between the load

disturbance and the process output, divided by the dynamics between the control signal and the process output, with reversed sign. However this ideal compensator is seldom realizable. Therefore, there is a need for design methods. There are surprisingly few such methods presented in the literature, and the methods do normally not take the feedback control into account in the design.

In a first phase, new simple tuning rules for feedforward compensators have been derived. The design objective is to minimize IAE without getting any overshoot in step load disturbance responses. This work has been done in collaboration with University of Almeria in Spain.

Using a structure that decouples feedback and feedforward action, optimal design rules that minimizes ISE has been developed. The used structure simplifies tuning of the feedforward controller by allowing the controller to be tuned with respect to the open-loop system while maintaining its properties and performance when used in a closed-loop setting.

FED-BATCH CONTROL - OPTIMIZING FERMENTATION CONTROL FOR *B. LICHENIFORMIS*

Researchers: Ola Johnsson, Charlotta Johnsson, and Tore Hägglund

This project is performed in collaboration with Novozymes AS and Department of Chemical Engineering within the PICLU centre.



The project will focus on developing, improving and optimizing fermentation control strategies for the *B. licheniformis* fed batch processes. This process can produce vast amounts of protein but is sensitive to overdosing and process disturbances which lead to process variations and possibly crashed fermentations. There is thus a strong motivation for developing more robust control strategies for this process. The project aim is to develop a general method for finding optimal control strategies for various *B. licheniformis* production strains.

In addition to developing and evaluating bioprocess control strategies which can improve robustness and yield of specific *B. licheniformis* processes, it is also of interest that the developed methods are general enough to allow for implementation on various enzyme-producing processes utilising different *B. licheniformis* strains. This will require the identification of key physiological variables in the strains and an understanding of the interaction between these properties and the way the process is controlled.



Fermentation tank

ROBOTICS

ROBOTICS RESEARCH

Researchers: Rolf Johansson, Anders Robertsson, Isolde Dressler (until Sept 2012), Magnus Linderoth, Andreas Stolt, Olof Sörnmo, Björn Olofsson, Karl Berntorp, Karl-Erik Årzén, Mahdi Ghazaei, Anders Blomdell, Anders Nilsson, Jang Ho Cho and Pål Johan From in close cooperation with colleagues from Dept of Computer Science and Dept of Mathematics at the Robotics lab at LTH, Lund University, ABB CRC and ABB Robotics, Västerås, Sweden.

Robotics offers both theoretical and practical challenges. Robotics is a multi-disciplinary topic and we collaborate with both national and international robotics colleagues regarding different aspects of robotics and we also have a close cooperation with industrial partners. Our main research are in motion and compliance control, control system architectures and different sensor fusion problems with application mainly to industrial manipulators. We use mainly modified and extended ABB robot control systems as experimental platforms.

The laboratory for robotics and real-time systems is centered around industrial manipulators with open control system architectures. In the lab we have several generations of robots from an elderly ABB IRB6 robot, an ABB IRB2000 robot, an ABB Irb2400 (S4CPlus) to the more modern ABB IRB140 (IRC5), Gantry-Tau robot (IRC5) and the latest dual-arm concept robot Frida (ABB IRC5). Hardware interfaces have been developed to create an open system suitable for control experiments (Orca/Orcinus). The computer hardware is either PCI-based with both microprocessors and signal processors integrated into an embedded system for hard realtime control in one of the labs and integrated with an additional PCI-based G4 PowerPC for the new Open Control system based on S4CPlus and the newly developed networked architecture running on Linux/Xenomai-platforms.

The systems are connected to a network with workstations, which are used for program development and control design. A purpose of the current project is to show how to organize open robot control systems and to verify these ideas by means of experiments.

One goal is to permit efficient specification and generation of fast robot motions along a

geometric path which requires coordinated adjustment of the individual joint motions. Another aspect of robot motion control is how to integrate simultaneous control of force and position according to ideas of impedance control in which stability is an important theoretical issue. A major topic in this project is to integrate aspects of control, sensor fusion and application demands using robot vision and force sensing. Another project is on the structure and programming of control systems for industrial robots. The problem addressed is how the software architecture and the realtime structure of a robot control system should be designed to allow easy and flexible incorporation of additional sensors and new control algorithms.

A software layer between a supervisory sequence control layer and the basic control level has been proposed. Case studies and prototype experiments show promising results and further implementation is going on. The project Autofett aimed towards use of force control in manufacturing operations such as robotized fettling and is now continued in the SMErobot and FlexAA-projects. New sensor interfaces with modification of hardware and realtime software architectures have been developed to accommodate the use of force control algorithms based on workspace sensing.

Several research interests are represented in Robotics Lab:

- Open Control Software Architectures
- Exteroceptive Robots
- Force Control
- Robot Vision
- Sensor Fusion
- Adaptive and Iterative Learning Control
- Task-level Programming
- Productive Robotics & Work-space Sensing

ROBOTICS LAB

Robot control systems and other manufacturing equipment are traditionally closed. This circumstance has hampered system integration of manipulators, sensors and other equipment. As a result, such system integration has often been made at an unsuitably high hierarchical level.

The purpose of past and present projects is to show how to organize open robot control systems and to verify these ideas by means of ex-

perimental verification. As a part of this research, we have developed several experimental open robot control systems. The systems are built around industrially available robots that have been reconfigured for experimental purposes.

The developed specific robot interfaces and the integration of the robots into a complete system forms a unique environment for testing and development of algorithms for improvement of performance, sensor integration, programming automation and autonomous operation.

PROFLEXA

Researchers: Rolf Johansson, Anders Robertsson, Olof Sörnmo and Björn Olofsson in cooperation with Dept. of Computer Science, Lund University and Div. of Assembly Technology, Linköping University and several industrial partners.

Funding: This project is financially supported by the Swedish Foundation for Strategic Research (SSF) under the programme ProViking.

Duration: 2009-2012

The Swedish casting and foundry industry is under high pressure to reduce its production cost in order to maintain its competitiveness and avoid moving its activities to low cost countries. This means that there is a need to improve efficiency, product quality and consistency and to reduce costs and lead-time. The project focuses on achieving productive and profitable robotized automation of the fettling for small and medium sized volumes.

The project has the following work packages that also reflects the expected results and deliverables.

- WP1: Development of components and methods for handling of castings, including development of modular, configurable, simple and inexpensive grippers.
- WP2: Development of technology and configurators for flexibility and quick start-up of new products or product changes.
- WP3: Development of methods for measurement of excess material and compensation of gripper errors.
- WP4: Build-up of database of process parameters for optimal material removal rate.

- WP5: Development of a Lead-through programming concept.
- WP6: Development of the Off-Line programming concept.
- WP7: Development of physical demonstrator.
- WP8: Exploration of the potential for the developed technology in other industry branches.

All of these benefits strengthen Swedish foundry industry and delivers important knowledge to other adjoining industry sectors.

- Swerea SWECAST AB
- Artech Automation AB
- SVIA — Svensk Industriautomation AB
- Smålands Stålgjuteri AB
- Saab Aerosystems
- DELFOi
- Combi Wear Parts AB
- AB Bruzaholms Bruk AB
- Linköping University
- Lund University

COMET - PLUG-AND-PRODUCE COMPONENTS AND METHODS FOR ADAPTIVE CONTROL OF INDUSTRIAL ROBOTS ENABLING COST EFFECTIVE, HIGH PRECISION MANUFACTURING IN FACTORIES OF THE FUTURE

Researchers: Rolf Johansson, Anders Robertsson, Björn Olofsson and Olof Sörnmo in cooperation with Dept of Comp Science, Lund University and several academic and industrial partners.

Funding: This project is financially supported by the European Union's Seventh Framework Programme FP7 under the programme "Factories of the Future", ref. #258769 COMET.

Duration: 2010-2013

The COMET project aims at creating solutions enabling the use of industrial robots for high-end machining tasks in industry. The goal of the project is to develop a Plug-and-Produce platform, which will fulfill the needs from the manufacturing industry for cost effective, flexible and reliable manufacturing solutions.

The four pieces of the puzzle define the different parts of the project, which also constitute the technical work packages:

- WP1: In this work package, a methodology for describing kinematic and dynamic models of an industrial robot will be developed. Those models will accurately define the static and dynamic behavior of any industrial robot, which then is represented by its unique signature.
- WP2: An integrated programming and simulation environment for adaptive robot path generation will be developed in the second work package. The path generation system will utilize the models of the robot obtained in WP1 for accurate path generation.

- WP3: The third work package is to develop an adaptive tracking system for industrial robots to detect deviations from the programmed robot path and to adaptively initiate real-time corrections via the robot controller to ensure the necessary machining accuracy.

- WP4: For high-precision machining, a high-dynamic compensation mechanism will be developed. By utilizing this mechanism, the aim is to accomplish an absolute accuracy better than 50 μm in machining tasks. This is significantly below the structural capability of the robot system on its own, due to the limited stiffness and positioning accuracy of the robot.

Members: AMRC Manufacturing Ltd, United Kingdom; ARTIS, Germany; BTU Cottbus, Germany; Delcam, United Kingdom; DemoCenter-Sipe, Italy; Fraunhofer IPA, Germany; Gizelis Robotics, Greece; Lund University, Sweden; N. Bazigos S.A., Greece; Nikon Metrology, Belgium; Nisaform s.r.o., Czech Republic; SIR SpA, Italy; TEKS, France; University of Patras, Greece.

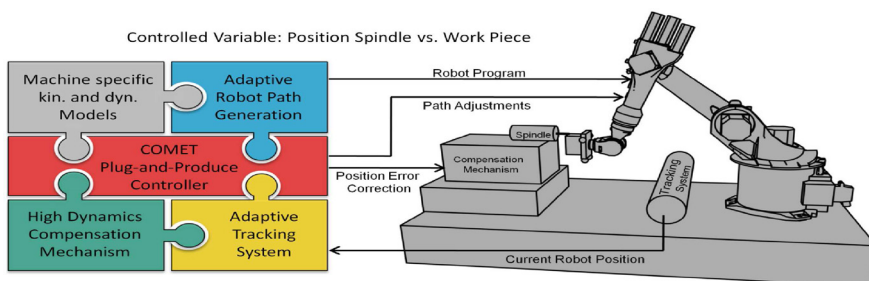

ROSETTA

Integrated project funded under the European Union's Seventh Framework Programme (FP7), (Ref. FP7 ICT-230902 ROSETTA)

Researchers: Rolf Johansson, Anders Robertsson, Magnus Linderöth, Andreas Stolt in cooperation with Dept of Comp Science and Dept of Mathematics, Lund.

The ROSETTA research project develops technology for industrial robots that will not only appear more human-like, but also cooperate naturally with human workers. This project is funded by the European Union under the FP7 grant 230902.

The following 4 objectives are set forth:

- to enable robots to be used in complex tasks with high flexibility and robustness
- to ease the deployment effort to allow fast production changeover from product A to product B
- to produce an easy-to-use programming system to access ROSETTA robot functionality without the need for highly skilled robot programmers
- to provide new sensing, control and decision making methods for safe physical human-robot interaction.

Members (in alphabetical order):

- ABB AB (Sweden, Coordinator)
- ABB AG (Germany)
- Dynamore GmbH (Germany)
- Fraunhofer IPA (Germany)
- K.U. Leuven (Belgium)
- Ludwig-Maximilians-Universität Munich (Germany)
- Lunds Universitet (Sweden)
- Politecnico di Milano (Italy)

Project information

ROSETTA is the acronym for a new European Large-Scale Integrating Research Project "RObot control for Skilled ExecuTION of Tasks in natural interaction with humans; based on Autonomy,

cumulative knowledge and learning". The 4-year project started March 1st, 2009, and has a total budget of 10 MEUR.

Goals

ROSETTA develops "human-centric" technology for industrial robots that will not only appear more human-like, but also cooperate with workers in ways that are safe and perceived as natural. Such robots will be programmed in an intuitive and efficient manner, making it easier to adapt them to new tasks when a production line is changed to manufacture a new product.

Key Issues

The need for such robot systems stems from analyses showing that future factories will produce more and more goods with high volumes, but with many variants and limited product lifetime. This requires a flexible manufacturing system allowing for frequent production changes. Robot systems are the automation method of choice to meet these demands, but they need the ability to adapt even more quickly to new tasks, and to obtain full production output faster than today. Also, it is mandatory to easily integrate robots into manufacturing lines with human workers, as the combination of manufacturing by humans and robots promises highest flexibility. Tasks difficult to automate will in this scenario remain the domain of humans, whereas operations with low automation threshold or high quality requirements will be performed by these robots.

Scientific/Technical Approach

The project will address the challenges by developing methods to engineer and program robot

systems in ways that are more intuitive, more related to the task, and less specific to the installation. This will require robots to be able to execute tasks more autonomously, without the need for detailed description of every step, and will lead to a significant reduction in programming effort. Once programmed, the robots will use sensor-based learning to autonomously improve their abilities ("skills") to perform the task quickly, quite like a human worker. When the operation is optimized in this way, the robot shares the knowledge of how to best perform the operation with other robots by sending the parameters over a network to a central server. Other robots do the same, which results in a quick build-up of production knowledge ("cumulative learning").

Storing and sharing production-related data will make use of latest techniques developed for the Web 2.0, representing such data as form of "knowledge" that can be accumulated, enhanced and re-used by a population of robots.

The production scenario that involves robots and humans working side-by-side and interacting safely requires that design, control and supervision devices and methods are found for robots to be harmless, and to act in a way that humans anticipate and feel comfortable with. This involves developing human-like motion patterns, speech interaction as well as avoidance of any situation that may pose a hazard or uncomfortable situation to human workers or operators. The human-machine cooperation will be supervised by a multi-level sensor system involving different sensor types and a reasoning unit that will analyse the robot environment and give the robot instructions in real-time how to adjust to changing environments and to human presence.

Expected Impact

The engineering and production methods will make robot automation accessible for a variety of new applications, in particular where production is frequently adapted to new product lines. This will enable the European industry to

increase its competitiveness by reducing production cost and by increasing production quality. A thorough understanding and modelling of the human/robot contact and interaction in a production scenario are major efforts of ROSETTA. The theoretical and experimental investigations will lead to injury risk classifications with the goal of creating future safety standards for human-robot cooperation, helping the industry to better utilise the potential of robots working in human environments.

Research so far has been focused on force controlled assembly. The implementation has been based on iTaSC, instantaneous Task Specification using Constraints. The main scenario has been the assembly of an emergency stop button.

The assembly of an emergency stop button has been performed using the ABB concept robot FRIDA. A table-mounted force sensor has been used for some operations, while forces estimated from the joint control errors has been used for screwing the nut. The assembly is implemented using both standard position based RAPID code, and force controlled parts using the iTaSC framework and the ExtCtrl interface.

Another assembly scenario considered was the assembly of a shield can onto a mobile phone PCB (printed circuit board). The assembly was performed as a sequence of guarded search motions, and the the forces were estimated based on the joint control errors.

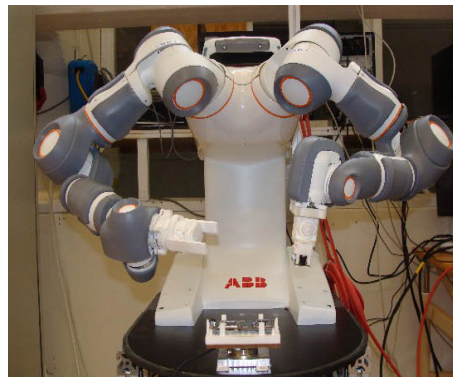

Frida two-armed robot

ENGROSS

Researchers: Karl Berntorp, Anders Robertsson, and Karl-Erik Årzén, in collaboration with the Department of Computer Science, Lund University and the Department of Mathematics, Lund University.

Funding: SSF

Duration: 2009 - 2013

The ENGROSS project is an SSF framework project on software-intensive systems. This project is focused on the central problems of complex software systems; how such systems can be built in order to be more flexible, robust and possible to compose at the same time. The project is structured in three layers:

- Systems Research
- Demonstrator
- Disciplinary Research

The systems research is based on previous work at Department of Computer Science in the form of the Palcom middleware for loosely interconnected systems. In ENGROSS Palcom is extended to support real-time applications and safety-critical applications.

The main demonstrator in ENGROSS is a grocery-store mobile service robot and surround-

ing IT systems, sensing, and communication. The primary task for a grocery robot is to put arriving items on shelves in the shop. The robot demonstrator gives rise to many situations where systems need to be integrated in new ways. The current version of the demonstrator is based on the Frida two-armed robot from ABB and a mobile service robot platform from the Fraunhofer Institute for Manufacturing Engineering And Automation (IPA).

The robot demonstrator also serves as a platform for the disciplinary research in the project:

- Mobile manipulation
- Vision
- Localization and navigation
- Resource-constrained embedded systems
- Safety

INROSY

Researchers: Klas Nilsson, Dept. Computer Science, Rolf Johansson and Anders Robertsson in cooperation with Prof. Il Hong Suh, Hanyang University, Seoul, Korea.

STINT-KOSEF Institutional Grant for cooperation with Hanyang University (Prof. Il Hong Suh), Seoul, Korea.

Nowadays, we are living with automation systems that have intelligence such as cleaning robot, human care robot and guiding robot within everyday life. These robots will be key components of our daily life. It is true that quality of our life can be improved by these robots. Unlike the industrial robots that continuously repeat their given jobs in a fixed environment, service

robots have to provide event-driven services, while keeping natural human-robot interaction in dynamic changing environment. Therefore, intelligence including sensory-motor coordination is thought as a core element of everyday life robot. The intelligence of a robot depends on the cognitive ability for environment, and how the robot acts properly with cognitive results.

In this project, we address research issues on software architectures for reactive, cognitive behavior in robotics work spaces.

PRACE

PRACE—The Productive Robot Apprentice, Project funded under the European Union's Seventh Framework Programme (FP7), (Ref. NMP-ICT-FoF 285380 PRACE), 2011-2014,

Researchers: Rolf Johansson, Anders Robertsson, Mahdi Ghazaei, Anders Nilsson in collaboration with colleagues from Dept of Comp Science, Lund

The objective of PRACE is the development of a highly adaptable two handed, mobile robot system for automation of typical small batch assembly operations. An important key feature is the fast and intuitive training of the PRACE system.

Driven by the trend to a more and more customer specific production the boundary conditions for assembly automation have changed significantly. As the systems available on the market cannot cover this extreme flexibility towards weekly changing applications a new robot system concept will be developed within PRACE. An important requirement is the ability to train the robot system with worker skill fast and intuitive.

The PRACE concept basically relies on robot learning by demonstration. We compare the robot learning to a master-apprentice-relationship. There, a master teaches an apprentice by instructing certain skills by demonstration. The apprentice watches the actions and effects to categorize this newly gathered knowledge into his knowledge base. Then, while applying this new skill, the master corrects the execution by refining the experience. This loop is iterated until the master is satisfied with the result.

Another important aspect of the PRACE robot system is the operation without safeguards to reach the target of fast setup times. Operation without safeguards however limits the maximum robot velocity. To remain competitive with the human worker a dual-armed robot approach is followed to reach a similar working output as the human worker by modest robot velocities.

With the combination of dual-armed manipulation and a mobile platform to provide local mobility within the working place basically new application tasks may be now automated economically by this new system approach. Using a modular approach the PRACE system can even be recombined to use only parts of the robot system for dedicated applications, i.e. using only a single arm or using the system without mobility.

Different assembly use cases are defined as test environment of the PRACE concept. At end of the project an evaluation phase in real production environment is planned to test the functionality of the system and to ensure the ability to train the system by non-expert users within half a day.

MONROE

Hyper-Modular Open Networked Robot systems with Excellent performance --- An experiment within EU FP7/ECHORD – the European Clearing House for Open Robotics Development

**Researchers: Rolf Johansson, Anders Robertsson, Isolde Dressler in
cooperation with Dept of Computer Science, Lund University, Gudel AG, Switzerland
and IPA Fraunhofer, Germany.**

Robots so far suffer from several up to now necessary trade-offs that result in:

- Stiff robots are heavy (in terms of moving mass), and thereby slow and/or too expensive.
- Parallel robots providing stiffness and high forces have small and closed workspace.
- Precise robots are very expensive, slow, and/or cannot stand process forces.
- Modular robots have low performance due to lack of mechatronic optimization.

The first two of these items were successfully tackled in SMERobot (FP6; smerobot.org) by means of the Tau PKM structure. As the basis for MONROE we have ideas that overcomes all of the four tradeoffs above, but convincing demonstrations are needed before (the first) customers are willing to buy the concept. For software and

networking we want to combine loosely coupled networked devices, which should communicate via asynchronous messages that are both self-describing and possible to be compiled into real-time communication with multi-kHz control over standard Ethernet. An integrated demonstration is outside reach for robot manufacturers from a business point of view, and hence the crucial need for this Echord experiment.

The goal of MONROE is to enhance and apply a new type of hyper-modular parallel robot that also enables a performance increase in terms of stiffness, precision, and bandwidth with respect to feedback from external sensors. Most efforts have been put into redesigning networked control and robot joints such that performance potentials are achieved, and such that the robot can be produced in an efficient/affordable manner.



Automatica, Munchen 2012

SMEROBOTICS

The European Robotics Initiative for Strengthening the Competitiveness of SMEs in Manufacturing by integrating aspects of cognitive systems, Project funded under the European Union's Seventh Framework Programme (FP7), (Ref. ICT 287787 SMERobotics), 2012-2015.

Researchers: Rolf Johansson, Anders Robertsson, Björn Olofsson, Olof Sörnmo in cooperation with Dept of Computer Science, Lund University.

Over two-thirds of European workers in manufacturing are employed in small and medium-sized enterprises (SMEs). Their primary means of competition is to respond rapidly to changing production needs and to keep product quality at a very high level.

While robots are able to carry out repetitive tasks to a high standard, they do not meet the demands of SMEs for high flexibility. Today's robots know only their nominal task, which limits their ability to deal with frequent changes in the manufacturing process.

For the operation of robots in a SME environment, which is typically less structured and involves more uncertainties than large-scale or mass-production industries, the currently available solutions result in overly complex system integration.

Instead, cognitive abilities should be included in the equipment and cognition should take place in both the robot and the human, such that the worker's knowledge can be fully utilised and productivity demands can be met. Additionally, the concepts and symbols used in dialogues need to have a common grounding in order to guarantee ease of use.

Therefore, we propose the SMERobotics work system, which covers all phases of the robot lifecycle and in which humans and robots can together deal with SME manufacturing uncertainties and are symbiotically able to learn from each other and to learn from the past handling of uncertainties. The SMERobotics vision is to deploy such robots on SME shop floors, with the benefit of long-term improvements in productivity.

The SMERobotics initiative pays careful attention to SME-related issues and scientific challenges, as is reflected by its strong industrial involvement supported by leading researchers and building on successful collaboration between industry and academia as well as on demonstration-driven research from the SMERobot project.

Additional partners will be included in order to widen the initiative's impact by transferring project results to European pilot applications of SME-compatible cognitive robot systems.

AUTOMOTIVE SYSTEMS

KCFP, CLOSED-LOOP COMBUSTION CONTROL

Researchers: Rolf Johansson and Anders Widd in cooperation with Patrick Borgqvist, Assoc. Prof. Per Tunestål and Prof. Bengt Johansson, Div. Combustion Engines, Lund University

Competence Center Combustion Processes (KCFP) at Lund University focuses on research of combustion processes between HCCI (Homogeneous Charge Compression Ignition) and classical Otto and Diesel engines.

Project aims:

- Reducing emissions, improving efficiency and repeatability of HCCI and partially premixed combustion (PPC) using closed-loop control;
- Control-oriented modeling and simulation of combustion processes;
- Model-based control and optimization evaluated on test beds.

Within the project a cycle-resolved physics-based HCCI model has been developed. The model includes a low-complexity model of the cylinder wall temperature dynamics in order to capture the relevant time-scales of transient HCCI when only small amounts of hot residuals are trapped

in the cylinder. The temperature evolution of the gas charge is modeled as isentropic compression and expansion with three heat transfer events during each cycle.

Model predictive controllers based on linearizations of the model have been designed and evaluated experimentally. The considered control signals were the inlet valve closing and the intake temperature. The control performance was evaluated in terms of response time to set-point changes and the resulting output variance. The benefits of using hybrid models comprised of several linearizations of a nonlinear model have also been investigated.

During 2011, a continuous time model of partially premixed combustion was developed and implemented in the Modelica language. The JModelica.org framework was used to formulate optimization problems on the resulting model. One use of this possibility is automatic calibration of the model parameters.

DIESEL COMBUSTION WITH LOW ENVIRONMENTAL IMPACT

Researchers: Rolf Johansson and Maria Henningsson in cooperation with; Kent Ekholm, Prof. Bengt Johansson, Dr. Per Tunestål, Div. Combustion Engines, Lund University; Petter Strandh, Johan Dahl, Stefan Strömberg, Volvo Powertrain; Urban Carlsson, Anders Höglund, Cargine

This project is financially supported by Volvo Powertrain, Inc., Cargine, and the Swedish Energy Agency (program FFI P32067-1)

The heavy-duty engine market is dominated by compression-ignition diesel engines because of their high energy conversion efficiency. High efficiency is essential both in terms of fuel economy

and the impact on global warming through CO₂ emissions. Beside the goal of energy efficiency, diesel engines must fulfill numerous other requirements, such as legal constraints on emissions

of NO_x, soot particles, and hydrocarbons. There are also legal restrictions on the audible noise from the engine, and market demands for reliability, durability, and competitive pricing.

To steer the combustion process to the optimal trade-off between emissions, fuel economy, and audible noise, a number of sensors and actuators are available. We work on optimal control methods to manage the trade-off between emissions and fuel economy on-line. Among control methods successfully applied, linear quadratic Gaussian control and model-predictive control have been implemented and tested. Our current focus is to integrate the control of the gas flow

and fuel injection processes in the engine. We also investigate dual-fuel operation, combining direct injection and port injection of different fuels to improve fuel economy.

During 2011, a new six-cylinder heavy-duty Volvo engine was installed in the lab. Research focused on machine-learning methods to extract information from in-cylinder pressure sensors to predict emissions during transient engine operation. Niklas Everitt, a master's thesis student, implemented and evaluated an experimental setup for using Cargine's free valve system on a six-cylinder engine.

PREDICTIVE CONTROL AND SYSTEM OPTIMIZATION OF WHEEL LOADERS

Researchers: Toivo Henningsson and Anton Cervin, in cooperation with Bobbie Frank and Mats Alaküla, Dept Industrial Electrical Engineering and Automation, Lund University, and Anders Fröberg, Volvo Construction Equipment

Duration: 2011—2014

Funding: Energimyndigheten

Today evaluating a hybrid drivetrain concept for construction machine applications is a time consuming process. This is true as the control strategy needs to be developed by hand and tuned for the concept and each new sizing of the components and eventually optimized such that the concept can be compared with other concepts at its best. The result is that too few concepts are studied and strategic decisions on drivetrain types is most suitable per machine / region / application / customer type and in overall are stalled due to insufficient decision material. The project at hand implements tools for comparing concepts in a fast manner where the control strategy

is generated during concept optimisation. The same control strategy is input to online control performed in the prototype machine used for validation of the results within the project. The goal in the project is to make the transition from the generated control code to implementation in machine with real-time constraints as smooth as possible. Actual concept comparison is carried out in the project and will be used as decision material for which future drivetrain layout to use for wheel loaders of different sizes. The project also results in competence development at Lund University and that the Volvo CE industrial student reaches a licentiate degree.

BIOMEDICAL PROJECTS

ANESTHESIA IN CLOSED LOOP

Researchers: Tore Hägglund (area leader) and Kristian Soltesz in collaboration with professor Guy Dumont and the ECEM group, University of British Columbia, Vancouver, Canada

Computer controlled, or automatic, drug delivery is the process of administering a therapeutic regime to a patient with computer assistance for calculation of optimal dose and delivery schedules. Computer control can improve drug therapy by reducing drug usage and costs, by permitting health care staff to work more efficiently and to provide better standard of care, by allowing the safe use of drugs that are difficult to administer, and by compensation for human failings with computer strengths, such as unlimited attention span and patience, and capacity for quick, accurate and redundant calculation.

Our goal is to develop an automatic control system for anesthesia and to demonstrate its efficacy, safety and benefits in an operating room. Although closed-loop anesthesia has previously been proposed and tested, it has yet to have a significant impact on clinical practice. Recent

developments in sensing for anesthesia have opened new possibilities for closing the loop. Our research will focus on the deployment of new sensors optimized for controlled drug delivery, robust control methodology and extensive clinical validation.

Clinical partner in the project is the Department of Anesthesia at the British Columbia Children's Hospital (BCCH), Vancouver, Canada, where patient modeling data is collected and clinical trials of the control system are conducted.

A PID controller based drug delivery system for depth of hypnosis control was evaluated in a patient study (BCCH REB approval H10-01174) during 2011.

Our current aim is to extend the system to control hypnosis and analgesia simultaneously, by adding a second drug.

CEREBELLAR CONTROL AND ADAPTATION

Researchers: Jonas Dürango, Anders Rantzer and Rolf Johansson in collaboration with Dr. Henrik Jörntell (Div. Neurophysiology, Dept. Experimental Medical Science, Lund University)

Project Leader: Rolf Johansson

Funding: LCCC, Swedish Research Council; Ref. VR 2007-8646

Cerebellar contribution to motor control and motor learning

The cerebellum is a structural unit of the central nervous system that plays a significant role in motor control and coordination, motor adaptation and the acquisition of new motor skills. It also provides large contributions to cognitive

functions such as speech. Rather than initiating movement, the cerebellum influences movement control by integrating sensory signals and cerebral cortical signals related to the movement task at hand, and projecting it back to the motor areas of the cerebral cortex and brainstem. This is evident from studies where cerebellar lesions

won't cause paralysis, but rather by leaving the patient with poorly controlled movements and unable to learn new motor skills or adapt existing movement patterns to new conditions.

The cerebellar cortex is built up from networks of different types of neurons. Purkinje cells act the main output of the cerebellar cortex, and each of these cells recombines information from a vast amount (~200 000) of other cerebellar cells. Each Purkinje cell is also contacted by a single climbing fiber, which is thought to encode information signalling to the cerebellum that an erroneous output is being made, and from this error the connection strengths between the Pur-

kinje cell and the innervating cells are altered. This highly plastic and modular wiring of the cerebellar cortex allows for the cerebellum to adapt its output to better control and coordinate complex movement tasks.

From a control theory point of view the cerebellum can be viewed as an adaptive element contributing to motor control tasks in a larger decentralized control scheme. The aim of this project is to combine recent experimental findings with control theory to gain better insight of how the mechanisms of cerebellar contributions function.

DIADVISOR

Researchers: Marzia Cescon, Fredrik Ståhl, Meike Stemmann, Rolf Johansson, Georgios Chasparis, Dawn Tilbury

Project leader: Rolf Johansson

Partners: Novo Nordisk A/S, Bagsværd, Denmark; Johannes Kepler University, Linz, Austria; Lunds University, Lund, Sweden; University of Padova, Padova, Italy; Centre Hospitalier Universitaire de Montpellier, Montpellier, France; Toumaz Technology Ltd, Abingdon, UK; Sensor Technology and Devices Ltd, Belfast, UK; Ondalys, Montpellier, France; RomSoft, Iasi, Romania; Institute for Clinical and Experimental Medicine, Prague, Czech Republic; RICAM, Linz, Austria; Ramboll, Virum, Denmark; Federation Internationale du Diabete Region Europe, Brussels, Belgium

Sponsoring Organization: the European Commission through the Information Society Technologies (IST) programme under the Seventh Framework Programme (FP7) n° 216592

Diabetes Mellitus is a chronic disease of disordered glucose metabolism due to defects in either insulin secretion from the pancreatic beta-cells or insulin action. Type-1 diabetes (T1DM), also called insulin-dependent diabetes mellitus (IDDM) is characterized by no production of insulin what so ever, whereas type-2 diabetes is caused by decreased sensitivity of the tissues to the metabolic effect of insulin. The basic effect of insulin lack or insulin resistance is to prevent

the efficient uptake and utilization of glucose by most cells of the body, resulting in abnormally high blood sugar levels (hyperglycemia). Sustained hyperglycemia is associated with acute ketoacidosis, nephropaty, rethinopaty, neuropathy and damages to the cardio-vascular system, therefore intensive insulin therapy aiming at near-normoglycemia (80-100 mg/dL) has been strongly promoted during the last decade, following the results of the major Diabetes Control

and Complications Trial (DCCT) and follow-up Epidemiology of Diabetes Interventions and Complications (EDIC) studies. Focusing on tight blood glucose targets, the strategy comprises test of blood glucose levels at least four times a day, taking insulin at least three times a day by injections or using a pump and patient assistance by healthcare team through visits and phone calls. Meanwhile, the lack of improved quality of life and above all, the occurrence of induced hypoglycemic events which may result in seizure, coma and eventually death preclude the feasibility of such a DCCT-like intensive therapy.

The problem of maintaining glucose levels within a predefined range by acting on insulin delivery is a control problem, whose controlled variable is glucose utilization, measured output is either the subcutaneous glucose provided by the CGMS or the capillary glucose provided by the fingerprick, control input is the insulin intake, and the clinical criterion for success is plasma glucose. The system is subject to disturbances, the most important one being the meals. Control strategies involving the regulation of blood glucose levels in type 1 diabetes subjects range from classic PID feedback controller, run-to-run strategies to MPC algorithms.

The DIAdvisor™ is a large-scale integrating project (IP) aiming at the development of a prediction based tool which uses past and easily available information to optimise the therapy

of type 1 and developed type 2 diabetes. The DIAdvisor™ is not dependent on specific sensor technologies and can be adapted to technologies like standard strip sensing, minimally-invasive continuous glucose sensors and emerging non-invasive methods.

For safety reason, the DIAdvisor™ system will be able to self-assess the confidence of its proposed decisions. For safety reasons as well as for the sake of therapy improvements, the system connects and provides information and trends to the Health Care Provider.

Glucose prediction is difficult and requires advanced science within the fields of physiological modelling, identification theory, control theory, medical device technology, risk management theory, sensor science and user understanding. It can be achieved only by a well balanced group of eminent experts, including academics, clinicians, user representatives and leading companies.

The expected impact of DIAdvisor™ will be improved diabetes control and quality of life in large populations of insulin treated patients, leading to fewer diabetic complications and lower Health Care costs. Moreover, the project will constitute a valuable opportunity for European companies to build up a special know-how leading to products that profoundly and positively have an impact on the lives of millions of people with other indications than diabetes.

TOOLS

GRAFCHART FOR INDUSTRIAL AUTOMATION

Researchers: Alfred Theorin, Charlotta Johnsson

Funding: LCCC and LISA

Grafchart has proven to be a very capable and suitable language for various control applications on both local and on supervisory level as well as for all levels of automation. It also has potential for formal descriptions, validation, and analysis. It has been used with for a wide variety of applications, e.g. batch control, discrete control, and diagnosis and the paradigm fits all of these very well.

Project aims:

- To evaluate the advantages and disadvantages of using Grafchart for industrial applications compared to the languages used today
- To improve the state of art of Grafchart

The research in this project primarily focuses on aspects that are considered important and useful for the industry. In particular the current focus is

on the following topics:

- Add SOA support for Grafchart, and evaluate it in real setups. The SOA paradigm is a promising approach to deal with the increasing complexity, increasing requirements on flexibility, and increasing demand for vertical integration.
- Real-time execution of Grafchart applications. This also enables exploring how to handle e.g. reconfiguration of running applications. Reconfiguration is taken for granted in the automation world but is rather unexplored from a research point of view.
- Improved object orientation support for Grafchart. Analyse various constructs of other modern programming languages, check if they are possible to add to Grafchart, and evaluate the benefits of adding them.

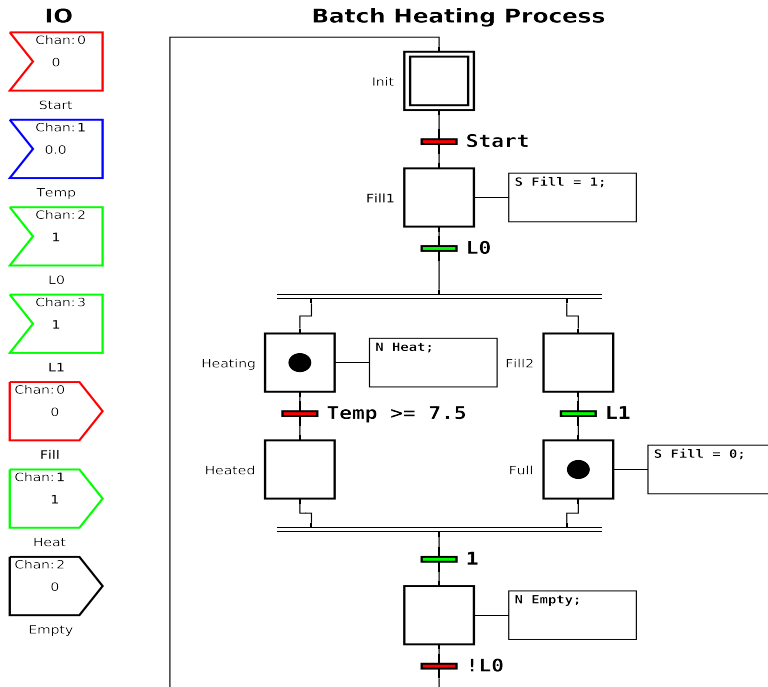

Above: Batch Heating Process

Grafchart is a language for supervisory level sequence control and procedure handling that has been developed at the department since 1991. Grafchart is based on ideas from Grafcet/Sequential Function Charts, Petri nets, Statecharts, and object-oriented programming.

The original implementation of Grafchart had the same name and was developed in G2 from Gensym Corporation. Using this platform Grafchart was used for batch recipe control, diagnosis of mode-changing processes, alarm filtering, implementation of operator decision support systems, and implementation of robot cells.

In the beginning of 2001 a new implementation of Grafchart was made in Java. It is called JGrafchart and is used in our laboratory exercises on logical sequence control and batch control as well as in the Grafchart for Industrial Automation project. It has also been used within the EU/ GROWTH project CHEM.

JGrafchart is available for download as free-ware. The included documentation for the latest version is also available online.

During 2012 a large rewrite of the tool was initiated to enable real-time execution. There has also been one public release of JGrafchart, for more details see the release notes.

JITTERBUG

Jitterbug: A Matlab toolbox for real-time control performance analysis

JITTERBUG is a MATLAB-based toolbox that allows the computation of a quadratic performance criterion for a linear control system under various timing conditions. Using the toolbox, one can easily and quickly assert how sensitive a control system is to delay, jitter, lost samples, etc., without resorting to simulation. The tool is quite general and can also be used to investigate jitter-compensating controllers, a periodic

controllers, and multi-rate controllers. As an additional feature, it is also possible to compute the spectral density of the signals in the control system. The main contribution of the toolbox, which is built on well-known theory (LQG theory and jump linear systems), is to make it easy to apply this type of stochastic analysis to a wide range of problems.

JMODELICA.ORG

JModelica.org is an extensible Modelica-based open source platform for optimization, simulation and analysis of complex dynamic systems. The main objective of the project is to create an industrially viable open source platform for optimization of Modelica models, while offering a flexible platform serving as a virtual lab for algorithm development and research. As such, JModelica.org provides a platform for

technology transfer where industrially relevant problems can inspire new research and where state of the art algorithms can be propagated from academia into industrial use. JModelica.org is a result of research at the Department of Automatic Control, Lund University, and is now maintained and developed by Modelon AB in collaboration with academia.

MPCTOOLS

MPCtools is a freely available Matlab/Simulink-based toolbox for simulation of MPC controllers. MPCtools provides easy to use functions to create and simulate basic MPC controllers based on linear state space models.

The key features of the toolbox include:

- Support for linear state space models for prediction
- Quadratic cost function
- Linear inequality constraints on states and controls
- Observer support for state and disturbance estimation
- Integral action by means of disturbance estimation
- Two different QP solvers for solving the optimization problem

TRUE TIME

TrueTime is a Matlab/Simulink-based simulator for real-time control systems. TrueTime facilitates co-simulation of controller task execution in real-time kernels, network transmissions, and continuous plant dynamics. Features of the simulator include

- Written in C++ MEX, event-based simulation
- External interrupts
- Possibility to write tasks as M-files or C++ functions. It is also possible to call Simulink block diagrams from within the code functions
- Network block (Ethernet, CAN, TDMA, FDMA, Round Robin, Switched Ethernet, FlexRay and PROFINET)
- Wireless network block (802.11b WLAN and 802.15.4 ZigBee)
- Battery-powered devices, Dynamic Voltage Scaling, and local clocks
- Stand-alone network interface blocks

From June 2010 the network parts of TrueTime are also available for Modelica using the Dymola 7.4 simulation tool from Dassault Systemes.

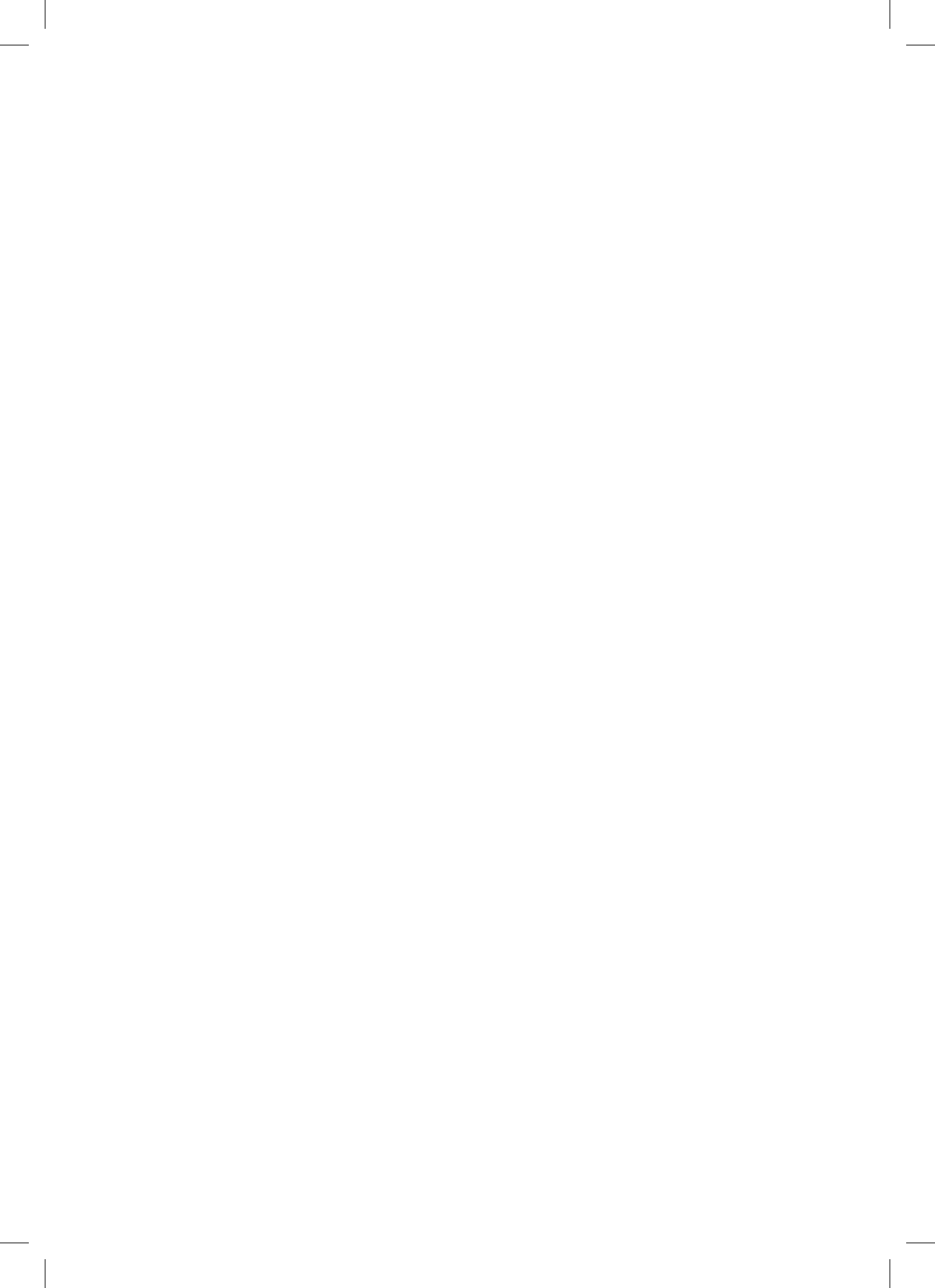

External Contacts

A healthy mix of fundamental and applied work is a cornerstone of our activities. In the applications projects the goal is to solve real control problems together with external partners. In these projects the problems are approached with an open mind without glancing at particular methods. One purpose is to learn about real problems, another is to learn about new problems that are suitable for theoretical research. An important role for universities is to organize knowledge in such a way that the results can easily be digested by engineers in industry. There is naturally a strong symbiosis with teaching in this activity. A good mechanism is thus to introduce new research material into existing and new courses. A related form of technology transfer is to write books and monographs and to develop software. Exchange of personnel between industry and university is another very effective vehicle for technology transfer.

ACADEMIC CONTACTS

We have very good and fruitful relations and cooperations with a number of universities and academic institutions throughout the world. This year we have had important contacts with;

- Centre Hospitalier Universitaire de Montpellier, Montpellier, France
- Lund University, Div. Combustion Engines, Department of Heat and Power Engineering,
- Lund University, Dept. Computer Science
- Lund University, Div Neurophysiology
- Lund University, Dept Mathematics
- Lund University, Dept of Chemical Engineering
- Norwegian University of Science and Technology (NTNU), Trondheim, Norway
- Umeå University, Dept. Applied Physics and Measurements, Umeå
- Hanyang University, Department of Computer Science and Engineering, Seoul, Korea
- Istituto Italiano di Tecnologia (IIT), Department of Advanced Robotics, Genova, Italy
- Fraunhofer IPA, Stuttgart, Germany,
- University of Michigan, Dept Mechanical Engineering
- TU Kaiserslautern, Germany
- DFKI GmbH, Kaiserslautern, Germany
- Zhejiang University, Hangzhou, China
- Universidad de Almeria, Spain
- UNED, Spain
- UP Valencia, Spain

INDUSTRIAL CONTACTS

We have very good working relations with many companies and organizations. The interactions are at different levels and of different intensities, from visits and discussions to joint projects. Master's theses and education are also important ingredients. During the year we have had major projects with;

- ABB Corporate Research Västerås
- ABB Robotics Products, Västerås
- Volvo Powertrain, Inc.
- Novo Nordisk AS,
- Toumaz Technology Ltd, Abingdon, UK
- ABB CRC, Germany
- Gambro, Lund, Sweden
- Perstorp AB, Sweden
- Novozymes AS, Denmark
- SAAB Bofors Dynamics, Linköping, Sweden
- Stora Enso Hylte AB, Sweden

EUROPEAN COLLABORATION

During 2012 the department was involved in the 7th Framework Program of the European Commission.

- DIAdvisor Consortium
- ROSETTA Consortium
- COMET Consortium
- PRACE Consortium
- SMERobotics Consortium
- HYCON II
- MONROE



Staff

During 2012 the staff at Automatic Control stabilized in size. Six new PhD students have been employed and two new post docs. We have also had the pleasure of hosting several international guests for shorter or longer periods.

In the coming parts the personnel and its activities will be described.



PERSONNEL AND VISITORS

PROFESSORS

Årzén, Karl -Erik
 Åström, Karl Johan, senior professor
 Bernhardsson, Bo
 Hagander, Per, senior professor
 Hägglund, Tore, prefekt
 Johansson, Rolf
 Mirkin, Leonid, visiting professor (from August)
 Rantzer, Anders
 Robertsson, Anders
 Wittenmark, Björn, professor emeritus

ASSOCIATE PROFESSORS

Cervin, Anton
 Johnsson, Charlotta

ASSISTANT PROFESSORS

Åkesson, Johan, 20%
 Como, Giacomo
 Gulchak, Andrey, 50%

MARIE CURIE FELLOWS

Bini, Enrico (from March)

RESEARCH ENGINEERS

Andersson, Leif, 30%
 Andersson, Pontus (from May)
 Blomdell, Anders
 Braun, Rolf
 Nilsson, Anders

ADMINISTRATORS

Borgeram, Lizette (from February)
 Mårtensson, Britt-Marie (retired in April)
 Nilsson, Ingrid
 Rasmusson, Monika, 50%
 Schildt, Eva (retired in April)
 Westin, Eva

POSTDOCTORS

Chasparis, Georgios (until October)
 Cho, Jang Ho
 From, Pål Johan, 20%
 Ishido, Yumiko

Kristalny, Maxim (until August)
 Lessard, Laurent (until October)
 Lovisari, Enrico (from September)
 Maggio, Martina (from January)

PHD STUDENTS

Berner, Josefin (from August)
 Berntorp, Karl
 Cescon, Marzia
 Dellkrantz, Manfred (from June)
 Dressler, Isolde (until September)
 Dürango, Jonas
 Garpinger, Olof, 75% (from September)
 Ghazaei, Mahdi
 Giselsson, Pontus
 Grussler, Christian (from January)
 Hast, Martin
 Henningsson, Maria (until October)
 Henningsson, Toivo (until December)
 Johnsson, Ola
 Lindberg, Mikael
 Linderoth, Magnus
 Lindholm, Anna
 Madjidian, Daria
 Magnusson, Fredrik (from February)
 Mannesson, Anders
 Mårtensson, Karl (until August)
 Nordh, Jerker
 Olofsson, Björn
 Pettersson, Anders
 Reuterswärd, Philip (until December)
 Romero Segovia, Vanessa
 Rubanova, Alina
 Soltesz, Kristian
 Sootla, Aivar (until May)
 Sörnmo, Olof
 Ståhl, Fredrik, 50%
 Stemmann, Meike
 Stolt, Andreas
 Theorin, Alfred
 Widd, Anders (until April)
 Xu, Yang (from June)

LONGER AND SHORTER STAYS

Mirkin, Leonid; guest professor, Technion Israel (from August)

Mitter, Sanjoy; professor, MIT USA, October

Papadopoulos, Alessandro; PhD, Politecnico di Milano, June-September

Hosoe, Yohei; PhD, Kyoto University, September-October

Ceriani, Nicola; PhD, Politecnico di Milano (from November)

Li, Yuling; PhD, University of Science and Technology Beijing (from September)

Hwang, Jae Pyung and Lee, Sang Hyoung; PhD students, Hanyang University, April

Wang, Hong; PhD student, Zhejiang University, China (until June)

LCCC focus period

Garin, Federica; focus period guest, INRIA France, 3 weeks

Park, Se Young; focus period guest, UC Berkeley USA, 3 weeks

Farhadi, Alireza; focus period guest, University of Melbourne Australia, 3 weeks

Bolognani, Saverio; focus period guest, University of Padova Italy, 3 weeks

Yuan, Ye; focus period guest, Cambridge University England, 3 weeks

Ramesh, Chitrupa; focus period guest, KTH Sweden, 3 weeks

Saldi, Naci; focus period guest, Queens University Canada, 3 weeks

Coogan, Sam; focus period guest, UC Berkeley USA, 3 weeks

Misra, Vinith; focus period guest, Stanford University USA, 3 weeks

STAFF ACTIVITIES

Åkesson, Johan

Assistant Professor, PhD (2007); joined the department in 2001. Johan's main research interest is in the field of languages and tools for dynamic optimization of large scale systems, including language design, compiler design and implementation, numerical algorithms, and industrial applications.

During 2012, Johan was leading the LCCC theme Modeling for Design and Verification, and he is currently leading the JModelica.org project aimed at developing a Modelica-based open source platform for simulation and optimization of dynamic systems.

During the year, Johan took part in the supervision of five PhD students.

Johan is also associated with Modelon AB, where he works part time.

Andersson, Leif

MSc, Research Engineer since 1970. Leif started at the department with a responsibility for the teaching laboratory.

His professional activities, apart from computer system maintenance, have ranged from computer typesetting (TeX and LaTeX) to using Java as a tool for writing educational software.

During the last few years he has been involved in converting the department web server from the 'Roxen Webserver' to the more common 'Apache Webserver'. In that connection the creation of web pages has been moved from direct editing of HTML code to the use of a Content Management System.

He retired formally in February, but was immediately rehired, working 30% part-time.

Andersson, Pontus

Research engineer at the department since May 2012.

His main tasks include maintenance and development of laboratory equipment and also mechanic and electronic design and implementation.

Årzén, Karl-Erik

Professor (2000), PhD (1987): Joined the department in 1981. His research interests are real-time and embedded control, real-time systems, feedback computing, and programming languages for control.

Co-director for the strategic research area ELLIIT on IT and mobile computing. During the year he has primarily been involved in the VR project Feedback-based resource management for embedded multicore platforms and in the SSF project ENGROSS. He has been responsible for and taught the undergraduate course Real-Time Systems.

He is partly or fully involved in the supervision of four PhD students.

Åström, Karl-Johan

Professor in Automatic Control since 1965, founder of the department, emeritus from 2000, senior professor since 2009. Gave a PhD course in History of Control in the spring of 2012. Delivered plenary lectures at the 2012 ACC in Montreal, the 9th Modelica Conference, and the 50th Allerton Conference. Participated in the celebrations of Kumar and Spong.

Berner, Josefin

MSc in Engineering Physics. PhD student since August 2012. So far most of her time has been spent on taking courses.

Her research area will be within energy usage in buildings. She has also been a teaching assistant in the basic course in automatic control.

Bernhardsson, Bo

PhD (1992). Professor since 1999, has also worked at Ericsson for 9 year. Director of Studies for the PhD education at the department and a member of the LCCC board.

His research interests are in linear systems, applications of control theory and the connection between communication and control theory.

During 2012 he gave the Predictive Control course, and organized three PhD courses: Convex Optimization, Nonlinear Control (with Anders Robertsson) and Convex Optimization II (with Stephen Boyd as main lecturer).

He is the supervisor or co-supervisor of six PhD students.

Berntorp, Karl

M.S. in Engineering Physics, graduate student since January 2009. Karl is part of the SSF funded project ENabling GROwing Software Systems (ENGROSS).

He is currently focusing on sensor fusion algorithms for autonomous localization, particle smoothing algorithms for simultaneous localization and mapping (SLAM), and convex optimization formulations for path planning and trajectory generation in mobile robotics.

He is also involved in the eLLIIT excellence center, investigating optimization-based methods for safety systems in automobiles. During the year he has been involved in teaching the course Real-Time Systems. He has also been attending PhD courses.

Bini, Enrico

Since March 2012, Enrico Bini is Marie-Curie fellow within the EU project Virtual Cyber-Physical Systems (ViCyPhySys). Before, he was assistant professor at Scuola Superiore Sant'Anna, Pisa, Italy. He received the PhD in Computer Engineering from the Scuola Superiore Sant'Anna in October 2004. In 2003 he was a visiting student at University of North Carolina at Chapel Hill, collaborating with prof. Sanjoy Baruah. In January 2010 he also completed a Master degree in Mathematics.

He has published more than 70 papers on scheduling algorithms, real-time operating systems, sensitivity analysis in embedded systems, design and optimization techniques, and real-time and control systems.

Blomdell, Anders

Research Engineer at the department since 1988. Heavily involved in almost all aspects of Robotics Research at the department, also responsible for the department network and lab computers for teaching and research.

Borgeram, Lizette

Administrator at the department since February 2012. She handles student registry in Ladok and have contact with the printing office when comes to dissertations and other publications. She is responsible for the library and archives and for purchase of office supplies, books and furniture.

She also updates parts of the web pages and keep keys in order among other things.

Braun, Rolf

Research Engineer at the department since 1969. Designs and builds equipment for Education, research and robotics. Handles hardware maintenance of computers, robotics and safety systems. He also plans and supervises maintenance and rebuilding of offices and labs.

He is the security representative? (skyddsombud) for the department.

Cervin, Anton

Associate professor, PhD (2003); joined the department in 1998. Anton's research interests include real-time systems, event-based and networked control, and computer tools for analysis and simulation of controller timing. During 2012, he was leader of the research projects "Sub-optimal methods for event-based control and estimation" (funded by the Swedish Research Council and LCCC) and "Integrated scheduling and synthesis of networked embedded event-based control systems" (funded by ELLIIT). He was coordinator and lecturer in the basic-level courses Systems Engineering, Process Control, and Automatic Control, Basic Course (China). He was also program director for the China Profile and deputy member of the Academic Appointments Board 2 at LTH.

He was on part-time leave of absence during November-December to work in industry.

Cescon, Marzia

Tech. Lic., at the Department since July 2008. Her main research interests are in system modeling and identification, in particular applied to biological systems.

Up to August 2012 she was active in the 7th framework project DIAdvisor, targeting modeling of the glucoregulatory systems in type 1 diabetic patients.

She served as teaching assistant for the following courses: predictive control, automatic control basic course (in China for Kinainriktingen).

Chasparis, Georgios

PhD 2008. Georgios has been a post-doctoral scholar in LCCC since December 2010. His research interests lie in the general area of distributed control and optimization.

Cho, Jang Ho

PhD 2010. Jang Ho has been a post-doctoral researcher in LCCC since September 2011. His research interests include haptics and teleoperation. He is currently working on the optimal control of bilateral teleoperation systems with time delays and hybrid control of medical robots to improve operator awareness and safety.

Como, Giacomo

He has been with the Department of Automatic Control since August 2011 as Assistant Professor. In December 2012 He has been appointed docent. His research interests are in the mathematics of control information and networks.

Since January 2012 he has been Principal Investigator of the 4-year-long VR-supported junior research project 'Information Dynamics over large-scale networks'. In Spring 2012 he has been co-teaching (with Anders Rantzer) a the Nonlinear Control course, and in Fall 2012 He taught a Ph.D. course in Information Theory. He has been serving as co-advisor for the PhD student Christian Grussler, and, since September 2012, He has served as advisor for the post-doctoral associate Enrico Lovisari. In May 2012 He has served as a PhD committee member for Florian Hug who graduated from the EIT

Department. In October 2012 He has been organizing the LCCC focus period and workshop in Information and Control in Networks. Together with Anders Rantzer and Bo Bernhardsson, he has edited a book collecting the contributions of the participants, expected to be published by Springer in 2013.

Dellkrantz, Manfred

MSc in Computer Science since November 2011, graduate student at the department since June 2012. Works with automatic elasticity control of applications deployed in cloud environments.

He was involved in teaching the Real Time Systems course during the autumn and also supervised a course project at EIT.

Dressler, Isolde

Msc, graduate student since September 2004. Isolde is interested in robot modeling, calibration and control, particularly of parallel kinematic robots. In September, she defended her PhD Thesis, *Modeling and Control of Stiff Robots for Flexible Manufacturing*.

Dürango, Jonas

MSc in Engineering Physics and with the department as PhD student since July 2010. His main research interest has been in biological motor control and learning, with emphasis on the role of the cerebellum. During the year he has also been involved in the teaching of several of the graduate courses given by the department, as well as taking courses himself.

From, Pål Johan

PhD 2010. He has been a researcher with the LCCC since July 2011. His research includes surgical robotics and he is currently working on improving the haptic perception for the surgeon during robotic surgery.

Garpinger, Olof

Lic. Tech., graduate student since August 2005 with a break from January 2010 to September 2012. Currently on a 75 % work load, Olof is doing research on four parameter design of

robust PID controllers, trade-off plots for PID design criteria as well as control of a Friction Stir Welding machine for thick copper welds. Since he came back to the department in September, he has co-supervised a project group in a joint Real Time Systems/Predictive Control project.

Giselsson, Pontus

Postdoc, PhD (2012). Pontus defended his PhD thesis entitled *Gradient-Based Distributed Model Predictive Control* on Nov. 23 2012. His research interests include optimization and model predictive control (MPC). His work covers both practical and theoretical aspects of MPC. The practical work, in which MPC is applied to a pendulum system, became a laboratory exercise in the under-graduate course Nonlinear Control and Servo Systems. His current research focus is on theory for distributed MPC.

Ghazaei Ardakani, M. Mahdi

He has received a M.Sc. in Secure Telecommunication from the Department of Electrical Engineering of Iran University of Science & Technology (IUST) in 2006. He also received a master degree in Robotics and Intelligent Systems from Örebro University, Sweden in 2011. Since the beginning of 2012, he is with the Automatic Control Department as a PhD student. His research interests include Developmental Robotics, Machine Learning, Artificial Neural Networks, System and Control Theory.

His major assignment, is within the scope of an European robotic project named PRACE (the Productive Robot ApprentiCE). The target is to develop a dual-armed mobile robotic system to automatize a part of shop floor environments. A challenge is to increase flexibility and productivity by shortening the set-up time through intuitive demonstration of tasks to the robot.

During 2012, he started a collaboration with Jang-Ho to build a haptic teleoperation system which facilitates demonstrating assembly tasks. He was also involved in the system identification course as teaching assistant and lab supervisor.

Grussler, Christian

Since 2012, I am a PhD student at Lund University. So far, my research interests included Model reduction, Positive systems and Numerical analysis. Prior to my PhD studies, I was a double degree student of Industrial Mathematics (Technomathematik) at TU Kaiserslautern and Engineering Mathematics (Teknisk Matematik) at LTH Lund. I received a Diploma (Dipl.-Math. techn.) from TU Kaiserslautern and a MSc in Engineering Mathematics from LTH Lund in 2011. In 2012 I was a teaching assistant for Reglerteknik AK FIPi, ED and CMN.

Hagander, Per

Senior Professor, PhD (1973). Per has been with the department since 1968 and works with linear system theory and with applications in biotechnology and medicine.

Hast, Martin

M.Sc. in Engineering Physics, Ph.D. student since February 2010. Martins research interests are in optimal controller design for disturbance attenuation for both feedforward and PID-controllers, supervised by Prof. Tore Hägglund. During the autumn Martin has worked together with Karl-Johan Åström, Bo Bernhardsson and Stephen Boyd with convex optimization methods for design of PID-controllers. Martin has previously been involved in the development of a Modelica-based version of TrueTime and has been a teaching assistant in both the basic control course and the project course.

Henningsson, Maria

PhD, graduate student since 2005. She defended her PhD thesis, *Data-Rich Multivariable Control of Heavy-Duty Engines*, in May 2012. She left the department in November to work as an engineering consultant at Modelon.

Henningsson, Toivo

LicTech, graduate student since August 2005. He defended his PhD thesis, *Stochastic Event-Based Control and Estimation*, in December 2012.

Hägglund, Tore

Professor, PhD (1984). Has been at the department since 1978 except for four years when he worked for ABB.

He is responsible for two of the basic courses in Automatic Control in the engineering program.

His main research interests include process control, PID control, adaptive control, control loop monitoring and diagnosis.

Main research activities during the year have been design of PID controllers, decentralized control structures, and valve stiction diagnosis.

Tore Hägglund is also head of the department and deputy centre director of "Centre for Research and Competence Development for the Process Industry", PIC-LU.

Ishido, Yumiko

PhD. She has been a postdoc at the LCCC since April 2011. Yumiko's main research interests are analysis and synthesis of nonlinear systems. Previously, she has suggested a new mathematical framework for stability analysis of quantized feedback systems in her PhD work. She joined the department in 2011 with a strong interest in a project of developing a new, practical framework for a wider class of nonlinear systems. In the LCCC, she has started with Associate Professor Anton Cervin a work on extending her PhD results to event-triggered networked systems for the purpose. She received SICE 2012 Awards for Outstanding Paper in August 2012.

Johansson, Rolf

Professor, MD, PhD. Active at the department since 1979. Rolf Johansson's research interests are in system identification, robotics and nonlinear systems and automotive control. He is participates and leads the research projects DIAdvisor, SSF ProViking ProFlexa, Vinnova PFF Diesel HCCI, Vinnova NFFP5 Adaptive Control, KCFP Control, ROSETTA, SMERobotics, COMET, PRACE and VR Active Control. He is coordinating director for Robotics Laboratory with cooperation partners from Dept Computer Science and

industrial partners. He has industrial cooperation with ABB Robotics, ABB Corporate Research, Novo Nordisk AS, Volvo. He is responsible for the two courses FRT041 System Identification and FRTN15 Predictive Control.

Johnsson, Charlotta

PhD (1999). Charlotta has been at the department since 1993 except for 4 years (2000-2004) when she worked in industry. Charlotta's main research interest is in Production Control, Batch Control Systems, Manufacturing Operations System. Charlotta is the co-chair of the LCCC research program. She is also part of the management team for the research centers LCCC, PIC-LU and LISA.

Charlotta is serving as the Program Leader for Technology Management, a joint programme run by Lund Institute of Technology and the School of Economics and Management at Lund University. During the year, Charlotta has been involved in a variety of courses.

Johnsson, Ola

MSc in Biotechnical Engineering, graduate student since August 2010. Works within the field of fermentation control, as a project within Process Industrial Centre Lund (PICLU), supervised by Prof. Tore Hägglund.

Spent 2012 developing a fermentation control strategy and performing studies in industrial production scale to determine its feasibility there.

Has also taken various courses and been a teaching assistant in the process control and multivariable control courses.

Kristalny, Maxim

He has been a post-doctoral researcher at the LCCC since August 2010. His research interests include analytical methods in distributed control and the use of preview in control and estimation.

During 2012 he continued his work in a project related to the use of distributed control techniques in teleoperation and haptics. He also continued his work on the use of previewed information for the control of wind turbines.

Lessard, Laurent

PhD, post doc. Laurent joined the department as an LCCC post-doctoral researcher in October 2011. His research has been primarily focused on finding analytical and structural results related to the optimal control of decentralized systems. Specifically, he has been studying sparsity and time-delay constraints, which are very prevalent in distributed systems such as the internet or power grids. He left the department in October 2012 for a research at University of California in Berkeley.

Lindberg, Mikael

Tech. lic, graduate student since July 2007. Main research interests lie in feed back resource management for cyber physical systems, such as cellular phones and autonomous robots.

Linderoth, Magnus

Lic. Tech., PhD student since September 2008. He works on force control and vision feedback for assembly robots as a part of the ROSETTA project.

He was awarded "Best Automation Paper" at International Conference on Robotics and Automation 2012 for the paper "Force Controlled Robotic Assembly without a Force Sensor", co-authored with Andreas Stolt, Anders Robertsson and Rolf Johansson.

During 2012 he has been involved in teaching of Real-Time Systems and Projects in Automatic Control.

Lindholm, Anna

Anna has a M.Sc. in Engineering Physics and has been a graduate student at the department since February 2009.

Her research interests include scheduling and disturbance management within the process industry, and she is involved in a project within the Process Industrial Centre at Lund University (PIC-LU). The project is conducted in collaboration with the Department of Mathematics and the Department of Management and Engineering at Linköping University, and the specialty chemicals producer Perstorp AB.

During 2012, Anna published three conference papers on the topic of management of utility disturbances in the process industry.

She was also a teaching assistant in the Systems engineering course, and gave a guest lecture in the course "Market-driven systems".

Lovisari, Enrico

PhD (2012). He has been a post-doctoral researcher with the Department since September 2012, under the scientific supervision of Associate Professor Giacomo Como. Enrico's research interests are mainly in control and estimation in large-scale networks. His main research topic is distributed control for transportation networks, with a special interest for robustness with respect to exogenous perturbations. He is also interested in synchronization of heterogeneous systems and in river basin identification.

Madjidian, Daria

Daria has a M.Sc in Electrical Engineering and started as a Ph.D student at the department of Automatic control in August, 2008. Until September 2011 he was involved in the EU-funded research project Aeolus with Anders Rantzer. The objective of AEOLUS is to address the effect of aerodynamic coupling in wind farms. Daria's current topic of research is coordinated control of wind turbines in wind farms.

During Spring of 2011 Daria supervised the Master Thesis of Paolo Mattachini, titled "Wind speed prediction models and their use in wind turbine control".

Maggio, Martina

Postdoctoral Researcher since January 2012, PhD education at Politecnico di Milano. Her-research area is control of computing systems and real-time systems. She has been working in the continuations of the ACTORS project. Her-main research topic this year has been resource management in computing environments. In modern computing systems applications must share finite computational resources in a coordinated way. Some application are also able to

dynamically adjust their requirements to provide different service levels. Traditionally the problem of distributing the resources and selecting the applications service levels are treated jointly, to produce an optimal solution, however with a high overhead. The research aims at decoupling the resource allocation and the application adaptation problem, lowering the complexity of both the application manager and the resource manager.

Her contributions toward this end have been the implementation of a resource manager based on the SCHED_DEADLINE Linux scheduling policy to allocate computing resources among the active applications, the development of a library to provide information about the applications execution, the definition of a systematic test suite for applications adaptation and resource allocation. Also, she has addressed the implementation of a simulator for the resource allocation scheme in embedded systems with the TrueTime simulation tool, developed previously here in Lund.

Magnusson, Fredrik

M.Sc. in Engineering Mathematics (2012), Ph.D. student since February 2012. Fredrik's research regards numerical and symbolic algorithms for solution of non-convex dynamic optimization problems and is a part of the research area Modeling Support for Design and Verification of LCCC. During the year the focus has been on collocation methods. He was a teaching assistant in the basic control course during the fall.

Mannesson, Anders

M.Sc. in Electrical Engineering (2005) and B.Sc. in Business and Economics (2005), Graduate student since June 2010. Anders joined the department with 4 years of experience from the electronics industry. He is now working together with Professor Bo Bernhardsson on cellular based indoor navigation within the ELLIIT project. His main research topics involves estimation, filtering and optimization. During the year 2012 Anders has been teaching the project course for the undergraduate students.

Mårtensson, Britt-Marie

Britt-Marie has been a Secretary at the Department since 1974. She was responsible for the department library, and was taking care of the contacts with printing offices for dissertations and other publications. She also was responsible for stock and purchase of office supplies as well as ordering books and journals to the departmental library.

She was an all-round service person who retired in April 2012. These responsibilities are now managed by Lizette Borgeram.

Mårtensson, Karl

MSc, graduate student since December 2006. Karl's research concerns Distributed Control, where he is focusing on structured LQG controllers. He defended his PhD Thesis, *Gradient Methods for Large-Scale and Distributed Linear Quadratic Control* in April 2012.

Mirkin, Leonid

Professor; since Aug 2012; sampling and sampled-data systems, time-delay systems, distributed control.

Taught the PhD course "Introduction to Time-Delay Systems" in Fall 2012.

He is sharing his time between Lund University and Technion in Haifa, Israel.

Nilsson, Anders

PhD (2006), Research Engineer since 2010. Spends most of the time trying to replace Leif's duties looking after the department computers.

With a past at the department of computer science developing compiler and runtime system for real-time Java, he also tries to squeeze in some time for research. For the last three years this has meant being involved in the EU FP7 ROSETTA project, trying to use compiler technology knowledge and tools for managing formal knowledge and ontologies with the goal to make industrial robots easier to use.

Nilsson, Ingrid

Finance officer at the department since 2009. Ingrid is mainly responsible for the financial transactions at the department such as book-keeping, budget managing and balancing of the books. Another big task is administration of research projects and reporting to the sponsors.

Nordh, Jerker

MSc Engineering Physics, graduate student since August 2010. During 2012 the teaching duties have been fulfilled by teaching in the Non-linear Control course, the Projects in Automatic Control course and the Predictive Control course. The research has been focused on indoor navigation, especially on ultrasound based methods, within the ELLIIT project and the rest of the time has been spent following courses.

Olofsson, Björn

MSc in Engineering Physics, PhD student at the department since August 2010. His research interests are in robotics and optimal control. During the year, he has been active in two EU/FP7-projects, COMET and SMERobotics. In the former project, he is performing research on methods for increasing the position accuracy of machining tasks performed with industrial robots. In the latter project, methods for modeling and system identification related to task execution with industrial robots, are investigated. Within the ELLIIT Excellence Center, he is investigating optimal control for mobile robots and vehicles in time-critical maneuvering situations. He has also taken graduate courses within control theory and mathematics and taken active part in the teaching at the department, both within the undergraduate engineering programs and by supervision of Bachelor and Master Thesis projects.

Rantzer, Anders

Professor of Automatic Control since 1999 and head of department 2003-2011. He is coordinator of the Linnaeus center LCCC and has broad interests in modeling, analysis and synthesis of control systems, with particular attention to

robustness, optimization and distributed control. Anders Rantzer is the main supervisor for several PhD students. Three of them finished their PhD during 2012: Aivar Sootla, Karl Mårtensson and Pontus Giselsson. He was also responsible for the courses "FRTN05 Nonlinear Control and Servo Systems" and "FRT095 Mathematical Modelling".

Rasmusson, Monika

Economist/administrator at the department since August 2011. As a part of a team, her work includes reimbursement, travel bills, reporting projects among other administrative tasks.

She has been a Member of the Board at BMSL (Bilingual Montessori School of Lund) during 2011-2012.

Reuterswård, Philip

Civ.ing., Dipl.-Math. techn., PhD student. He is looking into pseudospectral optimization and has recently realized that one should never mobilize without first fixing an objective.

In December 2012, he presented his licentiate thesis, *Towards Pseudospectral Control and Estimation*.

Robertsson, Anders

Professor (2012), Associate professor (2007), "Docent" (2005), Research Associate (May 2003), PhD (1999). Excellent Teaching Practitioner (ETP) in 2007. His main interest is in nonlinear control, robotics and control of computing systems.

Currently he is working on parallel kinematic robots, sensor-data integration and force control of industrial robots in collaboration with ABB Robotics/ABB CRC. The research has been conducted with the LUCAS project, the Robotics Lab, The Linnaeus Centre LCCC, ELLIIT network and the EU funded projects ROSETTA (FP-7), COMET (FP-7), MONROE (FP-7), PRACE (FP-7), SMERobotics (FP-7). He has also been doing research on admission control in network nodes and control of server systems in cooperation with the Department of Electrical and Information Technology, LTH, Lund University, Ericsson AB, Karlskrona

and within the VR-funded CloudControl-project together with Umeå University.

He has lectured in the multivariable control course, and in the project courses on automatic control (FRT090), on machine construction (MMK150) and on electronics and sustainable development (ESSF05), respectively.

He has acted as advisor/co-advisor for 11 PhD students and several Master's Thesis projects.

Romera Segovia, Vanessa

Born in Peru, she has a Lic. Sc. since September 2009 and an M. Sc. in Electrical Engineering since August 2008. Vanessa is a PhD student at the department since September 2008. Her current research interests are related to Adaptive Control, and to the design of measurement noise filters for PID and PI controllers, which can be used in process control applications.

She is an active member of the Process Industrial Centre at Lund University (PICLU). Her past research activity has been related to real-time systems. She has been an active member of the EU Project ACTORS (Adaptive Control of Resources in Embedded Systems), where her task was the design and implementation of different control algorithms to achieve CPU bandwidth adaptation in multicore systems.

As part of her PhD duties she is a teaching assistant of courses such as Automatic Control, Process Control, Market-Driven Systems, International Project Course in Automatic Control, and Real-Time Systems.

Rubanova, Alina

Alina is a Ph.D Student at the Department of Automatic Control since October 2009. She is doing research as part of the project Active Control of Compressor Systems Based on New Methods of Nonlinear Dynamic Feedback Stabilization (Rolf Johansson, Anders Robertsson in cooperation with Prof. A. Shiriaev, Umeå University).

She is also teaching in Automatic Control basic course at laboratories and exercises.

Schildt, Eva

She has been a Secretary at the Department since 1970. She was responsible for the overall administration, for budget and economy, for the personnel administration and took care of the administration concerning visitors at the department.

She retired in April 2012 and Eva Westin is now taking over her main duties in human resources including visitors. Ingrid Nilsson is responsible for budget and economy, together with Monika Rasmusson.

Soltész, Kristian

M.Sc., graduate student since October 2008. Kristian presented his licentiate thesis, *On automation of the PID tuning procedure*, in January 2012.

During the year he has visited the group of professor Guy Dumont at the University of British Columbia, Vancouver, Canada, as part of an ongoing collaboration on closed-loop control of anesthesia, funded by LCCC and locally supervised by professor Tore Hägglund. A successful patient study, authorized by British Columbia Children's Hospital (BCCH) REB: H10-01174, was completed during 2012 and has resulted in several published or accepted contributions to journals and conferences.

During the spring, Kristian has supervised two student groups within an advanced course in mathematical modelling at Lund University.

During the fall he spent two months at Zhejiang University, Hangzhou, China as course responsible lecturer of the basic course in automatic control.

Sootla, Aivar

Aivar was a PhD student until May 2012. He was working on optimization based model reduction algorithms for linear time invariant, linear parameter dependent systems and structured systems. He defended his PhD Thesis *Model Order Reduction Based on Semidefinite Programming*, in January, 2012.

He has moved to the Centre for Synthetic Biology and Innovation in the Department of Bionengineering at Imperial College.

Ståhl, Fredrik

M.Sc.(2003), 50 % graduate student since 2008. Fredrik is involved in the DIAdvisor project, where his research has focused on modeling, identification and prediction of blood glucose dynamics. In December 2012 he presented his licentiate thesis, *Diabetes Mellitus Glucose Prediction by Linear and Bayesian Ensemble Modeling*.

Stemann, Meike

MSc, graduate student since November 2009. Meike was involved in the DIAdvisor project within the European FP7-ICT program, which is aimed at developing a blood glucose prediction and treatment advisory system for diabetic patients. Within this project, she has worked on developing control algorithms, that determine the doses of insulin injections and eventual additional carbohydrates for diabetic patients which use, e.g., insulin pens to administer their insulin. These control algorithms use individualized patient models and determine the doses of insulin and carbohydrates based on solving an optimization problem.

Stolt, Andreas

Lic. Tech., graduate student since March 2010. He defended his licentiate thesis, *Robotic Assembly and Contact Force Control*, in December 2012. He is working in the Rosetta project, which aims to develop technology for industrial robots that will not only appear more human-like, but also cooperate naturally with human workers. Andreas main focus in the project has been force controlled compliant assembly. During the spring, he was a teaching assistant in the basic course, and during the fall, he was a teaching assistant in the multivariable control course.

Sörnmo, Olof

MSc in Engineering Physics, PhD student since May 2010. Olof's main research interests are within robotics and he is involved in the EU/FP7-projects COMET and SMErobotics, as well as the SSF/ProViking-project ProFlexA. His research focuses mainly on improving machining processes performed with industrial manipulators. Topics include adaptive force control, stiffness compensation and mid-ranging control.

Theorin, Alfred

M.Sc. in Engineering Physics. Ph.D. student since January 2010. Alfred's main research interests involve control languages and industrial automation and he is working on the Grafchart for Industrial Automation project. During the year he has worked to improve JGrafchart, mainly to enable real-time execution. During the spring he was a teaching assistant in the Market-driven Systems course as well as assistant supervisor for a master's thesis. During the fall he was a teaching assistant in the Real Time Systems course.

Xu, Yang

I am a PhD student in the Department of Automatic Control since June 2012.

My main research is Integrated Scheduling and Synthesis of Networked Embedded Event-Based Control Systems.

I am a teaching assistant in Automatic Control course.

Westin, Eva

PhD in French linguistics. Administrator at the department since 2008 and administrative coordinator from 2012. She has the overall responsibility of human resources, guests and conferences. She also handles part of the administration for the research study program. Eva is the project administrator for the LCCC Linnaeus project. She is the co-supervisor of a PhD thesis in French linguistics at the Center of Languages and Literature (SOL) at Lund University.

Widd, Anders

PhD, graduate student since December 2006. He was working with Professor Rolf Johansson on the Project "KCFP, Closed-Loop Combustion Control", which is a cooperation with the Division of Combustion Engines. He has also participated in the project "Diesel-HCCI in a Multi-cylinder Engine". In April 2012, he defended his PhD thesis, *Physical Modeling and Control of Low Temperature Combustion in Engines*.

Wittenmark, Björn

He joined the department in 1966 and took his PhD in 1973. He became full professor at the department 1989.

His main research interests are adaptive control, sampled-data systems, and process control. His current interests are in the areas of process design and control and control of communication networks.

He is now emeritus professor at the department.

During 2012 he was temporarily Head Librarian for Lund University Library.

LOOKING BACK AT ADMINISTRATION AT AUTOMATIC CONTROL

The administration at the Department of Automatic Control has always been a role-model. Apart from smaller variations, a core team composed of Eva Schildt, Britt-Marie Mårtensson, Eva Dagnegård and Agneta Tuszynski, were setting the standards for the administration. Eva Dagnegård started in 1975, she was responsible for various activity reports, and handled the contacts with printing offices for dissertations and publications. She was also the expert in the word processing TEX and worked with graphic design and layout, both for paper publishing and for the web. Agneta Tuszynski started in 1981, at first as temporary for writing- work, then as Secretary at the Department, and was responsible for the registration of students and their exam results, writing letters, articles and reports. She took over the responsibility for the activity report when Eva D left the department in 2000.

Automatic Control was founded in 1964. Karl Johan Åström was appointed professor in 1965 and began to build up the Department of Automatic Control in Lund. We still recognize some names from the very beginning as active at the Department today. Automatic Control has remained one Department, even though there have been many changes within the University over the years. A strong leadership and a good economy have helped to preserve the Department of Automatic Control as one unit. Automatic Control has almost all the time been located in the M-building.

Eva Schildt was engaged at the age of 23. She had studied English at Lund University, and she had a secretarial education from Polhem high school, Lund. This was her first job, apart from different jobs during summers, when still studying. Britt-Marie had a 2-year clerical/office education and had studied map-drawing in Stockholm. After having spent 5 years at different companies and 2 years at the Architect center at Lund University, she was employed at the Department mainly doing drawings for reports,

education and research. In those days the work was handmade using ink pencils. The new entry by computers changed the work dramatically for both of them. To begin with the work was manual using pencils, typewriters, telephones, dictating machine and making copies using carbon-paper, all correspondence by mail. The development continued with teletypewriter, telefax and electrical typewriters with rubber key and symbolic ball, which was a "must" for a secretary. Today the use of computers, e-mail, photocopy machines and all kinds of administrative on-line systems for different purposes is the standard. What will the future bring us in terms of new development?

With a working experience of more than 40 years each, it was time for Eva Schildt and Britt-Marie Mårtensson to retire and spend their time on other interests in life. They are both taking part in their grandchildren's lives, travelling, gardening, genealogy and training. To be retired does not at all mean a less active life, on the contrary they are more busy than ever.



Britt-Marie Mårtensson

Looking back they have had the responsibility of forming the administration at the Department almost from the very start. The Department grew from being about 17 individuals in 1970 up to around 60 today. Through a phase of enormous development of new technical support, they managed to find a way, not only to adjust to new challenges that occurred over time, but also to use the novelties in smart ways. The "revolution" within administration came with the use of computers and the different administrative systems that have seen the light over the years. Using the new tools as well as introducing them to the staff has not been easy and many times the systems have not been ready when taken into use. Trial and error has sometimes, and even very often, been the most efficient method.

The Department has always had an international profile with many contacts around the world. One reason was the network Karl Johan Åström brought with him when starting up the Department of Automatic Control, a network which has evolved over the years. He has always given the secretaries a large freedom and responsibility and also his full support to form the administration. This attitude has been adopted by later heads of the Department. Alumni is another useful tool for keeping track of people who have defended their licentiate and/or doctoral theses at Automatic Control and the Faculty of Engineering in Lund. Here we find people at positions in various fields in manufacturing industries, universities etc. The administrative team have been a very valuable source when welcoming and taking care of employees and guests, but also keeping track and contact with people after they have left the department.

During the years there have been many occasions to celebrate and a familiar atmosphere was created from the beginning where weddings, births, licentiate and doctoral dissertations, birthdays and jubilees have been reasons for festivities. Time and age have had an impact on the type of social activities performed over the years. Eva and Britt-Marie have been organizing, keeping track of and of course taken part in all kinds of events. To have coffee breaks at 10 and 15, was and still

is a natural way to meet colleagues and guests.

Within Lund University, the secretaries at the Department of Automatic Control have kept their dead-lines whatever task to fulfill. A milestone was when Eva was awarded the Peter Honeth's price for "excellent administrative contribution along with an innovated initiative" in 2008, which recognized Eva for all the work she has put into the Department of Automatic Control. It is an honourable reward to receive.

To summarize, it is the ambience, the meetings with new people and the get-togethers they will remember and cherish most.

Last but not least, they both say "how did we know that we were to work at the best department ever"?

A new administrative team taking over

For many years, the core team - composed of Eva S, Britt-Marie, Eva D and Agneta, formed the administrative working team at the Department of Automatic Control.

Eva Dagnegård left in 2000 after 25 years helping colleagues with the writing of articles, dissertations and books. When Eva D left Britt-Marie handled the contacts with printing offices and the administration concerning conferences, workshops and meetings at the department.

Agneta Tuszyński retired in 2008, after having served for 27 years as Secretary. By her retirement a transformation of the team began. In 2008, Eva Westin was engaged to replace Agneta.

By that time Eva S and Britt-Marie had already started to think about their own retirement and in 2009/10, they both decided to cut down on working hours to half-time. Ingrid Nilsson joined the department to be responsible for budget and economy.

In 2011 they both planned for the next step which was full-time retirement to be in spring 2012. Monika Rasmusson was engaged for economic and administrative tasks at the Department.

In the beginning of 2012, Lizette Borgeram was employed to replace Britt-Marie. She is



Eva Schildt and cake "typewriter"

now one of the corner-stones in the new administration team, challenging new possibilities in the years to come.

After many “good byes” to the last two secretaries at the Department, Eva Westin was now appointed administrative coordinator and has an overall responsibility for administration.

To conclude, Eva and Britt-Marie have also taken part in forming the new team, which might have influenced the “let go” in a positive way, to be assured about the continuity of the good work at the administration.

Lizette Borgeram – (the most recent colleague of the team)

My employment at the department began in the beginning of 2012. I work mainly with course administration and the various duties Britt-Marie left when retiring. When I applied for this employment I was attracted by the variation of tasks and decided to accept because of the possibilities to form my work situation. I look forward to being part of the administrative team and its development.

When it comes to education I have a degree in Business Administration from Linnaeus University. I have also studied in the field of cultural studies with focus on sub- and youth cultures. Art history and design are other disciplines I have enjoyed. Beside my university degree, I have an education in pattern construction and sewing, which I like to explore.

After my studies I've had some administrative positions and also worked practically with textiles. Before I started at the department I worked as an exhibition assistant at Malmö Konsthall.

I live in Malmö with my fiancé. In my spare time I like to read books, do creative stuff and cook vegetarian food. I also practice Bikram Yoga which is traditional Hatha Yoga but in 40 degrees heat, it's real sweaty and challenging!

AWARDS

ICRA2012 Best automation paper

The paper *Force Controlled Robotic Assembly without a Force Sensor* written by Andreas Stolt, Magnus Linderöth, Anders Robertsson and Rolf Johansson received the "Best automation paper" award from the IEEE International Conference on Robotic and Automation (ICRA2012).

Young Author Award

At the International Symposium on Advanced Control of Chemical Processes, for the paper *Formulating an Optimization Problem for Minimization of Losses due to Utilities* written by Anna Lindholm and Pontus Giselsson, they received the "Young Author Award".

INCOM'12 Best Paper Award

Alfred Theorin and Charlotta Johnsson received the "Best Paper Award" from the 14th IFAC Symposium on Information Control Problems in Manufacturing (INCOM'12) for their article *Service-oriented Process Control with Grafchart and the Devices Profile for Web Services* written together with Lisa Ollinger.

SICE 2012 Outstanding Paper Award

Yumiko Ishido received SICE 2012 Award for Outstanding Paper in August 2012 (the Japan Society of Instrument and Control Engineers) for the paper *Robust L_p stability and robust L_{inf} stabilization over a rate-limited digital channel*, published jointly with co-author Kiyotsugu Takaba in Journal of Control, Measurement, and System Integration.

Carlo-Guido Stella Award 2012

Charlotta Johnsson received the Carlo-Guido Stella Award in 2012. The Carlo-Guido Stella award is given to professionals who have excelled in the field and/or who have been an inspiration and mentor to all in the process industry.

IEEE Fellow,

Rolf Johansson was awarded IEEE Fellow, for contributions to system identification and adaptive control.

ASME 2012 Best-Paper-in-Session Award (Session: Biochemical Systems):

Marzia Cescon, Meike. Stemmann, Rolf Johansson received "Best Paper in Session Award". Impulsive Predictive Control of T1DM Glycemia: *An In-Silico Study*. Proc. ASME 2012, 5th Annual Dynamic Systems and Control Conference & JSME 2012, 11th Motion and Vibration Conference (DSCC2012-MOVIC 2012), Oct 17-19, 2012, Fort Lauderdale, Florida, USA.

ASSIGNMENTS

BOARD MEMBER

Årzén, Karl-Erik

Member of the Board for the ELLIIT strategic research area project.

Member of the Steering Committee for the International Conference on Cyber-Physical Systems (ICCPs)

Member of the Strategic Management Board for the EMSIG Special Interest Group on Embedded Systems

Hägglund, Tore

Expert member in legal proceedings for patent at Svea Court of Appeal.

Johansson, Rolf

Board Member of DIAdvisor Executive Board

Board Member of ROSETTA Project Management Board, 2009-2013

Board Member of ROSETTA Project Scientific Board, 2009-2013

Johnsson, Charlotta

Board member in Technology Management Center (TMC) at Lund University.

Rantzer, Anders

Member of the Scientific Council for Natural and Engineering Sciences within the Swedish Research Council.

Member of the steering committee for the International Symposium on Mathematical Theory of Networks and Systems.

Member of the Advisory Board for Lecture Notes in Control and Information Sciences at Springer Verlag Heidelberg.

Member of the IEEE Control System Society Technical Committee on Nonlinear Systems and Control.

Member of the IFAC Technical Committee on Nonlinear Systems.

MEMBER OF INTERNATIONAL PROGRAM COMMITTEE (IPC)

Åkesson, Johan

9th International Modelica Conference 2012, Munich, Germany

Årzén, Karl-Erik

Member of the Program Committee for the 24th Euromicro Conference on Real-Time Systems (ECRTS 2012), Pisa, Italy, July 10 - 13, 2012

Member of the Program Committee for RTSS 2012, The 33rd IEEE Real-Time Systems Symposium San Juan, Puerto Rico, Dec 4-7, 2012

Member of the Program Committee for Feedback Computing - The 7th International Workshop on Feedback Computing

Member of the Program Committee for the Third International Conference on Cyber-Physical Systems (ICCPs 2012)

Member of the Program Committee for the 18th IEEE Real-Time and Embedded Technology and Applications Symposium (RTAS 2012)

Member of the Program Committee for the 9th International Modelica Conference

Member of the Program Committee for the International Workshop on Real-Time and Distributed Computing in Emerging Applications (REACTION 2012)

Bini, Enrico

Member of the Program Committee of the 24th Euromicro Conference on Real-Time Systems (ECRTS) 2012, Pisa, Italy.

Member of the Program Committee of the 17th IEEE Emerging Technologies and Factory Automation (ETFA) 2012, Real-Time and (Networked) Embedded Systems (RTNES) track, Krakov, Poland.

Member of the Program Committees of the 18th International Conference on Embedded and Real-Time Computing Systems and Applications (RTCSA) 2012, Real-Time Systems and Ubiquitous Computing/Cyber-Physical Systems tracks, Seoul, South Korea. Member of the Program Committee of the 20th International Conference on Real-Time and Network Systems (RTNS) 2012, Pont-à-Mousson, France.

Cervin, Anton

Member of the Program Committee for the 24th Euromicro Conference on Real-Time Systems (ECRTS'12).

Hägglund, Tore

Member of IPC. IFAC Conference on Advances in PID Control, Brescia, Italy, 2012. IFAC Symposium on Advances in Control Education - ACE 2012, Nizhny Novgorod, Russia. 10th Control Conference, Funchal, Madeira, 2012.

Johansson, Rolf

IPC Member of the 3rd Workshop on Engine Control, Simulation and Modeling (E-COSM'12), Paris, 25-27 October 2012.

Member of Advisory Committee, IEEE BioRob 2012, IEEE International Conference on Biomedical Robotics and Biomechanics (BioRob2012), June 24-28, 2012, Roma, Italy; Sponsored by IEEE Robotics and Automation Society & IEEE Engineering in Medicine and Biology Society.

IPC Member, 10th Controlo Conference (Controlo 2012), Funchal, Madeira, Portugal, July 23-25, 2012
IPC Member, IFAC Workshop on Automatic Control in Offshore Oil and Gas Production (IFAC ACOOG 2012), Trondheim, Norway, May 31-June 1, 2012.

IPC Member, Second International Conference on Communications, Computing and Control Applications (CCCA'12), Marseilles, France, September 12-14, 2012.

IPC Member, The UKACC International Conference on Control 2012, Cardiff, UK, 3-5 September, 2012.

Co-chair & IPC Member, The 6th International Workshop on Innovation and Commercialization of Micro & Nanotechnology (ICMAN 2012), November 4-7, 2011 Hangzhou, China

Mirkin, Leonid

NOC member and Associate editor, Itzhack Y. Bar-Itzhack Memorial Symposium on Estimation, Navigation, and Spacecraft Control, Haifa, Israel, 2012

IPC member, IFAC joint conference: Symposium on System Structure and Control; Workshops on Time-Delay Systems and on Fractional Differentiation and Its Applications, Grenoble, France, 2013

Technical Program Committee member, the 52nd IEEE Conference on Decision and Control, Florence, Italy, 2013

Rantzer, Anders

Member of the IPC for European Control Conference, Zürich, 2013. Member of the IPC for 9th IFAC Symposium on Nonlinear Control Systems, Toulouse, 2013.

Member of the IPC for 4th IFAC Workshop on Distributed Estimation and Control in Networked Systems, Koblenz, 2013.

Robertsson, Anders

Member of the steering committee and the Program Committee of FeBID 2012.

Member of the Program Committee ICAC 2012.

OPPONENT AND MEMBER OF EXAMINATION COMMITTEE**Årzén, Karl-Erik**

Member of the PhD thesis committee for Soroush Afkhami Meybodi, Oct 11, Department of Electronic Systems, Aalborg University

Member of the PhD thesis committee for Sajed Miremadi, Nov 16, Department of Signals and Systems, Chalmers University of Technology

Bernhardsson, Bo

Member of the examination committees for two PhD theses, Anders Möller, Optimization and System Theory at KTH and Deepak Dasalukunte, Communication Theory at LTH.

Bini, Enrico

Member of the examination committee of the PhD thesis "Scheduling in manufacturing systems" by Jan Kelbel, Department of Control Engineering, Faculty of Electrical Engineering, Czech Technical University, Prague, Czech Republic, October 15th.

Opponent for the PhD thesis "Pragmatic Approaches for Timing Analysis of Real-Time Embedded Systems" by Yue Lu, Mälardalen, University, Västerås, Sweden, June 18th.

Hägglund, Tore

Member of the Examination Committee for the PhD thesis by Andrzej Pawlowski, June 8, at Universidad de Almeria, Almeria, Spain, the PhD thesis by Torben Green, September 12, at DTU, Lyngby, Denmark, and the PhD thesis by Miguel Castaño Arranz, November 29, at Luleå University of Technology, Luleå, Sweden.

Johsson, Charlotta

Member of Examination Committee for the PhD thesis "A Simulation-Based Optimization Method for PLC Systems", Bo Svensson, Department of Signals and Systems, Chalmers University of Technology, Gothenburg, Sweden, April 13, 2012.

Mirkin, Leonid

PhD committee member at the University of Twente, The Netherlands, Dec 2012

Rantzer, Anders

Member of PhD examination committee for Dang Doan, TU Delft, The Netherlands.

Robertsson, Anders

Examiner of Licentiate thesis "Towards Pseudospectral Control and Estimation" by Philip Reuterswärd, 19 December 2012.

Member of evaluation committee for the PhD thesis "Adaptive flexibility in migratory behaviour of shorebirds" by Johanna Grönroos, Lund. 16 May, 2012.

Faculty opponent of Licentiate thesis by Jeroen De Backer, Trollhättan Högskolan Väst "Robotic Friction Stir Welding for Flexible Production", 15 June, 2012.

Member of evaluation committee for PhD thesis "Sustainable Design and Control of Automated Material Handling Systems Presentation" by Maziar Mashaei, Chalmers, 28 September, 2012.

ADVISORY COMMITTEES AND WORKING GROUPS

Årzén, Karl-Erik

Member of the Norwegian committee on assessment of competence for the title of full professor in IT.

Member of the evaluation panel for Signals and Systems, Swedish Research Council (VR)

Member of the Royal Swedish Academy of Engineering Sciences (IVA)

Johansson, Rolf

Member of IEEE EMBS Technical Committee (TC) for Biomedical Robotics

Member of Joint EMBS/RAS Advisory Committee on Biorobotics;

Reviewer FP7-ICT-2011 Call 9 ICT Challenge 2: Cognitive Systems and Robotics

Johnsson, Charlotta

Voting member in the standardisation committee ISA95 and an information member in the standardization committees ISA88 and ISA99.

Member in SIS and SEK and serves as the Swedish expert in the international IEC 62264 and ISO 22400 standards.

BOOK AND JOURNAL EDITOR

Årzén, Karl-Erik

Associate Editor for Real-Time Systems Journal

Area Editor for the Leibniz Transactions on Embedded Systems (LITES)

Hägglund, Tore

Editor for Control Engineering Practice.

Johansson, Rolf

Associate Editor, Int. J. Adaptive Control and Signal Processing;

Associate Editor, Chinese Journal of Scientific Instrument, (China Instrument and Control Society);

Associate Editor, Automatic Control of Physiological State and Function

Associate Editor, ISTE-Wiley & Hermes Science Publishing

OTHER ASSIGNMENTS

Årzén, Karl-Erik

Interest Group on Embedded Systems.

Member of Research Board of Mathematics, Physics & Information and Communication Technology, Faculty of Engineering, Lund University

Åström, Karl Johan

Organizer and Chairman of special industrial session on Future Perspectives on PID Control. IFAC Conference on Advances in PID Control, Brescia, Italy, March 29, 2012.

Bini, Enrico

Workshops chair of the 33rd IEEE Real-Time Systems Symposium (RTSS) 2012, San Juan, Puerto Rico. Organizer of the Workshop on Emerging Problems in Real-Time Embedded Systems, Pisa, Italy, July 2012.

Johnsson, Charlotta

Member in UN3 (utbildningsnämnd 3) at LTH.

Serving as the IFAC Liaison with IEC 65A

Editor of ISO 22400 Part 1.

Robertsson, Anders

Vice chair in educational board (Utbildningsnämnd UN1), Collage of Engineering (LTH), Lund University.

LONGER VISITS

Cescon, Marzia

PhD, Zhejiang University, Hangzhou, China 2012-10-23 - 2012-12-08

Johansson, Rolf

Guest Professor, Norwegian University of Science & Technology (NTNU), Trondheim, Norway, August 2012.

Visiting Professor, Tsinghua University, China, September-December, 2012.

Johnsson, Charlotta

Department of Cyber-Systems and Control, Zhejiang University, Hangzhou, China. September 1, 2012 – October 19, 2012.

Soltesz, Kristian

PhD, UCB Vancouver, Canada, 2012-01-28 - 2012-02-24

Course responsible lecturer of FRT010 "Automatic Control, Basic Course" at Zhejiang University, Hangzhou, China during the second half of the fall semester.



Economy and General Information

This chapter informs about Economy, Funding and Internet Services

ECONOMY

The turnover for 2012 was 53,9 MSEK, an increase by 7 MSEK since 2011. About 40% of the income comes from Lund University, and 60% from external grants. The distribution is shown in Table 1.

The activity and the number of employees have increased substantially in the last few years, mainly because of the Linnaeus grant "Lund

Center for Control of Complex Engineering Systems" - LCCC, and "The Linköping–Lund Initiative on IT and Mobile Communication" - ELLIIT, funded by the Swedish Research Council. However, now the situation seems to have stabilized, the number of employees is the same 2012 as 2011. The department participated in 7 projects funded by European Union, EU, during 2012 and The Swedish Foundation for Strategic Research has also provided substantial support of the activities.

Turnover 2008-2012

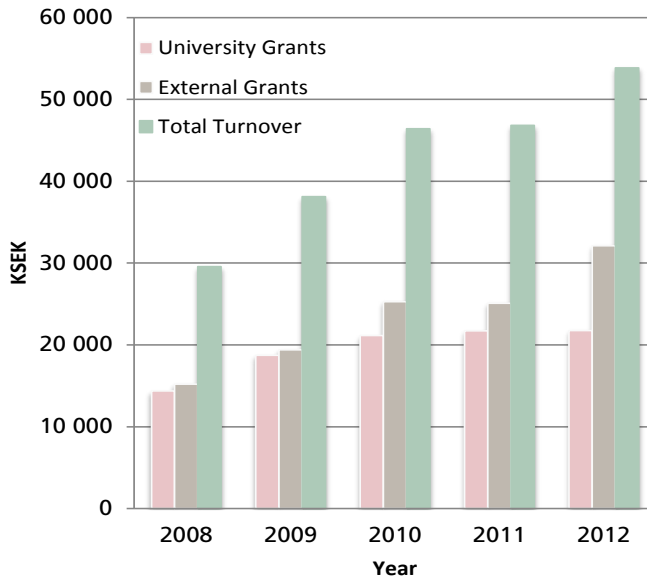

Table 1

FUNDING

During 2012 we had the following contracts:

VR – Linnaeus grant Lund Center for Control of Complex Engineering Systems LCCC
 VR - Active Control of Compressor Systems Based on New Methods of Nonlinear Dynamic Feedback Stabilization
 VR – Suboptimal Methods for Event-based State Estimation and Control
 VR – Remuneration for Anders Rantzers' function as a Member of the Scientific Council for Natural and Engineering Sciences within the Swedish Research Council 2010-2012
 VR – Resource Allocation and Control of Distributed Service Management Systems
 VR – Information Dynamics over large-scale networks
 VR – Feedback Based Resource Management for Embedded Multicore Platforms
 Vinnova-Saab – Adaptiv Control in Flying Vehicles
 Energimyndigheten - Predictive Control and System Optimisation of Wheel Loaders
 Vinnova – Line Information System Architecture, LISA
 SSF – Process Industrial Center at Lund University, PICLU
 SSF – Enabling GROwing Software Systems, ENGROSS
 SSF – Productiv Flexibel Automation
 SSF – ICT platform for lasting infrastructure, ICT-PSI
 SSF – Process Industrial Center at Lund University, PICLU 2
 EU – ICT-216592 Personal Health Systems for Monitoring and Point-of-Care Diagnostics, DIAdvisor
 EU – FP7 ICT-230902 ROBOT control for Skilled ExecuTion of Tasks in natural interaction with humans; based on Autonomy, cumulative knowledge and learning, ROSETTA
 EU – FP7 258769 Plug-and-produce COmponents and METHods for adaptive control of industrial robots enabling cost effective, high precision manufacturing in factories of the future, COMET
 EU – FP7 257462 Highly-complex and networked control systems, HYCON
 EU – FP7 231143 Hyper-Modular Open Networked ROBOT systems with Excellent Performance, MONROE
 EU – FP7 287787 The European Robotics Initiative for Strengthening the Competitiveness of SMEs in Manufacturing by integrating aspects of cognitive systems, SMERobotics
 EU – FP7 285380 The Productive Robot Apprentice, PRACE
 The Linköping–Lund Initiative on IT and Mobile Communication, ELLIIT
 Marie Curie – Virtual Cyber-Physical Systems
 Toyota Moter Corporation – Project on Nonlinear Model Reduction
 SKB - Control of Stirwelding Process for Sealing
 Vägverket –Estimation of Road Friction
 Novozymes – Agreement on Co-financed PhD study
 Emissions Control for Low Climate Impact, KCFP2
 Energimyndigheten – Diesel Combustion with Low Environmental Impact
 ACCM Mechatronics

The block grants from VR and some of the SSF projects are long range. Several projects do, however, have a duration of only two years. To match these with the length of a PhD position, i.e. 5 years, we have a long-term internal research planning, and we are careful to bid on projects that fit into our research plan. This has proven efficient to match short-term funding, research planning and personnel.

INTERNET SERVICES

WORLD WIDE WEB

Visit our homepage at this address: www.control.lth.se

Our webpage contains information about personnel, research, publications, seminars, education etc. It also contains fairly complete lecture notes for many courses and, in some cases, software tools such as Matlab tool-boxes developed at the department. Our home-page first appeared on the World Wide Web (www) in April 1994.

Appendix

This chapter contains a list of Publications, Seminars and Lectures given outside the Department during 2012

PUBLICATIONS 2012

You can find references to all the publications on www.control.lth.se/publications/ and almost all of them can be downloaded from this site. Only a limited number of copies of our reports are available for sale from the department. Any of the reports may, however, be borrowed through your library service or from the following libraries in Sweden:

- Linköpings Universitetsbibliotek, Svensktrycket, SE-581 83 Linköping
- Universitetsbiblioteket Lund, Svenska Tryckavdelningen, Box 1010, SE-221 03 Lund
- Stockholms Universitetsbibliotek, Svenska Tryckavdelningen, SE-106 91 Stockholm
- Kungliga Biblioteket, Box 5039, SE-102 41 Stockholm
- Umeå Universitetsbibliotek, Box 718, SE-901 10 Umeå
- Uppsala Universitetsbibliotek, Box 510, SE-751 20 Uppsala

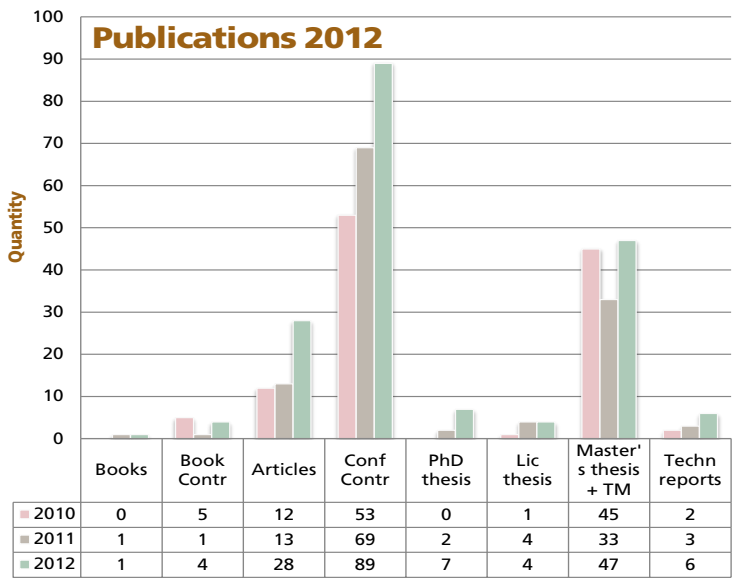

BOOK

Johansson, Rolf; Rantzer, Anders (Eds); *Distributed Decision Making and Control*, Springer January 2012.

BOOK CHAPTER

Anastasi, Gaetano F.; Bini, Enrico; Lipari, Giuseppe: *Extracting Data from WSNs: A Service-Oriented Approach*; In Giuseppe Anastasi, Emilio Bellini, Elisabetta Di Nitto, Carlo Ghezzi, Letizia Tanca, Eugenio Zimeo (Eds.): *Methodologies and Technologies for Networked Enterprises*, Springer, 2012.

Guzmán, José Luis; Häggglund, Tore; Visioli, Antonio: *Feedforward compensation for PID control loops*; In Ramon Vilanova, Antonio Visioli (Eds.): *PID control in the third millenium*, Springer, January 2012.

Henningsson, Maria; Ekholm, Kent; Strandh, Petter; Tunestål, Per; Johansson, Rolf: *Dynamic Mapping of Diesel Engine through System identification*. In D. Alberer, H. Hjalmarsson, L. del Re (Eds.). *Identification for Automotive Systems*, Vol. LNCIS 418, Ch. 14, Springer, London, 2012.

Jörntell, Henrik; Forsberg, Per-Ola; Bengtsson, Fredrik; Johansson, Rolf: *Mathematical Modeling of Brain Circuitry during Cerebellar Movement Control*; In Yunhui Liu, Dong Sun (Eds.): *Biologically Inspired Robotics*, CRC Press, Taylor & Francis, Boca Raton, FL, 2012.

Widd, Anders; Tunestål, Per; Johansson, Rolf: *Modeling for HCCI Control*; In D. Alberer, H. Hjalmarsson, L. del Re (Eds.): *Identification for Automotive Systems*, Springer, London, 2012.

JOURNAL ARTICLES

Åkesson, Johan; Laird, Carl D.; Lavedan, Geoffry; Prölss, Katrin; Tummescheit, Hubertus; Velut, Stéphane; Zhu, Yu: *Nonlinear Model Predictive Control of a CO₂ Post-Combustion Absorption Unit*; *Chemical Engineering & Technology*, 35:3, pp. 445–454, January 2012.

Amani, Payam; Aspernäs, Bertil; Åström, Karl-Johan; Dellkrantz, Manfred; Kihl, Maria; Radu, Gabriela; Robertsson, Anders; Torstensson, Andreas: *Application of Control Theory to a Commercial Mobile Service Support System*; *International Journal On Advances in Telecommunications*, 5:3&4, 2012. Accepted for publication.

Cederqvist, Lars; Garpinger, Olof; Häggglund, Tore; Robertsson, Anders: *Cascade control of the friction stir welding process to seal canisters for spent nuclear fuel*; *Control Engineering Practice*, 20:1, pp. 35–48, January 2012.

Chasparis, Georgios; Shamma, Jeff S.: *Distributed Dynamic Reinforcement of Efficient Outcomes in Multiagent Coordination and Network Formation*; *Dynamic Games and Applications*, 2:1, pp. 18–50, January 2012

Como, Giacomo; Savla, Ketan; Acemoglu, Daron; Dahleh, Munther A.; Frazzoli, Emilio: *Stability analysis of transportation networks with multiscale drivers decisions*; *SIAM Journal on Control and Optimization*, 51:1, pp. 230–252, 2012.

Como, Giacomo; Fagnani, Fabio; Zampieri, Sandro: *I sistemi multi-agente e gli algoritmi di consenso*; *La Matematica nella Società e nella Cultura*, 5:1, pp. 1–29, 2012.

Garin, Federica; Como, Giacomo; Fagnani, Fabio: *The performance of serial turbo codes does not concentrate*; *IEEE Transactions on Information Theory*, 58:5, pp. 2570–2588, May 2012.

- Gattami, Ather; Rantzer, Anders; Bernhardsson, Bo: *Robust Team Decision Theory*, IEEE Transactions on Automatic Control, 57:3, pp. 794–798, March 2012.
- Kristalny, Maxim; Mirkin, Leonid: *Input/Output Stabilization in the General Two-Sided Model Matching Setup*, SIAM Journal on Control and Optimization, 50:3, pp. 1413–1438, January 2012.
- Kristalny, Maxim; Mirkin, Leonid: *On the $H(2)$ Two-Sided Model Matching Problem With Preview*, IEEE Transactions on Automatic Control, 57:1, pp. 207–212, January 2012.
- Kristalny, Maxim; Mirkin, Leonid: *Input/Output Stabilization in the General Two-Sided Model Matching Setup*, SIAM Journal on Control and Optimization, 50:3, pp. 1413–1438, 2012.
- Larsson, Per-Ola; Åkesson, Johan; Carlsson, Niclas; Andersson, Niklas: *Model-Based Optimization of Economical Grade Changes for the Borealis Borstar Polyethylene Plant*, Computers & Chemical Engineering, 46, pp. 153–166, November 2012.
- Levinson, Yaron; Mirkin, Leonid: *FIR Stabilization in Discrete One-Sided Model-Matching Problems*, Automatica, 48:11, pp. 2990–2992, 2012.
- Li, Shen; Abdelzaher, Tarek; Wang, Shiguang; Kihl, Maria; Robertsson, Anders: *Temperature Aware Power Allocation: An Optimization Framework and Case Studies*, Sustainable Computing: Informatics and Systems, 2012.
- Lovisari, Enrico; Zampieri, Sandro: *Performance metrics in the average consensus problem: a tutorial*, Annual Reviews in Control, 36:1, pp. 26–41, 2012.
- Maggio, Martina; Terraneo, Federico; Leva, Alberto: *Task scheduling: a control-theoretical viewpoint for a general and flexible solution*, ACM Transactions on Embedded Computing Systems, May 2012. Accepted for publication.
- Maggio, Martina; Bonvini, Marco; Leva, Alberto: *The PID+p controller structure and its contextual autotuning*, Journal of Process Control, January 2012. Accepted for publication.
- Maggio, Martina; Hoffmann, Henry; Papadopoulos, Alessandro Vittorio; Panerati, Jacopo; Santambrogio, Marco Domenico; Agarwal, Anant; Leva, Alberto: *Comparison of Decision Making Strategies for Self-Optimization in Autonomic Computing Systems*, ACM Transactions on Autonomous and Adaptive Systems, 7:4, April 2012.
- Meinsma, Gjerrit; Mirkin, Leonid: *L^2 Sampled Signal Reconstruction with Causality Constraints. Part II—Theory*, IEEE Transactions on Signal Processing, 60:5, pp. 2273–2285, 2012.
- Meinsma, Gjerrit; Mirkin, Leonid: *L^2 Sampled Signal Reconstruction with Causality Constraints. Part I—Setup and Solutions*, IEEE Transactions on Signal Processing, 60:5, pp. 2260–2272, 2012.
- Mirkin, Leonid; Palmor, Zalman J.; Shneiderman, Dmitry: *H^2 Optimization for Systems with Adobe Input Delays: A Loop Shifting Approach*, Automatica, 48:8, pp. 1722–1728, 2012.
- Papadopoulos, Alessandro Vittorio; Maggio, Martina; Negro, Saga; Leva, Alberto: *General control-theoretical framework for online resource allocation in computing systems*, IET Control Theory & Applications, 6:11, pp. 1594–1602, April 2012.
- Ravi, Nikhil; Liao, Hsien-Hsin; Jungkunz, Adam F.; Widd, Anders; Gerdes, J.Christian: *Model predictive control of HCII using variable valve actuation and fuel injection*, Control Engineering Practice, 20:4, pp. 421–430, April 2012.
- Santos, Rodrigo; Lipari, Giuseppe; Bini, Enrico; Cucinotta, Tommaso: *On-line schedulability tests for adaptive reservations in fixed priority scheduling*, Real-Time Systems, 48:5, pp. 601–634, January 2012.
- Sou, Kin Cheong; Rantzer, Anders: *Controller reduction via minimum rank matrix approximation*, Automatica, 48:6, pp. 1069–1076, January 2012.
- Sou, Kin Cheong; Rantzer, Anders: *On a generalized matrix approximation problem in the spectral norm*, Linear Algebra and its Applications, 436:7, pp. 2331–2341, November 2012.

- Wang, Hong; Hägglund, Tore; Song, Zhihuan: *Quantitative Analysis of Influences of Model Plant Mismatch on Control Loop Behavior*; Industrial & Engineering Chemistry Research, 51:49, pp. 15997–16006, 2012.
- Widd, Anders; Ekholm, Kent; Tunestål, Per; Johansson, Rolf; *Physics-Based Model Predictive Control of HCCI Combustion Phasing Using Fast Thermal Management and VVA*; IEEE Transactions on Control Systems Technology, 20:3, pp. 688–699, April 2012.

CONFERENCE CONTRIBUTIONS

- Åkesson, Johan; Braun, Willi; Lindholm, Petter; Bachmann, Bernhard: *Generation of Sparse Jacobians for the Function Mock-Up Interface 2.0*; In 9th International Modelica Conference, Munich, Germany, September 2012. Accepted for publication.
- Aminifar, Amir; Samii, Soheil; Eles, Petru; Peng, Zebo; Cervin, Anton: *Designing High-Quality Embedded Control Systems with Guaranteed Stability*; In 33rd IEEE Real-Time Systems Symposium, San Juan, Puerto Rico, December 2012.
- Andersson, Christian; Andreasson, Johan; Führer, Claus; Åkesson, Johan: *A Workbench for Multibody Systems ODE and DAE Solvers*; In 2nd Joint International Conference on Multibody System Dynamics, Stuttgart, Germany, May 2012.
- Andersson, Christian; Gedda, Sofia; Åkesson, Johan; Diehl, Stefan: *Derivative-free Parameter Optimization of Functional Mock-up Units*; In 9th International Modelica Conference, Munich, Germany, September 2012. Accepted for publication.
- Andersson, Joel; Åkesson, Johan; Diehl, Moritz: *Dynamic optimization with CasADi*; In 51st IEEE Conference on Decision and Control, Maui, Hawaii, USA, December 2012. Accepted for publication.
- Andersson, Joel; Åkesson, Johan; Diehl, Moritz: *CasADi -- A symbolic package for automatic differentiation and optimal control*; In 6th International Conference on Automatic Differentiation, Fort Collins, Colorado, July 2012.
- Barcellini, Alberto; Bascetta, Luca; Raymo, Marco; Rocca, Paolo; Zanchettin, Andrea M.; Robertsson, Anders: *Integrating an Anti-Collision System Based on Laser Time-Of-Flight Sensor in an Industrial Robot Controller*; In 10th International IFAC Symposium on Robot Control, Dubrovnik, Croatia, September 2012.
- Berntorp, Karl; Årzén, Karl-Erik; Robertsson, Anders: *Mobile Manipulation with a Kinematically Redundant Manipulator for a Pick-and-Place Scenario*; In 2012 IEEE Multi-Conference on Systems and Control, Dubrovnik, Croatia, October 2012.
- Berntorp, Karl; Årzén, Karl-Erik; Robertsson, Anders: *Storage Efficient Particle Filters with Multiple Out-of-Sequence Measurements*; In 15th International Conference on Information Fusion, Singapore, July 2012.
- Blochwitz, Torsten; Otter, Martin; Åkesson, Johan; Arnold, Martin; Claus, Christoph; Elmqvist, Hilding; Friedrich, Markus; Junghanns, Andreas; Mauss, Jakob; Neumerkel, Dietmar; Olsson, Hans; Viel, Antoine: *Functional Mockup Interface 2.0: The Standard for Tool independent Exchange of Simulation Models*; In 9th International Modelica Conference, Munich, Germany, September 2012.
- Bolognani, Saverio; Lovisari, Enrico; Carli, Ruggero; Zampieri, Sandro: *A randomized linear algorithm for clock synchronization in multi-agent systems*; In 51st IEEE Conference on Decision and Control, Maui, Hawaii, USA, December 2012.
- Borra, Domenica; Lovisari, Enrico; Carli, Ruggero; Fagnani, Fabio; Zampieri, Sandro: *Autonomous Calibration Algorithms for Planar Networks of Cameras*; In 2012 American Control Conference, Montréal, Canada, 2012.

- Broman, David; Fritzson, Peter; Hedin, Görel; Åkesson, Johan: *A comparison of two metacompilation approaches to implementing a complex domain-specific language*; In 2012 Symposium On Applied Computing, Riva del Garda (Trento), Italy, March 2012. Accepted for publication.
- Burmyakov, Artem; Bini, Enrico; Tovar, Eduardo; *The Generalized Multiprocessor Periodic Resource Interface Model for Hierarchical Multiprocessor Scheduling*; In 20th International Conference on Real-Time and Network Systems, Pont-à-Mousson, France, November 2012. Accepted for publication.
- Cervin, Anton: *Stability and Worst-Case Performance Analysis of Sampled-Data Control Systems with Input and Output Jitter*; In 2012 American Control Conference, Montréal, Canada, June 2012. Accepted for publication.
- Cescon, Marzia; Stemmann, Meike; Johansson, Rolf: *Impulsive Predictive Control of T1DM Glycemia: an In-Silico Study*; In 2012 ASME Dynamic Systems and Control Conference, Fort Lauderdale, FL, USA, October 2012.
- Cescon, Marzia; Johansson, Rolf; Renard, Eric; Place, Jerome: *Modeling the impact of a standardized breakfast on T1DM fasting blood glucose*; In 12th Annual Diabetes Technology Meeting, Bethesda, MD, USA, November 2012.
- Cescon, Marzia; Stemmann, Meike; Johansson, Rolf: *Impulsive Predictive Control of T1DM Glycemia: an In-Silico Study*; In Reglermöte 2012, Uppsala, Sweden, June 2012.
- Cescon, Marzia; Johansson, Rolf; Renard, Eric: *Personalized short-term blood glucose prediction in T1DM*; In 5th International Conference on Advanced Technologies and Treatments for Diabetes, Barcelona, Spain, February 2012. Accepted for publication.
- Cescon, Marzia; Johansson, Rolf: *Patient-specific Glucose Metabolism Models for Model Predictive Control of T1DM Glycemia*; In 5th International Conference on Advanced Technologies and Treatments for Diabetes, Barcelona, Spain, January 2012. Accepted for publication.
- Chasparis, Georgios; Shamma, Jeff S.: *Control of Preferences in Social Networks*; In 4th World Congress of the Game Theory Society, Istanbul, Turkey, July 2012.
- Chasparis, Georgios; Shamma, Jeff S.; Rantzer, Anders: *Nonconvergence to Saddle Boundary Points under Perturbed Reinforcement Learning*; In 4th World Congress of the Game Theory Society, Istanbul, Turkey, July 2012.
- Chasparis, Georgios; Arapostathis, Ari; Shamma, Jeff S.: *Fair Scheduling in Common-Pool Games by Aspiration Learning*; In 8th International workshop on Resource Allocation and Cooperation in Wireless Networks, Paderborn, Germany, May 2012.
- Cho, Jang Ho; From, Pål Johan; Annerstedt, Magnus; Robertsson, Anders; Johansson, Rolf: *Design of an Intermediate Layer to Enhance Operator Awareness and Safety in Telesurgical Systems*; In IEEE/RSJ International Conference on Intelligent Robots and Systems (IROS 2012), Vilamoura, Portugal, October 2012.
- Cho, Jang Ho; Kristalny, Maxim: *On the H2 Decentralized Controller Synthesis for Delayed Bilateral Teleoperation Systems*; In 10th International IFAC Symposium on Robot Control, Dubrovnik, Croatia, September 2012.
- Cho, Jang Ho; Son, Hyoung Il; Annerstedt, Magnus; Robertsson, Anders; Johansson, Rolf: *Enhancement of Human Operator's Perceptual Sensitivity for Telesurgical Systems via Polytopic System Approach*; In IEEE International Conference on Biomedical Robotics and Biomechatronics 2012, Rome, Italy, June 2012.
- Como, Giacomo; Savla, Ketan; Acemoglu, Daron; Dahleh, Munther A.; Frazzoli, Emilio; *Robust distributed routing in dynamical networks with cascading failures*; In 51st IEEE Conference on Decision and Control, Maui, Hawaii, USA, December 2012. Accepted for publication.
- Dellkrantz, Manfred; Kihl, Maria; Robertsson, Anders; Åström, Karl Johan: *Event-Based Response Time Estimation*; In 7th International Workshop on Feedback Computing, San Jose, California, USA, September 2012.

- Dellkrantz, Manfred; Kihl, Maria; Robertsson, Anders: *Performance Modeling and Analysis of a Database Server with Write-Heavy Workload*; In 2012 European Conference on Service-Oriented and Cloud Computing, Bertinoro, Italy, September 2012.
- Filieri, Antonio; Ghezzi, Carlo; Leva, Alberto; Maggio, Martina: *Autotuning control structures for reliability-driven dynamic binding*; In 51st IEEE Conference on Decision and Control, Maui, Hawaii, USA, December 2012. Accepted for publication.
- Filieri, Antonio; Ghezzi, Carlo; Leva, Alberto; Maggio, Martina: *Discrete-time dynamic modeling for software and services composition as an extension of the Markov chain approach*; In 2012 IEEE Multi-Conference on Systems and Control, Dubrovnik, Croatia, October 2012. Accepted for publication.
- Filieri, Antonio; Ghezzi, Carlo; Leva, Alberto; Maggio, Martina: *Reliability-driven dynamic binding via feedback control*; In 7th International Symposium on Software Engineering for Adaptive and Self-Managing Systems, June 2012. Accepted for publication.
- Garpinger, Olof; Häggglund, Tore; Åström, Karl Johan: *Criteria and Trade-offs in PID Design*; In IFAC Conference on Advances in PID Control, Brescia, Italy, March 2012.
- Garpinger, Olof; Häggglund, Tore; Cederqvist, Lars: *Software for PID design: benefits and pitfalls*; In IFAC Conference on Advances in PID Control, Brescia, Italy, March 2012.
- Gerber, Tobias; Theorin, Alfred; Johnsson, Charlotta: *Towards a seamless integration between process modeling descriptions at Business and Production levels - work in progress*; In 14th IFAC Symposium on Information Control Problems in Manufacturing, Bucharest, Romania, May 2012.
- Giselsson, Pontus: *Execution time certification for gradient-based optimization in model predictive control*; In 51st IEEE Conference on Decision and Control, Maui, Hawaii, USA, December 2012. Accepted for publication.
- Grussler, Christian; Damm, Tobias: *A Symmetry Approach for Balanced Truncation of Positive Linear Systems*; In 51st IEEE Conference on Decision and Control, Maui, Hawaii, USA, December 2012. Accepted for publication.
- Grussler, Christian; Damm, Tobias: *Symmetric Positivity Preserving Balanced Truncation*; In 83rd Annual Meeting of the International Association of Applied Mathematics and Mechanics, Darmstadt, Germany, March 2012. Accepted for publication.
- Häggglund, Tore: *Signal Filtering in PID Control*; In IFAC Conference on Advances in PID Control, Brescia, Italy, March 2012.
- Hast, Martin; Häggglund, Tore: *Design of Optimal Low-Order Feedforward Controllers*; In IFAC Conference on Advances in PID Control, Brescia, Italy, March 2012.
- Hast, Martin; Häggglund, Tore: *Design of Optimal Low-Order Feedforward Controllers for Disturbance Rejection*; In 17th Nordic Process Control Workshop, Kgs Lyngby, Denmark, January 2012.
- Henningsson, Maria; Ekholm, Kent; Strandh, Petter; Tunestål, Per; Johansson, Rolf: *Dynamic Mapping of Diesel Engine through System Identification*; In Workshop on Identification for Automotive Systems, Linz, Austria, July 2012.
- Henningsson, Maria; Bernhardsson, Bo; Tunestål, Per; Johansson, Rolf: *A machine-learning approach to information extraction from cylinder pressure sensors*; In SAE 2012 World Congress, Detroit, Michigan, USA, April 2012.
- Henningsson, Maria; Tunestål, Per; Johansson, Rolf: *A Virtual Sensor for Predicting Diesel Engine Emissions from Cylinder Pressure Data*. Proc. 2012 IFAC Workshop on Engine and Powertrain Control, Simulation and Modeling (E-COSM'12), Les Rencontres Scientifiques d'IFP Energies nouvelles, Rueil-Malmaison, France 23 - 25 October 2012
- van Heusden, Klaske; Dumont, Guy A.; Soltesz, Kristian; Petersen, Christian; West, Nicholas; Ansermino, J. Mark: *Robust PID control for closed-loop propofol infusion in children*; In STA 2012 Annual Meeting, Palm Beach, Florida, USA, January 2012. Conference Abstract.

- Hoffmann, Henry; Holt, Jim; Kurian, George; Lau, Eric; Maggio, Martina; Miller, Jason E.; Neuman, Sabrina M.; Sinangil, Mahmut; Sinangil, Yildiz; Agarwal, Anant; Chandrakasan, Anantha P.; Devadas, Srinivas: *Self-aware computing in the Angstrom processor*, In 49th Annual Design and Automation Conference, San Francisco, CA, USA, June 2012.
- Johansson, Rolf; Robertsson, Anders; Shiriaev, Anton: *Observer-Based Strictly Positive Real (SPR) Variable Structure Output Feedback Control*, In 12th International Workshop on Variable Structure Systems (VSS2012), Mumbai, India, January 2012.
- Kristalny, Maxim; Cho, Jang Ho: *On the Decentralized H₂ Optimal Control of Bilateral Teleoperation Systems with Time Delays*, In 51st IEEE Conference on Decision and Control, Maui, Hawaii, USA, December 2012.
- Lamperski, Andrew; Lessard, Laurent: *Optimal state-feedback control under sparsity and delay constraints*, In 3rd IFAC Workshop on Distributed Estimation and Control in Networked Systems, Santa Barbara, California, September 2012. Accepted for publication.
- Larsson, Per-Ola; Hägglund, Tore: *Comparison Between Robust PID and Predictive PI Controllers with Constrained Control Signal Noise Sensitivity*, In IFAC Conference on Advances in PID Control, Brescia, Italy, March 2012. Accepted for publication.
- Lee, Sang Hyoung; Suh, Il Hong; Calinon, Sylvain; Johansson, Rolf: *Learning Basis Skills by Autonomous Segmentation of Humanoid Motion Trajectories*, In 12th IEEE-RAS International Conference on Humanoid Robots, Osaka, Japan, November 2012.
- Lessard, Laurent; Lall, Sanjay: *Optimal controller synthesis for the decentralized two-player problem with output feedback*, In 2012 American Control Conference, Montréal, Canada, June 2012.
- Leva, Alberto; Maggio, Martina; Terraneo, Federico: *Performance analysis of operating systems schedulers realised as discrete-time controllers*, In 2012 IEEE Multi-Conference on Systems and Control, Dubrovnik, Croatia, October 2012. Accepted for publication.
- Lindholm, Anna; Giselsson, Pontus: *Formulating an Optimization Problem for Minimization of Losses due to Utilities*, In International Symposium on Advanced Control of Chemical Processes, Singapore, July 2012.
- Lindholm, Anna; Johnsson, Charlotta: *A Tool for Utility Disturbance Management*, In 14th IFAC Symposium on Information Control Problems in Manufacturing, Bucharest, Romania, May 2012.
- Lindholm, Anna; Johnsson, Charlotta; Hägglund, Tore; Carlsson, Hampus: *Reducing revenue loss due to disturbances in utilities using buffer tanks - A case study at Perstorp*, In Conference on Foundations of Computer-Aided Process Operations (FOCAPO2012), Savannah, Georgia, USA, January 2012.
- Lindholm, Anna; Johnsson, Charlotta; Hägglund, Tore; Carlsson, Hampus: *Reducing revenue loss due to disturbances in utilities using buffer tanks - A case study at Perstorp*, In 17th Nordic Process Control Workshop, Kgs Lyngby, Denmark, January 2012.
- Lovisari, Enrico; Carli, Ruggero: *Robust synchronization of networks of heterogeneous double-integrators*, In 51st IEEE Conference on Decision and Control, Maui, Hawaii, USA, December 2012.
- Magnusson, Fredrik; Åkesson, Johan: *Collocation Methods for Optimization in a Modelica Environment*, In 9th International Modelica Conference, Munich, Germany, September 2012.
- Mannesson, Anders; Yaqoob, Muhammad Atif; Bernhardsson, Bo; Tufvesson, Fredrik: *Radio and IMU based indoor positioning and tracking*, In International Conference on Systems, Signals and Image Processing (IWSSIP), Vienna, Austria, April 2012.
- Meinsma, Gjerrit; Mirkin, Leonid: *Sampled-Data L_{∞} Smoothing: Fixed-Size ARE Solution with Free Hold Function*, In 20th International Symposium on Mathematical Theory of Networks and Systems, Melbourne, Australia., July 2012.
- Meinsma, Gjerrit; Mirkin, Leonid: *Yet Another Discrete-Time H_{∞} Fixed-Lag Smoothing Solution*, In 20th International Symposium on Mathematical Theory of Networks and Systems, Melbourne, Australia., July 2012.

- Nilsson, Carl-Henric; Johnsson, Charlotta; Jin, Jun; Yang, Qinmin; Luo, Shijian: *SME creation facilitation process at Universities*; In 2012 West Lake International Conference on SMB, Hangzhou, China, October 2012.
- Nordh, Jerker; Berntorp, Karl: *Extending the Occupancy Grid Concept for Low-Cost Sensor Based SLAM*; In 10th International IFAC Symposium on Robot Control, Dubrovnik, Croatia, September 2012. Accepted for publication.
- Olofsson, Björn; Sörnmo, Olof; Schneider, Ulrich; Barho, Marc; Robertsson, Anders; Johansson, Rolf: *Increasing the Accuracy for a Piezo-Actuated Micro Manipulator for Industrial Robots using Model-Based Nonlinear Control*; In 10th International IFAC Symposium on Robot Control, Dubrovnik, Croatia, September 2012.
- Papadopoulos, Alessandro; Maggio, Martina; Leva, Alberto: *Control and Design of Computing Systems: What to Model and How*; In Vienna International Conference on Mathematical Modelling 2012, Vienna, Austria, February 2012. Accepted for publication.
- Papadopoulos, Alessandro; Maggio, Martina; Casella, Francesco; Åkesson, Johan: *Function Inlining in Modelica Models*; In Vienna International Conference on Mathematical Modelling 2012, Vienna, Austria, February 2012. Accepted for publication.
- Pettersson, Anders; Åström, Karl Johan; Robertsson, Anders; Johansson, Rolf.: *Augmenting L1 Adaptive Control of Piecewise Constant Type to a Fighter Aircraft. Performance and Robustness Evaluation for Rapid Maneuvering*, AIAA Guidance, Navigation, and Control Conference, 13 - 16 August 2012, Minneapolis, Minnesota, USA.
- Pettersson, Anders; Åström, Karl Johan; Robertsson, Anders; Johansson, Rolf: *Analysis of Linear L1 Adaptive Control Architectures for Aerospace Applications*; In 51st IEEE Conference on Decision and Control, Maui, Hawaii, USA, December 2012.
- Sällberg, Elin; Lind, Alexandra; Velut, Stéphane; Åkesson, Johan; Gallardo Yances, Stephanie; Link, Kilian: *Start-up Optimization of a Combined Cycle Power Plant*; In 9th International Modelica Conference, Munich, Germany, September 2012. Accepted for publication.
- Samii, Soheil; Bordoloi, Unmesh D.; Eles, Petru; Peng, Zebo; Cervin, Anton: *Control-Quality Optimization for Distributed Embedded Systems with Adaptive Fault Tolerance*; In 24th Euromicro Conference on Real-Time Systems, Pisa, Italy, July 2012.
- Sen, Nevroz; Alajaji, Fady; Yüksel, Serdar; Como, Giacomo: *Multiple access channel with various degrees of asymmetric state Information*; In 2012 IEEE International Symposium on Information Theory, Cambridge, MA, USA, July 2012.
- Sörnmo, Olof; Olofsson, Björn; Robertsson, Anders; Johansson, Rolf: *Increasing Time-Efficiency and Accuracy of Robotic Machining Processes Using Model-Based Adaptive Force Control*; In 10th International IFAC Symposium on Robot Control, Dubrovnik, Croatia, September 2012.
- Sörnmo, Olof; Robertsson, Anders; Wanner, Anders: *Force Controlled Knife-Grinding with Industrial Robot*; In 2012 IEEE Multi-Conference on Systems and Control, Dubrovnik, Croatia, October 2012.
- Sörnmo, Olof; Olofsson, Björn; Schneider, Ulrich; Robertsson, Anders; Johansson, Rolf: *Increasing the Milling Accuracy for Industrial Robots Using a Piezo-Actuated High-Dynamic Micro Manipulator*; In 2012 IEEE/ASME International Conference on Advanced Intelligent Mechatronics, Kaohsiung, Taiwan, July 2012.
- Soltesz, Kristian; Dumont, Guy A.; van Heusden, Klaske; Hägglund, Tore; Ansermino, J. Mark: *Simulated Mid-ranging Control of Propofol and Remifentanyl using EEG-measured Hypnotic Depth of Anesthesia*; In 51st IEEE Conference on Decision and Control, Maui, Hawaii, USA, December 2012.
- Soltesz, Kristian; van Heusden, Klaske; Dumont, Guy A.; Hägglund, Tore; Petersen, Christian; West, Nicholas; Ansermino, J. Mark: *Closed-Loop Anesthesia in Children using a PID Controller: A Pilot Study*; In IFAC Conference on Advances in PID Control, Brescia, Italy, March 2012.

- Sootla, Aivar; Rantzer, Anders: *Convenient Representations of Structured Systems for Model Order Reduction*; In 2012 American Control Conference, Montréal, Canada, June 2012. Accepted for publication.
- Ståhl, Fredrik; Johansson, Rolf; Renard, Eric: *Bayesian Combination of Multiple Plasma Glucose Predictors*; In 34th Annual Conference of the IEEE EMBS, San Diego, CA, USA, August 2012.
- Ståhl, Fredrik; Johansson, Rolf: *Receding Horizon Prediction by Bayesian Combination of Multiple Predictors*. Proc. 51st IEEE Conf. Decision and Control (CDC 2012), December 10-13, 2012. Maui, Hawaii, USA.
- Stemmann, Meike; Johansson, Rolf: *Diabetic Blood Glucose Control Via Optimization Over Insulin and Glucose Doses*; In 8th IFAC Symposium on Biological and Medical Systems, Budapest, Hungary, August 2012.
- Stemmann, Meike; Johansson, Rolf: *Control of Type 1 Diabetes via Risk-Minimization for Multi Dose Injection Patients*; In 5th International Conference on Advanced Technologies and Treatments for Diabetes, Barcelona, Spain, February 2012.
- Sten, Jon; Mattsson, Tobias; Bergdahl, Tove; Mattsson, Jesper; Åkesson, Johan: *Implementation of a Graphical Modelica Editor with Preserved Source Code Formatting*; In 9th International Modelica Conference, Munich, Germany, September 2012. Accepted for publication.
- Stolt, Andreas; Linderöth, Magnus; Robertsson, Anders; Johansson, Rolf: *Adaptation of Force Control Parameters in Robotic Assembly*; In 10th International IFAC Symposium on Robot Control, Dubrovnik, Croatia, September 2012.
- Stolt, Andreas; Linderöth, Magnus; Robertsson, Anders; Johansson, Rolf: *Robotic Assembly Using a Singularity-Free Orientation Representation Based on Quaternions*; In 10th International IFAC Symposium on Robot Control, Dubrovnik, Croatia, September 2012.
- Stolt, Andreas; Linderöth, Magnus; Robertsson, Anders; Johansson, Rolf: *Force Controlled Robotic Assembly without a Force Sensor*; In 2012 IEEE International Conference on Robotics and Automation, St. Paul, Minnesota, USA, May 2012.
- Theorin, Alfred; Johnsson, Charlotta: *Polymorphism for State Machines*; In ISA Automation Week 2012, Orlando, FL. USA, September 2012.
- Theorin, Alfred; Årzén, Karl-Erik; Johnsson, Charlotta: *Rewriting JGrafchart with Rewritable Reference Attribute Grammars*; In Industrial Track of Software Language Engineering 2012, Dresden, Germany, September 2012.
- Theorin, Alfred; Johnsson, Charlotta: *Graphical Programming Language Support for Service Oriented Architecture in Automation*; In Reglermöte 2012, Uppsala, Sweden, June 2012.
- Theorin, Alfred; Ollinger, Lisa; Johnsson, Charlotta: *Service-oriented Process Control with Grafchart and the Devices Profile for Web Services*; In 14th IFAC Symposium on Information Control Problems in Manufacturing, Bucharest, Romania, May 2012.
- Tilbury, Dawn M.; Renard, Eric; Johansson, Rolf: *Integrating Multiple Controllers to Balance Competing Performance Objectives: Application to Blood Glucose Management*; In 2012 ASME Dynamic Systems and Control Conference, Fort Lauderdale, FL, USA, October 2012.
- Widd, Anders; Tunestål, Per; Åkesson, Johan; Johansson, Rolf: *Single-Zone Diesel PPC Modeling for Control*; In 2012 American Control Conference, Montréal, Canada, June 2012. Accepted for publication.

PHD THESES

- Dressler, Isolde: *Modeling and Control of Stiff Robots for Flexible Manufacturing*; PhD Thesis ISRN LUTFD2/TFRT--1093--SE, Department of Automatic Control, Lund University, Sweden, 2012
- Giselsson, Pontus: *Gradient-Based Distributed Model Predictive Control*; PhD Thesis ISRN LUTFD2/TFRT--1094--SE, Department of Automatic Control, Lund University, Sweden, 2012

- Henningssson, Maria: *Date-Rich Multivariable Control of Heavy-Duty Engines*; PhD Thesis ISRN LUTFD2/TFRT--92--SE, Department of Automatic Control, Lund University, Sweden, May 2012
- Henningssson, Toivo: *Stochastic Event-Based Control and Estimation*; PhD Thesis ISRN LUTFD2/TFRT--1095--SE, Department of Automatic Control, Lund University, Sweden, December 2012
- Mårtensson, Karl: *Gradient Methods for Large-Scale and Distributed Linear Quadratic Control*; PhD Thesis ISRN LUTFD2/TFRT--1091--SE, Department of Automatic Control, Lund University, Sweden, April 2012
- Sootla, Aivar: *Model Order Reduction Based on Semidefinite Programming*; PhD Thesis ISRN LUTFD2/TFRT--1089--SE, Department of Automatic Control, Lund University, Sweden, January 2012
- Widd, Anders: *Physical Modeling and Control of Low Temperature Combustion in Engines*; PhD Thesis ISRN LUTFD2/TFRT--1090--SE, Department of Automatic Control, Lund University, Sweden, 2012

LICENTIATE THESES

- Reuterswård, Philip: *Towards Pseudospectral Control and Estimation*; Licentiate Thesis ISRN LUTFD2/TFRT--3257--SE, Department of Automatic Control, Lund University, Sweden, 2012
- Soltesz, Kristian: *On Automation of the PID Tuning Procedure*; Licentiate Thesis ISRN LUTFD2/TFRT--3254--SE, Department of Automatic Control, Lund University, Sweden, January 2012,
- Stolt, Andreas: *Robotic Assembly and Contact Force Control*; Licentiate Thesis ISRN LUTFD2/TFRT--3256--SE, Department of Automatic Control, Lund University, Sweden, 2012
- Ståhl, Fredrik: *Diabetes Mellitus Glucose Prediction by Linear and Bayesian Ensemble Modeling*; Licentiate Thesis ISRN LUTFD2/TFRT--3255--SE, Department of Automatic Control, Lund University, Sweden, 2012

MASTER'S THESES

The Master's Theses completed within the Technology Management Program, marked TM, are published on the TM homepage: www.tmonline.se.

- Ahlén, Cecilia; Holmberg, Lydia: *On the Road to Winning at New Product Launch - Critical factors to consider in industrial new product launch*: TM
- Ambrius, Johan; Jönsson, Jimmie: *Improving the Inertial Navigation System of the CV90 Platform Using Sensor Fusion*; Master's Thesis ISRN LUTFD2/TFRT--5912--SE, Department of Automatic Control, Lund University, Sweden, December 2012.
- Benktson, Anna; Dahlberg, Sofia: *Modeling of Avionics Systems using JGrafchart and TrueTime*; Master's Thesis ISRN LUTFD2/TFRT--5907--SE, Department of Automatic Control, Lund University, Sweden, 2012.
- Berner, Josefin; Ingulfson, Aminda: *Optimal Control Algorithms for Klystron Efficiency in ESS*; Master's Thesis ISRN LUTFD2/TFRT--5902--SE, Department of Automatic Control, Lund University, Sweden, June 2012.
- Einarsson, Arnbjörn; Rajabian, Babak: *Optimal Control Algorithms of Pulsed Accelerating Fields in Superconducting Spoke Cavities in ESS*; Master's Thesis ISRN LUTFD2/TFRT--5905--SE, Department of Automatic Control, Lund University, Sweden, June 2012.
- Everitt, Niklas: *Multi-Cylinder Valve Control - FPGA-controlled Pneumatic Variable Valve Actuation*; Master's Thesis ISRN LUTFD2/TFRT--ISRN LUTFD/TFRT--5891--SE, Department of Automatic Control, Lund University, Sweden, January 2012

- Friberg, Michael; Cewers, Ola: *Pursuing Pole Position - Information sharing in the Chinese automotive supply chain*: TM
- Grussler, Christian: *Model Reduction of Positive Systems*; Master's Thesis ISRN LUTFD2/TFRT--5894--SE, Department of Automatic Control, Lund University, Sweden, February 2012.
- Hallberg, Jesper; Helldin, Malin: *The Standardization-Adaptation Dilemma: Emphasizing Global Processes or Local Conditions in Supply Chain Strategy? A Case Study at Tetra Pak Korea*: TM
- Hertz, Jonas: *MILP Modelling of Production-related Disturbances*; Master's Thesis ISRN LUTFD2/TFRT--5896--SE, Department of Automatic Control, Lund University, Sweden, May 2012.
- Hultquist, Daniella; Wahlgren, Filippa: *Investigating the Coordination Between Operations and Sales in an Industrial Environment - A Case Study at Tetra Pak*: TM
- Jeppsson Krell, Elisabeth; Olsson, Jennie: *Event Based Control of Server Systems*; Master's Thesis ISRN LUTFD2/TFRT--5904--SE, Department of Automatic Control, Lund University, Sweden, September 2012
- Jonason Bjärenstam, Magnus; Lennartsson, Michael: *Development of a ball balancing robot with omni wheels*; Master's Thesis ISRN LUTFD2/TFRT--5897--SE, Department of Automatic Control, Lund University, Sweden, March 2012.
- Johansson, Marianne; Rendahl, Robin K.: *A Case Study Approach on Manufacturing Alternatives in an Emerging Market – Evaluation from a cost , flexibility and risk market*: TM
- Landgren, Hanna; Manouchi, Meriem: *The Purchasing Function - a Catalyzer to Breakthrough Innovation*: TM
- Lind, Alexandra; Sällberg, Elin: *Optimization of the Start-up Procedure of a Combined Cycle Power Plant*; Master's Thesis ISRN LUTFD2/TFRT--5900--SE, Department of Automatic Control, Lund University, Sweden, June 2012.
- Lindstedt, Anna; Elofsson, Sofia: *Corporate Real Estate Management - Importance, Strategies and Development*: TM
- Magnusson, Fredrik: *Collocation methods in JModelica.org*; Master's Thesis ISRN LUTFD2/TFRT--5892--SE, Department of Automatic Control, Lund University, Sweden, February 2012.
- Mejvik, Sofia; Olin, Håkan: *Model Based Engineering of a Reverse Osmosis Water Purification Plant*; Master's Thesis ISRN LUTFD2/TFRT--5903--SE, Department of Automatic Control, Lund University, Sweden, August 2012.
- Meiton, Carl; Åkesson, Erik: *Corporate development: Assessing the attractiveness of a new market*: TM
- Nordström, Ulf: *Automatic Implementation and Analysis for Fixed-point Controllers in Modelica using Dymola*; Master's Thesis ISRN LUTFD2/TFRT--5898--SE, Department of Automatic Control, Lund University, Sweden, January 2012.
- Olofsson, Björn; Skovdal, Agnes: *Affärsutveckling inom fastighetsbranschen*: TM
- Påhlson, Erik; Ridderheim, Ylva: *Sweetening the Logistics: Drivers of Logistics Synergy Realization in Horizontal M&As - The case of the Cloetta and Leaf Merger*: TM
- Pla Ruiz, Albert: *Temperature Control of a Scientific Instrument*; Master's Thesis ISRN LUTFD2/TFRT--5901--SE, Department of Automatic Control, Lund University, Sweden, June 2012.
- Raskowski, Carl: *Reglering av transportband*; Master's Thesis ISRN LUTFD2/TFRT--5895--SE, Department of Automatic Control, Lund University, Sweden, May 2012.
- Ronnle, Erik; Holmgren, Michael: *Hydrocarbons in Greenland – Prospects for the Greenlandic Economy*: TM
- Rosendahl, Wilhelm; Fridman, Michael: *Diagnosing Innovation Capabilities – A Case Study at E.ON Sverige AB*: TM

- Staxäng, Emma; Almén, Erik: *Premium B2B services on a price sensitive – A case study of a digital web agency in India*: TM
- Teder, Hannes; Wiklund, Gustav: *Hedgingstrategier för elhandelsbolag på den svenska elmarknaden efter elområdesuppdelning*; Master's Thesis ISRN LUTFD2/TFRT--5899--SE, Department of Automatic Control, Lund University, Sweden, May 2012.
- Troeng, Olof: *Trade-offs in Control of Switched Reluctance Motors (Avvägningar vid reglering av switchade reluktansmotorer)*; Master's Thesis ISRN LUTFD2/TFRT--5906--SE, Department of Automatic Control, Lund University, Sweden, October 2012.
- Walberg, Anna; Bengtsson, Lina: *A Sweet Tooth for Innovations - A Case Study of Upstream Collaboration at Leaf*: TM
- Waldehorn, Cecilia, Ardbj, Emelie; Ly, Karin: *KAK-modellen, ett KontextAnpassat Kalkylverktyg*: TM
- Wallström, Henrik; Christiansson, Sara: *The Interrelation between Organizational Culture and Management Approaches in order to reach Strategic Goals*: TM
- Weibull Hartman, Peder; Sverdrup, Rasmus: *A Study of Wake Economics – Examining Spot Price Variation to Increase Wind Power Park Profits*: TM
- Zell, Isabella; Johansson, Niklas: *A Supplier Quality Performance Tool - An integration of Costs of Quality into future supplier selections at Sony Mobile Communication*: TM
- Åberg, Fredrik; Nordin, Sofia: *Calling for Collaborations - A Case Study of Swedish Telecom Industry*: TM
- Öberg, Anton; Lindblom, Sara: *Is it cost effective to screen against Helicobacter pylori in Sweden?*: TM

TECHNICAL REPORT

- Carlson, Martin: *Användargränssnitt för proaktiv störningshantering för utilities*; Technical Report ISRN LUTFD2/TFRT--7623--SE, Department of Automatic Control, Lund University, Sweden, August 2012.
- Chasparis, Georgios; Maggio, Martina; Årzén, Karl-Erik; Bini, Enrico: *Distributed Management of CPU Resources for Time-Sensitive Applications*; Technical Report ISRN LUTFD2/TFRT--7625--SE, Department of Automatic Control, Lund University, Sweden, September 2012.
- Giselsson, Pontus: *Gradient-Based Model Predictive Control in a Pendulum System*; Technical Report ISRN LUTFD2/TFRT--7624--SE, Department of Automatic Control, Lund University, Sweden, October 2012.
- Larsson, Per-Ola; Åkesson, Johan; Carlsson, Niclas; Andersson, Niklas: *Modeling of the PE3 Plant at Borealis AB*; Technical Report ISRN LUTFD2/TFRT--7622--SE, Department of Automatic Control, Lund University, Sweden, January 2012.
- von Platen, Carl; Eker, Johan; Nilsson, Anders; Årzén, Karl-Erik: *Static Analysis and Transformation of Dataflow Multimedia Applications*; Technical Report ISRN LUTFD2/TFRT--7626--SE, Department of Automatic Control, Lund University, Sweden, November 2012.
- Westin, Eva; Bernhardtsson, Bo: *Automatic Control 2011. Activity Report*; Technical Report ISRN LUTFD2/TFRT--4039--SE, Department of Automatic Control, Lund University, Sweden, August 2012.

SEMINARS AT THE DEPARTMENT

January

- 11 - *Recent advances in model reduction of large-scale systems*; Athanasios C. Antoulas, Rice University, USA.
- 12 - Defence Of Doctoral Dissertation: *Model Order Reduction Based on Semidefinite Programming*; Aivar Sootla, Dept. of Automatic Control, LTH, Lund University.
- 17 - *Computational algebraic methods for nonlinear control*; Enrique Pico Marco, Dept. of Systems Engineering and Automation, Universitat Politècnica de València, Valencia, Spain.
- 19 - *Towards automation in anaesthesia: What and how?*, Catarina Da Costa Nunes Duarte, Department of Anaesthesiology, Hospital de Santo António, Porto.
- 20 - Licentiate seminar: *On Automation of the PID Tuning Procedure*; Kristian Soltesz, Dept. of Automatic Control, LTH, Lund University.
- 24 - *Using Disturbance Recordings in an Open Smart Grid Concept*; Magnus Akke, Dlaboratory Sweden.
- 30 - Master's Thesis Presentation: *Visual tracking and control of a Quadrocopter*; Martin Ericsson

February

- 1 - *Robust design*; Kevin Otto, Robust Systems and Strategy LLC
- 1 - Master's Thesis Presentation: *Collocation Methods in JModelica.org*; Fredrik Magnusson
- 1 - Master's Thesis Presentation: *Model Reduction of Positive Systems*; Christian Grussler
- 8 - *On Synchronization and Security in Power Networks*; Francesco Bullo, Department of Mechanical Engineering, Center for Control, Dynamical Systems, and Computation, College of Engineering, University of California at Santa Barbara
- 13 - *Implementation and application of the Gauss Pseudo-Spectral method*; Christian Andersson, Numerical Analysis, Centre for Mathematical Sciences, Lund University
- 21 - *Synchronization in Multi-Agent Systems: analysis and applications*; Enrico Lovisari, Università di Padova, Italy

March

- 6 - *Real-Time and Control Systems: a Personal Perspective*; Enrico Bini, Marie Curie Fellow at Dept. of Automatic Control, LTH, Lund University
- 16 - Master's Thesis Presentation: *Bollbalanserande robot med omni-hjul*; Michael Lennartsson; Magnus Jonason Bjärenstam
- 20 - *Three complementary approaches to averaging in decentralized systems*; Julien Hendrickx, Université catholique de Louvain, Belgium

April

- 4 - Master's Thesis Presentation: *Automatic implementation and analysis for fixed-point controllers in Modelica using Dymola*; Ulf Nordström
- 10 - *On the engineering options of future automobiles*; Lino Guzzella, ETH Zürich, Switzerland
- 10 - Defence Of Doctoral Dissertation: *Physical Modeling and Control of Low Temperature Combustion in Engines*; Anders Widd, Lund University
- 11 - *Synchronous Controllers and State Machines in Modelica*; Hilding Elmqvist, Dassault Systèmes
- 11 - *Modeling and control of HCCI combustion timing and cyclic variation*; Bob Koch, Department of Mechanical Engineering, University of Alberta, Edmonton, Canada

- 16 - *Adaptive Learning Structures for Real-Time Optimal Control and Differential Games*; Frank L. Lewis, The University of Texas at Arlington, USA
- 20 - *Cooperative Control Synchronization: Optimal Design and Games on Communication Graphs*; Frank L. Lewis, The University of Texas at Arlington, USA
- 25 - *A Hierarchical Transactive Control Architecture for Renewables Integration in Smart Grids*; Arman Kiani, TU München, Germany
- 26 - *Standard forms for discrete time polynomial models with inequalities*; Torkel Glad, Linköping University
- 27 - Defence Of Doctoral Dissertation: *Gradient Methods for Large-Scale and Distributed Linear Quadratic Control*; Karl Mårtensson, Dept. of Automatic Control, LTH, Lund University

May

- 2 - *Stability guarantees for real-time model predictive control*; Melanie Zeilinger, Ecole Polytechnique Federale de Lausanne, Switzerland
- 2 - Master's Thesis Presentation: *Reglering av transportband*; Carl Raskowski
- 11 - Defence Of Doctoral Dissertation: *Data-Rich Multivariable Control of Heavy-Duty Engines*; Maria Henningson, Dept. of Automatic Control, LTH, Lund University
- 15 - *Tube-based distributed control for constrained systems*; Giancarlo Ferrari Trecate, Università degli Studi di Pavia, Italy
- 15 - *Trends in Control*; Paul K. Houpt, Automation and Controls Laboratory, GE Global Research
- 23 - Master's Thesis Presentation: *Hedging in Illiquid Markets, A Case Study on the Swedish Electricity Market*; Hannes Teder; Gustav Wiklund

June

- 1 - *Finite state rho/mu approximations for control design*; Danielle C. Tarraf, Johns Hopkins University, USA
- 5 - *Robust periodic optimal control of quadcopters: a benchmark for CasADi*; Joris Gillis, KU Leuven, Belgium
- 7 - *Optimal Sampling for Linear Control Systems*; Enrico Bini, Marie-Curie Fellow, Lund University
- 11 - Master's Thesis Presentation: *Optimering av uppstart av kraftverk med Modelica/JModelica*; Alexandra Lind; Elin Sällberg
- 18 - *Modular time integration: A framework for the analysis of time integration methods in co-simulation*; Martin Arnold, Institute of Mathematics, Martin Luther University Halle-Wittenberg
- 19 - *Two current topics: Nuclear norm based identification; and covert attacks on network control systems*; Roy Smith, ETH, Zürich, Switzerland
- 20 - Master's Thesis Presentation: *Optimal Control Algorithms for Klystron Efficiency in ESS*; Josefin Berner; Aminda Ingulfson
- 20 - Master's Thesis Presentation: *Optimal control algorithms of pulsed accelerating fields in superconducting spoke cavities in ESS*; Arnbjörn Einarsson; Babak Rajabian
- 21 - Master's Thesis Presentation: *Position accuracy with dual motor control for a Gantry-Tau robot*; Patrik Cairén
- 28 - Master's Thesis Presentation: *Temperature control of a calorimeter*; Albert Pla Ruiz

August

- 17 - *A simple mass balance controller for continuous sedimentation*; Prof Fernando Betancourt, Universidad de Concepción, Chile
- 22 - August - Master's Thesis Presentation: *Model Based Engineering of a Reverse Osmosis Water Purification Plant*; Sofia Mejvik; Håkan Olin
- 27 - Master's Thesis Presentation: *Modeling of Avionics Systems using JGrafchart and Truetime*; Sofia Dahlberg; Anna Benktson
- 29 - *The Sampling Theorem: A Century After Schmidt*; Leonid Mirkin, Technion, Israel
- 31 - *Multiple Delay Dead-Time Compensation: From Stability- to Performance-Driven Configurations*; Leonid Mirkin, Technion, Israel

September

- 4 - *Declarative Resource Management on Multicores*; Adrian Schüpbach, Department of Computer Science, ETH Zürich
- 6 - *Cable-driven parallel robots*; Andreas Pott, Fraunhofer, Stuttgart
- 6 - *Parallel Kinematic Machines - Summary of Latest Developments at UiA*; Geir Hovland, University of Agder, Norway
- 7 - Defence Of Doctoral Dissertation: *Modeling and Control of Stiff Robots for Flexible Manufacturing*; Isolde Dressler, Dept. of Automatic Control, LTH, Lund University
- 10 - *Automatic Partitioning and Simulation of Weakly Coupled Systems*; Alessandro Papadopoulos, Politecnico di Milano, Italy.

October

- 2 - *(Robust) Stability of Motion* ; Chris Kellett, University of Newcastle, Australia
- 2 - *Closed-loop stabilization of dynamical systems over a Gaussian interference channel*; Ali Zaidi, Royal Institute of Technology (KTH)
- 3 - *Variational Bayes and a problem of reliable communication*; Sanjoy Mitter, Massachusetts Institute of Technology, USA
- 4 - *Information and entropy flow in the Kalman filter*; Sanjoy Mitter, Massachusetts Institute of Technology, USA
- 5 - *Linear state estimation via multiple sensors over rate-constrained channels*; Subhrakanti Dey, University of Melbourne, Australia
- 5 - *Optimal randomizations in quantizer design with marginal constraint*; Naci Saldi, Queen's University, Canada
- 9 - *Fun with porosity and aliens in channel coding*; Vinith Misra, Stanford University, USA
- 9 - *Design of state-aware multiple access methods for networked control systems*; Chithrupa Ramesh, Royal Institute of Technology (KTH)
- 10 - *Variational Bayes and a problem of reliable communication (Part 2)*; Sanjoy Mitter, Massachusetts Institute of Technology, USA
- 11 - *Information and entropy flow in the Kalman filter (Part 2)*; Sanjoy Mitter, Massachusetts Institute of Technology, USA
- 12 - *Formation control with size scaling using relative displacement feedback*; Sam Coogan, UC Berkeley, USA
- 12 - *On the capacity regions of broadcast channel problems with receiver side information*; Tobias Oechtering, Royal Institute of Technology (KTH)
- 15 - *Optimal Realizable Networked Controllers for Networked Systems*; Nicola Elia, Iowa State University, USA

- 15 - *MIMO Communications in Wireless Networks*; Ather Gattami, Royal Institute of Technology (KTH)
- 16 - *A new framework for stability analysis of networked control systems*; Yumiko Ishido, Dept. of Automatic Control, LTH, Lund University
- 16 - *Disturbance propagation in formation control problems: Information-theoretic bounds*; Paolo Minero, University of Notre-Dame, USA
- 16 - Master's Thesis Presentation: *Trade-offs in control of switched reluctance motors*; Olof Troeng
- 23 - *Some results on the multiple access channel with state information*; Nevroz Sen, Queen's University, Canada
- 23 - *A Mean field games approach to consensus problems*; Mojtaba Nouraiian, McGill University, Canada
- 26 - *A networked control strategy for reactive power compensation in a smart power distribution network*; Saverio Bolognani, Università di Padova, Italy
- 26 - *Performance of linear average-consensus algorithm in large-scale networks*; Federica Garin, INRIA Rhône-Alpes, Grenoble, France
- 29 - *Robust stability analysis based on noncausal LPTV FIR scaling*; Yohei Hosoe, Kyoto University, Japan
- 30 - *Performance, information pattern trade-offs and computational complexity analysis of a consensus based distributed optimization method*; Alireza Farhadi, University of Melbourne, Australia
- 30 - *It may be "easier to approximate" decentralized LQG problems*; Se-Yong Park, UC Berkeley, USA
- 30 - *Network reconstruction using dynamical structure functions*; Ye Yuan, Cambridge University, United Kingdom

November

- 6 - *Fiat Lux: Optogenetic Feedback Control of Living Cells*; Mustafa Khammash, Swiss Federal Institute of Technology-Zurich (ETH), Switzerland
- 20 - *Aeroservoelasticity and Control of Wind Energy Systems*; Carlo L. Bottasso, Politecnico di Milano, Italy
- 22 - *Temporal Logic Testing and Verification for Cyber-Physical Systems*; Georgios Fainekos, Arizona State University, USA
- 23 - *Distributed Synthesis and Computation of Predictive Controllers*; Colin Jones, École Polytechnique Fédérale de Lausanne, Switzerland
- 23 - Defence Of Doctoral Dissertation: *Gradient-Based Distributed Model Predictive Control*; Pontus Giselsson, Dept. of Automatic Control, LTH, Lund University

December

- 4 - *Event-based control: simple stability conditions, and how to make them applicable*; Alberto Leva, Dipartimento di Elettronica e Informazione, Politecnico di Milano, Italy
- 6 - Thesis Presentation: *Wind Speed Prediction Models And Their Use In Wind Turbine Control*; Paolo Mattachini Advisor: Daria Madjidian, Dept. of Automatic Control, LTH, Lund University
- 17 - *The Design of an Artificial Pancreas - Closing the Loop on Type 1 Diabetes Mellitus*; Eyal Dassau, University of California Santa Barbara, USA
- 17 - Licentiate seminar: *Diabetes Mellitus Glucose Prediction by Linear and Bayesian Ensemble Modeling*; Fredrik Ståhl, Dept. of Automatic Control, LTH, Lund University
- 18 - *Randomized Methods for Large-Scale Games with Applications to Robotics and Network Security*; Joao Hespanha, University of California Santa Barbara, USA
- 18 - Defence Of Doctoral Dissertation: *Stochastic Event-Based Control and Estimation*; Toivo Henningson, Dept. of Automatic Control, LTH, Lund University

- 19 - Master's Thesis Presentation: *Improved Inertial Navigation for the CV90 platform using Sensor Fusion*; Johan Ambrius; Jimmie Jönsson
- 19 - Licentiate seminar: *Towards Pseudospectral Control and Estimation*; Philip Reuterswärd, Dept. of Automatic Control, LTH, Lund University
- 20 - Manipulation Primitives: *An Interface between Hybrid Control and Robot Task Specification*; Torsten Kroeger, Stanford University, USA
- 20 - Master's Thesis Presentation: *Varvtalsreglering av peristalisk blodpump*; Gabriel Ingesson; Helena Sandberg
- 20 - Licentiate seminar: *Robotic Assembly and Contact Force Control*; Andreas Stolt, Dept. of Automatic Control, LTH, Lund University
- 21 - Reflexes Motion Libraries - *Highly Reactive Robot Motion Generation*; Torsten Kroeger, Stanford University, USA

LECTURES BY THE STAFF OUTSIDE THE DEPARTMENT

Åkesson, Johan

Generation of Sparse Jacobians for the Function Mock-Up Interface 2.0, 9th International Modelica Conference 2012, Munich, Germany, September 5, 2012.

Vertical Integration in Tool Chains for Modeling, Simulation and Optimization of Large-Scale Systems, LCCC Workshop: Systems Design meets Equation-based Languages, Lund, Sweden, September 19, 2012.

Vertical Integration in Tool Chains for Modeling, Simulation and Optimization of Large-Scale Systems, invited lecture: Challenge Workshop Modeling Simulation and Optimization Tools 2012, Berlin, Germany, September 24, 2012

Årzén, Karl-Erik

Real-Time Control: Tools and Techniques for Control Performance Evaluation, Hamilton UTC, Rockford, May 10, 2012

Rewriting JGrafchart with Rewritable Reference Attribute Grammars, Industrial Track of Software Language Engineering (SLE) 2012, Dresden, Germany, Sep 25, 2012

Simulation of Cyber-Physical Control Systems, Workshop on the Control of Cyber-Physical Systems, London, Oct 20, 2012

Simulation of Cyber-Physical Control Systems, Halmstad University, Nov 14, 2012

Åström, Karl Johan

Accomplishments and Prospects of Control. Plenary lecture 2012 American Conference Montreal, Canada, June 29, 2012.

Modelica - Quo Vadis? Plenary lecture 9th International Modelica Conference 2012, September 5, 2012.

Controls - Past, Present and Future. Golden Anniversary Jubilee Lecture 50th Allerton Conference on Communication, Control and Computing. UIUC Urbana Champaign, October 1, 2012.

Future Technology Trends and Their Impact on The Process Control Industry. Emerson Process Management. Round Rock, Texas, October 30, 2012.

Controlling Pendula - A Tribute to Mark Spong. Internal Workshop on Recent Developments In Robotics and Control (SpongFest). University of Texas at Dallas, November 5, 2012.

Cervin, Anton

Stability and Worst-Case Performance Analysis of Sampled-Data Control Systems with Input and Output Jitter. American Control Conference, Montréal, Canada, June 28, 2012.

Sporadic Event-Based Control of Stochastic Systems. Department of Control Science and Engineering, Zhejiang University, Hangzhou, P.R. China, October 26, 2012.

Cescon, Marzia

Linear modeling and prediction in diabetes physiology, Linköping University, Automatic Control Department, May 10, 2012.

Grussler, Christian

Balanced truncation of positive systems, 83rd Annual Meeting of the International Association of Applied Mathematics and Mechanics, Darmstadt, Germany, Mar 29, 2012.

A Symmetry Approach for Balanced Truncation of Positive Linear Systems, 51st IEEE Conference on Decision and Control, Maui, Hawaii, USA, Dec 12, 2012.

Hägglund, Tore

Signal filtering in PID control, Plenary lecture. IFAC Conference on Advances in PID Control, Brescia, Italy, March 28, 2012.

Signal filtering in PID control, DTU, Lyngby, Denmark, September 9, 2012.

Johansson, Rolf

Industrial Robots and Work-Space Sensing, 2012 RoSEC Winter School, RoSEC (Robotics Specialized Education Consortium) & Hanyang University, Seoul, Korea, 4 January 2012. Invited Lecture.

Robotic Obstacle Avoidance and Work-Space Force Interaction, 2012 RoSEC Winter School, RoSEC (Robotics Specialized Education Consortium) & Hanyang University, Seoul, Korea, 5 January 2012. Invited Lecture.

Optimal Coordination and Control of Posture and Movements, CHIC (Center of Human-centered Interaction for Coexistence), KIST & 2011 RoSEC Winter School, RoSEC (Robotics Specialized Education Consortium) & Hanyang University, Seoul, Korea, 6 January 2012. Invited Lecture.

Observer-Based Strictly Positive Real (SPR) Variable Structure Output Feedback Control, 12th IEEE International Workshop on Variable Structure Systems (VSS2012), Mumbai, India, January 14 2012.

Topics on Kalman Filter Implementation and Nano-MEMS Modeling, Tsinghua University, Dept. Precision Instruments and Mechanology, Beijing, China, 30 March 2012.

Single-Zone Diesel PPC Modeling for Control. 2012 American Control Conference (ACC2012), Fairmont Queen Elizabeth, Montréal, Canada, June 29 2012.

Force Controlled Robotic Assembly without a Force Sensor, Norwegian University of Science and Technology (NTNU), Dept. Engineering Cybernetics, Trondheim, Norway, 23 August 2012.

Sensor Fusion in Robotic Work-Space Sensing and Control, Peking University, Microelectronics & MEMS Group, Beijing, China, 28 September 2012. Invited Lecture.

Sensor Fusion in Robotic Work-Space Sensing and Control, Tsinghua University, Dept. Precision Instruments & Mechanology, Beijing, China, 11 October 2012.

Sensor Fusion in Robotic Work-Space Sensing and Control, University of Science and Technology Beijing (USTB), School of Automation & Electrical Engineering, Beijing, China, 17 October 2012. Invited Lecture.

Continuous-Time Model Identification and State Estimation Using Uniformly Sampled vs. Non-Uniformly Sampled Data, Tsinghua University, Dept. Precision Instruments & Mechanology, Beijing, China, 25 October 2012.

Force Controlled Robotic Assembly with or without a Force Sensor, 14th Annual Conference of the Chinese Society of Micro-Nano Technology & 3rd International Conference of the Chinese Society of Micro-Nano Technology (CSMNT2012), Hangzhou, Zhejiang, China November 4-7, 2012, 5 November 2012.

Sensor Fusion in Robotic Work-Space Sensing and Control, The 6th International Workshop on Innovation and Commercialization of Micro & Nanotechnology (ICMAN2012), Hangzhou, Zhejiang, China, 4-7 November 2012, 6 November 2012.

The Development of Automation and Robotics, Tsinghua University, Dept. Precision Instruments & Mechanology, Beijing, China, 16 November 2012.

Diabetes Mellitus Modeling and Short-Term Prediction Based on Blood Glucose Measurements, Tsinghua University, Dept. Precision Instruments & Mechanology, Beijing, China, 21 November 2012.

EU-China Research Cooperation, Second Meeting of China Instrument Society on Micro-nano Devices and Systems Technology, Guilin, Guanxi, China, 1-2 December 2012, 1 December 2012. Invited Lecture.

Robotic Work-Space Sensor Fusion and Control, Binzhou University, Binzhou, Shandong, China, 6 December 2012. Invited Lecture.

Johnsson, Charlotta

MES-Manufacturing Execution Systems; MES och den internationella standarden IEC 62264 (ISA95), Invited presentation ÅF Consultats Industrial IT Kick-off, Stockholm June 1, 2012.

How can standards help with Key Performance indicators for Industrial Automation?, Invited presentation at Automation University (Rockwell Automation), Copenhagen, May 9, 2012

Hva er MES og hvordan kan en finne ROI?, Invited presentation at Prediktor User meeting, Oslo, Norway, April 25, 2012.

Vad är MES?, Presentation at Sesam-Sverige Seminar, January 18, 2012.

Lindholm, Anna

A Tool for Utility Disturbance Management, 14th IFAC Symposium on Information Control Problems in Manufacturing, Bucharest, Romania, May 24, 2012.

Utility Disturbance Management in the Process Industry, PIC-LU conference, Mölle, Sweden, May 29, 2012.

Formulating an Optimization Problem for Minimization of Losses due to Utilities, International Symposium on Advanced Control of Chemical Processes, Singapore, July 12, 2012.

Utility Disturbance Management, Department of Mathematics, Linköping University, Sweden, September 27, 2012.

Hierarchical Scheduling and Utility Disturbance Management, PIC conference, Örenäs slott, Sweden, December 10, 2012

Maggio, Martina

Presenting a paper and a poster at Feedback Computing 2012, September 17, 2012

Presenting the ongoing research work at KTH in Stockholm as invited speaker, November 16, 2012.

Rantzer, Anders

Distributed Control of Positive Systems, Invited lecture at Mathematisches Forschungsinstitut Oberwolfach, Germany, March 1, 2012.

Distributed Control of Positive Systems, Jiao Tong University, Shanghai, China, July 4, 2012.

Scalable Control of Positively Dominated Systems, 20th International Symposium on Mathematical Theory of Networks and Systems, Melbourne, Australia, July 9, 2012.

Distributed Control of Positive Systems, University of Newcastle, Australia, July 18, 2012.

Lyapunov Functions, Density Functions and Monotone Systems, Invited Workshop on Contraction Analysis, Université catholique de Louvain, Louvain-la-Neuve, October 10, 2012.

Distributed Control using Prize Mechanisms, 10th European Workshop on Advanced Control and Diagnosis, Copenhagen, Denmark, November 8, 2012.

Distributed Control of Positive Systems, Seminar, TU Delft, The Netherlands, November 21, 2012.

Optimizing Positively Dominated Systems, 51st IEEE Conference on Decision and Control, Maui, USA, December 10, 2012.

Scalable Positivity Preserving Model Reduction Using Linear Energy Functions, 51st IEEE Conference on Decision and Control, Maui, USA, December 12, 2012.

On the Kalman-Yakubovich-Popov Lemma for Positive Systems, 51st IEEE Conference on Decision and Control, Maui, USA, December 11, 2012.

Distributed Control of Positive Systems, Lunch Seminar, Caltech, Pasadena, USA, December 17, 2012.

Robertsson, Anders

Presentation EU Fp7-projects ROSETTA and MONROE, Exhibition at Automatica Fair, May 20-25, 2012 in Germany

Workshop presentation "*Event-Based Response Time Estimation*", 7th International Workshop on Feedback Computing, San José, California, USA.

Presentation of ProFlexA-project and paper "*Cost-Efficient Drilling Using Industrial Robots with High-Bandwidth Force Feedback*", SSF/ProViking Resultdag, Lund September 27, 2012.

